

# HI-FI WORLD

**AUGUST 2008**

**UK £3.80**

**www.hi-fiworld.co.uk**

**FREE READER CLASSIFIED ADS IN THIS ISSUE!**



**AVID DIVA II**  
turntable



**STELLO CDT/DA100**  
transport & DAC



**NAIM SUPERLINE**  
phono stage

## TUNER FISHING

top tuners tested from  
Creek, Cyrus, Myryad,  
Pioneer, Rotel  
and Yamaha...



**COMPETITION**  
WIN A SUPERB LEEEMA  
PULSE AMPLIFIER  
WORTH £1,195!



- > FREESAT & INTERNET RADIO EXPLAINED
- > THE BLACK ART OF MAKING AUDIOPHILE VINYL
- > THE GLOBIES: HI-FI WORLD'S ALTERNATIVE AWARDS!

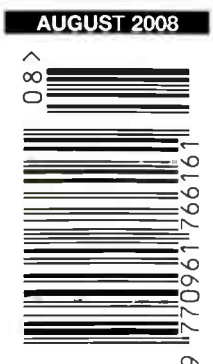

**9 PAGES OF YOUR QUESTIONS ANSWERED**

# M.C.X



36

Quadral Pico - affordable standmounters with impressive ribbon tweeters.



40

Raysonic's C200 - a top new tube preamplifier.

32

Acousti FM/A/B - rugged all-in-one integrated amplifier.



10

Stello CDT 100/DAC100 Signature - top value CD transport/DAC combination.



88

Townshend's stunning new Rock V turntable/Excalibur II tonearm.



47

Hi-Fi World's illustrious 'Globe' awards are bestowed here!

**WE ARE THE UK'S FASTEST GROWING AUDIO TITLE!!!**

# welcome

## EDITOR

David Price  
tel/fax: +44 (0) 20 7625 3129  
e-mail: [editorial@hi-fiworld.co.uk](mailto:editorial@hi-fiworld.co.uk)

## ASSISTANT EDITOR

Adam Smith  
e-mail: [editorial@hi-fiworld.co.uk](mailto:editorial@hi-fiworld.co.uk)

## DESIGN EDITOR

Faiza Chunara  
tel: +44 (0) 20 7625 3129  
fax: +44 (0) 20 7328 1844  
e-mail: [adproduction@hi-fiworld.co.uk](mailto:adproduction@hi-fiworld.co.uk)

## PRODUCTION EDITOR

David Noble  
tel: +44 (0) 20 7625 3134  
fax: +44 (0) 20 7328 1844  
e-mail: [classifieds@hi-fiworld.co.uk](mailto:classifieds@hi-fiworld.co.uk)

## ADVERTISING

tel: +44 (0) 20 7372 6018  
fax: +44 (0) 20 7328 1844  
e-mail: [advertising@hi-fiworld.co.uk](mailto:advertising@hi-fiworld.co.uk)

## ACCOUNTS

tel: +44 (0) 20 8841 8892  
fax: +44 (0) 20 8841 9144  
e-mail: [accounts@hi-fiworld.co.uk](mailto:accounts@hi-fiworld.co.uk)

## PUBLISHER

Noel Keywood  
e-mail: [publisher@hi-fiworld.co.uk](mailto:publisher@hi-fiworld.co.uk)

## FREE READERS CLASSIFIEDS

tel: +44 (0) 20 7625 3134  
fax: +44 (0) 20 7328 1844  
e-mail: [classifieds@hi-fiworld.co.uk](mailto:classifieds@hi-fiworld.co.uk)

## SUBSCRIPTIONS

tel: +44 (0) 1442 879097  
fax: +44 (0) 1442 872279  
e-mail: [hifiworld@webscribe.co.uk](mailto:hifiworld@webscribe.co.uk)

## PHOTOGRAPHY

David Noble  
tel: +44 (0) 20 7625 3134  
fax: +44 (0) 20 7328 1844

## WRITERS

Andrew Harrison, Steven Green,  
Channa Vithana, Paul Rigby, Peter Comeau



"Is FM still worth having?" asked one reader to me on the phone this morning, "because it's not going to last long, is it?" I get this sort of question all the time, and the shocking thing is that it's not only from worried members of the public, but even occasionally from hi-fi manufacturers too!

The short answer is that yes, VHF/FM is well worth having – especially if you like listening to music on the radio.

It is not, in fact, being switched off as we speak (that's analogue TV, a very different kettle of fish...), and the government authority that issues broadcasting licenses, only two years ago, was handing out licences to new FM stations lasting twelve years. Even in an absolute worst case scenario then, we've got a decade of ye olde analogue wireless.

Why, as Catherine Tate would say, "am I bothered"? Well, we at *Hi-Fi World* are music fans first, and technology fans second. Digital Radio (DAB) scores poorly on the first count and almost as bad on the second (thanks to it using a prehistoric music coding system). I listen to it every day, because it's better than the stations I'd otherwise pick up on AM (BBC 5 Live), but when 'Late Junction' comes on Radio 3, you'll find me diving for the FM button!

In the UK, radio is in an interesting transitional phase – analogue soldiers on because the BBC has a remit to cater for all of the country, and DAB can't reach some areas. DAB itself is looking increasingly creaky, as other countries announce the uptake of the superior sounding DAB+ system. And internet radio, along with the BBC iPlayer, is establishing a foothold, showing DAB up in even worse terms...

This issue of *Hi-Fi World* celebrates this new golden age of wireless, with features on getting the best from your tuner (p24), the new world of internet radio (p28) and Freesat (p56). And along with our affordable tuner supertest (p15), we look back at one of the greatest high end tuners ever made, Naim's NAT-01 (p66).

For those who like to 'play their own', there's so much more – from an exclusive review of Avid's new Diva II turntable (p98) to Arcam's brand new FMJ A38 integrated amplifier (p32) and Quadral's great little Pico loudspeaker (p36). Oh, and don't forget our 'alternative awards', The Globies (p47) to remind you we're in the silly season. Enjoy!

**David Price, editor**



## testing

To ensure the utmost accuracy in our product reviews, *Hi-Fi World* has extremely comprehensive in-house test facilities, and our test equipment - from big names like Rohde & Schwarz and Hewlett Packard - is amongst the most advanced in the world.

Loudspeakers are measured using a calibrated Bruel & Kjaer microphone feeding a Clio-based computer

analyser, using pulsed and gated sinewaves, in a large room to eliminate the room's influence. Pickup arm vibration is measured with a Bruel & Kjaer accelerometer.

No other UK hi-fi magazine has in-house testing, and none has access to such advanced tests across all types of equipment. That's why you can depend on *Hi-Fi World* reviews.



## hi-fi world

SUITE G4, ARGO HOUSE  
KILBURN PARK ROAD  
LONDON NW6 5LF  
[www.hi-fiworld.co.uk](http://www.hi-fiworld.co.uk)

## verdicts

- ● ● ● ● OUTSTANDING
- ● ● ● EXCELLENT
- ● ● GOOD
- ● ● ● MEDIOCRE
- ● POOR
- £ VALUE

simply the best  
extremely capable  
worth auditioning  
unremarkable  
seriously flawed  
keenly priced

## ELECTRONIC MAGAZINE

Go to our website [www.hi-fiworld.co.uk](http://www.hi-fiworld.co.uk) to buy an electronic version of this magazine, individual issues or a subscription. At present we do not offer back issues, but hope to soon.

Distributed by Seymour Distribution Ltd 86 Newman Street London, W1T 3EX Tel: +44 (0) 20 7396 8000 Printed by St.Ives, Plymouth Tel: +44 (0) 1752 345 411  
Our Agents in Malaysia Millennium Hi-Fi & AV Simon Chang Showroom & office, 500-1-3 First Floor Wisma Indah (Shen Court), Jalan Tun Razak 50400 Kuala Lumpur, Malaysia  
Tel: 603 9283 8171 Fax: 603 9281 3762 e-mail: [info@millennium-audio.com](mailto:info@millennium-audio.com)

All unsolicited submissions and goods are at the owner's risk. We accept no responsibility for such submissions, nor do we undertake to return them.  
No material may be reproduced from this magazine without the publisher's written permission. © Audio Publishing Ltd



### LOUDSPEAKERS

#### QUADRAL PICO 36

David Price takes a listen to these stylish standmounters.

#### SUNFIRE HRS-12 50

Adam Smith adds some low end to his life with Sunfire's new HRS-12 subwoofer.

#### MORDAUNT SHORT MEZZO 2 52

Mordaunt Short's new mid-price standmounters are auditioned by Adam Smith.

### DIGITAL

#### STELLO CDT100/DA100S 10

David Price checks out this diminutive CD transport and DAC from April Music.

### AMPLIFICATION

#### ARCAM A38 32

Arcam's new mid-price integrated amplifier gets the treatment from David Price.

#### RAYSONIC C200 40

Andrew Harrison auditions Raysonic's stylish new preamplifier.

#### BELLES SOLOIST 3 AND 5 54

Adam Smith checks out this diminutive pre/power combo from the USA.

### SYSTEMS

#### ONKYO DR-S501 42

Noel Keywood explores Onkyo's versatile DVD receiver.

### RADIO

#### GROUP TEST 15

Noel Keywood pits tuners from Pioneer, Creek, Yamaha, Myryad, Rotel and Cyrus against one another.

### DIY

#### WD25T v2 - THE SEQUEL 80

Peter Comeau continues the development of the updated WD25T loudspeaker by explaining how the crossover was optimised.

### FEATURES

#### TUNING UP 24

Noel Keywood explains how to get the best from your tuner.

#### NET TRAWLING 28

Steve Green guides you through the world of Internet radio.

#### THE GLOBIES 47

It's that time of year again! David Price and Adam Smith are your hosts for the awards ceremony that the Oscars can only dream of being...

#### HEAVENLY SOUND? 56

Noel Keywood takes a look at the recently-launched Freesat digital TV and radio service.

### OLDE WORLDE

#### MEGA TRAWLERS 66

Channa Vithana remembers Naim's classic NAT-01, 101 and 02 tuners.



### 7 NEWS

Words from the front...

### 27 COMPETITION

Your chance to win a Leema Pulse amplifier worth £1,195!

### 51 SOUNDBITES

Quick reviews of Gato Audio's Phase-It loudspeaker phase tester and VLSI Solutions' DSPeaker Anti-Mode 8033 subwoofer equaliser.

### 59 WORLD CLASSICS

Our favourite designs that have stood the test of time.

### 64 AUDIOPHILE CD

Paul Rigby rounds up the latest audiophile CD releases.

### 69, 71, 73, 75, 77 OPINION

The team get to grips with matters music, hi-fi and life!

### 78 SUBSCRIPTIONS

Ensure your copy every month and save money too.

### 100 MAIL

Nine pages of your views, opinions and queries.

### 121 DIAL-A-DEALER

A comprehensive guide to UK hi-fi retailers.

### 123 FREE READERS CLASSIFIEDS

Four pages of second-hand bargains.

### 128 NEXT MONTH

What we hope to bring you in the next issue!

### 129 ADVERTISERS' INDEX

### 130 CLASSIC CUTS

Paul Rigby reviews Bill Frisell's 1992 album, 'Have a Little Faith'.

### VINYL SECTION

#### 86 VINYL NEWS

Paul Rigby has all the latest black plastic releases.

#### 88 TOWNSHEND ROCK V/EXCALIBUR II

Adam Smith gets tweaky with the latest version of this classic turntable.

#### 92 NAIM SUPERLINE

David Price checks out Naim Audio's new high performance phono stage.

#### 94 BLACK ART

In the first of a two-part feature, Paul Rigby examines the process of making LPs.

#### 98 AVID DIVA II

Avid's new entry level Diva II turntable is auditioned by Adam Smith.



MELDY VALVE Hi-Fi Pty LTD  
KUNMING



1688 Signature

Stereo Preamplifier

**Select Audio**

[www.selectaudio.co.uk](http://www.selectaudio.co.uk)

E-mail: [select.audio@tiscali.co.uk](mailto:select.audio@tiscali.co.uk)

Tel: 01900813064

World Radio History





news@hi-fiworld.co.uk

# news

## FULL PHAT

Musical Fidelity's new AI FBP fully balanced preamp challenges assumptions about performance and price, the company says. Designed to work with the company's 550K and 750K Superchargers, both of which can operate as conventional power amps, it costs £1,499. It features a useful array of features and functions, including two balanced inputs, phono (MC +MM) and USB, home theatre bypass, balanced and single-ended outputs - as the FBP suffix suggests, this new preamplifier operates in fully balanced mode from beginning to end, and can thus drive any length of cable to power amplifiers. The external power supply ensures that the circuitry does not suffer electromagnetic interference from the transformer or power supply elements, says Musical Fidelity. Its internal four-stage choke filtering conditions the AC power supply before it gets to the preamp. Available from August, those wishing to know more should call Musical Fidelity on +44(0)20 8900 2866.

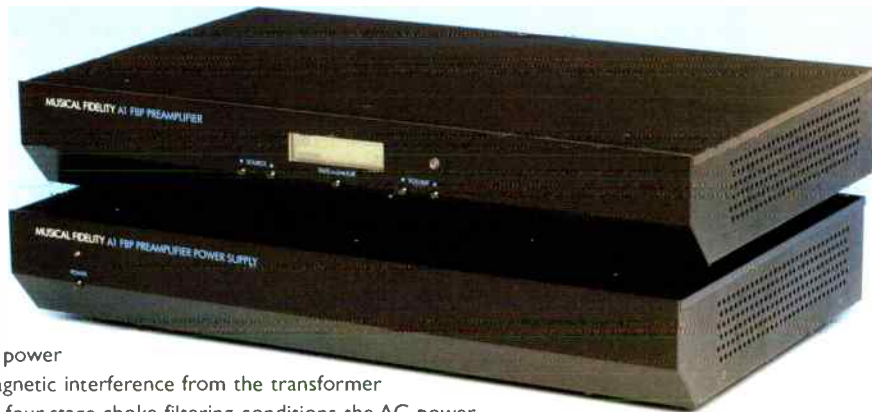

## MY CREMONA

The new £2,690 Auditor Elipsa loudspeaker is the little pretty one of the growing Sonus Faber Cremona range - described as, "a compact design intended to offer exceptional flexibility in terms of its siting, to suit a wide range of hi-fi and A/V applications". The 341x335x224mm design boasts "many of the benefits" of the flagship Stradivari Homage loudspeaker, in a more compact and economical package. A wall-mountable design said to be "equally comfortable" on a shelf or stands, its sandwich construction is achieved by using hand-selected layers of various woods and solid maple, quality-graded and oriented to enhance performance. The two-way driver configuration sports a 25mm ring-radiator tweeter, the same unit found in the range-topping Stradivari Homage speaker, and a mid/bass driver with a 150mm selected black wood fibre cone, treated for break-up control, plus Sonus Faber's Symmetric Drive Motor System. The rear-ported speaker cabinet comes finished in a choice of sumptuous natural maple and light graphite options, multicoated with medium-gloss, ecologically sensitive lacquer. Sensitivity is quoted at 89dB. For more information, call Absolute Sounds on +44(0)20 8971 3909 or click on [www.absolutesounds.com](http://www.absolutesounds.com).

## VOX POP

AQVOX have two interesting new products in the shape of the Phono 2Ci Mk II balanced phono preamplifier and the USB 2 Mk II balanced DAC. The former is a "state of the art, fully balanced phono stage", that allows both MC and MM cartridges to be connected in all balanced mode - provided the turntable/ arm combination has floating outputs. The input adjusts automatically to optimise the load and capacitance settings. The USB 2 Digital to Analogue Converter has selectable upsampling to 24bit/192kHz resolution, via S/PDIF, coaxial and AES/EBU and USB - this latter input meaning it can work as an external computer soundcard via USB 1.1 connection, with no drivers needed for Windows or Mac OS X. It also sports an integrated headphone amplifier, so all digital inputs (even USB) can be monitored. Both units are available in silver or black, priced at £950 for silver and £980 for black, with 19" rack mounts available as an optional extra. For more information, contact Acoustic Perfection on +44(0)845 166 8364 or click on [www.acousticperfection.co.uk](http://www.acousticperfection.co.uk).



## BLING-TASTIC!

Our favourite mad scientist type, John Nilsen of Audio Origami, has been hard at work in his secret laboratory, and can now offer chrome or gold plated finishes for his Rega arm upgrades, in addition to the basic £75 strip and alloy polish. Prices for the glossy newcomers come in at £120 for the arm tube plating, which includes foam filling, £50 for the bearing yoke, £30 for the rear stub and £60 for a matching new rear weight, which is available in concentric or lowered types. The plating is only a few microns thick and so does not affect the effective mass of the arm once carried out. For more information, please click on [www.audioorigami.co.uk](http://www.audioorigami.co.uk).



## NOW EAR THIS!

Audio Technica has launched a new pair of high performance two-way earphones. The £249.95 ATH-CK10 is said to "deliver standards of sound quality previously unheard from such miniature headphones", thanks to its use of two separate drivers per side. These small transducers, weighing just 4g apiece, incorporate neodymium magnets for maximum energy density. The new Audio-Technicas come complete with a 1.2m cable and are supplied in a high quality protective pouch. Also new is a pair of flagship hi-fi headphones, the £699.95 ATH-W5000. Sporting a striped ebony housing carved from a solid block, these high-end headphones are said to deliver "extremely high sound pressure levels with true fidelity and absolute neutrality". The powerful, large aperture 53mm neodymium magnet based transducers have coils wound with super-pure 8N-Oxygen Free Copper, giving an extended 5-45,000Hz frequency response. For more information, click on [www.athheadphones.com](http://www.athheadphones.com)

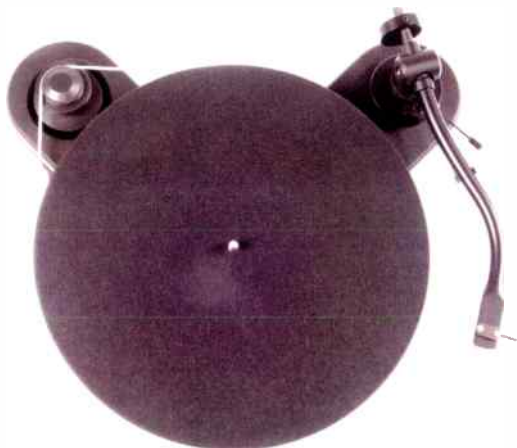

## OUT OF THE BOTTLE

Pro-Ject's new £140 Genie 2 turntable uses a peripheral drive for improved speed stability, an inverted main bearing with close-tolerance bushes, a quiet running synchronous drive motor completely decoupled from the plinth and a substantial machined MDF platter with a felt mat. The newly developed, one piece S-shaped 8.6inch tonearm has a tube and bearing housing made from aluminium, with high purity silver plated copper internal wiring. It is fully adjustable and comes fitted with an Ortofon OM3e cartridge. The drive motor is isolated on its own base and is completely decoupled from the plinth in order to eliminate the transfer of any vibrations to the surface of the disc. The motor is fitted with a two-step pulley giving the choice of 33 and 45 rpm speeds and drives the platter's periphery through a round belt. In addition, the power switch has now moved from the power lead onto the motor's pod. For more information, click on [www.henleydesigns.co.uk](http://www.henleydesigns.co.uk) or call +44(0)1235 511166.



## PAINT IT BLACK

The Astin Trew range of audiophile separates is now available in black, alongside the current silver fascia option. The finish also extends to the forthcoming new AT2000 integrated amplifier and AT3000 CD player, out later this year. Designer Michael Osborn says, "we have become aware over the past year or so of an increasing demand for a black fascia option - it seems we are going 'back to black' as a product style trend". For more information, click on [www.astintrew.co.uk](http://www.astintrew.co.uk) or call +44 (0)1491 414494.

## RADIO TALK

Sales of DAB digital radios have topped seven million, according to the latest figures from GfK, the industry's marketing service. At the end of April, cumulative sales stood at 7.05 million following a record Christmas period and growth of 28% year-on-year in quarter one, 2008. DAB radios are now selling at more than two million a year and can be found in more than a quarter of all UK homes. Set sales for 2008 continue to run ahead of DRDB forecast. There are currently more than 300 DAB products in the market, with form factors including handheld MP3/DAB radios, docking stations with DAB, Wi-Fi radios with DAB and touch-control radios, along with a growing number of DAB clock radios, kitchen portables and hi-fi systems. The entry price for a DAB radio has fallen this year to under £15, although the average price remains higher, reports GfK. Nearly 11% of all listening is now via a DAB radio according the Rajar Q1 data, compared to 2.1% via the internet and 3.2% via DTV.

The Digital Radio Development Bureau expects to see over nine million DAB radios in UK homes, and this will doubtless be helped by a statement from Ofcom that AAC+, a technically superior digital audio carrier to MPEG2 used in existing DAB radios, will not be introduced into the UK for fear they will upset the developing digital radio market. "We are not saying never to DAB+, but what we are saying is not currently," an Ofcom spokeswoman said. "If we were to adopt the MPEG4 [AAC] standard we would have a severe effect on existing users". A number of other countries have expressed an intention to use the new system, including Australia and France.

## MAINS ATTRACTION

The new TCI Baby Constrictor 08 Power Block costs £79.99 for a 6-way block with a 1m cable – the same price as the older 4-way version. It features TCI's Baby Constrictor mains cable (with 8 PTFE insulated Silver-plated copper conductors) and a quality German made Brennstuhl UK mains distribution block (as used in the pricier Constrictor range). The Baby Block filters incoming noise and reduces outgoing radiated noise. Although the 'Baby' is TCI's cheapest mains cable, "continuing development has enabled the TCI Baby Constrictor to outperform many far more expensive competitors", the company says. Prices range from £99.99 for the 1.5m version to £159.99 for the 3m. For more information, click on [www.tcicables.com](http://www.tcicables.com) or call 07710 196 949.

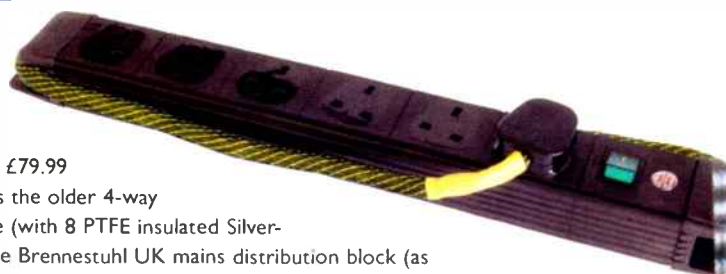



## SOUND SENSE

The new FMJ A28 is Arcam's latest mid-price integrated amplifier, claimed to give "stunning sound quality and an exceptional specification". Replacing the ageing £530 Diva A70 and £950 Diva A90 models, the luxuriously finished £750 FMJ A28 uses the wide-band power amplifier

technology and ultra stable thermal management from the range topping A38 amplifier tested in this issue – see p32. Its preamplifier section uses studio components, while six line level inputs are provided plus a high quality moving magnet phono stage. Electro Magnetic Interference is damped using Arcam's proprietary 'Mask of Silence' technologies, with a SoundDeadSteel damped-steel low-resonance chassis. A large, clear 9 character VFD display works with a slick menu driven control system. New Sanken output devices provide stable device temperature resulting in much improved linearity, while the chunky toroid based power supply delivers "effortless power". For more information, click on [www.arcam.co.uk](http://www.arcam.co.uk) or call +44(0)1223 203 200.



## HAPPY ANNIVERSARY

The new Thorens Jubilee is a stunning flagship, described as "a turntable without limits". The 58kg monster is to be launched later this summer and will come with a price tag of about £28,000. Said to match the world's most legendary record players, it is a universal, heavily dampened affair designed between 'subchassis' and 'mass' principles, and incorporating four independent "levels of operation". There are two exchangeable tonearm platforms, making the range of usable tonearms "practically unlimited". It comes with a Thorens TP125 arm in a choice of 10 or 12 inches, with optional 'foreign' tonearms from 9 to 12 inches accommodated. A choice of RCA or XLR output sockets are provided. The 11.5kg outer platter is said to have a very low centre of gravity through "layer construction" and is balanced in all three axes, while the 1.9kg inner platter is filled with 200 grams of RDC. This in turn is driven by a synchronous motor via a precision flat belt, from an electronic speed control giving 33-1/3, 45 and 78rpm speeds. Vital statistics are 600x500x150mm without tonearms fitted. For more information, click on [www.ukd.co.uk](http://www.ukd.co.uk).



## CUSTOM SOUND

Klipsch's new Custom Series of premium in-ear phones is said to offer "total immersion in complete comfort". It comprises three models, costing £199, £149 and £69, all of which feature patent-pending Contour Ear Gels which are anatomically designed to accurately fit inside the human ear canal. These soft, oval silicon tips reduce ear fatigue as well as provide an amazing seal for excellent noise isolation and bass response, the company says. Flexible ear wires bend over and around the ears so they can be formed to whatever fit is best for each user, while the 1.27m cables feature strain relief at every cable connection point to avert wire damage. The top Custom-3 model employs exclusive KG723 tweeters, KG731 woofers, and a patent-pending electro-acoustic crossover system, in a black soft-feel paint finish with copper accents and includes a high-quality vinyl carrying case that will also fit an 80G iPod. The package also comes complete with a 1/4-inch adaptor, an airline adaptor, five sets of ear gels, and a cleaning tool. For more information, click on [www.klipsch.com](http://www.klipsch.com).



## MUSIC CENTRAL

"A music centre for the twenty first century" is how Vita describe the new R4 Integrated Music System. It comprises a slot loading CD player, integrated iPod dock, USB playback port, DAB/FM tuner and auxiliary inputs allied to a powerful 80W amplifier and speaker system. Said to produce "a scale and quality of sound that will please even the most zealous audio and music enthusiasts", it is also claimed to be very easy to use thanks to their trademark RotoDial seen on the excellent R1 DAB table radio – this can now be detached and used as a remote control! The compact 145x450x255mm unit is superbly finished in rich walnut veneer at £499.99 or 'dream white' high gloss lacquer at £549.99. For more information, click on [www.vitaaudio.com](http://www.vitaaudio.com).



## XQ HERE

KEF's new XQ series of loudspeakers boast a wealth of enhancements, and there's now a version suitable for almost any room size, says the company. The new Titanium finished driver arrays, complete with the latest Uni-Q technology, feature a 'tangerine-waveguide' said to improve HF dispersion. This boasts greater HF extension so there is no longer a requirement for the hyper-tweeter that crowned the previous model, providing a smoother 'point source' sound output and ensuring a much cleaner cabinet design. An improved crossover circuit has been added, making use of some sophisticated high-end components previously reserved exclusively for the Reference series. This, coupled with the WBT terminals fitted directly to the cabinet, make the new XQ series a highly credible loudspeaker, says KEF. Prices range from £699.99 for the XQ10 compact two-way bass reflex stand mount to £1,999.99 for the XQ40 three-way floor-standing loudspeaker. For more information, click on [www.kef.com](http://www.kef.com).





A distinctive two-box CD transport and DAC, Stello's CD-T100/DA100 Signature is a digital delicacy you won't want to miss, says David Price...

# Spice World

**H**ere in the West, it's all too easy to think of all Far East (Japanese, Chinese, Korean, Malaysian) audio electronics as fairly generic and faceless. This is understandable - the massive success of Japanese hi-fi in the seventies and eighties made much mass-market audio look very homogenous indeed. But having lived and worked in that part of the world for a good long time, first hand experience tells me it's simply not true - and one country that's going its own way is South Korea...

In terms of electronics, we've

all now heard of (or indeed bought) Samsung and Lucky Goldstar (LG) - but move 'up' the evolutionary scale to high end hi-fi and South Korean names don't exactly roll off the tongue. But the country's big enough and rich enough to support a thriving audiophile scene, and one of its greatest exponents is April Music. A quirky but fascinating company, it's different to your average Japanese giant in that it specialises in 'affordable audiophile' products. Having met MD Simon Lee and daughters EJ and Claudia several years ago at the Las Vegas Consumer Electronics Show, I came

away impressed by the fact that they were focusing on high performance, high value two-channel kit - and not jumping Lemming-like into AV like all the Japanese companies at the time...

The dynamic duo you see here epitomises their approach. There's very little that's superfluous on the T100 transport - including a disc drawer. Being a top-loader (something becoming increasingly fashionable right now), it does away with a costly and rather unnatural feeling disc tray. Disc trays can be nice - as Yamaha's new CD-S2000 proves - but this is the exception rather than the rule, as most are



plasticky tat with all the finesse of wrecking ball. Stello's decision to do things this way makes a lot of sense then – save money and give the user a more 'hands on' user experience. The only downside is you have to manually fit the magnetic puck (not a chore if you've ever used a turntable with a record clamp) and place the smoked acrylic top cover on yourself – although the unit will play CDs without it fitted perfectly happily.

"a delightful combination of sweetness and strength.."

A half-width affair, the T100 is satisfyingly compact at 212x55x290mm, so when sat next to the DA100S it's the same size as a conventional CD player. You can of course site the T100 on top of the DA100, making a miniature stack. Its fascia has only the basics – transport controls plus a large red LED display, which I personally love – it's bright and bold like a nineteen seventies clock-radio (or a bomb, as my other half put it)! Round the back, there's a simple power on-off switch, plus a host of digital outputs, including AES/EBU, coaxial and TOSLINK, plus an i2s via a mini DIN socket [see BOX] and an IEC power input.

As you might expect, the matching DA100 Signature digital-to-analogue converter duplicates these digital connectors, with the exception of course of RCA phono and balanced analogue outputs, and a USB digital input. Although the UK audiophile market, shall we say, hasn't been persuaded of the benefits of audio from computers, much of the Far East has – hence the ability for the DA100S to act as a USB audio output device, whereupon you can pipe your iTunes songs out to the Stello in all their direct digital glory. The front panel has power on-off and input source selection, plus an Upsampling button – alluding to the circuitry inside...

Yes, the DA100 Signature is indeed a true 24bit, 192kHz upsampling design, said to have a jitter-free timing circuit and 6th-order digital filter, plus a fully discrete Class A analogue output stage. The unit features 1% tolerance metal film resistors, WIMA polypropylene capacitors, Cardas RCA connectors, and Neutrik balanced connectors, plus an impressively sized (for a DAC) 25VA toroidal transformer, while the voltage regulation circuit is said to have very low output impedance. Overall, both units are very tidily finished; not lavish in the

Japanese high end sense, but very crisp to the touch and purposeful all the same.

### SOUND QUALITY

Starting with the T100, I chose to audition it against a favourite high end reference transport, the Sony CDP-R1. The little Stello was no match for the massively more expensive classic Sony of course, but the comparison showed me it was

getting the basics very right indeed. Very fast access times told me that this little transport very likely has a bespoke CD mechanism in it, which can only be a good thing. Through the Stello DA100 via coaxial digital in, both transports showed a strong, confident sound with plenty of focus, dynamics and detail. Listening to Supertramp's 'Breakfast in America', I could hear the Sony adding a little more finesse and a stronger bottom end, but certainly didn't sound like its original selling price had been ten times more. Indeed, I found that placing FoculPods beneath the Stello T100 gave noticeably improved bottom end weight, plus a more expansive soundstage.

Next, I concentrated on the sound coming from the DA100S via the reference Sony transport – to assess the Stello DAC in outright terms. Impressed as I'd been with the CD transport, I wasn't expecting such a heroic performance from the convertor. With upsampling switched off, it was an enjoyable, detailed and musical device with song bass, a smooth treble, oodles of midband detail and a satisfyingly musical gait. 808 State's 'Ancodia' sounded punchy and dynamic, but with real finesse.

Stepping up to full oversampling via the front panel button made a difference to almost every aspect of the DA100S's performance. Most noticeable was the treble, which 'moved back' slightly in the mix – those Supertramp ride cymbals sounding less grainy, silkier and more atmospheric. These improvements went down to the midband, with the sense of more space around instruments in the mix, slightly greater dynamics and a sweeter, more natural tonality. Notes seemed to stop and start more explicitly, and sound less of a blur. In the bass, there was a fraction more warmth, and a more natural, easy demeanour.

Next it was time to listen to the Stello combination together in full-

on i2s linked mode, as a £1,270 CD player. At this point I wheeled in – yes, you've guessed it – our reference integrated player at this price point, the Astintrew AT3500... Starting with this mid-price fave, Supertramp's 'Oh Darling' sounded beguiling, as I'd expected. We got the (now customary) capacious soundstage, fulsome bass and silky treble. Moving the Stello raised an eyebrow, as the soundstage didn't shrink back as I'd expected. Instead it stayed just as vast, instantly marking this Korean combo out as special in this respect. But there was more; within the mix, instruments were more precisely located, the Stello duo singling out the placement of Rick Davies's vocals

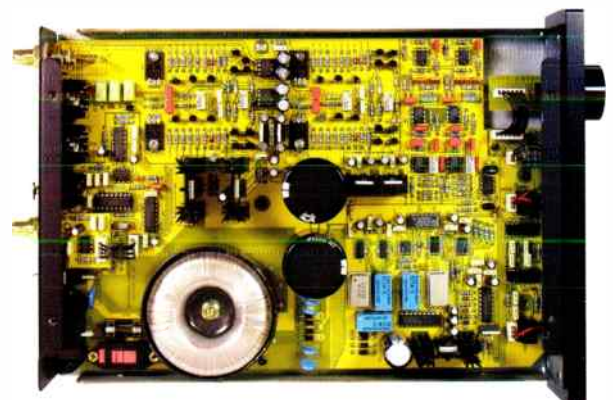

DA100 Signature Internal.

with riflebolt precision. Moving back to the AT3500, and I could hear the player 'obfuscating somewhat', as if it was saying, "maybe he's over here, or maybe he isn't". Back to the Stello and again, instruments seemed to click back into their rightful places.

Although this was the most obvious difference, it was by no means the only one. The Stello's midband seemed more dynamic, with more space between the notes, as if the studio engineer had switched the sustain pedal off. Rhythmically, this made the T100/DA100S combo snappier sounding, at the same time giving it a more relaxed gait – you could 'listen in' to what was going on in the mix between the drum

# A new star is born



Each year the European Imaging & Sound Association (EISA) assembles a panel of expert judges from some of the continent's leading hi-fi press to investigate the world's finest technology.

After rigorous evaluation they return to vote on one product in each category that they believe offers not only exceptional levels of performance but also provides Incredible value. This year they chose the Cambridge Audio Azur 840A Class XD integrated amplifier.

"...a genuinely novel approach... a highly sophisticated, efficient and attractive-sounding amplifier" EISA citation



 **Cambridge Audio**



To find your nearest approved Cambridge Audio specialist, read extensive reviews and more, visit: [www.cambridge-audio.com](http://www.cambridge-audio.com)



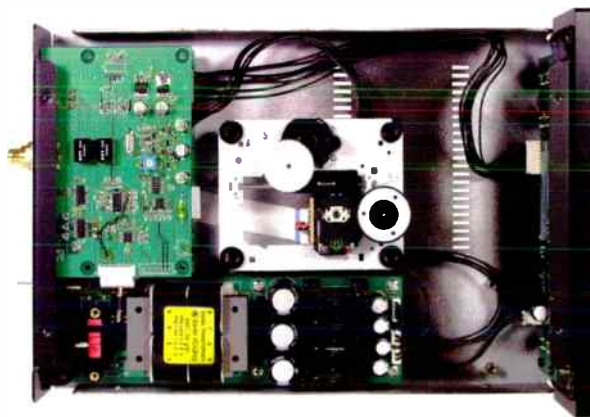

CDT100 internal

beats. In this respect, the combo reminded me of the Prima Luna ProLogue Eight CD player I reviewed last month – although it didn't quite match its sublime timing, it came close.

Crisp, classy nineties pop such as Prefab Sprout's 'Carnival 2000' was another pleasure. The opening guitar part sounded snappier through the Stello, more clearly imparting the sound of Paddy McAloon's hand on the body of guitar. His voice was quite different in texture – sounding a little grittier and more natural than the Astintrew, which 'airbrushed' the grain out and removed some of the studio reverb. The complex mix was better 'explained' by the Stello, revealing as it did its many strands with greater clarity, yet hanging everything together convincingly and enjoyably.

Where up to now it had been at least a points win to the Stello, moving to Aphex Twin's 'Pulsewidth' showcased the essential differences between the two players more starkly still. A classic slice of early ambient electronica (as NME would invariably describe it), the warm analogue synth pads and Roland MCS505 percussion came across more enjoyably via the Astintrew. Its more laid-back, louche nature suited the mood of the music, whereas the Stello combo went, Rottweiler-

like, for the rhythmic jugular vein. Hi-hats and snare sounds were more explicit, snappier and stronger, as was the recording's original tape hiss, and all the other warts too. It was an enjoyable listen, but not quite as soulful as via the Astintrew.

The Stello CD-T100/DA100S is an astonishingly capable pairing at the price. It majors on detail and dynamics, but is by no means hard or biting – in fact it has a delightful combination of sweetness and strength. Although musically very enjoyable, it's less romantic sounding than either the Astintrew or my reference integrated CD player, the Marantz CD63KI DP (whose ability to turn any combination of notes on a score into gushing, heartrending music remains unsurpassed, in my system at least) – so don't buy it you want an emotionally 'over the top' source.

Via i2s especially, it's a great combination; the CD transport is the more rigid and cerebral sounding of the two boxes, imposing a taut, tight discipline on its

partnering DAC. (Using the Marantz or Astintrew as transports made the DA100S sound a little more fluid, if less punchy). For me though, the DAC is the star – via the CD-T100 it makes a very nice noise indeed, but absolutely flies with a high end transport from the likes of Sony or Esoteric. It's very neutral, yet subtle and musical too – with brilliantly implemented upsampling. I can see it upgrading ageing £300 CD players, or working as a brilliant stopgap until you've bought your dream DAC to match your £5,000 transport. Whereas some Japanese CD players can sound rather mechanical but technically brilliant, while British ones often are over smooth but sweet – here we have the best of both worlds. Just like Korean kimchi fermented vegetables, it will spice up your life.

**REFERENCE SYSTEM:**  
 Marantz CD63KI DP CD player  
 Astintrew AT3500 CD player  
 Sony CDP-R1 CD transport  
 Sugden IM4 integrated amplifier  
 German Physiks HRS120 loudspeakers  
 Monitor Audio PL100 loudspeakers

**VERDICT** ●●●●●  
 Superbly designed, well built but characterful CD transport/DAC combination with svelte but snappy sound.

**STELLO CDT100** £595  
**STELLO DA100**  
**SIGNATURE** £675  
 Select Audio  
 +44(0)1900 813 064  
 www.selectaudio.co.uk

- FOR**
- pin-point midband precision
  - sweet, finessed treble
  - punchy dynamics
  - build, styling, connectivity
- AGAINST**
- nothing at the price

**INTER IC-SOUND**  
 Although relatively rare on audiophile CD transports, the i2s system is reckoned by many to be the most accurate digital audio transmission protocol. A mini DIN connector from the transport sends five separate channels of information serially down the cable to the DAC, comprising the Word Clock sync, the Bit Clock synch, the digital audio datastream itself, the master clock and a de-emphasis flag. Because it handles audio data separately from clock signals, and yet has extensive clocking information, it eliminates the need for anti-jitter reclocking devices. Confusingly, there doesn't seem to be any standard between different manufacturers' implementations of i2s – one can see various terminations, such as Cat5 (RJ45) and others – so the Stello transport and DAC's i2s link should be regarded as designed for one another only. We found it really worked, offering subtle but useful gains in clarity, dynamic articulation and bass power over the coaxial digital input. As such, whenever the two Stello boxes were used together, i2s became the default setting.

**MEASURED PERFORMANCE**

Frequency response of the CDT100 and DA100 Signature combination was level across the range, with just a gentle drop down towards 20kHz which will ensure a smooth top end, and extension down to 2Hz at the low end. Distortion levels were low across the board, with a more than acceptable figure of 0.24% at -60dB.

The EIAJ dynamic range figure was again a respectable value of 109dB; a little short of the best at 112dB but perfectly acceptable nonetheless. Channel separation was good at 88dB and the noise levels from the player were very good, measuring -105dB. Results were consistent across both balanced and unbalanced outputs, the former also giving an output level figure double that of the unbalanced, as is common.

Measuring jitter from the output of the transport gave a Random jitter figure of 8pS with program related elements reaching up to 40pS with a -80dB signal. Changing to the AES balanced output dropped the random figure to around 5pS and almost completely removed the program related components, so this is the output gives excellent results. We were unable to test the I2S data link.

Engaging upsampling on the DA100 Signature DAC did not affect frequency response, but lowered the noise floor of the unit further – removing a noise peak at 39kHz and dropping the level at this point by 15dB. All in all, the Stello pairing measure well and should

turn in a fine performance together. AS

Frequency response (-1dB)  
 CD 2Hz - 20.4kHz

Distortion (%)

0dB	0.05
-6dB	0.022
-60dB	0.24
-80dB	2.9

Separation (1kHz) 88dB  
 Noise (IEC A) -105dB  
 Dynamic range 109dB  
 Output (unbalanced/balanced) 2.4/5.2V

**FREQUENCY RESPONSE**

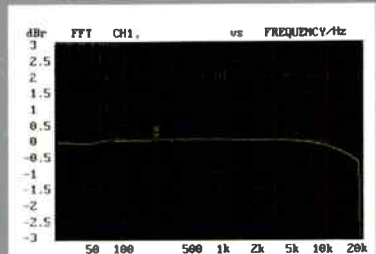

**DISTORTION**





# perfect duo



## CDT100 disc transport / DA100 Signature DAC

- Designed by and for music lovers • AES/EBU, COAX, OPT, USB, I<sup>2</sup>S
- Custom-built power supplies • 192 kHz / 24 bit upsampling
- Music-optimized circuitry • 120 dB Signal : Noise ratio
- Top loading CD Mechanism • Compact form factor
- High Quality I<sup>2</sup>S interface • Affordably priced

The CDT100 / DA100 Signature combo from April Music is one of audio's greatest bargains. You can spend more money, but you can't buy more music.

*"One of the best-kept secrets in high-end audio today . . ."*  
Doug Schneider - SoundstageAV.com

April Music, Inc.  
[www.aprilmusic.com](http://www.aprilmusic.com)  
[www.hifi500.com](http://www.hifi500.com)

**APRIL**  
*music*

UK distributor  
Select Audio  
Tel: (44)1900 813064  
Email : [select.audio@tiscali.co.uk](mailto:select.audio@tiscali.co.uk)



# Air Craft

High quality radio means VHF/FM; a dying art as digital slowly takes over. Still, if you love radio, some tuners have much to offer, Noel Keywood finds...

**A**lthough analogue TV is to be switched off, analogue radio will not be for the foreseeable future. It works well, remains enduringly popular and suitable alternatives are unclear. Coverage in the UK is good, as Band II signals get through to distant hills and glens fairly well, certainly better than DAB in Band III. Freesat, launched in May this year, can reach every nook and cranny of Britain's green and pleasant land, but the signal is too weak for portable or car radios. That leaves VHF/FM as the most effective medium for radio, especially if you value quality, something broadcasters in the UK prefer not to talk about. The reason is that there is a direct trade off between quality and quantity, and quantity appeals to broadcasters, possibly more than the public. Being a hi-fi magazine of course, we are judging quality!

DAB provides quantity: a wide range of stations are available in most

areas, each area differing in its mix. To find what is available in your area it is best to run an internet search. You will find all BBC stations of course, but the selection of commercial stations can vary greatly, and change too as inviable stations close and new ones open up as hopeful replacements.

DAB, Freeview and Freesat all pipe radio in compressed digital form, which compromises quality. Yes, there's no hiss or interference and both low and high frequencies are evident, but the sound picture is messy when a lot of instruments are playing, having a peculiarly shaky or jittery quality about it. Violins in particular become an entity that represents violins, rather than being a group of individual instruments. DAB will sound okay until you listen to VHF, then the superiority of uncompressed audio via VHF/FM becomes obvious...

The tuners here should be able to reveal how good VHF/FM

can sound. Unfortunately, standards are slipping as VHF/FM goes out of vogue. They worked well but, in measurement terms at least, did not match up to 1980s designs. However, the shortfall wasn't great and sound quality reached a high standard, due to other factors such as better componentry and circuitry, largely of the integrated variety these days.

To hear VHF/FM at its best, you still need a good aerial to provide a strong signal, our measurements show. Today's tuners are slightly less sensitive than those of thirty years ago. But they still sound very good and offer great entertainment all the same.

#### THE CONTENDERS:

Cyrus FM6	£450	p16
Creek Evaluation RDS	£285	p17
Pioneer F-F6-J	£350	p18
Myryad Z132	£399	p19
Rotel RT-06	£399	p21
Yamaha TX-761DAB	£299	p22





## CYRUS FM6 £450

**T**he Cyrus FM6 possesses both VHF/FM and Medium Wave AM bands. It has 32 preset memories for VHF and 16 for AM. The tuner looks radically different to the others in our group because it uses the distinctive and excellent Cyrus cast casework complete with rear cooling fins, but the FM6 is conventional. It is easy to slot in, due to a low 75mm height and 215mm width, but the depth of 365mm is similar to the other tuners.

The FM6 has two audio output options. "For best audio performance" Cyrus say, "use Output 1" (marked OUT1 on the rear panel). It is "unfiltered", meaning it lacks the usual pilot tone notch

filter at 19kHz. Subjectively, removing this filter gives spacious imaging across a wide and seemingly open soundstage, I find. But it does let through pilot and subcarrier, as well as subcarrier modulation sidebands; all unwanted supersonic information. Does this matter? My experience suggests not in most systems and that Cyrus and Pioneer are right to offer an unfiltered output. Pioneer do not provide a filtered alternative, but Cyrus do - a nice touch. They say Output 2 cuts out whistles when recording, where pilot interacts with bias. It may remove similar intermodulations in some systems, offering a cleaner sound, so choice may be system dependent.

The FM6 was easy to set up,

auto-tune ignoring noise from my aerial and hitting stations accurately. However, there's no tune indicator to aid manual tuning so stations must be selected by frequency. A Mono button is prominent, good for reception of weak stations. Radio Data System is fitted and programme information text scrolls across the small backlit LCD screen.

### SOUND QUALITY

As expected the FM6 sounded open, spacious and airy in its delivery, with superb imaging. Voices of The Stylistics on Radio 2 hung in an arc between the loudspeakers on a believable canvas, with hand drums sounding light but nicely resolved at far left, metallic percussion tinkling sweetly at right. The filtered output was similar in nature, but with letterbox sound stage, and head position image shift. The Stones 'Let's Spend the Night Together' was delicately rendered too, but the Rotel showed more low end push and atmosphere.

Scottish Folk Songs on Radio 3's Breakfast programme were depicted with a lovely spread of vocals and instruments, but not the stage depth and sense of atmosphere of the Creek, direct comparison showed. Gentle occasional strikes on the kettle drum in Ravel's 'Bolero' emitted a short but deep rumble from the Creek that the FM6 missed.

The choral accompaniment to Phil Collins' 'I Wish it Would Rain Down', on Magic FM, sounded light and ethereal, spread wide between the loudspeakers, guitar placed sharply left of centre, Phil Collins enunciation especially clear.

The pretty little FM6 offers a pleasingly light sound, with spacious sound staging that's more ethereal than visceral.

### MEASURED PERFORMANCE

The Cyrus FM6 has two audio outputs: OUT1 has no pilot tone filter and OUT2 has the common 19kHz notch. Our analysis shows OUT1 as this is the best choice, according to Cyrus. There's no response ripple caused by filter misterrmination (nor in-band phase shifts). The result is a frequency response that rolls down slowly to a -1dB limit at 10kHz, but extends past 21kHz, our analysis shows. The downside is the presence of high frequency rubbish above 20kHz in the audio output, not just pilot and sub-carrier, but also programme sidebands around the subcarrier. OUT2 lacks. There is also a bass roll down (-1dB at 50Hz) on both outputs.

Hiss was a little high at -67dB, via either output. Distortion levels were average, measuring 0.24% at 50% modulation at 1kHz, mostly innocuous low order harmonic our analysis shows. Sensitivity was good at 637µV for full quieting and 60µV for -50dB stereo IHF sensitivity. Audio output measured 0.67V.

The Cyrus should sound even and accurate through OUT1 (i.e. no filter), with wide open imaging and an excellent sound stage. NK

Frequency response 50Hz - 10kHz  
Stereo separation 32dB

Distortion (50% mod.)	0.24%
Hiss (CCIR)	-67dB
Signal for minimum hiss	0.67mV
Sensitivity (IHF)	60µV
mono	5µV
stereo	0.67V
Output	

### FREQUENCY RESPONSE

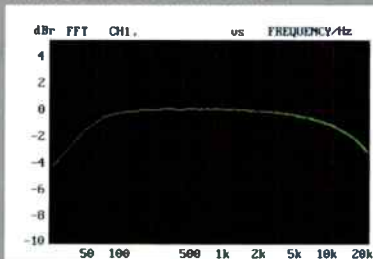

### DISTORTION



**VERDICT** ●●●●  
Handsome, well made tuner with a smooth and spacious sound.

**CYRUS FM6** £450  
Cyrus Audio UK  
+44 (0) 1480 410900  
www.cyrusaudio.com

**FOR**  
- superb imaging  
- ease of setup and use  
- optional filter

**AGAINST**  
- lacks atmosphere  
- small display  
- weak bass drive

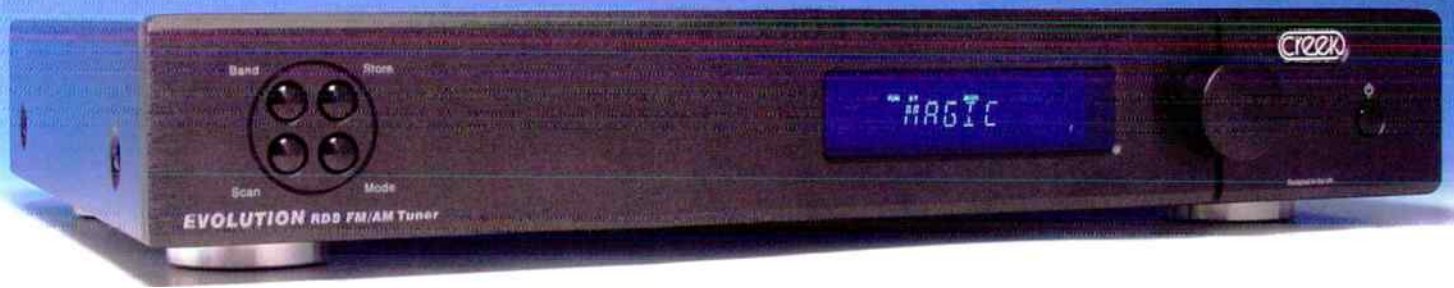

## CREEK EVOLUTION RDS £260

Like all Creek products the RDS tuner is neatly styled and well finished. It is also quite large, measuring 430mm wide, 75mm high and 330mm deep, although it needs a deeper shelf to accommodate rear lead protrusion. On offer are VHF/FM and AM Medium Wave reception. A Radio Data System provides station name automatically, but no additional info, such as the presenter/show name. Eighty station memories are provided, and they can be allocated freely between either waveband. Tuning is then a matter of selecting a preset, either by jumping through them or from the numeric keypad on the remote. There are no facilities, not even a Mono button. However, the tuner automatically switches to mono with weak signals, and noise muting is lifted. A ribbon FM aerial is supplied, and a loop AM aerial, the FM input being a male coaxial connector as usual.

The RDS can be tuned from the front panel or from its remote control. This was a fiddly process, stations often defaulting into preset 1. An alternative to scan tuning is entry of station frequency from the keypad and this is the safest option, as the Creek will settle on noise and distant transmitters otherwise. Like most tuners the Creek's auto-tune system was overwhelmed by the strong aerial signal from my outdoor aerial array, stopping at noise, so it was manually tuned to London station frequencies.

### SOUND QUALITY

A Radio 4 talk about the economy picked out some prominent features of the Creek. It has a slightly warm balance that is very easy on the ear and there's plenty of insight into the studio environment,

making for an atmospheric sound. Hiss was non-existent even at high volume and the three people talking, a presenter and two experts, sounded full bodied and credible. One person spoke at left, the presenter at middle and the third at right, so imaging was specific!

Another feature of VHF/FM is almost embarrassing revelation, reminding me of current BBC High Definition production guidelines that warn HDTV reveals the spots on people's faces! Well, VHF/FM reveals all sorts of huffings and puffings in the studio with live discussion and at times I winced at the wheezings of someone in this discussion. It was riveting though, as live broadcast done well can be. Radio 2 offers a

consistently high standard of sound quality and here the Creek served up a weighty sound with strong deep bass, a sonically impressive delivery.

Virgin also provide a clean sound that's nicely balanced and the Creek performed well here, sounding smooth and relaxed, subjectively preferable to the Pioneer F6 and reference Hitachi FT-5500 MkII, I felt. There's was little sign of the treble peak, just a hint of emphasis to sibilance being apparent. Classic FM and Radio 3 were handled with aplomb too.

The Creek was a bit fiddly to set up and use but it has a lovely full bodied, open sound with superb levels of insight and was, I felt, thoroughly entertaining.

### MEASURED PERFORMANCE

Our analysis shows a frequency response much like the Rotel, but high frequencies peak up a bit more. Ignoring the +2dB peak at 12kHz the limit is a high 17.5kHz. The Creek will sound brighter than the Rotel and quite forward.

Channel separation was very high across the audio band, better than 40dB. Distortion levels were also on the high side - less good - hitting 0.7% at full modulation, which may affect clarity. A filter notches out pilot tone at 19kHz, introducing a useful -53dB attenuation. There was little subcarrier, so the output is rubbish-free above 20kHz.

Output measured an unusually high 2.8V, way above Creek's own specification of 1.2V!

Sensitivity was quite high, a low 0.85mV (p.d.) needed from the aerial to reach full quieting (minimum hiss). The stereo IHF sensitivity was a mediocre 34µV and mono sensitivity was also low at 2.7µV. Hiss was on the low side of typical, measuring -72dB.

The RDS turns in a reasonable set of figures. It isn't reference standard, but it is respectable. NK

Frequency response 18Hz - 17.5kHz  
Stereo separation 47dB

Distortion (50% mod.)	0.26%
Hiss (CCIR)	-72dB
Signal for minimum hiss	0.85mV
Sensitivity (IHF)	
mono	2.7µV
stereo	34µV
Output	2.8V

### FREQUENCY RESPONSE

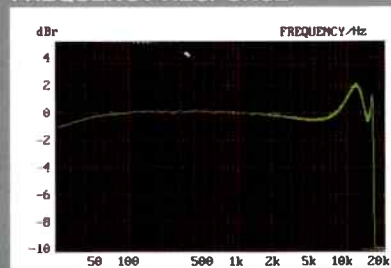

### DISTORTION

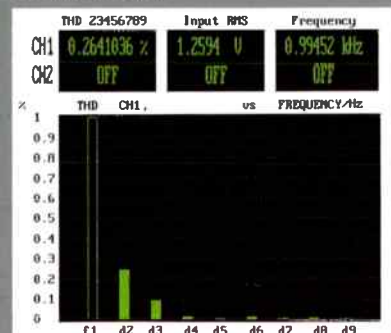

### VERDICT

Brilliant sonics on VHF/FM at a low price makes this a better, although some may miss its lack of DAB.

### CREEK EVOLUTION RDS £260

Creek Audio UK  
+44 (0)1442 260 146  
www.creekaudio.co.uk

### FOR

- tangible, organic sound
- legible display
- strong deep bass

### AGAINST

- awkward set up
- fiddly remote
- limited features





## PIONEER F-F6-J £350

**T**he F-F6-J from Pioneer offers VHF/FM, Medium Wave AM and DAB, including auto-tuning of the L Band (very high frequency/short range) which will likely never see use. It boasts 100 presets for FM and AM, plus another 100 for DAB. Pioneer say it has a 24bit/192kHz DAC, which seems a little spurious as 16bit at 44.1kHz is never likely to be exceeded on DAB! VHF/FM has full RDS, with not only station name, but programme information too, seen as scrolling text on a well illuminated screen. Usefully, mono can be selected on the remote control to reduce hiss on weak VHF/

FM stations.

The rear panel carries digital outputs, both optical and electrical, an RDI data link for a computer, analogue outputs and three aerial inputs. Like the Rotel, the Pioneer comes well equipped. It lacks a signal strength indicator for DAB (or VHF/FM) but it has both bit rate and Bit Error Rate (BER) readouts, and arguably BER is more important than analogue signal strength with DAB.

The Pioneer is light and easy to put into place. It is reasonably sized, measuring 420mm wide, 350mm deep (including connector protrusion) and 78mm high.

Set up wasn't quite as straight-

forward as the Rotel, but manual or auto tune are available, and DAB carries out an initial scan as usual.

### SOUND QUALITY

The Pioneer was obviously quite different in its sound, as our measurements suggested it might be. It had an open and spacious presentation that was uncoloured in the sense that it had light but broad and cohesive palette the other tuners lacked. It was like listening to an electrostatic loudspeaker, compared to a bunch of boxes.

The Pioneer sounded just right, against the varying characters of the other models, but with limitations. Like an electrostatic it had little bass

impact: listening to the Cream playing 'Sunshine Of Your Love', Ginger Baker's drumming was dynamically subdued. Switching quickly to the Rotel brought his contribution to life, underpinning the track nicely. Whilst there was plenty of airy detail, violins almost shimmering on Classic FM, stage depth was truncated. A live studio discussion with Libby Purves on Radio 4 lacked the sense of studio atmosphere behind presenter and guests of the Rotel. Much of this was attributable to its lean sound I suspect. At times there was a sense of edginess too, a lack of real purity in the sound.

DAB worked well, especially at 160kbps on Virgin and 192kbps on Radio 3, where switching to VHF/FM revealed less difference than usual, because the latter has a DAB-like tonal balance. Using an external Russ Andrews DAC I-USB improved focus just a little.

The Pioneer offers a light, airy sound that's insightful, suiting classic music especially. It has a good range of features and was reasonably easy to operate, if not as good as the Rotel here.

### MEASURED PERFORMANCE

The Pioneer F-F6-J has no pilot tone filter, so none of the ripple caused by mistermination. The result is a singularly flat frequency response that extends past 21kHz our analysis shows, and there'll be none of the severe in-band phase shift caused by the usual pilot tone filter. This will give the Pioneer a tonally accurate and even sound, together with open sound staging. The downside is the presence of a lot of high frequency rubbish above 20kHz in the audio output, not just pilot and sub-carrier, but also programme sidebands around the subcarrier. This will affect its sound in an unpredictable manner, according to how items in the hi-fi system react to strong supersonic signals.

In-band hiss was fairly low, measuring -71dB and distortion levels were reasonably low, measuring 0.18% at 50% modulation at 1kHz, mostly innocuous low order harmonics our analysis shows. Output was a useful 0.88V.

Lack of pilot tone filtering makes the Pioneer radically different to most VHF tuners. It should sound even and accurate, but supersonic rubbish may colour the sound. NK

Frequency response 12Hz - 21kHz

Stereo separation	45dB
Distortion (50% mod.)	0.18%
Hiss (CCIR)	-71dB
Signal for minimum hiss	0.95mV
Sensitivity (IHF)	
mono	6µV
stereo	42µV
Output	0.88V

### FREQUENCY RESPONSE

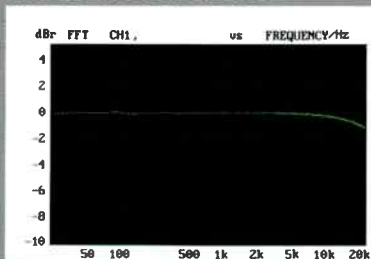

### DISTORTION

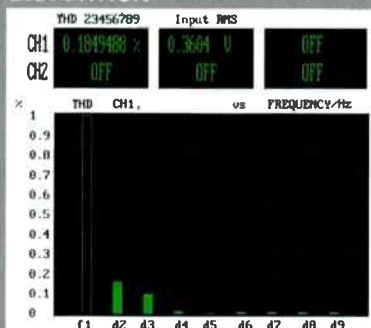

**VERDICT** ●●●●  
Open and airy sound from VHF/FM, but weak in bass delivery and lacking warmth. Good DAB.

**PIONEER F-F6-J** £350  
Pioneer IIK  
☎ +44(0)1753 789789  
www.pioneer.co.uk

**FOR**  
- light and airy on VHF  
- clean sounding DAB  
- strong insight

**AGAINST**  
- weak bass  
- edgy treble  
- small display

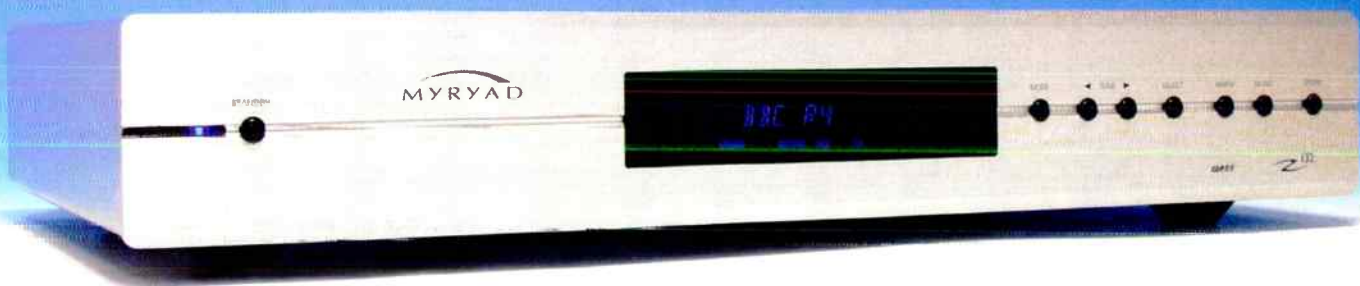

## MYRYAD Z132 £399

**T**he Z132 is a VHF/FM tuner also fitted with AM Medium Wave. It is cleanly styled and has an attractive brushed alloy fascia, with a deep blue fluorescent

display to show Radio Data text, frequency, etc. Unfortunately, as attractive as this is, it wasn't easily legible at a distance, like the brighter if slightly more garish display of the Creek. I had to pre-programme the Z132's presets from close up, but this was straightforward and without difficulty. As with the other tuners, station frequency was directly entered by numeric keypad to avoid mistuning, as the Myryad auto-tune system was overwhelmed by the powerful aerial signal of many millivolts for each station. The Radio Data System shows station name only, not programme data such as the presenter's name.

The Myryad is large, measuring 436mm wide, 78mm high and 288mm deep, or 330mm including protrusion of rear connectors. It has remote control and also a link for synchronised operation with other Myryad products. Otherwise rear connections are a pair of analogue phono output sockets and aerial inputs, coaxial for VHF/FM and spring terminals for an AM aerial.

This tuner has a mono button to reduce hiss and lift noise muting, so weak stations can be received. There are 39 FM presets and 19 for Medium Wave.

### SOUND QUALITY

Although the Myryad measures similarly to the Creek and Rotel, there were some obvious differences in terms of its sound quality. The most striking feature of its sound was superb soundstaging, instruments stretching in a smooth, equally

lit canvas between the loudspeakers. It was more specific here than the other models, pushing Radio 2 DJ, Steve Wright forward on the soundstage, his speech made highly intelligible by strong midband insight. This made the Z132 similar to the Pioneer in terms of stage depth, with slightly shortened perspectives and a little less apparent atmosphere compared to the Creek.

Changing from the Myryad to the Creek and Hitachi confirmed a sense I had that the Myryad is a little short on deep bass, lacking the rumbling lows of the Creek in particular. The bass line of 'Every Little Thing She Does Is Magic' from The Police on Virgin radio sounded pleasingly

supple but was a little short of bottom end power.

The Myryad was very impressive in terms of the amount of information it seemed able to retrieve. Radio 4's Making History programme was completely noise-free; there was absolutely no trace of hiss even at high volume. Interviews again showed the Myryad had superb intelligibility due to its revealing midband, and there was no lack of treble either, sibilance being well captured, but not excessive.

The Myryad Z132 has a forward and highly insightful delivery that reveals much within music and speech. It is a revealing performer, if light on deep bass.

### MEASURED PERFORMANCE

Frequency response was like that of the Creek and Rotel, with a slow roll down at low and high frequencies, but a high frequency peak at 12kHz. Ignoring the -1.7dB dip at 8kHz the -1dB limit is 13.5kHz. This response pattern will likely give a warm sound.

Channel separation was high in the midband, at 52dB, decreasing to 37dB at 10kHz. Distortion levels were on the high side too, hitting 0.7% at full modulation and 0.24% at 50% modulation. Our analysis shows low order harmonics which may affect clarity just a little. There is a filter to notch out pilot tone at 19kHz, introducing a useful -61dB attenuation, similar to the Rotel and Creek. Output was a high 1.9V, close to that of CD players.

Sensitivity was reasonably good, the Z132 needing 0.95mV (p.d.) from the aerial to reach full quieting (minimum hiss). Hiss was lower than usual, measuring -73.5dB stereo, IEC A weighted, with pilot filtered out.

The Z132 is quite a lot different from earlier Myryad tuners, turning in results much like the Creek and Rotel. NK

Frequency response 19Hz - 13.5kHz  
Stereo separation 52dB

Distortion (50% mod.)	0.24%
Hiss (CCIR)	-73.5dB
Signal for minimum hiss	0.95mV
Sensitivity (IHF)	
mono	5µV
stereo	38µV
Output	1.9V

### FREQUENCY RESPONSE

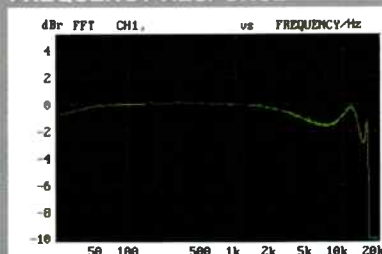

### DISTORTION

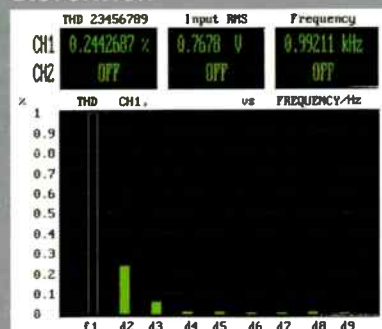

### VERDICT

Smooth and insightful sound on VHF/FM, that brings music and speech right into the room.

**MYRYAD Z132** £399  
Myryad UK  
+44 (0)1279 501111  
www.myryad.co.uk

### FOR

- detailed midband
- wide sound stage
- smooth

### AGAINST

- weak low bass
- shortened stage depth
- price



# Raysonic®

CANADA

The Fusion of Sound and Style



FOR:  
DESIGN, BUILD, MUSICALITY & VALUE  
• IN THE \$2.5K CD PLAYER CATEGORY •

CD 168AWARD



FOR:  
DESIGN, BUILD, MUSICALITY & VALUE  
• IN THE <62K CD PLAYER CATEGORY •

CD 128AWARD

**HI-FI WORLD**

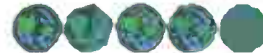

CD168 CD-Player



CD 228 CD-Player



CD 128 CD-Player



Integrated Tube Amplifier  
SP-120MKII

Raysonic Inc.

P.O. BOX 46565 Toronto, Ontario Canada M1T 3V8

E-mail: [sales@raysonicaudio.com](mailto:sales@raysonicaudio.com)

[www.raysonicaudio.com](http://www.raysonicaudio.com)



## ROTEL RT-06 £399

**R**otel's RT-06 tuner offers VHF/FM, Medium Wave AM and DAB. As a result it is more complex than many, having three aerial inputs for example, an F connector for DAB, coaxial male socket for VHF/FM and spring clips for the AM aerial. The handbook refers to a signal strength meter, but this is DAB only. There is a digital output, but again this is DAB only.

The Rotel is large, measuring 437mm wide, 72mm high and 319mm deep, or 350mm including protrusion of external connectors. It is nicely finished and functional in styling. However, its display panel has large, bright characters easily legible at a distance, which was useful and a notch up on the others of our group. The RDS data includes programme info as well as station name, lengthy descriptions scrolling across the screen - very neat.

As with the other tuners I programmed station frequency directly using the keypad to avoid tune errors, as the Rotel stopped at noise and distant transmitters, given a strong aerial signal. This was a speedy process using Rotel's excellent remote control. The RT-06 has been very well thought through in terms of usability. VHF/FM and AM have 30 presets available, whilst DAB has 99.

The DAB section simply has to be auto-tuned and stations topple in. The aerial supplied wasn't good enough to get Alexandra Palace transmitter a few miles north, even in a third floor room, showing how weak the DAB signal is. I used a dedicated, multi-element vertically aligned loft aerial for listening.

### SOUND QUALITY

The VHF/FM tuner was one of the most revealing - and that's

saying something in this very strong group. The upper midband has a pleasant sheen and treble proved strong. As a result the sound stage was wide, Chad Kroeger's vocals in Nickelback's 'Rock Star' sounding well lit, kick drum having good presence, although with a somewhat soft quality from Virgin Radio. Switching to DAB showed a general loss of stage depth, warmth and bass drive, making for a flat and somewhat edgy sound, so as usual VHF/FM offers significantly better sound quality. Feeding the digital output into a Russ Andrews DAC-1 USB made little difference, so the internal DAC does a good job.

A discussion about Brahms on Radio 3 showed the Rotel was

quiet, voices had great presence and small details like intakes of breath were strongly portrayed. The Rotel had a peculiar stark, forward quality to its upper midband that seemed just a little less natural than the others, yet it was arguably the most forensic sound of all. The RT-06 had the projection of the Myryad, but stronger bass, although it does have a slightly soft nature at times. All the same, in total the RT-06 came across as vivid and dramatic on VHF/FM, with great imaging, fabulous levels of detail and strong bass.

The RT-06 is a great all round package, very easy to set up and use, with the wide variety DAB provides and offering a dramatic sound from VHF/FM.

### MEASURED PERFORMANCE

Our analysis shows a slow roll down at low frequencies and high frequencies. The former may lighten bass just a trifle, the latter will add appreciable softness to the midband. A small peak at high frequencies will keep metallic percussion in the picture.

Channel separation was good right across the audio band and distortion levels reasonably low, especially at full modulation (i.e. music peaks). A filter notches out pilot tone at 19kHz, introducing a useful -53dB attenuation. There was little subcarrier too, so the output is much free above 20kHz. Output measured a useful 1V, high enough to match just about any integrated amplifier.

Sensitivity was low, the tuner needing no less than 1.8mV to reach full quieting (minimum hiss), a level only a large external aerial can supply usually. The stereo IHF sensitivity was a mediocre 106µV and mono sensitivity was also low at 7µV. Hiss was a little worse than usual at -69dB, although not bad enough to be easily audible.

The RT-06 VHF tuner fares reasonably well. It's not a class leader but it is decent. NK

Frequency response 18Hz - 14kHz  
Stereo separation 38dB

Distortion (50% mod.)	0.07%
Hiss (CCIR)	-69dB
Signal for minimum hiss	1.8mV
Sensitivity (IHF)	
mono	7µV
stereo	106µV
Output	1V

### FREQUENCY RESPONSE

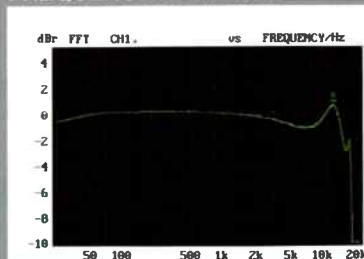

### DISTORTION

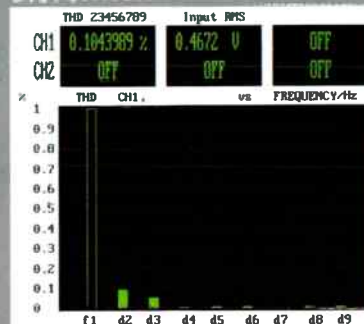

### VERDICT ●●●●£

Dramatic, riveting sound from VHF/FM, albeit less finessed than the Creek. Excellent value.

**ROTEL RT-06** £399  
Rotel UK  
+44(0)1903 221500  
www.rotel.com

### FOR

- forward and detailed
- plentiful bass
- facilities, ease of use

### AGAINST

- a little edgy at times
- truncated stage depth
- appearance





## YAMAHA TX-761 DAB £299

**T**he TX-761 DAB offers VHF/FM, Medium Wave AM and DAB in one package - at an attractive price. It's no cut down design when it comes to facilities.

VHF/FM has a full Radio Data System including programme information, time and traffic announcement auto search. Up to 30 stations can be stored in presets on each band, and can be recalled from a keypad on the remote control, or the presets can be scanned. The remote is an unlovely black slab, but is dedicated to the tuner alone, so isn't loaded with unwanted buttons and is easy to use. If a stereo VHF/FM station gets noisy mono can be selected. There is a signal strength meter, but it is for DAB only.

The TX-761 DAB is light at 3.2kgs, and just a little smaller than some of the others here, measuring 435mm wide, 87mm high and 280mm deep, or 310mm deep including rear connector protrusion. I tuned in VHF/FM manually because it stopped at distant stations and noise from my aerial even though Yamaha say it won't in the handbook; direct frequency entry from the keypad isn't available. The tune process was fairly straightforward, but single digit preset numbers need two digits entered (e.g. 1 is entered as 01).

The DAB section has 99 presets and covers L band as well as Band III. It auto tunes as usual and tuning is by stepping through the presets.

The rear panel carries analogue outputs, digital (coaxial and optical, DAB only), plus an F connector DAB input and coaxial VHF/FM male connector.

### SOUND QUALITY

The Yamaha comes across as easy on the ear and unchal-

lenging in its sound, with rather vapid bass. As the Yamaha is an obvious competitor to the Rotel I swapped between them and this showed that with the Police singing 'Every Breath You Take' on Virgin Radio at 95.3 the Yamaha was a little weaker in conveying the bass line, suffered some muddle in the midband, had foreshortened sound stage perspectives, but was easy on the ear at high frequencies, without sounding dull or warm. I had rather hoped the TX-761 DAB would be a giant killer, but the Rotel showed otherwise. Nevertheless, it's an enjoyable and smooth listen, with strong detailing, but better is possible in sound staging and insight.

All the same, on both Radio 3 and Classic FM, strings were smooth and concerts enjoyable. On Radio 4 speech was convincingly natural and lacked the slight spitch of sibilance others displayed, but there was a rather curtailed sense of atmosphere.

The Yamaha was more sensitive than the Rotel when using the supplied indoor aerial to receive DAB. Using the loft aerial the Yamaha sounded smooth enough, differences between DAB and VHF/FM being less obvious than the Rotel. Using optical digital connection to a Marantz SR8002 receiver brought improved clarity, sound staging and dynamics, so the output stages appear to hold this tuner back.

### MEASURED PERFORMANCE

Frequency response of the Yamaha rolls down at high frequencies to an extent that is likely to make it slightly soft or warm sounding. It peaks back up at 12kHz like the other tuners in this group except the Pioneer, and it possesses a slow roll down at low frequencies too. Ignoring the -2dB dip at 8kHz response reaches up to a high 18kHz, before a pilot tone filter takes effect.

Channel separation was wide across the audio band and distortion levels reasonable, measuring 0.13% at 50% modulation, comprising low order harmonics our analysis shows. The pilot tone filter has a useful -67dB rejection, keeping output free of unwanted mush above 20kHz.

Output measured a high 1.7V, much like that of CD and enough to drive power amps directly.

Sensitivity was good, the tuner needing 1mV to reach full quieting (minimum hiss). The stereo IHF sensitivity was 47µV and mono sensitivity was a low 3µV. Hiss measured -72dB.

The TX-761 DAB VHF/FM section measures well and is likely to sound smooth. NK

Frequency response 17Hz - 18kHz  
Stereo separation 45dB

Distortion (50% mod.)	0.13%
Hiss (CCIR)	-72dB
Signal for minimum hiss	1.8mV
Sensitivity	
mono	7µV
stereo	106µV
Output	1.7V

### FREQUENCY RESPONSE

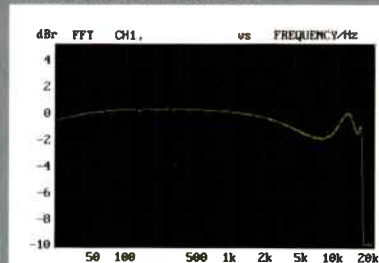

### DISTORTION

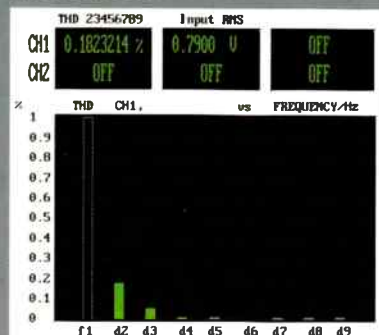

### VERDICT

Fine build, easy sound and lots of facilities, but lacks the audiophile pedigree of some others.

**YAMAHA TX-761 DAB £299**  
Yamaha Electronics UK Ltd  
+44(0)1923 233166  
www.yamaha-uk.com

### FOR

- low price
- extensive features
- sensitive DAB

### AGAINST

- weak bass drive
- flat sound stage
- some muddle



Listening to a good tuner is a simple pleasure I'll always enjoy. And during the working day when I'm, errm, working, others are providing great entertainment for us all. Some of the daytime discussion programmes on Radio 4 in particular are intriguing, both in the topics they cover, often off my radar, and the gentle but erudite way they cover them. Okay, it can be very BBC-ish; I could just as easily be listening to Isobel Barnet on 'What's My Line' instead of Libby Purves in 2008, but the subject matter is current and worth hearing. A good VHF/FM tuner like those here can take you right into the conversation. Having done a few of these radio chats in my time I know what studios are like and what the microphones are picking up. It's lovely to be at the receiving end, listening intently to what others are saying via high quality VHF/FM. That's why tuners are a real pleasure, as well as a unique one - you can't get this experience through any other medium.

Studios are well damped acoustically and have a 'dark' sound. Only the Creek Evolution RDS conveyed this accurately. It also sounded wonderful with music. Bass quality isn't something commonly raised with tuners, because most don't have it! That's what the Creek showed, reproducing deep bass like none of the others, with an authoritative delivery. The Evolution RDS was silky smooth, very sweet in its treble and seductively clear, having a fluid and unforced sound. At £285 (for the latest revision) it is a steal, but you don't get the variety offered by DAB because it doesn't have it. Whether this matters is entirely up to you of course. In terms of sound quality it's easy for me to place the Creek as my top choice, irrespective of price. That it is also the least expensive model of the group is a massive bonus, making it a clear and unequivocal number one.

If you want DAB then the Rotel, Yamaha and Pioneer have it. There's

nothing much to report here in terms of sound quality because, as we have said so many times before, DAB quality is poor. I've tried good aerials and external digital-to-analogue converters (DACs) to improve the sound of DAB but they make little difference. Compression removes all subtleties, so there's no way of recovering this data from the incoming signal to improve sound quality. This isn't consequential if you're perched on scaffolding with a transistor radio at your side hammering away at brickwork, like the builders I passed on my way to work this morning - DAB is for the portable market. At home it offers a lot of choice, but where a station also broadcasts on VHF/FM this is always preferable if you want the most listenable result.

Precisely what is available on VHF/FM and DAB depends upon where you live, which is why I cannot be specific. In London, VHF/FM serves my purposes, as it has the main BBC stations, plus Virgin, Heart, Magic and Classic FM, if not Virgin Classic Rock nor Mojo - but this isn't on DAB either, only Freeview! Of the three DAB tuners here the Rotel was quite clearly ahead of the others in sound quality, on VHF/FM where it was mightily impressive, and to a lesser extent on DAB too. I can easily place it a short distance behind the Creek in VHF/FM quality but some may just prefer its slightly more forward midrange. That it has good quality DAB is a bonus, but of course you pay the price, for £399 is a fair hike

"good tuners are a real pleasure, and a unique one..."

above the £285 Creek.

My Hitachi FT-5500 MkII tuner is a golden oldie from 1984 and demonstrates how a wonderfully engineered tuner can fall flat on its face in sound quality. Even in its day the Hitachi was obviously deficient and today it shows the same common failing of so many tuners

- poor low frequency resolution. This robs the sound of atmosphere, as low frequency ambient cues are lost, and it sucks the life from drums and bass lines, weakening the rhythmic underpinnings of broadcast Rock. Both the Creek and Rotel transcend this drawback, but the remaining tuners fall victim to it, to a greater or lesser extent...

Pioneer's F-F6-J was a nice listen, possessing the open, ethereal sound of the Cyrus, both lacking pilot tone filtering. Like the Cyrus though, it fails to tease out either studio ambience or the power behind drums and bass guitar. It offers DAB and VHF/FM at a fair price and is a decent choice if you do not want to shell out for the Rotel. However, the impecunious may look to Yamaha's TX-761 DAB, if DAB reception is important, because it is a pleasant, if undistinguished, performer with excellent DAB sensitivity, and costs little more than the Creek.

Both the Myryad Z132 at £399 and the Cyrus FM6 at £450 offered good sound quality and ease of use, but I'm afraid that, in close comparisons, neither could match the Creek or Rotel in their ability to look right into a studio during live broadcasts (this is what the Leak Troughline does so well and why I love it). Both had lacklustre low frequency dynamics and a seeming lack of stage depth. They were impressive in midband clarity and imaging, but ultimately lacking both drive and insight. As such, they're best recommended for people wishing to complete their systems with

matching tuners.

If you enjoy listening to radio then there are some interesting models here, but you really must have a decent aerial to appreciate what VHF/FM can do. It's worth it, as listening to radio when it comes in such high quality is truly something to cherish.



# Tuning Up

Get the best from your tuner with these simple tips from Noel Keywood...

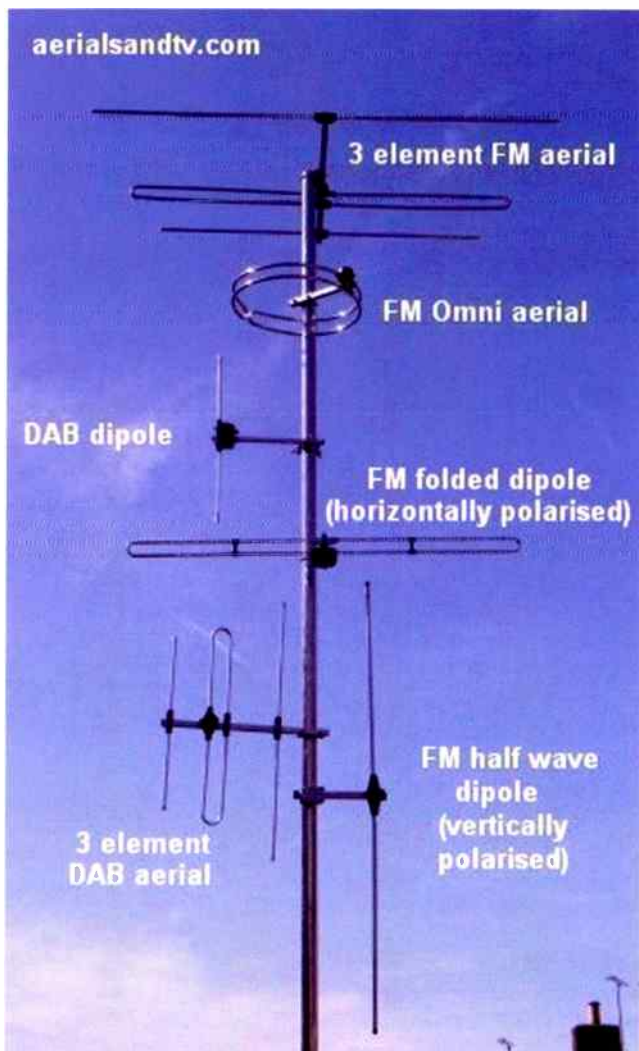

On top is a large directional 3-element VHF/FM aerial, needed to receive weak signals. In the middle is a similar width VHF/FM folded dipole that receives from back and front, strong signals only. Above it is a curved Omni, able to pick up all round - not always a good idea - for strong signals only. For DAB, a dipole mounted high is usually enough, but where the signal is weak, a 3-element DAB might be necessary. Picture courtesy of [www.aerialsandtv.com](http://www.aerialsandtv.com)

**A**nalogue radio tuners suffered a range of problems, like hiss and interference. Digital was the answer of course, but it just brought us a different set of problems! This feature is a short practical look at ways of getting the best from VHF/FM, as well as DAB and Freeview.

## VHF/FM

So VHF/FM is noisy, advertising for DAB tells us. Actually, it isn't, unless the signal is weak. With enough signal, hiss becomes inaudible. However, all VHF/FM tuners need 1mV or more from an aerial for hiss to sink to a minimum, known as 'full quieting'.

Except for those living close to a powerful transmitter situated in an urban area like Crystal Palace, a simple indoor aerial of any sort will not give a signal of this strength. VHF regional transmitters are usually put atop high moors like North Hessary Tor, meaning they will always be distant, unless you have hooves and woolly coat, and live in a nearby shed. Indoor ribbons commonly give around 0.3mV from distant transmitters and can sink well below this - too little for ideal reception. So what to do?

The easiest effective solution, if you live within about ten miles of a transmitter, is to try a loft aerial. These are unavailable from Maplin, their website suggests, but [www.tvaerials.com](http://www.tvaerials.com) lists Antiference and Triax as remaining makers of multi-element, high gain VHF (Band II) designs that typically cost £25-£30. Loft aerials usually have just a few elements (directors and reflectors) to keep them compact. Find a local supplier from the internet and DIY, or get aerial fitters in. Costs are not usually great, in the order of £80-£200.

They should have a signal strength meter to ensure you are getting enough signal; for reference my large outdoor array on a high pole in Central London gets 4mV from Radio 2, transmitted from Wrotham 30 miles away. Most other stations are weaker, down to 0.8mV or so. VHF tuners can accept at least 10mV

with alacrity, so you cannot have too strong a signal. Do not expect good results from cut down mini-indoor aerials, by the way, even if they are powered.

A good VHF tuner must have a decent outdoor array to give best sound and, with live programme, quality can be stunning, better than other sources, especially DAB. Expect the smooth, natural presentation of analogue. Live studio talks and music quality can be especially impressive. Our measurements show low levels (0.2%) of analogue distortion and bandwidth to 16kHz or so, or even 20kHz (Pioneer), with noise at -72dB, so the high quality of VHF/FM is no mystery.

## DAB

DAB needs little signal to work properly, the trouble here being that in many locations transmitter power is low and the signal very weak, leading to poor reception characterised by severe breakup distortion or no reception at all, because it is an all or nothing system, unlike analogue radio. DAB is transmitted at double the frequency of VHF/FM (around 200MHz), within Band III. The aerials are smaller, which is convenient, but DAB signals are more affected by buildings and hills. There are many more black spots as a result and it isn't practicable to either raise signal strength (by 14dB NTL estimated) or install myriads of fill-in transmitters to eliminate them. To strengthen the signal you can get multi-element DAB aerials from Maplins and a small one, especially in a loft, will usually do. DAB aerials look like those for

*The Pioneer F-F6-J tuner has a Bit Error Rate display to judge DAB reception quality.*



VHF, but are smaller and are aligned vertically, because DAB is vertically polarised to suit car and portable whip aerials.

Watch out for transmitter direction, which may be quite different to VHF and TV. Where I live, TV and VHF signals come from the South East (Wrotham and Crystal Palace) but DAB comes from the North (Alexandra Palace). And my view of London rooftops suggests no one has a DAB aerial pointing in that direction.

DAB sound quality isn't linked to signal strength so an aerial doesn't improve sound quality by any great amount. The error rate should fall but quality is set by MP2 compression, which is an outdated

Four around the same time, atmospheric inversion being blamed.

When Freeview goes wrong it goes very wrong too, not just a snowy picture but severe picture blocking and freeze ups, as well as ripping audio. Getting Freeview properly is often best left to aerial riggers because large, high gain aerials, sitting atop high poles, perhaps with a masthead amplifier are not uncommon, my skyline tells me. Whilst VHF/FM tuners will accept 10mV input without overload, I suspect Freeview TVs and set-top boxes may be less tolerant.

Modern Freeview televisions,



*Hitachi's renowned FT-5500 MkII VHF/FM tuner, from 1984, presented signal strength in dB and was able to cover a wide range.*

## FACILITIES

Nowadays, VHF/FM tuners do not come laden with facilities and the most important one, a signal strength meter, is always missing! Having said that, DAB tuners are sometimes fitted with an indicator of some sort, the Rotel in this month's group showing signal strength and the Pioneer Bit Error Rate which, ideally, should read zero!

More obscure DAB issues are RDI and L Band reception. An RDI output could feed an AAC decoder, as and when AAC compression arrives to update MP2. This would improve sound quality. L Band isn't in public use as yet and may never be. It is short range, running at 1.4GHz. See [www.wohnot.demon.co.uk/DAB](http://www.wohnot.demon.co.uk/DAB) for more info. Also, [www.digitalradiotech.co.uk](http://www.digitalradiotech.co.uk) offers a deep insight into DAB and satellite.

With VHF/FM tuners a means of selecting Mono, which cuts out the stereo decoder to reduce hiss with weak signals is common and useful. Otherwise, the use of presets, presence of Radio Data System programme data readout, with traffic information, are about all that is available nowadays. That makes VHF/FM easy to use and, if set up properly, a delight in its sound quality.

"when set up properly, FM is both easy to use and a delight in its sound quality..."

horror story, especially when an orchestra is playing at high level and DAB has 'exhausted its bit pool'. Generally, DAB sound is bright, lacking atmosphere and jittery. BBC Radio 3 runs at the highest bit rate of 192kbps for best quality and Virgin is close at 160kbps, which is fair.

DAB tuners commonly have a digital output which can be linked to an external DAC or surround-sound receiver, for improvement in sound quality, but it isn't usually great due to the poor intrinsic sonics of DAB.

## FREEVIEW

Many DAB programmes are available on Freeview, in equivalent or better quality (i.e. higher bit rate). Freeview is a digital TV signal transmitted at higher frequencies than DAB, from 474MHz up to 850MHz, London being covered by Crystal Palace transmitting at 20kW for example. This compares to a 3kW DAB signal from Alexandra Palace, so reception is often better, television being given priority of course (i.e. the highest hills!). Not all radio programmes available on DAB are on Freeview, but there is often a good selection. Differences depend upon your area so we cannot be specific.

Freeview reception has its own peculiar problems, especially shading by cranes, buildings and what have you, and often a good aerial mounted high is essential. However, my Freeview suddenly went haywire recently after years of stability. Forums suggest much of Britain suddenly lost ITV and Channel

as well as set-top boxes, commonly incorporate signal strength and Bit Error Rate (BER) indicators buried deep in their setup menus and these can provide a rough guide to how well the aerial is performing on various stations. Aerial fitters should have and use a decent signal strength meter, something that is worth insisting on.

As with VHF radio, there can be large differences between weak and strong stations, the ITV Mux 2 being weak in London for example. Getting good reception with stations on this Mux may run the TV close to overload on the others, my experience suggests, something that is best sorted out with a large aerial mounted high for good basic reception, plus a set of attenuators to trim the signal level to suit the TV.

The Humax F2-Fox T is a sophisticated Freeview receiver with a reputation for delivering good sound. Being a digital receiver, like DAB, it has a digital output and this should give best quality.

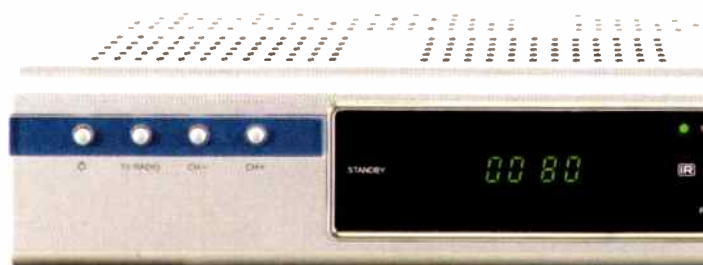

*Humax F2-Fox T Freeview receiver, or 'set top box' (above), offers digital radio at DAB quality or better and a digital output on the rear panel (below).*

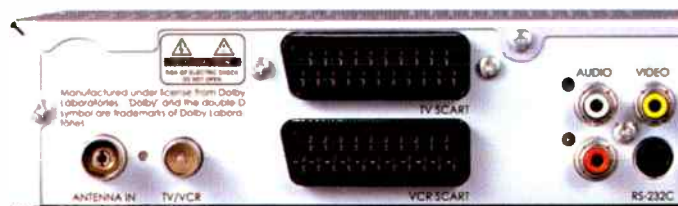



# emillé

*just for your musical bliss*



## Distributors

UK:

**Angelsound Audio**

Tel: 01923 352 479 E-mail: [info@angelsoundaudio.co.uk](mailto:info@angelsoundaudio.co.uk)

Denmark, Norway, Sweden:

**Marten**

Tel: +46 31207200 Fax: +46 31207270 E-mail: [info@marten.se](mailto:info@marten.se)

Israel:

**Audio Dreams**

Tel: +972 50 5601711 Fax: +972 3 9222237 E-mail: [ilansudry@bezeqint.net](mailto:ilansudry@bezeqint.net)

**Emillé Labs**

**Division of Kwangwoo Electronics co., Ltd**

Tel: +82 55 382 7373 Fax: +82 55 383 7375

E-mail: [info@emillelabs.com](mailto:info@emillelabs.com) Web: [www.emillelabs.com](http://www.emillelabs.com)



**WIN LEEMA'S SUPERB NEW PULSE INTEGRATED AMPLIFIER WORTH £1,195 IN THIS MONTH'S GREAT GIVEAWAY!**

**H**i-Fi World gives you the chance to win a fantastic new Leema Pulse integrated amplifier in this month's competition! In his July 2008 review, here's what David Price said...

"Not to put too fine a point on it, this is a cost-cut version of Leema's highly acclaimed Tucana amplifier. Costing £1,195 it's less than half the latter, but is actually very similar, save for a few added features and a slightly less muscular power supply. Leema claim 80W into 8 Ohms, or nearly twice that into 4. The case is a thoroughly conventional size (435x90x375mm) – no half-midi boxes here – and weighs a hefty 12kg.

It's very well built and finished, and the knobs, fascia styling and electronic switching all work superbly. In fact, it's a pretty complex beast; there's a battery of RCA phono inputs on the back panel, including separate MM and MC cartridge inputs, a LIPS-configurable A/V input and a front panel mounted MP3 player input. There's also a record output, remote control and full short circuit protection.

I kicked off the listening with Madonna's 'Frozen', a wonderful William Orbit produced song that's almost exclusively electronic, and I found myself wanting to 'listen in to the soundstage', rather than sit back being pulverised by it. This amplifier is definitely tonally smoother

than its rival Yamaha A-S2000. The result is that it impresses less and satisfies more. Moving to Primal Scream's 'Gentle Tuesday' showed the differences no less starkly, the Leema making it an altogether more intuitive event. Singer Bobby Gillespie's fey vocals sounded creamier through the Leema. The overall effect was a smoother, more inviting wash of sound. It consistently turned in a far wider and more capacious recorded acoustic; Kraftwerk's 'Tour de France Soundtracks' showed the Leema to be truly a capacious performer, pushing out big, wide images into the room. It has a lovely warmish tonality, a wide and deep soundstage and a highly inviting demeanour – you just want to turn the volume up and listen more."

For a chance to win this superb amplifier, just answer the following four easy questions. Send your entries on a postcard by 31st July 2008 to: **August 2008 Competition, Hi-Fi World magazine, Unit G4, Argo House, The Park Business Centre, Kilburn Park Road, London NW6 5LF.**

**RULES AND CONDITIONS OF ENTRY**

- ONLY ONE ENTRY PER HOUSEHOLD
- MULTIPLE ENTRIES WILL BE AUTOMATICALLY DISQUALIFIED
- PURCHASE OF THE MAGAZINE IS NOT A PRE-CONDITION OF ENTRY
- NO CORRESPONDENCE WILL BE ENTERED INTO
- THE EDITOR'S DECISION IS FINAL
- NO EMPLOYEES OF AUDIO PUBLISHING LIMITED, OR OF ANY COMPANIES ASSOCIATED WITH THE PRODUCTION OR DISTRIBUTION OF THE PRIZES, MAY ENTER

**QUESTIONS**

**[1] The pulse is a cost-cut version of which amp?**  
 [a] Leema Tucana  
 [b] A&R A60  
 [c] Naim 32.5/250  
 [d] Lescan AC1/AP3

**[2] How did DP describe its case size?**  
 [a] "thoroughly conventional"  
 [b] "absolutely excessive"  
 [c] "utterly vast"  
 [d] "quite small"

**[3] According to DP, what sort of beast is it?**  
 [a] "pretty complex"  
 [b] "wild and hairy"  
 [c] "unconventional"  
 [d] "bonkers"

**[4] What sort of short circuit protection is there?**  
 [a] full  
 [b] partial  
 [c] token  
 [d] measly

August Competition  
 Hi-Fi World Magazine  
 Unit G4 Argo House  
 The Park Business Centre  
 Kilburn Park Rd.  
 London NW6 5LF

**entries will be accepted on a postcard only**

**MAY 2008 MIT SPEAKER, MAINS & INTERCONNECT CABLES WINNER:  
 Scott Lewis of London**



# Net Trawling



**Whilst DAB has been the word on the high street for the past few years, Internet radio has been making gentle inroads and is now really beginning to fly. Steve Green explains why...**

Internet radio has been going for a good number of years now, but until recently was considered even the poor relation of DAB, thanks to its poor sound (due to the quality being constrained by people connecting to the Internet using 56k dial-up modems) and inaccessibility (because of the lack of standalone 'radios' on sale in the high street). Following the mass move to broadband this decade however, there has been an explosion in the number of Internet radio stations that are providing good audio quality, and excellent radios are available for less than £150 now [see p31]. Things have changed...

The number of stations available over the Internet has mushroomed to nearly 11,000 – and this includes a sizeable amount of major UK radio broadcasters joining the party too. GCap Media, the UK's biggest commercial radio broadcaster, was the first to improve its act, as it's been providing higher quality on its stations' Internet streams than it provides on DAB for over a year now. Furthermore, the BBC has recently announced that it is going to improve the quality of its live radio station and Listen Again streams in July and May respectively as well. This should mean that most, if not all, of the BBC's Internet streams will

overtake DAB in terms of quality. And the quality of Internet radio is likely to go up over time as well. So with such a quality-fest on offer, both now and especially in the future, this article provides some tips for people who're just taking their first steps into the world of Internet radio.

## WAYS TO LISTEN

There are three ways to listen to Internet radio: listening whilst sitting at a computer, listening on a Wi-Fi Internet radio, which are portable radios that work very much like DAB radios do, and listening via a Wi-Fi Internet radio media adaptor that you plug into your hi-fi system. As their name suggests, the Wi-Fi radio devices connect to the Internet via your home wireless network, and if you're using a wireless router you don't need to have your computer on in order to listen to Internet radio. Wi-Fi radio devices also include a built-in media player, which allows the device to playback music that's stored on a computer, and some Wi-Fi radio devices also come with an Ethernet socket for people with wired home networks.

Wi-Fi radio devices are actually a lot simpler to set up than many might imagine,

because there are only three steps involved: When the device is switched on for the first time it asks if you want to scan for networks, after scanning it displays the name of your wireless router, so you press 'OK' again, and you're then asked to enter your wireless network's password. The whole process only takes about a minute before you can start listening to Internet stations. The only area where things can get more complicated is if you try to use the media player side of Wi-Fi radios, but the Internet radio side is simple to setup and use.

## DISCOVERING NEW STATIONS

The easiest way to discover new stations is to visit one of the Internet radio portal websites, some of which hold information on over ten thousand Internet stations – there is a lot of overlap between the different portals, though. All Internet radio portals allow stations to be listed by genre, and they provide a link to allow you to start listening to the stations straightaway. Apart from this, though, the information that the

Audio codec	Lowest bit rate levels to consider kbps
MP3	128
WMA	96
Ogg Vorbis	80
AAC+	64

different portals provide varies from website to website, and the portal I'd recommend people use to discover new stations is [www.shoutcast.com](http://www.shoutcast.com) [pictured above], which is run by the company behind the Winamp media player – Winamp is available for Mac and Linux as well as Windows.

What I like about Shoutcast is that it provides more information about stations than the other portals do, which is helpful when considering which stations to try out. The most important information from an audio quality perspective is the bit rate and the audio format that a station is using, because this allows you to avoid trying stations that will provide poor audio quality due to them using bit rate levels that are too low – see the table on suggested bit rate levels to consider for the different audio formats.

Shoutcast also allows you to click on 'Bit rate' at the top of the bit rate column, which then lists stations for that genre in descending bit rate order, so the stations that potentially provide the highest quality are listed first. By default though, Shoutcast displays stations in order of popularity according to how many people are listening at the time, which is also a useful feature, because the best stations do tend to have more listeners. Another useful piece of information that Shoutcast provides that few other portals do is what material each station is currently playing, although you need to refresh the page to keep this information up to date.

Once you've selected the genre of music or talk stations you want to listen to, it's then just a case of trying the stations out for size, and using the information provided to guide you in the selection process. As there are so many stations to choose from, my advice is to be very selective at first to sort the wheat from the chaff, and then give more consideration to the ones that stood out.

Wi-Fi radio devices have their own dedicated Internet radio portals, which allow you to manage your list of favourite stations, and the stations you add subsequently appear in the Favourites menu on the radio itself. However, some of these portals don't list the bit rate level that stations use, and none provide as much information as Shoutcast does, so I would still recommend owners of Wi-Fi devices to use Shoutcast as a means of discovering new stations. One area where the dedicated portals for Wi-Fi devices score over Shoutcast, though, is that they do include stations that transmit on FM or DAB, whereas Shoutcast does

not. One website that is dedicated to Internet streams for UK stations that transmit on FM and DAB is [www.radiofeeds.co.uk](http://www.radiofeeds.co.uk).

When you've found some stations you like, rather than having to go back to Shoutcast each time you want to listen to the stations, what I'd suggest is that you create a new Internet radio folder in which to save files that link directly to the stations' streams, which then allows you to simply double-click on the files the next time you want to start listening to the stations.

To save a file that links to an Internet radio stream, you need to visit the radio station's website (radio stations' websites are linked to from Shoutcast and from most other portals), then right-click on the link that would allow you to start listening to the station, and in Internet Explorer you would select Save Target As, or in Firefox you

main types of radio content that's available on the Internet is termed 'on-demand', where people click on a link and start listening straightaway from the beginning of a programme.

The best-known radio on-demand service is BBC Listen Again (whose audio quality will be improved within the next few weeks), which allows users to listen to shows that have been broadcast over the past seven days – it's the radio equivalent of the BBC iPlayer TV catch-up service, although radio programmes aren't available to be downloaded yet. BBC Listen Again has recently been renamed as the 'BBC iPlayer Radio', and it can be launched by clicking on the 'Listen' link at the top of most BBC Radio web pages. Classic FM has also launched a listen again service, which is accessible via the station's website, and it's likely that other big UK commercial radio stations will follow

"most, if not all, of the BBC's Internet streams will overtake DAB in terms of quality..."

select Save Link As, and save the file in the Internet radio folder. For stations that use MP3, AAC+ or Ogg Vorbis, the file saved should have a .pls or .m3u file extension, which are referred to as 'playlist' formats. For stations that use WMA the file extension is usually .asx or .asf.

Don't try to save the links to the streams on the Internet radio portals themselves though, because the portals change the URLs for stations quite frequently, so the files would stop working within days. A simpler alternative to saving playlist files in a folder is just to add radio stations' websites to the Favourites menu in your web browser, and then to tune in via the website itself, but I find this method slower, especially when I want to change channels.

**ON DEMAND**

Stations available on Internet radio portals are termed 'live' streams, because they're like ordinary live broadcast radio stations that play audio continuously. One of the other

suit, because it's predicted that both TV and radio on-demand is going to become very popular over the next few years.



Apple's iTunes is a great way in to internet radio.

**PODCASTS**

Another area that is intimately related to Internet radio is podcasts, which consist of audio files, usually in the MP3 format, that are downloaded to a computer first before you can play them back – some Wi-Fi Internet radio devices can start playing podcasts back immediately, though.

The best way to find podcasts that may be of interest is to install iTunes, and go to the podcasts section in that, because iTunes provides an attractive visual



## The ADAM ART Tweeter

### Accelerating Ribbon Technology

ADAM's unique folded ribbon diaphragm moves air four times faster than any driver in any other loudspeaker, resulting in incredible clarity, breathtaking detail and imaging like you've never heard before.



## Home Monitors

From the moment of their introduction, the professional S Series line had an immediate impact on the professional audio world, and has received many awards from a plethora of sources. The Home Monitors are three passive versions derived directly from this professional series. They have been designed with the explicit goal to provide the passionate music lover with the same precise sound of the studios.

In addition to the ART tweeter which ensures the best possible clarity and precision in the high frequencies, the Home Monitors captivate the listener's ear with the stunning performance of the HexaCone™ woofer. The extraordinary properties of this material permit the low frequencies to match the quality of the high frequencies by providing a precise and powerful (yet never overemphasized!) bass.



HM1

HM2

HM3

**ADAM professional monitors are at home at some of the most prestigious studios around the globe:**

Abbey Road Studios, Sir George Martin & Gilles Martin (Beatles 'Love'), The Prodigy, Kevin Killen, The Chemical Brothers, Dani Elfman, Dave Pensado, Philipp Nedel, etc...



interface that is very well laid out, and it covers an extensive range of podcasts. The method of actually selecting which podcasts to try is similar to that of discovering new Internet stations, as described above, because once you've selected the genre of podcast you want to try, it's then just a case of trial and error to see which ones are right for you – a lot of podcasts are produced by recognisable names such as the BBC, so it's easy to find good ones.

**PERSONALISED INTERNET RADIO**

A relatively recent phenomenon is the rise of personalised radio stations, such as [www.last.fm](http://www.last.fm). Personalised radio stations allow listeners to rate music that's being played, so that over time the software that runs the personalised station becomes acquainted with a listener's likes and dislikes, and the software then plays music that it predicts the listener will like. One personalised radio station that's been launched recently is My Classic FM, which consists of seven different channels, six of which are for different forms of classical music, and there's one for jazz, so ex-listeners to thejazz (which closed down on DAB recently), do have somewhere to turn. Additionally, there are over 300 jazz stations on Shoutcast to choose from as well.

**COMPUTER SOUND CARDS**

Ready-made computers typically come fitted with cheap sound cards, which provide poor audio quality. Luckily, the price of good quality sound cards has dropped a lot over the last few years, and there are a few sound cards in the £60 price bracket that will provide far higher quality than cheap sound cards do. Three sound cards that have had good reviews are the M-Audio Audiophile 2496, the EMU 0404 24/96, and even Creative Labs has apparently finally got its act together in recent times with its X-Fi Xtreme Music card.

**BITRATES AND AUDIO CODECS**

The table at the bottom of page 28 is a guide to the lowest bit rate levels that I suggest you should consider for the different audio codecs that Internet stations use

– Real Player isn't included in the table because Real supports various different codecs, so it's impossible to generalise. If a station is using sufficiently high bit rate levels it doesn't guarantee that the quality will be good, but thankfully the quality is fine in most cases. The bit rate levels in the table are for stereo music stations, but speech stations can get away with lower bit rates than those listed, especially if they're using mono.

**DATA RATES**

A common query people raise is how much data they would be downloading when listening to Internet radio stations, and whether they might exceed their monthly download allowances, so the following table shows how much data would be downloaded and how many hours you can listen per gigabyte (GB) of data downloaded for typical Internet radio bit rate levels – a typical station on Shoutcast uses 128 kbps MP3, and the BBC's radio station streams are currently using 64 kbps.

There are very few broadband packages these days with monthly download allowances of less than 5 GB, and most provide 'unlimited' downloads but with a 'fair use' policy attached. So I think it's safe to say that the vast majority of broadband users wouldn't need to worry at all about the amount of data downloaded due to listening to Internet radio, because heavy Internet users tend to be on broadband packages that have higher download allowances anyway.

All in all, internet radio is a great new way of accessing radio - it may seem a little impenetrable right now, but that's down to the sheer diversity of programme material and its lack of familiarity. Give it a try - you may never want to go back to DAB!

**INTERNET RADIO PORTALS**

- [www.shoutcast.com](http://www.shoutcast.com)
- [www.reciva.com](http://www.reciva.com)
- [www.icecast.com](http://www.icecast.com)
- [www.tuner2.com](http://www.tuner2.com)
- [music.aol.com/radioguide/bb](http://music.aol.com/radioguide/bb)
- [www.publicradiofan.com](http://www.publicradiofan.com)
- [www.radiotime.com](http://www.radiotime.com)

Station bit rate Kbps	Data downloaded per hour	Time listening per GB downloaded
64	27 MB	37 hours
128	55 MB	19 hours

**WI-FI WORLD - OUR FAVOURITE INTERNET RADIOS:**



*Revo Pico - compact portable*



*Tangent Quattro - easy to use*



*Roberts WM201 - high end*

**REVO PICO WI-FI £150**

This minimalist box packs a lot of power into its diminutive (105x165x95mm) case. Not only is it a portable with a built-in NiMH rechargeable battery (giving 4 hours playback via Wi-Fi), it has analogue FM for when it's out of range of a wireless network (giving nearly 10 hours of playing time). Six buttons and a scroll wheel operate the Revo, along with a nicely readable two-line display. Although the Pico's light plastic case makes it easy to carry, it's not the best sounding Wi-Fi radio around. Still, it's a handy little portable that's well made and sensibly priced.

**TANGENT QUATTRO £189**

With similar design to Tangent's superb DAB Table Radio, the compact (210x111x145mm) Quattro has a head start in life. It's an intuitive machine to use, and feels satisfyingly well made too. The fast response to button pushes and stable Wi-Fi reception heighten the quality feel, as does the rich, detailed sound emanating from the single top-mounted 5W speaker. Compared to the class-leading Roberts, the Tangent has a warmer and more natural character, making it ideal for smooth jazz or sophisticated soul music.

**ROBERTS WM-201 £200**

Surely the best Wi-Fi radio around right now, the big (290x215x115mm) Roberts cleans up on all counts – especially ease of use. A single pushable rotary knob, working in conjunction with a small but clear five line backlit display, does what some other radios take ten or more buttons and two knobs to do. It impresses with superb sonics too, being by far the smoothest and most detailed here. Factor in its flawless piano black finish, crisp control action and general air of quality, and this is the best advertisement for Wi-Fi radio so far. DP





# Cam Belter

**After some cracking lifestyle products, Britain's best known hi-fi brand is revamping its serious hi-fi separates, and the new A38 integrated shows how. David Price applauds Arcam's artistry...**

**C**hanges are afoot at Arcam. In fact, they have been for a while, but it's only recently we've begun to see the new, twenty-first century face of one of Britain's most famous hi-fi brands. As many of us know, the company was founded and run by electronics whiz John Dawson for years, and that proved both its strength and its weakness. Arcam made superbly engineered products, but played it safe with ergonomic design and sometimes lacked "the vision thing", staying rooted to conventional hi-fi separates in a changing marketplace.

The arrival of Charlie Brennan, ex-Linn, has injected some Celtic spice into the company's roster – and now we're seeing Arcam with added pizzazz [see *BOXING CLEVER*, overleaf]. To wit, we've had a raft of interesting new releases from the Huntingdon hi-fi house – from the leftfield but brilliant rDock iPod dock to the instant classic one-box music system, the Solo Mini.

Now it's time for the conventional hi-fi range to be revamped, and that means the end of the Diva separates, to be replaced

by more affordable FMJ products (previously the company's high range marque) and a re-jig of the higher end FMJ fare. That's where the new FMJ A38 fits in – a brand new £1,200 integrated amplifier promising sharper sound and superior functionality to the earlier A32 incarnation. The A38 is not the whole story, because there's an accompanying P38 power for £800 more, which we hope to review in a forthcoming issue.

As anyone familiar with Arcam's original, now iconic, A60 amplifier will know, the company was never about giving you a flimsy metal box with a single volume control and on-off switch for your money. Accordingly, the FMJ A38 is a fully featured integrated, with a range of switching options, a bright green (defeatable and dimmable) dot-matrix display and swish learning remote control. As such, its user-interface is fully electronic, down to the point of letting you trim each source input level and set the rate of the master volume control. This gives a swish feel to the A38 that, for example, the similarly priced Yamaha A-S2000 and Leema Stream integrations I tested in the July issue lack.

The medium-sized Arcam doesn't impose itself on your equipment rack, but at 430x370x110mm and 9.5kg is hardly invisible either. The English-built integrated is superbly finished, and the quality extends under the SoundDeadSteel-damped casework. Hermetically sealed reed relays from Arcam's range-topping C31 preamplifier are fitted, for ultra low contact resistance and long lifespan. The power amp sports new Sanken output devices and a hefty toroidal transformer for a claimed 105W RMS per channel [see *MEASURED PERFORMANCE*]. Round the back are two pairs of speaker sockets (switched on the front panel), and a plethora of line inputs. There's an optional MM/MC phono stage, and a preamp output for the matching P38 power amplifier.

## SOUND QUALITY

The A38 is unmistakably Arcam sounding, in the best sense of the word, but it sounds a little different to the previous A32 all the same. With the amplifier powered up for forty eight hours, I found it began to loosen up like no other similarly badged product before it, demonstrating real rhythmic



suppleness and poise in addition to the usual brand strengths of smoothness and ease of listening.

Blame's '360 Clic', a sinewy drum'n'bass classic the like of which wouldn't normally be flattered by a do-it-all integrated amplifier at this price, actually proved quite engrossing. The defining characteristic of the A38 is its space, which is truly vast left-to-right. Even with the high end German Physiks HRS120 omnidirectional speakers I had *in situ*, this amp served up a huge soundstage. Within this, images were located with a good degree of precision, although they weren't quite nailed to my cranium in the way a higher end integrated such as the Sugden IA4 I had to hand allowed.

Soul II Soul's 'Keep on Moving' also highlighted the prairie-like expansiveness of this amplifier, allied to its characteristically warm Arcam tonality. Whereas its predecessor also achieved such warmth, it lacked the grip and the width that the A38 afforded, making the new amplifier an altogether more satisfying listen. Bass was deep and barrel-chested, with little sense of breathlessness even pushing these massive, hungry high end boxes to high levels in a largish room. The Yamaha A-S2000 achieved altogether larger amounts of low frequencies, sounding more like a disco amp, but it was the Arcam that made me want to keep listening, being an altogether more sumptuous and inviting musical companion.

It is subtle too, in a way the A32 wasn't. There's real delicacy and insight; not quite up to Sugden A21a S2 levels, but it's there all the same and has a physical presence that the Sugden cannot muster with its thirty something Watts of pure

Class A. I really enjoyed the hi-hat work on Carlito's 'Heaven' from the late-nineties 'Future Soul' drum'n'bass compilation. The gentle flute work was set in sharp relief to a pounding, 120bpm electronic percussion track, one that was handled deftly and without the slightest sense of the amplifier falling over its own feet. In this respect, the new Arcam A38 reminds me of the Leema Pulse reviewed last month – the two major on an infectious blend of sweetness and subtlety, although the Arcam pips the Leema in the motive power stakes, sounding a little less flustered at maximum volume.

Switching to altogether more 'natural' source material – unmediated by synthesisers, midi channels and studio trickery – and The Smiths' 'The Queen is Dead', taken from the 'Rank' live album was delivered in a highly satisfying manner. This recording is something of a dirge, and any lack of insight on the amplifier's part turns it into a chore to listen to. It wasn't the case with the A38, which captured the hectic vocals of singer Morrissey, frantic percussion of Messrs Rourke and Joyce and the guitar histrionics of Johnny Marr with real skill. Bass guitar was enjoyably taut, snares tight and those guitar power chords really kicked the song along. Indeed, dynamically, the A38 is impressive; it's

not the sort of amplifier that sets out to show off its ability to go loud then quiet (Naim's Nait 5i is far better at signposting the dynamic contrasts of a piece of music), but still this made it no less involving. It was able to capture the essence of the song with real skill, giving you the impression of a musical performance with a beginning, a middle and an end - one that really went somewhere.

What I like about this new Arcam is how it hides its tracks so well. No amplifier at this price is invisible, but it never tries to bite off more than it can chew, then trip over. There's a degree of diffuseness about the midband - it doesn't have the searing, forensic detail retrieval that then removes some of the natural flow of the music, like Yamaha's A-S2000 for example. Instead, you get a slightly opaque upper midband that never imposes itself. Rather, you find yourself coming away from a long listening session, satisfied and ready for more. Randy Crawford's 'You Might Need Somebody' is a stunning showcase for her redoubtable vocal talents, and the Arcam never left me breathless after dizzying displays of dynamics or detail; rather, I simply enjoyed the song so much that I played it again and again. Self-effacing and subtle, but highly satisfying all the same...

Even with classical music such







LEEMA ACOUSTICS

take me to your leema



FROM THE VALLEYS – TO THE UNIVERSE...

ENGLAND

Audio Affair
Birmingham B9 4AA
T: 0800 520 0710
www.audioaffair.co.uk

Audio Destination
Tiverton, Devon EX16 6BL
T: 01884 243 584
www.audiodeestination.co.uk

Analogue Seduction
Peterborough PE7 8DD
T: 01733 344768
www.analogueseduction.net

Basically Sound & Vision
Reymerston, Norfolk NR9 4QD
T: 01362 820800
www.basicallysound.co.uk

Cool Gales Ltd
Bath, Wiltshire BA2 6LU
T: 0800 043 6710
www.coolgales.com

Cymbiosis
Leicester LE1 5AW
T: 0116 262 3754
www.cymbiosis.com

Fusion
Wickham Market, Suffolk IP13 0AB
T: 01728 748471
www.fusionsv.co.uk

Guildford Audio
Guildford, Surrey GU1 2RR
T: 01483 537577
www.guildfordaudio.co.uk

HighEndHiFi.co.uk
Spalding, Lincolnshire PE11 2TA
T: 01775 761880
www.highend-hifi.co.uk

KJ West One
London W1G 8TY
T: 020 7486 8263
www.kjwestone.com

Matt's HiFi - Salisbury
Charlton-All-Saints, Wiltshire SP5 4HQ
T: 01725 513510
www.matts-hifi.co.uk

Music Matters, Solihull
West Midlands B92 8JL
T: 0121 742 0254
www.musicmatters.co.uk

Oxford Audio Consultants
Oxford OX1 1JD
Tel: 01865 790879
www.oxfordaudio.co.uk

Progressive Audio
Rainham, Kent ME8 8QY
T: 01634 389004
www.progressiveaudio.co.uk

R.J.F. Audio Visual
Camborne, Cornwall TR14 8RE
T: 01209 710777
www.truesoundav.com

Sevenoaks Sound & Vision
Lincoln, Lincolnshire LN2 1HN
T: 01522 527397
www.sevenoakssoundandvision.co.uk

Synergy AV Ltd.
Congleton, Cheshire CW12 1JR
T: 01260 286017
www.synergyav.co.uk

The Green Room
Exeter, Devon EX2 8RG
T: 01392 425567
www.thegreenroomav.co.uk

Ultimate Home Entertainment Solutions
Stroud, Gloucestershire GL6 6YE
T: 0845 678 0787
www.uhea.co.uk

VideoTech
Huddersfield, Kirkstiles HD1 2PT
T: 01484 516670
david\_jacques\_3@msn.com



NORTHERN IRELAND

Kronos Audio Visual
Dungannon, Co Tyrone BT70 1AR
T: 028 8775 3606
www.kronosav.co.uk

SCOTLAND

Kevin Galloway Audio
Kilmarnock, Scotland
T: 01563 574185
www.kevingallowayaudio.co.uk



LEEMA ACOUSTICS

Visit: www.leema-acoustics.com
Phone: +44 (0)1938 811900
Email: info@leema-acoustics.com

BEAUTIFULLY ENGINEERED SOUND
World Radio History

**BOXING CLEVER:**

David Price talks to Arcam's John Dawson and Charlie Brennan...

"Call yourself a specialist? Then do something special", says Arcam's Charlie Brennan. He's a large, softly spoken man with a gentle Irish lilt and a twinkle in his eye, and right now he's being UK hi-fi plc's most vehement critic! "If I had a mission, it's to bring high end products to most people... I'm trying to save them from style systems that just don't f\*\*king work."

Since joining the company, moving south from Linn Products, Brennan has given Arcam quite a sense of pep. The product range - which has always been impressive sounding, sometimes quirky and unfailingly well designed - is becoming sharper and making gentle, blinking steps out in to the big wide world, moving out of the cloistered environs of specialist hi-fi...

"Time was that if you couldn't afford a Linn or Naim, then you'd buy an Arcam. This was a truism that tripped off people's tongues - I want to change that. Better sound for more people is my mantra. I think we can build a special business - we have pluck, we're mad enough to have a go! In the future, we could be dangerous, we could be interesting", Charlie tells me.

The Arcam story is an amazing one. By British hi-fi industry standards, the company is a big fish, employing eighty people with a turnover of £13.5m last year, but it was built up from nothing by John Dawson, a trained material scientist, and Chris Evans. Dawson remembers how (the then) A&R Cambridge Ltd's first product was the A60 amplifier. Retailing for around £200 in 1976, it occupied the same sort of price point that the FMJ A38 now resides in. "We started building 50 and ended up building 30,000," John remembers. "We pitched them to dealers as a design exercise, but ended up selling most of them to the trade."

"It's a nice piece of work, even if I say so myself... it was a very good beast, pretty reliable. We were very careful

about what we did, and that included making it dead easy to make - we even made 2,000 from CKD (Completely Knocked Down) kits in New Zealand", adds John. That's been a key part of the Arcam story since then - they've always been very thoroughly engineered - but not the whole story.

Although invariably interesting and intelligent, Arcam products have traditionally been a little hit and miss. For every Alpha CD (1990's entry level silver disc spinner, "we sold bucket loads"), there's been a Delta 150 TV tuner. This 1989 NICAM digital receiver, running at half the data rate of CD, "worked extremely well in practice", although the sales didn't follow due to the concept being too leftfield. For every Black Box (1988 standalone DAC using Philips TDA1541 chipset) "we sold 5,000 - it was another very good piece of work", there's been a Delta 100 cassette deck. John remembers affectionately, "we always wanted to do one and the opportunity came with the introduction of Dolby S, so in the end we bought Denon's top drive and added cards, putting everything round it with the Dolby S stop". Arcam built about 400 machines in the end; it was hardly a success but, "we didn't bet the company on it!"

Now though, that eclectic product mix of the weird and the wonderful is becoming more savvy, with the Solo Mini being an object lesson in how to do hi-fi for more people. "We wanted to do a Linn Classik-type product since 1986, but didn't have the time", he adds. Now they do, and they're doing things a little differently whilst keeping the essential Arcam ingredients.

"The problem with the hi-fi industry has been that it puts barriers between people listening to music. We compete and fight and squabble over crumbs", adds Charlie Brennan. But things are changing in the hi-fi world, and now Arcam is leading the way.

as Linn Records' superb new recording of Bach's 'St. Matthew Passion' (Dunedin Consort & Players), where you'd think large

doses of detail and icy clarity are the order of the day, I found the Arcam worked brilliantly. Strings had a satisfyingly wiry, acoustic feel, but I didn't find my fillings falling out, while female vocals had real force but again didn't assault the ears. Yes, you could call for a touch more fine detail at the back of the hall and a fraction more precision in the location of instruments, but the expansive recorded acoustic, satisfying tonality and lovely, lilting ebb-and-flow of the music more than made up. Overall, a result.

**REFERENCE SYSTEM:**  
 Mitchell GyreDec/TecnoArm/viñt Frog turntable  
 Note Products PhoNote phono stage  
 Marantz CD63KI DP CD player  
 Sugden IA4 integrated amplifier  
 German Physiks HRS120 loudspeakers  
 Monitor Audio PL100 loudspeakers

**CONCLUSION**

Whereas I've often recommended Arcam amplification for the 'all round package' (i.e. fine sound, great facilities, good power, strong build, great value), the new A38 can simply be endorsed on sonic grounds alone. It's utterly class-competitive, and most important of all is a musically satisfying performer. Don't expect a brash, showy, in-your-face style; the new Arcam is the complete opposite. Instead, it beguiles you, draws you into the musical performance and keeps you engrossed. On top of this of course, it has all those other Arcam attributes - serious power, creamy tonality, superb build, reliability and after service - plus the convenience of a comprehensive and flexible electronic user interface. Don't underestimate this new integrated - although utterly practical and as characteristically unprepossessing as ever, the A38 shows that Arcam have raised their game.

**VERDICT** ●●●●●

A twenty first century A60, this sweet, musical sounding integrated has power, quality and flexibility to match.

**ARCAM A38** £1,200  
 Arcam  
 ☎ +44(0)1223 203 200  
 www.arcam.co.uk

- FOR**
- expansive soundstaging
  - beguiling, subtle musicality
  - powerful sound
  - build, styling, connectivity

- AGAINST**
- nothing at the price

**MEASURED PERFORMANCE**

The Arcam FMJ A38 delivered 145 Watts into 8 Ohms on the test bench, rising to 225 into 4 Ohms, so it has a strong power supply and should have not have any problem with loudspeakers that present a difficult load. Damping factor was average at 30, so the Arcam will not grip poorly damped loudspeakers as well as some rivals but will not be obviously lacking in control at the bottom end.

In distortion terms, the FMJ A38 shows a pattern with third harmonic dominant and other odd order harmonics decreasing gradually up the scale. This was consistent over the full range of output levels and frequencies so the amplifier should retain a nicely consistent performance across the board.

The sensitivities for each input are adjustable over a displayed range of '-12' to '+12' with the measured figure of 800mV for the CD input being achieved in the centre '0' setting. This is not particularly high but the range of options is very wide - from a maximum sensitivity of 210mV at the '+12' end, down to 3.26V at the '-12' setting, so the FMJ A38 is very versatile in this respect.

All in all the FMJ A38 amplifier should turn in a typically competent Arcam performance with a well balanced and clean sound. AS

Power	145 Watts
CD/tuner/aux.	
Frequency response	2Hz - 50kHz
Separation	75dB
Noise	105dB
Distortion	0.03%
Sensitivity	800mV
Damping Factor	30

**DISTORTION**

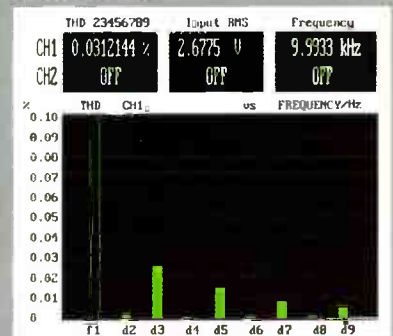



# Solid Metal Gear

**Quadral's diminutive Pico standmounting loudspeaker sports a ribbon tweeter and aluminium, titanium and magnesium mid/bass driver. David Price declares it an unalloyed success...**



**A**s we know only too well, there's no such thing as the perfect loudspeaker – despite what the marketing men may say. Rather, when you're buying yourself a new pair of boxes, it's better to think in terms of finding the least imperfect design at the price. Different manufacturers approach the task of designing loudspeakers in different ways, ones which can vary far more than equivalently priced CD players or amplifiers, for example. Essentially, speaker design is an exercise in mechanical engineering, with a bit of electronics thrown in for good measure. When real, physical materials are used then there are many ways of spending the cost price of the product – so it's not simply a case of choosing between several fairly generic op-amp chips, as is the case with so much modern audio electronics...

The £650 sticker price of the

Quadral Picos will normally buy you a standmounter with a combination of a metal or cloth dome tweeter and plastic or Kevlar mid/bass unit. There are a few exceptions, but it's very unusual to find boxes with ribbon tweeters – which are costlier to manufacture – at this price, and rarer still to find designs with matching metal mid/bass drive units. Given that the design of the drive units are as important to a speaker as the engine and gearbox are to a car, it's safe to assume that this unusual combination of drive units will give it a distinctive character that rival, differently equipped designs will lack.

Starting with the tweeter, it's not often that you see ribbon types fitted to speakers costing £650, so this a good thing. The design of its ribbon-shaped 60x8mm metal diaphragm gives excellent horizontal dispersion, so unlike a dome tweeter there's no left-to-right 'sweet spot', although

vertical dispersion is more limited, so it's important to get the tweeters close to ear height – I used 20" stands.

Quadral claims that its ribbon tops off at a giddy 65kHz, running all the way down to 3,500Hz where it crosses over to the Altima bass driver, running a 135mm cast chassis and a 100mm metal cone made from aluminium, titanium and magnesium. This alloy is said to give superior resonance characteristics to using one type of metal, or indeed other materials. Again, the idea is that it's light and stiff for speed and yet doesn't ring like a bell, keeping distortion and colouration to a minimum.

The mid/bass unit is reflex-loaded by a largish rear-mounted port, in the smallish 336x194x263.5mm (HxVxD) cabinet. The review sample boxes came superbly finished in Graphite paint, and weighed in at 8.15kg apiece. High quality bi-wire



"those ribbons run all the way down to the business end of the midband, and remain couth even when asked to reproduce female vocals"

terminals are fitted around the back. From this smallish but pretty box, Quadral claims a nominal power handling of 60W RMS, a frequency response of 44-65,000Hz and 86dB per Watt efficiency [see MEASURED PERFORMANCE].

### SOUND QUALITY

Being a 'metal' fan myself, I'm aware that loudspeakers using this material in their transducers are more susceptible than others to listening room temperature, and they also don't really 'relax' until they've been playing for a few minutes. As such, it's never a bad thing to get some heat into them, one way or the other. The Sugden IA4 Class A integrated amplifier I used for the review obliged in both respects, warming the room itself and providing a solid 40 Watts to tickle the Quadral's transducers – proving ample for my largish listening room.

Having heard no small number

of ribbon tweetered speakers – one of the nicest having recently been Monitor Audio's £2,300 PL100 which I had on hand as a reference for this session – I expected a sweet, delicate treble from the Picos. However, metal mid/bass units can be more hit and miss – some sounding quite hard and unforgiving. Fortunately this wasn't the case with the little Quadral's, which – if anything – proved the opposite. What we have here is a very clean, smooth and svelte sounding pair of boxes, offering a degree of delicacy unexpected for £650.

Listening commenced with Supertramp's 'Child of Vision', taken from the spryly recorded 'Breakfast in America' album (from 1979). It has a lively sounding arpeggio piano solo towards the end, which can sound strident through some speakers, but not so here. Instead, the Picos stayed slightly on the warm side throughout, their smooth ribbon tweeters

flattering to conceal their rising high treble frequency response. Refusing to behave like crude, directional, fizzy domes, those ribbons imbued hi-hat cymbals with a silky sound, glinting with detail. Of course they were metallic – just as they should be – yet were unsullied by ringing distortion.

This happy situation doesn't just go for the high treble – those ribbons run all the way down to the business end of the midband, and remain couth even when asked to reproduce female vocals. Stereolab's 'Cybele's Reverie' would have had me thinking that the Picos were recessed in the midband, so gentle was their treatment of Laetitia Sadier's deep but icy tones. Still, that didn't mean to say these mini-monitors glossed over the grain of her voice – instead, they gave a very direct and realistic feel. Meanwhile, the edgy electric organ that runs through the track was carried with a good degree of grit, the instrument's natural timbre being



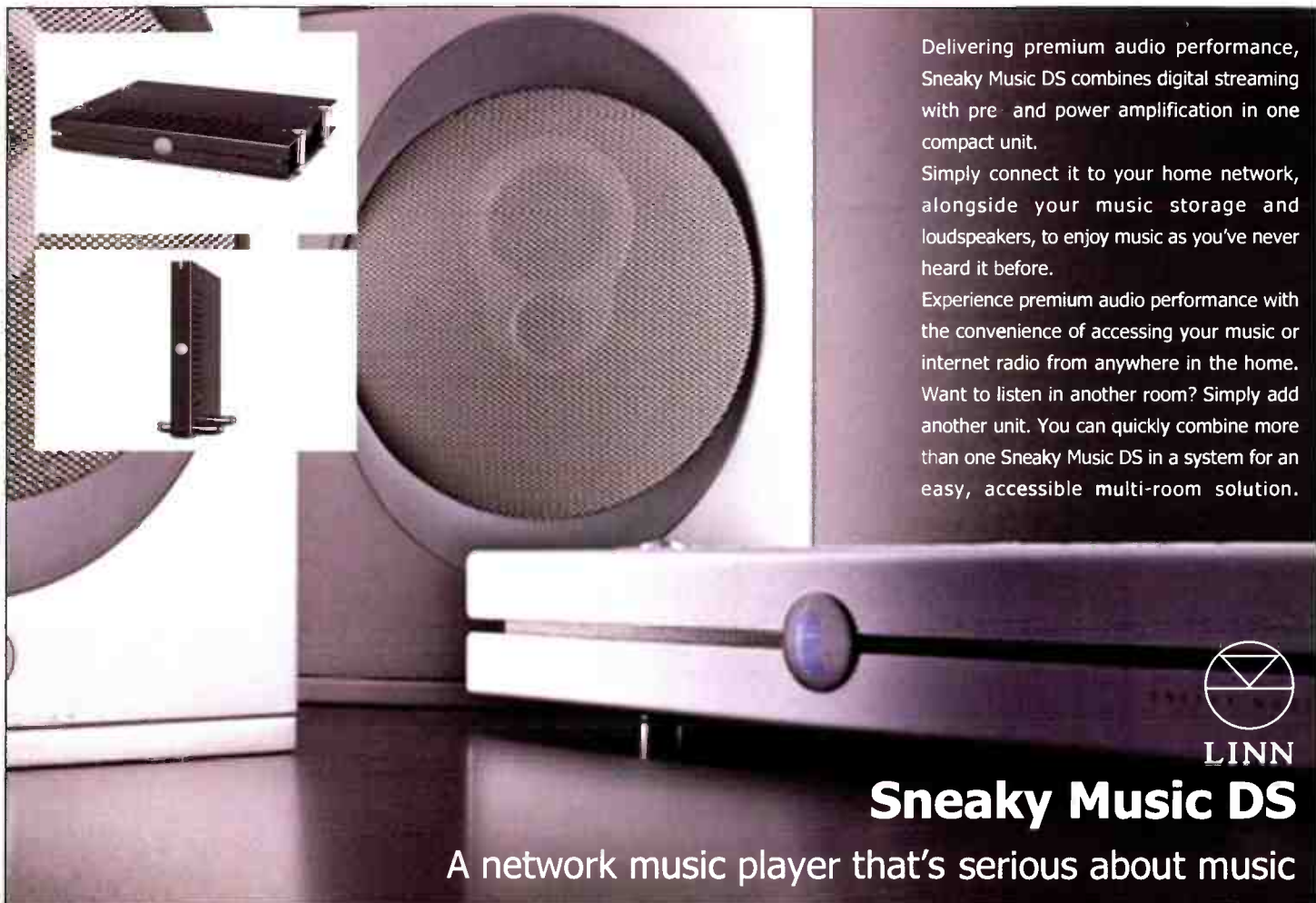

Delivering premium audio performance, Sneaky Music DS combines digital streaming with pre- and power amplification in one compact unit.

Simply connect it to your home network, alongside your music storage and loudspeakers, to enjoy music as you've never heard it before.

Experience premium audio performance with the convenience of accessing your music or internet radio from anywhere in the home. Want to listen in another room? Simply add another unit. You can quickly combine more than one Sneaky Music DS in a system for an easy, accessible multi-room solution.



LINN

## Sneaky Music DS

A network music player that's serious about music

# Linn Majik system offers

Please call for our latest prices on this superb system

Price includes full UK installation

EXTENSIVE EX DEM & USED LIST ALWAYS AVAILABLE PLEASE PHONE WITH YOUR REQUIREMENTS.

### Latest

## ARCAM Solo Mini



Just arrived. This fantastic new product from Arcam An evolution of the Solo range. Combining CD, DAB Tuner in an even more compact stylish box. This wonderful product also comes complete with an iPod interface.

Please call instore to hear this superb system.

**VARIOUS SPEAKER PACKS AVAILABLE AT SPECIAL PRICES PLEASE CALL OR SEE OUR WEBSITE FOR DETAILS**

### Latest Award winning Onkyo Receivers

Award winning AV products on permanent demonstration



Including TX-SR506E, 606 and 876.



**VARIOUS SPEAKER PACKS AVAILABLE AT SPECIAL PRICES PLEASE CALL OR SEE OUR WEBSITE FOR DETAILS**



Award winning brands stocked Linn, Arcam, Marantz, B&O, Bose Chord Electronics, InFocus, JVC, Monitor Audio, Mordaunt Short, Pioneer, REL, Roksan, Sim2, Tannoy, Teac, Tivoli, Velodyne, Yamaha. Plus many more.

### Linn Ex Dem List

Source	Price	Condition	Colours available
Linn CD12 CD Player	£6000	Used	Silver
Unidisk 1.1 Universal Player	£4500	Ex Dem	Black & Silver
Unidisk 2.1 Universal Player	£2500	Used	Black & Silver
Unidisk SC	£2250	Ex Dem	Black & Silver
Kank CD Player	£350	Used	Black
Numerik DA Converter	£400	Used	Black
<b>Control</b>			
Kisto AV Processor	£5000	Ex Dem	Black
Kinos AV Processor	£3750	Ex Dem	Black
Katni Pre Amplifier	£400	Used	Black
<b>Playback</b>			
Klimax Solo Power Amplifiers	£4950	Ex Dem	Silver
Klimax Solo Power Amplifiers	£4000	Used	Silver
Chakra 5100 Power Amplifier	£1400	Ex Dem	Black & Silver
Chakra 2100 Power Amplifier	£1000	Ex Dem	Black
2250 Power Amplifier	£900	Used	Silver
LK140 Power Amplifier	£400	Used	Black
LK85 Power Amplifier	£400	Used	Black
Komri Loudspeakers	£14000	Used	Maple
Linn Keltic Loudspeakers	£1800	Used	Rosenut (Immaculate)
Artikulat 350A Loudspeakers	£15000	Ex Dem	High gloss Black & Cherry
Artikulat 350P Loudspeakers	£8000	Ex Dem	Rosenut
Artikulat 345 Subwoofer	£2600	Ex Dem	High gloss Cherry
Artikulat 340A Loudspeaker	£6000	Ex Dem	High gloss Cherry
Artikulat 320A Loudspeakers	£9000	Ex Dem	High gloss Cherry
Akurate 212 Loudspeakers	£4000	Ex Dem	Rosenut
Akurate 212 Loudspeakers	£2500	Ex Dem	Maple
Akurate 221 Subwoofer	£1400	Ex Dem	Maple & Black

Various Linn Knekt multiroom Ex Dem and used Products available. Please call for details.

## Pioneer Latest G9 KURO

Call for new latest prices

Price includes free delivery in the UK.

Please call for details.



Now showing, the fantastic new C3X 1080 DLP 3 Chip Projector.

### Special

Used Sim2 C3X

3 chip DLP

projector for sale

normal RRP £12000

Available at £7000



6 Abbey Street, Carlisle, Cumbria. CA3 8TX  
 Telephone 01228 546756  
 www.petertyson.co.uk  
 Email sales@petertyson.co.uk  
 Open Monday-Saturday 9am-5.30pm

newcastle



153 Kenton Road, Gosforth, Newcastle. NE3 4NQ  
 Telephone 0191 2857179.  
 www.newcastlehifi.co.uk  
 Email mark@newcastlehifi.co.uk  
 Open Monday-Saturday 10am-5.30pm

well conveyed. Likewise, strings and saxophones in 'Percolator' sounded lifelike and believable.

In the bass, the Picos win no prizes for sheer rib-rearranging power, but what low frequencies these baby Quadral's possess is impressively integrated with that clean, open midband. This means a basically warm sound, erring slightly on the soft side, but satisfyingly even and unobtrusive. Instead of attempting to wrest vast amounts of air movement from small boxes and failing (as some manufacturers invariably do), the designer erred on the side of caution and hasn't spoiled the natural light, airy balance of these

with tonal smoothness was a lovely one, and a great party trick to make those used to common or garden dome tweeters green with envy. Dynamically, these little loudspeakers worked well, but I wouldn't characterise this as an obvious strength of theirs. The strains of 4hero's 'Morning Child' were a joy, but lacked the visceral dynamic contrast heard with the pricier Monitor Audios. Still, these speakers more than made up with a wonderfully smooth and detailed sound that had a rhythmically lilting quality. Midband was very wide, and within it instruments were accurately located and surprisingly extensively detailed

"an essential audition for those wanting a sound that's more finessed than it is fearsome..."

boxes as a result. The expansive stadium rock of Coldplay's 'X&Y' showed as much; as the band kicked in after that memorable opening guitar riff (and *homage* to Kraftwerk's 'Computerwelt'), the great scale of the sound didn't have the Picos struggling to catch up. Rather, the Quadral's served up a tuneful bass guitar line, with a decent amount of weight and warmth.

Being an ardent fan of Monitor Audio's PL100 – a slightly larger ribbon tweetered standmount costing four times the price – I began to feel as sense of, as the saying goes, "déjà vu all over again". Yes, in many ways the Quadral's sounded like a slightly downsized version of the above! Both speakers have a lovely, gossamer-soft treble, clean and open midband and a full warm bass. While, just as you'd expect, the Monitor Audio is a superior speaker in most respects, the ease of integration between the Quadral's drivers was obviously superior – unlike the MAs, there was little sense of listening to 'two speakers in one'. Indeed, I went immediately from using the superbly integrated omnidirectional German Physiks HRS120 to the Picos, so my ears would have been particularly attuned to this. Remembering the price differential, this is all the more impressive...

Rhythmically, the Picos are very good, but this doesn't come from vice-like grip in the bass. Instead it's a product of the ribbon tweeter's innate clarity and delicacy – leading edges aren't blurred or sullied in any way, making on-the-beat drums and hi-hat as clear as day and easy to discern. This combination of speed

– from the timbre of the cellos and violins to the gentle percussive piano playing and the vast cor anglais chorus leads.

## CONCLUSION

The Quadral Pico is a very fine small loudspeaker indeed, and with its recent £200 price reduction has become all the more convincing. So much so that I don't think I can think of any other £650 mini monitor I'd rather have right now. It isn't all things to all men (no speaker is), thanks to a bass performance that doesn't boast the last word in dynamic articulation or scale (not that one would expect such as small box to), but in every other aspect it romps away from the fray. The midband is clean and detailed yet superbly even and well finessed, and this goes all the way up to the high treble. It's at this point that the contrast between the Pico and most price rivals is most marked; in my view, however well a dome is done, they've got one hand



– tied behind their back when going side-by-side with a good ribbon unit. This loudspeaker came as something as a surprise to me – I hadn't expected such a big performance from something so small – and as such is an essential audition for those wanting a sound that's more finessed than it is fearsome.

## REFERENCE SYSTEM

Technics SL1210/Audio Origami RB250/Lyra Dorian turntable  
Note Products PhoNote phonostage  
Marantz CD63KI DP CD player  
Sugden IA4 integrated amplifier  
Monitor Audio PL100 loudspeakers

## VERDICT

Excellent engineering makes for a finely finessed yet musical performance. Small speakers with a grown up sound.

**QUADRAL PICO** £650  
Axcelle Ltd.  
+44(0)20 8991 9200  
www.quadral.co.uk

## FOR

- delicate, finessed treble
- open, detailed midband
- warm, tuneful bass
- quality of design and build

## AGAINST

- nothing at the price

## MEASURED PERFORMANCE

The Quadral Picos have a nicely flat frequency response which lifts up above 15kHz, to finish around 4dB up at 20kHz. This will add sparkle to their treble but, as with most ribbon tweeters, the resultant effect will be dependent upon positioning of the ear relative to the loudspeaker – best results will require tweeters to be positioned securely at ear height. Through the midrange the curve is very smooth, showing that the two drive units have been well integrated – not something that is always easy with a ribbon tweeter in a two way design.

At the low end, the Picos' driver runs down to 80Hz or so and is augmented by a rear-firing port tuned to around 50Hz, so the bass from the Quadral's will not be enormous but should be solid enough for the cabinet size. The Picos are also reasonably well damped and so the low end should nicely taut.

Electrically, the Picos show the typically even high frequency response of a ribbon tweeter, with the usual woofer and port resonant peaks lower down. These are not large, helping to give an average measured impedance

of 5.8 Ohms, not dropping far to a minimum of around 4.5 Ohms. The Quadral's are thus an undemanding 4 Ohm load with a good measured sensitivity of 87dB, so a minimum of 30-40W should power them nicely. AS

## FREQUENCY RESPONSE

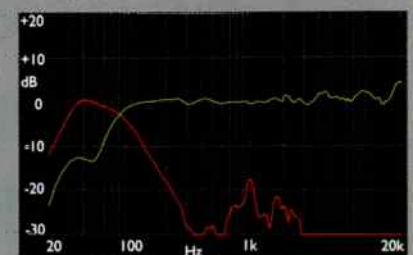

Green - driver output  
Red - port output

## IMPEDANCE

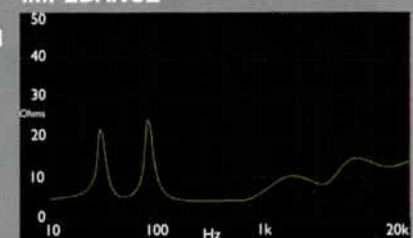





**Raysonic's new C200 preamplifier has more blue lamps than a police car, but it's the performance at the price that Andrew Harrison finds most arresting...**

# Light Saver

**Y**ou could never accuse the Raysonic C200 of hiding its blue light under a bushel. With three brightly lit knobs at the front, this will always be a distinctive design, especially when used in a darkened room. And with no means to dim or extinguish these bulbs, some people may find the effect just too distracting, leading them to pass over this rather, errm, 'eye-catching' (read: 'bling') design in favour of something less ostentatious. This would be a shame, because in audio terms the Raysonic C200 preamplifier has a sophisticated sound at odds with its styling...

It's a relatively minimalist stereo preamp based entirely on valves, offering just three line-level inputs, and two pairs of stereo outputs. All connections are unbalanced types using sturdy chassis-mounted RCA phono sockets. Besides that smattering of socketry, the only other rear panel features are an IEC mains inlet and user-replaceable fuse. Mod cons such as remote control, balance and unity-gain bypass are all absent, pegging the C200 as a straightforward control unit aimed at the committed audiophile.

With a nod to Classé Audio's curved corner designs, the Raysonic C200 has a truly modern look to its solid-feeling brushed aluminium case. Like Classé, the top plate is flush embedded within the thick side walls, helping to lending the boxwork clean lines. And when viewed from the front there is little clue that this is a valve-powered unit, excepting the tell-tale glass nipples of six triodes, just visible from their home in a deeply rebated circle in the preamp's centre. These valves – two 12AX7, two 12AU7, a 12BH7 and an EF86 – are sited around a central round plug, polished and concaved, such that a casual glance could lead you to think this was some kind of top-loading CD player.

Those control knobs, clear acrylic and each one backlit by four concealed blue LEDs, have no markings to show their position. This leads to uncertainty as to which of the Aux, Line and CD inputs is selected, and at what volume the central knob is set. Adjusting the volume requires a little care too, as quite high levels of gain are available by the time the featureless knob is at a nominal 10 o'clock position.

Further examination inside the

case reveals a superb standard of construction, a mixture of several small PCBs and point-to-point wiring techniques. The main transformer is an R-core type, popular in high-end Japanese designs, and typically possessing very low flux leakage and good efficiency in a compact size. On the opposite side of the case we see two large transformer-like chokes, used in the power supply. Wiring is neatly laid out and dressed, and joints are well-finished with high tin content solder. More evidence for the care that's gone into this design can be found in the choice of components, with expensive Rubycon, MIT and Solen-MKP capacitors used throughout.

In all, this is a rather well made unit, although I would have liked to have felt a smoother action on the

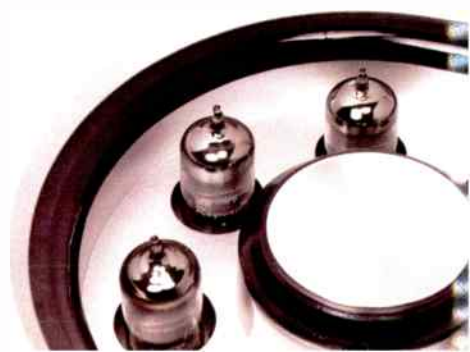

main volume knob and less play on the source selector. And on a matter of styling, I found the company's cursive logo on the front panel too redolent of budget Chi-fi, while the labels for Selector, Volume and Power are all in different fonts and sizes. While manufacture is indeed in China, Canadian-based Raysonic is trading at the higher end of the audio market and deserves to present its forward-facing fascia more subtly. Vital statistics are 340x335x80mm and 11.8kg.

**SOUND QUALITY**

First considerations of the Raysonic relate to noise. Although reasonably quiet, it is of course hissier than MF Audio's transformer-based Passive, which was used as a reference in this review. A black mark is awarded for some trace mechanical hum, perhaps from a choke or transformer, which was faintly audible in late night sessions with the unit a few metres distant. Placing the preamp on a trio of additional squishy Sorbothane pods went some way to stopping the insidious hum from being carried to the support below, however.

Breakthrough was an occasional issue on this three-input design. With a disc playing on the CD input for example, an intrusive amount of distorted signal was sometimes apparent when switching to the unused Aux and Line inputs, regardless of volume settings. A

the Ortofon MC Windfeld proudly able to show off all the rich timbres of orchestral instruments it had found in Melodiya's classic nineteen sixties recording. Contrasting with a Music First Silver preamp on the same piece, the Raysonic had a slightly more liquid flow, where the MF Audio transformer control unit majored on transparency at the expense of midband palpability. In effect, the Raysonic subtly softened where the MF Audio gently spotlighted.

That darker sound of the Raysonic could be experienced as a slight reduction in soundstage space. While still very wide when given the right material, there was less an impression of limitless depth into the distance. In a sense perhaps, there was a little editorialising going on here, with some aspects of the mix brought out in fuller colour that actually served to flatter the overall sound. But there was integrity to that soundstage, with all instruments arranged in a natural order and place.

Take the two rhythm acoustic guitars in 'Dogs' from Pink Floyd's 'Animals', for instance. These were sat in a more contained space but interplayed very effectively from their hard left and right positions, as nuances in strumming technique demonstrated that these were two separate instruments rather than one that had been automatically double-tracked. A softer and gentler presentation actually made for a

**TUBES VS. TRANSISTORS**

To some, valves are noisy, unreliable and inefficient, but to those who have spent time with them, there is an ineffable magic about the way the thermionic vacuum tube presents sound that is somehow just 'right'. Transistors all but pushed out valves after first germanium and then silicon transistors became the standard means of switching and amplifying current in the middle of last century. They could run cooler and, after initial reliability issues, more dependably. They also had an extended lifespan compared to valves which ultimately wear out with normal use. But the valve soldiered on, in places where solid-state devices were not suitable such as high-power RF transmitters, and military radar systems that required electronics immune to the effect of nuclear EMP. Not to mention an underground following of committed audio valvephiles... In small signal applications, such as phono stages and line-level preamplifiers, valves have often been associated with higher noise levels than are available now with transistors and solid-state op-amps. But thanks to the perseverance of valve enthusiasts in tracking down high-quality glassware, such as military-spec components, combined with the shrewd use of modern circuitry and low-noise power supplies, it is possible to get measured performance to appease even the most hawkish 'scope watchers.



busiest of tracks, taking in the strands of music at will rather than being overwhelmed by an onslaught of every facet of the sound. And, as for treble quality, the valve heart of the C200 played its trump card with a top end that was blissfully sweet, just as it should be.

**CONCLUSION**

Very clean and predominantly neutral, the Raysonic C200 crucially communicates music well, and reaffirmed the beauty of well-tuned valve audio electronics to me. Basic build quality is good - even if there are some niggles - and careful attention to component quality and circuit execution has resulted in a design of undeniable musical merit. As such, it shines out as an interesting, quirky and highly capable 'affordable high end' preamplifier.

**VERDICT** ●●●●£  
Highly capable affordable high end preamplifier bringing the best in valve sound.

**RAYSONIC C200** £2,499  
Rochester Hi-Fi  
☎ +44(0)1634 880037  
www.raysonicaudio.com

**FOR**  
- engaging, mellifluous sound  
- blissfully sweet treble  
- impressive detail

**AGAINST**  
- styling is not for everyone  
- switching glitches

"if ever there was a case for introducing valve euphony into the sound, this would be it..."

solution to this annoyance is to ensure that no other sources are playing while listening to your chosen input.

Switch-on is an extended process. After the right-hand power switch is twisted clockwise, the C200 takes a full minute and a half to wake up, with the volume knob slowly blinking blue all the while as you await its readiness. Yet the wait is worth it, if you value sweet, open sounds and an easy musical flow...

From the opening of Borodin's 'In Central Asia', the C200 kept a beautiful balance between the high strings continuo and woody solo of cor anglais, with soft horns rising thereafter in a sweeping soundstage to conjure panoramic Siberian majesty. Rarely has this tone poem performed by the USSR State Symphony Orchestra with conductor Svetlanov sounded as spellbinding,

more enticing sound in my system, which can claim great analysis and clarity at the expense of rose-tint romance. With the Raysonic in circuit, a smoother, more mellifluous sound resulted. If ever there was a case for introducing valve euphony into the sound, this would be it.

Leading edges were eased fractionally with the Raysonic, but I found myself thoroughly enjoying the calmer, ordered sound that ensued. And bass, perhaps not as level and low-reaching as with reference designs, was nevertheless sincere and well-timed within the context of the music. This made it strangely easier to see into even the

**MEASURED PERFORMANCE**

The Raysonic C200 has a useful gain of x10 and will swing a maximum output level of 33V. This, combined with its maximum input overload value of over 6V, means that it will work well in a wide range of setups, and with a variety of sources.

Distortion levels from the C200 were very low, at around 0.001% for 3V output at both 1kHz and 10kHz - this rose to a maximum of 0.5% at maximum output, which is still a good result. Noise levels were reasonably low at -73dB (A weighted).

The Raysonic C200 measures well and is a usefully flexible unit. It should offer a clean and detailed sound that shows valves at their best. AS

Gain	x10
CD/tuner/aux.	
Frequency response	1Hz - 300kHz
Separation	54dB
Noise	-73dB
Distortion	0.001%
Overload	>6V





# Two's Company

**Onkyo's new DR-S501 receiver turns surround-sound into stereo - and very nice it is to live with too, says Noel Keywood...**

**L**ike Pavlov's dogs I've become programmed to possess a set pattern of expectations, so Onkyo+receiver+DVD means something the size of fallout shelter, of similar construction, and with more sockets than a Hoover factory. So I'm still puzzled by an almost complete absence of socketry in the DR-S501, just two 50 Watt amplifying channels in an A/V world where seven are the norm, and minimal onboard processing. This is a real left-field device. The onboard DVD player spins not only DVD and CD as I'd expected, but also DVD-A and SACD - definitely unexpected as both are surround-sound formats. They have been rudely abandoned by the global CE business, even though people around the world have bought millions of discs. Onkyo have obviously gone to pains to include them on the DR-S501 receiver to appeal to two channel audiophiles: very promising, I thought, especially for £400...

Onkyo are aiming this receiver at those who refuse to engage in multi-channel madness: quite a brave move in some ways, as this automatically eliminates bragging rights to a whole myriad of signal processing schemes. It's basically a stereo amplifier, with a subwoofer output, but without Bass

Management for diverting bass away from small satellite loudspeakers and into the subwoofer. This is fine, because hi-fi loudspeakers do not need bass management. A subwoofer output handles the discrete LFE channel for explosions and what have you from video DVDs.

There's inevitably a video output and our European model carried the increasingly rare SCART socket for easy connection to European TVs. The Onkyo also has shiny new HDMI, but with limitations. The receiver upsamples DVD to High Def, believe it or not and, although this cannot in theory add in information, in practice I've found there's a big improvement due to the use of a high resolution screen.

Video is output as analogue Component, RGB through SCART or Composite. There are no S-Video sockets on the European model. Digital output through HDMI reaches 720p and 1080i resolution maximum in the on-screen menu. There is an HDMI input, but it is for pass through only, and will pass a 1080p signal. It won't process incoming signals, so you cannot hook up a Blu-ray here and get high def audio into the Onkyo; HDMI In is strictly for passing video through to a TV.

When you play a video DVD the receiver simply plays standard

DVD spec. audio: Dolby Digital, DTS or PCM up to 24bit/192kHz. It will mix down multichannel to stereo, if you don't choose the stereo mix on the disc. This all seems a little wimpy in light of what Blu-ray offers audio wise, so the addition of SACD and DVD-A replay looks like a welcome addition, bringing in a bit more audio credibility to the receiver.

There's even a super onboard VHF/FM tuner, better than that fitted to flagship TX-SR875 I reviewed recently, with forty presets that can be allocated freely to FM or Medium Wave AM. Take a peek at the tuners in our group test this month (p15) and you will see the Onkyo has flatter frequency response and lower distortion, so it is no afterthought.

With so much on board there's little need to connect up anything externally except, of course, a record deck. Onkyo don't provide an LP input, and there's no audio input labelled as such, suitable for an external phono stage. However, there are two Composite Video inputs with accompanying audio sockets and these can be used, sensitivity being very high.

The front panel is solid, nicely finished and the controls have a firm feel. The handbook is fair in terms of clarity. Remote control is provided and it is a good deal easier



to use than that of a surround-sound receiver. Pressing DISPLAY brought up an on-screen menu showing the audio quality, including bit-rate, number of channels and compression or packing used (e.g. MLP, Dolby, etc). I found the DR-S501 easy to set up and pleasant to use.

Under the impartial glare of measurement the 50 Watts output claimed turned out to be 24 Watts, explained by Onkyo using a rare power rating test for this receiver, one not used with their bigger models - nor most other products on the market - that gives flatteringly high figures or, you could say, deceptively high ones!

## SOUND QUALITY

The real output power of 24 Watts is limited, although you get 42 Watts into 4 Ohms and most loudspeakers hover around this value nowadays. Using sensitive Revolver R45s in my 17ft x 14ft lounge, only 5-10 Watts is used normally so I had no difficulty in this respect. The hundreds of Watts seen in current receivers is unnecessary, not the limited power available here. Even today's large bookshelf loudspeakers manage 86dB and will go usefully loud with the DR-S501. I realised after some time that the amplifier stages of this receiver sound superb, with a gloriously open midband and sweet, detailed treble, so there's another side to low power. If you want really high volumes from small insensitive loudspeakers, however, then the DR-S501 isn't for you.

Initially, listening to a CD whilst carefully studying the handbook - as one must with these things - I wondered where the bass had gone. Switching on Straight - hidden in a Listening Mode function - bass suddenly appeared. Images came into focus too. Pure Audio is provided,

which switches displays off, but was no more effective. There was a bigger gap than usual between processor on or off.

The good news is that in Straight mode the DR-S501 really did sound engagingly crisp and sweet. It has generous bass, a clear and open midband and sparkling treble. The strings of strummed guitar and the gentle tinkle of percussion in James Blunt's 'You're Beautiful' sounded bright and pure, lifted nicely from the mix to stand stably in space between the loudspeakers. I was surprised to find the Onkyo was better lit than a Russ Andrews DAC-1 USB I use as a benchmark, in this case connected up to the Video 1 input audio sockets, and with Straight selected. Bass dynamics and clarity were impressive, the bass line in 'Wisemen' being obvious and easy to follow. There was some slight loss of stage depth and ultimate image focus, but this is against a DAC that costs more than this whole receiver.

The Onkyo didn't remove the jitter, heard as messiness, of old recordings such as Gerry Rafferty's 'Time's Caught Up On You' in the almost magical way the Samsung BD-PI400 Blu-ray player manages due, our jitter measurements show, to especially effective clock extraction and reclocking. All the same, CD was thoroughly enjoyable, and fine at the price. But I had a bigger shock coming when I tried playing surround sound DVD-As through two loudspeakers...

The stereo mix of Santana's 'Supernatural' gave a flat frontal image, but choosing the surround mix had instruments whizzing to the rear of the room. Out-of-phase info can jump to the rear from some CDs - it's a psycho-acoustic effect exploited some time ago by EMI's Sensaura. Onkyo's own Theater Dimensional

Virtual Sound (aka TD), incorporated in the player to expand stereo may be used to alter surround-sound inter-channel phase relationships before mix down to stereo in the DR-S501 I suspect, giving pseudo surround-sound that's spacious and quite convincing. Spinning Toy Matinee's 24/96 DVD-A 'Things She Said' didn't have the chorus emerging from the rear though, as it does in a discrete system, and what you get in these synthesised systems is a little *ad hoc*, if entertaining and convincingly spacious. It all became a little weird when I turned volume right down and the sound changed completely, becoming phasey with a peculiar double drum echo effect. This did not happen on other albums, though.

Much the same performance was delivered with video. As Czech pilot Karel dives through Heinkels in 'Dark Blue World' the rush of sound at the rear is as loud and convincing as that provided by discrete surround-sound, but the whistle of Messerschmitt bullets from rear to front was barely appreciable, unlike a discrete set up.

Within Temptation's Broerenkerk concert on DVD had the choir sounding as majestic as I have ever heard them in 'Mother Earth', drums displaying good dynamic impact, filling the room with rolls across the soundstage, cymbals coming from behind me at times. With TD off the DR-S501 seemed to be throwing a lot of information to the rear and with it on the effect was heightened, audience hand clapping sounding more like rain at times - odd.

Sound quality with 24/96 PCM from DVD-A was superb, with fine midband insight and clarity, sweet treble and firm bass, if not quite the low frequency power that is possible. I also found SACD sound quality enjoyable, again with spacious





**A masterful cable that will cause a stir.**

**MIT** Music Interface Technologies™



**MIT Oracle MA loudspeaker cable:  
2007 Golden Ear Award winner.**

*“Instrumental images within the soundstage were presented with more air and space around them...Had I not heard the Oracle MA, Magnum MA would be my reference.”*

**Robert Harley—The Absolute Sound**

Distributed by:



P.O. Box 988, Cheltenham, Glos., GL50 9FJ  
www.audiobility.co.uk  
Telephone: 0870 777 2991

## AWARD WINNING RINGMAT PRODUCTS

Ringmat is the world's leading supplier of products that are truly designed to improve sound and picture quality in hi-fi and home cinema systems.

All Ringmat products are of unique design and tackle distortion problems in a manner that is quite different from all other attempts. We do not just create products if satisfactory solutions are already available.



**RINGMAT and RINGMAT SUPPORT SYSTEM**

Use this modular system on every flat turntable platter



**STATMAT CDi BLUE**

Use a Statmat for playing all CDs and DVDs, other than with multi-disc players



Statmat CDi Blue  
Ultimate Guide to Home Cinema 2004

**VIVACITY AR ANTI-RESONANCE PLATFORMS**

Use VIVACITY AR Platforms under all equipment to free the sound, and pictures, from resonance and vibration based distortion

**RINGMAT FEET, DOMES AND SPIKE STOPPERS**

Use these Ringmat products for the most effective means of isolating your hi-fi and home cinema equipment

**RINGMAT MAINS LEADS, INTERCONNECT, TONEARM and SPEAKER CABLES**

Use Ringmat cables for the cleanest transfer of signals, from power source to speakers

RINGMAT DEVELOPMENTS PO BOX 200 BRENTWOOD ESSEX CM15 9FB  
++44(0) 1277 200 210 WWW.RINGMAT.COM

imaging across a wide sound stage and superb midrange clarity that had Fleaor McEvoy's voice particularly well picked out, piano chords chiming out with a deliciously light, yet rich texture. There was little dynamic push to drums at the start of 'The Rain Falls' and this was carried over to piano in Rachmaninov's 'Piano Concerto No2', on Deutsche Grammophon, where piano played by Lang Lang lacked body. Orchestral strings were brightly lit and seemingly very clear, but the flip side of this was a distinct edginess that, with strings at least, was a little tiring. With Rock this effect was generally more tolerable. So SACD was a mixed bag of good and not so good. TD isn't available with SACD, as with DVD-A, but the sound was very spacious with multichannel area selected. SACD text is also provided, a nice touch.

The VHF/FM tuner was quiet and very even tonally, sounding balanced and smooth, cymbals having a nice solid ring in the Eagles 'Long Road Out Of Eden' on Radio 2 and bass had the same full body to it as on CD. Radio 4 discussion in a live studio emerged from an environment where the surrounding acoustic could be easily perceived, which was satisfying, and there was no hiss.



Perhaps Onkyo realise that VHF/FM is a traditional analogue medium that is likely to appeal to buyers of the DR-S501, so they've deliberately put a little more into it than is common nowadays.

**PICTURE QUALITY**

In use, picture quality from DVD looked superb. Tests using our Burosch DVD test discs confirmed this impression, with a few small caveats. A test pattern using the CCITT 0.33 codec showed the Onkyo was dropping fields a Samsung BD-PI400 could recover, and an HQV Benchmark test disc suggested jaggies performance was average. However, video bandwidth reached 6.76MHz, allowing the finest vertical gratings to be reproduced, colour ramps were smooth and progressive, programme content handled cleanly and 100Hz writing speed was superb. Real life pictures, including panned roofs, etc., held up very well, showing superb detailing and little shimmer, confirming my impression

of excellent picture quality, even with panned shots.

**CONCLUSION**

In spite of measured weaknesses, in use this receiver provided a lovely sound, at its weakest only with SACD and even here still engaging. Fine build and finish, ease of use and wide ranging ability make the DR-S501 a great product. Its analogue amplifier stages were particularly sweet and clear, I felt. Upscaled picture quality was excellent too and the VHF tuner one of the best I have heard for a long time, excluding dedicated audiophile designs like the Creek Evolution RDS in this issue. All the same the Onkyo was real class here and suitable for VHF/FM fans. I even hooked up LP via an Icon Audio PS1.2 phono stage and got great results. Low powered perhaps, but the DR-S501 offers impressive entertainment all round - well almost - at a bargain basement price. I was delighted by it, and suspect a lot of people will be too.

**VERDICT** ●●●●£  
 Fine sound from CD, DVD-A and VHF/FM - all at a bargain price.

**ONKYO DR-S501** £400  
 Onkyo UK  
 ☎ +44(0)1494 681585  
 www.eu.onkyo.com

**FOR**

- plays almost everything!
- great sound quality
- impressive upscaled video

**AGAINST**

- low power
- mediocre SACD
- unlit remote

**MEASURED PERFORMANCE**

Rated by Onkyo at 50 Watts per channel (both driven), our measurements showed just 24 Watts were delivered into 8 Ohms, rising to 42 Watts into 4 Ohms - well below spec. This discrepancy is explained by Onkyo's use of 'IEC power' instead of the Continuous (sine wave) power rating used generally, including their own more expensive receivers. We measured 60 Watts into 8 Ohms and 104 Watts no less using the IEC method (peak Watts using band limited pink noise) but changing the measurement method doesn't alter the fact that the DR-S501's amplifier is low on power, so high volumes are out, unless sensitive loudspeakers are used.

The VHF tuner is a good one, with a wide, flat frequency response (see our analysis), low noise and distortion. It deserves a good aerial, and it also needs it as sensitivity is satisfactory rather than wonderful.

Likewise, the CD/DVD player turns in low distortion and a broad flat frequency response with CD our analysis shows. With a high EIAJ dynamic range of 111dB it is well engineered.

The DVD-Video and DVD-A part of the player delivers PCM digital up to 24bit/192kHz. With 24/48 frequency response reached 24kHz and -60dB distortion was lower than noise (i.e. below 0.2%). Running 24/96 PCM bandwidth reached 46kHz, noise fell 6dB to -97dB and distortion at -60dB fell to a low 0.1%, so 24bit conversion was more linear than 16bit from CD. With 24/192, frequency response reached 41kHz, falling slowly above this frequency, and distortion was below noise, so high resolution

digital worked well.

Unfortunately, SACD was a token offering, since, with the SACD layer selected, frequency response stops dead at 20kHz and linearity is worse than CD, hampered by noise.

So the DR-S501 is something of a mixed bag, processing digital from CD and DVD well, measurement shows, handling SACD poorly, but doing a fine job with VHF/FM from the tuner. The amplifier has little power, but otherwise measures well too. NK

**AMPLIFIER**

Power	24 Watts
Frequency response (Multi ch. in)	2Hz - 80kHz
Separation	81dB
Noise	-97dB
Distortion	0.03%
Sensitivity	90mV
Damping factor	30

**TUNER**

Frequency response	18Hz - 16kHz
Stereo separation	45dB
Distortion (50% mod.)	0.15%
Hiss (CCIR)	-69dB
Signal for minimum hiss	1mV
Sensitivity	
mono	6µV
stereo	67µV

**CD**

Frequency response (-1dB)	10Hz - 21.1kHz
Distortion	
0dB	0.02%

-6dB	0.032%
-60dB	0.22%
-80dB	4.4%
Separation (1kHz)	80dB
Noise (IEC A)	-91dB
Dynamic range	111dB

**CD FREQUENCY RESPONSE**

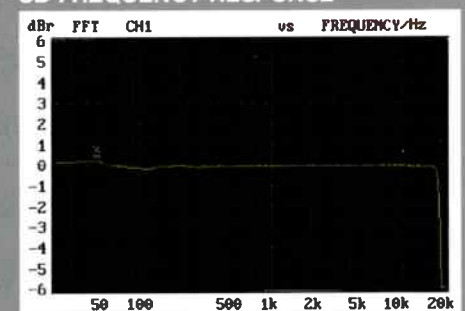

**VHF/FM FREQUENCY RESPONSE**

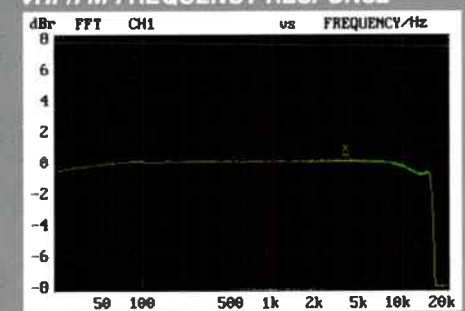





# 7"/12" vinyl storage

iCube vinyl storage cubes make it easy to stack, access and re-arrange your records in any way. These stylish cubes are beautifully made from 18mm mdf and come in two sizes to fit 7" and 12" records. Both sizes are available in natural or black. Your favourite music will be safely stored for years to come.



Buy 7 Get 1  
**FREE**

7" was £36 now  
**£17.99**

12" was £56 now  
**£27.99**

48hr p&p  
**£5.99**

Call **01328 730405** 24hrs  
or visit our new website [www.i-cubes.co.uk](http://www.i-cubes.co.uk)



The **No. 1** choice for  
Speaker Building &  
speaker upgrade /  
refurbishment  
projects



See our **NEW Website** [www.audio-components.co.uk](http://www.audio-components.co.uk)

A fresh approach for those who want to save money designing & building their own high-end **Loudspeakers** or who want to breath new life into broken or aging **Speakers**

**Ask about**

- Crossover design
- Speaker upgrades / rebuilds
- Open Baffle Designs
- Free advice – chat about your project



**For Speaker Builders**

- Loudspeaker Drive Units
- Crossover Components
- Enclosure Accessories
- Loudspeaker Kits
- Design & Measurement Services

Leading brands,  
Help & advice,  
Wide product range,  
Phone or buy on-line  
**FREE DELIVERY!**

Tel: 0118 989 0151

Email: [enquiries@audio-components.co.uk](mailto:enquiries@audio-components.co.uk)

# “Well worth the wait”

Andrew Harrison - June 2008



## Reference Preamplifier

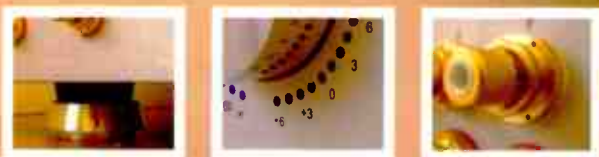

[www.mfaudio.co.uk](http://www.mfaudio.co.uk) :: [info@mfaudio.co.uk](mailto:info@mfaudio.co.uk) :: +44 (0)1424 858260

# The Globbies

Forget the Emmys, Grammys or Oscars, HI-FI World's alternative awards are what everyone's talking about during the hi-fi silly season! David Price and Adam Smith don their dinner jackets and hand out the gongs for the weirdest and/or most wonderful things they've seen this past year...

## **MOST ABSOLUTELY FABULOUS HI-FI PERSON: Geoff Meads**

Hi-fi public relations people, practiced in the 'dark arts' of deception (sorry, communication) can sometimes be so slick that we poor unsuspecting journalists can't tell whether they're telling the truth or not. So it's always nice to meet a spin doctor with a life beyond such nefarious media malarky. As such, Geoff Meads is this year's recipient of the Ab Fab PR award, not least because when he's not penning PowerPoint presentations as Brand Manager of Arcam, there's nothing he likes more than writing musicals! 'Joined at the Heart', co-written by Geoff, was inspired by Mary Shelley's famous tale of 'Frankenstein', and the original stage show excited global interest as a finalist in the BBC's 2006 'World Wide Search for A Musical' competition. With music and lyrics by Geoff and close friend Graham Brown, the two hour show features some 27 songs by the pair, and was premiered at last year's Edinburgh Fringe Festival, with a cast of thirty no less! "I've been writing pop songs since my teens," said Geoff, "and it's certainly a departure from my day job, where there's more listening to music than writing it!" Click on [www.myspace.com/joinedattheheartthemusical](http://www.myspace.com/joinedattheheartthemusical) for some serious thespian action! DP



## **MOST PERFECT PACKAGING: Monitor Audio PL100**

It's a sad fact of life that hi-fi boxes always take a battering. The items contained within are invariably delicate and often large and heavy, and couriers are notorious for having a tendency to, ermm, chuck 'em out of the back of the van! Let's face it, Jim Carrey's representation of a delivery person kicking a box along the street in the film 'Ace Ventura: Pet Detective' didn't come totally from a writers' imagination... A pristine new box may leave the manufacturer, but often it looks like it's been through a war zone by the time it arrives with us, as occasionally does the equipment inside. Not so with the Monitor Audio PL100s, however. These arrived in a box consisting of solid wooden ends, surrounded by seriously hefty cardboard, all held together with the sort of staples that could bind an entire copy of 'War and Peace' with still room for a multi-language A/V receiver instruction manual behind them. Inside is the most dense polystyrene type foam we have ever seen and all this holds the lovely PL100s in a snug and secure way. In fact, the only downside is that the box is so heavy on its own that we can't tell if it's empty or not. We've been assuming that our box was full, because of difficulty moving it, but it turns out that it is actually empty. I wonder where the speakers have gone? AS



## **THE 'OUT OF THIS WORLD' AWARD: German Physiks HRS120**

Is there anybody out there who doesn't think these pint-sized pylons resemble the sort of thing Dr Zachary Smith from 'Lost in Space' would rig up as a force field to keep the aliens from attacking his beached Jupiter 2 spaceship? Or maybe a jelly baby-chomping Dr Who would insert his sonic screwdriver in one of the speaker's binding posts, only to see its DDD 'bending wave driver' start glowing bright green, whereupon a lost space city would rise up from the deep murky depths of Pinewood Studios (erm, I mean a hidden valley on the planet Spiridon)? Yes, it's true - the Germans do have a sense of humour, as the 'retro electro' space-age styling of the HRS120 loudspeakers shows. We loved their looks, but they're, ahem, a little more distinctive than your average Mission floorstander and this may prove a stumbling block in any great, noble plan to bring high end hi-fi into the house - as spouses might view them in an altogether less loving light. Especially when £18,000 leaves the joint bank account... DP







**STROPPIEST SEPARATE: Consonance Forbidden City Orfeo CD**

As you may have seen in my review of the Consonance Forbidden City Orfeo CD player in the June 2008 issue, our sample did occasionally throw a wobbly, refuse to skip tracks and obstinately return to the start of the disc. The thing is though, that this wasn't random - it seemed to occur every time that I tried to forward it onto a less than good track. Now hi-fi reviewers' CD collections are full of these, as although the music may be rubbish, sometimes a particular track that we might never buy is particularly well produced. Well, the Consonance was having none of it, and I have to say it has fine

taste in music - It strolled through Norah Jones, Diana Krall and Kate St. John without a murmur, but gave up the ghost and sat glaring at me when I had the temerity to select Celine Dion [along with the rest of the humans in the room - Ed.]. It also took a severe dislike to one or two of Noel's test CDs, undoubtedly because it knew its 16bit, non-oversampling internals wouldn't measure quite as well as a fancy multibit player! The Orfeo is a superb sounding player and a fine buy, but do beware - it might start planning out your listening material for you... AS



**THE HI-FI TRIBBLE AWARD: AudioPro Mondial**

A new category this year, the 'Hi-Fi Tribble' Award goes to the year's item of audio equipment you'd most like to, ermm, stroke. As Captain Kirk found to his chagrin in an episode of 'Star Trek' called 'The Trouble with Tribbles', these small, cuddly little critters that produce a soothing purring sound are so cute that they beguile any race they encounter (with the exception of Klingons, of course). Well, you don't often get hi-fi that elicits the same reaction in this magazine's production team as the Tribbles did to the crew of the Starship Enterprise, but this year produced one notable exception. The AudioPro Mondial loudspeakers are small enough to pick up in the palm of your hand and covered in beautifully stitched, soft chocolate-brown leather - causing everyone to gently caress them. The key word here is of course is 'everyone'. because whilst the editorial team have sometimes felt the need to caress certain pieces of high end hi-fi, never have we seen our colleagues Faiza Chunara and

Marina Nik fondling a small pair of speakers before! When these AudioPro mini monitors were taken out of their box, it was as if someone had walked in with the world's cutest baby. As we hardened hi-fi hacks stood on in amazement, the girls went all gooey-eyed and started enquiring about possible 'long loans', 'taking them home' and generally 'borrowing them for ever' - just like James T. and those furry little refugees from the planet Iota Geminorum IV! DP

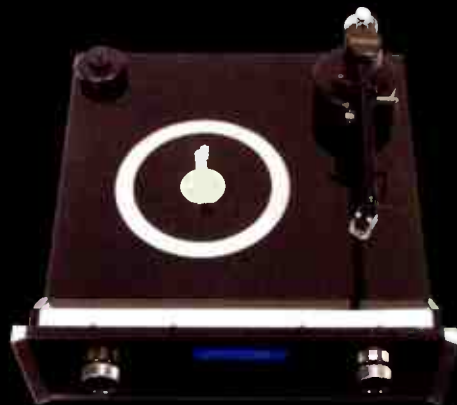

**THE 'LEAST LOVELY LOOKALIKE' AWARD: McIntosh MT10**

As recent letters into the postbag at Hi-Fi world will attest, the design of hi-fi components is very much a contentious issue, with one person's 'ugly' being another's 'stunning'. One of the most polarising pieces of equipment I have come across in this respect is the McIntosh MT10 turntable [pictured left...or is it right?], with the verdict seemingly firmly weighted in favour of the former! I stand proud and confess to loving it, but my adoration did waver once when editor DP walked into the office not long after the MT10's arrival. At this point it was sat on the floor, without platter and he glanced in its direction and enquired, "where did the Dansette come from?" Confused, I glanced down and realised to my horror that the illumination LEDs under the platter are set in a white ring which, frankly bears more than a passing resemblance to the light trim ring adorning the horrible, nasty platter of many a horrible, nasty BSR autochanger [pictured right, no left...no, right!]. So if you buy an MT10, don't ever take the platter off in public! AS

**THE 'WHAT'S IN A NAME?' AWARD: Adam Audio**

There are many reasons why manufacturers choose their names. Sometimes it is as simple as being developed from the initials of the founders, or a combination of their names, like Bang & Olufsen or Bandor, and this mostly gives rise to easy to remember monikers, particularly if you know the reasoning behind them. Of course, sometimes, a name will have more of a link than normal to someone, and this was certainly the case for me when I learnt of the existence of ADAM Audio. Now, as previously mentioned, this actually stands for Advanced Dynamic Audio Monitor, but I can't help feeling a little twinge of excitement on seeing my very own name glowing away on the front of a loudspeaker as I listen to it - call me vain if you like! Fortunately, their loudspeakers also happen to be utterly brilliant, and I always treat the accusation "You only like them because they've got 'ADAM' on the front" with the contempt it deserves! Mind you, if they'd turned out to be rubbish, I'd have been on the 'phone, demanding they change the name... AS

**MOST APPEALING APPENDAGE: Yamaha CD-S2000**

Having more than a passing interest in automobilica, I often ponder the art of steering wheel design. There are so many extreme examples, from the beautiful thick rimmed, small diameter, leather clad Moto-Litas fitted to every nineteen sixties wannabe rally car to those tragic moulded plastic 'quartic' (i.e. square) wheels that British Leyland bolted on to everything from the Allegro to the Rover 3500 in the seventies. CD disc drawers are 'the steering wheels of hi-fi', the critical contact point that says so much about the care and attention (not to mention cost) expended by the product designers. The sad fact is that most companies - even some very respected ones - are happy to send their silver disc spinners to market with a ratty old piece of tat that wouldn't look out of place on a

fifty quid computer CD-ROM drive from the early nineties. It really is a crying shame. There are exceptions of course - Linn's CD12 sported the most exquisite, chromed metal disc drawer with a gliding action that made the damped ashtray of a Bentley T2 seem crude, while the likes of Naim do an amazing cantilevered loader on the CDP555. The trouble is though, such designs will set you back around £15,000 - putting them a bit out of range of your average audiophile. Big respect due, then, to Yamaha for the swish metal disc drawer of the CD-S2000! Around £1,000 buys you a great sounding CD/SACD device, with a disc loader that the lads' mags would describe as "to die for". Good on Yamaha - here's hoping everybody else follows! DP

**MADDEST PRODUCT OF THE YEAR AWARD: Edgar CD1**

Can a CD player have a character? Try anthropomorphising the average silver disc spinner and it would be called 'Bob', like playing 'Need For Speed' on a PlayStation 3 and drinking pints of Stella. It (he) would drive a Vauxhall Vectra with oversized alloy wheels, think Chris Rea a musical visionary and Bianca from EastEnders to be "a bit of alright". The Edgar CD1 however, is different. Very probably the digital audio disc playing equivalent of Patrick Moore, it would wear a monocle, drive a battered Triumph 2000 and read maps of the cosmos whilst playing a Debussy prelude on an old piano. The Edgar is of one of the rare CD players that sounds, looks and feels like its name - clever but mad. Inside its flimsy steel casework, you'll find more glowing glass bottles than a nineteen fifties supercomputer, whilst inset into the thick real wood fascia is a little slot housing a disc tray that sometimes wants to open, when it feels like it, maybe, perhaps... If you finally manage to coax the CD1 into life, you're rewarded by a supernaturally musical sound, one that takes £1,500 CD spinners to new levels. Don't ask me how they did it, but Edgar have come up with a dramatically different, characterful and occasionally brilliant machine. Buy one and love it, but your friends will think you've lost the plot. DP





# Solar Flair

Adam Smith checks out Sunfire's characterful 1,000W HRS-12 subwoofer...



**W**ith the enthusiasm for home cinema products increasing, thanks to Blu-ray and the like, the usefulness of a good subwoofer is becoming more important. Even the efficacy of such an item in a two channel setup cannot be underestimated as, if your room or wallet cannot accommodate a pair of suitably large loudspeakers, then a sub is your only option if you want really low bass...

Sunfire is a company started by U.S. amplifier design supremo Bob Carver in 1994, and they are a well known name in home cinema circles for their powerful receivers and processors, as well as their subwoofers. Power is also a feature of their subs, as the top model, the True Subwoofer EQ Signature delivers no less than 2,700W to the drive units! This is achieved through a 'Tracking Downconverter' power supply, where the supply rails basically follow the input signal in order to not waste unwanted voltage when it is not needed.

The HRS-12 is the largest model in the 'High Resolution Series' and uses a similar amplifier design to generate a more sensible (but still hefty) 1,000W to feed its 12in drive unit in a compact, sealed enclosure measuring 343x343x343mm. High and low level inputs and outputs are provided, plus the usual level, frequency cutoff and phase adjustments. The HRS-12 weighs in at 17.2kg and is available in gloss black.

## SOUND QUALITY

Most notably, the HRS-12 does not suffer the timing issues that afflict many sealed box designs where the bass notes lag behind the rest of the frequency range - it is a taut and speedy performer in this respect, and never ruins the essential rhythm of music.

Unfortunately though, the HRS-12 does still tend to still give something of an on/off effect to bass

- it's either there or it isn't. This does not affect pace or detail but does rather rob the flow of the low end, not letting it breathe as well as some other units. When the bass is there however, it's pretty darn impressive, punching out well and really adding in the dose of impact that smaller loudspeakers can lack.

As suspected from the filter measurements, the HRS-12 is not quite as universally adaptable as it might be. I like to

let a sub under review do as much of the work as possible in order to properly hear it in action, but with the crossover at maximum, the HRS-12 only just 'met up' with the low end of a pair of Rogers LS3/SAs. Some more upward adjustment on this filter would be welcome.

Where the HRS-12 really scores is in an A/V setup when the explosions and car crashes from action films commence, and here it can more than hold its own in terms of impact and power. The 1,000W amplifier has fine reserves of welly and the Sunfire never seemed to be struggling, even if my ears - and some items on a nearby shelf - were!

## CONCLUSION

The Sunfire HRS-12 is a neat, powerful and well designed subwoofer that comes highly recommended for A/V systems. It is still more capable than many for music use, thanks mainly to good timing, but a rather limited filter adjustment range and a lack of bass fluidity mean that it lags slightly behind the best in this respect.



**VERDICT** ●●●

Compact and neat design with plenty of grunt thanks to a powerful amplifier, and good musical timing.

**SUNFIRE HRS-12** £900

Gecko Inc. Ltd.

+44(0)845 262 2882

www.homecinema.uk.com

**FOR**

- size
- power
- timing

**AGAINST**

- narrow filter range
- bass lacks 'flow'

## MEASURED PERFORMANCE

The Sunfire HRS-12 offers a reasonable level of low bass from its compact enclosure, output dropping by around 5dB at 20Hz, which should help to reinforce smaller floorstanders as well as standmounters.

The frequency cutoff adjustment range is marked as 30-100Hz on the rear panel control, but does not stretch up to the 100Hz upper figure - its limit is closer to 80Hz. This is something to watch if the unit is to be used with very small satellite loudspeakers that have little or no output below 100Hz, as a slight 'hole' in the frequency range could well result. With full range designs however, this should not be an issue. The frequency control also does not adversely affect output level

- something that is not always the case.

All in all, the HRS-12 should be a capable partner for small and medium sized loudspeakers over a good range of A/V and two channel setups. AS

### FREQUENCY RESPONSE

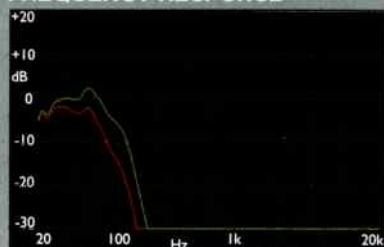

Green - Frequency cutoff max  
Red - Frequency cutoff min



### GATO PHASE-IT £55

Checking your drive units are all phased correctly is vital to correct sound reproduction. Obviously the external wiring is easy to check, but confirming the phase of that mystery woofer you found in the loft, or troubleshooting the internal wiring of your new loudspeakers that don't sound quite right usually involves applying a battery to the terminals and seeing which way the cone moves - a little Heath Robinson! It is not even a foolproof method, as any series capacitors in the crossover will block the D.C. from the battery and, when it comes to tweeters, trying to see which way a 19mm dome is moving is virtually impossible.

Fortunately Gato Audio's little Phase-It gadget comes to your rescue. A small item, powered by a 9V battery, it has a built in

microphone and a jack connector for a lead that terminates in two crocodile clips. It's then simply a case of connecting the clips to your loudspeaker's terminals, holding the microphone end of the unit towards the drive unit you wish to check and hitting the 'Pulse' button. The Phase-It sends out a test signal and lights the indicator LED green for positive phase and red for negative. It worked beautifully on all the loudspeakers in the Hi-Fi World listening room, but it should be noted that most of the tweeters came back as out of phase - although they are not wired like this, second order high-pass crossovers reverse the signal's phase, so this is something to be aware of! All in all, though, a very handy gadget. **AS**

[Contact: Gato Audio on 0045 4095 2205, [www.phase-it.com](http://www.phase-it.com)]

# soundbites

### DSPeAKER ANTI-MODE 8033 SUBWOOFER EQ £190

Many hi-fi enthusiasts view the subject of subwoofers with concern or even scorn, mumbling about how they are always obvious and don't perform as musically as a large pair of loudspeakers. Whilst nothing beats a proper pair of big full-rangers, subwoofers can actually work very well with music, but the key is to set them up properly and position them appropriately...

Unfortunately, modern house decor and the demands of house-proud partners usually means that the poor old sub gets tucked away somewhere unobtrusive where it can often boom merrily away. The likes of Mordaunt Short have thought of this, and include Notch filters on most of their subs which can attenuate these unwanted booms very effectively. The trouble is, their setup really requires a sound level meter, is rather fiddly, and automated systems are still relatively uncommon. What would be superb would be a universally applicable automated tool...

Enter the DSPeaker Anti Mode 8033. This is a clever little box that sits between amplifier/processor and sub and has its own measurement microphone. Operation is simplicity

itself - simply connect up, position the microphone at your listening position, press and hold both front panel buttons, and the 8033 runs through an automated sequence of tones, equalising the signal to attenuate room modes. Once done, the setting is stored in memory and can be switched on or bypassed at will. A second sweep can be performed with the microphone in a different place (called 'Wider Area Correction') if it is felt the original adjustment was not enough, and two additional fixed options are built into the unit - one boosts the 15-25Hz region and the other the 25-35Hz region for restoring low bass that may be sucked out by less than optimum positioning. Or indeed, if you just fancy annoying the neighbours a bit more...

Using the unit with the Sunfire HRS-12 showed subtle but effective improvements over the standard unit, already optimally positioned and tuned in. Bass rhythms became tighter and unwanted 'thump' was lessened, making the bass more fluid and natural. To really test the 8033, however, I pushed the HRS-12 right into the corner, tuned it again and then re-ran

the calibration. This time the 8033 made a very impressive effort of sorting out the booming mess that resulted from the poor positioning - the result being quite listenable!

All in all, the DSPeaker Anti-Mode 8033 is a very useful gadget that's verging on essential if your subwoofer does not already have a notch filter or some sort of room correction facility, or if you do not have free rein over placement. **AS**

[Contact: - 2001 Electronic Components +44(0)1438 742001 [www.2kl.co.uk](http://www.2kl.co.uk)]







Adam Smith finds great strengths in Mordaunt Short's new mid-price Mezzo 2 standmounters...

# Mezzo Forte

**A**s we've seen recently, a number of manufacturers well known for affordable loudspeakers have upped the ante somewhat and produced a highly successful flagship model or range of models. Revolver came up with the Cygnis, our 2007 loudspeaker of the year, Monitor Audio gave us the Platinum Series and Mordaunt Short resurrected the Performance name to score an impressive success.

Of course, this immediately introduces another problem - when you have a budget range and a dearer flagship, you are invariably left with a hole in the middle. In the case of Mordaunt Short, this meant a huge

hop, skip and jump from the top of the Avant range, the 908i at £500, to the Performance 6 at £3,500. Fortunately however, the MS boys have not been resting on their laurels, and have now plugged that gap with the Mezzo range, starting with the Mezzo 1 standmounters at £350, and topping out in the Mezzo 6 floorstanders at £800. There's still a bit of a jump up to the Performance Series, but at least they've moved into view now...

The Mezzo 2s are the larger standmounters of the range, retailing at £450 and, I suspect, are something to do with the reason why the old Declaration 912s were not given an 'Avant' makeover along with

their floorstanding 914i brethren! In broad terms, the Mezzo 2s are very similar to the 912s, featuring a 6.5in (165mm) CPC bass driver and 1in (25mm) aluminium dome tweeter. This is where the similarity ends though, as the Mezzos feature several design aspects trickled down from the Performance series. Most notable of these is the Aspirated Tweeter Technology - although not using the impressive-looking protruding rear spike of the Performance 6s, the Mezzo 2s have vent holes facing out of the top of the tweeter pod. MS claim that this reduces the colourations that afflict closed-back designs and allow high frequencies to 'breathe'.

The two units are linked by a second order crossover using audiophile grade components and making use of Mordaunt Short's Dual Value Parallel capacitor configuration, where two components in parallel are used to make up the desired value, rather than just one.

The cabinets are available in light oak or dark walnut finishes, and the Mezzo 2s are supplied with a grille that affixes magnetically to magnets buried in the baffle. The grill also fits around the tweeter, not over it, for it has its own non-removeable metal grille. The overall look is very smart indeed. Two pairs of good quality binding posts allow for bi-wiring or bi-amping and vital statistics are 352x220x280mm (HxVxD) and 8.0kg.

**SOUND QUALITY**

Straightaway the first question I asked myself was whether I was going to obtain a healthy dose of performance for a lot less money, and the answer is a resounding yes. As on the Performance 6s, the Aspirated Tweeter Technology really

"high frequencies were couth, airy and spacious, with superb levels of detail..."

does lift the sound of the Mezzo 2s up a level. Rather naughtily, I couldn't resist covering the holes up to check the difference and the result is an enjoyably competent but rather unspectacular loudspeaker - uncover them again and the sound takes on a whole new dimension.

Letting the tweeter breathe in this way gives the Mezzo 2s' top end more sophistication than it has any right to at the price, frankly. High frequencies were couth, airy and spacious, with superb levels of detail right into the background. The merest

tap of a triangle off in the distance of an orchestra was clear, ringing out across the soundstage with alacrity and cymbals had a delicious metallic crispness. Equally, violins were couth and with fine levels of resolution; not

a screech was to be heard.

Across the mid, acoustic instruments were vivid and hung in the air right between the loudspeakers. Pianos were very impressive and, combining this with a delicacy and palpability to vocalists, meant that the likes of Tori Amos on 'Pretty Good Year' was an auditory delight. The Mezzo 2s really do have a very impressive level of visceral impact to their reproduction - those pianos benefitted from a real sense of the hammers hitting the strings, and snare drums came across with a delightful 'thwack' - it sounded like the drum skins had been tightened compared to other, similar loudspeakers.

Helped no doubt by the top end spaciousness, the little Mordaunt Shorts were able to set up an image that belies their size and fill the listening area with the music. Performers could be easily located within the image and this stretched well back behind the cabinets and a good level to the sides as well.

Where things were a little less convincing however, was right at

the bottom end. Generally, bass was full, confident and detailed with impressive punch and pace. This worked superbly with rhythmical material, such as dance music and a bit of good old rock, but when things slowed down, became more intimate and more detail was required, the Mezzo 2s faltered somewhat...

Plucked double basses lacked their customary woody nature, and bass instruments generally tended to lack a certain amount of character. There was even a hint of boxiness to the Mezzo 2s in this area at times, which could occasionally stretch up into the midband - Diana Krall sounded a little 'chestier' than usual, for example.

I cannot help thinking that the front port is the issue here,

as it has an output peak almost up to the main driver level at 1kHz and is likely to be adding this unwanted effect. Ultimately, this was not a total disaster and can be managed by judicious partnering - the Anatek A50R amplifier tamed it nicely, but connecting up the Quad II-eightys to push that lovely midrange even further was not a good combination at the low end.

**CONCLUSION**

Frustratingly, the Mordaunt Short Mezzo 2s are within a gnat's whisker of being truly exceptional loudspeakers. The £500-ish price point hardly ever turns up a design that offers their combination of spaciousness, sophistication and insight. Less than perfect bass quality does hold them slightly back from true greatness, but this really only stands out because the rest of the frequency range is so impressive.

Taken all in, however, the Mezzo 2s are never less than thoroughly enjoyable, particularly with dance or rock music, and still come highly recommended.



**VERDICT** ●●●●£

Impressive standmounters that give a goodly portion of the MS Performance's spacious and sophisticated sound for much less outlay.

**MORDAUNT SHORT**  
**MEZZO 2** £450  
 Mordaunt Short  
 +44(0)207 940 2200  
 www.mordauntshort.com

- FOR**
- treble atmosphere
  - midrange detail
  - crisp dynamics
  - build and styling

- AGAINST**
- low bass lacks character

**MEASURED PERFORMANCE**

The Mordaunt Short Mezzo 2s have a generally even trend to their frequency response with just a slight lift in the 100-300Hz region, which should add a little dose of extra presence to the upper bass. Across the midrange there are one or two undulations, but nothing of major concern. The drop of around 3dB at 8-9kHz may push some top end detail back into the sound somewhat, however. Fortunately the tweeter's output is even up to 20kHz and so the Mezzo 2s will not sound dull in any way.

At the low end, bass rolls off below around 80Hz which is standard enough for an enclosure of this size, and the port reinforces this down to its tuning frequency of 50Hz. There is some stray output from the port at 1kHz, which is a little unusual, as Mordaunt Short's ports are usually very well behaved. As this item is on the front panel, this may add some unwanted effects.

Electrically the Mezzo 2s are fine, with an undemanding impedance response, and an average measured impedance of 7.1 Ohms, dropping to a minimum of around 4.5 Ohms, but this is at high frequency, which makes

relatively little demand on an amplifier. Sensitivity was 86dB and so the Mezzo 2s should work well with amplifiers of 40W and more. AS

**FREQUENCY RESPONSE**

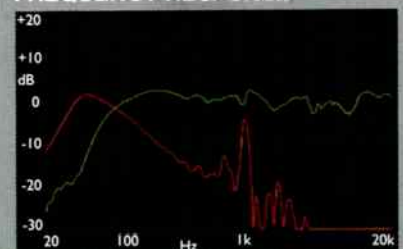

Green - driver output  
 Red - port output

**IMPEDANCE**







All the way from New York comes this compact pre/power amplifier combo from Belles - Adam Smith listens in...

# American Team

It sometimes seems to me that we here in the UK are sometimes short-changed when it comes to hi-fi equipment that is not designed within our shores. When one considers the fact that large Japanese corporations have a history of not sending us their biggest and poshest products, and the sheer number of unknown names that can be found fairly close to home when one visits the likes of the High End Show in Munich, there is definitely a whole lot of equipment out there that we're missing out on!

the smaller names are still unknown; I certainly can't name a UK store that currently stocks Salk Sound, Salagar, Portal Audio or Magico. Fortunately, some more intrepid distributors looking for high quality equipment have had the sense to venture further afield in this direction...

One of those distributors is Tony Sallis of Coherent Systems, a man with extensive experience within the industry and a keen ear for a good product. It should come as no surprise then, that one of the product lines for which Coherent

Modules products are state-of-the-art designs, using top quality components. Each unit is hand assembled and tested to ensure it meets our high quality standards for fit, finish and audio performance". As a result, their range encompasses several preamplifier and power amplifiers, including a hybrid valve/solid state preamp, plus a forthcoming integrated design. The most recent additions to the lineup however, are the Soloist range, currently comprising a preamplifier and power amplifier, with an MM/MC phono stage rumoured to be on the way soon.

The Soloist 3 preamplifier features five line level inputs (although one is labelled 'phono' it is still a line level item), plus a single fixed level input and output that can act as a bypass in the context of an A/V system. Rear panel socketry is completed by two pairs of preamplifier outputs. Remote control is provided for input switching, volume, balance and muting and I

"I have not heard another £900 amplifier that held our Spondor S8es with such control..."

Unsurprisingly, this is true of the U.S. which one would expect to have a large number of manufacturers, simply because of the size of the place. Obviously, we know of the bigger players such as McIntosh, JBL, Martin Logan and Krell, but some of

are responsible in the UK are indeed a small US manufacturer. Power Modules Inc. is based in Pittsford, New York and run by David Belles, who has over thirty years experience in high quality amplifier design.

David states that "All Power

was a little disappointed to see that the remote is the only way to switch inputs and to activate the preamp on power-up (it starts up in a 'mute' condition).

The remote is a small item and could easily be lost, whereupon you lose your sounds until you obtain a new one - something we know all too well from our pre-production Anatek A50R, which had the same muting operation. Needless to say, in a recent office move, this was the only remote we lost! The Soloist 3 is compact design, measuring 51x305x216mm (HxVxD) and weighing in at 4kg.

The Soloist 5 power amplifier is equally small, but taller at 90mm high, and tipping the scales at a healthy, but still reasonable 7kg. Under the bonnet is a simple amplifier circuit rated as delivering 65 Watts into 8 Ohms and 110 Watts into 4 Ohms [see MEASURED PERFORMANCE]. The Soloist 5 offers a pair of phono input sockets and two pairs of good quality gold plated binding posts and that's it, apart from a 12V turn-on trigger input for remote operation.

**SOUND QUALITY**

After a thorough warm-up the Belles combo set off to a highly promising start. What struck me instantly was the bass provided by the power amplifier - I can safely say that I have not heard any £900 design that grabbed hold of our Spondor S8es with such authority and control. Bass lines were massively deep, confident, swift, highly rhythmical and blessed with superb amounts of detail. The bass guitar on the intro to Simply Red's 'Sad Old Red' was amongst the best I have ever heard it and, through a less than capable loudspeaker and amplifier combo, it can sound like a sluggish, marshmallowy blob. Through the Soloists however, it was taut, focused and each string pluck was immaculately defined.

The rest of the performance was equally capable. Soundstaging was not the widest I have ever heard but it was impressively deep and well ordered between the loudspeakers. The most impressive facet, however, was the stunning solidity that the units conferred upon the central image. The main action really did step out of the soundstage, smack in the middle of the loudspeakers, which gave a quite uncannily realistic effect at times.

Aiding this was the realism that the combo imparted onto instruments. Individual string plucks were crisp, drum strikes were snappy and piano keys hit home with pleasing precision. Thanks to that



central image stability, lead vocals stood well clear of the backing track, giving a lovely atmospheric turn to proceedings. Kate St. John's 'Paris Skies' was delightful - the introductory glockenspiel rolling across the soundstage and Kate's vocals projecting expertly.

The more I played with the Belles combo, the more I was impressed, but I did start to detect a certain hint of hardness across the upper mid with some more strident vocalists, or less well recorded classical material. The Soloists' top end was sweet and insightful, without any harshness, but there was definitely an occasional stridency slightly lower down.

Switching equipment round a little, it seems that the power amplifier is the source of this, as swapping the preamp for the Creek OBH-22 did not remove the problem and, in fact, dulled the overall sound, removing the life, atmosphere and ebullient presentation of the Soloist 3.

**CONCLUSION**

The Belles Soloist 3 and 5 combo really are a musically coherent and pleasingly dynamic pairing. The preamplifier is a sweet and open performer with a good range of inputs in a compact package that is not excessively priced. The power amplifier is even more impressive in some respects, particularly in its superbly tight, deep and well controlled low end. It does also introduce the only slight issue with the sound, namely a slight hardness across the upper midband at times, but it is in no way a hard and steely sounding device and this aspect of its

sound should be easily tuned out by choosing a relatively laid-back pair of loudspeakers.

All in all, I enjoyed my time listening to the Belles Soloist 3 and 5 combo; they work very well together to offer a musically cohesive whole, and offer fine quality at a sensible price - welcome visitors from across the pond!

**REFERENCE SYSTEM**  
 Avid Diva II/Jelco SA-250ST turntable  
 Ortofon 2M Black cartridge  
 Whest Two phono stage  
 Yamaha CD-S2000 CD player  
 Anatek A50R amplifier  
 Spondor S8e loudspeakers

**VERDICT** ●●●●£  
 Superlative bass, sweet top and fine atmospherics make this a great value pairing at the price.

**BELLES SOLOIST 3** £900  
**BELLES SOLOIST 5** £900  
 Coherent Systems  
 +44(0)1684 310849  
 www.coherent-systems.co.uk

- FOR**
- magnificent bass
  - central image solidity
  - atmospheric nature
  - compact and well built
- AGAINST**
- upper midband hardness
  - don't lose the remote!

**MEASURED PERFORMANCE**

The Soloist 5 power amplifier comfortably exceeded its rated power output into 8 Ohms, delivering 85 Watts, rather than the expected 65W. This increased to match the rating of 110W into 4 Ohms, so the power supply is not quite hefty enough to double output into the lower load, but the amplifier does not lack power and should drive most loudspeakers. The Soloist 5 has an unusual negative damping factor, but this is a high value of 138 so it should have tight and well controlled bass.

Distortion was commendably low at 1kHz at both 1W and full output, but increased by a factor of ten or more at 10kHz. This is the effect of classic crossover distortion so is not an uncommon phenomenon. Channel separation and noise were both very good.

The Soloist 3 preamplifier offers a gain of x2.2 across its line level inputs and has a similar frequency bandwidth to that of the power amplifier, being 2Hz-30kHz. Noise was low, channel separation good and distortion low at 0.002% across medium and high frequencies. Output overload occurred at a high 8.5V so the Soloist 3 should be capable of driving an insensitive power amplifier if required.

All in all the Belles combo measures well and should offer a tight and focused performance, but the higher frequency crossover distortion noted in the power amplifier may

make them a touch less smooth and refined towards the top end than some of their competitors. AS

SOLOIST 5 POWER AMP	
Power	85 Watts
Frequency response	2Hz - 27kHz
Separation	90dB
Noise	-95dB
Distortion	0.2%
Sensitivity	1V
Damping Factor	-138

SOLOIST 3 PREAMP	
Gain	x2.2
Frequency response	2Hz - 30kHz
Separation	93dB
Noise	-98dB
Output Overload	8.5V
Input Overload	>6V

**DISTORTION (SOLOIST 5 - 4 OHMS)**

THD	Input RMS	Frequency
0.2156098%	2.0484 V	9.9962 kHz
OFF	OFF	OFF

Graph axes: Y-axis is % THD (0 to 0.30), X-axis is FREQUENCY/Hz (f1 to f9).



# Heavenly Sound?

**Freesat is a new, free satellite TV service that's just launched UK-wide. Noel Keywood investigates...**



**F**reesat, a free satellite service delivering both television and radio to the whole of the UK was launched in May this year. It has the potential to deliver high quality music and High Definition television to 93% of the UK, better coverage than earth-bound terrestrial transmitters which, as they proliferate, are becoming a political and environmental issue. Here's an early look at Freesat, with an emphasis on the quality it provides...

Freesat is a non-profit joint venture company set up by the BBC and ITV to offer free, and open (i.e. unencrypted) access to television and radio. The BBC in particular has an obligation to make its programmes available to the whole of the UK which, as Steve Green has explained in the case of DAB, can be prohibitively expensive, because of the transmitters needed. Satellite transmissions are beamed from above, making them available to every part of the U.K., with the exception of those in flats unable to erect a satellite dish. Because the Astra 2D satellite (see [www.astra2d.com](http://www.astra2d.com)) serving Freesat sits roughly over the Congo, it is 24,000 miles away. Solar panels provide 1,600W of power to the on-board electronics, and 640W transmission power. This is miniscule to the 20,000W or more delivered by terrestrial transmitters, over just



fifty miles or so. Only a focused satellite dish, precisely aligned, can receive such a weak signal, so satellite is no use for portable radios, or car receivers - putting a large audience beyond its reach. Dishes cannot be mounted indoors either, and countries like the Irish Republic ban dishes for visual reasons, so satellite transmission has difficulties.

There are tremendous advantages though; wide coverage being one, high quality another. Sufficient bandwidth is available to transmit High Definition television and radio, without compromising the broadcasters' current obsession with variety. Freesat currently offers eighty programmes and claims this will rise to two hundred by the end of 2008. Programme listing is available at [www.freesat.co.uk](http://www.freesat.co.uk). All BBC national and regional channels, television and radio, are provided - a daunting list - as well as all ITV channels.

Conspicuously absent is UKTV, a joint venture between the BBC and Virgin Media, which provides programmes supported by advertising, like Dave and UKTV History on Freeview. Also missing are Sky, who run the confusing alternative Freesat on Sky, and there are no commercial radio stations, such as Heart, Virgin, Capital, etc. So Freesat isn't yet a replacement for Freeview, DAB or even VHF/FM, although ultimately it could be.

There are some interesting differences to Freeview, including the inclusion of Al Jazeera (see Wikipedia on this station's origins and funding) and EuroNews, so a broader news picture is available than that from Freeview.

## QUALITY

We used a budget Bush Standard Definition BFSAT01SD receiver (set top box) costing £50 and a quality Humax Foxsat-HD High Definition receiver costing £149 to assess picture and sound quality, as well as ease of use. See the box-out with details of dish installation and hardware.

The budget Bush comes with Scart connection to the TV as it offers Standard Definition only. After tuning in, BBC HD is nowhere to be seen in its programme listing. SD over Scart can give good results but from this box quality was poor, significant chroma shift causing obvious colour fringing, low definition making trees and grass look bland and plasticky, whilst noise added a fizziness to edges, even though both signal strength and error rate bar graphs were at maximum (i.e. max signal, least error rate). The picture was worse than VHS tape, making it the worst video I have ever seen. This box is only for the lodger; even the kids would reject it!

Freesat radio offers much the



same audio quality as DAB. It is heavily compressed using archaic MP2 so there are no depth perspectives, and a flat sound with is free of hiss but has little finesse. Connected digitally to a Marantz SR8002 receiver, quality was determined by MP2 compression, not the Bush.

Humax have a reputation for the quality of their Set Top Boxes and the Foxsat HD showed why. It can receive High Definition television, sending it out to the TV through an HDMI cable. It also outputs analogue Component, as well as RGB via Scart. However, Component is often disabled to prevent copying so it cannot be used reliably as a TV



**Rear panel of the Humax carries Scart, Component and Composite video outputs, plus analogue and digital audio outputs. The HDMI digital output carries HDTV.**

connection. Audio exits via HDMI, S/PDIF (optical only) and analogue stereo through phono sockets. I used HDMI into a Marantz SR8002 surround-sound receiver, then on to a 42in Samsung M8 HD TV. Signal strength and quality were both 100% on the Humax indicators. Pressing the 'i' button I got an info bar across the screen showing both meters, picture resolution, audio type (not bit rate), clock and other data - nice. This is a box for those who want to know what's happening.

An afternoon preview of forthcoming HD programmes from the BBC was more impressive than I expected. Forget TV and think Cinema experience. A water buffalo pulling a plough through a terraced rice paddy 300 metres up a hillside had China falling away into the distance behind, fine details in the foreground, such as the workers clothes and the buffalo's hide looking realistically detailed. The sound was the most impressive part, water lapping around me in full surround-sound. It was startling as TV goes, more cinema than the telly.

HDTV was every bit as good - sometimes better - than watching Blu-ray. Colours were vivid, making SDTV look a little washed out in comparison, and the level of detail across a wide range of material consistently superb. But it was the sound that changed everything. An amusing short excerpt from 'The No.1 Ladies Detective Agency' in Botswana brought richly accented African dialogue and music right into

my room. It was a huge step up from ordinary TV. I was using a surround-sound system of course, TV sound being fed in digitally through the HDMI cable.

With current Standard Definition programme the Humax upscales to High Definition picture format and does a very good job. I felt the Samsung TV, which does this internally, was a trifle sharper and clearer (internal noise reduction was Off), but differences were minimal.

High Definition television from the BBC is broadcast typically from 8pm to 12pm at present, with extensions for Sport, and Previews at 6am and 12am. Curiously, news is not

in HD. ITV will begin transmissions soon.

Technically, HDTV is transmitted as 1080 interlaced lines from the BBC. ITV say they will be using 720p or 1080i. Transmission will be made using MPEG4 compression, the BBC PVT (Public Value Test) document says. The Humax showed BBC HD picture resolution was consistently 1080i.

Either two channel stereo or surround-sound using traditional Dolby Digital, as found on DVD, are the sound formats. Bear in mind that surround-sound isn't really appropriate for studio based productions like news. Dolby Digital gives a softer and more atmospheric sound than MP2, both being music compression schemes.

The BBC told us opaquely that improved audio formats "would be considered for the future", most likely Dolby Digital+ we suspect, an upgraded version of Dolby Digital aimed at broadcasters.

You will need a High Definition TV to appreciate HD picture quality from a receiver like the Humax Foxsat-HD, with an HDMI input that carries pictures and sound in digital form. The Humax does output HD as SD via Scart I found, so you can view BBC HD on an ordinary TV and the picture remains good.

Is Freesat worth having? At the price I would say yes. BBC HD is a superb experience and is alone worth the £200 or so. Current programming is family friendly and very much what the BBC does well (and sells around the world). The only problem is that it shades everything else. The other channels are either available on Freeview, or are not compelling viewing I feel. Al Jazeera News, from their studios in Malaysia, is well produced and interesting, but this apart there is little outstanding on Freesat at present, the absence of UKTV being a disappointment.

It's a pity that Freesat radio lacks the popular commercial stations and sound quality is limited by outdated and, on satellite, unnecessary MP2 compression. Perhaps favourable public reaction to Britain's first HDTV broadcasts will change perceptions here. Quality could be improved by increasing bit rates, using AAC compression or even moving to Dolby Digital+, which would allow surround-sound radio.

Freesat can deliver high quality and a compelling viewing experience. It's worth having, if just for HDTV alone which will have the family in awe I suspect, at both the pictures and the sound.

## INSTALLING A DISH

To receive Freesat you need a satellite dish pointing South East with, roughly speaking, a view to the horizon unobstructed by trees or buildings. It must point at the Astra 2D satellite, not others, and alignment is critical. I installed an elliptical dish roughly 60cms wide on a roof in London and, using a simple £10 German made alignment device (all available from Maplin) that issues an audio tone that rises in frequency when the dish sees a satellite signal, got a strong, clean signal. Freesat offer a one-off £150 setup fee that includes fitting, the dish, cabling and set top box, using a well regulated service that is superb value. I DIY simply to discover what the basic issues are, not because it is cheaper or better. My dish, cable and tester cost £75 in all and

involved a lot of faffing around; add in a £149 Humax satellite receiver and that's £225 in all, so there's no saving. Aerial fitting is best left to the experts as some peculiar difficulties can arise with satellite dishes.





hiaudio



# Accessing the Source, Unleashing the Performance



With a list of awards that would fill this page and more, this new system offers amazing synergy across HIAudio's portfolio to present a truly symbiotic whole.

With a stunning analogue front end, matched by the new 1Tb NuForce MSR1 music server; this can all be played through the Solo headphone amplifier, or via the class leading NuForce P9/Ref9SE V2 amplification to the loudspeakers of your choice.

Bespoke cabling is by Black Rhodium, keeping the system tidy and offering an amazing sound to boot.

System Price - depends on choice of deck, arm, amplification and cabling.

Dimensions - (W x D x H)  
47cm x 56cm x 80cm

For further information or to book a demonstration, contact HIAudio on 08450 525259 or email [bling@hiaudio.co.uk](mailto:bling@hiaudio.co.uk).

System Shown RRP £17,000 inc cables.

Classic Cartridge, Conductor Tonearm, Machine TT, Solid Stand, Solo MC, Revelation Phono stage, P9 Pre amp, Reference 9SE V2 power amplifiers, MSR1 Music Server, Acrylic Rack, Custom Opera Interconnects.

Available only through approved retailers

- GH
- USHER
- NUFORCE
- theCartridgeman
- Black Rhodium
- GRAHAM SLEE
- METAVISION
- INVIDE
- Acoustic Solid
- Storm Audio Technology

## HIAudio - UK Distribution

For your nearest stockist of the HIAudio [www.hiaudio.co.uk](http://www.hiaudio.co.uk) or call direct on 0845 0525259

# WORLD CLASSICS

In this heavily revised section, you'll find the great and the good from audio's glorious past. Most are seminal designs which have earned their place in hi-fi history, but you'll also see some oddities which aren't classic as such, but are great used buys. The year of introduction is given, alongside the original UK launch price. Think we've overlooked something? Then write in and let us know!

## DIGITAL

### CAMBRIDGE AUDIO CD1 1986 £1500

Inspired Stan Curtis redesign of Philips CD104, complete with switchable digital filter. Lean but tight and musical performer.

### CAMBRIDGE AUDIO CD4SE 1998 £200

A touch soft in the treble and tonally light, but outstanding in every other respect.

### LINN KARIK III 1995 £1775

The final Karik was a gem. Superb transport gives a brilliantly tight, grippy dynamic sound, albeit tonally dry.

### MARANTZ CD73 1983 £700

A riot of gold brushed aluminium and LEDs, this distinctive machine squeezed every last ounce from its 14x4 DAC -super musical



### MARANTZ SA-1 2000 £5,000

The greatest argument for SACD. This sublime Ken Ishiwata design is utterly musically convincing with both CD and SACD, beating most audiophile CD spinners hands down.



### MERIDIAN 207 1988 £995

Beautifully-built two-box with pre-amp stage. Very musical although not as refined as modern Bitstream gear. No digital output.

### MUSICAL FIDELITY TRIVISTA 2002 £4000

When playing SACDs, the sweetest, most lucid and lyrical digital disc spinner we've heard. Old school stereo, pure DSD design. CD sound is up in the £1000 class, too! Future classic.

### MERIDIAN MCD 1984 £600

The first British 'audiophile' machine was a sweeter, more detailed Philips CD100. 14x4 never sounded so good, until the MCD Pro arrived a year later.



### NAIM CDS 1990 £ N/A

Classic Philips 16x4 chipset with serious attention to power supplies equals grin-inducing sonics.



### SONY CDP-101 1982 £800

The first Japanese CD spinner was powerful and involving. Brilliant transport more than compensated for 16x2 DAC, and you even got remote control!

### SONY CDP-R1/DAS-R1 1987 £3,000

Sony's first two boxer was right first time. Tonally lean, but probably the most detailed and architectural sounding machine of the eighties.



### SONY CDP-701ES 1984 £890

Sony's first ever bespoke high end audiophile machine used a 16x2 DAC to provide a clinically incisive sound; supreme build quality allied to the pure unadulterated luxury of a paperback-sized remote control.

### TECHNICS SL-P1200 1987 £800

CD version of the Technics SL-1200 turntable. Massively built to withstand the rigours of 'pro' use and laden with facilities - a great eighties icon. Sonically, it's pure fun, with hefty bass that can still show weedy modern players a thing or two!

### YAMAHA CD-X1 1983 £340

Nicely built 16x2 machine with a very sharp and detailed sound; sometimes too much so. Excellent ergonomics, unlike almost every other rival of the time.

## COMPACT DISC TRANSPORTS

### TEAC VRDS-T1 1994 £600

Warm and expansive sound made this a mid price hit. Well built, with a slick mech.



### ESOTERIC P0 1997 £8,000

The best CD drive bar none; TEAC's Tokyo boys pushed the boat out in style. Brilliantly incisive, ridiculously over engineered.

### KENWOOD 9010 1986 £600

The first discrete Jap transport was beautifully done and responds well to re-clocking even today.

## DACs

### CAMBRIDGE AUDIO DACMAGIC 1995 £99

Good value upgrade for budget CD players with extensive facilities and detailed sonics.



### DCS ELGAR 1997 £8500

Extremely open and natural performer, albeit extremely pricey - superb.



### DPA LITTLE BIT 3 1996 £299

Rich, clean, rhythmic and punchy sound transforms budget CD players.



### PINK TRIANGLE DACAPO 1993 £ N/A

Exquisite; the warmest and most lyrical 16bit digital audio we have ever heard. Clever plug-in digital filter modules really worked!



### QED DIGIT 1991 £90

Budget bitstream performer with tweaks aplenty. Positron PSU upgrade makes it smooth, but now past it.



**TURNTABLES**

**ARISTON RD11S** 1972 £94  
Modern evolution of Thorens' original belt drive paradigm, Scotland's original super-deck was warm and musical, albeit soft. Still capable of fine results today.

**ADC ACCUTRAC 4000** 1976 £300  
Bonkers 1970s direct drive that uses an infra red beam to allow track selection and programming. More of a visual and operational delight than a sonic stunner.

**PIONEER PL12D** 1973 £36  
The beginning of the end for the British turntable industry. When vinyl was the leading source, this bought new standards of noise performance and stability to the class, plus a low friction S-shaped tonearm. Later PL112D was off the pace compared to rivals



**PIONEER PLC-590** 1976 £600  
Sturdy and competent motor unit that performs well with a wide range of tonearms. Check very thoroughly before buying due to electronic complexity and use of some now-obsolete ICs.

**DUAL CS505** 1982 £75  
Simple high quality engineering and a respectable low mass tonearm made for a brilliant budget buy. Polished, smooth and slightly bland sound.

**GOLDRING LENCO GL75** 1970 £15.65  
Simple, well engineered motor unit with soft, sweet sound and reasonable tonearm. Good spares and servicing support even today from specialists. Eminently tweakable. Similar 88 and 99 motor units are budget 301/TD124 rivals.

**LINN AXIS** 1987 £253  
Simplified cut-price version of the Sondek complete with LVX arm. Elegant and decently performing mid-price package. Later version with Akito tonearm better.

**LINN SONDEK LP12** 1973 £86  
For many, the Brit superdeck; constant mods meant that early ones sound warmer and more lyrical than modern versions. Recent 'SE' mods have brought it into the 21st century, albeit at a price..



**MARANTZ TT1000** 1978 £ N/A  
Beautiful seventies high end belt drive with sweet and clean sound. Rare in Europe, but big in Japan.



**MICHELL GYRODEC** 1981 £599  
Thanks to its stunning visuals, this bold design wasn't accorded the respect it deserved until recently. Early examples sound cold and mechanical, but now right on the pace. Clean, solid and architectural sound.

**TECHNICS SP10** 1973 £400  
Seminal Japanese engineering. Sonics depend on plinths, but a well mounted SP10/II will give any modern a hard time, especially in respect of bass power and midband accuracy.

**REGA PLANAR 3** 1978 £79  
Brilliantly simple but clean and musical performer, complete with Acos-derived S-shaped tonearm. 1983 saw the arrival of the RB300, which added detail at the expense of warmth. Superb budget buy.

**GARRARD 301/401** 1953 £19  
Heavy metal - tremendously strong and articulate with only a veiled treble to let it down. In many respects, better than the seventies 'superdecks' that succeeded it.



**ROKSAN XERXES** 1984 £550  
Supposedly the first to 'better' the LP12. Super tight and clean sound, with excellent transients. Less musical than the Sondek, but more neutral. Sagging plinth top-plates make them a dubious used buy.

**SONY PS-B80** 1978 £800  
First outing for Sony's impressive 'Biotracer' electronic tonearm. Built like a tank with a clean and tidy sound, albeit lacking involvement. Scarily complicated and with no spares support - buy with caution!

**THORENS TD124** 1959 £ N/A  
The template for virtually every 1970s 'superdeck', this iconic design was the only real competition for Garrard's 301. It was sweeter and more lyrical, yet lighter and less impactful in the bass.



**TOWNSHEND ROCK** 1979 £ N/A  
The product of academic research by the Cranfield Institute, this novel machine has an extremely clean and fluid sound. Substantially modified through the years, and capable of superb results even today.

**TRIO LO-7D** 1978 £600  
The best 'all-in-one' turntable package ever made, Trio/Kenwood threw their 'engineering best practice' book at this one with startling results. Clean, powerful and three-dimensional sound, ultimately limited by the tonearm.

**ACOS LUSTRE GST-1** 1975 £46  
The archetypal S-shaped seventies arm; good, propulsive and involving sound in its day, but ragged and undynamic now.

**AUDIO TECHNICA AT 1120** 1978 £75  
Fine finish can't compensate for this ultra low mass arm's limited sonics - a good starter arm if you've only got a few quid to spend.

**ALPHASON HRI005** 1981 £150  
First class arm, practically up to present-day standards. Buy carefully, though, as there is no service available now. Totally under priced when new, exceptional.



**SME 3009** 1959 £18  
Once state of the art, but long since bettered. Musical enough, but weak at frequency extremes and veiled in the midband. Legendary serviceability and stunning build has made it a cult, used prices unjustifiably high.

**GRACE G707** 1974 £58  
This early Japanese example of the tonearm art has a smooth, lyrical sound. Imported by Linn, fitted to early LP12s. Sonically way off the pace now, though.

**REGA RB300** 1983 £88  
Inspired budget esoterica. Detailed, tight, neutral sound but tonally grey sounding in absolute terms. Responds well to tweaking, and its cheaper RB250 brother better still.



**SME SERIES III** 1979 £113  
Clever variable mass design complete with Titanium Nitride tube tried to be all things to all men, and failed. Charming nonetheless, with a warm and inoffensive sound.

**HADCOCK GH228** 1976 £46  
Evergreen unipivot with lovely sweet, fluid sound. Excellent service backup.



**LINN ITTOK LVII** 1978 £253  
Arguably the first 'superarm'; Japanese design to Linn specs made for a muscular, rhythmic sound with real dynamics. Now off the pace, but the final LVIII version worth seeking out.

**NAIMARO** 1986 £875  
Truly endearing and charismatic performer - wonderfully engaging mid-band makes up for softened frequency extremes.



**TECHNICS EPA-501 1979 £ N/A**

Popular partner for late seventies Technics motor units. Nice build and Titanium Nitride tube can't compensate for middling sound.

**INTEGRATED AMPLIFIERS/COMBOS**

**DELTEC 1987 £1900**

Fast, dry and with excellent transients, this first DPA integrated is the real deal for eighties obsessives. Ridiculously punchy 80W per channel from a tiny, half-size box. Radical, cool and more than a little strange.

**ROGERS A75 1978 £220**

The prototypical Audiolab 8000a - lots of sensible facilities, a goodly power output and nice sound in one box. The later A75II and A100 versions offered improved sonics and were seriously sweet and open to listen to.

**EXPOSURE VII/VIII 1985 £625**

Seminal mid-eighties Exposure pre-power, offering most of what rival Naim amps did with just that little bit extra smoothness and sweetness. Still, it's by no means 'sweet' by today's standards, being lean, punchy, musical. It's also possessed of that quintessentially eighties look - frumpy black steel boxes with rough silk screened logos!

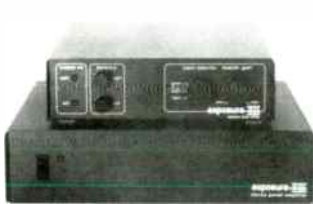

**SUGDEN C51/P51 1976 £130**

Soft sounding early Sugden combo with a plethora of facilities and filters, complete with seventies-tastic DIN socketry. A sweet and endearing performer as you'd expect, but lacking in power and poor load driving ability, so partner carefully.

**VTL MINIMAL/50W MONOBLOCK 1985 £1,300**

Vacuum Tube Logic was one of the Europe's biggest tube names in the eighties, and it shows. Rugged, professional build and finish allied to a lively and punchy sound (albeit with limited power) make them an excellent used buy.

**A&R A60 1977 £115**

Sweet and musical feature-packed integrated: the Audiolab 8000A used its blueprint to great effect.



**CREEK CAS4040 1983 £150**

More musical than any budget amp before it; CAS4140 loses tone controls, gains grip.

**AUDIOLAB 8000A 1985 £495**

Smooth integrated with clean MM/MC phono stage and huge feature count. Extremely reliable, too. Post '93 versions a top used buy.



**MCINTOSH MA6800 1995 £3735**

Effortlessly sweet, strong and powerful with seminal styling to match.

**SUGDEN A21 1969 £ N/A**

Class A transistor integrated with an eminently likeable smoothness and musicality. Limited inputs via DIN sockets.

**MISSION CYRUS 2 1984 £299**

Classic eighties minimalism combines arresting styling with clean, open, lively sound. Further upgradeable with PSX power supply.



**MUSICAL FIDELITY A1 1985 £350**

Beguiling Class A integrated with exquisite styling. Questionable reliability.



**NAIM NAIT 1984 £350**

Superb rhythms and dynamics make it truly musical, but tonally monochromatic. Fine phono stage, very low power.

**NAD 3020 1979 £69**

Brilliantly smooth, sweet and punchy at the price and even has a better phono stage than you'd expect. The archetypal budget super-amp.



**MYST TMA3 1983 £300**

Madcap eighties minimalism, but a strong and tight performer all the same.

**ROGERS CADET III 1965 £34**

Sweet sounding valve integrated, uses ECL86 output valves, even has a half useable phono stage, sweet, warm a good introduction to valves



**ROTEL RA-820BX 1983 £139**

Lively and clean budget integrated that arguably started the move to minimalism.

**CHAPMAN 305 1960 £40**

Smooth pre/power combo with a sweet and open sound. Not quite up to Leak/Quad standards but considerably cheaper second-hand.

**PREAMPLIFIERS**

**AUDIOLAB 8000C 1991 £499**

Tonally grey but fine phono input and great facilities make it an excellent general purpose tool.

**AUDIO RESEARCH SP-8 1982 £1,400**

Beautifully designed and built high end tube preamplifier with deliciously sweet and smooth sound. Not the last word in incision or grip, but that didn't matter to those who aspired to it.

**CONRAD JOHNSON MOTIV MC-8 1986 £2,500**

Minimalist FET-based preamplifier from the Yank valve specialists is brilliantly neutral and smooth with a spry, light balance in the mould of Sugden high end stuff. Something of a curio, but worthwhile nonetheless.

**CROFT MICRO 1986 £150**

Budget valve pre-amp with exceptionally transparent performance.

**LEAK POINT ONE STEREO 1958 £ N/A**

Good for their time, but way off the pace these days. Use of EF86 pentode valve for high gain rules out ultra performance. Not the highest-fi!

**LINN LK-1 1986 £499**

A brave attempt by the Glasgow boys to bring remote controlled user-friendliness to hair-shirt audiophile hi-fi. Didn't quite work, but not half bad for under £100.

**NAIM NAC32.5 1978 £ N/A**

The Salisbury company came of age with this, their classic high end pre. Brilliantly fast and incisive sound that's a joy with vinyl but a tad forward for digital.

**LECSON AC-1 1973 £ N/A**

Amazing styling courtesy of Allan Boothroyd can't disguise its rather cloudy sound, but a design classic nonetheless.

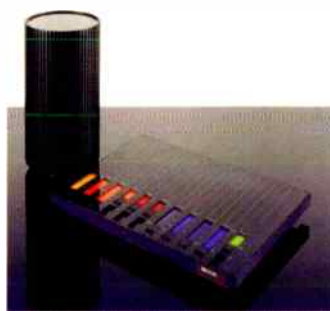

**QUAD 22 1958 £25**

The partner to the much vaunted Quad II monoblocks - cloudy and vague sound means it's for anacrophiles only.

**QUAD 33 1968 £43**

Better than the 22, but Quad's first tranny pre isn't outstanding. Responds well to tweaking/ rebuilding though...

**POWER AMPLIFIERS**

**HH ELECTRONICS TPA-50D AMPLIFIERS 1973 £110**

Simple design with easily available components, solid build quality and fine sound make for a surprisingly overlooked bargain. Not exactly stylish, however.

**LEAK STEREO 60 1958 £N/A**

Leak's biggest valve power amp offers 35 Watts per channel and more low end welly than the smaller Stereo 20. Despite concerns over reliability their rarity means high prices are the order of the day.



## CLASSICS

**LEAK STEREO 20** 1958 £31

Excellent workaday classic valve amplifier with decent power and drive. Surprisingly modern sounding if rebuilt sympathetically. Irrepressibly musical and fluid.



**LECSON API** 1973 £ N/A

Madcap cylindrical styling alluded to its 'tower of power' pretensions, but it wasn't. Poor build, but decently clean sounding when working.

**MARANTZ MODEL 9** 1997 £8000

Authentic reproduction monoblocks still more than cut the sonic mustard. Highly expensive and highly sought after.

**MICHELL ALECTO** 1997 £1989

Crisp, clean and beautifully controlled with gorgeous styling. Partnered with the £1650 Orca this sounds delicious!

**LEAK POINT ONE, TL10, TL12.1** 1949 £28

Early classics that are getting expensive. Overhauling is de rigueur before use, using original parts if possible. Surprisingly crisp and musical sound, that's far more modern than Quad IIs. Deeply impressive when in fine fettle.

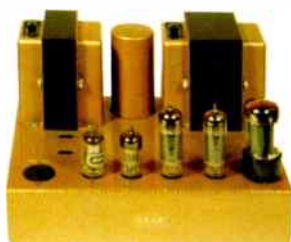

**MUSICAL FIDELITY XA200** 1996 £1000PR  
200W of sweet smooth transistor stomp in a grooved tube! Under-rated oddity.



**QUAD II** 1952 £22

The all-time classic valve amplifier, with a deliciously fluid and lyrical voice. In other respects though, it sounds hopelessly dated. Low power and hard to partner properly



**QUAD 405** 1978 £115

The first of the current dumpers is a capable design with smooth, effortless power and a decently musical sound. 606 and 707 continue the theme with greater detail and incision.

**QUAD 303** 1968 £55

Bullet proof build, but woolly sound. Off the pace, but endearing nonetheless. Some pipe smoking slipper wearers swear by them!

**RADFORD STA25 RENAISSANCE** 1986 £977

At the time, very possibly the least cool amplifier on the planet – and we're not talking heat dissipation here. This reworking of Radford's original late sixties design was possessed of a wonderfully rich, old school valve sound with enough power (25W) and lots of subtlety.



**KRELL KMA100 II** 1987 £5,750

Ludicrous monoblock version of the giant KSA-100 is one of the seminal eighties transistor power amplifiers. Massive wallop allied to a very clean and open Class A sound makes this one of the best amplifiers of its type, ever.

**PIONEER M-73** 1988 £1,200

Monster stomp from this seminal Japanese power amplifier, complete with switchable Class A and Class B operation. Clean, open and assured sounding, albeit a tad behind the pace on high speed dance music. Rosewood side cheeks and black brushed aluminium completes the eighties-tastic experience.



## PHONO STAGES

**CREEK OBH-8 SE** 1996 £180

Punchy, rhythmic character with oodles of detail makes this a great budget audiophile classic. Partner with a Goldring G1042 for an unbeatable budget combination.



**LINN LINNK** 1984 £149

Naim-designed MC phono stage built to partner the original Naim NAIT - yes, really! Fine sound, although off the pace these days.

**MICHELL ISO** 1988 £ N/A

This Tom Evans-designed black box started the trend for high performance offboard phono stages. Charismatic, musical and punchy - if lacking in finesse.

## TUNERS

**MARANTZ ST-8** 1978 £353

Marantz's finest radio moment. Warm, organic sound plus an oscilloscope for checking the signal strength and multipath.



**CREEK CAS3140** 1985 £199

Excellent detail, separation and dynamics - brilliantly musical at the price. T40 continued the theme...

**NAD 4040** 1979 £79

Tremendously smooth and natural sound allied to low prices and good availability make this budget analogue esoterica. Needs a good antenna to work properly, however.

**NAIM NAT03** 1993 £595

The warm, atmospheric sound is further proof of Naim's proficiency with tuners.

**PIONEER TX-9500** 1976 £295

Another of the serious classic solid-staters. Boasts the usual high end Jap package of fine sound, brilliant sensitivity and superb build.

**LEAK TROUGHLINE** 1956 £25

Series I an interesting ornament but limited to 88-100MHz only. II and III are arguably the best-sounding tuners ever. Adaptation for stereo easy via phono multiplex socket. Fed by a modern outboard decoder they're deliciously lucid with true dimensionality.



**YAMAHA CT7000** 1977 £444

Reputedly the best of the classic Jap analogues, this combines sleek ergonomics, high sensitivity and an explicit, detailed sound.

**QUAD FM4** 1983 £240

Supreme ergonomics and styling allied to a pleasingly lyrical sound with plenty of sweetness and detail made this one of the best tuners around upon its launch.



**REVOX B760** 1975 £520

More of a semi-pro machine than a domestic bit of kit, the Revox offers superlative measured performance although the sound isn't quite as staggering as the numbers. Fine nonetheless, and surely the most durable tuner here?

**NAD 4140** 1995 £199

Brilliant affordable digital tuner has a smooth, detailed musical sound plus sensible real-world facilities.

**ROGERS T75** 1977 £125

Superb mid-price British audiophile design, complete with understated black fascia. Fine sound in the true Rogers mould – smooth and sweet with fine dimensionality.

**SANSUI TU-9900** 1976 £300

A flagship Japanese tuner designed to steal sales from the likes of Accuphase and Revox, it boasts superlative RF performance and an extremely smooth and lucid sound, along with very fine build and finish.

**SONY ST-5950** 1977 £222

One of the first Dolby FM-equipped tuners, a format that came to nought. Still, it was Sony's most expensive tuner to date, and boasted a very good sound quality allied to brilliant ergonomics.

**SEQUERRA MODEL I** 1973 £1300

Possibly the ultimate FM tuner. Massive in terms of technology, size and features dedicated to extracting every ounce of performance from radio, including impressive multi-purpose oscilloscope display.



**TECHNICS ST-8080** 1976 £180

National Panasonic's specialist hi-fi brand was a big hitter back then, and this is no exception. Superb FM stage makes for a very clean and smooth listen with lots of detail and depth.



**ANALOGUE RECORDERS**

**YAMAHA TC-800GL** 1977 £179

Early classic with ski-slope styling courtesy of Mario Bellini. Middling sonics by modern standards, but cool nonetheless!



**AIWA XD-009** 1989 £600

Aiwa's Nak beater didn't, but it wasn't half bad nonetheless. Massive spec even included a 16x4 DAC!

**NAKAMICHI CR-7E** 1987 £800

The very best sounding Nakamichi ever - but lacks the visual drama of a Dragon.



**PIONEER CTF-950** 1978 £400

Not up to modern standards sonically, but a great symbol of the cassette deck art nonetheless.



**REVOX A77** 1968 £145

The first domestic open reel that the pros used at home. Superbly made, but sonically off the pace these days. B77 better, but couldn't match the Japanese



**SONY WM-D6C** 1985 £290

Single capstan transport on a par with a Swiss watch, single rec/replay head better than most Naks. Result: sublime.



**SONY TC-377** 1972 £N/A

A competitor to the Akai 4000D open reel machine, the Sony offered better sound quality and is still no slouch by modern standards

**DIGITAL RECORDERS**

**SONY MDS-JE555ES** 2000 £900

The best sounding MD deck ever, thanks to awesome build and heroic ATRAC-DSP Type R coding.



**PIONEER PDR-555RW** 1999 £480

For a moment, this was the CD recorder to have. Clean and detailed.

**MARANTZ DR-17** 1999 £1100

Probably the best sounding CD recorder made; built like a brick outhouse with a true audiophile sound and HDCD compatibility.



**KENWOOD DM-9090** 1997 £500

Serious and sophisticated sound thanks to well implemented ATRAC 4.S; surprisingly musical MD recorder.

**SONY TCD-8 DATMAN** 1996 £599

Super clean sound makes this an amazing portable, but fragile.

**LOUDSPEAKERS**

**ACOUSTIC RESEARCH**

**ARI8S** 1978 £125

Yank designed, British built loudspeaker became a budget staple for many rock fans, thanks to the great speed from the paper drivers, although finesse was most definitely not their forte...

**BBC LS3/5A** 1972 £88

Extremely low colouration design is amazing in some respects - articulation, stage depth, clarity - and useless in others (both frequency extremes). Came in wide variety of guises from various manufacturers building it under licence. Partner with Rogers ABI subwoofers for an extra two octaves of bass!

**HH ELECTRONICS TPA-50D**

**AMPLIFIERS** 1973 £110

Simple design with easily available components, solid build quality and fine sound make for a surprisingly overlooked bargain. Not exactly stylish, however.



**LOWTHER PM6A** 1957 £18

EACH

This seminal full-range driver is still manufactured. High sensitivity, as fitted to many classic horn designs.

**TANNOY**

**WESTMINSTER** 1985 £4500

Folded horn monsters which certainly sound good if you have the space. Not the last word in tautness but can drive large rooms and image like few others.

**JR 149** 1977 £120

Infamous cylindrical speaker that was ignored for decades but now back in fashion! Based on classic KEFT27 / B110 combo as seen in the BBC LS3/Sa. Doesn't play loud, needs a powerful transistor amplifier, but rewards with fine clarity and imaging.



**SPENDOR BC1** 1976 £240

Celestion HF1300 tweeter meets bespoke Spendor Bextrene mid-bass unit - and the result is a beautifully warm yet well focussed sound. A little bass bloom necessitates careful low-stand mounting, but these prove that the seventies did have some fine designs after all!

**QUAD ESL57** 1956 £45

EACH

Wonderfully open and neutral sound puts box loudspeakers to shame. Properly serviced they give superb midband performance, although frequency extremes less impressive. Ideally, use in stacked pairs or with subwoofers and supertweeters.





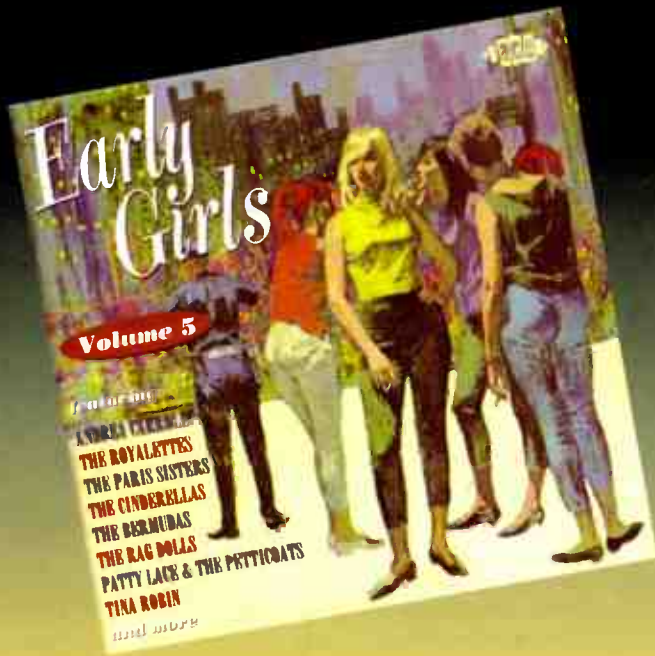

**EARLY GIRLS VOLUME 5**  
*Various*  
**Ace Records**

This might be the fifth volume in the series of 'Early Girls', but it also looks like the last in a successful compilation sequence that features American girl groups from the rock'n'roll genre, spanning the mid-fifties to the pre-Beatles era, around 1964 (at least in the USA), that not only reached Billboard's Top 100 chart in the USA, but also the 'bubbling under' region. That is, around the Top 100 to 130...

Mick Patrick, A&R consultant for Ace Records, specialises in American girl groups and was involved in the creation of many volumes in the series. "Mastering sources came from all over. We have been fortunate in accessing the original master tapes for just about all the tracks - we're good at tracking them down - there haven't been many disc dubs," said Patrick. One example was close to home, "London Records, a British label, existed mainly to release American product. They would have master tapes shipped over. As the years went by, they accumulated quite a few tapes which were maintained. Subsequently, they were lumbered with these things. Ace eventually bought them and now look after them for posterity. They number in the hundreds and include some of the masters for this series."

Ace booklets are normally packed with lots of informative

details - this example comes with a twenty three-page booklet packed with photographs and label images plus cut-outs from contemporary music publications. Patrick's own love of music and his standing as a collector in his own right came to the fore here. "I supplied records, photos and memorabilia from my own collection that were scanned for use in the booklet." These included French EPs of American artists which often featured unique images but also unique song tracks. In contrast to our standard 2-track singles, French EPs were 4-track affairs which meant that rarities would often be included. Each well mastered CD packs twenty-eight tracks plus a fascinating series of historical notes for collectors, such as catalogue numbers and the like. Artists such as Patti Duke ('Don't Just Stand There'), Doris Troy (Just One Look) and The Starlets ('P.S. I Love You) are just some of the highlights.

**MICHAEL NESMITH**  
*Live At The Britt Festival*  
**Edsel**

Nesmith, the chap who used to be in the US-pop band The Monkees, has had an interesting solo career. He released an array of excellent country rock albums in the seventies, for example. This live gig at Jacksonville, USA in 1991 shows the man at his best. You'll also be able to hear how funny he is as a person, via his between song patter. For a live gig, the recording is excellent. In fact,

Nesmith declared that the latest surround mix has had a beneficial effect on the stereo version. "When it came to recording this album, I recorded Surround information as well as mixing the record in Dolby Surround. I placed five microphones around the amphitheatre in the same places speakers would be in an average Dolby Surround playback setup. Then I used these as ambience for the surround mix. The default mix is stereo but if one has a Dolby Surround system, it plays the full Dolby Surround mix. So the listener has the sound from a seat at the concert about ten rows back from centre stage," said Nesmith.

The default stereo mix that plays on a regular CD player - that came from these Dolby mixes - is far superior to a standard stereo mix. "I'm not sure why," said Nesmith, "since the Dolby Surround mix is embedded in the digital information it will always be a part of these records and will always play whenever they are played back on a Dolby Surround system, whether anyone knows it or not." Even if this enhancement was somewhat of a happy accident, Nesmith is satisfied with the technical results. "I can safely say that of all my albums, 'Live At The Britt Festival' and 'Tropical Campfires,'" which has also been reissued by Edsel, "are by far the most technically advanced for their times and I think the aesthetics of the Dolby Surround mix are a real addition."



**KENNY BAKER**  
*Baker's Dozen/  
The Half Dozen*  
**Vocalion**

When talking about jazz, most people's minds wander over to the US greats: Duke Ellington and Count Basie, Miles Davis and John Coltrane, Herbie Hancock and Bill Frisell [see p130 – Ed.]. But what about British jazz? Okay, to begin with, we aped the American 'heroes', but after a while, British jazz found its own sound via the likes of John Dankworth, Michael Garrick, Dave Holland, Stan Tracey and Evan Parker. Often grossly under-valued, British jazz has found a new niche and, via original LPs, cult collector status. Vocalion has recognised this and has been releasing excellent British jazz LPs, often via value-for-money sets of two LPs on a single CD. Well mastered, the latest batch includes John Dankworth's '5 Steps To Dankworth' paired with 'Journey Into Jazz', Kenny Graham's 'Presenting...' along with bonus tracks, Johnny Keating's 'British Swinging Scots' and '...All Stars' plus, trumpeter, Kenny Baker's 'Midnight At Nixa' and 'After Hours'.

This particular Baker duo completes the latest batch of new releases. Baker was a member of the famous British big band lead by Ted Heath. Leaving this ensemble, he began a solo career and then subsequently moved onto soundtrack work. The albums here provide two sides of Baker. The larger

ensemble reflects more on Baker's arrangements and his earlier big band works whilst the smaller group gives more freedom for soloing – especially from George Chisholm, trombonist and later TV personality. Featuring a selection of his own works (i.e. 'How's This?' And 'Baker's Boogie'), Baker also pays homage to earlier jazz cuts from the twenties and thirties including Duke Ellington's 'Blues I Love To Sing' from the 1920s. Of note to enthusiasts of British rock music, the sound engineer on the 'Half Dozen' album was Joe Meek – the eccentric and innovative character who would later produce groundbreaking works on his own label.

**JOHNNY CASH**  
*Original Album Classics*  
**Sony/BMG**

Sony/BMG has recently launched a new imprint concept called 'Original Album Classics'. Basically, the company has taken five original albums from the targeted artist and packaged them in a miniature LP facsimile of the original sleeve with the original liner notes and photograph(s) on the rear. Each album is also often accompanied by bonus tracks. All five albums are then wrapped in a thick card, slip-case cover. The price? Amazon is shifting them at a very reasonable £14 per box set. I have two boxes here but Sony/BMG has declared that there are another nineteen sets on the way featuring the likes of Jeff Beck, The

Isley Brothers, Big Audio Dynamite and more.

The ethos of the series is that the box often features albums which have been long out of print or are relatively difficult to get hold of. One of the two resident sets is from Waylon Jennings, featuring: 'This Time', 'Lonesome, On'ry And Mean', 'The Ramblin' Man', 'Ol' Waylon' and 'Waylon & Willie'. The Johnny Cash box, featured here, includes: 'The Fabulous Johnny Cash', 'Hymns by Johnny Cash', 'Songs Of Our Soil', 'Ride This Train' and 'Orange Blossom Special' – you would find it tough to get many of these from the Internet.

There doesn't seem to be any pattern as to why this particular set of CDs was selected – Cash's discography was wide ranging – except that each and every one of the albums in this box is a corker. 'Fabulous...' was Cash's first album for Columbia – here, he brought the best of his unissued Sun songs (i.e.: 'Don't Take Your Guns To Town' and 'I Still Miss Someone'); 'Hymns...' doesn't sound overly religious, rather, it scans like a typical Cash song round-up. Even traditional tunes have the Cash twist; 'Soil...' is almost a concept album, featuring Cash-penned American folk tales and protest songs targeted at your conscience; 'Ride...' is another concept piece on trains and their place in American life, complete with educational narration, whilst 'Orange...' is almost a 'best of' of non-hits.





# Mega Trawlers

Channa Vithana spends quality time with Naim Audio's seminal NAT 01, 101 and 02 tuners...

**N**aim Audio's NAT 01 tuner is the complete opposite of my other favourite 'wireless', Leak's seminal Troughline. Heavy, black-cased and olive-fronted, transistor instead of valve and replete with LED display instead of a 'magic eye', you couldn't think of two more superficially different products. And yet both are key members of the true hi-fi aristocracy, resolutely purist in design and without fripperies, which means they both eschew presets in favour of superbly tactile tuning dials, and both require serious FM signals from roof-mounted aerials for best results. The Naim is as equally iconoclastic as the venerable Leak - devastatingly clear in aesthetics, its minimalist fascia, rubber-gripped tuning dial and illuminated display whose glow indicates signal strength leave a lasting impression on

anyone who encounters it...

The seminal Naim NAT 01 began life in 1981 as a three waveband prototype called the NAT 301 [pictured right], designed by Naim Audio's founder Julian Vereker and an outside consultant. Subsequently Julian, while overseeing, gave the tuner development to designer Guy Lamotte (who also worked on Naim's highly musical ARO tone arm). The first NAT 01 came out in 1984 but it wasn't until 1986 that Guy designed a bespoke Naim tuner head for it. Naim says that the NAT 01 had several changes in comparison to its '301 predecessor; there was a separate power supply called the PST, removal of Long Wave and Medium Wave, superior final output-stage filtering, higher-performance IF and stereo decoder chips, smoother mono to stereo blend and the elegant use of display brightness to

indicate signal-strength.

With purer electronic design and ergonomic simplicity as a result (no noisy signal-strength meters, presets, extra wavebands and the like) the NAT 01 is a testament to the higher art of audiophile engineering where less is more. The NAT 01 in 2001 cost £1,945 new and now sells for £800 to £1,400 second-hand, depending on vintage.

Another model, the NAT 101 appeared in 1986. A lower cost design compared to the '01, it also had a separate power supply, but this time a SNAPS instead of the '01's PST. The '101 sports a beautiful bit of mechanical-engineering in the shape of a wonderfully designed analogue tuning display. This consists of a metal disc with an illuminated strip showing FM frequencies, which lights brightly when signal strength is best. Inside there is a superb multilayered

pulley mechanism that transfers the movement of the tuning dial at the fascia into the chassis and then turns the disc very smoothly around.

The SNAPS differed from the PST by having a single +24V rail to its power supply which had to be re-regulated to 15V in the '101 for the circuitry while the PST utilised three secondary windings in its transformer to supply 4 DC regulators; +5V, +15V, +24V, +28V and a 15V AC rail for the vacuum fluorescent (VF) display for the original versions of the '01. From its evolutionary lifespan of 1984 to 2002, the NAT 01 had changed its VF display to LED, increased its output level and had an early PST redesign in around 1987. The '101

supply of the SNAPS driven '101 to have been better in Naim engineering terms, but it was not quite that way. What I heard was an even quieter, deeper musical background with the NAT 02 and this afforded the Bach piece superior bass and midrange timbre, so the music was fuller, and more convincingly rounded. However, the '101 did sound more free-flowing than the '02, with a more lyrical musicality in comparison. As a result, I felt the '02 sounded a tad dry in comparison to the '101.

Then it was the turn of the NAT 01, and what I heard was the best of both worlds - it combined the effortless free flow of the '101 with the superior timbre of the '02.

"make sure you never forget tuners such as this..."

would sell for around £471 in the late '80s and would cost a similar price now. It was then superseded by the NAT 02 in 1989 which featured the same bespoke tuner head and power-supply architecture as the NAT 01 and its PST power-supply but within the same case, using a smaller toroidal transformer and dispensing with the SNAPS. The '02 cost £1,240 new when it was discontinued in 2002 and goes for £1,000 second-hand for most vintages. The NAT 01 and '02 in their later guises featured 'olive' or 'shoebox' classic solid-aluminium casework measuring approximately 86x206x300mm.

**SOUND QUALITY**

I was in the lucky position to try a late eighties Naim NAT 101 and a 2000 model NAT 02 together, in addition to a 1996 NAT 01. An afternoon concert on Radio 3 provided a stable listening reference for a few hours, and the old '101 showed why the classic Naim tuners have become such cult classics.

It provided a deep, quiet background to a very high-resolution sound on a Bach cello piece. Spoken word announcements and interludes were excellent, with very accurate pitch and not a trace of the dense, stodgy tonality you get with compressed DAB or loose-sounding FM tuners.

Substituting the NAT 02 was very interesting indeed, as you would have expected the separate-box power-

Here I was left listening to a rare combination of hi-fi and musical - where hi-fi attributes such as detail, instrumental separation and depth were seamlessly coalesced with the fluid musical timing and instrumental phrasing of an orchestra. Listening to a more mainstream station like Radio 2, which was playing the compressed-sounding Coldplay was an unexpected pleasure as the '01 opened out the sound and ably revealed the musicality of these pieces without doing a 'hi-fi autopsy', and clinically deconstructing the sound.

**CONCLUSION**

Listening to the Naim's NAT 101, '02 and especially the '01, one suddenly remembers how wonderful radio is - the airwaves crackle with wondrous stories, music that evokes memories of youth and the discovery of the new. The sheer unadulterated sound quality of the NAT 01, along with its

wonderfully tactile user experience, makes it one of the most profound ways to experience this source, while the 101 and 02 give a slightly lighter but barely less satisfying taste of the magic. As the world moves to DAB, make sure you never forget tuners such as this - sadly we won't have listening experiences like these for ever.

**TUNING**

The NAT 01 [pictured opposite] is a late 1996 vintage and was supplied by Andy Blockley of Phonography - and he also supplied a very fine Naim Audio system to match which included a classic silver fronted 32.5 preamplifier, costing £134 second-hand, fitted to a Hi-Cap power supply and a pair of NAP 135 mono power-amplifiers bought new for £1,486 each in 1994. The '01 could, apparently, also be modified and upgraded with a Naim XPS power-supply. The XPS, which was originally utilised in combination with the CDX and CDS range of Naim CD players was reportedly used in a few Naim-modified NAT 01s and I have it on good authority that its inclusion is superior to the standard PST power supply - this, obviously, was not an official Naim upgrade!

Cabling was all standard Naim Audio including NAC A4 loudspeaker wire feeding into a beautifully finished pair of Shahinian Arc floor-standing loudspeakers which cost £3,495. The NAT 01 and '101 have IEC mains sockets and in this instance we used standard Naim (Crabtree) mains cables (a new Naim Power-Line mains lead is imminent). I tried to connect a 5-pin to 5-pin Naim Hi-Line interconnect, which works brilliantly with the Naim equipment I have used it on so far, but it didn't appear to fit so easily into the 5-pin DIN sockets of the Nat 01/02 in this instance, so I left well alone.

I had access to a standard 4-element FM aerial connected to the roof, but this would be an absolute minimum for a serious tuner like the NAT 01: Naim recommended Ron Smith aerials for their tuners. The only problem is that they are substantially constructed and require a very robust scaffold-grade tubular pole for support and stability during strong winds, storms, etc. With a very sensitive high-end source like the NAT 01, supporting it is crucial, and consequently a very elegant and finely engineered set of '60 series' shelves by Isobue Hi-Fi were used. These cost about £135 each and have two distinctive pointed wedge lengths of solid wood for feet which fit neatly into a corresponding groove on the next shelf down, or spiked base. This enables each shelf to slide back and forth enabling easy access.



1981's Naim NAT301 Prototype.

**THANKS TO:**  
 Andy Blockley at [www.phonography.co.uk](http://www.phonography.co.uk)  
 (+44 (0)1425 461230)  
 Doug Graham & Robin Holloway at [www.naim-audio.com](http://www.naim-audio.com)  
 (+ 44 (0)1722 426600)  
 Chris Brampton at [www.isobuehifi.com](http://www.isobuehifi.com)  
 (+44 (0)208 1236777)





# HIFI CONFIDENTIAL

*Sounding Better And Better..*

SONY	BOSE	marantz	PHILIPS
DENON	Pioneer	audiolab	MISSION
QUAD	Pro-Ject	Jamo	YAMAHA
TANNOY	ROKSAN	SAMSUNG	Wharfedale
KEF	NAD	Q ACOUSTICS	MS

sales@hificonfidential.co.uk

www.hificonfidential.co.uk

0870 850 7835

32 Buckingham Palace Road  
London, SW1W 0RE



...listen pal! the last guy that tried to  
take my new Naim HDX got the stuffing  
knocked out of him...



naim specialists

1  
et rip...

*The NEW HDX Hard Disk player from Naim.*

The Naim HDX reads small data from CDs, stores it on a hard disk, reconstructs the audio signal and tracks it back out at the point of listening, replacing it with ultra hi-res compressed sound quality. The HDX, cause of the digital transport complexity and it even offers the option of operating as a hi-res CD player by directly playing a disc loaded in the drive.

Call us your Oxford Audio today so that we can help you get the most from your Naim HDX.

www.oxfordaudio.co.uk  
Tel: 01865 790 879



design - audiology 08 HF0080E

"I rediscovered a whole host of albums I'd forgotten that I had bought..."



## adam smith

So, as the year marches on from May into June, and I see my wife less and less in the evenings owing to her Financial Director job for a U.S. firm keeping her busy into the late night as their financial year end strikes again, I find myself at something of a loose end after work...

Now, naturally, there is always a reasonably-sized pile of hi-fi equipment at Smith Towers that requires my attention but, as we are having a kitchen extension undertaken, the resulting dust that encroaches upon my technical workbench (or "kitchen worktop" as my wife insists on calling it) means that any delicate equipment is best kept well away. As a result, that pile which, I have to say, is quite extensive at the moment thanks to a fruitful few weeks on eBay, is tucked safely away in the loft room until the builders have gone.

So what is left for a fella to do of an evening? Sitting in the garden with a beer doesn't appeal as much as usual as, even if it isn't raining, I am surrounded by bricks, drainpipes, breeze blocks, scaffolding and other assorted building ephemera. Furthermore, all of this dumped in the garden is killing off the lawn that I laboured successfully to revive back in February and March, after last winter did its best to kill it off.

Playing with the cat is out as well as, firstly, he turned thirteen last year and spends more time asleep than awake and, secondly, he wasn't impressed by the building work disturbing his repose, and so packed up his dish, scratching post and favourite toys, and left to stay with my parents a fortnight ago. With few options left, I found myself engaged in the task that comes right at the bottom of a music collector's list... that's right, I alphabetised my LPs [oh

my gawd - Ed.]!

Now, people who like hi-fi and music are often classed as geeks. Frankly, I hold my hand up to this quite proudly (after all wasn't it Matthew who said in the bible, "blessed are the geeks; for they shall inherit the earth"?) but, it has to be said, many people I know view a strictly ordered LP or CD collection as being on a par with wearing socks with sandals, or having nicely ironed jeans. The trouble is that, when your LP collection measures a few thousand, to say nothing of a good few hundred twelve inch singles, there is a good chance you won't be able to find anything you want to play when the time comes, unless there is some sort of organisation. As Harry Hill is so fond of reminding us, "you've got to have a system..."

So, sleeves rolled up and determination firmly in place, I started and, I have to say that I quite enjoyed myself! It was an interesting journey - I rediscovered a whole host of albums I'd forgotten that I had bought, found a handful I thought I'd lost and was amused by the odd one or two I seem to have bought twice or even, in the case of Asia's 'Alpha', three times. My elusive copy of Diesel Park West's 'Shakespeare Alabama' turned up tucked neatly inside the gatefold sleeve of 'Frampton Comes Alive' (honestly, 'D' next to 'F' - terrible...) and my brother-in-law will be delighted to know that his copy of Energy Orchard's eponymous album that I swore I gave back to him ages ago and he subsequently, erm, couldn't find, has turned up safe and sound!

Also notable were a few rarities from long forgotten artists. Anyone else remember Skipperwise? I bought the album 'The Clock and the Moon' as I liked the track 'Standing Outside

in the Rain' which was on an obscure compilation cassette given to me. Then there were LPs from the likes of Botany 5 and Sam Philips, both introduced to me courtesy of a free compilation cassette from a hi-fi magazine, to introduce the then new Dolby S system.

Rediscovering my comedy LPs was also a delight - I knew quite a lot of Jasper Carrott's vinyl output was lurking in my collection somewhere, plus some 'Round the Horne' and Billy Connolly, but I was pleased to find three 'Not the Nine O'Clock News' sets as well, one of which included the famous hi-fi shop sketch - "I don't think we've got any gram-o-phones here, grandad..."

Finally, it was interesting for me to note the largest number of albums I own by one artist, and who that artist was. You see, I have been a committed Eric Clapton fan since my young days and, thanks to my aforementioned brother-in-law and his musical education, I also have quite a catalogue of albums from seventies rockers like Pink Floyd and Rush. Naturally, I assumed that it would have been one of these that was most numerous in my library, with Clapton being the most likely, but no. My largest tally is actually fifteen albums by Dan Fogelberg, a US singer/songwriter who I have always viewed as criminally underrated - quite a surprise.

This was also a rather poignant discovery for me, as I only recently learned of Dan's untimely death last December at the age of 56, due to prostate cancer. For me this was a sad loss to the music industry and will make me treasure those fifteen albums even more, plus increase my determination to complete my Fogelberg library. Even better, thanks to my fruitful organisational work, I'll always know where to find them! ●





# Practical Hi-Fi

**Obsessive about hi-fi.**

At **Practical Hi Fi** we just love all things hi-fi. We are driven by our love of music and are excited by new products that get us closer to the music. We stock a wide range of very serious equipment from a wide range of manufacturers and distributors. We get especially excited when we know something "new" is coming...

So, when we heard about the groundbreaking new CD players from Cyrus we could hardly contain ourselves. Using new servo system technology, the prototype player we heard recently was very special. You need to hear this, before you make a potential mistake by buying something else. Demand for these players will be extremely high, and we invite you to pre-order yours now!

Likewise when a loudspeaker specialist like Dynaudio tells us their new series of products has surpassed even their expectation, we sit up and take notice. It is no accident that Dynaudio has christened the new speakers "Excite". These are the most exciting boxes we've heard in ages. The speakers are dynamic and musical with an "ease of sound" that makes them most beguiling. Formidable by any standards, book your demonstration now!

On the loudspeaker front we are proud to announce that our **Preston** store is now a stockist of the superb Monitor Audio Platinum series of loudspeakers. Call in for a demonstration and find out why the guys have been chasing these since their launch. Another classic in the making!!

**Stop Press:** Our **Manchester** store will be holding a Musical Event on Saturday 26th July, presenting the brand new series of Cyrus CD Players and Dynaudio Excite range of loudspeakers. These products are very special and we are proud to showcase them together. Diverse Vinyl will be attending with their vast range of LP's for sale. All in all this will be an event not to be missed. Please ring or email to book your place. Tel: 0161 839 8869 Email: manchester@practicalhi-fi.net



**BLACKPOOL**  
Tel: 01253 300599

**BOLTON**  
Tel: 01204 395789

**PRESTON**  
Tel: 01772 883958

**LANCASTER**  
Tel: 01524 39657

**MANCHESTER**  
Tel: 0161 839 8869

**WARRINGTON**  
Tel: 01925 632179

[www.practicalhi-fi.net](http://www.practicalhi-fi.net)

Stockists of:



...and too many other hi-quality manufacturers to list in one advert.

"the pace of change in the Chinese hi-fi world is akin to an Olympic sprinter..."



## David Price

As the Beijing Olympics draw ever closer, it depresses me that the Western media continue to obsess over China's human rights record rather than the forthcoming global festival of sport. Lest we forget, the reason the country was gifted the Olympics several years back was to bring it in to the world community rather than to force it to retrench and hide away – in my opinion, very good sense.

Having travelled to China a good few times over the past years, both for business and pleasure, I find a land full of warm and welcoming people, excited by the chance to play host to the rest of the world this August, and to show China as the modern and generally open country that it is now. And if those foreign visitors doubt the latter, there's nowhere better to go than Beijing's numerous and vast retail emporiums, where free enterprise very visibly reigns supreme!

Whilst visiting Beijing last Christmas, I was fascinated to find a Chinese 'Roewe' car showroom, proudly showing off a stretched version of what used to be the Rover 75 – but visiting Beijing's hi-fi dealerships was even more of an eye-opener. The great thing is that the Chinese hi-fi buyers have very few preconceptions about what constitutes a good brand, or what makes a bad one. Just as its 150 million strong middle class (think the entire population of Great Britain and Germany) is starting afresh with cars, so it knows nothing about hi-fi and the market is there for the winning.

So where is it now? Well, there's certainly no sense of the market being especially 'backward'. Indeed, it seems to have made great leaps since the first time I went to China's

capital in 2004. I asked my native Beijing audiophile friend (who goes by the handle of Isaac to spare me the embarrassment of mispronouncing his real name) the brands that serious Chinese hi-fi buffs aspire to, and he came up with an exhaustive list. Surprising in some respects, it showed familiarity with some brands that even we can't get in a mature hi-fi market like Britain!

Starting with source components, he named the best selling serious brands as Wadia, Meridian, Marantz, Mark Levinson, Sony, Linn and Gryphon. As for amplification, the names include Mark Levinson, Classe, Krell, Pass, Jeff Roland, Accuphase, Cello and Naim, although in his words, "most beginners choose an English brand like Audiolab or NAD". (Interesting that these brands are still perceived as "English" considering that they're built much closer to Shanghai than they are Slough). As for speakers, think: Dynaudio, ATC, B&W, KEF, DALI, JBL, Rogers, Sonus Faber, ELAC, Tannoy, MBL and Egglestone.

Speaking to some Chinese audiophiles, I found that they could hold their own with even the nerdiest Brit (i.e. me) on subjects of 'tube' amplification, horn loudspeakers and upsampling DACs, although interestingly their historical knowledge just isn't there – hi-fi's year zero in China seems to be somewhere around the year 2000. Whereas yours truly was reading about Audio Research D150s whilst still in short trousers back in the seventies (no, I wasn't talking about last summer's hols in Cornwall), Chinese hi-fi buffs are interested in the 'here and now'.

In a sense, having little in the way of hi-fi history is immensely liberating – it feels like in China, anything is possible. That goes a long way to explaining some of the madcap products that have come out of this

vast country, which are – by and large – more 'off the beaten track' than those coming out of Japan. The other side of this is of course that they're generally not built as well, and are often 'here today, gone tomorrow'. The Japanese market is far more mature, and far less prone to faddism. However, the sheer size of the Japanese hi-fi industry is such that it's less prone to experimentation; half of China's native hi-fi brands make extensive use of valves, whereas it's left to the small Japanese specialists like Leben.

The sad thing is that my Chinese friend Isaac doesn't rate his own country's products much. A graduate of Peking University (think China's Oxbridge) in International Relations, Mr Chen isn't very diplomatic on this subject. "Shanling doesn't sell well in China. It tries to establish itself as a high-end brand, but has not made it yet, at least domestically. Generally I don't think there is any high-end Chinese brand. Even if a product sells at a high-end price, it doesn't reach the high-end quality criterion", he told me.

Well, I know what he means, but I think he's being hard on his country's hi-fi. Shanling does indeed make some very good stuff, certainly in the mid-price sector, and we've certainly found Chinese manufactured British products (such as the Arcam Solo Mini) to be of excellent quality.

Still, one thing you can be sure of, is that by the next Olympics in London, the Chinese hi-fi market will be – once again – a dramatically different place. Considering that country's culture dates back some six thousand years, and on the way has produced everything from paper and the compass to gunpowder and printing, the pace of change in the Chinese hi-fi world is more akin to an Olympic sprinter. ●





# shadow audio

T: 0844 800 0074 | www.shadowaudio.co.uk

" At Shadow we get to listen to a lot of speakers - but the speaker we listen to most - is you the customer. "

Hi-Fi World

## VERDICT

" Magnificently designed and built monitor loudspeakers with neutrality, central image stability and bass like very few others. "

Adam Smith, Hi-Fi World July 2008

" The way in which the Tensor Gammas fill the space in between themselves is nothing short of astounding. "

Adam Smith, Hi-Fi World July 2008

With its TENSOR Series, ADAM has set a new benchmark in high-end loudspeakers concerning sound authenticity and precision. The engineering progress of these speakers is based on extensive experiences and developments in professional studio monitors: ADAM monitors can be found in some of the most famous and prestigious studios around the globe.

TENSORS combine all of ADAM's technical innovations, exclusive usage of high quality materials, and with the utmost care in the production. The aim is to achieve a new level of experiencing music.

Full series available from Shadow Audio:  
A5, Home Monitor, Classic, TENSOR and OSS



## (NEW) Wadia iTransport

At just £350, can you afford not to have one? The iTransport, which is certified 'Made for iPod', turns any currently available iPod player into a high-wind media server by providing a bit-perfect digital audio output to an audio/video system, bypassing the player's internal D/A conversion and output stages. Subsequently, the digital signal remains clean and unaltered throughout the path.



## Hi-Fi World VERDICT

" it's right at the top of the tree in terms of sound quality... "

McIntosh MT10 Turntable  
Hi-Fi World, May '08, Adam Smith



## Pre-owned

Our list changes daily, so please visit web site for latest up-to-date list.

### DIGITAL

Advantage CD-15	£1199
Audio Synthesis DAX Decade 2 SE D/A converter	£995
Audionet ART V2 (£2400)	£1095
Eastern Electric Minimax CD player (£999)	£749
Teac Esoteric DV-50	£1295
McIntosh MCD201, CD/SACD (£3400)	£2695
Musical Fidelity DM25 DAC and Transport (£4000)	£2895
Resolution Audio Opus 21, 2 box cd (£2950)	£2395
Rotel RCD 1070 (£500)	£295
Stello CDA 220 dac + CDT 200 cd transport	£1495

### AMPLIFIERS

Anatek CM 0.5 Pre / MB50 Monoblocks (£4100)	£2295
Arcam FMJ P7 Multichannel Power Amplifier	£1495
Audio Zone AMP 1 dual mono integrated (£1395)	£1295
Audionet SAM V2 Integrated (£2400)	£1295
Bryston 4B-SST Power Amp (£2750)	£2249
Cairn 4810 Integrated (£2700)	£1295
EAR Yoshino 834T Hybrid Integrated (£2800)	£2250
Eastern Electric M520 Integrated (£1699)	£1099
Electrocompaniet EC4.8 pre and AW120DMB power combo, brand new! (£4500)	£3795
Graaf GM50 Integrated (£4000)	£3250
KR Audio Products VA320 Power Amplifier	£1495
LSA Signature hybrid integrated amp (£5000)	£3395
LSA Standard Integrated (prev DK Design) (£2500)	£1795
McIntosh MA2275 (£6500)	£3995
McIntosh MA6900, ex-display model (£5195)	£3495
Musical Fidelity A5 Pre (£1499)	£795
Musical Fidelity 550K Supercharger (£2998)	£2199
Musical Fidelity KW550 Integrated (£5000)	£2495
Musical Fidelity KW550 Integrated (£5000)	£2995
Papworth TVA-8 Class A Integrated (£2000)	£1195

Qinpu A1.0x Integrated (£300)	£230
Qinpu A-8000 MK II Integrated (£1295)	£795

### LOUDSPEAKERS

ART Speakers Emotion, Rosenut veneer (£5000)	£3750
ART Emotion Monitor, Cherry (£4000)	£3250
ART Stiletto 6 ex-dem in Oak (£2000)	£1495
ART Emotion Signature, Ex-dem (£9000)	£5995
ART Emotion Monitor (£4000)	£3250
ATC SCM50ASL, cherry finish (£7958)	£4995
AVI Pro Nine Plus Standmount, cherry (£890)	£695
Dali Euphonia M54, Appli upgrade finish (£7500)	£4995
Dali Helicon 400 (£2995)	£2250
Hyperion 938, one owner, gloss black (£3750)	£2995
JAS Audio - Plato Reference (£13995)	£7995
JAS Audio - Orior (£2300)	£1495
JAS Audio - Orsa (£1399)	£1095
JAS Audio - Supertweeters, Pair (£649)	£449
Leema Acoustics Xone, ebony finish (£1895)	£1395
Spendor S9 Maple (£2795)	£1395
Tannoy 15" Monitor Gold Speakers	£2500
Wilson Benesch Arc, silver stands-side cheeks (£2600)	£1695

### ANALOGUE

Origin Live Aurora Mk1 T.Table + Origin Live Silver tonearm	£995
SME Model 10 Tonearm (£900)	£595
Wilson Benesch Full Circle (£2150)	£1695

### MISC

Isotek Nova (£1750)	£1195
Isotek Titan Multiink 6 way socket (£395)	£325
Isotek Nova (£1750)	£1295
Isotek Sigmas, unmarked condition (£995)	£749



Chord Cables  
Full range available

For the latest news and special offers - sign-up to the FREE shadow audio weekly newsletter (visit shadow audio home page)

design: © audiography 2008. HF08004

Specialist Brands include: ADAM Audio, Apollo, ART Loudspeakers, Audio Zone, Audio Physic, ATC, AVI, Bel Canto, Bryston, Chord Cables, Creek, EAR/Yoshino, Eastern Electric, Epos, Gamut, Hovland, Hyperion, IsoTek, JAS Audio, JungSon, Manley Labs, Marantz Legendary, McIntosh, Mordaunt-Short, Musical Fidelity, Musical First, Music Tools, Nordost, Opera, Origin Live, Pathos, PMC, Project, Resolution Audio, Shanling, SME, Tannoy Prestige, Unison Research, Vertex AQ, VPI, Wadia, Wilson Benesch and many more.

"the BBC wants to block access to its own higher quality Internet radio streams on DAB radios – unbelievable!"



## steven green

**T**he BBC and ITV have finally launched Freesat, the satellite equivalent of Freeview, which requires a one-off payment to receive digital TV and radio. Freesat is mainly being sold on the basis that it's the first platform to provide free access to HDTV channels though, as the BBC HD channel is already available, and the ITV HD channel (and possibly Channel 4 HD) will be available in the near future. One thing that most people won't be aware of however, is that only one of the Freesat set-top boxes – the Humax Foxsat-HD – can receive all of the 200 digital TV channels and 100 digital radio stations that are freely available on satellite, whereas all of the other Freesat set-top boxes can only access the 80 or so channels that are listed on Freesat's electronic programme guide (EPG).

This is because channels have to pay to be listed on it, and Freesat also chooses which channels can be included on the EPG, which depends on the content the channels provide. That's their prerogative of course, but they certainly shouldn't be blocking access to the other free channels that are available, which is exactly what's happening at the moment on all of the Freesat receivers apart from the Humax!

One interesting feature that all current Freesat set-top boxes include is an Ethernet port to allow connection to the Internet, which the BBC is planning on exploiting to make the BBC iPlayer streams available to Freesat owners by the end of the year – Freesat set-top boxes will receive an automatic software upgrade that's broadcast via satellite once the work to support the iPlayer has been completed. The BBC has said on a

number of occasions that it would like to allow people to watch iPlayer programmes on TV sets rather than users being limited to watching on computers or laptops, and they're also working on bringing the iPlayer to Freeview, although there are no Freeview set-top boxes available that include an Ethernet port at the present time.

The iPlayer has also launched on the Virgin On Demand TV service recently, with programmes being broadcast at higher quality than computer users receive via the Internet, and the BBC has said that it hopes to make the iPlayer available on the other video-on-demand services (BT Vision, Tiscali TV, Orange TV and the Sky Player) in the near future. As well as providing access via TV platforms, the iPlayer has been available on Apple's iPhone and iPod touch and on the Nintendo Wii games console for some time now, and the BBC has said that it's planning to add support for more smartphones and games consoles throughout the year.

Given how keen the BBC is to make the iPlayer TV streams available on as many platforms and devices as possible, it's interesting to contrast this with the way the BBC views using the Internet as a platform for digital radio. I wrote in last month's column about how the BBC had been inventing wholly inaccurate excuses for why the Internet shouldn't become a major platform for digital radio, and their hypocritical stance continued recently when they unveiled a new prototype DAB portable radio, which they had commissioned a design consultancy to produce for them. The prototype DAB radio, called 'Olinda', has had Wi-Fi added to allow it to connect to the Internet, but the BBC actually

specified that the radio should only receive DAB broadcasts! The Internet connection has only been added to enable 'social networking', which in practice means that the radio would allow listeners to see which radio stations and music their friends were listening to...

The BBC has since told me that they are looking to provide access to on-demand content (such as the BBC's Listen Again streams) on DAB radios that have Internet connectivity, but they said that they're not planning on providing access to live Internet streams. Although we will still see plenty of Wi-Fi and combined Wi-Fi/DAB/DAB+ receivers that will be able to receive live Internet streams, it's the principle that counts. The BBC's Royal Charter states that the BBC should help "to deliver to the public the benefit of emerging communications technologies and services", so I would say that they're disobeying their Charter here. And the general public pays for the BBC anyway, so the BBC should act in the public's best interests, but it is hardly doing that by encouraging manufacturers to block access to live Internet streams on DAB radios that have an Internet connection. The same applies to the blocking of freely available channels on Freesat, and Freesat is also a company that's jointly owned by the BBC.

What makes this even harder to take is that the BBC knew that the audio quality on DAB would be severely degraded when it added five stations to its national DAB multiplex in 2002, yet now that the BBC's Internet radio streams are about to overtake DAB in terms of audio quality later this summer, the BBC actually wants to try and block access to its own higher quality streams. Unbelievable. ●



# Walrus 11 New Quebec St, London W1



Brinkmann La Grange+10.5 Tonearm (£10,990)  
 Another in the (very) shortlist for the best, at a price only a fraction of some competitors.  
 You may never want another turntable after auditioning the Brinkmann combination!



Heco  
 Celan 500 (£1129)  
 These impressive floorstanders are both sensitive and subtle offering superb value for money.



Pure Sound A30 Amp (£1199)  
 British designed / Far Eastern made the A30 is stunning value. It might look plain, but boy, does it sound good! We also stock the amazing P10 valve phono stage (£449).



Aura Note Music Centre (£1400)  
 The complete solution. CD, FM/AM tuner, USB stick/drive reader (MP3, WMA, OGG), and digital audio from your PC/Mac via USB. Sound is clear and clean, with 50W/ch on tap. A Killer Product!



Musical Fidelity A1 (£999)  
 The legend returns! The all new A1 has a very difficult act to follow but does it by a wide margin. Features remote control, 6 inputs including phono and USB, 30W/channel, and still a true Class A design (MF spec). Come and have a listen now - waiting list expected!

## STAX

Stax



2050 Mk2 System  
 SR-007 Omega System 2

Luxman L550A (£2795)  
 A very complete solution. The usual excellent Luxman sound quality, 20W class A (although measures far more), decent phono stage, balanced inputs, tone controls. I want one. Now.



Lyra

We consistently sell more Lyras than any other enthusiast pickup. They succeed in being both extremely musical and accurate at the same time.  
 Dorian - £495 Helikon - £995  
 Argo i - £795 Skala - £1849  
 Titan i - £2695



\* Please ask about our ex-demo stock; many items are virtually as new but with large reductions.

We deliver by Business Post 24hr service (subject to stock availability) and internationally by DHL, TNT or UPS  
 Major credit/debit cards accepted, even known to take cash on occasions!  
 Please visit our website for product technical and ordering info



- a2t
- acoustic signature
- acoustic solid
- acuhorn
- aesthetix
- air tight
- amazon
- amity
- amplifon
- amr
- apollo furniture
- audio aero
- aura
- basis
- benz micro
- black rhodium
- bocchino
- breuer dynamic
- brinkmann
- cartridge man
- cawsey
- clearaudio
- consonance
- decca london
- duevel
- dynavector
- ear yoshino
- emt
- funk firm
- goldring
- graham (tonearms)
- graham slee
- hadcock
- harmonix
- heco
- heed audio
- horning
- hyperion
- incognito
- isolda
- jadis
- kibri
- koetsu
- luxman
- lyra
- lyra connoisseur
- mcintosh
- melody
- michell engineering
- mit cables
- morch
- musical fidelity
- nordost
- nottingham analogue
- origin live
- ortofon
- pro-ject
- pure sound
- rega
- reimyo
- revolver
- ringmat
- roksan
- shun mook
- shanling
- sme
- solid tech
- something solid
- sonneteer
- spendor
- stax
- stello
- stirling broadcast
- sumiko
- tannoy
- tci cables
- tom evans
- townshend audio
- transfiguration
- trichord
- usher
- van den hul

tel: 020 7724 7224 fax: 020 7724 4347 contact@walrus.co.uk www.walrus.co.uk

"I have been a firm believer of the power of the niche for many years..."



## paul rigby

I have been a firm believer of the power of the niche for many years now. When any market becomes satiated, when the masses have consumed all that they require of a particular basic item – they go looking for 'me' products. A 'me' product is something apparently tailored to that person's taste, lifestyle and financial circumstances. Many mature industries have already developed to cater for the 'me' consumer: housing, transport and food are obvious examples. The person, for example, who is a devout push-bike enthusiast will, more than likely, differ in their transportational view and priorities to the driver of a Jaguar saloon. They both get you from A to B but the philosophy behind each is completely different.

Other industries are moving towards 'me' status. The mobile phone industry is one example. The larger manufacturers are targeting China and India as the next mobile growth markets because all Europeans, for example, are deemed to already own a phone. Nokia *et al* will have to create niche phones, in Europe, to create new markets. In fact, this has already begun. Blackberrys target business users, pink handsets target ladies, JCB Toughphones target construction workers and so on. We are now seeing the same effect in audio. Downloads target those looking for portability, CDs target those wanting convenience and good quality audio, vinyl targets hard core audiophiles and reel-to-reel tape sellers (yes there are some) target Luddites [steady on Paul! – Ed.]. Now SACD is joining the niche gang – slipping somewhere in between the CD and the vinyl brigades. SACD enthusiasts are those looking for convenience whilst worrying about

the quality of the final sound. No, SACD will never be a mass medium for audio but yes, it might survive for a long time as a niche product...

You can now find SACD productions appearing from a range of small to medium record labels covering a wide range of musical genres and artists, including the new Eleanor McEvoy album, 'Love Must Be Tough' (Moscodisc). Mick O'Gorman, who runs the label, is well aware of the SACD niche. "We tilt what we're doing partially to the hi-fi community; they were the first people to take to Eleanor, so you're very much in mind. In the past we recorded in the traditional way using analogue tape but that's becoming harder to do. Analogue tape is scarce and the machines are becoming unreliable and they're large so they tie you to a particular location. Also, there's a pressure on us from our distributors to make a product cheap enough that Tesco wants it. This is why we have a CD version and an SACD version."

The recording costs are the same for each but SACDs are much more expensive to manufacture – up to three times as much. "Because we respect the hi-fi community, we thought we'd also make an SACD product with extra tracks," said O'Gorman. In this case two extras: 'Whistle For The Choir' and 'Please Heart, You're Killing Me'. Also, the packaging is more lavish, within a fold-out digipack. Vinyl fans shouldn't despair however, as Diverse Vinyl is currently working on a vinyl version.

"We record everything to DSD," said O'Gorman, "so the CD version was derived from a DSD as well as the SACD. There's something about DSD that provides the final recording with a lovely musical quality in the same way that pristine vinyl does.

It's more open, faster... it's like taking the roof off the car. It's out there. To me it's the last, great, uncompressed audio medium."

Well, we will see what any possible audio variant of Blu-ray delivers, of course. O'Gorman did make extra efforts to maintain the sound quality throughout the recording chain, however. "This new album was the first time we recorded digitally. However, we did record on a valve desk". O'Gorman is not a fan of surround sound, however. "We mixed the 2004 album, 'Early Hours', from Eleanor in surround. We did it because we could but we were grappling, trying to find things to do. We haven't found any particular reason to do it again."

Which means that I should qualify my statement. It's stereo SACD which will become the survivable niche. Actually, in this case a sub-format of SACD: a niche within a niche. Is this the first of a new level of niche-ness? Well, no. Vinyl has beaten stereo SACD to the punch as audiophile vinyl is a niche product from standard vinyl. Downloads too, have split into low-fi MP3s and high [or higher] quality formats such as Linn's 'studio quality' downloads. Even CD has its extra level – HDCD!

That there are markets to support these niche products is testament to the maturity of the audio industry and the world-wide distribution network that is the Internet. So what's the next stage? As I predicted over a year ago in this column, hi-res downloads via fast broadband. Another niche? Oh yes. But then, how else will you fill the hard disk of the likes of the audiophile grade Naim HDX network audio player? Behold! The dawning of yet another 'me' product... ●



Controlling bass in your system is crucial to tempo and timing, even if your favourite music has no deep bass. Why?

# Get the bass right

Customers sometimes say, "I don't like bass." Usually it's because they've had boomy speakers, a room that's difficult or limited space.

Yet getting bass right is one of the most difficult parts of **INTEGRATING** a system into a room – something we take seriously with customers.

The problem is that bass below 30Hz starts to "EXCITE" THE ROOM which then adds its own character, exaggerating bass. Music becomes ponderous, lacking drive and energy. Deep frequencies from the studio acoustic may have **MODULATED THE AUDIO RANGE** which gains presence when the system is bass-capable.

We always like to install one sub-woofer (or better two) whether main speakers are large or small to control bass and **DRIVE THE ROOM**. These are not bass-blasters but subtle devices placed carefully.

Music gains space and pace, rhythm is tight and the whole performance is more **INVOLVING**.

Subs are especially successful when room space is tight and there's little scope for moving speakers. Then the best option is smaller main speakers placed close to the wall, supported by subs **TAILORED TO THE ROOM**.

Results can be awesome.

Large speakers with deep bass output may also be a problem. Sub-woofers **FINE-TUNED** to the room can cancel the excess and reveal nimble, rhythmic bass. A new system!

Let us advise you about *your* bass.

Customers say we make some of the **BEST SOUNDS** they have ever heard, so you know we can do the same in your home. Our advice will take account of your best components and guide you where change is needed, in stages you can afford. You **AVOID EXPENSIVE MISTAKES**, enjoy music along the way and save money in the long run.

**JUST LISTEN AND YOU'LL KNOW**

The Right Note  
Music in the home



01225 874728  
or lo-call  
0845 230 7570

**CD:** ACCUSTIC ARTS, BEL CANTO, dCS, GAMUT, RESOLUTION AUDIO, STELLO, WADIA.  
**VINYL:** AESTHETICS, CLEARAUDIO, DNM, GRAHAM, THE GROOVE, LEHMANN, MICHELL, SUMIKO BLUE POINT SPECIAL, TRANSGURATION. **AMPLIFIERS:** BEL CANTO, CAT, DNM, GAMUT, HALCRO, HOVLAND, SONNETEER, STELLO. **LOUDSPEAKERS:** AUDIO PHYSIC, DALI, ETHOS, GAMUT, NEAT, TOTEM. **CABLES:** CHORD CO., DNM, NORDOST, SILTECH, VERTEX AQ. **MAINS:** VERTEX AQ. **SUPPORTS:** ARCICLI, STANDS UNIQUE, VERTEX AQ

# Better off DEAD

**KILL UNWANTED NOISE**  
**ACOUSTIC DAMPING PRODUCTS**  
ISOLATION AND SHOCK ABSORPTION      DAMPING & BACK WAVE CONTROL



WORLD RENOWN PATENTED ACOUSTIC DAMPING PADS

Spectra Dynamics developed and produced the Deflex Acoustic Pad over 15 years ago. One of the most cost effective ways to upgrade your system. Still one of the best "tweaks" for performance and value.

Now available in a range of sizes:

Standard panel 28cm x 21cm.....	£6.00
Medium panel 28cm x 18cm.....	£5.00
Small panel 24cm x 13cm.....	£4.00
NEW SIZE panel 18.5cm x 12cm.....	£3.00
NEW SIZE panel 15.5cm x 15.5cm.....	£3.00
NEW SIZE panel 12cm x 12cm.....	£2.00
NEW SIZE panel 8.5cm x 8.5cm.....	£1.50
Sub-woofer panel 34cm diameter.....	£12.00
NEW SIZE panel 30cm x 30cm.....	£12.00

### ANTI-VIBRATION FEET & PADS

FOCULPODS & POLIPODS brought inexpensive isolation feet to Hi-Fi enthusiasts all over the world without the need to cut squash balls in half. Tried and tested with noticeable improvements in a range of equipment. Supplying "feet" to the trade for over 12 years

Now available in a range of sizes:

Superpods standard 75mm dia x 40mm - ea.....	£14.00
Foculpods pack of 4 (50mm dia x 20mm).....	£14.95
Polipods pack of 8 (40mm dia x 15mm).....	£14.95
Isolation block 75mm sqr x 20mm ea.....	£4.00
Isolation block 115mm sqr x 20mm ea.....	£6.00
Isolation block 150mm sqr x 20mm ea.....	£10.00
Isolation block 43mm dia x 25mm ea.....	£2.50
Isolation block 43mm dia x 15mm ea.....	£2.25
Isolation block 43mm dia x 15mm hard base ea.....	£2.50
Isolation block 80mm dia x 14mm thick ea.....	£2.50
Iso block 120mm dia x 30mm - 40mm hole ea.....	£10.00
Deflex pad 102mm x 102mm x 4mm thick ea.....	£2.50
Deflex pad 102mm dia x 4mm thick ea.....	£2.25
OEM foot 38mm dia x 20mm ea.....	£0.90
OEM foot 66mm dia x 24mm ea.....	£4.50

OTHER SIZES AVAILABLE  
DELIVERY FREE for FOCULPODS & POLIPODS

### PLAIN & RIBBED DAMPING SHEET

DEFLEX material has been used for damping in a range of vibration sensitive equipment such as electron microscopes and laser instruments.

Available in a range of sizes:



Plain sheet 15cm x 15cm x 2mm thick.....	£2.50 ea
Plain sheet 28cm x 21cm x 3mm thick.....	£5.00 ea
Plain sheet 28cm x 21cm x 4mm thick.....	£6.00 ea
Plain sheet 28cm x 21cm x 6mm thick.....	£8.00 ea
Plain sheet 28cm x 21cm x 8mm thick.....	£10.00 ea
Plain sheet 47cm x 22cm x 3mm thick.....	£10.00 ea
Plain sheet 47cm x 22cm x 5mm thick.....	£15.00 ea
Plain sheet 52cm x 38cm x 4mm thick.....	£15.00 ea
Plain sheet 52cm x 38cm x 8mm thick.....	£30.00 ea
Plain sheet 63cm x 50cm x 5mm thick.....	£25.00 ea
Ribbed sheet 28cm x 21cm x 3mm thick.....	£5.00 ea
Ribbed sheet 28cm x 21cm x 6mm thick.....	£8.00 ea
Heavy ribbed sheet 28cm x 21cm x 10mm thk.....	£12.50 ea
Sealing strip 10mm x 3mm x 3mtr long.....	£6.50 ea

### MISCELLANEOUS DAMPING / ACOUSTIC PRODUCTS

#### MAGNET DAMPING PADS

Magnapad - 75mm dia.....	£1.75 ea
Magnapad - 125mm dia.....	£2.75 ea
Magnapad - 175mm dia.....	£4.50 ea
Magnapad - 225mm dia.....	£8.00 ea

#### TUBING

Tube 25mm dia / 10mm bore x 60cm long.....	£30.00 ea
Tube 25mm dia / 16mm bore x 60cm long.....	£25.00 ea
Tube 32mm dia / 10mm bore x 1mtr long.....	£37.50 ea

#### VARIOUS

Corner block - edge length 38mm.....	£0.50 ea
Corner block - edge length 50mm.....	£0.75 ea
Washers 25mm or 20mm x 5mm thick.....	£0.25 ea



# DEFLEX

All prices include VAT - Delivery from £2.00 ALL MAJOR CREDIT CARDS ACCEPTED

**SUPPLYING THE HI-FI INDUSTRY SINCE 1992**

DEFLEX POLYURETHANE LTD, UNIT 12, VICTORIA TRADING ESTATE, ABERGEELE ROAD, BODELWYDDAN, DENBIGHSHIRE, LL18 5SS  
www.Deflex.org or telephone 01733 819002 fax 01745 583543

# "What a confused world British broadcasting has become!"



## noel keyword

**W**hat a confused world British broadcasting has become! DAB digital radio was meant to represent the future but it barely works. I can't get it on a portable in Central London, just four miles from a transmitter! As for Freeview, tuning into 'Trooping the Colour' brought up picture quality that was worse than my outdated Panasonic 3CCD camcorder. Trees were blurry, uniform details barely discernible and all the splendours of a parade like this lost in a low resolution blur. At times I feel the BBC is in disarray over programme delivery, but the arrival of Freesat and Britain's first high definition television transmissions on BBC HD may change this...

The stations available on Freesat don't wow me, but BBC HD does. And to be fair to the BBC, it wasn't just sound and picture quality that I find impressive, but programme quality too. BBC HD shows just how powerful the result can be when high quality exists throughout the chain, allowing viewers to become immersed in what's happening onscreen, or should I say 'in room'? I mentioned the pithy 'No.1 Ladies Detective Agency' in my piece on Freesat, beautifully filmed and fascinatingly different from the usual fare on TV. Dolby Digital delivers an easy-on-the-ear sound that is more atmospheric than impactful, but it brings a nice easy feeling to dialogue, unlike the rasping nature of MP2. Rear channel information was weak for much of the time, which was a pity as this sort of situational programme exists in a soundscape that really needs to be captured and conveyed into the home.

Unfortunately, the capture of an audio sound field, although understood, hasn't yet been formalised for live sound recording

and so frontal stereo remains common, which is disappointing. I'm sure a directional stereo mic, pair pointed rearward could be used to gather an ambient rear field, even if it wasn't perfectly composed, Ambisonic fashion. When the credits rolled sound did appear in the rears. This isn't unusual; surround-sound on DVD and Blu-ray is commonly dubbed on during editing in the studio, not captured on location, which is what happened here.

Then we got an interesting studio based music session with Paul Simon singing 'Graceland', followed by Yusuf Islam (aka Cat Stevens) singing 'Peace Train'. He's still in good voice and the band was well miked up and balanced, giving very pleasant sound quality. It wasn't comparable to the latest Blu-rays like Elton John's 60th birthday concert in New York, or Nine Inch Nails in concert, both in hard hitting uncompressed PCM. But it was a whole lot better than usual from TV, the picture was sharp and detailed, with well saturated colour. Sound mixing was conservative, with little in the rear channels, except audience applause at the end. But even this distinguished the performance as something of a useful step up from the frontal stereo we get at present. It was television that compares well with Blu-ray, which is saying something.

The sound could easily be better. Satellite has enough capacity to carry Dolby Digital+, which provides an easy upgrade to the normal Dolby Digital, which is getting long in the tooth. But programme makers and broadcasters really need to sort out how to record rear channel information and what it should comprise - and then do it. Leaving the rears silent isn't doing the job. I was surprised when football came on and accompanying a wonderful picture

was - stereo. The rears were silent, with no sign of crowd noise - and how easy is that to capture? Later, France versus Italy was in surround-sound though.

Inconsistency doesn't only affect sound. Trooping the Colour is a glorious event, a feast for the eye and the ear, with the shining breast plates, deep reds of the uniforms, sound of the band and clatter of boots and horses' hooves. It's an event where HD cameras can be used with ease, yet the picture was atrocious. Capturing high quality sound at an event like this isn't a great problem either, but the BBC just hadn't bothered. The mics sounded very distant from the parade, even though at one point a camera on a dolly was closely tracking the marching lines and clearly able to provide close miked sound, but it didn't.

Trooping the Colour was relegated by the BBC to a hazy, distant low def event, made very obvious by the contrasting sound and picture quality from BBC HD just a few clicks away on the remote control. Switching between the two was a shock. I can't help but feel that when Britons see what HDTV has to offer, they won't be putting up with sloppy SDTV like this. It was poor even as 576i goes, quite frankly.

Freesat has great potential to deliver quality programmes into the home. I'm not sure technologically confused and obdurate broadcasters will be quick to exploit it, but I certainly hope they do. All the technology is finally in place to deliver fantastic quality into 93% of British homes - without a transmitter in sight. This leaves DAB and Freeview in a strange place. Someone still has to work out how to transmit to portables and cars, then the confusion that currently besets broadcasting may clear. ●



# SPRING INTO SUMMER

VISIT OUR WEBSITE: [www.hi-fiworld.co.uk](http://www.hi-fiworld.co.uk)

## UK SUBSCRIPTION SAVE UP TO

# 12.5%

**SAVE UP TO 12.5%** off the cover price when you subscribe to Hi-Fi World. That's an amazing £3.33 per issue, including postage.



FOR BACK ISSUES ENQUIRIES PLEASE CALL

**01442 879097**

OVERSEAS SUBSCRIPTIONS IF YOU LIVE OUTSIDE THE UK,  
PLEASE CALL FOR OUR LATEST PRICES

**+44 (0) 1442 879097**

**SO WHAT ARE YOU WAITING FOR? CALL NOW!!!**

**SUBSCRIPTION HOTLINE 01442 879097**

Lines open Mon-Fri 9.00-5.00 or (weekend answering service available)

FOR OUR  
ON-LINE MAGAZINE  
SEE P120

email:  
[hifiworld@webscribe.co.uk](mailto:hifiworld@webscribe.co.uk)

Fax No:  
01442 872279

# WITH HI-FI WORLD

## WHY SUBSCRIBE TO HI-FI WORLD?

- 12 issues a year delivered straight to your door.
- Be first to grab a bargain in our "Free Reader Classified Ads" section.
- Run by dedicated hi-fi engineers and enthusiasts.
- Subscribers receive a minimum 10% Discount annually.
- Hi-Fi World has become famous for its informative reviews and radical kit designs.
- **PLUS!** Subscribe by Direct Debit and receive a 12.5% discount (UK only).

I would like a years subscription to Hi-Fi World and receive a discount off the cover price (I have read and accept the terms and conditions).

I would like to pay for my 12 issues by:

- 6 monthly Direct Debit: Pay £19.95 every 6 months saving 12.5% off the yearly subscription rate of £45.60
- Annual Direct Debit: Pay £39.90 every 12 months saving 12.5% off the yearly subscription rate of £45.60
- Annual cheque/credit card: Pay £41.04 saving 10% off the yearly subscription rate of £45.60

### Instruction to your Bank or Building Society to pay by Direct Debit



Please fill in this form and send to:  
Hi-Fi World, Webscribe Ltd, PO Box 464, Berkhamsted, Herts., HP4 2UR

Originator's Identification Number

4	2	7	0	4	9
---	---	---	---	---	---

Name and full Postal Address of your Bank/Building Society

To: The Manager Bank/Building Society

Address Postcode

Name(s) of Account Holder(s)

Branch Sort Code

--	--	--	--	--	--

Bank/Building Society Account Number

--	--	--	--	--	--	--	--	--	--

Reference

HF

**Instruction to your Bank or Building Society**  
Please pay Webscribe Ltd Direct Debits from the account in this Instruction subject to the safeguards assured by the Direct Debit Guarantee. I understand that this instruction may remain with Webscribe Ltd and, if so, details will be passed electronically to my Bank/Building Society.

Signature(s)

Date

Bank and Building Societies may not accept Direct Debits Instructions for some types of accounts  
**The guarantee should be detached and retained by the Payer**

#### The Direct Debit Guarantee

- This Guarantee is offered by all Banks and Building Societies that take part in the Direct Debit scheme. The efficiency and security of the Scheme is monitored and protected by your own bank or Building Society
- If the amounts paid or the payments dates change Webscribe Ltd will notify you 10 working days in advance of your account being debited or as otherwise agreed
- If an error is made by Webscribe Ltd or your Bank or Building Society, you are guaranteed a full and immediately refund from your branch of the amount paid
- You can cancel a Direct Debit at any time by writing to your Bank or Building Society. Please send a copy of your letter to us.



### Your Details

Title \_\_\_\_\_ Forename \_\_\_\_\_

Surname \_\_\_\_\_

Address \_\_\_\_\_

\_\_\_\_\_

\_\_\_\_\_

Post Code \_\_\_\_\_

Daytime Tel: \_\_\_\_\_

Email: \_\_\_\_\_

Please debit my  VISA  MASTER  MAESTRO  AMEX (SWITCH)

Security No:    (last three digits printed on the signature strip)

Valid from Date: \_\_\_\_/\_\_\_\_/\_\_\_\_ Expiry Date: \_\_\_\_/\_\_\_\_/\_\_\_\_

Switch card issue No:

Cardholder Signature: \_\_\_\_\_

**Outside UK:-**  
**EUROPE** Airmail £50.00   
**OVERSEAS** Airmail £70.00



## Send this form to:

Hi-Fi World, Subscriptions Department PO Box 464, Berkhamsted, Hertfordshire, HP4 2UR.



# WD25T v2

## Peter Comeau looks at the process of refining the crossover for the redesigned WD25T v2

### Part 2 - The Crossover

push those areas forward slightly in the overall tonal balance. For example if the level through the crossover region is raised by, say, 0.5dB around 3kHz then listeners will be aware of all sorts of noises in the treble region that they may not have been aware of before. Hearing that little extra frisson of squeak as fingers slide over strings, or the intake of breath as a vocalist begins to sing, can make a listener exclaim 'Wow, I've never heard that before'.

But artificially 'revealing' these details by exaggerating a selective frequency band does not make the speaker 'transparent'. By transparency we mean that the speaker, in itself, begins to disappear so that all you hear is what the performers are doing. Such transparency of reproduction is an exceedingly difficult trick to bring off in a loudspeaker, surrounded as we are by distortions, colourations, cabinet panel resonance and overhang from the drive units.

However it can be done. One listener to the final version of WD25T 'The Sequel' commented that he couldn't get over how the musicians seemed to be right there in the room with him. That's the effect of a 'transparent' loudspeaker.

### TRANSPARENCY AT ALL COSTS

So just how do you achieve this transparency with your speaker designs? The only way, in my experience, is to try out different techniques for every single part of the speaker design. That means listening to drive units, cabinets, crossover designs and crossover components. Every single aspect of the design has to gel together to deliver that realistic transparency of

sound reproduction.

Remember, what we are looking for is a method of reproduction where the musical performance becomes of greater audible significance than the item that is producing the sound. Naturally your source components and amplifier need to follow these attributes too. And that's sometimes difficult to achieve in itself.

It is unfortunate that, all too often, commercial products do not achieve this level of transparency. There's a good reason for this and it is called 'marketing'. As an example if a speaker manufacturer wants to make his product stand out from the crowd the simplest design 'trick' is to artificially boost bass, midrange and treble.

All three at once? Let me explain. The ideal fast selling speaker has what I like to call the 'three hump' response. Imagine the frequency response having a hump in the bass, a hump through the upper midrange and a hump in the upper treble. We can, perhaps, narrow this down to a 2dB lift in output around 80Hz, a 1dB lift around 1kHz and a 2dB lift at 15kHz.

Actually the very nature of today's bass reflex, two-way designs makes this easy to achieve. Tune the bass reflex driver/cabinet combination so that the Q of the system is rather higher than optimal for 'perfect' damping and you'll see the output rise between 80 – 120Hz. In a stand mount speaker this will give rise to comments like 'how do they get amazing bass from such a small box?' or a reviewer's write up along the lines of 'great bass extension from a stand mount'.

In fact the bass isn't extended at all. Sweep a sine wave generator

If you read last month's introduction to WD25T v2 'The Sequel' you'll have seen how I used our new ARCEA cabinet material to remove mid-range 'bloom' by reducing output from the WD25T cabinet panels. In addition we have added a solid oak plinth to improve mechanical stability for the whole speaker. As a result the tonal balance of the speaker as it stands has changed (for the better) requiring a rethink for the crossover.

In fact the crossover changes result in more than just a tidying up of the tonal balance. I had been aware, for some time, that there was an area of undue 'brightness' through the crossover region. Other listeners, in the main, have not noticed this but, to my ears, the effect is one of enhanced output around 2kHz which can make some modern recordings slightly uncomfortable to listen to at times.

The trick with making a high performance, and musical, loudspeaker is to balance it so that it is transparent through to the source but not so 'revealing' that it does not suffer poor recordings gladly. How, I hear you ask, can a speaker be 'transparent' but not 'revealing'?

In essence it is easy to make a speaker design sound extremely detailed in certain areas. You just

# 'The Sequel'

through the bass and you'll hear that the 40Hz input has a strong output at its second harmonic, namely 80Hz. As few people know what 40Hz sounds like (it's hardly audible from most instruments in real life), they assume that the 80Hz output is indicative of 'deep' bass.

Now let's look at the midrange area. In a small driver the output rises significantly as the frequency increases. Of course the series coil in the crossover is used to suppress this but, as the crossover region at 3kHz is approached, you can't depress the midrange too much or you'd have virtually no output at crossover in order to match with the treble unit. So the best thing to do is to let the midrange rise a little up to the 1 – 1.5kHz area and then bring the crossover in so that the output is 6dB down at 3kHz.

This naturally leaves the 1kHz area slightly exposed. But that's no bad thing because, as we've seen, it adds a forward 'presence' to the speaker which enhances midrange power, brings vocalists and strings forward in the mix, and makes the speaker sound very detailed.

Similarly, adding a crossover to a treble unit also provides for an output which rises with frequency unless the treble unit voice coil has enough inductance to prevent this. That's unusual in today's treble units because of the insistence of designers that treble has to extend well into the ultrasonic region. So low inductance and a light voice coil are absolutely necessary.

As a result, the output of most speaker designs does lift between 10 – 20kHz. Again, this isn't audibly obvious as these frequencies are too high to make themselves objectionable, but it does have the effect of enhancing the extreme overtones of instruments, for example adding a little extra 'shimmer' to cymbals.

In effect, this type of three humped tonal balance is very attractive and immediately gets the speaker noticed in the demo room. And speakers that get noticed get

sold. So, if you want to go ahead and design a 'best-selling' commercial loudspeaker you won't go far wrong if you dial a little bit of the three hump response into your speaker! But does this make for a 'transparent' speaker even though it certainly makes for an apparently revealing one? The answer isn't 'no', but it isn't 'yes' either, and here's why.

The biggest problem with many commercial speakers designed to sound attractive on first listen is that they can prove wearing over time. They also tend to respond to good 'hi-fi' recordings well but mediocre and poor recordings sound awful. That's might be because the non-hi-fi 'pop' recording has been mixed with exactly the same 'three hump' approach.

In that case the bass will sound overblown and indistinct, the mid will sound strident and grating and the treble will sizzle and sound grainy. Being only able to play 'hi-fi' standard recordings unfortunately limits your musical appreciation severely because there aren't many recordings of music you want to hear that are made to top-notch hi-fi standards.

## THE WELL TEMPERED SPEAKER

That doesn't mean that a transparent speaker has to have a ruler flat frequency response. In fact those that do tend to sound even worse than ones with the 'three hump' design approach. To look at why this should be we need to consider other aspects of speaker design than just frequency response.

Remember that the measured frequency response is taken from the initial transient of the speaker. It has little indication of what happens over time. In other words it doesn't show what is being produced by the speaker after the initial transient has passed.

Nor does the frequency response show what the speaker is doing off axis. And that is important because the off-axis output is reflected from walls, floor and ceiling to arrive at our ears and 'fill in' the tonal balance.

So we need to look at both these aspects to find out what elements of the speaker's behaviour is affecting our listening experience in the room.

For a start it's worth considering the 'BBC dip' because this is elemental to our understanding of why a ruler flat frequency response is NOT desirable. The origin of the BBC dip seems to date back to the plastic coned monitors developed for nearfield studio monitoring in the late '60s. The commonly held view is that the combination of plastic cones and nearfield proximity of the studio engineer to the speakers resulted in an unpleasant and disturbing 'hardness' through the lower treble region of 2 – 4kHz. By depressing this region by 3dB the output was made more relaxing and easier to listen to with a slightly distant perspective.

In fact, analysis of the famous BBC LS3/5a nearfield monitor shows no evidence of the BBC dip, but it is present on some of the larger monitors of the time. This indicates that it wasn't so much an engineering policy but more a reaction to the overall balance of the design of individual monitors. So why was the dip considered necessary in the first place? The answer lies both in the ear's sensitivity to certain frequency bands coupled to the behaviour of modern speaker drive units.

It's no secret that the ear is most

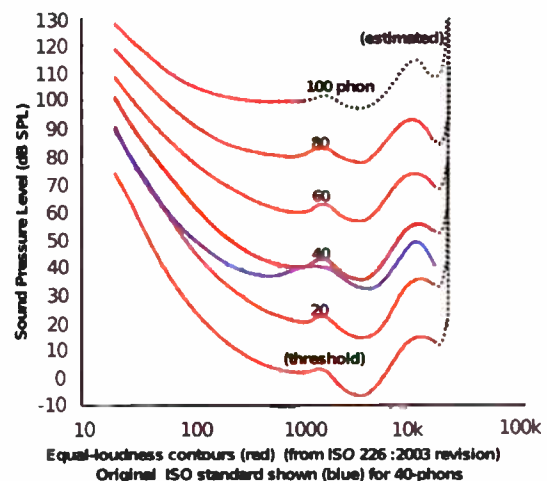

*The ISO curves of equal apparent loudness. Simply inverting these does not make a good crossover!*



sensitive through the 2 – 5kHz region as this can easily be discerned from the ISO Robinson-Dadson (or earlier Fletcher-Munson curves) graph of equal apparent loudness. Look at the graph and you'll see that you need the lowest output at 4kHz to sound equally as loud as other frequencies.

That doesn't mean that we should design a speaker that has a response that looks like the ISO curve of equal loudness. This curve just indicates sensitivity of the ear for which your brain automatically compensates.

What these curves do indicate is that any anomaly in the performance of the speaker in the 2 – 5kHz region is going to show up like a sore thumb simply because this is where the ear is most sensitive. And, as I've indicated before, peaks are easily heard and dips are easily ignored.

Now if we look at what is happening with the outputs of our drive units in a speaker with a typical 3kHz crossover we find that there is, indeed, an anomaly between the behaviour of the drive units. That anomaly in behaviour is caused by the fact that we are crossing over from a cone drive unit that has a narrowing dispersion as frequency increases to a dome drive unit that has a hemispherical output.

So when we look at the in-room behaviour we will see that the power radiated into the room is reduced as we reach the top of the bass-midrange driver's output. However, as soon as the treble unit starts to radiate, the radiated power in the room increases dramatically.

In practice the output of the bass-midrange unit is starting to beam from 800Hz upwards and we can compensate for this by increasing the on-axis response through the 1 kHz region. So speakers which exhibit a good 'presence' range and project vocals naturally typically have a hump in the response through this area.

As soon as the crossover begins

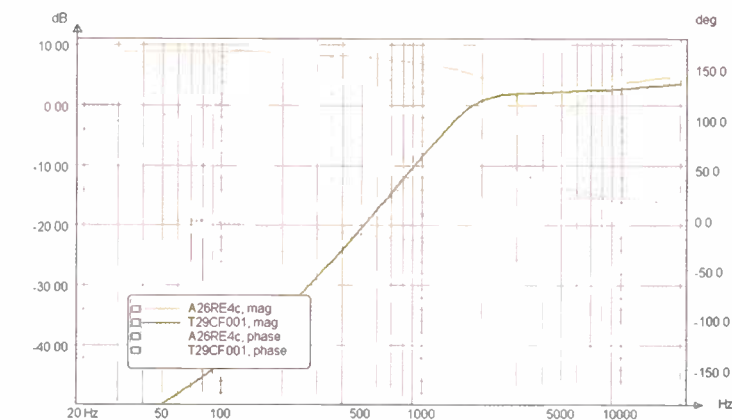

**Graph showing transfer characteristics – the voltages fed to the drive units from the crossover – of the bass/midrange output (light brown) and treble output (olive).**

to send power to the treble unit, however, something different starts to happen. In comparison to the falling response of the bass-midrange unit the hemispherical output of the dome treble unit audibly appears to come in too fast. This is because its radiated power into the room is greater than that of the bass-midrange it is taking over from.

With a 3kHz crossover the radiated power from the treble unit in the 2 – 5kHz region audibly appears to be 3dB higher than the on-axis frequency response would indicate. It is this that lends the sharpness and hardness to the perceived sound.

The answer is, therefore, to depress this region as far as the on-axis response is concerned. The BBC dip is therefore a technique to flatten the overall power response of the speaker and make it sound more natural.

Now what does this have to do with the WD25T v2 crossover design? The interesting aspect of this, for me, was the effect of the MDF cabinet. The midrange 'bloom' imparted by the output of the cabinet panels added to that from the bass-mid unit and, apparently, balanced the output of the treble unit. So the original crossover did sound best balanced for a near-flat

on-axis frequency response.

Remove the output of the cabinet, however, and the 2 – 5kHz regions suddenly shows the hardness and sharpness that I was dimly aware of before, but this time it is very noticeable and objectionable on anything but good recordings.

So what we need is a 'well tempered' speaker. One that takes into account the behaviour of drive units and cabinet to deliver a tonal balance which sounds natural and which doesn't make a fuss of itself. With a speaker like that, all you should be aware of is the musical performance.

**REDESIGN FOR LISTENING**

Obviously it is very difficult to dial in the exact level of 'BBC dip' necessary to compensate for the behaviour of the drive units. For example I would surmise that this dip was not applied to the LS3/5a because it was not found necessary. The reason for this is entirely physical. With the thick LS3/5a grille fitted, the output of the treble unit is severely curtailed off axis and, while I don't have an analysis of the radiated power, I would guess that the directivity of the drive units is not markedly different as they cross over.

Whilst we don't exactly know the level of 'dip' to apply to the WD25T crossover we can start to use measurements and LspCAD6 to predict a crossover that might sound 'correct'. The technique is actually to look at the transfer characteristics of the crossover.

As an illustration look at the transfer characteristics of the original and new crossovers. See that the 'knee' of the treble unit transfer function in the original circuit 'olive green curve' is much sharper than that of the v2 crossover. Throughout the 2 – 5kHz region the power fed to the treble unit is brought in much more gradually, and at a lower level, than in the original crossover.

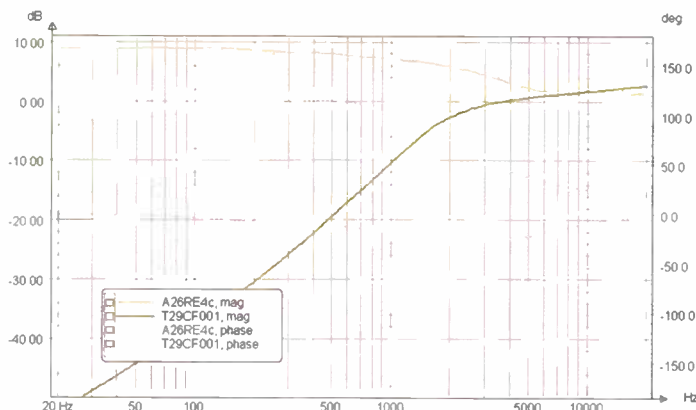

**Comparison graph of the Version 2 crossover. Note that the 'knee' of the new treble crossover is much less sharp.**

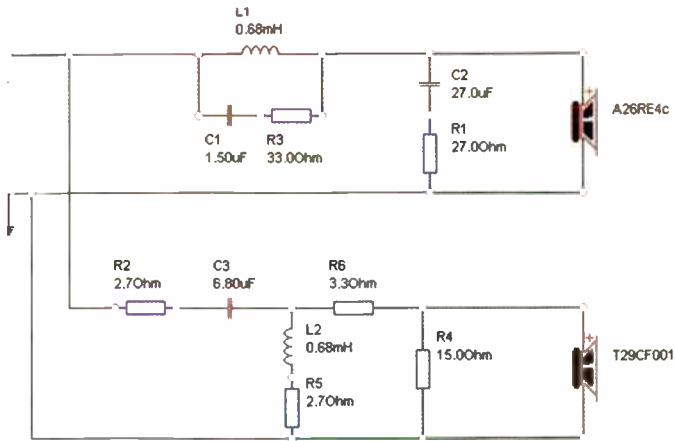

**Finalised crossover for WD25T v2 'The Sequel'. Note that R5 is a combination of the internal resistance of L2 plus a series resistor. So if the resistance of L2 is 1.2 Ohms, R5 as fitted should be 1.5 Ohms**

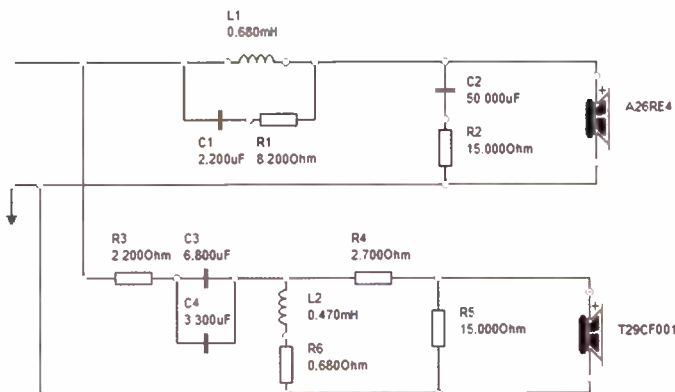

**Original WD25T crossover schematic, for comparison.**

Of course, achieving this graph wasn't the result of a few moments work. Adjusting the transfer characteristic threw the whole crossover into disarray as far as the response and phase integration of the drive units was concerned. What followed was a re-appraisal of the treble crossover to, once again, make it integrate properly with the bass unit so that the transfer between the two sounded seamless.

First of all, the obvious way to decrease power to the treble unit is to reduce the value of the series capacitor feeding it. Accordingly this was gradually reduced and around 6.8uF seemed to fit in with what we were trying to achieve.

This, however, leaves not just a depression of output in the 2-5kHz region but a great valley opens up as the crossover frequency itself is now too high for the limited output of the bass unit at high frequencies.

Restoring level in this area can also be achieved by raising the coil value in parallel with the treble unit. This would normally make the crossover 'peaky' again so the effect of the coil is damped by a combination of its own series resistance and a separate series

resistor.

After lengthy listening the combination of the 6.8uF capacitor and a 0.68mH inductor was decided on, with the total resistance in series with the inductor arriving at 2.7 Ohms. This combination is overdamped, not a bad thing in a treble crossover, and yielded the desired transfer characteristic.

Now it was necessary to balance the actual outputs of the two drive units. Because the midrange output of the cabinet itself had been reduced the overall treble level seemed a trifle exposed so the attenuation to the driver was increased slightly by the two series resistors.

### ADJUSTING THE SLOPES

In addition, the change to the treble crossover transfer characteristic had upset the phase integration between the two units. This was a fairly simple solution reached, in the usual manner, by inverting the virtual phase of the bass unit in LspCAD6 and adjusting for a deep notch at the crossover frequency of 2kHz.

Keeping the series coil the same, the phase adjustment was accomplished by the high

frequency slope adjusting capacitor and resistor combination in parallel with the coil, C1 and R3. Finally, to allow for the slower rate of feed of power into the treble unit it was found necessary to increase the power fed to the bass unit as it approached the crossover point. This was achieved by reducing the strength of the impedance compensation across the drive unit, C2 and R1.

Old and new crossovers are shown side by side on the left. As you can see the topology is the same but some of the key values are different, especially in the treble circuit. One of the benefits of this 'new' crossover is that the phase relationship between the drivers now stays constant even if one deviates from the value of series capacitor to the treble unit or series coil to the bass unit.

This means that it is now much easier to adjust the crossover to personal taste should one wish to slightly alter the overall tonal balance of the speaker. For example an increase in midrange coil will reduce the presence region and make the speaker sound warmer. Similarly an increase in treble capacitor will adjust the 'brightness' of the overall balance.

You may wish to alter these values to suit either your room or your partnering equipment. Make small changes and evaluate their effect using a wide range of music.

### MUSICAL RANGE

And that brings me neatly to how WD25T v2 'The Sequel' performs. Has the 'well tempered' speaker been achieved? I'm happy to say 'yes' because now I am digging out records and CDs that haven't seen the light of day for a long time and playing them with gusto. For example an old, and slightly battered, copy of 'Fragile' by 'Yes' comes up so gleaming new that listeners are aghast that it was recorded

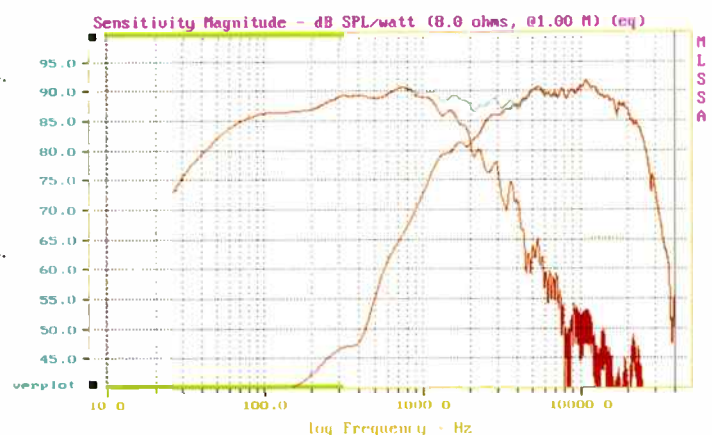

**Final response curves of WD25T v2 drive units and complete loudspeaker**



# The all-new M-series from ROKSAN



High performance hi-fi separates  
that will make your heart sing



To find out more about the M-Series of high performance hi-fi separates  
from Roksan, and where you can buy them  
visit: [www.henleydesigns.co.uk](http://www.henleydesigns.co.uk)

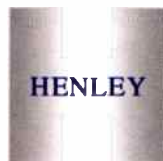

[www.henleydesigns.co.uk](http://www.henleydesigns.co.uk)

ROKSAN CENTRES OF EXCELLENCE

Midland Hi-Fi Studio, *Wolverhampton* • Audio Merchants, *Glasgow* • Audio Republic Ltd., *Headingley, Leeds* • HG Rapkin, *Northampton* • Hi Fi Sound, *Darlington*  
Home Media, *Maidstone* Kronos Hi Fi, *Dungannon* • Merlin Music, *Melrose* • Music Unlimited, *Leverton, Boston* • Sevenoaks Sound & Vision, *Yeovil*  
Sevenoaks Sound & Vision, *Southgate* • Sevenoaks Sound & Vision, *Holborn* • Technosound Systems Ltd., *Dunstable*  
Unilet Sound & Vision, *New Malden* • Videotech, *Huddersfield* • Zouch Audio, *Asby-De-La-Zouch*

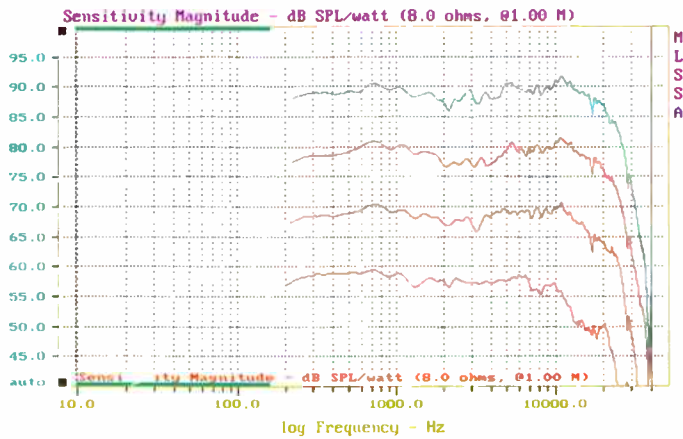

Graph showing the responses of WD25T v2 at (from top) 0, 5, 15 and 30 degrees off axis

over 36 years ago! Hardly 'natural' recording techniques were used on this album – direct injection bass and synthesiser, Chris Howe's guitar panned across the audio stage, Jon Anderson's voice recorded in mono, but still it almost does seem as though they are in the room playing for you.

Similarly Dire Straits 'Private Investigations' from 'Love Over Gold', a favourite hi-fi demo track recorded a scant 10 years after 'Fragile' has more musical impact than I remember from playing it in the past. In complete contrast, and coming bang up to date, the 'Wailin' Jenny's', a three girl Canadian folk-type band singing with mellifluous harmony and with acoustic accompaniment of guitar, banjo and bodhran, showed off exactly what a realistic modern recording can achieve with a most lifelike presence in the room.

I could go on but I'll leave further comment to Adam's review next month as he'll give a more independent appraisal. In the meantime let's look at the measurements to see how the WD25T 'The Sequel' shapes up on paper.

First the frequency response on axis, between the two drive units at a typical ear height for the seated listener. The crossover behaviour for

the individual drivers is shown in red with the combined response in blue.

Note that the output apparently drops below 300Hz which is entirely due to the baffle step effect. This area is recovered when the speaker is measured in room due to the proximity of the rear wall. Similarly the bass below 100Hz is lifted by room gain as the frequency decreases.

Now look at the family of responses. Top is the response on axis followed by the performance as the mic is moved 5 degrees vertically. Next is the response 15 degrees off the horizontal axis and finally that taken at 30 degrees horizontally displaced

On the top trace, follow the response above 300Hz and you can clearly see the 'presence' hump that I talked about centred around 800Hz and gradually falling towards the crossover region from 1kHz. This leads to the WD25T's version of the BBC 'dip', in this case only a 2dB depression between 2 – 4kHz, enough in my view to do its job. This results naturally from feeding the power gradually into the treble unit from 1kHz so that it achieves a crossover at 2kHz, slightly higher than before, and reaches full output beyond 5kHz.

But what really matters, as far as

the listening experience is concerned, is the off-axis response. Because this is where we start to see how the speaker radiates power into the room. Most gratifyingly the response is maintained over the plus and minus 5 degree vertical axis meaning that the speaker does not change character in a major way if you either stand up or lie on the floor! This is also a good indication of the excellent phase integration between the drive units, resulting in a stable and accurate stereo image with easily discernible depth. This all adds to the realism of the reproduction.

Move off axis horizontally by 30 degrees and we start to see how the balance of the bass speaker levels out due to its restricted dispersion compared to the treble unit. Now we can see how the BBC dip works in levelling out the off axis response. Similarly the ultra high frequencies roll off (treble units start to beam above 10kHz too) which is why it does no harm to have a slight lift above 10kHz when measuring on axis.

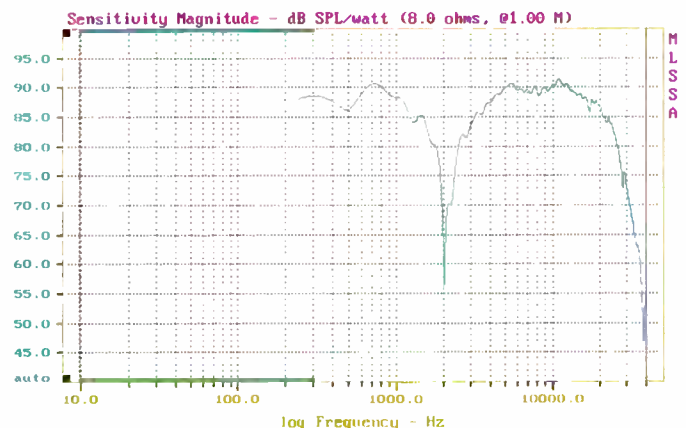

The steep notch resulting from changing the phase of one of the drive units shows excellent integration.

The final check is to reverse the phase of one of the drivers and measure on axis again. This graph shows a steep notch at the crossover frequency, again indicating the excellent phase integration between the drivers.

Impedance of WD25T 'The Sequel' is more benign than before, staying above 6 Ohms at all times and averaging out at an 8 Ohm load. The impedance peak through the crossover region is smooth, peaking at 15 Ohms which shouldn't cause any amplifier any problems whatsoever.

Sensitivity taken across the bandwidth indicates 89dB for 2.83V input (1 Watt, 8 Ohms) so, including the benign impedance performance, this is a very easy to drive loudspeaker. Which, of course, is exactly how it should be!

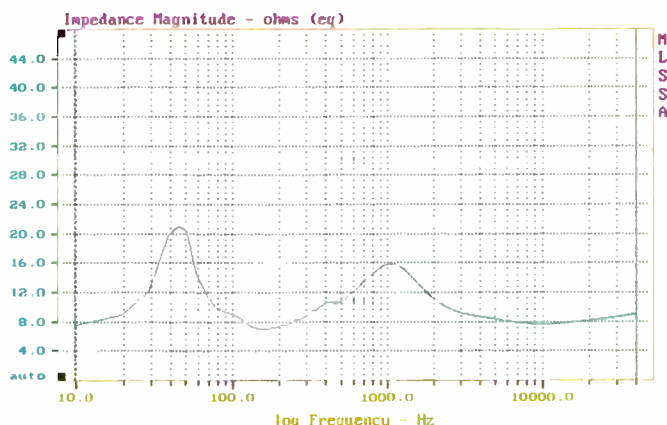

WD25 v2 final impedance curve - a nice, easy load.



# vinyl section

## contents

AUGUST 2008

[www.hi-fiworld.co.uk](http://www.hi-fiworld.co.uk)

### TOWNSHEND ROCK V/ EXCALIBUR II 88

Adam Smith samples this important new turntable and tonearm combination...

### NAIM SUPERLINE 92

This new high end phonostage is a veritable Salisbury thrill, says David Price!

### BLACK ART 94

In the first of a two-part feature, Paul Rigby looks at how audiophile vinyl is pressed.

### AVID DIVA II 98

Adam Smith reviews a superb new 'budget high end' turntable...

## LET THEM EAT VINYL

Two well produced albums from the Let Them Eat Vinyl stable, Bauhaus' 'Go Away White' sees the founders of Goth rock releasing a new studio album for the first time in twenty five years – and a fitting anniversary present it is too, sounding powerful and intense.

Flux Of Pink Indians on the other hand, were a brilliant cult band - a left-wing punk outfit in fact. This reissue of 1982's 'Strive To Survive Causing Least Suffering Possible', arguably their best album, is an anarcho-punk experience.



## news

### PRE AND POST PUNK

Italian labels have released three albums by artists who epitomise the pre- and post-punk ages. From Vinyl Lovers comes the iconic New York Dolls, arguably the very first punk group and their highly praised 1974 release, 'Too Much Too Soon'. The music is both seedy and wild, and so indeed were they!



BAUHAUS  
GO AWAY WHITE

### THE FELICE BROTHERS

Imagine The Band for the noughties, The Felice Brothers' self-titled album on Coppertree Records tells a tale of scruffy country boys who drink too much whisky, stand outside their log cabins and croak a song, through the trees, arms akimbo, to the mountain moon itself. This lot look young but they were born a long, long time ago!

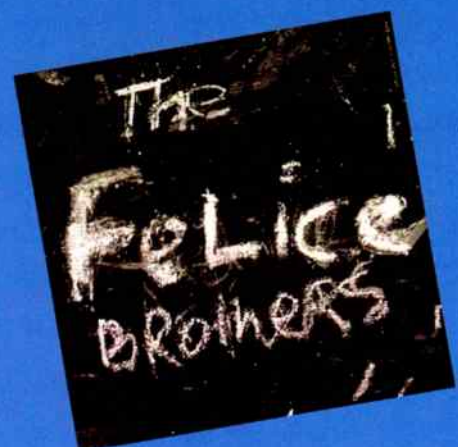

Next, from Get Back, is Iggy Pop's 'Pop At His Top'. Iggy was to influence just about every punk band in some form. His legendary wild performances would see Pop build into a manic rage.

This collection of thirteen classic tracks includes 'China Girl', 'Louie Louie' and 'Lust For Life'.

Finally, Julian Cope was one of post-punk's greatest

inventions. Ex-lead singer of the Teardrop Explodes, his subsequent successful solo career showed him for the eccentric he is. With 'Fried', via Lillith, Cope's debut solo effort, the album provides a raw, yet atmospheric, journey around Julian's crazy head.







## BLACK ROCK

Here's an intriguing release - Sound Way Records' 'Nigeria Rock Special: Psychedelic, Afro-Rock, Fuzz Rock In 1970s Nigeria'. Apart from sporting an epic title, shows what influence can really do. After ex-Cream man Ginger Baker took his Airforce group to Africa, he left a trail of seedlings which turned into Nigerian rock bands such as Ofege, The Elcados and The Funkees. Featuring recognisable stylings from the likes of Led Zeppelin and Traffic, this two-disc compilation, presented in a gatefold, is a revelation and has been unheard for around thirty years.

## SPV JOIN THE PARTY

Making its debut in *Hi-Fi World*, SPV releases a range of vinyl based on contemporary rock bands and recently released, latest albums. Ayreon is a prog-metal outfit from Holland. Their epics are always interesting in both conception and scope and '01011001' is no different. It's a sprawling, magnificent and above, all long(!) album spanning three records and featuring many guest vocalists from the likes of Katatonia and Pain Of Salvation.

Heaven & Hell was Black Sabbath in all but name: Tony Iommi on guitar, Geezer Butler on bass, Vinny Appice on drums and Ronnie James Dio on vocals. This reunion live gig, from 2007 is a thunderous lesson in old school hard rock. 'Radio City Music Hall Live', from New York, is a cracker of a live event.

Finally, Whitesnake's new album, 'Good To Be Bad' is a thirtieth anniversary of the band's formation and the first studio release in ten years. An amazing album (because it sounds so good for a reformed band), it's a feast of good, old fashioned hard rock guitars. The album does what Whitesnake do best; takes the Led Zeppelin template and rewrites it for the noughties.



## SUNDAZED ROCK OUT

The Pretty Things' 'S.F. Sorrow' follows the life and times and death of the man himself. This was the very first rock opera. Released a year before The Who's 'Tommy' it, nevertheless, heavily influenced Pete Townshend. 'S.F. Sorrow' is a classic rock album from an undervalued band. Nicely produced by Sundazed too. Also from the Pretties, the 'Singles '64-68' album does what it says on the can. The band's raw vocal take on R&B influenced many a garage band. 'Don't Bring Me Down' and 'Honey I Need' were minor British hits but there's plenty of additional goodies to please fans as Sundazed take you through several stages of The Pretties' musical evolution.

Finally, Sundazed give you The 13th Floor Elevators and 'The Psychedelic Sounds Of...' with its iconic cover art. Arguably the band's best album, it is a classic of psychedelic rock. Sundazed are shouting about this particular issue as it has been re-released, for the first time, in mono!



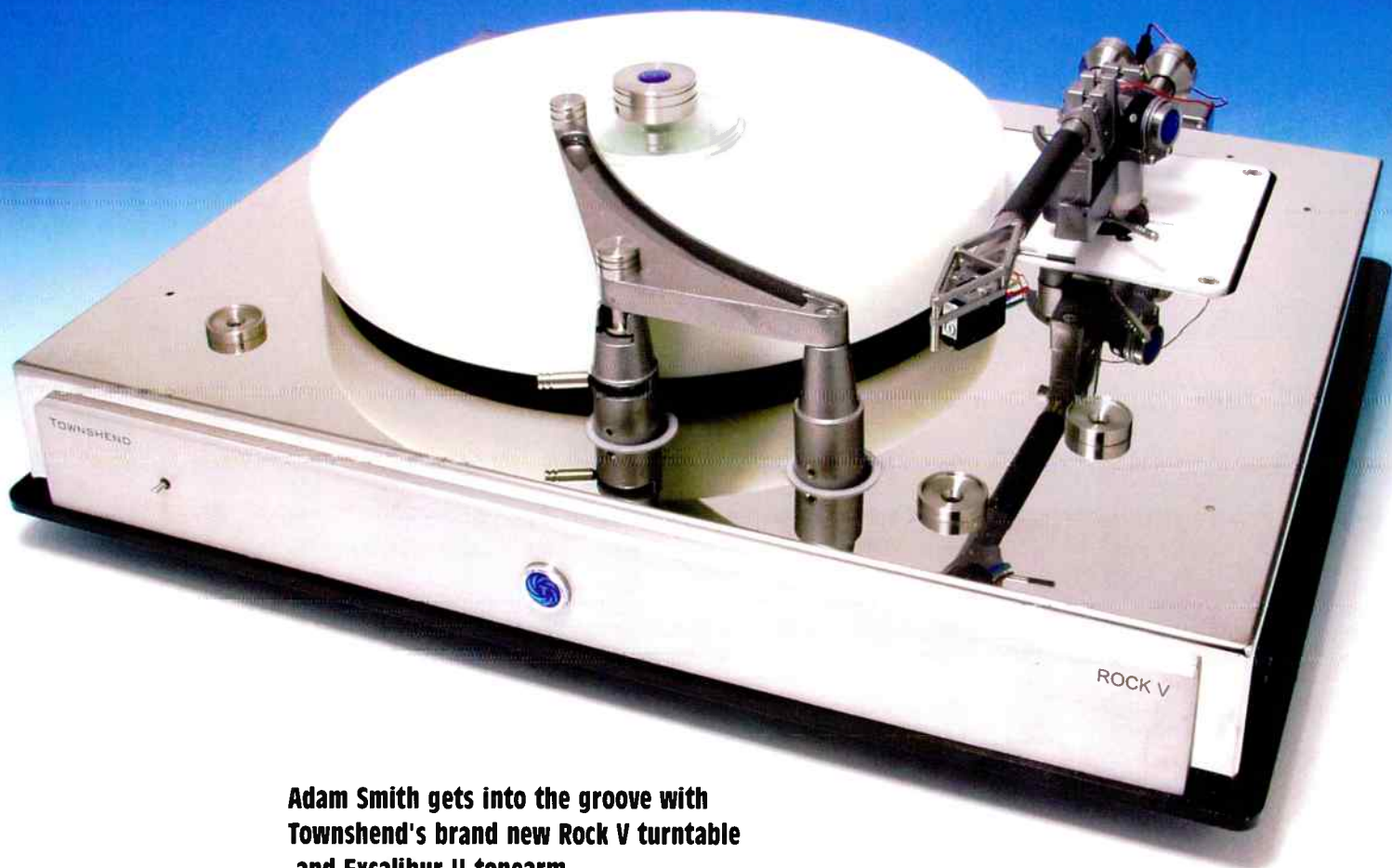

**Adam Smith gets into the groove with Townshend's brand new Rock V turntable and Excalibur II tonearm...**

# Let's Rock!

**A**s a regular 'surfer' of the AudioKarma online audio forum, it never ceases to amuse me that the main area of interest of many of their subscribers seems to be the huge, button and gadget-festooned receivers that were common during the 1970s. They like to discuss them at length, and compare specs and, particularly power outputs, referring to the battles for the lowest THDs and the highest watts as the

'great receiver wars' of the seventies...

Now, AudioKarma is a mainly US based forum and things were a little different on this side of the Atlantic during that time, with us having to wait until the next decade for our own battle, namely the 'great turntable wars' of the 1980s. Lest we forget, the Linn Sondek had appeared in the 1970s and completely turned the turntable world on its head. By the time the 'decade of excess' arrived, direct drives were a swear word and belt drive was where it was at. The Linn was king, if you believed everything you read, but there were a whole host of challengers that attempted to come along and steal its crown.

In purely sonic terms, many succeeded, but they never quite managed to usurp the cult of the LP12 and quietly faded away again. Decks like the Alphason Sonata, Heybrook TT2, AR Legend, Logic DMI01, Ariston RD80 and Pink Triangle PT TOO all came, impressed

and then went, although the Funk Firm has now risen from the ashes of the latter. Like the LP12 though, one or two of those challengers have endured; the Roksan Xerxes is still with us and the Thorens TD160 lives again, but perhaps the most endearing competitor to be still standing proud in the noughties is the Townshend Rock.

Back in the 1970s, John Bugge, a mature master's student at the Department for the Design of Machine Systems at the then Cranfield Institute of Technology, chose 'The Design and Evaluation of a Production Prototype High Performance Gramophone Record Player' for his MSc thesis, under the supervision of Professor Jack Diinsdale, co-inventor of the first transformerless transistor amplifier who was then senior lecturer in mechatronics at Cranfield. He had patented the front-end damping trough, and he approached Max Townshend of (then) Elite Electronics to market the concept.

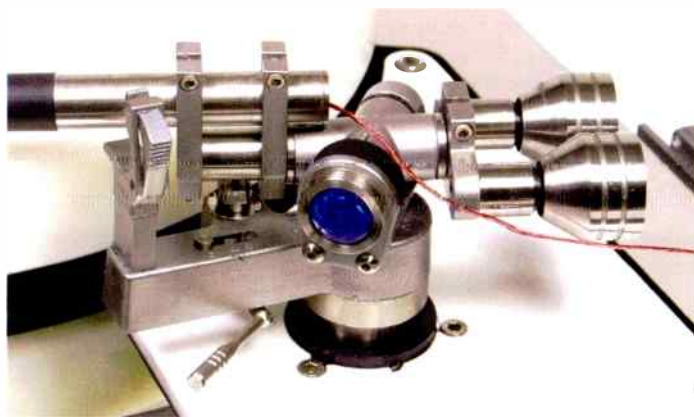

The simple idea was that damping was most effectively applied to the front of the arm, rather than the rear, hence the damping trough that swung across the record, with a paddle attached to the end of the headshell that sat in the silicon damping fluid contained therein, whilst the arm tracked the record. The result was the original Rock turntable, which went through several incarnations, up to the ultimate Rock Reference, with its touch sensitive controls. A matching arm, the Excalibur, was also made. This quietly faded out however, but after a gap of a few years, the Rock is back once more now in MkV guise, and accompanied by the Excalibur II arm.

For the Rock V, Max Townshend has made some very important changes. The deck's basics are still the same - a belt driven two-speed unit, using a Rega subplatter and bearing, driven by a low voltage AC motor with its own power supply and electronic speed change via a front panel toggle switch. On top of the subplatter sits a main platter made from high density white polyethylene atop a disk of D Flex acoustic damping sheet which in turn sits on a glass disc. A clamp is provided which screws into the threaded centre spindle and around this is a circular washer which can be screwed up or down to compensate for dished records - lifting this washer up allows the clamp to flatten such items down effectively. The washer is also the right diameter to act as an adaptor for 45s with large centre holes, when unscrewed further.

The platter and armboard assembly rests on a three-point suspension system that utilises three springs surrounded by rubber bellows, containing 1mm holes. The result is a very high Q damped system that allows small oscillations of the springs to go unhindered, but the air movement through the holes to act as a brake to larger movement giving rise to, as Max puts it, "the best of both worlds - maximum isolation with minimum oscillation". Certainly the Rock V is not a bouncy, wobbly deck - a great relief to those of us who view such designs as more trouble than they're generally worth.

If you squint very carefully at the Excalibur II arm, you may well just detect the remains of the Rega RB300 that gave it life, but it's a bit like trying to discern the Range Rover Sport DNA lurking somewhere beneath the depths of a Bowler Nemesis! In the case of the Excalibur II, Townshend upgrade the bearings and fit their own dual rear counterweights, mounted low down

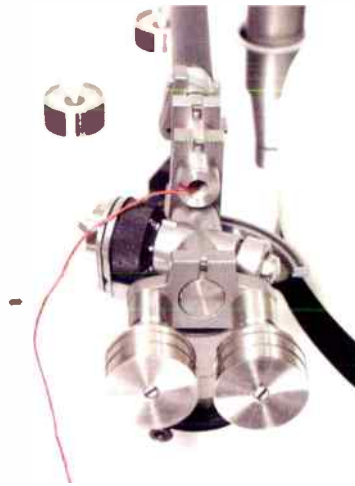

to keep the centre of gravity low. The armtube has had a hacksaw taken to it and the front portion junked. This is replaced by a one-piece unit that is fixed to the remainder of the original tube by two clamps, the main tube being sat above the level of the old tube.

The new tube is made from thin-walled stainless steel and damped with a low density polyurethane foam, with a further rubber 'jacket' fitted to the outside. The headshell is made from magnesium and the piece used includes the damping paddle as part of the construction, in a 'space frame' assembly. This is fixed to the arm by means of a scarfed joint, which "offers not only very high torsional stiffness and strength close to the cartridge mounting position, but also a large area of contact with the arm", according to Townshend. The joint is held with three high tensile pins and strong epoxy. Cartridge mounting uses two sets of holes, rather than slots, to ensure that cartridge offset angle is accurate. Fitment involves locating the pair that put the stylus nearer to the cross-brace on the headshell and then fine alignment is achieved by loosening the arm tube clamps and sliding the whole tube backwards or forwards.

The arm wiring consists of four bundles of four-strand ultra-thin Enhanced Deep Cryogenically Treated (EDCT) enamelled copper wire, which connect to a rear-mounted junction box via a small locking plug. Handily, this will allow for more arm tubes to be purchased to allow quick changes of cartridge. Also on the box are output sockets; Townshend can supply phono or balanced XLR types and this allows the user to experiment with their preferred choice of interconnect.

Finish of the complete arm and deck is rather quaint but good - Max had apparently had complaints about the aesthetics of the white platter and armboard but, as he points out, they're that colour and material

for a reason! The deck's top plate is finished in mirrored chrome and incorporates holes for a forthcoming dust cover. Another couple of nice touches are a well below the end of the arm when it's in the armrest to collect any dripping silicon fluid, plus two rest posts for the record clamp whilst it is not in use - one for right handers, one for left handers - very thoughtful!

Finally, it has to be mentioned that setup of the Rock is either a glorious adventure, or a complete pain in the neck, depending on how you view such activities. As a guide, I had the Avid Diva II spinning an LP within about half an hour of opening the box, but was still fine-tuning the Rock after three hours...

## SOUND QUALITY

After encountering such a unit that takes a fair bit of fettling and setup, it is always a nerve-wracking moment when the stylus first hits groove. Will all that effort be worth it, or will I end up cross that I've wasted a few hours of my life trying to make a silk purse out of a sow's ear? Fortunately, every second of the time spent setting up the Rock V proved to be time well spent - this really is one highly impressive vinyl spinner.

Starting off with the Eagles, the Rock proved that it does not dig quite as deep as, say an Avid Volvere Sequel or SME10A, but you really have to listen hard to find out, as it is difficult to get past the staggering transient response and lightning fast







simply musical



**SUGDEN AUDIO TEL 01924 404088**  
rescuing music from technology

transients that the deck serves up. Snare drums are as crisp as I have ever heard them, cymbals leap out of the loudspeakers at you and bass lines stop and start with the sort of precision that you simply do not hear from most rivals. The bass line from 'Hotel California' underpinned the rest of the track in a seriously impressive manner and Don Henley's drumming rhythm could easily have been set by a metronome.

In terms of spaciousness, each performer was laid out beautifully between the loudspeakers. The Rock V does not have quite the image depth of an SME10A, or the left to right distance of a Michell Orbe, but the space which its image does occupy is quite alarmingly vivid. I almost felt that I could reach out and touch the players as they seemed so close. This was showcased perfectly on the second track from the Eagles album, 'New Kid in Town', where Glenn Frey's lead vocals were quite perfectly just right of centre-stage. Not all turntables can pick up on this, but the Rock had no problem at all.

Equally, the deck proved similarly adept when it came to revealing the fine details of the performers within the soundstage. Vocalists were emotive and vivid, and instruments all sounded incredibly real. A perfect example was Ian Anderson's flute work on Jethro Tull's 'Budapest' - the flow of the air from the instrument was as clearly outlined as I have ever heard it from an LP. My wife plays the flute and so we are both aware of how instruments like this can sound rather limited when reproduced from a recording, but the Rock is absolutely first class in this respect.

The more I listened to the Rock/Excalibur combo, the more I was taken aback by the way in which it presents transients. There is never any overhang, no sense of bloom or wallow and the deck makes some other turntables sound rather less than sure of themselves. What this means is that the Rock is an incredibly rhythmical machine,

even if, as mentioned, it does not dig quite as deep as some competitors. A perfect showcase for this was a spot of Jean Michel Jarre - the Rock absolutely lapped up 'Oxygene' and 'Equinoxe', making every note from those classic synthesizers absolutely precise. Equally though, it has the ability to reveal that these are proper old-fashioned analogue synths and not new digital versions, meaning that each note has more of a sense of warmth and decay that distinguishes such a machine from its more modern, and rather more clinical sounding, counterparts.

This nature continued through every record that I chose to spin, and the Rock affected a disdainful

of, or have never heard before...

It isn't a quick job to set the deck up, and there are a myriad of adjustments that need to be set and tuned before listening commences. Get these right however, and you will need to make sure that your diary is clear when you do start listening - as you won't want to stop.

**REFERENCE SYSTEM**

Ortofon Rondo Bronze cartridge  
Naim Superline/Hi-Cap phono stage  
Creek OBH22 passive preamplifier  
Quad II-eighty power amplifiers  
Spendor S8e loudspeakers

"one of the most musical vinyl spinners out there..."

ease at all times, whether whispering out the distant subtleties of the orchestra playing Ravel's 'Bolero', placing you into that smokey jazz club in front of Herbie Hancock's 'Canteloupe Island', or pounding out the superbly impactful percussion from Philip Bailey's 'Chinese Wall'. This really is one of the most taut, focused and unfailingly musical vinyl spinners out there.

**CONCLUSION**

The Townshend Rock V/Excalibur II can best be thought of as the record playing equivalent of a lens cloth - the deck takes your music, polishes, buffs and waxes it and presents it in a way that you either had forgotten it was capable

**VERDICT**

It's quirky, controversial and complex, but get past all of this and the Townshend Rock V rewards like few others.

<b>TOWNSHEND</b>	
<b>ROCK V</b>	£4,950
<b>EXCALIBUR II</b>	£2,495
Townshend Audio	
+44(0)208 979 2155	
www.townshendaudio.net	

**FOR**

- precise soundstage
- magnificent realism
- balanced top end
- superb crispness

**AGAINST**

- complex setup

**MEASURED PERFORMANCE**

The Townshend Rock V is actually based around a Rega subplatter and bearing but with a more complex motor control system and longer belt. The resulting wow and flutter figure of 0.070% is a fine result and flutter components in the visible signal are low, showing that the bearing is of good quality. The 3150Hz reference tone was measured as 3160Hz, a variation of 0.03% which is low and likely to be inaudible. Speed accuracy was excellent over a period of several hours.

The Excalibur II arm also measured well, with a well suppressed main arm tube mode. More modes were visible than might be expected normally but this is likely due to the arm effectively being made up of two tubes clamped together. All peaks showed good levels of suppression, however, undoubtedly helped by the main arm tube being clamped in more than one place, and damped by both internal foam and an external cover. Further up the frequency range, the arm's skeletal headshell design also performed well, being less lively than many conventional designs.

Measuring the Excalibur II both with and without the use of the damping trough showed subtle differences across the measurement bandwidth of 15Hz - 10kHz. With damping applied, the main arm modes were better suppressed and a notable amount of energy was taken out of the headshell, as might be expected. The damping applied helps to deaden the main resonances in the tube and should - this will bode well for top end clarity and detail.

Of course, the largest effect that this damping will have is in the 2-10kHz region, critically damping out the effects of arm/cartridge resonance

and increasing stability of the playing system as a result.

All in all, both the Rock V and the Excalibur II measure very well and should be capable of an impressive and tightly focused performance. AS

**WOW AND FLUTTER**



**ARM VIBRATION - NO DAMPING**

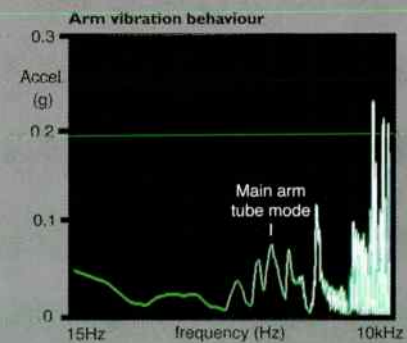

**ARM VIBRATION - DAMPED**

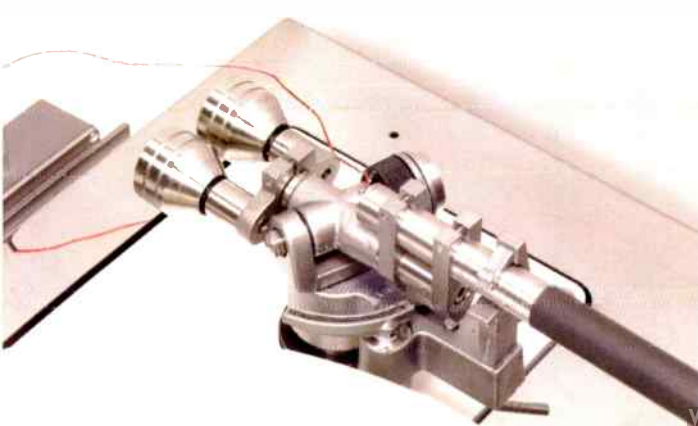
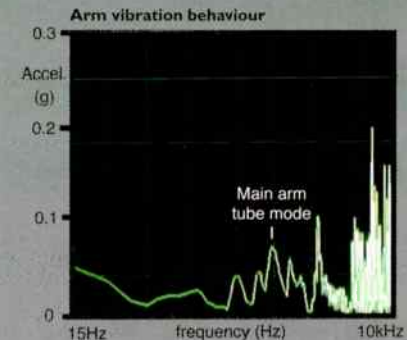





# Life Line

**Hardcore vinylistas will find Naim's brand new SuperLine phono stage a most life-enhancing thing, says David Price...**

Once upon a time, in the olden days of audio when vinyl was everyone's serious music source, one of the greatest arguments for buying a Naim preamplifier was its phono stage. Back when the two were effectively one and the same thing (you bought a preamp and it came with a phono stage), I spent a lot of time listening to the respective 'phono inputs' of different preamplifiers (well, I was a student, so I didn't have anything better to do) and it was always the Naim that I liked best...

The sound held whether it was a top of the range Naim NAC32.5 preamp, a mid-price 42.5 preamp or even the phono input of the little Naim Nait integrated. Even going back to the original NAC12S, I remember it having a super MC stage. They all sounded bold, confident and powerful, unlike those fitted to so many rival designs that came with noisy, vague, ponderous designs. Where others seemed to be struggling to extract anything resembling music from those few microvolts going into them, Naim stages were lively, crisply etched and dynamic – and so it is with the new SuperLine some thirty years later...

Fifty years after the Recording Industry Association of America set the original standard for modern LP playback, Naim's new flagship £1,650 box claims to, "extract the ultimate musical presentation and maximum

possible detail from vinyl records", with "true RIAA equalisation accurate to 0.1dB".

Quite why it has taken so long for Naim to come up with such a product is beyond me. The company's absence at this end of the market has meant one less choice for those who take their vinyl replay seriously, until now. The good news though is that the SuperLine is flexible thing with a pleasingly small form factor (it comes in Naim's Hi-Cap-sized aluminium chassis, 87x207x314mm), a wide range of impedance matching options and a choice of three power supplies. It can be powered by the SuperNait amplifier, our sample of which is currently still being 'reviewed' by Adam! [You mustn't rush these things, you know...AS]; from any 'Aux 2' power supply output of a Naim preamplifier, or of course from a dedicated Naim Hi-Cap or Super-Cap external power supply (the £1,025 former being supplied for this review, making a total cost of £2,675). Aspirated via the Burndy connector from the Super-Cap, it uses the unit's thirteen supplies together with twenty five of its own internal regulated supplies – but such a combination will cost you a cool £4,850.

At its heart is a new, two stage single-ended Class A discrete amplifier with part-passive RIAA filtering and features the transistor 'quiet room' thermal isolation technique originally developed for

the NAP 500 power amplifier. Its independently sprung 4.4kg brass subchassis is unique in the world of phono stages – just like a turntable, the electronics board inside 'floats' on springs inside the case, effectively decoupling it from sound-degrading mechanical vibrations. This is a brilliant idea, but you have to remember to remove the transit screws first!

Round the back, you'll find duplicate VBT nextgen phono and BNC sockets, along with two 5-pin DIN sockets for cartridge impedance matching. Four resistive and three capacitive load plugs are supplied with the SuperLine (10k Ohms, 500 Ohms, 220 Ohms or 100 Ohms resistive loads or 1nF, 2nF, 6nF and 11nF capacitive loads) which alter the unit's internal input load giving twenty different permutations – comprehensive instructions are supplied. The unit has fixed gain, and is said to work with any cartridge from 100uV to 500uV.

## SOUND QUALITY

Given the consistency of 'the Naim sound' over the years (and across model ranges), it shouldn't surprise you to know that the SuperLine is indeed a very taut, tight and musically engaging product. Having the excellent Note Products PhoNote to compare it with (admittedly a little cheaper at £2,000, but a super valve phono stage all the same) was an ear opening experience, the Naim

showing its mettle against one of the best 'affordable audiophile' tube designs I've heard.

Dire Straits' 'Sultans of Swing', that nineteen seventies hi-fi shop stalwart, proved a brilliant way in to the joys of the SuperLine. Kicking off with my reference PhoNote, I got a large, widescreen sound - a little flat front to back and slightly indistinct in terms of image location, but it proved very enjoyable all the same - with a warm, full bass guitar sound and a lovely sweet Fender Stratocaster tone to Mark Knopfler's lead guitar. Moving to the Naim, and both the song's soundstaging and the timing snapped into focus like a missile having just acquired its target.

Where I'd previously heard a sweet, seductive 'amble' through the song, I now felt like I'd be press-ganged into hearing it, warts and all, head on, right there in front of me. The recorded acoustic suddenly dropped deeper back, giving a sharp impression of where the studio booth boundaries lay, while some instruments within the mix jumped forward. That pick-less lead guitar became as commanding and distinctive as the track's vocals, whereas it had previously seemed there simply to fill out the sound. The bass guitarist seemed like he'd just taken a 'sharp intake of breath' in the bathroom, while the drummer sounded far more motivated. The track was transformed - sounding urgent and impassioned instead of louche and lackadaisical. Interestingly though, the Naim didn't sound hard. All this extra detail and grip came not at the expense of any midband forwardness or biting treble.

Tonally, the SuperLine isn't in the least bit forward. It's certainly less sumptuous than the tube PhoNote, but doesn't suffer for so being. Strings on a Karajan recording of Beethoven's 'Pastoral' symphony (Berlin Philharmonic, DG) were ever so slightly more 'wiry' sounding than the reference, but this in turn now seemed a little opaque. Think of it as turning up the contrast on your plasma screen and finding the fine detailing quite 'challenging', whereas you notch it down only for it to seem dull! This 'finely etched' quality characterises the Naim; it gets right down into the minutiae of what's in the recording and faithfully imparts it, whereas others simply gloss over it and look the other way.

Michael Jackson's 'Don't Stop 'Till You Get Enough' was a riot, showcasing the SuperLine in all its glory. It's an immensely 'dense' track, packed with sublimely syncopated percussion, brass and bass. The

Naim was in another league here, floating like a butterfly through the complex rhythms, never stumbling or faltering or tripping over itself. Instead, it displayed a vice-like grip on everything, yet seemed so effortless - its timing is truly special, and the stand-out feature of an already superb phono stage.

The next most distinctive point of its performance is stereo imaging - again, here the SuperLine is special. The strains of Led Zeppelin's 'Stairway to Heaven' proved an interesting experience. Having heard this, admittedly great, track once too

"it brings massive analysis, grip and power together in an intoxicatingly musical way..."

often, I sometimes find it hard to concentrate through the long, lyrical build-up - and so it proved with the reference PhoNote. Switching to the SuperLine, I suddenly felt like I had to concentrate, because Robert Plant had just come in to my room. The precision and confidence with which this new phono stage places instruments in the mix is remarkable; they become as easy to place as if they'd been nailed to your cranium.

Again, this isn't to say the sound is shrill, it's just very direct and to the point. Move over to the PhoNote, and the soundstage, although just as wonderfully wide, is altogether more diffuse and uncommitted. An easy way of demonstrating this is the way I could suddenly get optimum stereo imaging from any point of my sofa, instead of just the softer and somewhat worn centre.

It's hard to criticise the SuperLine, but I think that tube phono stage fans may still find it a tad too transitory for their tastes. Focusing in on the mix with such precision makes in a very embracing, gripping and enthralling listen - seat of the pants stuff, like that old Maxell cassette advert. This isn't what some are looking for, and here the altogether more laid back PhoNote will still win friends - it's an altogether less exacting listen, but funnily enough, a no less enjoyable one.

**REFERENCE SYSTEM**  
Technics SL1210/Audio Origami RB250/Lyra Dorian turntable  
Note Products PhoNote phono stage  
Sugden IA4 integrated amplifier  
German Physiks HRS120 loudspeakers



**CONCLUSION**

I would very much like to hear a Naim SuperLine powered from the top of the range (£3,200) Super-Cap power supply, but time constraints for this review didn't make it possible. So all I can do is speculate then, when I say that when thus aspirated it's probably one of the most detailed and dynamic phono stages ever made. Even in more affordable (£1,025) HiCap form, this is an absolutely redoubtable tool - bringing massive amounts of analysis, grip and power together in an intoxicatingly musical way. Being solid-state, it lacks the euphony than some crave from vinyl, but personally that can go hang, as the way it turns any of your old pieces of black plastic into a profound and at times breathtaking musical experience marks it out as an essential audition. Another Salisbury thrill.

**VERDICT** ●●●●●  
Breathtakingly musical phono stage with massive insight and striking soundstaging - expensive, but justifiably so.

**NAIM SUPERLINE** £1,650  
**NAIM HICAP** £1,025  
Naim Audio Ltd  
+44 (0)1722 426600  
www.naimaudio.com

- FOR**
- superlative musical timing
  - enthralling dynamics
  - forensic detailing
  - upgradeability

**AGAINST**

- tonality not to all tastes

**MEASURED PERFORMANCE**

Equalisation accuracy was accurate from 20Hz to 74kHz, within 1dB limits, our analysis showing a smooth, flat in-band characteristic. There's a slow roll off below 20Hz, resulting in -6dB attenuation at 5Hz so warp signals will be attenuated a little.

Noise was low at 0.08uV equivalent input noise, IEC A weighted. This is low so hiss will be inaudible even with low output Moving Coil cartridges. It's just as well because the SuperLine has a low overload ceiling of 2.5mV in (3.5V out). Most phono stages have four times more headroom, primarily because they can swing 10V or so out, against the SuperLine's low 3.5V. High output MCs like Ortofons can produce around 3mV at 25cms/sec rms and can overload the SuperLine, although this will happen rarely in practice. The SuperLine best suits low output MC

cartridges.

The SuperLine measures well in all areas except overload, where it runs close to acceptable limits. NK

Frequency response	20Hz - 74kHz
Separation	54dB
Noise (e.i.n., A wtd.)	0.08uV
Distortion	0.001%
Gain (MM, MC)	x1555
Overload	2.5mV in / 3.5V out

**FREQUENCY RESPONSE**

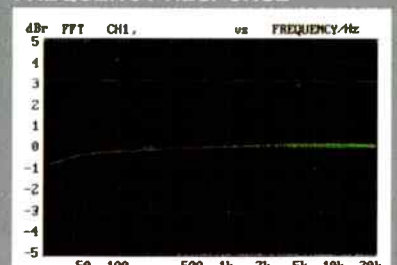



# Black Art



**Paul Rigby unravels the mysteries of the LP production process. This month we look at how LPs are made, next month how they are made better - for audiophiles...**

**W**e'll never return to the heady days of 1975, with the likes of Mike Oldfield's 'Tubular Bells' accounting for nearly ninety million LPs sold, but it's fair to say that just recently, vinyl is enjoying something of a renaissance. In the audiophile sector, we have Tony Hickmott, MD of UK label Pure Pleasure reporting that, "sales have increased five-fold over the past two years," while Paul Hawkins, MD of retailer Diverse Vinyl told *Hi-Fi World* that, "our vinyl sales were 20% up on 2006 which was 20% up on the year previous to that". Meanwhile on the music distribution side, Paul Callaghan, MD of F-Minor says, "our competitors are complaining, but they all deal in CD. We're doing well - 80% of our daily business is vinyl-based".

Even in the cut-throat chart sector, vinyl is holding its own. According to Matt Philips, Director

of Communications from the British Phonographic Industry (BPI), the record industry's trade association, "thanks to record companies catering for a niche market of music fans who love the authenticity of the 7", the format is holding its own in a volatile and fast-moving market - a success that deserves recognition!" Sales for the format remained static in 2007, compared to 2006, at just over 1 million.

People also have a basic affection for the black plastic. Rob Barnes, head of broadband and mobiles at moneysupermarket.com, the price comparison site, said, "it's clear, whilst people are embracing the digital age they still revere some things from yesteryear." Research, by moneysupermarket.com, highlighted what people would save from the "technology graveyard". Of the published Top 10, vinyl came first, CD was second and cassette tape seventh. Intriguingly, the telegram was

fifth, the Teas Maid was eighth and the Ford Granada tenth!

## MAKING IT

There's an awful lot of mystery surrounding how vinyl is actually made, so we asked Holger Neumann, MD of Pallas (one of the most revered audiophile pressing plants in the world) to give us a guided tour of the creation of a vinyl record. Based in Germany, Pallas press records for a range of respected record labels, including Speakers Corner and Pure Pleasure.

After an artist records in the studio, they or a third party creates and sends Pallas a soft vinyl disc called a cutting plate or acetate. Pallas examine and clean it, "with 80% water and 20% chemicals, a special mix, not available in any shops," said Neumann.

The cleaning is performed for five to ten minutes, in a special bath-like machine which immerses the



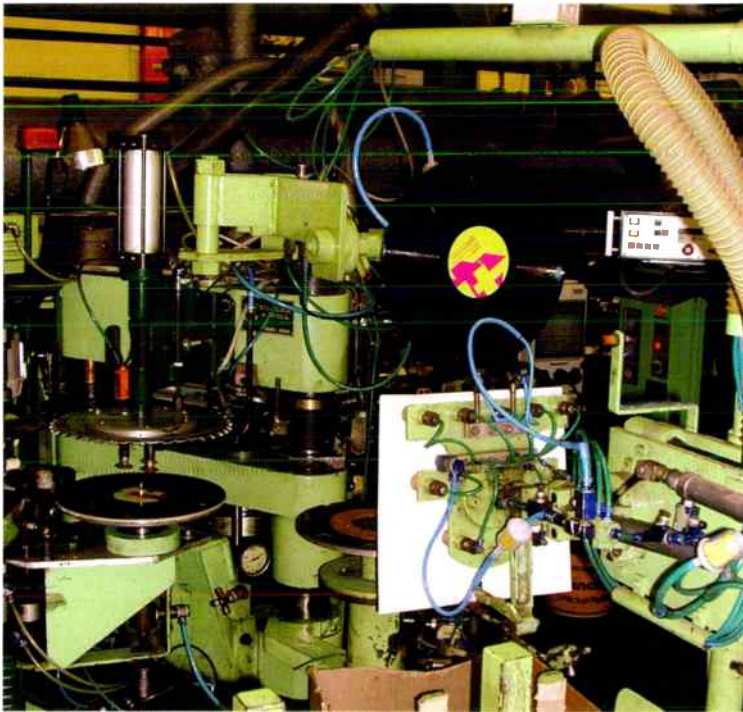

**A full automatic vinyl press based in the Pallas plant.**

acetate totally. Afterwards, air is fired at the cutting plate, "Once dry, the plate is then placed in a turntable-like machine. We then pour silver nitrate over the top of the rotating cutting plate. The cooled silver nitrate disc, known as the Original, is then separated from the cutting plate," said Neumann.

This disc, if you looked closely at

it, would look a little odd because all the grooves would be raised, sticking up into thin air. "Then we perform the first galvanic process," Neumann continued. "We take the Original and put it, rotating, into another base full of a green soup full of nickel sulphamide and melting nickel pellets. They deposit themselves onto the Original in around ninety minutes.



What we're left with now is an exact copy of the cutting plate."

This new copy, made from nickel, is called the Mother. It looks like a normal record, with the grooves pointing inwards, as nature intended. The Mother will then undergo a series of tests. Any imperfections, such as stray nickel particles, will be corrected under microscopic conditions using a very small cutting knife. This can often take eight hours per side to complete. Once that process is complete - and don't forget each record will require two Mothers for sides A and B - then it's back into the green soup to produce another copy, with the grooves pointing outwards...

"This newly created disc, made from the same material as the Mother, only takes 60 minutes to form. This is called a Stamper. We then clean the Stamper with chemicals," explained Neumann. So, you ask, why go through this rigmarole? Why not just create vinyl from the Original? Because the pressing plant keeps the Original as a sort of back-up, as you would keep back-up data on a PC, in case the Stamper develops problems.

"A hole is then put in the middle of the Stamper and the outside 'flash', the excess, is trimmed. The Stamper is cleaned again. At this point, the Stamper is ready to press some vinyl," said Neumann.

Before we continue, a quick word about the vinyl itself. Before Pallas receives the raw vinyl material, a third party will create the raw material to a set recipe. Vinyl is not naturally black, incidentally. Its natural colour is a murky grey. A substance called Carbon Black is added to the recipe to create the shiny black plastic we're all familiar with. This material is then extruded through a sausage machine-like device and a cutter chops the extrusion into pellets, which is then stored for shipping. The pellets are then melted. Pallas' press will actually hold and press a sort of 'patty', cake-like blob. When the pressing occurs, however, the vinyl will flow, lava-like, filling in the grooves.

This is a critical period which can ultimately affect the final sound quality. Poorly filled grooves will result in a situation called 'non-fill', producing information loss on the final record. To help the proper filling of all the grooves, the vinyl record includes something called a 'groove guard'. This is the thick lip on the

**Each pressed record is removed from the stamper by hand at Classic.**





When it comes to Vinyl,  
you need the best

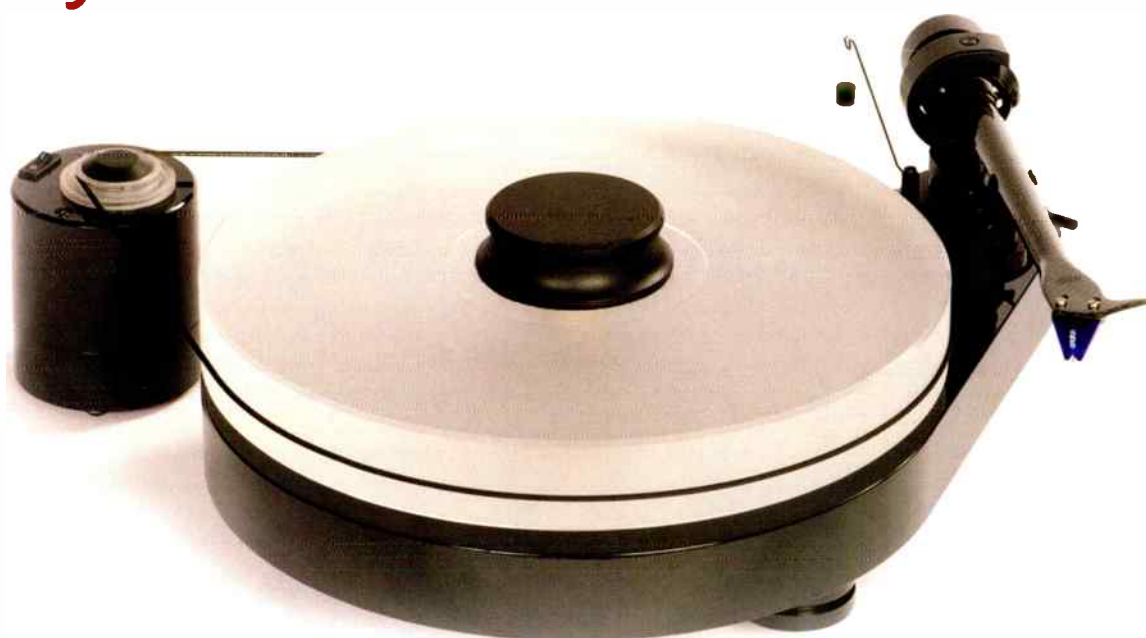

Pro-Ject  
AUDIO SYSTEMS

Makers of  
award-winning  
turntables

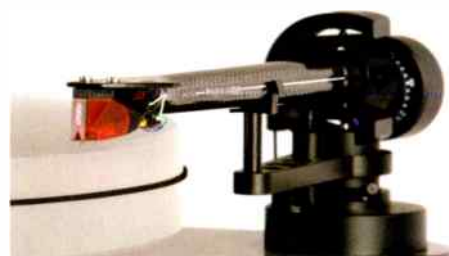

To find out more about the full range of turntables from Pro-Ject, and where you can buy them visit: [www.henleydesigns.co.uk](http://www.henleydesigns.co.uk)





Checking the grooves, at Pallas, by microscope.

outside of the record, shaped like a tear-drop. During the process, the groove guard creates back pressure to aid perfect pressing.

Another factor affecting sound quality is the amount of grooves cut

on the surface, known as the groove density. As Kevin Gray, mastering engineer for US-based outfit, RTI, explained, the less grooves on a record, the louder it'll be. "As a general rule an LP should be under

twenty minutes long – twenty-four minutes maximum.

Also, you need to balance the side times, preferably within one minute. If one side has to be longer, it's best to put more of the quiet material on that side. This will ensure even levels. If the sides are long, the studio has to remember that the more bass, the lower the cutting level (volume). It is possible to squeeze thirty minutes on a side but the level will be so low you'll have to crank it to hear it!"

The actual pressing is done in a robotic manner,

**BRUSH STROKES**

Whilst making the stuff is a tricky, complex business, caring for vinyl is straightforward. Always store it in a cool, dry environment, away from direct sunlight. Use a carbon fibre brush, such as a Goldring Super Exstatic, to clean the dust off the playing surface (which you should never touch with your fingers), and make sure you replace the record back into its inner dust sleeve. Ideally, these should be polythene lined to minimise record wear, such as Goldring Exstatic (£15 for a pack of 25).



Goldring's Exstatic Record cleaning brush (top) and record sleeves (bottom) - essential first steps towards record care...



Your stylus should be kept clean, by periodic cleaning with a soft brush dipped in isopropyl alcohol and distilled water (in a 25%:75% solution) – or you can buy stylus cleaning fluid such as Audio Technica's AT607 off the shelf. DP

without any human interference, on a fully automatic press. "Each vinyl requires twenty to twenty-six seconds to complete the pressing and the fixation of the paper label in the centre," Holger Neumann added. Pallas's pressing machines can press vinyl in different colours and in 120gm or 180gm weights. The extra thickness allows the record label to request a deeper cut of the groove to increase sound quality. "Once pressed, the record is placed within a paper sleeve and then a special box, containing twenty-five to thirty records. The records then need twenty-four hours to cool. Then the records are placed in an outer sleeve. Next stop – your turntable!"

That's how most records are produced, but not all. Specialists, such as US-based Classic Records do things slightly differently in a bid to deliver a superior sounding product. It has approached the process from different angles, something I will cover in part two of this feature next month...

**CLEAN MACHINES**

For really dirty records, a record cleaning machine is the only solution. You can have them professionally cleaned by someone that uses a Keith Monks machine (usually around £1 per disc), or there are a wide range of models available for home use. These start with the surprisingly effective Disco Antistat (£30 - below), right up to the likes of the Loricraft PRC4 at £2000 (bottom).







# Viva la Diva

Adam Smith loves life with Avid's new budget Diva II turntable...

**T**he rise of the LP from the ashes, where various nay-sayers thought that it was permanently residing, has prompted an impressive resurgence in new models.

As is so often the case, the £1,000 price point has become a hotly contested arena as, not only is it still relatively affordable, but marking as it does a transition point from three to four figures, many people see this as a serious step towards the high end. Consequently products at or around this price are invariably notably better than something of, say, half the price...

Of course, the view can be a little different if you are a manufacturer known for more expensive designs, and the £1,000 point is where your entry level product lies. In

this situation it is a case of downsizing your designs in order to see what can be removed, or what can be economised, without affecting the quality for which you

have become known.

Such a problem affected Avid Hi-Fi, as the original Diva turntable, a well respected design, was originally developed for Avid's Japanese distributor, with whom they no longer deal. Combined with the cost of raw material rising and making the deck uneconomical to manufacture, along with the fact that Avid's design styling had moved on, clearly the Diva II was inevitable.

Looking much neater, to my eyes at least, than its predecessor, the Diva II is based around a rigid one-piece cast aluminium chassis, that means "vibrations continually created by the stylus during playback are channelled to the chassis, through the main bearing and pick up arm and then rapidly dissipated", according to Avid. The bearing is similar to that used on the dearer decks such as the Volvere, and uses a similar clamping system to rigidly couple the LP to the platter. Speaking of the platter, this is an MDF item, fitted with the same type of mat as the more expensive models, which is based around a cork material. This is intended to provide a deliberate impedance mismatch with the record, in an attempt to prevent vibration

from entering the platter and thus causing distortion.

The platter itself is mounted onto a subplatter, which is belt driven by a freestanding synchronous AC motor. Avid state that "platter speed is adjustable through placement of the motor housing" which basically means that if it's running a bit fast, you pull it further away from the deck to reduce the speed by tensioning the belt. I'm not entirely convinced by this system, as when the motor is loaded like this, vibration is likely to increase, affecting wow and flutter. I also can't help feeling that if this works, then the motor isn't all that strong, despite Avid's claims of it being a "high torque" design. Fortunately though, the Diva II's speed was practically spot on, with little need to put the belt under too much tension.

The arm fitment portion of the chassis comes cut out with an SME type base, but with additional further holes for mounting plate adaptors to fit other arms, which can be supplied by Avid. Our review sample had an impressive chunk of machined metal fitted, containing a Jelco SA-250ST arm, which can be purchased for

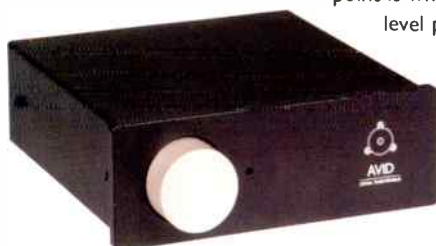

a £300 premium over the £1,000 price of the armless deck. Regular readers will know that this arm gets a thumbs-up from me and it is a simple straight design that is nicely adjustable and feels very well built - it has a certain 'budget SME' feel to it, which is no bad thing!

**SOUND QUALITY**

From the first bars of music, it was clear that the Diva was going to be an engaging companion. It is a crisp and dynamic performer with plenty of emotion and presence, and a healthy dose of rhythmicity. In this respect it actually has quite a direct-drive character to it, as it loves a spry beat and hangs onto it with pleasing tenacity. Bass lines were deep and confident, with fine amounts of detail thrown in for good measure.

This meant that the bass guitar from the Eagles' 'Hotel California' was vivid, fulsome and highly tuneful, whereas it can sometimes drop into the background a little. In many ways, the Diva II apes its bigger brother, the Volvere Sequel in this respect, as both have highly capable low end abilities - more than those of us who are used to Garrard 301 levels of bass were expecting!

The rest of 'Hotel California' was equally accomplished, with the musicians nicely set up within the soundstage. The image pushes well outside the loudspeakers' boundaries but is not as well ordered as bigger brother, the Volvere Sequel, in the centre. That said, it was still not difficult to place instruments within the performance, and the Diva II is more than capable of putting you nicely into the middle of the action.

Across the top end, the Diva II is an open and inviting performer, with plenty of atmosphere and detail, whilst still managing to maintain an underlying smoothness without ever falling into the trap of being dull. I think the arm is a big helper here, as I have always found the Jelco to be a lithe and polished sounding arm that has the ability to tame hard sounding cartridges without dulling their innately extrovert nature.

Another plus point for the arm is

its midrange emotiveness. Much more involving than the rather stark Regas, the SA-250ST works well with the Diva II to bring out the underlying message conveyed by the music it is spinning. Instrumental character is well revealed and vocalists positively

soar from the loudspeakers - Diane Schuur sounded sublime on her track, 'Love Dance'. Frankly the only area in which the Diva II was a little uncomfortable was with processed, complex material, when it did have an ever so slight sense of muddle to it when things became more strenuous.

Compared to the pricier Scheu Analog Black Diamond, the Scheu remained more composed but, at the same time, it was notable that it did have a slightly more aloof character

**REFERENCE SYSTEM**

- Scheu Analog Black Diamond/RB250 turntable
- Ortofon 2M Black cartridge
- Whest Audio Two phono stage
- Anatek A50R Amplifier
- Spendor S8e loudspeakers

"it sounds like a mini Volvere, at a quarter of the price..."

optional Jelco arm suits it well. The resulting £1,300 combo is more than able to take on our current £1,500 favourite, the Scheu Analog Black Diamond, and is actually a little more emotive than the German contender with its Rega arm.

In many ways, the Diva II struck me as sounding like a 'mini-Volvere' and, at a quarter of the price of its bigger brother, but with far more than a quarter of the performance, it deserves a hearty recommendation!



**VERDICT** ●●●●●  
Stylish, superbly built turntable that turns in an emotive and highly musical performance.

**AVID DIVA** £1,000  
Avid Hi-Fi  
☎ +44(0)1480 457300  
www.avidhifi.co.uk

- FOR**
- solid, tuneful bass
  - fine image depth
  - smooth, detailed top end
  - build quality, styling

- AGAINST**
- nothing at the price

to it. I felt that the Avid/Jelco combo was digging deeper into the heart of the music and finding the source material lacking, rather than failing to reproduce what was actually there.

**CONCLUSION**

The Avid Diva II is a very fine turntable. Well built, neatly styled and easy to set up, it's a highly capable addition to the £1,000 turntable market and the



**MEASURED PERFORMANCE**

The Avid Diva II turned in a wow and flutter measurement of 0.089%, IEC weighted - this is a respectable result at the price and should bode well for a stable and solid sound. Speed accuracy was good, the 3,150Hz test tone being resolved as 3,147Hz, and the speed remained stable during the measurement session. Some higher frequency flutter components are present but at a low level, so the bearing is of good quality.

The Jelco SA-250ST arm supplied fitted to the Diva II is a good performer under the accelerometer. Its main arm tube mode is at a low level and has a good level of damping, suggesting that the midband should be clean. The headshell is also less lively than many competitors which should take the sting out of the performance and ensure a smooth top end.

All in all, the Diva II measures well and should turn in a fine performance AS

**WOW AND FLUTTER**

**ARM VIBRATION**

Arm vibration behaviour



# mail



## LETTER OF THE MONTH PRIZE



**KEF iQ3 LOUDSPEAKERS**

**Visit our website at [www.hi-fiworld.co.uk](http://www.hi-fiworld.co.uk) or send your emails to [letters@hi-fiworld.co.uk](mailto:letters@hi-fiworld.co.uk). Letter of the month wins a pair of KEF iQ3 loudspeakers and one years FREE subscription to Hi-Fi World.**

## Letter of the Month

### THE RIGHT PRICE?

Firstly, many thanks for a refreshingly down to earth magazine in a hobby dominated by overpriced snake oil. It's very easy in the exploitative market that is hi-fi to lose real world perspective. I think that I should preface my comments by making it clear that I have been an enthusiast (nut?) for forty years now and where most people buy a house then fit the hi-fi system into it, I bought the house to fit the hi-fi system. I suppose therefore that on a nut scale of 0-10, I score 20 - a genuine 24 carat gold plated loon. I hope that my ensuing rant might be viewed in this light...

For some time I have been inwardly seething at the casual and even dismissive way that money and the cost of kit is referred to in editorials and reviews. (HFW is better than most but still regularly falls into the trap). I was finally minded to put pen to paper when I read Tony Bolton's review of valve phono stages in your March 2008 issue. I would like to be clear that my comments are not intended to get at Tony; I am simply using his review to make what I think is an important wider point. An extra £500 or £600 for an item is frequently viewed in the hi-fi press as an almost negligible sum to invest in the quest for perfect sound. I have a serious problem with this from two points of view. Firstly the money aspect. The reality for many cash strapped enthusiasts is that £500 or £600 probably equates to more than a month's disposable income and it should perhaps not be dismissed so lightly.

My second point is that there is an almost subliminal assumption in the world of hi-fi that somehow price and quality/value are in some way correlated. In most cases this is simply not true. The reality is that the price of a product depends much more on the nature of the manufacturer's business model, where the product is made, the



**An Englishman's home is his castle, for which Tannoy designed the Westminster Royal SE. A full range horn design, they need a big, big room so reader David King bought a house specially for them.**

number of handoffs in the supply chain and last but not least the size of the margin at each handoff point. Suppliers who buy in most of the components they use are likely to have a much higher base product cost than those who manufacture their components in house. The more handoffs in the supply chain the larger the proportion of the total cost that is likely to be accounted for by margins which in some cases to my certain knowledge are truly obscene. This was brought home to me a few years ago when I bought a very exotic piece of kit (no names no pack drill!). The product was faulty and required replacement. The replacement was delivered directly to my home and due to an oversight it was accompanied by a copy of the dealer's invoice which told me exactly what the dealer was paying and therefore what his margin was. In percentage terms it was a little over 100% but in cash terms it was many thousands of pounds. Admittedly it was a flagship product but I could not help

thinking that I was being taken for a very expensive ride.

Sadly the hi-fi industry appears to be in terminal decline despite the plethora of new products that are emerging. It occurs to me that if this decline is to be arrested manufacturers, importers and dealers should take a step back and take a long hard look at one of the basic principles of economics - Elasticity of Demand. In simple terms the lower the price the greater the demand. In a world where more and products and services are competing for our scarce cash we disregard price at our peril, particularly in a market where the age profile of customers is increasing.

Coming back to Tony Bolton's valve phono stage review. There was an unintended but nonetheless disparaging comment from Noel and Adam in their 'second thoughts' paragraph that the Icon Audio PS1.2 was 'superb for the price'. As one who has used the PS1.2 for two years now, in a very good

system, (picture attached) I can tell you that it is superb regardless of its price and in my view that is exactly what the review should have said. This type of comment unwittingly perpetuates the myth that price and quality correlate which is incorrect and is for the would-be buyer very misleading. Companies like Icon Audio who provide great products at a reasonable price and back them with unparalleled quality of service should be lauded at every opportunity. Long may they survive and thrive.

One final point (you'll be glad to hear!). Out of curiosity I recently went to a meeting of my local 'Recorded Music Appreciation Society' now in its fiftieth year. Twice a month around fifty members meet to listen to music collectively in a village hall. They play their CDs on a tatty makeshift system through a pair of very elderly Tannoy loudspeakers on tall wooden stands. All of the kit could have been bought on eBay for less than £150 and yet it sounded really good. Not cutting edge in a way that we hi-fi enthusiasts might look for but a big airy and highly enjoyable sound with terrific imaging. It just underlined for me the importance of the room. It showed me that even very humble systems can sound enjoyable when unconstrained by the listening environment which certainly gave me food for thought.

**David King**

The problem here, David, is one of perceived value. With the phono stages, imagine blind listening to the Icon and MiniMax - Noel and I both agreed that the MiniMax was better but, when you consider the extra cost of it over the Icon, this has to be taken into consideration. As a result, if you still want the best sound, regardless of price, then we both feel the MiniMax is the one to go for, but whether it is worth two Icon Audio PS1.2s is a matter for debate. Effectively the icon gives you 90% of the MiniMax's performance for 50% of the cost - it just depends whether the 50% or the 10% are most important to you.

The problem is that, whether you like it or not, price and value are often related, as they should be. Why, for instance are there not a pair of small Tannoy floorstanders in your (very nice by the way!) home setup, instead of a huge pair of Tannoy's Westminster Royals? Presumably this is because you liked the sound and considered that their huge price increase over a pair of simpler, but still good, £1,000 Tannoys was well worth the extra expenditure. I also feel that their very presence in your system is countermanding your argument somewhat - consider that,

for their £18,000 price, they consist of a big cabinet, containing one big driver with a paper cone and foam surround. Now consider, for example, Meridian's new DSP7200 loudspeaker, which for £500 less contains four drive units, four amplifier modules, an active crossover and comprehensive digital signal processing circuitry. Now I know which ones I'd prefer, but I also assume that you bought the Tannoys for their sound quality, which is exactly what you should have done.

differences in price between phono stages. So there's something of a schism between your views and your situation, methinks David!

The subject of manufacturing, margins and final price is not, in the modern world, as you describe it. Specialist parts and operations are largely contracted out for reasons of cost. It was long ago that Quad did everything in-house, including casting, but it was disastrous. Specialist foundries supply castings cheaper



**Is the Eastern Electric Minimax phono stage above worth twice the price of Icon Audio's PS1.2 below?**



However, suddenly, by your own criteria, those Westminster look like very poor value for money! **AS**

My abiding dream is being able to buy a house big enough and far enough from civilisation to run Tannoy Westminster Royals from a decent valve amp. - without worrying about a local uprising. But it's an extravagance I will probably never manage. Buying a house for Westminster Royals, as all those not domiciled in Windsor, Warwick, Cardiff, or any of Britain's many other castles will understand, is going to involve sums of cash that eclipse any

and better, one reason being they have the volume to efficiently utilise expensive machinery that reduces manufacturing cost. Far East factories rely on armies of subcontractors for this reason, as do UK manufacturers. Casework comes in from outside contractors, as do PCBs, often populated with components and fully tested. In-house work usually comprises design, prototyping assembly and packaging.

As product price moves to stratospheric heights, notions of value get very subjective and your system is a good enough example.

**NK**



I think you make some interesting points, David. Before I worked as a hi-fi journalist (i.e. when I was a civilian), I used to cringe at the way hi-fi hacks would try to spend my money for me. For example, I remember one mag calling the Linn Sondek LP12 "your perfect first turntable" even though it cost £1,500 (in today's money). Why? Because according to that particular magazine, it was "the only one worth buying" anyway, so any other would be a waste of money and thus "a false economy". Well, memories of this sort of nonsense - namely, what went on in the late seventies and early eighties in the UK hi-fi press - keep me rooted to the ground. That's why we often put products which are considerably cheaper than others in our group tests, in the hope (and sometimes the expectation) that they'll beat the pricier ones. I get complaints from certain manufacturers and PR people for so doing, but I think buyers have a right to know about what constitutes real 'value'...

As Noel and Adam have eruditely explained, I think it's perfectly alright to talk about something being "excellent at the price". Just because we describe it as such doesn't mean we're disparaging it. For example, the Trichord Dino is a great little phonostage for £299, but it's not in absolute terms as good as Naim's new SuperLine (far from it). This is no slur against the Dino - rather, it's giving the whole story, saying that other, better, more expensive products are available. Now, whether they're worth the extra is a very good question - and my experience is that they generally are but certainly not always! **DP**

### THE MAINS EVENT

*My primary source is an Arcam FMJ CD33T via Chord Chameleon Silver Plus to an Arcam FMJ A32 amp. with Chord Odyssey-4 bi-wiring Spendor S6e loudspeakers. I arrived at this combination stepwise over four years by careful home audition and with the help of a good and very patient dealer. My secondary is a 1992 Rotel RT-950BX AM/FM tuner via Audioquest Quartz interconnect. I also have a Denon DRM-800 cassette deck (1990) and, from my first system, a Pioneer PL-51A Direct Drive turntable (1976) plus ADC LMG-1 magnesium diecast headshell with a Goldring Exstatic Mat and Roksan Corus Black phono cartridge added in 1993.*

*Next I am planning to find out whether bi-amping the S6es by adding a matching FMJ P35 power amp. would improve the sound further, and then fine tune by upgrading the*

*interconnects. I then await Blu-ray audio (if it happens). As it stands now, the sound can be wonderful, spacious and three dimensional but is spoilt when sometimes the volume drops (by up to 2dB or so on the A32's display) and both the sound-stage and dynamics appear squashed. Turning up the volume does not appear to fully restore the other two entities. TV sound, which is not connected to the system, also seems to be affected. In my previous amplifier, an Audiolab 8000A, in addition, the transformer buzzed so loud that it could be heard above quieter music over eight feet away (although not via the 'speakers'). Audiolab told me that the*



***If you're up a dead end, use one of these!***

*cause was mains pollution.*

*As all heavy industry within a mile of us was wiped out in the 1980s and 90s, that is unlikely to be the cause. The problem frequently occurs on Saturdays between about 7pm and 11pm and sometimes on other evenings. For instance, it occurred when the Christmas editions of 'Eastenders' and 'Coronation Street' were broadcast, but not before or after. The power supply must be inadequate. To the best of my knowledge, the mains cable beneath the lane has not been upgraded since 1964 when there were only twelve houses, of which eight were old with basic electrics. By 1990 there were nineteen modern houses with all mod. cons. and now there are twenty one.*

*So how do I overcome the problem? I have been told variously; to audition an Isotek GII Mini Sub; that only a mains regenerator at £1,500 would be effective (by which I suppose he meant an Isotek Titan); that all these devices squash dynamics; that the cure depends on what is wrong with the mains; and that I should contact my power company (surely they will not upgrade the supply just for me). So what do you advise? I have been reading HFW virtually since it began and although Channa Vithana reviewed the Isotek GII Vision in July 2006 and Adam Smith the Advance Electronics ASR250UK in March 2007, I do not remember your doing an article on the subject. Given*

*that some say that mains pollution is increasing, maybe you might find time and space to do so.*

**Dennis Roy Whittaker**

Regarding the Advance Electronics ASR250UK that I reviewed, I am still using it in my main system and am still delighted by its performance, so I can heartily recommend one of these. I found that a regenerating design was much more beneficial than a more basic type that just takes the signal and buffs it up a bit, and it sounds like you could well do with one of these as well. If you do buy one however, make sure it is your

amplifier that plugs into it first - the power amplifier is one of the few components in the hi-fi chain that uses unfiltered A.C. mains and so it is here that the mains treatment will have the biggest difference. I use mine on my amp and turntable (Garrard 301 which uses a synchronous 240VAC motor) - plugging in the likes of a CD player, which steps down, rectifies and passes the mains through untold filters and regulators before sending it to the circuitry seems rather pointless to me and, indeed, listening tests in my own system like this confirmed that it made no difference. Nice turntable, by the way! **AS**

### NEEDLE TALK

*I thought I would contact you so I can ask for some advice. Late last year my Audio Technica OC9 stylus broke and I needed to find a replacement. At that time my system consisted of a Linn LP12 turntable with Cirkus upgrade, Ittok LVII arm, Naim 42.5/140 amplifiers and Linn Sara loudspeakers. The LP12 sat on a Sound Organisation table. Both turntable and pre/power amps had been recently serviced. I was happy with the sound of the OC9 but decided to try something different.*

*Unfortunately I was unable to audition cartridges before buying. After a lot of research, reading reviews and talking with local dealers I shortlisted*

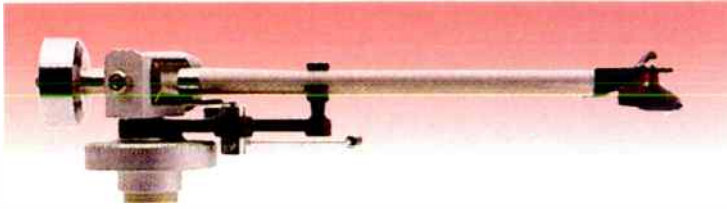

### Is the Argo too good for an Ittok?



the Lyra Argo and the Linn Klyde; both very different cartridges from what I could gather. I decided to go for the Argo. Initially I found it very bright and harsh and thin on bass. Lowering the end of the arm helped improve things and after about 100 hours the cartridge has calmed down a bit. I liked the Argo's detail and clarity but not the high treble. I read on some forums that the Argo is not really suitable for the Ittok due to the arm being "hard and bright in the upper mids". Is the Argo too good for my venerable Ittok? At this stage I don't plan upgrading to the Keel or Ekos. Also it was commented that the Naim amps similar to mine are rather "forward sounding".

I then tried the Linn Klyde which was the opposite to the Argo. I liked the warmer richer sound of the Klyde but it lacked a bit of detail and clarity at the high end. Would changing to Naim "K" boards make much difference to the Klyde? (presently have Naim 323/5 "S" phono boards) Both cartridges were set up by experienced authorised dealers. Since then I have added a Hi-Cap and Lingo which has improved the overall sound quite noticeably.

I realise music is subjective but I would appreciate your comments and advice on some alternatives to the above cartridges or how to improve the sound. Would a Koetsu Black be a viable option? Unfortunately I don't have the skill to personally "tweak" or change components. I enjoy my music and if it sounds right I usually leave well alone unless the change is simple and reversible! e.g. would graphitic turntable mats, cones, graphite shelves help my present set-up?

**Roger Ngan**

It isn't really a case of the Argo being "too good for" the Ittok, but more of a case of them being mismatched items. As you say, the Ittok has a reputation for being a bit hard and forward in the upper mid and treble,

and the Lyras tend to have quite a prominent rise in output towards 20kHz. Put these together and you have a recipe for forwardness. Equally, the Klyde is at the opposite end of the spectrum and so may well sound somewhat dull to your ears, having been used to the OC9, which is quite bright, although not as much so as the Argo.

Personally, I would give serious consideration to a new ATOC9-MLII if you liked the sound of the original as it takes it and builds on it to add a sense of sophistication that the original could miss out on, thanks to the new stylus and cantilever. I am a big fan of my own OC9-MLII and still think it's one of the big record playing bargains of the decade, at around £270, or less if you do a bit of shopping around. If you really would like to give something else a try, however, do consider the Ortofon Kontrapunkt b, a perennial favourite of this magazine and around the same price as the Lyra and Linn. **AS**

Oh boy - system matching woes! The Lyra's definitely a tad tippy with a Naim NAC42.5 but, as Adam says, the latest MLII incarnation of the AT-OC9 will be smoother. Sweeter still will be the Koetsu Black you mention, but I fear that you're back to the Klyde type softness with this, albeit in a rather more romantic way. Personally, I'd go for the Ortofon Kontrapunkt b. At the other end of the system, ensure you're running your Saras on the correct Linn stands, pushed hard against the wall. **DP**

### I SPY

Greetings and HELP! I am removing the last bits of my hair in frustration at not being able to find an instrument with which to inspect my stylus; not even on eBay! I know a company called Colton used to make one but, other than that, I am lost. Any help would be most gratefully received,

**Pete Allen.**

Ah, the good old long-lost Colton stylus viewer. I'm sure I used to have one somewhere but after having a rummage for it after seeing your letter, it appears that it has fallen through the small hole in the space-time continuum that consumes odd

socks with alacrity. As you rightly, say, though, there don't seem to be any of these about any more, but a bit of lateral thinking on my part may have found a solution, so you need worry about enforced baldness no longer.

Basically, the stylus viewers were always described as "jewellers type" magnifiers, and if you take a glance at [www.jewellersequipment.co.uk/eyeglasses.html](http://www.jewellersequipment.co.uk/eyeglasses.html) you will see a wide range of such items, with magnification factors of up to x20 - not quite as good as the x30 of some of the older items, but still pretty good. The one that caught my eye was the 'Triplet' for £21.49, which features three lenses - x10, x15 and x20 and apparently comes in a rather nice leather case. **AS**

Ah yes, after long wrestling sessions with my little Colton, driven by a desperate desire to see the oh so important stylus tip and what I imagined to be its exquisite geometry, I realised I was up against certain basic optical problems I was unlikely to overcome. That was in addition to the biological problem of having to hold my breath to prevent the Colton moving out of focus.

The higher the magnification, the lower the depth of field, so if the area of interest wasn't in the plane of focus - it was out of focus! This meant I could never quite get the Colton lined up for perfect focus and it was very difficult to make sense of the 3D form of a stylus. Huge magnification is needed to see the working bit, which is the very tip. Related to this was the need to carefully manipulate the cartridge so that area of interest could be held in focus. This really demands a adjustable table, to which the cartridge must be attached.



**One way to see your stylus - but remember to hold your breath!**



And to see anything with the Colton or many other similar devices I tried, powerful illumination was needed. Whilst I was holding my breath I was being cooked nicely by a 100W spotlight.

All in all the problems were so daunting and the solutions, mainly industrial microscopes, so expensive I gave up. It's an interesting subject though - check out [www.brunelmicroscopes.co.uk](http://www.brunelmicroscopes.co.uk) for things that will do the job, from £60 to £1000. **NK**

### SPRING CLEAN

As the sun is now showing signs of warmth I have decided to spring clean (upgrade) my present hi-fi set up so hence my letter to you all for your honest and fair advice on this rocky upgrade path. Having now saved some £2,000 over the past four years it is time to use it and improve the sounds of my living room, size 4.5m (L) x 3.7m (W) x 2.5m (D).

My present setup is a Michell GyroDec (AC motor) with an unmodified Rega RB300 and Dynavector 20X low output moving coil cartridge into a John Linsley Hood K1450 phono amp with Andante 20 PSU. Interconnects are standard Rega from the arm and home made silver core from phono stage to amplifier. The amplifier is a Cyrus 3 with PSX power supply into Tannoy Revolution R3 speakers. CD is provided by an original Naim CDS 1 and PSU. My interconnects are Chord Cobra 2 from the CD player to the amplifier and Cyrus Flat cable from amp to speakers, run in a bi-wired configuration. The GyroDec replaced a Rega Planar 3 turntable which I had from 1980, and its arm is now on the GyroDec.

A I listen to 60/40 in favour of records I would like to start with the

deck/arm cartridge then speakers/amp. The CDS, although 1995 vintage, still sounds brilliant. As I upgrade once every five or ten years, I am looking to spend wisely.

**Nigel Sach**

Well Nigel, I think it's time to titivate your GyroDec! A new Michell DC motor, powered by the HR power supply, will dramatically improve speed stability, and you'll need to invest in a new acrylic base (or Spyder base) at the same time. This will also take some noise out of the turntable, in turn raising the Gyro's performance still more. Also, get the latest springs and armboard mounts while you're at it. This should set you back about £650, and will give you a brilliant platform for Michell's matching TecnoArm tonearm (£450). Now over to Noel for the next steps... **DP**



### The Audio Technica ATOC9-MLII, a good budget moving coil cartridge

I'd replace the Dynavector DV 20X with the Audio Technica AT OC9-MLII mentioned earlier or an Ortofon Rondo Bronze. The AT has an obvious lift in treble, but it is of such good quality, due to a fine stylus, as to be tolerable. The Rondo is more even handed, if a little hard

faced. A good modern phono stage is the Whest Two at £650. Alternatively, drop low price MCs and move back to high price MM in the form of the superb Ortofon 2M Black. **NK**

### DIRECTLY DRIVEN

I am a retired engineer and have a 'mix and match' hi-fi system set up around a World Audio Designs 300B amplifier system. My desire is to build a direct drive record deck which would incorporate some unique features. The very fact that direct drive is not currently in favour for quality hi-fi equipment has been quickly proven by the fact that a suitable motor seems unavailable.

I have considered various options in my search for a motor, NOS spares for defunct decks, 'gutting' a classic for the motor (yes it does sound criminal) and even looking at the current better quality DJ decks. Ideally, I was hoping to find a motor manufacturer which could supply a suitable quartz lock motor. My hope is that you or perhaps some of your magazine readers could provide me with information on sourcing my requirement. Dare I add that price is not a problem for the right piece of equipment.

**Eric Vant.**

Hi Eric, I can and cannot help! Behind me lie a heap of boards from the Vestax PDX-2300 MkII that I hoped to rebuild on a decent plinth, with hi-fi arm like a Rega. Unfortunately, all controls are fixed to a surface mount circuit board that is very difficult to work with, ruling it out as a simple DIY project I felt. If you can handle surface mount, using special tools, this is one route, but I don't advise it. The best solution is that adopted by David Price, who can tell you more here. **NK**

**HOUSE OF LINN**

**The listening experience at house of linn is so good demonstrations last for hours.... Discover how we make music sound real in your home.**

Independently owned and operated by former Linn staff to give you the best Linn experience from **Komri to Klassik**.

Call or email for appointment or advice. Visit our website for news and events.

Demonstration, Sales, Installation, Upgrades, Aftercare for all Linn Hi-Fi Components & Systems.

**You've never heard it so good. Do the tune-dem!**

[www.houseoflinn.com](http://www.houseoflinn.com) ▲ [info@houseoflinn.com](mailto:info@houseoflinn.com) ▲ +44 (0)161 766 4837



Room: **majik**



**The Technics SL1200 - a superb place to start for a bit of DIY upgrade activity, as editor DP has found.**

Do you want to do this as a kit project, or simply get a great sounding DD turntable, or a bit of both? If the former is true, I'd suggest you butcher a Technics SL1200 (or derivative). Why? Well, easy and relatively cheap parts availability is the reason - something you cannot say about practically every other DD in existence. If the latter is the case, trawl the classifieds for a Technics SP10 mk II from an old broadcast studio and then you can spend all your time modding the power supply, turntable plinth and platter mat, etc.! The third way is a new SL1210 with an Origin Live Technics adaptor, an Audio Origami RB250 (or similar) tonearm, Isonoe isolation feet and a SoundDeadSteel platter mat - giving you the set-up I'm running right now. In most respects, it has comfortably seen off most high end turntables it's been up against... **DP**

### ATTENUATION SITUATION

I have seen advertisements for in-line attenuators from various sources ranging from £40 to £100 for similar equipment. The problem they identify, of little effective volume adjustment, is one I experience on my system, comprising a Cyrus 7Q CD, Cyrus 7 amplifier and Monitor Audio GR10 speakers which are an easy amplifier load. I am interested in the reasoning behind the use of attenuators, and whether they deliver the claimed sonic benefits.

At the same time I note that on both of my systems, an Arcam Alpha system from the early 1990s and my current Cyrus system there appears to be what is claimed as a mismatch between the CD output and amplifier input. The Arcam would appear to output 2.0V into a 135mV sensitivity line input. The Cyrus outputs 2.1V into 200mV sensitivity line input. According to one source both would require -16dB

attenuation which is, I believe, a 2.5 times drop in volume. Both however quote headroom margins considerably above that level of attenuation.

Given that both of these are respected British manufacturers, and that output voltages and input sensitivities of this order were typical in your autumn round-ups of CDs and amplifiers (including Cyrus and Arcam equipment), if this is really a problem why have manufacturers not responded to it? You described the Cyrus CD as having "near perfect measured results" and the amplifier offered "a neat measured performance which shows how well honed this amplifier has become". Is there then no case for attenuation, then, which is really smoke and mirrors?

**John Hurley**

Possibly, maybe John. Traditionally, sources like tuners and cassette decks output around 300mV. When CD arrived in 1984 it had 2V output (these are all maximums) so that signals at -90dB or thereabouts were still discernible above noise. For a modern amplifier to work with old sources, unusual ones such as MP3 players, and even low gain external phono stages, it needs 100mV-300mV input sensitivity. This is too high for modern silver disc players (CD, DVD, Blu-ray) that output 2V - 2.5V, meaning volume must be turned right down.

Two problems arise. The one you experience is limited volume control resolution with CD. The other is that silver disc effectively gets attenuated down heavily by the volume control, only to be amplified back up again, and a whole gain stage may exist in the signal path that is not needed. I see no benefit in doing this again in external attenuators, except insofar as it allows a different part of the volume control to be used and gives greater control resolution.

Ideally, amplifiers should have low sensitivity, high level inputs for CD etc that feed the volume control directly, plus high gain inputs that use a x10 preamp, or perhaps a switchable x10 gain block after the volume control, but I'm not aware of any. Arcam do provide internal attenuation (input trim) within their amplifiers, however, so this is a nice halfway house

Another small but not insignificant point is that users commonly think their amplifier is powerful when it seems loud at low volume settings and a small twitch upward seemingly makes it go very loud. Having to wind the volume control to max to get high volume doesn't seem right, yet technically it is. **NK**

### HOME (NET) WORKING

There appears to be a gap in the market for quality hi-fi MP3s in the home. It's true that hand held MP3 players such as the ubiquitous iPod can be plugged into the auxiliary port on a hi-fi but these devices, for all their charm, portability and convenience can hardly be classed as hi-fi sound can they?

Recently, I was looking for a dedicated hi-fi MP3 player to replace my Slim Devices SqueezeBox and hopefully provide something with a sound output similar or, if possible, better than CD. What I found was there is not a lot of choice, especially if you are looking for a dedicated hi-fi box and not a Wi-Fi enabled multi-room system such as those from Sonos, Naim and even Cambridge Audio. So what is out there?

Well if you hunt through product lists at the back of some hi-fi magazines you will find reference to only five products and only three of those have



**Going up. Creek's revised Evolution RDS tuner, tested this month, produces a whopping 2.8V out. Is this too much for John Hurley?**



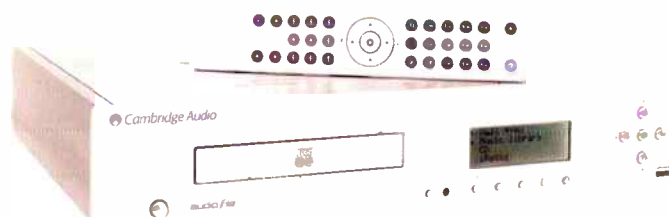

**Cambridge Audio Azur 640H hard drive "scare the pants off most budget to mid-price CD players when the higher bit rates are used" says Garnet Newton-Wade**

hard drives. These are: the Acoustic Solutions SP150, the Cambridge Audio Azur 640H and the Yamaha CDR-HD1500. The Azur 640H and the Yamaha are both around the £600 mark which effectively rules them out of the budget end, and the SP150 only has a 40GB hard drive which, by today's standards, is mean and certainly not enough for a full music collection at the higher bit rates.

I went for the Cambridge Audio Azur 640H which certainly produces sound good enough to scare the pants off most budget to mid-price CD players when the higher bit rates are used. It can also offer a pretty decent CD Recorder with playback that occasionally provides me with a change and interesting comparison to my main player, a Naim CD5x. It can also provide Internet Radio, way down in hi-fi terms but with 512K capability, when hooked up to Broadband via a LAN connection or in my case Wi-Fi enabled.

There is a BUT in there and it is that searching through the Hard Disk requires it to be hooked up to a TV/Monitor; so the addition of Wi-Fi, Keyboard, Mouse and TV/Monitor which are nigh on essential, adds another £150 to £200 to the overall price.

So why have none of the big hi-fi companies brought out a product between the £250 and £600 price mark that does everything my set up can? It certainly can't be down to profit margin. I would have expected this to herald a thriving cottage industry, after all a decent laptop is only around £300 to £400 these days and a desktop even cheaper. You can kit out a dedicated device with quiet components, a small screen, keypad and remote, running a Media Centre GUI interface (Linux and Microsoft both have fine offerings, so no real development costs) and maybe even with video capability that would not cost a fortune.

If such hi-fi separates existed, with space for consumers to upgrade or add additional hard drives then I could see CDs becoming nothing more than backup devices to restore lost data. I would certainly think very hard about including one in my hi-fi rack and am pretty certain they would soon be as

common place as CD Players are now. In the meantime where is that business plan?

**Garnet Newton-Wade**

Indeed - couldn't have put it better myself, Garnet! There's been a paucity of such devices for a long time, despite the likes of me banging on about how great it would be if there was such a thing... Still, things are moving, albeit at a glacial pace. There are two solutions that spring to mind. First, Apple's iPod Classic 160GB (£200) running Apple Lossless Audio Coding (ALAC), in conjunction with iTunes gives CD quality and ease of use via a Mac or PC. You can squirt your music to the iPod then play it via an Arcam rDock (£120) via an auxiliary input on your hi-fi, or stream it wirelessly (if you have a Wi-Fi network) to an Apple Airport Express (£45). This has line level audio outputs, which give decent sound, but it's better to feed the optical digital out into the likes of a Russ Andrews DAC-I USB (£600).



**Place turntables away from loudspeakers to avoid feedback.**

Alternatively, there are a number of off-the-shelf systems on the market, by far and away the best I've tried - from a user-friendliness and/or ergonomic point of view - being the Sonos Music System ([www.sonos.com](http://www.sonos.com)). Around £1,000 will kit you out with a really nice bit of kit that feels like it's designed for people as opposed to computer

network specialists. Then there's Linn's new Sneaky DS network music player (£995). This great bit of kit hooks up to your wireless network, then plays music from your PC at up to 24/96 resolution via its hard drive or Network Attached Storage Device. The Sneaky DS has a built in stereo power amp too - you just add speakers and you're off. As you'd expect from Linn, it's capable of excellent sound and brings multi-room to life; look out for a full review soon (I've used it extensively, but not yet in formal review conditions)! **DP**

**FEED IT BACK**

*I get bad feedback through the speakers when using my Dual C505-4 turntable. It is used via a Roksan Kandy amp. The Dual does not have upgraded output cables as it has no facility for these. The cheap original wires go directly into the case. If I move the unit around and disturb the wires, outputs and power cable the feedback comes and goes. Is there a solution or do I need to be looking for a new turntable?*

**Walter Clough**

It sounds like your Dual has a dodgy connection or an internal wire that is on its last legs, to me. The cable can be replaced, if you know of a friendly electronics shop that would do the job for you, or it's about a half an hour job if you're handy with a soldering iron and know one end of a screwdriver from the other. After undoing the transit screws and angling their tops towards the side of

the deck each one is nearest, the top plate can be lifted from the plinth, allowing you to get at the underside. This will also allow you to upgrade the cable if you want to do so at the same time. **AS**

Or you may have the turntable too near to the loudspeakers, or insufficiently isolated from the floor. I

suggest you try moving it away from the loudspeakers and on a firm, heavy table or suchlike. Also ensure it is not in or near to a corner, where low frequency sound pressure is greatest.

**NK**

### RECYCLED SOUNDS

*I found you online and wanted to write firstly to thank you for your useful archive reviews and buying guide. While I'm not new to hi-fi, I'd never bought secondhand before and yet, reading around suggested to me that I might achieve better results buying used equipment that was rated in its day rather than going for a cheaper, brand new system.*

*A week ago, for instance, I was seriously considering Onkyo's popular CR-515DAB unit (new) coupled with Q-Acoustics 1010i speakers. But then I found a company online called Green Home Electronics who repair, recycle and resell well-known-brand hi-fi kit. So I took a chance and ordered two items that seemed to me to be going for a reasonable price. They are a Cambridge Audio A3i amplifier and a Rotel RCD-865 CD player.*

*My question now is: which bookshelf speakers in your opinion would go well with these two units? A few people have suggested to me that, for £150 or less, Monitor Audio's Bronze BR1s (new) would do the job better than most. But I wonder whether you think a SIH pair might achieve even better results? If so, could you point me in the right direction? I listen mainly to jazz (old and new), and the system would be for a medium-sized kitchen.*

**Simon Oxtan**

To be honest, I think that your requirements would be best satisfied by a small pair of new bookshelf speakers - budget speakers do seem to improve in quality faster than other product categories and modern affordable standmounters really are very good, especially for a second system in the kitchen. The MA Bronze BR1s are a fine choice,

but I would personally plump for the Mordaunt Short Avant 902is at the same price, so don't forget to check these out as well. If you do fancy going secondhand for £150, then basically you can consider the next models up in the range, such as a pair of Bronze BR2s or some B&W DM602S3s.

If you really want to save the pennies, the likes of some Goodmans Maxim 3s, JPW AP3s or Mordaunt Short MS20i Pearls could be yours for as little as £30-£40 but they will be older and so care should be paid to the usual problems that afflict older units, like burnt out voice coils, frazzled tweeters and perished surrounds. **AS**

### STUDENT DAZE

*I am hoping that you would be able to provide me with some information regarding tweaking and upgrading my setup. The equipment I have now would certainly not be considered "hi-fi" by most people's standards, but I bought it last year whilst still a student, so price was the main consideration. I currently have a Pioneer PL-12D Mk II sporting a Shure M55E cartridge. This is put together with a Pioneer SX-636 receiver; I got both these for £25, so I think it was fair value. I have grown rather fond of these components now, and really enjoy the sound they produce, as they far surpass any mini-system or cheap separates I've heard, and deal quite well with the eclectic selection of music I play through them!*

*My main question involves speaker choice, as I am currently running with a pair of dodgy Wharfedale speakers that came with the S-991 system I had before this. They seem to produce slight distortion on high notes and can sound quite sibilant at times. I have a reasonable amount to spend on speakers, around £300, but would any speakers of this price be "too good" for what I have? I am also interested to know whether you think my turntable is capable of taking a cartridge upgrade, as I know the M55E is getting on a bit now.*

**Neil Fifoot**

Frankly, Neil, I think a PL12D and SX-636 for £25 are better than "fair value"! I know both units and they're good quality, well built designs that will most likely outlive us all, but I think we can help with a few tweaks to maximise your listening experience.



**"For £150 or less, Monitor Audio's Bronze BR1s (new) would do the job better than most" Simon Oxtan is told - and Adam agrees.**

Firstly, loudspeakers - I wouldn't use the full £300 you have available as the SX-636 will work very well with a good quality budget pair that will also stand you a good few years use once you do decide to upgrade the Pioneer. Consequently, as per the previous letter, have a listen to the Monitor Audio Bronze BR1, Mordaunt Short Avant 902i (both £150) and also the Acoustic Energy Aegis Neo 1 (£200).

Next up, the turntable. Yes, the PL12D can take on a better cartridge than the M55E and personally I would hurry down to your local needle emporium and grab a £30 Audio Technica AT-110E as soon as you can, as I am hearing horrible rumours that this fine little budget device is now no longer made - something I still need to confirm. An AT95E for £25 would also be fine, but the 110 does offer that little bit extra.

Finally, invest in some Kontak contact cleaner, arm yourself with a cotton bud or two and attack the receiver with them - giving all the input and output sockets a good buff will bring an extra level of sparkle to the sound. **AS**

I used an M55E eons ago and it was - er - horrid! It also mistracked and damaged my records. The simplest, cheapest upgrade is a Nagaoka MP-11 which is utter refinement, if rather warm sounding. Otherwise, for the PL12D MkII I'd get a Goldring 1012GX if your funds will stretch that far. This is more tonally balanced than the Nagaoka. **NK**

### GRILLING NOEL...

*I picked up a copy of your magazine for the first time recently and found it an informative and indeed entertaining*



**Pioneer PL12D, famous in its day for superb quality. But what cartridge suits it?**





**World Audio Design KLS9, with heavily radiused edges and asymmetric driver placement for cohesive imaging without a grill.**

read. However I would like to raise a point on which Noel was surprisingly silent in his article about getting the best from small loudspeakers in the February 2008 issue. That is the question of whether grilles should be left on or taken off.

Now I know that accepted wisdom is that grilles should be removed, but for me this compromises the visual aesthetic. Also, manufacturers who strive to achieve the best performance/cost ratio for their product actually spend money to provide these items, which seems to be a bit of a contradiction. I suspect that the type of music being played, the quality of the recording and partnering equipment and the room acoustic all come into this. Or is it a simple trade-off between performance and appearance? An informed opinion would be welcome.

**Brian Bradshaw**

Personally, I always leave mine on - I find the sight of woofers flapping away whilst I'm trying to concentrate on listening far too distracting!

**AS**

Ah, yes, there's even controversy in loudspeaker grilles! Good ones that use acoustically transparent cloth alter frequency response and sound balance little; however most have a profile that wrecks surface wave behaviour across the baffle and you can hear this as incoherent imaging. A smooth front baffle with heavily rounded edges and asymmetric driver

placement, to detune diffraction break frequencies gives a tidy and cohesive sound. I remove grilles to give the underlying physical structure a chance to perform, if it has been designed to do so. Not all manufacturers are especially clued up on the not unknown effects of surface wave behaviour though, and one of the daftest I have encountered in the distant past used a heavy baffle cloth to damp tweeter peaking, so when I removed the cloth for measurement they objected. Fair enough in some ways, but only if you see the grill in terms of cloth! It is a physical structure that destroys surface wave behaviour and generally is best removed. If you don't like the sound, then put it back on. Simple, no? **NK**

### **COSTLY CD**

I am writing in response to Noel Keywood's article in the May edition of *Hi-Fi World*. In this article he discusses the latest Meridian CD player, the 808.2, and states, in the context of LP versus CD, that although CD is now vastly better than it used to be, "what a pity it ... is so expensive that it will never be offered by the NHS". He continues, "not many of us are ever going to be able to afford fabulous CD players like the new Meridian, so although CD can now perhaps be burnished to approach LP in terms of imaging, few will ever hear it."

Can I ask him how much his cartridge cost? And his tonearm? And his phono stage? Not to mention a turntable, maybe a slate plinth, a silver rewire for his arm? And can he also tell me how much LPs now

cost compared to CD? Considering that we are talking about one of the most expensive CD players available, I think his comments against it on the basis of cost is spurious when compared to the cost of an equivalent vinyl setup.

Take a Linn LP12 (£1,540), for example, with an Ekos tonearm (£2,950), an Akiva MC cartridge (£1,980), a Linto phono pre-amp (£1,100), a Lingo power supply (£990), and perhaps a Keel subchassis (£1,950). Total £10,510. Compared to that, an 808.2 starts to look quite cheap! A Meridian 808.2 costs £7,195, while an 808i, which includes a pre-amp, costs £8,250.

Of course both vinyl and CD systems are available for much less. But I still feel that vinyl systems will end up costing much more, especially when you factor in the cost of the format. I have recently seen 'The Cole Porter Song Book' by Ella Fitzgerald, a double LP on 200g vinyl, on sale for £39. The same thing on remastered CD now costs around £15 (it used to be a lot more). Where CDs used to be twice as expensive as LPs, it is now the other way round.

**Siman Coxall.**

Hmmm - lot of standard-pattern speculation in there Simon. I tend to use a lot of different items and my observations are generalisations from the overall experience. Sure, the Ortofon Kontrapunkt b and SME312 on a Garrard 401 I use cost a bit, but I have a £350 Nagaoka MP-500 in the arm at present and swap budget items in and out regularly. You devote a paragraph to a hypothetical vinyl replay system costing £8,250 that I do not recognise. This is a contrived argument I have seen before. We commonly use and recommend budget vinyl replay systems.

Vinyl replay at a decent level costs this: Rega Planar 3 with RB300 arm, £350; Ortofon 2M Black £350; Icon Audio PS1.2 valve phono stage £600. That's £1,300 in total. With a

Goldring 1042 and Whest Audio Two at £170 and £650 the price drops to £1,170. Okay, it's still expensive, but not unaffordable. As I said in my Onkyo DR-S501 receiver report this gives you a sound that questions digital.

You are right that LP now costs more than high definition formats. But it seems a lot

of people want to enjoy the sizeable collections that they already own, whilst others buy second hand. I shell out big money on vinyl and note, in delightful irony, that it is priced like that other high definition format, Blu-ray. **NK**

Indeed - let's not forget that you can kit yourself with a great LP music collection from £1 a disc upwards at certain second-hand record shops and charity shops. I once walked (staggered!) out of the Brighton Record Fair with 60 LPs, with not a single James Last waxing present, for £30. Howzat? **DP**



**Quality LPs are more expensive than CD - £15.99 in this case**



Heatherdale audio limited



202 Findon Road, Worthing, WEST Sussex, BN14 0EJ  
Tel. 01903-872288 or (after hours) 07860 660001 Fax. 01903 872234  
e-mail: heatherdale@hifi.stereo.com //www.hifi.stereo.com

0% FINANCE AVAILABLE FOR UP TO 3 YEARS ON  
SELECTED ITEMS.  
SUBJECT TO STATUS. CONDITIONS APPLY.

**SPEAKERS**

- Ruark Templars Mk 2 speakers £245
- B&W ASW-4000 sub woofer £795
- B&W DM 1800 speakers with stands £150
- B&W DM 640 floor standing speakers £295
- Apogee Diva speakers, rare and fantastic £365
- Mission 753 speakers £349
- Revel Salons (mini)boxed £795
- Quad 21L speakers £385
- Acoustic Zen Adagio Junior speakers with stands (new) £340
- Acoustic Zen Adagio Centre speaker with stand (new) £340
- Mordaunt Short MS-40 speakers £125
- Mordaunt Short Avant 902 speakers with stands £2695
- New Acoustic Zen Adagio speakers "SPECIAL OFFER" £2695
- New Almarro speakers £2895
- Hales Transcendence 5 speakers £2895
- Dynaudio Audience 7 speakers with stands £395

**AMPLIFIERS**

- Roksan Caspian monoblocks Boxed/superb £1295
- Audio Note OT0 with phono £495

- Bel Canto EVO 2 power amp £1295
- Musical Fidelity A308 integrated amp £895
- Goldmund SRM-250 monoblocks, ex demo, (£6590) only £4995
- Wavac MD-805 SET monoblocks As new, (£16500) our price £7950
- John Shearpe Phase 2 integrated amp with phono £350
- Nakamichi Amp 1 with Cassette Deck 2 & CD Player 3 £795
- Kora Triode 100 SB Monoblocks £3500

**PRE-AMPS;**

- Trichord Dino phono stage with large PSU £275
- Audio Note M8 pre-amp with phono/remote MINT £7995
- Yamaha DSP-E800 processor/3 ch amp £175
- Audio Note Zero monoblocks with pre-amp (ex demo) £795
- Audio Research LS2 (bal/outputs) £695
- Proceed PAV pre-amp £695

**CD PLAYERS & TRANSPORTS**

- Musical Fidelity NuVista 3D CD player, superb/boxed £1595
- Esoteric X-03 ex demo, full manufacturers warranty, please phone
- Marantz CD 873 £65
- Audio Note DAC 5 Signature, as new latest spec, (£39,000) £29,950
- Goldmund Eidos CD/SACD player ex demo.

- mini/boxed/full warranty (£3195) only £2495
- Sony CDPM41 CD Player £60

**MISCELLANEOUS**

- Revox B760 tuner £195
- Selection of NEW Madrigal CZ Gel balanced interconnect @ 30% discount. £150
- Musical Fidelity XPSU-V3 power supply POA
- 3 mtr pair Acoustic Zen reference speaker cable £795
- Isoclean Power 50A 111 US power block & noise filter (£as new) £850
- Selection OYALDE plugs and power strips £75
- Sony AM/FM ST-SE370 Tuner £75
- Technics ST-610L Tuner (FM/MW/LW) £65
- Winds ALM-01 Stylus Gage (New) £425
- Sony ST-SE570 Tuner £60

**TURNTABLES, CARTRIDGES & TONEARMS**

- Dynavector 507 MK2 arm (£2995) only £1995
- My Sonic Eminent cartridge (new) £2750

**Main dealer for Esoteric**

ALL USED CARTRIDGES ARE CHECKED UNDER A MICROSCOPE BEFORE BEING OFFERED FOR SALE.

VISA - SWITCH - MASTER CARD - AMEX - DINERS CLUB WELCOME.  
WE TAKE PART EXCHANGE ON NEW & USED STOCK and buy in for cash

USHER

Sound Hi Fi

marantz

PREMIUM

because music matters



Usher Class A



520 Loudspeakers



Avid & other turntables



Usher, Marantz, Avid, Audio Technica OC9, Acoustic Solid, NuForce, Black Rhodium, Graham Slee, Hadcock, Clearaudio, 78rpm reproduction, Advance Acoustic, and much more.

All demonstrated in a relaxing setting with river views! Very high part exchanges & mail order.

Sound Hi Fi Dartmouth Devon 01803 833366 web www.SoundHiFi.com

plug 'n' play 'n' smile

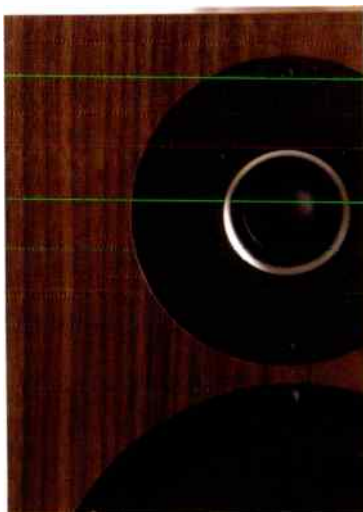

kudos  
www.kudosaudio.com

0845 4586698 for details...



One Decent Wallshelf

Thoroughly Recommended - David Price, Hi-Fi World Jan 06

- featuring:
- steel frame with multipoint fixing
- upto 25mm thick 1/2 metre acrylic isolation platform
- tuning pack for system matching available:
- hdw - £129
- odw (pictured) - £249
- odwt (2 shelf) - £349
- all in either silver or black

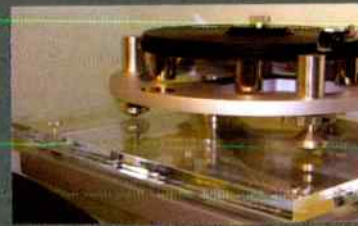

The Decentscale

- featuring:
- non metallic construction suitable for all types of cartridge
- record height measuring platform (patent applied for)
- upto 20% more accurate than any other sub £100 scale
- available:
- now! - £35



Wallshelves, Isolation Platforms, Digital Tracking Force Scales, Cables

Decent Audio 0845 6019390



# HEATHCOTE AUDIO

TEL: 07860 511111 WEB SITE [www.heathcoteaudio.co.uk](http://www.heathcoteaudio.co.uk)

E-MAIL [heathcoteaudio@aol.com](mailto:heathcoteaudio@aol.com)

## VINYL

VPT ARIES3 BLACK KNIGHT/SUPER PLATTER/MINI FEET  
10.5 TONEARM FEW HOURS USE (£5000?)  
VOYD VALDI/HELIUS AUREUS MKII/MILTEK CART.  
MUS.FID.XLPS V3 PHONO STAGE  
ZETA TONEARM (ORIGIN LIVE RE-WIRE)  
HELIUS CYALINE  
ORACLE DELPHI V/TURBO PSU/VPI JMW ARM/FULL COVER  
ORACLE DELPHI V & TURBO POWER SUPPLY (£4000)  
CLEARAUDIO EVOLUTION & TANGENT PARALLEL ARM  
ACOUSTIC SIGNATURE SAMBA MK II & ARM (£2300?)  
VPI JMW MEMORIAL ARM  
GRAHAM 2 TONEARM  
FIDELITY RESEARCH 64S? (SILVER WIRED)  
NVA TWO BOX PHONO STAGE  
ANTIQUE SOUNDLABS MINI PHONO STAGE 2-BOX  
MEIXING MING DA MC767 RD MM/MC PHONO STAGE  
BILL BEARD MM/MC PHONO STAGE  
McCORMACK MINI PHONO DRIVE (MM/MC £600?)

## VALVE AMPS

SOUND DESIGN DCO-150 MONOBLOCKS (RARE/SUPERB)  
VACUUM TUBE LOGIC 225 WATT KT90 MONOBLOCKS  
MUSICAL FIDELITY NU-VISTA PRE (WITH SPARE VALVES)  
ANTIQUE SOUNDLABS AQ1001 KT88 INTEGRATED (EXCLT)  
ANTIQUE SOUND LABS AQ1000DT TWIN 845 MONOBLOCKS (£5000)  
ANTIQUE SOUND LABS LJO1 PRE AMP/HEADPHONE AMP  
ANTIQUE SOUNDLABS MINI PHONO STAGE 2-BOX  
ROGUE AUDIO 66 MAGNUM REMOTE PREAMP  
GAAAF 50/50 POWER AMP (KT-88S)  
COUNTERPOINT SA-5000A LEGENDARY PRE/PHONO STAGE (2 BOX)  
UNISON RESEARCH FEATHER PRE/35 POWER  
TUBE TECHNOLOGY SYNERGY INT.AMP  
AUDIO RESEARCH SP-9 C/W PHONO STAGE (RARE BLACK)

## CD/SACD/TRANSPORTS/DACS

MUSICAL FIDELITY A3 24 BIT CD PLAYER  
McKINTOSH MCD-201 SACD/CD/VOLUME (£3500)  
CHORD 1500E DAC/DIGITAL PRE AMP (£6800)  
MUSICAL FIDELITY NU VISTA 30CD PLAYER  
UNISON RESEARCH UNICO (£1750) NEW MECH  
ORELLE EVO-100 CD PLAYER  
CONSONANCE 120 LINEAR CD PLAYER (£650)  
EINSTEIN 'THE CD PLAYER'  
MICROMEGA CLASSIC SOLO XLR/RCA (NEW MECH)  
AUDIO ALCHEMY DDS III CD/TRANSPORT  
ARCAM CD 82  
DENON 2800 MKII GOLD (HDCD)  
PRIMARE V-25 CD/DVD PLAYER (£1000 NEW)  
MERIDIAN 602/606 TRANS/DAC (STILL EXCELLENT)  
PROCEED (LEVINSON) PDT-1 TRANSPORT & 20 BIT DAC  
ACCUPHASE DP-90 TRANSPORT  
RESOLUTION AUDIO CESCIUM TRANSPORT (RARE)  
THETA CARMEN CD/DVD TRANSPORT  
THETA DATA II TRANSPORT (SILVER) AES/RCA ETC  
THETA DATA TRANSPORT (BLACK)  
MERIDIAN 200T TRANSPORT  
PERPETUAL TECH .P1A/P3A/MODULAR PSU MODRIGHT SIG.2  
PERPETUAL TECH .P3A 24/96 UPSAMPLING DAC  
MODWRIGHT SIGNATURE-2 (SUPERB)  
AUDIO ALCHEMY DDE V.II HDCD DAC  
AUDIO ALCHEMY DDE V.I 2 HDCD DAC  
AUDIO ALCHEMY DDE V1.1 HDCD DAC.  
MSB LINK DAC-III 24/96 MODULE  
DPA LITTLE BIT 3  
AUDIO ALCHEMY DDE V1 DAC & PSU  
Z-SYSTEMS UPSAMPLER (£1500)  
MARANTZ CD 63 CLASSIC PLAYER

## SOLID STATE

QUAD 34 PRE AMP 2 X 306 POWER AMPS FM4 TUNER  
& QUADRACK VERY LATE SET  
H-CAT 12-B PRE WITH WTC CONTROL (£2800)  
H-CAT P-12A PRE AMP (£2500?)  
LAVARDIN PRE & 2 MONO'S (CURRENT SPEC)  
KRELL KMA-100 MONOBLOCKS (3 YEARS USE)  
NAD SILVERLINE S-200 POWER AMP XLR/RCA  
MERIDIAN 502 PRE INC. MM PHONO STAGE & MSR  
PASS LABS ALEPH P PRE AMP  
PASS LAB ALEPH O MONOBLOCKS  
MUSICAL FIDELITY NU-VISTA PRE (WITH SPARE VALVES)  
McCORMACK RLD-1 REMOTE PRE & DNA-125 POWER AMPS (4.5K)  
PLINIUS SA-201 (RETAIL £4K?)  
PLINIUS SB-300 (£5K+ NOW)

DEM/BOXED £2995  
EXCLT £895  
EXCLT £225  
BOXED £595  
EXCLT £595  
MINT £2795  
MINT £2250  
MINT/BOXED £1895  
NEW £1595  
DIS/BOXED £695  
MINT/BOXED £995  
EXCLT £695  
EXCLT £395  
EX.DEM £299  
MINT/BOXED £299  
EXCLT £375  
EX DEM £349

VGC £1695  
VGC £1250  
MINT/BOXED £795  
EXCLT £795  
EXCLT £2750  
MINT/BOXED £295  
EX.DEM £249  
MINT/BOXED £895  
MINT £1295  
SERVICED/BOXED £1995  
MINT/BOXED £1495  
MINT £2999  
MINT/BOXED £895

EXCLT TBA  
NEW/BOXED £2850  
MINT/BOXED £2750  
BOXED £1295  
MINT/BOXED £795  
MINT/BOXED £795  
NEW/BOXED £495  
EXCLT £1475  
EXCLT/BOXED £895  
N.O.S. £395  
MINT/BOXED £295  
MINT/BOXED £299  
NEW/BOXED £475  
EXCLT £1195  
MINT/BOXED £895  
EXCLT £2750  
EXCLT/BOXED £995  
MINT/BOXED £1295  
MINT/BOXED £795  
VGC £395  
EXCLT £350  
LAST SET.BNIB £1895

BRAND NEW £895  
N.O.S. £350  
N.O.S. £275  
N.O.S. £250  
MINT/BOXED £275  
VGC £149  
EXCLT £149  
MINT/BOXED £475  
VGC £99

DUE IN TBA  
DEM £1750  
DEM £1250  
EXCLT £5500  
MINT/BOXED £2750  
MINT/BOXED £695  
MINT/BOXED £750  
EXCLT £1150  
EXCLT/CRATED £2500  
MINT/BOXED £795  
MINT/BOXED £2250  
EX.DIS £2395  
DEM/BOXED £2750

MUSIC FIRST SILVER PRE AMP (£3K?)  
MUSIC FIRST COPPER PRE AMP (£1600)  
CONRAD JOHNSON PFR PR/MF-2500A POWER AMPS (£6500+?)  
ROTEI RB-1090 MONSTER POWER AMP (50 KG?)  
ROTEL RB-870BX STEREO/MONO AMPS X 2  
AVI S-2000 MONOBLOCKS  
CONRAD JOHNSON PF-1 PRE C/W PHONO STAGE  
ORELLE EVO-100 PRE AMP/POWER AMP  
ADVANTAGE I200 INTEGRATED AMP  
MARANTZ PM66 KI-SIG AMP  
ALCHEMIST FORSETTI 2 BOX PRE & POWER AMPS

## LOUDSPEAKERS

MARTEN BIRDS (£15000)  
MARTEN MILES II CHERRY (8k+ NEW)  
QUAD 989 ELECTROSTATICS  
HARPER QUARTETO (£4000)  
MIRAGE M1si BIPOLAR GIANTS (£6500)  
LIVING VOICE AVATAR OBX (4K?) CHERRY  
SNELL TYPE-AII (VERY RARE)  
CELESTION A-3  
CELESTION A-2 SANTOS R/WOOD (£15/1600?)  
REFERENCE 3A VEENA (SUPERB £3000)  
REFERENCE 3A DULCET (FANTASTIC LITTLE SPEAKER £1700)  
BKS 128 RIBBON HYBRID (STAR GRANITE £2800)  
FAB AUDIO MODEL-ONE (RETAIL £7500)  
EGGLESTONWORKS ROSA  
EGGLESTONWORKS ANDRA II  
MARTEN MILES II CHERRY (8k+ NEW)  
REGA XEL (ROSEWOOD £1250)  
MONITOR AUDIO GS 10 & STANDS (£1000)  
A.L.R. JORDAN NOTE 5 FLOORSTANDERS (£2500)  
CURA CA-30 FLOORSTANDERS (MAPLE)  
AURUM CANTUS V3M GLOSS BLACK (£1700)  
AURUM CANTUS M-103 FLOORSTANDERS (CHERRYWOOD £1300)  
AURUM CANTUS SUPREME (AWESOME! £10,000)  
AURUM CANTUS VOLLA (RETAIL £2500)  
AURUM CANTUS MUSIC GODDESS £2500  
PROAC STUDIO 150  
CASTLE HOWARD S2 ROSEWOOD

## TUNERS/MISC

AVI 7 BAND TUNER RDS (S SERIES VERY RARE)  
HITACHI FT-5500 MKII  
SONY ST 5950 SD TUNER AM/FM

## MAINS CABLES/BLOCKS/CONDITIONERS ETC

TARA LABS RSC AIR-2 6FT POWER CORDS (SHUKO)  
BLACK RHODIUM SUPER MAINS POWER CORDS  
BLACK RHODIUM POWER CORD RHODIUM PLATED EASYGRIP PLUG  
ISOTEK POWER CORD  
INTERCONNECT CABLE  
SILVER ARROW 1 METRE XLR BALANCED (£1200)  
BLACK RHODIUM ORATORIO 1 METRE XLR  
BLACK RHODIUM CONCERTO 1 METRE RCA (£180)  
BLACK RHODIUM SYMPHONY 1 METRE RCA  
QED SILVER SPIRAL 1 METRE RCA  
QED SILVER SPIRAL 0.8 METRE (2 OFF)  
CHORD CO.COBRAC/COBRA2/SILVER SIREN DIN TO RCA  
XLO 1METRE AND 0.5 MTR RCA (SIX OFF)  
QUANTITY OF ITALIAN ART AUDIO CABLE 3 INTERCONNECTS 1M/1.5M/2M  
AND 4 LENGTHS OF 3 METRE LOUDSPEAKER CABLE

## LOUDSPEAKER CABLE

BLACK RHODIUM POLAR NINJA DCT +++  
NORDOST SPM 3 METRE BI-WIRE  
SILVER SOUNDS 6 METRE BI-WIRE (EXPENSIVE!)  
TARA LABS RSC AIR 2METRE PAIR  
TARA LABS PRIME RSC 18 FEET BIWIRE !!  
DPA BLACK SLINK (£100 PER M.) 4.5 METRE PAIR WBT LOCKING PLUGS  
SONORAM PLATEAU 4 METRE+ PAIR (HI END USA HEAVY COPPER CABLE)  
MIT MH-750 BI WIRE 3 METRE PAIR  
TRANSPARENT MUSIC WAVE ULTRA 8FT PAIR  
TRANSPARENT SUPER BI CABLE 10 FT PAIR  
RENAISSANCE SILVER SIG. 3 METRE PAIR (£1300)  
RENAISSANCE SILVER 4 METRE PAIR  
PS AUDIO X-STREAM 3 METRE PAIR (VERY HEAVY!!)  
DIAMOND HI SILVER 3 METRE PAIR  
AUDIONOTE AN-L 3 METRE PAIR SILVER SPADES  
CHORD RUMOUR 2 4 METRE PAIR  
BLACK RHODIUM S-300 BI WIRE 5 METRE BI WIRE PAIR (£400)  
BLACK RHODIUM S-300 BI WIRE 4 METRE PAIR (£240)

WEB SITE [www.heathcoteaudio.co.uk](http://www.heathcoteaudio.co.uk) UPDATED DAILY!

QUALITY EQUIPMENT REQUIRED FOR IMMEDIATE PURCHASE.

**Billy Vee**  
SOUND SYSTEMS

UNIQUE PRODUCTS FROM AN ESTABLISHED NAIM

CALL SALES: (020) 8318 5755 or 8852 1321 - 248 Lee High Road, London, SE13 5PL

0% APR Credit options are available for purchases of new products exceeding £900, please call for details. E&OE

### New - Naim HDX Hard Disk Player



Also available for audition the Linn Akurate DS and Klimax DS music players

The new Naim HDX is an ideal product for those who value their album collection but want it all in one place with a flexible search facility while retaining that unique Naim quality. The HDX will play CD, most popular formats, store 600 albums, offers USB, extra NAS storage and helps grow your musical horizons with 6 streamed outputs. You can also upgrade the power supply. Contact us to audition this unique performance product. (For more info visit - [billyvee.co.uk](http://billyvee.co.uk))

### New - Naim Superline & PowerLine



The new SuperLine high performance Moving Coil phono stage with brass suspended chassis and a class A amplifier feeding 25 regulated supplies is awesome. - The new PowerLine cable is the most impressive mains cable upgrade we have heard, a must for all Naim owners at only £395. Visit [billyvee.co.uk](http://billyvee.co.uk) for more info or, come and listen.



# Cymbiosis

## Linn Products

Sondek LP12 specialist  
setup, upgrades, rebuilds

25+ years experience with international reputation

## Naim Audio

500 series stockist

always available for demonstration  
including DBL Loudspeakers

## Arcam • Atacama

Chord Company • Denon

Dynavector • KEF

Kudos • Neat Acoustics

Quadraspire • Rega Research

Spendor & more...

We are hi-fi specialists, so please call us for  
advice, recommendations and demonstrations

We always carry a selection of quality used hi-fi  
check our website for more details

6 Hotel Street, Leicester, LE1 5AW

Tel: 0116 262 3754

e-mail: shop@cymbiosis.com

[www.cymbiosis.com](http://www.cymbiosis.com)

## IAN HARRISON HI-FI TEL: 01283 702875

HIFI AT DISCOUNT PRICES. FREE NATIONWIDE DELIVERY

### SALE!

TRADE IN YOUR OLD MOVING COIL CARTRIDGE & SAVE UP TO 60% OFF THE RRP.

MICHELL ORBE	£POA	WHEST AUDIO PS30R	£POA
MICHEL ORBE SE	£POA	TRICHORD DIABLO	£599
MICHELL GYRO SE	£POA	TRICHORD DINO MK2	£279
MICHELL TECNOARM A	£POA	TRICHORD D300	£POA
DENON DL304	£175	GRADO GS1000	£800
DENON DL103R	£169	GRADO RS1	£605
DENON DL103	£85	GRADO RS2	£450
DENON DL160	£80	BEYER DT880	£195
DENON DL110	£60	SENNHEISER HD650	£250
DENON DL103SA	£385	RRR FS100	£899
DENON AHD2000	£215	EAR MASTER DISK	£POA
DENON AHD5000	£425	CLEARAUDIO CONCERTO	£800
AUDIO TECHNICA AT-OC9ML2	£225	TRANSFIGURATION PHOENIX	£1100
AUDIO TECHNICA ATHW1000	£320	KOETSU BLACK	£1050
AUDIO TECHNICA AD700	£85	TOM EVANS GROOVE X	£1700
GOLDRING G1042	£155	EPOS M12i	£POA
GOLDRING G2500	£155	CREEK DESTINY AMPLIFIER	£POA
GOLDRING ELITE EXCHANGE	£210	CREEK DESTINY CD PLAYER	£POA
CLEARAUDIO TURNTABLES	£POA	GRADO PRESTIGE GOLD	£105

I ALSO SUPPLY:  
VAN DEN HUL, ZYX, CARTRIDGE MAN, SUMIKO, ORTOFON, RESON, SME, GRAHAM, MOTH, HADCOCK, THORENS, EAR/YOSHINO, ACOUSTIC SOLID, HEED, GRAHAM SLEE, PURE SOUND, AESTHETIX, ACOUSTIC ARTS, NAD, SONY, NU FORCE, SUGDEN, HALCRO, C.A.T. GAMUT, GRAAF, MONRIO, AUDIO ANALOGUE, PATHOS ACOUSTICS, UNISON RESEARCH, OPERA, TRIANGLE, FINAL, HARBETH, USHER AUDIO, DIAPASON, TANNOY, AUROUSAL, ERGO, STAX, AKG, BLACK RHODIUM, TRANSPARENT, QED, IXOS, HI DIAMOND, SUPRA, WIREWORLD, KEMP ELEKTRONICS, JUAL, B.C.D, CUSTOM DESIGN, OPTIMUM, ASH DESIGN, APOLLO, ALPHASON, B.D.I.

PLEASE PHONE TO CONFIRM PRICE & AVAILABILITY PRIOR TO ORDERING. ALL GOODS ARE BRAND NEW & BOXED WITH FULL U.K. GUARANTEES. NO EX. DEM OR EX DISPLAY GOODS. NO GREY IMPORTS. GOODS ARE NOT SUPPLIED ON APPROVAL. SORRY, NO GENERAL CATALOGUES. PLEASE PHONE OR WRITE FOR SPECIFIC REVIEWS, BROCHURES OR PRICES. SUPPLIER OF HIFI PRODUCTS & ACCESSORIES SINCE 1986 MAIL ORDER ONLY FROM: IAN HARRISON, 7 MILL HILL, REPTON, DERBY, DE65 6GQ.  
TEL: 01283 702875. 9am - 9pm INCLUDING SUNDAYS.

## New From *icon Audio* 30+30w Entry Level Integrated Amplifier



### Stereo 25

## A Serious Valve Amplifier for Only £499.95!

Based on our award winning £900 Stereo 40. "Entry level" does not have to mean low power or quality! Smooth, precise and powerful. 30+30w is plenty of power for modern speakers. Inspired by "Leak" Will exceed the performance of many other brands Check our specification: New all valve design by David Shaw. All Triode driver stage. Silver Teflon audio cable. Hand crafted "Point to Point" wiring. Hand wound transformers. Versatile: can use 6L6, EL34, KT66 or KT88s. Beautiful stainless steel and Plexiglas cover included. Limited offer of free EL34 upgrade worth £100

### Stereo 20 SE Remote

We Only  
Make 100%  
Pure Valve  
Amplification



### Stereo 20 Single Ended

Our first Single Ended design! A very simple, traditional 19.5 watts of pure Class A sonic heaven! KT88s for solid bass and upper detail. All triode valves Inc excellent 6SN7 drivers and fabulous WE 274 rectifier with big choke for super smooth power. This amplifier will perform on all kinds of music. Remote control inc. Beautiful stainless steel and Plexiglas cover included.

### Only £999.95 complete

### Passive Pre-amp (Featured in HiFi World)

4 inputs, tape loop. Alps Blue Pot, silver Teflon cable

Gold plated terminals. Ideal for Leak, QUAD Only £249.95

### NEW! Remote Control Version Available Only £329.95 (silver)

Common Features: Designed in Leicester by David Shaw. Hand built 'Point to Point' wiring. No printed circuit board. ALPS Volume control. Gold plated terminals. Audiophile components. Silver Teflon audio cable. Steel & alloy plate construction. Soft start. Unique HT delay. Comprehensive manual Inc DIY valve change info Telephone helpline. Dealer, export (VAT free and discounted shipping) enquiries welcome.

Find out more: website at [www.iconaudio.com](http://www.iconaudio.com)

Or ask for an illustrated leaflet Ask Your Dealer

Phone 0116 2440593 Email sales@iconaudio.com

*icon Audio* 351 Aylestone Road Leicester LE2 8TA

\*Conditions apply

Debit, Visa and MasterCard accepted



# BIGEARSAUDIO

website: [www.bigearsaudio.org.uk](http://www.bigearsaudio.org.uk) updated daily

## VALVE AMPS.

WOODSIDE 15A230 INTEGRATED VALVE AMPLIFIER [£1200]	£525	TANNOY RECTANGULAR GRFS. 15" GOLDS, AS NEW.	£4500
AUDIO INNOVATIONS 2ND AUDIO 2A3 VALVE MONO-BLOCKS	£1250	ACOUSTIC ENERGY ELITE 2'S, BOXED, AS NEW. [£449]	£225
SUMO VALVE LINE PRE-AMP	£525	REVOLVER R33'S, BOXED, AS NEW.	£325
LECTOR VFI-70L	£675	MORDAUNT SHORT SYSTEM 442 FLAGSHIP SPEAKERS	£475
AUDIO NOTE OTO SE	£1950	TDL STUDIO 10'S, BOXED. [£499]	£150
HEART RHYTHM 300B SET VALVE AMPLIFIER	£775	EPOS M12.2'S, AS NEW	£325
QUAD II 4040'S AND THE QC-TWENTYFOUR PRE-AMP WITH FITTED VALVE PHONO STAGE	£2750	WHAREFADALE DIAMONDS NEW	£150
PAPWORTH M100'S	£1550	QUAD ESL63'S SERVICED PANELS, GUARANTEED.	£1250
AFFORDABLE VALVE COMPANY MODIFIED VR-70E VALVE AMPLIFIER	£325	QUAD ESL 57'S BRONZE, FULLY SERVICED, CLAMPS FITTED, BOXED, NEW RECTIFIER BLOCKS.	£1150
AUDIO INNOVATIONS SERIES 500 INT. MINT, BOXED.	£550	ROGERS BBC LS3/5A'S, RAYMOND COOKE SPECIAL ED	£850
CROFT VITA, MINT.	£750	TANNOY 3L2'S 10 GOLDS MINT	£850
AUDIO RESEARCH LS2 PRE, MINT.	£750	CASTLE 75	£325
CR. DEVELOPMENTS ROMULUS, BOXED, AS NEW, 58B1 (25WATTS) [£2995]	£1250	ROGER LS7T'S, VERY NICE WITH STANDS.	£295
AUDION STERLING MK1 EL34	£650	QUAD ESL57'S BLACK, REBUILT & SERVICED BY BIGEARS BOXED.	£1250
ANTHEM X1 EL34 SINGLE ENDED VALVE INT. AMPLIFIER	£425	JORDAN WATTS EX-BBC	£295
AUDION CD1 PRE	£315	NAIM ARV1AS EX-DEM [£1300]	£950
ARIA 300B, EXCELLENT VALVE-NEW	£550	USHER S-520 PIANO BLACK	£320
BAT 3K1, HYBRID, PHONO STAGE, BOXED	£1400		

## TRANSISTOR AMPS + TUNERS

CONRAD JOHNSON M180	£550	PURE SOUND VALVE.	£950
NVA P90 PASSIVE PRE	£190	SONY X3000ES, MINT.	£325
ARCAM A75 INTEGRATED AMP WITH PHONO STAGE.	£250	NAD CS411, RUSS ANDREWS DAMPER+POWER UPGRADE.	£325
PRIMARE A20 MK II.	£450	AUDIO NOTE CD2.1	£1950
NU-FORCE IA7 V2	£1250	MERIDIAN S63 DAC, MINT.	£425
NU-FORCE P9/REF P9EV2'S	£5598	SONY PLAYSTATION 1 CD CONVERSIONS AMAZING	£475
PIONEER STEREO REFERENCE CONTROL AMPLIFIER C-73	£275	MICROMEGA STAGE3 CD, BOXED.	£350
QUANTUM ELECTRONICS 102/202 PRE & POWER AMPS	£175	LECTOR CDP-7T, TOP LOADER	£2150
CYRUS 5 MINT	£325	ROKSAN KANDY CD AS NEW, BOXED	£525
QED VECTOR REFERENCE PRE-AMP, REMOTE [650].	£425	LECTOR DCP-04T VALVE CD PLAYER	£875
MUSICAL FIDELITY 3A-X PRE-AMP.	£225	NAIM CD51	£850
ONIX OAZ1	£175	MARANTZ CD17 MKII [£850]	£495
EXPOSURE SUPER 8.	£325		
NAIM NAIT S1	£750		
CYRUS 2 WITH PSU, BOXED.	£395		
ROTEL R0A4, AS NEW, 6 MONTHS OLD, BOXED, PHONO.	£185		
ARCAM ALPHA 8, PHONO, BOXED.	£215		
CONRAD JOHNSON SONOGRAPHE SC-1	£225		
NAIM SNAPS, JUST SERVICED.	£225		
QUAD 33/306	£450		

SPEAKERS		CD PLAYERS	
ROGERS JRI50'S	£425	PURE SOUND VALVE, PHONO.	£450
KAPPA 9'S	£850	LINN LP12 AFFORMOSA PLINTH, OL. DC, BASIC2.	£575
PROAC RESPONSE 1	£550	MUSIC MAKER III CARTRIDGE [£625]	£395
PMC GB1'S, CHERRY, BOXED.	£650	LYRA CARTRIDGES	P.O.A
SONUS FABER GRAND PIANO LOUDSPEAKERS	£1250	PROJECT DEBUT III. [£210]	£125
VANDERSTEEN AUDIO MODEL TWO [£4000]	£1500	CLEARAUDIO AVANTGARDE	£1720
B&W 602.5 S3 SPEAKERS, EXCELLENT CONDITION.	£275	DYNAVECTOR 10XS	£255
NAIM CREDOS IN CHERRY BEAUTIFUL, BOXED	£775	QUADRASPIRE 3 TIER STAND £415	

CHRIS BIRCHLEY @ BTINTERNET.COM  
01736 740421  
07947 678256



9 Finchfield Road West, Finchfield, Wolverhampton, WV3 8AY

**EX DISPLAY (NEW BOXED)**  
 One only T-A V10 valve integrated amplifier (£4998) 'save £1500' £3498  
 One set only T-A Mini Talis Surround Speaker System (aluminium) £2199 'save £1000' £1199  
 One only Perspective Project Turntable c/w Ortofon Rhomann cartridge £995  
 One only Inca Design Talon integrated 'save £300' amplifier (£650) Bargain £350  
 One only Inca Design Katana CD Player (£650) 'save' £250 £400  
 One only New Perpetual Technologies P1A/P3A Modwright PSU Signature (£1895) £1100

**SECOND HAND**  
 Spectral DMC 10 Beta Preamplifier £985  
 Theta Carmen Transport boxed excellent (£2700) £1195  
 Theta Pro Basic 3 DAC boxed (£3300) £1195  
 Theta Chroma HDCD DAC boxed new (£995) £595  
 Theta TLC (£229) £100  
 Magnum Dynalab FT101 Tuner (black) boxed £445  
 Roksan Xerxes Cognisenti/XPS3 DSU2 Arta Xerxes c/w SME £1150  
 Audio Research LS15 preamplifier £975  
 Audio Research Classic 120 power amps (serviced) £1800  
 Audio research SP9 pre £750  
 Audio Research D70 II £495  
 Counterpoint DA10 (black) (DAC ultra analogue) £1150  
 ATC SCM 10 loudspeakers (rose) £596  
 KEF Ref Model 1-2 (black) £525  
 Albarry Model 408 mono blocks + AP4 preamplifier £425  
 Alchemist Forseth integrated amplifier £495  
 Mission 753 Rosewood EPOA  
 Krell KMA 200 Mono blocks EPOA

**EX DEMO ISOTEK NOVA**  
 Quad 405 2/34 FM4 complete in Quad housing and floor stand EPOA

Tel/Fax: 01902 380 083 Email: [hifi3.zone@blueyonder.co.uk](mailto:hifi3.zone@blueyonder.co.uk)

*Analogue Seduction*  
 where music is our passion

Analogue Seduction are dedicated towards two channel Hi-Fi, specialising in vinyl replay.

As well as our on-line shop we have dedicated demonstration retail facilities based in Peterborough, Cambridgeshire and we can offer our customers home demonstrations.

We stock the finest in amplification, analogue, digital replay and speakers. We also specialise in a cable termination and cable burn in service.

Please visit our website [www.analogueseduction.net](http://www.analogueseduction.net) to browse or purchase products that are not easily available elsewhere.

New vinyl records now stocked

Tel: +44 (0)1733 344768

**audioXpress... It Just Sounds Better**

Your Favorite Audio - One New Magazine!

- PROJECTS
- REVIEWS
- THE NEWEST TECHNOLOGIES
- AUDIO CLASSROOM
- and Much More!

Subscribe To This Great Monthly Publication Today!

**Only \$59.95 us for 12 Issues!**

audioXpress • PO Box 876 • Peterborough, NH  
 03458-0876 USA • Phone: 603-924-9464  
 Fax: 603-924-9467 • E-mail: [custserv@audioXpress.com](mailto:custserv@audioXpress.com)

ORDER ONLINE AT: [www.audioXpress.com](http://www.audioXpress.com)

// the singularly most addicting  
piece of gear I have ever heard"

10 AUDIO REVIEW

"A new benchmark for musical communication" STEREOTIMES

"One of the truly special products I've reviewed in the past 18 years" STEREOPHILE

Winner of Stereo Times magazine Most wanted component of 2005 award 

"The best tonearm I've heard" HI FII WORLD



Your cartridge can deliver vastly improved results if coupled with a high grade arm. Great tonearms of the past were recognised for what they contributed but we would suggest it's time to upgrade. Massive performance improvements are now possible, so why not advance your system to a new level? After all, a significant tonearm upgrade offers many times the improvements of those given by cartridge upgrades, and last a lot longer. Our multi-award winning arms are offered with a no risk, money back guarantee should you be anything other than delighted.

**Tonearm Models**

- Enterprise
- Conqueror
- Illustrious
- Encounter
- Silver
- OLI

 2005 World Awards



Closest to the original sound



**UNIVERSAL MOTOR UPGRADE**

Upgrades & replaces motors & power supplies for ALL belt drive turntables

**"The single most important upgrade you can ever make to any record deck concerns the motor**

drive...nothing can prepare you for the shock of going DC. In a word, gobsmacking." COMMON GROUND MAGAZINE

"It's value is nothing short of tremendous." LISTENER MAGAZINE

"The LP12 remains a classic ...but ..upgrade kits by Origin Live can bring a vast improvement to it's performance" HI FI NEWS

**UNIVERSAL TURNTABLE MOTOR KIT** - No one would blame you for being sceptical of an easy to fit, inexpensive dc motor upgrade. Especially one that improves on the best of other power supplies costing over 4 times as much or your money back. It is simply impossible to imagine the level of improvement attained by eliminating the motor vibration that your stylus amplifies over 8,000 times! Our DC motor kit offers massive improvements to all versions of Linn Lingo / Valhalla, Rega, Systemdeck, Roksan, Rock etc. The kits consist of a drop in replacement high grade DC motor and off-board 2 speed control box. Why not order now? - see web site or phone.

Standard dc Motor Kit - £250

Advanced dc Motor Kit - £339

Ultra dc Motor Kit - £570

Upgrade Transformer - £175

Upgrade DC 200 motor - £129 with kit

ORIGIN LIVE

Tel/Fax: +44 02380 578877

E-mail: [originlive@originlive.com](mailto:originlive@originlive.com)

[www.originlive.com](http://www.originlive.com)

# Rochester Hi-Fi

30 HIGH STREET, ROCHESTER, KENT, ME1 1LD - 01634 880037

**ORACLE AUDIO**

**Raysonic**



**UK DISTRIBUTOR FOR ALL RAYSONIC & ORACLE PRODUCTS.**

ANATEK, ARCAM, ATACAMA, AUDIOPHILE BASE, AVI, CHORD COMPANY, CHORD ELECTRONICS, CLEARAUDIO, CREEK, DALI, EDGAR, EPOS, EUPEN, EXPOSURE, FOCAL JMLAB, GAMUT, GRAHAM SLEE, LAT, LSA, METRONOME, NORTHSTAR, NOTTINGHAM ANALOGUE, NU FORCE, OPTIMUM, ORIGIN LIVE, ORACLE, PARTINGTON, PROJECT, QUAD, QUADRASPIRE, RAYSONIC, RESOLUTION AUDIO, RENAISSANCE, TANNOY PRESTIGE, USHER.

**PLEASE SEE OUR WEBSITE FOR DETAILS OF VERY SPECIAL SALE**

**[www.rochesterhi-fi.co.uk](http://www.rochesterhi-fi.co.uk)**



# SEVENOaks

## SOUND & VISION

**CLEARANCE ► SAVE UP TO 70%**

There is up to an incredible 70% off the original RRP on these end-of-line\* hi-fi and home cinema separates, speakers and accessories. Stock is limited and when it's gone, it's gone so don't miss a chance to pick up a bargain!

### BRIGHTON 01273 733338

Arcam DVA A70 Amplifier	£349.00
Arcam DVA CD73 CD Player	£299.00
Arcam DVA A90 Amplifier	£499.00
Arcam DVA CD192 CD Player	£499.00
Arcam DVA P90 Power Amplifier	£299.00
Arcam FMJ A32 Amplifier	£699.00
Arcam FMJ CD36 CD Player	£699.00
Arcam FMJ P35 Power Amplifier	£499.00
Cyrus CD8X CD Player	£599.00
Cyrus PSXR Power Supply	£349.00

### BRISTOL 0117 974 3727

Arcam DVA P1000 AV Power Amplifier	£949.00
B&W AS2 Sub Woofer	£179.00
Marantz SA7001 CD Player	£259.00
Marantz SA7001Ki CD Player	£389.00
PMC TB2+ Centre Speaker	£295.00
Primare CDI-10 CD/DAB System	£849.00
Quad 12L2 Speakers	£309.00
Rotel RT06L DAB Tuner	£259.00
Yamaha DSPAX861SE AV Amplifier	£349.00
Yamaha TX761 DAB Tuner	£199.00

### BROMLEY 020 8290 1988

Arcam DVA AVR250 AV Receiver	£399.00
Arcam FMJ C31 Pre Amplifier	£899.00
Cyrus Link Power Power Amplifier	£299.00
Denon AVR3806 AV Receiver	£599.00
Denon AVR4306 AV Receiver	£749.00
Fujitsu P50XHAS8EB Plasma Monitor	£1,499.00
KEF KIT200 DLP System	£349.00
Primare CD21 CD Player	£639.00
Primare I21 Amplifier	£599.00
Sim2 Domino D35 DLP Projector	£1,499.00

### GLASGOW 0141 332 9655

Project RPM1 Genie Turntable	£89.00
Denon DVD1940 DVD Player	£159.00
KEF IQ8DS Surround Speakers	£259.00
Marantz SR5002 AV Receiver	£319.00
Arcam DVA A70 Amplifier	£339.00
Yamaha DSPAX759SE AV Amplifier	£349.00
Monitor Audio GSLCR Centre Speaker	£349.00
Yamaha RXN600D AV Receiver	£389.00
Arcam DVA AVR280 AV Receiver	£379.00
Yamaha DVDS2700 DVD Player	£649.00

### GUILDFORD 01483 536666

Denon SCM201 Speakers	£69.00
Marantz DV7600 DVD Player	£349.00
Marantz SR8500 AV Receiver	£449.00
Meridian G68J Processor	£2,999.00
Meridian G98DH DVD Audio Transport	£2,699.00
Musical Fidelity A5 Pre Amplifier	£399.00
Primare CD21 CD Player	£639.00
Primare I21 Amplifier	£599.00
Sim2 C3X Lite DLP Projector	£6,499.00
Toshiba HD-EP30 HD DVD Player	£99.00

### HOLBORN 020 7837 7540

Arcam DVA AVR280 AV Receiver	£449.00
Arcam DVA DV137 DVD Player	£584.00
i-Scan VP30 Line Scaler	£724.00
Denon S302 DVD System	£809.00
Yamaha DVDS1700 DVD Player	£199.00
Yamaha DVDS2700 DVD Player	£399.00
Marantz DV9600 DVD Player	£779.00
Yamaha DSPAX861SE AV Amplifier	£349.00
Pioneer DSC370 DLP System	£199.00
Screen Play SP7210 DLP Projector	£974.00

### LOUGHTON 020 8532 0770

Arcam DVA AVR350 AV Receiver	£749.00
Arcam DVA AVR280 AV Receiver	£499.00
Arcam DVA DV137 DVD Player	£649.00
B&W XT2 3-speakers	£585.00
KEF Picoforte 3 i-Pod Speaker System	£259.00
Loewe Modus L37 LCD TV	£975.00
Musical Fidelity X-Ray V8 CD Player	£519.00
Musical Fidelity X-T100 Amplifier	£585.00
Pioneer DVLX50 DVD Player	£325.00
Yamaha YSP900 Sound Projector	£299.00

### MAIDSTONE 01622 686366

Audio Pro Porto i-Pod Speaker System	£124.00
Denon DVD1740 DVD Player	£115.00
Denon DVD1940 DVD Player	£124.00
KEF Model 7 KHT5-2 Speakers	£299.00
Pioneer DVLX50 DVD Player	£174.00
Pixel Magic MB100 HD Media Box	£149.00
Yamaha DSPAX861 AV Amplifier	£349.00
Yamaha DVDS2700 DVD Player	£519.00
Yamaha RXN600D AV Receiver	£324.00
Yamaha YSP1100 Sound Projector	£584.00

### MANCHESTER 0161 831 7969

Arcam DVA A90 Amplifier	£749.00
Arcam DVA CD192 CD Player	£475.00
Audica CS-Sub 8 Sub Woofer	£399.00
KEF HTS5001 Speaker Stands	£115.00
M&K KX10 Sub Woofer	£215.00
Monitor Audio GSW12 Sub Woofer	£799.00
Arcam CD73 CD Player	£275.00
Primare SPA21 AV Amplifier	£1,149.00
Revel M12 Speakers	£175.00
Revel S12 Surround Speakers	£215.00

### POOLE 01202 671677

Denon AVR3806 AV Receiver	£499.00
Denon DVD3930 DVD Player	£549.00
In Focus IN78 DLP Projector	£974.00
Yamaha RXN600D AV Receiver	£299.00
Yamaha DVDS1700 DVD Player	£199.00
In Focus IN76 DLP Projector	£649.00
KEF KIT100 DVD System	£499.00
Loewe Xelos 20 LCD TV	£389.00
Pioneer DCS360 DVD System	£174.00
Toshiba HDE11 HD DVD Player	£99.00

### READING 0118 959 7768

Arcam DVA DV137 DVD Player	£549.00
Cyrus Linkserver Quattro HD Audio Server	£949.00
Loewe Individual LCD TV Speakers	£425.00
Musical Fidelity A1008 Amplifier	£1,949.00
Musical Fidelity A1008 CD Player	£1,949.00
Sim 2 HT3000 Evo DLP Projector	£6,499.00
Wilson Benesch Square 1 Speakers	£974.00
Wilson Benesch Square 2 Speakers	£1,429.00
Yamaha DVDS1700 DVD Player	£149.00
Yamaha DVDS2700 DVD Player	£499.00

### SEVENOAKS 01732 459555

Bose Lifestyle 38 / III DVD System	£1,999.00
Cyrus DVD6 DVD Player	£399.00
Denon AVR2307 AV Receiver	£349.00
Denon DVD/A1 DVD Player	£599.00
In Focus SP5700 DLP Projector	£499.00
KEF KIT100 DVD System	£629.00
Pioneer DV989 DVD Player	£499.00
Quad Lite Centre Speaker	£79.00
Sim2 HT3000 Xtra DLP Projector	£4,499.00
Yamaha DSPAX861 AV Amplifier	£499.00

Can't find what you're looking for?

Visit [www.SSAV.com](http://www.SSAV.com) for more amazing clearance offers!

### CAMBRIDGE 01223 304770

Cyrus Hark Hi-Fi Rack	£389.00
Denon DVD1940 DVD Player	£194.00
KEF KHT 2005.2 AV Speaker Package	£389.00
Loewe Concept 3 LCD TV	£749.00
Marantz DVD41000SE DVD Player	£199.00
Monitor Audio G3LDR Centre Speaker	£249.00
REL Strata 5 Sub Woofer	£519.00
Yamaha MCXA10 MusicCAST Client	£1,039.00
Yamaha MCXX1000 MusicCAST Server	£389.00
Yamaha YSP1 Sound Projector	£449.00

### EDINBURGH 0131 229 7267

Arcam DVA AVR280 AV Receiver	£584.00
B&W HTM61 Centre Speaker	£299.00
Denon DVD2930 DVD Player	£419.00
Denon DVD3930 DVD Player	£714.00
In Focus IN76 DLP Projector	£649.00
Panasonic TH42PX70PED Plasma TV	£714.00
Yamaha DSPAX861 SE AV Amplifier	£454.00
Yamaha DVDS1700 DVD Player	£199.00
Yamaha DVDS2700 DVD Player	£499.00
Yamaha RXN600D AV Receiver	£299.00

### EPSOM 01372 720720

Arcam Solo Movie DVD System	£1,299.00
B&W FPM4 Surround Speakers	£519.00
B&W AS2 Sub Woofer	£225.00
Dali Mentor 5 Speakers	£1,234.00
Denon DVD2930 DVD Player	£419.00
Monitor Audio Bronze BR2 Speakers	£149.00
Monitor Audio G3LDR Centre Speaker	£355.00
Surfire TrueEQ Signature Sub Woofer	£1,429.00
Surfire HR50 Sub Woofer	£419.00
Yamaha DVDS2700 DVD Player	£499.00

### EXETER 01392 218895

M&K Xenon LCR36 Surround Speakers	£549.00
Meridian G51 Receiver	£1,299.00
Meridian G51 DH DVD-A Player/Controller	£1,299.00
Naim Arriva Speakers	£675.00
Naim AV2 AV Processor	£1,599.00
Naim NAP175V AV Amplifier	£1,079.00
REL R205 Sub Woofer	£425.00
Sim2 Domino 35 DLP Projector	£1,699.00
Spendor C5e Centre Speaker	£424.00
Spendor S6e Speakers	£1,314.00

### KINGSTON 020 8547 0717

Arcam DVA AVP700 AV Processor	£724.00
Arcam DVA CD192 CD Player	£449.00
Arcam DVA A70 Amplifier	£264.00
Arcam DVA A90 Amplifier	£474.00
Denon AVR2807 Surround Receiver	£519.00
Denon AVR3806 Surround Receiver	£499.00
M&K Xenon AV Speaker Package	£1,559.00
Primare SPA21 Surround Receiver	£1,299.00
Marantz DV7600 DVD Player	£299.00
Yamaha YSP1000 Sound Projector	£584.00

### LEEDS (Wetherby) 01937 586886

Cyrus CD6s CD Player	£419.00
KEF KHT2005.2 AV Speaker Package	£399.00
Marantz PM6002 Amplifier	£179.00
Rotel RCD06 CD Player	£225.00
Onkyo TXSR705E AV Receiver	£389.00
Bose Lifestyle LSV30 DVD System	£1,494.00
Sonos BUI30 Wireless Music System	£454.00
Pioneer BDPLX70a Blu-Ray Player	£649.00
Denon DVD3930 DVD Player	£714.00
Nevo SL Universal Remote Control	£419.00

### LEICESTER 0116 253 6567

Arcam FMJ AV8 Pre Amp / Processor	£1,574.00
Arcam FMJ C30 Pre Amplifier	£599.00
Arcam FMJ P1 Power Amplifier	£599.00
Arcam Alto Speakers	£249.00
Harman Kardon AVR630 AV Receiver	£359.00
Harman Kardon AVR7300 AV Receiver	£679.00
Onkyo TXDS989 AV Receiver	£994.00
Vienna Acoustics Schonberg Speakers	£749.00
Yamaha MCX1000 MusicCAST Server	£794.00
Yamaha MCXA10 MusicCAST Client	£264.00

### LINCOLN 01522 527397

B&W 683 Speakers	£649.00
Musical Fidelity X-DAC V8 Tube DAC	£599.00
Musical Fidelity X-Plora V8 DAB Tuner	£399.00
Musical Fidelity XT100 / Triple X Amp & PSU	£1,449.00
ProAc D38 Speakers	£2,999.00
ProAc Studio 130 Speakers	£849.00
ProAc Tablette Reference 8 Speakers	£499.00
Spendor S5e Speakers	£925.00
Spendor S6e Speakers	£1,199.00
Yamaha RXN600D AV Receiver	£249.00

### NORWICH 01603 767605

Audica CS Tower 1 Speakers	£399.00
Audica CS-C1 Centre Speaker	£89.00
Audica CS-S1 Satellite Speakers	£109.00
KEF HTS-6001 Satellite Speakers	£309.00
Lexicon RT10 Universal Disc Player	£1,295.00
Spendor C5e Centre Speaker	£419.00
Yamaha DVDS2700 DVD Player	£649.00
Yamaha MCX1000 MusicCAST Server	£1,035.00
Yamaha MCXA10 MusicCAST Client	£339.00
Yamaha RXN600D AV Receiver	£389.00

### NOTTINGHAM 0115 911 2121

Arcam FMJ A32 Amplifier	£844.00
Arcam FMJ CD36 CD Player	£939.00
Harman Kardon AVR347 AV Receiver	£485.00
Harman Kardon AVR145 AV Receiver	£299.00
Harman Kardon DV447 DVD Player	£174.00
Harman Kardon HS500 AV Speaker Package	£499.00
KEF KIT100 DVD System	£599.00
Onkyo TXSR674E AV Receiver	£249.00
Wharfedale Diamond 9CC Centre Speaker	£49.00

### PETERBOROUGH 01733 897697

Meridian DSP5200 Digital Active Speakers	£3,995.00
Meridian G02 Balanced Stereo Controller	£1,135.00
Meridian G51 Stereo Receiver	£1,499.00
Meridian G55 AV Power Amplifier	£1,749.00
Meridian G57 Power Amplifier	£1,299.00
Meridian G68ADV Surround Controller	£3,245.00
Meridian G91 DVD Controller Tuner	£2,534.00
Meridian G95 DVDD/DAB Receiver	£2,855.00
Meridian G98DH DVD Audio Transport	£2,175.00
Runco CL610 DLP Projector	£2,999.00

### PLYMOUTH 01752 226011

Arcam DVA AVR300 AV Receiver	£499.00
Denon DVDS770 DVD Player	£39.00
Fujitsu P50XTAS1EB	£1,499.00
KEF KIT100 DVD System	£499.00
Loewe Modus L37 LCD TV	£1,399.00
Onkyo DV-HD805 HD DVD Player	£325.00
Pioneer DV1630H DVD / HDD Recorder	£279.00
Rotel RDV1060 DVD Player	£249.00
Samsung BDP1000 Blu-Ray Player	£349.00
Sony RDRHX900 DVD / HDD Recorder	£399.00

### SOUTHAMPTON 023 8033 7770

KEF KIT140 DVD System	£974.00
KEF KIT510 DVD System	£844.00
Arcam E57001 Sound Processor	£519.00
Marantz SA7 S1 CD/SACD Player	£3,249.00
Marantz SR4002 AV Receiver	£299.00
Marantz SR5002 AV Receiver	£324.00
Marantz VP11 S1 DLP Projector	£5,499.00
Yamaha DSPAX861 SE AV Amplifier	£349.00
Yamaha DVDS1700 DVD Player	£199.00
Yamaha TX761 DAB Tuner	£199.00

### SWINDON 01793 610992

Arcam DVA AVR300 AV Receiver	£665.00
Fujitsu 42HTS51 Plasma Monitor	£749.00
KEF KIT100 DVD System	£499.00
KEF PSW3500 Sub Woofer	£499.00
Marantz RC9500 Universal Remote Control	£515.00
Mission M-Cube AV Speaker Package	£519.00
Quad L-Centre Centre Speaker	£159.00
Yamaha DSPAX861 AV Amplifier	£454.00
Yamaha RXN600D AV Receiver	£389.00
Yamaha YSP1000 Sound Projector	£584.00

### TUNBRIDGE WELLS 01892 531543

Arcam DVA AVR250 AV Receiver	£399.00
Denon AVR4306 AV Receiver	£749.00
Denon DVD/A1 DVD Player	£499.00
Fujitsu P42XHAS8EB Plasma Monitor	£499.00
In Focus SP7205 DLP Projector	£599.00
Panasonic TH50P2700 Plasma TV	£1,699.00
Samsung LE52M87B0X LCD TV	£1,399.00
Sharp LC64XL2E LCD TV	£1,199.00
Sim2 C3X DLP Projector	£5,999.00
Yamaha RXV2700 AV Receiver	£599.00

### WATFORD 01923 213533

Acoustic Energy Evo Centre Speaker	£74.00
Denon DVD 1740 DVD Player	£99.00
KEF KHT2005.2 AV Speaker Package	£2,999.00
Fujitsu P42XHAS8EB Plasma TV	£2,999.00
Loewe Connect M37 DR+ LCD TV	£1,754.00
Meridian G55 AV Power Amplifier	£1,754.00
Meridian G68 Surround Controller	£3,249.00
Meridian G98DH DVD Player	£2,175.00
Pioneer PDP37 Plasma Accessory Sprs	£149.00
Spectral PL115 Plasma / LCD TV Stand	£324.00
Wharfedale Diamond 9 Centre Speaker	£49.00





**Specialist Suppliers of Audio Accessories**  
[www.mantra-audio.co.uk](http://www.mantra-audio.co.uk)  
**ORDER SECURELY @ <https://shop.mantra-audio.co.uk>**  
 SEE WEBSITE FOR MONTHLY OFFERS & FULL PRODUCT RANGE  
 ITEMS EX STOCK DELIVERY BY RETURN OTHERWISE 3 - 10 DAYS

CARTRIDGE SELECTION		STYLUS	HEADPHONE SELECTION	
Goldring			Grado	Prestige SR-60 £75
Elektra	£37	£26		Prestige SR-80 £90
1006	£100	£65		Prestige SR-325I £260
1012 GX	£139	£75	Goldring	DR 50 £30
1022 GX	£153	£97		DR 100 £40
1042	£171	£120		DR 150 £70
Eroica LX/H	£185	£157	EX	N/A
Elite	£273	£230	EX	N/A
2400	£152			£119
2500	£175			£133
<b>Audio Technica</b>				
AT 95 E	£25			£18
AT 440 MLa	£90			£70
AT OC9 ML II	£270	£255	EX	
<b>Denon</b>				
DL 103	£105	£95	EX	N/A
DL 103R	£190	£170	EX	N/A
DL 110	£79	£69	EX	N/A
DL 160	£95	£83	EX	N/A
DL 304	£210	£190	EX	N/A
<b>Grado</b>				
Prestige Black	£46			£32
Prestige Gold	£119			£83
<b>Lyra</b>				
Dorian	£495	£395	EX	N/A
Argo	£795	£635	EX	N/A
<b>Shure</b>				
M 97 XE	£98			£58
<b>Sumiko</b>				
Blue Point Special	£195	£165	EX	

**HI FI ACCESSORIES**

ARTcessories USB Phono Plus PreAmp £85  
 analogue-digital computer interface  
 MiltyPro Super Exstatic Brush £13  
 Shure SFG2 Stylus Force Gauge £24

**REPLACEMENT STYLI**

Swiss Quality Diamond Styli

ADC	XLM Mk III	£17
Akai	AN 5, AN 60	£13
	AN2, AN 70	£15
Aiwa	AN11	£13
Dual	DN 145 E, DN 165 E	£17
JVC	DT 55, DT 60	£13
National	EPS 24 CS, P 30 D, P 33 D	£13
Ortofon	FF15/VMS20 EII, OM5/10/10/20	£17
Pioneer	PN 210/220/240	£13
Shure	N75C, N75-6, SC35C	£13
	N75ED/EJ T2 N75-3, N95ED/EJ	£17
	N 97 HE, VN 35 HE	£27
Sony	ND 142/155 G, CN234	£13
	ND 143/150/200 G	£15
Stanton	D 681 EEE	£21

\*\*\*Over 500 Styli Types Stocked\*\*\*

**EX - Exchange price same make moving coil cartridge**

Order direct online or Tel/Fax (01757) 288652

MANTRA AUDIO (HFV), Town End House, Skipwith, Selby, North Yorkshire YO8 5SQ

# RETRO REPRODUCTION

QUALITY HIGH FIDELITY & VINTAGE

<b>AMPLIFIERS</b>		Neat Motive 1 oak finish ex dem	£995
Albany pre amp with phono	£95	Neat Vito floorstanding speakers with	
Albany 10008 mono blocs 100W	£495	ultratumium upgrade, beech finish	£1495
Audio Analogue Puccini special addition	£395	Neat Ultimatum MFS 1 red velvet finish with stands	
Audio Innovation 300 Int amp valve phono	£395	new £5000 now	£2795
Audio Innovation series 700 integrated amp	£595	Neat Ultimatum MF9 flagship	
Audio Innovation series 200 MK2 power amp	£295	speaker £10500 New	£3995
Audio Innovation L1 pre	£195	PMC DB1	£350
Audio Research M300 MKII monoblocs	£2995	ProAc studio1 50s cherry finish	£695
Audiolab 800S new style	£295	Ruark Equinox last edition	£995
Audio Research VT60 valve power re-valved	£995	Sonus Faber concerto	£595
Cairn 100W remote integrated amp x dem	£595	Tannoy Dimension 10 £5000 new 1year old	£2495
DNM Plastic case pre & power	£795		
Edison 12 Valve Power Amp	£395	<b>TURNABLES</b>	
Korato renaissance mono blocs 30W class A	£995	Henley MC50 phono stage	£95
Krell KAV 300i integrated box	£895	LFD Minstral phono stage	£295
Krell KSP7B pre amp	£595	Linn Axis Turntable with Linn Arm	£295
Leema Tucana	EPOA	Micell Gyrodec SE with Rega arm boxed	£795
Leak 12+ mono blocs restored	£595	Micell Gyrodec SE with Rega arm 4 mths old EPOA	
Linn Classik silver 1 yr warranty	£595	Micell TechnoArm as new	£295
LFD integrated amp X dem	£795	Micell QC Power supply	£295
LFD Power amp silver wired x dem	£650	Morch 6 tone arm	£650
Melody Astro Black 40	EPOA	Musical Fidelity XLP9 phono stage	£115
Mendian 568 digital surround processor	£695	Nottingham Analogue horizon	£395
Musical Fidelity A300 CR power amp	£995	Naim Aro tonearm boxed just serviced	EPOA
Musical Fidelity X Pre V3 boxed as new	£345	Nottingham analogue horizon SE with rega arm	£495
Musical Fidelity MA100 power amps (x2)	£225	Roksan Radius 5 no arm	£395
Musical Fidelity all in one		Technics SL150 direct drive SME cut-out	£225
system new £5000	now £2500	Trichord Dino phono stage 6mths old	£295
Musical Fidelity A1001 Class A int amp	£795	Wilson Benesch Full Circle with 0.5 Act Tonearm EPOA	
Musical Fidelity Pre Amp 2 with			
Avondale output PSU	£195	<b>CD PLAYERS, DACs</b>	
Naim NAC92 serial 165888	£175	Audio Analogue Phmo	£350
Naim 42 5	£125	Audio Analogue Paganini 24bit	£375
Naim 90 3 Power amp boxed	£225	Cyrus CD 8 silver	£495
Onyx Integrated Amp OA215	£195	Cyrus PSX - R silver	£275
PS Audio IV Pre Amp with separate PSU	£195	DCS P8i	EPOA
Quad 2 mono blocs mint original valves	£795	DCS Purcel upsampler factory serviced	£995
Quad 34 Pre Amp	£195	HIFI World project 24.96 valve DAC rare	£395
Quad 303 Power Amp	£195	Leema Anila od	EPOA
Quad 405 Power Amp boxed	£195	Lector CD Player Top Loader 2 boxed	£1295
Quad 909 Power Amp boxed mint	£595	Micro Mega Stage 6 upgrade player	£245
Rega Mira integrated Amp remote boxed mint	£350	Mendian 206 Original Multi bit player	£245
Rotel RA-01 integrated Amp	£245	Musical Fidelity Tri Vista 21 Tube DAC	£695
Rotel RB-03 Power Amp	£245	Naim CD3 boxed as new	£295
Rotel RB970 BX Power Amp	£145	Primare CD20	£395
Rotel RB850	£145	Quad 77 bus CD player	£295
SYNTHESIS Nimis valve int amp	£595	Quad 99 CDP2 CD player	£695
Suggden Transimpedance Amp 6months old	£395	Rega Planet Transport & DAC	£495
Suggden P51 Power Amp with control unit		Roksan Kandy III DVD player	£350
serviced excellent condition	£195	Roksan Rok dp1 transport	£375
Theta Dreadnaught Amp	EPOA	Teac VRDS 10	£350
Yamaha DSPA1 Amp	£195		

<b>SPEAKERS</b>		<b>MISCELLANEOUS</b>	
Acoustic Energy AE1 6 months old	£495	Musical Fidelity XPSU	£175
Beutorn Virtuoso reference lowther	£3995	HD headphones	£125
B&W DM4	£95	Revox B77 two track with remote	
B&W 604 series 3	£445	control & perspex cover	£495
Cyrus CL550	£245	PS Audio statement biwire speaker cable	
Dynaudio Audiance 40	£245	boxed as new	£795
Galle 401chrome ends drivers replaced boxed	£550	PS Audio statement 3 mtr XLR interconnect	£375
Gamma floor standing speaker new £5000	£695	Quad FM4 last edition boxed mint	£245
JBL T1-6K floor standing speakers as new	£795	Teac X3 open reel	£395
JBL century 100s	£195		
JM Labs Electra 926	£995	<b>DUE IN....</b>	
KEF Reference 1s black finish	£495	Leak Varslope point 1 stereo pre amp various	
Leema XYP	£595	Lecson pre amp power amp & tuner RARE	
Leema X one rosewood finish ex-dem	£1495	Linn Kan speakers with stands	
Leema sub ex-dem	£495	Russ Andrew Quad 33 303 upgrade	
Mission 751 rosewood	£175	Garrard 301 first class condition	
Mission 750 limited edition anniversary	£195	Quad 2 pre valve & radio various	
Mission 775s boxed	£395	SME V tone arm ex-dem mint	
Mission 75c Centre beech finish	£95	SME model 10 with tone arm	
Mission M7 Ds wall mount speakers	£95	Naim Headline 2	
Mono Pulse 32A 8 months old ex dem.	£595	Naim Flatcap	
Monitor Audio G10 gold signature phono blk	£495	Naim NAPSC	

GENEROUS PART-EX. ON ALL EQUIPMENT, NEW OR USED. WILL BUY GOOD QUALITY EQUIPMENT AS ABOVE. NEXT DAY MAIL ORDER & UPLIFT FACILITIES



Opening times: 10.30 - 5.30 Tues. to Sat.  
 28a Haddington Place, Edinburgh EH7 4AF  
 Tel/Fax: 0131 558 9989  
 Email: [retro.reproduction@virgin.net](mailto:retro.reproduction@virgin.net)  
 Website: [www.retroreproduction.co.uk](http://www.retroreproduction.co.uk)

## High End Cable

visit [www.highendcable.co.uk](http://www.highendcable.co.uk)  
 For the best prices telephone Dave Jackson on  
 01775 761880  
 Free P&P worldwide on all interconnects

Argento Audio  
 Analysis Plus  
 Audience  
 Chord Company  
 Ecosse  
 Furutech  
 Hovland  
 Nordost  
 MIT  
 Oehlbach  
 Purist Audio Design  
 Stereovox  
 Townshend  
 True Colour Industries  
 van den Hul  
 Wyrewizard  
 IsoTek  
 Cable Tower  
 Oehlbach Accessories  
 Acoustic Resonators  
 Bel Canto  
 Leema Acoustics  
 Project Turntables  
 Audio Physic Speakers  
 STAX headphones  
 Tannoy  
 Echo Busters  
 Arye CD - IsoTek CD  
 The Rock V turntable  
 Universal speaker cradles  
 Moving Coil  
 Lyra - Ortofon - Sumiko

Component cables  
 Digital cables  
 HDMI  
 Optical cables  
 S video  
 SCART  
 Firewire  
 XLR cables  
 Sub woofer cables  
 Chord iPod cables  
 Nordost iPod cables  
 DIN cables  
 Chord cables for Naim  
 Mains & Power cables  
 Jumpers  
 ONLINE SHOP

Up to 25% Trade in

Previously owned cables. Reference cables include free Burn In.



Severity TOWNSHEND AUDIO



ISOteK







**Anatek Research**

The award winning  
Phonostage!



**Anatek-Research**

Sussex  
England  
Tel : 01273 261 229  
www.anatek-research.co.uk



*We have a passion for music,  
visit our demo rooms, hearing  
is believing with Yamaha's  
superbly built Soavo range of  
real Hi-Fi components, offer-  
ing today's true excellence in*



**A.N.Audio**

34 Huntingdon Street St. Neots

phone:- 01480 472071 e-mail sales@anaudio.co.uk  
Hours:-Monday-Friday 9am-6pm  
Tuesday 9am-1pm Saturday:- 9am-5.30 pm

atc "sorry, can't get to the  
creek phone just now  
arcam  
dynavector

epos  
focal  
grado  
infocus  
isoblu  
kudas  
lexicon  
lyngdorf  
lyra  
>naim audio  
neat acoustics  
nottingham

we're too busy playing  
records through the  
naim superline"

ortofon  
rega research  
sim2  
stax  
sumiko  
trichord  
well tempered



hi-fi for grown-ups

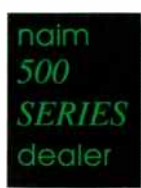

ipswich (01473) 655171  
www.signals.uk.com

**DR. FEICKERT ANALOGUE**

**DFA-Twin Turntable**  
Where form meets function!



Angelsound Audio is very pleased to bring the  
astonishing and world-renowned range of  
'Dr. Feickert Analogue' products to the UK  
including the wonderful 'Twin' Turntable.

angelsound audio

UK Distributor for Dr Feickert Analogue. Full range available.  
www.angelsoundaudio.co.uk | tel: +44 (0)1923 352 479

Months

Unique Visitors

Page Impressions

14

123,121

523,465

Pressblog.net is one of the fastest and simplest ways for Hi-Fi Dealers, Distributors and Manufactures to publish their news online daily - for all music lovers to read...

Call or e-mail us to find out more:

+44 (0)1273 394 184

[publish@pressblog.net](mailto:publish@pressblog.net) | [www.pressblog.net](http://www.pressblog.net)

multiroom, home cinema, hi-fi, plasma & lcd,  
consultation, supply & installation



**soundseduction.co.uk**



162 London Road • Sevenoaks • Kent • TN13 2JA  
Telephone: 01732 456573 • Fax: 01732 451938  
[www.soundseduction.co.uk](http://www.soundseduction.co.uk)

Densen NAD

Rega Lyngdorf

Tannoy/Prestige

Revolver Focal

Black Rhodium

Triad Shure

Dali Atlas Cables

Sunfire Fatman

Sennheiser QED



# London Audio Consultants

tel: 0208 856 5290 | mobile: 07894 014 811 | w: [www.no1-audio.com](http://www.no1-audio.com) | e: [john@no1-audio.com](mailto:john@no1-audio.com)

London Audio Consultants is a new, passionate, refreshing and very energetic Hi-Fi specialist.

We will never stock an endless list of brands because we feel this offers very little benefit to our customers.

Instead, we have hand-picked a small number of brands, which makes choosing the right product or system so much easier.

Some of these brands you may not know, but rest assured, each delivers a performance that will astound!

London Audio Consultants prides itself on expert advice, service, care and long-term support.

Call us today to find out how we can help you.

**John Hannant**



audio physyc | bel canto | edge | msb | nola | synergistic research cables | weiss digital



exciting range of brands



great after-sales support



expert advice



part-exchange / trade-in



we listen to you



relaxed demonstration suite

sota  
**comet**

*We take an entirely different approach to turntable design.*

For details on the complete Sota range please contact:

UK Distributor : RPM-Audio

Tel: +44 (0)7790 907 737 • [www.rpm-audio.co.uk](http://www.rpm-audio.co.uk)

Read the  
Comet Review  
in this issue



- Platters utilised are made of special high-density polymers. An interface mat is added to both platters, for the best possible record-to-mat interface.
- State-of-the-art Spindle/Bearing Assembly.
- Bearing cup is manufactured of a high-tech material called Turcite®.
- Drive System consists of a high-density polymer sub-platter driven by a 24-pole AC synchronous motor originally designed for ultra-precise computer use.
- Chassis and Cabinet Damping System ensures isolation from noise and spurious vibrations.
- Environmental isolation has been accomplished by way of a monolithic, massive internally dampened cabinet, which effectively isolates the turntable system.
- Special energy-absorbing levelling feet are utilised and incorporate a proprietary visco-elastic polymer pad to damp vibrations.
- Turntable equipped for both 33 and 45 RPM.
- **MRP £850 (includes the Rega RB-300 tonearm).**

# hifisound

NEW PREMISES OPEN 5TH JULY 2008



all images taken on location at

Castlegate Mill, Quayside, Stockton on Tees, TS18 1BZ 0845 6019390

Avid, Chord, EAR, Esoteric, Martin Logan, Michell, NAIM, Pathos, Sugden, SME, Usher and many more



**SPECIAL INTRODUCTORY OFFER!!!!**

# **HI-FI WORLD ELECTRONIC EDITION**

**VISIT OUR WEBSITE: [www.hi-fiworld.co.uk](http://www.hi-fiworld.co.uk)**

**Queries to - [esubs@hi-fiworld.co.uk](mailto:esubs@hi-fiworld.co.uk)**

**Subscribe to our  
eco-friendly e-edition of  
Hi-Fi World and receive a  
50% discount!!!**

- **Receive your issue a week before on-sale dates.**
- **Be the first to grab a bargain in our Free Reader Classified Ads.**
- **In-house lab. tests to AES and IEC standards**
- **Run by dedicated hi-fi engineers & enthusiasts.**
- **No missed issues, or postal delays.**
- **Access your issues from anywhere in the World.**
- **PC and Mac friendly.**
- **Eco-friendly.**

**Subscribe today and receive 12 issues for  
£20 – that's an amazing £1.90 per issue!**

**check out our free trial issue**

**VISIT OUR WEBSITE:  
[www.hi-fiworld.co.uk](http://www.hi-fiworld.co.uk) and select  
"ELECTRONIC EDITION"**

**To purchase your e-edition click here**

Pay in Sterling, US Dollars or Euros. Non-sterling prices vary according to exchange rate.  
**Cards accepted:** Visa, Maestro (Switch), Mastercard, Solo and Delta.



# DIAL A DEALER

This is a comprehensive directory of Hi-Fi Dealers throughout the UK and Ireland.

## BERKSHIRE

### LORICRAFT AUDIO

Loricraft Audio are now in the new premises and we will announce an official opening as soon as the work is complete. You can buy all our products directly from us or through your local dealer. Our internet shop site can take direct orders for our turntables and accessories!

Loricraft Audio, The Piggery, Mile End Farm, Wantage Road Lambourn, Berkshire, RG 17 8UE  
Office Phone/Fax: +44 (0) 1488-72267  
email: [terry@garrard501.com](mailto:terry@garrard501.com)  
web site: <http://garrard501.com>

## BRISTOL & BATH

### THE RIGHT NOTE

Tel: 01225 874728. Happy with your system? Wonder why there's so much for sale secondhand? Avoid the frustration and expense of "upgrade-itis", never quite "there". With infinite patience we'll help you plan longer-term. Brands selection: Accustic Arts, Audio Physic, Aesthetix, Bel Canto, CAT, Chord Co, Clearaudio, dCS, Gamut, Graham, Halcro, Sumiko, VertexAQ, Wadia.

## CHESHIRE

### ACOUSTICA

17 Hoole Rd, Chester CH2 3NH.  
[www.acoustica.co.uk](http://www.acoustica.co.uk)  
Tel 01244 344227. HiFi & Home Cinema from Amphion, Arcam, ART, Ayre, B&W Nautilus, Classe, Focal, JM Lab, Monitor Audio, Naim Audio, Primare, Rega, REL, Rotel, Spondor, Sugden, Thiel, Wadia. We offer full demonstration facilities, interest free credit, delivery & install systems throughout Cheshire, Merseyside & North Wales. Tuesday to Saturday 10.00 to 5.30.

### ACTON GATE AUDIO

[www.acton-gate-audio.co.uk](http://www.acton-gate-audio.co.uk)  
4 Ruabon Road, Wrexham, LL13 7PB,  
(01978) 364500  
Arcam, Atlas, Audiolab, Croft, Denon, Grado, JM Labs, KEF, Michell, Monitor Audio, Musical Fidelity, NAD, Ortofon, Opera, Onkyo, Project, QED, Quad, Rel, Roksan, Sugden, Sennheiser, Unison, van-den-Hul, Wharfedale, Yamaha.  
Tuesday - Saturday 9.00 - 17.00  
email: [info@acton-gate.com](mailto:info@acton-gate.com)

### DOUG BRADY HI FI

Kingsway Studios, Kingsway North, Warrington, WA1 3 NU Tel 01925828009 Fax 01925 825773. Visa MasterCard, Lonbard Tricity. 2 demo rooms, home trial. Agencies include : Arcam, AudioLab, AV1, Caspian, Chord Electronics, Exposure, Krell, LFD, Michelle Engineering, Meridian, Musical Fidelity, Monitor Audio, Naim, ProAc, Roksan, SME, Wilson Benesch, and many more.

## CORNWALL

### BIGEARS AUDIO

To find a system that will allow you to hear the music instead of the equipment phone Bigears Audio, here you will find an interesting array of new and good quality used equipment! my intention is to have satisfied customers whatever their audio preferences. Naim dealer for the South West.  
[chrisbirchley@btinternet.com](mailto:chrisbirchley@btinternet.com)  
Tel: 01736-740421

## KENT

### SUGARBUSH RECORDS

8 Hawkenbury Road, Tunbridge Wells Kent, TN2 5BJ, United Kingdom  
tel: (+44) 01892 541 746  
Free vinyl LP catalogue. Every month-24 pages-rare & deleted ex+ and mint LPs starting at only £4.99. 60's & 70's Rock, Jazz, Blues, Psych, Progressive, Soul, Folk. It is the best regular vinyl catalogue in the UK! Call or write today.

## LANCASHIRE

### HOUSE OF LINN MANCHESTER

Telephone: 0161 766 4837  
Email: [Info@houseoflinn.com](mailto:Info@houseoflinn.com)  
[www.houseoflinn.com](http://www.houseoflinn.com)  
The Linn specialists. Independently owned by former Linn staff.  
Straightforward, professional expertise with demonstration, sales, installation and support for the Linn range of components and systems. The listening experience is so good that demonstrations can last for hours. Discover how we make music sound *real* in your home! Appointments only.

## MIDLANDS (WEST)

### SOUND CINERGY

37 high street, aldridge, WS9 8NL  
01922 457926  
[www.soundcinergy.co.uk](http://www.soundcinergy.co.uk)  
[clive@soundcinergy.co.uk](mailto:clive@soundcinergy.co.uk)

quality hifi and home cinema from black rhodium, chord co, creek, epos, exposure, linn, marantz, monitor audio, mordaunt short, nad, okki nokki, ortofon, project, rel, roksan, themescene, trichord, vdh. Check our website for ex dem and secondhand bargains. free car parking.  
tues - sat 10 -5.30

## MIDDLESEX

### RIVERSIDE HI FI

422 Richmond Road, East Twickenham, Middlesex, TW 1 2EB. Tel 0208 892 7613  
[riversidehifi@mac.com](mailto:riversidehifi@mac.com)  
[www.riversidehifi.com](http://www.riversidehifi.com)  
Audio Research, Blueroom, Bose, B&O, Copland, Denon, Krell, Living Control, Michell, Monitor Audio, Prima Luna, Project, QED, Rel, Sennheiser. Sonus Faber, Teac, Theta. 0% Finance available. Subject to status. Written details available on request. Export orders welcome. UK mailorder available. Demonstration room. All major credit cards. 10am-5.30pm Mon-Sat

## SOMERSET

### ALTERNATIVE AUDIO,

Taunton, Somerset,  
Tel: 01984 624242  
[www.alternativeaudio.co.uk](http://www.alternativeaudio.co.uk)  
Email: [peter@alternativeaudio.co.uk](mailto:peter@alternativeaudio.co.uk)  
We specialise in valve amplification and vinyl replay with the accent on high quality musical enjoyment. Ex-Dem and used equipment for sale. Art Audio, Border Patrol, Clearaudio, Diapason, EAR/Yoshino, Experience Filtration, Lector, LFD Audio, Lyra, Music First Audio, Nottingham Analogue, Opera, Quadraspire, Shun Mook, SME, Transfiguration, Unison Research, Vandersteen Audio.

## YORKSHIRE ( EAST )

### THE AUDIO ROOM

2 George Street, Hedon, Hull, HU12 8JH.  
01482 891375. [www.theaudiroom.co.uk](http://www.theaudiroom.co.uk)  
Authorised agents for Ayre, Arcam, Bowers and Wilkins inc 800series, Classe, Cyrus, Densen, Dynaudio, Dynavector, Grado, Hutter, Isoblu, Isotek, Linn, Lyra, Mark Levinson, Meridian, Naim, Nordost, Proac, Quadraspire, Rega, Rotel, Stax, Stereovox and others.  
0% finance available, free parking, 3 demonstration suites, friendly and quality staff and advice, mail order service.





# FREE READER CLASSIFIEDS

**TERMS AND CONDITIONS:** Only one advert per reader. No Trade adverts. This section is strictly for readers selling secondhand hi-fi equipment only. Maximum length per advert is 30 words, Adverts over 30 words will not be accepted. Telephone numbers and E-mail addresses are treated as one word. Model numbers are treated as one word i.e. Quad 303 = two words. Email your advert to; [classifieds@hi-fiworld.co.uk](mailto:classifieds@hi-fiworld.co.uk) or fill in the form on page 129 and post it to Hi-Fi World Free Readers Ads, Suite G4, Argo House, Kilburn Park Road, London NW6 5LF. Sorry, we cannot accept adverts over the telephone. The Publisher reserves the right to judge submissions.

CONRAD-JOHNSON  
PV10AL preamp. Excellent  
condition. £500 ono.  
Nakamichi CR2. Excellent  
condition. £120 ono.  
Cambridge CD6 player.  
Excellent condition. £60 ono.  
Technics SL10. Very good con-  
dition. £160 ono. Tel: 01209  
610 181 or 07842 199 372

QUAD 306, 34, FM4. Grey.  
Excellent condition. £585 or  
will split, £195 each. Tel: Andy  
0116 239 2373

AUDION SILVER Night 300B  
PSE. A pair of monoblock  
valve amps, highly reviewed,  
mint condition, one owner,  
boxes and manuals. (Cost  
£3600.) £1750. Tel: 01844 275  
310 (Aylesbury area)

BRIGGS 'LOUDSPEAKERS'  
handbook. Rare item. Hi-Fi  
Year book 1971. Plus two  
valve radio servicing books.  
£20 plus postage. Tel: 01453  
546 191 (Gloucs)

WANTED FAULTY or non  
working Quad 34 or 44 pre-  
amps, 405 power amplifiers,  
fm3 tuners. also decoder  
panel for fm2 tuner. No deal-  
ers. Contact Mike 01758  
613790 with price.

CLASSIC KRELL KSA 50  
Amp £600, Krell KAV 400xi  
20 hours use, boxed and  
warrenty £1650. Van den  
Hul The First Ultimate Mk  
II new £120 contact Steve  
0208 776 0044, e-mail  
[sj.verrier@ntlworld.com](mailto:sj.verrier@ntlworld.com)

ORTOFON MC10 Supreme  
Cartridge. Light usage, cantile-  
ver/ tip inspected described  
as mint condition.c/w original  
box/packaging. Upgraded  
& too good to put in a draw-  
er. Stuart, T: 07870 912 963  
e: [stuart.wittering@  
raisedfloorsystems.co.uk](mailto:stuart.wittering@raisedfloorsystems.co.uk)

NAIM HI-CAP 2. Latest spec.  
£600. Proac D15 Response  
loudspeakers. £750. Tel: 07530  
581 717

PMC GB1.  
FLOORSTANDING speak-  
ers, cherry veneer, perfect  
condition, superb build and  
sound, room friendly size,  
huge saving on new (£1145)  
£595. Stephen 01462 680262  
(Herts)

WANTED: QUICKSILVER  
Monoblocks, V4 or Mono 100  
model type. Must be in full  
working order. Contact  
[ewancameronscott@  
hotmail.co.uk](mailto:ewancameronscott@hotmail.co.uk)

LEAK 2075 speakers £850  
ono. JBE Slate Mk3 direct  
drive turntable £850 ono.  
Audio Alchemy MM/MC  
phonostage £175. B&W 1800  
speakers £250. Tel: 01798  
813133/ [reconcile@  
bdlrs.freeseerve.co.uk](mailto:reconcile@bdlrs.freeseerve.co.uk)

EXTREMELY RARE High-  
End Bose Lifestyle 901 Music  
System bought last year new  
for £5,000 and being sold  
now for £2,000. To arrange  
a sound demonstration in  
London call 07920033044.

LFD MMC PHONOSTAGE  
for MC/MM cartridges.  
Reluctant sale, less than 60  
hours use, hardly burned  
in. Accurate, open, detailed  
soundstage. Superb product  
C/W LFD special Isolation  
feet. £750.00 ovno. Stuart  
T: 07870 912 963  
e: [stuart.wittering@  
raisedfloorsystems.co.uk](mailto:stuart.wittering@raisedfloorsystems.co.uk)

PAIR OF Jordan Watts 6.5"  
aluminium cone speakers,  
reconditioned. £45. Early edi-  
tions of Hi-Fi world suppl-  
ments, offers, postage to be  
added. Pair 5.5" Kevlar Cone  
midrange. Unused £25. 0118  
9693377

NAIM AUDIO CD3 CD  
Player. Excellent condition.  
Includes interconnect, remote,  
original box & manual. Little  
use. £220. Tel: 077902079233.  
Email: [paul.taplin@  
homecall.co.uk](mailto:paul.taplin@homecall.co.uk) (Surrey/  
London)

ORIGINAL, EXCELLENT  
condition Quad Type II valve  
amplifier, Quad II control  
unit, and FM1 tuner. E-mail  
[jeffbyard@orange.net](mailto:jeffbyard@orange.net) for pic-  
tures, or tel. 07971 000091.  
Sensible offers please. Need  
to sell quickly.

PURE DRX 702 ES DAB/  
FM/AM Tuner. Boxed, as new  
condition. Silver polished alloy  
front. 299 pounds. Whafedale  
Pacific Evo30 speakers maple,  
boxed as new 399 pounds.  
Tel 01493 665761  
[davidtyrrell1@btinternet.com](mailto:davidtyrrell1@btinternet.com)

OPTIMUM PREMIER Hi-Fi  
stand, glass & stainless steel.  
7 shelves available. Build up  
to suit your system. £95.  
Tel. 01234 7113583 (Olney,  
North Bucks)

VINTAGE CAMBRIDGE  
AR60 amplifier £45, matching  
Cambridge T21 tuner £35,  
awesome Cambridge R50  
transmission line speakers  
£180, all vgc. 01379 898676  
or 07515 284997  
[j.king142@btinternet.com](mailto:j.king142@btinternet.com)  
(suffolk)

SYSTEM COMPRISING,  
Mission PCM 7000 C.D.  
Player, Mission Cyrus amp,  
Celestion DLS speakers with  
Heybrook stands. Excellent  
condition. will consider  
separating. £300. phone  
07952905698

KISEKI BLACK Heart MC  
cartridge #093. As new. Used  
for 150 hours; for the last 15  
years has been stored in it's  
original box. £270.  
[iordanov.i@gmail.com](mailto:iordanov.i@gmail.com)

MISSION 754 rosewood  
speakers. Floor standing.  
Were £1200. Articulate and  
informative sound with fine  
imaging and tight deep bass.  
Packaging and paperwork.  
Perfect. £200. 01869 248589.  
[platypus1657-mission@  
yahoo.co.uk](mailto:platypus1657-mission@yahoo.co.uk)

PMC OBI speakers, unused,  
boxed, cost £2850. Will sell  
£1750. Light oak. Tel: 020  
8529 6764 or 0972 024 888



## FREE READER CLASSIFIEDS

PROJECT VALVE phono stage for sale. Boxed. Manual. Still needs to be run in. Paid £300, want £165 ono. Worthing West Sussex 01903 231172

KIMBER SELECT KS3033 Speaker Cable. 9ft pair terminated with WBT0645 banana plugs. Plus KS9033 jumper cables. Perfect condition with pelican case. Cost over 2200, sell for 1100. alan.dalvarez@btinternet.com

REL STRATA/2 Subwoofer Brittex black 225.00 Denon 1604 AV Receiver and five Tannoy speakers 150.00. All excellent condition. o.n.o. Tel 01159229176. Email aaaa.w2@ntlworld.com.

MISSION 754 rosewood speakers. Were £1200. Articulate and informative sound with fine imaging and tight deep bass. Packaging and paperwork. Perfect. £200. 01869 248589. platypus1657 mission@yahoo.co.uk

QUAD FM4, 34, 306, Quad rack, late model, manuals. MC module, unmarked condition £499:00. Spendor BCI matched loudspeakers, rosewood. Original stands. Mint condition £399:00. Tel: 01273 462454 (West Sussex).

UNISON RESEARCH Hybrid valve system. Unico Secondo 120w/ch integrated amplifier. Unico CD player, Unico 'R' FM/RDS/AM tuner. Mint with boxes. £2500. May split. Spare Quad 99, Primare CD110 remote controls. Offers? Tel: 023 8073 8935

TEAC TI Transport. New laser fitted. £350. Musical Fidelity A3-24 DAC, mint, boxed, £350. Cambridge DAC1, mint, £50. Nordost Flatline silver £30. Sonic Link Violet 1 metre, 0.5 metre interconnects, £15. Tel: 0785 416 0942

PROAC TABLETTE 2000, maple, mint condition, boxed, £275. Soundstyle ST60 stands, silver, Soundbyte loaded, £60. Tel: 01329 667 809 (Hampshire)

HI-FI NEWS 1962 to 2007. £10 per annum. Wharfedale Super 10 RS DD £10 each, floorstanding cabinets available. Dual CS500 turntable, teak plinth, spare headshells, £50. Buyer collects. Tel: 01502 562 622 (Lowestoft)

KRELL KAV 400xi, superb 200wpch, sparkling detailed sound. 2 years old. e.w.o. Offers around £1500. KT88 single ended integrated amplifier, compact, boxed, still guaranteed £475. Bargains. Tel: Stanley 07951 553091 (London)

DENON DVD 2800 high end quality black DVD player and remote (£750) only £250 ono. Pioneer SACD DV575A + remote, silver (£250) £75. JVC AKII amp FMJ silver only £40. Wanted: Quad L-ite sub. Tel: 01206 510 392

THORENS TD150 £60. Thorens TD160S Mayware Formula 4 arm £120. Roksan Xerxes Rega Planar 3 arm. £200. Celestion SL6 speakers £160. Tel: 023 80777067

LINN LP12 (1996) Basik LXV Goldring Elektra (new) serviced and re-set (Feb 08) £499 ovno. Tel: Mark 07891 700 542 or 01352 714568 (Holywell, N.E. Wales)

CYRUS CS50 speakers, mint and boxed. (£500 new) included 2x2 MTS Cyrus cables and Apollo stands. £175 ono. Tel: 0115 928 8006 (Nottingham)

CASTLE 7s speakers. Floorstanders, mahogany, immaculate, £250. Linn Aquito tonearm, Goldring 1042 cartridge, on Linn armboard. £140. Rotel RT-950BX AM/FM stereo tuner. Offers. Speakers, tuner boxed with manuals. Tel: 01559 370 067

NAIM CD5, boxed, instructions, immaculate. £500. Mint. Pioneer F401L tuner £20. Pioneer PL-514 belt drive turntable, suprisingly good, £30. Sony 377 spares or repair, £20. Tel: 0772 962 0621 (Worcs)

AUDION SILVER Night 300B valves monoblock. Costs £1995. Valves need replacement. £700 ono. Michell Iso Hera power supply. £250 ono. One owner. Tel: 020 7263 5702 after 7pm

THORENS TD 150/II record deck £25. Trio stereo integrated amplifier KA 3700, £25. Technics stereo cassette deck RS-BX 501, £25. Tel: 01529 304 343

SEXY LITTLE bargain. Quad 988s, black, mint, (£4000) £1600 ono. AVC KT88 valve amp triode (£1500) £700 ono. Sell both for £1900 ono. Tel: Robert 07976 621 529 (Leeds)

SONY SACD DVP705 + remote £200 (£470), STSB920 tuner £100, DVPNS33 + remote £70. Marantz CD63 II K.I.S. £349, PM66KIS £270, CD65DX £35, Dual 505 + arm £35, Philips CD601 £20. Rotel RT950BX tuner £75. Tel: Jim 01206 510 392. Mobile 07880 983 630

PINK TRIANGLE T00 turntable (rosewood) with pink lid. One careful owner. Alphason Xenon arm fitted/included. £350 ovno. Tel: Shaun 01226 244 341 evenings 8pm-10pm

CABASSE POLARIS AM 1000 100 w/p mono amplifiers, Wilson Benesch Full Circle turntable. Croft pre-amp upgraded. Russ (four) Andrews mains leads. Please phone for prices. Tel: 020 8524 2181

GENESIS 400 3 way dipole speakers, rosewood as new £1100. Jeff Rowland One preamplifier MR11 £1150. Jeff Rowland Model 3 mono power amps. All with manuals. £1300. Tel: 0777 917 4951

SPENDOR SP3-IP loudspeakers with Target stands. Suitable for valve amps. Sell £550 complete. Tel: Gordon 0787 174 6360 (Edinburgh)

DENON TU1800 DAB tuner. silver. 6 months old. boxed. As new condition. £100. 07949910455 (Essex)

SLATE AUDIO Garrard 401 marble plinth, SME IV, glass mat. Bought direct from Slate Audio. Pristine. Immaculate. True classic. Superb for serious vinyl audiophile. £1500. Tel: 020 7263 5702 after 7pm

MARANTZ CD94 recent new drive belts fitted plus new spare set available. Very good condition. £200. Tel: 01277 219 639 (Essex)

CLASSIC AMPS: Pioneer A88X £190, Rogers Ravensbourne £60. Unused speakers! Wharfedale 708's (black) £145. Goodmans 'Imagio' IC100's £85. Mint, boxed, various quality interconnects. Phone for details. Tel: 07837 188 670 (mobile)(Essex)

AUDIOLAB 8000Q preamp £220. Cyrus CD7Q £350. PreX £350. PSXR £210. Epos ES22 speakers £275. Tel: 01977 609 839 (Pontefract)

AUDIOPHILE VINYL playback system. Garrard 401, SME IV, glass mat. By Slate Audio £2100 (£1500) Audion Silver Night 300B valve monoblock £2100. Valves need replacement hence £600. One owner. Tel: 020 7263 5702

MK1 HALF track Revox A77. 3.75 + 7.5 ips. with mk4 knobs & switches, brushed aluminium lower case, clean machine good working order. cover & manual. £85.00: p6blueslover@aol.com or 02476 276666.

CHORD ELECTRONICS SPM 1200c power amp and Music First passive preamp (copper) for sale; both mint condition, boxed and with manuals £2,500 the pair. Will split. Email Keith on DobsonKeith@aol.com.

TOWNSHEND ELITE Rock Mk2 complete with Rega RB250 Tonearm, Mint Condition. Would assist buyer with transportation £400 or near offer contact Roy on M 07764694287 - H 02085318576 or delroypowell@ntlworld.com

2 CAMBRIDGE AUDIO R50 Speakers. Kef b319, b110a, t27, Coles super tweeter. d450 x w330 x h1080. 44 kg each + 3 kg for box. £499 ono. Tel: 01865-557700

VINYL LP'S Wanted. Rock: Folk: Jazz: Soul: Reggae: Blues: Classical: Memorabilia. Must be in Excellent condition. www.tantrel.com tantrel@bigfoot.com 0845 0941997

RUARK EQUINOX Speakers, Piano Black in very good condition, Superb sound. (£2100) bargain at £680. Tel: 07812 914460 (North Hants)

TANNOY PRESTIGE Glenair 10 in factory sealed boxes. Never played, full 5 years warranty. American cherry finish, made in the UK (£3300) £2550 ono, South London Tel 07855343330 naissus@hotmail.co.uk

B+W ZEPPELIN i-Pod dock. Boxed, unwanted gift, £325. 01992 300713 (Herts.)

AUDIO NOTE Zero pre-power system. Boxed, mint condition, less than yrs use, recent service. £1200. (£3000). 01992 300713. Herts.

SUMO ATHENA Polaris pre and power amps. Class AB 150 watts. £1000 pair. Meridian 200/203 CD transport and DAC £500 pair. Tel Pete 07801 917291 eves.

WANTED - REGGAE & Ska 45s and LPs - 1960 to 1980. Condition immaterial if priced accordingly. Any quantity from 1 to 1,000. Telephone 01732 832452 or email de.koningh@virgin.net (Kent)

NAIM NAIT 5i Integrated amplifier. Ex-demonstration model, boxed and in perfect condition. £450. Please call David on 07736 280018 or e-mail davidp.warren@ntlworld.com.

YAMAHA NS1000M speakers, look o.k. from front, but cabinets slightly scruffy, great sound, £675. Thorens TD150, Thorens arm, plinth, cover £65.00. Leak Delta turntable (GL75) £55.00. Graham 07976 904381 Lincolnshire.

GARRARD 401 turntable, SME 3009 Series II pick-up arm and SME 2000 plinth (rosewood), £470. Telephone 01189 413708.

AUDIO ANALOGUE Bellini Pre, Donizzetti Power (X2) amps £500, Slate Audio 26" solid slate custom stands for LS35A or similar £350, Arcam Alpha + £50 Tel 07738200088.

MANA 5 TIER rack £350, Naim Aero tonearm £300, Linn LP12 with Mantra power supply £300, Naim NAT 01 £400. All priced to sell. Tel: 07831 745391 (Berkshire)

LINN CD12 CD Player. Fantastic sound and hardly used. Comes with its original metalsuitcase. Sounds amazing!!!! Write to: janmichaelsen@hotmail.com

AUDIOLAB 8000A. Mint condition. Sealed boxed includes handbook £160. Rega P3 Rega Elys immaculate £130 Both for uplift. Tel: 0141 775 1015

WANTED: TOP quality Hi Fi separates and complete systems, Naim, Linn, Cyrus, Meridian, Arcam etc. fast, friendly response and willing to travel/pay cash. Please call me on 0781 5892458

WANTED: AUDIOLAB 8000P power amp E or F. serial number boxed. Wanted: Chord Odyssey 2 speaker cable 2x3 mt with Chord plugs. Wanted: PMC DB1 speaker wallbrackets. Please phone Paul on 01234 302769 or 07840 428253

WANTED: LINN Sondek LP12 clear turntable lid in good condition. Tel: 01926 853 106

B&W NAUTILUS 804 Speakers. Cherry. Excellent condition. Boxed with original accessories. £1200 Rel StrataIII Subwoofer. Cherry. Excellent condition. £275. Tel: 07592 558608 (Hampshire)

KIMBER SELECT 1121 Balanced Interconnect. 0.5m purchased from Russ Andrews four years ago. Excellent condition with pelican box. £315 or trade for high quality non balanced interconnect. Alan 07867 832626.

KIMBER SELECT KS3033 Speaker Cable. 9ft pair terminated with WBT0645 banana plugs. Plus KS9033 jumper cables. Perfect condition with pelican case. Cost over 2200, sell for 1100. alan.dalvarez@btinternet.com

SONY TCK-700ES Quartz lock direct drive cassette deck, £95, mint. Technics SB-FI high end micro monitor loudspeakers, cast aluminium cabinets, vgc, £145. Sony SS-5050 Carbocon 3-way monitor loudspeakers, carbon fibre cone, mint, £295. Fidelity Research FR64FX tonearm, legendary design, mint, offers. Ortofon SPU E GM Gold cartridge, excellent condition, offers. 07985 323279.

**GUIDELINES FOR BUYING AND SELLING SECOND-HAND EQUIPMENT**

**FOR THE BUYER**

1. Not everyone is honest - Buyer Beware!
2. Don't send cash!
3. Accept no verbal guarantees.
4. Have you heard the item or something similar? If not, why do you want it?
5. Don't pretend to have knowledge - it's your fingers that will get burnt!
6. Is it working? If not, why not? Can it be repaired and if so is it worth it?
7. Has it been modified and, if so, have notes been kept?
8. Was it any good in the first place?
9. Don't send cash!
10. If you are in the slightest doubt, arrange an audition (see point 5) If it's too far, wait for another time.
11. Either buy it or don't: vendors are excusably impatient with 'consultation' exercises.
12. Don't send cash!

**FOR THE SELLER**

1. Not everyone is honest - Seller Beware!
2. Make no verbal guarantees.
3. Even 'nearly new' is still second-hand. If the manufacturer's guarantee is no longer in force, your price should reflect this.
4. There is very little intrinsic value in second-hand hi-fi; it's only worth what someone will pay for it.
5. The best guide to pricing is last month's Classifieds: that a 'classic' was worth £xxx a year or two ago is no guide. Values fall as well as rise.
6. Amateur second-hand dealing is not a big money game: you win some, you lose some.
7. Be prompt with despatch. If in doubt about buyer's bona-fides, either wash out the deal or send C.O.D.
8. There will always be time-wasters; be tolerant within reason!

**Choice hifi**

BUY/SELL HOME CINEMA MULTIROOM INSTALL HI-FI

**www.choice-hifi.com**

tel: 020 8392 1959 mob: 07768 720456

info@choice-hifi.com





## WDKEL84 Valve Amplifier Kit

*"The quality that can be gleaned from this amp is a fine introduction to the joys of the valve sound"*

The WDKEL84 features a pair of EL84 valves in Push Pull configuration per channel, providing two channels each 18 Watts into an 8 Ohm load. Described by users as a 'Giant Killer' this kit is available as a 5 input integrated amplifier with ALPS volume control.

**WDKEL84 kit** £449

**WDKEL84 built & tested** £599



## WD88VA Valve Amplifier Kit

*"It proved itself to be an engaging valve amplifier that measured well and sounded superb. Quite simply it plays music, and plays it extremely well."*

Adam Smith, Hi-Fi World Dec 06

Often described as a 'sweet sounding' valve, our implementation of the KT88 makes sure that it is driven to its ultimate performance. Available as a 35W stereo power amplifier with single input volume control, or as a relay switched integrated with five inputs.

**WD88VA Integrated Amp kit** £949

**WD88VA built & tested** £1249



## WDHD3 Headphone Valve Amplifier Kit

*"Headphone 3 is a single-ended design with the power pentode wired up in triode configuration for added purity and is as quiet as a mouse"*

A beautifully simple stereo headphone amplifier design using Mullard ECL83 valves. It works directly from any source. The circuit uses twin high specification E/I output transformers that can be wired to drive any headphones between 16 to 300 Ohms.

**WDHD3S kit** £349

**WDHD3S built & tested** £479



## WDPRe3 Modular Preamplifier System

*"So there we have it, a pre-amplifier capable of driving any load and maintaining its linearity no matter what cables or partnering equipment you prefer to use."*

This 5 input line level preamp is essentially an SE triode power amplifier in concept. WDPRe3 uses an ECC82 double triode arranged as input voltage amplifier and power output amplifier stages, the latter driving oversize 20:1 output transformers.

**WDPRe3 kit** £369

**WDPRe3 built & tested** £494



## WDPhono3S MM/MC preamplifier

*"...only a few designs meet the requirements of tonal accuracy and maximum retrieval of musical detail."*

Twin input preamp with MM and MC relay switched inputs, passive RIAA equalisation and wide bandwidth MC step-up transformers.

**WDPhono3S kit** £399

**WDPhono3S built & tested** £524



## WDPSU3 Power Supply

*Can be used to power either WDPRe3 or WDPhono3 units individually or together.*

High performance choke power supply with separate HT and Heater feeds for both WDPRe3 and WDPhono3 preamplifiers.

**WDPSU3 kit** £199

**WDPSU3 built & tested** £299

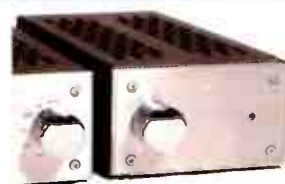

All our kits are complete with pictorial easy-to-follow instructions.  
All parts are included - all you need is a screwdriver and soldering iron.  
World Designs, 59 Main Street, Great Gidding, Huntingdon, Cambs, PE28 5NU

www.world-designs.co.uk  
Tel: 01832 293320

**WANTED:**  
**QUADRAPHONIC-**  
 Demodulator  
 Denon UDA-100.  
 quadmastersound@yahoo.de

**SHANLING CDT100.** Very good condition, boxed with manual etc. Demo possible. Bargain. £795. Tel: 01384 79402 or 01384 812034 after 6pm

**LOWTHER LOWTHER**  
 Acousta twin speaker wanted. Made late 1960's. PM7A drive units wanted. Any condition. Working drawings, mounting screws also wanted. Tel: Jeff 020 8220 0380

**WANTED: AUDIOLAB**  
 8000P power amp, E or F serial number only. Manual, boxed. Wanted: Chord Odyssey 2 speaker cable 2x3 mt with Chord plugs. Wanted: PMC DB1 speaker wall brackets. Please phone 01234 302 769 or 07840 428 253

**CAMBRIDGE AZUR 640H**  
 one year old little used, c/w Vesenet Mains Ethernet adapters, original box, A1 condition, (£599) £450 ono + p&p if required contact Garnet on 07814853747

**ATACAMA FIVE** tier equipment stand. £150. Brenell Mk5 mono recorder, working. £25. Classical records, EMI, ASD, RCA, Red Seal etc. Atacama three leg speaker stands, £40. Cossor transistor radio. Tel: 01522 820 179 (Lincs)

**DUAL 505-2** turntable, 33/45, with stand alone phono pre-amp uses Tape or Aux or Radio input sockets. As new with new belt and P77 cartridge. £90. You collect - Brighton. Tel: 07710828286

**MICHELL GYRO SE DC** motor! Origin RB300, Ortofon MC20, Supreme Unicover clamp, VTA adjuster ring. Used for approximately 10 hours. Boxed, as new, £825. No offers. Tel: 01722 334 694 or 07979 705644

**WORLD DESIGNS KT88** integrated valve amp. Upgraded capacitors and diodes. Assembled by professional audio engineer. £900 ovno. Reason for sale is I've changed to a pre/power combination. Tel: 0771- 737 232 (Edinburgh)

**DECWARE RL3** floorstanding radial loudspeakers. 93db efficiency, ribbon tweeter, 5" midrange, 6.5" bass and matching 6.5" auxiliary bass radiator. Maple, pyramidal cabinet approx 95cm tall. Only crossover components are a capacitor and resistor (user tunable) to protect the tweeter. Current model (see Decware's website) - £625. Great with lower powered amps. Fantastic soundstage. Stephen 01458 860765. Glastonbury. stephen.judge@homecall.co.uk

**MILLER AND Kriesel V125** active sub, £300. Marantz CD 60 SE, £50. Music Works 6 way mega block, three 1.5m IEC mains leads, £250. Audio Technica vibrating stylus cleaner! Boxed. £30. Tel: 01722 334 694

**ARCAM ALPHA 7 SE CD** player. Excellent condition and boxed. £80. Tel: 02476 457 897 (Coventry)

**GARRARD 401** turntable, SME 3009 Series II pick-up arm and SME 2000 plinth (rosewood), £470. Telephone 01189 413708.

**MUSICAL FIDELITY CD 24** pre £850.00. ATC SCM 20 pro actives, grey, flight cased, plus 36" or 42" Quiklok stands £2500.00. 0791 2208525 andydaish@aol.com London/Hants.

**KINGREX T20U / PSU** combination - latest model with upgraded Noble potentiometer. Brand new, boxed, unused and with full guarantee. £289. Beautiful, better than valve sound from small amp - contains inbuilt USB DAC for direct connection to digital source and line input. See reviews on 6 Moons website. Stephen 01458 860765. Glastonbury. stephen.judge@homecall.co.uk

**QUAD 306, 34, FM4.** Grey. Excellent condition. £585 or will split, £195 each. Tel: Andy 0116 239 2373

**WANTED: LINN Sondek LPI2** clear turntable lid in good condition. Tel: 01926 853 106

**NAIM HI-CAP 2.** Latest spec. £600. Proac D15 Response loudspeakers. £750. Tel: 07530 581 717

**CLASSIC CONTACTS**

When a classic goes 'poof' your troubles have just started, but there may be a good ending. Replacing failing parts can improve the sound, so here is a short listing of all those companies who specialise in getting a classic up and running again after its deposited a small ring of soot on your ceiling!

**CLASSIQUE SOUNDS**  
 (Paul Greenfield, Leicester)  
 ESL-57s restored, rebuilt, fully renovated or improved. Leak, Quad valves amps etc.  
 Tel: 0845 123 5137 / Mob: 0116 2835821 Email: classique\_sounds@yahoo.co.uk www.flashbacksales.co.uk/classique

**GT AUDIO**  
 (Graham Tricker, Bucks)  
 Leak Troughline specialists. Also Quad and most classic tuners, radios and amplifiers restored, repaired.  
 Tel: 01895 833099 / Mob: 07960 962579 www.gtaudio.com

**TECHNICAL AND GENERAL**  
 (East Sussex)  
 Turntable parts - wide range of spares and accessories, plus arms and cartridges. Tel: 01892 654534

**AUDIOLAB**  
 (Phil Pmbloitt, Leeds)  
 Renovation, repair and restoration. Specialist in valve hi-fi, radio transmitters, cinema amps, kit building.  
 Tel: 0113 244 0378 www.audio\_labs.co.uk

**QUAD ELECTROACOUSTICS**  
 (Cams)  
 Quad's service department, able to repair almost all Quad products, from the very first.  
 Tel: 0845 4580011 www.quad-hifi.co.uk

**ARKLESS ELECTRONICS**  
 (Northumberland)  
 Specialist in repairs, restoration and modifications to all amplifiers, valve or solid state, ancient and modern.  
 Tel: 01670 829891 Email: arkless.electronics@btinternet.com

**SOWTER TRANSFORMERS**  
 (Brian Sowter, Ipswich)  
 Large range of audio transformers for valve amps, cartridges, line drive, interstage plus all associated services.  
 Tel: 01473 252794 www.sowter.co.uk

**WEMBLEY LOUDSPEAKER**  
 (Paul MacCallam, London)  
 Comprehensive loudspeaker servicing.  
 Tel: 020 8 743 4567 Email: paul@wembleyloudspeaker.co.uk www.wembleyloudspeaker.com

**EXPERT STYLUS COMPANY**  
 (Wyndham Hodgson, Surrey)  
 Stylus replacement service for all types of cartridge. Including precise profiling for 78s  
 Tel: 01372 276604 Email: w.hodgson@btlink.com

**Dr MARTIN BASTIN**  
 (Shropshire)  
 Garrard 301/401 restoration, renovation and service. Special plinths; rumble cures, etc.  
 Tel: 01584 823446

**ONE THING**  
 (Coventry)  
 Specialist in electrostatic panel manufacture and repair. Can refurbish ESL 57s and 63s as well as Leak Troughlines and Quad IIs.  
 Email: one.thing@ntlworld.com www.oneathingaudio.com

**D.K LOUDSPEAKER SERVICE**  
 (Dave Smith, Hornchurch, Essex)  
 Re-coning of hi-fi loudspeakers, high quality loudspeaker systems, P.A., power loudspeakers.  
 Tel/Fax: 01708 447 344

**LOCKWOOD AUDIO**  
 (London)  
 Tannoy loudspeaker parts, restoration and repair. Also Epos and TDL loudspeakers.  
 Tel: 020 8 864 8008 www.lockwoodaudio.co.uk

**CLASSIC NAKAMICHI**  
 (Paul Wilkins, Worthing, West Sussex)  
 Restore, Repair & Service Nakamichi Cassette Decks.  
 Tel: 01903 695695 Email: paul@bowersandwilkins.co.uk www.bowersandwilkins.co.uk

**OCTAVE AUDIO WOODWORKING**  
 (Bristol)  
 Unit 2, 16 Midland Street, St Phillips, Bristol.  
 Tel: 0117 925 6015 www.octave-am.co.uk

**LORICRAFT AUDIO**  
 (Terry O'Sullivan, Bucks)  
 Garrard 301/401 and their own 501 repair, spares and service.  
 Tel: 01488 72267 www.garrard501.com

**CARTRIDGE MAN**  
 (Len Gregory, London)  
 Specialist cartridge re-opping service and repairs. High quality special cartridges.  
 Tel: 020 8 688 6565 www.listen.to/thecartridgeman

**REVOX**  
 (Brian Reeves, Cheshire)  
 Revox tape recorder spares, service and repair. Accessories also available.  
 Tel: 0161 499 2349 Email: brian@revoxservice.co.uk www.revoxhifi.co.uk







BUY / SELL      HOME CINEMA      MULTIROOM INSTALL      HI - FI

www.choice-hifi.com

tel: 020 8392 1959    mob: 07768 720456

info@choice-hifi.com



# NEXT MONTH



With its typically eclectic mix, September's *Hi-Fi World* is an excellent excuse to stay out of the summer sun (or rain)! The silly season will be upon us, so with that in mind we're looking at the best ways to take your favourite music away on holiday with a test of the top digital portables and headphones. If you'd prefer to rest in, then we've also got plenty for your perusal, from a scoop review of the superb new Kudos C20 floorstanding loudspeaker [pictured], to the brilliant Martin Logan Purity active electrostatics. Tube types will love the Leben CS-300X valve integrated straight from Japan, while we also hear Musical Fidelity's brand new A1 Fully Balanced Preamp, plus much more. Here's just some of what we hope to bring you...

CYRUS CD8SE CD PLAYER  
NAGAOKA MP500 CARTRIDGE  
SPENDOR S3/5R LOUDSPEAKERS  
PROMITHEUS TVC PREAMPLIFIER  
MONOPULSE 42A LOUDSPEAKERS  
YAMAHA DSP-AX863SE AV RECEIVER  
KUDOS CARDEA C20 LOUDSPEAKERS  
SCHEU ANALOG CANTUS TONEARM  
RIPFACTORY RIPSERVOIR MUSIC SERVER  
LEBEN CS-300X INTEGRATED AMPLIFIER  
MUSICAL FIDELITY A1 FBP PREAMPLIFIER  
AUDIO TECHNICA ATH-W5000 HEADPHONES  
MARTIN LOGAN PURITY ACTIVE LOUDSPEAKERS  
OLDE WORLDE: FIDELITY RESEARCH FR64 TONEARM

DIGITAL PORTABLE SUPERTTEST: COWON iAUDIO D2,  
SONY NWZA826, IRIVER CLIX 2 & IPOD NANO

**PICK UP THE SEPTEMBER 2008 ISSUE OF *HI-FI WORLD* ON SALE JULY 31ST,  
OR SUBSCRIBE AND GET IT DELIVERED TO YOUR DOOR: p78**

**ADVERTISERS INDEX**

AN Audio 116  
 Analogue Seduction 112  
 Anatek Research 116  
 Angel Sound Audio 116  
 April Music 14  
 Audio Components 46  
 AudioXpress 112  
 Big Ears 112  
 Billy Vee 110  
 Cambridge Audio 12  
 Choice Hi-Fi 125,127  
 Cymbiosis 111  
 Decent Audio 109  
 Deflex 76  
 Electrocompaniet OBC  
 Emille Labs 26  
 Exposure IFC  
 Heathcote Audio 110  
 Heatherdale 109  
 Henley Designs 84,96  
 Hi-Fi Confidential 68  
 Hi-Fi Sound 119  
 HiAudio 58  
 High End Cable 115  
 Ian Harrison 111  
 Icon Audio 111  
 iCubes 46  
 Kudos 109  
 Leema Acoustics 34  
 Linn 104  
 London Audio Consultants 118  
 Mantra Audio 115  
 Melody 6  
 MF Audio 46  
 Midland Audio Exchange 122  
 Midland Hi-Fi Studio 112  
 MIT Cables 44  
 Newcastle Hi-Fi 38  
 Origin Live 113  
 Oxford Audio Consultants 68  
 Practical Hi-Fi 70  
 PressBlog 117  
 Raysonic 20  
 Retro Reproduction 115  
 Right Note 76  
 Ringmat Developments 44  
 Rochester Hi-Fi 113  
 RPM Audio 118  
 Sevenoaks 114  
 Shadow Audio Consultants 72  
 Signals 116  
 Sound Hi-Fi 109  
 Sound Seduction 117  
 Sugden 90  
 Unity Audio 30  
 Usher IBC  
 Walrus Systems 74  
 Whest Audio 90  
 World Designs 126

# FREE READER CLASSIFIED ADS ORDER FORM

**STOP PRESS**

**TERMS AND CONDITIONS:** Only one advert per reader. Maximum length per advert is 30 words, Adverts over 30 words will not be accepted. No Trade Adverts. This section is strictly for readers selling secondhand hi-fi equipment only. Telephone numbers and E-mail addresses are treated as one word. Model numbers are treated as one word i.e. Quad 303 = two words. Sorry, we cannot accept adverts over the telephone. The Publisher reserves the right to judge submissions.

You can email your advert to us at: [classifieds@hi-fiworld.co.uk](mailto:classifieds@hi-fiworld.co.uk) or write or type your advertisement copy in block capitals with one word per box and post it to us at:

**Hi-Fi World Free Readers Ads,**  
 Unit G4, Argo House, Kilburn Park Road,  
 London, NW6 5LF.

**WE WILL ACCEPT PHOTOCOPIES OF THIS FORM**

1	2
3	4
5	6
7	8
9	10
11	12
13	14
15	16
17	18
19	20
21	22
23	24
25	26
27	28
29	30

Name: \_\_\_\_\_  
 Address: \_\_\_\_\_  
 \_\_\_\_\_  
 Post Code: \_\_\_\_\_  
 Daytime Tel: \_\_\_\_\_

**FREE READER CLASSIFIED ADVERTS COPY DEADLINES**  
 SEPTEMBER 2008 - 9TH JULY 2008  
 OCTOBER 2008 - 6TH AUGUST 2008





# BILL FRISELL

## HAVE A LITTLE FAITH

### 1992

**F**rom Nonesuch, this album is one of the best releases produced by a jazz/rock/avant-garde/country/bluegrass guitarist whose extensive discography is

full of excellent material. On this album, he's supported by Don Byron on both clarinet and bass clarinet, Guy Klucevsek on accordion, Kermit Driscoll on bass and Joey Baron on drums. One of Frisell's prime talents is to adapt his guitar work to just about any genre in music and to do it, not just well, but to trigger acclaim from aficionados in each specific musical genre. He is also able to extract weird and wonderful sounds from his instrument which adds substance and ambience to the piece he is playing. This album is no different, with pieces from Bob Dylan, Aaran Copeland, Stephen Foster and Sonny Rollins tackled with aplomb.

A wonderfully inventive musician, *Hi-Fi World* asked Frisell's long-term producer Lee Townshend what Frisell's influences are and why he is such an explorer of music. "Bill is a naturally curious person who instinctively and consciously seeks ways to make musical and personal connections with other musicians and artists who make work that he finds moving," said Townshend. "His influences range from traditional to modern in many art forms. And he approaches his work both from a sense of adventure and a desire to keep learning. I find him to be artistically restless - always searching, which makes producing his music a constantly shifting challenge."

This extends to his collaborators, who he uses both as a soundboard and as a catalyst to create new sounds. However, Frisell doesn't

"his talent continues to shine as his style develops and his boundaries are pushed..."

just play with anyone, as Townshend explained. "It seems to me that a collaborator, for him, requires a musical affinity, a personal connection and an opportunity to create and learn in a stimulating environment."

Frisell's has developed his own 'voice' through his guitar. His technique gives you the impression that he's thought about what he's about to play. His technical quirks aid that. For example, he is known to use a guitar with a flexible neck, although there is some debate about that. "Bill's playing tends to encounter music from within through his own special filters in order to integrate the various styles that you allude to in an organic manner rather than confronting it as an outsider", said Townshend. "Plus, he is a composer and melodist of the highest order. Thus he commonly makes musical contributions that are at least sensitive and often quite elevating to a particular musical setting. I don't know of a guitar he uses with a neck that is any more flexible than normal. The experimentation can run the gamut from a subtle playing level all the way through a more overt orientation to effects, such as spontaneous looping, etc."

The technical aspects of Frisell's work apparently hold an equal importance to his artistic endeavours. He does, however, place that area of music into the hands of others. "I think both sound quality and emotional content are very important to him, but Bill tends to put himself

in situations with producers and engineers whom he trusts so that all he has to be concerned with is his playing rather than being preoccupied about whether someone is capturing his sound properly," confirmed Townshend. "In my experience, Bill pretty much leaves the sound approach to the producer and the engineer. He usually saves any suggestions on microphone placement, etc. for the rare occasion where a problem is encountered in terms of achieving the desired sound".

Frisell's new album is out now. Called 'History, Mystery', again via Nonesuch, it features Ron Miles and Greg Tardy on horns, Eyvind Kang, Hank Roberts and Jenny Scheinman on strings, Tony Scherr on bass and Kenny Wollesen on drums. The album is full of space, full of quiet moments, onto which the music treads. There have already been comparisons between the tone of some of the tracks on this double album and the Penguin Cafe Orchestra and that's certainly the case. There's lots of space in between the instruments on this 'suite'. In fact, that's what this album sound like as well; a series of often short pieces, threaded into a soundtrack or a guitar masterwork. And there is no doubt of Frisell's talent, which continues to shine as his style develops and his boundaries are pushed. This is the only aspect of the new release which is at all exhausting. Even the up-tempo numbers have a gentle relaxation about them. **PR**

# USHER

www.usheraudio.com

# Be there.

THE BERYLLIUM EVOLUTION

With the music

The new Usher Beryllium 718



**July Road Shows**  
25th and 26th July 2008  
RJF Audio Visual,  
Camborne, Cornwall TR14 8NJ,  
Tel 01209 710777

## USHER AUDIO TECHNOLOGY

67 Kai-fong Street Sec.1 Taipei 100 Taiwan Tel:886-2-2381 6299 Fax:886-2-2371 1053 E-mail: usher@ms11.hinet.net

## UK SALES:

HiAudio, 3 St Fort Place, Wormit, Newport on Tay, Fife, DD6 8NT, Tel/Fax: 08450 525259 E-mail: sales@hiaudio.co.uk

### Approved Usher Audio "Dancer Dealers"

Audio Affair, Birmingham, 0845 869 3237  
Audio Elevation, Doncaster, 0800 035 1620  
Classic Hi Fi, North London, 0208 374 3958  
HiFi Corner, Edinburgh, 0131 5567901

Hi Fi Sound, Darlington, 0845 6019390  
Mike Manning, Yeovil, 01935 479361  
RJF Audio Visual, Cornwall, 01209 710777  
Sound Hi Fi, Devon, 01803 833366

The Emporium, Suffolk, 01502 719704  
Walrus, London, 020 7724 7224

For a full list of dealers offering other Usher Audio loudspeakers visit [www.hiaudio.co.uk](http://www.hiaudio.co.uk)





ELECTROCOMPANIET

If music really matters...



»» MORE THEN THREE DECADES OF EXCELLENCE »» AWARD-WINNING PRODUCTS WITH OUTSTANDING DESIGN AND QUALITY »»

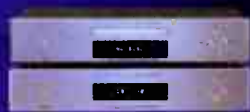

**Dealers**

**Midland Audio X-Change** - Belbroughton.  
**Rowles Music Limited** - Sussex.  
**Unilet Sond & Vision** - Surrey.  
**HOME MEDIA LIMITED** - Kent.

**Audio Destination** - Tiverton  
**Kronos audio visual** - Northern Ireland.  
**Kevin Galloway audio** - Ayrshire, Scotland.

**Service Centre**

**NSS Ltd, London** - Tel: +44(0)20 8893 5835

[www.electrocompaniet.no](http://www.electrocompaniet.no)

Made in Norway