

HI-FI WORLD

JANUARY 2008

UK £3.80

www.hi-fiworld.co.uk

FREE READER CLASSIFIED ADS IN THIS ISSUE!



EXCLUSIVE!

SHANLING CDT-1000SE
CD player



EXCLUSIVE!

TRICHORD D300
power amplifiers



D'VEVEL BELLA LUNA
omnidirectional speakers

CHRISTMAS CRACKER!

Vyger's super new Timor in our turntable supertest...

COMPETITION
WIN A SUPERB
ORIGIN LIVE AURORA 2
TURNTABLE WORTH
£1,000!



HI-FI WORLD AWARDS 2007

JANUARY 2008



- > AVID VOLVERE SEQUEL HIGH END TURNTABLE **EXCLUSIVE!**
- > QUAD QC24P & AUDIOLAB 8000PPA PHONO STAGES **EXCLUSIVE!**
- > NAD C315BEE vs. CAMBRIDGE AUDIO 340A SE AMPLIFIERS

7 PAGES OF YOUR QUESTIONS ANSWERED
World Radio History

exposure



Those who appreciate good sound will prefer the tighter "S."

New 3010S series:

Tighter bottom-end, livelier sound, more drive...same price

CD player £1200

- Brand-new "CD solution" – custom-made transport mechanism, servo units and control mechanisms
- Twin Burr-Brown PCM 1704 mono DACs and a discrete output stage
- Low jitter clock and a large toroidal transformer with separate windings for the transport mechanism and audio stages.

Integrated Amplifier £1000

- Larger power supply
- 110 watts RMS (as compared to 100W for the previous model)
- 6 line inputs, bi-wiring and bi-amping compatible
- Option to fit a MC or MM phono cartridge
- Remote control

Power Amplifier £800

- Larger power supply
- 110 watts RMS (as compared to 100W for the previous model)
- Capable of driving sophisticated speaker systems, in bi-amping mode or monoblock mode
- Clean and extended low frequency response

HAIRBUSH
Towel

WE ARE THE UK'S FASTEST
GROWING AUDIO TITLE!!!

welcome

EDITOR

David Price
tel/fax: +44 (0) 1275 371 386
e-mail: editorial@hi-fiworld.co.uk

ASSISTANT EDITOR

Adam Smith
e-mail: editorial@hi-fiworld.co.uk

DESIGN EDITOR

Faiza Chunara
tel: +44 (0) 20 7625 3129
fax: +44 (0) 20 7328 1844
e-mail: adproduction@hi-fiworld.co.uk

PRODUCTION EDITOR

David Noble
tel: +44 (0) 20 7625 3134
fax: +44 (0) 20 7328 1844
e-mail: classifieds@hi-fiworld.co.uk

ADVERTISING

tel: +44 (0) 20 7372 6018
fax: +44 (0) 20 7328 1844
e-mail: advertising@hi-fiworld.co.uk

ACCOUNTS

tel: +44 (0) 20 8841 8892
fax: +44 (0) 20 8841 9144
e-mail: accounts@hi-fiworld.co.uk

PUBLISHER

Noel Keywood
e-mail: publisher@hi-fiworld.co.uk

FREE READERS CLASSIFIEDS

tel: +44 (0) 20 7625 3134
fax: +44 (0) 20 7328 1844
e-mail: classifieds@hi-fiworld.co.uk

SUBSCRIPTIONS

tel: +44 (0) 1442 879097
fax: +44 (0) 1442 872279
e-mail: hifiworld@webscribe.co.uk

WRITERS

Steven Green, Channa Vithana, Patrick Cleasby,
Haden Boardman, Paul Rigby, Peter Comeau.



This month's issue is a suitably seasonal affair, with our annual Awards Special and a free Christmas present for you from Naim Label and ourselves...

This superb Compact Disc is something you really must listen to. Although Naim Audio has established itself as one of Britain's premium hi-fi brands, its music software division is less well known.

So here's your chance to acquaint yourself with its excellent artist roster and superlative technical standards.

Naim Label's 'True Stereo' recording system – all analogue and direct into a high quality, high speed Nagra tape recorder – has to be heard to be believed, and the bundled Sampler 6 has twelve examples of their recording art for your pleasure. Enjoy!

Whilst everyone will surely love the free CD, not all will like *Hi-Fi World's* 2007 Awards - I'm waiting for the inevitable cries of "foul!" and "shame" coming from those whose products didn't get a gong! You see, here's where we nail our colours to the mast and decide the best new turntable, tonearm, cartridge, phono stage, CD player, integrated amplifier, preamp, power amplifier, loudspeakers and all-in-one system of the year. Believe me, it wasn't easy.

This is because there have been so many superb new products this year – turntables, CD players, amplifiers and loudspeakers that have genuinely moved the game forward. Reducing them to a single winner and runner up took much deliberation - read the results on p27. On behalf of the all the team here at *World*, I'd like to wish Linn, Audio Origami, Ortofon, Anatek, Leema, Naim, Melody, Channel Islands, Revolver and Meridian our hearty congratulations for a job well done.

Just to complicate matters, several of this month's reviewed products will surely be candidates for next year's Awards – not least the Avid Volvere Sequel turntable (p86) which I found quite exceptional, even at its near-£5,000 price. We were also enamoured with Duevel's Bella Luna Omnidirectional speakers (p10), beguiled by Quad's QC twenty four phonostage (p90), impressed by Trichord's D300 monoblocks (p51) and surprised by Arcam's little Muso mini monitors (p56). So, when you've spun your CD and digested the Awards, there's still a feast of festive treats inside. Happy Christmas.

David Price, editor



testing

To ensure the upmost accuracy in our product reviews, *Hi-Fi World* has extremely comprehensive in-house test facilities, and our test equipment - from big names like Rohde & Schwarz and Hewlett Packard - is amongst the most advanced in the world.

Loudspeakers are measured using a calibrated Bruel & Kjaer microphone feeding a Clio-based computer

analyser, using pulsed and gated sinewaves, in a large room to eliminate the room's influence. Pickup arm vibration is measured with a Bruel & Kjaer accelerometer.

No other UK hi-fi magazine has in-house testing, and none has access to such advanced tests across all types of equipment. That's why you can depend on *Hi-Fi World* reviews.

hi-fi world

SUITE G4, ARGO HOUSE
KILBURN PARK ROAD
LONDON NW6 5LF
www.hi-fiworld.co.uk

verdicts

- ● ● ● ● OUTSTANDING
- ● ● ● EXCELLENT
- ● ● GOOD
- ● ● ● ● MEDIOCRE
- ● POOR
- £ VALUE

- simply the best
- extremely capable
- worth auditioning
- unremarkable
- seriously flawed
- keenly priced



ELECTRONIC MAGAZINE

Go to our website www.hi-fiworld.co.uk to buy an electronic version of this magazine, individual issues or a subscription. At present we do not offer back issues, but hope to soon.

Distributed by Seymour Distribution Ltd 86 Newman Street London, W1T 3EX Tel: +44 (0) 20 7396 8000 Printed by St.Ives, Plymouth Tel: +44 (0) 1752 345 411
Our Agents in Malaysia Millennium Hi-Fi & AV Simon Chang Showroom & office, 500-1-3 First Floor Wisma Indah (Shen Court), Jalan Tun Razak 50400 Kuala Lumpur, Malaysia
Tel: 603 9283 8171 Fax: 603 9281 3762 e-mail: info@millennium-audio.com

All unsolicited submissions and goods are at the owner's risk. We accept no responsibility for such submissions, nor do we undertake to return them.
No material may be reproduced from this magazine without the publisher's written permission. © Audio Publishing Ltd

10

Duevel's Bella Luna omnidirectional loudspeakers - like no other!



15

This Vyger turntable meets three other £1,500 superdecks in this month's group test...



42

Tubular Belle - Shanling's super new CD T1000se CD player.

51

Trichord's D300 monoblocks - state of the art Class D design



56

Arcam Muso mini-monitors - good things come in small packages!

86

Christmas cracker - Avid's Volvere Sequel turntable.

LOUDSPEAKERS

DUEVEL BELLA LUNA 10

Noel Keywood listens to Duevel's striking omnidirectional loudspeakers

ARCAM MUSO 56

David Price finds these new pint-sized mini monitors larger than life!

DIGITAL

SHANLING CDT-1000SE 42

David Price auditions this stunningly styled Shenzhen-built silver disc player.

AMPLIFICATION

NAD C315BEE vs CAMBRIDGE AZUR 340ASE 46

Adam Smith pits these two new budget integrated amplifier greats against one another.

LIZARD WIZARD PMC AMPLIFIER 41

This enigmatic and unconventional integrated is reviewed by Noel Keywood.

TRICHORD D300 51

Noel Keywood auditions this brand new pair of Hypex-powered Class D monoblock power amplifiers.

FEATURES

HOUSE MUSIC 59

Channa Vithana visits Manchester's House of Linn on a Linn system-buying odyssey...

SHOWTIME 62

Adam Smith goes roamin' in the gloamin' to check out last month's Scottish hi-fi show.

WISHFUL THINKING 94

In which Channa Vithana, Adam Smith and Steven Green send Santa their Christmas present lists...

NAIM LABEL RECORDS 54

David Price looks at Naim's record label, and this month's free CD

SPECIAL FEATURE

AWARDS 2007 27

David Price rounds up the latest and greatest new products of 2007.

OLDE WORLDE

THREE SERIES 64

Haden Boardman looks back on Chapman's classic Leak pre/power rival.

DIY SECTION

DIY FEATURE PART 14 78

Peter Comeau looks at Supertweeters

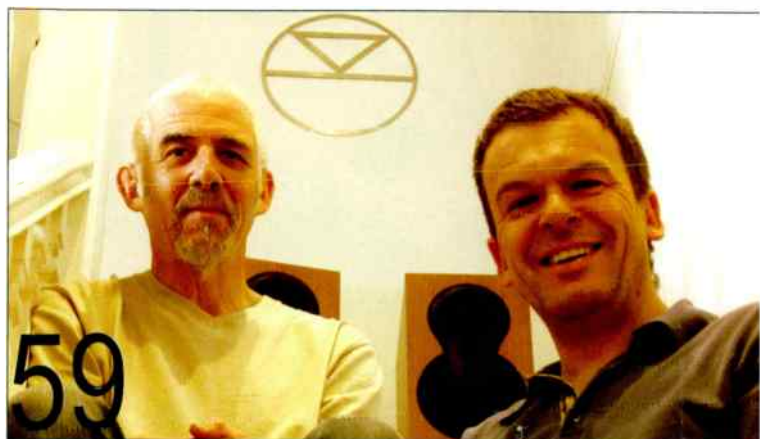

7 NEWS

Words from the front...

50 COMPETITION

Your chance to win a superb Origin Live Aurora 2 turntable, worth £1,000!

67, 69, 71, 73, 75 OPINION

The team get to grips with matters music, hi-fi and life!

76 AUDIOPHILE VINYL

Paul Rigby rounds up the latest black plastic releases.

98 KIT & COMPONENTS

Suppliers of kit and components.

99 MAIL

Seven pages of your views, opinions and queries.

116 SUBSCRIPTIONS

Ensure your copy every month and save money too

118 DIAL-A-DEALER

A comprehensive guide to UK hi-fi retailers.

119 MEET YOUR MAKER

Who makes what and how to get in touch.

121 SPECIALIST HI-FI DEALERS

Purveyors of specialist hi-fi services.

123 FREE READER CLASSIFIEDS

Three pages of second-hand bargains.

128 NEXT MONTH

What we hope to bring you in the next issue.

129 ADVERTISERS' INDEX

130 CLASSIC CUTS

Patrick Cleasby looks at the new 2007 reissue of Jean Michel Jarre's 'Oxygene'.

VINYL SECTION

15 TURNTABLE GROUP TEST

Adam Smith takes four new £1,500 turntables for a spin.

85 VINYL NEWS

Paul Rigby with all the latest black plastic releases.

86 AVID VOLVERE SEQUEL

David Price is beguiled by this new British high end turntable.

90 AUDIOLAB 8000PPA & QUAD QC24P

Noel Keywood compares and contrasts these two brand new phonostages, solid-state and transistor respectively.

Sings Like a Class Leader



Gold signature

We've claimed that Gold Signature reaches unprecedented standards of design, innovation, performance, technical excellence, build quality and value in its class. But you don't have to take our word for it.

Of the GS10, Hi Fi Choice said '...this one most definitely sings...its appeal is obvious...it is a vice-free, expressive and refined speaker with more than enough subtlety and transparency to suit almost any taste, and the resolving ability required to extract the most from high-quality amplifiers and source components.'

And for Hi Fi World the GS60s 'are a class act...an addictive listen...clear, fast and detailed like little else'. It awards top marks 'for the totality of its engineering, superb finish and great price.'

If you're looking for affordable high-end performance and engineering wrapped in beautiful wood veneers and piano lacquer finishes, just listen to the chorus of acclaim.

monitoraudio.co.uk



 **MONITOR AUDIO®**

HA 780221
news@hi-fiworld.co.uk

news



BANDWAGONESQUE

Vinyl is the word on everyone's lips right now, so it's no surprise that a number of great British brands have recently (re)discovered their passion for it, and Cambridge Audio is the latest. The new TT50 is an entry-level design with a swish piano black finished MDF plinth, fitted with a one-piece "proprietary arm" with non-

contact magnetic anti-skate and a fitted Audio Technica AT95E moving magnet cartridge. In addition, the mass-loaded, elastomer-coated acrylic platter gives an acoustic impedance matched to the record for maximum detail retrieval, says the company. The isolated motor floats freely on the plinth for minimal vibration, and gives both 33 and 45rpm. High quality gold-plated phono/RCA connections allow choice of interconnect cable, and there's a ground wire and power supply provided, plus a good quality Perspex lid. Fully factory set up, the TT50 is ready to use from the box. For more information, see www.cambridgeaudio.com.

NEW REFERENCE

KEF's new Reference range is now in dealer showrooms, at the company's Reference Series appointed retailers throughout the UK. The company claims "remarkable contemporary looks with the most impressive technology and performance available today" for the range, and it's available in a selection of furniture-quality finishes, including High-Gloss American Walnut, Piano Black, Satin Sycamore and High-Gloss Cherry. The three high-gloss variants are finished with multiple layers of lacquer, each one polished to a mirror finish by hand before applying the next one. The result is a rich, deep, shine that surpasses that of most luxury cars, says KEF. The new Reference Series line-up includes the classic bookshelf Model 201/2, the floorstanding Models 203/2 and 205/2 and the top-of-the-range Model 207/2. There are also two newly developed centre-channel speakers, Models 202/2c and 204/2c; and an interesting 3-way dipole surround speaker, Model 206/2DS. Two subwoofers, Model 208 and Model 209, complete the range. For more information, click on www.kef.com.



OPENING TYNE

A new branch of Lintone Audio has just opened in Newcastle Upon Tyne. Located at 19 Newgate Street (NE1 5RE), where the old Sevenoaks shop was, it looks set to offer new brands hitherto unavailable to Newcastle customers. For more information, call Tony Gascoigne on 0845 632 5195.



ALL IN ONE

Linn Products are offering their the new Majik System at a special price of just £3,500 for a limited period, "to make genuine hi-fi performance accessible to even more music lovers", the company says. Until the end of this year, the Majik System will be available at Linn specialist retailers. It's a dedicated music system comprising the Majik CD player, the brand new Majik-I integrated amplifier and Katan loudspeakers, and the price includes full set up and installation by a Linn specialist dealer. The company's Director of Engineering, Gilad Tiefenbrun, says "the system demonstrates the outstanding quality and performance of Linn products at an unbeatable price". For more information, see www.linn.co.uk/majikoffer.

(R)EVOLUTIONARY

Cyrus Audio has just announced major updates to its highly regarded CD player range. The new SE suffixes denote its Servo Evolution project, claimed to deliver "a radical advance in measurable and perceived definition", with superior data recovery and lower system-induced noise compared to other systems currently available, the company says. Specifically developed for audio data standards, the new transports offer "up to five times fewer data errors", making the players less dependent upon error correction. A better signal to noise ratio and improved laser control accuracy is also claimed, and the good news for existing Cyrus aficionados is that older players are upgradeable. The technology starts with the £700 CD 6SE and £1,000 CD 8SE, and also appears on the CD Xt SE which is an £850 CD transport with a bespoke power supply design. Servo Evolution is a wholly Cyrus-developed CD servo system, replacing the company's dependence upon ordinary OEM CD and DVD-ROM drives, and uses a new low-contact, slot-loading, disc drive system. The new models also benefit from a shorter signal path that protects the data stream from spurious outside RF interference, says Cyrus. For more information, click on www.cyrusaudio.com.

AIR WAVES

News comes of airSOUND, "a unique new stereo reproduction system that provides an evenly balanced high quality stereo signal from a single speaker cabinet". The technology is based on the work of the British scientist Alan Blumlein in reproducing stereo signals as 'direct' and 'spatial' sound, instead of discrete left and right channel signals. Single point stereo reproduction has been of interest for years because it overcomes the shortcomings of conventional left and right channel stereo, promising an evenly balanced stereo soundfield of uniform frequency and phase response throughout a room, rather than at a fixed limited point between two speaker cabinets. The airSOUND concept has been productionised, and the first loudspeaker using it is Orbitsound, claimed to give "your own personal stereo aura" around your head. It hangs around your neck and plugs into any line level stereo source, and is claimed to give "music literally in the air, all around your head - and in perfect spatial stereo", no less. For more information, call Orbitsound LLP on +44 (0)1923 465 641 or click on www.airsound.net.

**SURROUND, ABOUT**

Marantz's range of multichannel AV receivers have proved justifiably popular with audiophiles of late, so the new £1,299 SR8002 will be of interest to those into surround sound. A high end THX Select II certified, 7.1 home cinema receiver with HDMI outputs, it's said to be packed with useful features, from a premium auto set-up system to true multiroom capability and also now boasts HDMI 1.3a and decoding for a range of new HD audio formats such as Dolby Digital Plus, Dolby True HD, and DTS Master Audio lossless audio. This makes it a powerful audiophile tool - Dolby True HD for example delivers lossless coding with up to eight channels of 24bit/96 kHz audio. Power output is claimed to be conservatively rated at 7x125W. The unit also boasts Audyssey's MultEQ Room Acoustic Calibration auto set-up feature, giving bespoke settings for any listening room in around fifteen minutes, it is claimed. For more information, click on www.marantz.co.uk.

MULTI CHOICE

Spatially challenged multichannel music and movie fans may be interested to know about Yamaha's new range of one-box surround sound systems. The new YSP speakers are claimed to be "the only true 5.1 one box Surround Sound systems on the market", and combine 5.1 channels in a single cabinet with Yamaha's exclusive sound reflecting technology (Intellibeam Automated System Calibration) which automatically calibrates the sound to your room's layout. All models also come with a variety of sound modes claimed to increase the enjoyment of your home cinema experience. The range spans the £499 YSP-500, £599 YSP-900 and £899 YSP-1100, plus the £799 YSP-30D and £1,199 YSP-40D, the latter two models featuring DAB tuner and iPod compatibility. All models are available in silver or black finishes with optional wall mount bracket. For more details, click on www.digitalsoundprojectors.co.uk.

NOW EAR THIS!

Here's one of the most interesting products we've seen for a while. Acclaimed tube specialist Tim de Paravicini, not one who has famously espoused digital audio in the past, has taken his first foray into CD player design. The new EAR Acute starts life as an Arcam CD player, but uses nothing of the original machine except the transport and the well regarded Wolfson, 24/96 upsampling DAC. Everything beyond this (except the display) is of Tim de Para's design, including the filters and the output stage, and one thing that makes the player highly unusual is the fact that the filters are analogue, not digital. Another, less surprising perhaps, facet is the transformer-coupled tube output stage as in EAR pro audio equipment, using two PCC88 tubes. This allows true floating balanced output as well as identical quality unbalanced line out by RCA connectors. EAR say this gives it enough gain to drive a power amplifier directly, via the front-panel volume control. The Acute CD player offers both true balanced and single-ended analog outputs, and both coaxial and optical digital outputs. The front panel comes in 19in rack-style or 17in chrome variants, with gold knob and buttons. For more information, click on www.ear-yoshino.com.



ACTIVE-PASSIVE

Acoustic Energy have "returned to the studio" with the new AE22 loudspeaker, designed for both pro and domestic applications alike. Recently unveiled at London's famous Metropolis Studios, the AE22 is available in active and passive versions and is "perfectly voiced for accurate mixing and reference monitoring". The passive version sports Neutrik speaker connectors for those preferring to specify their own amplification, while the AE22 Active boasts over 200W of power across dedicated LF and HF power amplifiers, and there are LF/MF and HF gain and equalisation controls. The speaker is based on a heavyweight 250x350x330mm sealed cabinet featuring a new 200mm alloy bass driver and a 25mm ring-radiator tweeter with neodymium magnet. The active version features both balanced and unbalanced XLR inputs and separate power amplifiers for each driver. Price is £450 per pair for the passive, £800 for the active. For more information, click on www.acoustic-energy.co.uk.



RECEIVING LOUD AND CLEAR

In today's multichannel-obsessed world, the notion of a humble two channel receiver might seem quaint, but Teac is continuing to support the breed, as the new AG-980 shows. A long way from the tuner/amplifiers ubiquitous in the nineteen seventies, the 980 is a dual zone design allowing users to run four pairs of speakers grouped in one Main-Zone and Sub-Zone, and each zone can be controlled individually; including selecting the input source, switching speakers on and off and adjusting the volume level. A Sub-Zone preamplifier output delivers line-level audio to an additional amplifier in a separate location such as a garden, while a standard 12VDC Trigger In/Out extends the flexibility of the system by allowing on/off from a remote location. Furthermore, the TEAC RS-232C provides controllability of every single command of the unit from a third-party remote control unit, and in the best traditions of the breed there's even a standard MM phono input for vinylistas. Available for £279 in any colour you like as long as it's black, for more information see www.teac.co.uk or call 0845 130 2511.

HEADS UP



Although famous for its phono cartridges in the UK, Japanese transducer specialist Audio-Technica has made headphones of great repute for years. Now available in the UK, the new range comes in both open and closed back variants, all featuring high-performance neodymium magnet transducers and Oxygen Free Copper conductors. The open back range, aimed at the audiophile, starts with the AD300 model with 40mm drivers in a honeycomb aluminium casing featuring soft velvet ear-pads. The larger AD500 model has powerful 53mm drivers yet weighs only 260gms. The AD700 [pictured] also features a honeycomb aluminium casing but with a magnesium frame structure, CCAW voice coils and a higher quality hybrid PCOCC and titanium alloy cable. The AD900 models offer a higher than normal (700mW) power handling and can generate an undistorted crystal clear level of 100dB, claims the company. Top of the range is the AD1000 model, with a unique 2-part headband featuring self-adjusting wings which exert no force on the top of the head. For more information, click on www.atheadphones.com.

SPOTTED: BROTHERS IN ARMS

All types of human relationships are on display to those visiting Berlin for its annual IFA consumer electronics show, and here we see two men of a certain age in a hearty, manly embrace

— in this case long time Denon duo Robert Follis and Roger Bachelor. Don't they look good together, eh readers?



KEF®



new iQ5SE

'The iQ5s are now, once again, star performers at the price: they're small, easy about positioning and partnering, and we reckon Monitor Audio's BR5s should worry. KEF obviously wants its crown back - and we suspect that's what the iQ5SEs are all about.'

'The bass is tighter, leaner and more powerful'

'the iQ5SEs are more exciting and entertaining, no matter what genre you favour'

'Retuned, refined and fun!'

All quotes - What Hi-Fi? Sound and Vision, October 2007.



www.kef.com

GP Acoustics (UK) Ltd., Eccleston Road, Tovil, Maidstone, Kent, ME15 6QP U.K.
T: + 44 (0) 1622 672261 F: + 44 (0) 1622 750653

 S E R I E S



pressure driver at the end of a waveguide. However, there was no great insight into Earle's vocals, something most omnis suffer, trading analysis for effect. These speakers are still better balanced than a lot of conventional designs, which these days are engineered to sound bright in order to appear "clearer" to customers in a quick showroom demo. In the home they will sound piercing, especially with poor quality CDs. The Bella Lunas avoid this, managing well with CD and DVD-A I found but surprisingly, I felt they better suited LP, coming alive with this source.

The Bella Lunas sounded light at low frequencies and this caused some amplifier changing to occur. Surprisingly, a Naim Supernait did not really suit, its strengths being a bit lost, but a Marantz SR6001 receiver and Anatek A50R did and any grippy amplifier should match well also. Over-damped loudspeakers usually benefit from near-to-wall placement, coming alive at higher volume levels - exactly what I found with the Bella Lunas. They need not be much more than one foot or two from an end wall, allowing them to fit a medium sized room with little intrusion.

The benefit of over-damping is tight bass with no discernible overhang. Whilst the Bella Lunas weren't eager to boogie at low levels, at least with much CD material, they perked up as I wound volume upward, at least in my medium sized Victorian lounge with stud walls, suspended floor and ceiling, where their bass was reticent. In a large office with solid concrete and breeze block surfaces, bass was tight, deep and fast - quite impressive in fact. Santana's 'Yaleo' sped along, percussion sounding fast and clean, horns and vocals spread wide. Room size and build always affects bass

quality, but I suspect the Bella Lunas do not output enough low energy to well drive an absorptive room like my lounge. In the larger, non-absorptive room they shone though.

Spinning LP, the upper midband hardness became less obvious and bass was nicely in balance. Vinyl always sounds expansive and the Bella Lunas capitalised upon this property, stretching a beautifully wide soundstage out across the end of my listening room. The Scissor Sisters' first album, for example, sounded more natural on LP than CD through the Bella Lunas, but this isn't necessarily the case through other loudspeakers. Bass sounded composed and free from whoomph or waffle. I could hear some boxiness at times, but this was minor in the scheme of things.

CONCLUSION

If you want to fill your room with music then a quality omnidirectional loudspeaker like Duevel's Bella Luna is a good choice. You get soundstage images that are consistent and believable, wherever you



are in the room. Stereo imaging isn't lost with this loudspeaker, it's just that you can appreciate anywhere. Music even sounds natural outside the room.

The Bella Lunas are a well worked out omnidirectional loudspeaker. All the same, they have some idiosyncrasies: matching is a little more critical than might be expected. Partnered with a smooth,

REFERENCE SYSTEM
 Garrard 401/SME 312 turntable
 Ortofon Kontrapunkt b cartridge
 Eastern Electric MiniMax phono stage
 Eastern Electric MiniMax CD player
 Anatek A50R amplifier

gutsy power amplifier - a Vincent would likely work well - the Bella Lunas offer a sound that's easily enjoyable by anyone. As such they are loudspeakers that lift high fidelity from a somewhat intense personal activity to one that family and friends can enjoy also. Omnis might look like the whacky side of hi-fi, but in truth they're the opposite. Duevel's Bella Lunas are a sensible choice if you want fine sound quality that everyone can enjoy, from an eye catching package.

VERDICT ●●●●
 Well designed omnidirectional loudspeaker offering a room-filling sound that is pleasingly balanced.

DUEVAL BELLA LUNA £3,750
 Distributed by REAL HI-FI
 ☎ +44(0)870 9096777
 www.realhi-fi.com

FOR
 - expansive sound
 - even and accurate
 - easy placement
 - styling

AGAINST
 - well lit midband
 - limited deep bass

MEASURED PERFORMANCE

The Duevel Bella Lunas have an impressively flat response trend for an omnidirectional loudspeaker, free of the large peaks and dips that can sometimes afflict such designs. There is some smaller unevenness across the upper midrange and treble but this is only to be expected as a result of the diffusers onto which the drive units fire in order to dissipate the sound. Treble extension is good and does not show a falling response, again a common feature of off-axis drive units. The response lifts slightly towards the top and bottom of the frequency range and so the Duevels should offer a lively and punchy presentation but without becoming hard or boomy.

Although the loudspeakers are large overall, the bass enclosure only makes up around two thirds of this, so cabinet volume is not as large as with a similar loudspeaker of conventional design. That said, bass output falls from around 90Hz but is reinforced by the port which is tuned to 50Hz, so the Bella Lunas should still have decent weight for their size. The port output is also very clean and should not offer a noticeable contribution to the sound

Electrically the Bella Lunas are not all that well damped around the bass region and show an inductive peak above 1kHz unless the crossover impedance compensation is switched on, in which case it disappears without

affecting frequency response. Average measured impedance was 6.8 Ohms without the impedance compensation and sensitivity in listening position was 85dB. These factors mean that the Bella Lunas are not a particularly difficult load, but will work best with around 40 Watts minimum. AS

FREQUENCY RESPONSE

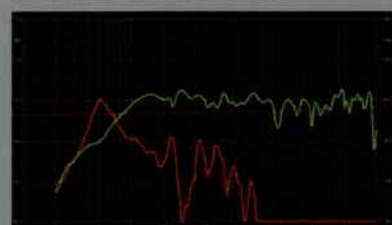

Green - driver output
 Red - port output

IMPEDANCE

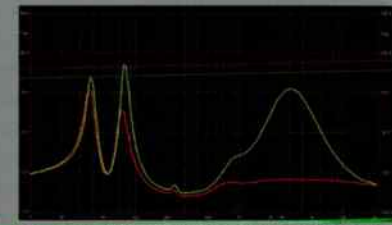

Green - Impedance Compensation off
 Red - Impedance Compensation on

ELECTROCOMPANIET

Professional - High End - Lifestyle

Electrocompaniet has been in the High End audio market for 35 years. The last few years have been characterised by continuous innovations and a rapidly expanding international market. Our products are sold in more than 40 countries, with a range spanning audio, visual, stereo and multichannel technologies.

We have today one of the most complete High End product lines with more than 30 products in all price ranges.

Please visit one of our shops for a demonstration and let us show you why our products are so popular throughout the world.



Electrocompaniet / NSS Ltd.
Unit 38
Waterside Trading Estate
Trumpers Way
Hanwell, London W7 2QA
Tel: +44(0)20 8893 5835
Fax: +44(0)20 8893 5836
www.electrocompaniet.no/uk

www.electrocompaniet.com
Made in Norway

World Radio History

Festive Four

There was a time when believing in a vinyl revival was as much an act of faith as expecting Santa Claus to come down your chimney on December 25th, but with brand new turntables appearing thick and fast right now, the humble vinyl record is making a comeback that no one can deny. In this month's supertest, Adam Smith is filled full of Christmas cheer by four mid-price contenders from Consonance, Revolver, Scheu Analog and Vyger...

It's a funny thing; here we are in 2007 with 2008 looming rapidly on the horizon and it is interesting to look back at some of the predictions for the future that were made, in order to see just how much of it has come true. Admittedly we're not all driving round in our own personal hover-cars and space exploration hasn't advanced quite as fast as Trekkies might have hoped, but some advancements bear uncanny resemblances to the ideas that flowed from the pens of science fiction writers. Surely the mobile phone is a very close relative to the old Star Trek communicator, most tasks you can think of in everyday life have some sort of powered gadget to make them easier and, when considering GPS, security cameras and the internet, we may even conclude that 'Big Brother' is indeed watching us...

The advance of technology has been felt in the arena of entertainment as well. Electronic instruments can recreate an entire symphony orchestra, television and radio is increasingly reaching us by digital means and many people carry their entire music collections around with them on a pocket-sized gadget. One thing that no-one predicted, however, was that the biggest increase in sales of a 'hard' music reproduction format in 2007 would be by an ungainly piece of plastic that only makes music when a tiny lump of rock is dragged through it...

Contrary to everyone's futuristic expectations, vinyl is doing very nicely, thank you very much. Be it DJ fashion cachet, nostalgic value or superb sonics, black plastic's recent resurgence is such that previously dormant pressing plants are having the dust blown off their stampers and being coaxed back into life, while new turntables are cropping up everywhere you look, sometimes from quite unlikely sources.

On the following pages you'll find three brand new decks from Consonance, Revolver and Vyger enjoying their very first reviews, and one slightly older but still recent unit from Scheu Analog that has only just arrived in the UK. We were very keen to see just what sort of sound these decks offered for around £1,500. All are superbly engineered, solidly built and styled with refreshing flair - but which will extract the very best from your precious record collection? Read on to find out...

THE CONTENDERS

Consonance Forbidden City Liu	£1,395	p16
Revolver Replay	£1,500	p18
Scheu Analog Black Diamond	£1,500	p20
Vyger Timor	£1,700	p22

REFERENCE SYSTEM

Ortofon 2M Black cartridge
Trichord Diablo phono stage
Anatek A50R amplifier
Spendor S8e loudspeakers





CONSONANCE FORBIDDEN CITY LIU £1,395

As with many innovative Chinese corporations, the Opera Audio Company, who hail from Beijing, market a surprisingly large range of equipment.

Sources including turntables, tuners and CD players, along with loudspeakers including the quaintly named Eric series and some large and hearty horn-loaded designs all roll steadily from their factory. Amplifier-wise, the company embraces both valves and transistors, their amplifiers ranging from single-ended thermionic designs using 2A3 valves to generate 3.5 watts per channel, up to a mighty 200W from the solid-state Calaf.

This latter amplifier comes from the new Forbidden City range, named after the Chinese Imperial Palace in Beijing. Not only did this inspire the name but also the styling of the products, as the gates themselves are red

and feature rows of studs embedded in them. Hence the reason why all the Forbidden City components are available in red, and why they feature rows of distinguishing squares...

The Liu is the turntable of the Forbidden City range and is a belt drive design based on the range-topping Droplet LP5.0 deck. It features a standalone motor that sits in a circular cutout within the plinth. Drive is transferred to the periphery of the 30cm platter via a circular section belt and two grooves on the pulley allow for 33 and 45rpm operation.

The platter is a machined acrylic item with a depression for record labels and sits on an inverted ceramic bearing, the housing of which is sandwiched between two graphite damping layers and is thus isolated from the plinth. The plinth itself is a two piece anodised aluminium construction and is impressively weighty as a result; the whole deck sits on four tower feet and is heavy and also quite large, measuring 480mm wide by 420mm deep.

The most interesting aspect of the Liu, however, is that Consonance fit it with the base model in their

brand new range of tonearms, the ST100. This is a four-strong range, topping out in the ST600, which is an oil-damped unipivot design, featuring adjustable effective length from ten to twelve inches. The ST100 is a conventional pivoted type but still features a carbon fibre armtube and an unusual skeletal headshell. According to Consonance, the bearings are of a floating design and this is the reason why the arm's vertical bearings exhibit more play than might be expected - apparently it's quite normal.

Tracking force is applied via a pair of uncalibrated rear weights that allow for a good range of cartridge mass matching, and anti-skating by the good old thread and weight method. A nifty multi-purpose alignment tool/tracking force gauge is supplied. The arm is very well finished but has a couple of rough edges, the first of which is the rather underdamped cueing device that dumps the stylus down rather unceremoniously - personally I prefer a nice slow descent. My main gripe, however, was in terms of the connection to the arm, which is via a standard 5 pin DIN-style tonearm



"the Consonance picked up on the leading edges of stringed instruments with impressive precision..."



plug and socket. This was a disappointingly loose fit on our sample, falling out at the slightest provocation. I ended up relying on a lump of Blu-Tac on the shelf below to hold the connector in place - not so impressive!

SOUND QUALITY

The Consonance Forbidden City Liu announce itself as an impressive performer from the moment the stylus hits the groove. Most prominent is the startling sense of clarity that it imparts onto all music material, cutting through the recording with surgical precision to let you exactly what's going on in the very depths. I strongly suspect the arm is to thank for this, as it has a quite different character to the Rega-based designs that are used by so many manufacturers these days. It lacks the rather grey tonality of the Rega and thus imbues the mid and treble with a pleasing sense of dynamism.

High frequencies were strong and clear, with a lovely sheen imparted to the treble. Spinning my twelve inch single of 808 State's 'Pacific 202', the Consonance picked up every single aspect of the backing electronic track and pushed it nicely out into the mix. With many decks, it can be a struggle to separate everything that is going

on in this particular track, but the Forbidden City Liu managed this with ease.

Equally adept were conventional acoustic instruments which were replayed with commendable scale. The Consonance picked up on the leading edges of stringed instruments with impressive precision, ensuring that notes started instantly but faded away gently, as required. Spinning the new Antonio Forcione release from the Naim label, 'Touch Wood' the Forbidden City Liu picked up on the interplay between the acoustic guitars on the track 'Tarantella' and weaved the cello into them with considerable aplomb. The soundstage offered up by the Liu tends to hang back somewhat within the plane of the loudspeakers but everything is laid out with almost mathematical precision, making it easy to follow the action as it moves from instrument to instrument.

Moving to material of a different kind, and 'Til Tuesday's 'Everything's Different Now', Aimee Mann's vocals were sharp and well defined, cutting through the rest of the track to stand clear of the backing instruments. Rhythmically, this sort of track showed the strengths of the Liu very well, as it takes the flow of the music and races along with it in a very pleasing manner. Where I did have a continual nagging doubt, however was in the bass end of the spectrum, as the Liu did not seem quite so confident here.

Further investigation was needed and so onto the platter went a recent release in the form of the seven inch single of Amy McDonald's 'Mr. Rock and Roll' - definitely

a contender for chart single of the year as far as I am concerned, and a superbly boppy pop tune. However, the bass line on the single is a little reticent and a good deck is needed to really coax it out from the back of the recording.

Here, however, the Consonance struggled. The flow of the track was loud and clear and it boogied along very nicely, but the low end underpinning was definitely rather lacking. Upping the ante with 'Suzie - You Are' from Maxi Priest's 'Maxi' album, the truth became clear that the Consonance is not exactly lightweight as it has enough bass weight to satisfy on a reggae track like this, but it seems unsure of itself and is lacking in low end agility. All Maxi's bass notes were there but they seemed to fall out of the loudspeakers rather than being pushed out with authority.

CONCLUSION

A fine turntable, the Consonance Forbidden City Liu offers impressive build quality and performance. The arm in particular is an absolute star and well worthy of consideration in its own right, but it matches well with the turntable to offer a convincing overall package.

If Consonance could just sort out the arm connection issue and tighten up the low end a little, which I suspect is as a result of the motor's relatively poor wow and flutter performance, then they could well have something of a giant killer on their hands.

VERDICT ●●●●£

A fine turntable package with an particularly impressive arm, the Forbidden City Liu is a solid and stylish addition to the turntable market.

CONSONANCE FORBIDDEN CITY LIU £1,395
Distributed by Alium Audio
☎ +44(0)1273 325901
www.aliumaudio.com

FOR

- top end clarity
- precise soundstage
- sonic verve
- excellent arm

AGAINST

- loose bass
- a few fit and finish issues

MEASURED PERFORMANCE

The Consonance Forbidden City Liu seemed to suffer from some low frequency wow artefacts, shown by its IEC weighted Wow and Flutter figure of 0.145%, which is rather high. This was worse with the second belt supplied with the deck, being closer to 0.2%, but this item was visibly riding up and down on the pulley. This should not be audibly obvious but may impact on low frequency timing.

Happily, the fitted ST100 arm was much more impressive, with a main arm tube mode that only just reached 0.1g - a low value. This peak was rather broad, suggesting the carbon fibre tube is nicely damped. Additionally, the ST100's headshell is reasonably well behaved, apart from one large peak which is its main resonance. This is most likely exacerbated by the skeletal form, as there is no top surface to provide innate damping.

All in all, the Forbidden City Liu should sound nice and clean across the frequency range but may suffer from some low frequency uncertainty as a

result of the higher than normal wow and flutter figure. AS

ARM VIBRATION

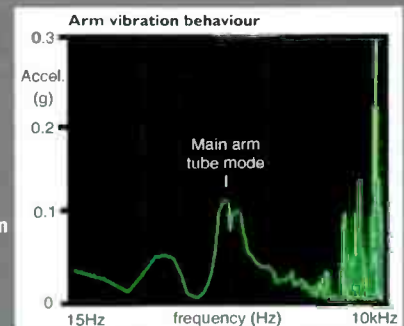

WOW AND FLUTTER

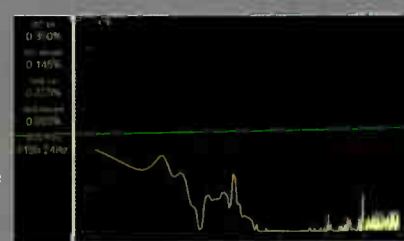



REVOLVER REPLAY £1,500

It was back at the tail end of the nineteen seventies that Colin Higham formed Sundown Electronic Engineering and announced the arrival of their turntable, the Revolver. This was a two speed belt drive design that went head to head with the likes of the Rega Planar 2 throughout the nineteen eighties. Neatly styled and well built, featuring a two part plinth for good isolation and a good quality Japanese-sourced tonearm, the Revolver sold well, thanks to its fine performance and range of quality finishes. Most of these were wood based, but there was also a limited edition blue marble effect one, available with matching stand!

The original Revolver evolved and further versions were introduced, such as the premium Redwood variant and the budget Rebel, both of which

continued to uphold the tradition of fine quality at a reasonable price. Unfortunately, ill health forced Colin to retire in the nineties, leading to the demise of Revolver as a turntable manufacturer. After some years in the wilderness, however, the brand was rescued by Mike Jewitt and Charles Greenlees and has gained a formidable reputation for high quality, reasonably priced loudspeakers, as well as the superb Cygnis flagships.

Talking to Mike last year, I jokingly asked when a new Revolver turntable was going to be making an appearance and was shocked to hear him reply that it was already being looked at! It has been a tense wait but the Replay has finally arrived, along with a brand new phono stage and a new variant of the 'Pig' record clamp (see last month's *Hi-Fi World*) bringing Revolver's vinyl technology upmarket, and firmly back onto the map.

Although visually different to its forebears, the Replay features a similar split plinth design, but this time a marble base is allied to a polyester resin sub-plinth, supported on three chrome-plated towers. The drive belt still drives the periphery of

the platter, also made of polyester resin, and this is supported on a single point bearing of very fine tolerance. A nice feature over the Revolvers of old is that push-button speed selection with indicator LEDs has been added - always very welcome.

Also harking back to the original Revolver is the arm, which is sourced from Jelco in Japan. Now many audiophiles can be rather sniffy when the name Jelco is mentioned, pointing out (quite rightly) that they used to make budget OEM arms for many manufacturers, including Revolver, throughout the nineteen seventies and eighties. The thing is, as a result, they have over thirty years of experience in arm design and many people forget that they also made the Sumiko MMT and FT3, along with the Audioquest PT9. All of these were proper high quality designs so they know what they are doing, and to dismiss them is a folly!



"the Replay's quality low end added that extra level of involvement and pace..."

The SA-250ST fitted to the Replay is a straight design (they also make an S-shaped version, the SA-250) with fixed headshell. Tracking force is applied via a simple calibrated counterweight and bias via a spring-loaded dial.

The arm is comprehensively adjustable, and you can fine-tune

cueing height and even arm rest height with

the right size allen keys, which are supplied with the deck. The only slight concern I had during setup was that the arm seemed to be right at the top of its height adjustment range to obtain correct VTA on our Ortofon 2M Black - a little more adjustment range would not go amiss.

Both arm and deck are superbly finished and the overall unit is surprisingly compact, measuring 440mm wide by 360mm deep. Thanks in no small part to that marble base, however, the Replay weighs 23kg and so a sturdy support is mandatory.

SOUND QUALITY

After the Consonance, the most noticeable aspect of the Revolver is its bass, which is very impressive. It has a low end that not only goes low, but is tight, well-controlled and rhythmical. Clearly the drive system has been well designed and the taut drive belt confers excellent stability to the platter, allowing it to power through highly modulated grooves without missing a beat. This time, Maxi Priest's bass lines were deep and strong, but the Replay added in

a magnificent sense of timing and pace to the low end. This aspect of a reggae track is vital to its successful reproduction and the Revolver walked away with full points here. Equally, Amy McDonald's bass line started to peek round the edge of the rest of the track and show itself, which was a very pleasing.

Moving on to dance, both the 808 State track and Gouryella's 'Gouryella' were kicked out with gusto by the Revolver. Maintaining a healthy pace as the going got tough, the Replay never faltered once and remained composed at all times. The 808 State track did show that the Replay was not quite cutting into the depths of the mix like the Consonance. However, although lacking the Forbidden City Liu's icy clarity, the Replay offers a better sense of composure across the midband and treble.

Switching again to Antonio Forcione, the Replay really came into its own. Strings were superbly vivid with the delightfully precise leading edges that I had heard previously. However, the composure and hint of warmth across the midband added a lovely fluidity to the guitars, cello and acoustic bass giving them an inspiring palpability and basically making them sound incredibly real. Once again, each instrument remained superbly delineated, but the Revolver was able to meld them all together into an impressively musical whole.

The impression of this continued with classical material, the Deutsche Grammophon recording of Ravel's 'Bolero' by the Boston Symphony Orchestra being reproduced with a majestic sense of atmosphere. Brass instruments had a pleasing rasp to them but never became harsh and, as the crescendo built up, the Revolver turned the excitement and anticipation up nicely as well. The soundstage was superbly enveloping and deep behind the loudspeakers although, as per the Consonance, the sound still did not quite project out into the room in the

way that the very best decks can.

Moving back to rockier material, 'Til Tuesday were again larger than life but the Replay's quality low end added that extra level of involvement and pace to the material. When the track 'Everything's Different Now' starts, it goes from a strummed guitar straight into the main action and the Revolver picked up on the change of pace and flew along with it. Backing cymbals were slightly softer than with the Consonance, but still had plenty of feeling and a good metallic nature to them.

CONCLUSION

The Revolver Replay is a very well engineered turntable unit that offers an excellent presentation from top to toe. The taut timing of the turntable combines well with the flowing nature imparted on the sound by the arm, and the whole deck gels incredibly well across the frequency spectrum. Although lacking the very last ounce of top end crispness, the Revolver never sounds dull and instead offers a beautifully weighted upper midrange and treble that flow together in almost sinuous fashion and is particularly adept when it comes to acoustic instruments.

Revolver may have been away from the vinyl game for over fifteen years, but the Replay shows that they certainly have not lost their touch - welcome back!

VERDICT

A welcome return to the vinyl market, the Revolver Replay is a stylish and well built deck, with excellent bass and a lovely flowing nature.

REVOLVER REPLAY £1,500

The Acoustic Partnership

☎ +44(0)1752 847779

www.revolveraudio.co.uk

FOR

- bass speed and grip
- smooth and detailed mid
- even-handed musicality
- build quality

AGAINST

- lack of top end crispness

MEASURED PERFORMANCE

The Revolver Replay sports a very tightly engineered drive system, as startup time is swift (no doubt assisted by the taut-fitting belt) and speed remained very stable throughout the measurement session. This resulted in a very low IEC weighted wow and flutter figure of 0.06%, which suggests that the Replay should be more than able to keep a tight grip on the sound with little likelihood of pitch instability or transient wow.

Equally good in measurement terms was the Replay's arm. The main arm tube mode is at a low level and appears to be well damped, suggesting that the Replay should be clean and detailed through the midband. The headshell is also less excitable than many we have measured, which should make for a smooth and even top end when partnered with a suitable cartridge.

All in all, the Replay turns in a very good measured performance, both in terms of the motor unit and arm. As a result, it should offer a consistently

even and good performance across the frequency spectrum. AS

ARM VIBRATION

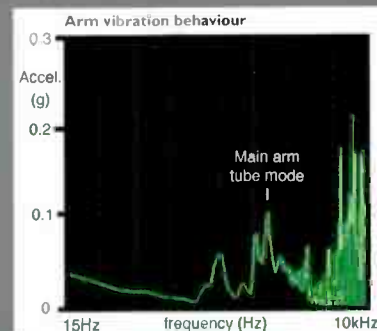

WOW AND FLUTTER

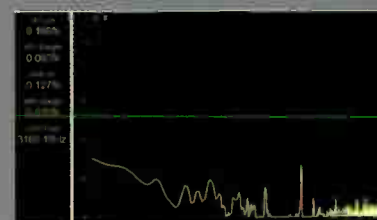



SCHEU ANALOG BLACK DIAMOND £1,500

One of the first two names on test that may well be new to many readers, Germany's Scheu Analog have a solid history behind them and manufacture a range of turntables as well as their own arms which have finally arrived on UK shores through three dealers, namely Sounds4Enjoyment, Tom Tom Audio and Musicology.

Founded by a trained toolmaker and musician by the name of Thomas Scheu the first turntable was built in 1985. The company expanded and Thomas increased the range of designs available,

eventually concentrating more on a fixed range of designs rather than the more kit-oriented, made to order items he

had started out with. This culminated in him winning The Absolute Sound's "Golden Ear Award" in 2001 for the Premier II turntable.

Sadly, in December 2004 Thomas passed away, but his wife Ulla took the decision to carry on running the company, continuing her husband's ideas but also expanding the business to bring his designs to a wider audience. One of the most notable aspects of this was the development of a turntable with female customers in mind...

That deck was the Diamond and it is available in a stunning range of colours and finishes, including transparent, blue and the obvious one - pink! Scheu even offer to make one to your favourite colour, to order (see www.ladylikescheu.com for further details and pictures). For those less adventurous souls among us, the Diamond is also available in black and this was the finish chosen

by singer Katie Melua, who became the proud owner of the first deck to roll off the production line. Every part of the deck is made in-house and Scheu also make parts for one or two other well-known turntables.

Fitted with a large acrylic platter of 50mm thickness, drive is provided by a freestanding motor with electronic speed switching and adjustment on both speeds through individual pots. One interesting aspect of the deck is that you won't find a belt lurking in the box, but instead a reel of fine nylon wire for you to make your own drive cord. Good eyesight is essential for tying the knot in the cord, however, and small fingers go a long way towards helping as well!

The thinking behind the use of this material is that the non-stretch nylon removes the resonances that a belt can introduce and also minimises any thickness variations that can be

"the Black Diamond has some of the tightest bass I have heard from any deck without an idler wheel..."

found in a rubber belt which can, in turn, cause wow. However, handily, it also allows you to place the motor fifteen feet away from the deck if the mood takes you...



The arm supplied with the Black Diamond is the good old Rega RB250 to which Scheu Analog have fitted their upgraded counterweight and fitting stub, and the package is completed by a supplied Benz Micro MC Silver high output MC cartridge. Future upgrades to the easily-adjustable armboard could possibly include one of Scheu's own arms, such as the rather striking Perspex Cantus.

The main Perspex body of the Black Diamond is quite large, taking up a triangular area with each side 500mm long, and the motor sits outside this. Each foot is adjustable in order to level the deck, and is located at the end of each plinth leg. As a result a good sized support area is required.

SOUND QUALITY

If the increase in bass solidity and depth had been a pleasant surprise when changing from the Consonance to the Revolver, then finding a similarly impressive improvement when changing to the Black Diamond was an equally grin-inducing event. Even though the startup time of the Scheu Analog is slow, apparently as a result of the nylon cord's lack of friction against the motor pulley, it appears that once up to speed, the combination of heavy platter and a driving method free of the theoretically possible undulations of a rubber belt do indeed work, as the Black Diamond has some of the tightest bass I have heard from any deck without an idler wheel or hefty direct drive motor.

As a result, the Scheu Analog was the only deck to really tease the recalcitrant bass line from the depths of the Amy McDonald track, setting up an almost healthy low end underpinning to it. Bass notes from all material started and stopped with metronomic precision, the Black Diamond really relishing Maxi Priest's driving bass lines. If dance music is your thing, then the Black Diamond may well be right up your street, as it pounded out 808 State with incredible enthusiasm. Something else I noted was that the track 'Pacific 202' has a subtle shift in tonality as it starts proper, as if someone tweaked a knob on the mixing desk to bring the treble up. With the other decks, you gradually realise that some of the backing effects have become clearer, but the Black Diamond pinpointed the instant that this happened.

The sense of drive and rhythm continued up into the midband, where the Scheu Analog proved adept at teasing the last ounce of character from instruments, Antonio Forcione and his cohorts being brilliantly reproduced. The deck picked out the minutiae of each string as it was plucked and enabled each instrument to clearly stand out from the others. I was able to place each performer in the soundstage easily, and I suspect that if a professional musician was listening to the album on this deck, they may well have been able to tell me the manufacturers of the instruments being played...

As mentioned, the soundstage of the Black Diamond is most impressive. Not only does it spread everything out expertly within the plane of the loudspeakers, but was quite uncanny in the way it was able to project the performance right out into the room, bringing performers to life. Although not quite up to the standards of the SME 10A, which generates the sort of imagery that you feel you could get up and walk around in, the

Scheu Analog nevertheless has a gratifyingly atmospheric nature. In fact, I was so enjoying this nature that it came as something of a shock when everything went wrong and started collapsing and slurring. Fortunately the problem soon became apparent; namely that my join in the drive cord had come apart. Tip for future users - make sure your knots are tight!

With everything re-joined, the Black Diamond continued to impress with its beautifully clear and crisp top end, the treble aiding in achieving the sharp leading edges of notes and the dynamic nature noted previously. Some more strident material did reveal a slight hardness to the upper registers which added a little more forcefulness to some material than I would have liked, but this was not intrusive and mostly served to increase clarity and detail.

CONCLUSION

The Scheu Analog Black Diamond is a mightily impressive turntable. It is superbly built and this is reflected in its sound, which is dynamic, crisp and detailed, but with a capacious soundstage that brings music to life.

The supplied Rega RB250 arm seems to match very well with the character of the deck aided, I suspect, by the well documented improvements that a better end stub and counterweight can bring. Add in the supplied good quality MC cartridge and you have an excellent value package that gels incredibly well to turn in an extremely convincing performance.

Grateful thanks to Dave Barker at Sounds4Enjoyment (+44(0)2392 717628; www.sounds4enjoyment.com) for supplying our review sample.

VERDICT ●●●●●

Highly impressive turntable that punches well above its weight, wrapped up in a sleek package.

SCHEU ANALOG BLACK DIAMOND £1,500

Scheu Analog
☎ +49 212 380 858 30
www.scheu-analog.de

FOR

- seriously impressive bass
- excellent soundstage depth
- dynamic and pacy nature
- build quality

AGAINST

- fiddly DIY drive cord

MEASURED PERFORMANCE

The Scheu Analog Black Diamond is unusual in its use of a thread drive system and I was concerned that the knot in the thread might have an adverse effect on the wow and flutter measurement. Fortunately, thanks to the massive platter this is not the case and the Black Diamond posted an IEC weighted figure of 0.055%. This is a very good result in any terms and is actually the best result seen in this test, so Scheu Analog have engineered the deck very well indeed. Speed stability was excellent during testing and the Black Diamond ran smoothly and quietly.

The Scheu Analog's arm shows the usual result for the Rega RB250 item on which it is based, namely a high main arm tube mode, one that appears undamped as it is narrow. The headshell is also quite active in vibration terms and this has the potential to add midrange harshness with certain cartridges.

Overall the Black Diamond turntable and arm measure well and should be

more than capable of turning in a good performance. AS

ARM VIBRATION

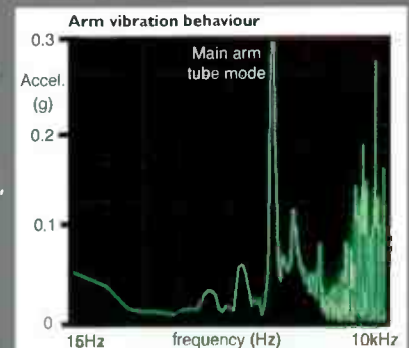

WOW AND FLUTTER

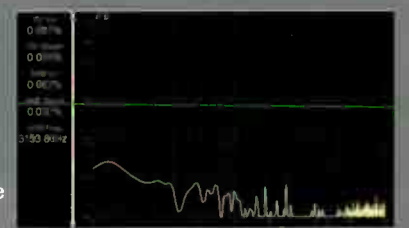



VYGER TIMOR £1,700

Another relative unknown here in the UK, the Italian company Vygger do indeed apparently take their name from the word 'Voyager' with the 'o' and 'a' removed; just like the central character/thing from *Star Trek: The Motion Picture*... Somehow this seems fitting, given the amount of sheer engineering that goes into the company's products and some of the unusual (some might even say space-age) technologies they use.

Founder Pino Viola is a hands-on engineer with a good knowledge of physics and the way it relates to turntable design. He has a passion for LP reproduction and one or two firm ideas about the ways in which this can be best achieved. These can be seen in his flagship deck, the Indian Signature Reference, as it resembles a small oil rig and features an air bearing that means the 18kg platter is supported on nothing more than a cushion of air when running.

Furthermore, the record is sucked onto the platter by a vacuum before playing, but this is disengaged once the seal has been established (it apparently lasts for up to two hours), ensuring no pump noise during playing. Fitted with Vygger's own air-bearing linear tracking arm, this deck is a serious statement about vinyl

replay, explaining its price of around £20,000.

However, at the other end of the model scale, the base model Timor is far from being a poor relation. Constructed around a triangular base which has similar dimensions to that of the Scheu Analog Black Diamond, the deck is made from solid blocks of aluminium and is available in silver, anthracite and blue metallic finishes, as well as the rather eye-catching red of our review sample. A thinner block of the same material provides support for the arm. The whole unit sits on three feet that are in two parts; the bottom is adjustable for height and this is isolated from the top part, which is in turn isolated from the plinth, by a rubber O-ring. It is worth noting that the next model up in the range, the Baltic, looks



"the soundstage set up by the Timor was truly capacious..."

similar to the Timor but features magnetic isolating feet that effectively leave the deck floating freely.

A standalone motor pod in the same colour as the deck offers two speeds via a long drive belt to the periphery of the platter, which is 30mm thick, and tips the scales at 5.5kg. Speed switching is electronic and there is a pot fitted for fine pitch adjustment. The platter is aluminium but has an acrylic insert for record support and so no mat is needed. This is topped off by a simple record clamp weighing 465g, coloured the same as the plinth and styled to match its shape. If you didn't know that Vyger were an Italian company, I don't think it would be hard to guess from looking at the styling of the Timor - personally, I think it's gorgeous!

Supplied with the deck is another stalwart Rega arm offering, but this time the RB300. This goes to make up a good vinyl playing package to which you only need add the cartridge of your choice and you're ready to spin those discs.

SOUND QUALITY

Setting the Timor up as per Vyger's instructions required positioning the motor such that the distance between its pulley centre and that of the spindle's centre was 300mm. This left the belt incredibly stretched and on the verge of toppling the motor pod over. Moving the motor inwards to give a distance of 270mm helped things along but after running for an hour or so I was aware that the motor was making audible noise. Reducing the distance further to 240mm helped again, but the motor still remained noisy whenever the belt was looped onto it, becoming quiet only when run with no load, which is not an ideal situation.

Still, with everything running as best as it could, the Timor proved to be far from disappointing. It has a sweet and flowing top end

with an agreeable cleanliness to its presentation. The Vyger pulled high frequencies out of the depths of the music very well, but there was a sense of not knowing what to do with them at times, meaning that cymbal strikes could be rather undefined within the soundstage. Equally, with processed material such as 808 State, the Timor seemed reluctant to fully reveal the fast crispness of the backing drum machines that provided the cymbal type effects. Although never losing them within the mix, the Vyger did not reveal the change in tone within the mixing that the Scheu Analog picked up on so readily.

Things across the midband were much better, however, the Timor having a beautifully liquid nature that made light work of complex instrumentation and orchestral works. As with the Revolver, the Timor captured the nature of each part of the Boston Symphony Orchestra playing Ravel's 'Bolero' and following the action with the tenacity of a bloodhound. The soundstage set up by the Timor was very capacious and well ordered, falling somewhere in between the Revolver and the Scheu Analog. Further listening revealed that it is definitely better projected out into the room than the Revolver, but it lacks the sheer precision of the Replay's atmospherics.

Once again though, Antonio Forcione's assembled musicians sounded excellent with a supple precision to their playing and a precise delineation of each instrument from the next. However, the Vyger did stumble slightly in terms of sheer engagement with this piece. As mentioned, everything was there, but the Vyger seemed to be giving something of an Italian-esque shrug when asked to really capture the album's emotion.

The Vyger proved itself to be something of a mixed bag once again at the low end of the spectrum. Bass was deep and weighty with good control and detail and each note seemed to be pounded out with great

gusto. Whilst this behaviour worked like a dream on the 808 State and Gouryella twelve inch singles, adding an impressive dance floor feel to proceedings, it was somewhat less welcome when more of a sense of tunefulness was required. Sometimes I wished that the Timor would curb its enthusiasm a little and calm down a bit! The phenomenon was particularly noticeable on Maxi Priest's album, with the low end effectively becoming something of a series of, admittedly deep and punchy, notes rather than a flowing continuous bass line as it should be.

On the other side of the coin again, though, Til Tuesday's 'Rip in Heaven' has a steady and solid bass line and this time, the low end nature of the Timor worked well, capturing the essential rhythm of the track and running with it very well indeed.

CONCLUSION

The Vyger Timor proved an interesting audition, and, in many ways, is as characterful as an Italian car. It does have a couple of areas that could be improved upon, particularly in terms of bass flow and physical motor noise.

That said though, it is still a very enjoyable listen, with a detailed midband and a soft, encompassing treble, underpinned by a healthy bass depth. It also has very impressive imaging abilities, generating the sort of soundstage that a CD player could only dream about. Finally, and I know it's the sound that matters, but it really looks rather special...

VERDICT

A supermodel of a turntable, boasting impressive design and build allied to stunning looks, with sonics to match.

VYGER TIMOR £1,700

Angelsound Audio

+44(0)1923 352479

www.angelsoundaudio.co.uk

FOR

- looks
- midrange subtlety
- good soundstaging
- decent bass weight

AGAINST

- rather unengaging at times
- lack of bass flow
- motor noise

MEASURED PERFORMANCE

The Vyger Timor turned in another fine set of test results under measurement, with its IEC-weighted wow and flutter figure of 0.081% being a perfectly respectable value, although still not quite as good as the Revolver and Scheu Analog docks. Nonetheless the Timor ran smoothly and its speed remained stable over a period of some hours. This should endow its sound with a good stable foundation on which to build and ensure that rhythms are taut.

The Timor comes pre-fitted with a Rega RB300 arm and it was interesting to compare this to the RB250 type fitted to the Scheu Analog deck. The main arm mode is very similar in frequency, size and width but the RB300 has an extra peak in the midband, most likely as a result of its differing bearing and tracking force arrangement. Interestingly the trace is somewhat cleaner at higher frequencies, suggesting the RB300 is better damped and should sound rather cleaner across the mid and treble as a result.

Ultimately, the Timor measures well and should turn in a good performance in combination with the RB300. AS

ARM VIBRATION

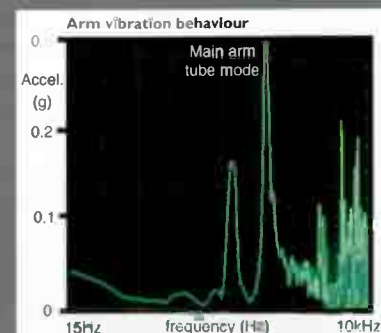

WOW AND FLUTTER

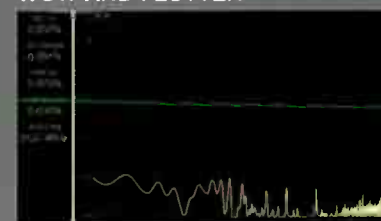



C315BEE

Stereo Integrated Amplifier

Budget. Reference. Power.

NAD has an enviable reputation for creating some of the best performing budget amplifiers of all time. The lineage is impressive, all the way from the 3020 of 1978 to the current C325BEE, with many "Best Amplifier" Awards and Five-Star ratings along the way. As loudspeaker quality and performance has continued to improve, especially at modest price points, NAD felt there was room for a lower cost amp that could take advantage of these speakers; creating a new entry point for serious musical performance. Enter the C315BEE. The latest incarnation of the world's most famous amplifier incorporates sonic refinements that keep NAD far ahead of the game.

And at a price that belies its extraordinary performance it could only be NAD.



Powered by passion
www.nadelectronics.com

Distributed in the UK by Armour Home Electronics

Thorburn Hall Industrial Park, Dunthorpe Road, Edinburgh, Midlothian, EH20 1JG, United Kingdom | www.armourhome.co.uk | info@armourhome.co.uk
AHC25



Well, as I suspected, the four contenders under consideration here do indeed fly the flag for vinyl very proudly indeed but even I was not expecting them all to be quite so good. Let's be clear straightaway, none of these decks is what can be described as a duffer; they all excel at vinyl replay and really show what can be achieved if you are either starting off with a budget around the £1,500 mark, or upgrading from a starter turntable. In particular, choosing the top two spots was a real headache - more so than for any other group test I have carried out so far, in fact! Still, enough of my woes, on with the verdict...

Bringing up the rear in verdict terms, but about three laps in front of all the others in style terms, is the Vyger Timor. I think most people would agree that it is a visually arresting deck, and when you consider its fine sonic performance, it is very definitely worthy of serious consideration. It has a lovely flowing nature with excellent bass weight and a nicely expansive soundstage that suits all sorts of music. My only real complaints are the occasional lack of tunefulness to the low end and the slight vagueness to the treble within that soundstage. I would also like to hear less audible noise from the motor when it is running...

The next unit to consider is the Consonance Forbidden City Liu. This was an interesting deck, in that it could easily have romped away with top spot, if not for a few foibles. The

fitted ST100 arm is a delight, and a very welcome addition to the market. Making use of an exotic material in the form of carbon fibre in the armtube, along with an immaculate finish, it should be high on your list if you have £600 to spend on an arm. The rather abrupt cueing device and the loose socketry are my only minor complaints about it but, apart from that, it's a gem.

Regarding the rest of the Liu, it is again very thoughtfully designed and well built, but I feel that the motor's poor wow and flutter performance is holding it back from real greatness. This phenomenon can be heard as a lack of agility and pace in the low end. Again, it is certainly by no means bad, but just rather outshone in this company.

So to the top two, and the source of my headache. Firstly we have the Revolver Replay, which is another beautifully designed unit with a sturdy and stable drive system that shows itself through the solid and deep bass it produces. The arm is another positive, imbuing the sound with a composure and sophistication that few others can match at the price. Add a deep and stable soundstage and I was sure I had a winner... then I cued up the Scheu Analog and realised it wasn't going to be that simple.

The Black Diamond is another stunning turntable, that uses an unusual (and occasionally frustrating!) drive method to superb effect. Bass was the deepest of the whole group, but it remained lithe, detailed and taut at all times. The Revolver had

the edge in terms of poised self-assurance across the midband, but the Black Diamond made up for this with an extra *souppçon* of dynamic pizzazz. It also traded the Replay's soundstage stability for the ability to really project out into the room at the listener. Frankly I was almost stumped.

In the end, after days of record swapping and putting a good few hours onto the Ortofon 2M Black, I came to the conclusion that the Revolver is sensational but, for me, the balance was just tipped in favour of the Scheu Analog Black Diamond. Its innate verve and that superbly projected soundstage are quite addictive and, when you consider that it comes complete with a high quality Benz Micro MC cartridge, it ticks all the boxes including value for money. £1,500 really isn't a great amount for a vinyl spinning package of this calibre

THE CHRISTMAS CRACKER...

Finding a winning turntable (the Scheu Analog) and a very impressive new arm that uses a Rega mounting (the Consonance ST100) proved too much temptation for a tiddler like me, so out came the toolbox... With the Consonance arm duly installed onto the Black Diamond, and the 2M Black back in place I lowered the stylus into the groove and wondered what the result would be.

In a word, sensational! The Black Diamond with its own Rega-sourced arm is a formidable performer, but the ST100 lifted it that little bit higher. The already capacious soundstage opened up further and images within it gained that extra ounce of precision and stability - particularly vocalists who gained extra body. The bottom end was still mightily impressive, but the ST100 offered up an extra dose of litheness to the upper bass, making bass lines zip along with that extra little bit of gusto. All in all, this proved to me that, not only does the Black Diamond have even more potential waiting to be tapped, but the Consonance ST100 really is a very fine arm.



“This is one of the most impressive hi-fi products I’ve heard this year”

KETAN BHARADIA, TECHNICAL EDITOR WHAT HI-FI? SOUND AND VISION, AWARDS 2007

THE ANTILA CD PLAYER WITH ITS UNIQUE MD ACTIVE DIFFERENTIAL MULTI-DAC CONVERTER TECHNOLOGY PROVIDES BREATHTAKING REALISM AND A TACTILE PANORAMIC IMAGE.

LIPS ENSURES THE ULTIMATE SIMPLICITY IN USE AND FLEXIBILITY FOR THE FUTURE.

ONLY THROUGH HEARING WILL YOU TRULY BELIEVE. TO LOCATE YOUR NEAREST DEALER CALL LEEMA ACOUSTICS ON 01938 811900 OR LOG ON TO WWW.LEEMA-ACOUSTICS.COM



To locate your nearest dealer
 Visit: www.leema-acoustics.com
 Phone: +44 (0)1938 811900
 Email: info@leema-acoustics.com

BEAUTIFULLY ENGINEERED SOUND

AWARDS 2007

Welcome to Hi-Fi World's ten-page Awards special, where you'll find our favourites from the products we've reviewed over the past twelve months. Competition has been exceptionally tough, making for heated debate in Hi-Fi World Towers, but we're delighted to bring you what, in our opinion, are the year's best offerings in specialist hi-fi...



AWARDS 2007: THE WINNERS

TURNTABLE:	LINN SONDEK LP12SE
TONEARM:	AUDIO ORIGAMI PU7
CARTRIDGE:	ORTOFON 2M BLACK
LOUDSPEAKERS:	REVOLVER CYGNIS
PHONO STAGE:	ANATEK MC1
SYSTEM:	MERIDIAN F80
CD PLAYER:	LEEMA ANTILA
INTEGRATED:	NAIM SUPERNAIT
PREAMPLIFIER:	MELODY PURE BLACK 101D
POWER AMPLIFIER:	CHANNEL ISLANDS D100



TURNTABLE

WINNER: LINN SONDEK LP12SE £3,510

Ask many audiophiles what "the ultimate turntable" is, and the chances are that they'll reply with the words "Linn Sondek". With hundreds of thousands of units sold, this deck has permeated every layer of British life – making its way into the listening rooms of everyone from literary greats like Douglas Adams to small screen heroes like Inspector Morse. And unlike almost every other rival, it has acquired true cult status whilst still being in production - having survived thirty five years at the top.

The main reason for the deck's success is the nature of the people that make it. A proud British engineering-led manufacturing company, Linn Products has constantly updated the LP12 from day one, offering a rolling programme of modifications – from small grommet and screw updates to major bearing or power supply

changes. This has kept the deck in the news, its customers in Linn dealers and, most importantly, the sound up with the best...

Over the past few years however, the turntable market has undergone something of a renaissance and there have been a slew of new high end designs coming on stream. Although none has truly, comprehensively bettered the LP12, some have shown that the Sondek was falling off the pace in some respects. With this in mind, when news came last year that Linn was to launch one of the biggest upgrades in the deck's history, a great many Sondek owners got justifiably excited...

It was a long wait, but finally this summer, *Hi-Fi World* magazine got one of the very first production samples of the new Linn LP12SE to try, featuring the brand new £1,950 Keel subchassis. Having A-B'd it against a

standard, non-SE deck, we couldn't do anything but be impressed. The new LP12SE, with its stiffer, stronger and lighter subchassis, is a revelation – and this year's worthy winner of our turntable award.

Sonically, the new subchassis brings a tighter, tauter, stronger and more dynamic sound – with soundstaging being a particular beneficiary. Whereas the non-Keel LP12 is a little diffuse compared to the best of the rest, the new LP12SE is both dramatically more dimensional and more precise in terms of imaging and depth perspective. It removes the biggest criticism of the previous deck at a stroke, yet doesn't tamper with its greatest strength – the Sondek's instantly recognisable rhythmic sound. Still the most 'foot tapping turntable' around, it's one of the nicest ways to play vinyl records.



**RUNNER UP:
SME MODEL 10/SERIES V £4,556**

Take SME's entry level Model 10 turntable and pair it up with the classic Series V tonearm and you have one of the most impressive turntable packages around. The exquisitely finished, small-footprint Model 10 is a masterpiece of cool, understated design and the tonearm is brilliantly adjustable and a joy to handle. With a tremendously accurate, clean and dimensional sound, this little package punches way beyond its price and is well made enough to give faultless performance for life.



TONARM

WINNER: AUDIO ORIGAMI PU7 £1,300 (see text)

Proof positive that what goes around comes around is this year's recipient of the tonearm gong. The story of the Audio Origami PU7 is an unusual one to say the least, beginning with the now-legendary Syrnix Precision Instruments back in the early nineteen eighties. Syrnix, lest we forget, made some very desirable and superb sounding tonearms – most famous of which was the PU2, which gave the (then new) Linn Ittok a good run for its money. Having a friend who worked at the Glasgow company inspired John Nilsen to start up his own machine shop, and he duly started Audio Origami doing very high quality work on special projects for audiophiles. The PU7 was his own evolution of the PU3, which was Syrnix's finest hour, although "it would be wrong to describe it as a copy of a PU3, as I believe it has a bit of every arm that I admire in its design", he says.

It's very much a low volume product with one hundred and forty hours of build time in each one – and comes 'bespoke tailored' for each individual customer, in a range of anodised colours. It is available in any effective length from nine to twelve inches, and the arm tube effective mass can also be pre-specified to suit your cartridge, coming in alloy or brass versions as a result. There's even a choice of Linn or Rega arm mountings. Prices vary according to specification, but a standard mass and length nine inch design comes in at £1,300. Fit and finish of the arm are both impeccable, and the PU7 comes complete with a DVD of how to set it up and a comprehensive range of accessories.

In action the AO PU7 is magnificent, sounding as tight as a drum with dizzying speed and insight, and a sense of timing that makes similarly priced rivals seem

musically aloof. Despite its brilliantly taut and engaging nature however, it doesn't suffer the associated pitfalls of similarly 'animated' sounding arms. Instead, it is never less than silky smooth, maintaining the sense of clarity and composure that can sometimes slip up with a less than couth pickup system. Soundstaging is another forte, the PU7 being able to throw images far stage left or right, or hang them back with ease. Such is its ability to render a soundstage well beyond and behind the loudspeakers that it offers admirable scale.

As you might expect considering its provenance, the Audio Origami PU7 is a very special product, offering a unique blend of qualities – from superlative sonics to bespoke build. There have been a number of excellent pickup arms released this year, but such is the tremendous ability of this one that it's a worthy and clear winner.



RUNNER UP:
GRAHAM PHANTOM B44 £2,495

There's no shortage of 'super arms' these days, but special notice should surely be paid to this new US-made design, which offers every last penny's worth of performance. The engineering is superlative, the installation easy, calibration a joy and the removable arm wands make this the natural choice for enthusiasts with more than one cartridge. Sonically excellent, it's self evidently the best Graham pickup arm to date and looks set to give all its top high end rivals a serious headache.

Maria Callas, Metallica, Miles Davis, Muse, Muddy Waters, Madonna, Massive Attack.

Whatever your tastes in music, the Linn Majik System enables you to experience the full emotion of the artist's original performance in your home.

We would normally let the sound speak for itself. However, in this instance it's also worth mentioning that you could own the new Linn Majik System for only **£3500**.

Visit www.linn.co.uk/majikoffer to find out more and arrange a demonstration at your nearest Linn specialist.



The Linn Majik System comprises the Majik CD Player, the new Majik-1 Integrated Amplifier, Katan Loudspeakers with stands, installation and a 5 year* warranty. (* when you register your products with Linn)
This exclusive offer must end 31st December 2007.

The usual price of the Linn Majik System is £4,290



LINN

World Radio History

www.linn.co.uk



CARTRIDGE

WINNER: ORTOFON 2M BLACK £350

It's no secret that we at *Hi-Fi World* are big fans of Ortofon, but even we have had trouble recommending their moving magnet cartridges over the past decade. Whilst the company has been romping away with some great moving coils such as the superb Kontrapunkt b, further down in the range it was still doing derivatives of its late nineteen seventies OM series – all of which possessed a pleasantly smooth but unfailingly bland sound...

To the company's credit, Ortofon had the good grace to admit this, and a couple of years ago intimated to us that they were working on a totally new 'clean sheet' design to put them back on the moving magnet map. The 2M Black you see here is the ultimate expression of that new platform, and is a worthy winner of this year's cartridge award. Tipped with a Shibata nude diamond stylus, as used on their £1,100 Jubilee

MC, it's a blisteringly good moving magnet – offering analogue addicts the chance to use the (often higher quality) moving magnet input of their phono stages, without recourse to a step up transformer.

Although you'll need a decent tonearm to get the best out of this cartridge, it's a fairly easy match. At 7gms, it's light but should go into most arms, and the high cantilever compliance dictates that lowish tracking forces are needed – around 1.7gms. Both the Black (and its cheaper £200 stable mate, the Bronze) have a steadily rising high frequency response, which marks the cartridge(s) out as very modern and incisive designs, made to give clear, sparkling, DVD-Audio-style treble. As such, the presentation is quite unusual to those used to traditional 'warm and woolly' moving magnets, and there's little in the way

of romance – so those possessing heavily 'distressed' vinyl collections should get their discs cleaned or look elsewhere. The 2M Black is incisive and brightly lit, designed to make the most out of the new generation of superb sounding vinyl reissues.

This said – providing this cartridge is well set up in a high quality turntable and asked to play decent vinyl – the Ortofon 2M is one of the most cohesive sounding moving magnets we've yet heard. It is natural and unforced in a way that makes listening a pleasure, bristling with fine detail and totally engaging on a musical level. A masterful design for anyone keen to get the best from LP, without moving up to the complexities, cost and delicacy of moving coils, it's a blistering first 'high end' cartridge and, as such, a worthy recipient of this year's *Hi-Fi World* Award.



RUNNER UP:

LYRA DORIAN £495

Lyra is a cartridge manufacturer of serious repute, and the Dorian shows why. It's essentially a high end moving coil which has been ingeniously cost cut, thanks to clever use of materials and a slightly less expensive (in Lyra terms) out-of-house build. Because the pennies have been saved in all the right places, in all but the most expensive systems the Dorian isn't far behind the company's top designs – which is praise indeed. At the price, we've heard no other cartridge with such speed, incision and clarity – and it's unerringly musical too. A rising treble response means it's not ideal for every system, but with the right ancillaries it's unbeatable. True budget esoterica, and one of the best mid-price MCs of recent years.



LOUDSPEAKER

WINNER: REVOLVER CYGNIS £5,000

It is always risky for any company hitherto known for good quality, affordable loudspeakers to pull out all the stops and attack the upper echelons of the market. Not because of the difficulty of design; in fact, the opposite tends to be true as, freed from budget constraints, the designers can really go to town on both the drive units and cabinet, and incorporate features that just would not be feasible on less costly products.

No, the problem comes from brand image. The idea of 'trickle-down technology' when a manufacturer offers a more affordable version of an expensive product, can be quite a draw to buyers, as they feel they are buying a high percentage of the top product's performance for a much lower percentage of its cost. Conversely however, when an

affordable product manufacturer brings out something dear, there can be a sense of indifference as to exactly what that manufacturer has done to one of their cheaper designs to make it much dearer.

In Revolver's case, you know exactly where your money has gone. Three brand new drive units adorn the Cygnis, and its solid cabinet is split into two parts, an infinite baffle upper section housing the midrange and tweeter, with a dedicated, ported enclosure below this that is home to the bass driver. Designer Mike Jewitt believes, like us here at *Hi-Fi World*, that proper bass comes from a proper driver and, as a result, the driver in question is a sturdy and heavyweight ten inch design.

As to sound, we cannot help but think of the Cygnis as being akin to

a miniature B&W 801D. Not only do these share a similar appearance, but they also both have a sense of effortlessness about them. The Revolvers never seem strained or give the impression that they are being pushed to their limits and they are also a little more emotional than the big B&Ws, seeming to have a broader tonal palette of sonic colours at their disposal with which to paint an accurate aural picture.

From the high frequencies to the very deepest bass, the Cygnis integrates beautifully, showing that they have been very well designed and that the money that a buyer invests in them will be well spent. Ultimately, however, their greatest strength is that they leave you able to concentrate on the music, surely the sign of an award-winning loudspeaker.

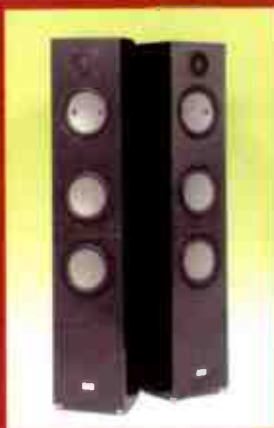

RUNNER UP:

ISOPHON CASSIANO £12,900

In a world of bland 'me too' boxes, even at the high end of the market, it's good to know that companies like Isophon are pushing things forward with innovative products such as this. This highly distinctive German design uses ceramic-coned bass and midrange drivers sourced from Theil in Germany, and can be specified with either a diamond or ceramic tweeter. These are fitted to an exquisitely finished cabinet, with a choice of over two hundred finishes, and the result is big audio dynamite. A massive sound greets the listener; immensely deep and powerful, with a sense of scale rarely heard from any domestic loudspeaker. Expensive yes, but unlike so many high end speakers, you can instantly see and hear where your money's gone.



PHONOSTAGE

WINNER: ANATEK MC1 £800

It seems that phono stages are appearing in a wide variety of shapes and sizes at the moment. From huge, shelf-bending behemoths with multiple inputs and a bewildering array of cartridge matching options, to tiny little boxes that sometimes have an increasingly common USB output facility, there is something on the market to fit all requirements and budgets. You might well think, therefore, that choosing a winner from the selection we have enjoyed this year would leave us with a huge collective headache, but this was not so.

You may remember that last year's winner, the Eastern Electric MiniMax, became our reference phono stage here at *Hi-Fi World Towers* and, despite some impressive competition, still successfully withstood onslaughts from many a rival, sometimes at several times its price. Quite a surprise then, that the unit that finally knocked

the MiniMax off its pedestal was an unassuming, simple little box from Worthing!

Anatek Acoustics are the company, founded in 2001 by Martyn Hook and Clive Read, both passionate audio fans who were well versed in the complexities of the audio industry, and have gained a name for their company's amplification products which include a preamp, monoblock power amplifiers and the A50R integrated. The new MCI is their only phono stage currently, and has no bells, whistles, flashing lights, multiple inputs or multifarious loading options. It is designed around Anatek's patented Class A, zero-feedback circuit and is very well built, featuring high quality WBT phono input and output sockets and a thick and simple, but well machined, front panel. The MCI comes pre-set with a 100 Ohm input load and a fixed gain making it suitable for

low output MCs only and, as a result, it is simple to use; you simply connect up, plug in and forget.

The thing is, as soon as you start listening, you are going to be unlikely to forget this little unit in a hurry. The MCI is an incredibly impressive performer and it has a magnificent sound right across the spectrum. Bass is deep, tight and lightning fast, midrange is enveloping, emotional and detailed, and the top end is sweet and flowing, but with a pleasing crispness. The MCI takes your records and positively envelops you in their contents, equally happy to put you right next to a string quartet, in the middle of a stadium rock concert, or under a load of foam in an Ibiza nightclub.

The way it does so much so well - and with so few vices - is very impressive, making it a very worthy winner.



RUNNER UP:

NOTE PRODUCTS PHONOTE £1,750

There are surprisingly few top quality tube phono stages, but here's one we can recommend with confidence. Although a tad pricey and not the most impressively finished bit of kit, the PhoNote delivers the sonic goods with alacrity. It's effortlessly musical, but unlike many transistor designs it doesn't force things on the listener. Instead, you get a laid back and seductive listen - possibly a touch too smooth in less revealing systems - that unlocks the magic of vinyl in a way that no other sub-£2,000 design can.



SYSTEM

WINNER: MERIDIAN F80 £1,495

One of the surprises of the year, twelve months ago nobody here at *Hi-Fi World* would have expected to be reviewing a £1,500 Meridian 'table radio' in the summer of 2007, let alone one part-manufactured by Ferrari! The F80 is a CD player, DVD player, FM and DAB radio all rolled into one, with onboard amplification and stereo speakers built in.

The F80 is not a serious 'hi-fi separates' product (and nor has Meridian ever pretended it to be), but it is a serious sounding 'portable' – one which has proved so endearing to everyone who tries it that it's practically carved out a new niche of its very own. The striking, elliptical styling is also distinguished (and comes in five official Ferrari colour options, while limited edition luxury finishes are available too), and the F80's controls are beautifully detailed,

from the superb display to the easy, intuitive ergonomics. The overall effect is of a music machine that engenders an 'I want one' response in nearly everyone who tries it, even those who previously had never supposed they'd countenance such a thing.

The F80 sounds superb – for a compact (408x230x185mm) semi-circular piece of plastic – and the reason is that inside this 6.5kg machine is a solid diecast metal base with three loudspeakers mounted in separate, inert enclosures. These are created from a special alloy-injected composite, courtesy of Ferrari. The speakers are all under digital signal processing control, with three power amplifiers delivering 80W to the two front speakers, plus an integral rear subwoofer. The loudspeakers themselves are special full-range designs, custom-made with

powerful neodymium magnets and cones fashioned from magnesium and aluminium alloy.

Like all modern Meridian kit, the F80 has a very clean sound with lots of detail, and a sense of finesse that shows its high end origins. It impresses with real midband insight, yet doesn't sound thin thanks to the rear mounted subwoofer. With a decently recorded CD, you get a genuinely musically enjoyable sound that's taut, controlled, punchy and clean and, even when you turn the volume right up, it remains clean and undistorted, showing the benefit of what is clearly very robust internal construction.

More than just a portable, the Meridian F80 is a unique compact music machine that bestows a feeling of satisfaction upon all who use it – and as such is a worthy winner of the *Hi-Fi World* 2007 Systems award.



RUNNER UP:

SHANLING MC30 £500

A typically quirky product from Shanling, but don't let this fool you – inside its all-aluminium case is a decent CD player, more than competent single-ended tube amplifier and a fine FM radio, plus a small cradle for a portable iPod-type digital music player. The sound is simply too good for the price – providing you manage to partner it with high quality, efficient loudspeakers such as Revolver Music 3s. Smooth, sumptuous and tremendously lyrical, rival mini systems simply don't offer this level of refinement. True, it's not quite as elegant to use as the Denons and Onkyos of this world, but it's in another class for sonics.



CD PLAYER:

WINNER: LEEMA ANTILA £2,495

It's always nice to see a new name in high end hi-fi, and Leema Acoustics is one of the most impressive we've come across of late. Why? Because just months after we'd been beguiled by their beautifully built Xen loudspeakers, this new British brand unleashed a CD player and amplifier on the market that made a Lewis Hamilton-style entry into an already ultra-competitive electronics market.

Ironically the Antila almost suffers by being too good looking. So solidly built and crisply (yet originally) styled is it, that the temptation is to dismiss it as just another piece of audiophile eye-candy. However, in this case at least, beauty is more than just skin-deep, and one listen to the Antila confirms that the company put a lot of work into voicing it. Big and heavy, the company has built mechanical integrity into the machine, rather

than doing the standard pressed steel box with a fancy finish.

Inside, there's a dedicated hi-fi transport - Philips VAM 1202 mechanism mated to an LI210 loader - and a novel DAC arrangement which Leema describe as 'MD2 active differential multi-DAC converter technology'. This equates to ten Crystal Semiconductors surface-mount CS4345C stereo 24bit/192kHz chips, controlled by a programmable FPGA using software designed in-house by Leema. This has the aim of dramatically reducing the distortion inherent when using a single or dual DAC configuration, says the company. To ensure the hard work done by the DAC stage is not undone in the following analogue stage, high quality Analog Devices OP275G surface mount op amps are then used in the I/V stage before feeding the dual RCA

and XLR outputs which are driven simultaneously.

Considering the pro audio background of the guys behind the Leema brand, it's unsurprising that their electronics have a very powerful, live sound - and the Antila is no exception. This player doesn't so much put discs under a microscope as perform a dissection on the recording, yet it's not analytical in the traditional sense. Rather, it seems able to distil out the recording's essence like no other player at or near the price. With the kind of engineering more familiar to purchasers of £5,000 machines, a refreshingly different look and a sound good enough to worry rivals at nearly twice the price, this an impressive entry into the high end CD player market, and a worthy winner of this year's *Hi-Fi World* Award.



RUNNER UP:

ASTIN TREW AT3500 £1,150

Something of a bolt from the blue, we hadn't expected this new silver disc spinner from a relatively unknown British company to beat all comers in our recent £1,000 CD supertest, but it did - and convincingly. Although the AT3500 wins no prizes for original aesthetics or superlative finish, there's a lot right with it inside, and it's obviously been very carefully voiced. The result is a very entertaining and confident sounding machine with a massive soundstage and oodles of fine detail. Right now, there's nothing that has such a strong combination of talents at the price.

the future of music.



Visit our stores and experience the highest performing digital music player in the world. The Linn Klimax DS is a breakthrough product with the performance to transform your life and alter the way you listen to music.



EXTENSIVE EX DEM & USED LIST ALWAYS AVAILABLE PLEASE PHONE WITH YOUR REQUIREMENTS.

Linn Majik System

With two new product launches from Linn, the Majik system now includes the fantastic new Majik-I integrated amplifier and the stunning new Majik 140 Loudspeakers.

Please call in store to listen to this fabulous system.



Majik system promotion

Purchase a Linn Majik CD Player, Majik Integrated Amplifier, Katan Loudspeakers* and Katan stands All for only £3500. RRP £4290

* other speaker options available

Price includes nationwide delivery and installation by Linn trained staff.

For more information on purchasing visit www.petertyson.co.uk or www.newcastlehifi.co.uk

Special Linn Unidisk SC and Majik 5100 promotion.

Simply purchase a Linn Unidisk SC, universal disc player and a Majik 5100 or 6100 Power Amplifier and receive a **fantastic 25% off.**

Price was £5340 now **£3999**

Price includes free HDMI cable and nationwide delivery and installation by Linn trained staff.



LINN

Pioneer Latest Pioneer G8 Plasma TV's

PDP-LX508XD
on permanent demonstration.
The best prices
please call for details.

Ex Demonstration and used stock list

Linn Klimax Kontroll Please Call
Linn klimax Solos Please call
Linn LP12/Ekos/Arkiv now £1600.00
Linn Ikemi CD player now £1100.00
Linn Karik CD player now £350.00
Linn Genki CD Player now £600.00
Linn Pekin Tuner now £400.00
Linn Chakra C4200 Amplifier £2350
Linn 2250 Amplifier now £900.00
Linn Klout Amplifier now £900.00
Linn Kaber Aktiv Loudspeakers now £850
Linn Ninka Loudspeakers now £700.00
Linn Keilidh Loudspeakers now £300.00
Linn Isoharik Loudspeakers now £300.00

Don't miss out call today.

Latest Award winning Onkyo Receivers

Award winning AV products on permanent demonstration.



Capable of Processing Today's High-Resolution Media
Including Blu-ray Disc and HD DVD
with Effortless Efficiency.



Award winning brands stocked
Linn, Arcam, Marantz, B&O, Bose
Chord Electronics, InFocus, JVC,
Monitor Audio, Mordaunt Short,
Pioneer, REL, Roksan, Sim2, Tannoy,
Teac, Tivoli, Velodyne, Yamaha.
Plus many more.



6 Abbey Street, Carlisle, Cumbria. CA3 8TX
Telephone 01228 546756
www.petertyson.co.uk
Email sales@petertyson.co.uk
Open Monday-Saturday 9am-5.30pm



153 Kenton Road, Gosforth, Newcastle. NE3 4NQ
Telephone 0191 2857179.
www.newcastlehifi.co.uk
Email mark@newcastlehifi.co.uk
Open Tuesday-Saturday 10am-5.30pm



INTEGRATED AMPLIFIER WINNER: NAIM SUPERNAIT £2,350

Given that Naim's first Nait was the original 'super integrated', it's perhaps fitting that the company's new SuperNait wins *Hi-Fi World's* top integrated amplifier gong some quarter of a century later. The SuperNait is a very special amplifier, and could only be from Naim considering how it does what it does, and why...

The company has, in our minds, been responsible for some particularly fine industrial design throughout its history, from the stripped down minimalism of the ARO tonearm to the formidable battleship construction quality of the CD555 CD player. It's from the latest range of electronics however, that come some of the best presented amplifiers of modern times – and the SuperNait shows why.

Inside the large 'classic' series

box is an array of high quality passive componentry and Naim's traditionally 'stiff' power supply resulting in a muscular 80W per channel, plus – very unusually for an integrated – an onboard digital to analogue convertor. This makes it, in Naim's words, "not so much an amplifier as an analogue and digital audio control and connection hub".

Of course, excellent build from Naim Audio is a given, but the front panel architecture is also a joy. Beautifully located, backlit buttons with a fine action give easy access to the amplifier's myriad functions, and – for the first time on a Naim – there's a front panel iPod (or similar line level) input. Round the back, there's a welter of connection options for a power supply or power amplifier upgrade, plus a superb quality offboard phono stage.

In action the SuperNait is a delight, offering one of the very best sounds possible at its price, and one which majors on speed, grip and dynamic accenting. Unlike any of the older or lesser Nait's, it seems totally disinterested in the speakers it's asked to drive – its 'velvet glove on an iron fist' nature serves up power whenever it's needed with nonchalant ease. Despite sounding so feisty and dynamic though, the SuperNait is deceptively smooth – standing in opposition to earlier incarnations of the breed in this respect.

Overall, the combination of superb, 'real world' functionality and the sheer accessibility of all these features, plus a massively assured yet smooth and musical sound makes this the pick of this year's new amplifier releases. A true audiophile amplifier in a box – high end hi-fi without tears.

RUNNER UP:

SUGDEN A21a s2 £1,199

Imagine our surprise when we heard that our favourite affordable audiophile amplifier was due for a revamp! In July it arrived, and it was better than we could hope. Removing the one major bugbear of the original evergreen A21a at a stroke (namely its very limited power output), the new Series 2 version smoothed off a few more rough edges (questionable build, middling finish) to make a brilliantly polished all rounder with stunning 'sound per pound' quotient. Practically no other amplifier at or anywhere near the price can match its icily clear sound – fresh as the driven snow.





WINNER

PREAMPLIFIER: MELODY PURE BLACK 101D £3,295

The whole topic of preamplifiers and how they are sometimes overlooked somewhat is something that we have covered before on the pages of *Hi-Fi World*, but the situation still seems to be the same. Many audiophiles will spend fortunes on big power amplifiers, hefty loudspeakers and stunning turntables but can have a tendency to be a little blasé about the, often simple, box that links these together and allows one to switch between sources.

The preamplifier, in theory at least, has one of the simplest jobs in the audio chain. It doesn't need to dig the last ounce of information from a groove or disc, it isn't faced with forcing tens of volts into a hideously difficult electrical load and it does not need to be carefully positioned on special stands at the right height in order to drive the listening room

properly. It is all too easy to forget, then, just what contribution a good preamplifier can make, until an absolute stunner turns up.

This year's stunner is the Melody Pure Black 101D - £3,295's worth of heavyweight, Australian-designed and Chinese-built modern technology, that also happens to use, as voltage stabilisers, some of the oldest valves known - the 1920s 101D triodes. We did briefly wonder whether this was going to result in an all show, no substance result, but this was instantly dispelled from the first opening bars of music.

The Pure Black 101D is like no preamplifier we have heard before. Whether driving a Naim NAPI50 or the matching Melody Pure Black 88D monoblocks, the 101D gives the sort of scale and transparency that are rarely heard outside systems that

bear price tags that look more like telephone numbers. The old valves certainly do not give an old fashioned sound, but take the clarity, insight and emotion of the very best thermionic designs and add to it a breathtaking level of dynamics and grip. Initially we wondered if the Pure Black 101D was actually telling the truth or not, so different was its sound to anything else we had on hand for comparison, but the more we listened, the more we realised that it gets absolutely everything very, very right indeed.

It takes a truly special product to be awarded five globes AND a 'pound sign' for value in our ratings, but there was no doubt in our minds when we awarded the Melody this accolade. Surely one of the best preamplifiers ever made, the Pure Black 101D is a very worthy 2007 award winner.



RUNNER UP:

NUFORCE P9 £2,200

It's rare to come across a preamplifier at any price that offers the P9's combination of performance and flexibility, and there's also a dash of style too - especially when ordered in the company's trademark Rose Copper hue. A two box, op-amp based design, the NuForce is a quintessentially solid-state sounding preamp - in the best sense of the word. This means ultra low noise and commensurately high levels of clarity, with lightning transients and a grippy, dynamic nature. If you're looking for a superb, do-it-all high end design with a refreshingly small footprint, this is the one.



POWER AMPLIFIER

WINNER: CHANNEL ISLANDS AUDIO D100 £1,595pr

It is inevitable that technology drives the consumer electronics market, and in hi-fi it's a new generation of Class D amplifier chipsets that are setting the power amplifier market alight right now. A number of manufacturers, from Tripath to B&O, have their own versions on sale, and hi-fi manufacturers are making good use of these designs and feeding them through into ever more affordable products.

The advantages of Class D amplifiers are many – massive power output without the associated disadvantages of copious heat production, relatively low distortion and very low current consumption. Coming on small silicon chips, they're also very easy to implement – the addition of a box and a decent power

supply being all that's needed...

Well, after all the hype comes the reality – some people think that Class D sounds fundamentally wrong. In the same way that Bitstream Compact Disc was superbly clean and low in distortion but just didn't seem to deliver the musical goods, so many people think 'D' is a long way behind both transistorised Class A and AB in the musical stakes. As for valves, it's not even within shouting distance, they allege...

One chipset that we've been consistently impressed by, however, is the Philips 'Hypex' module, and it's these that the Channel Islands Audio D100s feature, albeit in a tweaked form. Indeed, they make the most of them, offering up a very smooth, distortion-free sound that's gently

musical yet massively powerful. In absolute terms, the Channel Islands aren't especially muscular for Class D, but they make up for it in sheer neutrality. Here's one of the few amplifiers of this type we've heard that can be listened to at any volume level, low or high, yet consistently offers up the same natural, organic sound.

Something of an oddity, fit and finish of these monoblocks isn't quite up to similarly priced NuForce designs for example, and the styling is a little on the frumpy side for us, but all such considerations disappear from view when you switch them on and start listening. Sounding free, unfettered and really not like any type of amplifier at all, the D100s are in a class of their own.



RUNNER UP:

ROTEL RB-1092 £1,595

Funnily enough, Rotel haven't made much of the RB-1092 stereo power amplifier – they rather modestly describe it as a high power workhorse. Well, this it is – at 586W per channel into 8 Ohms it offers massive amounts of welly and the ability to drive almost any load. So impressive is this that, a decade ago you'd be into Krell territory with an extra nought on the end of the price tag. Still, the Rotel's not just about power – it's a smooth and calm sounding device that might be just what lovers of light classical and gentle jazz crave. It can rock out too, but you could say it doesn't wear its immense power output on its sleeve. Superlative value, this unlocks the world of massive, power-hungry speakers to those on a budget.



T SERIES

YPL SPEAKER



T5 MINI SPEAKERS



T6 BOOKSHELF



T7 FLOORSTAND

YIN PU LI CO., LTD.

Address :

1F, NO. 351, Sec.2, Nantuen Rd.,
Taicung, Taiwan 408.

FAX : 886-4-24730446

E-mail : ypl@yplaudio.com.tw

<http://www.yplaudio.com.tw>

To

**advertise in this
space please call**

020 7372 6018

or email:

advertising@hi-fiworld.co.uk

Strange Brew

Brewed from a TV amplifier chip, mixed with certain magic ingredients, this is a "Paramagnetic amplifier that relies upon quantum mechanical behaviour", says designer Peter Gyarfás. Can it enchant Noel Keywood...?



This unusual amplifier turned up at our offices the other day, securely packed in a screwed wooden case, with a label identifying Budapest as the source. It was accompanied by an unusual technical description in which designer Peter Gyarfás says the Lizard Wizard is a "PMC (ParaMagnetic Current) amplifier. It is a virtualcoil-amplifier, and it is totally analogue. It's rather an acoustical invention in physics, not only in electrical engineering. This device works as a quantum mechanical device, not only an electronic device". You can check out his claims in their entirety at www.lizardwizard-audio.com.

Peter Gyarfás told me that I should not measure the amplifier as normal "measures" don't represent an amplifier as different as this, and that he would send me their "measures". However, the "measures" on their website show a gliding sine wave tone captured over a long time period, likely on a computer, and this is no measure at all. Suspicious, we opened up the box and found inside an LM3875 amplifier on a chip. National Semiconductor rate this as a 56 watt amplifier for Component or Compact stereos, Surround-Sound amps and High End TVs...

The amplifier was hard wired, none too neatly, and wires disappear into two areas of white mastic. One appears to contain a coil, another twisted wires that go nowhere. Power comes from an external switch-mode supply. As the Wizard

didn't produce 56 watts, the National chip certainly exists within some unusual circuit arrangement, but different isn't necessarily better - it's just different.

SOUND QUALITY

Measurement gave a peculiar set of results, as expected, but they weren't entirely out of consideration. Most interesting was a very consistent distortion pattern, suggesting a easy on the ear sound. With poor regulation and little high treble, this amplifier would likely have a soft sound - and that's exactly what I found in listening tests. Bass guitar and drums sounded limp and recessed, making The Stranglers seem like a polite bunch, JJ Burnell's efforts on bass guitar largely passing unnoticed. A relaxed midband had Hugh Cornwell's vocals floating effortlessly in front of the performance and lack of high treble made the whole performance gentle on the ear. It wasn't an unpleasant presentation, but against conventional amplifiers you would have to decide for yourself whether this is what you want to hear, instead of what

everyone listens to.

CONCLUSION

The Lizard Wizard amplifier is as unusual as it looks. A paramagnetic amplifier that exploits quantum mechanical behaviour? I'd call that an imaginative description. It sounded different, that's for sure but I'm afraid to say it cast no spell on me, or others that heard it.

VERDICT

Eccentric and bizarre design that sounds unusual, if not unpleasant.

LIZARD WIZARD
PMC AMPLIFIER £2,000
 Lizard Wizard Audio
 ☎ +36 1385 2641
www.lizardwizardaudio.com

FOR

- small size

AGAINST

- limpid sound
 - crude build quality

MEASURED PERFORMANCE

Output power measured 21 watts into 8 Ohms and 36 watts into 4 Ohms, modest but by no means unusable amounts, especially for those with sensitive floorstanding loudspeakers. However, there was an unusually large change in output between 8 Ohm and 4 Ohm loads, the Wizard not being a 'constant voltage source', even though it uses a National LM3875 chip that has been designed to act in this way. Damping factor was resultantly low at 0.68(!), meaning the amplifier will have a frequency response affected by the impedance modulus (curve) of any loudspeaker connected to it, giving notionally correct results only with a non-reactive load.

Worse, high frequency output rolled away above 4.6kHz (-1dB) into a resistive load, meaning the sound will lack high treble, especially into real loudspeakers where impedance usually plunges downward.

Distortion levels were low and comprised mostly second and third harmonics, which will not be aurally offensive. Sensitivity was very low at 1.2V as the inputs seem to feed direct into the LM3875 chip, without

additional gain. Only CD players suit this.

The Lizard Wizard's curtailed frequency response and low damping factor will largely determine its sound, pushing the midband forward with most loudspeakers, as impedance commonly peaks around 2kHz. By normal standards this amplifier does not measure well. NK

Power	21watts
Frequency response	7Hz-4.6kHz
Separation	52dB
Noise	-103dB
Distortion	0.1%
Sensitivity	1.2V
Damping factor	0.68

FREQUENCY RESPONSE

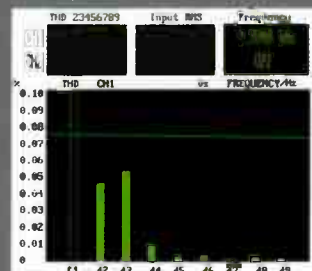

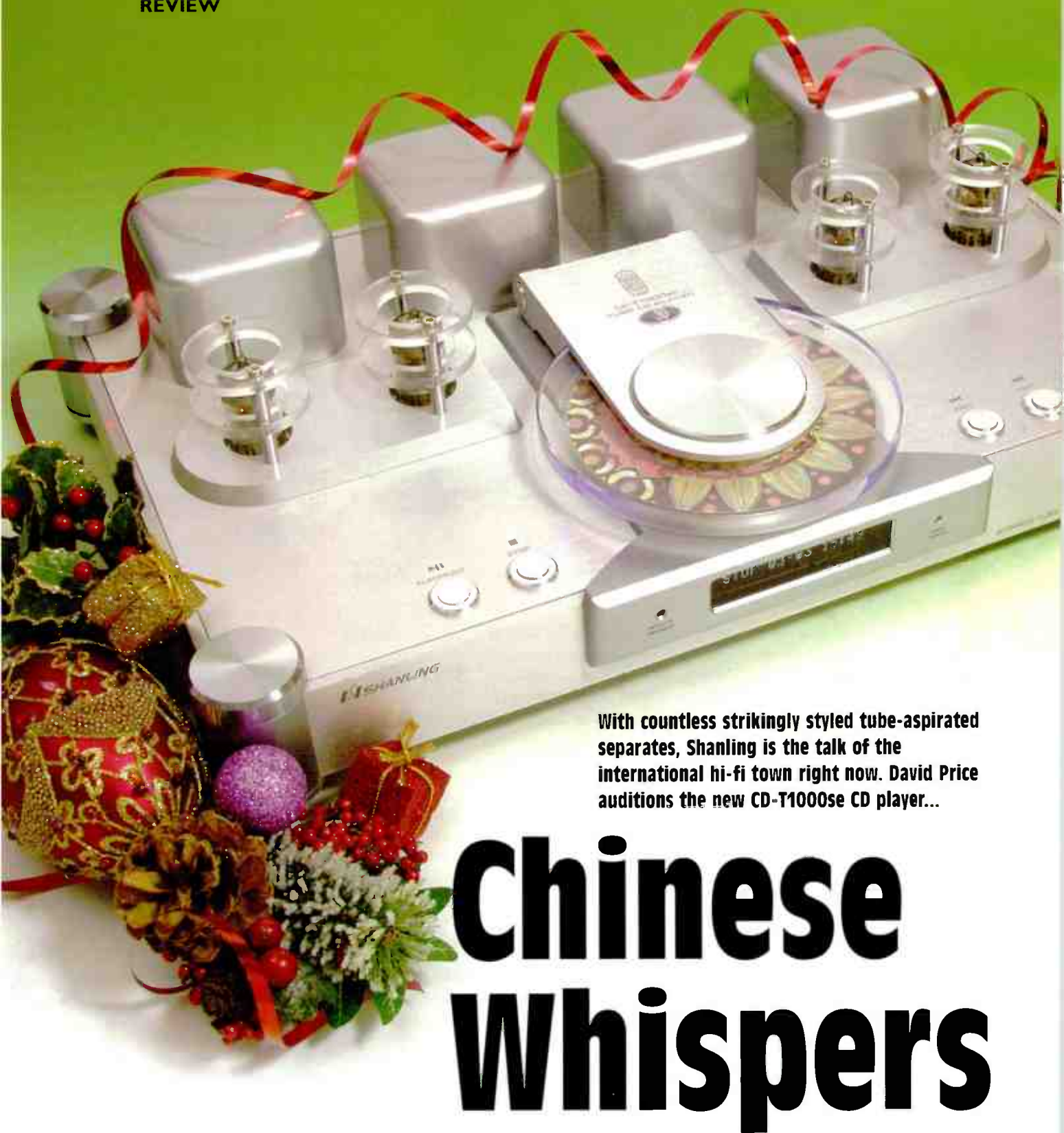

With countless strikingly styled tube-aspirated separates, Shanling is the talk of the international hi-fi town right now. David Price auditions the new CD-T1000se CD player...

Chinese Whispers

Figuratively speaking, until very recently the hi-fi world was a place where you could get any colour you wanted as long as it was black. Whereas in the fifties the audio industry was about selling relatively small volumes of very diverse kit, by the nineties it was pretty much variations on a very similar theme, sold in vast quantities.

For this of course we have large Japanese consumer electronics corporations to blame. They sold to a very well established and fairly

conservative market which was feature-driven and updated every autumn, as regular as clockwork. Although it's a bit reductive to say they were implementing Henry Ford's famous dictat, it still wasn't too wide of the mark...

Now though, the likes of Sony, Victor, Hitachi, Sharp, Matsushita and Sanyo are pretty much out of the audio market, and the homogeneity and conservatism that they embodied – at least at the 'affordable' end of the market is also gone. In its place have moved the specialists, many of

which are either Chinese or joint ventures between Chinese and western companies. And any serious student of the Chinese market will tell you that they are precisely the opposite of those grand old Japanese CE brands – being fast moving, short termist and unrelentingly opportunistic.

This isn't necessarily such a bad thing; the likes of JungSon, Eastern Electric, CAV, *et al.*, have been manna from heaven for a small bunch of audiophile hobbyists, who can't get enough of their quirky design, strong

build and diverse product ranges. And it's fair to say that Shanling have been at the vanguard of all this – making dramatically different designs

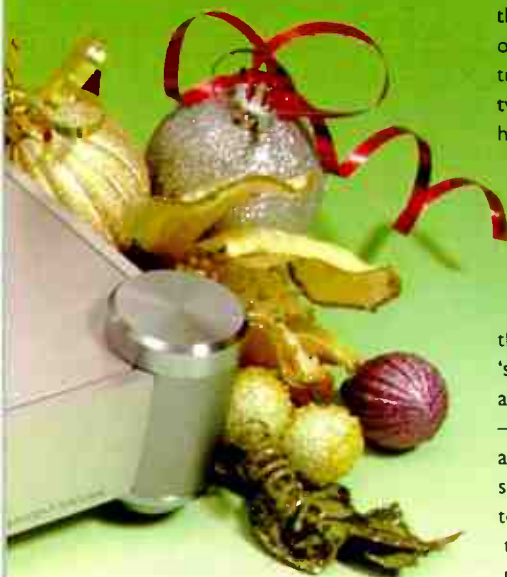

(compared to mainstream Japanese manufacturers) with superb sound per pound.

Shenzhen Shanling Digital Technology Development Co., Ltd. – as it was originally called – started as a joint venture specialising in research and development, manufacture, processing, marketing and sales of audio products, as well as the provision of “high-calibre metalware” for audio components. It made its first product, a power amplifier, in 1988. Two years later it started an audio equipment plant in Jieyang TV University, and in 1996 it moved to China's special economic region of Shenzhen (down in the south, near Hong Kong) and renamed itself Shanling Electronic Co., Ltd.

Since then, it has beefed up its research and development resources considerably, along with its manufacturing capabilities and now does a lot of metalwork for other companies from all around the world. Shanling says it, “has become one of the few enterprises that are self-developing, co-produce and manufacture high-end audio products”. In the UK, thanks in no small part to importer Real Hi-Fi, the brand has gone from strength to strength, and is now challenging all the established UK and Japanese brands in the budget and mid-price sectors.

The CD-T1000se you see here is the culmination of all this. It sits in the middle of the company's range and should prove one of its best sellers. A quintessentially Shanling product, it is a veritable symphony of brushed aluminium, looking more like a tube amplifier with a disc recess in the middle of the top plate than a

conventional CD player. This makes it striking to look at, and the four 6N3P valves add additional visual impact.

These also betoken the fact that it is quite unlike the sort of machines the Japanese offer at this price – two of these glowing bottles form the tube analogue output stage, the other two actually constitute the valve headphone amplifier which feeds a 6.3mm jack! Look round to the back panel and there are even two ‘direct’ analogue outputs, which bypass the tubes.

The top loading CD mechanism is another of what those in the auto industry call ‘surprise and delight’ features. It's not as rare as it used to be of course – the Rega Saturn tested last month also shares a ‘drop loader’ – but it's still, in my opinion at least, far nicer to use than the invariably creaky disc tray that you'd otherwise get at this price. Disc drawers done the Linn

this is the sort of thing you'd never find on a Japanese machine, and betrays the fact that the CD-T1000se's chassis is used on other models.

SOUND QUALITY

At £1,695, this Shanling is half way between true high end designs from the likes of Linn and Naim and the braying pack of circa £1,000 machines, some of which are getting rather good considering their modest retail price. With this in mind, I felt it only fair to use my current fave Astin Trew AT3500 (at £1,150) as a reference, which came top of our recent £1,000 CD supertest. This really is a fine machine, and ought to be able to at least not disgrace itself in the Shanling's company.

Suitably run in, warmed up and connected by the massively chunky OFC mains cable that Shanling supply, I started off my listening test with

“the Shanling set up a wonderfully warm and intricate acoustic”.

Sondek CD12 way are a delight, but then they cost £12,000...

Underneath the translucent plastic disc loading lid, invariably lit bright in compulsory noughties blue I'm afraid, lurks a high quality Philips CD1201 pick up mechanism, running the latest CD-711 servo system. The box is a veritable showcase (‘scuse the pun) for Shanling's metalworking abilities, which are getting very good. The 430x290x65mm case feels gloriously solid and fairly unresonant (something a number of other manufacturers could learn a lesson from), and is commensurately heavy at 10kg. Inside it has a very tidily laid out main board housing two Burr Brown PCM1792 DACs and a Burr Brown SRC4192 upsampling chip.

The CD-T1000se is nice to use, although sadly there's no powered disc lid lifter – again, this sort of thing comes with your £14,000 Naim CD555s. You simply pull the lid up yourself, place the CD on to the spindle, close it and wait as the disc spins up to read the Table of Contents. There are four crisply acting buttons on top – play/pause, stop, and track skip forward and back. The front display is attractive, clean and easy on the eye, and there's a small 24/192 legend to the right which glows when you've selected upsampling on the good quality metal-fronted remote control unit. To the left of the display is a CD/SACD legend, which is redundant on this machine as it's CD-only. Interestingly,

4hero's ‘Morning Child’. Via the direct output (i.e. bypassing the valves) and with the upsampling switched off, the CD-T1000se proved a decent enough performer. It showed a lively, detailed sound with a nicely smooth balance and a fair degree of incisiveness. In absolute terms, it was a tad closed-in sounding and just a little too centred around the plane of the loudspeakers for my liking, but there was no denying its essentially musical nature.

Switching on the upsampling via the remote control yielded a bigger improvement than I'd expected – the sound came alive with a good deal more space across the midband and, most obviously, treble. Hi-hats assumed a more silky and ethereal sound, without sounding any more



OBSESSIVE ABOUT...?

Its been a fantastic few months in the world of audio and quality hi-fi. Many new names and some very old ones are coming through with some of the most exciting products to emerge in the last 10 years!

From America, PS Audio are such a company who although for many will be a new name, they are in fact steeped in history. Paul McGowan of PS Audio has been designing and manufacturing audio products for more than 30 years and has a string of International awards under his belt. Currently PS are making a big splash with their innovative and unique range of power regulation devices, as well as some very fine audio equipment. The PPP is an affordable power regenerator, taking your household electrical supply with all its noisy spikes, dips, rf and other irregularities and remanufactures that same into a quiet, smooth ac sine wave of integrity. And it works. Every home demonstration of this device has resulted in a sale so far, (at time of writing 5 units in 4 weeks). No one is more sceptical than we are when it comes to snake oil, mirrors and smoke etc., but this unit is engineered from its input all the way to its outputs. You can run your Turntable, pre-amp, CD and power amp from this, or indeed your home cinema! You will not believe the effect the PSA PPP makes to a Plasma tv or projector, you can actually see the before and after differences.

So, you can understand why we're excited about this particular power regenerator, but there are also differences to be heard by using the PS Audio power cables too, and the Phono stage is to die for. Indeed the PS DAC is another gem waiting to unleash its abilities on any good system. We have a wide variety of PS Audio products on demonstration, so please do book a demonstration to take a listen and hear for yourself, remember home demonstrations are our speciality, listen in your own system for the improvements.

For the valve enthusiasts out there, a new name to the UK is Pure Sound. This is a small specialist company with a hand full of really, really good sounding products. The obvious reason for this is because the company is headed up by Guy Sergeant of Audio Innovations fame. The A30 is an integrated amplifier using a quartet of 6550 output tubes, offering sensible domestic power levels, and makes a great sound. Their CD player is a bit special too, and sounds warm and lucid with a most musical presence. These form the heart of a great hi-end system that won't break the bank. Pure Sound have recently added two brand new products to the stable in the form of a second integrated amplifier, simply called the 2A3 and a MM phono stage. At £1800 and £400 respectively, you will struggle to better these

in a like for like situation. As soon as we heard the 2A3 amplifier, we "had to have one". The boss groaned as the cheque book was forced open, but was soon convinced by the alluring, spacious big sound!

Totem Acoustic are famous for their range of small footprint loudspeakers. Although the physical size of the boxes is indeed diminutive, the sound is huge! These speakers create a soundstage so unbelievably three dimensional that they literally make listeners jaws drop! With a high wife-acceptancy factor, these speakers are designed to blend in with any style of home, modern or traditional. And if the wife is happy, then the husband is too! The Arro and Sttaf are the entry into floor standers, and although these are not new designs, they have been refined over the years to bring music lovers closer to the original performance. We love these speakers and enthuse over them, to find out why, please arrange an audition. Again we have a big range of Totem on demonstration, we think these are the best sounding small speakers money can buy. Please check'em out.....

If you are an owner of an LP12 and have been reading on the forums about the pros and cons of non Linn based upgrades to the deck, we have on dem a fully Funk'd LP12. We are happy to let you listen and compare with what you have (whichever age or level of LP12). We are most impressed with the quietness of surfaces, the dynamic punch and speed of the bass reproduction. The Funk Firm have rightly achieved genuine cult status in the lp loving community, we encourage you to listen to their own fully fledged record players as well as the renowned LP12 mods that the company offers. Listen and decide for yourself.

Meridian have been busy creating what must be one of the finest portable music devices ever to hit the marketplace. The F80 "portable radio" is designed by Bob Stuart to be a "round the house, portable sound system that even he would be happy with". Now, Mr. Stuart is one of the owners of Meridian and has designed some fairly outrageous and innovative products throughout his career, from active loudspeaker systems to modular amplifiers and lossless digital music conversion software. So to satisfy this mans high expectations we knew the "radio" must be something special. Nothing could have prepared us for our first listen. To say we were "blown away" is the understatement of the year. The F80 is a CD player, DVD player and DAB radio, compact in size beautiful in design and totally awesome in performance. In fact this machine will no- doubt outperform some full size hi-fi systems! Yes you read it right... If your looking for a serious second system for the home or office, this is gonna be hard to beat. Pop in and take a listen... available in a colour to suit your taste too!



Practical Hi-Fi Obsessive about hi-fi.

BLACKPOOL

81 Whitegate Drive, FY3 9DA
Tel: 01253 300599

Opening Hours: 9.30-17.30 Mon - Sat

BOLTON

33-35 Knowsley Street, BL1 2AS
Tel: 01204 395789

Opening Hours: 9.30-17.30 Mon - Sat

LANCASTER

84 Penny Street, LA1 1XN
Tel: 01524 39657

Opening Hours: 9.30-17.30 Mon - Sat

MANCHESTER

65 Bridge Street, M3 3BO
Tel: 0161 839 8869

Opening Hours: 9.30-17.30 Mon - Sat

Please call for Sunday opening times

PRESTON

43 Friargate, PR1 2AT
Tel: 01772 883958

Opening Hours: 9.30-17.30 Mon - Sat

WARRINGTON

88 Bridge Street, WA1 2RF
Tel: 01925 632179

Opening Hours: 9.30-17.30 Mon - Sat

www.practicalhi-fi.net



World Radio History

diffuse, as can sometimes be the case when the number crunching is switched in. More importantly, the whole musical performance seemed to gel better, and suddenly the machine began to sound like a genuinely impressive silver disc spinner...

Moving to the tube output yielded further rewards. I had expected a softer and hissier sound, but not a bit of it. Instruments sounded a little more tonally natural and the timing of the music improved subtly, really letting each track get into the groove. The Shanling could never be described as having a strong bass, but now it sounded just a little fuller without slurring the progression of the bassline, making for a very balanced musical performance.

ELO's 'Last Train to London' showed the CD-T1000se to be just a little soft up top; it's certainly not as incisive or as delicate as the Rega Saturn in the treble region, and I can see that it could seem a tad too restrained in already smooth systems. This was underlined when I switched to my reference Astin Trew, which again seemed a tad better resolved on hi-hats and more spacious in general. Likewise, the midband of the Shanling – although very nicely detailed and satisfyingly subtle – couldn't match the expansiveness of the Astin Trew. The latter pushed wider left and right, and hung images back a little deeper.

Moving to some classic rock in the shape of Simple Minds' 'New Gold Dream', and the Shanling set up a wonderfully warm and intricate acoustic, allowing the bass guitar to drive the song along with gusto while the drummer's cymbal work provided a silky counterpoint. Singer Jim Kerr's vocals were very clean and direct, and the CD-T1000se caught his phrasing with great skill, making for a suitably subtle and dreamy rendition of the music. Moving to the Astin Trew showed just a touch more dynamic contrasting, the AT3500

catching the musical accents better, giving the sense that the musicians were exerting themselves more. Whilst sounding more spacious right across the frequency spectrum, the AT3500 did sound a tad more diffuse in its stereo image location, the CD-T1000se having more knowledge of precisely where the various instruments were located in the stereo mix.

The Shanling's greater midband accuracy proved more marked with a Deutsche Grammophon pressing of Beethoven's 'Pastoral' Symphony (Karajan), in which the instruments were located more precisely within an admittedly slightly less capacious recorded acoustic. At heart, the Shanling is a very precise sounding machine, to which a touch of air and warmth is added by the tubes - by contrast, the Astin Trew is a bigger hearted but looser player. Overall, it made a great fist of this piece of music, showing itself to be nicely rhythmic yet possessed of a pleasing tonality that – unlike the Astin Trew – wasn't overly on the warm side of neutral. Violins had fine timbre, the

very well, without ever sounding dry or sterile as some CD players can. It's not the last word in powerful dynamic presentation, but many listeners may actually regard this as a plus point because it's very even and easy to listen to.

The option of tube or direct outputs is a genuinely useful one – allowing users to tailor the CD player's sound closer to their systems, whereas the 192kHz upsampling is an excellent feature that should remain switched on.

Although the styling won't be universally adored, I'm very much of the opinion that Shanling are to be congratulated for doing things just a little differently. Add the fact that those tubes will surely respond to 'rolling' (i.e. replacement with other, more expensive items and/or DCT treatment), and it's a fine package at the price for those seeking an easy, natural and subtle sound.

REFERENCE SYSTEM
Astin Trew AT3500 CD player
Sugden IA-4 amplifier
Yamaha NS1000M loudspeakers

Real Hi-Fi are currently running a special offer, selling the Shanling CD-T1000se and a pair of very worthy Audio-Technica AD700 headphones (worth around £100) for a combined price of £1,600, reduced from £1,695.



VERDICT ●●●●

Interesting, characterful CD player with a smooth, svelte and musical sound plus fine build.

SHANLING CD-T1000SE £1,695
[SEE BOX]
Real Hi-Fi
+44 (0)870 9096777
www.realhi-fi.com

- FOR**
- detail, evenhandedness
 - natural tonality
 - presentation, styling, build
 - fine headphone output

- AGAINST**
- limited dynamic articulation

Shanling giving a real sense of their sound.

For me, the CD-T1000se's weakest point was its dynamic accenting – whilst in no way a flat or unengaging machine, the cheaper reference Astin Trew seemed a tad better at signposting when drumsticks had hit home on snares with real visceral power, and when they had been simply been casually brushed. Again, the Rega Saturn also did better in this respect, seeming a tad more expressive and emotionally committed.

CONCLUSION

An interesting machine, the Shanling CD-T1000se is a very smooth and detailed machine that also conveys the tonality of instruments and voices

MEASURED PERFORMANCE

Through its direct output the CD-T1000se has an absolutely flat frequency response that stretches up to 21kHz, our convolved impulse response analysis shows. The Tube output measured identically so there will be no audible difference in basic balance here.

Distortion levels were low from full output down to -80dB, but here the Tube output predictably produced some extra second harmonic distortion at peak output, but not at ordinary music levels. At -30dB Tube measured 0.012% against 0.006% for the normal output.

Noise was low through both outputs and EIAJ dynamic range high at 111dB. Output levels were normal also.

The CD-T1000se measures well in all areas and is a carefully crafted product, as usual from Shanling. NK

Frequency response (-1dB) 2Hz - 21kHz

Distortion	
0dB	0.0006%
-6dB	0.0008%
-60dB	0.27%
-80dB	2.2%

Separation (1kHz)	106dB
Noise (IEC A)	-116dB
Dynamic range	111.5dB
Output	2.2V

FREQUENCY RESPONSE

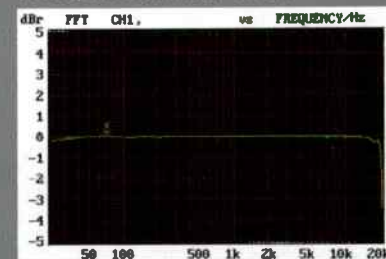

DISTORTION

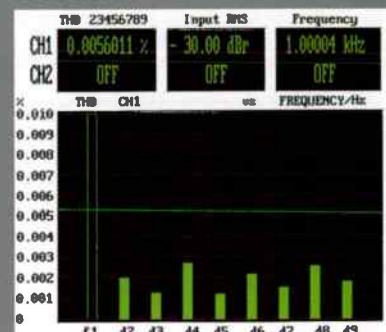



Adam Smith pits NAD's latest budget amplifier contender, the C315BEE, against the SE version of Cambridge Audio's Azur 340A...

Power Games

Ask any audiophile to reel off the names of classic amplifiers and I have no doubt you'll be rewarded with the likes of Krell, AudioNote, Radford, Quad and Leak, with the odd Naim thrown in for good measure. However it's only if you push them for more names that they will suddenly switch their attention from the top end of the market to the lower echelons, and I'm willing to bet that the first candidate they'll think of will be the NAD 3020.

Introduced in 1979, the 3020 was a seminal product that almost single-handedly defined a new category in hi-fi - the budget audiophile amplifier. The 3020 came in a rather drab

box, finished in NAD's traditional brownish-grey, was definitely a little on the flimsy side and rated power output was 20 watts per channel. Having just come from a decade where big and brash was king, and power outputs had been creeping higher and higher, it wouldn't have been a surprise if the 3020 had just faded into the annals of hi-fi history.

The thing is, even the most hardened cynic changed his or her tune when they listened to the little NAD. Whilst it did indeed only have 20 Watts, it had the now-legendary current delivery capabilities that we take for granted from NAD, and could drive loudspeakers down to 2 Ohms without breaking into a sweat. When first introduced into the UK,

some early demonstrations had it plugged into Linn Isobariks, such was its driving capability. Add in a sound quality which although a little smooth round the edges, had warmth, weight and musicality by the bucket-load, plus a fine phono stage, and you had one of the original superamps - all for less than £100.

The design evolved into the 3020A, B, e and i but the market and NAD moved on and the moniker was quietly dropped a few years back. Since then, NAD's more budget items have been very good, but have not really attacked the real budget end of the market until now.

The C315BEE is another diminutive amplifier, measuring 70x435x242mm (HxWxD) and

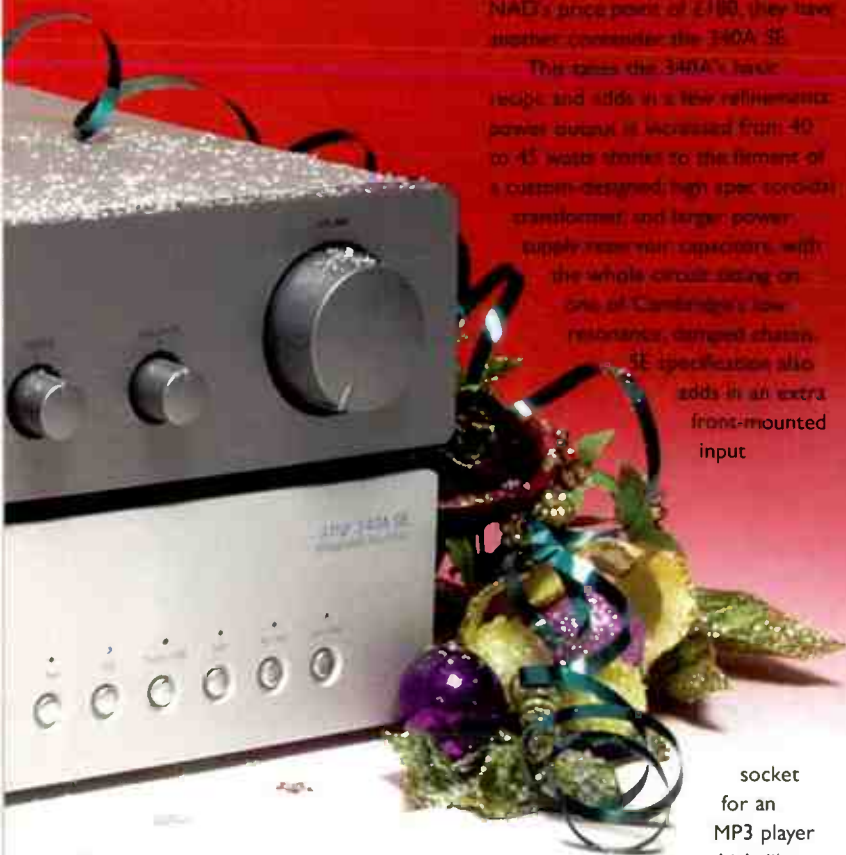

weighing 5.25kg, but this time it is finished in a rather smarter silvery titanium finish which is more aesthetically pleasing than the drab finish of the original 3020. The front panel looks solid but is actually plastic - disappointing but inevitable I suppose. Input count is six at line level plus and an extra one on the front panel for an MP3 player or similar, plus a full tape loop. Sadly, one casualty of modern times is the 3020's phono stage, but NAD do offer the fine, standalone PP2 phono stage if you still have one of those old gramophone things. The C315BEE is also supplied with a NAD 'Amp 1' remote control handset that offers basic controls for a NAD CD player.

Rated at 40 watts per channel into 8 Ohms, not only do our measurements show that this is a very conservative rating [see MEASURED PERFORMANCE], but it rises to a specification of no less than 180W of dynamic power into 2 Ohms, so NAD have still maintained their baby's current driving capabilities.

Of course, many others have followed the budget amplifier path paved by NAD and one of the most successful of recent times has been Cambridge Audio. Starting off with the A1, A3 and A5 amplifiers, the budget flag is now flown by their Azur range which, although now stretching up to the £750 840A, also reaches right down to the £150 Azur 340A. However, right at the

NAD's price point of £180, they have another contender the 340A SE.

This takes the 340A's basic recipe and adds in a few refinements: power output is increased from 40 to 45 watts thanks to the firming of a custom-designed high spec toroidal transformer and larger power supply reservoir capacitors, with the whole circuit riding on one of Cambridge's low-resistance, damped channel SE specifications also adds in an extra front-mounted input

socket for an MP3 player which, like that on the

NAD, is automatically selected when something is plugged into it. Naturally, the 340A SE is supplied with a typically impressive Cambridge remote handset, and this can also control the basic functions of an iPod, as well as Cambridge CD players.

The remaining inputs number five

"the NAD serves up a spacious and well ordered soundstage, whereas the Cambridge really loves to boogie..."

at line level and, again, a tape loop is provided, along with two pairs of loudspeaker outputs. The 340A SE tips the scales at 6.2kg and the tape measure at 70x430x310mm (HxWxD), and is available in both black and silver finishes.

SOUND QUALITY

It was almost something of a shame not to have an original NAD 3020 on hand for comparison purposes, but having heard my brother-in-law's 3020e only the previous weekend, I am fairly confident in saying that the C315BEE more than carries its predecessor's crown into modern times.

The C315BEE offers a sophistication to the sound that is often lacking in amplifiers at this price point, with a precision and insight that is most impressive. Across the midband, the NAD serves up a

spacious and well ordered soundstage that gives both instruments and vocalists plenty of space to perform and be easily heard. Ronald Jones was larger than life in front of me and was singing away happily with all her backing instruments snugly in place. Equally, Jeanie Carrillo's 'Late Night Grande Noche' on twelve inch single had magnificent spaciousness to its performance and the C315BEE grabbed every little inflection in her voice.

In terms of instrumentation, the NAD was equally adept here. Spinning 'Tarantella' from Antonio Forcione's 'Touch Wood' album, the C315BEE picked up on the character of each instrument perfectly and captured the nature of each with impressive perspicacity. One aspect I did notice, however, was that the double bass was very well rendered and nicely resonant in its feeling, but that each bass note seemed to be staying around for a little longer than was strictly necessary.

Shifting gear and musical style to the Chemical Brothers' 'Star Guitar' showed that the NAD was indeed a little loose at the very bottom end, as the essential rhythm of the track was well captured, but the bass line did seem to fall over itself a little bit.

At the top end, however, the NAD once again impressed. Its treble is sweet and detailed with excellent levels of atmosphere and high frequency separation. The

cymbals backing Diana Krall positively shimmered out of the loudspeakers and the percussive strikes from The Cinematic Orchestra's 'Every Day' faded off into the distance with commendable aplomb.

So, with things off to a good start, I duly switched over to the Cambridge and found that this was something of a change. Most noticeable was the lack of bass wallow from the 340A SE - things were much tauter and faster. On the downside, though, low end detail seemed to have suffered as bass guitars and acoustic basses faded into the background somewhat. They were all still there but had to be listened for.

Again, a differing character presented itself across the top

REFERENCE SYSTEM

Goldring GR1 turntable/Ortofon 2M Red
Cambridge Azur 640P phonostage
Eastern Electric MiniMax CD player
Usher S520 loudspeakers
Sound Organisation Z1 stands



A masterful cable that will cause a stir.

MIT Music Interface Technologies™



the absolute sound
2007 Golden Ear
Award Winner

**MIT Oracle MA loudspeaker cable:
2007 Golden Ear Award winner.**

*"Instrumental images within the
soundstage were presented
with more air and space around
them...Had I not heard the Oracle MA,
Magnum MA would be my reference."*

Robert Harley—The Absolute Sound

Distributed by:



P.O. Box 988, Cheltenham, Glos., GL50 9FJ
www.audiobility.co.uk
Telephone: 0870 777 2991

Audio Destination
Tiverton, Devon
01884 243 584

Brighton Hi-fi
Flimwell, East Sussex
01580 878 101

Divine Audio
Market Harborough, Leicestershire
01858 432999

Doug Brady Hi-fi
Warrington, Cheshire
01925 828009

Loud & Clear
Bonnington Mill, Edinburgh
0131 555 3963

Loud & Clear
Finnieston, Glasgow
0141 221 0221

Mike Manning Audio
Yeovil, Somerset
01935 479 361

Music Matters
Solihull, Birmingham
0121 742 0254

O'Brien Hi-fi
Wimbledon, London
0208 946 0331

Progressive Audio
Rainham, Kent
01634 389004

sound proof

Moon Electronics by Sim Audio, manufacturers of high end audio since 1980.

Multi award winning CD Players, Integrated Amplifiers, Pre-amplifiers, Power Amplifiers available only from specially selected dealers.



redline

MOON
ELECTRONICS

Velodyne
SPEAKERS

ARTISON
LOUDSPEAKERS

ABBEEY ROAD CABLE

Distributed in the UK by Redline T: 0131 555 3922 E: info@red-line.co.uk www.red-line.co.uk

end, with the Cambridge proving to be crisper generally but lacking a certain amount of fine detail from gently brushed cymbals for example. In addition, with less than well recorded material, the 340A SE could have a tendency towards edginess, adding a certain amount of roughness on occasion.

Across the mid, the Cambridge proved as equally adept as the NAD at teasing out the nature of instruments. Again, Antonio Forcione's instrumentation was well delineated and this time the bass was firmer and flowed better. In soundstaging terms, everything was again neatly laid out and the action was easy to follow, but the Cambridge did not project the action into such a wide arena as the NAD. In addition, the slight top end edge did rob a certain element of realism from the cello, almost making it sound slightly processed.

With the Chemical Brothers back on the platter, however, the Cambridge really came into its own. The 340A SE really loves to boogie and laps up anything with a dynamic nature. The NAD is very good on material like this but the Cambridge just adds that extra element of toe-tapping ability, thanks to its tauter low end, and impressive sense of timing.

CONCLUSION

The spirit of the NAD 3020 well and truly lives on in the soul of the C315BEE, as it is an excellent all round amplifier with the sweet, open nature of its ancestor, along with similarly impressive drive capabilities. It does have that slight bass bloom [as indeed did the 3020 - Ed.] but this can be managed through judicious choice of partnering loudspeaker, and is much less likely to be a problem if the amplifier is used with smaller bookshelf designs, as is highly likely.

The Cambridge Audio Azur 340A SE is an equally adept budget design with an addictive rhythmical ability, better tautness in the bass and good top end crispness that will add a bit of verve to MP3s, for example. It also has rather better build quality than the C315BEE. Where it stumbles a little is in the finer details and soundstaging, not really quite picking the last little nuances out of the depths of recordings.

All in all, the Cambridge is a very good budget amplifier, but the NAD is an excellent amplifier that just happens to carry a budget price tag.



MEASURED PERFORMANCE

NAD C315BEE

Into a 4 Ohm load, most common nowadays, this little amp delivers 80 watts, so has impressive amount of grunt for its size. The figure falls to 55W into 8 Ohms - still enough to go very loud and higher than NAD's conservative rating of 40W.

Distortion levels were extremely low at all levels and frequencies, the distortion residual looking particularly benign. This is what NAD are well known for, their budget amplifiers measuring like the best.

With tone controls switched out, frequency response measured flat and wide, running from a low 5Hz all the way to 133kHz. Selecting tone controls introduced slight bass boost with both set to zero. Each control was effective, providing well defined boost levels at spectrum extremes, with a nicely defined low level trim ability to subtly alter tonal balance.

The amplifier is usefully sensitive at 230mV across all line inputs, so it will match low gain external phono stages well.

The C315BEE is a well worked out design that performs well in all respects under measurement. NK

Power	55watts
CD/tuner/aux.	
Frequency response	5Hz-133kHz
Separation	78dB
Noise	-110dB
Distortion	0.0045%
Sensitivity	230mV
Damping factor	76

DISTORTION

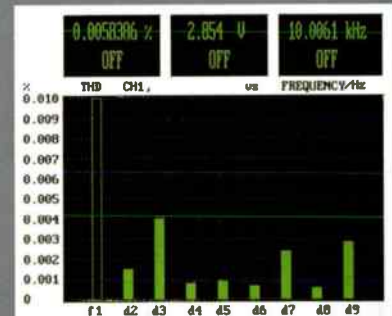

MEASURED PERFORMANCE

CAMBRIDGE AZUR 340A SE

The Cambridge 340A se produces a modest but useful 44 watts into 8 Ohms, rising to 60W into 4 Ohms. They are not shattering levels of power, but sufficient to play loud with reasonably sensitive loudspeakers of 87dB/Watt or more. Although not billed as Class D there were some similarities, with a very high frequency residual output, plus a peculiar triangular distortion pattern and decidedly odd spectral distribution of harmonics.

As distortion levels were fairly low, measuring 0.05% worst case, this is unlikely to be overtly audible, but I would expect some slight roughening of treble. With an extended treble response and distortion pattern like this the Cambridge is unlikely to sound warm and cuddly, more like fast and incisive. The damping factor is also peculiarly low, so bass might be a little more sizable than usual. The tone controls work only at spectrum extremes, providing nicely tailored trim shapes that should be useful.

The 340A se is a little unusual

under measurement. It will likely sound fairly fast and incisive, and may have fulsome bass. NK

Power	44watts
CD/tuner/aux.	
Frequency response	7Hz-80kHz
Separation	74dB
Noise	-100dB
Distortion	0.02%
Sensitivity	400mV
Damping factor	19

DISTORTION

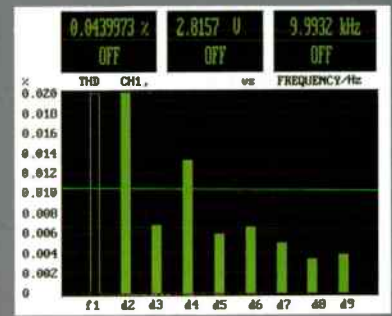

VERDICT ●●●●● Stylish and well built budget amplifier with an infectiously dynamic nature.

CAMBRIDGE AUDIO
AZUR 340A SE £180
 Cambridge Audio
 +44(0)845 900 1230
 www.cambridgeaudio.com

- FOR**
- bass control
 - dynamic nature
 - build quality
- AGAINST**
- bass lacks detail
 - treble insight

VERDICT ●●●●● Couth, polished sounding budget super amp with serious power at the price. The spirit of the 3020 lives on!

NAD C315BEE £180
 Armour Home Electronics
 +44(0) 1279 501111
 www.nadelectronics.com

- FOR**
- excellent soundstaging
 - bass detail and punch
 - sweet, open top end
 - power delivery
- AGAINST**
- slightly loose bass



**WIN A
FANTASTIC
ORIGIN LIVE
AURORA 2
TURNTABLE
WORTH £750!**

QUESTIONS

[1] ACCORDING TO DP, THE OL IS A LEAN AND MEAN WHAT...?

- [a] "record playing machine"
- [b] "record cleaning machine"
- [c] "thrilling machine"
- [d] "grilling machine"

[2] HOW MANY TIERS DOES THE AURORA'S DESIGN USE?

- [a] two
- [b] three
- [c] four
- [d] seven

[3] WHAT DOES THE AURORA'S BEARING ROTATE ON?

- [a] a film of special oil
- [b] a cushion of air
- [c] a bed of feathers
- [d] a handful of leaves

[4] ACCORDING TO DP, WHAT ARE THE WATCHWORDS OF THIS DECK?

- [a] "effortless control"
- [b] "shock and awe"
- [d] "swings and roundabouts"
- [c] "bread and butter"

January Competition
Hi-Fi World Magazine
Unit G4 Argo House
The Park Business Centre
Kilburn Park Rd.
London NW6 5LF

Here's your chance to win one of the very best mid-price turntables on the market, the finely engineered Origin Live Aurora 2. This is what David Price wrote about it in the December 2007 issue of *Hi-Fi World*... "As soon as you unpack it, one immediately begins to understand designer Mark Baker's claim that it's, "based on a Formula 1 design approach rather than Mercedes Benz". To wit, you don't get acres of glossy Perspex, chintzy chrome plated detailing or silky smooth SME-style surfaces. Instead, it's a stripped down, lean and mean record playing machine. By the standards of Michell's rival TecnoDec for example, it's less 'lavishly finished' but is also mechanically more sophisticated. A two-tier turntable that's far more complex than it looks, it features a non-suspended subchassis resting on a single point to isolate it from vibration. The deck has a very high grade bearing which is precision bored, honed and polished, letting it rotate in a pure film of special oil. The platter's made of a "special plastic that is a considerable advance on the standard acrylic commonly employed in the industry", and is driven by a large standalone ironless

DC motor pod with no cogging effect. All materials used in respective parts of the deck have been carefully chosen to complement one another, as have the shape and forms of the materials and how they're attached.

The Aurora's obvious complexity rewards with a class-leading sound. It's an extremely neutral, open and incisive tool with a surprisingly grippy yet free-flowing musicality and natural tonality. The new deck served up a very wide, spacious recorded acoustic which was impressively three dimensional. Within this, there was a good degree of detail, especially across the midband which was as transparent as any deck I've heard at this price point (and indeed the equal of several more expensive designs). Tonally, the Aurora is a tad more stark than some rivals,

which isn't to say it's bright. It gives the impression of a turntable with its running shoes on. Effortless control is the watchword(s) of this deck – it has grip aplenty but still has a nice, relaxed demeanour which doesn't sweat as it tries so hard to tell you what's on the disc. Mark Baker set out to make a no-compromise, best-sound-per-pound sub-£1,000 turntable, and has succeeded."

If you'd like to win this superb turntable, all you have to do is answer the four easy questions at left. Send your entries on a postcard by 31st December 2007 to: January 2008 Competition, **Hi-Fi World magazine, Unit G4, Argo House, The Park Business Centre, Kilburn Park Road, London NW6 5LF.**

RULES AND CONDITIONS OF ENTRY

- ONLY ONE ENTRY PER HOUSEHOLD
- MULTIPLE ENTRIES WILL BE AUTOMATICALLY DISQUALIFIED
- PURCHASE OF THE MAGAZINE IS NOT A PRE-CONDITION OF ENTRY
- NO CORRESPONDENCE WILL BE ENTERED INTO
- THE EDITOR'S DECISION IS FINAL
- NO EMPLOYEES OF AUDIO PUBLISHING LIMITED, OR OF ANY COMPANIES ASSOCIATED WITH THE PRODUCTION OR DISTRIBUTION OF THE PRIZES, MAY ENTER

entries will be accepted on a postcard only

**OCTOBER 2007 SHANLING SYSTEM WINNER:
Hans Lennart of West Lothian, Scotland**



Noel Keywood tries out an interesting new Class D monoblock power amplifier from Trichord, the D300...

In Accord

Mammoth amplifiers are going the way of the mammoth it seems - into extinction. I'll not be one to miss them, as a variety of monsters have graced my lounge over the years and I never quite fell in love with any of them. It wasn't just size that was a problem, but also the threatening bangs they commonly delivered to a loudspeaker when the fridge switched on or off. This seemed to echo their sound - as powerful as a Mack truck, and just as subtle. Amplifiers like this are moving into history as Class D powerhouses, a fraction of their size, take over. Trichord's new D300 monoblocks are an interesting example of this new breed. Producing 300 watts apiece, Trichord claim, each one can be picked up using just one hand, as they weigh 5kg each!

Small size raises interesting possibilities. I put both D300s on

the floor, connected by 1m long Chord Company signal leads to a preamplifier. This gets rid of heavy loudspeaker leads, in my case Van Den Hul Royal Jades, snaking up the back of the rack. A couple of flexible phono cables are easier to cope with. It also frees up a shelf which is handy, as I need as many as I can get. This usefully tidies up back of the rack, leaving my small, much tweaked KLP1 preamplifier as the control centre, as it were. Unfortunately, as the case of each D300 is 360mm deep, and at least 420mm if you take into account rear signal leads; with a case width of 220mm two of them actually consume as much floor space as my 300B World Audio Designs valve amplifier. The less powerful Channel Islands D100 monoblocks we reviewed in the June 07 issue are more compact. With both, however, it is possible to get the power amplifiers away from the rack, to an inconspicuous position on the floor,

or even behind the loudspeakers, connected only by a very short loudspeaker cable. This is a distinct benefit of monoblocks.

Long signal cables are arguably a better idea than long loudspeaker cables, especially if sound quality suffers in solid-state amplifiers due to radio pickup (well, general r.f. crud) by long loudspeaker cables. This has always been a problem close to transmitters like Crystal Palace, one I used to fix by soldering small capacitors across the base-emitter junction of an amplifier's input transistors. Nowadays we commonly run wireless routers and mobile phone transmitters at home, as do neighbours my network scanner tells me, so there is more r.f. around than ever.

Shortening unscreened loudspeaker leads and lengthening the screened signal cables is a good idea in such circumstances. It may also be a good idea if colouration is at all

iCube™ 7"/12" vinyl storage

super-stylish storage cubes for 7"/12" vinyl



7" £18.99
natural was £40 save £21.00
12" £28.99
natural was £50 save £21.00

buy 7 get 1
free

p&p only
£4.99

orderline: 01328 730405

www.i-cubes.co.uk email: info@i-cubes.co.uk

iCube™ 12" new black finish vinyl storage

new & exclusive limited edition black iCube



12" £33.99
black was £60 save £26.00

ready-made
18mm mdf

holds up to
100 lps

orderline: 01328 730405

www.i-cubes.co.uk email: info@i-cubes.co.uk

Analogue Seduction

where music is our passion



Analogue Seduction are dedicated towards two channel Hi-Fi, specialising in vinyl replay.

As well as our on-line shop we have dedicated demonstration retail facilities based in Peterborough, Cambridgeshire and we can offer our customers home demonstrations.

We stock the finest in amplification, analogue, digital replay and speakers. We also specialise in a cable termination and cable burn in service.

Please visit our website www.analogueseduction.net to browse or purchase products that are not easily available elsewhere.

New vinyl records now stocked

Tel: +44 (0)1733 344768

MAGNUS AND LARSSON HOME THEATRE PRODUCTS



SIGNATURE EDITION
2100 SERIES: £539.00



SIGNATURE EDITION
3100 SERIES: £439.00

DOLBY DIGITAL

DOLBY DIGITAL

DESIGNED IN DENMARK

www.dragon-i.com.au
dragonidistributors@yahoo.com

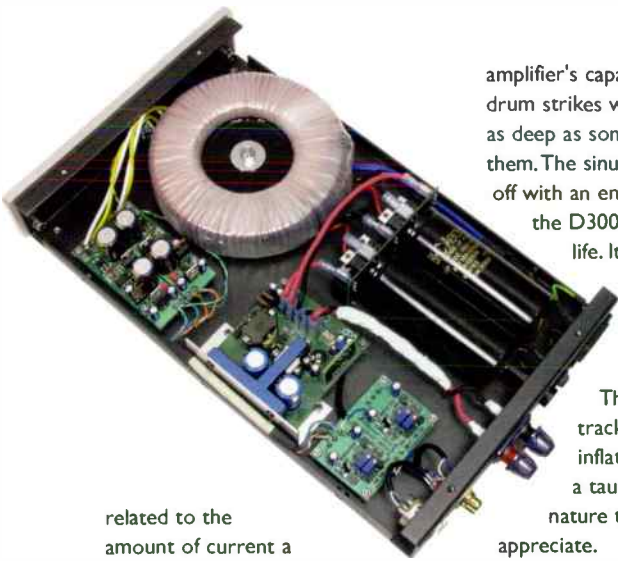

amplifier's capabilities. The initial drum strikes were taut, if not quite as deep as some amps will portray them. The sinuous bass line kicked off with an enthusiasm that showed the D300s have real dynamic life. Its portrayal was concise, standing out clearly from what is a complex mix of instruments. This underpinned the track nicely, not by dint of inflated power, so much as a taut and pacy rhythmic nature that was easy to appreciate.

The many inflections within Angelique Kidjo's lively vocal style were laid out clearly: this is a truly insightful amplifier, vividly so at times. Its relatively dry bass delivery was repeated across the midband, laying bare echoes and effects used to embellish Tina Turner's Break Every Rule. This track is another test of bass control and again the D300s displayed enormous grip and fast pace. With both women, however, tremendous insight into their performances was attained through a crisp delivery free from any hint of warmth. The D300s are revealing, that's for sure, but they place analysis a notch above emotion. The sound stage sat relatively far back in my lounge, stretching widely between a pair of RRR FS100 loudspeakers.

related to the amount of current a cable carries. Long signal leads are technically acceptable, as preamps usually have line drivers on board that will happily drive the capacitance of a long line.

Such lines are unarguably better if they are balanced and screened. Balancing automatically cancels interference and is always used in studios, P.A. systems, music venues and outside broadcast - anywhere where signal leads must be long. The Hypex module comes with a fully balanced input, but whilst Channel Islands use it unbalanced, offering only a phono socket input, Trichord fit both XLR and phono sockets, with switched selection, so the D300 can be run balanced, from a preamplifier with a balanced output.

As my valve KLPI preamp has only unbalanced outputs I did not run it like this, but where the option exists balanced working is sonically preferable; it sounds clearer and appreciably more concise.

Output to the loudspeakers is provided by 4mm terminal posts that accept bare wires, 4mm plugs and spades. The power switch is a small rocker on the rear panel, whilst the front panel sports a single blue LED power on indicator. Power on is silent and thump-free but power off brings forth rude noises from the loudspeakers, after a short time delay, which was irritating.

Strictly speaking, this amplifier is not digital - and nor is any Class D, but that is a little academic. It uses the same basic system - pulse width modulation or PWM - commonly referred to as digital nowadays. In the D300 Trichord have mated Hypex modules with a conventional power supply, much like the impressive Channel Islands DI100 monoblocks we reviewed in our June issue, but Trichord use a more powerful version of the module.

SOUND QUALITY

Spinning Angelique Kidjo's 'Agolo' gave me a good impression of this

Spinning Carlos Santana's Supernatural DVD (DVD-A, 24/96) underlined just how open and frankly revealing these amplifiers are. I could hear right into the complex percussion work of Yaleo, and Santana's guitar work scythed sharply out of the mix. The track's sudden change of tempo was vivid, horns punching out their strong refrain. The D300s teased out the multiple instrumental strands of Yaleo, laying all out for inspection. Abrupt pace changes within Put Your Lights on were made obvious and here the D300s shone a light on Santana's stabbing interjections. His guitar work was sharply provocative, rather than languid as I know it through my 300Bs!

CONCLUSION

Trichord's D300s are highly revealing monoblocks capable of tremendous insight. They are vivid and fast in the way they deliver music, but need to be partnered with care for a balanced sound. Sendor S8es would do nicely, I'd suggest, as they have a silky smooth midband but an exuberant bass end in need of control. Compact and powerful, the D300s currently have little competition for anyone wanting to run modern Class D monoblocks from balanced lines. Evolution has brought us an altogether more nimble replacement for the mammoth.

VERDICT ●●●●●
Super sounding compact monoblocks with 'state of the art' Class D sound, but don't suffer poor sources gladly.

TRICHORD RESEARCH
D300 £2400/PAIR
Trichord Research
+44 (0)1684 311600
www.trichordresearch.com

FOR
- vividly insightful sound
- clean power
- balanced option

AGAINST
- careful matching needed

MEASURED PERFORMANCE

Using Dutch Hypex modules, which are based on a Philips spin-off technology, Trichord's D300s are Class D switching amplifiers. As such they are efficient and run cool, even when delivering high power. Under test the D300s delivered 144 watts into 8 Ohms and 240 watts into 4 Ohms without even getting warm, using sine wave tests. I could not quite get the claimed 300 watts from them even with short sine wave bursts, managing 280 watts absolutely maximum.

Class D technology currently suffers many drawbacks, one being high distortion, but the Hypex modules come out well here. Distortion never exceeded 0.1% at any power or frequency. At low powers second and third harmonic dominated; only as power increased did upper harmonics take over.

There was no d.c. (common mode offset) on the loudspeaker terminals, nor any between them (differential offset). Noise was low, although there was a high frequency switching residual at 435kHz, but this is unlikely to affect loudspeakers. Frequency response rolled off smoothly above 30kHz; the amplifier isn't band limited at 20kHz, nor is its frequency response seriously affected by load, dropping

from -1dB at 30kHz to -1.3dB at 8 and 4 Ohms respectively, with no change at all to the audio band characteristic from 5Hz to 20kHz.

Damping factor was an unusually high 126, suggesting there is no output network with a series inductor.

Trichord's D300 turns in an impressive set of results, characteristic of Hypex modules we have measured before. A good sound is almost guaranteed. NK

Power	144watts
Frequency response	7Hz-30kHz
Noise	-117dB
Distortion	0.008%
Sensitivity	900mV
Damping factor	126

DISTORTION

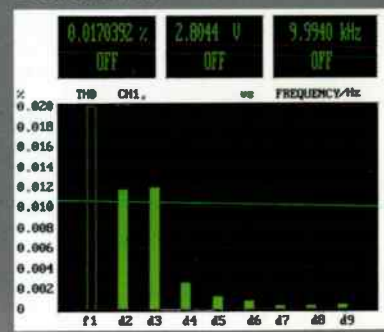

Naim That Tune

David Price tells the story of Naim Audio's music division, Naim Label...



Every aspect of the recording and mastering process receives serious attention to detail...

It's not every manufacturer that starts its own music label to demonstrate the abilities of

its brand new CD player, but this is what happened back in 1992 when Salisbury's hi-fi specialist took its first step into the Compact Disc hardware market.

"Having designed our first CD player in the early nineties, we found that we couldn't rely on poor quality mass market discs to demonstrate our hardware. So, in 1993 the first true Naim label release found its way to the counters of hi-fi stores in the form of Gary Boyle's 'Electric Glide'. Lovingly remastered by Naim's founder Julian Vereker MBE, the record was licensed to Naim purely as a demonstration that CD could be an audiophile format after all", says Naim Label boss Simon Drake.

Naim's first official release became a great tool for demonstrating the company's new CDS1 silver disc spinner, sidestepping one of the biggest problems the company had back then – the audio quality of existing software. "We aimed to introduce an audiophile alternative to the over-produced, generically mastered music, which incidentally is still available on the mass market today", adds Drake.

Interestingly though, despite the label's birth as a unashamedly 'audiophile' label, Naim Label hasn't gone the way of some others which obsess about sonics to the detriment of artistic merit. Rather than simply building its roster around superlative quality recordings, the label's trajectory has taken it to great artists, who it then records to

the highest possible standards. Simon Drake adds, "I

am confident that Naim stands tall amongst other audiophile labels, because we have not lost sight of an

artistic approach. Hi-fi is all about the music, and this is something that underpins everything we do. We hear something we love, irrespective of genre, irrespective of audience and we want to translate it in the audiophile way".

Amongst Naim's higher profile artists are Charlie Haden ("possibly the most influential free-jazz double bass player in the world"), Antonio Forcione ("one of the most diverse, creative and experimental guitar virtuosos"), pianist Fred Simon (ex-Windham Hill), Mike Lindup (Level 42 keyboard maestro), guitarist Nicolas Meier ("Metheny-esque") and jazz pianist Laurence Hobgood ("incredible"). Naim Label has also featured ex-Pat Metheny Group drummer Paul Wertico, Sting's guitarist Dominic Miller, John Taylor, Chris Anderson, now Brazilian Girls star Sabina Sciubba, Jason Carter, and Grammy award winning jazz vocalist Kurt Elling.

Keeping these artists happy is paramount. "I think Naim appeals to so many artists of different genres, because of our belief in rightful artistic reward," says Drake. "We make sure our artists are given larger proportions of the profits than other labels would dream of. And of course, I think musicians relish the opportunity to have their work produced to such inherent high standards.

People like Charlie Haden, who has always been signed to major labels while we have worked with him, makes sure he can record performances for Naim at the same time. In general our artists record on 'a per album basis'. This means they are free to do as they please, and will never walk away having to owe us lots of cash! This is the respect that is due for the immense artistry they provide."

ON THE RECORD

Over its fifteen year lifespan, Naim Label has built up a redoubtable network of producers, one of the most prolific being Ken Christianson, "a fantastic live engineer who incidentally owns Chicago's biggest Naim retailer in the US". He has pioneered the company's True Stereo

technique over forty releases. "Ken achieves an incredible instrumental and spatial balance with an innovative live stereo mic technique that upholds indigenous analogue sound properties by going straight to tape on a Nagra IV-S reel to reel", says Simon Drake.

The label is very aware of acoustics – either sonically excellent ones in their own right, or those conducive to getting the right sound for a particular recording. "For example, a pianist might love the feel or notoriety of a certain piano at a certain venue. Sometimes studios in the middle of nowhere can help provide the inspiration and calm necessary to get the required performance".

Recording engineers are no less vital to the Naim Label sound. Working on twelve albums with Antonio Forcione has cemented a friendship with Peter Williams, who has recorded the likes of U2, while Martin Levan, whose client list includes Andrew Lloyd Webber, Iron Maiden, John Martyn and Barbara Thompson operates out of Red Kite Studios. Both appreciate Naim Label's 'hands off' policy, giving them the space to get the job done without interference.

Of course, another critical aspect is mastering, and for this Naim have used Finesplice since the early days because, "they understand perfectly the necessity of purity and the importance of preserving our analogue sources! We insist on going to Abbey Road to work with Steve Rooke, who always puts a lot of heart in to the listening process", says Drake.

Meticulous attention to detail with the recording - using the simple but very critically balanced True Stereo technique – plus the right choice of venue (chosen more for the musician's peace of mind than for simple considerations of acoustics), the right producer, engineer and mastering – allied to a hands-off artistic policy - is what constitutes the Naim Label sound. All this goes to capture, "that moment in time, that spellbinding take, where everything truly fell in to place for the musicians".

naim
world class music...

INTO TOMORROW

Although Naim Label started out very much as CD-centred, it is releasing more music on vinyl now. Over the past decade and a half, it has released over eighty titles, ten of which are also available on black plastic. "We have pressed just under 400,000 records since the label's conception - we are very proud of what we have achieved", adds Drake.

Currently their output is very much focused on physical formats (i.e. CD and LP), but increasingly the roster is being distributed electronically via iTunes, eMusic, Napster and Wipit - the four largest download services. "The tectonic plates of a very confused music industry are rumbling in several different directions at present. It is great to see pop artists releasing 7" vinyl and even USB keychain albums, and even greater to see people buying it", says the Naim Label boss.

"From here on in, it's our job to enlighten people to life beyond MP3. In the not too distant future our first hard discs player with fully uncompressed music file storage and playback will be launched. We are confident that this 'sign of the times product' will really surprise the MP3 playback generation. Of course, we will be preloading them with some tasty Naim Label tracks! We have a first-class small team behind us, dedicated to making the most of every recording opportunity."



Naim Label boss Simon Drake.

**Sampler 6
NAIMCD106**

This celebratory musical gathering summarises an eventful two-year term for The Naim Label. Sampler 6 encompasses everything from nostalgic Jazz to cutting edge World Dance music. Superb sound quality is complemented by outstanding instrumentalism, honesty and most significantly, passion.



**'Tears Of Joy' from 'Tears Of Joy'
ANTONIO FORCIONE
NAIMCD087**

Teaming up with Nathan Jones (upright bass), Jenny Adejayan (cello) and Adriano Adewale (percussion), this title track from Forcione's latest and most extravagant studio album, demonstrates not only the intricate delicacy of Forcione's unique guitar technique, but also the supreme talents of the Antonio Forcione Quartet.

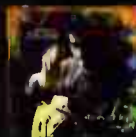

**'Fallen Angel' from 'Pigeon Coup'
DANIEL MULHERN
NAIMCD096**

London based singer-songwriter Daniel Mulhern plucks tenderly from a diverse range of inspiring rock and folk influences, both young and old. 'Fallen Angel' is the opening track from his 2006 Naim Label debut album 'Pigeon Coup', capturing the imagination with modesty and style.



**'9/11' from 'The Ark'
JOHN VAN DER VEER
NAIMCD105**

Handpicked from an album of bold and blissful instrumental music for five acoustic guitars, 'The Ark' is John van der Veer's debut for The Naim Label. In this conceptual piece, the guitars capture the tragic events of 9/11 with despairing and evocative prosodic imagery.



**'Remember The River' from 'Remember The River'
FRED SIMON
NAIMCD081**

Fred Simon exhibits his contemplative and beautiful repertoire of piano-led composition in this beautiful True Stereo recording from the eagerly awaited album of the same name. This unedited live session features Oregon reed player Paul McCandless and Metheny Group bassist Steve Rodby. The ex-Windham Hill pianist is currently working on new material with the addition of Oregon percussionist Mark Walker.



**'Anna' from 'Heartplay'
CHARLIE HADEN & ANTONIO FORCIONE
NAIMCD098**

The subtle and sublime yet powerful fusion of these two instrumental greats on The Naim Label, can be summarised by this unforgettable rendition of one of Forcione's fondest and most timeless compositions, 'Anna'. The piece is taken from a magical True Stereo album recording in which the guitar and double bass exchange melodic complexities as if it were child's play.



**'More Than You Know' from 'Crazy World'
LAURENCE HOBGOOD TRIO
NAIMCD084**

A unique True Stereo recording experience, 'More Than You Know', is a timeless classic, embodied by Kurt Elling,



the guest vocalist's unique tone and style and supported by the supreme talents of jazz pianist Laurence Hobgood's smooth jazz trio; Rob Amster (double bass) and Frank Parker (drums).

**'Voices From Across The Ocean' from 'Digital Dreaming'
HELD LAMPI PROJECT
NAIMCR03**

The embodiment of producer Zeus B. Held and Jim Lampi's inspiration for Digital Dreaming. Stimulated by the culture and geography of Aboriginal Australia, 'Voices' features everything from Didgeridoo to Lampi's Chapman Stick with a fruitfully evocative and uplifting aesthetic.



**'From The North' from 'The Helsinki Project'
JASON CARTER
NAIMCD102**

Described as Global Fusion, Carter's vision as a producer, composer and classical guitarist has undoubtedly been fulfilled with 'The Helsinki Project'. Jason's clever combination of musical cultures creates an aesthetic that propels the listener into Carter's nomadic lifestyle, on this occasion celebrating Nordic culture, through the thought-provoking medium of Middle Eastern, Western and Asian instrumentation.



**'Vatan/Homeland' from 'Yüz'
NICOLAS MEIER
NAIMCD103**

Vatan/Homeland is an upbeat extract from Yüz, Nicolas Meier's multi-cultural extravaganza. Combining aspects of jazz and blues with world music, guitarist Meier's second Naim Label release is underpinned by the superb talents of Asaf Sirkis (drums), Gılad Atzmon (Turkish clarinet) and Tom Mason (double bass).

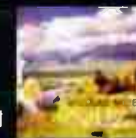

**'Ballad For Nori' from 'Of Recent Time'
REUBEN HOCH
NAIMCD088**

As one of Reuben Hoch's own compositions, this experienced bandleader and highly proficient drummer makes his Naim Label debut in glorious True Stereo with both delicacy and vigour. Taken from the 2006 album 'Of Recent Time', the track features Don Friedman (piano) and Ed Schuller (upright bass).



**'Dining By Rail' from 'Another Side'
PAUL WERTICO
NAIMCD093**

Whilst cleverly maintaining the sense of train travel through Wertico's drum patterns, 'Dining By Rail' demonstrates the lighter side of Paul Wertico Trio's boundary pushing Jazz. Once the drummer of Pat Metheny Group, 'Another Side' is Wertico's only Naim Label recording to date.



**'Prayer For The Enemy' from 'Crazy World'
LAURENCE HOBGOOD TRIO
NAIMCD084**

'Prayer For The Enemy' reminds listeners of the great skill of pianist Hobgood. This time unaccompanied by Elling's commanding vocal presence, Laurence and company are free to roam an intricate world of melody with commitment and conviction. 'Prayer' is one of Hobgood's finest compositions and a personal favourite of the pianist, who was described by The Chicago Reader's Neil Tesser as "one of the most powerful and accomplished pianists in American Jazz".





It's been a while since Arcam did loudspeakers, so – despite its diminutive dimensions - the new Muso is a big moment in the company's history, says David Price...

Small Time

The last time Arcam sold loudspeakers, the Falklands war was making the news pages and Duran Duran the gossip columns. Indeed, the company was still going by the laborious title of the Amplification and Recording Company, Cambridge Ltd., and their best selling product was the legendary A60 integrated amplifier...

It's a very different world into which the Muso is born. The company's first loudspeaker for a quarter of a century, it's a long way in terms of design, build and manufacture from the late, lamented Arcam One, and has come to market for very different reasons. Now, Arcam's star seller is the Solo – a superb one-box music system that deserves all the (not inconsiderable) praise it has garnered, in both 2.0 Music and 5.1 Movie variants. Along

with the Logo subwoofer, the Musos complete the package – by offering these little boxes, the company is able to offer, for the first time in a long time, a complete system.

The temptation is then to suspect that the Musos are simply a range-filler – a way of giving dealers the chance to sell an all-Arcam system. And indeed, I must confess to having thought this very thing before I opened the two small boxes these £280 (per pair) loudspeakers come in. However, pull them out of their packaging and you soon realise that there's more to them than that – Arcam have obviously approached their new speaker with all the seriousness that the Solo electronics were accorded. Indeed, they sport some very interesting construction methods. These are most definitely not just your average wooden boxes, as the combined aluminium and steel

enclosures show...

Materials usage is critical – the elementary building blocks of everything man-made have a profound effect on the finished article; it's not just what you do but what you do it with. In the case of the Muso, we have a loudspeaker enclosure that is super-rigid and acoustically dead (the differing resonant frequencies of the two metals doubtless helping to cancel vibes out in the other). In addition to this, Arcam uses resin-damped metal-to-metal bonding and specifies 'SDA' Sound Dead Aluminium to further damp the cabinets – and there's a compliant rubber isolation mat included, for sitting the Musos on bookshelves.

This is esoteric stuff for budget boxes, but in other respects the Muso is more conventional, being a two-way bass reflex design (with

the port at the front for positioning close to walls). The tweeter is a 25mm (1") ultra light aluminium dome, and the mid/bass unit an 85mm (3.5") polymer/aluminium cone. The crossover is an eight element design with an air-cored HF inductor on a Glass Fibre PCB. Round the back there are single-wired, gold-plated 4mm binding posts. At 120x155x230mm, the Muso is small by any standards, although still a tad larger than my current favourite micro speaker, the Monitor Audio Radius 90, and weighs quite a lot (considering its size) at 3.3kg apiece. A bespoke Muso floor stand and wall bracket are available.

SOUND QUALITY

Arcam says that the Muso's bass performance is "far beyond that of a typical satellite speaker, meaning it can be used as a simple stereo pair when placed close to a wall". Well, this is precisely what I did – choosing not to complicate matters by the addition of the matching Logo subwoofer. Indeed, in my experience, subs can be more trouble than they're worth – the old maxim 'two's a company, three's a crowd' often applying in situations like these.

The important thing is to make sure the Musos are solidly locked to their supports, be that a windowsill, speaker stand or kitchen unit. I tried them in a number of locations, and wrongly sited they could sound ponderous and a little lost – it was only when I tightly coupled them to my listening room's deep windowsills with blu-tack and removed their slightly rattly (but admittedly very neat) grilles that they really came on song, and came on song they most definitely did...

Kicking off with Soul II Soul's 'Keep on Movin', a classic slice of late eighties house with a strong, pounding bassline, the Muso's impressed by not falling over themselves trying to keep up. As you'd expect from any loudspeaker of their small stature, low frequencies weren't exactly overpowering, but the speakers were surprising in the way they made a real stab at trying to reproduce the mix in its entirety. Despite the odds, they remained couch and didn't let the fact that they obviously had their hands full in the low frequency department spoil things further up.

I found the Musos sounded very smooth and even, almost bass-heavy by the standards of rival miniatures. Ramping up the volume saw them remaining as couch as ever, and unlike the similarly sized MA Radius 90s they didn't harden up as the

drivers reached the end of their natural excursion, nor did they sit on dynamics as much as I remember fully extended Radius 90s doing.

Again, the midband was smoother and warmer than I'd have expected, the Musos proving clean and open (at least by the standards of other speakers at their price), with a wide and accurate stereo image. They're not the most expansive, capacious speakers I've heard, but still manage to drive a small to medium sized room with surprising alacrity. The Crusaders' 'Street Life' on vinyl saw the Musos hanging singer Randy Crawford's voice back with glorious restraint – just as this song should be. Where other budget speakers nail her tonsils to your cranium, so to speak, the Arcams gave a very smooth and even rendition of the track, showing refinement unexpected at the price.

REM's 'Welcome to the Occupation' showed their fine mid/treble integration. This late eighties indie rock song, with swinging power chords from ace guitarist Peter Buck, was smooth and even in balance. Some aluminium HF units I've heard have made their presence all too apparent, but not so here. True, they lack the last degree of finesse of a good ribbon, but they were crisp and well integrated with the midband. What this track showed off to best effect was the Muso's timing – they're nicely musically engaging and can really carry a groove if called upon so to do. In absolute terms, the Musos sounded a tad congested and dynamically compressed – but this is an observation rather than a criticism considering their size and price.

CONCLUSION

An excellent pair of highly compact loudspeakers, these almost suffer from being billed as partnering speakers to a pre-existing system; many won't take them seriously for this reason, but they should. Clean, punchy and above all couch and smooth, they're an ideal partner to both harsh budget systems and highly incisive higher end ones. Factor in an interesting

"the Musos sounded very smooth and even."

approach to their design and fine styling and detailing, and many will love Arcam's new Muso. Times may change, but Arcam's speaker design nous remains.



REFERENCE SYSTEM

Technics SL1210/Audio Origami RB250/Lyra Dorian turntable
Note Products PhoNote phonostage
Sugden IA-4 amplifier
Mel Audio Horama loudspeakers

VERDICT ●●●●£

Fine sounding, superbly built micro-monitor able to stand up to many similarly priced full-size hi-fi loudspeakers in the sonic stakes.

ARCAM MUSO £280
Arcam
+44 (0)1223 863384
www.arcam.co.uk

FOR

- smoothness, finesse
- sense of ease
- design, build, finish

AGAINST

- demand rigid mounting

MEASURED PERFORMANCE

The diminutive Arcam Musos measure well, with a nicely engineered flat response across most of their bandwidth, which should give a nice even nature to the sound - very much in the Arcam tradition. The only deviation from this is in the midrange, where output drops at around 800Hz, before peaking up by around 4dB at 1500Hz. This may rob some vocal detail and give a hint of stridency with some material.

Bass output is impressive for such a tiny enclosure, with the main driver operating down to 100Hz and the port, with its broad output spectrum, taking over down to its tuning frequency of below 50Hz. As a result, the Musos should have an impressive low end for their size and not sound ostensibly lightweight.

Electrically the Musos are nicely damped and with a fairly benign impedance response. Average impedance however, is low at 4.8 Ohms, dipping to a minimum of just over 3 Ohms, so the Arcams do present a genuine 4 Ohm load to an amplifier.

Sensitivity for such small units is good at 85.5dB meaning they should work well with 50W or so. AS

FREQUENCY RESPONSE

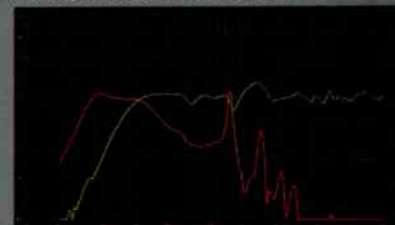

Green - driver output
Red - port output

IMPEDANCE

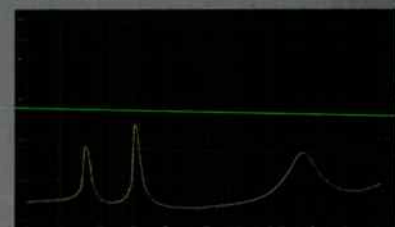



hi audio

Accessing the Source, Unleashing the Performance



*Acoustic Solid Small Machine,
Music Maker MkIII/
Haddock 242 Export Cryo,
Music Maker Classic/
The Conductor.*



*The Conductor "One of the most
musically convincing tonearms ever
made, with a massive performance
to price ratio."*

David Price Hi Fi World November 2006 (5 globes)

*Haddock combo £2500
Conductor combo £4050*

*Features Bruil Stabilising Ring and Acoustic Solid Solid Weight
(not included)*

Featured Analogue Dealers:

Analogue Seduction
(Cambridgeshire)
Tel: 01733 341883.

Audiofile Objective
(Hertfordshire)
Tel: 01279 724024

Audio Merchants
(Glasgow)
Tel: 0141 5522598

Choice Hi Fi
(Surrey)
Tel: 020 8392 1959

Cool Gales Ltd
(Bath)
Tel: 0800 0436710

Doug Brady
(Cheshire)
Tel: 01925 828009

Hazlemere Audio
(Buckinghamshire)
Tel: 01494 865 398

Hi-Fi Corner
(Edinburgh)
Tel: 0131 556 7901

Hi Fi Sound
(Co Durham)
Tel: 01325 241888

Ian Harrison Hi Fi
(Derbyshire)
Tel: 01283 702 875

Noteworthy Audio
(Buckinghamshire)
Tel: 01296 422224

Origin Live
(Hampshire)
Tel/Fax: 02380 578877

Progressive Audio
(Kent)
Tel: 01634 389004

Robson Acoustics
(Cumbria)
Tel: 01768 484000

Rochester Hi Fi
(Kent)
Tel: 01634 880037

South West Analogue
(Somerset)
Tel: 01643 851351

The Audio File
(Cambridge)
Tel: 01223 368 305

The Cartridge Man
(Surrey)
Tel: 020 8688 6565

Walrus Systems
(London)
Tel: 020 7724 7224

Sound Hi Fi dot com
(Dorset)
Tel: 01803 833366

HiAudio - UK Distribution

For your nearest stockist of the full range of HiAudio products visit www.hiaudio.co.uk or call direct on 0845 0525259

House Music



One facet of Linn products is the clear upgrade path, but it's hard to find somewhere to hear every possible permutation. With this in mind, Channa Vithana visited Manchester's House of Linn...

One of the greatest problems with buying hi-fi is knowing where to go with your upgrading plans, and indeed when to stop. Whilst *Hi-Fi World* is happy to advise readers on the worth (or otherwise) of individual products, the key thing is how they work together - or don't, as the case may be. Seemingly random, haphazard system building may be fine for hobbyists, but for those actually chasing the best sound per pound, there's no substitute for listening, and this of course is where a good dealer comes in. Interestingly, this holds just as much for one-make systems, where the wrong combination of same-brand products can be underwhelming, whereas the right combination is precisely the opposite.

The long-term customer satisfaction, assurance and service a good dealer provides is a far more profound saving than bagging a bargain on eBay, for example. A dealer's ability to install the equipment in the customer's home

"it's fascinating to flit between products in all price ranges..."

- to a much higher standard than he or she would be able to - and to provide easy swaps or exchanges if the customer is unhappy with the final result, can be immensely valuable in terms of both time and money saved. But perhaps most important of all is the ability to demonstrate a clear upgrade path. Even if you've decided on a one-make system, then simply buying the newest model isn't necessarily the most cost-effective solution.

This became acutely apparent when visiting Manchester's House of Linn. Having heard countless Linn products in both review and show conditions - and thinking I had a good idea of how they compared with one another and of the relative value they offer - hearing four separate Linn systems, entry level and high end,

stereo and multichannel, in natural domestic surroundings proved a real ear opener.

House of Linn is an interesting concept - being quite literally someone's house, but full of Linn equipment. It is a joint venture between Brian Morris and Trevor Liddle, both of whom are former long-standing senior Linn employees. Rather than a conventional shop-front dealership, this residential house has every Linn product immaculately installed and grouped into both price points and purposes.

For example, there's an entry-level AV room and a high end one, and you can walk directly between the two to see what the extra outlay brings. Similarly, there's the top Sondek LPI2SE installed, up against the classic Sondek CD12 silver disc spinner, should you wish to make analogue vs. digital decisions.

It's fascinating to be able to flit between systems and products in all price ranges like this. With so much kit on dem, without careful organisation there would be a danger of

vast numbers of sprawling racks of hi-fi boxes on show, but this isn't so. Instead, Brian and Trevor have a very clear approach to system building which they have delineated into distinct, adaptable rooms named Majik, Akurate, Artikulat and Komri within the house.

MAJIK ROOM

My Linn system auditioning odyssey began with the Majik Room, which had an 'entry level' LPI2 turntable, Majik CD player, Unidisk SC universal player, Majik Kontrol preamplifier, Majik-I integrated amplifier and Majik series power-amplifiers installed, plus the one box Classik Music and Movie systems. Loudspeakers were Majik, Ninka, Katan and the beautifully designed yet reasonably priced Komponent series. With Komponent



104 loudspeakers starting at £195 each and a Classik Music system at around £999, the Majik Room is very much the affordable entry point for the House of Linn.

Listening sessions commenced with the brilliant cello playing of Yo Yo Ma via the £3,140 Unidisk SC directly connected into a £1,400 Majik 2100 power amplifier and £1,275 Ninka loudspeakers. This is a great way into the Linn sound, being an 'affordable' option that gives an excellent blend of power and finesse. Here I experienced the speed of a Linn system at first hand, allied to its fine timbral resolution. The system served up a highly vivid, powerful sound with serious weight, yet was delicately lyrical too. Tonally a little dry, in the Linn tradition, this isn't one for Quad valve amplifier fans, and instead majored on delivering the clean power of modern recordings with the greatest possible accuracy. Overall, the Majik Room achieved a taut, poised and yet very clear and tuneful sound. It was sufficiently impressive to make me wonder how and where the improvements would come, so I upped and moved on...

AKURATE ROOM

This is where we started reaching the higher end of Linn's product roster, to wit there was the full LPI2SE turntable running alongside a £3,985 Akurate CD/SACD/DVD-A

NEW ringmat anniversary gold spot ●

Be the first to experience this improved version of the Ringmat

- Faster, cleaner sound
- More dynamic yet more transparent
- Noticeably wider soundstage
- Special upgrade price

Buy your New Ringmat Anniversary at:

www.ringmat.com
for easy secure ordering and information
or telephone ++44(0) 1277 200 210

ringmat.com
PUTTING SOUND INTO FOCUS

whestTWO *west-tōō, n* musical, detailed; radical



www.whestaudio.co.uk
t: 020 8965 4535



stereo player, £995 Akurate tuner, £1,750 Akurate Kontrol preamplifier, Akurate power amplifiers and £6,040 Akurate 242 loudspeakers plus a high end Klimax range of amplifiers. Unlike many high end systems, it wasn't a case of gaining on the swings to lose on the roundabouts.

To wit, the lyrical, flowing quality of the Majik system was not lost, but in other areas things sounded more delicate, with more natural textural quality and greater levels of acoustic decay to the notes. The full-bodied three-dimensionality of the music was more obvious, and the music had more spatiality within the Akurate room.

There was a new caress of sweetness to the high frequencies, but this didn't come at the expense of the Majik room's crisp timing. Recordings were revealed with a finer sophistication, and were presented within a much wider musical canvas. Impressive then, as I'd say there was a very comprehensive, if not quite 'night and day' improvement in the sound.

ARTIKULAT ROOM

This is where the proverbial 'jaw dropping' began, thanks in no small part to what, in my view, is Linn's most aesthetically pleasing loudspeaker design yet – the Artikulat. Here, House of Linn had two beautifully crafted £19,400 Artikulat 350 piano black lacquer floor standing models with matching £11,420 340A centre channel and two £16,070 320A standmount Artikulats for the rear channels. Completing this monster loudspeaker set-up were two active 345A Bass Extension loudspeakers (subwoofers) costing £4,820 each. The sources were a £6,830 Unidisk 1.1 universal player, Akurate tuner and fully loaded Linn LP12. The amplification included the high-end £8,390 Kisto and £4,820 Kinon AV preamplifiers with the beautifully crafted solid-aluminium Klimax power-amplifiers and Klimax Tunebox crossovers – a formidable array of equipment!

Coming in to a serious high end Linn system having moved up the ranks, so to speak, was a real ear opener. Unlike many systems at this price, 'the law of diminishing

returns' wasn't the first thought that went through my head upon hitting the volume up button. This system proved superb at music and movies alike, as David Gilmour's 'Remember That Night - Live from The Royal Albert Hall' and Peter Gabriel's 'Growing Up Live' tour concert DVDs proved, where the sheer, massive grunt and atmospheric of big, live music was felt deep, through the bones.

Yo Yo Ma sounded considerably deeper than previously heard, with a discernibly smoother and more lyrical quality. This was a pleasant surprise, as in my experience the further 'high end' I go with hi-fi, the less musical it tends to be. So, what I heard was definitely more revealing music in the traditional sense, but importantly had an even more inspired, free-flowing quality also – which is what is expected but rarely delivered at this price level. With this in mind, I was more than a little sceptical that House of Linn's ultimate room could bring much more to the party...

KOMRI ROOM

Well, the final frontier as far as Linn systems go met me in the Komri room. Here Brian and Trevor have installed a fully active and balanced set of £27,500 Komri loudspeakers with four Klimax 500 Solo power amplifiers (£6,600 each) and one Klimax Tunebox crossover per channel. The sources included two LP12SEs, Akurate CD/SACD/DVD-A stereo-player, Akurate tuner and the late, great Sondek CD12 CD player (£12,000 when new). Within the Komri Room, even the compressed sounding 'Balance of Power' by ELO was staggering in its bass authority, and the sophisticated textural qualities of the phrasing of instruments and vocals. There was huge dynamic range on offer where the music had an immense source of scale and power.

Best of all, just like the Artikulat Room before, the most important aspect, the musicality, remained and was actually improved so that there was a wonderful free-flowing quality. The intricacies of the musical arrangements were very clearly revealed, whether it was the superbly recorded Roy Orbison and Yo Yo Ma pieces or the somewhat compressed but indubitably enjoyable ELO recording. Still, it was scale of the sound, and sheer untrammelled power of it, that impressed on the most immediate level. It is rare to hear systems of any description go so loud so cleanly, and with so few signs of strain – even on the pro side. Ironically, this was most apparent



with DVD music discs such as Peter Gabriel's 'Growing Up Live', which took the listener/viewer right into the concert hall in a way that no other AV systems I've heard can.

The critical point here was that, as the volume levels seriously increased, the system didn't fall over itself trying to deliver massive levels of bass, and remained tight, taut and controlled in the manner of top quality PA system. Obviously though, there was far more finesse and subtlety, and my only criticism was really the lack of any euphonic warmth. It's always the case that Linn systems don't 'sugar the pill' for you, and those not looking for hi-fi that compels you to sit up and listen may be better off looking elsewhere.

CONCLUSION

House of Linn is a fascinating place to visit, because it gives an amazing perspective to Linn's entire model range. In just a few minutes, you can hear systems from £2,000 to near £100,000, and find out precisely what the differences are and why on the company's upgrade ladder. It's also



intriguing to hear the differences between different formats – LP, CD and SACD for example, which are so ably demonstrated here. And needless to say, the quality of the House of Linn premises, the staff, servicing facilities and customer service proved second to none. Hi-fi 'choppers and changers', constantly experimenting with system purchases via costly trial and error, should hear for themselves just how convincing a properly set up one make system can be, and just what is – and isn't – needed to upgrade it.

CONTACT:
House of Linn Ltd.
+44 (0)161 766 1021
www.houseoflinn.com



Show Time

The 27th and 28th October saw the Marriott Dalmahoy Hotel in Edinburgh play host to the annual Scottish High Fidelity Show, and Adam Smith was there with his camera...

TANNOY

Tannoy used the occasion of their local show to launch the new Revolution Signature range. Making use of their renown Dual Concentric technology, housed in some pleasingly sleek and stylish cabinets, the floorstanding models sounded very promising indeed, driven by a valve amplifier and fed by a computer source.



USHER

Hi Audio were demonstrating the stylish and sonically superb Usher BE-10 floorstanders, driven by NuForce amplification and fed by both an Acoustic Solid/Cartridge Man vinyl front end, and a music server through their new Pandora DAC. Also on display and making some very impressive sounds, was the new compact Graham Slee headphone amplifier.

STAMFORD AUDIO

As well as a tempting array of vinyl delights, Stamford Audio were also showing prototypes of their new Hercules Volterra turntable power supply. A stand-alone version of the excellent Hercules, this is again suitable for AC-motored decks like the Linn LP12 and is simply wired straight into the deck's motor.



TRANSCRIPTORS

Transcriptors were showing their new Reference MkII and Spyder turntables alongside a display of classic models including the very rare Round Table. Also in this room were my stars of the show, the Dovetail Audio Series One loudspeakers. Sizeable and rather 'stylistically challenged', nevertheless the dynamics, scale and effortless volume emanating from these had to be heard to be believed.



MERIDIAN

Meridian had three setups running in their room. First up was the F80, resplendent in its two new colours of graphite and burgundy, and sounding very fine indeed. Also playing were the new on-wall 330w loudspeakers, combined with an SW1600 subwoofer and driven by the G91 integrated system. Finally, excellent sounds were also heard from the final system consisting of an 800 series disc player and pair of DSP5200 active loudspeakers.



ROBSON ACOUSTICS

Robert Hudson from Robson Acoustics was demonstrating his flagship open-baffle, six driver designs, the Greystoke Elixirs, using NuForce amplification and another computer-driven source. General feedback would seem to suggest that yours truly wasn't the only one impressed by them...



SHADOW AUDIO

Shadow Audio were demonstrating some serious kit in their main room, namely the Marantz Legend system CD player, pre and power amps through Art Emotion Signature loudspeakers. Vinyl duties were taken care of by a Clearaudio turntable and cartridge, fitted with a very stylish rose gold version of the Audio Origami PU7 arm.



TETRA ACOUSTICS

Tetra Acoustics had a crowded room, showing an impressive range of loudspeakers from Morel as well as their own ranges, including the digitally controlled Primo5, as well as the more conventional Muso 26 Mk2s plus matching subwoofers, resplendent in shiny gloss black.

AUDIO NOTE

Simplicity was the key in the Audio Note room, with a sign on the door boasting that the room contained 2 channels only! The CD Player 2.1X MkII, TT2 turntable, Meishu amplifier and 'E' loudspeakers were excellent advertisements for this approach, sounding musical and enjoyable.





Three Series

Although not quite achieving Quad's massive sales success, Chapman audio electronics sold in high enough numbers to make finding a good example of the popular 305 pre-power amplifier a practical proposition even today, says Haden Boardman...



The dominance of the Leak Stereo 20 as the classic vintage valve power amplifier cannot be underestimated. Looking through our classifieds this month revealed just how much value these older amps now have. This was a bit of a surprise when you consider the total flood of budget amps hailing from China; but then again, although a lot of those seriously look the part, and measure well, the quality of that all-important output transformer can be called into question. The Chinese bean counters know exactly what is the single most expensive item on the chassis! Good as these amps can be, they rarely seem to get in to the absolute top flight... With most vintage amps, it's this part that is usually

the best thing on the chassis.

Rather less well known than the Leak, but very pretty and very sweet is the little Chapman 305 pre-power combination. Priced in 1960 at £18-8s for the preamp and £21 for the power amp (The Leak Stereo 20 was £30-9s and a 'Point One' stereo pre £21). There was also a larger EL34-based monoblock, called the 205 which could be used with the 305 preamp. In addition, two integrated amps bear the Chapman name, one in the '305' style, and a later version more akin to a Rogers HG88.

Aesthetically, the shape of the fascia apes the Leak Point One Stereo (or indeed, was it the other way round?) but the Chapman is simpler and more solid. The black preamplifier controls are illuminated

by a small Plexiglass rod, a nice styling trick, and all the controls are smooth and simple, with no overly complicated slopes or filters other than the basics. Circuitry-wise, classic EF86 pentodes are used in the usual Mullard style circuit, resulting in a 4.5mV input sensitivity for phono, and 100 mV for line level sources.

The power amplifier is built on a much smaller chassis than the Stereo 20; at just 12x5x6in. Build quality is exceptional, with very tidy little output transformers. The output stage is the classic setup of EL84 pentodes wired in 'ultra-linear' (same as the Leak) but biased in 'low loading', a technique that reduces overall output power to a 'sine wave' RMS rating of 8 watts (peak to peak power remains about 15W,

Chapman Pre Amplifier.

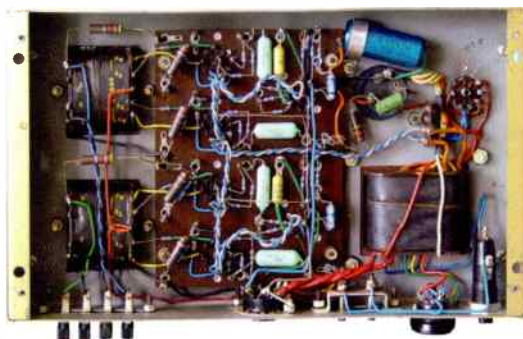

but continuous sine wave power rolls away at 10) and 0.1% distortion. The drive setup uses a single ECC83 dual triode; in a circuit not unfamiliar to the classic Williamson configuration, but without the latter's push-pull driver stage (not required for the EL84s of course!), and overall negative feedback is pretty low at just 10dB. Power supply is based around an EZ81 valve, rather than the usual GZ34.

Connections to the preamp are via the usual poor quality phono connections of the era, and speaker connections a little more sophisticated than the Leaks, with slightly better screw terminals. Two impedances are offered, namely 3 and 15 Ohms, which must be set via a soldering iron on the output transformer (on this, you connect taps 1 and 3 together, plus 2 and 4 together for 3 Ohm, and connect 2 and 3 together for 15 Ohm with output on terminals 1 [ground] and terminal 4 [live]). The majority of modern loudspeakers work well on the 3 Ohm tap.

Some remedial work was required on my own samples before serious auditioning took place. As is common with a lot of vintage amplifiers, most of the high value resistors had drifted even higher in value, and the coupling capacitors had started to become a little leaky; when first powered up, one of the EL84 output valves was glowing cherry red! In the end, most of the components had to be replaced; wherever possible with like for like types, namely carbon resistors and new old stock capacitors. The simplicity of the circuit helped a little here.

SOUND QUALITY

Auditioned as a combo, using a decent Technics CD player and a set of Spondor SPI loudspeakers, this little combination displayed a lot of high end valve amp strengths. The stereo image was wide and deep, bass extension was smooth, if a tad rounded. Midrange was dynamic and actually quite forceful, and the treble end matched the bass; with what appeared to be a gently rolling-off response. Much more than the modest 10 watts per channel are really needed to get the best from the classic Spondors, so a switch to a 1980s set of JBL TLX9 speakers was much more of a sensible match (with around an extra 7dB of sensitivity!).

This was a clear improvement. Although the TLX9 was a late 1980s budget three way speaker, it is a surprisingly good performer; and very much suited to valve amps. Playing

"a great little pre-power combination, and around half the price of the Leak..."

the usual torture drum and bass Kruder and Dorfmeister sessions tracks displayed a level of balance and control in the bass that would not normally be expected from moderately powerful vintage valve amplification.

Removing the preamp from the loop, and running the power amplifier directly with a passive preamp straight from the CD player did transform the overall sound. A lot of the softness disappeared and, as you would expect, overall focus and definition improved drastically. The power amp needs just 350mV for full output, so a passive preamp is an eminently sensible option.

Listening in this configuration and making comparison to a standard, non-modified Stereo 20 revealed quite a lot of subtle differences between the two. The Leak gave more weight to the sound; if in a slightly drier and less focused way. Both amps gave very good results, but the Chapman had an edge on vocals and in the midrange. My usual (nee favourite) ABBA reference track of 'The Day Before You Came' was delivered in a very convincing manner; Agnetha's shaking vocals were expertly replayed, as was Ricky Lee Jones' demo track version of 'Easy Money', and a 'new' discovery of the 1950s artist Joni James. As with

the Leak Stereo 20. In the midband, the Chapman had the edge, but the overall balance was in the favour of the Leak.

Switching to my shiny new Fostex FI20A full range speakers really transformed the overall sound of the Chapman combo. These are a very easy loudspeaker to drive, and they suited this little amplifier. It really helped underline the fact that a little vintage amp like this does need careful matching to its loudspeakers. Dynamics took on an amazing dimension, the low feedback design suiting the diminutive 4" Fostex units down to the ground.

CONCLUSION

This little Chapman is a great unit. It needs careful matching with speakers, and is best considered as a good 'car boot' find - I would guess its value would be around half that of a Leak Stereo 20. The Chapman has its

Chapman Power Amplifier.

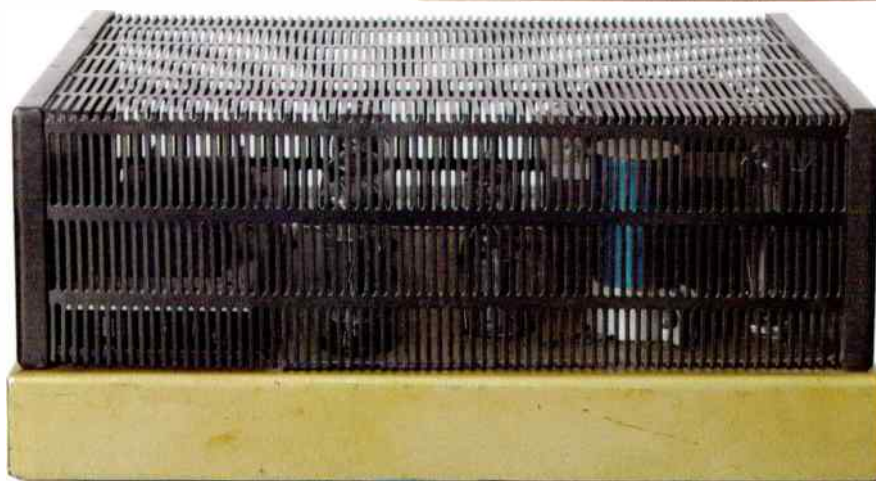
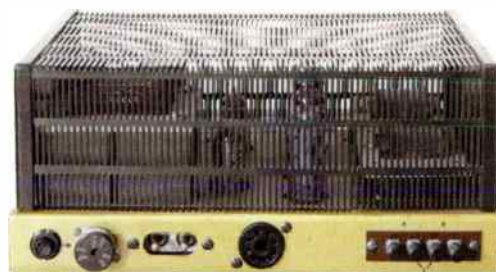

many older valve products, vocals really suited this little Chapman amp.

However, even by bypassing the less-than-perfect preamp, and using more suitable speakers, I still noticed a softening of the very bottom and very top ends. This was not necessarily a bad thing; the overall presentation was much more rounded, and slightly softer than

strengths, in standard factory form it is more open and offers faster microdynamics than the Leak, but with less weight and solidity. With a few modifications, the Leak must be considered the more serious amplifier. A good bit of fun, and no sonic slouch, but perhaps one more for the vintage enthusiast than an audiophile on a budget.



tangent Quattro

WIRELESS INTERNET RADIO - ACCESS LIKE NEVER BEFORE!

The award winning Tangent Quattro is the first internet-capable member of the Tangent audio family. Connecting to several thousands of internet radio stations is as simple as it is pleasurable.

To find your local stockist please contact Sennheiser UK Ltd, Tel: 01494 551551



UK distributor • Sennheiser UK Ltd • Tel: 01494 551551

DESIGN | ENGINEERING | PERFECTION

For more information please visit
www.tangent-audio.com

Discover more detail,
more ambience, more
music, more *involvement*
when you improve the
source in your system.

Super

Sources

Better amplifiers, better cables and even better speakers cannot really improve a system with a source that's sub-standard, out of its depth.

You will hear more information but you'll also hear the **SOURCE'S FAULTS** more clearly. You've spent more money but lost enjoyment.

Handling the most delicate signal in the system, phono stages are very vulnerable to mains pollution. **NEW** Clearaudio rechargeable "Plus" series **BATTERY-DRIVEN PHONO STAGES** avoid the problem. Hear a *major* jump in **REALISM AND PRESENCE**.

Teamed with a Clearaudio **SOLUTION** or **CHAMPION** turntable expect stunning results from about £2500.

Vinyl lovers tend to denigrate CD but then we find they often have rather "ordinary" players. It's no surprise their CD replay is mediocre.

Bel Canto's new top-loading **CD-2** brings hope to CD-haters with the unforced, natural sound common to the whole Bel Canto range – from a designer of **TRIODE VALVE** amplifiers!

The CD-2 has already won a 2007 technology award for its advanced design, including the **CD-PRO2M** professional transport and the Ultra-Clock circuit that gives master clock decoding accuracy for realism without any aggressive edge.

Bel Canto's stunning **DAC3** brings even higher levels of refinement and realism. Both digital units (about £2k each) drive power amps direct. So – dump the preamp, **SAVE AND ENJOY!**

Customers say we make some of the **BEST SOUNDS** they have ever heard, so you know we can do the same in your home. Our advice will take account of your best components and guide you where change is needed, in stages you can afford. You **AVOID EXPENSIVE MISTAKES**, enjoy music along the way and save money in the long run.

JUST LISTEN AND YOU'LL KNOW

CD: ACCUSTIC ARTS, BEL CANTO, dCS (ELGAR, DELIUS, PURCELL, VERDI, VERONA, P8), GAMUT, RESOLUTION AUDIO, STELLO, WADIA. **VINYL:** AESTHETICS, AVID, CLEARAUDIO, DNM, GRAHAM, THE GROOVE, LEHMANN, MICHELL, ORIGIN LIVE, SUMIKO BLUE POINT SPECIAL, TRANSGURATION. **AMPLIFIERS:** BEL CANTO, CAT, DNM, GAMUT, HALCRO, HOVLAND, SONNETEER, STELLO. **LOUDSPEAKERS:** AUDIO PHYSIC, DALI, ETHOS, GAMUT, NEAT, TOTEM. **CABLES:** CHORD Co., DNM, NORDOST, SILTECH, VERTEX AQ. **MAINS** Vertex AQ. **SUPPORTS:** ARCICI, STANDS UNIQUE, VERTEX AQ

The
Right
Note

Music in the home



BATH

01225 874728

or lo-call

0845 230 7570



For superior sound quality you should try the Isoplatmat. Made from SDS Aluminium, the Isoplatmat isolates your vinyl and needle from vibrations and feedback, giving an exceptionally high quality audio. Just place the Isoplatmat on your turntable and, to further enhance your music, you can also use Isofeet placed under the components, subwoofers and speakers. You will be amazed at the sonic improvement to your system.

This is the
best turntable
mat I've
ever heard.
At well under
£100, it's
a bargain.

David Price,
HiFi World.

Isoplatmat £79.95 + p&p
Isofeet x 4 £18.00 + p&p

order by phone on
0191 250 0900
order online
www.sounddeadsteel.com

SDS
SOUNDDEADSTEEL.COM

"Mince pies and cassette decks do not mix..."



adam smith

Well, judging by the surfeit of decorations appearing in the shops and the fact that I bought two packs of mince pies for the price of one at the weekend, it would appear that the Christmas season is well and truly upon us. Now, I have never been one of these "Bah, Humbug" types - I freely admit that I love Christmas and still have just as much trouble sleeping on Christmas night as I did when I was about nine years old. Although, being older does have the advantage in that I find that a glass or five of port does help to overcome this seasonal nocturnal restlessness, but I digress...

As an obsessive audiophile, I have always found that Christmas offers a good opportunity to take a breather from work and settle down for a few choice tunes over the seasonal break whilst our other halves hit the sales but it isn't always this simple. You see, I have often felt that Christmas can be unnecessarily stressful for the hi-fi and music enthusiast and if you don't believe me, read on.

It all starts months beforehand when, in between tolerating Slade's 'Merry Christmas Everybody' for the umpteenth time, family members start the usual, "What would you like for Christmas?" round of questioning. To the Non Hi-Fi Savvy (henceforth referred to as the NHFS) an answer the likes of "Well, I could do with a new stylus" or "I'm nearly out of record cleaning fluid" or, worst of all, "I've been eyeing up some new interconnects" is most likely to be met with confusion, incredulity or even downright hostility. It's no wonder we all acquiesce in the end and agree that, actually, some socks and a nice new jumper will be fine.

I remember vividly when, in my mid teens, I spotted that Maplin

was stocking Nick Beer's 'Servicing Audio and Hi-Fi Equipment' book and, when my sister asked me what I would like for Christmas, I announced that this would fit the bill perfectly. I was talked out of it that year and the following one (and all birthdays in between), until she finally relented and it made it under the tree. So was she finally pleased that I was delighted with my new book? Was she heck, I got moaned at for spending Christmas afternoon reading it and not being sociable!

So the presents can be an issue but surely you have the opportunity to let your hair down and party a bit, to forget all the woes of the year? Well, yes indeed you do, but the unwary audiophile can be caught out in a number of ways here as well. Particularly troublesome can be when you are the host of the party yourself and you do not have a dedicated listening room which can be locked to prevent access to the uninvited NHFS and their heathen ways. Sadly, from experience learnt the hard way, I can offer some pearls of wisdom for when the party is at your place...

(1) Mince pies and cassette decks do not mix. It took me the best part of two hours to extract one from a friend's top-end Akai. He tells me that he still gets a faint smell of pastry when using it now, quite a number of years on.

(2) Never allow yourself to be swayed by your friends' protestations that they are superstar DJs. Even if they are actually quite handy 'on the decks', your Rega/Linn/Pro-Ject lacks sufficient torque for fancy turntablism moves. Oh yes, and your average hi-fi MM or MC was NOT designed to go into reverse...

(3) When your crazy mate finally gets his hands on your volume control, your tweeters will die first, so check

availability of replacements before everyone arrives.

(4) It's impossible to get beer stains out of real wood loudspeaker cabinets.

All in all you would be a lot safer heading for a dedicated party night at your local restaurant/hotel. In that way, you know your equipment will be safe, the cat will remain undisturbed and someone else will have to clear up the spilled beer and nuts. However, this gives the opportunity to encounter possibly the very worst aspect of audiophilia and musical reproduction - yep, that's right, the cheesy party DJ!

Dating back to the days of FAL, Discosound, Watney's Red Barrel and Party Sevens, the cheesy party DJ is an enduring tradition guaranteed to give our NHFS friends a great time, whilst simultaneously distressing the rest of us. I'm not even going to go down the sound quality route, suffice it to say that the evolution from two Garrard Disco Driver 80s to a pair of Mini Disc decks has at least stabilised the reproduction quality somewhat, even if it means we no longer have the opportunity to leap up and down like maniacs on the dance floor near the DJ booth to see if the stylus can be shifted from the groove.

In addition, I was just going to moan about the Grease Megamixes, Jive Bunny tracks and endless repetitions of 'I Will Survive' that drive a music lover to the edge of insanity, but my wife has just pointed out that, after a bottle or so of Cabernet Sauvignon, I'm usually the first one onto the dance floor. Ah, alcohol-induced memory loss - truly nature's way of preserving one's dignity.

Now, if you'll excuse me, I'm off to unwrap those mince pies and start practising my 'Birdie Song' moves... Merry Christmas! ●

Why not treat yourself this Christmas?

Used Product Listing - Remember !! List is updated on our web site daily!

DIGITAL

Accuphase DP-500 (£3950)	£3495
AudioNet ART V2 (£2400)	£1395
McIntosh MCD201, CD/SACD (£3400)	£2795
Meridian 508.24 CD player	£995
Moon Nova CDP CD player (£3000)	£1395
Musical Fidelity KW 250S (£4999)	£3795
Resolution Audio Opus 2 I, 2 box (£2950)	£2305
Shanling CDT300 Omega Drive (£4000)	£2295
Sony SCD-1 SACD player (£5000)	£1995
Theta Chroma DAC	£295
Vincent CD 3 CD player (£800)	£649

AMPLIFIERS

Accuphase E408 Integrated (£3000)	£3995
Audio Zone AMP 1 dual mono integrated (£1595)	£1195
Audiolab 8000C and 8000P pre power combo	£399
Audiovalve Baldr 70 Monoblock power amp (£3100)	£1595
Bel Canto S300i Integrated (£1799)	£1495
Cairn 4810 Integrated (£2700)	£1795
Cyrus 8 amplifier and PSXR outboard power supply	£849
Densen Beat 200/310 pre power	£1595
DK Design VS-1 Reference (£2500)	£1995
MiniMax Power Amp (£995)	£649
Exposure 3010 Integrated (£1000)	£595
Flying Mole PA-S1 Digital Pre (£999)	£795
Krell KAV 400xi (£3000)	£2250
Krell FPB 300 Poweramp	£2995
Krell KAV 250P pre amplifier (£2495)	£1095
Manley Labs Neo Classic 300b Monoblocks	£2995
Mark Levinson 380 Pre (£4500)	£2695
McIntosh C2200 pre-amplifier (£4850)	£3695
Musical Fidelity AS Integrated (£1495)	£995
Musical Fidelity AS Pre (£1495)	£995
Musical Fidelity A308 integrated amplifier (£2000)	£949
Musical Fidelity KW550 Integrated (£5000)	£3995
Nagra PSA Power Amp	£3195

Qinpu A1.0x Integrated (£300)	£230
Qinpu A-8000 MK II Integrated (£1295)	£795
Tact SDAi 2175 (£1245)	£749

LOUDSPEAKERS

Acoustic Energy AE1 Classic (£845)	£650
ART Emotion Monitor, Cherry (£4000)	£3250
ATC SCM20SLI (£2400)	£1395
ATC SCM19 (£1499)	£1195
Hyperion 938 (£3750)	£2795
JAS Orio (£2300)	£1495
JAS Audio Orsa (£1399)	£1095
JAS Audio Supertweeters (£649)	£449
Leema Acoustics Xone (£2745)	£1695
Monitor Audio GR10, (£800)	£595
Opera Callas Mini (£650)	£450
PMC FB1+ (£1695)	£1295
Soundlab Millenium M3 Electrostatics (£8995)	£2795
Waterfall Iguascu Loudspeakers (£1500)	£600
Wilson Benesch Arc (£2600)	£1795

ANALOGUE

Clearaudio Performance Turntabl	£1199
Eastern Electric MiniMax Phonostage (£1099)	£795
Graham Slee Elevator (£510)	£295
SME 20/2A (£6300)	£4495

MISC

Hovland Reference Speaker Cable (£1200)	£795
Isotek GII Minisub (£545)	£399
Isotek Nova, only 5 months old (£1700)	£1295
PS Audio Powerplant 300 (£1750)	£695
PS Audio Ultimate Outlet (£400)	£295

You can receive our Used Product List and e-newsletter by email each week for free!
visit www.shadowaudio.co.uk and sign up today - simple!

shadow audio

0844 800 0073 or 74 : www.shadowaudio.co.uk

Specialist Brands include:

- Apollo . ART Loudspeakers . Audio Zone . Audio Physic . ATC . AVI . Bel Canto . Bryston . EAR/Yoshino
 Eastern Electric . Gamut . Hyperion . IsoTek . JAS Audio . JungSon . Manley Labs . Marantz/Legendary . McIntosh
 Musical Fidelity . Musical First . MusicTools . Nordost . Opera . Origin Live . Pathos . PMC . Project
 Resolution Audio . Shanling . SME . Tannoy Prestige . Unison Research . VPI . Wadia . Wilson Benesch and many more.

"having used the new BBC iPlayer for a while now, my impressions are mixed..."



steven green

Since the BBC iPlayer launched in beta form at the end of July, it seems to have come under constant attack, but from wildly different directions. First to knock it were some disgruntled Internet service providers (ISPs), followed shortly after by the normally placid open-source software community and anti-DRM (Digital Rights Management) campaigners.

The ISPs complained that the Internet wasn't designed to carry high bandwidth video traffic, and that the BBC should contribute towards paying for the bandwidth that the iPlayer would generate. This makes me wonder whether they've asked Google, YouTube, iTunes and other popular websites that consume a lot of their bandwidth to contribute to their costs, and if they haven't asked them, I'd love to know why they think they can ask the BBC for money...

Furthermore, if they think the Internet hasn't been designed to carry high bandwidth video traffic, they should pay a bit more attention to how their customers are using it, because peer-to-peer file sharing networks – which the iPlayer is just one example of – account for around two thirds of all Internet traffic, and most of that will be video nowadays. They should also ponder the fact that the theoretical capacity of a single fibre optic cable (which are used to carry data around the Internet) is 10,000,000,000,000 bits per second, and the speed of Internet routers has been increasing in line with Moore's Law since 1986 – i.e. doubling in speed every couple of years.

Thankfully, other ISPs are taking a more bullish approach to this issue, as they see providing higher broadband speeds as a way to differentiate themselves from their

competitors. For example, the UK's second biggest ISP, Virgin Media, is planning on launching a 50 Mbps broadband package over its cable network late next year, and this will support Internet multicast, which will enable their customers to receive HDTV over broadband as well as the higher quality BBC and commercial radio station streams available on multicast. Sky's chief executive, James Murdoch, has also recently said that he's in favour of Internet bandwidth demand increasing, because he thinks it will help Sky Broadband, and BT will be rolling out ADSL2+ across the country from early next year, which will offer connection speeds of up to 24 Mbps.

Moving on to the open-source software community's gripes, they're not happy with the fact that the iPlayer only works with Microsoft software (it only works if you have the Windows operating system, Internet Explorer and Windows Media Player), and they think it should be available for Mac and Linux users as well. And they have a point, because the BBC is a public service broadcaster, so they're supposed to serve everybody, not just the majority. Furthermore, there have apparently been hundreds of people working on the iPlayer for the last couple of years, and it's been in development for around four years, so you have to question why the BBC hasn't ported it to the Mac and Linux operating systems by now?

To placate Mac and Linux users, however, the BBC has decided to launch a streaming version of the iPlayer by Christmas using the Flash video format. Flash is the format used for video on YouTube, and it is optimised for very low bit rate levels, so it'll be interesting to see what the quality of the streams will be like

when they launch.

The other issue the BBC has come under fire over is its use of Digital Rights Management. The BBC says that it needs to use it to protect performers' rights, but I suspect it's far more to do with them protecting their own copyrighted material from being shared freely over the Internet so that they can charge people from overseas to use the iPlayer – which is their stated aim. I would be inclined to agree with the BBC on this one, but only because people are still free to record programmes off TV.

Having used the iPlayer for a while now, my impression of it is mixed. The video and audio quality have been pretty mediocre, and the web-based user-interface for it has been badly designed. The problem with the user-interface is that programmes are only displayed nine at a time, so if you want to browse for programmes you have to click through page after page, and they would be far better off concentrating less on flashy images and relying more on good old-fashioned text. One thing I have been very impressed with, however, is how quickly it takes to download programmes, especially at off-peak times when it's taken as little as five minutes to download a thirty-minute programme.

Ultimately, it's early days for the iPlayer, and the current problems with it are easy enough to fix – apart from the DRM issue, which arguably isn't broken. As for the ISPs that are moaning about the traffic that the iPlayer will generate, they seem to be forgetting that we already pay them £15–£20 per month precisely because we don't just use the 'net for email and reading web pages any more, so I have no sympathy for them. ●



Hi-definition audio

Explore your senses with the ultimate in world class Hi-Fi



world class sound...

www.naimaudio.com

World Radio History

"Apple has hijacked the English language and changed audio nomenclature for ever..."



paul rigby

I'm feeling grumpy this month, and it's all down to the single most annoying letter in the alphabet. Why oh why does just about every brand name have to either start or end with the letter 'i'? It's Apple's fault of course. iPod - I'm sick of it!

To pay my local authority its extortionate Council Ransom – sorry, Tax - maintain and illuminate my abode to Blackpool Lights standards (I shout at the family to turn them off, but do they listen?) and keep the wife in Liquorice Allsorts, I am forced to write for other, lesser magazines in addition to this august journal. And it was while penning an MP3 group test for a home improvement periodical (that shall remain nameless) when I realised just how endemic this curious phenomenon had become...

One of the music portables was from iRiver, then there was another from an outfit called Cowon, labelled as an iAudio. But that's not all, oh no. Over to a mobile phone magazine I scribble within and coverage for a relatively new handset from Sony Ericsson, called an S500i. They also have a V810i, a V880i, a K610i, Samsung have a D900i and so it continues ad nauseam. There's even a company which offers access to mobile phone games called iPlay...

Music of course is dominated by downloads and – you guessed it – iTunes. But then Apple itself doesn't restrain itself to just a couple of irritants. Don't forget iMovie, iPhone or even the iMac. More serious, professional occupations, such as computer programmers, have also been infected. iText is a way of generating text in the popular PDF format and there's many more I won't even go into here...

Into computer games? You can't hide there, buddy. Reports say that The Nintendo Wii will be the most

popular console sold this Christmas. The Wii? That's two 'i's! Two! It's like a bad metaphor to the Cold War but, instead of an arms race, we've now got a irace. Why stop at two 'i's, eh? Print three or four why don't you? But you know what really makes me grumpy? If you Google the word iGrumpy, there are pages and pages of links to sites either called iGrumpy or sites that feature the word iGrumpy. Is nothing sacred?

By now, I was beginning to rage. My blood pressure was rising. I madly Googled random words with that dratted 'i' stuck onto the front to find some semblance of sanctuary, in an effort to find some word, any word, that might have escaped. How about iBlob? No chance. Take your pick from a music controller or a HTML template. Trying to be clever, I typed iEye. No escape there...something to do with high resolution digital photography. iDeath then? Which, by now was suiting my mood. Google produced lots of Internet users who now go under that moniker.

Throwing my arms to the heavens and cursing Steve Jobs, his relatives and his pet gerbil, I stormed out of the house to seek solace in chocolate whereupon, cruising down the aisles of my local supermarket I saw a food, which will now remain nameless (mostly due to petulance and spite) previously labelled with the 'Lite' term to denote it's low fat content, now redesigned as LiTE. That dratted letter, once restricted to the beginning or the end of the word, had now spread, like some rabid bacteria, to the centre!

That's it, then. Apple has hijacked the English language, transformed audio nomenclature for ever and left me a jabbering wreck, unable to go anywhere near most modern consumer electronic devices due to their 'i' content. And now, just to

make things even worse, Hi-Fi (or should that be iFi?) is in on the act thanks to Naim's new CD5i and Nait 5i CD player and integrated respectively. In this case, just to make life especially hard for everyone, the 'i' is italicised! This is all too much, and I'm considering launching a protest site. iCan'tCope maybe? Or how about iCame, iSaw, iRan Away Screaming?

On a more serious note, I also note with interest a product that links turntable stylus cleaning and female breast enlargement operations. Admittedly it's a tenuous link, but the item is the wonderful Onzow Zerodust which will clean your stylus up a treat. Essentially a sticky blob of what looks like the silicon gel used in breast implants [err... not sure if that's a terribly useful reference point for most HFW readers, Paul – Ed.]. It's fixed to the base, under a lid which features a magnifying glass which is great for close examination of the stylus tip. In operation, you place the base portion of the Zerodust on your deck, then you swing the arm over to the base and gently dip the stylus into the silicon. Any hair, muck or gunge on your stylus is instantly removed, sticking to the silicon.

You should have no fears of the stylus tip breaking off because the silicon itself is very supple and 'gives' very easily. Of course, I'm sure it is possible to break the stylus if you're too heavy-handed but, with care, even the most delicate of styli should work fine. When the Zerodust eventually becomes clogged, you just run the silicon-laden base under a tap to clean. Leave to dry and, hey presto, you're off and running again. Costing £34.95, you can grab one from Hi-Fi For Sale (www.audiophilecandy.com), and the absence of unnecessary 'i' prefixes makes it all the more recommendable. Merry Christmas everybody! ●

Walrus 11 New Quebec St, London W1



Teddy the Terrier
We like a dog with attitude
Just like his owner in fact!

Basis 2500 Signature + Vector 3 (100Watt) 100-120 + 120Watt increasing ProgramMtr VTA) + controller for the Basis 1100000 for top

Shanling MC-30 (£500)
3w/ch Amp, CD, AM-FM, with mp3 player jack input in an aluminium chassis with stunning visuals. mp3 player pictured not included!

Acoustic Signature Challenge (L1250 without illumination)
Narrow mode turntable with stainless steel and powder coated Super VTA

Pure Sound A30 Amp (£1095)
British designed and Far Eastern made the A30 is stunning value. It might look plain, but boy, does it sound good!

Klipsch Speakers (£1125/1)
Klipsch come from a "warm" past, speakers that are compact and unobtrusive but the sound is huge! It's worth absolutely raving them. So will you!

Hyperion HPS-938 (£3750)
We keep featuring these brilliant speakers 'cos we don't think there's anything to touch them at the price!

Heritage Model 2 (£1800 without illumination)
Reissue of the original Model 2. Now with 220V line select and even better performance. VTA's a treat as possessed with the Scotch Airman

Musical Fidelity 550K
"Superchargers" (£2998/pair)
Ever wished for more power and headroom from your present amp? Or maybe you just fancy a pair of top quality monoblocks at an affordable price.
The 550K Superchargers will fulfil either need - a win-win product!

Acoustic Signature Challenge (L1250 without illumination)
Narrow mode turntable with stainless steel and powder coated Super VTA

Acoustic Masterpiece AM 201 (£2495)
Beautifully made, gorgeous sounding. Made by A&M Ltd. The meter has "Air Tight" on it. Hmmm!

STAX
The best sound you can get...
Stax
2050 Mk2 System
SR-007 Omega System 2

Lyra Skala (£1849)
The latest in a long and distinguished line, the Skala is the first Lyra to feature a non metallic body. We have this beauty on demo now, and are very, very impressed by it. We are confident you will be too...

Two black Mineral capacitors of (Woodch made) GoldTech, making this the best value at which you can obtain a pair of perfect balance. Due to direct from factory purchase our prices are perfect too!

Luxman L550A (£2795)
A very complete solution. The usual excellent Luxman sound quality, 20W class A (although measures far more), decent phono stage, balanced inputs, tone controls. I want one. Now.

SolidTech
Reflex
Atmos
These clear looking wood grained amplifiers are not expensive and are giving a huge amount of pleasure to our clients.

- a2t
- acoustic signature
- acoustic solid
- acuhorn
- aesthetix
- air tight
- amazon
- amity
- amplifon
- apollo furniture
- audio aero
- basis
- benz micro
- black rhodium
- bocchino
- breuer dynamic
- brinkmann
- cartridge man
- cawsey
- clearaudio
- consonance
- decca london
- duevel
- dynavector
- ear yoshino
- emt
- funk firm
- goldring
- graham (tonearms)
- graham slee
- hadcock
- harmonix
- heed audio
- horning
- hyperion
- incognito
- isolda
- jadis
- kibri
- koetsu
- luxman
- lyra
- mcintosh
- melody
- michell engineering
- morch
- musical fidelity
- nordost
- nottingham analogue
- origin live
- ortofon
- pro-ject
- pure sound
- rega (turntables)
- reimyo
- revolver
- ringmat
- roksan
- shun mook
- shanling
- shelter
- sme
- solid tech
- something solid
- sonneteer
- spendor
- stax
- stirling broadcast
- sumiko
- tannoy prestige
- tcj cables
- tom evans
- townshend audio
- transfiguration
- trichord
- van den hul



* Please ask about our ex-demo stock; many items are virtually as new but with large reductions.

We deliver by Business Post 24hr service (subject to stock availability), and internationally by DHL, TNT or UPS. Major credit/debit cards accepted even known to take cash on occasions! Please visit our website for product, technical and ordering info

tel: 020 7724 7224 fax: 020 7724 4347 contact@walrus.co.uk www.walrus.co.uk

"as hi-fi enters a new golden age, here's hoping the new hi-fi media can reflect this..."



david price

In the nineteen sixties, hi-fi was largely a minority, specialist hobby pursuit, in the same way it is becoming now. By the early seventies however, the market was taking off like the Apollo space mission - as well as reaching new and unexplored places, it was achieving a worldwide audience with money to spend. This sheer momentum swept companies that knew their own trajectory onwards and upwards - with Linn, Naim and Meridian being three shining examples. Others were not so lucky, with once great players like Quad left on less secure ground and others like Garrard and Leak going the way of the Dodo.

With all this came a new consumerist attitude to hi-fi, and new magazines started up to reflect this. What Hi-Fi personified this 'buying guide' approach, giving clear and uncomplicated information to a world hungry to experience the wonderful world of stereo, or simply keep up with the Joneses by buying even bigger loudspeakers. Seventies hi-fi magazine sales were high by the standards of today's titles, and the massive amount of advertising found in each one was testament to this. Some were often more like phone books than hi-fi mags, jam-packed full of advertisements by everyone from Laskys to Comet.

What you'd read inside these thick tomes began to change too. Hi-fi journalism was shifting from its traditionally sterile, quasi-academic discourse to a much more easy and approachable tone - for the first time we could read "I think" instead of "it is apparent that". The arrival of the 'first person' tense heralded a completely new era of subjective reviewing, one which we completely take for granted today. For example, a review of a cassette deck from the early seventies would have comprised

a two-page long description of the unit's fascia layout, ease of use, specifications and 'field reliability, followed by a paragraph about the so-called "subjective sound quality". By the end of that decade, it had become two pages on how good (or bad) the reviewer thought it auditioned, which some technical specs thrown in for good measure...

With this came the cult of personality. Although the likes of Gilbert Briggs, Raymond Cooke, Harold Leak and Peter Walker had become minor celebrities a decade earlier to owners of Wharfedale, KEF, Leak and Quad respectively, the young Turks of the industry took it upon themselves to tell the world how to listen to music, and we saw the likes of Ivor Tiefenbrun and Julian Vereker (Linn and Naim) rise to the status of demi-gods as far as many audiophiles were concerned. Correspondingly, the then new generation of hi-fi hacks obligingly stepped up to the parapet to become minor celebrities in their own right, and opined strongly about products to readers and manufacturers alike.

Of course, such new-fangled 'subjective reviewing' was two fingers raised to the excesses of the journalistic old guard. I'd be the first to agree that the old pseudo-scientific style of hi-fi writing was bogus - couching things in obfuscatory language that tried to hide the reviewer's own feelings on the subject. But, right as 'all the young dudes' were to move hi-fi journalism on, so the new order brought their own conceits too. The worst of which was to obsess on those big characters (and brands) in the British hi-fi firmament, to the almost complete exclusion of what was happening beyond our shores.

These days, we live in less extreme times. Hi-fi journalists are

more down to earth, more interested in the kit and less in themselves. Although they still have their tastes (who doesn't?), the days of having to actively decipher or decode reviews are largely passed. British hi-fi magazines these days are generally fairer and more catholic places, and are all the better for it.

Another thing that's improved the quality of life for hi-fi enthusiasts is the advent of the Internet. Forums have, I think, moved the debate about hi-fi away from a select bunch of monthly periodicals and become a sort of universal hi-fi club. They've added an extra dimension to our hobby, bringing in the accumulated wisdom of many to anyone who can be bothered to seek it out. These days many manufacturers take them very seriously. Some, like Naim, have their own online communities and the company's MD Paul Stephenson plays an active part. Others check out what's happening in the likes of Hi-Fi Wigwam, Pink Fish, et al., on a surprisingly regular basis.

The only downside is that, if a hi-fi journalist wrote a malicious piece about an individual, he would likely find himself answering a libel charge. Of course, the same laws of the land apply to people posting on forums, but poor moderation can and does let unpleasant posts up online sometimes. I'd don't think we should let hi-fi forums become repositories for extreme views about companies, products or people. Rather, we should celebrate the fact that they're conduits for a vast amount of collective experience. They can do what magazines of all eras never have, which is to give a fascinating third dimension to the hi-fi world. As high fidelity music reproduction enters a new golden age of affordability, specialisation and diversity, here's hoping new hi-fi media can reflect this. ●

Precision engineering

A passion for the music

Ortofon Cartridges

at last you will
find all the music
in your vinyl

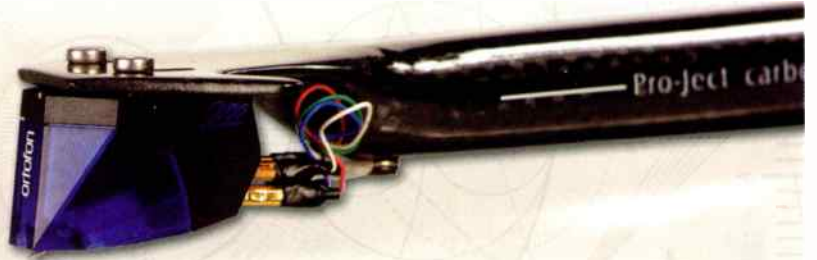

ortofon
accuracy in sound



www.henleydesigns.co.uk

To find out more about the full range of hi-fi cartridges from Ortofon, and where you can buy them visit:
www.henleydesigns.co.uk

WBT nextgen.



For 20 years now WBT have been developing high quality connectors, sockets and pole terminals for hifi enthusiasts as well as for well-known manufacturers of audiophile hifi devices so that audio reproduction devices can prove their capability and you can enjoy your hifi system at home to the full.

nextgen is the next chapter...

Anatek Acoustics

In 'A Class' of their own



o A50R Integrated Amplifier

HI-FI WORLD
VERDICT 

“ Anatek’s own unique Class A output without the inherent heat issues... ”



o MC1 Phono Preamp

HI-FI WORLD
VERDICT 



Designed & Built in Britain

For all product and dealer enquiries call +44 (0)1903 524 602
or visit www.anatekacoustics.co.uk

"listeners will always want to access the vast treasure trove of classic music, and the LP has no parallel as its original carrier..."



noel keywood

Once again, we've been chided by a reader in our Letters pages for pooh-pooing CD, apparently in favour of LP! Of course - as eagle-eyed readers will have noticed - we do have more than a passing regard for LP on this magazine. Today's CDs are very, very good, yet I have never come to regard the CD with real affection. It does a great job in so many ways, and I have less of a beef with sound quality than most vinyl spinners, but in the twenty first century Compact Disc seems a datedly simple medium whose attraction has departed.

Walking into Oxford Street's music megastores like the giant HMV at the East end of the street (you know, the one with a decent LP collection!) underlines this. Pass through its portals into prime retail space the size of a small aircraft hanger and you are met by racks of CDs stretching into the distance. Prices are tempting, commonly down to £8.99 nowadays, yet even on a busy weekend there are few takers. It's a sad spectacle. The long aisles are empty of browsers and buyers. Instead people walk down them to get elsewhere - and that includes me.

I don't browse CD any more; I walk past it. Usually I am on my way to the vinyl section, to see if it has some must-have albums. For example, I am no Elvis Presley fan; he was before my time and those short, simple song constructions of the period seem quaint to me even now. But seeing a recently pressed 180gm SVX virgin vinyl disc, I couldn't help but buy what was a compilation album of his classic songs: price £20.99. The sound quality isn't great; a lot of these oldies have little high treble. But if sound quality is poor and the music not exactly to my taste, why did I walk past lines of £8.99

CDs to buy this £20.99 LP?

A vinylista I know who avidly collects LPs and has thousands of them tells me CDs "aren't genuine" and this is the answer. For him you can't separate the music from the medium; the two go hand-in-hand. They are historically linked and essentially indivisible. To tear them apart makes for something that he sees as false - and I take the point. Elvis will forever be associated with his time, the nineteen fifties, and that time wasn't BC, but BCD! Elvis on CD doesn't work for me, much as Led Zeppelin doesn't either. Here's another even more cogent example of divorcing message from medium. The early Led Zeppelin albums sound nothing other than awesome on LP, but dreadful on CD. I have the original albums, the later "perfect" digital CDs and, now, reissues on 200gm Quiex SV-P vinyl that cost an eye-popping £27.99 apiece - but they are a bargain. They sound superb and recreate the original performance in even more splendour than my worn out originals...

This is one of the predicaments CD finds itself in. It did a poor, often miserable job of carrying music that predates it, leaving thirty years of some of the most wonderful performances ever to languish unappreciated. They're performances that spanned three generations, music not lost but certainly desecrated by the silver frisbee. Those generations of listeners - and later ones - will always want to access this treasure trove of music - and the LP has no parallel as the original carrier and a part of history. This, I suspect, forms a significant part of its attraction today and represents its future, not as a mainstream medium, but as the only acceptable carrier for performances predating the eighties.

The CD progressively replaced

the LP during the nineteen eighties but early limitations in digital recording and mastering often made the LP preferable to the CD, whilst both formats were being produced alongside each other. At that time both CD players and CDs were expensive and considered "audiophile". It wasn't until 1988, BPI sales figures show, that CD sales overtook those of LP and the CD had truly arrived as a mainstream medium.

CD sound quality came right in the end, during the 1990s as digital electronics improved. Specifically, digital converters became faster and more distortion free as the simplistic notion that digital was "perfect" faded and the nature of its own peculiar problems became apparent. Now it too carries great performers and performances. As good as the first Scissor Sisters album sounds on LP, for example, I marginally prefer it on CD, and even the 45rpm 'Tah Dah' LP sounds mediocre. CD today is cheap, convenient and sounds good, but still the racks in HMV are ignored.

HMV alone continues to make a profit, albeit a declining one that last Christmas was blamed on a lack of compelling acts. Here again the CD has found itself a victim of outside circumstance. Persuaded by a low price of £8.99 and the in-store play of a catchy track I foolishly bought the Eagles' latest CD, 'Long Road Out of Eden' the other day. My son bought 'Shaun the Sheep' on DVD. I won't tell you which was the most entertaining! DVD is running a stake through CD's heart.

I am looking forward to enjoying truly amazing digital recordings in future on High Definition discs, but will likely spend even more on my historic vinyl collection. I'm afraid that means I will walk past those racks of unloved CDs - just like everyone else. ●

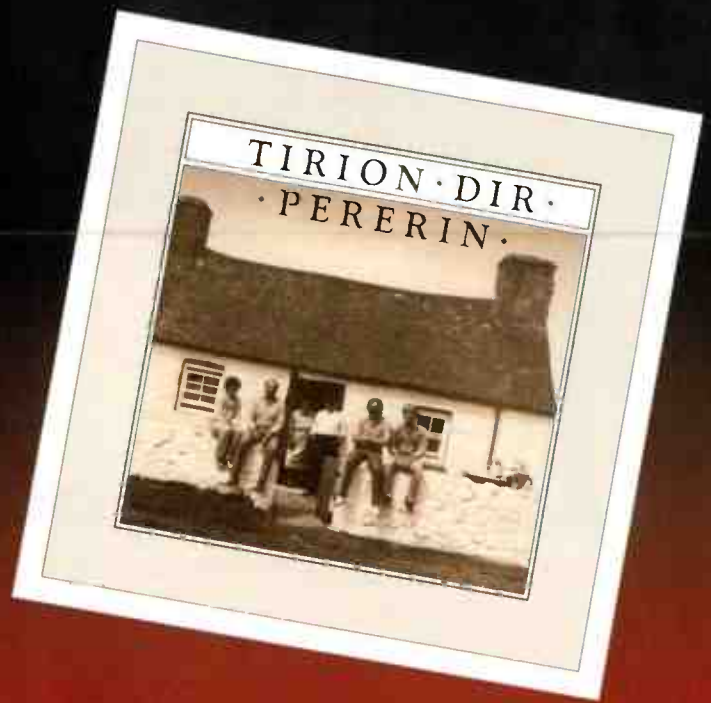

ELVIS PRESLEY
Elvis Christmas Album
Speakers Corner/RCA

The biggest issue with the release of this album was not the record or even the sleeve, but the sticker on the front of the sleeve – which was only on a very few examples of the original release. The gift tag sticker itself is a From/To address sample. That is, you were supposed to write the person you were giving the ‘Christmas Present’ record to on the sticker with your name under the ‘From’ bit.

“This sticker was extremely difficult to find,” said Kai Seemann, MD of Speakers Corner. “It was very rare. To give you an idea, a good copy of the original issue record is \$300-\$400. With the original sticker in place, you pay around \$800. It took me months to get the sticker. I contacted almost every Elvis Presley fan club in the world, searching for a sample of this sticker. The initial response was, ‘Oh, that’s no problem, I have this in my collection’. However, none of the guys had the original sleeve, with the booklet inside. They had the standard issue with Elvis on the front in some kind of furred winter jacket in front of some mountains. Our cover is rarer. I eventually found a stickered cover via a website auction for pop memorabilia.”

The record itself featured an array of seasonal standards plus other worthies such as Blue Christmas along with four tracks

included from an earlier Elvis EP called ‘Peace In The Valley’. In addition, Elvis sings ‘Santa Claus Is Back In Town’ which is strictly for adults. As ever with Speakers Corner releases, the record is a true duplicate of the original with no betrayal of modern nomenclature or small print on the product itself – only the shrink-wrapping. The sound quality is also up to Speakers Corner’s high standards; dynamic and quiet where appropriate, never fighting your hi-fi and acting as a perfect source. You can count the number of truly good Christmas albums on the fingers of one hand whilst probably ignoring the thumb, and this is surely one of those fingers.

PERERIN
Tirion Dir
Guerssen Records

If you didn’t know that Pererin, a talented folk group, are Welsh, you will certainly realise it after getting together with this 1983 album. The track names are in Welsh, the band sing in Welsh and the large, fold-out leaflet insert displays the lyrics in that language. This is accompanied by an introduction in Welsh, French and English (hurrah!) where my bemused ignorance at least found that the album title refers to Anglesey, ‘The Tender Land’.

In fact, all of the songs on this album relate to that beautiful island, a recipient of many a childhood family holiday for this writer and, obviously, a place where I should have paid far more attention to the

spoken language! The album itself is surrounded by many an acoustic, folk-driven number where, even if you cannot understand the words, you can wallow in the beauty of the music; of both lyrics and instrumentation.

Antoni Gorgues, owner of the Guerssen company, explained why this Spanish record label decided to publish a Welsh-speaking record. “We’re making available again obscure and hard-to-find records in the psych, prog and folk vein, from the late-sixties to early-eighties. There’s so many incredibly good records like this. It’s pretty disappointing that only people who found an original, possibly battered, copy can know that music so we’re glad to put them back into circulation. Pererin is an amazing band that definitely deserves these reissues. We got in touch with Pererin’s Arfon Wyn and things worked out very easily. Now we have heard that the band will play a gig in our Musiques Disperses folk festival in March 2008, after more than 20 years!”

This is the first time I’ve ever heard a record produced by the Guerssen record label and I must say that I was pleasantly surprised at just how high the production values are. The vinyl itself is very quiet and the music sounds clean. This is doubly interesting as this particular record’s master tapes were lost so this re-release was dubbed from an original vinyl. I look forward to more releases from this interesting outfit.

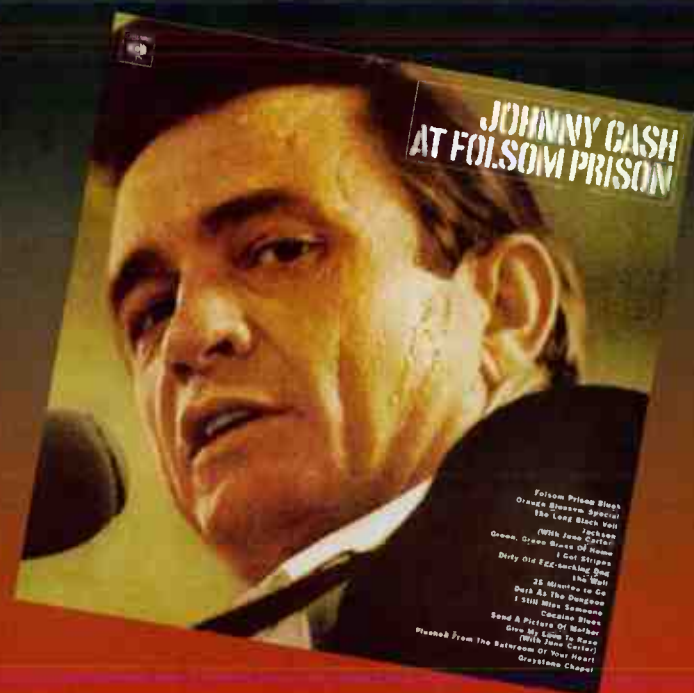

CULTURAL AMNESIA

Press My Hungry Button

Vinyl On Demand

An impressive post-punk outfit from the early eighties, Cultural Amnesia might not be known to too many music enthusiasts out there but, if you enjoy that raw period of New Wave which saw many new, creatively naive, bands taking the punk ethic and applying it to emerging synthesiser technologies, then you certainly need to hear this outfit. German-based label, Vinyl On Demand has released this double album of rarities spanning 1980-1983, taken from three cassette-based albums. In fact, almost half the tracks on this collection have not been previously heard, including pieces from two unreleased albums from the band. Fans of the cult-band Coil will also be interested to hear that Coil's John Balance, a close friend of Cultural Amnesia, contributes three songs to the release.

Band member Gerard Greenway explained why the band released their works on cassette in the first place. "We were part of the so-called 'cassette culture' that thrived in the UK from the late 1970s to the mid-1980s," says Greenway. "In the wake of punk's DIY ethic and the increasing availability of cheap domestic stereo cassette recorders, bands without a record contract and perhaps with little prospect of getting one, began to do cassette-only releases through an underground of small companies. These companies ranged from a

lone teenager in a bedsit with a dual-deck tape machine to small alternative businesses that might also be releasing vinyl. The tapes were then sold through newsletters and fanzines, and a few independent shops such as Rough Trade."

Cultural Amnesia released three cassette-only albums through small companies in the UK and Germany and appeared on a number of compilations. "We worked closely with John Balance of Coil, before Coil had properly got going. Balance, who edited a fanzine called Stabmental at the time, acted as a kind of manager for the band and also wrote a number of songs for us." Highly recommended and maintaining Vinyl On Demand's high production standards, this is a cracking release, featuring a whole host of gems in the raw – mined straight from the New Wave seam.

JOHNNY CASH

At Folsom Prison

Columbia

Cash's release is actually part of an intriguing development – Sony/BMG releasing vinyl under its own auspices and not sullenly parting company with a master tape copy to a smaller independent (see this issue's Classic Cuts for more on that story). Seemingly out of the blue, Sony/BMG has released fourteen albums from its archives. Some of the releases are not exactly rare and others have not been mastered with too much care and attention but there are

gems out there including the three albums mentioned in this issue's Vinyl News section. More to the point, the releases put major label vinyl back on the shelf – and that can't be a bad thing. There are even reports of more vinyl releases in early 2008. We have obviously been graced with a high ranking Sony/BMG executive who has a passion for vinyl. More power to him or her (although we think it's a 'him').

This Cash album is another mystery as this particular vinyl has been due for release for many months. Then all went quiet until it appeared in this 'gang' of wax, to paraphrase Sinatra. The album itself is a classic and, if you've ever wondered about buying a Johnny Cash album and were never too sure which one to get first, it is a great way to introduce yourself to the talents of the man. On this album, which was recorded within the prison itself, Cash is on the side of the prisoner, singing about prison life, the family and religion. Featuring his wife June Carter on 'Jackson' and 'Give My Love To Rose', on this album, Cash is truly the Man In Black; his dark approach is 'from the hip', unvarnished and harsh on tracks such as 'The Wall', 'Dark As The Dungeon', '25 Minutes To Go', 'I Got Stripes' and 'Cocaine Blues'. Complete with a set of liner notes, created for this album, printed on the back of the record sleeve in Cash's own hand, this is a very welcome release for this 1968 original.

CONTACTS:

Diverse Vinyl
+44(0)1633 256261
www.diversevinyl.com

Stamford Audio
+44(0) 8456035781
www.stamfordaudio.com

Designing

Part 14 – The perfect supertweeter?

Just what, exactly, do supertweeters do? Peter Comeau explores...



In recent years the term 'supertweeter' has come back to haunt us, but in a very different guise to how this appellation was originally used.

Today you'll see 'supertweeters' adorning a wide variety of commercial loudspeakers, some from manufacturers with a heritage that indicates that they ought to know better. But how can they resist the commercial fashions in an industry which supports all sorts of 'snake oil' upgrades?

Now I'm not suggesting that supertweeters all fall into the category of 'snake oil', but I do want to open your eyes (and ears) as to what they really do and how they affect the performance of loudspeakers, including your own designs.

BANDWIDTH, WHAT BANDWIDTH?

First of all let's explore the nonsense aspect of supertweeters. The current fashion is to claim that supertweeters extend the bandwidth of a loudspeaker. That's true. You will also, usually, see claims that by extending the bandwidth into the supersonic region you'll be able to hear details normally 'hidden' by speakers with bandwidths limited to 20kHz.

Well I won't go as far as to say

that is nonsense, but it is only half the story. Let's look at the facts.

Whether we can, or cannot, hear the effects of frequencies above the limit of our hearing is not, I contend, the issue where supertweeters come into play. There are plenty of reasons why extended bandwidth components in hi-fi systems may sound 'better' and most of them have nothing to do with hearing frequencies above 20kHz.

If I may divert your attention from loudspeakers for a moment, because this is the crux of the current 'fashion' for supertweeters, there is considerable evidence that extended bandwidth digital

systems, such as DVD-Audio and Sony's SACD, do sound 'better' than standard CD with its sampling rate of 44.1kHz.

I contend that the reason for this is basically simple (though technologically the complete explanation could be the subject of a book in its own right!). Standard CD has an absolute limit of 22kHz before massive waveform distortion becomes apparent (digital sampling of waveforms is limited to half the sampling frequency). So CD playback systems must introduce very steep filtering at around 20kHz to avoid audible distortion artefacts.

Now if I tried to sell you an amplifier which had steep bandwidth filtering in it, what would you do? You'd probably prefer an amplifier with no filtering, on the basis that filters and tone controls and other methods of 'modifying' the signal waveform are considered 'bad form'. Not without reason, I may add. Steep filters can easily be seen to introduce all sorts of undesirable ringing and intermodulation distortion artefacts which hi-fi systems can well do without.

So why do we put up with the same, audibly obnoxious, filters in CD players? Because we don't have much of an option. There are players which use oversampling methods to 'push' the bandwidth higher and therefore adopt 'cleaner' filters. There are players which use

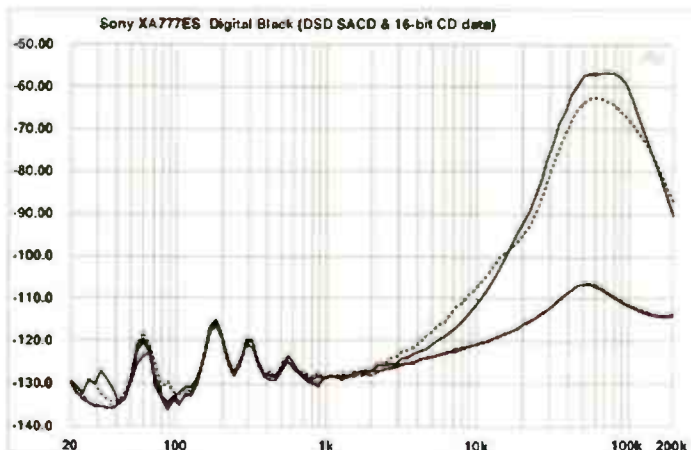

Rising ultrasonic noise floor of an early SACD player without filtering.

Speakers



interpolation methods to extend the digital bandwidth and adopt clever filtering techniques to avoid audible distortions. But the simplest method is to extend the bandwidth AT SOURCE.

This is where SACD and DVD-Audio come in. By sampling at a higher frequency, say 96kHz or 192kHz, there is the opportunity to use much gentler filtering and not only avoid filter distortions but also push the audible effects of these distortions outside the human hearing range.

So do SACD and DVD-Audio follow this dictum? Unfortunately not! Instead they both try and promise that you'll hear extra musical detail through, in Sony's case, an extended bandwidth to 100kHz. So eager were the marketing men at SACD's launch to maximise the commercial potential of SACD's extended bandwidth that they promoted the concept that you wouldn't hear the full benefit of SACD unless you had amplifiers and speakers which also stretched their output to 100kHz!

Now that is nonsense. How do we know? Because if you look at the output of SACD you will see a rapidly rising noise floor above 60kHz. This noise is so obtrusive that the original speakers designed to attempt to reproduce frequencies up to 100kHz suffered from burnt out treble units due to the supersonic power that amplifiers were putting into the speakers. As a result SACD players have filtering above 40kHz to reduce this noise level plus, of course, any source signals in this region (if there ever were any).

LA SOURCE

Oh yes, the source. Let us not forget the source. There are a few instruments which do, indeed, generate frequencies beyond 20kHz. The fundamentals of a triangle and cymbals, for example, occur up to 16kHz, which means their harmonics extend well into the supersonic range. Violin, flute, piccolo and piano are all capable of fundamental

frequencies up to 4kHz so, again, one can expect their harmonics to extend beyond 20kHz.

However if we look at the acoustic power these instruments are producing at high frequencies it is very small. Whereas the acoustic power of an orchestra can be 70 Watts at a crescendo, the output of a piano is in the order of 0.5W and a triangle at 0.05W. Now if we relate this to the ear's sensitivity at frequency extremes we get quite a shock.

If we look at equal loudness contours at lower sound intensity levels (up to 50dB SPL) we see that

could not hear frequencies above that. It is true that many teenagers (unless they have partially damaged their hearing by regularly attending loud rock concerts and nightclubs or by a consistent injection of loud music directly into their ears from ipods) can hear to 20kHz whilst the hearing of babies may extend beyond 22kHz, but very few adults are able to ascertain tones above 18kHz.

I am not going to go, here, into the question of whether the human hearing mechanism can tell the difference between the waveshape of complex musical signals with, or without, these extended harmonics

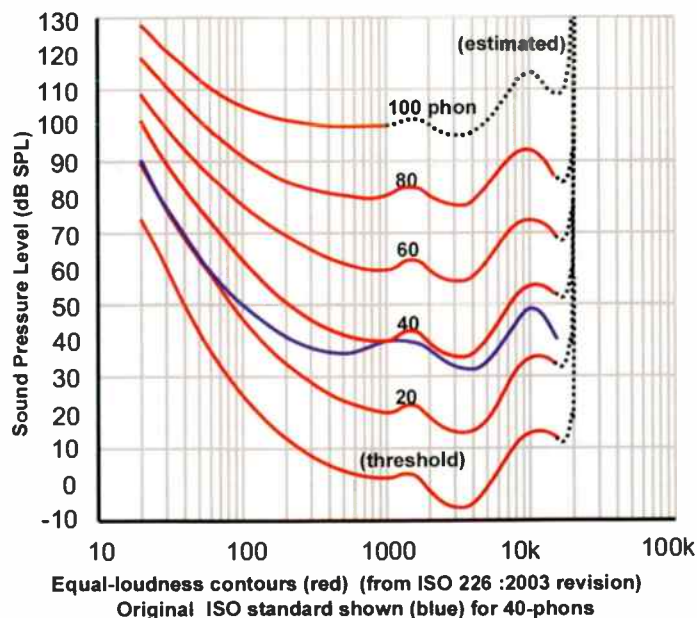

Ear sensitivity curves with contours showing the level adjustments necessary to achieve subjective equal loudness with frequency.

frequencies above 7kHz need to be raised in level by 20dB to make them as equally loud as a 3kHz tone. We can expect, therefore, that the majority of harmonics from these instruments are effectively masked by more powerful instruments or, in the case of solo performances, rendered nearly inaudible by the power of lower fundamentals.

Of course the other factor is that the equal loudness curves stop at 16kHz because the majority of the test subjects used for analysis

present. Certainly it is understood that listening to pure tones is not essentially relevant to the way we hear a musical waveform complete with its variety of tone and dynamic structures. But all the evidence points in the opposite direction, that is that complex musical waveforms tend to mask the audibility of high frequencies (in fact the mp3 recording format utilises this masking effect to discard 'inaudible' frequencies when storing music).

What all this means is that we

can hear the effects of filters in the supersonic region because they produce intermodulation products in the audible region. But it is unlikely that we can hear musically related frequencies above the human ear's physical bandwidth.

THE FIRST SUPERTWEETER

In that case why did hi-fi pundits claim that the performance of hi-fi systems was improved when supertweeters were introduced? The answer lies in what supertweeters really do, and for this we need to look back to the history of the supertweeter.

The first mention I saw of a supertweeter, and here I'm showing my age, was for the Spondor BC1 in the '60s where the original BBC design's choice of Celestion HF1300 treble unit was embellished with a Coles 4001G 'supertweeter'. According to the designer, Spencer Hughes, this was done for 'purchase tax reasons' (three way speakers were designated 'professional equipment' and therefore purchase tax exempt) but it also 'improved the overall dispersion characteristics' and 'made the detection of any 625 line breakthrough more easily detected'. The PAL 625 line frequency lies at 15625 Hz.

In this case, and for the Radford Studio Monitors and B&W DM2 and IMF monitors which followed the BC1, the addition of the Coles supertweeter was to make up for the falling HF response of the Celestion HF1300 above 14kHz. Plenty of perfectly satisfactory commercial speakers had



Spondor BC1 baffle showing Coles 4001G supertweeter.

been produced using just the HF1300, probably the most successful being the legendary Celestion Ditton 15, and no-one had ever noticed a 'lack of treble', but the inclusion of the Coles certainly added a frisson of sparkle to these speaker designs.

As Spencer Hughes correctly opined, the Coles supertweeter made an audible difference because of the improvement in dispersion. This is a simplistic explanation which covers a wealth of detail changes to the performance of the speakers in the treble region.

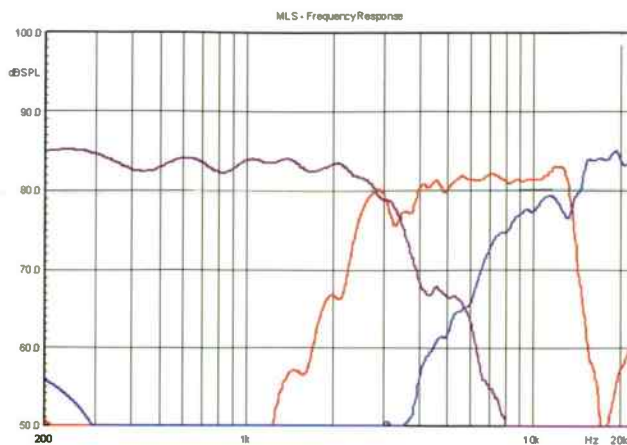

Crossover of Spondor BC1. The Supertweeter makes a significant contribution to the treble output.

WHAT DO WE MEAN BY 'TREBLE'

First let's look at why many successful speakers used the HF1300 without users complaining of, say, a dull treble output. There seems to be a contention amongst both the public, and many reviewers, that 'treble' covers frequencies from 3kHz upwards. You will often see mentions of speakers which have a rising response above 10kHz as likely to have a 'bright' treble performance.

Yet if we look at musical terminology the term 'treble' usually denotes the region from 700 Hz upwards (with the treble clef starting at a lowly 261Hz!). If you play just single tones and ask where they lie most listeners identify frequencies from between 600 – 800 Hz as 'treble'.

Similarly a 'bright' instrument is classed as one where the harmonics in the 1 – 3kHz area are emphasised. For example a brass instrument is considered to be playing 'loud' when the harmonics in the 1 – 3kHz range are exaggerated. In these pictures the fundamental sounds from a trombone only increase by 9dB between soft and loud, whereas the harmonics increase by 45dB!

So where does this nonsense about 'treble' starting at 3kHz come from? I would guess it is a natural follow-on from where the 'treble' unit's crossover frequency lies. Again, delving back into history, I note that Gilbert Briggs, of Wharfedale fame, talks about crossing over to a treble unit at 400Hz in the 1950s. This was when two way speakers incorporated a 12 inch bass unit, so the 'treble' unit really did cover the treble musical range!

As bass/midrange units have gradually improved to, now, cover much of the treble range as well it reduces the role of the treble unit to the upper treble range. There is nothing wrong with calling a driver

crossing over at 3kHz a treble unit, just bear in mind that it is largely dealing with harmonics and that what happens through the crossover area between 2 – 4kHz is far, far more significant, audibly, than what you can see happening at 10 – 20kHz.

Given all that, (phew), what does it mean in practice when we look at

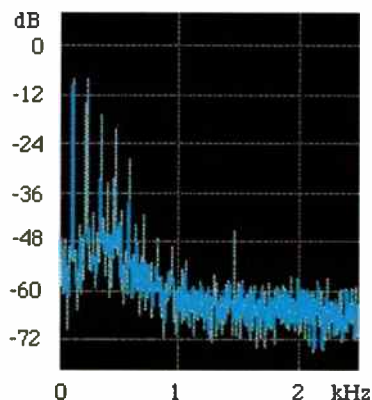

Acoustic spectrum of fundamentals and harmonics of a trombone played 'soft'.

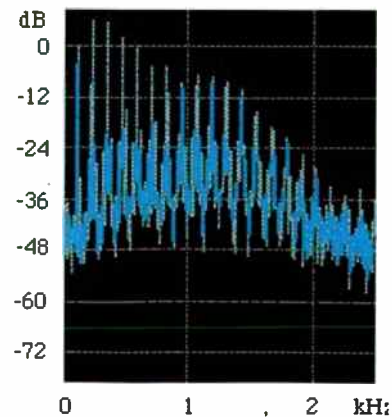

Spectrum of trombone played 'loud'. Note that the fundamental frequencies (the 'note') are only raised by 9dB whilst the upper harmonics (the 'tone') are raised by 20 – 45dB!



supertweeters? Let's go back to that Spencer Hughes quote – 'improved the overall dispersion characteristics'. Whether a supertweeter will do this, or not, for your speakers is immaterial. What really matters is the level of treble energy reaching your ears.

FRESH STRINGS

Now it's time for a short story. In my commercial design life I've consistently found that speakers with a lift in the region above 7kHz sell better than ones with a flat or drooping response. That doesn't mean they sound 'better', just that they are more exciting to listen to.

One of the sales managers I worked with was an amateur acoustic guitarist and his favourite response when listening to any of my prototypes was 'Peter, I want fresh strings'. When quizzed what he said he wanted to hear was the equivalent of an acoustic guitar fitted with new strings, in other words a sort of sheen or zing to be added to the upper harmonics. Once I had realised what he wanted I was easily able to dial it in by giving a 1.5dB lift above 7kHz. This always got the result he desired, though I never told him how I did it, and the designs always sold well.

If we look at what happens when we add a supertweeter to any speaker design there is always an element of this upper harmonic boost. For example take a design which has an apparently 'flat' response but which has a supertweeter mounted in a 'pod' on top of the speaker. Look at the upper treble dispersion and I bet you'll find that there is far higher treble power put into the room from where the supertweeter takes on much of the work compared to the output of the treble unit alone.

This is hardly surprising. The treble unit proper is on a baffle which restricts its output to the forward plane only. The supertweeter is pod mounted and is free to radiate through a much wider area. Although the direct sound measures 'flat' on the frequency response, the net effect of the sound reaching your ears from both direct sound and that reflected off walls and ceiling is a boost in upper harmonic power.

Subjectively this will sound more exciting, will add a frisson of apparent extra treble detail and will liven the speaker up musically. Conversely the extra treble power may make the speaker sound lighter in the bass, but that is just a balancing exercise.

So why does the treble apparently gain extra detail if the

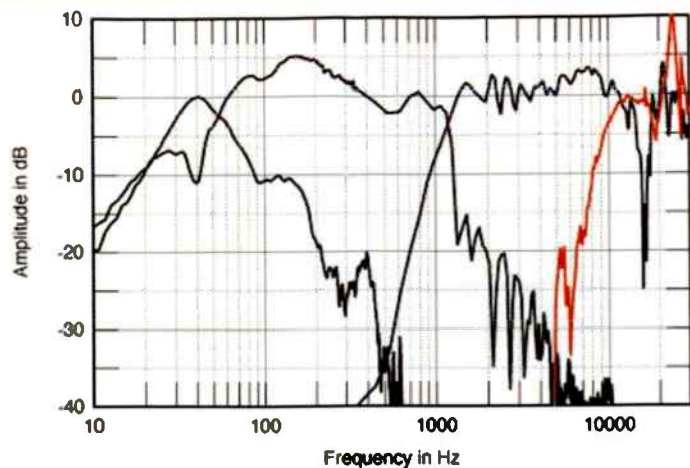

Tannoy Dimension 12 drive unit responses showing contribution of supertweeter in red down to 5kHz. You can also clearly see the dome resonance at 24kHz with limited output beyond that.

supertweeter is only enhancing the upper harmonics? For that you have to look at the psychology of our hearing mechanism. By adding extra power to the upper treble region our brain focuses more on the fundamentals associated with that energy. In other words if you exaggerate the upper harmonics the musical notes associated with them become emphasised.

Remember the graphs of the trombone playing 'loud'. The fundamental was hardly increased in level but the instrument sounds 'louder' because of the massive emphasis given to the upper harmonics.

Again we are not talking, necessarily, about what is happening in the 20kHz area. If anything is happening up here (and very little musical power is present in this frequency region) trust me, it won't be audible. Instead I would ask you to look at the crossover.

Even if the supertweeter is rolled in at 18kHz it is unlikely to have a crossover slope greater than 3rd order. That means that it is still producing significant output at 9kHz (-18dB) and will be adding to the audible effect of the treble unit down to 5kHz. In practice there are supertweeters out there that are blended with the treble unit using second or first order crossovers. In those cases removing or adding a supertweeter is bound to make a significant audible difference that has nothing to do with its supersonic output (if, indeed, it has any).

ADDING A SUPERTWEETER

There are plenty of cases where a loudspeaker will benefit from the addition of a supertweeter. One is where the treble unit is coaxial with the bass cone, for example KEF UniQ or Tannoy Dual Concentric or, indeed, the SEAS HI333 we used

in the WD20T design last month. Another is where you are playing with a so-called 'full range' drive unit such as a Lowther or Fostex.

Now I like the sound of all of these types of drive units. I'm happy to use them without a supertweeter. But they wouldn't give my ex sales manager his 'fresh strings' sound. The problem really stems from the reduced dispersion of treble power, either when a treble unit is buried in the bass cone of a coaxial unit or where you are relying on the dust cap or centre of cone to produce the treble output from a full-range unit.

You may also encounter a dull treble aspect from panel speakers, where dispersion at very high frequencies is notoriously poor, as these have a tendency to beam giving only those listeners on axis a true representation of the original signal.

In these cases the addition of a supertweeter may well work wonders, but beware. In order to work to its full potential a supertweeter must blend with the treble unit. This requires two aspects of performance. One is that the distortion from the supertweeter should be at a low level. The other is that it should integrate well with regard to phase.

Both of these are difficult, but not impossible, to achieve with a dome treble unit. Ideally the dome should have a very high material resonance (ideally above 40kHz), not suffer unduly from cavitation effects (where the centre of the dome moves independently of the surround) and have a low frequency of mechanical resonance (ideally below 1kHz if using a 2nd order crossover).

All these aspects are not easy to find in standard dome treble units. Metal domes tend to have tin can material resonances in the 22 – 28kHz region with corresponding



When it comes to Vinyl,
you need the best.



Pro-Ject
AUDIO SYSTEMS

Makers of
award-winning
turntables

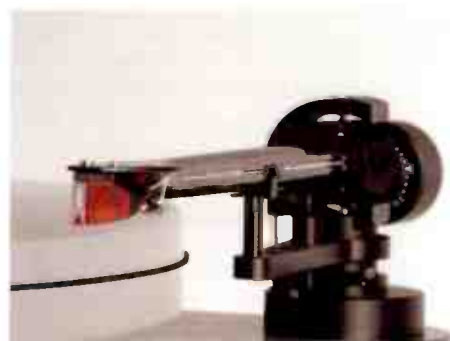

To find out more about the full range of turntables from Pro-Ject, and where you can buy them visit: www.henleydesigns.co.uk



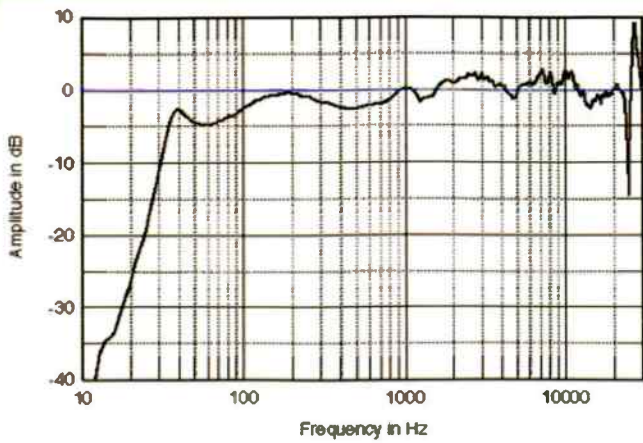

Typical speaker response showing ultrasonic resonance of metal dome treble unit at 28kHz.

intermodulation effects within the audible area. Small fabric domes have considerable cavitation problems and mechanical systems where the fundamental resonance lies between 1.5 – 2kHz. As the phase response changes markedly as resonance is approached you will almost certainly hear a level of interference between your treble unit and the supertweeter.

Probably the best combination is from treble units that use a combination of materials. For



Fountek Neo CD3.0 Ribbon treble unit

example they may have metal deposition on a fabric former. Or a sandwich construction that is both light and stiff.

This is where the concept for the WDXRS supertweeter comes from. We chose a diaphragm that does have a light but stiff sandwich construction, in this case formed as a true ribbon. Only 0.02mm thick and 8mm wide the Fountek CD3.0 ribbon is 60mm in length, weighs just 18mg, yet has a sensitivity of 95dB and a response extending cleanly to 40kHz.

As usual with true ribbons the dispersion characteristics are limited compared to domes. This unit has excellent horizontal dispersion whilst the vertical dispersion is confined to the mainly forward direction. Actually this is very useful as it neatly avoids reflections from the speaker cabinet it is sitting on as well as removing any possibility of high frequency bounce from the ceiling.

The unit, shown here naked, is housed in an oak cabinet with neatly profiled edges and a terminal panel containing switching for level and crossover frequency.

Three sensitivity levels and three crossover frequencies are provided which, in combination, should allow the user to dial in good integration with their existing speakers just by listening. The simplest method is to start off with the crossover at its highest frequency, and the sensitivity either set at minimum or set to your speakers published sensitivity, and then try reducing the crossover frequency and/or raising the sensitivity until the effects of the supertweeter can be heard.

Just like introducing a subwoofer into a system for the first time, the temptation is to change the settings until the supertweeter is audibly obvious. Naturally the listener will want to hear what he has paid for! However this type of initial setting will almost certainly mean that the supertweeter is contributing far too much to the overall treble output which will modify the tonal balance of the speaker too far towards the treble region.

So don't be afraid to back off the settings as you continue to listen. The ideal state is where you cannot actually hear the supertweeter consciously but DO notice when it is unplugged!

There is one more thing to play around with (or adjust by ear if you want the 'technical' terminology) and that is the time alignment with your existing speakers. This is easy to achieve simply because the supertweeter is free standing. All you have to do is move the supertweeter backwards and forwards on top of the speaker until it sounds best integrated with the treble unit.

Generally, because of the linear

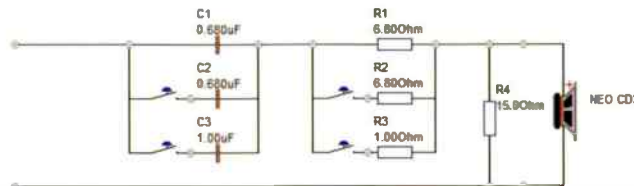

Prototype crossover for WDXRS supertweeter. Switching in C2 or C3 lowers the crossover frequency. Switching in R2 or R3 raises the sensitivity.

phase nature of the ribbon, you can set the supertweeter's front surface so that it coincides with the front to back position of your existing speaker's treble unit. If you are using a full range driver then position the supertweeter so that it lies in the same plane as the centre of the cone.

Of course if you are using a speaker measurement facility, like LspCAD, you can easily measure the effects of position, crossover frequency and level. Whether using measurement or listening you'll soon find a setting where the supertweeter simply adds a little extra sparkle to the music without drawing attention to itself.

Next month: How to obtain bass from open baffle speakers.

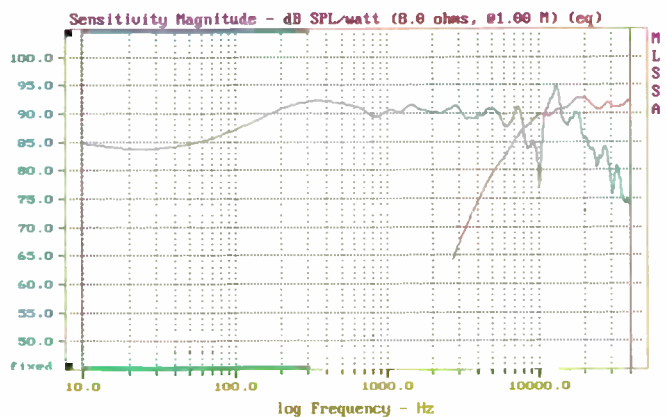

WD20T (blue) with added WDXRS supertweeter (red) showing the crossover.

The home entertainment

sale

Fri 28th & Sat 29th December only

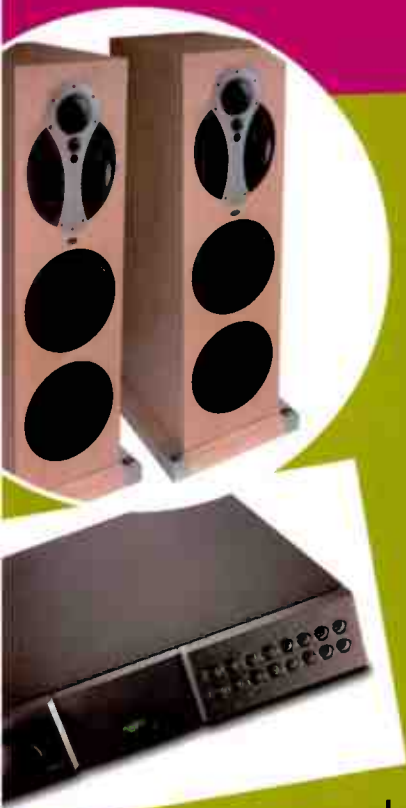

	Was £	Sale £
• Linn Ninka Speakers (Ex Demo)	1100	500
• B&W 804s Speakers (Ex Demo)	2700	1600
• Linn Unidisk 1.1 Disc Player (Ex Demo)	6830	3300
• Linn Komri Speakers (Ex Demo)	27500	13000
• Panasonic TH42PX700B 42" Plasma (Ex Demo)	1304	990
• Naim SL2 Speakers (Ex Demo)	5843	2900
• Arcam DV137 (Ex Demo)	1300	800
• Tag McLaren DVD 32R (Ex Demo)	4795	800
• Tag McLaren AV32R (Ex Demo)	2995	800
• Naim Allae Speakers (Ex Demo)	2345	990

...plus **10%** off selected stock and many, many more amazing sale bargains!

MartinKleiser

consultdesignsupplyinstallsupport

For Home Entertainment & Control

109 Chiswick High Road • London W4 2ED Tel: 020 8400 5555

9 London End • Beaconsfield • Bucks HP9 2HN Tel: 01494 681 300

www.martin-kleiser.com

vinyl section

contents

NOVEMBER 2007

www.hi-fiworld.co.uk

news

AVID VOLVERE SEQUEL 86

David Price takes this superb high end turntable for a spin...

AUDIOLAB 8000PPA & QUAD QC24P 90

Noel Keywood tells a tale of two phonostages from the International Audio Group.

DEPECHE SOLO

Depeche Mode lead singer Dave Gahan has released a new solo album, 'Hourglass', which sees his songwriting skills showing confidence and assuredness. In fact, Depeche Mode fans will feel very comfortable with this album and will recognise the stylings. Released by Mute, in an attractive gatefold, the vinyl also features the entire album on CD included within the package.



STEVE MOORE

Out now on cult indie label Static Caravan is Steve Moore's recommended new album, 'The Henge'. If you've never heard of Moore then you might possibly have heard of his day job in Zombi, an excellent two-piece instrumental band that takes classic prog and space rock vibes, translating them to the noughties. Here, Moore adopts a rather more haunting, even Krautrock instrumental, approach without ever losing his English roots. This grey vinyl edition is limited to just 500 copies.



BEARDED WONDERS

Two new re-releases from the increasingly worthy stable of 4 Men With Beards include output from two respected singer-songwriters. John Cale's 'Paris 1919' was released in 1973, and remains one of his best albums. A real 'grower' which rewards continued replays, it is a beautiful creation. As is Tim Buckley's 'Blue Afternoon', an album that begins in a folk-like manner but quickly assumes more jazz-like structures. This release was the third album in a highly creative time for Buckley. Both vinyl releases are essential buys.



PET SHOP BOYS

Called 'Disco 4', in an ongoing series, this double album features remixes for a variety of other artists such as The Killers ('Read My Mind'), David Bowie ('Hallo Spaceboy'), Yoko Ono ('Walking On Thin Ice') and Madonna ('Sorry'). Two remixes are squeezed onto each side.

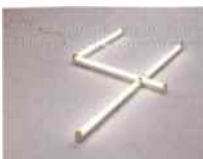

SONY/BMG REISSUES

Sony/BMG has reissued fourteen albums on 180gm vinyl, including Janis Joplin's 'Pearl', Leonard Cohen's 'Songs Of...', Miles Davis' 'Kind Of Blue', Simon And Garfunkel's 'Bridge Over Troubled Water', Elvis Presley's 'Golden Records', Patti Smith's 'Horses', Bob Dylan's 'Blood On The Tracks', Lou Reed's 'Transformer', Pearl Jam's self-titled album and Bruce Springsteen's 'Born In The USA'. Of special mention, because they've been out of circulation for some time, are the following: The Clash's 'Combat Rock', a 1982 release which saw The Clash tearing themselves into two by the diverse talents of Joe Strummer and Mick Jones; Michael Jackson's 'Bad' which became the first album to feature five No.1 hits – the album was seen as the 'impossible' follow-up to 'Thriller' - and Rory Gallagher's 'Live In Europe', the 1972 release, a huge hit and one of the best live blues-rock albums ever, that set him up in the USA at the early age of just 23. More are promised during 2008.



NEW FROM GUERSSEN

Guerssen has also issued three other top quality albums ranging over a variety of artists. From Genesis (no, not that one) comes 'Yakta Mama' (1975), the third album by the band. The album takes a folk-rock theme with psychedelic harmonies. Barry Dransfield's (1972) self-titled album is a classic singer-songwriter folk release and was one of the most startling debuts in many years. The original fetches silly money in collecting circles. Finally, Extradition's 'Hush' from 1971 shows the band to be a progressive folk outfit, not afraid to integrate both relatively modern folk structures and alternative instrumentation – it's highly recommended to anyone interested in folk. These releases are limited to just 500 copies each, so get 'em while you can...



GET BACK JAZZ

Italy's Get Back recently reintroduced jazz content to its issue schedule, releasing two high quality box sets. First off is Charlie Mingus and 'Stuttgart Meditations', a 3LP set based on an intense live gig in Stuttgart on April 28th, 1964 featuring Johnny Coles, Eric Dolphy (just two months before he died), Clifford Jordan, Jaki Byrd and Danny Richmond. Next up is Sonny Rollins' 'Soneymoon', a double album which is a mixture of live work recorded during the sixties, much of it surprisingly experimental.

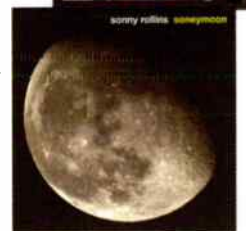
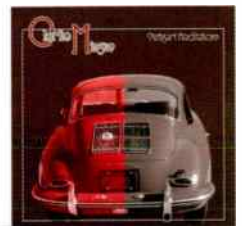



Born Again

David Price lives with one of the most interesting new turntables in years – Avid's Volvere Sequel...

We all know the story – vinyl's staging a comeback the like of which hasn't been seen since Take That hit the top spot again.

A format once almost universally written off as going the way of the Dodo has risen Phoenix-like from oblivion, and is now what everyone's talking about...

In fact, it's more than mere hyperbole, because the rush of new turntables, many of which are tested in this very issue, shows that countless companies are investing considerable time and money in making products to play it on – and they're all doing things rather differently to black plastic's last heyday back in the nineteen seventies.

For me, one of the most interesting brands to surface of late is Avid. Although the company's been trading since the late nineties, it now has a mature range of high end turntables, all of which show

genuinely fresh thinking on precisely what is (and what is not) needed to get the very best sound from this venerable fifty something year old format.

For me, a keen student of turntable best practice with some ideas of my own about how to (and how not to) do a record player, the Avid Volvere Sequel – at £4,600 a mid-price deck in the company's range – is a real eye opener. Above all else, what has impressed me most about this deck is designer Conrad Mas's joined up thinking, which informs every aspect of its design.

Rather than fixating on one component of a turntable, such as the motor, bearing or suspension, the Volvere Sequel exhibits current 'best practice' right across the board, and adds a twist or two. As such, unpacking, assembling and auditioning the deck proved a delight, and a constant source of eyebrow-raising pleasant surprises.

First and foremost, the Volvere

Sequel is a belt drive, which regular readers will know isn't my favourite way of spinning a disc right now, but the way the drive system has been done is such that many of the problems intrinsic to them have been eliminated by lateral thinking. As the design of this Avid shows, although the drive system is important, it's less a case of what you do and more of how you do it...

The Volvere runs a near-peripheral belt, which is closer to the ideal for belt drive in my opinion (running the belt around a small sub platter is more prone to speed stability/torque shortfall issues). Whereas some decks have high torque motors driving light platters, and most others the opposite of this, the Volvere uses a very high torque motor driving a heavy platter. The "extremely powerful" AC motor puts out 130mNm of torque, claimed to be ten times that of the Impex-type motors used on the likes of Linns and Regas, and is powered by a

split-phase quartz-locked purpose-designed power supply.

It's all very well having a seriously beefy motor, but like a high performance car it's pretty irrelevant if it can't put its power down, and this is where the next clever trick comes in. The key problem with belt drive turntables is their unstable suspension, which causes speed instability when the distance between platter and pulley changes as the stylus encounters differently modulated passages along the groove. Here, the tendency is for the subchassis to try and rotate around the bearing causing both wow and distortion. The sprung suspension doesn't just float up and down, but side to side, pitching like a boat in a choppy sea as the belt pulls it towards the motor spindle in to itself (and releases it back) as the varying drag exerted by the groove on the stylus (as the groove modulation varies) tries to find an escape path.

"the strongest, most stable and powerful sounding belt drive design I've heard to date..."

Like SME's high end decks, Avid's answer is to lock the lateral movement of the springs, so they can move up and down but not side to side. Designer Conrad Mas has done this very simply with three rubber bands, one on each suspension turret, that severely curtail sideways movement whilst having minimal impact on the springs' ability to go up and down. This suspension design, allied to the massy plinth, round section belt and torquey motor, give solid power transmission with minimal drama, and this in turn has a profound effect on the basic sound of the Avid.

These three spring turrets are built into the Volvere's base, and locating its three height adjustable feet (resting on rubber pads) on a level surface is the first part of setup. Done this way, the suspension has a low centre of gravity and each spring is equally adjusted regardless of load, giving near-perfect vertical movement at 3.5Hz when the second tier of the deck, the subchassis, is fitted. This one piece aluminium casting couples the arm mount to the bearing very directly, and has no parallel edges so as to discourage standing waves.

The Avid main bearing is curiously shaped for a reason – tapered upwards, it's designed to pass energy to the subchassis in only one direction, much like an

electrical diode. It's inverted for several reasons; crucially the point of contact is only 4mm from the record aiding rapid energy transfer, and its high centre of gravity gives stability. The point contact is made from a sapphire cup jewel and a tungsten carbide ball that rotates concentrically. The supporting shaft is 16mm diameter hardened stainless steel. Interestingly, it's self lubricating and Avid don't supply any oil for the user to add.

On top of this sits the platter which is again a little different from the norm. Instead of using a mat, which allows the record to vibrate locally or an acrylic platter which Avid says "offer impedance matching, but have the same frequency characteristics as records, exciting the resonating LP as one large vibrating mass", an NBR/Cork surface is used which is claimed to be more inert. The clamp is designed to contact the inner few centimetres of the

record, which is in turn pushed up by a raised mat centre and effectively locks the record to the main bearing, say Avid. It works simply, with a turn of the knurled knob dishing the disc down to the mat in one action.

Setting up the deck proved very straightforward, thanks in no small part to the superb packaging the turntable comes in. It's a three tier affair, like the turntable itself, and everything goes together very straightforwardly in the space of about twenty minutes. It's best to install the arm (and cartridge) onto the subchassis first, then locate the base just where you want it and drop the subchassis on, then add platter and motor.

For the purposes of this review, an SME V was used with a Koetsu Red K Signature cartridge (with no fluid damping), and it proved a fine match, although a more neutral Lyra Titan went on later for the sake of completeness.

The build of the Avid seems faultless, although the crackle black finish of the review model lacked the flawless perfection of the gorgeous SME turntables, for example. Worst of all was the cheap plastic tonearm lead p-clip, but I understand this has now been upgraded to something more in keeping with the very high standards of the rest of the deck. In use, the Avid felt as robust as an

EMT studio deck, and the way the pulley 'wheelspinned' on start up (and indeed pulled the heavy platter up to speed so fast) was reassuring. Properly levelled, the deck felt strongly locked in place, suggesting that periodic readjustment won't be needed.

SOUND QUALITY

I often find that auditioning high end belt drives leaves me beguiled by their delicacy, finesse and subtlety but a tad underwhelmed by other aspects of their performance – put pithily, many lack 'true grit'. Not so this one, which was undoubtedly the strongest, most stable and powerful sounding rubber band spun design I've ever heard. Pithily put, the Avid Volvere Sequel is 'the belt drive Garrard 301'.

The trouble with powerful sounding decks is that they can be 'all mouth and trousers', possessed of great bombast, bluster and general attitude but so full of themselves that they gloss over the very smallest subtleties that vinyl is so rich in. With the greatest respect to our esteemed publisher and assistant ed, I find Garrards err towards this a little more than I'd like, which is why I've nailed my colours to the direct drive mast of late. Unfortunately, the results I got with the Avid were such that I feel I may have to un-nail them rather hastily.

For example, Simple Minds' 'Alive and Kicking' is an excellent torture track for a turntable, especially in highly modulated 45RPM 12" single form. There's a lot of energy in the groove, lots of crashing power chords, musical climaxes and dynamic contrasts. Other high end belt drives can sound just a little unstable, whereas I've found the 401 can be a little over exuberant and forward. The Avid pretty much got the best of both worlds; giving great solidity in the bass allied to a wonderfully neutral and open midband without a trace of hardness or opacity.

The opening electric piano chords were an ear opener, sounding less 'cracked' than anything with a belt I've heard to date. Most impressive was the clarity, and the lustrous harmonics practically 'glistening' there in front of my very ears. When the bass guitar,



You don't know what you're missing

– until you try a van den Hul cable in your hi-fi system

van den Hul cables provide a signal path for your music that will deliver it accurately and as completely as possible

To find out more about the full range of interconnects, a/v, HDMI and speaker cables from van den Hul, and where you can buy them visit: www.henleydesigns.co.uk

van den Hul



www.henleydesigns.co.uk



simply musical



SUGDEN AUDIO TEL 01924 404088

rescuing music from technology

made in England

pure class A



REFERENCE SYSTEM

Technics SL1210/Audio Origami RB250/Lyra Dorian turntable
 Michell Orbe/SME Series V/Koetsu Red K Signature turntable
 Linn LP12SE/Ekos SE/Archiva turntable
 Pioneer PL-L1000/ADC XLM turntable
 Note Products PhoNote phonostage
 Sugden IA-4 amplifier
 Yamaha NS1000M loudspeakers

bass drum and snares kicked in, I was greeted with a delightfully tight, taut punch which again was totally devoid of harshness or grain. Singer Jim Kerr's melancholic strains were remarkably clear and direct, sounding far less nasal than I usually hear him. Excited, I moved on to my next torture track...

UB40's 'Don't Let it Pass You By' has a very strong, underslung bass line that can take the song down like a lead balloon when played on most belt drives. Not so the Avid, which offered up a wonderfully fleet of foot rendition of this finely recorded slice of classic reggae (the track harks from long before the shame of 'Red, Red Wine', you understand!). The song also showcased the Avid's wonderfully expansive midband, offering a deliciously wide stereo soundstage that fell back many metres too. Again, I've struggled to hear many decks that can out do Michell's Orbe in this particular respect, but the Avid was head and shoulders above it – no small feat. Likewise, it proved wonderfully dynamic, making the sometimes 'matter of fact' sounding SME sound positively profound and uncharacteristically emotionally committed to the music in hand.

Moving to some late sixties jazz and Herbie Hancock's 'I Have a Dream' on a 1969 BlueNote waxing showed the deck working consistently across a range of musics. This song is delicate and brooding, with subtle rhythms breaking through to gently push the song along. It's

the sort of music that Linn's LP12 really shines with, and it came as a surprise to find the Volvere Sequel doing no less well. Here, I think the gently romantic sound of the Koetsu cartridge helped, but it was Avid's startling transparency and rhythmic integrity that really swung it. This deck is truly exceptional in its ability to impart the natural tone of an instrument, conveying all its intrinsic texture and lustre in its entirety without colouring it, embellishing it or indeed dulling it.

The result was a mesmerically live sound, with brass, piano and drums all sounding as if they were in the room with me. The Avid's almost supernatural solidity really came into play here too, giving the track a mastertape like feel that left me enraptured with what on lesser equipment sounds quite a mediocre recording. From down in the bass, where it's only a percentage point or two shy of my heavily modified Technics direct drive in tautness, to the midband where it's eerily translucent, icily clear and yet smooth as silk, to the treble where it is spectacularly open and atmospheric and delightfully precise, the deck was nothing but a pleasure to listen to.

Over the past few weeks I've duly been running the gamut of my not inconsiderably sized record collection. The deck is music-neutral; time and again I've found myself letting the turntable I'm reviewing dictate the music I listen to; SMEs work wonders

with classical, Michells are a joy with electronica, Linns love rock; the Avid seemed as happy as a pig in poop with everything it was asked to play. Now numbering nearly 3,000, I rarely reach the inner recesses of my vinyl vaults these days, but this turntable had me searching out some of my least played discs.

CONCLUSION

Eagle-eyed readers may have gleaned from all this that I rather liked the Avid Volvere Sequel, and they're right. This is one of the most impressive ways to play music I've come across to date, showcasing vinyl's jaw-droppingly powerful and musical sound in no uncertain terms. My reviews of high end turntables are often full of praise but invariably tempered with some caveat or another, but here I can't really think of one. It combines the rugged build and superlative mechanical integrity of an oil rig with the delicacy, precision and finesse of the best hand-made mechanical watches.

Its sound is so neutral and open that it's almost impossible to ascribe character to; in this review, I felt I was listening to the SME Series V tonearm and Koetsu cartridge far more than the turntable.

And on a personal note, I love its lack of showiness – we're not talking acres of black Perspex or superfluous gold adornments here. Its styling, if you could call it that, is simply a function of how it does what it does. A brilliant high end turntable then; expensive - but justifiably so.

VERDICT

A high end turntable of rare completeness, it offers breathtaking all round sound from a superbly balanced belt drive chassis.

AVID VOLVERE SEQUEL £4,600

Avid Hi-Fi

+44(0)1480 457300

www.avidhifi.co.uk

FOR

- superb stability
- glassy transparency
- breathtaking dynamics
- unerring musicality
- design, packaging, set-up

AGAINST

- nothing

MEASURED PERFORMANCE

The Avid Volvere Sequel performs very well under measurement conditions. The flutter component of the measurement is particularly low, showing that the bearing and motor are well designed. As a result, the IEC-weighted wow and flutter result of 0.064% is very good.

Startup is swift, showing that the motor has plenty of torque and the speed did not waver over a period of 3-4 hours whilst warming up, although our 3150Hz test tone was recorded as 3175Hz, meaning the Volvere Sequel is running around 0.7% fast, which is

a little high and not adjustable by the user.

Apart from this small point, the Volvere Sequel measures very well and should offer a dynamic and pacy performance. AS

WOW AND FLUTTER



Time

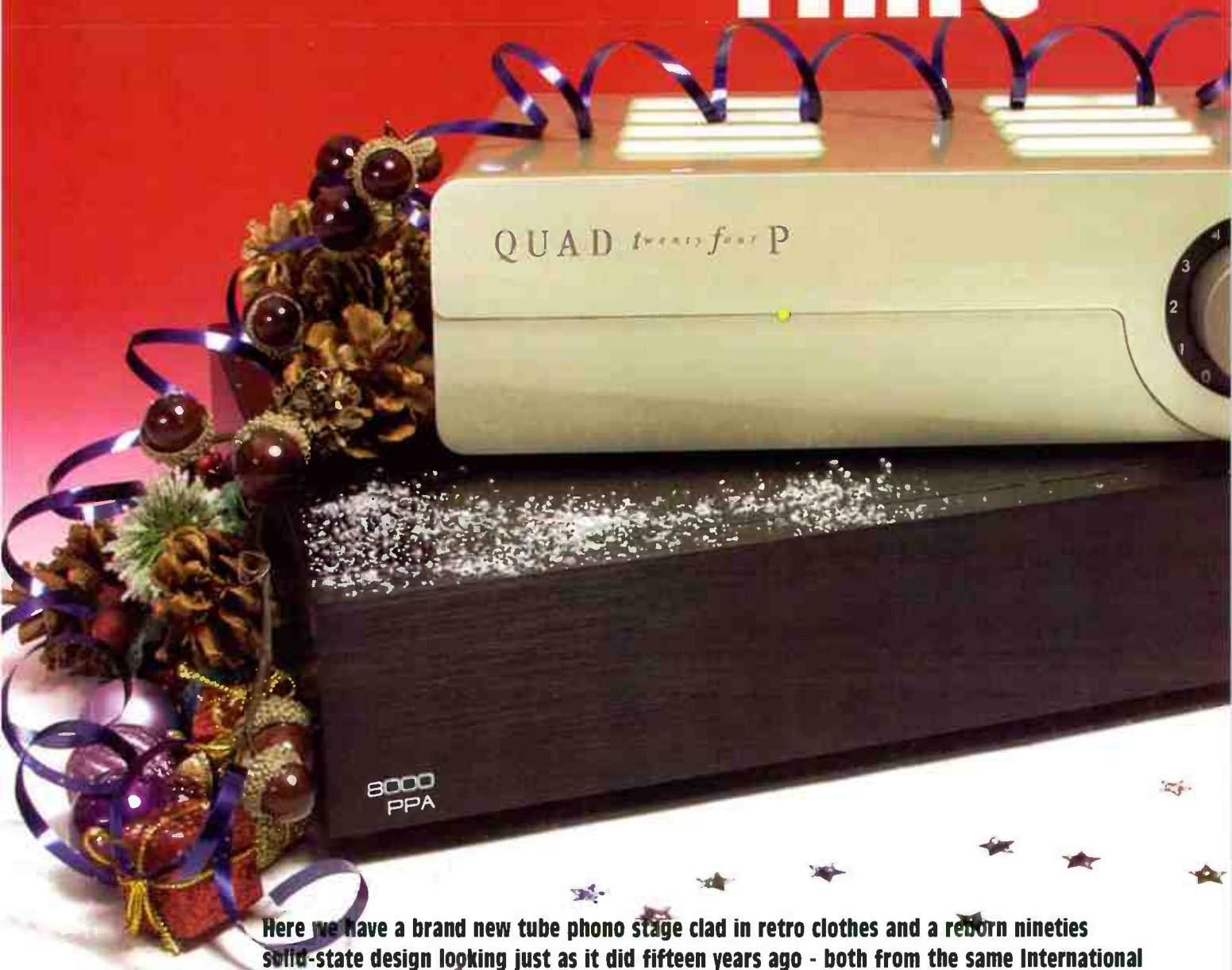

Here we have a brand new tube phono stage clad in retro clothes and a reborn nineties solid-state design looking just as it did fifteen years ago - both from the same International Audio Group. Noel Keywood compares Quad's QC twenty four P and Audiolab's 8000PPA...

Audiolab's 8000PPA is a brand new, solid-state phono stage relying upon the impeccable performance transistors provide nowadays to give a result that in some areas hovers close to perfection. Ironic then - or so it may seem - that another part of IAG (International Audio Group), Quad, should come up with a rival phono preamp based on those things that transistors and chips were meant to replace: valves. Their new 'twenty-four P' as it is called, cocks a snook at transistors, so we thought it would be interesting to take an in-depth look at both...

Housed in the casework of an Audiolab amplifier, the new 8000PPA covers a fair bit of ground area for

what it is, measuring 445mm wide, 330mm deep, but just 75mm high. Unusualness, if that's a usable word, continues with the fascia controls and their layout. There are four switched functions, with indicators showing the status of each, but the indicators are not physically aligned to their function switches, for easy visual association. Form has overwhelmed function in an unfortunate manner here, especially as function can be a little obscure to ordinary mortals not deeply versed in phono stage topology. The 8000PPA is a peculiarly awkward design in this respect and not especially intuitive. The functions on offer are unusual too.

There is a variant of RIAA correction, called IEC. This usually adds in a 40Hz filter to suppress

warp signals - the whole point of the IEC addition if I remember rightly. Unfortunately, on the 8000PPA selecting IEC reduces gain below 1,000Hz, affecting a broad area of the audio band. As a warp filter it could be better engineered.

A button marked Input toggles between two pairs of phono socket (i.e. unbalanced) inputs, so that two turntables can be used, with indicators that light up green. The last input used is the one selected at switch on, together with its associated settings - a useful feature. To minimise disc surface noise on old records a bandpass filter can be selected, which cuts both bass and treble. This is another unusual feature, and, as filters go, something of a blunderbuss. Mono can be selected

Passages



too, which on occasion can be useful.

Two phono outputs are provided, but no balanced variant. There is a rear panel attenuator, but as gain is unusually low with both moving magnet cartridges and moving coils on the MC setting, this is unlikely to be needed. A higher selectable gain of x2200 is also available for MC cartridges and this is closer to that usually provided by MC preamps.

The Quad twenty four P phono stage is so radically different from the Audiolab you'd be forgiven for thinking they come from different planets, not associated companies. It uses the now tried, tested and popular path of employing valves to amplify MM cartridges and a step-up transformer for the MC input. Whereas Audiolab gains are all on the low side, the Quad gain range varies from high to stellar! For super low output MC cartridges like those from Linn, x7000 gain is available, three times greater than the Audiolab and higher than most preamps available.

The reason for this is that the Quad can be used as a standalone preamp able to drive a power amplifier directly, because it has enough gain, plus a volume control. Pair it with solid-state power amplifiers and you get a hybrid set

up of course. The only drawback is there's no line level input so such a set up would be strictly vinyl only. The twenty four P does have an additional output at fixed level, however, so it can still be connected to a conventional, line-level preamplifier and just used as a phono stage.

SOUND QUALITY

Comparing these stages wasn't as straightforward as I had expected. Solid-state phono stages like the Audiolab are fairly common these days and, being based on low noise microphone preamp chips, sound much alike. Generally, they have a mechanical delivery, coming across

"both these phono stages are, in sound quality terms, up there with the best..."

as a little soulless, if fundamentally accurate. Priced at £550 the 8000PPA competes head on with the herd and I was expecting similar results, but it turned out better than expected.

Set to Moving Coil, High Gain and standard RIAA the 8000PPA was hiss and hum free with my Ortofon

Kotomizuki II, spinning over 180gm vinyl version of Phil Collins' I Can't Believe It's True, from Hello I Must Be Going made it clear straight away that the 8000PPA packs a very wide sound stage that is open and spacious. With horns sharply outlined and Collins' percussion work delivered with strength and speed I was both surprised and intrigued.

There was plenty of filigree detail, without the sharpness that often accompanies it. Lacking the hardness of much solid-state, which I view as colouration, the Audiolab was both listenable and engaging, having a full-bodied sound that was also highly detailed and insightful.

No matter how hard I tried, over a period of many days using this preamp alongside the Quad twenty four P and my resident Eastern Electric Minimax valve phono stage, the 8000PPA held its own, which is quite a feat, as both valve phono stages cost twice as much.

The Quad twenty four P was as accurate, but sounded less expansive laterally, having a sound stage that reached to the loudspeakers, but not beyond them. However, it established denser and more dimensional images of vocalists and instruments, with more internal detailing to them. It also brought images forward of the loudspeakers and gave a sense of depth to the sound stage. So whilst the Quad generally sounded less complex and forensically insightful in its delivery, it better fleshed out individual images into a cohesive and believable whole.

I found it hard to choose between the two, quite frankly, as

both were impressive, if in different ways. On balance I would just choose the Quad, on the basis of sound quality alone. Less superficially impressive than the Audiolab, it struck me as slightly more lifelike. All the same; there was just a bit less of that frigid dissection solid-state

STOCK CLEARANCE SAVE UP TO 35%

Time to pick up a bargain. With savings of at least 25% off the original RRP, these end-of-line* hi-fi and home cinema separates, speakers and accessories are outstanding value. But hurry, stocks are limited.

BRIGHTON 01273 733338

Arcam DiVA A80 Amplifier.....	£399.00
B&W HTM7 Centre Speaker.....	£375.00
KEF iQ2c Centre Speaker.....	£109.00
KEF iQ5 Speakers.....	£259.00
KEF iQ7 Speakers.....	£389.00
KEF KHT3005 AV Speaker Package.....	£649.00
KEF PSW3500 Sub Woofer.....	£389.00
KEF PSW4000 Sub Woofer.....	£795.00
KEF PSW5000 Sub Woofer.....	£1,599.00
KEF Reference 202C Centre Speaker.....	£695.00
Musical Fidelity A5 Amplifier.....	£1,125.00
Musical Fidelity A5 CD Player.....	£1,125.00
Yamaha RXV1700 AV Receiver.....	£549.00

BRISTOL 0117 974 3727

Arcam DiVA AVR280 AV Receiver.....	£899.00
Arcam DiVA DV137 DVD Player.....	£935.00
Audiolab 8000Q Pre Amplifier.....	£359.00
Audiolab 800C CD Player.....	£249.00
Audiolab 800CDE CD Player.....	£249.00
KEF iQ8DS Speakers.....	£259.00
Linn Klassik Musik CD System.....	£649.00
Mendian G91A DVD/Processor.....	£2,529.00
Roksan Kandy KD1 // II CD Player.....	£419.00
Sharp LC46XD1E LCD TV.....	£1,169.00
Sim2 C3X DLP Projector.....	£7,145.00

EALING 020 8579 8777

AVI Labs Series Amplifier.....	£975.00
B&W CM7 Speakers.....	£645.00
Fujitsu P42XH58 Plasma Monitor.....	£1,229.00
In Focus iF67 DLP Projector.....	£645.00
Optoma HD73 DLP Projector.....	£1,119.00
Primare i21 Amplifier.....	£449.00
Roksan Caspian M Power Amplifier.....	£649.00
Toshiba 20W330 LCD TV.....	£299.00
Yamaha DSPAX7595E AV Amplifier.....	£409.00

EXETER 01392 218895

Arcam DiVA A80 Amplifier.....	£485.00
Loewe Individual 40 DR+ LCD TV.....	£1,949.00
M&K K4 Surround Speakers.....	£225.00
M&K K5 Surround Speakers.....	£75.00
M&K KX12 Sub Woofer.....	£409.00
Marantz CD50010SE CD Player.....	£185.00
Marantz PM40010SE Amplifier.....	£185.00
Mendian i21 Receiver.....	£1,299.00
Musical Fidelity A5 Amplifier.....	£1,125.00
Musical Fidelity A5 CD Player.....	£1,125.00
REL R305 Sub Woofer.....	£599.00
REL Stampede Sub Woofer.....	£405.00
REL Storm 5 Sub Woofer.....	£649.00
Roksan Caspian M Amplifier.....	£649.00
Sim2 Domino D35 DLP Projector.....	£2,249.00
Sunfire D12 Sub Woofer.....	£585.00
Yamaha DVDS2700 DVD Player.....	£749.00

GLASGOW 0141 332 9655

Arcam DiVA A80 Amplifier.....	£409.00
Arcam DiVA AV700P AV Processor.....	£939.00
Arcam DiVA P1000 Power Amplifier.....	£1,099.00
Audica CS-T1 Speakers.....	£339.00
Audica CS-C1 Centre Speaker.....	£89.00
Audica CS-S1 Satellite Speakers.....	£109.00
Audica ST1 Speaker Stands.....	£79.00
B&W DM600 (S3) Speakers.....	£149.00
B&W DM601 (S3) Speakers.....	£185.00
Bob Carver WBB8 D8 Sub Woofer.....	£419.00
Denon AVR3806 AV Receiver.....	£649.00
Denon AVR4306 AV Receiver.....	£969.00
Denon S101 DVD System.....	£579.00
Denon AVCA11XVA AV Amplifier.....	£1,799.00
KEF KIT 100 DVD System.....	£649.00
KEF KIT 100 Stands.....	£95.00
Marantz SA11-S1 SACD Player.....	£299.00
Marantz PM11-S1 Amplifier.....	£1,599.00
Monitor Audio i-Deck iPod Dock.....	£109.00
Monitor Audio GS20 Speakers.....	£1,125.00
Musical Fidelity X-Ray V8 CD Player.....	£499.00
Musical Fidelity XT100 Amplifier.....	£579.00
Primare DVD26 DVD Player.....	£649.00
Primare SPA21 Amplifier.....	£1,299.00
Quad 99CDS CD Player.....	£419.00
Quad 99P Power Amplifier.....	£349.00
REL Stampede Sub Woofer.....	£355.00
REL Strata 5 Sub Woofer.....	£499.00
REL Storm 5 Sub Woofer.....	£649.00
Wharfedale SW150 Sub Woofer.....	£159.00
Yamaha RXV459 AV Receiver.....	£259.00
Yamaha DVDS559 DVD Player.....	£79.00
Yamaha DSPAX7595E AV Amplifier.....	£349.00
Yamaha YSTSW1500 Sub Woofer.....	£449.00

HOLBORNE 020 7837 7540

Denon AVR1907 AV Receiver.....	£299.00
Denon AVR2807 AV Receiver.....	£599.00
Denon DVD3930 DVD Player.....	£825.00

KEF KHT3005 AV Speaker Package.....	£649.00
KEF iQ5 Speakers.....	£299.00
Marantz DV5600 DVD Player.....	£189.00
Marantz DV9600 DVD Player.....	£969.00
Marantz SR7001 AV Receiver.....	£699.00
Nevo SL Universal Remote Control.....	£499.00
Project RPM5 Turntable.....	£295.00
Sim2 Domino 35 DLP Projector.....	£1,949.00
Yamaha CDRHD1500 CD/HDD Recorder.....	£389.00
Yamaha RXN6000 AV/DAB Receiver.....	£449.00

HULL 01482 587171

Acoustic Energy AE1 Classic Speakers.....	£549.00
Audiolab 8000CD Player.....	£449.00
Denon DF102 DAB System.....	£299.00
Denon TU260 // II Tuner.....	£69.00
KEF iQ5 Speakers.....	£259.00
KEF iQ7 Speakers.....	£389.00
KEF KIT100 DVD System.....	£649.00
Monitor Audio RS6 Speakers.....	£389.00
PMC DB1 MC+ Centre Speaker.....	£439.00
Project RPM9 Turntable.....	£649.00
Q Acoustics Q1030 Speaker.....	£145.00
Quad 99 Pre Pre Amplifier.....	£559.00
Quad CDP2 CD / Pre Amplifier.....	£749.00
Quad ESL2805 Speakers.....	£2,595.00
REL T2 Sub Woofer.....	£319.00
Spectral 151 Glass Rack.....	£519.00
Spectral CL1551 Equipment Rack.....	£1,419.00
Tvoti PAL Portable Analogue Radio.....	£79.00
Tvoti Model One Portable Analogue Radio.....	£59.00
Tvoti Model Three Portable Analogue Radio.....	£129.00
Yamaha YSP1100 Sound Projector.....	£579.00
Yamaha YSP900 Sound Projector.....	£389.00

KINGSTON 020 8547 0717

Arcam AVP700 AV Processor.....	£939.00
Arcam P1000 Power Amplifier.....	£1,095.00
Audiolab 8000Q Pre Amplifier.....	£389.00
Cyrus Smart Power Plus Power Amplifier.....	£449.00
Cyrus 6 Power Power Amplifier.....	£249.00
Cyrus 8 Power Power Amplifier.....	£499.00
REL R305 Sub Woofer.....	£499.00

LEICESTER 0116 253 6567

Arcam DiVA AVR300 AV Receiver.....	£999.00
Arcam DiVA DT81 DAB Tuner.....	£485.00
Arcam FMJ AV8 AV Pre Amplifier.....	£2,359.00
Arcam FMJ C30 Pre Amplifier.....	£1,119.00
Arcam FMJ CD33 CD Player.....	£1,009.00
Arcam FMJ P1 Power Amplifier.....	£899.00
Arcam FMJ P35 Power Amplifier.....	£689.00
Harman Kardon AVRE30 AV Receiver.....	£669.00
Harman Kardon AVR7300 AV Receiver.....	£1,269.00
Monitor Audio Silver FX Surround Speakers.....	£259.00
Monitor Audio Silver LCR Centre Speaker.....	£159.00
Onkyo DV5555 DVD Player.....	£269.00
Onkyo TXDS989 AV Receiver.....	£1,869.00
Pure DRX701ES DAB Tuner.....	£119.00
Vienna Acoustics Shoneburg Speakers.....	£969.00
Yamaha DVSL100 DVD Player.....	£69.00

LOUGHTON 020 8532 0770

Denon PMA1500AE Amplifier.....	£409.00
Denon DCD1500AE CD Player.....	£375.00
Grado SR60 Headphones.....	£65.00
Grado SR80 Headphones.....	£79.00
KEF iQ1 Speakers.....	£149.00
KEF iQ3 Speakers.....	£179.00
KEF iQ5 Speakers.....	£259.00
Marantz RC5400 Universal Remote Control.....	£259.00
Pioneer VSX1016 AV Receiver.....	£375.00
Pioneer VSXA2 AV Receiver.....	£319.00
Pioneer DV989 DVD Player.....	£649.00
REL Strata 5 Sub Woofer.....	£519.00
Samsung BDP1000 Blu-Ray Player.....	£449.00
Samsung LE40F71BX LCD TV.....	£1,039.00
Sennheiser HD485 Headphones.....	£45.00
Sennheiser HD555 Headphones.....	£75.00

MANCHESTER 0161 831 7969

Arcam DiVA A80 Amplifier.....	£419.00
Castle Compact Speakers.....	£299.00
Cyrus Link Power Power Amplifier.....	£319.00
Denon AVR2807 AV Receiver.....	£519.00
Denon AVR3806 AV Receiver.....	£499.00
Fujitsu P42HTS40GS 42" Plasma Monitor.....	£995.00
Fujitsu P55XHA40US 55" Plasma Monitor.....	£1,499.00
Jamo A3 SUB.5 Sub Woofer.....	£399.00
KEF KHT3005 AV Speaker Package.....	£675.00
M&K K7 Surround Speaker.....	£175.00
Monitor Audio GS10 Speakers.....	£509.00
Pioneer DVR540H-S DVD Recorder.....	£214.00
Pioneer VSX2016 AV Receiver.....	£149.00
Primare DVD26 DVD Player.....	£599.00
Yamaha RXV1700 AV Receiver.....	£449.00
Yamaha RXV2700 AV Receiver.....	£649.00
Yamaha YSP900 Digital Surround Projector.....	£389.00

NORWICH 01603 767605

Arcam DiVA T81 Tuner.....	£175.00
Atacama SL400 Speaker Stands.....	£65.00
Atacama Nexus 5 Speaker Stands.....	£45.00
Audica CS-S1 Satellite Speaker.....	£129.00
Audica Pro Stats Speaker.....	£119.00
Lexicon MC8 AV Processor.....	£3,749.00
Lexicon RT10 DVD Player.....	£1,779.00
Lexicon CX7 AV Power Amplifier.....	£2,275.00
REL Stampede Sub Woofer.....	£449.00
Rotel RC03 Pre Amplifier.....	£199.00
Sound Org Z1 Speaker Stands.....	£64.00
Spectral PL61 Plasma Stand.....	£289.00
Van Den Hul The First Interconnect Cable.....	£129.00
Yamaha MCX1000 MusicCAST Server.....	£1,349.00
Yamaha YSP1000 Digital Surround Projector.....	£585.00

NOTTINGHAM 0115 911 2121

Harman Kardon AVR145 AV Receiver.....	£335.00
Harman Kardon AVR245 AV Receiver.....	£449.00
Harman Kardon HD970 CD Player.....	£219.00
Harman Kardon HK970 Amplifier.....	£259.00
KEF C150R In Ceiling Speaker.....	£29.00
KEF iQ5 Speakers.....	£259.00
KEF iQ6c Centre Speaker.....	£189.00
KEF KHT3005 AV Speaker Package.....	£649.00
KEF KIT100 DVD System.....	£649.00
M&K LCR750 // II Speakers.....	£389.00
M&K Surround 55 Surround Speakers.....	£519.00
M&K VX860 Sub Woofer.....	£649.00
Musical Fidelity A5 Amplifier.....	£299.00
Onkyo TXSR604E AV Receiver.....	£369.00
Project Debut III Colour Turntable.....	£129.00
Project Debut III Turntable.....	£119.00
Project Xpression II Turntable.....	£185.00
REL R305 Sub Woofer.....	£599.00
REL R505 Sub Woofer.....	£649.00
Yamaha DVDS1700 DVD Player.....	£299.00
Yamaha DVDS2700 DVD Player.....	£749.00
Yamaha RXV1700 AV Receiver.....	£499.00
Yamaha RXV2700 AV Receiver.....	£939.00

PETERBOROUGH 01733 897697

Arcam DiVA A80 Amplifier.....	£419.00
Arcam DiVA P80 Power Amplifier.....	£1,299.00
Arcam FMJ DV139 DVD Player.....	£1,169.00
Arcam FMJ AV9 AV Processor.....	£2,435.00
Arcam FMJ P7 AV Power Amplifier.....	£1,885.00
Cyrus CD6s CD Player.....	£485.00
Cyrus CD8s CD Player.....	£749.00
Denon AVR2807 AV Receiver.....	£519.00
KEF iQ1 Speakers.....	£149.00
KEF iQ6c Centre Speaker.....	£195.00
KEF iQ7 Speakers.....	£389.00
KEF iQ8ds Surround Speakers.....	£259.00
Marantz SR8001 AV Receiver.....	£779.00
Yamaha RXV1700 AV Receiver.....	£449.00
Yamaha RXV2700 AV Receiver.....	£649.00

SHEFFIELD 0114 255 5861

B&W XT2 Speakers (Inc Stands).....	£615.00
B&W XTC Centre Speaker.....	£325.00
Harman Kardon HD970 CD Player.....	£195.00
Marantz SR4001 AV Receiver.....	£245.00
Marantz SR5001 AV Receiver.....	£309.00
Marantz SR6001 AV Receiver.....	£449.00
Marantz SR7001 AV Receiver.....	£585.00
Yamaha RXV2700 AV Receiver.....	£845.00

SOUTHAMPTON 023 8033 7770

Arcam DiVA DV135 DVD Player.....	£669.00
B&W CMC Maple Centre Speaker.....	£259.00
Cyrus 6 Power Power Amplifier.....	£299.00
Cyrus 8 Power Power Amplifier.....	£519.00
Cyrus PSXR Power Supply.....	£299.00
Denon DVD2930 DVD Player.....	£479.00
Marantz SR5001 AV Receiver.....	£669.00
Marantz CD00010SE CD Player.....	£179.00
Marantz PM11 S1 Amplifier.....	£1,599.00
Marantz PM40010SE Amplifier.....	£179.00
Marantz PM7001 Amplifier.....	£259.00
Marantz SA7001 CD Player.....	£299.00
Marantz SA7001 KI CD Player.....	£449.00
Marantz SR4001 AV Receiver.....	£259.00
Marantz SR5001 AV Receiver.....	£339.00
Marantz SR6001 AV Receiver.....	£519.00
Marantz SR8001 AV Receiver.....	£899.00
Marantz ST15 S1 DAB Tuner.....	£399.00
Marantz VP11 S1 DLP Projector.....	£7,499.00
Pioneer BDP1X70 Blu-Ray Player.....	£749.00
Q Acoustics 1000s Sub Woofer.....	£129.00
Samsung PS63P76FDX Plasma.....	£3,499.00
Yamaha DVDS2700 DVD Player.....	£749.00
Yamaha RXV1700 AV Receiver.....	£579.00

SOUTHGATE 020 8886 2777

Denon AVR1907 AV Receiver.....	£299.00
Denon DVD2910 DVD Player.....	£349.00

Denon S301 DVD System.....	£899.00
Pioneer VSX516 AV Receiver.....	£199.00
Yamaha DVDS1700 DVD Player.....	£299.00

STAINES 01784 460777

Arcam Alto Speakers.....	£285.00
Monitor Audio GS60 Speakers.....	£1,499.00
Monitor Audio GSLCR Surround Speaker.....	£369.00
Project Xpression 2 Turntable.....	£185.00

SWINDON 01793 610992

Arcam DiVA DV78 DVD Player.....	£485.00
Denon AVR1507 AV Receiver.....	£185.00
Denon AVR2807 AV Receiver.....	£599.00
Denon DVD1930 DVD Player.....	£185.00
Denon DVD2930 DVD Player.....	£485.00
Quad L-Sub Sub Woofer.....	£449.00
Roksan Kandy/III Amplifier.....	£419.00
Roksan Kandy Power Amplifier.....	£355.00
Sim2 Domino D35 DLP Projector.....	£2,249.00
Toshiba 37WL768 LCD TV.....	£819.00
Yamaha DSPAX759 AV Amplifier.....	£355.00
Yamaha DSP29 AV Amplifier.....	£1,949.00
Yamaha DVDS2500 DVD Player.....	£449.00
Yamaha DVDS2700 DVD Player.....	£649.00
Yamaha RXN600 AV/DAB Receiver.....	£449.00
Yamaha YSP1000 Digital Surround Projector.....	£579.00

WATFORD 01923 213533

B&W CCM645 In-Ceiling Speaker.....	£109.00
B&W CM1 Speakers.....	£369.00
B&W CM7 Speakers.....	£749.00
Denon AVR1507 AV Receiver.....	£159.00
Denon AVR1907 AV Receiver.....	£299.00
Denon AVR1907 AV Receiver.....	£259.00
Fujitsu P42XH58 Plasma Screen.....	£1,719.00
KEF HTS2001 Speaker Stands.....	£59.00
KEF iQ2c Centre Speaker.....	£95.00
KEF iQ6c Centre Speaker.....	£189.00
KEF KHT2005 AV Speaker Package.....	£559.00
Monitor Audio Radius 360 Sub Woofer.....	£225.00
Mendian G56 Power Amplifier.....	£939.00
Mendian G98HD DVD Transport.....	£2,175.00
Mendian G01 Pre Amplifier.....	£939.00
Q Acoustics 1010s Sub Woofer.....	£75.00
Project Xpression II In-Ceiling Speaker.....	£69.00
Wharfedale Diamond 9 Centre Speaker.....	£59.00
Yamaha RXV2700 AV Receiver.....	£749.00

WITHAM 01376 501733

Arcam DiVA A90 Amplifier.....	£709.00
Arcam DVD37 CD Player.....	£335.00
Arcam DiVA T81 Tuner.....	£159.00
Audiolab 8000CD CD Player.....	£359.00
Creek Destiny CD Player.....	£899.00
Cyrus CD6S CD Player.....	£485.00
Cyrus CD8S CD Player.....	£749.00
Denon DVD3930 DVD Player.....	£819.00
Fujitsu P50XH58US Plasma Monitor.....	£2,469.00
Arcam DiVA i11 Mini-Sub Mains Conditioner.....	£499.0



so ably achieves, and more holistic construction - if you get my drift. It too is super quiet like the 8000PPA, so there is nothing between them here.

How did the Minimax fare? Obvious against both the Audiolab and Quad was lighter bass, due to the smallest equalisation error, and this is what would concern many listeners I suspect. However, it has the constructional ability of the Quad, the open sound staging of the Audiolab and a sense of crystal clarity I find attractive. Differences at this level of the game start to become very subtle, a tribute to how well these stages are engineered.

Fitting a Goldring 2500 Moving Magnet cartridge to my SME312 arm swung the pendulum in favour of the Audiolab I felt. What was a vague suspicion of more rounded bass from the Quad with the Kontrapunkt b became more obviously the case with Goldring's 2500. By way of contrast,

with this cartridge the Audiolab sounded particularly firm and well defined across the lower frequencies, right down into the deep bass region. Tina Turner's Steamy Windows brought out differences clearly, its strong bass line sounding taut, and with a nicely defined independence about it through the 8000PPA. The Quad delivered a massive bass line, but it was overly enthusiastic and a little too pervasive, I felt.

Unfortunately, moving magnet gain from the Audiolab was so low that I had to wind volume right up with the Goldring. Also, the IEC option offered no real subjective benefit and neither did Filter, so I have to confess that I am baffled by these options...

CONCLUSION

Bearing in mind the competitive pricing of Audiolab's

8000PPA, it is great value and something of a gem in terms of sound quality, providing it suits the amplifier it will be used with, which must be sensitive. It is both analytical and enjoyable, having a polish to its sound that most solid-state stages lack. By way of contrast Quad's twenty four P is a well worked out design that will suit all needs. More emotionally engaging, if a tad less 'correct', it is still a great choice for anyone who is serious about playing LP, especially if it is used as a vinyl only preamp.

I could live with either of these phono stages. Both were an enjoyable listen, teasing out the best from LP. Neither has a "ho hum" presentation able to make knitting seem recreationally more challenging. Quite which to choose will depend upon your system and the depth of your pocket. Funny how after forty years of valves being rendered obsolete they should still be duelling transistors neck-to-neck in such a critical area as a phono stage, but then I think we are all better off for it. Both these stages are, in sound quality at least, right up with the best.

REFERENCE SYSTEM

Garrard 401/SME 312/Ortofon Kontrapunkt b turntable
World Audio Design KLP1/300B pre-power amplifiers
RRR FS100 loudspeakers

MEASURED PERFORMANCE

AUDIOLAB 8000PPA

A gain of x75 is provided for the Moving Magnet setting, which is low; x100 minimum is common. Switching in MC also switches in 470 Ohm input loading so higher MC gains cannot be used for MM, making the PPA inflexible and not the best match for low sensitivity integrated amplifiers.

Moving coil cartridges are better served, with gains of x693 and x2200 available. Input overload figures were fine, being set by gain and a maximum output of 13V.

Equalisation was accurate with MM, with just the slightest rise above 1kHz, whilst MC went the other way, exhibiting a slight fall above 1kHz, as our high resolution analysis shows. As these differences in equalisation amount to fractions of a dB they are unlikely to be apparent.

The IEC curve introduces significantly lower gain below 1kHz and will subjectively result in a lightening of bass, as well as performing its original intended task, as I remember it, of attenuating warp signals. As a result, using this

filter to lessen warp signals will also affect lower midband balance.

Noise was very low with both MM and MC.

The 8000 PPA measures well in outline, but it could be better tailored to its purpose. NK

Frequency response	
MM	1Hz-120kHz
MC	2Hz-65kHz
Separation	88dB
Noise (e.i.n. MM,MC)	0.26mV / 0.06mV
	0.006%
Distortion	
Gain (MM)	x75;
(MC)	x693, x2200
Overload	
MM	180mV in / 13V out
MC	19mV/6mV in / 13V out

FREQUENCY RESPONSE

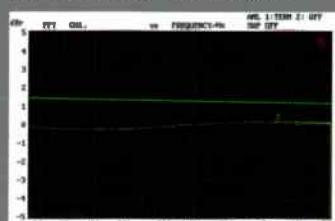

MEASURED PERFORMANCE

QUAD TWENTY FOUR P

The MM section has three gain options: x184 up to x737. The lowest is sufficient for all MMs and even the highest gain (x737) is usable, as input overload is an acceptable 27mV. As the output can swing no less than 19V, there is plenty of output leeway.

The high gain setting can drive a power amplifier directly from the volume control (variable) output. Input noise (MM, e.i.n., A wtd.) was a normal enough 0.6uV, meaning hiss will be inaudible, and there was a negligible hum component. Channel separation measured 67dB and distortion 0.025% second harmonic only at all gain settings.

Frequency response measured flat from 23Hz up to 35kHz (-1dB) with MM. Our analysis shows output rolls down slowly below 100Hz, due to the presence of a slow warp filter which reduces gain by -10dB at 10Hz.

The MC stage has a similar frequency response. Gain levels were vast, measuring x1785 at Low, x3565 Medium and x7135 at High. At High, 0.5mV in would give over 3V out, so again the twenty four

P could drive all power amplifiers direct, as most need just 1V. Noise with MC was very low 0.08uV (e.i.n., A weighted), making the twenty four P very quiet.

Measuring the Quad twenty four P shows it can act as a phono stage or preamp. In both roles it measures very well. NK

Frequency response	
MM	23Hz-35kHz
MC	24Hz-32kHz
Separation	67dB
Noise (e.i.n.)	0.6mV / 0.08mV
Distortion	0.025%
Gain (MM)	x184, x366, x737
(MC)	x1785, x3565, 7135
Overload	
MM	110mV/56mV/27mV in/19Vout
MC	11mV/5.2mV/2.7mV in/19Vout

FREQUENCY RESPONSE

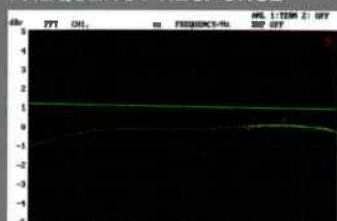

QUAD TWENTY FOUR P £1,000
IAG Group
+44 (0)845 4580011
www.quad-hifi.co.uk

VERDICT ●●●●●
Atmospheric with superb imaging and great dynamic vigour, this is a beguiling phono stage to listen to.

- FOR**
- deep soundstage
 - natural and dynamic
 - huge gain range

- AGAINST**
- bassy with MM
 - no XLR in or out

AUDIOLAB 8000PPA £550
IAG Group
+44 (0)845 4580011
www.audiolab.co.uk

VERDICT ●●●●●
Sounding open, expansive, fast and dynamic with both MM and MC cartridges, this is a great phono stage.

- FOR**
- wide soundstage
 - precise yet engaging sound
 - two inputs

- AGAINST**
- insufficient MM gain
 - weird facilities

Wishful Thinking

NAME: Channa Vithana
DESCRIPTION: audiophile with muso tendencies

Merry Christmas

The fire is lit, the mince pies warming gently and the port making its way round the table at Hi-Fi World towers as the CD player gently croons 'White Christmas'. And now it's time to unwrap the presents, so raise your glasses as Channa Vithana, Adam Smith and Steven Green rip off the wrapping, and read on to find out what they've got...



JOHN MELLENCAMP, 'WHENEVER WE WANTED' (AMAZON, £10)

Often critically derided as a poor facsimile of Bruce Springsteen, John Mellencamp really came into his own with this superb renaissance of a recording. Released in 1991, 'Whenever We Wanted' was a stunning riposte to the occasionally brilliant but mostly wayward and sometimes clunky musicality of his early releases. Here Mellencamp finally celebrates the purity of stripped-down rock and roll by directly injecting superbly hummable songs with the colours and harmonics of well-played rhythm guitar, precision drumming and tight groove-led bass playing. A wonderfully instant recording that does not fade with familiarity, and the 2005 reissue CD is better still.

JOY DIVISION, 'STILL' (DIVERSE VINYL, £30)

Never mind the quality, feel the packaging! This stunning double LP reissue will instantly warm even the coldest of digital hearts (Patrick Cleasby, take note). Beautifully



presented and comparable to the original packaging from 1981/82, it's finished in heavyweight card and wonderfully textured hessian fabric. 'Still' (Fact 40) is described in the book, 'Factory Records The Complete Graphic Album' by Matthew Robertson, where "The austere cover, with block-printed lettering in Copperplate, has a simplicity that aims at longevity – the eternal." Joy Division's epic, beautiful music can also be described in the same way.

CLEARAUDIO STAINLESS STEEL LEVEL GAUGE (AUDIO REFERENCE, £23)

There are many levelling devices available today - from the humble DIY-store OEM spirit levels, to those wonderful but expensive instruments with decimal-pointed digital displays for the most fastidious obsessive, there is something for everybody. However, being someone who prefers elegant simplicity, I really rate this



beautifully built and finished stainless steel level gauge from turntable manufacturer Clearaudio. It is ideal for straightening-up equipment tables, racks, and source components which are very sensitive to being out of level, especially turntables. I got mine from Audio Reference .

QUADRASPIRE QX! SILENCER QX 25 ISOLATION SUPPORTS (QUADRASPIRE, £25)

Finished in Quadraspire's visually attractive reference-grade acrylic, the miniature QX 25s (25x25mm) are a superb tweak for isolating hi-fi source components. I tried them under a Linn Majik CD player and got superior timing - the rhythms and



phrasing of instruments and vocals was discernibly improved, making for a brilliantly musical sound. The QX! Silencer series is also available in QX 50 and QX 165 sizes which likewise allow sound-enhancing vibration isolation for hi-fi cables, standmount loudspeakers and amplifiers.

'MOTLEY CRÜE THE DIRT...', TOMMY LEE, MICK MARS, VINCE NEIL AND NIKKI SIXX WITH NEIL STRAUSS (AMAZON, £10)



The combined hell-raising antics of the 'Stones, Led Zeppelin and The Who cannot compare to the sheer depravity and *outré* of glam-metal band Motley Crüe throughout the nineteen eighties. From bassist Nikki Sixx being pronounced clinically dead for two-minutes after overdosing, and following resuscitation, injecting heroin again and waking up in pools of his blood - every rock and roll cliché is crushed by the Crüe with nonchalant disdain in this riveting, hilarious, and tragic deterrent of a bestseller. Published by ReganBooks (Harper Collins, 2002).

AMAZON
www.amazon.co.uk

DIVERSE VINYL
 +44(0)1633 259661
www.diversevinyl.com

AUDIO REFERENCE
 +44(0)1252 702705
www.audioreference.co.uk

QUADRASPIRE
 +44 (0)117 986 3228
www.quadraspire.co.uk

NAME: Adam Smith
DESCRIPTION: analogue addict

Merry Christmas

GRANITE CHOPPING BOARD (ASDA, £9.75)

We all know that siting our equipment in a firm and stable location works wonders with its performance. However, whilst most isolation platforms work well, they are not cheap and some audiophiles are a little nervous about shelling out a good deal of money on such an item, initially at least.

Fortunately, help is at hand, from ASDA of all places, as they sell a rather nice granite chopping board for the princely sum of £9.75! A painless way to enter the world of dedicated equipment supports and if you can't hear a difference, well you've got yourself a nice chopping board for the kitchen...



NUMARK PT-01 (HARD TO FIND RECORDS, £69)

As with any obsessive, I find it's always a bit of a wrench to tear myself away from my vinyl for long periods, such as when going on holiday for example. Luckily, with the resurgence in interest in vinyl, Numark have come to my rescue with the PT-01 record player. This is a rather natty portable device with built-in amplifier and loudspeaker that is compact enough to fit into a standard size DJ record bag - the idea being that you can lug it

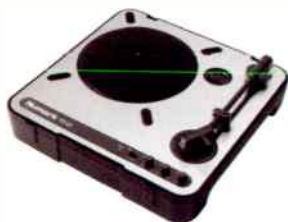

around to record fairs with you in order to check your prospective purchases before parting with the ready. However, as it can be battery powered, I think it would be perfect for my commute on the train, and a refreshing change from the MP3 players that surround me every morning.

VESTAX VCC-3W CARTRIDGE CASE (LEISURETEC DISTRIBUTION, £35)



As regular readers know, I do indeed have too many turntables, many of which are old-timers featuring lovely S-shaped arms with old SME/IEC fitting headshells. As a result, I have gathered a good collection of these, but the problem I found was, what do you do with those spare ones when you aren't using them? Luckily, a number of cartridge storage cases have appeared on the market recently, that accept a number of such headshells and store them out of harm's way when not in use. The likes of Stanton, Shure and Prostyle all have very nice items on offer but the one that really caught my eye was the Vestax VCC-3W, in a very fine real wood finish - there's a definite touch of class about it.

'SWISS PRECISION' BOOK (JOACHIM BUNG, 70EUROS)



Everyone needs a bit of a break over Christmas with a spot of light reading and, having just finished my last year's copy of Stefano Pasini's EMT book, the timing was spot on for this to arrive on the market. The second edition of Joachim Bung's 'Schweizer Präzision' has now been translated into English and covers the history of the Thorens TD124 turntable, along with the story of its development. Space is also given to the arms and

cartridges of the era, plus a few choice rival decks. All in all, a fascinating history in a beautifully presented tome.

CLEARAUDIO TURNTABLE CARE KIT (HARD TO FIND RECORDS, £55)



Continuing the vinyl theme, I do get rather tired of continually misplacing my record cleaning ephemera; I'm sure the cat moves it when I am not looking. Consequently, a nice collection in a handy box is just what I need, and those thoughtful people at Clearaudio have come up with just the thing. Their turntable care kit consists of a Carbon fibre record cleaning brush, stylus cleaning brush, "elixir of sound" diamond cleaning fluid, polishing paste, cleaning fluid for acrylic parts, microfabric cleaning tissue and a handy small screwdriver all enclosed in a neat wooden case. I need never lose my bits and pieces again!

BANG AND OLUFSEN A8 EARPHONES (BANG & OLUFSEN, £95)



In case you were wondering, the bit about using the Numark PT-01 on the train was a joke, and I do actually listen to the radio on my morning commute. Now I find that those in-ear 'earbuds' are hideously uncomfortable and won't stay in my ears for more than thirty seconds. Fortunately, Bang and Olufsen have come to my rescue with the A8s. These are incredibly stylish (naturally...) little units that sit over the ear and fit their driver into your ear courtesy of a three-way adjustable, beautifully damped mechanism. They are also well designed, so you will not be sharing your music with anyone else within a ten foot radius, no matter how loud you listen. They also sound great, with B&O's typically sweet mid and treble, allied to superb clarity and surprisingly healthy bass.

ASDA
+44(0)845 300 1111
www.asda.co.uk

HARD TO FIND RECORDS
+44(0)121 687 7777
www.htfr.com

LEISURETEC DISTRIBUTION
+44(0)1525 850085
www.leisuretec.co.uk

JOACHIM BUNG
+49 6084 3764
www.redaktionsbuero-bung.de

BANG & OLUFSEN
+44 (0)118 969 2288
www.bang-olufsen.com

STOCK CLEARANCE SALE AT LEAST 50% OFF

There's at least 50% off the original RRP on these end-of-line* hi-fi and home cinema separates, speakers and accessories. Stock is very limited, so hurry.

BROMLEY 020 8290 1988 GUILDFORD 01483 536666 SEVENOAKS 01732 459553 TUNBRIDGE WELLS 01892 531543

Arcam Alto Amplifier	£599.00
Arcam DVA AVR250 AV Receiver	£449.00
Arcam DVA AVR300 AV Receiver	£599.00
Arcam DVA DV78 DVD Player	£349.00
Arcam DVA DV79 DVD Player	£449.00
B&W D57 Surround Speakers	£399.00
Barb One + USB & RX Wireless Audio Bridge	£119.00
Barb One TX & RX Wireless Audio Bridge	£119.00
Barb Three + One TX Wireless Amplifier	£299.00
Cyrus D+ D2 DVD Player	£599.00
KEF PMA200	£119.00
Energy Veritas 2.0om In-Ceiling Speaker	£119.00
Harman Kardon AVR430 AV Receiver	£399.00
Immerge S1002-80 Sound Server (80 GB)	£999.00
Immerge S2002 160GB Harddrive	£599.00
Infocus SP5700 Projector	£699.00
KEF 5001 Sat/Surround Speaker	£69.00
KEF HT3001 Centre Speaker	£99.00
KEF HT33001 Satellite Speakers	£119.00
KEF I07 Speakers	£249.00
KEF KH1900ACE Surround Speaker	£249.00
LG 23L10R LCD TV	£399.00
LG 32L200 LCD TV	£549.00
LG 42L810 LCD TV	£549.00
LG AN110 DLP Projector	£399.00
LG BH100 Blu-Ray/DVD Combo	£499.00
LG RZ29L250 LCD TV	£299.00
LG RZ37P10 LCD TV	£499.00
M&K K15 Surround Speaker	£99.00
M&K K17 Surround Speaker	£99.00
M&K K7 Surround Speaker	£99.00
M&K LCR35 Surround Speakers	£129.00
M&K LCR750 Surround Speakers	£249.00
M&K LCR750C Centre Speaker	£129.00
M&K MP4512 AV Speaker	£299.00
Marantz SR8500 AV Receiver	£449.00
Monitor Audio + Deck iPod Dock	£99.00
Onkyo DV5338 DVD Player	£399.00
Onkyo DVSP501 DVD Player	£499.00
Onkyo TXDS989 AV Amplifier	£799.00
Panasonic DMRE50 DVD Recorder (Multi Region)	£399.00
Panasonic TH77800-CAB or WAL Plasma TV	£949.00
Panasonic TH42PX600-WAL or PED Plasma TV	£949.00
Panasonic TX32LX600 LCD TV	£599.00
Philips 42PF9731D LCD TV	£399.00
Philips 42PF9731D LCD TV	£399.00
O Acoustics 1000S Subwoofer	£399.00
O Acoustics 1020 Speakers	£59.00
Samsung BDP100 Blu-Ray Player	£349.00
Samsung DVDRH725 DVD/HDD Recorder	£199.00
Samsung HT100 2.1 DVD System	£249.00
Samsung LE23R18X LCD TV	£599.00
Samsung LE40T18X LCD TV	£699.00
Samsung PS429H Plasma TV	£599.00
Samsung PS429H Plasma TV	£599.00
Samsung PSE6700 Plasma TV	£399.00
Sharp XZ200E DLP Projector	£399.00
Sim2 Domino D35 DLP Projector	£1,499.00
Teac AL700P Power Amplifier	£299.00
Toshiba 20WL156 LCD TV	£249.00
Toshiba 27WL156 LCD TV	£299.00
Toshiba 32WL156 LCD TV	£499.00
Toshiba RDXS24 DVD Recorder	£199.00
Toshiba RDXS30 DVD Recorder	£199.00
Xantech UR22P Learning Remote	£99.00
Yamaha DFX1000 DLP Projector	£1,499.00
Yamaha DSPAX159 AV Amplifier	£499.00
Yamaha DSP29 AV Receiver	£1,299.00
Yamaha DVS1500 DVD Player	£119.00
Yamaha MCXA10 MusicCAST Client	£249.00
Yamaha RXV359 AV Receiver	£399.00
Yamaha YSP1000 Digital Surround Projector	£449.00
Yamaha YSP900 Digital Surround Projector	£299.00

BRIGHTON 01273 733331

Arcam DVA AVR250 AV Receiver	£499.00
Arcam DVA AVR300 AV Receiver	£649.00
Arcam DVA DV79 DVD Player	£499.00
Arcam FMJ C30 Pre Amplifier	£599.00
Arcam FMJ CD33 CD Player	£675.00
Arcam FMJ DV29 DVD Player	£799.00
KEF C400 CI Speaker	£69.00
KEF Reference 204C Centre Speaker	£395.00
KEF Reference 201 Speakers	£1,999.00
KEF XQ1 Speakers (Inc Stands)	£495.00
KEF XQ2 Centre Speaker	£299.00
KEF XQ5 Speakers	£795.00
Musical Fidelity KW250S System	£2,499.00

BRISTOL 0117 974 3727

M&K X660 Sub Woofer	£495.00
M&K K4 Surround Speakers	£239.00
M&K K5 Surround Speaker	£79.00
KEF Modet 1 Speakers	£495.00
Linn 104 Komponent Speakers	£609.00
Linn 110 Komponent Speakers	£629.00
Linn 106 Komponent Centre Speaker	£259.00
Linn 120 Komponent Sub Woofer	£395.00

CHELSEA 020 7332 9466

Arcam DVA DT81 Tuner	£149.00
Creek Evo Amplifier	£249.00
Creek Evo CD Player	£249.00
Arcam DVA DV78 DVD Player	£349.00
Denon DVDR300 DVD Player	£549.00
KEF I06C Centre Speaker	£149.00
KEF X30C Speakers	£499.00
Musical Fidelity KT100 Amplifier	£449.00
Musical Fidelity X-Ray v8 CD Player	£449.00
Musical Fidelity Triple-X Power Supply	£149.00
Diploma HD81 HD Projector	£1,999.00
Pioneer DV989 DVD Player	£499.00
Rotel RSP1096 AV Processor	£1,149.00
Yamaha MCX100 MusicCAST Server	£799.00

EXETER 01392 218905

Fujitsu P50XA40 Plasma Display	£1,499.00
Meridian G11 DVD Audio	£1,949.00
Ruark Taisman III Speakers	£749.00
Ruark Crusader III Speakers	£1,399.00
Sim2 HT300 DLP Projector	£2,999.00

GLASGOW 0141 332 9655

Arcam DVA P80 Power Amplifier	£219.00
Arcam FMJ T31 Tuner	£229.00
Arcam DVA DV78 DVD Player	£375.00
Arcam DVA AVR250 AV Receiver	£465.00
Arcam DVA DV79 DVD Player	£495.00
Arcam DVA AVR300 AV Receiver	£649.00
Boston Micro Sub Woofer	£75.00
Denon DVD3000 DVD Player	£399.00
Denon DVD3910 DVD Player	£399.00
Fujitsu P42HA40 Plasma Monitor	£1,499.00
Harman Kardon The Bridge Pod Dock	£49.00
Harman Kardon TC100 Universal Remote Control	£49.00
Linn Skelit In Wall Speaker	£175.00
Linn Slimik Sub Woofer	£69.00
Loewe Spheros 42 Plasma TV	£2,999.00
M&K V200 Sub Woofer	£349.00
Marantz RC140 Universal Remote Control	£39.00
Marantz RC120 Universal Remote Control	£49.00
Marantz DV4200 DVD Player	£399.00
Marantz DV4000 DVD Player	£399.00
Marantz SR7500 AV Receiver	£349.00
Marantz DV9500 DVD Player	£749.00
Onkyo DV5335 DVD Player	£399.00
Pioneer DV702 DVD Player	£149.00
Pioneer PDP507X Plasma TV	£1,499.00
Quadraspire Q4M Midi Rack	£149.00
Quadraspire OS Rack	£235.00
Teac Legacy 700 DVD System	£299.00
Yamaha YSP1000 Digital Sound Projector	£449.00

KINGSTON 020 8547 0717

Acoustic Energy Evo Centre Centre Speaker	£74.00
Denon TU1800 Tuner	£99.00

Denon AVR3806 AV Receiver	£499.00
In Focus IN72 DLP Projector	£324.00
KEF HT3000 Centre Speaker	£124.00
Marantz DV760 DVD Player	£299.00
Mission M-Cube Stands	£99.00
Philips RC900 Universal Remote Control	£199.00
Quad L-Centre 27" DLP Projector	£134.00
Sim2 Domino 30H DLP Projector	£1,499.00
Sim2 Domino 35 DLP Projector	£1,499.00
Wharfedale Diamond 9.4 Speakers	£149.00
Wharfedale Diamond 9.8 Speakers	£149.00
Wharfedale Diamond 9FS Rear Speakers	£174.00
Yamaha YSP1000 Digital Surround Projector	£449.00

LEICESTER 0116 253 6567

Loewe Xelos 28 CRT TV	£349.00
Loewe Vitos 32 CRT TV	£349.00
Yamaha MCX1000 MusicCAST Server	£795.00
Yamaha MCX-A10 MusicCAST Client	£259.00
Yamaha PDM1 Plasma TV	£3,999.00

LOUGHTON 020 8532 0770

Audiolab 8000S Amplifier	£249.00
Audiolab 8000X Pre Amplifier	£299.00
Loewe Concept LCD TV	£599.00
Sim2 Domino 30L DLP Projector	£1,999.00
Tvix Audio I-Pal Portable Analogue Radio	£69.00

MANCHESTER 0161 631 7003

Denon AVR3806 AV Receiver	£499.00
Fujitsu P42HT540GS Plasma Display	£995.00
Fujitsu P55XHA40US Plasma Display	£1,499.00
Jamo ASU.5.5 Sub Woofer	£29.00
Pioneer DV604S DVD Recorder	£209.00
Pioneer VSX2016 AV Receiver	£149.00

NORWICH 01603 767605

Acoustic Energy Aelite Centre Centre Speaker	£135.00
Audica G11 Pedestal Stand	£175.00
M&K K5 Surround Speaker	£79.00
M&K K7 Surround Speaker	£79.00
M&K K10 Sub Woofer	£1,299.00
Roksan Kandy DVD DVD Player	£325.00
Screen Play SP5700 DLP Projector	£1,099.00
Tannoy Superlink Supercenter Cable	£49.00

NOTTINGHAM 0115 911 2121

Musical Fidelity KW235 System	£1,999.00
Civil Scan Pro Video Processor	£249.00
GEQ Systemline MIRA Power Amplifier	£299.00
Tivoli Songbook Radio	£79.00
Wharfedale Diamond 9C Centre Speaker	£49.00
Wharfedale Evo 8 Speakers	£119.00
Yamaha MCXA10 Music Cast	£299.00
Yamaha MCXA100 Music Server	£799.00

PETERBOROUGH 01733 897637

Arcam FMJ P1 Monobloc Amplifier	£1,199.00
Arcam FMJ A32 Amplifier	£349.00
Arcam FMJ P35 Power Amplifier	£449.00
Arcam FMJ T31 Tuner	£249.00
Dali Concept Centre Speaker	£74.00
Harman Kardon AVR35 AV Receiver	£499.00
Living Control Music Box3 HDD Server	£1,475.00
Mendian DSP33 Active Speakers	£1,295.00
Mendian DSP500C Active Centre Speaker	£1,295.00
NAD TL43C AV Amplifier	£499.00
Samsung BD100 Blu-Ray Player	£299.00
Toshiba HD E1 HD-DVD Player	£175.00
Wharfedale Diamond 9 CS Surround Speakers	£74.00
Yamaha MCXA10 MusicCAST Client	£299.00
Yamaha MCX200 MusicCAST Server	£999.00

PRESTON 01772 825777

Arcam DVA CD73 CD Player	£299.00
Arcam DVA A80 Amplifier	£399.00
Arcam DVA DV78 DVD Player	£499.00
Arcam DVA DV78 DVD Player	£499.00
Arcam FMJ P35 Power Amplifier (3 Channel)	£599.00
Arcam FMJ CD36 CD Player	£799.00

Arcam FMJ C31 Pre Amplifier	£599.00
Arcam Alto Speakers	£199.00
Conex Compact Sub Woofer	£199.00
Castle Keep Centre Speaker	£100.00
Celestion AVF302 Speakers	£149.00
Cyrus DVD 8 DVD Player	£599.00
Cyrus Quattro CD / Pre Amplifier	£299.00
Cyrus DAC X DAC	£499.00
Cyrus Pre Xps Pre Amplifier	£499.00
Cyrus Link Power Power Amplifier	£199.00
Cyrus Rev Amplifier	£399.00
Cyrus Link Server (160GB) HDD Audio Server	£1,499.00
Denon TU1500R Tuner	£399.00
Denon ADMV71 DVD System	£199.00
Energy GR3 Surround Speakers	£399.00
Harman Kardon AVR30 AV Receiver	£499.00
In Focus IN74 DLP Projector	£599.00
KEF I03 Speakers	£149.00
Loewe Xenos 620RS DVD Player	£199.00
Marantz CD5010SE CD Player	£149.00
M&K K7 Surround Speakers	£149.00
M&K K4 Surround Speakers	£149.00
K9 Sub Woofer	£199.00
M&K XK7 / II Sub Woofer	£149.00
Mission M7DS Surround Speakers	£399.00
Mission M80 AV Speaker Package	£1,399.00
Mission e82 Speakers	£599.00
Mission e8AS2 Sub Woofer	£599.00
Monitor Audio Radius AV Speaker Package	£399.00
Pioneer VSXA110A-S AV Receiver	£1,399.00
Roksan Caspian Tuner	£299.00
Roksan Kandy Power Amplifier	£299.00
Yamaha DXP300 DLP Projector	£799.00
Yamaha DSP29 AV Amplifier	£1,499.00
Wharfedale DFS Surround Speakers	£199.00
Wharfedale Evo 20 Speakers	£199.00

SHEFFIELD 0114 255 5881

Arcam Alto Speakers	£475.00
Arcam AVR300 AV Receiver	£249.00
Denon AVR1707 AV Receiver	£749.00
Denon AVR2307 AV Receiver	£149.00
Denon AVR4306 AV Receiver	£349.00
KEF I07 Speakers	£229.00
Pioneer PDKT510 Table Stand	£499.00
Pioneer PDP507XD Plasma Monitor	£249.00
Samsung BD100 Blu-Ray Player	£299.00
Yamaha DSPAX159 AV Amplifier	£499.00
Yamaha RXV170 AV Receiver	£299.00

SOUTHAMPTON 023 8039 7770

Mirage Untheatre Surround Speaker	£349.00
Pioneer PDKT510 Table Stand	£109.00
Pioneer PDKT510 Table Stand	£79.00
Pioneer PDP325 Plasma Accessory Speakers	£39.00
Sim2 C3X DLP Projector	£5,999.00
Yamaha MCX100 MusicCAST Server	£699.00

WITHAM 01938 501733

Pioneer DV9020 DVD/HDD Recorder	£299.00
Pioneer PDS32L Plasma Accessory Speakers	£29.00
Ruark Taisman III Speakers	£749.00
Wharfedale Diamond 9 Centre Speaker	£49.00
Yamaha DXP300 DLP Projector	£299.00
Yamaha MCXA10 MusicCAST Client	£299.00
Yamaha YSP1000 Digital Sound Projector	£449.00

WOLVERHAMPTON 01902 312275

Denon AVR16 AV Receiver	£225.00
Denon AVR16 AV Receiver	£1,299.00
Fujitsu P42HT540GS Plasma Display	£995.00
Harman Kardon AVR24 AV Receiver	£299.00
M&K 850 AV Speaker Package (Inc Stands)	£1,795.00
M&K K5 AV Speaker Package	£1,595.00
M&K K5 AV Speaker Package	£1,095.00
Quad L-Centre Satellite Speakers	£199.00
Yamaha DSPAX159 AV Amplifier	£299.00

YEovil 01935 700078

Alcatraz Audio SL6000 Speaker Stands	£599.00
Denon AVR1907 AV Receiver	£199.00
Samsung LE40M18X LCD TV	£399.00
Yamaha MCX200 MusicCAST Server	£999.00
Yamaha MCXA10 MusicCAST Client	£299.00

STOCK CLEARANCE AT LEAST 35% OFF THE ORIGINAL RRP ON THESE PRODUCTS

BROMLEY 020 8290 1988 GUILDFORD 01483 536666 SEVENOAKS 01732 459553 TUNBRIDGE WELLS 01892 531543

Arcam A50-7.1 AV Amplifier	£599.00
Arcam FMJ DV29 DVD Player	£799.00
Audica CS-System 1 AV Speaker System	£399.00
B&W FPM2 Speakers	£129.00
B&W LCR600 (S) Centre Speaker	£149.00
Channel Plus 3425 2 Channel RF Modulator	£249.00
Channel Plus 5515 RF Modulator	£149.00
Channel Plus 5672 Nicam 2 Channel Encoder	£279.00
Cyrus BVS Amplifier	£399.00
Cyrus BVS Amplifier	£399.00
Cyrus Link Power Power Amplifier	£299.00
Cyrus Linkport CD Player	£399.00
Cyrus Linkserver 250 CD Player	£1,999.00
Cyrus Pre Xps Pre Amplifier	£499.00
Cyrus Smart Power Plus Power Amplifier	£399.00
Denon ADV5050 AV System	£269.00
Denon AVR150 AV Amplifier	£149.00
Denon AVR1101 AV Amplifier	£179.00
Denon AVR1907 AV Amplifier	£249.00
Denon AVR2105 AV Receiver	£249.00
Denon AVR2307 AV Receiver	£399.00
Denon AVR2807 AV Receiver	£549.00
Denon AVR3806 AV Amplifier	£699.00
Denon AVR3806 AV Receiver	£699.00
Denon AVR4306 AV Receiver	£399.00
Denon CC2001 CD System	£149.00
Denon DHT5050 AV System	£299.00
Denon DM31 CD System	£129.00

Denon DVD1930 DVD Player	£49.00
Denon DVD2910 DVD Player	£349.00
Denon DVA D1 DVD Player	£1,499.00
Denon DVA11XV DVD Player	£1,599.00
Denon DVA11XV DVD Player	£399.00
Fujitsu P52A00S Plasma Accessory Speakers	£199.00
Himax HDCI2000 HDTV Satellite Receiver	£199.00
In Focus	



the only compressed files my car stereo supports are MP3 and WMA. Furthermore, I seem to be forever changing CDs, which has never been the safest thing to do when I'm going round a roundabout, so I think it's time for a new car stereo... Surprisingly, I couldn't find one with a hard drive in it, nor one that supports FLAC, but the Pioneer DVH-P5900MP looks my best bet, because it can play writeable DVDs, so it ticks the 'less disc changing' box, and it also supports the all-important AAC.

'HIGH-FIDELITY MULTICHANNEL AUDIO CODING', YANG, KYRIAKAKIS AND KUO (HINDAWI, \$120)

I was hoping to find a book covering the old (DVD-Audio and SACD) and new (Dolby TrueHD and DTS-HD Master Audio) high-resolution audio formats, but I couldn't on Amazon, and the closest one I could find was this. It actually covers lossy rather than lossless audio compression, so there's quite a lot of overlap

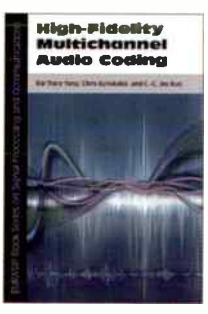

with other books that cover lossy compression, but as this is a relatively new book it has quite a few new MPEG-4 audio topics not covered elsewhere, and is unique (to my knowledge) in that it concentrates on multi-channel audio coding rather than stereo. Judging by the table of contents it's likely to be quite mathematical in parts, so for people not keen on mathematical tomes a good alternative covering a broad range of digital audio topics and written in a more descriptive style would be 'Principles of Digital Audio' by Ken Pohlmann.

WI-FI /DAB/DAB+-UPGRADEABLE/FM HI-FI TUNER £ ??

I would love a tuner that supports virtually all formats, systems and bands, but unfortunately it hasn't

been invented yet. Actually, I suspect it has, but it has yet to reach the market. So I'm reserving an exclusive place in my Xmas stocking for when it does! Anything that combines support for Wi-Fi Internet radio, DAB and FM, and which is also upgradeable to DAB+ and because the firmware of Wi-Fi Internet radios can be upgraded over the Internet as well, can be no bad thing. Of course, it would be very likely to receive support for the Internet multicast streams that are due to launch next year, and which are set to become the highest quality digital source of the bigger UK radio stations. And if all that wasn't enough, it' will even allow me to stream music wirelessly from my computer to my hi-fi system. Can't come soon enough...



VEHO VFM-002 FM TRANSMITTER (VEHO, £20)

Ultra-low power FM transmitters such as this Veho used to be illegal, but as so many people were using them to transmit audio from their MP3 players to their car stereos that Ofcom changed the law to allow their use. But the reason I want one is that it'll allow me to listen to my own music on an FM portable radio around my flat. I've already tried one of these, and you simply plug it into a headphone socket, select an unused FM frequency to transmit on and tune your FM portable to that frequency to pick up the transmission. I could pick the signal up with no problems anywhere in my flat (the advertised range is ten metres), and the sound quality was good enough for listening on a portable radio – not bad for something that costs only £10.



ROBERTS WM-201 WI-FI INTERNET RADIO (ROBERTS, £185)

The best portable I've reviewed to date, simply because it provides both superb sound quality and it's an Internet radio - which I've found a revelation ever since I first used one, due to the massive choice of stations available (over 8,000 at the last count). The fact that the basic audio quality of the stations tends to be a lot better than on DAB doesn't exactly put me off, either. Its ergonomics aren't so good though, because it only has a single button that acts as the on/off switch, volume knob and 'select' button all rolled into one! Still, it does have a small remote control. The only thing to stop you putting this on your Xmas pressie list is that there's a range of combined Wi-Fi/DAB receivers coming out shortly, so you might want to wait for them to come out before taking the plunge...

PIONEER DVH-P5900MP DVD CAR HEAD UNIT (PIONEER UK, £230)

I don't covet this little DIN-sized box of tricks for the 'bling', but rather for its safety features which will keep these Green fingers on the steering wheel rather than twiddling the stereo. You see, the vast majority of the audio stored on my computer is in FLAC or AAC formats, but

ROBERTS
+44(0)1709 571722
www.robertsradio.co.uk

PIONEER UK
+44(0)870 600 1539
www.htfr.com

HINDAWI PUBLISHING
www.hindawi.com

UPGRADEABLE TUNER
We'll let you know...

VEHO
+44(0)23 80016519
www.veho-uk.com

KIT & COMPONENTS SUPPLIERS

COMPONENT SUPPLIERS

AUDIO SYNTHESIS

PO Box 50 Nottingham, NG9 1DX.
Tel. 01159 224138 Fax. 01159 229701.
Email salesinfo@audiosynthesis.co.uk
Website www.audiosynthesis.co.uk

VISHAY BULK FOIL RESISTORS - unquestionably the world's finest resistor for audio applications. Thousands of VSRJ 0.3W 300V 5ppm 1% values in stock at the lowest possible prices eg. values up to 20K at £3.50+vat. HIGH PURITY SILVERWIRE - Teflon insulated >99.99% purity, 0.6mm and 1.0mm diameter. Ideal for internal wiring, interconnects or speaker cables.

NOTEWORTHY AUDIO LIMITED,

36 Buckingham Street, Aylesbury,
Buckinghamshire, HP20 2LH
Tel: 01296 422224
email: info@noteworthyaudio.co.uk
web: www.noteworthyaudio.co.uk

Suppliers of a selected range of audiophile valve kits and components. Including the Stoetkit range of valve amplifiers, Audio Note one times oversampling Dac Kit 1.1 and Lowther drive units. Plus a range of components and accessories from Eichmann, Furutech, Wonder Solder, Caig and many more. For a list of the extensive range of manufactured products and the special offers we stock please see our website or call for details. We are open from 9.30 to 5.30 Tuesday to Saturday, with demonstration stock of our kits available - please call in advance to book an audition.

LOUDSPEAKER KIT SUPPLIERS

ARENA ELECTRONICS LTD

59 Main Street, Great Gidding
Huntingdon, Cambridgeshire PE28 5NU
Tel: 01832 293320 Fax: 01832 293372
e-mail: sales@seas.co.uk
Website: www.seas.co.uk

Arena Electronics was appointed official UK distributor for SEAS high performance drive units in January 2006. We offer the full range of SEAS drive units, designed and built in Norway, together with speaker kits and advice for DIY speaker builders. These include the World Designs WD25A project, complete parts for which can be purchased on our website including the cabinet kit.

IPL ACOUSTICS,

Chelsea Villa, Torrs Park,
Ilfracombe, North Devon, EX34 8AY
Tel/Fax: 01271 867439

Please visit website for full catalogue of products:
www.iplacoustics.co.uk

IPL supply a range of 9 high quality transmission line speaker kits and a full range of Hi Fi and AV speaker kits including 2 powerful active subwoofers. Drive units are available from Hi Vi research, Seas, Morel, Fountech (Ribbon tweeters) and IPL custom built drivers. IPL also supply;-quality crossover components, cabinet accessories, including Silver plated PTFE insulated cables, and the very highly rated Aler-Hamblin Digital amplifier.

IMPACT AUDIO

Unit 102, The Courtyard
Radway Green Business Centre
Radway Green, Crewe,
Cheshire, CW2 5PR.
Tel : 01270 883243 Fax : 01270 882241
email : info@impactaudio.co.uk
Website : www.impactaudio.co.uk
Main UK distributors of VISATON loudspeaker kits, drive units and accessories. We offer over 35 professionally designed kits from one of Europe's leading manufacturers. Drive units include the MHT 12 ribbon tweeter, T1 100 titanium cone midrange and the new TIW range of high power woofers. Contact us for a free catalogue or visit our website for full details.

WILMSLOW AUDIO

50 Main Street, Broughton
Astley, Leicester, LE9 6RD
Tel: 01455 286603 Fax: 01455 286605
Email: sales@wilmslowaudio.com
Website: www.wilmslowaudio.com
Contact us for a copy of our FREE Full Colour Catalogue or visit our Website with secure online ordering.
The UK's largest supplier of loudspeaker kits, drive units and components. We also have a range of subwoofer kits and amplifier modules available. Official UK distributor for ATC, Morel, Peerless, Scan-speak, Seas, Vifa and Volt. Beware of imitations, we only stock drive units made by the genuine manufacturers. We offer a full repair and upgrade service on most makes of loudspeakers.

VALVE AND OUPUT TRANSFORMER SUPPLIERS

CHELMER VALVE COMPANY LTD

The Stables, Baddow Park
Great Baddow, Chelmsford, Essex,
CM2 7SY
Tel: 01245 241300 Fax. 01245 241309.
Email: sales@chelmervalue.com
Web Site: www.chelmervalue.com
Premium range of audio valves, tested/selected for low noise, hum, microphony; power valves burnt-in. Huge stock of valves/tubes of all type, audio valves (inc. NOS types), industrial etc. Also large stocks of semiconductor. Many obsolete types.

BILLINGTON EXPORT LTD

1E Gillmans Trading Estate
Billingshurst, West Sussex RH14 9EZ
Visitors by appointment only
Fax: 01403 783519
E-mail: sales@bel-tubes.co.uk
Web: www.bel-tubes.co.uk
Guaranteed new/old stock valves for audio & industrial use Vintage types including Mullard, GEC, Telefunken & RCA. Large stocks of Chinese & Tesla. Major stockists of the Billington Gold brand. Free catalogue on request. Attractive prices on large orders. Minimum order £100.00

REPAIRS & RESTORATION

AUDIO LABORATORIES (LEEDS)

3 Kildare Terrace Industrial Estate Leeds LS12 1DB UK
Tel/Fax +44 (0)113 2440378
The UK's Leading Service & Restoration Specialists.
Repairs/Restorations to Modern/Classic/Vintage valve hi-fi, musical and cinema amplifiers, control units etc. We will even build that kit for you or design something special. Please visit our Website at:- www.audiolabs.co.uk for complete details of our comprehensive services. Alternatively, contact us at:-

ARKLESS ELECTRONICS.

Tel. 01670 829891
E-mail: arkless.electronics@btinternet.com
Specialist in repairs, restoration and modifications to all amplifiers, valve or solid state, ancient and modern. Design service for companies and hobbyists. Amps, preamps, phonostages, active crossovers, psu's etc custom built to order. Kits built/debugged. Please enquire for any other services. Ex design engineer for well known hi-fi companies.

POWER SUPPLIES

PAUL HYNES DESIGN

Keld Cottage, Askham, Penrith, Cumbria, CA10 2PG.
Tel: 01931 712822
Email: paulhynes@freezone.co.uk
Website: paulhynesdesign.com
If your analogue or digital audio equipment is powered by a low cost linear or switching power supply, replace it with a **HIGH PERFORMANCE LINEAR POWER SUPPLY** for an immediate audible improvement. New, a special linear shunt regulated supply, for the Altman Attraction DAC outperforms the Optima Red Top battery.

**To advertise in this space
please call
020 7372 6018
or email:
advertising@hi-fiworld.co.uk**

mail

Visit our website at www.hi-fiworld.co.uk or send your emails to letters@hi-fiworld.co.uk. Letter of the month wins a pair of Precious Metals interconnects and one years FREE subscription to HI-FI World.



Letter of the Month

FAMILY VALUES

First, thank you all for the magazine - straightforward and a great help to a serious music fan. Hi-Fi World reports were the major influence in many of my purchases. As a result, my rear end is now a pair of Yamaha NS200M speakers, bought as a direct result of your comments on the NS1000Ms. I Googled and found these which I didn't previously know existed. Did you? Apparently they were one of their little brothers...

Without having 1000Ms to make a side-by-side comparison the difference appears to be just the 8" not 12" bass speaker. The midrange and tweeter look identical, beryllium-based, fast and clear and I have been staggered by the sound. They sit on Dreadnought stands from Peter Partington. I rang Peter in March 2002, he had a couple left over from the Bristol show, and I grabbed them. Just in time - they've gone up!

From the front end inwards I have a Dynavector DV10X5 high-output MC cartridge in John Michell TecnoArm 'A' both supplied and kindly installed by John Oakman at Grahams Hi-Fi in Islington. John is a serious classical musician and singing teacher as well as a thoroughly good guy. It also happens that in 2007 David Graham agreed to sponsor the choir I sing in: Highgate Choral Society - it truly is a small world at times!

Underneath these, my record rotation is by a Garrard 401 in superb original condition. Bought indirectly from an ad in Hi-Fi World, of course. The one advertised had already gone but a friend of the seller was also selling his, and I bought it on sight from Brian Jones, a precision engineer. Geoff Kremer (Mr. Servicesound in Bexhill-on-Sea) checked it over for me, pronounced it pristine and lubricated the bearing with a new oil he found recently. He had already reconditioned my (valve) kitchen radio, a 1950s Dynatron, a lovely old Vortexion microphone amp and the Ferrograph 422 I bought in 1969.

Amplification is by the said Geoff Kremer after Harold Leak. He took the beautiful beige-gold Stereo 20 I bought from the Audiojumble in Tonbridge and turned it into his Essence amp. This develops the bass, amongst other things. Geoff said I would not need a REL when he'd done it and he was right (sorry, Richard!), as there's nowt wrong with my bottom end now.

Preamplification is also by Mr. Kremer - his new Topaz preamp with built-in phone stage from his big Proteus amplifier, which replaced the Croft Vitale I had before. This gives good gain to cope with MCs so with the Dynavector I never need to go above 30-40% on the volume control (Alps Blue Velvet, of course). I'd better say "usual disclaimer" at this point or you will think I'm getting a backhander from English Valve Amplifiers - untrue! It's just that my setup is so damn good that I am going to bed later and later - I just can't stop putting on another LP and another, from Handel to Beethoven to Miles Davis to Weather Report to Joni Mitchell to Pink Floyd. All this is when not using my Leak Troughline Stereo bought from the same Audiojumble and overhauled by... Mr. Kremer!

I'm afraid to say that CD is non-existent. My fifteen year old Cyrus PCM bought from Radford Hi-Fi in Gloucester Rd., Bristol died recently as the laser has gone. John at Grahams favours Marantz, presumably the CD6000K1 you praised, but I haven't checked as I have no money right now. Is my system unique?

Again thanks and regards,
Martin D Eatough

Well, I have heard of the NS200Ms and I feel sure that David knows



Yamaha NS-200M - one of the NS-1000's baby brothers.

them as well. As you say, they came below the NS1000M along with the NS500M, NS600M and NS700X and basically seem to be a scaled down version of the bigger fellas. I have always thought that Yamaha knew how to build a decent loudspeaker and so you may well have found yourself a bargain if you've obtained a good percentage of NS1000M performance for a much smaller percentage of their price. Still, best keep this between us if you have, otherwise everybody will want some...

As to the rest of your system, well, yes, it very probably is unique and I imagine it sounds pretty good as well. It's nice to see so many classic names like Leak, Ferrograph and Garrard all together, but with a handy touch of modern restoration to ensure they really give of their best. We at Hi-Fi World approve! **AS**

I don't know about unique, but it's an interesting one for sure. You're a shining example of hi-fi upgrading best practice, Martin. You've made sensible, considered, non-impulse purchases and ended up with some fine components which will give superb sound if properly set up and maintained. By approaching things in this way, you don't feel the need to constantly chop and change

SEVENOAKS

SOUND & VISION

A perfect combination

Sevenoaks has over 35 years' experience in the world of sound and vision and has selected this combination of outstanding products from three of the UK's finest - Cyrus, Spondor and QED.

Take some of your favourite CDs along to one of our stores nationwide and hear them at their best.

FEATURED SYSTEM

Cyrus CD8 SE CD Player **NEW**
Cyrus 8vs2 Integrated Amplifier
Spondor S5e Floorstanding Speakers

CLAIM QED CABLES WORTH UP TO £300

or choose a combination of cables and accessories from QED, Soundstyle and Grado when you purchase this system. Ask in-store for details. (NICWAOO)



Hear them together

at these SEVENOAKS stores

ABERDEEN	01224 252797	MAIDSTONE	01622 686366
BEDFORD	01234 272779	MANCHESTER	0161 831 7969
BRIGHTON	01273 733338	NORWICH	01603 767605
BRISTOL	0117 974 3727	NOTTINGHAM	0115 911 2121
BROMLEY	020 8290 1988	PETERBOROUGH	01733 897697
CAMBRIDGE	01223 304770	PLYMOUTH	01752 226011
CHELSEA	020 7352 9466	POOLE	01202 671677
CHELTENHAM	01242 241171	PRESTON	01772 825777
EALING	020 8579 8777	READING	0118 959 7768
EXETER	01392 218895	SEVENOAKS	01732 459555
GLASGOW	0141 332 9655	SHEFFIELD	0114 255 5861
GUILDFORD	01483 536666	SOUTHAMPTON	023 8033 7770
HOLBORN	020 7837 7540	STAINES	01784 460777
HULL	01482 587171	TUNBRIDGE WELLS	01892 531543
KINGSTON	020 8547 0717	WATFORD	01923 213533
LEEDS	0113 245 2775	WITHAM	01376 501733
LINCOLN	01522 527397	YEovil	01935 700078

PLEASE NOTE

All brands may not be available at all the stores listed. Please confirm before travelling. Any published prices were correct at time of going to press. Special or added value offers are not in conjunction with any other offer or promotion (NICWAOO).

ADVERT VALID UNTIL 13/12/2007, E&OE.

CYRUS

spendor

QED

Visit the **NEW** Sevenoaks website www.ssav.com

World Radio History

- and whilst we always contemplate upgrading from time to time, the way you know you've got a good system is simply by how often you use it. **DP**

MORE VIRGIN VALVES

I've recently decided to upgrade my Musical Fidelity XA-2 amp that I have owned since new and have decided to delve into the world of valve amps before deciding whether to commit to the valve or transistor route. I've only ever owned transistor-based amps in the past. Like so many others, I have always suffered from the hardness of the sound on some recordings/volume levels and have needed to switch it off



The Tube Amplifier Company TAC 834 valve amplifier - valve loveliness but a healthy 85 Watts per channel.

after an hour or so of listening. This has prompted me to look into the option of a valve-based amp. However, after reading several articles from back issues of *Hi-Fi World* on the pros and cons of both transistor/valve amps, along with some of your recommendations over the months/years and also reading up on the internet, I am as confused as ever.

My current setup is the Musical Fidelity XA-2 Amp, a Marantz CD6000 KI Signature (very recently heavily modified by Mark Bartlett of Audiocom), a standard Pro-Ject RPM5 turntable and ATC SCM7 speakers (the older version) on original Atacama SE24 stands. I also use Chord Company Chorus interconnects and Chord Company Odyssey 2 loudspeaker cable. My listening room is approximately 12ft x 12ft and my musical taste is varied, including anything from Classical to Rock/ Pop/ Alternative/ Electronic. As space in my listening room is an issue I want to replace the XA-2 with another integrated amp. I also want to keep the SCM7s as they are perfect for the size of the room and I live on the 3rd floor, so I don't want to upset my 'next-floor-down' neighbours with anything that has more bass than the SCM7s.

My confusion comes from articles I

have read stating how power hungry the SCM7s are (to drive them well), along with how low powered most valve amps are. And then reading reviews that state that 'such-and-such' valve amp rated at 40W sounded like it had more power than a 100+ Watt transistor-based amp, etc.

I know that the way forward is to make a shortlist and go and listen to them, but initially I just want some recommendations on where to start my search. As far as budget is concerned I'm happy to pay anywhere up to £3,000 for the amp. From what I've read so far, I love the auto-biased function (being a newbie to valves) and simple lines/looks of the PrimaLuna ProLogue 2, but I'm not sure if it can drive my speakers well enough when playing rock/pop, at say, party levels (not that they happen often). I also like the Cary SLI-80 with its switchable 40W/80W (Triode/Ultra-Linear) modes, which may suggest that there would be enough power on tap for when it was required. Am I looking in the right direction? Or should I just steer clear of valve amps and go for something like ATC's own SIA2-150 or the Krell KAV 400xi instead?

This may be a dumb question, but valves are new to me. Can the power rating of an amp be increased just by replacing the output valves with a more powerful type? (e.g. replacing KT-88s with KT-90s for example?)

Duncan Cooper

If you occasionally want 'party levels' from small loudspeakers (which are, by their nature, insensitive) then you do need power, and a good rule of thumb is 80-100 watts. To get this from valves means using them in parallel pairs to share the current, making for a heavy and bulky amplifier. The most compact and well engineered unit I have measured is the TAC834, that uses parallel EL34s very close together. This isn't the best idea as they mutually heat each other, shortening life, but as EL34s are easy to obtain and inexpensive it isn't perhaps such an issue. Otherwise, 'standard' valve amps deliver 40W maximum and whilst this is enough to go very loud, I wouldn't call it party levels. Power will not increase by substituting valves and whilst direct substitutes can be made performance will suffer.

People often comment that "valve amps sound louder" and this is partly because they seemingly sustain stronger dynamic contrasts than solid-state amps, sounding more dynamic, especially at low levels. They also overload more gently when

cranked right up, moving progressively into muddle, often sounding louder as a result. So valve amps can seem both more dynamic and louder than solid-state amplifiers when you listen to them.

If all this is still too difficult to come to terms with, then can I suggest you consider a fine compromise, the £1,000 Vincent SV-236 hybrid amplifier, reviewed in our November 2006 issue.

It sounds to me that with £3k to spend you should be able to persuade someone to lend you a demo unit for home use and this is the best way ahead for you. **NK**

Just to confuse you, I'd counsel the new Sugden IA-4 transistor integrated reviewed in the last issue. I know that at £3,500 it's a little above your price limit, but it's worth saving up for! It is one of the few amplifiers I feel I could settle down with and never change. It boasts decent power driving capability, stunning, glassy clarity and an irrepressibly musical nature, and is good enough for most speakers up to and including the likes of B&W's £10,000 801Ds. Alternatively, a really gutsy tube amp, surprisingly close to the Sugden in sound (albeit a little more hazy and warm) is the Audio Research VSi-55, coming in just under £3,000. Either of these would stop you thinking about upgrading for a long, long time and comfortably surpass your already good Musical Fidelity. **DP**

Personally, I would also second the Tube Amplifier Company TAC834 amplifier that I reviewed back in our June issue. Not only is this a fine sounding amplifier but it kicks out an impressive measured 85 Watts per channel, which should be fine for your ATCs. **AS**

WALL FLOWER

I am in dire need of a new hi-fi and have decided to start with the speakers and build a brand new system to suit the room. My problem is that there appear to be very few speakers designed for close to wall use. My currently defunct system is World Audio Designs KT88 power amp, DACT attenuator in a box, TEAC VRDS 10 CD player and Impulse H6 speakers. Unfortunately, the CD player malfunctions and the power amp blew a valve and resistor, shortly after we were admiring the purple lightning effect that it was giving. I'll repair this system for use in the back room and I currently use a Sugden Headmaster and Sennheiser HD600 headphones with portable CD player.

What I need in the living room is

a pair of speakers that can go close to the wall and have the drivers higher than the arms of the three couches. I need them to be dynamic and natural sounding at low volumes and, as I'm teaching myself music theory and doing a lot of classical listening, they need to reach down to about the low C on the double bass i.e. about 30Hz, sounding natural rather than tuned for punch. Some of the bigger Tannoys might do this but the boxes are too large. My living room is 5.6m long (into the bay window) 4m wide and 3m high, with a suspended wooden floor that has a 1m



World Audio Designs KT88 amplifier - get it repaired!

gap below. The mid/treble drivers need to be at least 70cm from the floor, to clear the furniture, with ear height being 1.1m. Budget is £2,000 to £4,000.
Stuart Neil

One reason Tannoys work so well subjectively, I believe, is that their boxes are tuned very low, meaning that audible bass is not resonant and



RRR FS100 loudspeakers - large designs with a very low bass tuning frequency that should not upset the average-sized room too much.

boomy. But this demands a big box and similarly big prices. The product that comes to mind as suitable for you is the very large RRR FS100s we reviewed in our November issue. These go really low yet cost £1,055 - a bargain if ever there was one. **NK**

I refer the right honourable gentleman to the answer I gave to a similar question last month - Yamaha Soavo 1s would work a treat. The bass drivers won't quite clear your furniture, but this won't have any adverse effect. They should work beautifully with your KT88 which, incidentally, is well worth repairing. This will give a really clean, fast, musical but couth sound. **DP**

DIGITAL DISTRESS

I have just experienced the most depressing editorial I have ever read from a so-called hi-fi journal, that written by David Price in your November 2007 issue.

Your forever depressing picture of CD sound and the endless defamation of the format is not what I expect from a journal that should be doing its utmost to support formats and let the consumer decide. After all, I have many CDs that sound good and some less so and, despite investing heavily in upmarket turntables from the likes of Linn, etc. find that I still have a great many poor sounding LPs. I would like the opportunity to purchase CD if I so wish and not have you or anyone else do their utmost to curtail it.

If CD does not continue, which seems to be your wish, Hi-Fi magazines will suffer, the industry will go into further decline and you will have helped it along the way. I doubt that I will continue with my subscription if this is your attitude.

Furthermore, you do not think record companies will be bothering a great deal about any quality of sound as even they must realise that their most recent buyers are not interested in sound quality. Things are becoming worse as quality of sound has become internet orientated.

**Yours faithfully,
Mr. B [name illegible]**

P.S. - Maybe your editor and team should purchase and read Hi-Fi Critic and get a life.

Hmmm... I'm a little baffled by this letter as, after researching and writing my feature on 'CD's Silver Jubilee' some months back, I ended up rather dewy-eyed about the demise of the little silver beermat (sorry, format). Just because I don't believe Compact Disc is capable of the sonics possible from LP, doesn't mean I wish its

downfall. Quite the reverse in fact, as the point of my feature was that it may very well prove to be the last mass physical music carrier - and that, for reasons of nostalgia if nothing else, will be a sad thing. The next generation of music buyers may never get that lovely feeling of buying a freshly minted music disc from their favourite record shop (sorry, that should be "music software retailer" these days!). And whatever I say won't change the situation; the sales figures are clear as day - CD sales are well and truly on the decline now.

I'm not going to get into a debate with you about the relative sonics of LP and CD. Frankly, if you're of the opinion that the latter is better there's little I can do to change your mind, and nor should I try. What I will say is that even CD's greatest advocates (i.e. Sony and Philips, who created it) eventually admitted it didn't sound as good as it should, and designed a new Super Audio Compact Disc (i.e. SACD) to supersede it. The reason SACD didn't catch on, in truth, was that it was too little too late, and most of the music buying public had already been 'persuaded' to think CD was perfect... I agree that some CDs can sound 'good', and that some truly high end players make it sound special, but for me and anyone I know who has truly laid themselves open to a well set up vinyl system, ye olde 16/44.1 PCM digital can't cut it. What it does offer, of course, is convenience and durability, and there's nothing wrong with that - as anyone who's ever bounced a Koetsu cartridge or left his prized new LP in the back of the car in direct sunlight and come back to find it a slightly different shape will know! **DP**

We are pointing out the inherent limitations of a format that was claimed to offer "perfect sound forever". It never could and never did offer this and we are amongst the few able to identify clearly, with objective proof, why this is so. Such information is part of the reason people buy our fine publication! Our aim is to advise readers on how they can obtain the best sound for their money, free of commercial bias. If we feel that CD is ultimately not always the best way of doing this, then we would be deceiving readers by saying otherwise. In a similar vein, we will keep complaining about the whole DAB sound quality fiasco until something is done about it.

Ironically, as CD sales are falling, vinyl sales are increasing. They are still very small fry compared to CDs but



CD and LP - different technologies and different sounds, but we all use both here.

more material is being released on this old format and companies that stopped pressing vinyl are beginning production again. The quality of the end product is better than ever. If we have had a small hand in this then we are delighted, but I somehow doubt that the big players who are accomplishing this would have started back down this path were it not financially expedient for them to do so, and if there was not demand for the end product. **AS**

Pointing out the limitations of a format isn't the same as attacking it. I am glad CD has improved greatly over the years, after a sonically gruesome beginning. It remains, however, an early digital system with a fixed, non-extensible specification that is crude by today's standards. That is now a widely accepted fact, which is why the world is moving on to digital coding schemes of greater bandwidth (higher sampling rate) and lower distortion (24bit resolution).

As Adam says, we all use and enjoy CD (the good ones that is), but as a magazine our intention is to inform and help our readers, not support deceptive marketing hype that we know to be misleading, whether promoting CD or DAB. I was sitting in a restaurant only yesterday with the publisher of Hi-Fi Critic, Martin Colloms, listening to him talk about the decline of CD mastering and pressing quality and the wonders of modern vinyl, so our views on these topics are not as different as you might imagine. **NK**

SURROUND AND AROUND

Actually, I have four questions (I promise, I haven't been saving them up).

Firstly, concerning surround sound. Your articles in the October 2007 issue were well timed from my point of view as I am seriously considering expanding my system to include 5.1 surround capability. One of your articles mentioned the (potential) problem with a centre front speaker. I have read somewhere that this can be avoided by

splitting the centre front channel equally between the two front speakers and doing away with the centre speaker. Is this capability something that comes from the player and is it something that all players would be capable of doing? My source for DVD-A, DVD-V and SACD is a Pioneer 656A; do you know if this player can split the centre channel? Or, is it something handled by the receiver?

Secondly, still on the surround sound theme, the speakers I use for stereo reproduction are David's favourite Yamaha NS1000Ms and I would like to retain them as the main front Left and Right speakers. What would you recommend as surround speakers (and centre speaker if my system cannot do without one) to partner them?

Thirdly, I am finally ready to start a new project to build a balanced mains supply as Noel described in the September 2005 issue.. Who is your transformer supplier and is there a model reference number that I could use to look for a suitable transformer?

Lastly, I followed your series of articles about the 3rd generation World Designs preamplifiers. After all the articles in HFW over the last couple of years dealing with the advantages of balanced preamp operation (specially for phono preamps), I was hoping that we would be offered an option to build

the same way. Of course if you have positioned your speakers to give a good, stable, stereo image, and you position the screen between them, then you'll already have achieved that.

The secondary role for the centre speaker is to handle the prodigious amounts of power that is pushed into the centre channel by movie makers. This is something few surround sound users realise, consigning this power to a titchy centre 'satellite' even if they have full range, tower left/right speakers. In your case, with NS1000s, you'll lose nothing by avoiding a centre speaker and probably gain a lot.

Now, as to the processing of the centre channel into your left/right speakers you only have to tell whatever piece of equipment that is doing the processing that you don't have a centre speaker. If your receiver is your surround sound processor then get into its setup menu and choose the 'No Centre' option. That will force the centre channel to be shared by the left and right speakers.

Having got that out of the way, you will be delighted to know that the WDPRe3 preamplifier is available as an XL version with balanced outputs as standard. Unfortunately



World Designs WDPRe3 - also available with balanced outputs.

the phono and line preamps with fully balanced architecture. Please, please could you put that on the agenda for future developments?

Steven Cocking

For surround sound to work seamlessly you really need identical speakers all round, or at least speakers which are 'voiced' the same. I can imagine that five NS1000s in the same room might be a bit much, but at least, as you point out, you can do away with the centre speaker. The reason for the ubiquitous centre speaker in a surround sound system is to focus the dialogue to the screen. At least that's what they say at Dolby Labs. In practice you can achieve much the same effect by making sure that the central image from a pair of stereo speakers is focused in

we cannot provide balanced inputs, nor indeed a balanced output for the WDPhono3, as this would involve extra transformers or circuitry. So we have put the balanced option where it matters most and that is to drive long cables to the power amplifier. We'll be providing a balanced input option to a matching power amplifier early next year, so you can see that the 'agenda' is nearly complete! **PC**

SOLID BASS

I have read almost all your issues since you first started publishing and have found your help and advice of great use. For starters, Noel helped drive me to valve amplification and the lovely 300B valve. This is, however, also part of the cause of my current problem, namely, what amplifier to use to power a passive

subwoofer (your World Audio Design 8/9s) and a REL Strata (both high and low level inputs). This would partner an AudioNote Kit One fed by half an Audio Innovations 1000 preamplifier (the input selector part that feeds two pairs of outputs) and which, in one room (5m long x 3m wide x 2.25m high) feeds the WADs, and in another (4 x 3.5 x 2.5) Audio Note AN-J speakers that partner the REL.

I used to drive the subwoofers from the 300Bs and wondered what was wrong with the subs. When I tried them with a solid state amp, I understood. The 300Bs were lovely in every respect but one – no deep bass! So now I bi-amp, driving the subs from a solid state amp.

I don't want lots of bass and I don't need very high volumes either, but I would like deep controlled bass. I have access to a Cyrus 2, a NAD 372CT, a Harman Kardon 670 (oh, and a 30-year old Luxman L507 currently handling Sendor BC1s in a third set up). Ideally I would like to use an amp with a spare pre-amp output, two speaker sets and tone controls. These would allow me to use the Quad valve AM tuner more often and not suffer too much from unwanted noise. Would one of these amps suffice or should I look at a new Rotel (04 or 05?), NAD 352, or

Cambridge Audio Azur 640A, please?

My second question relates to hissed Ss on BBC Radios 3 & 4. The tuners I use are a fully GT'd Leak Troughline (thanks again there, guys) and an Onix BWD1 with SOAP power supply. The aerial is a chimney mounted largish Ron Smith design (through one of their splitters) with CT100 screened cable. Is the hiss sibilance or distortion? Does it come from the BBC? It is always there. I live in Twickenham and aim the aerial to Wrotham Heath.

By the way, you recently asked for nominations for World Classics. Surely the Onix tuner should be in there or wasn't it around long enough? And what about the Nytech 252 and the Edinburgh Wireless FM1? I'd also like to nominate the Meridian 200 and Audiolab 8000CDM CD transports, Pink Triangle record deck, Rotel 610 amp, Sendor BC3s and KEF Cadenzas.

William Comery

Let's see if I can understand this. By my reckoning you have an Audionote Kit One 300B valve amplifier in one room, driving Audionote AN-J loudspeakers and a REL Strata powered subwoofer., which all makes sense. In another room you have a WAD unpowered

subwoofer that you want to drive with a solid-state amplifier?

In one room, or is it the other room, you have an Audio Innovations preamplifier, feeding both rooms, by long cables perhaps? Or do you run between the rooms with it, using it first in one system, then in the other? I am a bit lost about where this preamp fits into the scheme of thing and what sort of life it leads...

I am also unsure about the room with the WAD subwoofers you want to actively power, as this room seemingly lacks loudspeakers, amplifier and a source of any sort. If we forget about such minor details and assume you want to drive the WADs through a power amplifier from the pre-amp then a NAD C272 stereo power amplifier (£470 or so) in bridge mode would do the job nicely. As a main amplifier in this system you could use a NAD 352. Alternatives are a Cambridge 640A integrated with 840W power amplifier in bridge mode.

You will not easily achieve good deep bass quality in rooms of medium size. A subwoofer like the REL, carefully tuned, will force low bass into the room, but in doing so it will also excite the rooms main resonant modes and there's little you can do to ameliorate this. **NK**

Thanks for the nominations William. Onix is (was) an interesting company, and I still hold their OA21 amplifier in very high regard. It was a classic case of a fine product whose face just didn't fit at the beginning of the nineties. I have for a long time been thinking about doing an Onix Olde Worlde, but lack both an actual product to audition (and photograph) and the true (as opposed to anecdotal) background to the Onix story - if any readers can help on



Onix - another lesser-known British company that made some very fine products. Can anyone tell us more about them?

Billy Vee
SOUND SYSTEMS

SPECIAL OFFERS & EX-DISPLAY BARGAINS

CALL SALES: (020) 8318 5755 or 8852 1321 - 248 Lee High Road, London, SE13 5PL
0% APR Credit options are available for purchases of New products exceeding £900, please call for details. E&OE

For more Special Offers, Systems & Pre-Owned Bargains like these - visit www.billyvee.co.uk*

♦ Linn Majik-I + Katan System - Save £790

System Comprises
Majik CD Player
Majik-I Amplifier
Katan Speakers
(pair) Inc stands
Delivery & Install
(within the M25)
5 year warranty



Normal Price £4290
£3500

Introductory Offer - Upgrade to Majik 140 Speakers? Add £700 Please Call for details.

*Ex-Display & Pre-owned bargains can be found in the Marketplace section

Arcam A90 Amplifier - Silver E/D (2Yr G/tee)(950.00)	£659.00
Arcam FMJ C31 Preamp - Silver E/D (2Yr G/tee)(1250.00)	£845.00
Arcam FMJ A32 Amplifier E/D (2Yr G/tee)(1300.00)	£895.00
Linn Unidisk 2.1 Disk Player E/D (2Yr G/tee)(4850.00)	£2695.00
Linn Chakra 2200 Power Amp Blk E/D (2Yr G/tee)(2530.00)	£1695.00
Naim SuperCap P/Supply E/D (2Yr G/tee)(3090.00)	£2239.00
PMC FB1 Speakers - Maple E/D (2Yr G/tee)(1695.00)	£1269.00
PMC GB1 Speakers - Maple E/D (2Yr G/tee)(1145.00)	£895.00
Sugden CD Master CD Player E/D (1Yr G/tee)(1299.00)	£839.00
Sugden MusicMaster Power Amp E/D (1Yr G/tee)	(1299.00)	£839.00

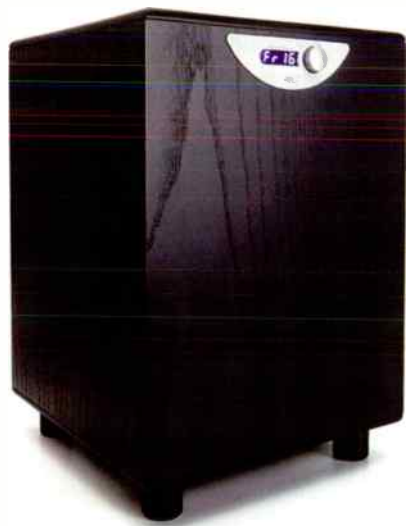

REL Strata subwoofer - a quick route to deep bass.

either score then please email me at editorial@hi-fiworld.co.uk. As for the tuner, I never actually heard it, but I suspect it was a cracker (judging by the sonics of the amps).

We've covered the Nytech CTA-252 "Calculator Tuner Amplifier" (i.e. receiver!) several times - and it sure has a fine tuner section. I had one for a while and developed an addiction to Radio 3 during that period; somehow it just didn't seem the same after I sold the Nytech. Remember though that it's an FM-only design, and you need a blooming great big aerial to escape hiss, such is the Nytech's insensitive front end. I'd concur with your choice of the Meridian 200 as a CD transport - its fine sonics and superb (period) styling make it surely a classic by now? Not quite so sure about the Audiolab, although ours was the most reliable transport we ever had at HFV towers, as I remember. It replaced the dreaded Pink Triangle Cardinal, which was a workshy silver disc spinner if ever there was one! **DP**

DAC DILEMMA

I thought I would drop you a line to see if you are able to advise me on potential upgrades for my system, please.

Currently this consists of a Gamut D100 amp, Roksan Attesa CD Transport (sprung suspension), a deceased MF X24 DAC, Lumley Ref Passive Pre, Audio Physic Tempo Mk I speakers complete with Essex Equaliser, REL Studio subwoofer, an old Pioneer 950 for tape duties and a Technics Linear Tracking SL-10 with Ortofon OM 20 cart (P-mount). These are connected with vdH the first interconnects and Musical Fidelity Nuvista speaker cables.

The first priority is a replacement DAC for the defunct MF unit, with an all up budget of about £1,000 I am

thinking of either a Roksan DPI DAC and PSU or an Audio Note DAC 2 or 3 (both s/h). The Roksan offers the advantage of a separate PSU while the Audio Note offers the analogue filter 1x oversampling approach - a sound I have listened to and quite like. My current system produces a wide soundstage up to and around the outside edges of the speakers with superb stereo imagery and could accommodate a DAC that some might describe as being on the warm side. Any advice or other options to consider would be appreciated.

I also need to replace my current cartridge - it lacks the ability to present vocals over bass-heavy music, during Led Zep's 'Dazed and Confused' the fast passage of bass work overpowers all else. The original Technics MC cart is as rare as hens teeth, so any advice on a P mount cartridge would be very welcome. I like the SL10's convenience and direct drive bass control and although I will no doubt upgrade at some stage, I am too busy listening to my album collection - again!

Bob Cusworth

Regarding your SL-10, Bob, as you say, it is a lovely deck and a nice piece of sturdily built vinyl playing history as well. The problem is, as you have found, the availability of cartridges - P mount never really caught on with the exception of more budget-oriented decks and the selection left nowadays is somewhat minimal to say the least. A brief perusal of the situation has led me to conclude that your choices appear to be the £30 Audio Technica AT-101EP, the £55 Shure MP94E, or an Excel ES-P300 for £35. I do not know the Excel but, with regards to the rest of the contenders, the Shure is probably well worth trying if you do not get on with the Ortofon. **AS**



P-Mount cartridges never really caught on, so choice of new items is rather limited these days.

On the DAC front, don't forget the excellent Russ Andrews DAC-1 USB, price just £599. This is an excellent upsampling design, lightly tweaked from its excellent original Stello design. It is very open, wide and spacious, but with plenty detail and insight too. A fine tonality completes

the package - it is ever so slightly on the sweet side. An easy upgrade for your cartridge would be the OM 30 stylus - fitted in 10 seconds and a major improvement on the 20, bringing extra detail and finesse to the treble and midband. **NK**

CONCRETE CAPERS REVISITED

Dave McReynolds letter in the recent November issue transported me back to those heady days of the early sixties when our home-grown products mostly led the hi-fi scene. None was more desirable to this young man then the issue from Wharfedale Wireless Works near Bradford in Yorkshire. The inspiration for these loudspeakers was, of course, Gilbert Briggs - an innovator whose influence is still felt to this day.

His series of Cabinet Construction sheets were invaluable to impecunious followers of the high fidelity faith. A good friend of mine with very catholic tastes in music, notwithstanding he was one of

Fig. 12. CIRCULAR COLUMN for 8" UNIT

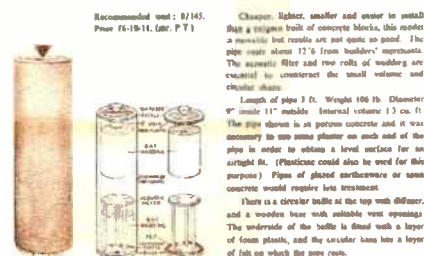
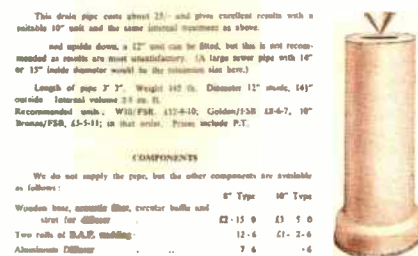

Fig. 13. CIRCULAR COLUMN for 10" UNIT



Issued by WHARFEDALE WIRELESS WORKS LTD., IDLE, BRADFORD, YORKS.
Telephone: IDLE 079-6
© 1966 W.W.W.

Wharfedale concrete pipe loudspeakers - reader Adrian Warwick has heard some...

my hi-fi converts, is remembered now as a practitioner of the Sewer Pipe Sound experience.

With many small mouths to feed he was obliged to seek a cheaper route on his own road to recorded music. nirvana whilst others in our circle (myself included) made great bass reflex designs of two, three or more cubic feet in the heaviest woods available, again to Mr. Briggs' suggested designs. Fortnightly musical evenings were shared between the residences of our circle, yet I was always eager to return to his home where sat unobtrusively in each corner of his small lounge a pair of circular concrete columns. The gentleman's wife had insisted they be wallpapered to match the room decoration and at first

Iconic design...

www.mission.co.uk

143 House, Sovereign Court, Emme Business Park,
Huntingdon, Cambridgeshire, PE29 6XU,
Tel: 01480 447700 Fax: 01480 431767

MISSION

E3

Mission has nailed it. For vitality, pace and sheer listening enjoyment, the E3 isn't just reminiscent of Mission of old, but class-leading in its abilities.



» i kon An important and enduring symbol



Fiercely independent, the E3 is a collision of traditional and contemporary design – a modern interpretation of the classic Mission aesthetic. Sensational in its poise and steadfast in its presentation it is, above all else, a genuine expression of a passion for performance.

A range of models has been developed including bookshelf, wall mount, floorstanding, centre channel,

subwoofer and surround speakers. E3 is a complete solution for the stereo and the home cinema enthusiast alike. Moreover, it has been engineered to reproduce the very best from any music or surround sound source.

Superbly detailed dynamic sound with not only the lowest distortion in its class, but a wide dispersion for a flat in-room frequency response.



they were not easily located!

As to sound, they were obviously omnidirectional in character and offered no resonance or booming, just a smooth and effortless outpouring of natural music making on the end of a little Rogers Cadet III. I recall that I never went home with a headache as I did from some other gatherings.

Maybe the little Wharfedale Super 8RSDD had something to do with this as, when I heard a ten inch unit in a larger pipe, I felt the eight inch unit had a better balance. Even to this day I doubt there is better value available to the home constructor than this column design; truly a case of "Rubbish in, Beauty out". Now, where do I find a pair of 3 foot pipes so that I can make a new home for those little Wharfedale units on top of my wardrobe? After I have toned up my muscles of course...

Adrian Warwick

Our thanks to Adrian and several other readers who have all written in with their memories of concrete pipes making beautiful music. It just goes to show that the dedicated enthusiast can achieve sonic nirvana from the unlikeliest of sources! **AS**

CLASSIC KITS

As you can see from my query, I am a long time reader of HFV. Would you still have within your archive, the schematic for the crossover for the KLS2 speaker kit you sold through WAD many years ago, please? This was the floorstander with direct connection to the bass-mid unit. My miserable soldering skills and construction techniques caused both crossovers to fragment into their component parts. I built the cabinets out of a very old wardrobe. They still sound really good (when working), and with their high 94dB sensitivity are an ideal partner for the Rogers Cadet integrated that powers them. Oh yes, the source is my computer. Not your usual desktop audio, then. Many thanks if you can help.

Steve Garnett

How nice to hear that our venerable designs are still being used! KLS2

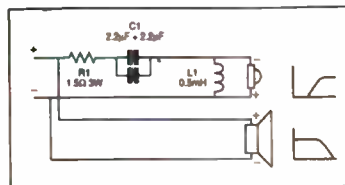

- Parts Lists
 C1 2 x 2.2µF polypropylene
 L1 0.5mH air cored
 R1 1.5Ω 3W

From the archives - the original WAD KLS2 crossover schematic.

dates back to one of the earliest issues of HFV's DIY Supplements and we have just put these onto a website and CD ROM for the benefit of those who want to retrace existing kits or just delve into the many classics that we have designed over the years. There is a small charge for this archive but we are sure it will provide useful to Hi-Fi World readers. Details can be found at www.world-designs.co.uk/diyarchive/

As to your crossover details they are very simple as you can see from this diagram. The bass unit utilises its natural roll-off and is directly connected to the amplifier, leaving all the crossover components in the treble circuit. The recommendation is for polypropylene capacitors and 3W resistors with an air cored inductor. These are all available from the World Designs catalogue at www.world-designs.co.uk/acatalog/. **PC**

LEAK LEGENDS

For three weeks now, I have been the proud owner of a Leak "Stereo 50" valve amplifier. Except some defective contacts at the tube bases everything works fine. Unfortunately the external condition is pretty poor. Therefore I decided to renew the lacquer. The only thing that displeases me is that the original "Leak" script nameplate legend will be missing afterwards. For this reason I would like to put a new (old) label onto the

case. Does somebody know where I can get hands on such a label?

Since I'm already reworking the whole thing, could somebody possibly tell me if and which components I should renew? Are there some circuit mods? Could somebody possibly tell me a source of supply for the spare parts? Also, I would like to put a first class volume potentiometer into the amplifier. Does somebody have any ideas about the value (10k Ohm or higher) and model?

Thanks in advance.

Michael Hans

Hi Michael. It is a simple matter to add a volume control. Connect the track of a 100k Ohm potentiometer across the input and lead the slider to the 22k grid stopper resistor, as our diagram shows. You can remove the old 1M Ohm 'grid leak' resistor when you do this. Use an Alps Blue pot.

Nearly all old components deteriorate with time, but the worst culprits are high value resistors (i.e. above 100k) and electrolytic capacitors, especially high voltage decoupling capacitors, which you must replace with 450V working types close to the power supply. Lower voltage ratings can be used elsewhere, and the circuit diagram, which you can find on the internet, shows voltages. We have circled these components in red, as well as cathode decoupling capacitors and inter-stage coupling capacitors, all of which can usefully be replaced with good, modern components. Favoured types are Elna Starget electrolytics for the HT, Rubicon Black Gates for decoupling and, for inter-stage coupling, Jensen paper-in-oil capacitors.

I suggest you measure all voltages to ensure they are correct, replacing resistors that have significantly changed value. Use modern carbon film resistors for their neutral sound, not metal films, unless they are audio grade. Have fun. **NK**

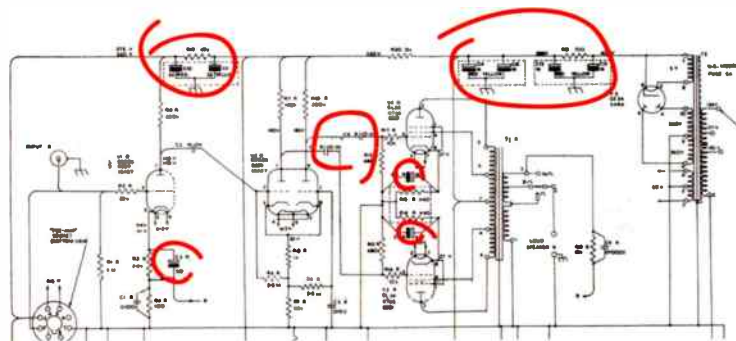
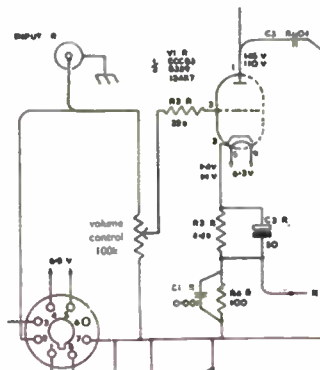

Adding a volume control to a Leak Stereo 50 is not that difficult - Noel shows how it's done in the left hand diagram, whilst the right shows the decoupling capacitors that should be replaced.

CARTRIDGE SELECTION		STYLUS	HEADPHONE SELECTION	
Goldring			Grado	Prestige SR-60 £75
Elektra	£33	£24		Prestige SR-80 £90
1006	£88	£65		Prestige SR-325i £260
1012 GX	£116	£77	Goldring	DR 50 £30
1022 GX	£153	£97		DR 100 £40
1042	£171	£120		DR 150 £70
Eroica LX/H	£153	£122 EX		Active Noise Reduction NS 1000 £140
Elite	£273	£217 EX		
2400	£152	£119		
2500	£175	£133		
Audio Technica				
AT 95 E	£25	£16		
AT 110 E	£30	£18		
AT OC9 ML II	£330	£295 EX		
Denon				
DL 103	£105	£95 EX	N/A	
DL 103R	£190	£170 EX	N/A	
DL 110	£79	£69 EX	N/A	
DL 160	£95	£83 EX	N/A	
DL 304	£210	£190 EX	N/A	
Grado				
Prestige Black	£40	£29		
Prestige Gold	£110	£77		
Lyra				
Dorian	£495	£395 EX	N/A	
Argo	£795	£635 EX	N/A	
Shure				
M 97 XE	£98	£58		
Sumiko				
Blue Point Special	£195	£165 EX		

EX - Exchange price same make moving coil cartridge

Order direct online or Tel/Fax (01757) 288652

MANTRA AUDIO (HFW), Town End House, Skipwith, Selby, North Yorkshire YO8 5SQ

HI FI ACCESSORIES

ARTcessories USB Phono Plus PreAmp £85
analogue-digital computer interface
Bib Universal Standard Headshell £15
Shure SFG2 Stylus Force Gauge £24

REPLACEMENT STYLII

Swiss Quality Diamond Stylii

ADC XLM Mk III £17
Akai AN 5, AN 60 £13
AN2, AN 70 £15
Aiwa AN11 £13
Dual DN 145 E, DN 165 E £17
JVC DT 55, DT 60 £13
National EPS 24 CS, P 30 D, P 33 D £13
Ortofon FF15/VMS20 EII, OM5/10/10/20 £17
Pioneer PN 210/220/240 £13
Shure N75C, N75-6, SC35C £13
N75ED/EJ T2 N75-3, N95ED/EJ £17
N 97 HE, VN 35 HE £27
Sony ND 142/155 G, CN234 £13
ND 143/150/200 G £15
Stanton D 681 EEE £21

Over 500 Stylii Types Stocked

RETRO REPRODUCTION

QUALITY HIGH FIDELITY & VINTAGE

AMPLIFIERS		Tannoy Dimension 10 £5000new 1year old £2495
Albany pre amp with phono	£95	Neat Motive 1 oak finish ex dem £995
Albany 10308 mono blocs 100W	£495	Neat Vilo floorstanding speakers with ultimatum upgrade, beech finish, work well with Naim £1495
Arion TYCHO valve amp	£795	
Audion Premier 0.5 pre	£350	
Audio Lab 8000P late serial number	£350	
Audio Analogue Puccini special addition	£395	TURNTABLES
Audio Innovation series 200 integrated amp	£595	Diablo phono stage NC psu and matching cable new £1400 £845
Audio Innovation L2 valve pre	£445	Henley MCS0 phono stage £95
Audio Innovation series 200 MK2 power amp	£295	Luxman PD131 direct drive SME mount £275
Audio Innovation L1 pre	£195	Linn LP12 Valhalla serial 076301 serviced £495
Audio Research VT60 valve power re-valved	£995	Linn LP12 black circus £595
Ayre Power amp	£2195	Linn LP12 various from £495
Bel Canto SAP2 pre upgraded to next model	£995	Linn Ittock mint boxed £295
Cyrus smart power	£275	Linn Lingo £495
Cyrus pre	£195	LFD Minstral phono stage £295
Calm 100W remote integrated amp x dem	£695	Morch 6 tone arm £650
Copland 401 valve integrated with phono	£795	Musical Fidelity XLPS phono stage £115
Crimson 630D mono blocs 100W	£495	Michell focus 1 turntable, linn arm £295
Chord SPM1000B power amp 200W	£995	Michell Gyrodec with QC power supply £895
Denson DM10 integrated	£695	Nottingham Analogue horizon £395
EAR 834L Valve Line Stage	£495	Naim NA 522/2B phono boards £45
Graaf GM5050	£1295	Roksan Xerxes new top plates very rare £POA
Heybrook signature 3 box pre power	£595	Roksan Radius 5 no arm £395
Korato renaissance mono blocs 30W class A	£995	Roksan Artaxerxes X with DSU MMMC £495
Krell KRC3 balanced pre amp remote	£995	Technics SL150 direct drive SME cut-out £225
Leema Tucana	£POA	Sansul SR222 MKIV £125
Leak 12+ mono blocs restored	£595	
Meridian 568 digital surround processor	£995	CD PLAYERS, DACs
Naim NAC92 serial 165888	£175	Audiolab 8000 CD £445
Naim 42.5	£125	Copland CDA266 HDCD £595
Quad 2 mono blocs mint original valves	£795	DCS P8I £POA
Quad 99 CD player with digital pre amp, as new, boxed	£595	DCS Purcell upsampler factory serviced £995
Quad 303 Power Amp	£175	Hifi World project 24/96 valve DAC rare £395
Quad 44 Pre Amp	£195	Leema Antlia cd £POA
Quad 405 Power Amp boxed	£195	Micro Mega Stage 6 upgrade player £295
Rotel RA-01 integrated Amp	£245	Meridian 596 DVD player £595
Rotel RB-03 Power Amp	£245	Meridian 506 20 bit CD player £495
Rotel RB970 BX Power Amp	£145	Meridian 206 Original Multi bit player £295
Rotel RC990BX blackgate remote pre	£195	Pink Triangle Ordinal with 22 bit DAC £295
Rotel RB850	£145	Primare CD20 £395
Sugden Transimpedance Amp 6months old	£395	Quad 77 standalone CD player £395
Unison Research UNICO SE	£795	Roksan Rok dp1 transport £375
		Sugden Masterclass CD player with upgrade £1295
		Teac VRDS8 cd player £395
SPEAKERS		
ATC SCM20 rose wood finish	£795	MISCELLANEOUS
Audionote ANJ silver speaker boxed	£495	Fanfare ft1 tuner, outperforms magnum etude remote control £595
Beauhorn Virtuoso reference lowther	£3995	Ben Duncan mains isolation transformer £245
B&W DM4	£95	Chord cables indigo- signature £POA
B&W 504 series 3	£445	Nordost Valhalla supplied in wooden box.
DynAudio contour 1.3 MKII	£595	
Gamma floor standing speaker new £5000	£995	DUE IN...
JBL T1-6K floor standing speakers as new	£795	Leema XYP £595
Linn Ninka 6 months old	£795	Mission logo style pre power £1195
Living Voice Auditorium MKII cherry	£1195	Yamaha CT7000 Boxed
Mission 750 limited edition anniversary	£195	Leak Varislope/point 1 stereo pre amp various £595
Mono Pulse 32A 8 months old ex dem.	£395	Lecson pre amp power amp & tuner RARE
ProAc studio 100	£395	Russ Andrew Quad 33 303 upgrade
Spendor BC1 with original stands	£395	Garrard 301 first class condition
Sonus Faber Minima amator	£695	Quad 2 pre valve & radio various

GENEROUS PART-EX ON ALL EQUIPMENT. NEW OR USED. WILL BUY GOOD QUALITY EQUIPMENT AS ABOVE. NEXT DAY MAIL ORDER & UPLIFT FACILITIES

cairn

EAR
of

IS

A

SME

11

Opening times: 10.30 - 5.30 Tues. to Sat.
28a Haddington Place, Edinburgh EH7 4AF
Tel/Fax: 0131 558 9989
Email: retro.reproduction@virgin.net
WWW WEBSITE: www.retroreproduction.co.uk

Vyger



Analogue Specialists

Helius Designs



angelsound audio
01923 352 479
www.angelsoundaudio.co.uk

HEATHCOTE AUDIO

TEL: 07860 511111 WEB SITE www.heathcoteaudio.co.uk

E-MAIL heathcoteaudio@aol.com

**LOOK!! PERPETUAL TECH.P3A MODWRIGHT SIG-2 24/96 UPSAMPLING DAC (£995) LAST FEW £750
PERPETUAL TECH P1-A (£995) P3-A MOD.SIG-2 (£995) MODWRIGHT SIG PSU (£495) TOTAL £2485
LAST SET BRAND NEW £1795.00**

VALVE AMPS

QUAD II MONOBLOCS SUPERB PAIR (GEC KT66)
UNISON RESEARCH 845 MONOBLOCS
UNISON RESEARCH MYSTERY PRE
ROGUE AUDIO METIS PRE AMP (REMOTE)
UNISON RESEARCH FEATHER PRE/35 POWER
AUDIO RESEARCH SP-9
TUBE TECHNOLOGY SYNERGY INT.AMP
GAMMA REF. 211 MONOBLOCS
AUDIO RESEARCH SP-9 PRE AMP/PHONO STAGE
ROGUE AUDIO 66 MAGNUM REMOTE PREAMP
AUDIO RESEARCH VT-200 POWER AMP

VINYL

ORACLE DELPHI V (£4000)
ACCOUSTIC SIGNATURE SAMBA MK II & ARM (£2300?)
GRAHAM 2.2 TONEARM
GRAHAM 2 TONEARM
HELIUS CYALINE TONEARM
NVA TWO BOX MC PHONO STAGE
GRAHAM SLEE ERA GOLD & ELEVATOR (MM/MC)
ANTIQUE SOUNDLABS MINI PHONO STAGE 2-BOX
MEIXING MING DA MC767 RD MM/MC PHONO STAGE
BILL BEARD MM/MC PHONO STAGE
McCORMACK MINI PHONO DRIVE (MM/MC)
ASR MINI BASIS PHONO STAGE (MM/MC)

TRANSPORTS/DACS/CD

DCS P-81 SACD/CD/VOLUME (8 WEEKS OLD) £7000
McKINTOSH MCD-201 SACD/CD/VOLUME
EINSTEIN 'THE CD PLAYER'
PROCEED (LEVINSON) PDT-1 TRANSPORT & DAC
CONSONANCE LINEAR CD PLAYER
PERPETUAL TECH. P1-A/P3-A/P3B MODWRIGHT SIG-2
PERPETUAL TECHNOLOGIES P-3A 24/96 DAC
LECTOR DIGIDRIVE-TL TRANSPORT & PSU
ACCUPHASE DP-90 TRANSPORT
THETA CARMEN CD/DVD TRANSPORT
THETA DATA II TRANSPORT (SILVER)
THETA DATA TRANSPORT
AUDIO ALCHEMY DDS III CD/TRANSPORT
MSB LINK DAC 24/96kHz MODULE
Z SYSTEMS Z-3src UPSAMPLER (£1450 NEW)
AUDIO ALCHEMY DDE V.III HDCD DAC
AUDIO ALCHEMY DDE V1.2 HDCD DAC
AUDIO ALCHEMY DDE V1.1 HDCD DAC.
DENON 2800 MKII GOLD (HDCD)
PRIMARE V-25 CD/DVD PLAYER (£1000 NEW)
ARCAM CD 82

SOLID STATE

ROTEL RB-1092 500 WATT X 2 (£1600)
ROTEL RB-870BX STEREO/MONO AMPS X 2
ORELLE EVO-100 CD PLAYER/PRE AMP/POWER AMP (£3.5K)
XTC PRE-1 POWER-1AMPS GLOSS BLACK
ATC SCA-2 PRE AMP
ADVANTAGE i200 INTEGRATED AMP
MARANTZ PM66 KI-SIG AMP

EXCLT £550
EXCLT £1995
EXCLT £750
EX.DEM £695
MINT/BOXED £1495
MINT/BOXED £995
MINT £2999
EXCLT £1295
MINT/BOXED £995
MINT/BOXED £1195
EXCLT £4450

NEW/DIS £2995
NEW £1595
BRAND NEW £1495
MINT/BOXED £995
EXCT £595
EXCLT £395
MINT £675
EX.DEM £299
MINT/BOXED £299
EXCLT £375
EX DEM £349
NEW/BOXED £495

ASNEW £3795
NEW/BOXED £2995
EXCLT £1500
MINT/BOXED £895
NEW/BOXED £650
BRAND NEW £1995
BRAND NEW £995
MINT/BOXED £1295
EXCLT £2750
MINT/BOXED £1295
MINT/BOXED £795
VGC £495
N.O.S. £395
MINT/BOXED £375
MINT/BOXED £450
N.O.S. £350
N.O.S. £275
N.O.S. £250
MINT/BOXED £299
NEW/BOXED £475
MINT/BOXED £295

MINT/BOXED £795
MINT £299
MINT/BOXED £1795
MINT/BOXED £1795
MINT/BOXED £1795
EXCLT/BOXED £995
MINT/BOXED £275

ALCHEMIST FORSETTI PRE & POWER AMPS
KRELL KMA-100 MONOBLOCS (3 YEARS USE)
AUDIO RESEARCH LS-3B PRE AMP
KRELL FPB-200 POWER AMP
JEFF ROWLAND MC-6 (\$16000?)
NORTH AMERICAN PRODUCTS H-CAT PRE AMP (£2850)
MAGNUM DYNALAB MD-208 RECEIVER (SUPERB)
McCORMACK RLD-1 REMOTE PRE & DNA-125 POWER AMPS (4.5K)
LUXMAN M-105 DUAL MONO CLASS A POWER AMP
PLINIUS SB-300 (RETAIL £4650)
PLINIUS SA-201 (RETAIL £3600)
CONRAD JOHNSON PF-1 PRE & PHONO STAGE
BEL CANTO PRE-1 PREAMP & EVO 200.2 POWER AMP
SONY TAE9000-ES PRE & TAN9-ES POWER AMPS
CONRAD JOHNSON PFR PR/MF-2500A POWER AMPS

LOUDSPEAKERS

AURUM CANTUS SUPREME (AWESOME! £10,000)
APOGEE DUETTA SIGNATURES
APOGEE CALIPERS
MONITOR AUDIO GS 10 & STANDS (£1000)
AURUM CANTUS BLACK ORCHID (£1200)
BKS 128 RIBBON HYBRID (STAR GRANITE)
EGGLESTONWORKS ANDRA II
EGGLESTONWORKS ANDRA II
EGGLESTONWORKS ROSA
EGGLESTONWORKS FONTAINE II
MONITOR AUDIO STUDIO 50 (ROSEWOOD) £4400
A.L.R. JORDAN NOTE 5 FLOORSTANDERS (£2500)
CURA CA-30 FLOORSTANDERS (MAPLE)
AUDIO PHYSIC CALDERA II (10K NEW?)
TANNOY GRF MEMORY T.W.
CELESTION A-3
CELESTION A-2 SANTOS R/WOOD
MARTEN MILES II CHERRY (8k+ NEW)
MIRAGE M1si BI POLAR LOUDSPEAKERS
FAB AUDIO MODEL-ONE (RETAIL £7500)
FAB AUDIO BRAT (£700)
AURUM CANTUS VOLLA (RETAIL £2500)
AURUM CANTUS MUSIC GODDESS £2500
AURUM CANTUS LEISURE 3SE (£1250)
AURUM CANTUS LEISURE 2SE
AURUM CANTUS BLACK ORCHID (£1200)
AURUM CANTUS LEISURE 3SE (£1250)
AURUM CANTUS LEISURE 2SE

MAINS CABLES/BLOCKS/CONDITIONERS ETC

TARA LABS RSC AIR-2 6FT POWER CORDS
BLACK RHODIUM SUPER MAINS POWER CORDS
BLACK RHODIUM POWER CORD RHODIUM PLATED EASYGRIP PLUG
ISOTEK POWER CORD

LARGE SELECTION OF INTERCONNECTS ,LOUPEAKER CABLE & STANDS ON THE WEBSITE

WEB SITE www.heathcoteaudio.co.uk UPDATED DAILY!

MINT/BOXED £1595
MINT/BOXED £2750
MINT/BOXED £995
EXCLT £2750
MINT £3995
EX.DEM £1475
MINT/BOXED £1795
MINT/BOXED £2250
MINT/BOXED £1795
EX.DEM/DIS £2995
EX.DIS £2395
EXCLT £895
SALE!! £2295
SALE!! £1250
MINT/BOXED £3450

BRAND NEW £6995
EXCLT £1650
NICE £850
MINT £595
EX.DIS £795
MINT/BOXED £1395
NEW £9995
EX.DEM £7500
NEW £4795
EX.DEM £2495
MINT/BOXED £1250
EX.DEM £1195
MINT £995
MINT/BOXED £2995
MINT £3750
MINT/BOXED £1250
BRAND NEW £995
EXCLT/BOXED £3750
EXCELLENT £2750
EX.DEM £4750
EX.DISPLAY £395
EX.DISPLAY £1750
NEW £1795
EX.DIS. £795
EX.DIS £695
EX.DIS £795
EX.DIS. £795
EX.DIS £695

BRAND NEW £199
BRAND NEW £65
BRAND NEW £95
£65

EQUIPMENT REQUIRED FOR IMMEDIATE CASH PURCHASE.

**To advertise in this space
please call 020 7372 6018**

or email:

advertising@hi-fiworld.co.uk

High End Cable

visit www.highendcable.co.uk
For the best prices telephone Dave Jackson on
01775 761880
Free P&P worldwide on all interconnects

Analysis Plus
Audience
Chord Company
Ecosse
Hovland
Nordost
MIT
Oehlbach
Purist Audio Design
Stereovox
Townshend
True Colour Industries
van den Hul
Wyreizard
IsoTek Power Conditioning
Cable Tower
Clearlight Audio Cones
Oehlbach Accessories
STAX headphones
Tannoy
Echo Busters
Arye CD - IsoTek CD
Furutech
Lyra Moving Coil
Ortofon Moving Coil
Sumiko Moving Coil

Second hand
Sub woofer cables
Media cables
Chord iPod cables
Nordost iPod cables
XLR cables
Pulsar Points
Component cables
Digital cables
DIN cables
HDMI cables
DVI cables
Jumpers
Optical cables
Mains & Power cables
SCART
S video

CHORD NÖRDOST

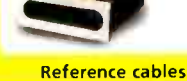
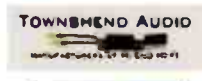
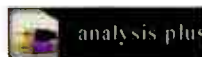

Reference cables include free Burn In.

Web.classiquesounds.co.uk

Classique Sounds

Specialist Supplier of Vintage Audio

61 Aylestone Drive
Aylestone,
Leicester, Le2 8qe



Tel 0116 2835821
Local call 0845 1235137
Mobil 07815 188040

Leak Stereo 20 full rebuild using Jensen Paper in oil caps £299.00
Conversion of Leak valve pre to passive including Silver wired/soldered/rhodium plugs £299.00
Rothwell Indus SE passive pre amplifier. Now in stock. Awesome. Just £799.00

wanted classic and modern hifi eqpt. FOR SALE/PRE/POWER AMPLIFIERS

NVA PASSIVE VER passive pre amp 2 inputs PTH pure silver wire Silver solder Alps pot Gold phono	£149
NVA PASSIVE VER passive pre amp 2 inputs PTH pure silver wire Silver solder Alps pot Silver phono	£179
Musical Fidelity "The Pre amp" Ex cond & boxed. £159	£159
Van der Heem single ended int valve amp C1964	£199
Leak Variolopoint 1 pre amp Converted to Passive Pure silver wire silver solder Silver plate phono/s pots	£425
Pair Art Audio Tempo moonrock valve amplifiers. £695	£695
Nakamichi CA5 pre-amplifier. Ex cond. Cost £750.	£375
Critt Vidale valve pre amplifier. Excellent condition. £299	£219
Musical Fidelity A1 Class A amplifier. Ex condition. £1089	£1089
Music first passive pre amplifier. Small dent. £199	£199
Armstrong 222 integrated valve amplifier 2X 10W	£139
Audio Innovations I1 Valve pre amplifier. Line only	£299
PS Audio pre amp with separate PSU. Cost £998.	£649
Quad 303 power amplifier. Boxed. Good condition. £169	£169
Nad 312 integrated amplifier. Boxed. Ex condition. £89	£89
Marantz PM7 int amplifier & remote. Mint. Boxed. £549	£549
Nad C303 BEH int amp. Titanium. Rem. bnd. As new	£149
Quad 303 power amplifier. Boxed. Good condition. £149	£149
Heybrook C2 pre amplifier. Includes MM & MC.	£199
Quad 33 pre amplifier. Mint. Boxed. Instructions. £125	£125
Rogers Cadet pre & power amplifier VG condition. £275	£275
Leak Stereo 20 valve power amplifiers from... £Various	
Quad 303 power amplifiers from... £125	£125
Leak Variolopoint pre amplifier. Ex condition. £149	£149
Arcam Alpha 9 integrated with remote & MM MC	£349
Quad 405 1. Boxed and in good condition. £195	£195
Harmon Karbon integrated valve amp 110V. A rare	£299
Rotel RA-920AX integrated amplifier. Ex condition.	£199
Marantz PM7 int amplifier & remote. Mint. Boxed. £549	£549
DNN pre amp with PSU. Audiophile enhanced	£395
Pioneer A30 integrated amplifier. £99	£99
Mendian Linear MC phono stage pre-amp. Boxed. £149	£149
Musical Fidelity A100 pre class A integrated. 50W	£295
Witmos Audio Mercury B power amp. Ltd edition	£295
Nad monitor series 1300 pre-amp with MM/MC. £149	£149
Unison Research Mystery. One line level pre amplifier. Stunning condition with box book. Serviced. Cost £1700	£995
Galactron MK-2121 amplifier. 60 watts per channel. Beautiful Italian styling. Wood cheeks. Cost new £1400	£699
Naim NAC 92 pre amp. S'NO 161840. Mint. Boxed £299	£299
Linn LK1 LK2 pre power amp. Good condition. £299	£299

TURNTABLES/CD PLAYERS

Dual 1019 turntable. 16.33.45 & 78 rpm. Nice. £79	Sony CDP-M303 CD player. Boxed. Remote. Cheap	£25
Arcam Diva CD92 CD player. Nice condition. £399	Exposure 2010 CD player. Super condition. Manual	£275
Nad 504 CD player. Ex condition. No display	Cambridge Audio CDS. Black finish. Boxed. Remote	£59
Rotel RP 830 turntable with AT cartridge. No lid. £49	Sony CDP-911E. CD player. Remote. Boxed. Cost £200	£119
Rotel 965 BX CD player. Tweakers dream machine. £149	Rotel 865 BX CD player. Super condition. £99	£99
Trichord Research Pulsar One Dac with book. £1399	Pioneer PD-S505 CD + PSU + Mod by Tom Evans	£499
Cynus DAD 3 CD player and remote. Ex condition. £199	Project 1.2 with cartridge. Ex condition & boxed. £275	£275
Rossan ROK-DA1 PSU for ROK-DA1 DAC. Stand alone DAC. Mint. £295	Robson ROK-DA1 DAC. Stand alone DAC. Mint. £119	£119
Nad C541 CD player. Mint & boxed	Sony HAR-L1150 CD with built in 80G hard drive	£249
Trichord Research Pulsar 1 Dac with Micheli PSU	Cambridge Audio CDS CD player with remote.	£399
SME 3009 series II improved. Excellent condition	Transcriptors Hydraulic Reference turntable. Nice	£799

SPEAKERS

Rogers LS1. Black finish and in nice condition. £89	Pair Sponder BC1's in original boxes. Good cond.	£249
Pair Quad ESL57 speakers. Fully reconditioned. Including 2 new	Otec treble panels. Awesome sound & dynamics	£1699
Quad 121. Ltd edition speakers. Mint & boxed. £550	REI. Quake subwoofer. Mint & boxed. £299.00	£249
Quad ESL57 speakers. All fully serviced with full 3 months warranty.	Hear what ESL57s should sound like from	£1150 pr
Ket Coda 7. Black finish. Boxed & mint.	Pioneer 3 piece speaker set. Brand new. Cost £200	£99
Apogee Acoustic Centaurus studio monitor speakers. Ribbon	tweeters. Bi wireable. Stand mounts. Awesome.	£499
Monitor Audio R252 speakers. Teak finish.	£59	£59
Celestion Little one speakers in white. Boxed. £99	Pair Quad ESL57 speakers. Black. Ex condition	£549
Rupert stnck for Quad ESL57 and EL363 speakers	£239	£239
	Monkaut Short MS201 pearl. Brand new. Black	£169

OTHER ITEMS

Marshall B.84's specially selected valves. Boxed	£899
Marshall ECC83 12AX7 specially selected valves.	£899
The Missing Link phono pre amplifier. Ex condition	£349
Musical Fidelity Xplorer tuner. Mint & boxed	£299
Troughline tuner in grey. Fresh Reconditioned serviced by One Thing Audio. Includes updated studio 12 decoder.	£375
Troughline 2 tuner in gold. Serviced by One Thing	£275
Denon DRR-M110 half width Cassette deck. Boxed with instructions.	£39
Nad 402 stereo tuner. Excellent cond. Great sound	£79
Nad 412 tuner. Mint. Boxed. Booklet original receipt.	£89
Russian 11.84 tubes. Superb quality. Price each.	£6.50
Bulgian plugs for Quad II amplifier. Brand new. Each	£95
Rotel RT 840 tuner. LW/MW/M. Missing buttons	£95
Quad FM1 Valve tuner. Various prices from only	£100
Musical Fidelity T1 FM tuner. Award winner. £300	£199
Linn Tuner. Mint. Boxed. Very unusual. Cost £549	£199
Quad FM3 tuner in excellent condition. From...	£99

QUAD ESL57 & EL563 PANELS/SERVICING ETC

New. One Thing Audio "Wiggle". All round improvement for 57's & a kinder load for amp £79 pr
Full rebuild of 57s including latest Otec treble panels for only £1190.00
We sell serviced Quad ESL57 speakers from only £1250.00 pr. Why spend £4000+?

ESL57 SPEAKERS STANDARD SERVICE £680. PR
Price includes 2 completely rebuilt treble panels etc. Ring for further info.

"Classique Sounds servicing restores the Quads to a position where they can hold their head high". Jon Marks. HIFI WORLD. April 1999. Full servicing facilities available.

TRANSLUCENT (some at a bargain) Hifi World Jan 1999
PURE SILVER INTERCONNECT CABLE

99.99% pure silver conductors. Quality gold plated RCA phono plugs.
Half Metre terminated £70.00 One metre terminated £90.00. Available with Eichmann plugs + £30
New Translucent ULTRA + Heavy duty. 99.99% pure silver (4N).
Eichmann 24 Kt gold plate plugs £199.00 per metre. Or £149 per half metre.
7 day money back guarantee if not better than existing cable

IAN HARRISON HI-FI TEL: 01283 702875

HIFI AT DISCOUNT PRICES. FREE NATIONWIDE DELIVERY

SALE!

TRADE IN YOUR OLD MOVING COIL CARTRIDGE & SAVE UP TO 60% OFF THE RRP.

CARTRIDGES & STYLUS	HIFI FURNITURE	HEADPHONES	DVD
VAN DEN HUL	JUAL	DENON	SONY
ZYX	B.C.D.	ERGO	
JAN ALLAERTS	CUSTOM DESIGN	SHURE	LOUDSPEAKERS
DENON	OPTIMUM	BEYER	OPERA
CARTRIDGE MAN	ASH DESIGN	STAX	TRIANGLE
AUDIO TECHNICA	APOLLO	SENNHEISER	FINAL
GOLDRING	SOUND STYLE	SONY	ELAC
SUMIKO	SOUND STYLE	AKG	HARBETH
TRANS-	ORGANISATION	GRADO	EPOS
FIGURATION	ALPHASON	AUDIO-	USHER AUDIO
GRADO		TECHNICA	DIAPASON
ORTOFON	CABLES		TANNOY
RESON	DENON	CASSETTE DECKS	AUROUSAL
CLEAR AUDIO	VIRTUAL -	PIONEER	AMPLIFIERS
KOETSU	DYNAMICS	SONY	CREEK
SHURE	BLACK RHODIUM	TUNERS	HALCRO
TONEARMS	TRANSPARENT	PURE DIGITAL	MOTH
SME	QED	DENON	C.A.T.
GRAHAM	ORTOFON	SONY	GAMUT
MOTH	NORDOST	CREEK	ALOIA
CARTRIDGE MAN	SUPRA	PHONO STAGES	EAR
CLEARAUDIO	WIREWORLD	HEED	AUDIO VALVE
HADCOCK	CD PLAYERS	GRAHAM SLEE	ACCUSTIC ARTS
MICHELL	AUDIO ANALOGUE	WHEAT AUDIO	GRAAF
TURNTABLES	MONRIO	TRICHORD	MONRIO
MICHELL	GAMUT	MOTH	AUDIO ANALOGUE
CLEAR AUDIO	SONY	CREEK	PATHOS -
EAR	CREEK	NAD	ACOUSTICS
ACOUSTIC SOLID		EAR	UNISON -
		TOM EVANS	RESEARCH
		CLEAR AUDIO	

PLEASE PHONE TO CONFIRM PRICE & AVAILABILITY PRIOR TO ORDERING.
ALL GOODS ARE BRAND NEW & BOXED WITH FULL U.K. GUARANTEES.
NO EX. DEM OR EX DISPLAY GOODS. NO GREY IMPORTS. GOODS ARE NOT
SUPPLIED ON APPROVAL. SORRY, NO GENERAL CATALOGUES. PLEASE
PHONE OR WRITE FOR SPECIFIC REVIEWS, BROCHURES OR PRICES.
SUPPLIER OF HIFI PRODUCTS & ACCESSORIES SINCE 1988
MAIL ORDER ONLY FROM: IAN HARRISON, 7 MILL HILL, REPTON,
DERBY, DE95 6GQ. TEL: 01283 702875. 9am - 9pm INCLUDING SUNDAYS.

// the singularly most addicting
piece of gear I have ever heard"

10 AUDIO REVIEW

"A new benchmark for musical communication" STEREO TIMES

"One of the truly special products I've reviewed in the past 18 years" STEREOPHILE

Winner of Stereo Times magazine Most wanted component of 2005 award



"The best tonearm I've heard" HI FI WORLD



Your cartridge can deliver vastly improved results if coupled with a high grade arm. Great tonearms of the past were recognised for what they contributed but we would suggest it's time to upgrade. Massive performance improvements are now possible, so why not advance your system to a new level? After all, a significant tonearm upgrade offers many times the improvements of those given by cartridge upgrades, and last a lot longer. Our multi-award winning arms are offered with a no risk, money back guarantee should you be anything other than delighted.

Tonearm Models

Enterprise
Conqueror
Illustrious
Encounter
Silver
OLI

2005 World Awards



UNIVERSAL MOTOR UPGRADE

Upgrades & replaces
motors & power supplies for ALL
belt drive turntables

"The single most important upgrade you can ever make to any record deck

concerns the motor drive...nothing can prepare you for the shock of going DC. In a word, gobsmacking." COMMON GROUND MAGAZINE

"It's value is nothing short of tremendous." LISTENER MAGAZINE

"The LP12 remains a classic ...but ..upgrade kits by Origin Live can bring a vast improvement to it's performance" HI FI NEWS

UNIVERSAL TURNTABLE MOTOR KIT - No one would blame you for being sceptical of an easy to fit, inexpensive dc motor upgrade. Especially one that improves on the best of other power supplies costing over 4 times as much or your money back. It is simply impossible to imagine the level of improvement attained by eliminating the motor vibration that your stylus amplifies over 8,000 times! Our DC motor kit offers massive improvements to all versions of Linn Lingo / Valhalla, Rega, Systemdeck, Roksan, Rock etc. The kits consist of a drop in replacement high grade DC motor and off-board 2 speed control box. Why not order now? - see web site or phone.

Standard dc Motor Kit - £250

Advanced dc Motor Kit - £339

Ultra dc Motor Kit - £570

Upgrade Transformer - £175

Upgrade DC 200 motor - £129 with kit

ORIGIN LIVE

Tel/Fax: +44 02380 578877

E-mail: info@originlive.com

www.originlive.com

Rochester Hi-Fi

30 HIGH STREET, ROCHESTER, KENT, ME1 1LD - 01634 880037

ORACLE AUDIO



Raysonic®



UK DISTRIBUTOR FOR ALL RAYSONIC & ORACLE PRODUCTS.

ANATEK, ARCAM, ATACAMA, AUDIOPHILE BASE, AVI, CHORD COMPANY, CHORD ELECTRONICS, CLEARAUDIO, CREEK, DALI, EPOS, EUPEN, EXPOSURE, FOCAL JMLAB, GAMUT, GRAHAM SLEE, LAT, METRONOME, NORTHSTAR, NOTTINGHAM ANALOGUE, NU FORCE, OPTIMUM, ORIGIN LIVE, ORACLE, PARTINGTON, PROJECT, QUAD, QUADRASPIRE, RAYSONIC, RESOLUTION AUDIO, RENAISSANCE, TANNOY PRESTIGE, USHER.

www.rochesterhi-fi.co.uk

hifisound

T U R N T A B L E W O R L D

£1/2 Million Moving Sale Now On

As soon as we can in the new year we'll be moving to our new 5000 sq ft premises, so help us move as much stock as we can. We have just one of many of the items shown below, and upto a maximum of 5 of some others - don't miss out!!!

tel 0845 6019390 Tues to Sat 10 til 5, or email world@2ndhandhifi.co.uk

Analogue	Amplifiers	Digital	Loudspeakers
Ariston R800, ex condition	Acrapulse 1212, mint boxed	Arcam DV79, excellent boxed bargain	Audiovector M3 Sig, active crossovers, new L4k+, amazing
Ariston R350 Superip, Rega arm, stunning	Arcam AVR200, ex boxed, REDUCED	Arcam DV89, bargain REDUCED	AVI Neutron IV
Ariston D115, excellent order	Arcam A65+, excellent hihi amp	Arcam CD73, excellent in silver	AVI Pro Nine Plus Actives, less than 6 months old
AVD Acutus	Audio Analogue Maestro Reference 150w monster Integrated	Arcam CD72, vgc boxed	AVI Trio
AVD Valere	Audio Analogue Primo, mini size integrated	Arcam DV27, excellent in black	B&W 805 Neutulus, ex boxed
Clearaudio Evolution with parallel tracking arm	Audio Analogue Maestro Settanta	Audio Analogue Puccini ex dem	B&W 805S, nr mint boxed in cherry
Clearaudio Emphion	Audio Innovations Series 700 integrated, excellent boxed	Audiolab B000DAX, vgc	Castle Harlech, excellent boxed
Clearaudio Performance	Audiolab B000, vgc boxed	AVI Lgh Series, mint boxed ex dem	Dynaudio Contour 1.8 mk2 ex boxed
Clearaudio Satisfy Tonearm Carbon Directwire	Audio Research I15 Preamp, ex boxed with remote	Bow Technologies L20, beautiful, vgc boxed	Dynaudio 42, nr mint boxed
Clearaudio Silent Matrix RCA	Audio Research D70 Power, ex	Chord DAC64	Epos S14 c/w matching stands
Clearaudio Satisfy Tonearm	AVI Lab Series Integrated	Chord DAC64	Jamo Concert 11, boxed
Clearaudio Satisfy Tonearm	AMT 52000 Integrated	Consomance Droglet, ex dem bargain - WOW!	Linn Lukan, excellent boxed
Clearaudio Satisfy Tonearm	AMT 52000 Pre, superb little preamp	Consomance CD701, ex dem HiFi Plus award winner	Linn Sato, excellent boxed with Sara stands
Clearaudio Satisfy Tonearm	AVRE VXE	Cyrus Quadra, c/w tuner, UNDER HALF PRICE!	Linn IsoMark DMS or FMS/Aerberg/Diak
Clearaudio Satisfy Tonearm	Chord SPM12008, boxed as new in black	Cyrus CDB, boxed ex c/w remote	Living Voice Auditorium 2, ex boxed
Clearaudio Satisfy Tonearm	Consomance Signatur 10, v lovely ZAS valve integrated	D/S Egan DAC/Pre, a taste of the high life!	Monitor Audio Bronze 2, ex beech
Clearaudio Satisfy Tonearm	Conrad Johnson P15, ex boxed	D/S Parcel Upsampler, bargain upgrade	Monitor Audio BR4
Clearaudio Satisfy Tonearm	Conrad Johnson MF2300A, mapster power amp	Esoteric SA60, ex demonstration, ex boxed etc. SAVE £1000	Monitor Audio RS1 in Natural Oak, nr mint boxed
Clearaudio Satisfy Tonearm	Conrad Johnson MF605E, excellent boxed	Esoteric DX1, brand new sealed box save £4000+	Monitor Audio RS range - Various available
Clearaudio Satisfy Tonearm	Cyrus AP4, Monos	Esoteric L40, ex demonstration, SAVE £3000+	Monitor Audio S8, ex boxed in Natural Oak
Clearaudio Satisfy Tonearm	Cyrus Pre V15, nr mint boxed	Esoteric DV505, ex boxed	Monitor Audio, mint boxed RSW12 subwoofer
Clearaudio Satisfy Tonearm	Cyrus Pre V12, ex boxed	Heart Audio CB6000, valve output, Trichord clock	Monitor Audio GS range - Various available
Clearaudio Satisfy Tonearm	EAR 834 Preamplifier	Krell KAV300CD, excellent boxed	Monitor Audio, mint boxed GS20 in Piano Black, ex dem
Clearaudio Satisfy Tonearm	EAR 870 Power Amplifier	Lector CD151, ex valve output stage	Monitor Audio Rogus range - Various available
Clearaudio Satisfy Tonearm	Exposure 3010, as new boxed with £200 mm phono stage	Linn Karik, v late version ex boxed	Monitor Audio, mint boxed RW12 subwoofer
Clearaudio Satisfy Tonearm	TL MA89/MA100/MA100 Pre/Power x2 lovely combo NOW	Linn Numerik, v late version	Monitor Audio GS range - Various available
Clearaudio Satisfy Tonearm	Iran Audio 40i Classic with KT88s, excellent	Meridian 507, 24 bit, excellent boxed	Monitor Audio, mint boxed GS20 in Piano Black, ex dem
Clearaudio Satisfy Tonearm	Krell KA1400i, excellent boxed	Meridian 200 transport, excellent boxed	Monitor Audio, mint boxed GS20 in Piano Black, ex dem
Clearaudio Satisfy Tonearm	Krell KSA1005 excellent lully serviced and rebuilt	Meridian 203 DAC, excellent	Monitor Audio, mint boxed GS20 in Piano Black, ex dem
Clearaudio Satisfy Tonearm	Linn Klaut power, ex from	Micromega Sigma 1, excellent	Monitor Audio, mint boxed GS20 in Piano Black, ex dem
Clearaudio Satisfy Tonearm	Linn LK10U, excellent	Musical Fidelity Np Vista CR CD player, excellent, boxed	Monitor Audio, mint boxed GS20 in Piano Black, ex dem
Clearaudio Satisfy Tonearm	Linn Maganda, vgc	NAIM CD1, boxed, p/s, new burndy	Monitor Audio, mint boxed GS20 in Piano Black, ex dem
Clearaudio Satisfy Tonearm	Linn Kolektor, ex boxed	NAIM CD5, ex boxed	Monitor Audio, mint boxed GS20 in Piano Black, ex dem
Clearaudio Satisfy Tonearm	Meridian 551 Integrated excellent boxed	Pathos CD50, ex boxed	Monitor Audio, mint boxed GS20 in Piano Black, ex dem
Clearaudio Satisfy Tonearm	Linn Kolektor, ex boxed	Pathos CDgraphin	Monitor Audio, mint boxed GS20 in Piano Black, ex dem
Clearaudio Satisfy Tonearm	Mintrol Fidelity B200, vgc	Primare CD2, vgc	Monitor Audio, mint boxed GS20 in Piano Black, ex dem
Clearaudio Satisfy Tonearm	NAIM NAC4/MAP140, excellent boxed pre/power	Primare CD3	Monitor Audio, mint boxed GS20 in Piano Black, ex dem
Clearaudio Satisfy Tonearm	NAIM 3279, pre/power, cute chrome bumper pair	Primare CD30.2, ex boxed c/w remote	Monitor Audio, mint boxed GS20 in Piano Black, ex dem
Clearaudio Satisfy Tonearm	NAIM NAIT 5, ex boxed	Quad 99,DC, as new boxed	Monitor Audio, mint boxed GS20 in Piano Black, ex dem
Clearaudio Satisfy Tonearm	NAI A 127/150 combo, excellent boxed	Quad Alesia, c/w Dac and power supply	Monitor Audio, mint boxed GS20 in Piano Black, ex dem
Clearaudio Satisfy Tonearm	NAIM MAC119, current style preamp	Roksan Sandy L3 CD player	Monitor Audio, mint boxed GS20 in Piano Black, ex dem
Clearaudio Satisfy Tonearm	NAIM NAP180, Olive, boxed, excellent	Roksan Caspian M Series CD Player	Monitor Audio, mint boxed GS20 in Piano Black, ex dem
Clearaudio Satisfy Tonearm	NAIM NAP140 Olive, boxed,	Rotel RC009, excellent boxed	Monitor Audio, mint boxed GS20 in Piano Black, ex dem
Clearaudio Satisfy Tonearm	Nut-orce Reference 95E Monoblocks, ex dem in silver	Suggen CD21, current version	Monitor Audio, mint boxed GS20 in Piano Black, ex dem
Clearaudio Satisfy Tonearm	Pathos Cassia One Mk2, ex boxed	Suggen CD21SE, ex dem	Monitor Audio, mint boxed GS20 in Piano Black, ex dem
Clearaudio Satisfy Tonearm	Pathos Laga Integrated	Shanling CD300	Monitor Audio, mint boxed GS20 in Piano Black, ex dem
Clearaudio Satisfy Tonearm	Primare A3	Shanling CD180	Monitor Audio, mint boxed GS20 in Piano Black, ex dem
Clearaudio Satisfy Tonearm	Quad 606, Power,	TEAC DV70 superb progressive scan etc	Monitor Audio, mint boxed GS20 in Piano Black, ex dem
Clearaudio Satisfy Tonearm	Quad 44 Preamp, 40S Power amps NOW from	TEAC PDD2610 Multi Disc player	Monitor Audio, mint boxed GS20 in Piano Black, ex dem
Clearaudio Satisfy Tonearm	Quad 32, 303, vgc for year fully serviced	TEAC DV85, excellent, remote, due in	Monitor Audio, mint boxed GS20 in Piano Black, ex dem
Clearaudio Satisfy Tonearm	Quad 99 Poweramp, as new boxed	TEAC VR810, good condition, boxed remote	Monitor Audio, mint boxed GS20 in Piano Black, ex dem
Clearaudio Satisfy Tonearm	Raffard STAR25 Renaissance and 3x25 Pre/Power, excellent	TEAC VRD50, excellent, remote	Monitor Audio, mint boxed GS20 in Piano Black, ex dem
Clearaudio Satisfy Tonearm	Roksan Caspian M Series Integrated, ex remote	Wadia 302, as new boxed	Monitor Audio, mint boxed GS20 in Piano Black, ex dem
Clearaudio Satisfy Tonearm	Roksan Caspian M Series Pre amp power amplifier		Monitor Audio, mint boxed GS20 in Piano Black, ex dem
Clearaudio Satisfy Tonearm	Roksan Caspian M Series Monoblock amplifiers		Monitor Audio, mint boxed GS20 in Piano Black, ex dem
Clearaudio Satisfy Tonearm	Roksan Kandy L3 Integrated and Power amplifier		Monitor Audio, mint boxed GS20 in Piano Black, ex dem
Clearaudio Satisfy Tonearm	Roksan Laga Integrated, ex remote		Monitor Audio, mint boxed GS20 in Piano Black, ex dem
Clearaudio Satisfy Tonearm	Rotel R991, ex boxed		Monitor Audio, mint boxed GS20 in Piano Black, ex dem
Clearaudio Satisfy Tonearm	Rotel RAO1, excellent boxed		Monitor Audio, mint boxed GS20 in Piano Black, ex dem
Clearaudio Satisfy Tonearm	Sonik Frontiers Anthem Pro II & Power I, Reduced to only		Monitor Audio, mint boxed GS20 in Piano Black, ex dem
Clearaudio Satisfy Tonearm	Suggen A41SE		Monitor Audio, mint boxed GS20 in Piano Black, ex dem
Clearaudio Satisfy Tonearm	Suggen A21, new version		Monitor Audio, mint boxed GS20 in Piano Black, ex dem
Clearaudio Satisfy Tonearm	TAC/Lyndford Audio SDA2175, great press, as new		Monitor Audio, mint boxed GS20 in Piano Black, ex dem
Clearaudio Satisfy Tonearm	Unison Research Preliudio		Monitor Audio, mint boxed GS20 in Piano Black, ex dem
Clearaudio Satisfy Tonearm	Unison Research Unico Integrated		Monitor Audio, mint boxed GS20 in Piano Black, ex dem
Clearaudio Satisfy Tonearm	Unison Research S6, superb		Monitor Audio, mint boxed GS20 in Piano Black, ex dem
Clearaudio Satisfy Tonearm	Unison Research SR 845 madness, a real treat		Monitor Audio, mint boxed GS20 in Piano Black, ex dem
		Radio Recorders	
		Arcam Alpha 7	
		AVI Lab Series tuner, ex demo boxed	
		Harran Karbon TUR10 DAB/FM Rev	
		Meridian 204, excellent	
		Nad 4020, v nice original	
		Nakamichi, ex boxed	
		Pure 70155, new	
		TEAC VR025, excellent multiband tuner	
		Quad FM3, excellent	
		Quad FM4, excellent	
		Radiobond	
		TEAC TR610DAB FM/DAB tuner	
		TEAC Portable R3 DAB radio, brand new boxed	
			Accessories/Systems
			B&O Full 5000 system inc CD and turntable, excellent, serviced
			Chord Chorus 1m interconnect
			Chord Singulus 1m interconnect
			H Karston AVR835 - wgs £395
			Linn Classic R with onboard tuner, as new boxed
			Linn IsoMark Active Xover box
			Marantz Laya CD/Receiver and cassette in Chelsea blue!
			NAD 3020 amp and 4020 tuner, excellent
			NAIM Filter 2
			TEAC Mini Systems - best deal in the UK!
			Tera Labs R8 8 Spkr table

www.2ndhandhifi.co.uk ...what are you up for?

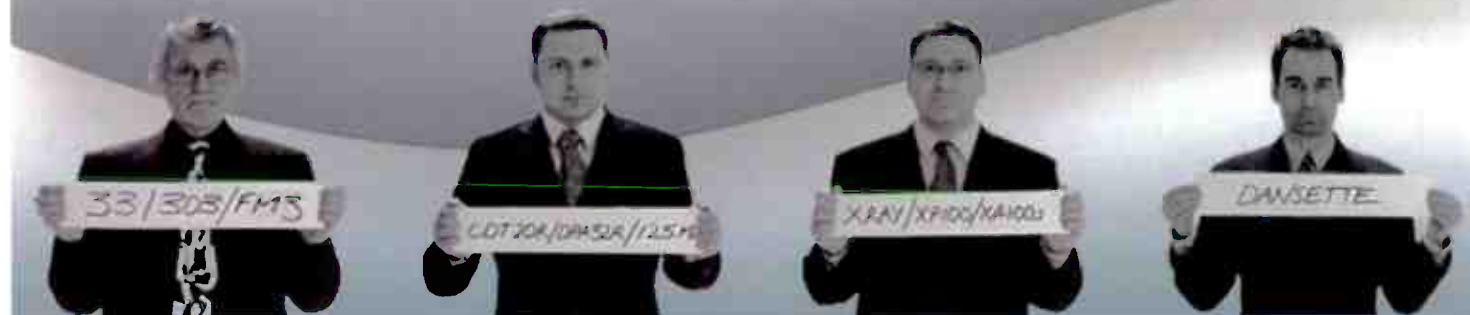

tel: 0845 6019390



BRITISH DESIGN AND
ENGINEERING AT ITS BEST

After 35 years, Michell is still a family run business with a team of dedicated and proud craftsmen, producing quality turntables and accessories



Orbe SE

The Michell flagship for music lovers who are not prepared to compromise



Gyro SE

The classic Michell turntable, refined over many years of development to its current level of performance.



TecnoDec

Entry level turntable incorporating features from the classic Gyro



MICHELL ENGINEERING

J A Michell Engineering Ltd
2 Theobald Street, Borehamwood,
Hertfordshire, England, WD6 4SE

Telephone: 020-8953 0771
Fax: 020-8207 4688
michell-engineering.co.uk

We are proud to announce that we are dealers for VPI RECORD DECKS, ROKSAN, ORTOFON, GOLDRING, PROJECT, E.A.R., INCA DESIGN, ISOTEK, WE HAVE VARIOUS CARTRIDGES IN STOCK - MORE EQUIPMENT ARRIVING DAILY - please ring, or see web.
EMAIL: mailto:info@matrixhi-fi.co.uk
WEB: www.matrixhi-fi.co.uk

matrix hi-fi

NEW AND GOOD QUALITY VINTAGE USED HI FI

65-67 DARENTH ROAD, DARTFORD
KENT DA11 1U - UK
TEL: 01322 281780 281781 292391 227668 FAX: 01322 229908

VPI RECORD DECKS, ROKSAN, ORTOFON, GOLDRING, PROJECT, E.A.R., INCA DESIGN, ISOTEK, WE HAVE VARIOUS CARTRIDGES IN STOCK - MORE EQUIPMENT ARRIVING DAILY - PLEASE RING, OR SEE WEB.

POWERINTEGRATED AMPLIFIERS - SOLID STATE

RECORD DECKS HEAD AMPS/TONE ARMS

TUNERS CASSETTE DECKS ETC.

CD/HDCD/SACD/DVD/MD PLAYERS

PRE-AMPS

SPEAKERS

POWER CONDITIONERS

MISC

Cymbiosis

Linn Products
Sondek LP12 specialist
setup, upgrades, rebuilds
25+ years experience with international reputation

Naim Audio
500 series stockist
always available for demonstration
Including DBL Loudspeakers

Arcam • Atacama
Chord Company • Denon
Dynavector • KEF
Kudos • Neat Acoustics
Quadraspire • Rega Research
Spendor & more...

We are hi-fi specialists, so please call us for advice, recommendations and demonstrations

We always carry a selection of quality used hi-fi check our website for more details

6 Hotel Street, Leicester, LE1 5AW
Tel: 0116 262 3754
e-mail: shop@cymbiosis.com

www.cymbiosis.com



Heatherdale audio limited



202 Findon Road, Worthing, WEST Sussex. BN14 0EJ
Tel. 01903-872288 or (after hours) 07860 660001 Fax. 01903-872234
e-mail: heatherdale@hifi-stereo.com //www.hifi-stereo.com

0% FINANCE AVAILABLE FOR UP TO 3 YEARS ON
SELECTED ITEMS.
SUBJECT TO STATUS. CONDITIONS APPLY.

SPEAKERS

Dali Royal Scepter speakers	£125
Quad 21L speakers	£395
TDL RTL 2 speakers	£75
Dynaudio Audience 42 wall speakers	£250
Spendor SP1 speakers with stands	£895
Thiel 2.2 speakers	£495
REL Stadium 11 subwoofer	£695
Tannoy Mini Autographs (ex demo, boxed mint)	£3400
Acoustic Zen Adagio Junior speakers with stands (new)	£1625
Mordaunt Short MS5-40 speakers	£99
Castle Pembroke speakers	£135
Mordaunt Short Avant 902 speakers with stands	£125
New Acoustic Zen Adagio speakers	£395
New Almaro speakers	£295
B&W 801 MK 1 speakers	£595
Hales Transcendence 5 speakers	£295
Dynaudio Audience 7 speakers with stands	£395

PRE-AMPS;

Wavac PR-T1 three box pre-amp. As new (£23500) only	£10750
Mark Levinson 26S Balanced pre amp	£2495
Spencer PAV pre-amp	£995

AMPLIFIERS

Quad 405 amp with 44 pre-amp	£395
Denon 5 ch' amp/processor (£1800)	£800
Conrad Johnson Premier 8 mono blocks (£18000) only	£5995
ASR 3 piece amplifier brand new (£8000) only	£5995
Lumley ST70 Power Amp with Passive Pre	£1595
Pathos Twin Tower Integrated Amplifier	£1295
Nakamichi Amp 1 with Cassette Deck 2 & CD Player 3	£795
Kora Triode 100 SB Monoblocs	£3500
Classe A CA201 Power Amp	£1595

CD PLAYERS & TRANSPORTS

Audion "Digital Analogue Company" CD player with HDCD	£1995
Mission DAD 7000 CD player	£65
Wadia 850 CD player, superb/boxed	£2495
Marantz CD 873	£65
Sony CDPMA1 CD Player	£60

MISCELLANEOUS

Nakamichi CR7E cassette deck, mint/boxed/remote just fully serviced by B&W	£1195
Quad FM 4 tuner	£125
Isoclean Power 50A 111 US power block & noise filter (as new)	£950
Selection OYALDE plugs and power strips	£295
Isotek Substation	£295
Accuphase P1200V mains regenerator (£5800) only	£3250
Nakamichi 682 Cassette Deck	£395
Sony AM/FM ST-SE370 Tuner	£175
Technics ST-610L Tuner (FM/MW/LW)	£65
Winds AL-M1 Stylus Gage (New)	£425
Sony ST-SE570 Tuner	£65
15 Foot Transparent Music Wave Super single mono run.	£795

TURNTABLES, CARTRIDGES & TONEARMS

SME series V "gold printed" arm, mint/boxed	£1195
Kuzma AIRLINE arm, silver wired as new (£4800)	£3600
Dynavector 507 MK2 arm (£2995) only	£2995
My Sonic Eminent cartridge (new)	£2750

Main dealer for Esoteric

VISA - SWITCH - MASTER CARD - AMEX - DINERS CLUB WELCOME.
WE TAKE PART EXCHANGE ON NEW & USED STOCK and buy in for cash

IAN EDWARDS
MAKERS OF FINE HAND MADE FURNITURE

Tel: 01423 500442 Fax: 01423 705200 www.iansbespokefurniture.co.uk

The Old Chapel, 282 Skipton Road, Harrogate, N. Yorks, HG1 3HE

*'Elegant Storage Solutions
for
Hi-Fi, Books,
LPs, CDs,
DVDs
Special orders welcome*



'Super 14 Wizard' Rotary Unit. 2296 CDs, etc



74" 'V-Max' can hold 660 CDs etc



JT Hi-Fi: CD/Cassette Unit



Charlotte Drawer unit for 480 CDs & 75 Cassettes 32" x 21" x 21"



plug 'n' play 'n' smile



kudos
www.kudosaudio.com

0845 4586698 for details...



One Decent Wallshelf

Thoroughly Recommended - David Price, Hi-Fi World Jan 06

featuring:
steel frame with multipoint fixing
upto 25mm thick 1/2 metre acrylic isolation platform
tuning pack for system matching
available:
hdw - £129
odw (pictured) - £249
odwt (2 shelf) - £349
all in either silver or black



The Decentscale

featuring:
non metallic construction suitable for all types of cartridge
record height measuring platform (patent applied for)
upto 20% more accurate than any other sub £100 scale
available:
now! - £35



Wallshelves, Isolation Platforms, Digital Tracking Force Scales, Cables

Decent Audio 0845 6019390

THE PERFECT

VISIT OUR WEBSITE: www.hi-fiworld.co.uk

UK SUBSCRIPTION SAVE UP TO

35%

SAVE UP TO 35% off the cover price when you subscribe to Hi-Fi World. Pay an amazing £2.47 per issue, including postage!



FOR BACK ISSUES ENQUIRIES PLEASE CALL

01442 879097

OVERSEAS SUBSCRIPTIONS IF YOU LIVE OUTSIDE THE UK, PLEASE CALL FOR OUR LATEST PRICES

+44 (0) 1442 879097

**SO WHAT ARE YOU WAITING FOR? CALL NOW!!!
SUBSCRIPTION HOTLINE 01442 879097**

Lines open Mon-Fri 9.00-5.00 or (weekend answering service available)

TEXT SUBS.HIFI TO 07797 800 800 and we'll call you back

FOR OUR
ON-LINE MAGAZINE
SEE P120

email:
hifiworld@webscribe.co.uk

Fax No:
01442 872279

CHRISTMAS GIFT

WHY SUBSCRIBE TO HI-FI WORLD?

- 12 issues a year delivered straight to your door.
- Be first to grab a bargain in our "Free Reader Classified Ads" section.
- Run by dedicated hi-fi engineers and enthusiasts.
- Subscribers receive a minimum 10% Discount annually.
- Hi-Fi World has become famous for its informative reviews and radical kit designs.
- PLUS!** Subscribe by Direct Debit this month and you'll also receive up to 35% saving (UK only).

Instruction to your Bank or Building Society to pay by Direct Debit



Please fill in this form and send to:
Hi-Fi World, Webscribe Ltd, PO Box
464, Berkhamsted, Herts., HP4 2UR

Originator's Identification Number

4 2 7 0 4 9

Name and full Postal Address of your Bank/Building Society

To: The Manager Bank/Building Society
Address
Postcode

Name(s) of Account Holder(s)

Branch Sort Code

Bank/Building Society Account Number

Reference

HF

Instruction to your Bank or Building Society

Please pay Webscribe Ltd Direct Debits from the account in this Instruction subject to the safeguards assured by the Direct Debit Guarantee. I understand that this instruction may remain with Webscribe Ltd and, if so, details will be passed electronically to my Bank/Building Society.

Signature(s)
Date

Bank and Building Societies may not accept Direct Debits Instructions for some types of accounts
The guarantee should be detached and retained by the Payer

The Direct Debit Guarantee

- This Guarantee is offered by all Banks and Building Societies that take part in the Direct Debit scheme. The efficiency and security of the Scheme is monitored and protected by your own bank or Building Society
- If the amounts paid or the payments dates change Webscribe Ltd will notify you 10 working days in advance of your account being debited or as otherwise agreed
- If an error is made by Webscribe Ltd or your Bank or Building Society, you are guaranteed a full and immediately refund from your branch of the amount paid
- You can cancel a Direct Debit at any time by writing to your Bank or Building Society. Please send a copy of your letter to us.



TERMS & CONDITIONS: You will receive 12 issues per year. Minimum subscription term is 12 months. Closing date for all Christmas offer orders is the 14th January 2008. Orders received before the 17th of December 2007 will begin with the Feb. 08 issue, published in January. Orders received after this date will begin with the next available issue. Prices include P&P and are correct at the time of going to press. All prices are quoted in sterling. Offer available for NEW subscribers only and for delivery to UK addresses, only. For enquiries relating to overseas pricing call + 44 (0) 1442 879 097

OFFER CODE: HFWJ08

CHRISTMAS DIRECT DEBIT OFFER

YES! I would like a Christmas gift one year subscription (UK ONLY, ends 14th January 2008).

- Pay just £7.98 every 3 months by Direct Debit (£2.66 per issue, saving 30%).
- Pay just £29.64 for 1 year only by Direct Debit (£2.47 per issue, saving 35%).

I'd like a year's subscription. Pay £34.20. (£2.85 per issue, saving 25% UK only).

Your Details

Title _____ Forename _____

Surname _____

Address _____

Post Code _____

Daytime Tel: _____

Email: _____

I would like to pay by Direct Debit (UK only) and receive a discount off the annual subscription rate of £45.60, as shown above. (Please complete the Direct Debit Form on the left).

I would like to pay by cheque – saving 25%. (Please make payable to Audio Publishing Ltd., and send to the address below).

I would like to pay by Credit/Debit Card – saving 25%.

Please debit my VISA MASTER MAESTRO AMEX (SWITCH)

Security No: _____ (last three digits printed on the signature strip)

Valid from Date: _____ / _____ / _____ Expiry Date: _____ / _____

Switch card issue No: _____

Cardholder Signature: _____

Outside UK:-

EUROPE Airmail **£50.00**

OVERSEAS Airmail **£70.00**



Send this form to:

Hi-Fi World, Subscriptions Department PO Box 464, Berkhamsted, Hertfordshire, HP4 2UR.

World Radio History

DIAL A DEALER

This is a comprehensive directory of Hi-Fi Dealers throughout the UK and Ireland.

BIRMINGHAM

MIDLAND RADIO SUPPLIES.

Tel: 0121 706 0313. Vintage & Classics. We buy and sell the best of British Designs and manufactured mono and stereo valve amplifiers radio tuners, turntables, pickups, loudspeakers systems, horns, drive units, tape recorders, microphones, mixers, measuring apparatus, valves and testers. Mono and stereo LPs and Tapes. Quality items required now.

BERKSHIRE

M&J DESIGN LTD (MUSIC)

Professional and Semi-Professional reel to reel machines and hi-fi equipment, The Finest Interconnects and Speaker Cables made to measure and guaranteed; User friendly web site will be available from June '07. M&J Design Ltd (Music) Maidenhead, Berkshire. 01628 622115
John50hifiman@btinternet.com

BRISTOL & BATH

THE RIGHT NOTE

Tel: 01225 874728. Happy with your system? Wonder why there's so much for sale secondhand? Avoid the frustration and expense of "upgrade-itis", never quite "there". With infinite patience we'll help you plan longer-term. Brands selection: Accustic Arts, Audio Physic, Aesthetix, Bel Canto, CAT, Chord Co, Clearaudio, dCS, Gamut, Graham, Halcro, Sumiko, VertexAQ, Wadia.

V'AUDIO

HiFi Consultants: 36 Druid Hill, Stoke Bishop, Bristol. BS9 1EJ.
Tel: 0117 968 6005.
ATC, AVI, Alon/Nola, ALR Jordan, Audio Analogue, Avid, Electrocompaniet, Infinity, Origin Live, Ruark, SME, Sugden, Triangle, Unison Research, VPI. Projectors / Sim2, JVC, Mitsubishi, Infocus. Screens/ Stewart, Draper, Da-lite. Demo's by appointment only - Please ring/e-mail for unbiased, honest advice based on 40 years experience. (icvhifi@yahoo.co.uk). We are not a shop!

CHESHIRE

ACOUSTICA

17 Hoole Rd, Chester CH2 3NH.
www.acoustica.co.uk.
Tel 01244 344227. HiFi & Home Cinema from Amphion, Arcam, ART, Ayre, B&W Nautilus, Classe, Focal, JM Lab, Monitor

Audio, Naim Audio, Primare, Rega, REL, Rotel, Spondor, Sugden, Thiel, Wadia. We offer full demonstration facilities, interest free credit, delivery & install systems throughout Cheshire, Merseyside & North Wales. Tuesday to Saturday 10.00 to 5.30.

ACTON GATE AUDIO

www.acton-gate-audio.co.uk
4 Ruabon Road, Wrexham, LL13 7PB,
(01978) 364500
Arcam, Atlas, Audiolab, Croft, Denon, Grado, JM Labs, KEF, Michell, Monitor Audio, Musical Fidelity, NAD, Ortofon, Opera, Onkyo, Pro-ject, QED, Quad, Rel, Roksan, Sugden, Sennheiser, Unison, van-den-Hul, Wharfedale, Yamaha.
Tuesday - Saturday 9.00 - 17.00
email: info@acton-gate.com

CLEVELAND

WAVEFRONT AUDIO

For 2 Channel Music Systems. Hear the Modwright Pre Amplifier, Albedo Cables, Almarro Valve Amplifiers, Cain & Cain Speakers, Rethm Full Range Speakers, Acoustic Zen Adagio, Battery Powered Amplifiers from Red Wine Audio. Digital Amps DAC's, Pre's and Head Amps from Channel Islands Audio. Pure Power APS. Contact andy@wavefrontaudio.co.uk. Web site www.wavefrontaudio.co.uk or Andy 01642 482 393.

CORNWALL

BIGEARS AUDIO

To find a system that will allow you to hear the music instead of the equipment phone Bigears Audio, here you will find an interesting array of new and good quality used equipment! my intention is to have satisfied customers whatever their audio preferences. Naim dealer for the South West.
chrisbirchley@btinternet.com
Tel: 01736-740421

KENT

SUGARBUSH RECORDS

8 Hawkenbury Road, Tunbridge Wells Kent, TN2 5BJ, United Kingdom
tel: (+44) 01892 541 746
Free vinyl LP catalogue. Every month-24 pages-rare & deleted ex+ and mint LPs starting at only £4.99. 60's & 70's Rock, Jazz, Blues, Psych, Progressive, Soul, Folk. It is the best regular vinyl catalogue in the UK! Call or write today.

MIDLANDS (WEST)

SOUND CINERGY

37 high street, aldridge, WS9 8NL
01922 457926
www.soundcinergy.co.uk
clive@soundcinergy.co.uk
quality hifi and home cinema from black rhodium, chord co, creek, epos, exposure, linn, marantz, monitor audio, mordant short, nad, okki nokki, ortofon, project, rel, roksan, themescene, trichord, vdh. Check our website for ex dem and secondhand bargains. free car parking.
tues - sat 10 - 5.30

ORPHEUS AUDIO

TEL:0161 4281539
E mail:orpheusaudio@tiscali.co.uk
www.orpheusaudio.co.uk
Now demonstrating the fabulous PODIUM SOUND .5 loudspeakers. Stunning clarity, speed and musical expression. A MUST HEAR LOUDSPEAKER.
Complemented by the following quality products; PS audio, Whest audio, EAR, Sh anling, Acoustic Zen, Consonance, Duevell, Wireworld, Heart audio, Custom design, Brilliance, Hyperion sound. Home demonstrations, Evening calls welcome upto 8pm

SOMERSET

ALTERNATIVE AUDIO, BY APPOINTMENT ONLY

Taunton, Somerset,
Tel: 01984 624242
www.alternativeaudio.co.uk.
Email: peter@alternativeaudio.co.uk
We specialise in valve amplification and vinyl replay with the accent on high quality musical enjoyment. Ex-Dem and used equipment for sale. Art Audio, Border Patrol, Clearaudio, Diapason, EAR/Yoshino, Experience Filtration, Lector, LFD Audio, Lyra, Music First Audio, Nottingham Analogue, Opera, Quadraspire, Shun Roock, SME, Transfiguration, Unison Research, Vandersteen Audio.

YORKSHIRE (EAST)

THE AUDIO ROOM

2 George Street, Hedon, Hull, HU12 8JH.
01482 891375. www.theaudiroom.co.uk
Authorised agents for Ayre, Arcam, Bowers and Wilkins inc 800series, Classe, Cyrus, Densen, Dynaudio, Dynavector, Grado, Hutter, Isotek, Linn, Lyra, Mark Levinson, Meridian, Naim, Nordost, Proac, Quadraspire, Rega, Rotel, Stax, Stereovox and others. 0% finance available, free parking, 3 demonstration suites, friendly and quality staff and advice, mail order service.

MEET YOUR MAKER

A reference guide to
Britain's manufacturers
and distributors

CREEK AUDIO LTD

12 Avebury Court, Mark Road,
Hemel Hempstead, Herts, HP2 7TA.
Tel. 01442 260146

E-mail: info@creekaudio.com
Internet: www.creekaudio.com

The beginning of 2006 saw Creek Audio launch two exciting new ranges, EVO at entry level and its high end - Destiny. At the same time, Creek's most popular products in the past 5 years, the 5350SE amp, CD50mk2 CD player and T50 tuner are now badged as Creek Classics. The OBH miniature range completes this new Creek line-up.

EPOS ACOUSTICS

2 Avebury Court, Mark Road,
Hemel Hempstead, Herts, HP2 7TA
Tel. 01442 260146.

Email: info@epos-acoustics.com
Website: www.epos-acoustics.com
Innovative design and superior sound distinguish EPOS speakers from other brands in similar price categories. Nine models in total including a 5.1 surround system. All available in 3 finishes. Supporting stands and plinths complement the speakers. In addition to its two channel appeal, Epos is now equally sought after in the fast expanding world of home cinema. -

E.F.G. (LONDON) LTD.

For service repairs upgrades and re-manufacturing of all valve audio equipment leak trough line specialists realigned etc. We have been restoring leak product back to new for over 40 years. Mail order service available worldwide. For more info contact E.F.G (London) Ltd. Inc.
E.Gane and Son. Established 1948
on 00 44 02087432727

LORICRAFT AUDIO

Loricraft Audio are now in the new premises and we will announce an official opening as soon as the work is complete. You can buy all our products directly from us or through your local dealer. Our internet shop site can take direct orders for our turntables and accessories!

Loricraft Audio, The Piggery
Mile End Farm, Wantage Road
Lambourn, Berkshire, RG 17 8UE
Office Phone/Fax: +44 (0) 1488-72267
email: terry@garrard501.com
web site: http://garrard501.com

MONITOR AUDIO LIMITED

24 Brook Road, Rayleigh, Essex SS6 7XL
Tel 01268 740 580.

Fax 01268 740 589
e-mail: info@monitoraudio.co.uk
website: www.monitoraudio.co.uk
Monitor Audio designs and manufactures British loudspeakers of the highest quality. Since 1972 Monitor Audio has been developing and perfecting the implementation of metal drivers, innovative crossovers, and exemplary speaker cabinet construction and finish to further the ideal of achieving sound which to the original is "as close as it gets".

M & J DESIGN LTD (MUSIC)

Superb Interconnect Cables; balanced or phono, made to measure. Using silver plated pure copper, and the finest connectors, these cables present the cleanest possible path for your signal, the end result being sublime listening pleasure. Each cable set is serial numbered and have their own instructions and are guaranteed. M&J Design Ltd (Music)
01628 622115 & 07809 394995.
John50hifiman@btinternet.com.

ORPHEUS INTERCONNECTS

Release your system's full potential with our hand-built solid silver interconnects, speaker cables and powercords. World-class connectors including the awesome new solid silver WBT phonos. High end performance at real-world prices, starting at £110, with a money-back guarantee. Sole UK agent for Voodoo Cable - www.voodoo-cable.com
Tel. 0115.982.5772 after 7pm. E-mail bob@skydivers.co.uk

PMC/BRYSTON

PMC & Bryston are Emmy award winning Loudspeaker & Amplifier manufacturers - Used throughout the professional world as reference. Our clients record for Deutsche Grammophon, Decca and countless blockbuster Movies. The identical, award winning ATL (Advanced Transmission Line) technology is used in all HiFi designs from the DB1+, TLE1 Sub through to the Active BB5 XBD.

PMC Ltd
43-45 Crawley Green Road. Luton, LU2 0AA.
Tel: 08704 441044 Fax: 08704 441045
Email: sales@promonitor.co.uk
website: www.pmc-speakers.com
website: www.bryston.ca

SUGDEN AUDIO PRODUCTS

Designed and manufactured in the UK each Sugden product is hand-built by one highly skilled technician. A full range of pure class A amplifiers are available including integrated, stereo power and the incredible Masterclass balanced monoblocks. The class A HeadMaster offers a pre-amp with three inputs a fixed and variable output with remote control. The HeadMaster can be used as a control unit in a high quality audio system and excels with headphones. Please contact us for product information, dealer list and brochures.
Tel: 01924 404088
email info@jesugden.co.uk.

To advertise in

Meet Your Maker

Dial A Dealer

Specialist Hi-Fi Dealer

please call

020 7372 6018

or email:

advertising@hi-fiworld.co.uk

SPECIAL INTRODUCTORY OFFER!!!!

HI-FI WORLD ELECTRONIC EDITION

VISIT OUR WEBSITE: www.hi-fiworld.co.uk

Queries to - esubs@hi-fiworld.co.uk

**Subscribe to our
eco-friendly e-edition of
Hi-Fi World and receive a
50% discount!!!**

- **Receive your issue a week before on-sale dates.**
- **Be the first to grab a bargain in our Free Reader Classified Ads.**
- **In-house lab. tests to AES and IEC standards**
- **Run by dedicated hi-fi engineers & enthusiasts.**
- **No missed issues, or postal delays.**
- **Access your issues from anywhere in the World.**
- **PC and Mac friendly.**
- **Eco-friendly.**

**Subscribe today and receive 12 issues for
£20 – that's an amazing £1.90 per issue!**

check out our free trial issue

**VISIT OUR WEBSITE:
www.hi-fiworld.co.uk and select
"ELECTRONIC EDITION"**

To purchase your e-edition click here

Pay in Sterling, US Dollars or Euros. Non-sterling prices vary according to exchange rate.
Cards accepted: Visa, Maestro (Switch), Mastercard, Solo and Delta.



specialist hi-fi dealers

Devon

Sound Hi Fi

marantz
PREMIUM
because music matters



USHER
Be-718 S520 Loudspeakers
Class A power amplifier



Usher, Marantz, Goldring, Audio Technica OC9, Acoustic Solid, NuForce, Black Rhodium, Graham Slee, Hadcock, Clearaudio, 78rpm reproduction, QED, Timestep, DC and much more.
All demonstrated in a relaxing setting with river views! Very high part exchanges & mail order.
Sound Hi Fi Dartmouth Devon 01803 833366 web www.SoundHiFi.com

London

Funk Factory in the UK

A warm welcome and a proper demonstration.
020 8447 8485

www.stereonow.co.uk

London

O'Brien Hi-Fi

60 Durham Road - London - SW20 0TW
020 8946 1528 or shop@obrienhifi.com
www.obrienhifi.com

Sonus faber. **WILSON** ALBIS
Velodyne

Martin Logan Clarity	Speakers - Ex Demonstration - Cherry	£1895	(£2200)
Moon i5	Amplifier - Ex Demonstration - Black	£2100	(£2695)
Sonus Faber Concerto	Speakers - Part Exchange - Walnut	£550	(£970)
Krell KAV300CD	CD Player - Part Exchange	£795	(£3000)
Copland CDA 823	CD Player - Ex Demonstration	£1595	(£2100)
Audio Analogue Enigma	System - New, Boxed with Warranty	£695	(£899)
Sonus Faber Cremona	Speakers - New, Slight damage	£4200	(£5000)
Unison Research CDP	CD Player - Ex Demonstration	£699	(£895)

Harbeth in the UK

A warm welcome and a proper demonstration.
020 8447 8485

www.stereonow.co.uk

London

Oranges & Lemons



020 7924 2040
www.oandlhifi.co.uk
61 Webbs Road, Battersea, SW11 6RX
email: oranges.lemons@virgin.net

Services & Consultants

Front End Problem?

contact

The Cartridge Man

It doesn't have to cost an arm and a leg to get the best - listen to my Koetsu - and Decca - eater.

Also agents for Croft, Hadcock, E.A.R, Michell & Moth.

plus cartridge re-tipping service

020 8688 6565

Website: www.thecartridgeman.com

LFD in the UK

A warm welcome and a proper demonstration.
020 8447 8485

www.stereonow.co.uk

North-Star in the UK

A warm welcome and a proper demonstration.
020 8447 8485

www.stereonow.co.uk

Valves & Tubes



Buy CVC. PREMIUM HI - FI valves direct from us. All valves processed for improved performance. We also have stock of MAJOR BRAND types inc. MULLARD, GEC, BRIMAR, RCA, GE, PHILIPS, etc.

The Stables, Battlow Park, Great Baddow, Chelmsford, Essex, CM2 7SY. Tel: 01246 241301 Fax: 01246 241309 Email: sales@chelmervalve.com

To advertise in this space please call

020 7372 6018

or email:

advertising@hi-fiworld.co.uk

Audio in the UK

A warm welcome and a proper demonstration.
020 8447 8485

www.stereonow.co.uk

To advertise in this space please call

020 7372 6018

or email:

advertising@hi-fiworld.co.uk



Offering you the very best in audio and visual system solutions.

- Two Channel Audio
- Multi Room
- Turntable Workshop
- Home Cinema
- Custom Installation
- System Set-up



ARCAM

LOEWE.



epos



...and others



Visit our showroom at:

Calveley Court, Southburgh Road,
Reymerston, Norfolk. NR9 4QD

tel: 01362 820800

email: enquiries@basicallysound.co.uk

www.basicallysound.co.uk



MUSONIC STYLI

How to get the most out of your record player in 3 easy steps:

1. Buy from Musonic
2. Fit your purchase to your player
3. Turn up the volume

After 50 years in the business
We know what we're talking about!

Manufacturers and suppliers of Styli,
Pickup Cartridges and Audio Accessories.

Musonic (UK) Limited
271B Wenta Business Centre
Colne Way, Watford
Hertfordshire WD24 7ND

Tel: 020 8950 5151
Fax: 020 8950 5391.

For info and to buy online visit:
www.musonic.co.uk

CLASSIC CONTACTS

When a classic goes 'poof' your troubles have just started, but there may be a good ending. Replacing failing parts can improve the sound, so here is a short listing of all those companies who specialise in getting a classic up and running again after its deposited a small ring of soot on your ceiling!

CLASSIQUE SOUNDS

(Paul Greenfield, Leicester)
ESL-57s restored, rebuilt, fully renovated or improved. Leak, Quad valves amps etc.

Tel: 0845 123 5137 / Mob: 0116 2835821

Email: classique_sounds@yahoo.co.uk
www.flashbacksales.co.uk/classique

GT AUDIO

(Graham Tricker, Bucks)
Leak Troughline specialists. Also Quad and most classic tuners, radios and amplifiers restored, repaired.

Tel: 01895 833099 / Mob: 07960 962579

www.gtaudio.com

AUDIOLAB

(Phil Pimblott, Leeds)
Renovation, repair and restoration. Specialist in valve hi-fi, radio transmitters, cinema amps, kit building.

Tel: 0113 244 0378

www.audiolabs.co.uk

QUAD ELECTROACOUSTICS

(Cams)
Quad's service department, able to repair almost all Quad products, from the very first.

Tel: 0845 4580011

www.quad-hifi.co.uk

LORICRAFT AUDIO

(Terry O'Sullivan, Bucks)
Garrard 301/401 and their own 501 repair, spares and service.

Tel: 01488 72267

www.garrard501.com

LOCKWOOD AUDIO

(London) Tannoy loudspeaker parts, restoration and repair. Also Epos and TDL loudspeakers. Tel: 020 8 864 8008

www.lockwoodaudio.co.uk

CARTRIDGE MAN

(Len Gregory, London)
Specialist cartridge re-tipping service and repairs. High quality special cartridges.

Tel: 020 8 688 6565

www.listen.to/thecartridgeman

TECHNICAL AND GENERAL

(East Sussex) Turntable parts - wide range of spares and accessories, plus arms and cartridges.

Tel: 01892 654534

REVOX

(Brian Reeves, Cheshire)
Revox tape recorder spares, service and repair. Accessories also available.

Tel: 0161 499 2349

Email: brian@revoxservice.co.uk

www.revov.freeuk.com

Dr MARTIN BASTIN

(Shropshire) Garrard 301/401 restoration, renovation and service. Special plinths; rumble cures, etc.

Tel: 01584 823446

SOWTER TRANSFORMERS

(Brian Sowter, Ipswich)
Large range of audio transformers for valve amps, cartridges, line drive, interstage plus all associated services.

Tel: 01473 252794

www.sowter.co.uk

ONE THING

(Coventry) Specialist in electrostatic panel manufacture and repair. Can refurbish ESL 57s and 63s as well as Leak Troughlines and Quad IIs.

Email: one.thing@ntworld.com

www.onethingaudio.com

OCTAVE AUDIO WOODWORKING

(Bristol)
Unit 2, 16 Midland Street, St Phillips. Bristol.

Tel: 0117 925 6015

www.octave-aw.co.uk

ARKLESS ELECTRONICS

(Northumberland)
Specialist in repairs, restoration and modifications to all amplifiers, valve or solid state, ancient and modern.

Tel: 01670 829891

Email: arkless.electronics@btinternet.com

WEMBLEY LOUDSPEAKER

(Paul MacCallam, London)
Comprehensive loudspeaker servicing.

Tel: 020 8 743 4567

Email: paul@wembleyloudspeaker.co.uk

www.wembleyloudspeaker.com

EXPERT STYLUS COMPANY

(Wyndham Hodgson, Surrey)
Stylus replacement service for all types of cartridge. Including precise profiling for 78s

Tel: 01372 276604

Email: w.hodgson@btclick.com

CLASSIC NAKAMICHI

(Paul Wilkins, Worthing, West Sussex)
Restore, Repair & Service Nakamichi Cassette Decks.

Tel: 01903 695695

Email: paul@bowersandwilkins.co.uk

www.bowersandwilkins.co.uk

D.K. LOUDSPEAKER SERVICE

(Dave Smith)
Hornchurch, Essex)
Re-cone of hi-fi loudspeakers, high quality loudspeaker systems, P.A. power loudspeakers.

Tel/Fax: 01708 447 344

FREE READER CLASSIFIEDS

TERMS AND CONDITIONS: Only one advert per reader. No Trade adverts. This section is strictly for readers selling secondhand hi-fi equipment only. Maximum length per advert is 30 words, Adverts over 30 words will not be accepted. Telephone numbers and E-mail addresses are treated as one word. Model numbers are treated as one word i.e. Quad 303 = two words. Email your advert to; classifieds@hi-fiworld.co.uk or fill in the form on page 129 and post it to Hi-Fi World Free Readers Ads, Suite G4, Argo House, Kilburn Park Road, London NW6 5LF. Sorry, we cannot accept adverts over the telephone. The Publisher reserves the right to judge submissions.

FOR SALE. Exposure XVII and XVII super. Superb pre/power combination, great for all types of music. As new condition, can also be demo'd, (Nottingham area) Reluctant sale £950.00 ono. Tel: 07764250691

QUAD ALL working 34 control unit, FM4 tuner, two 306 power amps in Quad rack. All cabled (£945). Musical Fidelity A300 (£800). Full instructions. Prefer sell as set. Offers. 01260 274501 (Cheshire)

CYRUS DISC and DacMaster includes manuals and receipts. Excellent condition £400. GyroPower power supply for Michell Gyrodec £75. Hi-Fi World magazines January 1996 through December 2006, £100. Tel: 01274 875 285 or Email: p.g.wilkinson@btinternet.com

PINK TRIANGLE Too turntable (rosewood) pink lid. Very good working condition! Alphason Xenon arm fitted/included. Offers around £400. Tel: Shaun 01226 244 341 (evenings after 8pm).

MF X-CANSV3 Mint (£250) £150. Townshend Seismic Sink (£200) £75. Kimber 1.5m Reference PowerKord HC IEC terminated (£175) £100. Blue Statmat, mint (£37) £20. Collection or +P&P. Tel: 0151 608 4481 (Wirral)

MUSICAL FIDELITY A3.2 pre-amp £325. Denon TU260II £60. Nakamichi BX125E £60. Sansui TU317 retro look tuner £45. Tel: 01883 342 039

FOR SALE Epos ES14 speakers plus dedicated stands. Award winning classic speaker in black ash. As new reluctant sale. Can be demo'd (Nottingham area). £250.00 ono. Tel 07764250691

CABBASE BLACK 100 watts per channel mono block amplifiers, £500. Wilson Benesch Full Circle turntable £1200. Project RPM5 turntable, new, £250. Naim 03 FM tuner, £200. Sugden phonostage MM/MMC £120. Tel: 020 8524 2181

QUAD 77 integrated amplifier £275. Quad 405/2 and 34 pre-amplifier £375. Thorens TD160 Super/SME 3 arm, no lid, £110. Records Classical 300 all excellent. Tel: 020 7386 9177 (evenings)

THORENSTD124 Mk2 turntable, SME 3009 arm, Shure V15 Type II cartridge. Denon DR-M20 stereo cassette tape deck. Sony stereo tuner ST 5150. Sony TA-1130 amplifier 70 watts. What offers. Tel: 01565 631 488

PURESOUND A30 amplifier, 35 watts per channel, as new, boxed (£1195) sell for £800. Weighs 25 kilos so buyer collects. Tel: 01491 614 325

MM INTERNAL phono stage for Creek Evo amplifier. Two weeks old, mint condition, £25 (ono). Tel: 01794 513 003

GARRARD 401, SME 3012 arm, Quad 303, Quad 33-303, Quad FM3. All are in exceptional condition with instruction manuals, mounting template. £700. Will sell separately. Must see. Tel: 01386 830 757 (Evesham, Worstershire)

PRIMARE D30.02 CD player, boxed, mint condition, with interconnects, remote control. Little used. £400 ono. Details. Tel: 077791 42961 or 01263 720 212

ARCAM FMJ A32 integrated amplifier, mint condition, boxed (£1300) sell for £650. Tel: 01491 614 325

KAILIN KN-7 valve pre-amp, Rotel RB-03 power amp. Both mint condition and boxed, £450 ono. Sansui T-5 stereo tuner, mint, £25. Leak Delta AM/FM tuner, excellent condition, £20. Tel: 01252 659 058

TACT S2150 integrated amp, cost £2000 three years ago, will accept £500. Elac speakers, light grey, cost £700 nine months ago, will accept £350. Buyer collects. Ring for details. Tel: 01254 330 343

CONRAD JOHNSON MV60SE mint £1000. Conrad Johnson Premier Fourteen, vgc, £500. Rel Storm 3, vgc, £395. Cadence Anina hybrid electrostatic speakers, vgc, £500. All boxed, instructions. Tel: 07931 177051 (London S.E.)

NAIM NAC112X/NAP150X, ace condition, £800. Hi-Cap silver bumper £325. CDI £450. Monitor Audio Radius 90 gloss black £150. Tel: Al 01297 444 148 (evenings)(Devon)

WANTED: NAD 3150 amplifier. Arcam Alpha 9P power amplifier. Exposure 2010S power amplifier. Cambridge P80 amplifier. Spondor SPI loudspeakers. Tel: 01843 843 145

DENSEN B300 power amp £550, Densen B100, integrated amp £350. Atlas Elektra interconnects, Hovland speaker cables, Target R2 speaker stands, £175. Tel: 07973 189 538 (London)

NAIM AUDIO pre and power amps for sale. 102 and 180. Serial No.s 125817 and 129293. Excellent condition with remote. £1100 for the pair. Tel: 01449 737 036 or Email: tim@tdhelectrical.co.uk

NAKAMICHI BX125, needs service, £50. Sansui T9 digital tuner £45. Kef Celeste II speakers, 2 pairs, £50 each. Tel: 0115 849 1003 (Nottingham)

LINN SARA speakers, black ash veneer with Linn stands. Excellent original condition. £225. Tel: 0151 924 5850 (Liverpool)

TAG MCLAREN CDT20R CD Transport £175. Sony cassette, 3 head, TCK 611S, Yamaha cassette, KX330. Open metal speaker stands Epos ES11, offers. Tel: 01275 462 948 (North Somerset)

AVANTGARDE ACOUSTICS sub woofers £150. Fitted to a pair of horn loaded speakers and subsequently replaced. They have built in 150 watt amplifiers. There are some light marks. Working perfectly. Tel: 01902 630 235

JBL L150 A, 20 years old, one owner, boxed, unmarked, walnut veneer, re-wired Russ Andrews, re-foamed DC Boultons, 1054 x 432 x 330. Buyer collects. £250. York. Tel: 01904 768 680

'ONE THING' stands for Quad 57 speakers, light oak finish. Transform your Quads, £110 ono. Tel: 01745 331 681 or 07714 530 889 (Rhyl, North Wales)

KT88 SE integrated, new, guaranteed, can demo, £650. Sony TT Ortofon cartridge £40. Wanted: all valve pre, remote MM/MM, GWO. Also Tara Labs RCA interconnects. Tel: Stanley 07951 553 091 (London)

NAIM FLATCAP power supply, olive green, little used, mint, boxed with manual, £220. Tel: 01302 854 426 or 07711 773 232 (South Yorkshire)

sounds of music



Providing generation after generation with the finest Music Systems money can buy.

By appointment only please.



Ypsilon



Eben



McIntosh



HRS



Musictools



DCS



Quad



Martin Logan



Krell



Edgar



Vitus



Audio Research



Coda



LSA



Furutech



Sonus Faber



Hovland



Boulder



Lumley



Ayon Audio

Tel: +44 (0) 1435 865 212, Fax: +44 (0) 1435 865 213, www.sounds-of-music.co.uk
Firgrove Business Park, Firgrove Road, Cross in hand, Nr Heathfield, East Sussex, TN21 0QL.

ARISTON RS80, no lid, £50.
Shure M75ED with Expert stylus, vgc, £30. N75/3, 78 stylus, vgc, £10. Tel: 01344 776 445 (Berks)
UNUSED BOX Four GE MO KT 88. Offers above pounds six hundred. Buyer collects from Caterham. Tel: Vimal 07988 602 431

MICHELL GYRODEC with Michell Technoarm, mint, £800. Unison Research S6 integrated single ended valve amp, mint, £850. Unison Research CDP valve CD player, mint, £400. Tel: 077142 16755

CREEK EVO amplifier with MM phono £275. Creek Evo CD player £275. Creek Evo tuner £180. Epos M12.2 speakers. Cherry, dedicated stands £350. All boxed as new. Tel: 01639 641 043

CYRUS 8VS amplifier, silver, excellent condition, boxed with remote £395. Bang & Olufsen MCL2P power amp £150. Tel: 01782 324 094

LEAK 2075 speakers, 77x20x15ins, only 51kg each!. Huge powerful detailed sonics. Very good condition, £390. Luxman L-85 integrated, excellent, instructions, £105. Granite slabs, 5 pieces, 26"x17"x30mm, unfinished project, £50 the lot. Tel: 01273 541 462 (Brighton)

MISSION 750 speakers mahogany with Mission stands, mint condition, marks on bottom where they fit on spiked stands, £100. No offers. Tel: 01772 687 748. (just off M55)

TRANSPARENT MUSIC Wave plus bi-wired speaker cable 15' £550. Transparent Power Link Super 2m £200. Two pairs silver wire Mandrake interconnects, balanced, one pair phono, £400 per pair. Tel: 020 8368 4228

SPENDOR CLASSIC Series SP2/3E speakers, rosewood, £650 ono (currently £1750). Suitable Acoustic Energy mass loaded stands available, £200 (£600 new). Unison Research 'Unico' hybrid valve/Mosfet integrated amplifier, 75w/ch £595 ono. Tel: 023 8073 8935

NAIM CD51, one year old, hardly used, £490 ono. Tel: 07716 139 026

AUDION SILVER Night premier 2 box valves pre amp power supply. Pair Audion Sterling power amp mono blocks. All gold plated. Hardly used, beautiful condition, boxed, £1700. Tel: 01252 614 055

QUAD 99 pre + remote, boxed, Quad ESL63's, vgc. P.O.A. Wharfedale Dentons £40. Meridian 596 CD/DVD £999. Classe Audio 151 amp £899. (£2100). Dual 505 £65. Kef Cresta 3's cherry £150. P/X? Tel: Jim 01206 510 392 or 07880 983 630 (Colchester)

TANNOYS 15 inch HPD in reworked cabinets, cones been replaced by D.K. Loudspeaker Service professionally. £400. Tel: 01634 221 102

CHORD ANTHEM, two XLR balanced interconnect 0.5m stereo pair. Just run in. Upgrading to Indigo (£348) £160. Tel: 01752 773 369

RECORD COLLECTION. 160+ LP's mainly classical including ASD's, SXL's and interesting Monos. £145. Buyer collects. Tel: 01604 410 726 (Northampton)

WANTED: MICHELL Syncro or Mycro in excellent condition with RB250 or RB300. Please contact Neil 01522 559 189 daytime or 01522 752 338 evening.

NAIM 82 pre amp 'S' phono, NAC SC, £825. Naim Hi-Cap £325. Thorens TD160 BC MkII. Hadcock Nipivot arm M20 Ortofon £225. Pioneer F676 tuner £40. Leak Stereo 20 £600. All immaculate. Tel: 01722 334 694

MONITOR AUDIO Gold Signature 10 speakers, piano black finish, mint condition, boxed with manual £450 ono. Tel: 07941 174 804

GRYPHON SONATA ALLEGRO pre amp £3450 ono mint condition remote. Gryphon balanced XLR (£950) £350 TEL: 01563 539 326

PIONEER REFERENCE Hi-Fi PD-73 CD, C-73 pre-amp, M-73 power. All matching system CD of high end quality unmarked condition manuals boxes £600. Rotel phono stage MM/MC RQ970BX £50. Tel: 01453 546 191

WANTED: 130MM Injection moulded cone speaker as fitted to Castle Harech Mk1 floor stander. Tel: 01952 249 627

NEW NEVER used Primare A20 integrated amplifier MkIII, £450. Tel: 01905 429 992 or Email: hallowhouse@hotmail.com

ATACAMA R724 speaker stands for sale. Excellent high quality stands for luxury monitors, £80 with Atabites. Nordost Blue Heaven interconnects for sale £70. Target S tier rack £50 bargain!! Tel: 01484 427 426

HEYBROOK HB200's black ash veneer, excellent condition £100. Stands for above mint £50. Tel/ Fax: 01782 205922 or 07794 732 840 (Staffordshire)

WORLD AUDIO Design KLS3 floorstanding loudspeakers. Three way carbon fibre drive units. Beautiful deep sound, excellent condition, £400. Tel: 0141 632 2079

LOWTHER ACOUSTA speakers with two year old DX3 drive units. Will sell drive units if wanted, £265. Nakamichi BX125E cassette deck £30. Rogers LS6 speakers £30. Tel: Martin 01702 601 956 or 01268 764 542

THORENS TD160, Alphason Xenon-MCS arm, Nagaoka MP-11 cartridge, £200 ono. Tel: 01493 700 381

YAMAHA KX580SE cassette deck, as new £149. Sennheiser HD-590 headphones £60. Arcam CD82T as new £400. Musical Fidelity X-Cans v3, as new £200. Tel: 01493 665 761 (Norfolk)

VITA R1 DAB/FM Table Radio's For Sale. Gloss Red or Gloss Grey £90. Walnut or Cherry £80. All in Excellent condition. Tel: 07949 910455

KEF AWARD wining AV high powered amplifier. Uniqe speakers, stands, txt panels, 10" sub-woofer vg £500 Jordan watts 6,5" speakers alloy, fully refurbished, £45 John Hardy, please ring Mike 01189693377

ATC SCM-20 Standmount Speakers, Cherry, immaculate condition with Target R Series Speaker Stands £950 (Demo Welcome located near M3/J4) Can arrange Delivery via courier. Jeremy 07977254160 / jeremyf@datasharp.uk.com.

HARMONIC TECHNOLOGY Truth Link , XLR balanced cables, 1 metre, outstanding sound, £95, Kef Kube for Ref 107, 105 etc, mint with instructions £75. Linn 5103 processor pre amp , dts, latest model, boxed as new £800. Phone 003531 2954076

FOR SALE Krell KSA 50 Power Amp £700.00 ono, Dunlop Systemdeck turntable £150 both in good condition. contact Steve on 0208 776 0044, or e-mail on sj.verrier@ntlworld.com

PROAC D100 in good cosmetic condition with crates, I live in Italy, payment via wire transfer, check my feedback on audiogon (335225996). Contacts 335225996@tim.it Skype a335225996

MARANTZ 6000 KI series amplifier and CD player (Black). Mint condition. £400. Pick-up London or will post at additional cost. Tel 07779017238 Email alan. roy@hotmail.co.uk

QUAD 57'S completely rebuilt by One Thing, black cloth finish, including new stands, see hi fi world for review. House not large enough. £750.00 for quick sale. Graham 01622 750732.

ELECTROSTATIC RESEARCH "vision" hybrid speakers, good condition, gloss birds eye finish, similar to Martin logan aeries, details on request, cost 3000, sell for £550. Leak Stereo 30 plus amplifier and Leak Stereofetic tuner, both in good working order and both in good condition. £100. Tel: 01604 584630 or 07920151588.







www.choice-hifi.com
 tel: 020 8392 1959 mob: 07768 720456
info@choice-hifi.com

WDKEL84 Valve Amplifier Kit

"The quality that can be gleaned from this amp is a fine introduction to the joys of the valve sound"

The WDKEL84 features a pair of EL84 valves in Push Pull configuration per channel, providing two channels each 18 Watts into an 8 Ohm load. Described by users as a 'Giant Killer' this kit is available as a 5 input integrated amplifier with ALPS volume control.

WDKEL84 kit £449

WDKEL84 built & tested £599



WD88VA Valve Amplifier Kit

"It proved itself to be an engaging valve amplifier that measured well and sounded superb. Quite simply it plays music, and plays it extremely well."

Adam Smith, Hi-Fi World Dec 06

Often described as a 'sweet sounding' valve, our implementation of the KT88 makes sure that it is driven to its ultimate performance. Available as a 35W stereo power amplifier with single input volume control, or as a relay switched integrated with five inputs.

WD88VA Integrated Amp kit £949

WD88VA built & tested £1249



WDHD3 Headphone Valve Amplifier Kit

"Headphone 3 is a single-ended design with the power pentode wired up in triode configuration for added purity and is as quiet as a mouse"

A beautifully simple stereo headphone amplifier design using Mullard ECL83 valves. It works directly from any source. The circuit uses twin high specification E/I output transformers that can be wired to drive any headphones between 16 to 300 Ohms.

WDHD3S kit £349

WDHD3S built & tested £479



WDPre3 Modular Preamplifier System

"So there we have it, a pre-amplifier capable of driving any load and maintaining its linearity no matter what cables or partnering equipment you prefer to use."

This 5 input line level preamp is essentially an SE triode power amplifier in concept. WDPre3 uses an ECC82 double triode arranged as input voltage amplifier and power output amplifier stages, the latter driving oversized 20:1 output transformers.

WDPre3 kit £369

WDPre3 built & tested £494



WDPhono3S MM/MC preamplifier

"...only a few designs meet the requirements of tonal accuracy and maximum retrieval of musical detail."

Twin input preamp with MM and MC relay switched inputs, passive RIAA equalisation and wide bandwidth MC step-up transformers.

WDPhono3S kit £399

WDPhono3S built & tested £524



WDPSU3 Power Supply

Can be used to power either WDPre3 or WDPhono3 units individually or together.

High performance choke power supply with separate HT and Heater feeds for both WDPre3 and WDPhono3 preamplifiers.

WDPSU3 kit £199

WDPSU3 built & tested £299



All our kits are complete with pictorial easy-to-follow instructions. All parts are included - all you need is a screwdriver and soldering iron. World Designs, 59 Main Street, Great Gidding, Huntingdon, Cambs, PE28 5NU

*www.world-designs.co.uk
Tel: 01832 293320*

WANTED FOR spares or repair faulty or non working Quad 34 or 44 preamps, Quad FM2, FM3, FM4 tuners, Leak troughline stereo tuner. Contact Mike on 01758 613790.

CHORD ELECTRONICS
Blu/DAC64 MkII, CPM 3300 Integrated amplifier. Nordost Valhalla 4m bi-amp speaker cables. All excellent condition. Offers invited. Telephone 07711 037273 email: j.evans452@btinternet.com

FISHER 400 tuner-amp, needs a new valve; Tandberg open reel tape deck, Thorens turntable complete TD150 model. Offers to: Duckworth1010@aol.com

VIRTUAL DYNAMICS Nite 2 balanced interconnects 1.0m Two pairs available £550 or £1000 for both Also Nite 2 speaker cable 10.25ft fitted with spades £795 cost £1300
01844 347729 - 07788667080

COPLAND CDA 823 CD player and Copland CTA 405 valve amp. Both mint condition - as new. Cost new £4250 will sell £3000 + postage. wont split. e-mail: alan395shona@btinternet.com

QUAD ESL 63s. These are 23 years old and in good original working condition with boxes. Would probably benefit from a service. £525 ono. Tel: Paul 01297 551416 (Devon).

GARRARD 301 turntable, with grease bearing, in cream. Vgc and fully serviced with oak plinth and with cut-out to suit 12 inch SME arm. Offers, 01204 578074 (Bolton)

QED Silver Anniversary biwire speaker cable, 3 metre pair with bananas £45 (£90). Mint. Lee, West Midlands 01384 412234.

FOR SALE : Naim XPS £900, Naim CDX £800, both in mint condition, boxed, with all accessories. roy.green7@tiscali.co.uk, Tel. 01980 611682

AUDIOLAB 8000Q pre-amp, remote, manual, vgc. £320.00 ono. Call Steve: 07905 762 363

FULL RANGE ribbon, off white, excellent condition, still under warranty, boxed, excellent reviews, cost 1350 with imported stands, sell for £595. Tele 01604 584630 or 07920151588.

PMC GB1 loudspeakers, maple finish, as new, boxed, can demo, sale due to upgrade. £625.00 ono. Tel 07843288719

QUAD ESL63 Pro in superb condition. Rosewood tops, brown grill cloth. Capacitor upgrade. Boxed £975. Pair Rogers Junior power amps. Sound lovely £295. Kenwood KT5020L £35. Tel 01684 (Malvern) 572547.

WANTED: TOP quality Hi Fi separates and complete systems, Naim, Linn, Cyrus, Meridian etc, fast, friendly response and willing to travel/pay cash. Please call John on 0781 5892458

NU VISTA Super intergrated amplifier with N300 power amplifier perfect condition with manual and connecting leads £450 or near offer phone alan 01279426046.

EPOS/ROTEL System. Epos M5 speakers, Rotel RA05 amp, Rotel RCD-06 cd player. All items 1 year old, immaculate & boxed £650 (£1050). Lee West Midlands 01384 412234

JAMO CONCERT 11. Superb Hi End Speakers. Mint Condition. Boxed with Manual. Complete with two 10 foot lengths of Kimber 8TC cable. Cost £ 2500. Offers around £750. Tel. 01844 358104.

JRI49 LIKE LS3/5a but better, excellent condition, all original. will post anywhere worldwide £350 07971977237 - 01639766354

LEAK 2075 speakers £1,000. JBE Slate Mk3 directdrive turntable £1,000. FR64S tonearm £650. FRB60 elevation base £100. Audio Alchemy MM/MM phono-stage £175. B&W 1800 speakers £250. 01798 813133/ reconcile@bdlrs.freeserve.co.uk

QUAD 44/405, Arcam CD 72, Kef 104aB. All used regularly. Quad FM3 tuner and Technics SL110 with SME 3009 series 11 unused for 15 years. £ Sensible offers for the lot brian.dreaves@btinternet.com

TUNER classic FM, AM, Hitachi FT5500. Michell ISO phono amp with Hera power surply unit, £245. Tonearm Rega RB300 £110. Tel: 01606784767

CYRUS PRE XVS Smartpower plus £550. Cyrus CD8x £550. Cyrus Psxr £275. All brushed black. Castle Stirling 3 loudspeakers. Dark Oak £275. All as new, Basingstoke 01256461453. mobile 07745565190.

SONY DAT recorder, DTC-60ES, ES Range, £195. Musical Fidelity CDPre24, CD Player/Pre-Amp/Multi Input DAC, (£2000) £595. SAE PA-10 Pre-Amp, MM/MC Twin Phono Inputs, £95. Tel: 01424 442802 (Sussex).

AUDIO ANALOGUE Bellini/Donizetti pre/ power amps. silver. £400. Marantz CD63 KI Sig classic CD player. £225. All boxed with manuals. Owned from new. Call Steve 07802 483911 or mcdonaldslawther@ricsonline.net (W London)

MERLIN VSM-MMe speakers, latest spec, Bam, hardly used, (£6,500) £2,700, Musical Fidelity Trivista Dac (£1,200) £625, Artemis Labs tube preamp, (£2,200) £600, All mint, boxed, Chord Anthem 1/C £85, 0788 915 6202 (London)

QUAD ESL63, pair for sale. One has One Thing Audio reconditioned panels, the other all Quad panels. Working but need further attention. £250 ono; further details ralphs@cfac.uk, Penarth, South Wales.

ROGERS BBC LS3/5As £395. Audiolab 8000A £175 and Rega Planar 3/RB300 £150, both boxed with manuals. The Chord Company Odyssey 4 bi-wire speaker cable, 9 metres £250. Two racks, speaker stands and cable, offers. East Sussex. Cash buyer collects. 01323 645942.

WORLD AUDIO 300b monos built by audio engineer, ex con £850. Yamaha NS1000m satin finish late model binding post also foundation stands £800. World Audio pre psu mm steve 01733561375 Peterborough.

MARANTZ SR8001 receiver 7X 125 watts £695. DV7001 player £395. SA-751. Best CD/SACD player £3950. Yamaha AX759SE AV amplifier £175 all mint condition Tel: 020 8951 3178

TANNOY Mansfield speakers - teak finish, 12 inch dual concentric drivers - £100. Telephone 01189 403439.

QUAD ESL 63's, including stands and boxes. £750.00. Tel: 01243 576 073

VINYL LP'S Wanted: Rock: Folk: Jazz: Soul: Reggae: Blues: Classical: Memorabilia. Must be in Excellent condition www.tantrel.com tantrel@bigfoot.com 0845 0941997

Quad 77CD and power amp, rare "Carbon" finish. Matching Sound Organisation stand. Epos ES11's on Slate Audio stands. Classic system cost over £2,500. Sell for £650 ono. Boxes. 07709-866296 roger@deeley18.plus.com

SD ACOUSTIC SD 1 speakers split into four boxes by sd with crossovers seperated and upgraded. New fostex ribbon tweeters. £360 ono Epsom 01737362796 Martin. Cook60@ntlworld.com

NEW, NEVER used, Primare A20 mkIII integrated amplifier. £450. Tel: 01905 429992 or email: hallowhouse@hotmail.com

KIMBER HERO 1 metre balanced XLR interconnect. As new (£130) £60. 07879 460935

CONRAD JOHNSON MV60SE mint £1000. Conrad Johnson Premier Fourteen, vgc. £500. Rel Storm 3, vgc. £395. Cadence Anina hybrid electrostatic speakers, vgc. £500. All boxed, instructions. Tel: 07931177051 (London S.E.)







BUY / SELL HOME CINEMA MULTIROOM INSTALL HI - FI

www.choice-hifi.com

tel: 020 8392 1959 mob: 07768 720456

info@choice-hifi.com

NEXT MONTH

'Tis the season to be jolly, and of course binge on some sumptuous Christmas goodies - but don't forget the food and drink too! Next month's Hi-Fi World is jam-packed full of tasty dishes of the audiophile variety, and we'll be serving them up with relish. So instead of watching that umpteenth repeat on the goggle box, why not relax in your comfy chair and feast your eyes on these:



BENCHMARK DAC-1 USB DIGITAL TO ANALOGUE CONVERTER
OLDE WORLDE: TRANSCRIPTORS HYDRAULIC REFERENCE
CAMBRIDGE AUDIO 840A V2 INTEGRATED AMPLIFIER
AUDIO TECHNICA AT-OC9 MOVING COIL CARTRIDGE
AYON AUDIO SPARK SINGLE ENDED AMPLIFIER
NHT CLASSIC ABSOLUTE ZERO LOUDSPEAKER
PURE SOUND P10 VALVE PHONO STAGE
NAIM NAIT 5I INTEGRATED AMPLIFIER
APPLE IPOD TOUCH MUSIC PORTABLE
CAMBRIDGE AUDIO TT50 TURNTABLE
[PICTURED] AURA NOTE MUSIC CENTER SYSTEM
KUDOS MODEL 10 LOUDSPEAKERS
AMAZON MODEL 2 TURNTABLE
EDGAR CD1 VALVE CD PLAYER
ATC SCM19 LOUDSPEAKERS
B&W 686 LOUDSPEAKERS

PICK UP THE FEBRUARY 2008 ISSUE OF HI-FI WORLD ON SALE DECEMBER 31ST, OR SUBSCRIBE AND GET IT DELIVERED TO YOUR DOOR: p116

ADVERTISERS INDEX

2nd Hand Hi-Fi	113
Analogue Seduction	52
Anatek/WBT	74
Angel Sound	109
AudioXpress	108
B&W	BC
Basically Sound	122
Big Ears	108
Billy Vee	104
Choice Hi-Fi	123,125
Classique Sounds	111
Cymbiosis	114
Decent Audio	115
Dragon I Distributors	52
Electrocompaniet	14
Exposure	IFC
Heathcote Audio	110
Heatherdale	115
Henley Designs	74,82,88
Hi-End Cable	119
Hi-Fi Sound	113
HiAudio	58
Ian Edwards	115
Ian Harrison	111
Icubes	52
KEF	12
Kudos	115
Leema Acoustics	26
Linn	30
Mantra Audio	109
Martin Klieser	84
Matrix	114
Michell Engineering	114
Mission	106
MIT Cables	48
Monitor Audio	6
Musonic	122
NAD	24
Newcastle Hi-Fi	36
Origin Live	112
Practical Hi-Fi	44
Redline	48
Retro Reproduction	109
Ringmat Developments	60
Rochester Hi-Fi	112
Sevenoaks	92,96,100
Shadow Audio Cons.	68
Sound Dead Steel	66
Sounds of Music	124
Sugden	88
Tangent	66
The Right Note	66
Tube Shop	108
Turntable World	113
Usher	IBC
Walrus Systems	72
Whest Audio	60
World Design	126
Yinpuli	40

FREE READER CLASSIFIED ADS ORDER FORM

STOP PRESS

TERMS AND CONDITIONS: Only one advert per reader. Maximum length per advert is 30 words, Adverts over 30 words will not be accepted. No Trade Adverts. This section is strictly for readers selling secondhand hi-fi equipment only. Telephone numbers and E-mail addresses are treated as one word. Model numbers are treated as one word i.e. Quad 303 = two words. Sorry, we cannot accept adverts over the telephone. The Publisher reserves the right to judge submissions.

You can email your advert to us at: classifieds@hi-fiworld.co.uk
or write or type your advertisement copy in block capitals with one word per box and post it to us at:

Hi-Fi World Free Readers Ads,
Unit G4, Argo House, Kilburn Park Road,
London, NW6 5LF.

WE WILL ACCEPT PHOTOCOPIES OF THIS FORM

1	2
3	4
5	6
7	8
9	10
11	12
13	14
15	16
17	18
19	20
21	22
23	24
25	26
27	28
29	30

Name: _____

Address: _____

Post Code: _____

Daytime Tel: _____

FREE READER CLASSIFIED ADVERTS COPY DEADLINES

FEBRUARY 2008 ISSUE - 3RD DECEMBER 2007

MARCH 2008 - 3RD JANUARY 2008

JEAN MICHEL JARRE

OXYGENE

1977/2005



Throughout the long hot summer of 1977, punk rock was fizzing into the public consciousness and taking all the tabloid headlines, but there were other revolutions going on elsewhere. As everyone spoke of raucous guitar combos, the echoes of Kraftwerk's pioneering synthetic work and Pink Floyd's VCS3 and ARP experiments from 'Dark Side Of The Moon' onwards lingered on in the minds of some...

In the charts, this manifested itself as novelty records such as Space's 'Magic Fly', and in a seminal piece of electronic rock music by a young Frenchman called Jean Michel Jarre. Even at the time, 'Oxygene IV' had a timeless quality. A set of jaunty and beguiling melodies, with a lilting electronic rhythm backing, it could never be mistaken for anything else.

Most heartening was the fact that the album constituted a cohesive whole, and still does. And we are now reminded of its brilliance as EMI release a version recorded on the original analogue gear to high resolution digital - the sessions, or at least a live recreation of them, were also filmed in HD and remixed in surround sound.

Unfortunately, much of what happened in the life and career of Jean Michel subsequent to his stellar debut blotted the immediate legacy of this near-perfect record. Album two, 'Equinoxe' was a close facsimile. Number three was better - 'Les Chants Magnetiques' (the French-language pun completely lost in English translation) introduced

"the latest version of 'Oxygene' reminds us how revolutionary Jarre's early work was..."

Fairlight gimmickry with some success. After that, only the early dabbling with digital synthesis and sampling, 'Zoolook', was worth bothering with. JMJ then shifted from pioneering studio-work to overblown, self-promoting, large-scale outdoor events and nonsense 'laser harp' showboating, all the way from China to Houston to London, etcetera...

As if to realise his error, Jean Michel has recently revisited his *chef d'oeuvre*, not once but twice. Three years ago he released a 5.1 version of his classics, featuring the key 'Oxygene' tracks, as the 5.1 DVD-V (with CD) 'Aero' on Warner Brothers. The best one can say about that project is that at least it highlighted the appeal of high-res and surround to the Frenchman.

Now, on the occasion of its thirtieth anniversary, he has gone one step further and reiterated the entire first album for the 21st century. On CD it is a total replica of the 1977 done-at-home recording, well-mastered, but so close to the original it makes one think 'why bother?' (if indeed it has been rerecorded). Regrettably the pre-production DVD samples from EMI do not include the high-res and/or surround elements, so I cannot pass comment on those. For the truly interested, the DVD extras are more compelling, adding instrumental variations on the original, those un-previewed

surround versions, and the intriguing prospect of watching JMJ and three others recreate the 'eight hands, eight tracks' original before your very eyes.

The gimmickry habit has not abated, as we are blessed here with the possibility of a 3D (with glasses in true seventies-style) viewing option in the most expensive version. However, that video of analogue synth tweaking remains the most exciting option for the fans, whether in 2D or 3D. Here we have a Mellotron and a Theremin, many VCSs and ARPs and multiple Moogs to fetishise.

Synth enthusiasts should also note that the recent DVD of an erstwhile EMI signing Thomas Dolby ('The Sole Inhabitant') also contains a highly interesting video demonstration of an arcane synth rig, albeit Thomas's heavily modernised/fake-antiquated current MIDI gigging set-up. Seek it out!

The high-res remasterings of Depeche Mode's early work have highlighted how impactful early 8-track recordings of pioneering analogue synthesis can sound, and the latest version of 'Oxygene' reminds us that JMJ's debut was equally revolutionary. Meanwhile those of us who love this stuff can only remain patient while we await the arrival of Kraftwerk's backpages in similarly flawless digital transfers. Just don't ask the Germans to remake them all JMJ-style or we will all be old and grey before they arrive! **PC**

USHER

www.usheraudio.com

Be there.

THE BERYLLIUM EVOLUTION

With the music

The new Usher Beryllium 718

BE-718

Two-way system

Tweeter: 1.25" (9980-20BEA)

Mid-bass: 7" (8948A)

Sensitivity: 87 dB @ 1 watt / 1m

Nominal impedance: 8 ohms

Frequency response (-3 dB): 42 Hz ~ 35 kHz

Power handling: 80 watts

Crossover frequency: 2.06 kHz

Weight: 14.2 kgs

Dimensions (w x d x h): 25.5 cm x 42.8 cm x 39 cm

USHER AUDIO TECHNOLOGY

7 Kai-fong Street Sec.1 Taipei 100 Taiwan Tel:886-2-2381 6299 Fax:886-2-2371 1053 E-mail: usher@ms11.hinet.net

HIA AUDIO

St Fort Place Wormit Newport on Tay DD6 8NT United Kingdom Tel/Fax:00 44 (0) 845 0 525259 Mob:00 44 (0) 7968 272614
Web: www.hiaaudio.co.uk Email: hugh@hiaaudio.co.uk

Audio & Cinema, Bodmin, Tel: 0870 458 4438.

Hi-Fi Gears Hi-Fi, Cornwall, Tel: 01736 740421.

Classic Hi-Fi, London, Tel: 0208 374 3958.

Wazlemere Audio, Buckinghamshire, Tel: 01494 865 398.

Hi-Fi Sound, Co Durham, Tel: 01325 241888.

Hi-Fi Corner, Edinburgh, Tel: 0131 556 7901

Hi-Fi Corner, Glasgow, Tel: 0141 226 5711.

Oxford Audio Consultants, Oxfordshire Tel: 01865 790879

Rochester Hi-Fi, Kent, Tel: 01634 880037.

Sound Hi-Fi dot com, Devon, Tel: 01803 833366

The Emporium Willow House, Suffolk Tel: 01379 870873

Walrus Systems, London, Tel: 020 7724 7224.



We're not trying to give the most. We're trying to lose the least. That was John Bowers' philosophy 40 years ago, and it lives on in our new 600 Series. Speakers that neither add to, nor take away from, the original sound. That requires world-class science – and extremely experienced ears. Because once we've selected exactly the right components, we begin the long, careful process of tuning. Listening and refining, over and over. Until the frequencies combine to conjure a sound so true, so alive, you want to reach out and touch it. *Dr John Dibb, Senior Development Engineer and Fellow of the Society of Sound, on the new 600 Series.*

Visit the Society of Sound at www.bowers-wilkins.com

B&W Bowers & Wilkins

Listen and you'll see