

# hi-fi

WORLD

APRIL 2004

UK £3.40



**DIY SUPPLEMENT NO.78**  
**INSIDE THIS ISSUE**

## GOING FOR THE ONE...

**Musical Fidelity's stunning new M1**



**THE GREAT DEBATE - DIGITAL vs. ANALOGUE**  
**AUDIO ANALOGUE ARIA PHONOSTAGE**  
**SONY SCD-XA3000ES SACD PLAYER**  
**OL TECHNICS SL1200 ARMBORARD**  
**DECCA LONDON REVISITED**  
**TOP TONEARMS TESTED**



### ROK IT

Roksan's new M Series-1  
integrated meets Anatek A50

APRIL 2004



**COMPUTER AUDIO - ECLIPSE TD307PA MONITOR SPEAKERS**

**MARKET PLACE - 100s OF BARGAIN CLASSIFIEDS INSIDE!**

**COMPETITION - WIN CREEK'S SUPERB CD50/II CD PLAYER**

# Opposites attract they say?

Dali ( DARLEE ) from Denmark

Korato from Serbia

Opus3 from Sweden

Silver Arrow from the UK

Clearcover from the UK

## Road Show

See you at Huntingdon Marriott Hotel  
Cambridgeshire on  
Sunday 7th March 2004



Denmark



'A'

*Audiosolutions*

*Sales & Marketing*

*www.a-audiosolutions.co.uk*

*Sales@a-audiosolutions.co.uk*

*01977 798844*

*Dealer enquiries welcome*

# Welcome!

**CONTACTS: Mon-Fri 9am-5pm**

## EDITOR

David Price  
tel/fax: +44 (0) 1275 371 386  
e-mail: [editorial@hi-fiworld.co.uk](mailto:editorial@hi-fiworld.co.uk)

## DESIGN EDITOR

Faiza Chunara  
tel: +44 (020) 7625 3129  
fax: +44 (020) 7328 1844  
e-mail: [adproduction@hi-fiworld.co.uk](mailto:adproduction@hi-fiworld.co.uk)

## PRODUCTION EDITOR

David Noble  
tel: +44 (020) 7625 3134  
fax: +44 (020) 7328 1844  
e-mail: [classifieds@hi-fiworld.co.uk](mailto:classifieds@hi-fiworld.co.uk)

## WRITERS

Dominic Todd  
LJK Setright  
Albert Lee  
Patrick Cleasby  
Stewart Wennnen

## ADVERTISING

Mike Ballance  
tel: +44 (0) 1908 616 116  
fax: +44 (0) 1908 218 836  
e-mail: [advertising@hi-fiworld.co.uk](mailto:advertising@hi-fiworld.co.uk)

## ACCOUNTS

Sharon Mehlhom  
tel: +44 (0) 20 8841 8892  
fax: +44 (0) 20 8841 9144  
e-mail: [accounts@hi-fiworld.co.uk](mailto:accounts@hi-fiworld.co.uk)

## WORLD AUDIO DESIGN

[www.worldaudiodesign.co.uk](http://www.worldaudiodesign.co.uk)  
tel/fax: +44 (0) 1908 218 836  
e-mail: [info@worldaudiodesign.co.uk](mailto:info@worldaudiodesign.co.uk)

## PUBLISHER

Noel Keywood  
e-mail: [publisher@hi-fiworld.co.uk](mailto:publisher@hi-fiworld.co.uk)

## PRIVATE & TRADE CLASSIFIEDS

tel: +44 (020) 7625 3134  
fax: +44 (020) 7328 1844  
e-mail: [classifieds@hi-fiworld.co.uk](mailto:classifieds@hi-fiworld.co.uk)

## SUBSCRIPTIONS & BACK ISSUES

tel: +44 (0) 1442 879097  
fax: +44 (0) 1442 872279  
e-mail: [hifiworld@websubscribe.co.uk](mailto:hifiworld@websubscribe.co.uk)

### Distributed by

Comag Magazine Marketing,  
Tavistock Road, West Drayton,  
Middlesex UB7 7QE  
Tel: +44 (0) 1895 444 055

### Printed by

Southern Print, Dorset  
Tel: +44 (0) 1202 628 300

### Our Agents in Malaysia

Millennium Hi-Fi & AV  
Simon Chang  
Showroom & office, 500-1-3 First Floor  
Wisma Indah (Shen Court), Jalan Tun Razak  
50400 Kuala Lumpur, Malaysia  
Tel: 603 9283 8171 Fax: 603 9281 3762  
e-mail: [info@millennium-audio.com](mailto:info@millennium-audio.com)

All unsolicited submissions and goods are at the owner's risk. We accept no responsibility for such submissions, nor do we undertake to return them.

No material may be reproduced from this magazine without the publisher's written permission.  
© Audio Publishing Ltd



**david price**

**R**eaders of this magazine are likely to fall into one of two camps. The first is people into using hi-fi that gets them as close to the music as possible. The second is the same, but who also love the rumour, gossip and politics too.

Well, if you're the latter persuasion, then you'll doubtless remember the

1980s - when CD hit the High Street, it was time to wear your audio allegiances on your sleeve. The LP was under siege and if you weren't with vinyl, then you were against it. Indeed, right up to the end of that decade, I frequented specialist dealers who wouldn't even have a CD player in their shop. (The ever-erudite Nigel Pearson - now of Garrard, then of Westwood and Mason hi-fi dealers in Oxford - memorably described digital as, "good for doing the Hoovering to" - his point being it's got a repeat function and when the vacuum cleaner's on, it's noisy enough anyway...)

Twenty years on, and analogue aficionados have won the argument - inasmuch as the new hi-res formats are the material embodiment of what we were saying about CD's poor digital specification all along.

This issue is devoted to getting the best from both formats, and examining the relative merits between the two. To wit, you'll find an in-depth look at Musical Fidelity's epochal M1 turntable on p12, our long-awaited tonearm supertest on p17 and Sony's SCD-XA3000ES SACD spinner reviewed on p34. Then there's a fascinating comparison between Unison Research's tube CD spinner and Pro-ject's ultra-modern RPM9X turntable on p38, a look at the latest Decca London cartridge on p54, and then on p58 four leading audio industry experts join the great debate.

We all love analogue here at Hi-Fi World. But if you're wedded to digital, then we'll happily show you how to get the best from this too. The good news is that there's never been a better time to get into either format. Times have changed, things move on and the war is over.

*David Price*

## how we test the products:

- *Hi-Fi World* has its own advanced test laboratory and acoustically treated listening room.
- *Hi-Fi World* has a dedicated in-house team of experienced listeners. We review thoroughly by extensive auditioning, rather than by quick-fire group listening tests.
- *Hi-Fi World's* engineering team designs a wide range of products in-house. No other hi-fi magazine is so expert and dedicated.

### WORLD VERDICTS:

As a rule we only review products we find interesting, so don't expect too many low scores. Likewise, five globe awards will be few and far between because there's only one superlative product of its type. The £ sign denotes great value for money.

- ● ● ● ● **OUTSTANDING** - Simply the best.
- ● ● ● ● **EXCELLENT** - Extremely capable.
- ● ● ● ● **GOOD** - Worth auditioning.
- ● ● ● ● **MEDIOCRE** - Unremarkable.
- ● ● ● ● **POOR** - Seriously flawed.
- £ **VALUE** - Keenly priced.

**www.hi-fiworld.co.uk**

**HI-FI WORLD**  
SUITE G4, ARGO HOUSE  
KILBURN PARK ROAD  
LONDON, NW6 5LF

# contents

## features

**THE GREAT DEBATE:  
DIGITAL VS.  
ANALOGUE** 58

So which is better, then? Well, it isn't that simple if you believe the four industry experts we invited to opine on the subject. Read the collected works of Peter Comeau (Mission), Tim de Paravicini (EAR), Richard Kelly (dCS) and Mark Baker (Origin Live) here...

## reviews

### analogue special

**MUSICAL FIDELITY M1  
TURNTABLE** 12

It isn't easy to design a class-leading disc spinner from a clean sheet of paper, especially if you've no previous 'form', but Mr Michaelson has done himself proud, says David Price.

**TONARM  
SUPERTEST** 17

It took months to organise and weeks to complete, but at last we can bring you our much-vaunted pick-up arm group test of seven of the best from SME, Linn, Origin Live, Roksan and Hadcock. Hi-Fi World's resident 'tone-meister' Stewart Wennen is the man in charge of bending cantilevers...

**PROJECT RPM9X VS.  
UNISON UNICO 1** 38

A straight fight – the latest £1,000 turntable and CD player face off. One is soft and warm, the other tight and punchy – but all is not what it seems... Dominic Todd investigates.

**DECCA SUPER LONDON  
CARTRIDGE** 54

Stewart Wennen gets into the groove of the latest Decca, but Noel Keyword goes off on an altogether different track...

**ORIGIN LIVE SL1200  
ARMBOARD** 70

A couple of years back, pro audio engineer Stewart Wennen came up with the idea of a high quality armboard that let any Technics SL1200 accept a Rega tonearm. Well, if imitation is the sincerest form of flattery, then Origin Live's Mark Baker was most kind to SW, as he has now productionised it! So we let Stewart, now a regular HFW scribe, return the compliment...

**DIY TURNTABLE  
STAND** 72

Albert Lee wields his hacksaw to show you how to make one of the best sounding turntable supports around, for under £30!

**digital  
SONY SCD-XA3000ES** 34

We were most impressed by Sony's budget price SCD-XB790 SACD spinner a few months back, but can its mid-price bigger brother repeat the formula? David Price listens in...

**amplifiers  
ROKSAN M-INTEGRATED  
VS. ANATEK A50** 50

...In which Roksan's new Class AB integrated meets Anatek's novel Class A design. David Price blows hot and cold about both...

**AUDIO ANALOGUE ARIA  
PHONO** 57

Renaissance man Dominic Todd tries out an exotic Italian phono stage.

**TRICHORD DINO+** 71

Albert Lee listens to the latest power supply option for the leading mid-price phono stage.

**software  
CLASSIC CUTS** 75

This month sees Patrick Cleasby revisiting that seminal early nineties outing from Lee Mavers and co., The La's eponymous debut album.

**SOUND BITES** 11

In which we opine on, variously, an Ikea coffee table, the Crystal Cloud isolation platform and the latest Sony rechargeable batteries...

PAGE 17



PAGE 34



PAGE 39



## computer audio

### ECLIPSE TD307PA NEAR FIELD MONITORS 76

Patrick Cleasby tries out one of the most innovative and charismatic studio mini-monitor packages around.

### THE SOFT PARADE 78

Patrick Cleasby rounds up the latest high resolution multichannel digital music software releases.



PAGE 76

## supplement No 78

### DIY CONTENTS 91

### DIY NEWS 93

All the latest from the weird and wonderful world of Do-It-Yourself hi-fi.

### LED STEREO VU METER KIT 94

Mike Ballance warms up his soldering iron and test kit to try out Maplin's 10 LED Stereo VU meter.

### POLE POSITION 96

Clive Meakins revisits his Williams Hart Phono Stage

### ALL NEW PSU 99

Neville Roberts plugs into the new Origin Live Ultra Turntable Power Supply.

## competition

Win Creek's superb CD50/II CD player in this month's great competition!

PAGE 26



## BUYING GUIDE

[www.hi-fiworld.co.uk](http://www.hi-fiworld.co.uk)

visit our website for a comprehensive list of all the products we have reviewed over the past 11 years

## SUBSCRIPTIONS HOTLINE

+ 44 (0) 1442 879097

Fax Number:

+ 44 (0) 1442 872279

Email address:

[hifiworld@webscribe.co.uk](mailto:hifiworld@webscribe.co.uk)

PAGE 96

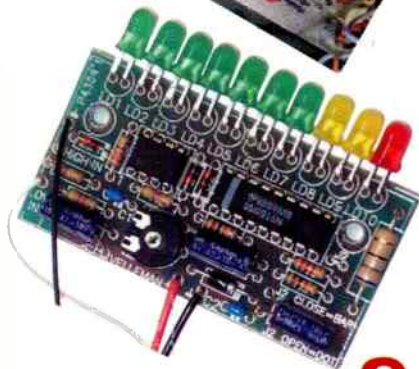

PAGE 94

PAGE 50



## regulars

### NEWS 7

### NEXT ISSUE 9

What's going on in January 2004!

### MAIL 42

The team get to grips with your comments and queries from hi-fi land...

### HI-FI WORLD KITS 64

Solder in one hand, glue in the other, satisfy your creative urges with a World Audio kit!

### HI-FI WORLD LIBRARY 68

A comprehensive selection of titles covering audio, valve amplifiers, loudspeakers, solid state electronics and more.

### SUBSCRIPTIONS & BACK ISSUES 74

Spare yourself the frenzied riot as you struggle with the hordes to claim the last copy of *Hi-Fi World* in the newsagent - Subscribe today!

### COLUMNS 81,83,87,89

Words from the front, from the team...

### DIAL-A-DEALER 84

Look before you leap, or alternatively listen before you buy. These are the people to talk to.

### SPECIALIST HI-FI DEALERS 86

The perfect mix - excellent coffee, a comfortable sofa, and someone who really knows how to guide you through the world of hi-fi.

### MEET YOUR MAKER 88

Not a call to the spiritual, but a list of manufacturers detailing who makes what, and how to get in touch.

### MARKETPLACE 103

### CLASSIFIEDS 117

The definitive place to find classic audio components.

### ADVERTISERS INDEX 129

### OLDE WORLDE 130

Dominic Todd fondly remembers Manticore's superb mid-eighties mid-price turntable spinner, the Mantra...



LINN

Developed for the music lover and cinema enthusiast who wants to seek out the most accurate and involving sound.

The AKURATE loudspeaker system has four distinct, acoustically matched loudspeakers. Three full range and one for bass reinforcement. They can be simply configured to comprise pitch-accurate, multi-channel sound systems for high performance music and cinema.

Featuring the unique 3-K Driver Array – a Linn designed driver configuration that creates a single point acoustic source independent of cabinet type. Any combination of loudspeakers with this technology achieve a perfectly balanced accurate result.

Designed to stand the test of time, Linn AKURATE loudspeakers are built to take advantage of new high-definition sound and vision formats.

**accurate *adj.* faithfully representing the truth; precise.**

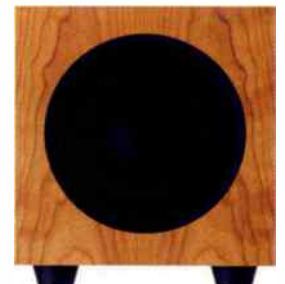
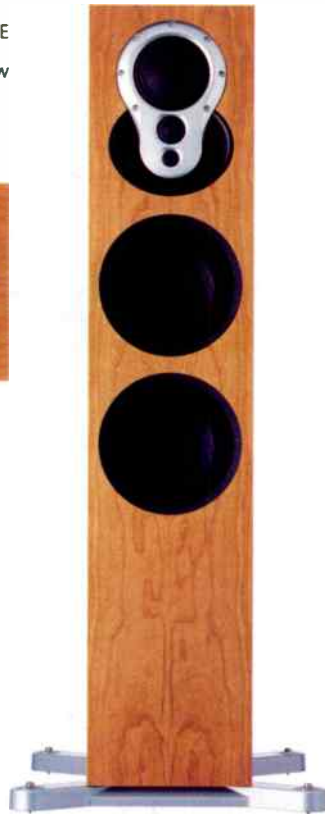

## The new Akurate Loudspeaker System. True.

Linn Products Limited.

For more information or a demonstration call 0500 888 909  
or email [helpline@linn.co.uk](mailto:helpline@linn.co.uk)

[www.linn.co.uk](http://www.linn.co.uk)

email: [news@hi-fiworld.co.uk](mailto:news@hi-fiworld.co.uk)

# news

## MEET ELEGANTE...

Mission has a new range of high end multichannel loudspeaker systems. The elegante's styling has been strongly influenced by Mission's flagship Pilastro, with luxurious Grania cabinets claimed to optimise sound dispersion. All speakers feature a seven-layer highly polished, hand-lacquered anthracite finish with black cloth grilles. Three elegante systems are available, in 5.1 and 6.1-channel home theatre configurations, with a simple option to upgrade to 7.1-channel. The e80 system is the smallest system, consisting of four bookshelf e80 loudspeakers, an e8c centre-channel and a compact e8as1 subwoofer. Price is £2,490 for a 5.1 system and £2,790 for a 6.1 system. The e82 is for medium to large-sized rooms, consisting of two slimline e82 floor-standing loudspeakers, two bookshelf e80 loudspeakers, and an e8c centre-channel, plus the e8as1 compact subwoofer. Prices are £3,490 for a 5.1 system and £3,790 for a 6.1 system. The largest e83 system has two e83 floor-standing loudspeakers, two e81 bookshelf loudspeakers, an e8c centre channel and a 500W e8as2 subwoofer that features four Pilastro-type 8" bass drivers. The price had not been confirmed at the time of going to press. For more details, call 01480 423700 or click on [www.mission.co.uk](http://www.mission.co.uk).

## RAY OF LIGHT

ColdRay Isolation Feet are the brainchild of Lars Kristiansen, designer of the acclaimed Nordost Pulsar Points, and extend his design using either a steel or ceramic ball held in a small cup over which a turned aluminium cone is placed.

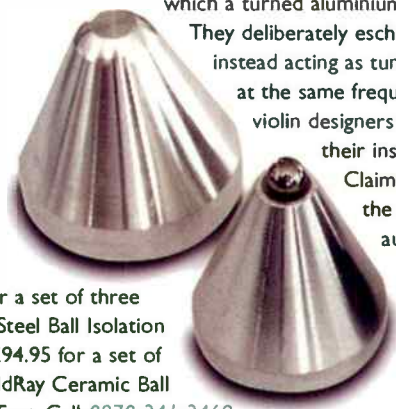

They deliberately eschew damping, instead acting as tuned resonators at the same frequencies that violin designers look for in their instruments. Claimed to increase the contrast in an audio system, they cost

£49.95 for a set of three ColdRay Steel Ball Isolation Feet, or £94.95 for a set of three ColdRay Ceramic Ball Isolation Feet. Call 0870 241 2469 or click on [www.hififorsale.com](http://www.hififorsale.com) for more details.

## HI, RESOLUTION!

Christchurch-based Resolution loudspeakers has a new transmission line design intriguingly entitled, 'Resolution'. Claimed to sound, "purer than science can measure" no less, it has high-quality 26kg enclosures with finishes in mahogany and gold plating. A patented single tri-axial drive unit is featured, claimed to use very rigid metallised diaphragms and powerful magnets, supported by an 8 foot sound-absorbent pipe, folded up inside. Price is £1,200 per pair. The company's unprepossessingly named website, [www.resolution-loudspeakers.co.uk](http://www.resolution-loudspeakers.co.uk), has full details – or you can call direct on 01202 470184.



## BACK IN BLACK

Black Rhodium's Super Mains Power Management block has an extruded case and an advanced 2-stage high frequency filter for greater attenuation of high frequency noise and a clearer sound. It sports eight 13A mains sockets, and is terminated with 2m of Super Mains 25 high current, low impedance mains cable, made from 19-core stranded wire of 0.45mm diameter silver-plated copper and is insulated to a very high voltage with silicone rubber. The internal wiring within Power Management is of the same high quality silver-plated wires insulated in silicone rubber that are used in Super Mains 25. Additional protection against excess voltages is provided a Voltage Dependant Resistor that clamps the supply voltage to a predetermined level, making the unit very suitable for use with computers as well as with hi-fi equipment using sensitive digital electronic circuitry. Price is £330. For more information on Black Rhodium, call 01332 361390 or click on [www.blackrhodium.co.uk](http://www.blackrhodium.co.uk)





## INSTANT REPLAY

KEF Audio has announced its new KEF Instant Theatre (KIT), a new complete DVD-based system with everything required to experience 5.1 digital surround sound from just two compact front speakers and a hide-away subwoofer. Its fascinating speakers are hybrids of KEF's proven Uni-Q® 'point source' driver array with a unique new application of NXT® flat panel technology. The vertical NXT flat panels behind the main arrays create virtual rear effects speakers, while the Uni-Q drivers create a perfect 'phantom' centre speaker right in the middle of the screen. The acoustic illusion of all three virtual speakers, rear and centre is accentuated by the Uni-Q driver front-channel configuration, which spreads the sound image over a much larger area than the narrow 'sweet spot' of a conventional speaker. Hefty bass punch comes from a 250 mm (10") bass driver, and the subwoofer contains the system's five high-power amplifiers, allowing the DVD player to be exceptionally compact.

The head unit is about the same size as the front speakers, and styled to match. Whatever is played - DVDs, CDs or MP3s, it automatically recognises what's been loaded. The decoding circuits also give the full benefit of Dolby® Digital, Dolby Pro Logic® II and DTS surround sound from any other equipment played through the system. With clear VFD displays and intuitive controls, the unit also

has an AM/FM radio with RDS, alarm and sleep functions. With built-in amplifiers for all channels alongside the 250 mm (10") bass driver, the omni-directional subwoofer can be placed wherever it suits the user - behind the TV or next to a wall. KEF instant theatre recognises whatever type of disc is loaded and automatically configures the system accordingly. Complete with a full-function remote control, expect to pay around £1,200. Call KEF on 01622 672261 or click on [www.kef.com](http://www.kef.com) for details.

## PRETTY AS A PORSCHE

LaCie has got seriously stylish. After years of distinctively styled - if a little wide-of-the-mark - computer peripherals, it has contracted the services of Porsche Design GmbH for its latest range. The result is a range of deliciously crisply styled bits of kit spanning a complete line of hard drives, ranging in capacity from 40GB to 250GB for PC or Mac via USB 2.0 or FireWire, plus CD-RW and DVD±RW drives, featuring a mirrored door that opens. For further information, click on [www.lacie.com](http://www.lacie.com).

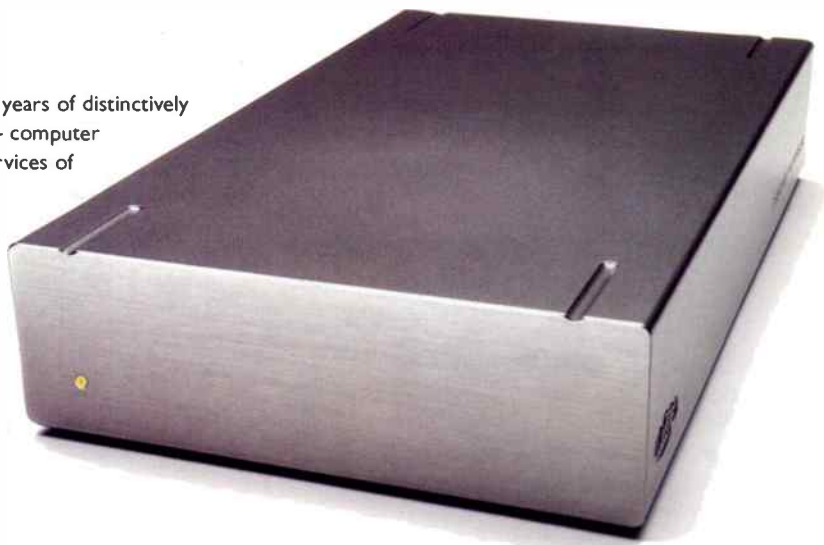

## CORRECTION:

The price of the MEL AUDIO RECHAV II CD player reviewed in February 2004's edition is Euros 2,980 £2,091 (Sterling).

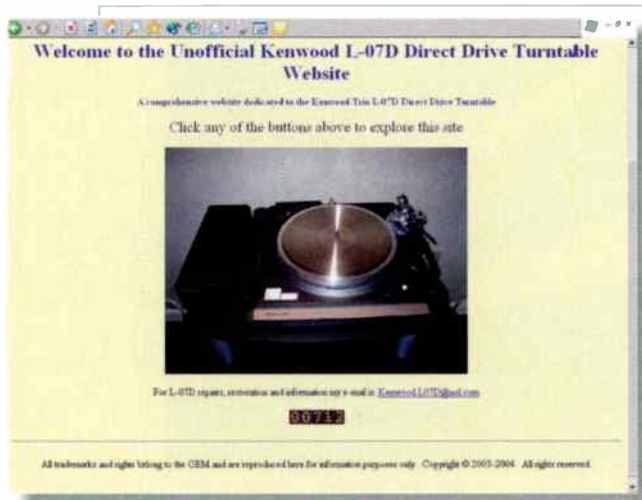

## WEBWATCH

Aficionados of what many consider to be the very best Japanese turntable ever made - the Trio L-07D - will find this site a 'compulsive click'. Created by a US-based fan, it makes for interesting reading for both the technically and non-technically minded alike. Anoraks will be delighted to hear that at CES in January, an L-07D was spotted in action on the Hovland stand - not bad for a deck that first surfaced nearly twenty five years ago! [www.L-07d.com](http://www.L-07d.com)

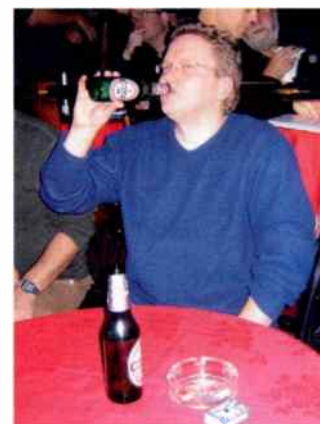

## GOTCHA!

Spotted - *Hi-Fi World's* very own high res digital guru Patrick Cleasby, at Ronnie Scott's in early January. "Tired and emotional" after listening to all those freebie discs, PC can be seen unwinding like a spool of Ampex...



## GOING DUTCH

Philips is calling itself 'the first major CE brand to launch a portable DAB radio'. The £149 DA1000 is the first portable Digital Radio from the Dutch electronics giant. Weighing in at just 100g, its sleek design incorporates a backlight for clearer viewing, and a joystick for simple control. The dot matrix LC display shows the text that accompanies most DAB broadcasts, including programme information, the latest news and sports scores. Six EQ settings and a built-in FM radio also feature, complete with signal strength indicator and 20 DAB/ FM presets. The DA1000 is powered by two rechargeable AA batteries that offer up to ten hours of playback, or AC mains. A carry pouch is provided for comfortable portability.



Philips also has a new music jukebox to compete with the iPod mini. The £169 HDD060 has a 1.5GB hard disk drive that stores up to 375 MP3 or 750 WMA tracks and can also be used to transport data files. The single lithium ion battery is claimed to give ten hours of listening time between charges, and a large display presents information clearly, even in bright conditions, thanks to a white LED backlight. Music file transfer is done using a single, high-speed USB 1.1 connection. The HDD060 weighs less than 95g thanks to its die-cast moulded magnesium body. For more information, call 0870 900 9070 or click on [www.philips.com](http://www.philips.com).



## FUTURE SOUND OF IRELAND

Digital Theater Systems, Inc. has announced a major research collaboration with Queen's University Belfast's Sonic Arts Research Centre (SARC). Jointly funded by Invest NI, a development agency in Northern Ireland, the project will focus on the development of new multi-channel audio technologies. SARC will conduct joint research and experimentation with DTS' Research & Development facility based in Bangor, Northern Ireland. "SARC is quickly becoming one of the world's leading research institutes in the area of multi-channel audio systems, and DTS has always been a company dedicated to developing new audio technologies," said Paul Smith, Vice President, Research & Development for DTS. "Working together is a natural fit, and we look forward to integrating our resources for this project." Dedicated to the research of music technology, SARC is a newly established facility within Queen's University Belfast. Uniting internationally recognized experts in the fields of music, electronic engineering and computer science, this unique interdisciplinary centre features a 20-person research team and a state-of-the-art sonic laboratory. This auditorium is a highly innovative structure allowing sound to be moved throughout the space, and is the only fully 3D studio of its kind for sonic art performance and experimentation.



## SILVER SERVICE

It seems the old days of gunmetal grey NADs have gone for ever, as the company is introducing more 'silver' Titanium finished systems. Latest off the production line is the highly acclaimed £329.95 C542 CD player, which can now match the excellent £349.95 NAD C352 integrated amplifier, also now available in the new livery. The latter also includes some circuit refinements over the original, specifically an improved DC servo circuit, claimed to tighten the amplifier's bass response. For more details, click on [www.nad.co.uk](http://www.nad.co.uk)



## next issue

Which is better - tube or transistor? It's a leading question, and one that May's issue seeks to answer! You'll find it packed with goodies from both sides of the fence, plus:

### MUSICAL FIDELITY X-150

At last, Mr Michaelson's new £800 Cyrus beater?

### ORTOFON KONTRAPUNKT C

'Pick up a bargain', or 'phono no go'?

### SONY SCD-XA9000ES

A brand new SACD spinner to beat the best?

### VIENNA SCHOENBERG

A magnificent pair of £1,500 floor-standers for your pleasure?

## next issue

LC Audio Technology  
**P r e d a t o r**

The Amplifier from the future!



New Technology On Test World Wide!

2 ch. Amplifier based on ZAPulse SE Technology. 2x200 Watts in 8 Ohms / 2x400 Watts in 4 Ohms RMS power at 44 mm enclosure Height. RCA and XLR inputs, WBT terminals, Function Bay, NO Heat dissipation, NO fans, Max 600 Watts/ch. in 2 Ohms cont. power! £1099

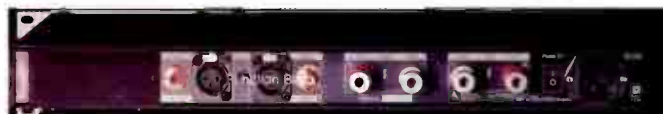

19" Rack Brackets are optional.  
 Blue Backlight is optional.  
 Environment Friendly Technology:  
 Idle Power Consumption 20 Watts

Electrostatic Speakers   
 Low Impedance Speakers   
 High Resolution Speakers

LC Audio Technology Ltd. Christiansgade 1 DK 7500 Holstebro Denmark tel. 0045 974 10863  
 Distributor Network see: [www.lcaudio.co.uk](http://www.lcaudio.co.uk)

# do you really listen to music?

does your system let you:

- discern the difference between CD and LP replay?
- differentiate between transistor and valve amplifiers?
- distinguish between Joshua Bell's and Itzak Perleman's playing?
- determine the sound of a Bosendorfer grand from that of a Brinsmead?

...if it doesn't, you need  
**Beauhorn speakers**

so, why not treat yourself  
 to an audition?

**Beauhorn™**



website: [www.beuhorn.com](http://www.beuhorn.com) e-mail: [info@beuhorn.com](mailto:info@beuhorn.com) Hastings TN35 4NB England Telephone: +44 (0)1424 8113888

## CRYSTAL CLOUD ISOFLOAT

A four layer isolation platform measuring 450x350x29mm, the top plate is machined from cast acrylic and supported by four compliant elastomer mountings. This is supported by a solid medium density fibre plinth mechanically grounded by four feet with very low surface contact area. It's a modular design, and platforms can be stacked on top of each other to reduce vibration further and improve isolation bandwidth. Maximum load per platform is 20 kg. It works; there's an obvious cleaning up of the sound,



making transients faster with less overhang, wider and deeper soundstaging and there's even a perceptible smoothing of the sound – it seems more natural and less edgy. At £120 it's a good deal more expensive than our fave

budget buy, the Base SP01, but it really does offer an extra degree of insight. Clever stuff from a small independent British company – call them on 01702 302712 or click on [www.crystalcloud.demon.co.uk](http://www.crystalcloud.demon.co.uk) for details.

## IKEA LACK COFFEE TABLE

The princely sum of £19.95 buys you this 95x55x45cm bit of clear lacquered, birch veneered MDF. It looks very neat (far better than the price suggests), has very crisp and clean proportions and best of all, sounds great – particularly when used in conjunction with the Crystal Cloud Isofloat. No matter what you put on it – turntable, CD player, DVD machine, you'll find it a relatively neutral and benign support. You will of course get better results with bespoke hi-fi furniture, but then you'll pay hundreds of pounds more... Check out [www.ikea.co.uk](http://www.ikea.co.uk)



## SONY RECHARGEABLE BATTERIES

The problem with rechargeable batteries is that most available in the High Street aren't of the best quality. Sony's NHAAB2C AA batteries are – they're premium priced, but we've found they last nearly five times longer than standard alkalines, and can be recharged 500 times over. The snappily entitled Super Quick Refresher Charger (model: BCG34HRC4-UK) gets the best from them, thanks to its clever 'discharge' function. At the touch of a button, it gradually drains the batteries down to empty before



recharging them, thus countering the memory effect. It charges fast, too, reinvigorating 4 AA or AAA batteries (NiMH 2100 mAh) in just a few hours. Factor in the safety timer, voltage regulator, temperature

monitoring function and automatic shutdown (should non-compatible batteries be loaded), and this is a clever bit of kit. For more information, click on [www.sony.co.uk](http://www.sony.co.uk)

# Going For

Time was, in the late eighties, when many hi-fi journalists found themselves – upon reviewing a new record player – writing things like, "this could be the last turntable ever made". How wrong they were. When a company like Musical Fidelity, with hitherto no immediate association with black vinyl, makes such a resounding commitment to analogue, you just know there's something in the air. David Price goes for a spin...

**M**usical Fidelity is not famous for its turntables, because – ermm – it's never made any before. Of course, Mr Michaelson is quick to point out that he and his are avowed analogue aficionados, and he is right so to do. (MF has always used vinyl and open reel tape among its source references, and has consistently designed products with serious phono stages, as opposed to token gestures.) Still, unlike Michell Engineering or Clearaudio, the company has not forged its success from any direct association with the black stuff.

To wit, it would be perfectly sensible – given the marque's enduring edge with CD spinners and amplification – to not venture into the viper's den of vinyl. Let's face it, manufacturing consistently successful audio electronics is one thing, but designing and producing top turntables is another. They're an altogether different problematic – that of mechanical engineering down to minute tolerances. I'm not saying there's anything about MF that makes the company unsuited to this (quite the reverse in fact), it's just that if you think you can waltz into the world of high end vinyl with no previous experience, then you're mad as a fish...

Let us consider the evidence. A turntable has to revolve at precisely 33.33RPM. It has to isolate the record, arm and cartridge from as much external vibration as possible, while locking the internal vibrations (i.e. the

groove modulations) in as tightly as possible. Oh, and it has to look good, because no one's going to lavish £3,000 on something that looks like an old Dual 505...

To fulfil the aforementioned design briefs, it has to be [a] intelligently and creatively designed with no weaknesses and [b] manufactured using expensive materials like acrylic, carbon fibre and/or aluminium, and [c] made to exacting tolerances that require meticulous machining and quality control. All of this is flipping expensive, and makes CD player manufacture look like a stroll down the street. That's why I think Musical Fidelity's decision to 'get into the groove', so to speak, is bold and/or foolish.

Well, Michaelson has his reasons. He, like many of us, has sensed something of a vinyl revival in the past decade (yes, really!) and points out that, "Despite huge pressure, the analogue market has survived and prospered. Witness the fact that, in the last three or four years, new analogue vinyl releases outnumber equivalent SACD or DVD-A launches. The big boys in the industry may want one thing, but the consumers want something else... the market's tectonic plates are moving". Enter MF.

## THE DESIGN

First things first, and the MF is not a conventional Linn/Thorens-style enclosed subchassis, 'plinthed' design, but close in spirit to SME's Model 30 – with the chassis sitting on a double, decoupled acrylic (nee Perspex) base. Acrylic is brilliantly suited to turntable (and indeed all anti-microphonic) applications because of its very low natural resonance, and MF has taken the idea further by giving each chassis



# The One?



plate a different mass, thereby putting their natural resonance points at different frequencies. The double pole isolation system between both chassis plates is both vertically and horizontally compliant thanks to rubber suspension, also with a very low natural resonant frequency.

As for the bearing, MF says it has spent time researching the best way to get an extremely low noise high performance long-life unit, the result being an inverted type manufactured from milspec high carbon steel ground to better than 5 micron tolerance with a 0.1 micron surface finish. At the top of the shaft is a high quality ball bearing in milspec high carbon steel, machined to a spherical accuracy of better than 2 microns. The surface finish is better than 0.1 microns. The outer shell is made from high tensile stainless steel with a milspec brass insert which has a tightly toleranced lubrication spiral. The contact point between the outside shell and bearing is an extremely closely toleranced PTFE pad.

Speed stability is achieved by an impulseless DC motor (what MF calls, "the most expensive brushless (DC) motor available" no less), with accuracy controlled by an optical sensor mounted on the motor which continually monitors the shaft speed. This is fed into a 16bit microprocessor running a 'fuzzy logic' algorithm to control the DC drive voltage. MF claims this guarantees speed accuracy within 0.2%, with excellent longer-term speed accuracy. Interestingly, there's a rotary pitch control fitted giving a semitone (i.e. 6%) of adjustment, with a centre detent to indicate precise speed. As is common practice these days, the power supply is in a separately shielded box, along with the electronics which drive the motor.

And so to the brand new SME

M2-9 tonearm that comes fitted to the M1. Now firstly, let me say that the Musical Fidelity is an 'integrated turntable system', inasmuch as it is not going to be sold as a 'motor unit' without tonearm in the way that Michells, Origin Lives, Linns, etc., are. Antony Michaelson is emphatic about this – he sees the M1 as a package for those who want to play music rather than spend their waking hours wielding Allen bolts, alignment protractors, drills and the like as they bolt and unbolt various arms. As such, the M2 is the ideal companion. This £582 arm has already been spotted on a T+A turntable, so it's not exclusive to the M1, but it seems the ideal – almost the natural - partner.

Put crudely, it's an updated 3009S2. It has a straight, internally damped stainless steel/alloy arm tube

#### NOTES:

- the M1 is relatively easy to set up, but screwing the M2's self tapping arm screws into the M1 armbase is a chore
- the pitch and speed knobs, previously seen on MF's X-CANS v1, are a tad fiddly and don't look the part
- the M1 comes with a beautiful little spirit level and even a soft dustcover sheet
- the height adjustable pillars can prevent the belt sitting in the belt groove cut around the edge of the platter; an annoying foible
- the M2 arm is an excellent performer at the price, with a beautiful liquid sound, but is no Series 309, IV or V

# EXPERIENCE THE CHORD EFFECT!

The first time you hear your sound system with Chord interconnecting cables will be the first time you've **really heard** it.

Be warned - the effect can be shattering.

Your eyes and ears will be opened. Your music will never sound the same again.

Specify Chord cables - Hear the light!

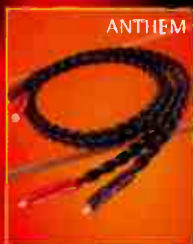
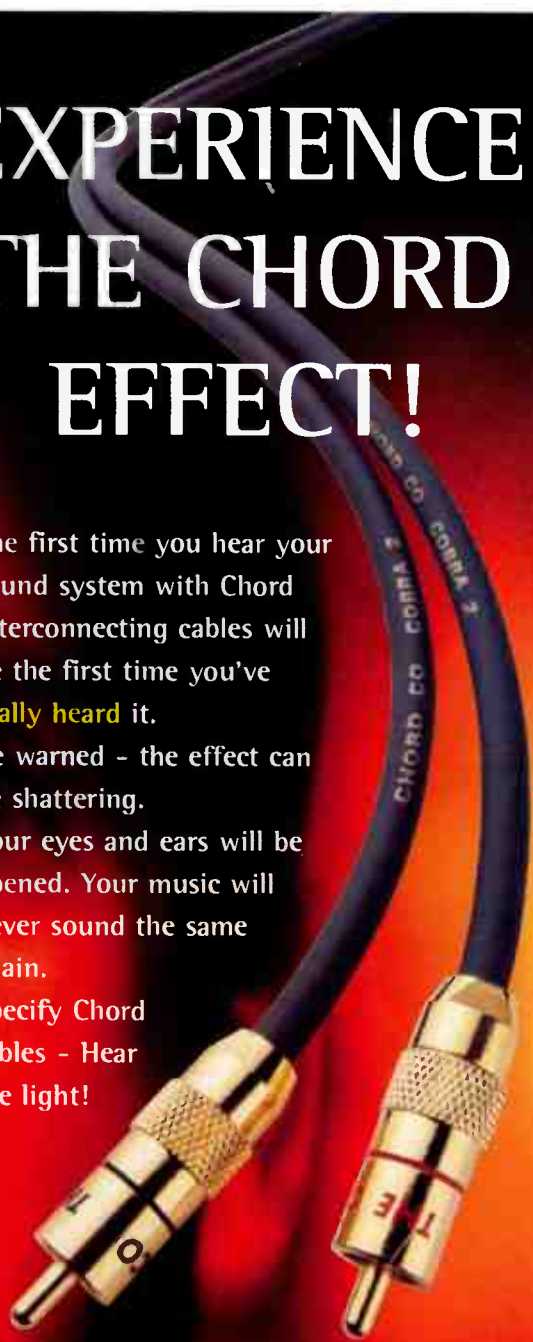

ANTHEM



RUMOUR 4

WHAT HI-FI?  
★★★★★  
July 01



CHAMELEON 2

WHAT HI-FI?  
★★★★★  
March 01



SILVER S VIDEO

THE  
**CHORD**<sup>TM</sup>  
COMPANY

MOVING SOUND & VISION

FOR SALES AND INFORMATION  
CALL: 01980 625700 FAX: 01980 625070  
E-MAIL: CHORD@CHORD.CO.UK  
OR VISIT US AT WWW.CHORD.CO.UK

We find that adding super-tweeters and sub-woofers to systems brings amazing improvements – in the *critical mid-range...*

## Highs

– and lows

You might reasonably say “What’s the point in a super-tweeter going up to 50kHz when I can barely hear 15kHz? Waste of money.”

A lot of people also say to us they don’t like or need deep bass, so what’s the point of a subwoofer?

And yet *another* thing: many sub-woofers add more boom than bass! So are we on a complete loser?!

Like absolutely **EVERYTHING** in audio, it depends **HOW** you do it.

Recordings contain frequencies – **HARMONICS** – that extend above and below our normal hearing range. If we reproduce these harmonics **CLEANLY**, music in the audible range becomes fuller, richer, more coherent and more **PRESENT**.

For the treble we use the **TOWNSHEND** ribbon super-tweeters, adjustable to match the main speaker sensitivity. They are simply placed on top of the speaker cabinet and plugged into its terminals. With them in place music is more real, has more **LIFE**.

Very low frequencies easily excite rooms to **BOOM**, so control of the bottom end of the range is crucial.

**AUDIO PHYSIC** Luna and Minos subs can be matched to the room, eliminating boom – *even from the main speakers*. Free, extended bass is revealed plus greater richness and ambience **IN THE MID-RANGE**.

Customers say we make some of the **BEST SOUNDS** they have ever heard, so you know we can do the same in your home. Our advice will take account of your best components and guide you where change is needed, in stages you can afford.

You **AVOID EXPENSIVE MISTAKES**, enjoy music along the way and save money in the long run.

### JUST LISTEN AND YOU’LL KNOW

**CD:** ACCUPHASE, AUDIO SYNTHESIS, Bel Canto, dCS (ELGAR, DELIUS PURCELL, VERDI), SUGDEN, WADIA. **VINYL:** BASIS, CLEARAUDIO, CROWN JEWEL, DNM, GRAHAM, THE GROOVE, LEHMANN, MICHELL, SUMIKO BLUE POINT SPECIAL, TRANSFIGURATION.

**AMPLIFIERS:** ACCUPHASE, ADVANTAGE, BEL CANTO, CAT, DNM, GAMUT, HOVLAND, NAGRA, SONNETEER, SPECTRAL, SUGDEN. **LOUDSPEAKERS:** AUDIO PHYSIC, BKS,

ETHOS, NEAT, TOTEM, VERITY AUDIO. **TUNERS:** MAGNUM DYNALAB. **CABLES:** ARGENTO, CHORD Co., DNM, NORDOST, SILTECH, VERTEXAQ, YAMAMURA CHURCHILL ETC. **SUPPORTS:** ARCICI, VERTEXAQ, STANDS UNIQUE

The  
Right  
Note

*Music in the home*

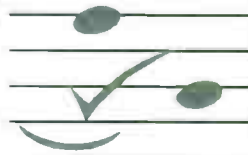

BATH

01225 874728

with a new, detachable, angled headshell. Interestingly then, it's not the ubiquitous 'SME headshell' that every Japanese arm of the 1970s (Acos Lustre, Audio Technica AT1010) seemed to use. The machined bearing housing looks pretty familiar to vintage SME watchers, but with height adjustable via a thumbwheel mounted at the ambase, and tracking force set by a calibrated counterbalance weight. The 'weight and pulley' bias compensation system is retained (with 0.25g increments) – some commentators, such as Hi-Fi World's own analogue anorak Stewart Wennen believe this to be the most sonically desirable choice (as well as being the cheapest), although it looks crude. Lift/lower height is adjustable, as is azimuth (SME Series 3-style, at the headshell).

The M1 has an incredible feeling of solidity and engineering excellence. The motor, the bearing, the plinth/suspension isolation system are all spot on. The SME M2-9 is also excellent – finish is up to the company's usual superlative standards, and the arm is a model of user-friendliness and adjustability – it's a sort of 'Series III without SME's moment of 'ultra low mass' madness. By only criticism is the poor quality cartridge mounting hardware supplied – decent stuff is available from the SME parts list, but should have come as standard.

**SOUND QUALITY**

Out of the box, fitted with the bundled SME M2-9 tonearm, the M1 sounds beautiful. Until the M1, Antony Michaelson used a Thorens TD124/SME 3009S2 in his own personal system, and it's spooky that the M1 sounds very much in the same vein, except with vastly superior transients, detailing and transparency – think of it as a twenty first century TD124.

If you've not heard this Thorens classic, then let me elucidate. Some ten years ago, we put a Loricraft rebuilt TD124 against a Loricraft rebuilt Garrard 301 with fascinating results. The Garrard was all power, muscle, punch, push, drive, guts. The Thorens seemed to be lacking the Garrard's bottom octave of bass, but in other respects had the legs on its classic rival – it was deliciously open, smooth, even, transparent, fluid, beguiling, unassuming and ultimately more charming. It was less hi-fi and more music. This also sums up the Musical Fidelity M1.

Of course, the M1 improves on the TD124 dramatically in all those 'hi-fi' areas of soundstaging, image articulation, low level detail, atmosphere, dynamics, yet its

character – if it has one at all – is very much along the same lines. Simply put, it's self-effacingly musical. It's not a 'character turntable' in the way that the LP12 is, or indeed the GyroDec (for very different reasons, I hasten to add!) You put a record on, and listen to the music. You're not struck by 'that old Linn magic', or 'that amazing GyroDec articulation' – rather, your attention is drawn to what you're listening to – the music. It's that Thorens all over again.

First I put the M1 against my own Michell GyroDec/SME IV. I heard a superior turntable with an inferior tonearm. In a sense, this is stating the bleeding obvious (considering the relative prices), but it's rarely this blatant. The M1 seems even more speed stable, which is saying something against the very 'solid' DC motor-aspired Gyro. This was apparent on two levels; first, that ever-so-slight (and I mean slight) wobble that the Gyro has (but which, trainspotters, the Orbe hasn't) on piano isn't there on the M1. Second, and this is more significant, the Gyro's faintly mechanical approach to making music, is lacking, and in its place, a natural, ebbing, flowing wash of music. The M1 has speed stability approaching that of the very best classic Japanese quartz-lock Direct Drives (Nakamichi Dragon, Sony TTS-8000) or telephone-number price tag Clearaudios or EMTs.

Of course, the Gyro beat the heck out of the M1 in terms of transparency, dynamics, soundstaging etc., but how much of this was down to the SME IV? Well, what followed was several days of yours truly slavishly bolting and unbolting SME arms from variously my GyroDec, my Orbe and the M1. Oh, and then there was the cartridges – I ran the gamut from Shure V15VxMR to the new Ortofon Kontrapunkt C (more of which next month). And to cut a long story short (as someone once said)....

The SME M2-9 is lovely - a direct price rival to the Origin Live Silver, you get a very smooth, lucid, lyrical sound that makes the OL sound fussy and pedantic. But then again, the OL has better grip and insight. (It's almost like a re-run of a A-B I once did of the boggo RB300 vs. SME 3009S2). Suffice to say, the SME is no slouch and is in some respects more musical – certainly in the midband (and that, folks, is why until recently the 3009S2 still sold new – it wasn't as bad by half as many said!). Anyway, it's no SME IV either. The IV (and V) bring masses of grip and attack to frequency extremes (especially the bass), plus better dimensionality and stunning detail and

**REFERENCE SYSTEM:**

- Michell Orbe/Origin Live Illustrious turntable
- Michell GyroDec/SME Series IV turntable
- Ortofon Kontrapunkt C, Dynavector DV20X-H,
- Shure V15VxMR cartridges
- Trichord Delphini NC phono stage
- MF Audio Passive Preamp
- Quad 909 Power amp
- Quad 989 loudspeakers
- Townshend Maximum Supertweeters

transient attack. Then again, there's really something rather beguiling about that M2-9 midband, almost more so than the 309, IV and V... but that's another story.

Back to the M1, and starting from bottom to top, it's lighter and faster than both Michells, lacking their vast, breathtaking scale and power - but it has less overhang too, making things sound just a tad faster. Moving up to the midband, and it's even-Stevens with the Orbe. I think the M1 is just a touch more lyrical lucid – it has that 'naturalness' that makes everything seem like an effortless flow of music, whereas the Michell is more about scale and image articulation, desperately trying (and succeeding) to convey the last detail of the recording (including stuff which frankly, you don't want or need to hear). The MF has capacious left to right imaging, but doesn't seem to run the recorded acoustic quite as far back behind the speakers as the Orbe. The treble on both decks is superb, open, even, smooth, neutral – enough said.

The quintessence of the M1 is that light, airy, spacious soundstaging and flowing, fluid, liquid musicality. The Orbe is more 'technical', more concerned with forensic detailing – it's Fisher Dieskau to the M1's Frank Sinatra. That's high end turntables – you choose your poison! The point is that the M1 is absolutely and incontrovertibly superb – it gives nothing away to the best of the big hitters at (or indeed above) its price point, and – here's its killer punch – it's a 'plug and play' deck-and-arm package, that requires merely the addition of a decent cartridge to start delivering the goods. It's a viceless, no-holds-barred enthusiast's high end deck, but ready to go with a lovely tonearm and even a pitch control – and it's one of the sexiest turntables ever made too. If you think about it, Antony Michaelson has made his reputation delivering super-fi at merely high end prices, and the M1 continues the theme. Although he's never done a deck before, with the M1 Musical Fidelity has hit the ground running.

**VERDICT** 

Superbly open, lucid and musical sound allied to beautiful build and an excellent bundled arm makes this the turntable package to beat.

**MUSICAL FIDELITY M1 £2,999**

**MUSICAL FIDELITY**

☎ +44 (0) 20 8900 2866

[www.musicalfidelity.co.uk](http://www.musicalfidelity.co.uk)

# Walrus Systems

11 New Quebec St, London W1

tel: 020 7724 7224

fax: 020 7724 4347

email: mail@walrus.co.uk

web: www.walrus.co.uk



Amplifon WL25 (left): 28W/channel using 6P3, £795  
 Amplifon WT40 (centre): 40W/channel using 6C33, £1995  
 Amplifon WT30 II (right): 31W/channel using 6H13, £1395

Amplifon is new to the UK, and you will be hearing a lot more about them! These exceptional value for money amplifiers, designed and manufactured in Poland, put to shame more expensive opposition in sound quality, build, and finish. All three models have automatic biasing, so there's no fuss when it's time to change tubes, they all feature heavy toroidal output transformers with a wide bandwidth and 4 and 8 Ohm taps, and the WT30 II and WT40 operate in Triode mode Push Pull, Class A.

They have classic valve amp attributes, sounding sweet and natural, but with enough power in reserve to rock when required!



The Trichord Dino (£299) outsells every other phono stage. Why? It sounds clean and clear, it's fully adjustable to virtually any MM or MC pickup, and when you fancy an upgrade, the Dino+ add-on power supply fits the bill, for an extra £225 (or buy them together from the start for £498).

If you prefer, the Tom Evans Microgroove (£450), suitable for MC pickups, is a worthy alternative, giving a level of detail retrieval difficult to better unless you spend an awful lot more. The Microgroove Plus (pictured above) at £800 is even better, and the famous Groove (£1900), below, has been described in various reviews as being state-of-the-art of phono stages. Like all products of it's standing, don't expect to walk away with one - it needs to be configured by the manufacturer for your particular pickup!



Cawsey (top) may not be the best known cable (others spend more on advertising) but it's quite possibly the best sounding. We have been selling these Australian made silver interconnects for several years and can recommend them without reservation. From £250 to £900 per metre set.



**Slinkylinks**

Slinkylinks (bottom) are solid silver air dielectric cables with the latest bullet plugs, fantastic sound at an amazingly low price: £195 for a 1.2m set!



The Michell Gyro SE (£895 + arm) remains one of the most successful turntables of all times, and for good reason. Sound is fast, neutral, and open. You have an upgrade route via the HR power supply, and the Orbe platter kit. Popular arms include the Regas, the Tecnoarm, the Origin Live Silver, and of course, the SME.

Compare the Gyro to the Spacedeck and the new Roksan Radius in our studio.



Duevel loudspeakers with their unique reflector system may look strange at first sight - don't let this worry you! Just put on your favourite recording, close your eyes, and enter the amazing three dimensional soundstage these omnidirectional radiators recreate. Starting from £1960/ pair for the Venus.



air tangent amazon amphion amplifon apollo furniture argento audible illusions audio physic audiovalve breuer dynamic brinkmann cabasse cartridge man cawsey chord electronics clearaudio clearcover consonance decca london dnm duevel dynavector ear yoshino ecosse final lab graham slee hadcock heart incognito infinity isolda jadis jbl k2 klimo koetsu korato lavardin loricraft lyra michell engineering morch musical fidelity nordost nottingham analogue opus 3 origin live ortofon papworth pro-ject rega revolver ringmat roksan shun mook shanling shelter slinkylinks sme sonneteer spendor stax sugden sumiko tannoy tci cables tivoli audio tom evans townshend audio transfiguration trichord trigon van den hul voodoo wireworld xlo



# Black Magic

**It's probably because they're so darned hard to organise that you rarely see a group review of top tonearms, but we were hell-bent on finding the best. So our own intrepid Stewart Wennen set about the long, laborious process of listening to seven models from Origin Live, SME, Linn, Hadcock and Roksan. And here, with only one cantilever bent, are our findings...**

**F**or something as apparently innocuous as a length of metal that sweeps a stylus across a disc, there's an inordinate amount of interest in the vexed subject of turntable pickup arms. Because they're so rarely compared, there are more myths and legends about these than most bits of hi-fi kit. And they really do excite great debate amongst analogue aficionados, which is curious for something that's – strictly speaking – merely a 'mechanical measuring instrument', designed to let a cartridge trace a record groove with minimal interference.

Of course, it's easy to make a cheap tonearm, but not a good one. In designing and – no less pertinently – manufacturing one, you need real theoretical skill, thousands of hours of listening experience and meticulously tolerated manufacturing facilities. Then there's the question of synergy. Different types of arms suit some decks and cartridges better, and respond differently to the way they're set up. As such, it's a veritable minefield out there for anyone wishing to buy one. How can any analogue addict gauge the relative merits of the models available? Well, we decided to have a go...

The first problem was how to get consistent results using different turntables and pick-up cartridges? It was obvious that I could not hope to achieve any type of consistency if these conditions were left to the manufacturers, as they would prefer their own pick up arms to be used with their own turntables and cartridges, which would make nonsense of an objective review. So, to hear any difference between components, it is vitally important that only one change takes place in the system, otherwise the results will make a mockery of the procedure. To wit, I'd use the same host turntable for the entire pickup arm selection, with the exact same cartridge.

Which to choose? Well, we opted for the Origin Live Aurora Gold, as it's one of the most neutral turntables available right now. OL's Mark Baker

duly agreed to offer us a deck and his engineering support, in the shape of range of bespoke armboards which had to demonstrate identical characteristics mechanically and audibly, and be accurately cut for all arms. Of course, we'd be reviewing OL arms, but I am satisfied that the Aurora is an excellent platform for any arm, such is its innate balance. As for the pickup cartridge? Well, I chose the very well regarded Ortofon MC25FL, which offers an almost flat frequency response works well in a large variety of pick up arms of very different design.

Of course, I am sure there will nay Sayers, criticising the methodology (the choice of deck and cartridge, and invariably my politics too...) But we simply had to draw a sensible, considered line in the sand and find one good deck and cartridge we could get to work with all the arms – and so we did. The debates about synergy, system matching and so on and so forth can be saved for the letters pages next month!

As I would be listening to so many different arms, I'd have to make very careful listening notes, and tabulate the results. I'd also have a 'backup' to both confirm my findings over a period of several days, and to demonstrate them to others! To wit, I used a digital recorder. Now, I know you're going to tell me that 16/44 isn't good enough to intricately assess analogue, and on its own it's not – but it proved an excellent 'backstop', to firm up my findings at the end of the (tortuously long) review period. Enjoy!

#### REFERENCE SYSTEM:

Origin Live Aurora Gold Turntable c/w Upgrade transformer  
Ortofon MC 25FL moving coil cartridge  
Trichord Dino/ Dino + phono stage  
Trichord High performance power interconnect  
ATC SCM 35 floorstanding monitor loudspeakers  
Crown DC 300A power amplifiers as a triamp rig  
Custom built passive preamplifier  
Custom built Connectronics Musilex and Miniflex interconnects  
all review equipment on individually spiked stands or rack mounts  
isolated mains power supply

*Hadcock GH242 Export*

*Linn Ekos*

*Origin Live Illustrious*

*Origin Live OL1*

*Origin Live Silver*

*Roksan Nima*

*SME Series IV*



**HADCOCK GH242 EXPORT £499**

**A**nother unipivot design with an effective length of 212.8mm, this latest evolution of a classic tonearm sports an aluminium armtube which is different to all of the other arms in this test, as it is very slender. The headshell is fashioned from cast aluminium and is attached to the arm with a single cap head bolt. This enables the user to change cartridges much more readily. The chromium-bearing pedestal is bur-nished to a very fine finish. The pedestal supports the arm lift assembly (which is one of the best I have ever used!) as well as the anti-skate mechanism. The rear arm stub is of the de-coupled variety and carries two balance weights. These counterweights are also decoupled and have the same finish as the pedestal. The effective mass of the arm is 10g. Pickup arm alignment is accurate and the headshell-offset angle is 23 degrees. At the pivot, the pivot point mates with a special patented housing in the top tube.

The GH242 Export can accommodate almost any cartridge with a weight within the range of 3-12gms. The top arm can be completely detached, because of this feature it is extremely easy to

mount cartridges, and has a rectangular socket that plugs into a corresponding connector in the pedestal assembly. Arm wiring is of first quality with a pair of flying leads equipped with phono sockets so the user can interchange cables between the RIAA and the arm. The arm also has a separate earth lead, which is grounded to the rear of the RIAA. This is a very fine arm as far as aesthetics go, and its build quality is second to none.

**SOUND QUALITY**

First on the turntable was a mono recording of John Williams playing his flamenco guitar. The arm displayed all of the weight I associate with a well-played guitar. Room size was easy to hear, along with the fingering on the fretboard. The Hadcock tracked the cartridge with ease and displayed a grip of the music that is rarely equalled. It also presented subtle details as well as a very wide dynamic range. James Brown on the track 'Get Up Offa that Thing' was delivered with tremendous clarity and verve. Bootsie's bass playing certainly drove the song along. Stereo imaging was enormous, with the image melting the listening room walls away. Image placement was rock-solid with a

very smooth frequency response, meaning this arm delivers all the musical clues.

Supertramp's 'Crime of the Century' was next on, and it was yet more obvious that I was listening to a very fine piece of British engineering. The GH242 allowed the music to burst from the monitors with tremendous aplomb. Percussion and bass instruments were boldly portrayed with real vivacity and little or no bass overhang. Such seamless transparency is the mark of a top pickup arm - treble to midrange balance was very smoothly displayed. Indeed, an airy spacious sound was evident with all my reference recordings.

Overall then, I was delighted with the Hadcock. It has such a large, feisty and vibrant sound, yet is a natural music maker. It has an ability to get you into the groove - and indeed the ebb and flow of the music - that is infectious. It makes the already fine OLI sound frigid, constrained, pernickety - although the OL did show it as just a tad too warm on female vocals. It's a versatile, well thought out and flexible tool that justifies its price premium over all the cheaper arms here, thanks to an even more expansive sound.



**LINN EKOS £1,850**

**T**his is the ultimate evolution of what many think 'the original superarm' – the Linn Ittok LVII. It is primarily designed for use with the Linn Sondek LPI2 turntable, and it is to Linn's credit that they were happy for us to try it 'behind enemy lines' so to speak (although they added the disclaimer that they could not guarantee the results). It uses a variation of the Audio-Technica pick up arm mounting plate, and is different to the others in this test in that its effective length is 211mm and has a cartridge overhang of 18mm. It also has a different type of stylus tip pressure arrangement. Stylus tip pressure is achieved by balancing the arm with the counterweight and then dialling in the tracking pressure on the adjuster on the right hand side of the arm pedestal. This "dynamically balanced" system uses a high quality spring to apply the force.

The armtube and the majority of the components are manufactured in Scotland, and the Ekos is hand assembled at Linn's own factory in Glasgow. The headshell design has strengthening fillets added to the rear sides to avoid the unwanted vibration effect due to the cartridge. All components have been bonded

together using an advanced adhesive technique. The bearings have a tolerance of 1 micron and have all been matched. This latest arm is supplied with Linn's silver 'T-cable', which is terminated with high quality phono plugs. The easiest arm in this test to set up, thanks in no small part to its dynamically balanced design, fixing the vertical tracking angle was an absolute breeze. It's also a joy to use and feels just nicer in the hand even than the Illustrious.

**SOUND QUALITY**

John Williams was first on the turntable, and the Linn proved quite distinctive. As with many products from this company – especially from the mid-eighties when the arm was originally designed – it was brilliant at some things and quite disappointing at others. It's best described as being 'the antithesis of a unipivot', in as much as it's very tight, taut and grippy with great musicality but poor imaging and lacklustre tonality. Indeed, the Ekos proved almost unmatched in its ability to play tunes, while at the same time making the recorded acoustic in 'Bop Till You Drop' quite curtailed - the width, depth and height of the image were limited to the outer edges of my ATC SCM35s.

Back to John Williams and the guitar was portrayed at centre stage, tonally correct, but with little indication of the scale of the instrument. The reverberation in the recording studio was almost completely absent. As the music moved along, I could not detect any change in Mr. Williams breathing. Johnny Guitar Watson's 'I Don't Want To Be Alone Stranger' (Fantasy F-984A) again revealed a truncated stereo image quality. Surface noise was commendably low in level however, and the cartridge tracked in the usual exemplary style.

Overall, the Ekos proved a disappointment in this context, which is of course outside the one it was designed to work in. Yet on an LPI2 there's no doubt it sings, and the editor reports fine results on a Michell Orbe too. The Sondek doesn't major on spatial articulation and scaling, so maybe the Ekos's performance in this area is less apparent when it's 'au naturel'... What's undeniable is the way it carries a tune, lending an almost supernatural sense of where the song is going. I could hear this via the Aurora too, but there was less synergy. This arm comes highly recommended for Sondek users, but owners of other decks should audition carefully.



**ORIGIN LIVE ILLUSTRIOUS £1,570**

**T**his is Origin Live's stab at building the finest pick up arm possible. The fundamental design objectives were good old-fashioned strength and rigidity. A static balanced design with bias compensation applied via a weight supported by a fine thread, its armtube is machined from a solid billet of very high-grade alloy. Effective length is 240mm, with an effective mass of 14 grams. Very low friction comes courtesy of bearings of the highest order, sat in an extremely wide yoke made from highly specified material. The Illustrious's arm bearing casing has been designed to offer high mass in the horizontal plane, whilst the mass in the vertical plane is commendably low for good tracking ability.

Headshell design has had the same precise attention to detail lavished on it, with minimal flexure. Arm wiring is similar to the OL Silver, except that the wires have been cryogenically treated and consequently require a longer running in period than normal. The lead out wiring is terminated by Eichman bullet phono plugs. Finish of this pick up arm is exemplary – up there with SME Series V standards, which is no mean feat. It has the strong but precise feel of the very best manual SLR camera or

shooting pistol. Detail has been attended to – even the arm lift lever has been ergonomically designed – although I can't say I thought the finger lift was long enough!

**SOUND QUALITY**

After the recommended forty hours burn in time (for the arm cables) this arm produced an almost immersive sound experience. All dimensions of the stereo image were clearly described, depth being tremendous. Height of the image was one of the most realistic I have been privileged to hear. The apparent width of the perceived image was enormous, as the image was so large that my living room walls seemed to melt away. This was complemented with a precision of spatial characteristics that made listening to the Illustrious an absolute pleasure. Oh, and surface noise was almost non-existent!

Pink Floyd's 'The Wall' had a character that I have not experienced before. The mixing on this album is such that lesser arms make it sound flat and two dimensional, but the top OL revealed it as vast and panoramic. Moreover, the extra dynamic range over all the other arms here was simply stunning. As a consequence, the level control was set at about a third possible volume and the

system still portrayed this piece of work as, quite possibly, the finest multitracked rock album of the 1970s. Along with firecracker dynamics, something SME V users will know, it possessed a seamless rhythmic ease and flow which SME V users will not! This is a beautifully fluid listen, yet gives nothing away to any other arm in terms of grip, detail and focus.

Ry Cooder has an awe-inspiring delicacy of play, and this arm had the ability to transfer this into my living room. I can hear his band working very hard behind him, the rhythm section driving the music along. Likewise, James Brown came over with a precision that is very rarely heard from any hi-fi component. Image transparency and transient recovery were without doubt very special, while timbral qualities and the breadth of its tonal palette are amongst the very best I have ever heard. This is the big league, where the equipment isn't just 'self-effacing' or 'uncoloured', but literally dissolves before your very ears. It has very little character of its own and presents the music as the musicians really intended. The Illustrious's performance befits its name all right, bringing almost all of the fluidity of the best unipivot with vastly improved grip and incision – the best of both worlds, if you like.



## ORIGIN LIVE OLI £449

In the beginning, there was the Rega RB250 - well, actually it was the RB300. Introduced in 1983, it put the cat amongst the pigeons by sounding almost as good as many superarms (Linn Ittok, Syrinx PU3) at one third of the price. Then, some fifteen years later, Origin Live came up with a 'structural modification' that addressed the arm's biggest weakness - its floppy counterweight. Then, OL's Mark Baker correctly 'discovered' that the RB250 actually sounded better than the more expensive RB300, thanks to its lack of tracking force spring and more solid bearing mounting. Thus was born the OLI, a modded Rega RB250 complete with new internal wiring.

The OLI modifications transform the rather sterile standard pickup arm. OL starts by removing rear end stub counterweight decoupling rubber washer, and bolting on a new rear stub in its place. Standard RB250s are dynamically balanced (just like the Linn Ekos) and this type of structure can be deleterious to sound quality, so the spring is removed and the armtube reassembled. The rear weight has also been modified as it is considerably larger than the original and the new counterweight has an offset mounting hole to let

the counterweight present a lower centre of gravity, with the added advantage of lowering the amount of transferred inertia.

The tapered arm tube has been shot peened and then anodised. Standard armtubes have a powder coat finish applied by Rega, which over damps the tube considerably. While the armtube is on the bench OL upgrade the bearings to a much higher standard also allowing the pick up arm to be, mechanically, integrally stronger. Internal wiring is Litz cable with silver plated copper cartridge wire and a very low resistance cryogenically treated cable. Phono plugs are again replaced with high quality connectors.

### SOUND QUALITY

The key to this arm is its all round competence, which is remarkable at the price. Although decently neutral by the standards of most tonearms, the OLI is characterised by a little lower midrange warmth. This is a good feature, as at this price most people cannot afford to install a very expensive pickup cartridge. Tracking ability is very good, as my assault course showed - there was no hint of the cartridge letting go at any time. Stage depth and width were wider than the standard Rega arm, which was also tonally more curtailed at frequency extremes and

more one-dimensional.

Solo guitar is reproduced with panache, the arm correctly displaying the size of the room and the timbre of the music. Despite that aforementioned gentle lower midband bloom, the OLI is generally unobtrusive. Multi tracked rock albums are handled in a way that's remarkable considering its budget origins - sounding detailed and analytical but never sterile. This arm captures the emotion and pace of the recording.

It's possible to criticise this arm for a slight lack of charm or character, and curtailed frequency extremes, but then you remember how affordable it is. Its skill is how it does everything so competently, at such a low price. It's less charming and beguiling than the Nima, but a damn sight easier to set up and - most likely - match to cartridges. I was amazed at this humble arm with its ability to replay the music with so much accuracy. Of course, it's a league below the likes of the Illustrious, sounding a vague and two-dimensional by comparison - but its genius is that it never sounds obviously compromised in any way. By contrast, even the tremendously powerful and commanding SME Series IV at three times the price seems a tad over-analytical. Think of the OLI and the phrase 'giant killer' springs to mind...



## ORIGIN LIVE SILVER £599

**A**t first sight, this looks similar to the Rega RB300 - but looks can be deceptive. The OL Silver is a complete redesign, and can be substituted for any OL or Rega arm as the designer has used the same geometry. This pickup arm has an effective mass of 13.5grams and has a total weight (excluding pickup cartridge) of a respectable 448g. Internal wiring has seen the use of high quality Litz cable. Headshell wiring uses stranded silver with individual PTFE sheathing, terminated with sprung gold plated cartridge tags.

Mechanical construction sees a variety of changes to the norm. Arm tube material is best quality aircraft alloy. A new headshell has been fashioned which is decoupled and at the same time rigidly attached to the arm tube, although the rear bearing stub is the same as the acclaimed OL RB250 modification. Horizontal bearings have been changed for much higher specification components. The horizontal bearing yoke has also been changed for a wider unit aiming to reduce the mechanical resonance and increase torsional stability. External arm interconnect is of the captive variety (but if you want to substitute arm leads a DIN socket can be

integrated by OL), and uses high-grade cable terminated with quality phono plugs. This is not wired in a semi-balanced fashion but is of the single ended type. An infinitely adjustable vertical tracking angle adjuster is included with this pick up arm.

### SOUND QUALITY

This arm has an ability to throw an accurate stereo image into the listening room. Tracking ability was exemplary with no hint of the cartridge leaving the groove at any time even with my audio assault course. It has very little character of its own, so accordingly has lightning transient recovery, although tonally it's very slightly warm.

The music of Donald Byrd's album 'Stepping into Tomorrow' (Blue Note BN-LA368-G) had all the dimensional characteristics I'd expect from a top tonearm. Spatial clues were all there as well as an evenly portrayed frequency balance which bodes well for the reproductive process. Bass instruments had drive and rhythm. The rhythm section kept the band on course with deftness and assured control that is rarely found in modern music. The alto saxophone of Gerry Bart floated majestically, right centre, over the other

instruments.

John Williams' transcription of Suite Number 3 in C for unaccompanied violoncello (Delyse ECB 3149) was on next. Although this piece of work was recorded in mono, in 1958, the spatial characteristic was boldly presented. Guitar was centre stage and the finger work was obviously portrayed. Subtlety was the order of the day with this piece of music and the OL Silver did not disappoint. The acoustic of the recording studio was clearly audible and with very little overhang this music certainly shines.

James Brown's 'Get Up Offa That Thing' certainly had an enormous amount of drive and vivacity. The whistling on the title track was rock solid in the stereo image, with the trumpets accurately to the right of centre, letting the feel of the album shine through. Indeed, the Origin Live Silver coped extremely well with all types of music that was put on the platter, bearing out this magazine's prior opinion that it's a gifted all rounder that's just shy of the very best arms around - but at a dramatically lower price. Still, it does lack that beguiling fluidity of the unipivots, so if you've got £600 to spend on an arm then you'll have to decide whether you ultimately want analysis or swing.



**ROKSAN NIMA £350**

**C**onventional pickup arms such as Regas and Linns use three bearings. This type of mechanical structure has many pitfalls for the design engineer, including matching the vertical and horizontal bearings for identical coefficient of friction – which has to be very low to enable the cartridge to track the record. Another way of allowing the arm to pivot is to use only one bearing, such as in unipivots like the Nima, which drops bearing friction to very low levels. This arm has an effective length of 240mm with an overhang of 17.5mm, plus an effective mass of 10grams with a decoupled counter weight. The rear stub is set well below the arm tube level in an attempt to lower the arm's centre of gravity.

Main bearing material is stainless steel and is critically machined to extremely tight tolerances. The unipivot is contained within an acrylic pedestal and the pivot has a fine adjustment available at the top of this housing. Unlike the Hadcock – the other unipivot here – the arm tube is of very wide diameter alloy. Interestingly, the headshell

material is Acrylic, accurately machined to enable the cartridge to sit square to the record. Roksan has included a very flexible printed circuit board (just like the type found in most digital watches) with no less than five tracks on it. The cartridge connectors are gold plated and very sturdy. The arm lift has a well-weighted feel to it and works well. Bias compensation is courtesy of a free weight suspended by fine thread. A little bit of confidence is needed with the set up procedure, which is simple providing you follow the well-laid out instructions carefully...

**SOUND QUALITY**

James Brown was first on the platter and the reward was an open, airy treble to midrange allied to a very good bass slam. The stereo image had good detail retrieval as well as an extremely wide sound stage. The percussion was striking as the quality of reproduction was of the highest order. The "Godfather of Soul" was singing with his usual passion with his band pushing the music along. Unusually for such an inexpensive arm, this one coped very well with almost all the music

that was put on the platter. Ry Cooder was certainly present with a delicious portrayal of vocal timbre that is his trademark. His band stretched from wall to wall with an extremely realistic portrayal of stage depth and height.

The transient ability of this arm is very good, along with a realistic decay which is very important for instruments like pianos and strings. Low frequencies are of the highest order, with superb lower bass grip. Furthermore, its bass to midrange balance is almost seamless – as is the mid-to-treble transition. So it's a smoothie, but not soft around the edges in any way.

In absolute terms, the Nima is a tad ragged in the high frequencies, and lacks the forensic detailing of the more expensive arms here. But its natural musicality allied to superb soundstaging (by comparison, the OLI sounds shut-in, constrained and generally distant) makes it fantastic value for money. A unipivot such as this is a different way of listening to music than a conventional multi-pivot – a bit like the gulf between tube and transistor, if you will. Setup is a little fiddly, but with care and attention gives super results.



**SME SERIES IV £1127**

If there is any tonearm here whose reputation precedes it, it is this. The Series IV appeared in the latter half of the eighties, as a slightly cost-cut version of the mighty Series V whose fluid damping system, silver Litz headshell wires and sprung tracking force system it lacks. Interestingly, these are all features of debatable, if not deleterious sonic merit anyway, and there are those who feel that (given the Series V's wiring) the IV is actually superior. The only obvious demerit is the slightly lower tolerance bearings, but the IV's are still so high that again this is an arguing point.

The arm itself was so radical when it first came out that it may as well have come from outer space! Constructed from a cigar shaped, one-piece magnesium tube, it had echoes of Rega's revolutionary RB300, but SME had moved the game along further. The IV boasted a massy counterweight locked close to the arm pivot, easy azimuth adjustment and superb low-friction, high strength bearings. Hand cueing this arm is an amazing experience – it feels like the best Leica camera to the touch. It's also extremely easy to set up very accurately, and the instructions are exemplary. As soon as you unpack this arm, you're aware you're using

a legend, and the sound is no different.

**SOUND QUALITY**

Best characterised as neutral and self-effacing, this arm brings unbelievable clarity to vinyl replay. Imaging and soundstaging are superb, while frequency extension is unmatched – bass is extremely tight and controlled, treble glass-clear. The only criticism is the rather dry, analytical sound; there's a conspicuous lack of euphonic coloration, and this can be a little stark for some tastes. The upside of this is the brilliant 'deconstructive' talents of this pickup arm – it can scythe through any mix to tell you precisely what's there and how it was recorded.

For example, Supertramp's 'Crime of the Century' gained a mastertape-like quality that none of the others so far possessed. While the Hadcock was deeply impressive in its musicality and the OL Silver commendably detailed, the SME V didn't seem to have any discernable character at all – aside from one foible I shall elucidate upon subsequently. The result is that it gave an amazing insight into all aspects of this classic nineteen seventies recording – from studio effects to multi-tracked vocals to the background train

announcements in 'Rudy'. Bass is stunning. It's rock-solid, vice-like and possessed of tremendous energy and articulation. Midband is three dimensional, with brilliant image placement. Treble is smooth and open and wonderfully extended. Dynamics are gobsmacking, and I found myself looking for big, impressive sounding productions to amaze myself with hi-fi!

The trouble is that the SME Series IV has a certain 'mechanical' nature to the way it goes about making music that actually makes it obviously less listenable than, say, the Hadcock. It's great at giving a seat-of-the-pants, whiz-bang sound, but proved strangely unrewarding just listening to music – much like CD, in fact. To wit, James Brown on the track 'Get Up Offa that Thing' wasn't such a moving moment as it had been on the Hadcock, Roksan or OL Silver. Some folk will think this really is 'the best pickup arm in the world' – it is not an overly ambitious claim – but others simply won't take to it. Whilst (you'll subsequently read that) the Ekos is great in one respect and poor in several others, the SME is great in most but poor in just one – but that particular aspect, many analogue addicts will believe, is the most important. Close, but no cigar.





# conclusion

**B**ringing up the rear of this test was the Linn Ekos, which was one of the very best here in terms of tunefulness, but – on our test deck at least – was unable to correctly describe the soundstage in depth, width or height. It's obviously not an all rounder, and is voiced in such a way as to appeal to a select group of listeners (LPI2 owners) who know what they like and what's not important to them. It's a beautifully made and designed bit of kit, but not right for everyone.

Next was the Origin Live OLI, which has the ability to present an extremely large sound stage, with correct timbral detailing. Ultimately it's a bit warm, a bit tonally and dynamically curtailed, but is brilliant value and streets ahead of a standard RB250. The beauty of this arm is that it's a middle ranking arm at a rock-bottom price – thus letting you spend more on your turntable and cartridge.

Roksan Audio was next with the Nima. This was one of the surprises of this group. At its price point, it's an astonishing piece of kit. It is quite difficult to set up but a little care and attention to detail rewarded me with a panoramic sound stage and superb tonal accuracy. It has a natural ease and grace that only the Hadcock matched – I can see why unipivots are cultish!

The OL Silver had an even wider stereo image than the preceding arms. Timbral detailing was more accurate, along with a much more believable portrayal of the musical event taking place in my living room. The pace of the music was correctly displayed with the panache and passion of the musicians very well displayed. Again, it's much better than it should be at the price – something of a recurring theme with OL. For many, this is all they'll ever need.

The Hadcock GH242 Export, which has been ignored by much of the hi-fi press for years, proved a veritable 'wolf in sheep's clothing'. I did not expect the imaging to be as precise, or transients to be as fast. On solo piano it proved exemplary, adding little of its own character to the overall experience. In many respects like soundstaging and depth

perspective, its performance was right up with the SME IV. Only in the SME's traditional areas of strength did the Hadcock falter, with a slight image foreshortening, an obviously 'warmer' midrange and looser bass. But it had a wonderfully natural, fluid and beguiling character that was never other than charming – something the SME lacks! The downside is that this is the fiddliest arm you're ever likely to own, and requires extreme care and patience to set up properly.

The SME Series IV is next. This is one of the most 'stunning' tonearms I've ever heard, but the initial euphoria settles to leave you rather cold. It is relentlessly incisive and forensically detailed, with firecracker dynamics and almost 'architectural' soundstaging. In hi-fi respects, it will leave the strongest devotee of digital audio speechless – given a serious turntable and arm it sounds ten times crisper than 24/192. Yet it lacks 'that old black magic' – charm, basically. Now, the jury's out on whether this 'charm' is actually 'euphony', or whether it's actually in the groove in the first (I suspect it is), but the point about the SME is that it's more like the ultimate measuring instrument than the greatest musician. In other respects – build, engineering, feel, ease of set-up, packaging, instructions – it is sublime.

And the winner is... the Origin Live Illustrious, a pick up arm that is quite simply breathtaking. Its ability to display a three dimensional stereo image is above criticism, as is its transparency and lack of artifice. It also has amazing tonal accuracy, which lets the 'flavour' of each instrument or voice flood out of the speakers. This is the respect in which it was most obviously superior to the SME. The only area which falls down – if that is the right phrase – is the bass. The latter's lows were just a tad tauter and more 'vice-like', but by any other measure the Illustrious was sublime.

On any deck – OL, Michell, Notts Analogue, Clearaudio – this is surely the best.

*Hadcock GH242 Export*

*Linn Ekos*

*Origin Live Illustrious*

*Origin Live OL1*

*Origin Live Silver*

*Roksan Nima*

*SME Series IV*



#### THANKS TO:

**Bob Polley at ATC in Gloucestershire, for their loan of the ATC Studio Control Monitors.**

For more tonearm talk, including a look at how the tested models relate to other established designs, see DP's column on p83.

# Great HI-FI WORLD'S COMPETITION Giveaway

WIN CREEK'S SUPERB CD50/II WORTH £850 IN THIS MONTH'S GREAT COMPETITION!



## Competition Questions

[1] Creek Audio is named after what?

- [a] its founder, Michael Creek
- [b] a section of water
- [c] the strange noise of floorboards
- [d] the sound of old bones rattling

[2] What does the CD50/II look similar to?

- [a] its owner
- [b] its founder
- [c] its predecessor
- [d] its replacement

[4] The CD50/II has 12 of what?

- [a] arms
- [b] tentacles
- [c] beaks
- [d] regulated power supplies

[4] How did AL describe the player's performance?

- [a] "one of the very best CD spinners at the price"
- [b] "one of the very best CD spinners, ever"
- [c] "now that's what I call music"
- [d] "careful with that axe, Eugene"

April Competition  
Hi-Fi World Magazine  
Unit G4 Argo House  
The Park Business Centre  
Kilburn Park Rd.  
London NW6 5LF

Here's your chance to win one of the best mid-price CD spinners on sale, a purpose-designed audio-ophile digital disc player from one of the acknowledged masters of the art. In Hi-Fi World's review last month, Albert Lee opined:

"The new Creek CD50mk2 looks similar to the earlier CD50 but is actually a very different machine..."

### Hi-Fi & Computer Audio World Competition rules and conditions of entry

1. Only one entry per house hold.
2. Multiple entries will be automatically disqualified.
3. Purchase of the magazine is not a pre-condition of entry.
4. No correspondence will be entered into.
5. The Editor's decision is final.
6. No employees of Audio Publishing Limited, or of any companies associated with the production or distribution of the prizes may enter.

The mk2 has a new transport and the circuitry is improved and with symmetrical layout and shorter signal paths, and a higher frequency clock oscillator is used that's synchronised with the micro controller and buffer clock to minimise internal interference. There are two discrete transformers for the digital and the analogue power supplies. This feature, along with separate grounding, enables the player to achieve much lower noise performance than the mk1. There are 12 regulated power supplies along with an entirely separate power supply for the CD drive mechanism.

Detailing was excellent – along with percussion, hi-hats, rim shots, cymbal strikes and wood block shots, I was able to tell the difference between the ride and crash cymbals with ease. With many mid-price CD spinners, this disc sounds confused, probably because of the amount of information in the mix, but with the CD50mk2 the sound was extremely well presented. For example, 'Street Scene' saw the flautist was finely etched in space as if it had a life of its own... Through the Creek, the

music had obviously more life in it, and that veil had been lifted... The CD50/II had an obviously better grip of the recorded acoustic, being better able to differentiate the musicians and the instruments they were playing.

It possesses the ability to describe the room in which the performance took place and the musical event itself. To put it in perspective, you'd struggle to find a DVD-A or SACD spinner under £2,000 that comes close to the Creek (on 16bit CD) – which suddenly makes ye olde Compact Disc look a surprisingly worthy format once again. One of the very best CD spinners at the price, this offers a captivating musical performance and clever future-proofed design."

If you'd like to win this superb CD player, then all you have to do is answer the following four easy questions, and send your entries to: **April Competition**, Hi-Fi World magazine, Unit G4, Argo House, The Park Business Centre, Kilburn Park Road, London NW6 5LF by **31st March 2004**.

## CONGRATULATIONS

...to Mr. Robert Swain of Southampton, the winner of our February 2004 competition. A Sugden Headmaster Headphone Amplifier/Pre Amplifier is on its way to you!

# Sevenoaks SOUND & VISION



Sevenoaks Sound & Vision stocks a wide range of Hi-Fi separates, DVD players, amplifiers, speakers, plasma screens, LCD televisions and projection systems from all the leading manufacturers.

From starter systems to custom designed multi-room and home cinema installations, our friendly staff are available in all stores to advise, demonstrate and guide you through the home entertainment jungle. If you're interested in home entertainment and want to avoid the confusion, contact your local Sevenoaks Sound & Vision store and **experience more.**

0% interest free option\* is available on most products.

\*Written details on request. Licensed credit brokers. Minimum balance £400. Subject to status.



## CUSTOM INSTALLATION

Are you looking to neatly and seamlessly integrate a Home Cinema or Hi-Fi System into your home? Our Custom Installation experts are fully trained in all areas and provide a prompt, reliable and professional service. Whether you're looking for lighting control systems, a dedicated home cinema installation with a retractable screen and built-in speakers or an integrated control system, Sevenoaks Sound & Vision has the solution.

## Product NEWS



### ARCAM'S entry-level DiVA DV78 DVD Player

Arcam's latest DVD player in the DiVA range is the DV78. The result of over four years' development, it uses the design team's insight and understanding to engineer their most affordable player ever.

The cost saving is substantial, but Arcam are proud to say that they have video performance which is truly world class. They have also used their expertise to ensure that the audio quality reflects the audiophile heritage, which is at the heart of every Arcam product.

The quality of components is identical to those used in the more expensive models, the DiVA DV88 Plus DVD player and DiVA DV89 DVD-Audio player. What has changed is the simplified construction and assembly techniques, which have substantially reduced both build and test times. The player comes equipped with a new remote control as well as a new navigation button.

Call your local Sevenoaks store for a demonstration and confirm that the DV78 provides reference class performance on both music and movies.



## ROKSAN upgrades its entire CASPIAN range

Roksan's CASPIAN range of Hi-Fi and Home Cinema components was originally introduced in 1998 and, having remained almost unchanged since, it was clearly time for an update.

The design aims for the new 'M' series were to improve reliability, enhance the aesthetics and, most importantly,

improve sound quality. And it seems these updates have been successful with What Hi-Fi? Sound and Vision magazine concluding: "Roksan's calculations were spot-on... The Caspian M Series-1 is well worth the extra money." JANUARY 2004

CASPIAN M RANGE AVAILABLE AT SELECTED SEVENOAKS STORES

- BEDFORD
- BIRMINGHAM
- BRIGHTON
- BRISTOL
- BROMLEY
- CAMBRIDGE
- CARDIFF
- CHELSEA
- CHELTENHAM
- CRAWLEY
- CROYDON
- EDINBURGH
- EPSOM
- EXETER
- GLASGOW
- GUILDFORD
- HOLBORN
- HULL
- IPSWICH
- KINGSTON
- LEICESTER
- LEEDS
- LINCOLN
- LIVERPOOL
- MAIDSTONE
- MANCHESTER
- NEWCASTLE
- NORWICH
- NOTTINGHAM
- OXFORD
- PETERBOROUGH
- PLYMOUTH
- POOLE
- PRESTON
- READING
- SEVENOAKS
- SHEFFIELD
- SOLIHULL
- SOUTHAMPTON
- SOUTHGATE
- STAINES **NEW**
- SWANSEA
- SWINDON
- SWISS COTTAGE
- TUNBRIDGE WELLS
- WATFORD
- WEYBRIDGE **NEW**
- WITHAM (ESSEX)
- WOLVERHAMPTON

PLEASE SEE PAGE 7  
FOR ADDRESS AND TELEPHONE  
NUMBER DETAILS

# Sevenoaks

SOUND & VISION



## HI-FI SEPARATES

**MICHELL GYRO SE**  
TURNTABLE / RB300 TONEARM  
**£1049.95**



WHAT HI-FI?  
Best Buy  
2003

"The Gyrodec SE sounds great, combining the best sonic characteristics of rivals. Quite simply, the Michell Gyrodec SE is terrific. Nothing compares at this price point - it's well deserving another Best Buy."

**CLAIM £50**  
TOWARDS THE CARTRIDGE OF YOUR CHOICE\*



**SYSTEM PRICE**  
**£949.95**

PRICE EXCLUDES CABLES & STANDS



WHAT HI-FI?  
Best Buy  
2002

**PRO-JECT 1 XPRESSION**  
TURNTABLE (BLACK) **£209.95**



"Compared with a £200 CD player this deck sounds remarkable: dig out your vinyl and give the Xpression a spin."

WHAT HI-FI?  
Best Buy  
2003

**FREE** GOLDRING EXSTATIC CLEANER\*

**ARCAM CD73T CD PLAYER £ CALL**



WHAT HI-FI?  
Product  
of the year  
2003

FANTASTIC OFFERS ON ARCAM DIVA AMPS & CDS

**HI-FI SYSTEM 1 SAVE £149**

WHAT HI-FI?  
Best Buy  
2002



**FREE**  
PRO-JECT DEBUT II TURNTABLE\*

**ROTEL**  
RCD-02 CD PLAYER  
RA-02 AMPLIFIER  
**B&W**  
DM601 S3 SPEAKERS

Rotel electronics and B&W speakers are natural partners for each other, giving excellent sound quality and stunning looks. So what better than this combination of class-leading detail with an even and robust sound.

But at Sevenoaks we always aim to offer you more and this means What Hi-Fi? Sound and Vision's Award-winning Project Debut II turntable is thrown in **FREE**.

HI-FI SYSTEM 1 - NOT IN CONJUNCTION WITH ANY OTHER OFFER OR PROMOTION

experience more

experience more  
experience more



**MARANTZ**  
CD5400 CD PLAYER  
**£119.95**

SAVE £30



**MARANTZ**  
PM7200 AMPLIFIER  
**£249.95**

SAVE £80



"This is one of the most powerful amos in its class, at 95w per channel, and it sounds it with anything from dance to a big orhedral work, offering a delicious combination of poise and impact. Stick with fast, dynamic speakers such as B&W DM601 S3s or KEF's equally capable Q1s and the results will amaze."



**PURE DIGITAL**  
DRX-702ES ANALOGUE/DAB TUNER  
**£299.95**

SAVE £30



### PRICING POLICY

We always try to ensure our prices are highly competitive.

In the event you can find the same products and excellent service at a lower price, please bring it to our store managers' attention.



### FINANCE OPTION\*

Spread the cost of buying. 0% finance option is available on the vast majority of products we stock.

\*Written details on request. Licensed credit brokers. Minimum balance £400. Subject to status.

Please Note: Some products may not be available at all stores. Please call before travelling. \*Cable Offer - From range available in-store. Not in conjunction with any other offer. Advertisement valid until at least 10/03/04, E&OE.

## HI-FI SYSTEM 2

**MUSICAL FIDELITY**  
A3 CD PLAYER & AMPLIFIER  
**MONITOR AUDIO**  
SILVER S8 SPEAKERS

One of our most popular systems at an amazing sale price. Full-scale dynamics with a lightness of touch makes this combination stand out.



SYSTEM PRICE  
**£2399.95**

HI-FI SYSTEM 2  
NOT IN CONJUNCTION WITH ANY OTHER OFFER OR PROMOTION

SAVE £379

**MISSION**  
780 SE SPEAKERS  
**£349.95**

"The revamped Mission 780s are hugely enjoyable: anyone with up to £400 to spend should consider these standmounters. Mission's clever move has paid off."



INCLUDES **FREE**  
SPEAKER CABLE WORTH £60\*



**MISSION**  
782 SE SPEAKERS  
**£899.95**

"Well, with the exception of the alderwood-veneer finish, these floorstanders look identical to the standard model, although there's a new tweeter and crossover design. One of the advantages of the three-way configuration is that each driver deals with only a narrow section of the frequency range, and the designers optimise each unit to perform its respective task. Mission's

engineers have excelled in this area: these elegant floorstanders sound beautifully balanced and few rivals under £1000 can match their wonderful levels of clarity. The 'special edition' tag is overused but these talented floorstanders are bona fide sonic stars."



INCLUDES **FREE**  
SPEAKER CABLE WORTH £120\*



SAVE £169

HI-FI SYSTEM 3

**ROKSAN**

KANDY KD1/III CD PLAYER  
KANDY KA1/III AMPLIFIER

**QUAD**

11L SPEAKERS

If you're after detail and excitement in your music then this system's for you. Here we've combined the Quad 11L speakers - Product of the Year 2002/2003 - with Roksan's double Award-winning Kandy KA1/III amplifier and its ideal partner, the Kandy KD1/III CD player.

Awarded five stars in a recent What Hi-Fi? Sound and Vision group test, the Kandy KD1/III CD player was described as "offering a great array of talents - team it with its amp s'ablemate and you have something close to the ideal visual and sonic combination."

But don't just take our word for it, come in for a listen.

HI-FI SYSTEM 3 - NOT IN CONJUNCTION WITH ANY OTHER OFFER OR PROMOTION



WHAT HI-FI?  
SOUND AND VISION  
Product  
of the year  
2003  
HI-FI & HOME CINEMA AWARDS

WHAT HI-FI?  
SOUND AND VISION  
Best Buy  
2003  
HI-FI & HOME CINEMA AWARDS

SYSTEM PRICE  
**£1399.95**

PRICE EXCLUDES CABLES & STANDS

**MONITOR AUDIO**

SILVER S8 SPEAKERS

**£699.95** SAVE £100



HI-FI SYSTEM 4

SAVE £399

**CYRUS** CD8 CD PLAYER & 8 AMPLIFIER  
**MONITOR AUDIO** SILVER S6 SPEAKERS

Another very popular combination that's more than the sum of its already talented parts - and that's before you've examined the upgrade options. The CD8 is a magnificent player (Best Buy - What Hi-Fi? Sound and Vision Awards 2003) and like most Cyrus products its performance can be maximised with the addition of a Cyrus PSX-R power supply.

The beautifully crafted Silver S6 speakers from British speaker specialists Monitor Audio complete the package.

HI-FI SYSTEM 4 - NOT IN CONJUNCTION WITH ANY OTHER OFFER OR PROMOTION



WHAT HI-FI?  
SOUND AND VISION  
Best Buy  
2003

WHAT HI-FI?  
SOUND AND VISION  
Product  
of the year  
2003  
HI-FI & HOME CINEMA AWARDS

SYSTEM PRICE  
**£1999.95**

PRICE EXCLUDES CABLES & STANDS

Please Note: Some products may not be available at all stores. Please call before travelling. \*Cable Offer - From range available in-store. Not in conjunction with any other offer. Advertisement valid until at least 10/03/04, E&OE.

experience more

# experience more

# experience more



**LINN CLASSIK ▽**  
MUSIC SYSTEM (EX SPEAKERS)  
**£749.95**      **SAVE £100**

"The Classik sounds simply marvellous. Boasting fine impact and drive, it retains its grip even as it thumps out rock and dance tracks. Ask it to



play quiet acoustic music and its smooth, liquid presentation impresses still further. The Classik offers the performance you'd expect from high quality separates in one lovely package - this is a very superior product."



**YAMAHA CDR-HD1300**  
CD-RW/HD RECORDER  
**£469.95**      **SAVE £60**



**PIONEER PDR-609**  
CD-RW RECORDER  
**£159.95**

**DENON DM31 ▶**  
UD-M31 CD RECEIVER  
**£179.95**      **SAVE £50**

"The D-M30 was exemplary, as its three What Hi-Fi? Sound and Vision Awards clearly show. The D-M31 is even better, making it phenomenal value for money."

OPTIONAL PROCEDES: DMS 101 MP3/ISO RECORDER • SPR 101 CASSETTE DECK  
PRICE EXCLUDES SPEAKERS

## HI-FI SYSTEM 5      **SAVE £169**

**ARCAM**  
CD73T CD PLAYER & A65 PLUS AMPLIFIER  
**MONITOR AUDIO**  
BRONZE B2 SPEAKERS



**SYSTEM PRICE**  
**£799.95**  
PRICE EXCLUDES CABLES & STANDS

Arcam and Monitor Audio both have an enviable reputation for producing great sounding kit without breaking the bank. This system shows why with a well balanced sound that's both musically involving and enjoyable.

At the front of this package is Arcam's upgradeable CD73T CD player - a What Hi-Fi? Sound and Vision 'Product of the Year 2003'. We've coupled this with Arcam's complementary A65 Plus integrated amplifier and Monitor Audio's beautifully balanced 'Best Buy' Bronze B2 speakers. According to What Hi-Fi? Sound and Vision (Awards 2003), these compact speakers: "Sound superb... Speakers don't get much better than the B2s."

HI-FI SYSTEM 5 - NOT IN CONJUNCTION WITH ANY OTHER OFFER OR PROMOTION



**WHAT HI-FI?**  
SOUND AND VISION  
**Product**  
of the year  
2003  
HI-FI & HOME CINEMA AWARDS





experience more

experience more  
experience more



## SEVENOAKS STORES NATIONWIDE

Within the M25

- BROMLEY** 39A EAST STREET  
• 020 8290 1988
- CHELSEA** 403 KINGS ROAD  
• 020 7352 9466
- CROYDON** 369-373 LONDON ROAD  
• 020 8665 1203 *OPEN SUNDAY*
- EPSOM** 12 UPPER HIGH STREET  
• 01372 720720 *OPEN SUNDAY*
- HOLBORN** 144-148 GRAYS INN ROAD  
• 020 7837 7540
- KINGSTON** 43 FIFE ROAD  
• 020 8547 0717 *OPEN SUNDAY*

- SOUTHGATE** 79-81 CHASE SIDE  
• 020 8886 2777 *OPEN SUNDAY*
- STAINES** 4 THAME'S STREET **NEW**  
• 01784 460777 *OPEN SUNDAY*
- SWISS COTTAGE** 21 NORTHWAYS PDE, FINCHLEY RD  
• 020 7722 9777 *OPEN SUNDAY*
- WATFORD** 478 ST ALBANS ROAD  
• 01923 213533 *OPEN SUNDAY*
- WEYBRIDGE** 43 CHURCH STREET, THE QUADRANT  
• 01932 828525 **NEW**

Nationwide

- BEDFORD** 29-31 ST PETERS STREET  
• 01234 272779
- BRIGHTON** 57 WESTERN ROAD, HOVE  
• 01273 733338
- BIRMINGHAM** ARCH 12, LIVERY STREET  
• 0121 233 2977
- BRISTOL** 92B WHITELADIES ROAD, CLIFTON  
• 0117 974 3727
- CAMBRIDGE** 17 BURLEIGH STREET  
• 01223 304770
- CARDIFF** 104-106 ALBANY ROAD  
• 029 2047 2899
- CHELTENHAM** 14 PITTVILLE STREET  
• 01242 241171
- CRAWLEY** 32 THE BOULEVARD  
• 01293 510777
- EDINBURGH** 5 THE GRASSMARKET  
• 0131 229 7267
- EXETER** 28 COWICK STREET  
• 01392 218895
- GLASGOW** 88 GREAT WESTERN ROAD  
• 0141 332 9655
- GUILDFORD** 73B NORTH STREET  
• 01483 536666
- HULL** 1 SAVILE RDW, SAVILE STREET  
• 01482 587171
- IPSWICH** 12-14 DOGS HEAD STREET  
• 01473 286977
- LEEDS** 62 NORTH STREET  
• 0113 245 2775 *OPEN SUNDAY*
- LEICESTER** 10 LOSEBY LANE  
• 0116 253 6567
- LINCOLN** 20-22 CORPORATION STREET  
• 01522 527397 (*OFF HIGH STREET*)
- LIVERPOOL** 16 LORD STREET  
• 0151 707 8417
- MAIDSTONE** 96 WEEK STREET  
• 01622 686366
- MANCHESTER** 69 HIGH ST, CITY CENTRE  
• 0161 831 7969
- NEWCASTLE** 19 NEWGATE STREET  
• 0191 221 2320
- NORWICH** 29-29A ST GILES STREET  
• 01603 767605
- NOTTINGHAM** 597-599 MANSFIELD ROAD  
• 0115 911 2121
- OXFORD** 41 ST CLEMENTS STREET  
• 01865 241773
- PETERBOROUGH** 36-38 PARK ROAD  
• 01733 897697 *OPEN SUNDAY*
- PLYMOUTH** 107 CORNWALL STREET  
• 01752 226011
- POOLE** LATIMER HOUSE, 44-46 HIGH STREET  
• 01202 671677
- PRESTON** 40-41 LUNE STREET  
• 01772 825777 *OPEN SUNDAY*
- READING** 3-4 KING'S WALK SHOPPING CENTRE  
• 0118 959 7768
- SEVENOAKS** 109-113 LONDON ROAD  
• 01732 459555
- SHEFFIELD** 635 QUEENS ROAD, HEELEY  
• 0114 255 5861 *OPEN SUNDAY*
- SOLIHULL** 149-151 STRATFORD ROAD  
• 0121 733 3727
- SOUTHAMPTON** 33 LONDON ROAD  
• 023 8033 7770
- SWANSEA** 24 MANSEL STREET  
• 01792 465777 *OPEN SUNDAY*
- SWINDON** 8-9 COMMERCIAL ROAD  
• 01793 610992
- TUNBRIDGE WELLS** 28-30 ST JOHNS ROAD  
• 01892 531543
- WITHAM (ESSEX)** 1 THE GROVE CENTRE  
• 01376 501733
- WOLVERHAMPTON** 29-30 CLEVELAND STREET  
• 01902 312225 *OPEN SUNDAY*



### WHO ARE SEVENOAKS?

Founded in 1972, Sevenoaks Sound & Vision is one of the largest and most successful hi-fi and home cinema retailers in the country.

Each Sevenoaks Sound & Vision store stocks a wide range of quality products, covering all categories of specialist home entertainment, from Hi-Fi separates and systems to DVD players, widescreen plasma televisions and projection systems, all at highly competitive prices.

Friendly staff are available in all stores to advise, demonstrate and guide you through the home entertainment jungle.

### NEW STORES

We are pleased to announce both the new stores in Staines and Weybridge are now open. For more information visit our website.

### CUSTOM INSTALLATION

Sevenoaks Sound & Vision's Custom Installation Service enables the integration of a home cinema or hi-fi system into your home as neatly and seamlessly as possible. All electronics can be hidden away, speakers discreetly mounted either in the wall or ceiling and the complete system operated via remote control.



Our installation experts are fully trained to the highest standards in all areas and provide a prompt, reliable and professional service. Whether you're looking for a multi-room system, a dedicated home cinema installation with a retractable screen and built-in speakers or an integrated control or lighting system, Sevenoaks Sound & Vision has a diverse range of products available to cater for all your requirements.

### SEVENOAKS WEBSITE

The Sevenoaks Sound & Vision website has news and information on the Sevenoaks group and its stores.

There are regularly updated special offer and stock clearance lists with hundreds of products available and detailed pages to help you locate your nearest store. To find out more, click on [www.sevenoakssoundandvision.co.uk](http://www.sevenoakssoundandvision.co.uk)

### DEMONSTRATION FACILITIES

Our comfortable demonstration rooms are among the finest in the country, many complying with full THX specifications.



### STOCK CLEARANCE

With 49 stores nationwide, the Sevenoaks Sound & Vision group stock and display a wide range of products. As models and product ranges are changed or superseded, the preceding models are made available at a reduced price, for clearance. Visit our Website for an up-to-date list of the clearance stock.

### PRICING POLICY

Whilst we do not claim always to be the cheapest, we try to ensure our prices are highly competitive. Take into account the expert advice, unrivalled product selection, demonstration facilities and excellent pre, during and after sales service and the lower price might not look such good value.

In the event you can find the same products and excellent service at a lower price, please bring it to our store managers' attention. We will always endeavour to offer you the best deal.

**OPENING HOURS:** PLEASE TELEPHONE OR VISIT OUR WEBSITE  
**E-MAIL:** [insert store name]@sevenoakssoundandvision.co.uk

[www.sevenoakssoundandvision.co.uk](http://www.sevenoakssoundandvision.co.uk)

# Esprit DE LP?



**We were most impressed with Sony's budget SCD-XB790QS SACD player a few months back, finding it a beguiling performer with quite an 'analogue' sound. What then of its bigger brother, the entry-level model in the prestige ES series? David Price tried the new SCD-XA3000ES.**

It's a sad reflection on the British market that a machine such as this should be labelled 'high end'. In Japan, Sony's ES range forms the mainstay of its hi-fi separates range – it's a sort of 'BMW 3 Series' of audio – classy but commonplace and not regarded as particularly esoteric. Here though, there was a considerable period of time in the mid-nineties when Sony UK was not importing any ES components at all to the UK. Shame! Instead, the company chose to rely on its budget 'Q series' to form the entirety of its separates sales. There was nothing particularly wrong with these, other than that Sony fans had nowhere to go if they (and I count myself in) wanted something more!

Fortunately, we're now blessed with not one but two ES machines – this, the entry level SCD-XA3000ES (which sort-of replaces the 333), and the XA9000ES which has just been launched in the UK as I write this (watch this space for a review). Selling for around £600, the 3000 occupies the classic Sony mid-price CD player segment of yore [see box]. You don't get the stunning copper plated, Black Gate encrusted internals of the top ES models (previously the 777 models, now the

9000), but you get a very nice box and a fair smattering of designer label discrete componentry inside.

This is one of the most attractive Sony digital disc spinners I've seen for many a year. I loved the late eighties CDP-X557ESD and CDP-X77ES era models, which were very clean and purposeful, but for a long time Sony's stylists haven't known whether they're Arthur or Martha – and the result has been variously cluttered or bland boxes. This looks cool, clean and contemporary – and exquisitely well finished. It's only when you open it up that you realise it's a case of 'plus c'est la change, plus c'est la meme chose' for the Japanese giant.

To wit, the casing comes off – rather less neatly than the beautifully hewn aluminium front panel would suggest – to reveal a sight that looks remarkably familiar to the Sony CDP-X333ESD (1990 vintage CD spinner) that I still have in my spare room. On the outside, it looks like an over-engineered Japanese battleship player, but inside it's – well – just a well engineered machine built very carefully to a price. In fact, close inspection reveals it actually has a lot of commonality with Sony's budget SCD-XB780 and XE680 machines,

inasmuch as it shares the same main board! The company hasn't even decided to disguise the fact – as the names of these players are printed on the PCB, while that of the SCD-XA3000ES is omitted.

So the XA3000ES is an extensively 'breathed on' budget machine, getting an altogether larger (430x290x124mm) and sturdier (8.2kg) casing which is presumably less susceptible to sound-degrading resonances, upgraded Twin R core mains transformer (with separate analogue and digital supplies) and peppering of middle-ranking Nichicon and Silmic capacitors all the way from downtown Akihabara.

To this, we can add all the standard bits from the other budget machines – including a reasonably quick access (by SACD/DVD standards) transport that plays CD, CD-R/CD-RW and SACDs, a defeatable fluorescent display complete with CD Text and 'music calendar', the 'Multi-jog' knob for track selection, gold plated headphone jack with volume control, a litany of playback modes including (32 track) program play, random play, all tracks repeat and one track repeat. Round the back there's a coaxial digital output, optical digital



output, six RCA phono sockets (i.e. multichannel analogue output) and one pair of RCA phonos (as a stereo line output).

**SOUND QUALITY**

This player is an interesting conundrum. Superficially it has quite a bright, punchy and upfront sound – just like Sony ‘three series’ CD players of yore. That means incision, grip, attack and no small degree of listening fun. On another level though, it is not the ‘digi fest’ that earlier mid-price Sony silver disc players have been. Whereas players as far back as the CDP-X33ES (1989, £600) have been very mechanical and obviously digital in their presentation, the SCD-XA3000ES has a fluidity (if not a tonality) that’s quite analogue in its style – precisely what we concluded about the XB970 a few months back, indeed.

When I say analogue, don’t confuse this with soft, warm, mushy, laid-back or any of those other tired epithets. The 3000ES isn’t any of these. Indeed, it’s actually more upfront sounding in both CD and SACD modes than the Pioneer DV-868 DVD universal player I had on hand for comparison purposes. This machine actually sounds more laid back and tonally warmer than the Sony. But the Sony does have a lyrical character in the mid-band which gives it ‘listenability’ that the Pioneer lacks.

In defence of the Pioneer, of course, the Sony doesn’t play DVD

movies, DVD Audio discs, MP3 CDs, VCDs or any of the other weird and wonderful digital Frisbees. This is an out-and-out hi-fi separate with CD and SACD as its sole remit. Although the Pioneer is about £200 more expensive, though, I thought it was a fine comparative tool, as potential Sony purchasers will invariably be thinking ‘do I get a universal player or keep to the SACD straight-and-narrow’.

Of the two machines, I’d choose the Sony. Here’s why: Let’s put aside the Pioneer’s brilliant connectivity (HDMI, iLink, etc.) and DVD-A compatibility for a moment. If you’ve committed to SACD (and CD), then the Sony is simply the better listen. It’s also dramatically better to look at, ergonomically superior, easier to use and has the joyous bonus of not requiring connection to a video display. If you slot in a Roxy Music ‘Avalon’ SACD and you want the 2-channel mix, you press the MULTI/2CH button and it switches to stereo, instead of requiring the negotiation of

seventeen sub-menus (I exaggerate for effect) to get your desired mix. Even the disc tray feels more solid.

Down to the nitty-gritty. I started the session with ye olde 16/44 CD. Steely Dan’s ‘Do It Again’ proved most interesting. The Pioneer was impressive, with a nicely warm and expansive sound and lots of bass energy through the Quads. It was smooth, sweet and frankly much better than any of us ‘purist’ audiophile snobs would expect from something with (shock-horror) video circuitry. Very tidy treble, sumptuous bass and a capacious three dimensional soundstaging (with Mr

**THREE IS THE MAGIC NUMBER – SONY £600 MACHINES THROUGH THE YEARS**

- CDP-337ES [1987]**  
One of the first Philips TDA1541 aspirated machines, this sturdily built 16x4 affair was a deeply engaging listen – albeit sharp enough to slice your ears off at 20 paces. Actually works better in the context of today’s smoother systems than it did back then.
- CDP-X33ES [1989]**  
The first of the Bitstream Sonys wasn’t, strangely, as smooth as you’d think – that was left to the top-of-the-range CDP-X77ES. It was very clean and detailed, but a tad cold, just like its forbear, and also quite mechanical. Great late eighties ‘black box’ styling, though.
- CDP-X303ES [1991]**  
This was much more like it – Sony produced a very slick sounding machine with fulsome bass, open midband and very couch treble, allied to a hitherto unfamiliar (for Sony ‘3 Series’ designs) musicality. Nice – well worth seeking out even today.
- SCD-XA333ES [1999]**  
Sony now had an SACD player to do occupy the role of its £600 mid-price separates machine, and very good it was too. If anything, on CD it was a bit loose and indistinct – obviously poorer than the X303ES, but then it did SACD as well, and decently too.

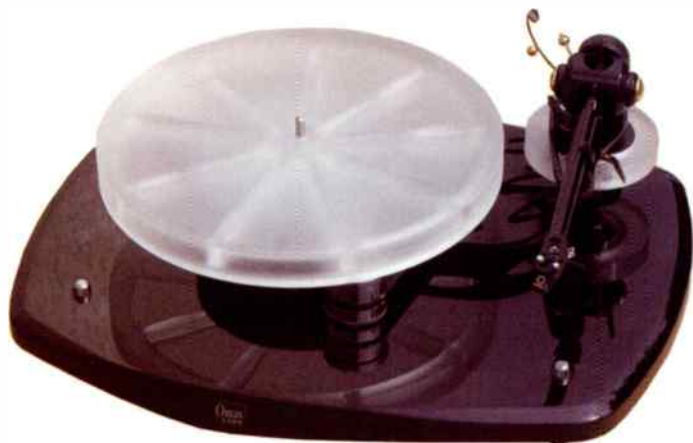

ORIGIN  
LIVE

You only  
have to listen

## Voted "best sound" in the ultimate test

You may know decks with great engineering or great looks - however, if it's the best sound quality that you want as well, then one make stands out in the crowd. Voted best sounding room at a large international show, people recognized the superb performance given by the Origin Live turntable and tonearm above many big names. Sometimes you wonder who or what to trust in reviews and awards - we have great reviews and awards but the ultimate award has to be what a large number of impartial members of the public decide, based on what they hear. Why not arrange an audition for yourself now at one of our specialized dealers.

### Turntables

Sovereign - £3850  
Resolution - £1970  
Aurora Gold - £1470  
Aurora - £997



Aurora - Group test winner in  
What Hi-Fi? Turntable group  
comparison

### Tonearms

Conqueror - £2500  
Illustrious - £1570  
Encounter - £970  
Silver - £599  
OL1 Fully modified - £359

A number of reviewers have described the above  
arms as the best they have heard - period!

Origin Live, Unit 5, 362b Spring Road, Sholing,  
Southampton, SO19 2PB, UK.

Tel / fax: 02380 578877

e mail: [originlive@originlive.com](mailto:originlive@originlive.com)

[www.originlive.com](http://www.originlive.com)

Affordable High PERFORMANCE  
PHONO Amplifier FROM  
TRICHORD RESEARCH

# DINO

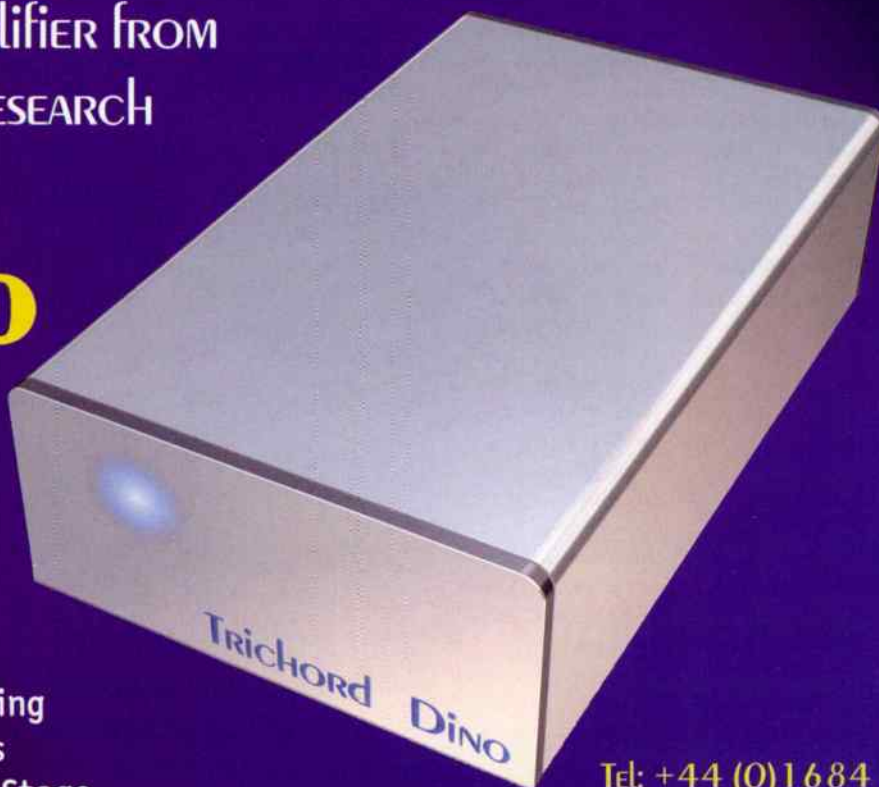

Moving Coil  
Moving Magnet  
Switchable Gain  
Switchable Loading  
Super Regulators  
Discrete Output Stage  
Upgradeable Power Supply

TEL: +44 (0)1684 311600

[WWW.TRICHORDRESEARCH.COM](http://WWW.TRICHORDRESEARCH.COM)

Fagen located well back behind the plane of the speakers) was all there to be enjoyed. Switching to the Sony, and the bass was a tad drier, the vocals a little forward (coming out in front of the plain of the soundstage) and the upper midband and treble just ever-so-slightly brighter.

Round one to the Pioneer, then? Well no, because the Sony was more engaging. Not only did instruments start and stop with greater precision, making for a punchier and more gripping listen, but the vocals were more believable. The keyboard playing was much more of a 'live event'; you really got the sense of how it was important to the structure of the song, its significance in the great scheme of things. This struck me as more significant to the overall experience than the Pioneer's superficially nicer tone. There was a sense of the Pioneer doing what the Unison Research Unico CD player does [see page 50], albeit to a greater extent, which is appealing to listeners simply by virtue of its sweet 'analogue-esque' tonality. The Sony, by contrast, was altogether more upfront and musically engaging.

Moving to Simple Minds' 'New Gold Dream' on CD, so the pattern continued. The Pioneer conjured a really rather impressive soundstage, with Jim Kerr's ethereal vocals hanging back with admirable reserve (just as they should, if you've got the original vinyl pressing). Switch to the Sony and it was more upfront and in-your-face, although never bright or strident. The vocals shifted forward again, and there was just a hint of upper midband glint that, maybe, shouldn't be there (this album always did sound like it was recorded in a studio lined with cotton wool, after all). But again, the musical performance was more engaging. Tonality aside, the SCD-XA3000ES was better able to convey the song's beginning, middle and end. You got the sense of a musical event, progressing and building to a climax. One could say it was more 'emotionally resolved', conveying the scale and power of the performance. Dynamic contrasts were more explicit. By comparison, the Pioneer was just a little bit too middle-of-the-road. In a sense, voicing a 'universal' player this way is correct – but if you're more into serious, 'take no prisoners' audiophilia, the Sony's presentation was more appropriate.

What then of SACD? Well, both players made distinctly nice noises with Propaganda's 'A Secret Wish'. Their respective characters, that CD had so explicitly signposted, remained

but interestingly there was a narrowing of the gap. The Pioneer remained the tonally richer and rhythmically more louche, whereas the Sony proved more engaging, detailed and incisive. But the superior resolution meant the Pioneer sounded less musically 'plodding' than before, turning in a seriously nice 'hi-fi' sound with oodles of bass weight, treble extension and fine dynamics. Again, the Sony was the more upfront and embracing, with more energy and clarity. Its bass assumed a good deal more weight, and this made for a most enjoyable listen – 'P Machinery' sounded powerful, grippy and dramatic. There was that same fluid midband, that same sense of a musical occasion, but more of the niceties you'd expect from SACD (warmth, space, depth, dimensionality).

Roxy Music's 'Avalon' was no less impressive. This much talked about disc was obviously more impressive on the multichannel mix, but even 2.0 proved powerful and propulsive in a way that the Pioneer was not. Once again, the DV868 relaxed and sat back, happy to give a commendably spacious and atmospheric rendition that the Sony simply couldn't equal. But likewise, the Sony took the music by the seat of the pants and got into the groove. It was 'arresting' and 'emotive' to the Pioneer's 'smooth' and 'sumptuous'. At this point, I thought I'd cue up my turntable (which costs some six times more expensive than either digital disc spinners here) to see how it should be done. And surely enough, we got the Pioneer's depth and dimensionality allied to the Sony's natural musicality and dynamics – and then some. Oh well, you can't have it all for £600, can you...?

Overall, it's a very accomplished machine, the Sony. If you're into music (as opposed to hi-fi) then you'll gravitate to this, much in the same way that you'd take a Naim NAIT 5 CD over the Unison

Research Unico CD for precisely the same reasons. You know it's not quite as 'pleasant' to listen to, but frankly neither is a live concert. In fact, it's actually a little brighter and more bracing than the SCD-XB790QS (at half the price), but altogether more musically coherent. Methinks that with a nicely neutral interconnect (Wireworld, LFD SpiroLink) and some Sorbothane feet to 'tweak' its tone down slightly, allied to a decently smooth integrated amplifier (Roksan M-integrated) and big, sumptuous loudspeakers (Castle Conways), you'd have the ideal mid-price digital system. Recommended.

## VERDICT ●●●●£

Not quite as smooth as some, but a very musically engaging and communicative design nonetheless. Brilliant ergonomics, nice build, fine CD playback and great SACD sound make it superb value.

SONY SCD-XA3000ES £599

Sony UK Limited

+44 (0) 1932 816786

www.sony.co.uk

### REFERENCE SYSTEM:

Michell GyroDec turntable  
SME Series IV tonearm  
Ortofon Kontrapunkt C cartridge  
Trichord Delphini NC phono stage  
MF Audio Passive Preamplifier  
Quad 909 power amplifier  
Quad 989 loudspeakers  
Townshend Maximum supertweeters

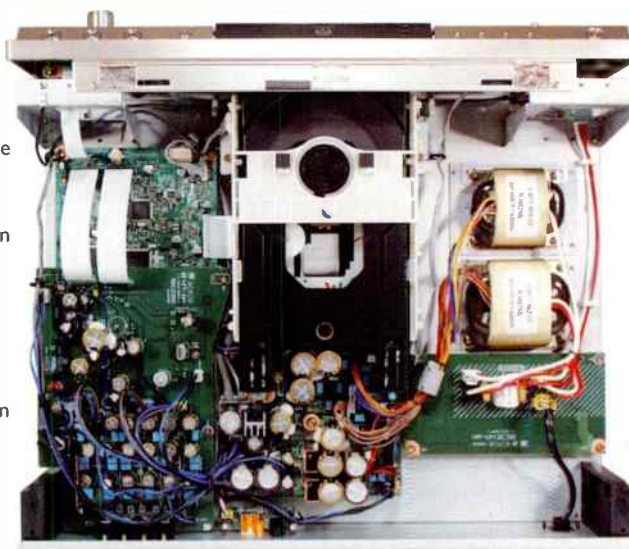

## MEASURED PERFORMANCE

Sony always engineer CD to a high standard, offering the best specs possible and this player is no exception. With CD it produces little distortion, with SACD it's minimal, our Rohde & Schwarz analyser reading SACD's noise floor. SACD will resolve signals below -100dB and our 5% distortion reading is actually noise.

SACD bandwidth reaches 38kHz (-1dB) before output rolls down to -3dB at 45kHz. Although there is output at 98kHz it is low.

CD manages the usual figures, with a super flat response to 21.2kHz (-0.05dB) with continuous signals, but only to 5kHz with an impulse, suggesting digital processing and a softer sound than usual (Sonzs are normally glassy bright). The player had very low distortion of 0.2% at -60dB resulting in large 112dB EIAJ dynamic range value. Output was low at 1.86V. There was a little programme related jitter, peaking at 100ps, not large but not as good as possible.

I suspect this player will sound unusually smooth and easy going. Sony

seem to be trying to tame the hardness of CD to bring it into line with SACD's presentation I have noticed with other players. That seems to be the case here. NK

Frequency response (-1dB)	
SACD	2Hz-38kHz
CD	5-21.2kHz
Separation	
	110dB
Distortion (-60dB)	
SACD	0.08%
CD	0.2%
Noise (IEC A wtd)	
	-104dB
Output	
	1.86V
Dynamic range (CD, EIAJ)	
	112dB

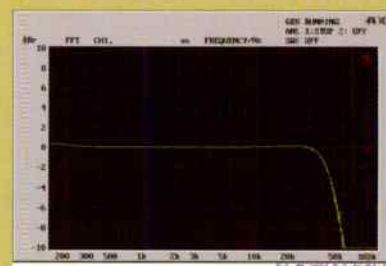

# Two Tribes



**When the decidedly digital Unison Research Unico CD player met the absolutely analogue Pro-ject RPM9X turntable, it was war – says Dominic Todd.**

**Y**ou have around one thousand pounds to spend on the best sound possible, and no prejudices about whether it's digital or analogue. All you want is the ultimate sonic performance at the price, from the format best able to provide it. So which do you choose? We decided to put two brand new, similarly priced new products from famous and well-respected European specialist manufacturers against one another – the only difference being that one was digital and the other analogue...

## UNISON RESEARCH UNICO CD

Just as vinyl enjoyed a revival as Compact Disc became the primary hi-fi source about fifteen years ago, so CD seems to be undergoing something of a renaissance now, with a host of interesting hardware launches and some great value software reissues. One such machine is the newly launched £1,195 Unison Research Unico CD, imported into this country by Italian hi-fi experts

UKD. As one would expect, there's nothing very ordinary or mainstream about this player, and it features everything that you'd expect from a brand seemingly obsessed by the presence of wood and valves. At 11kg, the Unico is heavier than many integrated amplifiers, and the generally solid build quality inspires confidence.

Cosmetically, there's little to get excited about. The slab-fronted panel is sturdy and, the now obligatory, silver. There's a neat wooden badge, and a rather unusual display. Unlike most other displays the Unico uses a large LC Display that features a 64 kb flash memory, allowing it to be personalised. The effect is rather attractive and not unlike using one of the better hard disc recorders. Fortunately, although clear, it's also far from intrusive, which is just as well as it can't be turned off. If you're impressed by the display, then you're even more likely to be bowled over by the remote control. Considering the price of the player, this is one of the nicest I've seen. Fashioned from

solid wood, the effect is extremely high end, and the ability for the remote to "stand up" is a further neat touch!

This is all very well, of course, but if the electronics inside don't match up, then the exercise will have been a waste. Fortunately as much effort appears to have been put into the internal gubbins. Of immediate interest to the audiophile will be the two ECC82 valves. Rather as Luxman did in the early 90s, these are used in the amplifier stage. Fully balanced, and running in triode mode they should offer a considerable input into the overall sound quality. The rest of the machine is less exotic, but well specified. There's a 24/192 Crystal DAC with three digital filters. The CD-ROM mechanism allows the machine to play most copied discs and track access is extremely fast. The downside is that it takes an age to initially read the disc, and then there's the inevitable zoom and whoosh noises that remind you that this transport could also sit happily in a cheapo desk top PC! Perhaps



more seriously is that a digital output is only available as an optional extra. Furthermore, it's only coaxial, so you'll struggle to connect a personal MiniDisc recorder. Overall though, for its £1200 price tag the Unico is a very solid and competitive product. Rivals around this price are many, including the superb Cyrus CD8 (£1,000), Meridian 507 (£1,200) and Naim CD5 (£1,200), so it faces stiff competition.

With the Unico plugged into my reference system, I began by listening to Royksopp's 'In Space'. The analogue quality, leant by the valve output was immediately apparent, and most soothing. Bass had good depth and a reasonable control. However, there are plenty of rivals that would show how it's possible to tighten things up noticeably at the bottom end, whilst throwing greater weight into the bargain to. Still, whilst rivals may have a more convincing bass response, they'd all be rather hard pushed to match the organic flow and relaxed pace of the Unison. Timing and detail retrieval may not have been quite top draw, but there was a measured pace about the Unico that proved engaging to listen to over extended periods of time. Although synthesised the music had a sweetness that was perhaps artificial, yet pleasant to listen to nonetheless. Anyone who finds the opposition too cold and clinical sounding would find

themselves well pleased with the cocooning and soothing Unison.

Norah Jones' 'Shoot The Moon' found this player in its element once again. Solid and well resolved, the vocalist was given plenty of space within the sound stage, and benefited from a fine height of sound to. Compared to my reference CD player I found the vocals to be refreshingly free from sibilance, and quite beguiling to listen to. Less good was the guitar which did lack precision. One couldn't really get a feel for the precise manner in which the strings were being plucked, and it's here that either a Cyrus or Meridian would show the Unison up most. Likewise, the percussion was far from being the sharpest, and would have benefited from a crisper definition. Better, however, was the piano's timbre which sounded natural and, unsurprisingly, rather analogue in its fluid response.

Going back in time, yet up in tempo, with David Bowie's 'Ziggy Stardust' found the Unison less than happy. I had feared that it would be too polite, and so it turned out to be. Bowie and Ronson's guitars were simply far too refined, and subsequently failed to really engage the listener. Similarly the drums lacked impact and there simply wasn't the dynamic scale needed for a song such as this. The effect this has is that the listener will turn the volume higher and higher in order to try and connect with the music, but never quite getting there, even at ear

splitting volumes. The timing did rather appear to drag it's feet, and whilst there was little actually at fault with timbre and staging, the over all sound was simply too smooth.

Moving forward to something a little more up to date, The Divine Comedy's 'Perfect Love song' proved more suited to the Unico's presentation. The laid back stance saw the vocals set a little too far back within the sound stage, although the texture was especially good. Those keen to hear detailed nuances from the lead vocal would be pleased by the Unico's ability to portray the details clearly without analytically stripping the voice bear of emotion. There was fine separation of instruments even during the more complex sections, when it can be a struggle to depict details such as a faint violin sound; no problems here for the Unison. Despite the fine resolution though, the lack of drive did once again let the player down. The bass response simply lacked the weight needed to underpin the track.

Much the same balance was evident with Classical music. Vaughan Williams' 'English Folk Song Suite', conducted by Adrian Boult, showed decent timing and some wonderful detailing. The decay of the triangle, for example, was superbly portrayed with the delicate instrument well supported and far from being overlooked. Another strength was the mellifluous string tone that ebbed and flowed in a sweet, almost vinyl-like, manner. Yet these qualities came at the expense of the dynamic scale, which simply couldn't compare to rivalling machines at this price. The brass lacked attack, and the tension and drama in the piece couldn't help but sound somewhat rose tinted and softened.

That the Unico CD player is special at this price point is beyond doubt, but it is not the very best sounding player. The designers have obviously voiced it for a very analogue sound, and the tube output stage is testament to this. As a result, its natural and expressive balance works particularly well with vocals and strings. Likewise, the frequency response appears well covered with no sonic nasties, and certainly no excessive sibilance. This is a player, that with the right music, one could listen to for hours on end without it ever becoming intrusive.

However, you don't get an analogue sound by simply adding few valves to a CD player. This player has an obvious lack of pace and impact that could prove annoying for some listeners, especially if one's system is

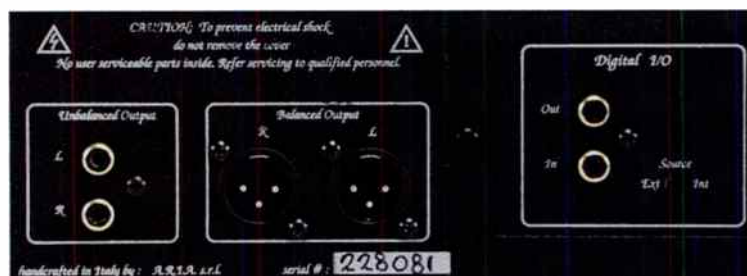

Balanced XLR audio outputs shows this player means business...



already biased towards a smooth sound. Detail retrieval can also be patchy, good at times, but slightly stifled at others. There were also times when the generally good sound staging became a little too reserved and recessed. Separation and height of sound, however, never turned out to be an issue. It's an impressively smooth machine, voiced in a very particular way that some will love and others will hate. How then does it compare to its closest analogue price rival, Pro-ject's RPM9X turntable?

**PRO-JECT RPM9X**

As far as the Pro-ject range is concerned, this is as good as it gets. It has subtly updated the range-topping £1,000 RPM9 with the effect of making their skeletal deck even more - skeletal. The MDF plinth, as used by the RPM9 reviewed by Hi-Fi World in May 2002, has been changed for a transparent Acrylic. It still houses three adjustable feet and an inverted type bearing, but now has a far more high-end look. Completing this is the existing 3.5kg Acrylic platter, although this is translucent. As before, the AC motor is wisely mounted separately from the plinth. It is metal cased, and sits atop a heavy metal stand not unlike the record clamp. Speaking of which - the brass clamp remains, and can be a real pain to use. Unlike some clamps it doesn't use a screw thread, but doesn't sit straight onto the spindle either. The upshot is that a twisting motion is needed to fit the thing, and if you don't hold on to the plinth hard enough, it can knock it out of kilter with the motor housing. Although the gauge will soon have things lined up, it's annoying none-the-less.

The tone arm is much less

frustrating. This is typically Pro-ject in that it offers much for the money, but not the best of finishes. The carbon fibre arm tube adds to the impression of something special, and you can adjust the VTA and azimuth. Anti skating is adjusted by the good old-fashioned (and arguably sonically superior, as there's no spring) means of a swinging weight. Best of all, the good quality tube cable is terminated by gold phono sockets, allowing the listener to choose their own interconnect. The finish is fine, but it's definitely no SME and even struggles to match Rega. Overall though, I found the deck easy to set up, good looking and with a true high end specification and not quite a true high end price. The finish is still not quite in the same league as some rivals, but still a great improvement on Projects of old.

And so to battle. Could the RPM9X work some that fabled 'analogue magic' and better an already very sophisticated CD player? The first disc to hit its twelve inch platter was Coldplay's 'Spies', and it immediately became clear that Pro-ject's tweaks have raised the game a notch or two. The precise and bold staging gave the lead vocalist a sense of 'being in the room' that the Unico could never quite replicate. For the price of the player, vocals were as good as they

get, with real presence, texture and coherence. There was a slight touch of sibilance, although this may have been able to be tweaked out by a different cartridge to the Ortofon MC20 Supreme I used. Rather like the vocalist, the guitar was beautifully resolved, with the reproduction being both detailed and precise in timbre. After the Unico, the bass came as something of a surprise. For ultimate weight the CD actually eclipsed it and, perhaps more surprisingly, was warmer in texture too! Yet in terms of timing and tautness, the Project was in another league. Whilst it didn't have the sheer weight of the decks from the class above, it possessed a pace that could really underpin the music, and drive through music in a particularly well integrated manner. In comparison to the Unico it was as though someone had lifted a veil from the speakers...

Grace Jones's 'Pull Up To My Bumper' showed similar control and insight. Bass certainly wasn't the deepest, but the Project made up for it in other respects. The percussion fairly leapt from the 'speakers, yet it managed to pull the whole track together without sounding stilted or disjointed. Key aspects were the fine timing and excellent mid-range clarity that, no doubt, the acrylic platter has done much to clean up. The upper-mid band detail was truly exceptional for a player of this price, despite a new-found alacrity of sound, the texture and involvement didn't suffer.

It was interesting to find that with Donald Byrd's 'Dominoes', the vocals almost sounded a tad too strident. There wasn't the warmth here that I was used to from the Unico. Having said that, of the two it was the Project that was more accurate if not necessarily the more pleasant to listen to. One aspect they had in common was a similarly smooth portrayal of strings. Neither were exactly analytical here, yet both could soothe with a smooth and fluid response. Yet again it was the bassline that showed the real differences between the rival formats. Whilst the RPM9X's proved addictively buoyant,

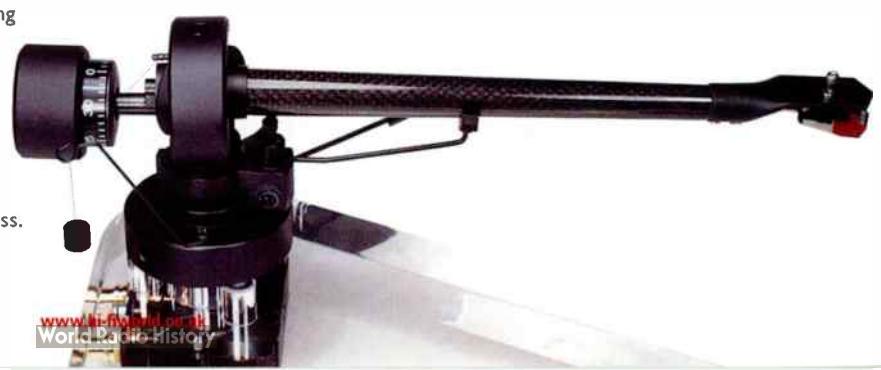



**THE EDITOR SAYS:**

Unison Research's new Unico CD spinner is a brave and earnest attempt to make a digital disc spinner that analogue aficionados will be able to live with. And they can. But ironically, it loses much of the grip and speed of digital in the process. It's a lovely sounding bit of kit, but one voiced more for lovers of dinner jazz than thrash metal. On the other hand, Pro-ject's latest RPM9X is vinyl 2004-style – which means tight and taut and incisive, rather than soft and fluffy like an old Thorens. The result is that the analog-in disc player for the digital age has, in some respects, more digital attributes than the CD player – and vice versa! Still, the innate irrevocability of analogue wins through, however marginally. These two new products have been noticed. If it's natural sound you're after then, pound-for-pound, we reckon vinyl still wins by a country mile.

although not especially deep, the Unico was far more sluggish in its response.

The Divine Comedy's 'Everybody Knows' had a bite and attack that proved engaging. The key to the Project's success here was that it allowed each type of instrument its own voice, without laying too heavy a colouration of its own across the board. Hence the stringed

captivating and I noticed here, more than with other types of music, the very low levels of surface noise. This no doubt helped the fair dynamic ability of the Project even if the lowest bass notes still didn't sound quite menacing enough.

As a deck in its own right, Project should be very proud of the new RPM9X. It shows a brilliant level of insight into the music and has a

particularly transparent midrange. It never fails to engage the listener, thanks to its fleet-of-foot timing, solid soundstaging and coherent balance. Its bass isn't the deepest and it isn't quite as analytical as some, but for most of the time the listener will be having too good a time to notice, or even care. With the right cartridge I would certainly rank it as one of the best turntables around this price.

Perhaps then it's a little unfair to compare it with the Unico which, in my opinion, isn't one of the best CD players at the price.

Still, it's one of the most characterful and its analogue stance makes it right for this comparison nonetheless. Indeed, in many ways it's remarkably similar to the Project, with a fluid and beguiling sound that could be the perfect tonic to listen to after a hard day at work. Yet in terms of timing, sound staging and sheer presence, the Project is in another league. Both have a likeable and musical sound, but it's only the Project that will keep you up all night rooting through your music collection. Now, just stop and think for a minute. Whatever would we be thinking if, back in 1984, we knew that twenty years later a brand new analogue turntable would have beaten a valve-aspirated digital Compact Disc player? The world is upside down.



instruments were sweet and natural whilst the electric guitar was far more raw with extra stridency and sheer oomph. At times the vocals were almost a little too harsh, but Hannon's vocals stayed just on the right side of brash for me. Had they been any mellower, then they would have somehow lost there intensity and character.

It was with classical music that the two players came closest in character. With Berlioz's 'Symphonie Fantastique' (Jean Martinon conducting the French National Radio Orchestra), the Project ebbed and flowed in a similarly smooth, melodic manner. There was a good balance of analysis and flow, yet it was really no better than the Unico. There are other CD players and turntables at this price that would strip more information off the disc, but whether they'd be as beguiling to listen to is another matter entirely. The RPM9X was never less than

**VERDICT** ●●●●£  
A significant improvement to an already excellent turntable, this sounds unrelentingly musical whatever you play. Only the middling finish detracts from a great package.

**PROJECT RPM 9X** £1,000  
Henley Designs  
☎ +44 (0)1225 511186  
www.henleydesigns.co.uk

**VERDICT** ●●●●  
An unashamedly analogue sounding digital disc spinner that's as smooth and sweet as they come, but lacks drive and determination.

**UNISON RESEARCH**  
**UNICO CD** £1,195  
UKD  
☎ +44 (0)1753 652669  
www.ukd.co.uk

**MEASURED PERFORMANCE**

The need to quell CD's oft-cited nature is evident here. Unison gives the player a classic slow response roll off at high frequencies, but impulse analysis shows, damping down any tendency to brightness. As a result the Unison will likely sound smooth and easy going, rather than fast and bright.

Distortion levels were very low, measuring a nominal 0.001% at -5dB. Digital distortion rises as signal level falls however, yet at -60dB the Unico still managed well retaining a low 0.32%. The valve output stage adds a little noise our distortion analysis shows, but at -55dB this will not be audible.

A healthy output of 2.3V will ensure this player makes itself heard in any comparative stem.

The Unico measures well in all areas and will likely sound smooth and open, certainly inoffensive. NK

Frequency response (-1dB)	5Hz-21.2kHz
Separation	111dB
Distortion (-6dB)	0.001%
Noise (IEC A wtd)	-90dB
Output	2.3V
Dynamic range	105.5dB

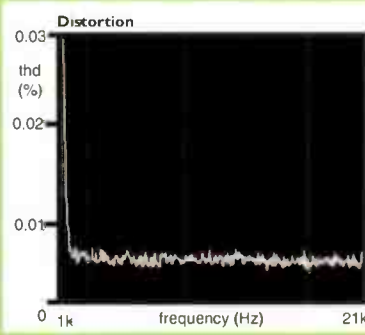
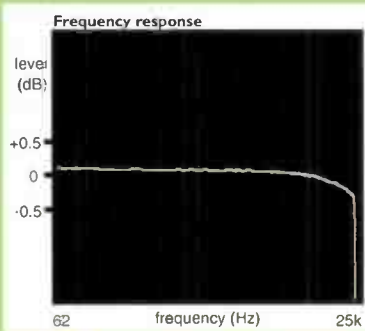

# mail

Visit our website at [www.hi-fiworld.co.uk](http://www.hi-fiworld.co.uk) or send your emails to [letters@hi-fiworld.co.uk](mailto:letters@hi-fiworld.co.uk). Letter of the month wins a pair of Precious Metals Interconnects and one years FREE subscription to HI-FI World.



## Letter of the Month

### LO-FI - MY PART IN ITS DOWNFALL

I am heavily indebted to your excellent magazine, which I started to read regularly in the summer of last year; I quickly realised that Hi-Fi World is in a different league from your many competitors, mainly due to the independence and integrity of your editorial policy and the sound technical knowledge of your contributors. It was with this background established, that my listening world was totally transformed beyond my wildest dreams by the purchase of your October 2003 issue ~ but the story begins forty years ago, when I managed in my early twenties to save up £40 (about one month's net income) as my budget for a new pair of loudspeakers.

Incongruous as it will seem, I was advised at the time by F. Cave & Son, running a very small but well-informed hi-fi dealership over a greengrocer's shop in Putney! When they had established that my main interests were in the fields of classical, operatic and choral music, I was then given the most wonderful piece of advice ~ go away and save up another £20 and then you'll be able to buy a pair of the speakers you liked the most when you listened to them - the Quad ESL57s. So I did just that, and a couple of months later I started my life-long love affair with my Quads ~ mind you, I wasn't too enamoured with the bronze grilles!

A few years later, Quad themselves realised that dull bronze was not the most lounge-friendly colour, and much to my chagrin, changed the grilles to black, which not only looked much better, but stopped friends holding their hands out in front of them on coming into the house in cold weather! A few years later I bought a Cyrus DVD 7 player ~ a superb compromise between the excellent CD7 player and a machine which also gives excellent pictures too! With a large CD collection, the quality of CD sound was vital, which the Cyrus

delivers in spades!

Readers who have followed my story thus far will therefore readily appreciate my great excitement at seeing a picture of my beloved Quad 57s on the cover of your October 2003 issue, with the wonderfully uplifting caption ~ 'Quad's Joyous ESL57 Reborn'. Within a few minutes of buying your October issue, I was reading about the ultimate ESL57s. Sorry to have to launch into superlative-drenched purple prose but, "a good pair of second-hand Quad ESL57s fully rebuilt by One Thing Audio is the best loudspeaker value I've ever come across. For around £1,500 you'll have one of the greatest ways of hearing music yet devised." For those of us reading those words who already owned ESL57s, the investment is even less, since your costing includes the purchase of a pair of used Quads in order to start the process.

Having read three of four monthly issues of your magazine before the fateful October issue in question, I had formed the impression that you were not an Editor to throw superlatives around willy-nilly, and I would have been impressed had you said, "you'll have a great way of hearing music", but it was your choice of, "you'll have one of the greatest ways of hearing music", which really caught my eye. After all, who amongst us who have read in awe of the many tens of thousands of pounds required to buy Linn, Naim, Krell, Macintosh, Wilson Audio, B&W Nautilus, Wilson Benesch, Musical Fidelity, Meridian et al, would ever have dreamt that for about £20,000 LESS, we could own one of the greatest ways of hearing music yet devised!

I can hear many people reading this saying - surely an additional outlay of another £20,000 would produce a better sound, but if your true quest is to achieve the closest approach to the original sound (pace Peter Walker) I think you would be obliged to concede that a top of the range audio set-up costing upwards of £20,000 sounds

different, but it would be a very brave soul to insist on saying that it sounded better than my fully rebuilt Quad ESL57s. (courtesy of first-class workmanship by One Thing Audio of Coventry). I should like to make it quite clear that I greatly respect the manufacturers of all top hi-fi equipment (i.e. all those I have listed above), but Tom Heinitz was right when he said - you don't need to spend a small fortune to achieve a very pleasing result.

For Yes ~ you've guessed it! Just like the man in F. Cave forty years ago, I instinctively felt that you were very sincere in your recommendation to proceed with a rebuild of ESL 57s, and now I can tell your readers that you were right to use superlative-drenched prose when describing the result ~ my rebuilt Quads sound simply state-of-the-art! And of course, my sub-woofer is now totally redundant! But as you might have guessed ~ thanks to your November 2003 issue, I was quite fascinated to read Noel Keywood's article on the Classique Sounds rebuilt Leak Stereo 20 which you yourself said sounded staggeringly good and again, you were spot-on, as I am now the proud owner of the amplifier I really wanted in 1967. I visited Paul Greenfield of Classique Sounds in Leicester, who I found to be very knowledgeable. What's more, I felt him to be completely trustworthy, which was even more reassuring. Anyone who wishes to have reliable advice on pre-owned valve amps, pre-amps and crucially - what goes really well with what ~ should beat a path to his door. In addition to my buying my Leak Stereo 20 from Classique Sounds, he also found me a pre-owned mint condition Rothwell Indus passive preamp (at a £500 saving on the new price!) which is a quite wonderful partner to the Leak. I found Andrew Rothwell of Rothwell Electronics extremely helpful about reasonably priced interconnects ~ I bought Rothwell River interconnects for £85 per pair and a pair of Rothwell

speaker cables for £200 ~ from my perspective, these amounts on cables will buy good quality with excellent sound.

I can promise your listeners that my Quads (£1,175) with my Leak Stereo 20 (£600) and my Rothwell preamp (£350) and my Cyrus DVD 7 (£1,000) set-up sounds like a £20,000 system (obviously without the sheer power available from huge power amps, and without the ability to satisfy headbanger rock music addicts) but for voices, strings, pianos, and orchestral music in an average domestic setting, I would eat my speakers if they were not truly EC-STATIC, as the Oct 03 Hi-Fi World cover put it, with the sound quality! I would be pleased to encourage any of your readers to correspond with me by email to aidanjones@ntlworld.com if they wish to discuss any aspects of my letter.

**Aidan Jones,  
Colchester**

Aidan, I'm delighted you're happy with your system. And to everyone else reading this – yes, I know it's a bit of a 'toadying letter', but I just had to make it LOTM because this guy is obviously over-the-moon with his purchases – and it's a 'good news' story in the middle of a grim winter. And I can see why Aidan's so happy - the One Thing Audio modded ESL57s are superb, in my humble opinion. Having moved to a brand new pair of ESL989s (plus Townshend Maximum super-tweeters), I can honestly say that – in some respects – the modded 57s win the day. They certainly sound less clinical and more punchy. (Still, I reckon the 989s are exquisite, all the same). I'm using the NS1000Ms as my secondary reference speakers these days, simply because Noel and I were of the view that I should be running contemporary products as a reference. When I had the One Thing modded 57s (often powered by the Audio Research Vsi55 – "kowabunga!"), I didn't find myself yearning for the Yam's visceral 'thwack'. Now, with the 989s, I do – they're an altogether politer and more refined experience. But I have to say they're the best looking loudspeakers I've ever seen – especially in the 'Granny's Knickers' finish mine are in... Oh, and by the way – Paul Greenfield from Classique Sounds is indeed a diamond geezer, and readers could do with giving him a buzz before bidding on an overpriced bit of tat on eBay! From now on, however, 'toady comes' will automatically be disqualified from LOTM – hit me

with the big issues, guys. Speaking of which... **DP**



**One Thing Audio  
modded ESL57s  
– sublime.**

**MOVING TO MULTICHANNEL**

*I am considering making the leap from stereo CD reproduction to surround sound, but am having a few problems interpreting some of the jargon despite being technical. I have come across a number of recordings from the 1950s and '60s which were only originally recorded in 2 track (e.g. Miles Davis 'Kind of Blue'), being sold as DTS 5.1 surround sound? How can this be, I didn't realise it was possible to separate sounds/instruments from a single recorded track even in the digital domain! What is the definition of true surround sound and does a recording have to be made with surround sound in mind to produce the proper result? I ask this with respect to the remastering of old multitrack recordings as well as two track.*

*The reason for my doubts is that I fear the advent of SACD and DVD-A although admirable, will give the record companies yet more opportunities to miss-sell by inaccurately describing the recording or production process. Also, in cases where the original artist cannot be present, remastering for surround sound will require more subjective decisions on the presentation of the music, maybe producing a result the artist would not have liked.*

*Another problem in the past has been record companies practice of not using original analogue masters to make CDs, even when available. Can we be sure this will not happen again, as this would infuriate the audiophiles they are trying to appeal to. What a cynic, I hear you say - go on take that leap into the 21st century! Some people still swear by 78s! Could the struggling record industry be about to shoot itself in the foot yet again?*

**Julian Davies**

Our correspondent Patrick Cleasby is actually a DVD mastering engineer by trade (eighties music fans look out for his multichannel remastering of John Fox's 'Metamatic', out soon), so I thought I'd defer to his God-like genius on this point. Excuse me while I put the kettle on, and – whatever he says – I couldn't agree more! **DP**

There is indeed a veritable minefield to be negotiated in trying to find your way to a 'true' surround mix. It's one of the reasons that we try to select and review the best examples of the genre for you. With a few exceptions (see this month's Depeche Mode review for a discussion of 'faux surround') we will present you with true 'discrete-mixed' titles for consideration. In my experience, very pleasing results can be obtained by remixing most multi-track material, even that from before the quad age. Sophisticated surround reverb may well be used in the digital domain as part of the process, most commonly using a TC Electronics TC6000. As you mention, it can be mystifying defining how mid-20th century recordings have been 'expanded' for 5.1, but if you're interested, the Sinatra DVD-A sleeve describes the process from a 4-track start point, or the Beach Boys DVD-A explains the complexities involved in syncing the separate vocal elements to the instrumental from their respective tapes.

'Kind Of Blue' was reputedly remixed from a three-track master, and the assumption has to be that the (minimal) rear channel ambience is artificially created. Who knows what Miles would have said? There are fine examples of surround mixes

based on copy masters through necessity - although the bulk and expense of 2" analogue means that you are much less likely to find a copy master unless a digital safety copy was struck at some point - albums such as 'Aja', 'Forever Changes', 'Close To The Edge' and 'Who's Next' are currently all stuck at the first hurdle with some or all their reels missing. Fear not and join the party! **PC**

Surround sound can be derived from stereo, although not from mono. The process of derivation from stereo is described at some length on the Dolby Labs web site ([www.dolby.com](http://www.dolby.com)), with relation to the workings of Dolby Pro Logic. These days, with the benefit of good steering logic, this processing yields impressive results; I often prefer Pro Logic surround-sound to stereo from CD. What you have to bear in mind here, as wise minds have pointed out, is that stereo is not theoretically perfect. Microphones fold ambient information into the front channel, which strictly isn't correct, and the sound stage is constructed in your head by a trick we all just accept. So there's nothing too perfect about stereo, although it does a fine.

Yes, modern surround-sound schemes are a contrivance, part of the production process - they are not faithful recreations of a sound field. All the same, you'll find most surround mixes are engaging or even dramatic. They are also a lot clearer than stereo. It's best not to get too sniffy about all this and just listen - I think you may well enjoy! **NK**



*When is a multichannel mix real, and when is it imagined - by the mastering engineer?*

### OH, AND ANOTHER (ONE) THING...

*I just got finished reading your recent review of the original Quad ESL loudspeaker. Overall, a very good review, however, there are several errors with this review. First, the clamp circuit does not in any way degrade the sound*

*quality of the speaker. I have allowed literally dozens of ESL owners compare the speaker both ways. No one has ever been able to tell which speaker was clamped, and which speaker was not. All ESL owners should fit their speaker with the clamp circuit no matter what amp they are using.*

*While the new One Thing Audio panel is very nice, it is a far cry from the original. Sonically it is quite different. Your own tests demonstrate my position, showing an overall efficiency of 82dB. This is far below the original spec of 86dB and this lower sensitivity is typical of after-market panel rebuilds. One Thing, as I understand it, does not use the original nylon coating on their panels.*

*Secondly, you noted a slight peak at 12kHz. Again, original panels will not demonstrate this peak. This is, again, quite common for panels that are not rebuilt correctly. One Thing is a great company, and does a great job of working with the ESL. Their tweeter rebuilds or new panels do not match what was originally delivered by Quad and sound quite different. There are rebuilders that can provide exact replicas of the original panel using the exact original materials and tensioning techniques. One Thing makes some major changes to their panels and this results in a rather major shift in the overall performance of the speaker. Lower efficiency, peaky top end.*

**Kent McCollum**

*"I refer the gentleman to the answer I gave some moments ago". You're right, the One Thing Audio panels do sound - and measure - differently; but better in my opinion. I'd say that your last sentence is a rather 'reductive' appraisal of the mods - things aren't as simple as that. As for the clamp - well, myself and ex-Eds Jon Marks and Simon 'Popemeister' Pope all agree that the clamps don't do the sound any favours, and even the Quad boys themselves mutter the same - quietly, under their breath, strictly off the record, you understand... Still - each unto their own; I'm not claiming my ears are definitive (no more than anyone else's). I stand by my warm words about the modded ESL57s. **DP***

The original ESL63 clamp circuit, which was a self powered limiter in the audio transformer primary circuit, introduced muddle and compression as volume was wound up - I remember it well! Quad acknowledged this and in the end came up with high voltage clamp diodes in the secondary that did a much better job.

I have always measured Quads out at around 82dB, never 86dB. Manufacturers often veer into extreme optimism here!

I personally liked the ESL-57 rebuild and was very impressed by the way it measured. No problems here.

**NK**



**Castle Howard S3 - big hearted, sweet natured.**

### SAMPLE THIS

*It's been some time since you published my ranting as your 'letter of the month', summer of 2003. I still think the same about the Philips Motional Feedback 'speakers, and did buy a second set to keep as spares to keep them going. These came with a torn bass driver and real shabby cabinets. I patched the cone up with wood glue, applied sparingly and teased the fibres out and together, let it dry and tried them. Believe it or not, they not only worked but sounded superior to the other pair by a fair margin! I believe they call it 'product variability' or something like that?*

*Now if this is consistent with all products, what chance of getting two the same let alone buying something that sounds like the demo model? I wonder how many manufacturers or distributors select the samples they let out for review? Call me cynical but I would guess it's fairly common. Any chance of covering this as a subject in the future and seeing how much a product varies during its production life?*

*The Philips have been put away while I find time to build new cabinets for them and improve and replace the DIN sockets. I am using a pair of Dalesford Ds, circa 1978, and an old Proton 930 receiver in the meantime.*

The *Proton* is truly excellent, if anything warranted inclusion in the classic section, this does. Smooth, detailed and powerful beyond its 30W rating. As you are probably aware it's made by the people who first made NAD gear, just seems to be even better built with more modern components. Same people made the AMC range also I believe?

I bought the Dalesfords after trying to buy a sensibly priced pair of JRI 49s, they aren't half bad and were my other choice way back in 1978 when I did buy a pair of JRs - wish I'd kept them, be worth a fortune now. My free LOTM cables? Not bad, but after a lot of A-B'ing I still prefer the ones I use on the CD player and the jury's still out when used on the other sources. Speaker cables are a home brew version of the many cat5 projects on the 'net - any of you guys tried them and if so what do you think? They successfully outperformed some QED silver coated stuff I bought. Anyway enough of my rambling, work calls. It's the bane of the drinking classes you know! Would appreciate any feedback on the above.

**Gary Francks**

Hi Gary,

Sample variability? This happens far more than we think. And it's not just between two different samples from the same batch (which will throw up differing component tolerances), but different batches change subtly as component suppliers change or minor mods are made to the design in the name of reliability (or cost saving). For example, I've had several Sony CDP-101 first generation CD players. The first one I bought was one of the best sounding silver disc spinners I've ever heard, bar nothing. The next one wasn't bad, but sounded thin and grey by comparison. I spoke to Eric Kingdon at Sony and he said that they'd changed something minor mid-way through the product's life, and - yes - the earlier ones did sound better.

Does this then mean that manufacturers cherry pick the samples they send to magazines? Well, who knows? But I'll say that it's more often 'cock-up' than 'conspiracy'. If I had a Cliff Richard single for every time we've come across a faulty and/or duff review sample, then I'd be Radio One's very own Mike Read, pop-pickers! As tantalising as it is for us to suppose that nasty, inscrutable manufacturers are constantly tweaking stuff for magazine reviews, in my experience it is not the case. More prosaically, they occasionally hold back review samples to run them in, because certain (other) hi-fi magazines have

been known to review them after having just plugged in brand new, never used products... Ho hum, enough said.

As for JRI 49s - time was when they were fifty quid in second hand shops, and now suddenly everyone thinks they're the ultimate! May I remind folk that they're just re-bodied LS3/5a, which are great little mini-monitors, but not flawless (sorry AL!). Give me Linn Kans any day... **DP**

My views on the above combinations are mixed and varied, but I find the Shelter cartridge slightly too soft and warm for me. It does sound very good, but in these combinations, not quite right for me. The two that impressed me most were [7] and [8], with [7] winning due to the Transfiguration cartridge. It is more in line with the balance I prefer, though I wonder whether using the Illustrious or SMEV would produce more bass?

Whilst waiting for your response, I

**Origin Live Illustrious tonearm, the JP Montoya of the turntable world...**



**WAITING IN VAIN**

Thanks for putting my query in the February edition of \*The\* magazine (uh oh - another 'toady alert' - Ed). Since that email, I have been busy listening to many turntables and arm and cartridge combinations:

- [1] Michell Orbe SE + Morch + Shelter 901
- [2] Origin Live Resolution + Illustrious + vdh MC One
- [3] SME 10 + IV + Shelter 901
- [4] Musical Fidelity M1 + Shelter 901
- [5] Linn LP 12 (Akito + Dynavector DV10) & (Ekos, Lingo, Akiva)
- [6] Avid Diva + Rega arm (I think) + Ortofon MC25FL
- [7] Orbe SE + OL Encounter + Transfiguration Temper V
- [8] OL Resolution + Illustrious + Lyra Helikon
- [9] Michell Orbe SE + SMEV

I have come to the conclusion that, as you already mentioned in your response, the Orbe is the best compromise. I am still waiting to hear the Avid Volvere (and or the Sequel) but this will only be possible (in London anyway) at the end of this month and this is probably the only one that could steer me away from the Orbe. Anyway, what I wanted to ask you was what is your opinion of Origin Live (Encounter & Illustrious) and SME arms (IV & V) with regard to their sonic characteristics and their strengths and weaknesses (assuming you've heard them)?

went on holiday to Hong Kong and bought a temporary cartridge upgrade for my ageing Sansui SR 212 - the Shure V15VxMR came up very cheap and I couldn't not take it up (your Dynavector was double the Shure in price). Anyway, will this Shure serve as a starter cartridge for the Orbe and one of the OL/SME arms until I can save up for something like the Temper? Please do not publish this in the magazine ... I can't wait another 3 months!

**Chi**

Hmmm. Nice simple query - that's what I like! Right, first things first. OL vs. SME arms. I haven't 'happened upon' the Encounter, so can only speak of the Illustrious. Right now, I have two reference vinyl sources - a Michell Orbe/OL Illustrious/Ortofon Kontrapunkt B and a Michell GyroDec/SME Series IV/Dynavector DV20X-H, both going through a Trichord Delphini NC. The OL arm sounds very different to the SME, although bizarrely quite similar. Both scavenge vast amounts of detail, both have very authoritative and commanding bottom ends and extended highs. Both are highly dynamic, yet very incisive with low level nuances. So they both press all the right buttons, yet their respective characters are so much at odds.

If I may use a Formula One analogy, if ever there was a Michael

# Sevenoaks SOUND & VISION



**SPECTACULAR SALE**  
**OFFERS** ONLY ON THE  
SEVENOAKS WEBSITE  
[www.ssav.com](http://www.ssav.com)



SAVE UP TO

# 50%

OFF ORIGINAL SELLING PRICE

**HUNDREDS OF BARGAINS**  
AVAILABLE FROM OUR 49 STORES NATIONWIDE

Special Buys ✓ Overstocks ✓ Ex-Display ✓ End Of Line ✓ And Much More - All Fully Guaranteed

Log on to [www.ssav.com](http://www.ssav.com) and click on [Special Offers](#)

**REAL STORES**

**REAL PEOPLE**

**REAL PRODUCTS**

**REAL SAVINGS**

## 49 STORES NATIONWIDE

Bedford • Birmingham • Brighton • Bristol • Bromley • Cambridge • Cardiff • Chelsea  
Cheltenham • Crawley • Croydon • Edinburgh • Epsom • Exeter • Glasgow • Guildford • Holborn  
Hull • Ipswich • Kingston • Leicester • Leeds • Lincoln • Liverpool • Maidstone • Manchester  
Newcastle • Norwich • Nottingham • Oxford • Peterborough • Plymouth • Poole • Preston • Reading  
Sevenoaks • Sheffield • Solihull • Southampton • Southgate • Staines • Swansea • Swindon  
Swiss Cottage • Tunbridge Wells • Watford • Weybridge • Witham (Essex) • Wolverhampton

CALL YOUR LOCAL STORE ON  
FREEPHONE

# 0800 587 9909

TURNTABLES

TUNERS

CD PLAYERS

RECORDERS

AMPLIFIERS

SPEAKERS

DVD PLAYERS

AV RECEIVERS

PLASMA

LCD TV

PROJECTORS

AND MORE

Why risk virtual shopping when there's a **REAL STORE** nearby?

World Radio History

Schumacher of tonearms, it is the SME IV (and V – they're virtually identical sounding). It is so darned efficient – it just goes in and does the job, without complaint, totally consistently, time after time, with dazzling results. Yet you can't help but feel it's all a little, ermm, boring. Now the SME isn't a boring listen – far from it – it's just that its sheer all round ability and general lack of definable character means it not naturally endearing to human beings! The Illustrious, however, is far more of a JP Montoya. It's fiercely capable, yet obviously more emotional in the way it does things. It has a certain swing, an obviously discernable character about the way it plays rhythms – it's very warm and beguiling, where the SME is mechanical. It also has superb tonal colour. Don't get me wrong, it's not coloured but rather boasts an 'inky black' signature that lets the music's own tonality shine through. The SME is a tad more homogeneous – it's full and open sounding, yet doesn't quite dissolve in the way the Illustrious does.

Well, this is my two cents – but for our intrepid correspondent Stewart Wennen's view, you'll have to turn to page 17. Oh, and sorry about the wait. We get a lot of letters from readers saying, 'please help NOW, because I'm just about to buy something tomorrow'. But as we have six week lead times, I'm afraid we can't always oblige. I try to give instant email replies when I possibly can, but you'll have noticed that Hi-Fi World has rather a lot of content compared to certain other publications, and doesn't write itself! I hope you understand. **DP**

### WASTING MY MUSIC?

Advice required on speaker choice! My system consists of Arcam 8 SE CD player, Pro-ject RPM4 with Goldring 1042, Croft Super Micro preamp rewired and recently Glen Croft modded, Audio Innovations 800 25w triode monoblocks (again Glen modded) cabled QED 2 interconnects with cheap Cable Talk tri-wired to SD OBS speakers with internal silver wiring. I listen to jazz and soul and will be listening about 7 hours a day, and I like bass but not boom. My living room measures 20x12x8ft. I need to reduce the speaker options down from my list of ProAc D1.5, Spondor SP2, Castle Howard S3, Living Voice Auditorium, PMC FB and IPL S3tm ribbon. I listened to the Perigee FK-1 at a hi-fi show and loved them, but can't afford them. My budget is about £1500.

**Alan Cross**  
Via email

Hi Alan – in a nutshell, I'd go for the Castle Howard S3. If you liked the big 'physicality' of the Perigees, then you'll find the Castles do the same – albeit on a slightly reduced scale, one that should work well in your room. The Howards are also ideal for jazz and soul, as they're full, rich and creamy with what my father would call 'a good tone'. They're easy to drive and with bass aplenty, but shouldn't boom unless you put them too close to a rear wall.

**DP**



**Sony CDP-101 – like many hi-fi separates, not every batch sounded the same...**

### THE MORAL OF THE STORY IS...

Having recently purchased a Pro-ject Xpression turntable for a mere £190 in the January sales, I feel inclined to write to share how much pleasure this little deck has brought me. Having previously owned LP12s and a couple of Regas, I have to say this deck knocks spots off them! Okay, it may not be built to the same Linn quality but in terms of sound in my eyes and ears it's way ahead. It is crisp, clear, has great imaging and stage depth with low colouration, and it has upgradeability built in, as the arm will take far costlier cartridges than the Ortofon OM10, and it comes fitted with along with electronic speed change if you want it. This deck sings through my Sugden A21a amp and Quad 111 'speakers. I suppose the moral of the story is you don't have to spend serious dosh for great sound.

**Tony Hodgkinson**  
Coventry

Blimey Tony – have you been on the Christmas sherry? A £190 Pro-ject that beats LP12s...? I'm very happy for you, and delighted at your finding a bargain, but am not completely sure that the 1 is a Linn beater... Each unto their own! **DP**

### NEW ADVENTURES IN HI-FI

Around 12 months ago I bought a second-hand Thorens TD160 Mk1 complete with TP16 arm, Shure V15 Type 3 cartridge with TP60 head shell alignment device. The whole package was delivered to my door for a total outlay of £160. When I eagerly unwrapped it I was delighted to find it

in pristine order, the cover had never been used as the previous owner had it installed in a cabinet. My new project had arrived. I started to research Thorens turntables using the Internet and found a plethora of useful resources several of which turned out to be invaluable. I would heartily recommend any interested parties visit <http://www.theanalogdept.com>, which has specific pages dedicated to Thorens turntables, <http://www.vinylengine.com> and not forgetting <http://www.tnt-audio.com>, though this page got me

making cables and power leads which postponing the project for several months!

The article that completely grabbed my imagination was in the TD-160 Department, and discussed setting up and tweaking a Thorens TD-160 and creating something to rival the very best suspended chassis turntables available. These were derived from the 'Legendary Chadwick modifications'. I have since learned that this particular gentleman, now sadly deceased, had a formula for modifying Thorens TD-125s which can be adopted for the TD-160. The recommendations are as follows:- Baltic birch plywood 1/2" replacing the existing bottom plate with three spikes or cones underneath.

- Isolation of the 3 suspension springs of the suspension using new gaskets and silicon.
- Dampening the top of the motor plate and the underside of the top plate with 2 kinds of silicon damping material.
- Readjustment of the bearings and selective damping of the arm tube.
- Dampening of the platter hub with silicon and rebalancing.
- Lining the underside of the arm board with cork for further isolation.
- Replacing the rubber mat with a Chadwick "Corktone" mat.
- Replacing the standard interconnect with a Sumiko PIP box and the interconnects of your choice.
- Installing and aligning of the arm and cartridge of your choice.

I am about two thirds of my way through the modifications and there are many more suggestions and set-up techniques throughout these sites which

I hope to try at some later date. I am also scouring and bidding on eBay for a good SME 3009 arm and am considering a cartridge upgrade (advice please). For the moment though my Thorens is spending much of its time on its side or being dismantled while I try to squeeze every ounce of performance from this brilliantly designed turntable. Many of these modifications should work well with any suspended TT such as Ariston, Linn LP12 and Systemdeks as well as most Thorens. Careful experimentation and research will lead you down the path of audio Nirvana. Oh! And by the way, the rest of my system consists of Quad 67 CD player, Quad 34 pre, Quad 306 power and Shahinian Super Elf speakers. All the speaker cables and interconnects bar those used for the turntable are home made using quality components. Finally, thanks to the magazine for introducing me to this fascinating and interesting hobby.

**Garnet D Newton-Wade**  
Wiltshire

Sounds like you're having fun, Garnet! You're right – the Thorens mods should work with any suspended subchassis belt drive (Linn, Systemdek, STD, etc.) as they're all close variations on the same theme! For your forthcoming SME 3009S2, get a Goldring G1042 (£120) MM cartridge, or if you can possibly afford it, a Shure V15VxMR (£350). When all this is finished, you should have a superb sounding deck. Don't forget the support though – you might be interested to see page 72! Do write in and tell us how you got on. **DP**

### GETTING BETTER ALL THE TIME?

I am thinking of upgrading my CD player. I have a Marantz CD 63 SE, and am thinking of a Marantz CD 6000OSE LE or NAD 541i. Are they significantly better than my '63 SE in their sound quality? Which sounds better - the NAD or the Marantz? I have two Rotel power amps; upgraded B&W 330i floorstanders, valve preamp and Kimber 8TC cable. Any advice would be greatly appreciated.

**Steve**  
Via email.

No, they're not significantly better! Indeed, even the new CD7300 isn't. Don't ever think that just by buying 'the latest version' of your existing machine, you'll get better sound. You'll probably get better ergonomics, more features, a nicer finish in a contemporary colour, etc., but you'll likely not get dramatically better sonics. That's because great sound comes from a mixture of

clever design and high quality components – and whilst the former may be improved slightly, the latter will only have got better if the price has gone up significantly. To wit, if you bought a Marantz SA-1751 (£1,400) you would get dramatically superior sound – but just replacing your '63SE with the latest model would change things – as opposed to improve them. Of the two, I'd say they're pretty evenly matched, with the NAD having possibly just a smidgeon more life and the Marantz just a tad warmer. The cheapest upgrade you could make is a CD6000 KI Signature (under £500 discounted), which would bring greater depth, power and expression – but for a comprehensive upgrade I'd go for a Meridian 507 (£1,100). This will yield an altogether more sophisticated and organic sound, with a rich and warm bass, beautifully lucid midband and smooth and spacious treble – by contrast, your Marantz will sound just a touch mechanical and two-dimensional. Good luck!

of the Nuvista on similar equipment to my own, other than the fact that rather than my budget £25 interconnects, Cardas Cross was used. The difference was quite staggering and I have once again gone down the Nuvista route but using Cardas golden cross interconnects. Not cheap, but the results are well worth it. I am currently experimenting with speaker cable to link to my Kef 405/3s. Generally I believe your system is only as good as its weakest link and that when considering an upgrade all areas need to be considered. Cables, all of them including power, form an equal part of the system and, as a rule of thumb, I would suggest that at least 25% of the total system cost should be invested here. No matter what you spend on your amplifier, CD deck, etc., you are heading for disappointment if you try to use the cables that come with the unit.

**Peter Bennett**

Hi Peter – yes, I take your point. You're absolutely right that poor cables can spoil an otherwise superb



**Audio interconnects – essential accessory or get-rich-quick scheme?**

### DP CROSS TALK

I read with interest your reply to Ben (May 2003 letter of the Month - sorry I am a little behind with my reading!) and whilst I am sure that your advice is valid there is one vitally important area I feel you have neglected. Some time ago I took the opportunity to purchase a second-hand Musical Fidelity Nuvista CD player at a very good, but still huge, price. This was run bi-amped through a MF F16 and P270-2 (I have been searching for another good 2nd hand F16 for months without success - if anyone has one for sale, please contact me on 07971 445704) which has the same circuitry as the F16. Having forked out the readies I was very disappointed with the result. So much so that I let the CD player go again at the same price I bought it for.

Some time later, I had the opportunity again to sample the delights

machine or system. But my low opinion of cables in general comes from the fact that the cost of manufacturing a £200 1 metre pair of interconnects is, I'd say, about one tenth of that of making £200 CD player, amp or speakers. I have no hard facts to substantiate this, other than anecdotal comments that certain manufacturers mumble to me from time to time. For example, cable manufacturer A will complain to me that cable manufacturer B's cables are cheapo proprietary wire bought from China, given a day-glo dielectric and shiny gold phono plugs – and sold with a massive mark up. There seems to be a lot of this going on. I'm not saying that all cable manufacturers are doing this (absolutely not so), but it happens more than it should, and it's easy to make a fast buck from cables than from most other things in hi-fi, or life



for that matter! So that's why I'm predisposed to being a sceptic. Which is not to say that all cables are rubbish, as there are patently some superb designs out there from established and not so established brands alike. You just have to listen to the cables in the context of your own system, with your music, and your ears – don't just buy on the strength of rave reviews. **DP**

I remember the Tandy LX5s, and recall hearing two completely different speakers in one box – a lovely, sweet and open tweeter allied to a boomy and flatulent woofer with little in the way of midband. But that's just me. If there's any one out there with help for 'Tandy man', please do write in...

**DP**



**Sony SCD-XB790 SACD spinner – creamier than a bottle of Baileys.**

**IMPROVING THE TANDY LX5**

Some months ago I read a couple of articles on the Internet published by Larry van Wormer and Eric Wallin, regarding improvements to the little Tandy LX5. You remember, the little reflex box with the Linacum ribbon tweeter? I have a couple of pairs of these great little units which, for the price, far outperform any normal box speaker I have heard. The main drawbacks were always an understandable lack of deep bass and a peaky midrange. The Internet articles suggested that changing the bass/mid driver to a SEAS unit worked well and brought about much more detail, smoothness and better power-handling. Additionally, a simple crossover modification could improve things still further.

So I swapped the stock drivers for the SEAS MRCY14P units expecting a minor revelation (they dropped directly in without needing any alteration). Shock horror – smooth yes, but what bass the originals did have has now completely vanished! Tests showed that bass response now falls off a cliff face below 300Hz. The originals got down to about 120Hz before starting to roll off. Now I am no speaker designer and assumed that the crossover, which I have not touched, would simply manage the interface between the bass and treble drivers and therefore make no significant difference to the depth of the bass response. So why has the bass disappeared? The wiring is in phase, the new drive units have been checked out OK. I have no way of contacting the publishers of the articles, despite placing this issue on various newsgroups etc.. Has anyone else tried this upgrade and did they experience similar problems? Any help would be greatly appreciated. **Anon.**

**(CLOG) COUNTRY LIFE**

Due to domestic circumstances, I listen to my stereo through headphones a lot. My dad gave me his Wharfedale Isodynamic headphones because he never used them anymore. They must be some twenty five years old, but still sound nice. But what is Isodynamic, or is (was) it just a marketing thing, and how were they rated in their days? Friendly greetings from clog country,

**Hans Bakker  
Nederlands**

As I remember it, they used a lightweight diaphragm onto which was printed a conductor that carried the audio current. The resultant varying magnetic field interacted with a static field generated by magnets. It's not a new idea by any means and it works tolerably well, but a step down transformer is often required and the whole is often bulky and expensive. **NK**

**NATURAL MAGNETISM?**

I've been recently concerned with a number of people reporting problems with their TV picture when hi-fi speakers have been placed next to the TV. I have a pair of floorstanding TDL G30s, and one of the speakers is next to my widescreen Sony TV. I've had these speakers for a number of years and therefore cannot remember if they have magnetic shielding. I've searched the internet and tried to find technical information for these speakers, however have had no luck so far! Can anyone offer any advice?

**Prafull**

If there is a problem you will see it as distortion of the picture and change of the colours. This is quite

obvious. Try moving the speaker away by 'walking' it and watch what happens to your picture. If it changes then you should move the speaker away. **NK**

**BLOW UP!**

I was interested in purchasing the Sony SCD-XA3000ESN A SACD player as the reviews rave about its smooth and rounded delivery. I listen to much rock and pop which often doesn't sound too great - thin and bright; and even if there is bass the treble can still be too unruly. Good hi-fi can often ruthlessly reveal these imperfections but it doesn't have to be like this. I have the new Sennheiser 650 headphones and they make everything sound wonderful - natural, warm, and easy to listen to, much better than the 600s. I wish I could find speakers that sound like these. After your fabulous review of the Sony SCD-XB790 I wonder if I might be better off with something like that?

Although the SCD-XA3000ESN SACD player may be more revealing I would always prefer something more easy to listen to in the long run - like the wonderful 650 headphones. So perhaps the XB790 may be a better bet. I might have to wait until you have reviewed XA3000ESN A - what do you think?

**Kevin Blow**

With an unusually soft and creamy sound, the XB790 is quite unlike any budget Sony CD spinner I've heard, but methinks you'd do better to hold out for the more expensive SCD-XA3000ESN if you can afford it. I've just heard one driving the PA at Ronnie Scott's jazz club in Soho, and it was very convincing indeed. We've got this on order – so watch this space for a full review - and I'm looking forward to hearing the new SCD9000 soon, too. Still, if you want the smoothest and sweetest SACD spinner that mere mortals can afford (just), I'd wager that Marantz's SA17 is it. **DP**



**Can TD160 tweaks take it up to Thorens Reference standard?**

# Hot and Cold



**Not to put too fine a point on it, there are two types of transistor amplifiers in this world – those biased towards Class A and those not. Anatek Audio's new A50 integrated is the former, while Roksan's new Caspian M Series-1 integrated is the latter. David Price works up a sweat...**

Life is never simple, and in hi-fi this rule is all too apparent. This isn't the story of a 'good' amplifier versus a 'bad' one - George 'Dubyah' Bush wouldn't approve. Rather, it's a tale of two tribes of audio amplifier design, all the more striking because this isn't about a small specialist British manufacturer versus the best a massive Japanese multinational can offer, but of two - ermm - small specialist British manufacturers... In the red corner we have Anatek Audio's A50 integrated. It's from a tiny specialist 'start-up' manufacturer, looks like a bag of bits in a box and gets very warm when switched on, thanks to its Class A design. Opposite, we have Roksan's new Caspian M Series-1 integrated, which is from an established and respected small-to-medium size manufacturer. It looks swish, is beautifully presented and is much more of a Class AB-biased device.

## ANATEK

Never heard of Anatek? No, I hadn't either. But pulling it out of the box, I was struck by an uncanny feeling of déjà-vu - as I was magically

transported back to the late eighties, where the likes of Exposure's X and NVA's AP30 'super integrations' reigned supreme. Aside from the blue power LED (which I assume hadn't been invented then), it was pure 1988-style minimalism. This isn't necessarily a bad thing, but these days even Naim's NAIT 5 is a sleek and svelte affair with electronically switched volume and inputs. The Anatek, by contrast, is - well - just as amplifiers used to be, with nothing more than a volume control, input selector (at six, thankfully a few more than standard-issue eighties stuff), tape monitor (hurrah!), power switch and err, that's it.

Inside, designer Clive Read has come up with - so Anatek says - patented output topology that 'resolves the performance issues associated with conventional output stages', essentially giving Class A performance without the problem associated with pure Class A output stages, that of excessive heat. Yet still the amplifier is not biased towards Class AB operation, which is cooler but produces sonically deleterious crossover distortion. Still, while it's

true that the A50 runs far cooler than classic Class A designs like Musical Fidelity's A1 and Sugden's A21a, it is not true to say that it 'runs cool', for it does not.

The Anatek's output stage is direct coupled, eliminating the need for sound-degrading electrolytic capacitors in the audio path. The circuitry is designed to have low dc drift, so thermal memory effects - the momentary distortion caused by loud transients - are negligible, and the amplifier has a single low frequency time constant, the input coupling capacitor, for fast bass. A non-invasive electronic protection system is also featured, that shuts down the output stage when the output current reaches 12 amps. Finally, the inputs, outputs and mains inlet of the A50 all have RF filtering, while all amplifying stages have minimal gain at RF. Round the back, it's much of a muchness - save some distinctly poor and weedy looking speaker terminals.

## ROKSAN

Now, if the Anatek sports pure unreconstructed Eighties ergonomics



Both back panels are similar, but the Roksan is better finished...



and styling (although, methinks, not self-referentially so), then the Roksan is 'state-of-the-art' late nineties high tech. It's a truly well packaged product that looks cool, feels great to use and never obstructs what the user wants from it. The fascia is silver metal, with a centrally inset display window which subtly shows which source is selected or whether it's muted or not, while the red LED on the volume control tells you how loud it should be. And all this is mirrored on a small, slick remote – which is one notable thing the Anatek lacks. As for the aforementioned heat issue, this amp runs cooler than James Bond in Casino Royale, by which you can infer that it won't provide much of a boost to your central heating.

This, the latest incarnation of the Caspian, is marginally more expensive than its predecessor, but boasts a lot for the money. Aside from the aforementioned swish styling and ergonomics, inside you'll find a new, 'super-quiet' transformer – a massive toroid that puts the Anatek's already decently sized donut to shame, with four regulated supply rails. The PSU makes up much of the 12kg weight, which is a little higher than that of the Anatek. There's also improved speaker switching and protection software, new mains filter circuitry and more efficient venting. Measuring 432x350x80mm, the M-integrated's casing is marginally slimmer than the Anatek. Round the back, you get chunkier speaker socketry than the Anatek, plus five pairs of RCA inputs plus a single tape monitor loop – and an IEC mains input with switch (the Anatek is, in a nod to convenience, switched on and off on the front panel). There's also a handy preamp output – for bi-amp or upgrading, whereas the Anatek is 'like it or lump it!' Upon switch on, the M Series-I goes into mute mode, signified on the front panel by three flashes of

the display and the 'mode' beacon glowing orange. Then, when ready for action, it goes green.

### SOUND QUALITY

It's a tricky one, this. Both amplifiers are truly excellent products, giving deeply impressive results, but they're so different that I'm struggling to judge which is 'better'. If that sounds like a cop out, then it's not – and here's why. As with all audio equipment, nothing is intrinsically right. Take the Quad 989 loudspeaker for example – it's so amazingly capable in some respects, but for a £6,000 design is quite mediocre in others. By contrast, my other loudspeaker reference – Yamaha's NS1000M is far better at the frequency extremes, but lacks the

**” When a kettle drum is pounded, it struggles from the speakers**

superb across-the-range integration of the Quads. Can I adjudge which is better? I think not. Same here – these two amplifiers have great abilities, but they don't ever overlap.

First the Anatek. Rumour has it that this is a 50 watter but you could have fooled me. With my two aforementioned reference 'speakers it was out of its depth simply because of lack of power. What these did show, however, was that what little power it has, it uses to great effect. The Yams – with their glass-clear sound, instantly told me it has a generally 'dull' sound. But it's dull only inasmuch as it's not bright, brittle, chrome plated or clanky. Indeed, when you listen at length, it's quite spacious and there's an amazing lack of midband mush. Compared to the Roksan, it's gutless, low on

power, curtailed at both frequency extremes, but boy doesn't that midband impress! Oh yes.

Move to the M-integrated, and it's obviously brighter. Actually, it's by no means bright in absolute terms, because I still had to turn up the tweeter level controls on the Yams a tad to get a good tonal balance, but it has obviously more upper midband and treble energy than the Anatek. Yet most noticeable is the bass – which is dramatically more impactful and better controlled. Essentially, it's like pressing a 'loudness' button compared to the A50. But this isn't because Roksan has voiced the M in a strange way, but more that the A50 is rather soft downstairs and lacking up top – the Roksan is actually a tonally a very well balanced and even sounding amplifier, with just a touch of that trademark transistor 'brightly lit' upper midband.

Corduroy's 'Out of Here' was first on the CD player, and the Roksan sounded obviously more engaging. Bass was fast and powerful – not in Naim NAIT 5 territory by any means, but it was still admirably taut and tight, with plenty of power and real articulation. I'm sorry to say that the Anatek proved completely unable to get any real bass out of the NS1000Ms, so I moved to my trusty Mission 752s for the rest of the review. With these easy-to-drive, high sensitivity loudspeakers (the Yams are the latter but most explicitly not the former), the Anatek really began to sing. Its bass isn't the tightest, nor the most dynamic but it proved even more fluid than the Roksan

- I was impressed. By comparison, the M was stronger, tighter but ever so slightly slower and more mechanical – like a massively powerful luxury coupe compared to a small, light sports car.

Moving up to the midband, and again the Roksan impressed greatly. It's very open and even, with an impressively varied tonal palette. Warm recordings such as 808 State's 'Lift' sound warm; colder ones like Rush's 'New World Man' sound cold. There's also a good degree of timbral and textural detailing on acoustic music, with real rasp to the brass stabs on UB40's 'Love is Alright'. This is all placed into a wide and expansive soundstage, with strongly placed images and fine front-to-back detailing. It's very hard to fault at the price – not far behind Marantz's



**West One**

*A visit to KJ West One is likely to exceed all your expectations.*

*Here, you'll discover an incomparable array of sound equipment on permanent demonstration. Many of these components represent the state-of-the-art while others offer truly outstanding value for money.*

*Grounded in a love of music, we like to think we can offer sensitive expertise as well as all the facilities you'll need to complete your search for a system of musical purity, dynamism and authenticity.*

*To audition any of these components, as well as others too new to list here, please call in or, better still, make an appointment for a personal demonstration.*

*Most items can be made available at our branches. You can also phone or email [info@kjwestone.com](mailto:info@kjwestone.com) to arrange a demonstration of high-end equipment in your own home.*

*Because we take your interest seriously we'll go out of our way to demonstrate it.*



**ARCAM**

Diva A65 Int  
Diva A80 Int  
Diva A90 Int  
Diva CD73  
Diva CD82  
Diva CD93  
Diva T61  
Diva DT81  
Divo AVR200  
Diva DV88  
FMJ A32 Int  
FMJ CD33 CD  
FMJ DV27A DVD  
FMJ DT26 Dig Tuner  
FMJ 7.7 ch power  
FMJ AV8 Pre Amp processor

**AUDIO ANALOGUE**

Puccini Int  
Puccini SE Int  
Bellini Pre  
Donizetti Power  
Maestro Int  
Maestro CD  
Paganini CD

**AUDIONET**

SAM V2 amp  
ART CD

**AUDIO RESEARCH**

CD3 CD Player  
PH3SE Phono Stage  
SP16 Pre  
LS25 Pre  
VSi Int  
VS55 Power  
VS110 Power  
VT100III Power  
VT200II Power  
Ref Phono  
Ref 2 MkII Pre

**BOSE**

Lifestyle Systems  
28, 35, 40 and 50  
System 321

**COPLAND**

CDA822 CD Player  
CSA29 Integrated  
CTA305 Pre  
CVA306 VT Multi Ch. Pre  
CTA520 Power (2 ch)  
CVA535 Power (5ch)

**CYRUS**

DVD6  
CD6  
DVD8  
CD8  
Cyrus 6 int  
Cyrus B int  
AV8 Dig 5.1 pre  
Pre X  
Mona X  
FM X  
Smart Power  
Q Power  
PSX-R  
Quattro

**DYNAUDIO**

Audience 42  
Audience 52  
Audience 52 SE  
Audience 62  
Audience 72  
Contour 1.8

**GRAAF**

GM20 OTL Power  
GM13.5B II Pre

**HARBETH**

HL-P3ES  
HL-Compact 7ES-2  
Monitor 30

**KEF**

Q1, Q3 & Q5

**KRELL**

KAV 280CD  
KAV400xi Integrated  
KAV280P Pre  
KAV2250 Power (2ch)  
SACD Standard  
Showcase DVD  
Showcase processor  
KPS28C CD  
KPS255C Pre/CD  
KCT Pre  
FPB400cx  
FPB700cx

**LINN**

Classik CD/Tuner/Amp  
Classik Movie  
AV5103 A/V pre  
5125 5ch power  
Tunebox  
2250 2ch power  
Ikemi CD  
Genki CD  
Wakonda pre  
Kolektor Pre  
Pekin Tuner  
LK140 Power  
LK85 power  
Espes Speakers  
Ninka Spks  
Katan Spks  
Kan Spks  
Ekwal Centre Spk

**MARTIN LOGAN**

Clarity  
Aeoni  
Ascenti  
CLS IIz  
Odyssey  
Prodigy  
Script  
Depth & Descent (subs)

**McINTOSH**

C2200 Pre valve  
MC2102 Power valve  
C42 Pre s.s  
MX134 Pre/processor  
MC402 Power s.s  
MA6900 int  
MVP842 DVD/CD  
LS320  
LS340  
LS360

**MERIDIAN**

G07 CD  
G08 CD  
G51 Stereo receiver  
G01 Pre  
G02 Pre  
G56 Power  
G57 Power  
G68 Processor  
DSP 5000  
DSP 7000  
G98H DVD-A Player

**MICHELL**

TechnoDec  
Gyro 'SE'

**OPERA**

SP2  
Super Pavarotti MKII

**PATHOS**

New Classic One  
Logos  
TT  
Inpol 2  
In control  
In Power

**PIONEER**

PDP 504HDE Plasma  
PDP-434HDE Plasma  
VSA-AX10iS AV rec  
VSA-AX5iS AV rec  
DV868AVI DVD-A SACD  
DV668AVI DVD-A SACD

**PROAC**

Tablette 2000  
Studio 125  
Response One SC  
Response D15  
Response D25  
Future One

**PRIMARE**

D30-2 CD  
D20 CD  
A30.1 Integrated  
A20 Int

**QUAD**

99 CD-P  
99 Pre  
99 Power  
909 Power  
QC24 Valve Pre  
Q1140 Valve mono  
ESL988  
ESL989  
Model 11L  
Model 12L  
Model 22L

**SHANLING CD-T100**

**SME**  
Model 10A  
Model 20/2A

**SONUS FABER**

Musica  
Concertino Home  
Concerto Home  
Grand Piano Home  
Wall  
Solo home  
Gravis  
Cremona  
Cremona Auditor  
Cremona Centre  
Cremona Sub  
Amati Homage  
Guarneri Homage  
Stradavarius Homage

**SPENDOR**

S3, S6, S8, S9 & SR5

**TRIANGLE**

Titus 202  
Celsius 202

**UNISON**

Unico P int amp  
Unico CD player  
S2K S/E valve int

**WILSON AUDIO**

Cub II  
Sophia  
Watt / Puppy 7

**WILSON BENESCH**

Full Circle  
Chimera  
Discovery  
Curve  
Curve  
Arc  
ACT

**SPECIAL OFFERS**  
[www.kjwestone.com](http://www.kjwestone.com)

**PARTEXCHANGE WELCOME**

**HOME DEMS BY ARRANGEMENT**

**SOUND & VISION INSTALLATIONS**

**INTEREST FREE CREDIT** Subject to status

26 New Cavendish Street London W1 Tel: 020 7486 8262/3  
NORTHAMPTON (01604) 637871 & PETERBOROUGH (01733) 341755

[www.kjwestone.com](http://www.kjwestone.com)

**REFERENCE SYSTEM:**

Michell Orbe/OL Illustrious/Ortofon Kontrapunkt B turntable  
 Sony CDP-X77ES/Trichord Clock 4 CD player  
 Marantz PM17 II KI-M integrated amplifier  
 Yamaha NS1000M and Quad ESL-989 loudspeakers

listen to A50 at either full tilt or as background music and it always seduces, yet never offends.

found this was extremely impressive when being driven by my turntable [see Reference System box] – being a far more synergistic match to vinyl, whereas the Anatek didn't mind the extra 'zing' from digital in the least.

£1,400 PM17 KI-M at all – until you switch to the Anatek, that is.

Now, the A50 sounds quite anaemic compared to the big, commanding Roksan. It's obviously less muscular, displaying a tendency to sit on dynamic transients that the M simply does not have. When a kettle drum is pounded, it struggles from the speakers, whereas with Roksan it jumps out at you with real resolve. But there's still something very special about the A50 that – to my ears – makes it win the day, and that is the fine and desirable combination of transparency and fluidity. Put simply, it sounds less 'mushy' than the already admirably open Roksan by a very fair way. You can hear right through the soundstage, to the studio itself. The M series has a propensity to make everything sound big, fresh, crisp and punchy – no matter how it was recorded – whereas the A50 does not. If it's fast and clean, that's just how the studio sounded. You find a far greater repertoire of 'sounds' with the Anatek.

The other, and in my opinion more significant, advantage of the A50 is its midband fluidity. Although the Roksan is a very musical amp – thanks in no small part to the grippy and muscular bass – the Anatek is more so, despite its absence of taut, punchy lows. It has a valve-like lucidity that makes listening to the music a more emotional and less cerebral (or physical) thing. It has a brilliant command of the complex rhythms on 'Out of Here', or the lazy but very infectious groove on 'Love is Alright'. Much in the same way that Linn's Ekos tonearm impresses with its speed, control and dynamics, so the Roksan is a commanding and powerful listen. And likewise, just as Naim's ARO tonearm is softer and more curtailed at the frequency extremes with less dynamic light and shade – but far more emotionally engaging – so the Anatek pulls you in and keeps you there. Put simply, it's a hoot to hear – time and time again, you can

the high ranges, and again the Anatek falls behind. It's soft and a bit rounded off. It's certainly sweet, with oodles of gentle, filigree detailing – but simply doesn't project well. This means its suits bright loudspeakers and/or CD players down to a tee – ideal for budget to mid-price stuff but not for extremely neutral reference systems like mine. The Roksan is obviously more 'zingy', but in the great scheme of £1,000 amplifier HF performance is still admirably clean and crisp. It's in no way harsh or hard, but lacks the superb intricacy of the Anatek. I

So which wins? Neither, or both. Give me the bass of the Roksan, the midband of the Anatek and the best aspects of the treble from both, and you'd probably have the best amplifier under £2,000. As it stands, you have two very capable and well executed – but different – solutions to the problem of the £1,000 'super integrated'. So sorry about that – no *What Hi-Fi*-style 'hard-as-nails' conclusion, but what I'm less unequivocal about is that the fine sound, serious power and excellent ergonomics and styling of the Roksan M-series I make it marginally better value for money.

**VERDICT** ●●●●£

Clean and powerful sound allied to serious power and great ergonomics make this super value for money.

**ROKSAN CASPIAN M SERIES-1 INTEGRATED** £1,195

Roksan Audio Limited  
 ☎ +44 (0)20 8900 6801  
 www.roksan.co.uk

**VERDICT** ●●●●

Wonderfully lucid midband, but modest power and uninspiring styling make this the choice for focussed audiophiles only.

**ANATEK AUDIO A50** £1,000

Anatek Audio  
 ☎ +44 (0)7817 681402  
 www.anatek-audio.co.uk

**MEASURED PERFORMANCE**

**ROKSAN CASPIAN M SERIES-1**

With 84watts into 8ohms and 121watts into 4ohms the Caspian has plenty of power. It delivers it smoothly too, producing very little distortion from low power t full output, right across the audio band. Producing just 0.013% third harmonic at 10kHz when delivering one watt, the Caspian measures well here. It will likely have a sharper sound than the Anatek though, since third-order adds edge.

Input sensitivity was a useful 0.28V, good enough for low output tuners and cassette decks etc. Bandwidth was wide, stretching form a low 5Hz up to 90kHz, ideal for DVD-A and SACD.

The Caspian measures well in all respects and will likely have a well defined and punchy sound. NK

Power (8ohms)	84W
Frequency response (-1dB)	5Hz-90kHz
Separation	86dB
Distortion (1W, 10k)	0.013%
Noise (IEC A wtd)	-103dB
Sensitivity	0.28V
d.c. offset	48/49

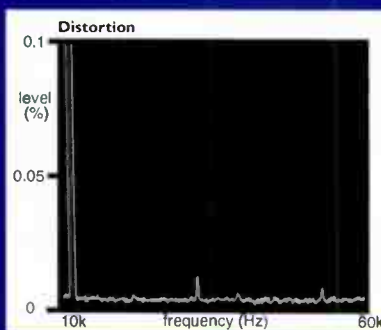

**MEASURED PERFORMANCE**

**ANATEK AUDIO A50**

Many new to the market amps don't measure up - literally - in one way or another. Usually, a crucial property like distortion is off target, but the Anatek looks good here. It produces little distortion at all frequencies and power outputs, and what little there was pure second harmonic - a very interesting property. It's also suggests a consistent transfer function which bodes well for sound quality. Other good points were wide bandwidth and useful power output of 55watts, rising to 100watts into 4ohms. The only questionable result was very low input sensitivity of 0.85V - fine for CD but too low for 0.3V-0.5V sources, of which there are many. I would expect a smooth, relaxing sound though, one likely to lack colour or hardness. NK

Power (8ohms)	55W
Frequency response (-1dB)	5Hz-50kHz
Separation	84dB
Distortion (1W, 10k)	0.016%
Noise (IEC A wtd)	-115dB
Sensitivity	0.85V
d.c. offset	9/28

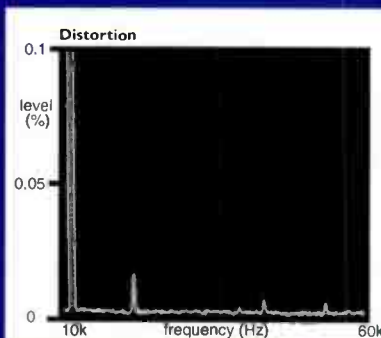

# Double Decca

**LONG TIME DECCA AFICIONADO STEWART WENNEN TRIES OUT DECCA'S LATEST LONDON SUPER GOLD PHONO CARTRIDGE, COMPLETE WITH DECCA POD MOD...**

**N**ow you may think I have completely lost my sanity. After all, Decca cartridges are supposedly rubbish - they cannot track a record and they damage precious vinyl. Well, both of these statements were true, in the past...

To understand a little more we have to return to the 1960s, when to own a serious high fidelity reproduction system was up with owning a Rolls Royce motor car in the 'status symbol' stakes. This was due to the cost of equipment and its relative rarity (it was extremely expensive in relation to the average weekly wage). There were plenty of records being sold but, sadly, very few shops selling hi-fi. A real hi-fi system generally consisted of a turntable, radio tuner, tape deck and amplifiers. Loudspeakers were the size of a small wardrobe and were very efficient but were extremely coloured with an uneven frequency response. The sound quality these systems reproduced was (and still is) magnificent.

## PAST TIMES

One of the heavyweight companies at the time was Decca. It recorded on vinyl, marketed it, had a research and development department and even a division that supplied special products - the 'Decca Special Products Division' no less! It produced a range of things, including Decca pick-up heads, pick-up cartridges and ribbon treble units. Unlike modern companies, these products were designed to work at their best with each other. Decca had tight control over the products, as it manufactured all the components

itself. It made and serviced everything, and the service department was unusual in that it turned customers' equipment around in approximately one-week - if only present day manufacturers could do the same! As recently as the nineteen seventies, Decca's re-tip service cost £15, which included post and packing.

The range of cartridges was not large, but included the Mk1, Mk2,

**” When Decca released the London in 1976, it was a quantum leap in advance of all other pick-ups. Even so, the cartridge had a few problems**

Mk3, Mk4, C4E and the London transducer. The early cartridges were intended to be used with the FFSS or other Decca pick-up arms. The C4E and London cartridges were the only products, which were intended to be used with other manufacturers' pick-up arms.

When Decca released the London in 1976, it was a quantum leap in advance of all other pick-ups. Even so, the cartridge had a few problems. The first was the microphony, which was obviated by painting the body with nail varnish. Second was the tracking ability, which was at best poor. The solution to this was to add mass (adhering a 10p to the headshell) to the pick-up arm certainly improved the sound. Thirdly the cartridges were not all the same, so it became a trial to discover the capacitive loading (Londons require 200pf). I remember Alan Willis and I tried to fill a London with Ferro fluid - we were trying to solve all of the

problems at once. It did not work of course, and cost us a fortune. We did not tell anyone... Still, the Decca's many problems were attended to, the results were stunning - the stereo image was detailed and large enough to walk around in.

## PRESENT DAY

These days, the Decca London is available new in Super Gold guise. My sample arrived from Brian at Presence Audio, and I felt like a little boy as I ripped the packing open to reveal the jewel box snug in its outer packing. As I have done so many times before - albeit many years ago - I mounted the London in my tonearm (in this case an Origin Live modded RB250) and cued up a record in heady anticipation. Unfortunately, this example sounded absolutely dreadful. I rechecked the set up, and there seemed to be nothing wrong - but wait, the pick-up arm lift was (just) touching the underside of the arm tube! The offending lift was dropped to enable the London to track the vinyl, and now was ready to listen to music in earnest.

The resulting sound was glorious, with superb image placement, powerful bass and detail retrieval of the highest order - all achieved at a tracking force of 1.6 grams! My jaw dropped. Believing that London cartridges can't do this, I duly set the tracking force to 1.8 grams and the sound changed to a richer, wider one, with an obviously deeper stereo image. Heaven - this is what I have been searching many years for!

I then duly ran the gamut of my record collection (not inconsiderable, if I do say so myself) and found that John Williams's flamenco guitar sounded superb, with a tremendously solid image and stage depth to die for. James Brown's 'Super Bad' album was wonderful too, with Bootsie's bass really propelling

**VERDICT** ●●●●£  
 One of the most musically engaging and characterful performers available, but questions still remain about its technical abilities.

**DECCA LONDON**  
**SUPER GOLD** £479  
 Presence Audio  
 ☎ +44 (0)1444 461611

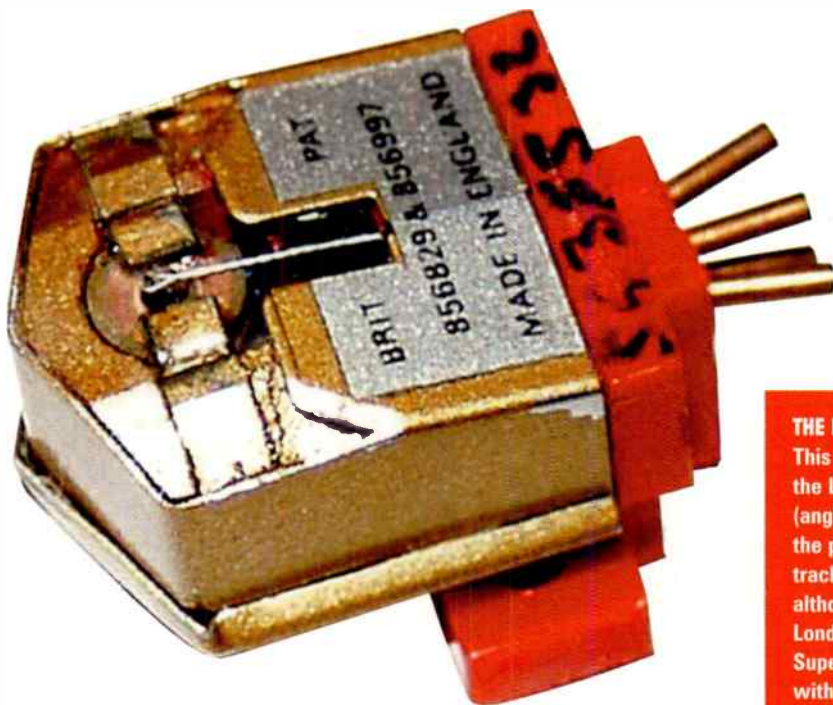

things along in a way that I've heard from few – if any – other pickup cartridges. This pickup also has a tremendous ability to discriminate between instruments - the drum kit is placed at the rear of the recorded acoustic, but I could still tell which cymbal was being used, for example. The difference between the ride, hi-hat and crash cymbals was so obvious that it made me wonder why I've bought so many expensive moving coils and MC step up devices over the years.

On female vocals, this device was chilling in that the sound was so realistic! Natalie Cole's voice was projected into my living room with the warmth she is famous for. The mix engineer did a fine job when he recorded her lush tones. After this session ended, I noticed my jaw was very sore because I'd been smiling all the way through. I have rarely found a pickup that plays records in such a manner. The bass is glorious, with a silky smooth midrange that glides effortlessly into a shimmering treble register.

Contrary to many people's findings, during this listening session the London Super Gold did not mistrack or harden up at all. Indeed, its ability to track even the most demanding vinyl was never in doubt [see Noel's measured performance – Ed]. These cartridges are the result of over 30 years of research and development. Their ability to transport the listener to the recording location is quite disarming at times. All of the orchestra, or rock and roll band, is portrayed with deftness and delicacy. With or without the Decca Pod [see box], this cartridge will suit most pickup

arms and should track like a limpet.

Life can be a circular chain of events, and even more so for audio addicts. After my formative years in love with the original London, I decided to purchase both of these cartridges after listening for three weeks, and Brian at Presence Audio will be receiving a fat cheque from me very soon! These are the Deccas that never were - they do everything I expect a pickup should do, and

**THE DECCA POD**

This is a solid piece of alloy, which is solidly attached to the top of the London Super Gold. Gone is the rather flimsy looking plastic (angle shaped) mounting bracket. The cartridge is bolted directly to the pickup arm. The cartridge seemed to be at its best with a tracking force of 1.9 grams. Set up is the same as the Super Gold, although volumes could be written about the conditions that suit London transducers best! Surface noise was even lower than the Super with this pickup. Stereo imaging seemed even more precise with an even greater depth, width and height. The overall sound signature is similar but this version has more of a grip on the music. Because of the more rigid mounting arrangement, the Decca Pod afforded the transducer, a slightly better tracking ability. A wonderful pickup! The Decca Pod is certainly worth the extra money in comparison to the Super.

more. And there's one more advantage to using a London, which is that you don't need a step up device. Forget moving coils – in my humble opinion this is the finest cartridge I've heard in my forty years in the industry.

**MEASURED PERFORMANCE**

The Decca has always been a controversial cartridge. The early London Blue had a great sound but terrible tracking, causing severe groove damage. The London Gold is an altogether more capable beastie, but it still has idiosyncrasies.

The Gold tracks well, but the London was designed for Hill-and-Dale recording (i.e. vertically modulated mono!). The cantilever's geometry is wrong for stereo, a displaced lateral pivot point resulting in severe waveform triangulation on lateral modulation, bringing no less than 10% distortion or more to centre images (e.g. vocalists). This is way above the norm, and will colour the sound. On vertical modulation, for which it was designed, distortion is very low. The vertical tracking angle is right too, so the Decca gets some things right.

It also gets frequency response right, as our analysis shows. It is ruler flat to 10kHz and there is almost no inner groove tracing loss from the stylus, an excellent performance. This again will be noticeable, impacting the sound.

Finally, the square wave response rings like crazy and spectrum analysis shows a large output peak at 20kHz-25kHz and output is in effect extended to nearly 30kHz by this, making the London the closest analogue equivalent to DVD-A

(96kHz) methinks.

The Gold is very right in some areas and very wrong in others. I know it's a dramatic sounding cartridge; part of which is real and part contrived. Measurement indicates the Gold does not plough up vinyl like the Blue, so it is worth a listen. No other cartridge sounds quite like a Decca - for good reason. NK

Frequency response (-1dB) 20Hz-20kHz	
Separation	18dB
Distortion (-6dB)	6%
Output (5cms/sec)	5mV
Tracking (lateral)	
300Hz	90um
1kHz	25cms/sec
VTA	18degrees
weight	6.7gms
VTF (optimum)	1.6gms

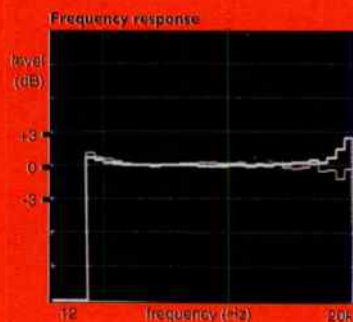

# PATHOS

"The Pathos Acoustics Classic One is one of the finest sounding amps I have ever heard, of any era, from anywhere. . ."

Sam Tellig – *Stereophile*, Nov 2003



UKD Ltd.  
23 Richings Way  
Iver  
Bucks  
Tel: 01753 652669

[www.ukd.co.uk](http://www.ukd.co.uk)  
[post@ukd.co.uk](mailto:post@ukd.co.uk)

## MICHELL TECNODEC

A SYMBOL OF PRECISION



Michell Engineering Ltd,  
2 Theobald St, Borehamwood,  
Herts, WD6 4SE

Tel: 020 8953 0771

Fax: 020 8207 4688

Email: [info@michell-engineering.co.uk](mailto:info@michell-engineering.co.uk)

Web: [www.michell-engineering.co.uk](http://www.michell-engineering.co.uk)



# Cell Phono

**Audio Analogue's Aria is a phono stage with a difference, thanks to its 'virtual battery' operation. Dominic Todd gets totally wired...**

**A**t first this £500 phono stage appears predictable enough. As you'd expect there's MM/MC switching, good quality internal components and a solid and well finished aluminium casing. Yet the Aria has two further surprises. The first is a 'virtual battery' power supply - the outboard power supply unit supplies banks of power supply capacitors in a double reservoir system. One bank feeds power to the amplifier circuit whilst the other is charged up, and vice versa. This means that the supplying capacitors are never directly connected to the mains, so should reduce mains borne noise and instability. The six Kendeil capacitors offer up 39000uf storage apiece, so should be up to providing the current without undue concern.

The second surprise is its 'tweakability'. As well as adjustments for MM/MC, there are three other sources of adjustment for perfect cartridge matching. MC gain is set at 27dB but can be adjusted from 22.5 to 33dB. One word of warning here though - changing the gain does involve soldiering resistors so, if you're uncertain of your ability, it's worth consulting your dealer first. The other adjustments are easier to manage. Both the capacitance and resistance can be altered to match your cartridge of choice, done via the simple expedient of plugging different RCA plugs into the rear of the unit. Capacitors values range from 100pf to 330pf and resistors from 100R to 470R. So there's a

great deal of scope for those keen to get exactly the right match with their pickup.

## SOUND QUALITY

Hooked up to a Project RPM9X, the first thing I noticed was slightly more noise from the phono stage than expected. Even with the virtual battery power supply it wasn't as silent as some of the competition. Nonetheless, it was quiet enough and better than most inbuilt phono stages. Most striking about its sound was the depth and power of the bass - it really is in another league from the Project Phono Box SE or Musical Fidelity X-LPSv3 - if not the Trichord Dino. It was the sheer depth of sound that impressed. Vocals were extremely well projected, and there was excellent staging and separation of various musicians. Percussion was smoothly portrayed though perhaps a little too much so - at times it felt as though some of the finer detail had been glossed over to achieve first rate refinement.

The acoustic strains of Richard Thompson's 'Fast Food' showed an appealingly musical side. Even though both violin and electric guitar were too refined for my liking they did show excellent timbre, as did the subtly portrayed mandolin. Once again, thanks to the depth of stage, Thompson's vocals were brought well forward from the backing vocals, and each given their proper authority within the song. The strong, powerful bass came to the fore with The



Cranberries

'Linger'. The downside was a slight lack of pace, and there are rivals that certainly would be fleetier of foot here. Certainly the bass has a fragrant 'bloom', which actually suited the guitar, and it took the edge off a vocalist whose performance can err towards harshness on some equipment..

'Rhapsody In Blue' by George Gershwin provided a superb piano timbre that was sympathetic to the key strokes and willing to follow the change in tempo and resonance. When the full orchestra kicked in there was plenty of weight to the sound if not quite the attack. It didn't quite ever make the hairs stand up on the back of the neck, or make the listener jump with surprise. I feel this was probably down to the reproduction of the brass section which lacked a little rasp. Detail ambience, though, was first rate, with subtle decays and strokes audible even when the music was at its densest. Best of all, the sound had an organic and effortless nature to it - in other words, it sounded most un-hi-fi-like, which often is no bad thing at all.

Rather like many of Audio Analogue's other products the Aria is perhaps something of an acquired taste. It lacks immediacy but boasts other qualities that really do give a taste of high end hi-fi, like three dimensional sound staging and instrumental timbre. Anyone seeking refinement will delight in the Aria's culture and polish. Add the superb build and tweakability and it looks as though Aria have got another winner on their hands.



## VERDICT

Impressively warm, smooth and dimensional sound, but some will crave more speed and grip.

**AUDIO ANALOGUE ARIA  
PHONO STAGE £500  
UKD  
+44 (0)1753 652669  
www.ukd.co.uk**

# the great debate: DIGITAL

Back in the eighties, everyone was talking about the relative merits of LP vs. CD. Most assumed digital was best, and that analogue addicts were old sticks in the mud. Fifteen years later, and the vinyl revival was proof positive with a growing dissatisfaction with digital, and it seemed the vinylistas were winning the day. Now, with SACD and DVD-A, we're into new territory yet again. So we decided to canvass the thoughts of four industry experts, from a variety of backgrounds. As usual, don't be shy about writing in to tell us what you think...

**NAME:** PETER COMEAU  
**JOB:** Director, Acoustic Design  
**COMPANY:** Mission

**A**nalogue is better because it is an exact trace of the require waveform. However the theoretical justification neatly avoids the problems of the storage medium which inevitably bring in noise and distortion. When these are taken into account the practical advantages of digital (low noise and distortion) begin to outweigh the disadvantage of never being an exact copy of the original waveform. One should always bear in mind that analogue systems mirror nature in the way that distortion increases with level, whereas digital distortion increases as level is reduced. Distortion is therefore of much greater importance to the subjective results from digital systems.

Good analogue still plays 'music' better than digital, so for pure pleasure I still find my turntable indispensable. However, digital is

easier to use and work with, and some systems and discs get close to the finest performance from analogue, close enough to indicate that it may be possible for digital to overtake analogue performance in the future. Analogue has

the advantage of natural, pleasurable sound quality over current digital systems. However, classical music on vinyl is a bind. Putting up with clicks, pops and end-of-side distortion is a pain. As for digital, undoubtedly the advent of CD improved the performance of the average stereo system dramatically. Compared to cheap turntables, low cost CD players offer much better results.

The music industry moved to digital in the eighties because it offers a multitude of advantages to the musical instrument and recording industry. The ability to manipulate and store digital music without apparent degradation is very alluring. The ease of duplication of CD has allowed completely automated manufacture of discs, reducing the cost to the manufacturer to a fraction of the expense of vinyl record manufacture. For the public, the promise of no noise and ease of use was a no-brainer for the purchase of a new format and method of reproducing it, offering a shot in the arm to a declining audio industry.

It is interesting that 'remastering' to digital of analogue studio tapes doesn't often work too well. To understand this one has to look at how records were recorded and mastered to sound 'good' on vinyl, taking into account the warmth, coloration and other idiosyncrasies of the vinyl medium. Remastering to transfer the original master tape sound as truthfully as possible onto CD therefore doesn't capture the result that was available from the



original vinyl record (Fleetwood Mac 'Rumours' is a typical example). Users may be buying turntables just to recapture the musical experience from their existing record collection...

High res digital formats certainly have a future. In stereo the systems offer higher sampling rates and more bits than CD, coming closer to that theoretical ideal of analogue reproduction. But the systems need to be used wisely, throughout the recording, mixing, mastering and duplication chain, if the advantages of high res are to be realised. In terms of popularity things are more difficult for these new formats. Except for hi-fi aficionados, most users do not see the reason for anything better than CD. The high res formats offer them nothing in terms of usability over CD. Only the carrot of multi-channel could persuade the average user to invest in new equipment. In practice the ability of new DVD players to automatically play multi-channel

**FAVOURITE ANALOGUE:  
REVOX G36 15IPS TAPE DECK**

*"This gets closest to the absolute requirement of analogue replay, its mechanical integrity and simple valve replay system defined the performance of domestic tape usage before the disruptions of Dolby and the cassette medium."*

**FAVOURITE DIGITAL:  
MUSICAL FIDELITY TRI-VISTA SACD**

*"With a well recorded SACD, this gets closest to a natural performance from stereo digital disc yet, though I'm keeping my eye on DVD Audio as it progresses..."*

# VS. ANALOGUE

SACD and DVD-A discs may lead to an interest in purchasing discs in these new formats.

DVD-A offers the higher sampling rate and bit allocation that CD should have had in the beginning. Unfortunately the current disc storage limitations mean these specifications are degraded for multi-channel, but this can be solved by new DVD high res formats in the future. SACD is more difficult to sum up. The wider bandwidth than CD, and simpler signal path than PCM, is an advantage, and is not compromised by multi-channel, but the requirement for filtering above 40kHz to avoid a rapidly rising noise floor will prove an irritation, as is the difficulty of mixing DSD in the recording studio ●

sound quality appears to have become merely incidental. In spite of the claims for the new formats it is plain that much is still not understood about the exact nature of digital. Things that look perfect on paper turn out to be far from perfect in practice. CDs were eventually discovered to have up to 30% distortion in the bass which is nowhere near as good as vinyl. This is just one example but there is also a raft of other misconceptions - were the designers not aware of these problems?

At face value it may seem straightforward to translate a digital code into analogue, so where does it go wrong? Is it sampling rates? Even with the new high sampling rate digital formats, the translation from

Which is better depends on the limitations of existing technology and knowledge

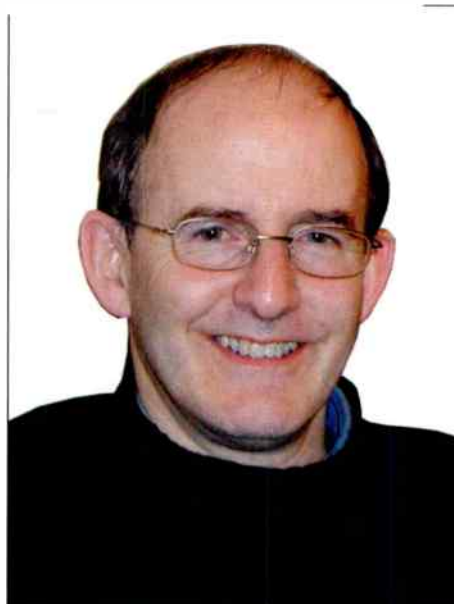

**NAME:** MARK BAKER  
**JOB:** Design Engineer  
**COMPANY:** Origin Live

**T**heoretically each format could claim superiority if the technology behaved perfectly. However the discussion ultimately boils down to the fact that both mediums have technical issues to overcome. Which is better depends on the limitations of existing technology and knowledge. When CD was first launched, people sited the technical superiority of the medium over vinyl - better dynamic range, lower distortion etc. The same old rhetoric is being repeated for the new digital formats - In the effort to claim technical superiority and the advance of technology, the issue of subjective

digital to analogue is bound to degrade the signal significantly. This is due to the limitations of the devices that read information on the discs - not all the information is read perfectly and disc reading errors occur continuously. The electronics required to compensate for the ensuing mess has a host of side effects that are most unpleasant. Severe and complex problems lie in the multitude of activities that the electronics must perform. The outcome is that the new digital formats are severely flawed as far as the human ear is concerned.

According to a number of expert opinions outside the digital marketing

departments, there are specific technical problems with the new formats which mean that they will never outclass vinyl in terms of sound quality. One easily understood issue is the "watermark" that is put on an increasing number of digital discs to prevent copying. This

#### FAVOURITE ANALOGUE:

**ORIGIN LIVE SOVEREIGN TURNTABLE/ CONQUEROR TONEARM**

*"In my opinion, this is the closest thing I've heard to live music. It also looks eye-catching, with an engineering quality that begs to be listened to!"*

#### FAVOURITE DIGITAL: SHANLING CD PLAYER

*"This looks absolutely superb, and is one of the best sounding in my opinion although it's rather on the euphonic side, and does not have the best bass quality."*

# definitive audio

Definitive Audio creates a quality of musical experience that is irresistible. We achieve this using some of the world's most splendid contraptions and by employing a value system that places musical considerations above all others.

Our inventory includes the tantalising KSL Kondo amplifiers from Japan. We have the M7 Line, M7 Phono, M77 Ongaku, the Neiro integrated and of course the extraordinary Gakuch. We also have a range of single minded amplifier designs from, amongst others, Border Patrol, Art Audio and Sugden. Our Aladdin's cave of analogue treasures includes 12 choices of moving coil cartridge, the Kuzma Airline, Triplanar 6, and SME Series V tonearms. Keeping this company is an enviable selection of turntables that includes the unequivocal SME Model 30 and Kuzma Stabl Reference.

We have the complete range of Living Voice loudspeakers including the internationally celebrated Avatar OBX-R2.

More importantly we have an attitude and an intent that breathes new life, interest and fascination into your relationship with music. Call us for an informal chat or to arrange an appointment. (+44) (0)115 9733222

Sale of part exchanged and ex-dem items	Sale	New
Voyd turntable - black - reference bearing and platter - no packaging	£900	£2000
Nottingham Analogue Space Deck - new	£750	£963
Voyd turntable standard - ash	£500	£700
Nottingham Analogue Space Deck - with Mytic Mat and psu	£900	£1500
Wadia 850 CD - very chunky chap - means business	£3200	£5400
Avid Volera Sequel - new - boxed - unused	£2500	£3500
Ariston RD11a with Signal low mass arm - old classic - original box - v. tidy	£300	
Roksan Xerxes Cognesenti - needs service - SME cutout - take it away	£400	
Wilson Bensch ACT1 tonearm - carbon fibre unipivot	£450	£900
Proac Studio 200 - yew finish - MTM 2 way - very nice	£1250	£2150
SME Model 20/2A (includes Series V tonearm) - serious - no film flam	£3500	£5270
Living Voice Auditorium - cherry	£900	£1500
Ruarik Crusader - dark cherry - very tidy	£900	£2000
Hovland Sapphire - stereo power amp - vgc - give away	£3500	£7000
SJS Arcadia Model 2 - valve rectified, choke input - boffin style line pre-amp - copper casework - interesting, lush and lovely	£1000	£2000
T.E.A.D. The Groove - phono stage MM	£1300	£1850
Canary Audio 309 - parallel push-pull - 300B monos - 45 endless watts of beefy joy - ex dem - perfect condition - champagne - boxed	£6000	£10000
Canary Audio 303 push-pull - 300B monos - 22 watts of loveliness - used only once at US hi-fi show - a joy and a steal	£4500	£7500
Audio Innovations P2 phono stage - MM - collector's item (another one!)	£700	
Canary Audio 301 push-pull stereo - 22 watts - great amp - champagne finish - boxed	£3500	£5400
Canary Audio 601 pre-amp - with saucy intestines - beautiful sound - new	£2200	£2850
Audio Note UK ANJ speakers with Huygens high mass 4 leg stands	£500	
SME Series V - with Audio Note silver intamal wire - a proper tonearm	£900	£1850
Living Voice Avatar OBX-R1 - cherry - 2002 - ex Hi-Fi World review pair	£2000	£4000
Revolver 45 speakers - cherry - new	£900	£1200
Revolver 45 speakers - standard finish	£700	£900
Quad 989 ESL - brand-new - black - boxed - big	£4000	£4400
Revolver R33 - standard finish - new	£300	£400
Triplanar V1 tonearm - boxed	£2300	£3350
Heart Rhythm - 8 watt valve rectified 300B monos - giveaway	£400	£1600
EAR MC3 - moving coil step up transformer	£300	£750

Tel: 0115 973 3222 Fax: 0115 973 3666  
Internet: [www.definitiveaudio.co.uk](http://www.definitiveaudio.co.uk) email: [shout@definitiveaudio.co.uk](mailto:shout@definitiveaudio.co.uk)

# AudioVenue

bespoke audio visual consultants

36 Queen St., Maidenhead  
Berkshire SL6 1HZ

01628 633 995

[info@audiovenue.co.uk](mailto:info@audiovenue.co.uk)



The finest showroom...  
The finest products

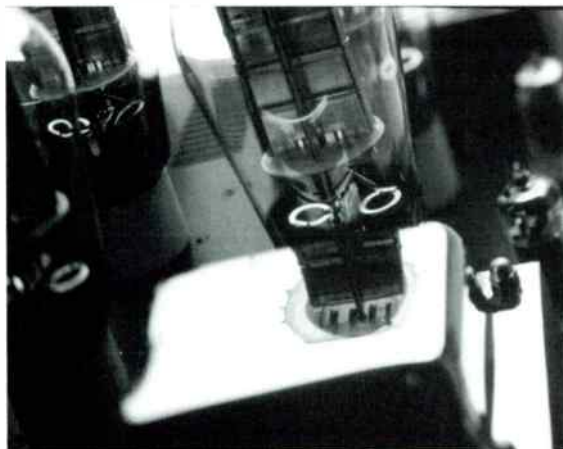

## The BorderPatrol P20

*'One of the best music appreciation devices available.'*

*Jason Kennedy Hi-Fi Choice Summer 2002. EDITORS CHOICE*

Full details on the P20 and other BorderPatrol amplifiers and power supplies can be found on line at [www.borderpatrol.net](http://www.borderpatrol.net)

Tel/fax 00 44 (0) 1242 717171  
e-mail [bp@borderpatrol.net](mailto:bp@borderpatrol.net)  
[www.borderpatrol.net](http://www.borderpatrol.net)



**BorderPatrol**



Musical Fidelity M1

Selection of our partners... Arcam • Artcoustic • Audio Access • Audio Analogue • Audioquest • Audio Research • BCD Engineering • Beyerdynamic • Bryston • Bose • Boston • Chord Cables • Clearaudio • Copland • Crestron • Definitive Technology • Denon • Draper Screens • Final • Fujitsu Plasma • Graaf • Krell • Harman Kardon • Integra Research • KEF • Lexicon • Linn Classic • Living Control • Loewe televisions • Michell Engineering • Miller & Kreisel • Monitor Audio • Musical Fidelity • Martin Logan • Nad • Nordost • Nakamichi • Onkyo • Opera • Ortofon • Panasonic plasma • Parasound • Pioneer plasma • PMC • Primare • Proceed • Project • OED • Quad • Quadraspire • REL • Revel • Revox Screens • Roksan • Runco • Sennhesier • SME • Sonus Faber • Spendor • Stands Unique • Stewart Screens • Straightwire • Sumiko • Tag McLaren • Townshend Audio • Theta • Transparent Audio • Unison Research • Vienna Acoustics • Vutec Screens • Wilson Audio and other leading components and accessories.

[www.audiovenue.co.uk](http://www.audiovenue.co.uk)

alone is known to cause significant sound degradation with no solution on the horizon. Yet another issue is the need to rectify disc reading errors - can a D-A converter really take an educated guess to fill in missing information with accuracy? A crude analogy of the problem is that of cutting up a prime fillet steak into tiny chunks - no matter how finely you cut it and try to put it back together, you still end up with a hamburger not fillet steak!

Vinyl analogue replay on the other hand has the following advantages:

[a] No sampling rate, unless you call 'infinity' a sampling rate!

[b] The conversion of an analogue mechanical signal into the final analogue electrical signal is much simpler than a digital to analogue conversion.

[c] The minimal errors of a cartridge do not need 'correction'. Although distortion may be higher it does not have the nasty nature of digital distortion that is thoroughly offensive to the ear.

Unsurprisingly then, I prefer analogue! It has a fluid sound quality as opposed to digital, which can be distinctly edgy at times. The hope is that the new formats will revive sales because everyone is going to rush out and want the best sound quality available. However there are problems with this perception: The improvements are not great and will never surpass vinyl replay. The formats can be pirated - if some form of encryption is put on the format then sound quality is severely degraded and the purpose of the change is lost. The hardware necessary to play all the different formats will mean either several players or a universal player. Having more players gets expensive and space consuming. Universal players mean degradation in sound quality and additional expense.

My honest opinion is that the new formats may have limited success but are unlikely to last for any significant length of time due to the rate of change in the technology of digital storage. Soon there will be further advances in sampling rates and increased storage capacity. However in spite of a number of possibilities the fundamental technical problems associated with digital to analogue conversion are likely to remain unsolved. If the accountants and PR people made a smart analysis there is a great argument for promoting vinyl as 'the new high end format'. The reasons are obvious:

[a] vinyl outperforms the new mediums even on inexpensive turntables like the new Goldring at less than £200. Better turntables simply run rings round most digital players.

[b] vinyl cannot be pirated without the loss of sound quality associated with CDs. People cannot produce another vinyl record whereas a digital recording can be perfectly copied.

[c] in the long term, vinyl will give far more musical satisfaction than digital formats which will mean increased sales of music.

The analogue side of the replay chain can be improved by looking at the phono stage. Listening to the GSP Gram Amp 2 SE was a revelation to me a few years ago. This moving magnet phono stage caused me to realize how many people have never appreciated the quality of vinyl simply because of the dire quality of integrated amplifier phono inputs. Phono stage design has advanced tremendously over recent years and inexpensive but excellent phono stages like the Gram amp 1 at £85 could be much better promoted. As for digital, the transports and mechanisms to read the discs need improvement. At present the need for D-A converters to take educated guesses to fill in the information missed by the laser is a cause of untold sound degradation." ●

scratches or damaged tape - but digital is also prone to the same problems, of course. On the other hand, its advantages are of possessing the ultimate resolution. Digital needs many times the bandwidth to achieve similar results. So it is not actually as efficient. I would have to write a book to explain in detail all my reasons! The advantage of digital is that, simply, it provided a low cost solution to providing sound at a fair standard to the mass market. As a result, low cost analogue tended to suffer. As such, my argument against it is purely on a cost-no-object basis. In the eighties, the music and audio industry moved to digital for cost

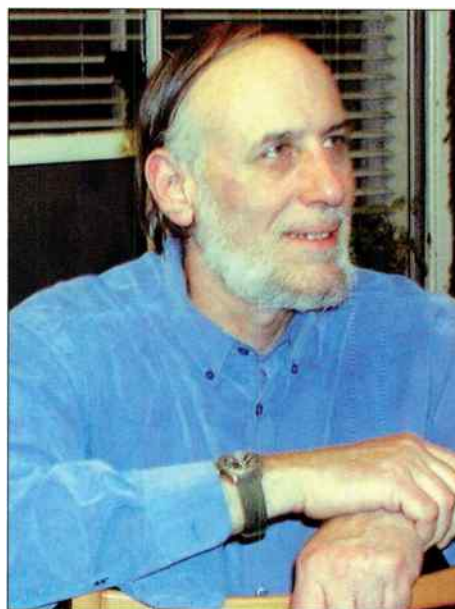

**NAME:** Tim de Paravicini  
**JOB:** Designer  
**COMPANY:** EAR Yoshino

**O**f course, theoretically speaking, analogue is better! Its disadvantages are the lack of ease of use, and the fact that careless handling produces

reasons, and the mistaken belief that you could not copy it - pure and simple money!

In the nineties, the vinyl revival started simply because a dejected few audiophiles realised what they were missing in sonic satisfaction, and disco DJs being more intimate with vinyl in its handling could still do many tricks that digital does not allow accurately, so they never went away from analogue - and so vinyl became synonymous with DJ culture for this reason. Do the new high res digital formats such as SACD and DVD-A have a future? Well, yes, if they conform to what I proposed in print more than twenty years ago about absolute standards to satisfy the human hearing

**FAVOURITE ANALOGUE:**  
**TOWNSHEND TURNTABLE**  
This is a bit of silly question to ask me, as I have many studio tape machines rebuilt to my own standards, but notwithstanding these then it's got to be the aforementioned record player.

**FAVOURITE DIGITAL:**  
**N/A**  
None - and why? Because there are none good enough, period.

# NEW 2004 FULL COLOUR DIY LOUDSPEAKER GUIDE NOW AVAILABLE

Featuring a comprehensive range of loudspeaker kits, drive units and components, many at reduced prices.



Phone today for your **FREE** catalogue or check out our Website.

**WILMSLOW AUDIO**

50 Main Street, Broughton Astley,  
Leicester LE9 6RD

Tel: 01455 286603 Fax: 01455 286605

Website: [www.wilmslowaudio.com](http://www.wilmslowaudio.com)



01376 521132

07802 483698

CHELMSFORD, ESSEX

E-MAIL: [soundstage@netlineuk.net](mailto:soundstage@netlineuk.net)

BY APPOINTMENT ONLY

## PRE-OWNED EQUIPMENT

ARCAM ALPHA 7SE CD PLAYER BOXED AND IMMACULATE	£249
ARCAM ALPHA 8 TUNER NO REMOTE AND MARKED HENCE	£149
ATC SCMS0A ACTIVE WALNUT WITH STANDS-BUYER COLLECTS-IMMACULATE	£3495
AUDIO INNOVATIONS SERIES 800 4-BOX VALVE PRE/POWER	£1495
CASTLE HARLECH CHERRY FLOORSTANDERS	£649
COUNTERPOINT SA100 POWER AMP VALVE/TRANS HYBRID BLACK BOXED	£649
CYRUS PRE PRE AMP NO REMOTE	£299
DEFINITIVE TECHNOLOGY PRO SUB 80	£249
DENON AVC-A11SR LATEST AV AMP BRAND NEW BOXED BLACK-NEW	£1700
DENON DVD1000 BLACK MULTI REGION DVD PLAYER AS NEW	£279
DENON DVD3300 BLACK AND SUPERB-CURRENT MODEL-£1000 NEW	£595
EPOS ES12 LIGHT CHERRY BOXED AND SUPERB	£299
KEF 104/2 ROSEWOOD + WALNUT CLASSIC FLOORSTANDERS EACH	£595
LFD PA2 POWERSTAGE POWER AMP MARBLE FRONT LOVELY LOOKS AND SOUND	£695
LINN SONDEK LP12 NORTON AIR POWER ITTOK TROIKA WALNUT SUPERB	£1295
LOEWE ACONDA 32" FLAT WIDESCREEN SILVER + LOEWE GLASS STAND	£1495
M & K SS150 THX TRI-POLE SURROUND SPEAKERS-£1300 NEW-BLACK	£795
MARANTZ CD5000 GOLD BOXED AND IMMACULATE	£129
MERIDIAN A500 BLACK ASH LOUDSPEAKERS BOXED LOVELY CONDITION	£399
MERIDIAN 200 TRANSPORT + 209 PANEL REMOTE CONTROL-SUPERB	£349
MERIDIAN 605 MONO BLOCKS BLACK	£995
MICROMEGA STAGE 5 CD PLAYER BOXED AND IMMACULATE	£349
NAIM NAP 200 2002 MODEL BOXED AND IMMACULATE	£1195
NAIM INTRO BLACH ASH BOXED AND SUPERB	£349
NAIM AV2/NAP 175 2002 MODEL BOXED AND IMMACULATE	£2795
NAKAMICHI BX-2 CASSETTE DECK-JUST BACK FROM SERVICE	£179
ONIX OA35/OA1200 PRE/POWER AMP BLACK LOVELY	£795
ONIX OA35/OA801 x 2 PRE/MONO/LOC'S STUNNING	£995
PRIMARE D.20 24 BIT CD PLAYER	£595
REGA RADIO R REMOTE READY TUNER BLACK BOXED AND IMMACULATE	£249
REGA CURSA LINE LEVEL PRE AMP BLACK BOXED AND IMMACULATE	£299
REGA MAIA POWER AMP BLACK BOXED AND IMMACULATE	£299
REGA XEL WALNUT FLOORSTANDING LOUDSPEAKERS-OVER £1K NEW	£449
REGA JURA FLOORSTANDING LOUDSPEAKERS CHERRY	£299
REGA PLANET ORIG TOP LOADING CD PLAYER IN BLACK	£299
ROKSAN DP1/ATTESSA DA2/ATTESSA DSS 3-BOX TOP LOADING CD PLAYER	£1295
ROKSAN XERXES ROSEWOOD TABRIZ ZI ORTOFON MC20 SUPREME	£995
ROKSAN L.I./DS1.5/S1.3 PRE/POWER SUPPLY/POWER AMP BLACK	£2495
ROKSAN XERXES BLACK ASH ARTEMIZ LYRA CLAVIS D.C. VDH MODDED	£1595
RUARK SCEPTRE NATURAL OAK BOXED AND MINT	£349
RUARK EPILOGUE YEW FINISH	£229
SONY SCD-XE670 SACD MINT BOXED JUST A FEW MONTHS OLD	£179
THORENS TD160 BLACK REGA RB250 GOLD DRING MM 1006	£229
TRIO KT917 TUNER SILVER HEAVYWEIGHT-SUPERB	£599
WADIA 3200 CD TRANSPORT WITH REMOTE AND INSTRUCTIONS	£995

PROFESSIONAL RECORD CLEANING SERVICE - KEITH MONKS MACHINE - PLEASE RING FOR FURTHER DETAILS AND PRICES.

**THREE MONTH WARRANTY ON ALL ITEMS**

[www.sound-stage.co.uk](http://www.sound-stage.co.uk)

## IAN HARRISON HI-FI TEL: 01283 702875

HI-FI AT DISCOUNT PRICES. FREE NATIONWIDE DELIVERY

### MASSIVE SALE!

TRADE IN YOUR OLD MOVING COIL CARTRIDGE & SAVE UP TO 60% OFF THE RRP.

CARTRIDGES & STYLII	HIFI FURNITURE	HEADPHONES	DVD
DENON	CUSTOM DESIGN	BEYER	SONY
SHURE	OPTIMUM	STAX	MINI DISC
AUDIO TECHNICA	ASH DESIGN	SENNHEISER	SONY
GOLDRING	APOLLO	SONY	LOUDSPEAKERS
SUMIKO	SOUND STYLE	AKG	OPERA
TRANS-FIGURATION	SOUND	GRADO	TRIANGLE
LONDON (DECCA)	ORGANISATION	AUDIO-TECHNICA	FINAL
GRADO	ALPHASON	TECHNICA	ELAC
ORTOFON	CABLES	DAT	HARBETH
RESON	BLACK RHODIUM	TASCAM	EPOS
CLEAR AUDIO	TRANSPARENT	SONY	ORELLE
KOETSU	QED	CASSETTE DECKS	AMPLIFIERS
SHUN MOOK	ORTOFON	PIONEER	CREEK
TONENARMS	NORDOST	SONY	HALCRO
GRAHAM	ARGENTO	TUNERS	MOTH
MOTH	AUDIO	DENON	C.A.T.
CLEAR AUDIO	SUPRA	SONY	GAMUT
HADCOCK	WIREWORLD	CREEK	ALOIA
MICHELL	CD PLAYERS	PHONO STAGES	EAR
TURNABLES	MONRIO	TRICHORD	AUDIO VALVE
GOLDRING	GAMUT	MOTH	ACCUSTIC ARTS
MICHELL	SONY	CREEK	GRAAF
CLEAR AUDIO	CREEK	NAD	ORELLE
	ORELLE	EAR	MONRIO
		TOM EVANS	AUDIO ANALOGUE
		CLEAR AUDIO	PATHOS -
			ACOUSTICS
			UNISON -
			RESEARCH

PLEASE PHONE TO CONFIRM PRICE & AVAILABILITY PRIOR TO ORDERING. ALL GOODS ARE BRAND NEW & BOXED WITH FULL U.K. GUARANTEES. NO EX. DEM OR EX DISPLAY GOODS. NO GREY IMPORTS. GOODS ARE NOT SUPPLIED ON APPROVAL. SORRY NO GENERAL CATALOGUES. PLEASE PHONE OR WRITE FOR SPECIFIC REVIEWS, BROCHURES OR PRICES. SUPPLIER OF HI-FI PRODUCTS & ACCESSORIES SINCE 1986. MAIL ORDER ONLY FROM: IAN HARRISON, 7 MILL HILL, REPTON, DERBY, DE65 6GQ. TEL: 01283 702875. 9am - 9pm INCLUDING SUNDAYS.

## WILLIAMS HART ELECTRONICS

HART ELECTRONIC KITS TRADED FOR OVER 30 YEARS



Mosfet Monoblock Power Amp Kits  
ONE OF THE BEST AMPLIFIERS YOU WILL HEAR! Regardless of price REVIEWED IN HI-FI NEWS AS '...EXCEPTIONAL... SELF EVIDENTLY CORRECT'



Single Ended Class A Valve Sound  
15Watt Power Amp modules  
FOR THOSE WHO WANT THAT VALVE MIDBAND BUT BASS AND TREBLE TO MATCH



ACTIVE R/Control SUBWOOFER MODULE £177.30



Speakers Designed & Built to Order

Advertise your Hi-Fi on my website (FREE)

Also: Award Winning Phono Stage Kit, Active Crossover Modules, Speaker Drive Units, M Cap Capacitors, Caddock Resistors, Remote Control Volume and much more.

WEB SITE: [www.williamshart.com](http://www.williamshart.com) e-mail: [sales@williamshart.com](mailto:sales@williamshart.com)

Tyn-Y-Coed, Llidiardau, Bala, Gwynedd, LL23 7SG Tel/Fax for catalogue 01678 520757.

PERSONAL VISITORS SHOULD PHONE FIRST TO AVOID DISAPPOINTMENT

Run by former Technical Director of Wilmslow Audio



mechanism; namely 400kHz sampling rates and 24bit words. Analogue vinyl can be improved by the simple and costly expedient of tender loving care in production of records, in the same way that CDs are produced in clean room conditions. Digital can only be improved with my aforementioned specifications – 24/400 resolution, maybe more..." ●

manipulate in the studio as digital. Digital technology allows very sophisticated manipulation such as re-tuning, cloning, re-timing and complex editing that cannot be done with analogue. With analogue you need to have musicians who can actually play the track all the way through. Digital record/ playback equipment and media can be much smaller than analogue equivalent and can also be made much cheaper.

our sacred audio systems! Having done extensive listening in studios to both DSD - the format used on SACD - and all PCM formats up to 24/192, whilst 24/192 is very good, DSD is more transparent and this is after all what the musician wants, so that his creation is faithfully delivered to the listener. Another advantage of SACD over DVD-A is that it is a secure format. You cannot bootleg the discs because of the special

**NAME:** ROBERT KELLY  
**JOB:** Digital Mastering Consultant  
**COMPANY:** ex-dCS

**A**nalogue is superior, theoretically. A digital system will have analogue front and back ends on the ADC and DAC, and as the digital section cannot be completely transparent, a purely analogue system must be better. So, given the choice I'd rather listen to analogue masters than digital masters. Analogue still has the edge, but this edge is getting smaller and it does require a lot of work to maintain an analogue system in peak condition. Digital playback systems are pretty fuss free in that respect. That said, a lot of care is required to set a digital system up to peak performance. Specifically clocking arrangements need to be properly set up and this is a frequently neglected area.

The advantages of analogue are that it produces a result that is very satisfying musically; is a very well understood and stable technology, does not require specialist equipment to maintain; most parts are easy to multiple source, so legacy equipment is easy to repair; degrades gracefully, so one has plenty of warning when things are starting to go wrong - digital breaks down suddenly with nasty results; storage

**I'd rather listen to analogue masters than digital...**

media have been shown to remain playable over many decades – fifty plus years for tape and I suppose one hundred or more for disc if one considers early cylinder recordings!

The disadvantages are that analogue needs care and attention to maintain peak performance; repeated playback gradually degrades the storage media. Not so easy to



Analogue media do not readily lend themselves to multichannel formats, whereas this is very easy with digital as is the achievement of extended playing times.

The music industry moved to digital en masse because they wanted a medium that would be cheap and easy to distribute, and that they thought they'd be able to adapt to prevent illegal copying. Someone also thought that a 20Hz to 20kHz bandwidth and 96dB dynamic range would give the "perfect sound

forever"... In the nineties, people discovered that their CDs weren't so perfect after all, and that despite

the surface noise vinyl still had something that made it a more satisfying experience than CD.

SACD has a long term future as it's very simple. You control what you listen to by pressing buttons on the player front panel or remote, without the need to get involved with complex on-screen menus. No need to have any nasty video clocks near

encoding equipment required at the factory and Philips rigidly controls distribution of the encoders and end users cannot rip the discs. DVD-A is far more complex to use as it can involve use of on screen menus. Contacts in the professional industry tell me that DVD-A disc sales are far lower than SACD disc sales. It looks like DVD-A will eventually whither, as the only strong proponent is Warner Brothers.

We can improve both analogue and digital simply by more care and attention at all stages of production. A lot of the problems with recording these days is that they are subject to too much processing. Making a good recording is like making a good meal - start

with good ingredients and then do as little as possible to them! Over-processing, like over-cooking, just leaves a nasty taste in the mouth..." ●

#### FAVOURITE DIGITAL:

##### DCS ELGAR DAC

Running with dCS 974 sample rate converter in DSD upsampling mode and dCS Verdi SACD/CD transport, the Elgar is the most argument for digital I've heard so far.

#### FAVOURITE ANALOGUE:

##### AMPEX ATR 100 TAPE MACHINE

With electronics by Tim de Paravicini, this produces the most satisfying result from the format.

**DEMONSTRATION ROOM AT 12A SPRING GARDENS, NEWPORT PAGNELL, MILTON KEYNES,  
BUCKS MK16 0EE BY APPOINTMENT ONLY - CALL FOR DETAILS ON 01908 218836**

**NEW KIT**

The Kecl82 is our latest introduction for the true beginner and designed by Andy Grove. A simple and elegant design based on the classic ECL82 valve, a triode and power pentode sharing the same glass envelope. The amplifier consists of two ECL82s per channel, the triode sections work as the input/phase splitter and the pentode sections work in push-pull for the output stage. The amplifier offers 8 watts into an 8 ohm load, the hum level is extremely low, comparison to solid state standards. The chassis is constructed of 1.6mm mild steel with a black powder coat finish. There is only one signal input pair controlled at the front by a volume control for that simple touch. The speaker connects are the standard 4mm banana type, positioned at the rear, as are the mains input which is received through an IEC lead, mains switch and earth post. We have made the construction as simple as is humanly possible with comprehensive instructions. The circuitry is based on a single printed circuit board. Ultimately this kit is for the guy who has always fancied a go at building a kit, but never dared. Simon Pope says, "It's a great introduction to the valve sound. For its humble price it delivers a full and rich sound with great detail and good depth." Kecl82 weighs 9kg. External dimensions are 30cm(w)x23.5cm(d)x11cm(h)

**KECL82 VALVE AMPLIFIER KIT****£195**

These are our new 6550 series amplifiers. A pure class A design providing 40 watts into a 8 ohm load. (available in a 4 ohm version if required) A truly high end design by Andy Grove, using Svetlana 6550Cs in push-pull (any 6550 or KT88 tube can be used with this amp). It features valve rectification (5U4) a choke pi filter power supply and is hard wired. Weighs 19kg with dimensions



390mm(w) x 330mm(d) x 190mm(h) with valves or 220mm(h) with cage. Simon Pope says - "If you favour attack and rhythmic grip, together with a smoothness of sound that's incredibly easy to live with, the Kit6550 could well be the kit amp for you. The 6550 is one for those who like a valve sound married to the attack and clout of a good quality solid state design".

**KIT6550 VALVE INTEGRATED AMPLIFIER KIT £615 KAT6550 VALVE POWER AMPLIFIER KIT £580**

The Kel84 features a pair of EL84 valves per channel in push-pull configuration. They give 15 watts into an 8 ohm load. The output transformers are Ultra Linear. Up front the ECF80 input/phase splitter valve has an extremely smooth sound. The Kel84 has very low hum, for simplicity the kit is built on a printed circuit board. A strong steel chassis is fronted by a 3mm anodised front panel and attractive chromed custom made knobs. There are five line level inputs, plus one monitor input, with a tape output included, all controlled from the front panel. At the rear is a mains switch/IEC power input, earth post, phonos, and 4mm banana sockets. Simon Pope says, "The quality that can be gleaned from this amp is a fine introduction to the joys of the valve sound. The Kel84 will highlight all the intricacies and depth of detail in your favourite recordings whilst retaining a warmth and fullness that is almost exclusive to pure valve amps and is rare at this price point." Kel84 weighs 10kg. External dimensions with valves are 300mm(w) x 270mm(d) x 150mm(h).

**KEL84 VALVE INTEGRATED AMPLIFIER KIT****£298**

The 2A3 PSE integrated amplifier offers a seriously hi-end sound, but without the cost usually associated with single-ended amplifiers. The stereo chassis houses, on the output, 2 x 2A3 in parallel single ended configuration and a single 6SN7 as the driver tube per channel. The valve rectified power supply consists of a 5U4 and a 10h choke. This feedbackless design provides 8.5watts into an 8 ohm load, so a good sensitivity speaker is required above 90dB. It can accept 6 line-level inputs fully controllable from the front panel. We provide the excellent Alps Blue potentiometer as standard. The amplifier is hard wired so plenty of scope for tweaking in the future. Simon Pope says, "The 2A3 PSE is extremely impressive piece of kit, good imaging, wide sound stage, nicely extended on the high frequency and tremendous bass thump. Weight - 20kg, external dimensions with valves fitted - 390mm(w) x 360mm(d) x 220mm(h)

**2A3 PSE INTEGRATED AMPLIFIER KIT****£570**



The PRE-II is a valve pre-amplifier with six inputs, tape monitor and two sets of output sockets. It utilises a high quality line driver transformer and x5 gain. The PHONO-II is a dedicated valve phono stage that incorporates a step-up transformer for MC users. Finally, PSU-II is a power supply unit that feeds both the PRE-II and PHONO-II.

Power Supply Unit (PSU-II)	£205.00
Pre-amplifier (PRE-II)	£215.00
Phono Stage (PHONO-II)	£110.00
Moving coil step-up transformer	£77.00
Passive pre-amplifier (PAS-II)	£235.00



## SERIES II MODULAR PRE-AMP KIT



KIT34 is a 32 watt stereo valve integrated amplifier, featuring a pair of EL34s, in push-pull mode, per channel, plus an ECF80 pentode/triode as input/phase splitter. The power supply is valve rectified (2 x 5U4), using a heavy duty choke to achieve exceptional smoothing. The output transformers are 14% Ultra Linear tapped to keep distortion down to its lowest level and the kit is totally hard wired utilising three tag boards. It has five line level inputs, plus a tape-in and



tape out, all controllable from the front. Simon Pope says, "This integrated brings together the best sonic virtues of our KIT88, kel34 and top of the range 300B PSE in an affordable package. The highlights of the sound are a deep and taut bass response, together with an open and highly detailed mid and high frequency response that only the best valve designs can achieve... a true valve classic." Weight 22kg. External dimensions with valves fitted - 390mm(w) x 360mm(d) x 210mm(h)

## KAT34 VALVE POWER AMPLIFIER KIT

£480

## KIT34 VALVE INTEGRATED AMPLIFIER KIT

£515

Our Parallel Single Ended amplifiers offer ultimate sound quality. Each monobloc has two of the beautifully linear 300B directly heated triode in its output stage, producing 20 watts into an 8 ohm load. At the front we have a 6AU6 pentode and an ECC82 as the driver valve. This design utilises a 5U4 rectifier valve in the power supply, in combination with a 10H choke, giving an extremely quiet supply. Both mains and output transformers use E/I pattern.

For purists, feedback is switchable and the kit is totally hard-wired. For those that require valves we provide the superb Tesla 300Bs, Russian SU4s and European 6AU6s & ECC82. Simon Pope says, "Not to put too fine a point on it, the sound these monoblocs create is among the finest that can be encountered in hi-fi." Our 300B PSE kit bears an affordable price of £895.00 (UK price) excluding valves. Each



monobloc weighs 23kgs., external dimensions with valves: 25cm(w) x 38cm(d) x 22cm(h) per monobloc.

The 300B PP monobloc shares the same look and chassis as the 300B PSE monobloc. The 300B PP kit has been created for those who prefer a bit more dynamics and drive to their valve sound. With a pair of 300Bs in push-pull configuration providing 26 watts output, these beauties will drive most modern loudspeakers to perfection. Andy Grove's design is totally feedbackless, using a 6AU6 pentode as the input valve and a 5687 as the phase splitter, the power supply uses

a Russian SU4 for rectification. The kit is constructed by point to point wiring so some experience is required. 300B PSE owners do have the option to buy the conversion kit for £250.00 to turn their monoblocs to push-pull status. Each monobloc weighs 23kg.

## 300B PSE MONOBLOC KIT

£895

## 300B PP MONOBLOC KIT NEW

£895

The HD83 headphone amplifier is a beautifully simple design using Mullard ECL83 valves, a triode and power pentode housed in the same envelope. It works directly from any source, be it CD, tape, tuner etc., or from an amplifier's tape out or pre-amp out sockets. The circuit uses high specification E/I output transformers that will drive any headphone load from 16 ohms to over 300 ohms depending on how the secondaries are wired up. The HD83 is a single-ended design with the power pentode wired up in triode configuration for added sonic purity, and it is as quiet as a mouse. For sound quality Jon Marks says, "The bass is punchy and controlled without becoming artificial, while treble has the crispness of the best solid-state, with the tonal purity, delicacy and speed associated with valves." External dimensions 18cm(w) x 30cm(l) x 8cm (h) weight 4kg.



## HD83 VALVE HEADPHONE AMPLIFIER KIT

£195

DEMONSTRATION ROOM AT 12A SPRING GARDENS, NEWPORT PAGNELL, MILTON KEYNES,  
BUCKS MK16 0EE BY APPOINTMENT ONLY - CALL FOR DETAILS ON 01908 218836

**KIT6550/KAT6550 mains transformers**  
2 inch stack, 130mm(h)x120mm(w)x135mm(l)  
drop through fitting with zinc cap. Secondaries  
425V-0V-425V, 350mA, 0V-5V, 6A, 3.15V-0V-3.15V,  
9A. Suitable for 120V & 240Vac operation

**KEL84 mains transformer**  
1.5 inch stack, 90mm(h)x 80mm(w)x 95mm(d)  
drop through fitting with zinc cap. Secondaries:  
0V-240V 300mA, 3.15V-0V-3.15V, 5.5A, suitable for  
120/240V operation

**KIT34/KAT34/KIT6550/KAT6550 choke**  
1.25 inch stack, 65mm(h)x105mm(w) with fitting  
holes x 60mm(d), clamp fitting, 2.5 H, 350mA

**300B PSE mains E/I transformer**  
130mm(h) x 95mm(w) x 115mm(d).  
drop through fitting with zinc cap.  
Secondaries: 380V-0V-380V, 180mA/150-0V-150V,  
25mA/0V-5V, 1.2A/0V-5V, 1.2A/0V-5V, 3A/3.15V-0V-  
3.15V, 0.4A suitable for 120/240V operation

**HD83 mains toroidal transformer**  
80mm dia. x 35mm(h). Secondaries: 0V-  
165V, 75mA/3.15V-0V-3.15V, 1A, suitable for  
120/240V operation

**PSU-II mains toroidal transformer**  
80mm dia. x 35mm(h). Secondaries: 0V-  
270V, 60mA/0V-10V, 2A, suitable for 120/240V  
operation

**TRANSI mains toroidal transformer**  
95mm dia. x 50mm(h). Secondaries: 0V-  
370V, 150mA/0V-6.3V, 3.5A 300B E/I choke  
65mm(h) x 70mm(d) x 80mm(w) open frame  
fitting, 10H, 180mA,

**KEL84 E/I choke**  
0.5 inch stack, 40mm(h)x 35mm(d)x 70mm(w)  
clamp fitting, 1H, 250mA

**PSU-II E/I**  
40mm(h) x 35mm(d) x 70mm (w) clamp fitting,  
15H, 20mA

**KIT34/KAT34 mains transformer**  
2.5 inch stack, 120mm(h)x115mm(w)x95mm(d),  
drop through fitting with zinc cap. Secondaries  
365V - 0V - 365V, 300mA/0V - 5V, 6A/3.15V - 0V -  
3.15V, 7.5A. Suitable for 120/240V operation.

**2A3 PSE mains transformer:**  
2.5inch stack, on a 120 size lamination,  
120mm(h)x115mm(w)x95mm(d), drop through  
fitting with zinc plated transformer caps.  
Secondary winding: 370V-0V-370V, 250mA, 0V-5V,  
3A, 0V-4V, 2A x4. Suitable for  
110V/120V/220V/230V operation. Can be used  
for a valve rectified, dc heater (2A3), dc regulated  
heater(input valve) stereo 2A3 PSE/PP amplifier.

**KECL82 mains transformer:**  
1.25inch stack, on a 29 size lamination,  
80mm(wide)x70mm(height)x70mm(depth), frame  
type 2 hole fixing. Secondary winding: 0V-185V,  
200mA, 0V-6.3V, 3.5A. Suitable for  
110V/120V/220V/230V operation. Good for low  
power amp, solid state rectification achieves a HT  
of 240Vdc. Could be used for ECL82 PP/PSE  
stereo amp.

### MAINS TRANSFORMERS & CHOKES

**KIT6550/KAT6550 E/I 16% TAPPED UL**  
push-pull output transformer 2 inch stack, 80mm  
(w) x 95mm(l) x 100mm(h), drop through fitting  
with zinc cap. Primary-secondary 4.5K, 16% UL  
tapped. Secondary 4 Or 8 ohm, pls specify on  
order. max output 45 watts, max current 180mA,  
valves, KT88, 6550 etc

**KEL84 E/I Ultra Linear push-pull output  
transformer**  
1.25 inch stack, 76mm(h)x 65mm(w)x 76mm(d)  
Primary - secondary, 8K with 12.5% UL tap -  
8ohms, max o/p-15watts, max current 150mA  
valves EL84 etc

**KIT88/KAT88 E/I push-pull output transformer**  
80mm(w)x95mm(l)x100mm(h). Primary-secondary  
10K - 8ohms, max o/p-40watts, max current-  
160mA valves-KT88, 6550, EL34

**Pre-II E/I driver transformer**  
80mm(w)x60mm(l) x65mm(h). 6:1 step down  
transformer, max current-10mA valves-6922 etc  
pre-amp stage

**KIT34/KAT34 E/I 14% tapped Ultra Linear**  
push-pull output transformer  
2 inch stack, 80mm(w)x95mm(l)x100mm(h), drop  
through fitting with zinc cap. Primary-secondary  
6.4K, 14% UL taps, Secondary 8ohm, max output  
34watts, max current 150mA, valves EL34, 6L6,  
6CA7

**HD83 E/I single ended output transformer**  
40mm(w)x50mm(l) x55mm(h).  
Primary-secondary 4K - 4 x 64ohms  
windings, max o/p-1watts, max current-25mA  
valves-ECL83 etc

**300B PSE E/I parallel single ended output  
transformer**  
130mm(h) x 95mm(w) x 115mm(d).  
drop through fitting with zinc cap.  
Primary 1K5 Secondary 8R, output .

**2A3 PSE E/I output transformer:**  
2A3 parallel single ended transformer, 2 inch stack,  
78 size lamination. Primary impedance is 2.5K,  
secondary impedance is 4ohm or 8ohm, max  
current is 100mA. Output is 8.5Watts.

**KECL82 PP output transformer**  
ECL82 push-pull ultra linear. 1inch stack, on a 29  
size lamination,  
80mm(wide)x70mm(height)x60mm(depth), frame  
type 2 hole fixing. Primary 7.5Kohm, secondary  
8ohms. Max current 85mA,  
Good for numerous low output pentode valves in  
push-pull configuration.

**300B PP E/I push-pull output transformers**  
2.5inch stack, on a size 120 lamination.  
130mm(h)x95mm(w)x115mm(d) drop through  
fitting with zinc plated cap. Primary impedance 4K,  
secondary 6ohm. Will suit 300Bs, 2A3s etc in  
push-pull configuration.

### PRINTED CIRCUIT BOARDS

- ECL82 Printed Circuit Board 200mm(w) x 140mm(l) x 1.6mm(d)
- Kel84 Printed Circuit Board 280mm(w) x 135mm(l) x 1.6mm(d).
- KT88/KaT88 Printed Circuit Board 140mm(w) x 310mm(l) x 2.4mm(d)
- Kel34 Printed Circuit Board 140mm(w) x 310mm(l) x 2.4mm(d).
- 189 Printed Circuit Board (a pair) 120mm(w) x 215mm(l) x 2.4mm(d)
- HD83 Printed Circuit Board 140mm(w) x 160mm(l) x 1.6mm(d).
- PSU-II Printed Circuit Board 105mm(w) x 130mm(l) x 1.6mm(d)
- PRE-II Printed Circuit Board 105mm(w) x 130mm(l) x 1.6mm(d).
- PSU-II Printed Circuit Board 105mm(w) x 130mm(l) x 1.6mm(d)

### OUTPUT TRANSFORMERS

#### Hi-Fi World in Malaysia at Millennium Hi-Fi & Av. Kuala Lumpur, Malaysia

Hi-Fi World is now distributed through good bookshops and newstands in Malaysia. For back issues,  
general enquiries and advertising, contact Simon Chang at Millennium Hi-Fi & Av.

Also available are products by World Audio Design,  
Michell, Trichord, Lowther and ReThm loudspeakers.

**Millennium Hi-Fi & Av**  
**500-1-3 First Floor, Wisma Indah (Shen Court),**  
**Jalan Tun Razak 50400 K.L.**

tel: 603 9283 8171 fax: 603 9281 3762

137 Jalan Pendekar 2, Taman Skudai Baru, 81300 Skudai, Johor DT  
tel: 607 554 5171 fax: 607 554 7645

e-mail: [info@millennium-audio.com](mailto:info@millennium-audio.com)



These are expert kits, not for the inexperienced. You must be able to solder and read a circuit diagram. The valve kits contain lethal voltages. We cannot be held responsible for any errors arising from the construction of these kits.



order on our website @ [www.worldaudiodesign.co.uk](http://www.worldaudiodesign.co.uk)

AMPLIFIER KITS DESCRIPTION	ORDER NO.	QTY	UK (inc vat & carriage)	OVERSEAS (exc. vat & carriage)
Kec182 (8 ohm)	Kec182 (with valves)	<input type="checkbox"/>	£195.00	£170.00
2A3PSE with valves (4ohm or 8ohm, pls specify)	2A3 PSE (with valves)	<input type="checkbox"/>	£570.00	£485.00
2A3PSE without valves (4ohm or 8ohm, pls specify)	2A3 PSE (without valves)	<input type="checkbox"/>	£470.00	£400.00
KaT6550 with valves (4ohm or 8ohm, pls specify)	KaT6550 (with valves)	<input type="checkbox"/>	£580.00	£495.00
KaT6550 without valves (4ohm or 8ohm, pls specify)	KaT6550 (without valves)	<input type="checkbox"/>	£450.00	£380.00
KiT6550 with valves (4ohm or 8ohm, pls specify)	KiT6550 (with valves)	<input type="checkbox"/>	£615.00	£525.00
KiT6550 without valves (4ohm or 8ohm, pls specify)	KiT6550 (without valves)	<input type="checkbox"/>	£485.00	£415.00
KaT34 with valves (4ohm or 8ohm, pls specify)	KAT34(with valves)	<input type="checkbox"/>	£480.00	£410.00
KaT34 without valves (4ohm or 8ohm, pls specify)	KAT34(without valves)	<input type="checkbox"/>	£415.00	£354.00
KiT34 with valves (4ohm or 8ohm, pls specify)	KiT34 (with valves)	<input type="checkbox"/>	£515.00	£440.00
KiT34 without valves (4ohm or 8ohm, pls specify)	KiT34 (without valves)	<input type="checkbox"/>	£450.00	£385.00
Kel84 with valves (8 ohm)	Kel84 (with valves)	<input type="checkbox"/>	£298.00	£255.00
Kel84 without valves (8 ohm)	Kel84 (without valves)	<input type="checkbox"/>	£268.00	£230.00
PSU II	PSU - II	<input type="checkbox"/>	£205.00	£175.00
PRE II	PRE - II	<input type="checkbox"/>	£215.00	£185.00
PHONO II	PHONO II	<input type="checkbox"/>	£110.00	£95.00
PAS II	PAS II	<input type="checkbox"/>	£235.00	£200.00
Step ups transformers for MC use with PHONO II	MC - step up (pair)	<input type="checkbox"/>	£80.00	£68.00
HD83 with valves	HD83 (with valves)	<input type="checkbox"/>	£195.00	£167.00
300BPSE with valves (4ohm or 8ohm, pls specify)	300B PSE (with valves)	<input type="checkbox"/>	£1197.00	£1020.00
300BPSE without valves (4ohm or 8ohm, pls specify)	300B PSE (no valves)	<input type="checkbox"/>	£895.00	£765.00
300BPP with valves (6 ohm)	300B PP (with valves)	<input type="checkbox"/>	£1197.00	£1020.00
300BPP without valves (6 ohm)	300B PP (no valves)	<input type="checkbox"/>	£895.00	£765.00
300BPP conversion pack	300B PP (conversion pack)	<input type="checkbox"/>	£250.00	£215.00

PARTS DESCRIPTION	ORDER NO.	QTY	UK (inc vat & carriage)	OVERSEAS (exc. vat & carriage)
2A3 mains transformer	2A3 PSE mains T	<input type="checkbox"/>	£115.00	£98.00
6550 mains transformer	6550 mains T	<input type="checkbox"/>	£120.00	£105.00
34 mains transformer	KiT34 - mains T	<input type="checkbox"/>	£100.00	£85.00
kel84 mains transformer	Kel84 - mains T	<input type="checkbox"/>	£60.00	£47.00
HD83 mains transformer	HD83 - mains T	<input type="checkbox"/>	£40.00	£34.00
PSU II mains transformer	PSU-II - mains T	<input type="checkbox"/>	£40.00	£34.00
300B mains transformer	300B - mains T (each)	<input type="checkbox"/>	£115.00	£98.00
34/6550 choke	KiT34 - choke	<input type="checkbox"/>	£34.00	£34.00
kel84 choke	Kel84 - choke	<input type="checkbox"/>	£20.00	£17.00
300B choke	300B choke	<input type="checkbox"/>	£40.00	£34.00
2A3 PSE choke	2A3 PSE choke	<input type="checkbox"/>	£40.00	£34.00
PSU II choke	PSU-choke	<input type="checkbox"/>	£20.00	£17.00
6550 output transformer (4ohm or 8ohm)	6550 - O/P T (pair)	<input type="checkbox"/>	£130.00	£112.00
34 output transformer (4ohm or 8ohm)	34 - O/P T (pair)	<input type="checkbox"/>	£130.00	£112.00
kel84 output (8 ohm)	Kel84 - O/P T (pair)	<input type="checkbox"/>	£90.00	£78.00
2A3 PSE output transformer (4ohm or 8ohm)	2A3 PSE O/P T (pair)	<input type="checkbox"/>	£130.00	£112.00
HD83 output (multiload secondary)	HD83 - O/P T(pair)	<input type="checkbox"/>	£100.00	£86.00
PRE-II driver transformer	PRE-II - driver T(pair)	<input type="checkbox"/>	£80.00	£68.00
300BPSE output transformer (4ohm or 8ohm)	300B PSE - O/P T (each)	<input type="checkbox"/>	£110.00	£94.00
300BPP output transformer (6ohm)	300B PP - O/P T (each)	<input type="checkbox"/>	£110.00	£94.00
kel84 PCB	Kel84 - PCB	<input type="checkbox"/>	£30.00	£26.00
kel34 PCB	Kel34 - PCB	<input type="checkbox"/>	£12.00	£11.00
kel80 PCB	Kel80 - PCB(pair)	<input type="checkbox"/>	£52.00	£45.00
KECL82 PCB	KECL82 - PCB	<input type="checkbox"/>	£25.00	£21.00
HD83 PCB	HD83 - PCB	<input type="checkbox"/>	£20.00	£17.00
PSU II PCB	PSU-II - PCB	<input type="checkbox"/>	£20.00	£17.00
PRE II PCB	PRE-II - PCB	<input type="checkbox"/>	£20.00	£17.00
PHONO II PCB	PHONO-II - PCB	<input type="checkbox"/>	£20.00	£17.00
tag board	TAG	<input type="checkbox"/>	£4.00	£3.00
ALPS 50K dual potentiometer	ALPS - 50K	<input type="checkbox"/>	£14.00	£12.00
ALPS 100K dual potentiometer	ALPS - 100K	<input type="checkbox"/>	£14.00	£12.00
stepped attenuator (10K or 50K)	Attenuator + resistor pack	<input type="checkbox"/>	£75.00	£65.00
LCR 22.5uF 440Vdc polyprop. Cap	LCR - 22.5U	<input type="checkbox"/>	£10.00	£8.00
Jensen 0.47uF 630V, aluminium foil	JEN - 0.47U 630V	<input type="checkbox"/>	£20.00	£17.00
Safety gloves	SAFETY GLOVES	<input type="checkbox"/>	£25.00	£21.00
2A3PSE/6550/34 safety cage	2A3 PSE/34/6550 cage	<input type="checkbox"/>	£80.00	£68.00

**WORLD AUDIO DESIGN AMPLIFIERS FULLY BUILT FROM MALAYSIA**

Title	Description	Price (exc. VAT + Carriage)	Title	Description	Price (exc. VAT + Carriage)
1A40	40W EL34 integrated	£590.00	MB80	80W EL34 monobloc	£1190.00
1A36	36W KT88 integrated	£895.00	PA11	Valve pre-amplifier	£695.00
P20A	20W 5881 power amp	£795.00	PH11	Valve phono stage for PA11	£199.00

Order from our Far East Distributor: Millenium Hi-Fi & AV  
 137 Jalan Pendekar 2, Taman Skudai Baru, 81300 Skudai, Johor DT, Malaysia  
 Tel: 07 554 5171 - Fax: 07 554 7645 - email:mha8@pd.jaring.my

**ORDER INFORMATION**

NAME: \_\_\_\_\_  
 ADDRESS: \_\_\_\_\_  
 \_\_\_\_\_  
 \_\_\_\_\_  
 POST CODE: \_\_\_\_\_  
 COUNTRY: \_\_\_\_\_  
 TEL. (DAY): \_\_\_\_\_

**Tel/Fax: 01908 218 836**  
 I enclose cheque/postal order for £\_\_\_\_\_ made payable  
 to World Audio Publishing Ltd. I wish to pay by Mastercard / Visa /Switch/ Solo.  
 Please debit my account no: \_\_\_\_\_  
 \_\_\_\_\_ ( )  
 Expiry Date: \_\_\_\_\_ Signature: \_\_\_\_\_  
 (Switch/Solo only) Valid Date: \_\_\_\_\_ Issue No. \_\_\_\_\_ ( )  
 (Visa/Mastercard only) Security number - last three digits of number on signature strip. ( )

Prices were correct at time of print, 01/01/04 they are subject to change.  
 If you wish for a built item, please phone for a quote / Valves Included except where otherwise stated.) If you would like a data sheet on any of the kits, please write a 'D' in the qty box  
**WARNING** - World Audio Publishing Ltd. accept no responsibility for kits, parts or modifications made or supplied by third parties. Order on our website [www.worldaudiodesign.co.uk](http://www.worldaudiodesign.co.uk)  
 Please send your completed order form to: WORLD AUDIO PUBLISHING LTD 12a Spring Gardens, Newport Pagnell, Milton Keynes, Bucks MK16 0EE  
 Tel/Fax: 01908 218836 e-mail: [oaclers@worldaudiodesign.co.uk](mailto:oaclers@worldaudiodesign.co.uk)



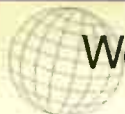

**WE HAVE OVER 30 TITLES ON OFFER!!!**

## AUDIO ELECTRONIC THEORY BOOKS



**Electronics made Simple**  
by Ian Sinclair  
This book covers the basic theory and principles of electronics. A good read for the beginner.  
Code No. 1420  
£12.99 + £2.50 P&P (UK)



**Build your own High-End Audio Equipment**  
by Elektor  
Build your own High-End Audio equipment contains construction projects for solid state preamplifiers and power amplifiers, active cross-over filters, an active subwoofer, a mono/stereo compressor and a headphone amplifier.  
Code No. 1390  
£14.95 + £2.50 P&P (UK)



**Audio/Radio Handbook**  
By National Semiconductor  
National Semiconductor's manual is an essential aid to engineers and experienced hobbyists in the application of National's line of consumer audio and radio ICs. Not only does it hold comprehensive data of their ICs but also discusses theory aspects of amplifiers and pre-amps and covers electronic principals.  
paperback 200pp, Code No. 1810  
£13.95 + £2.00 P&P (UK)



**Build your own Electronic Test Instruments**  
by Elektor  
This book contains designs for 17 measuring instruments, seven generators and analysers, ten miscellaneous instruments and a number of test ancillaries and auxiliaries. The designs range from a simple multicores cable designs contain a special printed circuit, drawing of which are given in an appendix.  
Code No. 1400  
£15.95 + £3.25 P&P (UK)



**The LP is Back**  
by Audio Amateurs  
Your complete guide to LP care and maintenance designed to offer you everything useful for those who love and enjoy this older music medium. This covers the theory and care of LPs and the electronics and mechanics of its players.  
£54pp Paperback, Code No. 1620  
£8.00 + £2.00 P&P (UK)

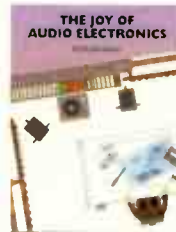

**The Joy of Audio Electronics**  
by Charles Hansen  
This is a fail-safe guide to the pleasures of hands-on electronic construction. This book covers test and measurement projects, how to build simple kits, safety issues, the workplace, theory and resources. A must for the beginner who plans to build more advanced electronic projects in the future.  
124pp Paperback, Code No. 1650  
£10.50 + £2.50 P&P (UK)

## VALVE BOOKS



**Audio Measurements**  
by Norman Crowhurst  
Famous compendium of measurement and test techniques for audio reproduction equipment of the tube era includes discussion of all instruments needed. Covers amps, transformers, preamps, turntables, changers, tonearms, cartridges, tape recorders.  
Code No. 1830  
£13.95 + £2.00 P&P (UK)



**Inside the Vacuum Tube**  
by John P. Rider  
One of the most thorough (and funny) books ever written on the way vacuum tubes function. Rider's mastery of analogies common to most of us makes the book especially useful to those who want to learn about vacuum tubes.  
Code No. 1840  
£24.00 + £2.50 P&P (UK)



**GEC Audio Tube Data**  
Full of data and circuits concerning the three most well known MO Valve power tetrodes, the KT66, KT77 and KT88, (the KT77 was GEC's answer to Mullard's EL34) and some data on the PX4 and PX25 triodes. The first section concerns preamplifiers of various types, with information regarding equalisation, tone controls, filters and suchlike. An excellent book for all valve heads.  
Paperback Code No. 1780  
£14.95 + £2.00 (UK)



**Understanding Hi-Fi Circuits**  
by N.H. Crowhurst  
Originally published in 1957. Discusses all aspects of amplifiers, pre-amplifiers and equalisation circuitry, well written, easy to understand. The author does concentrate on valve circuits, so no transistors here.  
Paperback, 224pp Code No. 1820  
Price £13.95 + £2.00 UK p&p



**Glass Audio Projects - 17 Vacuum Tube Designs**  
This book features 17 valve projects, designed, tried and tested by some of the best authors state side. Designs such as a 300B push-pull amp, a 33 power amp a 6528 single ended, a 300B parallel single-ended amp, a 6C33C-B single ended amp, a 70W KT88 push-pull amp, a 2A3 single ended amp to name a few. All information is provided so most projects can be built from scratch.  
Paperback 73pp, Code 1790,  
£8.00 + £1.50 P&P (UK)



**An Approach to Audio Electronic Valves in Audio Frequency Amplifiers**  
by E. Rodenhuis  
Discussing the use of valve data, the function of different amplifier stages and includes detailed descriptions of eight designs. A wealth of practical data, measurements and interesting features will be found. A very good read.  
Paperback 147pp, Code No. 1520  
Price £12.95 + £2.00 P&P (UK)



**The Best of Audioneditorial projects**  
by Luciano Mard  
This book contains six excellent audio projects - a high sensitivity speaker, a superb tube pre-amp, a 2A3 amplifier design, a project using the Russian 6C33CB and two projects using 300Bs as output valves. Overall the book is a fabulous read.  
62pp, paperback book code 1750  
£12.00 + £2.00 UK p&p



**Vacuum Tube Amplifiers**  
by Valley & Wallman  
This book is a well known reference valve text book and is assembled from pieces by ten knowledgeable authors. An absolute bible when it comes to valve electronics.  
734pp, Paperback, Code 1770  
£29.95 + £ 4.30 P&P (UK)



**Audio Reality**  
by Bruce Rozenblitz  
Investigates conductors, skin effect, impedance, interconnections, speaker cables, balanced lines, transmission lines, isolation transformers, tubes, acoustics and much more. Also, includes 6 excellent detailed valve design projects. 80watt OTL, 25watt OTL, grounded grid pre-amp, 150watt amp, 6550 5E amp, and a grounded grid cascode phono preamp.  
Paperback 128pp, Code No. 1640  
Price 21.50 + 2.50 P&P (UK)

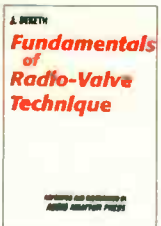

**Fundamentals of Radio-Valve Technique**  
by D.T.N. Williamson  
This is part of the Philips technical series written in 1947 it was one of the most authoritative and comprehensive treatments of the nature and function of the vacuum tube.  
534pp, Paperback  
Code No. 1630  
£21.50 + £2.50 P&P (UK)



**Build your own Audio Valve Amplifiers**  
by Rainer Zur Linde  
This book covers construction projects for preamplifiers, power amplifiers and two amplifiers for musical instruments aimed at the practical audio/hi-fi enthusiast. It offers much information on the operation of electron tubes, while the first chapter gives a short history of the thermionic valve.  
paperback, 251pp, Code No. 1320  
£14.95 + 2.50 P&P (UK)



**Mullard Tube Circuits for Audio Amplifiers**  
Includes full designs for eleven power and control amps, including 5-20, using valves. Begins with a four chapter tutorial on getting the best sound from valve amplifiers.  
142pp 8" x 10" Paperback Code 1030  
£13.95 + £2.00 P&P (UK)



**The Williamson Amplifier**  
by D.T.N. Williamson.  
Offers practical advice on how to build and set up the amplifier for best results.  
40pp Paperback  
Code No. 1040  
£9.95 + £1.50 P&P (UK)



**RCA Receiving Tube Manual**  
Technical Series RC-14  
This book presents RCAs commercial valve line-up as it was in 1940. The manual covers terminology, Technology and application, valve testing and then a larger section giving some circuit ideas and plenty of data on numerous valves, e.g. 6L6, 6N7, 6SN7.  
255pp Paperback, Code No. 1800  
£13.95 + £2.00 p&p (UK)



**The Beginner's Guide to Tube Design**  
by Bruce Rozenblitz  
This book takes a comprehensive look at tube audio design. It explains how vacuum tubes work and how to design with them. Rozenblitz covers stabilisation and testing, a description of 13 famous and classic amps and preamps and how to work effectively as a designer. A hands-on guide to construction techniques, tools and choosing components and tubes is provided. 1997.  
132pp Paperback Code No. 1340  
£15.50 + £2.50 P&P (UK)



# Board, Rigid

Back in July 2002, Stewart Wennen outlined his idea for a superior quality armboard for the world's most popular turntable, Technics' ubiquitous SL1200. Since then, Origin Live has taken the idea and developed it – so who better than SW himself to assess it...?

**A** couple of years ago, I discussed the possibility of replacing the very poor standard Technics pick up arm with an Origin Live RB250. This met with a lot of discussion amongst bedroom DJs as to the worth of this butchery, but the professionals in the entertainment industry welcomed this modification with open arms, as it does improve the

SL1200/1210 tremendously. Now, Origin Live has made the idea a commercial reality. The princely sum of £39 (inc. P&P) buys you one pick up

arm mounting

plate, fixing screws and an instruction sheet.

The first step is to remove the old pick up arm, which is covered in the original article in much more detail than in the OL data sheet. Remember that you can possibly sell the redundant SL1200 pick up arm (God knows why anyone would want one, but try it!), so be gentle with it. One point that is not covered on the data sheet is that the Pocan slab that sits directly under the motor board has to be removed before the arm retaining screws can be accessed. Don't throw these away but, when the SL1200 arm has been removed, loosely screw them into the original armbase.

Do not forget that the earth lead from the pitch control will have to be used to earth the new pick up arm! As modifications go this is an

extremely good one. I modified two SL1200s and I found that it took approximately 45 minutes to mount the new pick up arms into the turntables. There is no need to align the arm, as the plate has been laser cut especially for RB250. There is

**” This modification makes a good turntable into a stunning transcription unit**

also a spacer ring included with the kit to be used with cartridges like the Stanton 890 series. The only difficult part of mounting the replacement arm is setting the vertical tracking angle. Do not make the arm pillar higher than the headshell. Follow the instructions as they are written. This is very important. When the arm is mounted and earthed and the turntable is completely re-assembled, a break is necessary and after this, the listening can be started.

The first thing that struck me was the difference in the stereo imaging. The new pick up arm and plate mod. had an extra four feet of width within the image, and the height was much taller and the image depth extremely deep! I compared the modified SL1200 to a completely standard turntable and the differences were staggering. All frequencies seemed smoother, and the music was projected much more easily. One knows when something is correct and this arm and plate modification makes a good turntable into a stunning transcription unit.

Bass and midrange are extremely well presented, with an almost ethereal treble register. This again proves the Origin Live RB250 is a very well made pick up

arm. And it is extremely easy to 'mix' with, as the original Technics arm tends to jump out of the groove when being back-cued, and the resulting cue point is missed. As an arm for 'scratch mix' DJs, its performance is almost exemplary. OL

RB250s let cartridges track much more securely, especially when 'scratching' and it's also easier to visually cue with as the headshell is much smaller than the Technics

variation.

So if you're in the market for any new DJ equipment, I can recommend this new Origin Live armboard without any reservation at all. It's a neat way to fit an RB250 arm, which will dramatically improve your performance as a DJ or your listening pleasure as a music fan. A group of DJs in this country use OL RB250 modified Technics SL 1210s with glee - the mod. has paid for itself many times over and enables the music to be much more easily delivered to the dancefloor. Indeed, there's a competition between DJs and club owners in New York to build the best sound system in a nightclub. A few of these nightclubs use Origin Live equipped Technics SL1210s as their turntables. I think that this is enough recommendation in itself.

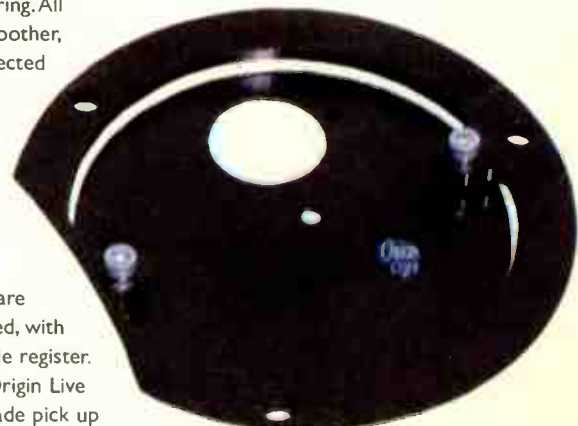

## VERDICT

A brilliant tweak for Technics SL1200 series turntables - essential equipment for DJs and music lovers alike.

**ORIGIN LIVE TECHNICS  
ARMBOARD MODIFICATION  
KIT**

£39

Origin Live  
[www.originlive.com](http://www.originlive.com)

# Plus Points

Trichord's already excellent Dino phonostage has just been improved with the option of the Dino+ PSU and High Performance Interconnect Lead. Albert Lee tries them for size...

**T**richord's new £225 Dino+ power supply is intended as the next logical upgrade from the standard Dino PSU, and contains a much larger transformer to supply the raw AC voltage. The case is crammed with electronics of a very high standard. AC voltage is usually changed into DC voltage with the aid of a bridge rectifier, but designer Graham Fowler has used two, using soft recovery diodes for very low radio frequency generation. These rectifiers are followed by a resistive and capacitive filter. This filter contains no less than four 1800-microfarad capacitors! A pair of further low noise, wide bandwidth, voltage regulation circuits mean that this PSU is very, very quiet.

The new £140 power interconnect is made from an alloy containing copper, silver and gold which has been refined to 99.9999% pure (this figure means that there is virtually no air inside the metal thereby enabling the electricity to continue its path to the Dino almost unheeded). It has a plating of 10 microns of rhodium and each cable is 0.7 mm in diameter. All of the cables are individually insulated using PTFE tube and then are further

encased with an other PTFE tube. The assembly is then covered in a black mesh outer jacket. Cryogenically treated this piece of wire seems to hold a lot of promise. First on was the new PSU using the standard power interconnect.

**“ the Dino is still the best at the price and these two mods put it even further ahead**

'The Wall' by Pink Floyd saw all the instruments firmly located within the stereo image, with kick drums slamming into me and lead guitars shooting across the living room with a precision and speed I've rarely experienced before. I heard for the first time a Hammond organ in the mix, which was amazing considering my familiarity with this music. Ry Cooder was next, and his guitar work was again tremendously expressive - I felt the raw emotion that the musicians were feeling in the studio.

The precision of the image is simply awe-inspiring. Ditto Bizet's

'Carmen', where the stereo image grew wider the orchestra seemed to have the correct amount of 'weight'. Next came the new high performance interconnect, and the difference was staggering. All of a sudden I was involved in the music not just listening to it! Bass instruments had a larger, truer character while midrange became even more believable, with just the right amount of treble definition.

This lead transforms the Dino into something even more special, and with the Dino+ PSU it assumes true greatness. Everything becomes more emotional and profound, with tremendous transparency given the price. If you're not into the soft, mellifluous sounds of the basic EAR 834P valve phonostage, preferring something altogether more neutral and incisive, the Dino is still the best at the price and these two mods put it even further ahead. The only serious improvement is indeed Trichord's own Delphini with Never Connected PSU at well over twice as much. Recommended, then...

## VERDICT ●●●●●£

Excellent quality allied to low prices make these mods essential for existing Dino owners and newcomers alike.

TRICHORD DINO+ PSU £225  
 TRICHORD HIGH PERFORMANCE  
 POWER LEAD £140  
 TRICHORD DINO/DINO+/  
 STANDARD LEAD £498  
 ☎ +44 (0) 1684 311600  
 Trichord Research Ltd.  
 www.trichordresearch.co.uk



# Broke and on

**Do you need support, but lack sufficient funds? Well, Albert Lee has the answer – a do-it-yourself turntable shelf that costs under £30 to make!**

**A**s any analogue addict knows, structure-borne resonance - or 'footfall' - is a killer. It will ruin the sound of any turntable, but is particularly parlous with non-suspended subchassis decks like Regas. So here's the answer – a DIY turntable shelf for under £30. This stand can be used under any hi-fi separates with excellent results, providing a stable platform as well as being impervious to structure and acoustic feedback. I have built many support systems over the years and this type is the simplest to construct, amongst the least expensive and one of the most effective.

The stand is in two parts. The first is a space frame construction into which is dropped a spiked platform. The materials required are all available from your local DIY supplier, who will cut the timber to size. This service is invaluable because each cut will be square. You'll also need 'T' nuts to suit the chosen spikes (available from Screwfix Direct) and spikes from your local dealer. The platform is constructed from 18mm hardwood ply, and measures 520mm by 475mm.

First, we need to rub the plywood down to a very smooth surface on both top and bottom, and you should also pay great attention to the sides to remove any marks left by the cutting blades. If you want to polish or paint the platform, this should be done at this stage. After we have applied our finish to the surface and let it dry, we're ready to drill the holes to locate the 'T nuts'.

Lay three strips of masking tape at the front top surface, marking this as per the diagram. The drill bit required for the pilot holes is a 3mm type. Drill all of the pilot holes through the platform, and then select the drill bit for the 'T nut' which is 9mm for an 8mm nut, or 7mm for a 6mm nut. After loading the bit into the drill, drill through the top surface but (and this is important) stop at

approximately 10mm then turn the board over and complete the drilling. This is to avoid ripping the ply with the drill. Now insert the 'T nuts' into the holes using a G clamp! Do not use a hammer, as this will mark the surface. Screw the spikes into the nuts and turn over and the equipment platform is complete.

Next, check that there are no pipes or wires at the point of attachment to the wall. There are various devices available to confirm the presence of pipes or cables buried in the plaster. If the chosen position has neither of these we are ready to start. (You will have noticed that the diagrams show the main support rails are 50x25mm, and the timber list has 45x21mm. This is so you can choose either softwood or hardwood - which has to be cut and planed to size - so choose your type of timber at this time.) Now, to construct the turntable wall frame. The timber required is as follows:

- 4 off 2-by-1 (planed all round) – 45x21mmx520mm
- 2 off 2-by-1 pair 45x21x400mm
- 2 off 18mm hardwood ply 550x00mm
- 50 (approx) No 8 by 2 inch countersunk Pozidrive screws
- 10 No 10-by-3inch countersunk Pozidrive screws
- 10 rawlplugs suitable for your wall type. If in doubt ask at your timber supplier.
- A small bottle of PVA wood adhesive (either the water proof or ordinary type will do)

The two main supports are made from the longest lengths of timber (45x21x520mm), and need to

resemble an 'L' shape - for further data see diagram. Pilot drill (3mm) three holes equidistantly spaced from the centre - these should extend into the rear of the 'L'. This is to stop the timber 'creeping' as they are screwed together. A clearance size drill is now used in the front halves of the main support in all three pilot holes. Next, these holes will need to be countersunk 5mm deep. We now glue and screw the two parts together making sure they are flush at the ends. This is repeated for the other main support. If you can see any PVA glue on the work make sure this is sponged off, as it will stain French or button polishes and is impossible to sand these marks out!

Next we need to make the side braces. These are cut from the two 18mm ply sections. It is most important that the marking out is accurate. We will use masking tape to mark onto. It also stops the ply tearing due to the cutting process. Check it out three times and cut once! You will have noticed there is a large hole in these panels; this is to be marked 50mm from all edges. I used a glass to get the curves as I marked them out. We now use a 12mm pilot drill at three positions close to the marked lines. Now use the jigsaw to cut (on the line) the large holes - not forgetting to don a pair of safety goggles and a dust mask! The next stage is to saw the diagonal line using a handsaw, and rub all of the timber down until it is as smooth as glass. At this point, we apply our chosen finish (French polish, paint or varnish).

Now have a pile of timber that has holes in it! Firstly, we will mount the rear main support on the chosen

**SOUND QUALITY**  
 Your new shelf should transform your system's sound – underlining the fundamental importance of proper isolation. The main difference is of greater musicality. Things sound smoother, sweeter and more relaxed yet more rhythmic too. There's better focus and dimensionality to the stereo imaging, and a sense of previously unheard cohesion – not bad for the price of a few CDs!



# the Shelf

**NOTE: USING POWER TOOLS CAN BE DANGEROUS! CARE AND PRECISION ARE REQUIRED. HI-FI WORLD CAN ACCEPT NO RESPONSIBILITY FOR PERSONAL INJURY OR DAMAGE TO YOUR PROPERTY AS A RESULT OF THIS ARTICLE!**

ILLUSTRATION: Peter Vivian

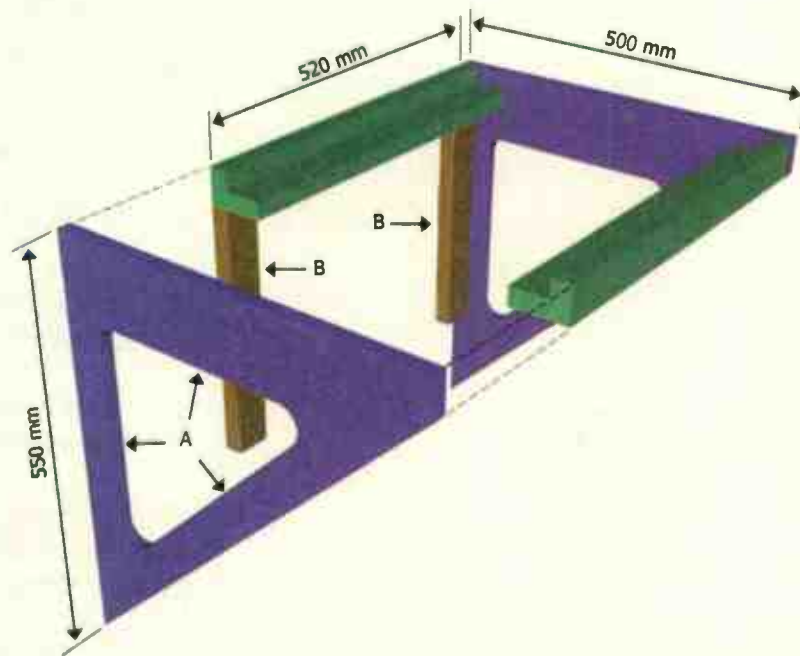
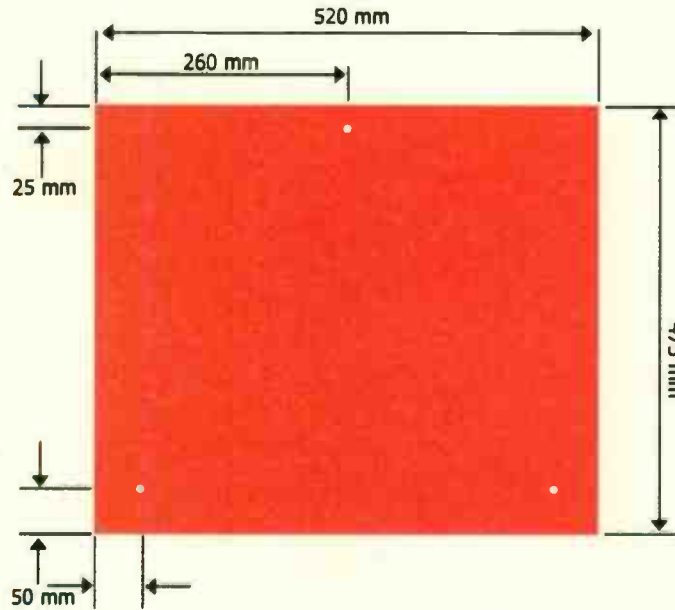

wall. Select the worst 'L' support and drill three pilot holes in the upright section of the 'L'. These holes should be symmetrical around the centre in height and also in width. I have found that the natural height for a turntable is 40 inches from the floor, so mark a line (lightly drawn with a pencil) using the spirit level 500mm long. Now offer the main support to the wall, making sure it is exactly sitting on the line, and pilot drill the wall with the 3mm-drill bit to mark the wall. Load a masonry bit into the drill again - these are to be pilot holes so choose a 5mm bit. Ensure the drill is switched to 'hammer', select the highest speed and now drill to the full depth of the drill bit into the wall.

On most wall plugs there is a gauge to help select the drill size for the plugs. So make your selection, load the drill and then drill to the full depth of the drill bit. Dip the rawlplugs into a little PVA and put them into the wall. They may need a little encouragement so lightly tap with a hammer until they are flush with wall surface. Drill the pilot holes in the main support with a clearance drill to fit three of the No 10 screws. Countersink both sides of the support rail. Screw the rail to the wall making sure that the rail is perfectly flush with the wall. If the rail is level (check to confirm this) and flush we are ready to start the assembly.

Offer one of the side panels against the wall making sure the top of this panel is flush with the rail and then mark around the edge onto the rail. Lay both panels onto the workbench and then pilot drill and clearance drill to suit. Countersink both sides of the panel. Only one hole is to be drilled in the panel. Repeat this with the other panel. Again offer the panels up to the rail and fix into position but not to tight. Next we fix, as the diagrams suggest, the short vertical supports. These as with the main supports have to be very firmly attached to the wall. The spirit level is now sited onto the side panels and two pilot holes are drilled

through into the vertical supports.

We now clearance drill and countersink, and then screw the side panels to the vertical supports. All that now remains to be done is to fix the front main support rail into position, ensuring that the rail is in exactly the same attitude as the rear rail. Now take your electric (or hand) screwdriver and re-tighten all of the screws, and put another screw

next to the top rear and front topside screws to make the structure rigid. Take a step back wards and have a look at the completed structure with the equipment support panel in position. All that is needed now is your turntable or your chosen signal source, a cup of tea (or something stronger) and some time to enjoy your handiwork!

# UK SUBSCRIPTION £36

VISIT OUR WEBSITE: [www.hi-fiworld.co.uk](http://www.hi-fiworld.co.uk)

✂-----  
**YES!** I want to subscribe to Hi-Fi World for:-

£36.00 for 12 months

Your Details

Title \_\_\_\_\_ Initial \_\_\_\_\_ Surname \_\_\_\_\_

Address \_\_\_\_\_  
\_\_\_\_\_

Post Code \_\_\_\_\_

Daytime Tel: \_\_\_\_\_

Start Issue \_\_\_\_\_

Delivery Address (if different)  
\_\_\_\_\_  
\_\_\_\_\_  
\_\_\_\_\_

I would like to pay by cheque made payable to Audio Publishing Ltd.

Please debit my VISA  MASTER  SWITCH  AMEX

Security No:  (last three digits printed on the signature strip)

Switch card issue No:  Expiry Date: \_\_\_\_\_ / \_\_\_\_\_

Cardholder Signature: \_\_\_\_\_



Please choose service:-

**ZONE 1** USA, Canada, Africa

**ZONE 2** Australia, Japan, Korea, China, Middle East & South East Asia

**ZONE 1** Airmail **£60.00**

**ZONE 2** Airmail **£70.00**

**Send this form to:**

Hi-Fi World, Subscriptions Department  
PO Box 464, Berkhamsted, Hertfordshire  
HP4 2UR

## SPECIAL INTRODUCTORY OFFER!

£36.00 for 12 months plus 1 additional issue free. That's a saving of 40p per issue and includes

**FREE postage & packaging.**

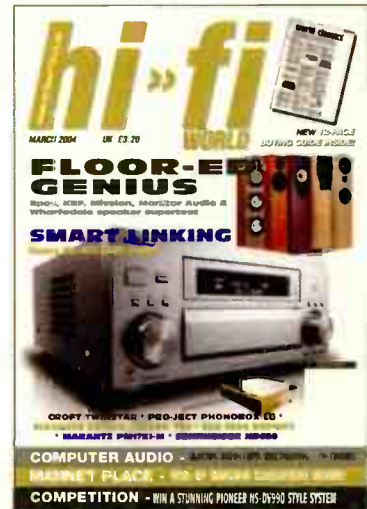

**Get your issue of hi-fi world straight to your door!**

**Get to our amazing classified ads first and grab a bargain!!**

- > **Run by dedicated hi-fi engineers and enthusiasts.**
- > **Hi-Fi World has become famous for its informative reviews and radical kit designs.**

## NEW NUMBERS

**Hotline**  
**+44 (0) 1442 879097**

**Fax No:**  
**+44 (0) 1442 872279**

**email:**  
**hifiworld@webscribe.co.uk**

**For Back Issues enquires please contact the above numbers**

# THE LA'S *The La's* 1990

**H**e we have the defining debut of the nineteen nineties, and probably one of the great career-closing albums too – the last will and testament of

The La's. It is an album that thoroughly deserves to be rediscovered by each successive generation: any teenage Coral fan should surely be made aware of the huge influence and timeless rock classicism of their 'scally' predecessors.

There is a curious story about the genesis of this record which will be retold eternally, and at its root is the striving of one individual, songwriter and lynchpin Lee Mavericks, to recapture the perceived magic of his demos in a professional recording. The fact that he was never remotely satisfied with the end result only deepens his mystery. This is after all a man who, much like Salinger and Barrett, receives the obsessive "where are they now?" pursuit by fans and writers which missing geniuses seem obliged to suffer.

Mavers' antipathy to the end result is hard to fathom and makes it difficult to justify the album as a classic, but the quality of the songs is impossible to ignore. 'There She Goes' will be on soundtracks and anthologies forever, and will probably receive ever more horrible cover version treatments every decade from now on, but there are many songs just as enthralling as that one to be found on this record - from the sprightly lead-in of 'Son of a Gun' to the epic closer 'Looking Glass', with its yearning quality dissolving into a cacophonous close. None of us have heard 'The Sound' as it exists in Mavericks' head, but to these ears the recordings do a reasonable job of reproducing the massive wall of energetic sound which was The La's live experience. You miss Mavericks' stomping, gum chewing, accelerated live delivery but over and above the still-present huge bass sound and deliberately rudimentary guitar tones the use of vintage microphones lends



a harsh patina to Mavericks' hollered vocals, which admirably convey the urgent sentiments of escape, drug-based or otherwise, which pervade many of the lyrics.

'The La's' was re-released in remastered form by Universal three years ago, and as my original copy suffered from the dreaded PDO Blackburn blight, the new version couldn't help but sound much improved. As a useful sleevenote from the band's A&R man details, the original album (with the exception of a remixed version of the Bob Andrews-produced 'There She Goes') is made up of Steve Lillywhite-produced versions - which must have been at least the third attempt to get these songs down on tape. Mavericks would probably have continued, but the record company called time and the album was released. Although the presence on the reissue of the B sides from 'Timeless Melody', the second release of 'There She Goes', and 'Feelin' is a useful round-up of the easy-to-find stuff for the uninitiated, it is a real shame that none of the Bob Andrews material is featured, particularly the superb trio of tracks from the original 'There She Goes' EP. I'm sure there is good reason for this, but it's a missed opportunity just the same...

As I wouldn't mind betting that the very idea of his sound being committed to Compact Disc was anathema to Mavericks, so it seems pointless to speculate about the possibility of a high resolution digital version of this record, but as the sleeve notes reveal it was recorded on vintage analogue equipment and the incredible enormity of the raw bass and guitar tones here might well benefit from a new transfer. As it will probably never happen we may have to content ourselves with what is a very acceptable CD version, as any brittleness in the sound is concealed by the deliberately primitive recording strategy. Of course if you're hanging on to a pristine vinyl copy you are probably a very happy person.

Even if Mavericks' never releases another note of music his place in history as the originator of this work is assured. There are many of us who would love to see him return in glory, but whatever came together would almost inevitably fall apart again in a welter of overweening perfectionism, skunk-fuelled sackings and recriminations, so it is perhaps best that things are left as they are, with one indelible monument to enjoy, unsullied by the thought of follow-ups which could never reach these heights. **PATRICK CLEASBY**

# The Sun Rising



**One of the most fascinating niche audiophile products of the year is surely Fujitsu-Ten's Eclipse TD 307PA active loudspeaker. Golden eared Patrick Cleasby tried these sun-sational Nipponese mini-monitors...**

**S**ometimes big surprises come in small packages. When two strange egg-shaped objects emerged from a nondescript cardboard box, I was prepared for novelty and nothing more. Of course, if I'd read the press release beforehand then I might have had a better idea of what to expect. It seems the 307's bigger brothers - the 512s and 508s - have gone down rather well with some top pro audio types (The Brecker Brothers, Sting's engineer Simon Osborne). Perhaps for this reason Eclipse are also not afraid of having the word "expensive" mentioned in association with the 307s...?

While the bigger eggs are serious recording studio monitoring machines, these are designed for where space is at an absolute premium, and the obvious application being computers. They're also, thanks to the stunning finish, particularly suited to style-conscious buyers. Put

these two categories together and you have Mac users! So it seemed entirely appropriate for a Mac-head like me [and a very stylish one, if I may say so? - Ed] to give them a go. Indeed, Eclipse are either prescient or very well informed, since although the 307s are also available in white and black, the gunmetal grey finish of the amp and speakers of this review sample sit much better next to a G5 tower than they do next to the translucent G4 styling of the current Apple Studio display as featured in the advertising. If Apple G5-ise the styling of their display, Eclipse will be right on the money and Harmon Kardon's transparent speaker/ sub combo will be looking in need of an update! Of course, the Eclipses are a whole order of magnitude more expensive...

Now, before we discuss prices, options and sonics, let's put this 'style' issue to bed. Like many men of similar age I spent my youth (and thankfully only my youth...) with a

serious Dr. Who affliction. Thanks to the wonderful ergonomics of the 307PA amp unit I can feel like The Doctor at the controls of the TARDIS - the satisfying palm-filling feel and dampened operation of the big blue under-lit aluminium volume knob is an old-time joy. Even my wife, who is quite fetishistic and judgmental about the action of computer keyboards and the like [oh yes... Ed] enjoyed a quick spin. There is not much else to the unit: a simple power switch, spring loaded gold speaker terminals, the DC power input (chunky transformer supplied), a crossover switch for when using the sub unit, and 3.5mm input and output (for the sub) sockets.

The speaker units themselves look very swish on their chrome feet, have optional speaker grilles and feel impressively substantial, containing an anchor weight as they do. Optional wall brackets are available for £50, and stands for £199, but these are more suited for

the use of five 307s with a sub in a small room 5.1 set-up, in which context the imaging of the 307s is reputed to do wonders. There is no equivalent of the stereo PA unit in a surround set-up – you just take your 5, 6 or 7 307s and a 316SW sub and use the multi-channel amp of your choice.

**SOUND QUALITY**

I have to confess that on initially plugging the system up with my G5, I was not turned on by the sonics. This was my fault entirely, however, as I'd left the 'Rock' preset switched on in iTunes (and the 'Sound Enhancer' to boot), and the Eclipses were remorselessly revealing this nasty audio affectation. So, to check that things were set up correctly after defeating the EQ, I tried playing some self-recorded uncompressed 24/48 PCM material - and was rewarded with fantastically dynamic sounds. Lurking in the same vicinity in iTunes was the official 192 kbps preview MP3 of Claudia Brücken (you didn't think a month was going to go by without a mention of my favourite diva did you?) and Andrew Poppy's version of 'Running Up That Hill'

from the forthcoming 'Another Language' album, and the simple piano and vocal are relayed by the Eclipses with lovely clarity and realism.

Deliciously crisp and open in the midband and treble as the 307s are, frankly the bass isn't up to much. To be fair, it's designed for near-field-use and therefore this should be an issue. But there's an optional subwoofer for those with a penchant for low frequencies, and this proved essential for serious listening. Now, I know that Joni Mitchell said, 'New Age rhymes with sew-age', but I happened to put on my encode of a twenty year old Windham Hill disc – Will Ackerman's "Passage", and the simple acoustic and violin formula was conveyed with wonderful precision by the Eclipse ensemble. Real music, real musicians, real musicality – and speakers to take me there.

Imaging is claimed to be the major selling point of the Eclipses, thanks to their small size, rounded enclosures and single, point-source driver - and so it was. They worked best at ear height, but if you're not so fussy you can tilt them back on

the stands so they are firing up to you. Once set up, a quick fix of the gonzo guitar stylings of Ted Nugent's first solo album resulted in quite the most satisfying experience of

that distinctive semi-acoustic guitar tone, tight drum sound and creamily authentic bass I have had for some time. All the detail in this wonderfully engineered classic rock recording was laid out in front of me. The

obligatory Steely Dan test, using the CD layer from the recent SACD of 'Gaucho', generated an almost eerie sense of presence. The Eclipses rendered the layered precision of the Steely Dan sound with considerable aplomb.

How did they cope with the carefully tailored midband of a modern rock record? A blast of Skunk Anansie's still awesome 'Selling Jesus' demonstrated

admirable control of a skittering bass part, and a drum kit being battered to death within sheets of Les Paul rifferama, while preserving Skin's histrionic vocal in the verse and angelic choral backing in the chorus. 'Little Baby Swastika' demonstrated phenomenally the three dimensional imaging too. Switching to Porcupine Tree's recent remaster of 'Signify', the edgy dampened Strat attack of the title track moved with tight efficiency whereas the hypnotic center-piece – 'Waiting' swung through its movements beautifully. Very impressive stuff indeed. This Eclipse

**VERDICT** ●●●●●

Superb visual and aural complement to the G5 Mac, these desktop speakers make a great show-off purchase for those with an eye – and an ear - for detail.

**FUJITSU-TEN ECLIPSE**  
**TD307PA (SEE BOX) £400**  
[www.eclipse-td.co.uk](http://www.eclipse-td.co.uk)



system made me want to sit in front of my Mac all day, throwing different tracks at it to see how it coped.

Here's a miniature active loudspeaker system with a difference. Its design and build quality are to the very best hi-fi standards, and the result is dazzling sonics (and styling) in a small package – ideal for multimedia and computer use. The only problem of course is that quality costs, and if you're wanting to grow the TD307s out of their desktop domain into a fully fledged, full-range sound system, then you'll need to spend £650 extra on the subwoofer too. This done, the results are remarkable, but even in 2.0 form as tested, this entry-level Eclipse is dazzlingly capable.

**SPECIFICATIONS (QUOTED)**

DRIVE UNIT:	65mm full range
FREQUENCY RESPONSE:	120Hz-20-kHz (-10dB)
POWER HANDLING:	24W
SPEAKER DIMENSIONS:	120x162x160mm
SPEAKER WEIGHT:	1.2kg (each)
AMPLIFIER POWER:	2x12W
AMPLIFIER DIMENSIONS:	144x150x148mm
AMPLIFIER WEIGHT:	1.5kg



**PRICING**

TD 307PA system	£400
TD 307/316SW 5.1 sat and sub system	£1300
TD 307 Micro Monitor	£130
Eclipse 316SW Subwoofer	£650



**THE WHO  
TOMMY  
(HYBRID SACD: STEREO AND  
MULTI-CHANNEL DSD)**

Following on from the masterful Deluxe Edition SACD of 'Goodbye Yellow Brick Road' Universal debut another significant Deluxe re-release as an SACD – The Who's classic rock opera 'Tommy', and this one is every bit as excellent as its predecessor.

To get the first piece of good news out of the way first: for the first time ever 'Tommy' is available in digital form as a transfer from the original quarter inch stereo master. As per the previous CD remasters Jon Astley has handled the mastering chores, but as a close Who collaborator his role was always much more than just mastering. The mid-nineties CD actually bore a remix credit so I presume the stereo was recreated from the one inch eight track, but this time Astley's searches have unearthed the tapes which were previously thought to have been lost. Coupled with the benefit of a new DSD transfer this means that a whole generation has the chance to hear 'Tommy' as it was originally intended to be. But over and above that we have the work as Pete Townshend now intends it to be – in surround.

Essentially what Townshend has done is to recognise the individual

brilliance of his rhythm section and push their contributions more to the fore in his surround mix. He has also decided that a much drier approach to the use of reverb is more suited to what is one of the true great rock bands playing great rock music. The original parts were so well recorded that anyone who really appreciates such stellar playing and great sounds should enjoy the new surround imagining as an alternate version of the album. A second disc also gives us the same rich bass sounds and great ensemble playing on twelve alternate versions and outtakes, available in both stereo and surround, while a handful of stereo-only original Townshend demos – cough - demonstrate how complete the tracks were in his imagination before he even presented them to the band.

DVD-Audio fans should once again be aware that US Universal release 'Tommy' in that form in a couple of months time. In either format this makes a great package, and an assured first foray into surround work for Townshend - this one should ensure that future Who surround projects are eagerly anticipated. At the present time work is under way on 'Quadrophenia' - regrettably, as mentioned elsewhere in this issue in a letter response, 'Who's Next' is

currently stymied by the old 'missing, lost or half-inched roll of multi-track' problem. A great shame indeed...

**ELVIS COSTELLO  
NORTH  
(HYBRID SACD: STEREO AND  
MULTI-CHANNEL DSD)**

For another month, new DVD-Audio releases remain thin on the ground while Universal International continue to release fine SACDs in increasing numbers. However it would appear that there are even some within the fold who remain unconvinced that the time for new formats is now, as despite 'North' being available in SACD form in the US and Europe, Deutsche Grammophon have yet to release it here in the UK. Attempts to elicit an official response as to why this should be have not been successful thus far...

The explanation could be the fact that Elvis's latest offering has not exactly set the world on fire, even among the cognoscenti. I like it, which could be because I am not a great lover of the classic Costello style of vituperative wordplay and tightly energetic rock, and this album has almost nothing to do with that. The DG emblem gives the game away that this is one of the long line of non-rock Costello projects – he has been doing it for so long now



that it is impossible to accuse him of dilettantism.

Last year's chat show circuit saw Elvis explaining how he happened to realise that he had written a song-cycle which took him from the dissolution of one relationship (his marriage to Cait O'Riordan) to the dawn of a new one (his recent liaison with Dana Krall). The result is an album of straightforward lovelorn balladry, with a pleasing arc from melancholy to hope. Beautifully recorded and subtly mixed (for both stereo and surround) by long-time studio partner Kevin Killen, the primarily piano and vocal setting foregrounds Costello's lugubrious baritone, but DSD conveys that frail instrument (and some haunting vibraphone parts) with great realism.

Bonus track 'Impatience' reunites Costello with Attractions drummer Pete Thomas and guitar collaborator of some fifteen years standing Marc Ribot, and highlights how fun surround reworkings of Costello's electric band work could be. If Killen can produce mixes like this I would like to hear his re-imaginings of Costello's nineties work, even though I have never been a huge fan. Anyone who is already a fan of this album should definitely seek this SACD out from Europe or the States and upgrade forthwith. However, if you are a DVD Audio fan be advised that

US Universal have a DVD-A of North slated as "Coming Soon".

### DEPECHE MODE 101 (HYBRID SACD: STEREO AND MULTI-CHANNEL DSD)

It may not be immediately apparent why Mute decided to launch into SACD with this title, but last year's re-release of D.A. Pennebaker's movie of the same name on DVD must have meant that the time was right to remaster the album too. Bizarrely, although I kept up with DM studio albums both before and after the considerable career landmark of 101 I never got the live album or video, so this is a welcome opportunity to see and hear what I missed.

At the time it seemed strange to see the bunch of gangly Basildon teenagers who had gauchely graced TOTP a mere handful of years earlier turn into stadium-shagging rock gods. Looking back it seems easier to understand, as from the inter-album singles 'It's Called A Heart' and 'Shake The Disease' through the two albums ('Black Celebration' and 'Music For The Masses') which preceded this one, it is possible to trace both increasing class and increasing rock inflections in the songwriting of Martin Gore. It wasn't until after 101 that Gore added significant guitar and

real drums to the mix, but you could see it coming. 101 was recorded at the Pasadena Rosebowl at the end of the US tour Pennebaker followed with his camera. Bereft of the images of white-clad Dave Gahan's gyrations causing teenage screaming, the album still works as a record of the energy the band released onstage and the adulation they received in return.

This double SACD consists of a Simon Heyworth DSD remastering of the original half-inch analogue master for SACD stereo and CD layers, and the results are very pleasing, as DSD seems ideal for conveying the fat synthesised bass and kick drum which characterises so much of this material. The original stereo was also used to create the multi-channel version by treating it with a Z Systems K6 surround processor. This approach is unlikely to generate great results for studio material, but may be deemed acceptable for live material where a "proscenium arch" approach to 5.1 mixing is most common, with the rears only being used for ambience and audience. Many might prefer to use their own surround processing such as Pro-logic II. Most hearteningly the whispers are that true discrete mixed surround versions of the studio albums are in the pipeline – a prospect which should have all DM fans slaving in anticipation.





# noel keywood



**F**unny that - twenty years after digital arrived, consigning LP to the great dustbin of history - the old analogue disc soldiers on. Good turntables still sell, and both cartridges and phono stages are in demand. Like most people who were alive when Led Zep roamed the earth, I've got a sizeable record collection. Worse - or should I say 'better' - still, it contains classics from artists like Janis Joplin to Jimi Hendrix that will, with the benefit of hindsight, never be equalled. They've been re-released on CD, but that still doesn't detract from the fact that it was LP where I first heard the original performance and it's LP where the music lies in its original form. A CD will never have the same value, even though it may carry an 'improved' version where the master tapes have been computer enhanced to reduce noise and improve balance.

A retro car that uses modern parts under a repro body would similarly offer better performance and reliability than the original, but museums and collectors wouldn't value it in the same way and for a lot of great music only the LP will do for much the same reason. No matter how convenient and durable the CD versions may be, it is on LP that the music historically belongs. That is how music reached us from the mid '50s to the mid '80s, a span of thirty years during which time some of the world's greatest artists were delivered to us on black plastic. This gives the LP great historical and sentimental value. I for one now treasure early Beatles singles and EPs that in their time were played hard and given little care.

CD 'seemed' to move us on into a new world of improved sound and easier access. I wouldn't deny it. It has proven to be a wonderful innovation, although not quite for the benefits originally claimed. Its laser

optics are a wonder; this part of the CD is in use today. The digital coding scheme used was abysmal though, worse in some crucial areas, like distortion, than the LP it replaced. Comparison of the two has always fascinated me because the LP just isn't the technical abomination it was once made out to be, mainly to further CD's case, and CD isn't the wonder it was originally cracked up

**“ A CD will never have the same value, even though it may carry an 'improved' version**

to be either.

It was interesting to measure frequency response of the Decca London Gold cartridge this month: it reached 30kHz. That's more than CD by a useful margin, from a cartridge designed for mono! It almost matches the 96kHz sample rate of DVD-Audio, which gives an analogue bandwidth to 45kHz. There is a way of arguing that the Decca tracking an LP likely outputs more above 20kHz than you'd get from much 24/96 digital. It may be peaky and a little artificial, but if there is anything on an LP in this region the Decca will find it! So what we hear from LP may sound good for subtle but real reasons. It's easy but dangerous to underestimate the LP and overestimate the CD, simply because the latter is digital.

LP hides its weaknesses well, unlike CD. The peculiar influence of RIAA correction is a prime culprit in bringing to LP a presentation that no digital medium could ever possess. RIAA boosts bass and cuts treble. It gives disc surface noise a warm quality. Low level noise affects our perception of sound. If RIAA were not there I suspect we would find the LP a lot less pleasant to listen to.

For a start surface noise would take the form of a thin, spitty hiss. Distortion harmonics would seem nastier, likely making the sound more wiry. And there would be less apparent air and space, because strong low frequency noise is the signature of large-space ambience to the brain. For these reasons digital done properly could never sound like LP, the replay processes are so different.

The best we can do with digital is to give it enormous resolution so that as signals sink in level they don't rise in distortion, an unfortunate phenomenon. Hence the decision to use 24bit resolution which, in theory at least, gives minimal

distortion. My measurements show that this is achieved in practice too, from test discs at least, where levels of 0.1% for DVD-A and SACD compare with 7% or more from CD at -80dB. That's a seventy fold decrease in distortion. But then you have to remember that at really low levels a cartridge tracking an LP groove is also very linear; there's little distortion and it is innocuous sounding second and third harmonic, one reason why LP sounds so smooth.

Today's cartridges are coming ever closer to the better technical features of CD, like a flat frequency response, whilst moving farther away from their traditional weak areas. Stylus get ever better at retrieving information and tracking has improved steadily too. Improving CD is difficult, arguably impossible. The 1970s digital coding scheme used by CD imposes a fixed limit upon the information that can be carried. So while CD stagnates and hi res digital struggles to get off the ground, the LP improves steadily - which always was one of the glories of analogue; it can evolve and digital cannot. Don't look at your LP collection as a relic: there's useful life in the LP still. ●

# Tube Shop

com

a lot easier!  
**'My tubes are impossible  
 to get hold of'**

Visit The Tube Shop  
[www.tube-shop.com](http://www.tube-shop.com)



You can even telephone your order  
**0870 9220404**

## Why choose Tube-Shop.Com

- Over 2,500 different tube types in stock at all times
- We offer you the best prices around, Guaranteed
- UK's first fully online tube ordering system
- Expert matching service by PM Valve Labs
- We sell only the world's BEST brands
- Next day delivery (if ordered before 3pm)
- Free delivery (on all orders over £50)
- MONEY BACK GUARANTEE
- Trade enquires welcome

## Billy Vee

SOUND SYSTEMS

## SAVE UP TO 50% ON EX-DISPLAY BARGAINS

SOME AS NEW (MARKED\*) WITH 2 YR WARRANTY 24HR DEL ONLY £5. CHECK STOCK BEFORE ORDER  
 CALL SALES: (020) 8318 5755 or 8852 1321 - 248 Lee High Road, London, SE13 5PL  
 Please call for details on deferred 0% APR for purchases of more than £660. S/H = Pre-Owned unit. E&OE

Arcam CD62T CD Player (2Yr G/tee) .....	(369.00)	£259.00	Linn LP12/Ekos/Arkive Boron (2Yr G/tee) .....	(5350.00)	£2675.00
Arcam CD82T CD Player (2Yr G/tee) .....	(599.00)	£499.00	Naim NAC 282 Preamp (2Yr G/tee) .....	(2750.00)	£2095.00
Arcam A85* Amp inc Phono- Blk (2Yr G/tee) .....	(909.00)	£649.00	Naim NAP 250 Power Amp (2Yr /Gtee) .....	(2250.00)	£1745.00
AVI Biggatron Speakers - Cherry (2Yr /Gtee) .....	(599.00)	£399.00	Naim CDS 2 S/H Head Unit (1Yr G/tee) .....	(4165.00)	£2395.00
B&W CDMcse S/H Centre Sp-Blk (6Mth /Gtee) .....	(400.00)	£179.00	Naim PSX S/H Power Supply (1Yr G/tee) .....	(2100.00)	£1295.00
B&W HTM2 Nautilus Centre Spkr - Blk (2Yr G/tee) ..	(850.00)	£499.00	Naim NAP 250 S/H P/Amp (1Yr G/tee) .....	(1890.00)	£1295.00
Linn Kolektor Preamp (2Yr G/tee) .....	(575.00)	£375.00	Naim Intro Speakers (2Yr G/tee) .....	(865.00)	£575.00
Linn LK140 Power Amplifier (2Yr G/tee) .....	(875.00)	£565.00	Naim SL2 Speakers - Maple (2Yr G/tee) .....	(4995.00)	£3595.00
Linn AV2250 AV Power Amp (2Yr G/tee) .....	(1995.00)	£1295.00	Naim NBL Speakers - Beech (2Yr G/tee) .....	(7700.00)	£5495.00
Linn Trikan Centre Spkr - maple (2Yr /Gtee) .....	(549.00)	£349.00	Revox E642 42" Plasma/Tuner (1Yr /Gtee) .....	(7499.00)	£2395.00
Linn Espek Speakers - maple (2Yr G/tee) .....	(2800.00)	£1795.00	Spendor S3 Speakers - Maple (2Yr G/tee) .....	(599.00)	£449.00
Mission M5c* Centre Spkr - Beech (1Yr /Gtee) .....	(199.00)	£99.00	Spendor S8 Speakers - Cherry (2Yr G/tee) .....	(1699.00)	£1185.00
Naim NAPV 175 3 Ch P/Amp (2Yr G/tee) .....	(1225.00)	£895.00	Yamaha DSP800 S/H Processor (6Mth /Gtee) .....	(399.00)	£149.00
Naim NAC 252* Preamp (2Yr /Gtee) .....	(3995.00)	£2995.00	Yamaha DVD 530* DVD Player (1Yr G/tee) .....	(149.00)	£89.00
Naim NAC 112 S/H Preamp (6Mth /Gtee) .....	(660.00)	£369.00	Yamaha RXV 630 RDS A.V. Amp (1Yr G/tee) .....	(459.00)	£299.00

## IAN EDWARDS

MAKERS OF FINE HAND MADE FURNITURE

Tel: 01423 500442 Fax: 01423 705200 [www.iansbespokefurniture.co.uk](http://www.iansbespokefurniture.co.uk)  
 The Old Chapel, 282 Skipton Road, Harrogate, N. Yorks, HG1 3HE

Elegant Storage Solutions for  
 Hi-Fi, Books,  
 LPs, CDs,  
 DVDs  
 Special orders welcome



New Brochure now available

'Super 14 Wizard' Rotary Unit. 2296 CDs, etc



74" 'V-Max' can hold 660 CDs etc



JT Hi-Fi CD/Cassette Unit



Charlotte Drawer unit for 480 CDs & 75 Cassettes 32" x 21" x 21"



# david price



**W**hen prototype Compact Disc players were first unveiled to the press back in 1982, such a thing as a laser tracked digital disc seemed so esoteric that it was the stuff of science fiction – how possibly could music emanate from a small, silver slice of lacquered aluminium? By contrast, plain old black vinyl records seemed so far behind that most commentators, understandably enough, predicted its speedy demise.

I for one was fascinated with CD theory. At the time of its launch, I was working as a contract programmer for Exxon, using machine code and assembly language on the (then) new 16bit processors in IBM PCs. Digital audio seemed a small step away from my daily travails, and an intriguing one. I soon realised that CD spinners were actually 'mini music computers', number crunching data read off their optical disc drive in real time.

Turntables were a very different kettle of fish. Essentially analogue measuring instruments, they possessed none of that sexy 'high tech' appeal of their new digital cousins. Simple, fault prone and fiddly with a nineteenth century user interface, was it any wonder that the thrusting, fashion-obsessed world of early eighties Britain simply couldn't be bothered with them anymore?

Ironically, two decades on, producing a CD spinner is not full of mystery and intrigue. Digital disc machines come on silicon chips these days. (Look inside a 1983 Sony CDP-101, jam packed with circuit boards and wires everywhere, and compare that to a 2003 Sony SCD-XA3000ES, which is a model of simplicity). Chuck in a 'mech', a display and a

'trannie' and Bob's your uncle...

By contrast, it is vinyl which is now enveloped in myth and magic. Manufacturing turntables is actually a more complex process, as it involves handling materials bigger than chips – and circuit boards, machining them – sometimes to incredible tolerances –

**Its fiddly setup and quaint looks will deter some, but its fluidity will amaze**

and doing it day in, day out with a supreme degree of consistency.

We're realising that the process of dragging a tiny lump of coal along a small, bumpy plastic groove is far trickier than it seems. Turntables, tonearms and cartridges require tremendously intricate mechanical engineering (especially the latter two), and are unbelievably time and labour-intensive to make relative to a 24/7 DVD player production plant in Shenzhen.

This month's tonearm supertest was a fascinating reminder of this. All the arms involved were quite superb compared to the standards of the nineteen eighties, when vinyl had its last mainstream moment. And so they should be – twenty years of Darwinian natural selection has separated the wheat from the chaff, leaving analogue addicts with a choice of fine, but quite different, sounding products.

The Rega-based Origin Live OL and Silver are now the staple of the modern pickup arm market, and are a dramatic improvement on the original RB300, boasting ease of setup and very high all-round competence. The Linn and SME serve as excellent late eighties reference points – in their respective ways,

they still do what they do better than anything else (i.e. tunefulness and analysis respectively). The Hadcock is stunningly underrated in my opinion – its fiddly setup and quaint looks will deter some, but its fluidity will amaze. The Roksan Nima is a thoroughly modern unipivot with an expansive and organic sound, and the only thing to have at £350.

What then of the others we've left out? Well, the first thing many Hi-Fi World readers will be thinking is, 'why didn't you do the Naim ARO, the Michell TecnoArm

(a), the Graham, the Wheaton Tri-Planar, the Rega RB900, the SME309...?' Well, we had to draw a line in the sand somewhere – and leave the others for next time!

You might have noticed that – while we're fascinated by new digital developments – we take vinyl extremely seriously, and hope to bring you the most thorough coverage of the format possible. Of course, we can't do this all at once, so I'd ask eager vinylphiles to be patient, as we run the gamut of all the goodies on sale, both new and second-hand.

As for digital devotees, we'll still strive to find the most musical MP3, AAC, CD, SACD and DVD-A players around. But don't rule vinyl out as a complimentary source to your CD player. The beauty of vinyl is that you can buy a second-hand Dual CS505 for £20, spend £20 on a new Audio Technica AT110E and £60 on a Project Phono Box LE – and you've suddenly got access to a massive archive of black plastic, much of which still costs 50p from charity shops. On one hand, we have the majesty of turntables like Musical Fidelity's M1, and on the other you can get going in analogue for under £100 – that's the magic of vinyl! ●

# dial a dealer

This is a comprehensive directory of Hi-Fi Dealers throughout the UK and Ireland.

## BRISTOL & BATH

**THE RIGHT NOTE** Tel: (01225) 874728. Are you happy with your system? We find that most audiophiles listen for most of the time to systems that are 'not quite right'. Forget the 'Best Buy' reviews and putting a system together like a patchwork quilt. Let us assess the vast range available, you judge the results. We'll help you to plan a system for the future, even if you spread the purchases. Leave 'up-grade-itis' behind, save money and enjoy music all the time. Just listen, and you'll know.

CD: Accuphase, Audio Synthesis, Bel Canto, dCS, Resolution Audio, Wadia. Vinyl: Basis, Clearaudio, DNM, Graham, Michell, Sumiko, Transfiguration. Amps: Advantage, CAT, DNM, Gamut, Spectral. Speakers: Audio Physic, NEAT, Verity Audio. Tuners: Magnum Dynalab. (Credit Cards Accepted).

**VAUDIO** HiFi Consultants: 36 Druid Hill, Stoke Bishop, Bristol. BS9 1EJ. Tel: 0117 968 6005. ATC, AVI, Alon, ALR Jordan, Audio Analogue, Avid, Black Rhodium, Electrocompaniet, Eslab Digital Amps, Harman Kardon, Infinity, Jamo, Lyra, Origin Live, Opera, Ortofon, PS Audio, Ruark, Michell, REL, SME, Sugden, Townshend, Triangle, Unison Research Valve Amps, VPI. Specialists in Video Projectors by SIM2, Infocus, Sanyo; screens by Stewart, Draper, Da-Lite, Owl, and Amps/DVD's by Harman Kardon etc. Demos by appointment only. Home trial facilities. We are not a shop.

## CAMBRIDGESHIRE

**THE AUDIO FILE** 41 Victoria Road, Cambridge. Tel. 01223 368305. Fax: 01223 354975. Email: s.streater@aol.com. 'For the best in British Hi-Fi and Home cinema entertainment'. Visit or call to arrange a dem with products from: Arcam, Linn, Naim, Cyrus, Absolute Sounds, Kef, Sony, Yamaha, Rel, Ruark, Denon.

## CHESHIRE

**ACOUSTICA** 17 Hoole Rd, Chester CH2 3NH. www.acoustica.co.uk. Tel 01244 344227. All the best in HiFi & Home Cinema from Naim, Rega, Rotel, Sugden, Tube Technology, Primare, Isotek, Harman Kardon, Teac, Acoustic Energy, JM Lab, B&W, Spondor, Royd, REL, Quadraspire, SIM2 & Sanyo projectors and much more. We offer full demonstration facilities, interest free credit and delivery & install systems throughout Cheshire, Merseyside & North Wales. Opening hours are Tuesday to Saturday 10.00 to 5.30.

**ACTON GATE AUDIO** 4 Ruabon Road, Wrexham, North Wales, Tel. 01978 364500. Audio Visual Specialists. Arcam, Audio Analogue, Bose, B&W, Celestion, Castle, Denon, Harmon Kardon, Jamo, Marantz, Michell, Mission, Onkyo, Pro-Ject, Musical Fidelity, NAD, Micromega, Myrad, QUAD, Radford, Rotel, Ruark, Tannoy, TDL, Teac, Thorens, UKD, Unison Research, Yamaha, DSP Club Member, Demo Room, installation service. Easy Parking and Motorway access. All major credit cards accepted. 9.30 - 5.30 daily. Closed Sunday & Monday.

**DOUG BRADY HI-FI** Kingsway Studios, Kingsway North, Warrington, WA1 3NU Tel 01925 828009 Fax 01925 825773. Visa, Mastercard, Lombard Tricity. 2 dem rooms, home trial; Agencies include: Arcam, Tag McLaren, AVI, B&W, Castle, Caspian, Chord Electronics, Exposure, Harbeth, Heybrook, Krell, LFD, Michell, Meridian, Musical Fidelity, Monitor Audio, Naim, Nautilus 800 series, Pink Triangle, ProAc, Roksan, SME, Wilson Benesch, XTC and many more.

## DEVON

**AUDIO DESTINATION** Audio Destination, 32b Bampton Street (above Hill House Hammond), Tiverton, Devon. Tel (01884) 243584. Hi-Fi/Home Cinema specialists. 2 demonstration rooms, home demonstrations, child's play area, interest free credit, relaxed/friendly service. Musical Fidelity, Ruark, Monitor Audio, Chord, Project, Primare, Tube Technology, Totem, Unison Research, NAD, Nordost, Lexicon, Trinity Audio plus others. e-mail: info@audiodestination.co.uk

## DORSET

**MOVEMENT AUDIO** 588 Ashley Road, Poole, Parkstone, Dorset BH14 0AQ. Tel: (01202) 730865/380018. Arcam, B&W, Castle, Chord Electronics, Cyrus, Denon, Marantz, Michell, Mission, Pioneer, Tannoy Dimension, Yamaha. 2 Dem rooms. Listen to the available choice and decide at your leisure - no pressure, no obligation. Our staff enjoy music, with our choice of products, you can too! Service Department. Free installation. Home trial facilities. Access, Visa, Amex, Diners Card. Credit facilities available. Open Tuesday-Saturday 10-5.30. www.movement-audio.co.uk

**MOVEMENT AUDIO** 926 Wimborne Road, Winton, Bournemouth, Dorset. BH9 4DH. Tel: (01202) 529988/520066 Arcam, B&W, Denon, Kef, Marantz, Mission, Musical Fidelity, Opera, Pioneer, Quad, Roksan,

Ruark, Yamaha. Full dem facilities available, also home dem. Friendly expert advice. Service Department. Free installation. Home trial facilities. Access, Visa, Amex. Open Tuesday-Saturday 9.30-5.30

**WEYMOUTH HI-FI** 33-35 Maiden Street, Weymouth, Dorset DT4 8BA. Tel (01305) 785729/766345. Arcam, B&W, Denon, Kef, Marantz, Mission, Musical Fidelity, Panasonic, Pioneer, Quad, Sony, Tannoy, Yamaha. Dem room. Friendly professional advice. Only quality hi-fi dealer in Weymouth area. Service Department. Free installation. Home trial facilities. Access, Visa, Amex, Switch, Delta Mastercard. Interest free credit. Instant credit. Open Mon-Sat 9.30-5.30

## LEICESTERSHIRE

**HIFI EXPERIENCE** 227 Tottenham Court Road, London W1. 020 7580 3535. Arcam, Cyrus, Denon Gold, Quad, Kef, Meridian, Yamaha, Marantz, McCormack, Mirage, Nakamichi, Musical Fidelity, PAFF and many more. Open 10.00-7.00 Mon-Fri. 9-6 on Sat. Service dept, Credit facilities, delivery and free installation.

**THOMAS HEINITZ LTD** 35 Moscow Road, Bayswater, London, W2 4AH. Tel: 020 7229 2077. Fax: 020 7727 9348. Email: info@thomasheinitz.com. Web site: www.thomasheinitz.com. Established in 1952, Thomas Heinitz has a long history of providing the best music and AV systems available. We continue to offer the highest standard of service in the most relaxed atmosphere. Whatever your needs, from multiroom and home cinema to a high quality stereo system, we offer consultation, design specification, architect liaison and installation in order to ensure your system is tailored to your exact requirements. For quotes contact our manager Johnny Drum.

## MIDDLESEX

**RIVERSIDE HI-FI** 422 Richmond Road, East Twickenham, Middlesex, TW1 2EB. Tel: 020 8892 7613 Fax: 020 8892 7749. www.riversidehifi.co.uk Audio Research, Blueroom, Bose, B&O, Copland, Denon, Elac, Infocus, Krell, Linn, Living control, Martin Logan, Michell, Monitor Audio, Musical Fidelity, NAD, Project, QED, Rel, Sennheiser, Sonus Faber, Teac, Theta, Wilson. Finance available. Subject to status. Written details available on request. Export orders welcome. UK mail order available. 3 demonstration rooms. All major credit cards. Open 10am-5.30pm Mon-Sat.

OXFORDSHIRE

OVERTURE HI-FI 3 Church Lane, Banbury, Oxon OX16 8LR. Tel (01295) 272158. Email sales@overture.co.uk Website: www.overture.co.uk Arcam, Bose, Denon, KEF, Linn Products, Miller and Kriesel, Mission, Mirage, NAD, Naim Audio, Spondor, Yamaha. For sensible unbiased advice, call Oxfordshire's audio experts. Superb demo facilities. No appts. necessary. Home Cinema, Plasma TV, Projectors, Lutron Lighting, MultiRoom and Commercial installations. Access/Visa, instant credit. Mon-Fri 10-6, Sat 9.30-5.30.

STAFFORDSHIRE

ACOUSTICA 114 Wolverhampton Rd, Stafford ST17 4AH. www.acoustica.co.uk. Tel 01785 258216. All the best in Hi-Fi & Home Cinema from Naim Audio, Arcam, Rega, Rotel, NAD, Sugden, Tube Technology, Yamaha, Harman Kardon, Bowers & Wilkins, Focal/JM Lab, Monitor Audio, Ruark, Mission, KEF KHT, REL, Quadraspire, Sim2, Optoma & Sanyo projectors and much more. We offer full demonstration facilities, interest free credit and delivery & install systems throughout Staffordshire & the Midlands. Opening hours are Tuesday to Friday 10.00 to 5.30, Saturday 10.00 until 5.00.

SUFFOLK

AUDIO IMAGES 128 London Road North, Lowestoft, Suffolk, NR32 1HB Tel: 01502 582853. Arcam, Acurus, Castle, Rotel, Moth, Triangle, QTA, Sugden, Denon, Yamaha, Mirage, M & K, Definative, Musical Fidelity, plus the incredible Rothwell range. Refreshingly different selection. Dem Room, Professional AV installer's from budget to high end. Full credit facilities. 9.30 to 5.30 Mon & Sat ~ 9.30 to 6.00 Tues to Fri.

SURREY

INFIDELITY 9 High Street, Hampton Wick, Kingston upon Thames, Surrey. KT1 4DA. Tel. 020 943 3530. Email: infidelity@compuserve.com - Web Address: infidelity.co.uk Stockists of: Linn, Naim, Arcam, Meridian, Rega, B&W, Nautilus, Neat, Proceed, Royd, M&K, Rotel, Stax, Shahinian, Dynavector. Open 10.30 - 7.00 Tues - Fri, 10.00 - 6 Sat.

WEST MIDLANDS

SOUND CINERGY 37 High Street, Aldridge. 01922 457926. Tues-Sat 10 - 5.30. AE, Arcam, Chord Co., Creek, Harman Kardon, Infinity, Linn, Loewe, Marantz, NAD, Project, PURE, REL, Tannoy, van den Hul. www.soundcinergy.co.uk http://www.soundcinergy.co.uk

MUSIC MATTERS Birmingham - 363, Hagley Road, Edgbaston, B17 8DL. Tel: 0121 429 2811. Solihull - 93-95, Hobs Moat Road, B92 8JL. Tel: 0121 342 0254. Stourbridge - 9, Market Street D48 1AB. Tel: 01384 444184. Sutton Coldfield - 10, Boldmere Road, B73 5TD Tel: 0121 354 2311. Arcam, Alchemist, Apollo, Audioquest, Audio Research, B&W, Cable Talk,

Castle, Celestion, Chord, Copland, Cyrus, Denon, DPA, JBL, Kef, Krell, Marantz, Martin Logan, Meridian, Musical Fidelity, Panasonic, Pioneer, REL, Rotel, Ruark, SME, Sennheiser, Sonus Faber, Tag McLaren, Teac, Theta, Yamaha etc. Classical CD's available at Birmingham only. Demonstration rooms, service and installation. BADA member. VISA / MASTERCARD / AMEX / SWITCH. Open: 10-5.30 Tuesday to Saturday. Late night Thursday till 7.00 (not Stourbridge).

SOUND ACADEMY For the Midlands. The Parade, Sutton Coldfield, Tel. 0121 321 2445 & High Street, Bloxwich, Nr Walsall, (sharing the ASDA shopping centre) Tel 01922 493499. Hosts 4 private studios plus a Home Theatre Cinema with Tube & LCD Projectors. The best in hi-fi from Naim, Arcam, Audiolab, Chord, Meridian, Monitor Audio and many more. So... if you've taken time to read this, please let us make you welcome. Phone 0121 321 2445 for Sutton or 01922 493499 for Walsall. Call in and to browse our exciting display of hi-fi and home cinema equipment. Mail order available. interest free credit S.T. Status. Open 6 days, 9am to 5.30pm. Please call for late night. Expert Advice, Cable Dressing and Installation.

WILTSHIRE

SALISBURY HI-FI LTD 15 Catherine Street, Salisbury, Wiltshire SP1 2DF. Tel (01722) 322169/330841. Arcam, B&W, Celestion, Denon, KEF, Marantz, Meridian, Mission, Musical Fidelity, NAD, Opera, Pioneer, Ruark, Tannoy, Yamaha, 2 Dem rooms. Friendly, relaxed atmosphere. Professional advice. Home dem available. Service department, Free installation. Home trial facilities. Access, Visa, Amex. Interest free credit. Instant credit. Open Mon-Sat 9-5.30.

YORKSHIRE (NORTH)

SOUND ORGANISATION YORK, 2 Gillygate, York YO31 7EQ. Tel (01904) 627108. Carefully chosen Hi-Fi and AV equipment includes Arcam, B&W, Nautilus, Denon, Linn, Naim, Rega, Rotel, Stax etc 3 dem rooms incl. Home Cinema and Linn connect. Service Department. Home installations. Instant Credit and major credit cards. Closed Mondays. Phone for chat and more details. www.soundorg.co.uk

YORKSHIRE (EAST)

THE AUDIO ROOM 2 George Street, Hedon, Hull, HU12 8JH. tel 01482 891375. www.theaudiroom.co.uk The Norths premier hi fi dealer, stunning showrooms and dedicated listening room, authorised agents for, Linn, Naim, Krell, Audio Research, Cyrus, Sugden, Rega, Ayre Acoustics, Mark Levinson, Pathos, Unison Research, B&W, Proac, Focal JM lab, Spondor, Sonus Faber, Martin Logan and others. Home demonstrations and credit facilities available. Open Mon - Sat, 9am - 6pm. The Norths friendliest hi fi dealer.

YORKSHIRE (SOUTH)

THE HI-FI STUDIOS Hi-Fi - Home Cinema - Custom Installation Tel: Doncaster

01302 727274 or 01302 725550. E-Mail: info@thehifistudios.freeserve.co.uk Web Site: www.thehifistudios.co.uk Musical Fidelity, Electrocompaniet, ProAc, PMC, JM Lab, Ruark, Castle, TEAC, Unison Research, Monitor Audio, Impulse, Primare, Harbeth, NAD, Michell Turntables, Nottingham Analogue Studios, Audio Analogue, Living Voice, Densen, Celestion, KEF, Opera, Trichord Research, Nordost, Stands Unique, Ortofon, Project, Goldring, REL, Denon, TAG McLaren, Rotel, Yamaha, Proceed - plus many more. Viewing & Demonstration by appointment in a unique setting. Home trials and installation. Card facilities and 0% available. Please phone for more information. BADA. CEDIA.

YORKSHIRE (WEST)

PREMIER AUDIO - now demonstrating - Room 1: DCS Elgar, Purcell & Verdi Transport, Plinius CD Lad & 250 Power, Verity Fidelo & Sonus Faber Speakers, Siltech Cables, Isotek Sub Station, BDA Equipment Stands Room 2: Audio Aero, Audio Synthesis, Kora Pre & Power, Pink Triangle CD/Amp, Martin Logan / Audio Physics Speakers, Arcici Equipment Stand, Isotek Sub Station P/S Audio Synthesis, Audio Physics, Audio Aero, Absolute Sounds, DCS, Kora, Plinius, Siltech, Arcici, BDA, Pink Triangle, Avid Turntables, Project, Ortofon, Van den Hul, Mirage. P/X welcome Home demonstration good selection of S/hand. We are 10mins J39 - M1 10mins J30 M62 Tel: Wakefield 01924 255045 - Colin Grundy.

AUDIO REPUBLIC, 78 Otley Road, Leeds 0113 2177294, www.audio-republic.co.uk for the very best in quality hifi in West Yorkshire and beyond, our relaxed and professional approach stems from over 10 years experience in designing and installing high quality music systems. We believe the following offer outstanding results; Naim Audio, Rega Research, Dynavector Systems (amplifiers and cartridges) Totem Acoustic, Conrad Johnson, Sugden, ProAc, Spondor, Shahinian, JM Lab, TEAC, Nottingham Analogue, Kuzma, Living Voice, Hutter Furniture, Benz Cartridges, Cardas Cables, Quadraspire, Chord Cables, Custom Design, Alphason Designs. Choice of shop or home demonstrations, open Tues - Sat 9.30am to 5.30 pm, most credit cards welcome. Please phone for a chat and directions.

WALES

ACTON GATE AUDIO 4 Ruabon Road, Wrexham, North Wales, Tel .01978 364500. See our main ad under Cheshire.

VINYL/RECORD MAIL ORDER

DIVERSE VINYL 10 Charles Street, Newport, NP20 1JU. Tel/Fax: 01633 259661/256261. Email: sales@diverse-music.co.uk Probably the most varied and impressive selection of brand new LPs you'll find anywhere: international new releases, reissues and audiophile products. Also UK distributor of the Disco Anti Stat LP Cleaning Device. Call for a free catalogue, or visit www.wwww.diversevinyl.com

# specialist hi-fi dealers

## LONDON



THE INNOVATIVE HI-FI,  
HOME CINEMA AND MULTI ROOM  
RETAILER/INSTALLER

SERVING LONDON  
FROM BATTERSEA

### ORANGES & LEMONS

Friendly and efficient service  
0% finance

JUICY FRUIT FROM LONDON'S FRESHEST RETAILER

ARCAM B&W CABLE TALK CASTLE CHORD  
CREEK DENON EPOS LINN MARANTZ  
NAIM NAD NEAT PMC QED REGA ROKSAN  
ROTEL RUARK STANDS UNIQUE SOUNDSTYLE  
YAMAHA XANTECH and many others

**020-7924 2040**

61/63 WEBBS ROAD, SW11

website: oandhifi.co.uk



We aim to provide a well chosen  
selection of quality hi-fi and  
accessories including  
FMJ, ARCAM, B&W, NAUTILUS,  
DYNAVECTOR, LINN, LOEWE, MERIDIAN,  
M&K, NAIM, PIONEER, PROCEED,  
NEAT, REGA, ROTEL, SHAHINIAN,  
YAMAHA + more  
www.infidelity.co.uk

## Infidelity

INDECENTLY GOOD HI-FI

9 High Street, Hampton Wick,  
Kingston upon Thames, Surrey KT1 4DA  
Tel: 020 8943 3530



Open  
Tues-Fri  
10:30am-7pm  
Sat-Sun  
10am-6pm

## NORTH

### Basically Sound

NORWICH • NORFOLK

Audio Analogue, Bryston,  
Chord Co., Denon, Epos,  
Naim Audio, PMC, Pro  
Unison Research, Teac,  
Creek and many

The Old School  
School Road, Brackley  
Nr Norwich, Norfolk  
Tel: (01508) 511111



## VALVES & TUBES



Chelmer Valve Company

Buy CVC PREMIUM HI-FI valves direct from us.  
All valves processed for improved performance.  
We also have stock of MAJOR BRAND types inc.  
MULLARD, GEC, BRIMAR, RCA, GE, PHILIPS, etc.

The Stradbos, Suddow Park, Snettisham, Norfolk  
The Stradbos, Suddow Park, Snettisham, Norfolk  
Tel: 01245 241301 Fax: 01245 241309  
Email: sales@chelmervalue.com

## MAIL ORDER

### Release the full potential of your system

#### STEP 1: SORT OUT YOUR MAINS

Start at the beginning! The truth is that poor  
mains quality ruins the sound of even the  
best equipment. The better the  
equipment the bigger the difference.  
Our Russ Andrews Mains Blocks  
and Power Cables remove  
mains pollution effectively,  
giving you a deeper more  
extended bass and a  
sweeter more natural sound.



HiFi Power Cable  
1m £29.95

Classic Powerford  
0.9m £55

£120  
4 Way Mains Block

Phone UK Freephone 0800 373467 (quote RA44) for a FREE  
catalogue or buy online at [www.russandrews.com](http://www.russandrews.com)



Russ Andrews International Ltd, Whitton Road, Stanbury, Reading RG2 4PL  
Tel: 01235 433999 Fax: 01235 433999 Email: [ra@russandrews.com](mailto:ra@russandrews.com)

FREE  
CATALOGUE

## SERVICES & CONSULTANTS

### Front End Problem?

contact

### The Cartridge Man

It doesn't have to cost an arm and a  
leg to get the best - listen to my  
Koetsu - and Decca -eater.

Also agents for Croft, Hadcock,  
E.A.R., Michell &  
Moth.

plus cartridge re-tipping service  
020 8688 6565

Website: [www.thecartridgeman.com](http://www.thecartridgeman.com)

For all your advertising  
requirements please call  
Mike Ballance on 01908 616116  
or email:  
[advertising@hi-fiworld.co.uk](mailto:advertising@hi-fiworld.co.uk)

# Ijk setright



I have just emerged from an extraordinary musical experience, which has served to remind me (not that I need reminding, but you might) how very important is the radio in our scheme of things. I have been listening to a performance, the like of which I had never heard before, of the tenth symphony of Shostakovitch. It was broadcast by the BBC on Radio 3, and it was not even a live performance but a recording made in May 2003.

To claim that I had never heard its like before might not in itself convey much, until I explain that I have been very keen on the Shostakovitch Tenth since it was new. When the score was first brought to England in 1954. I recall that a hurried preparation of it was performed in Manchester and broadcast from there. Then Sir Malcolm Sargent (or was he at that time still merely Dr Sargent?), who was very good at swotting up new scores for convincing performance, brought it to the Royal Albert Hall. I made a point of being there, having already recognised in the first movement of the symphony a new paragon of symphonic architecture, and I still remember vividly how moved I was by the whole work.

There are now four different versions (Mravinsky, Ormandy, Svetlanov and Rattle) on my LP shelves. Each differs clearly from the others, but they all have one thing in common, giving emphasis to the sheer anguish that pervades the music. That is what distinguishes them all from the performance I have just heard.

It was given by the BBC Scottish Symphony Orchestra under the direction of Ilan Volkov. Some pretty remarkable things are happening in

the supposedly minor orchestras under BBC control, and this is a good example. Whether it be inspired direction or better working conditions I have no idea, but since the coming of young Volkov the orchestra has become really good. I do not believe that it can have anything to do with the ample

**“ I do not believe that it can have anything to do with the ample current supply of highly-trained young musicians now available**

current supply of highly-trained young musicians now available, because the same thing has happened to the BBC Ulster Orchestra (it seems almost unbelievable that it should have evolved from the old BBC Northern Ireland Light Orchestra) since Thierry Fischer started conducting it – and that orchestra has to its credit a large proportion of long-serving senior players.

What made this Volkov Shostakovitch so wonderful? I do not think he missed giving expression to any of the intense feelings manifest in the music, but he did it with something not hitherto encountered: a kind of restraint or reserve, which allowed the sheer musicality of each line or phrase to emerge, all played with exceptional accuracy and synchronicity because the anguish was not allowed to devolve into mere fury and each of the players could play with a cool head as well as a warm heart.

There was something else. The sound was downright wonderful. As I

noted earlier, this was not a live broadcast but a BBC recording, which must mean that something was inevitably lost. What had been gained is a balance that cannot be heard in the concert hall: every section, every instrument of the orchestra could be heard at exactly the right volume for what it was doing. Nothing was swamped or unduly emphasised: this was a rendition more faithful to the music than anything to be heard in any concert hall capable of housing the necessarily large orchestra and an audience large enough to pay for it.

Here once again is proof that the supposed virtues of directly hearing a live performance can be illusory, and that the music can be assimilated better through that weird collection of electrical boxes that we call hi-fi. I am willing to go further: here, however the BBC engineers accomplished it, was sound better than I have ever heard from any CD, ever, and better than from the majority of LPs: when it is done well, the radio really is superb.

Let credit be given where credit is due. There are some people in the BBC who deserve eternal damnation for the despicable things that they are doing, especially to Radio 3 but probably (for all I know – I seldom watch) also to television. On the other hand, there are evidently some who manage to evade all that political nonsense and to work quietly and expertly to give us a musical service such as probably cannot be matched anywhere else in the world.

Whatever the virtues of the rest of your apparatus, acquire for yourselves good tuners and antennae, my friends, and enjoy a better life. ●

# meet your maker

A reference guide to Britain's manufacturers and distributors

**CREEK AUDIO LTD** 12 Avebury Court, Mark Road, Hemel Hempstead, Herts, HP2 7TA. Tel. 01442 260146 E-mail: info@creekaudio.co.uk Internet: www.creekaudio.co.uk - Creek Audio build stylish Hi-Fi products in the UK, combining state of the art electronic design, with full bodied, accurate and musically rewarding sound. Our standard size products come in two award-winning ranges, the entry level 43 series and higher priced 53 series. These include: CD43 Mk2 - CD player with 24 bit resolution DAC, T43 AM/FM Tuner, Integrated Amps - 5350, 5350SE and 4330 Mk2 (described by Stereophile Magazine as the best amp under \$1000). Our A43 Mk2 and A53 Power Amps range from 50 to 250 Watts and both P43 and P53 Pre-Amps offer passive and active operation with remote control. In addition we have an award winning OBH range of small products: OBH-8/8SE MM and OBH-9 MC Phono Pre-Amplifiers, OBH-11 and 11 SE Headphone Amplifiers, OBH-10 and 12 Remote Control Passive Pre-Amps and OBH-14 - 24 bit DAC. See our home page for further details or call us for leaflets.

**EPOS ACOUSTICS**

2 Avebury Court, Mark Road, Hemel Hempstead, Herts, HP2 7TA. Tel. 01442 260146. Email: info@epos-acoustics.com Website: www.epos-acoustics.com Innovative design and superior sound distinguish EPOS speakers from other brands in a similar price category. Adhering to the EPOS tradition of musicality and communication, the new M12 follows closely the style of the successful ES12, and was awarded five gold stars in the March 2001 edition of *What Hi-Fi?* For more information about the M12 or the new M15 please see our home page or call us for leaflets.

**FALCON ACOUSTICS LTD**

Unit 12 Damgate Industrial Estate, Damgate Lane, ACLE, Norwich, Norfolk, NR13 3DJ Tel. 01493 751100 Fax 01493 751155 e-mail: sales@falcon-acoustics.co.uk UK distributors of FOCAL drive units, SOLEN (SCR-Chateauroux) polypropylene capacitors, TAYDEN high quality PA loudspeaker units. Falcon are the largest specialist Audio-inductor manufacturer in the UK Comprehensive range of DIY speaker parts and kits, Accessories and Books. Sub-bass and electronic filters. Audio Amateur Publications and Audio Computer Software. Everything but the wood! Enquiries should be accompanied by a 46p stamped address envelope or see full price list with illustrated details and pdf data sheets on our web site: www.falcon-acoustics.co.uk.

**MONITOR AUDIO LIMITED**

24 Brook Road, Rayleigh, Essex SS6 7XL Tel 01268 740 580. Fax 01268 740 589 e-mail: info@monitoraudio.co.uk website: www.monitoraudio.co.uk Monitor Audio designs and manufactures British loudspeakers of the highest quality. Since 1972 Monitor Audio has been developing and perfecting the implementation of metal drivers, innovative crossovers, and exemplary speaker cabinet construction and finish to further the ideal of achieving sound which to the original is "as close as it gets". As we enter the 21st Century, Monitor Audio leads the way in offering speakers that suit every pocket and which integrate seamlessly with both Hi-Fi and AV systems.

**PMC/BRYSTON** Emmy award winning manufacturers of the highest quality loudspeakers and amplification. Industry standard in Mastering, Film Scoring, Broadcast and Post Productions. (5.1 & Stereo) PMC Products: Compacts, Floorstanders, and

Large passive & active monitors. Prices range from £500 to £32,000. Finished in a large selection of exquisite real wood veneers, all PMC loudspeakers are available in horizontal mirrored pairs, centre channels and complementary subs for 5.1 surround systems. Bryston's balanced range of products include R/C Preamps, Integrated, Amp modules for all the PMC range, Mono, Stereo 150W to 800w per ch, 3 Ch, 4 ch and 5 channel THX amplifiers, Surround processors, all with distortion figures and build quality to die for. Every product is available in silver or black backed by a 20 year warranty. PMC Ltd 43-45 Crawley Green Road. Luton, LU2 OAA. Tel: 08704 441044 Fax: 08704 441045 Email: sales@promonitor.co.uk Web: www.pmc-speakers.com

**SUGDEN AUDIO PRODUCTS**

Designed and manufactured in the UK each Sugden product is hand-built by one highly skilled technician. A full range of pure class A amplifiers are available including integrated, stereo power and the incredible Masterclass balanced monoblocks. Our stunning Bijou system now comes with a single-ended pure class A power Amplifier with optional integral stand. Two analogue tuners have joined the range matching our A21 and Bijou series, offering a digital user interface with excellent facilities. Each amplifier series has a matching CD player with a class A output stage and heavily modified transport. The class A HeadMaster offers a pre-amp with three inputs a fixed and variable output with remote control. The HeadMaster can be used as a control unit in a high quality audio system and excels with headphones. Please contact us for product information, dealer list and brochures. 01924 404088 email info@jesugden.co.uk

For all your advertising requirements please call Mike Ballance on 01908 616116 or email: advertising@hi-fiworld.co.uk



# dominic todd



**S**ometime ago I was offered a free car. Those sceptics amongst us will immediately be thinking what's the catch and so, in truth, did I. It turned out that by offering to drive a car, wrapped in a huge plastic wrapped advert, whilst going about your daily business, the car would be yours gratis. As with most free lunches, nothing ever came of it. So whilst I now believe there is no such thing as a free car, I still believe in the free hi-fi. Such is the strength of some second hand hi-fi equipment that it is possible to buy and sell hi-fi whilst making a minimal loss. If you're lucky you may even make a small gain.

Before I go any further, let me make it quite clear that very, very few people actually make serious money from buying and selling hi-fi. Although there may be the odd success from the Times Rich List, if you want to make a mint then property, fine art, or even cars are still really the way to go. Yet for the budding hi-fi enthusiast whose constantly changing their system, the hi-fi can be far less expensive than other recreations, and may even end up costing nothing at all.

The advent of the internet has brought about an explosion in the secondhand market place of just about all consumer durables. Hi-fi is no exception, and along with the booming traditional outlets of free ads, audio fairs and the classifieds of magazines such as this, auction web sites are really driving the business. Provided you pick carefully, it's quite possible to purchase a piece of hi-fi, use it for a year or two, and then sell it for near enough what you bought it for. Some items of hi-fi have almost become a currency in themselves such is the consistency of demand. Of course, not every

piece of hi-fi can guarantee you rock solid residuals, but there are some stalwarts. Ever since I've been into hi-fi, items such as Revox reel to reels, early Linn LPI2s and certain Tannoy dual concentrics have depreciated with a glacial slothfulness. Had I purchased any of these some 15 years ago, I'd be very

**Of course, not everyone wants to buy second-hand, but even brand new equipment can still represent excellent value**

surprised if I didn't get at least my money back by selling them today. These days, the number of stalwarts appears to have grown still further. Despite the near invisibility of cassette, Nakamichi decks still command extremely high premiums. Even the now twenty odd year old CR machines are have stiff prices - with even the basic, and not that great, CRI worth well over £100.

Other solid second hand investments include pretty much anything by SME, Quad's ESL 'speakers and early valve amps, and a good deal of Naim gear too. But one needn't necessarily be looking to spend a substantial amount of money to get your depreciation prove hi-fi. There is some excellent budget hi-fi out there that simply refuses to budge in price. If you want proof of this, then look no further than the NAD 3020 amp' which has hovered around the £60 mark for what seems like time and eternity. Older Arcam Alpha amps, and the budget wonder Pioneer A400 are also of the same mould. CD players such as the Cambridge

CD4 SE still make strong money, and if you fancy a piece of audio history, then an early Philips, Marantz, or Sony with a "I" in the name is, provided the laser is in good shape, a very solid place for your money.

Of course, not everyone wants to buy second-hand, but even brand new equipment can still represent excellent value. My parents always told me to buy antiques because, unlike new furniture, if times were hard one could always sell them and recoup a decent amount of cash. In some respects the same is true of hi-fi separates. Provided you pick carefully and go for discounted, end of line, products, a hi-fi

system can prove to be a good investment. The best products to look for tend to be similar the second-hand ones, hence NAD, Cambridge, Naim, Linn and SME are the usual suspects. Also Mission tend to hold their prices extremely well, so much so that a pair of discounted floorstanders can actually rise in value. Recently I've seen a pair of 702's that could have been bought for £120 two years ago, sell for £140. The fact that they were also a pretty decent 'speaker is further icing on the cake, but also the reason why somebody thought they were worth £140 to them in the first place!

Always remember that something is only worth what somebody is prepared to pay for it and, as with art and antiques, one should only really buy what you personally enjoy. The key is to enjoy the hi-fi. The fact that it may make you a little money over time is simply a bonus. Who knows, it might just prove to be invaluable when you can't rent out that buy to let. Happy listening. ●

# icon Audio *Stop Press!*



**Just arrived the amazing new AH! Tjoeb '66 hybrid amplifier. Featuring a double-triode valve front end & transistor output stage.**

Ideal for those who want the silky warm tones of valves combined with the muscle of solid state!

Features include: 2x 50watts rms. Full remote control. Built in phono stage **Only £649.95**

**Come and see us at the Heathrow Hi Fi show 3<sup>rd</sup> & 4<sup>th</sup> April**



## The Amazing AH! 'NJOE TJOEB' 4000 Valve CD player & 24bit 192khz 'UPSAMPLER'

- 1 Optional 192khz 24bit Swiss Upsampler only £249.95
- 2 Dual power supply with toroidal low noise transformer.
- 3 Massive 30,000uf of PSU smoothing caps
- 4 Philips Military spec 6922 valves
- 5 'Supercrystal clock' for super low jitter
- 6 High quality drive mechanism
- 7 Output voltage adjustable from 0.7v to 5v
- 8 AC 'Noise Killer' fitted
- 9 Full remote control with adjustable volume
- 10 Optional Audiophile mains lead
- 11 Optional Burr Brown OP amps
- 12 All versions upgradeable to 'Reference' model

AH! of Holland take a basic CD player and substantially modify it Inc adding a second power supply, an AC noise killer, a low jitter clock, a new PCB with valve output stage. Only quality audiophile parts are used such as Wima and Vishay. The Swiss Upsampler by Anagram technologies uses Analog Devices AD1895 2<sup>nd</sup> generation 24bit sample rate converter. For the upsampling a Wolfson Microelectronics WM8740 DAC chip, 24bit 192khz chip. The result is simply stunning value!

### Prices from only £429.95 to £899.95.

Basic	Inc 'Super Crystal', Digital Transformer	£429.95
Super	Upgraded version	£529.95
Ultra	Inc Burr Brown op amps & Siemens valves	£699.95
Reference	Inc 24bit 192khz Upsampler & all upgrades	£899.95

Or choose the Basic or Super and add your own upgrades

Rated 4.87 out of 5, with over 110 reviews on 'audioreview.com'

5 Page rave review in November's 'Stereophile'

*"I cant recall hearing a more musically involving, fulsomely detailed, three-dimensional presentation from any other CD player at such a modest price". - Chip Stern.*

Order now by phone or ask for our illustrated leaflet.

Auditions by appointment. [www.iconaudio.co.uk](http://www.iconaudio.co.uk)

Phone 07787 158791. Email [iconaudio@ntlworld.com](mailto:iconaudio@ntlworld.com)

## icon Audio

351 Aylestone Road Leicester LE2 8TA

Visa and MasterCard accepted

E&OE

**MANTRA AUDIO**

Specialist Suppliers of Audio Accessories  
[www.mantra-audio.co.uk](http://www.mantra-audio.co.uk)

PRICES INCLUDE P & P FOR UK DELIVERY 1 TO 10 DAYS -  
SEE WEBSITE FOR FULL PRODUCT RANGE AND SHIPPING  
CHARGES TO EU & WORLDWIDE

CARTRIDGE SELECTION	STYLUS	REPLACEMENT STYLUS	
Goldring		Swiss Quality Diamond Styl	
1000	£76 £92 GEX	ES2 AOC	XL8 Mk III £16
1012 GX	£95 £78 GEX	ES7 Alca	AN 5, AN 60 £12
1022 GX	£124 £100 GEX	ES6 AN2, AN 70	£14
1042	£143 £114 GEX	E100 Alwa	AN11 £12
Erica LXH	£133 £109 GEX	N/A Dual	DN 145 E, DN 185 E £16
Elite	£232 £190 GEX	N/A JVC	DT 55, DT 60 £12
Audio Technica		National	EPS 24 CS, P 30 D, P 33 D £12
AT 35 E	£23		Ortofon
AT 110 E	£39	£15	FF15/VM500 ER, OM20 £16
AT DCP Mk II	£330 £280 EX	£16	Pioneer
Grado			PN 210/220/240 £12
Prestige Black	£40	£27	Sture
Prestige Gold	£110	£73	N 75 C, 50 35 C £12
Ortofon			N 75 ED T2, N 75 EJ T2 £16
S10 Mk II	£34	£22	N 85 ED/EL, N 75 J (78) £16
MC 15 Super II	£130 £110 EX	N/A	VN 35 E £18
MC 25 FL	£227 £193 EX	N/A	N 97 HE, VN 35 HE £25
MC 10 Supreme	£304 £258 EX	N/A	Sony
MC 20 Supreme	£380 £303 EX	N/A	NO 142/155 G, CN234 £12
MC 30 Supreme	£452 £365 EX	N/A	NO 143/150/200 G £14
Kontrapunkt B	£343 £348 EX	N/A	Stanton
Rohmann	£337 £742 EX	N/A	D 681 EEE £19
Shure			***Over 500 Styl Types Stocked***
M 97 XE	£98	£58	
V 15 V xMR	£304	£204	
Sumiko			
Blue Point Special	£265 £237 EX		

GEX - Goldring new for old exchange price for any make/type of cartridge  
EX - Exchange price for any moving coil cartridge

Order direct online or Tel/Fax (01757) 288652  
MANTRA AUDIO (UK), 22 GAATH AVENUE, NORTH BIFFIELD, SELBY, NORTH YORKS YO8 5RP

## Absolute Demos

qualityaudio@2die4.com - +44 (0) 79 61 13 30 38

Audogram MB2- Integrated Amplifier	£268.00
Audogram MB1- Amplifier	£219.00
Apogee Mini Grands - Loudspeakers	£3499.00
Audio Research DAC1-20 - DAC	£700.00
Audio Research VT50-Valve Amplifier	£1999.00
California Audio Alpha - DAC	£495.00
California Audio DX1-CD Player	£349.00
Copland CDA277 - CD Player HDCD	£799.00
Copland CDA288 - CD Player HDCD	£1169.00
Copland CSA301 MKI - Valve Preamplifier	£720.00
Copland CSA303 - Hybrid Preamplifier	£550.00
Copland CTA504 - Valve Amplifier	£1099.00
Goldmund Mimesis 6B - Amplifier	£1400.00
Jadis Orchestra - CD Player	£999.00
Krell KAV250P- Preamplifier	£1899.00
Krell KSL - Preamplifier	£900.00
Krell CD-DSP-Top loader CD Player	£1200.00
Martin Logan Cinema - Centre channel	£348.00
Martin Logan Theatre - Centre channel	£1499.00
Martin Logan Prodigy - Electrostatic	£7299.00
PS Audio Ultralink II - DAC	£999.00
PS Audio Reference Link -Digital Preamp	£1899.00
Sonus Faber Concertino Home Loudspeakers	£429.00
Sonus Faber Grand Piano Home Loudspeakers	£1300.00
Theta Digital Dreadnaught -5 ch-amp	£479.00
Theta Digital Carmen II - CD/DVD Drive	£2979.00
Theta Digital David II -CD/DVD Drive	£2999.00
Wilson Audio CUB - Loudspeakers Silver	£2900.00
Wilson Audio CUB II w/stands Black	£3999.00
Wilson Audio Witt II Loudspeakers Black	£5400.00
Z Systems RDQ1- Transparent Digital Equalizer	£1840.00

no grey imports - all equipment comes with 1 year full warranty

**Contact Numbers**  
Mon-Fri 9am-5pm

**WEBSITES**  
[www.worldaudiodesign.co.uk](http://www.worldaudiodesign.co.uk)  
[www.hi-fiworld.co.uk](http://www.hi-fiworld.co.uk)

**Editor**  
Mike Ballance  
tel/fax: +44 (0) 1908 616 116  
e-mail: [diyeditor@hi-fiworld.co.uk](mailto:diyeditor@hi-fiworld.co.uk)

**Design & Layout Editor**  
Faiza Chunara  
tel: +44 (020) 7625 3129  
fax: +44 (020) 7328 1844  
e-mail: [adproduction@hi-fiworld.co.uk](mailto:adproduction@hi-fiworld.co.uk)

**Production Editor**  
David Noble  
tel: +44 (020) 7625 3134  
fax: +44 (020) 7328 1844  
e-mail: [classifieds@hi-fiworld.co.uk](mailto:classifieds@hi-fiworld.co.uk)

**Contributors**  
Clive Meakins  
Neville Roberts

**Advertising**  
tel: +44 (0) 1908 616 116  
e-mail: [advertising@hi-fiworld.co.uk](mailto:advertising@hi-fiworld.co.uk)

**Accounts**  
Sharon Mehlhorn  
tel: +44 (020) 8841 8892  
fax: +44 (020) 8841 9144  
e-mail: [accounts@hi-fiworld.co.uk](mailto:accounts@hi-fiworld.co.uk)

**Technical Editor**  
Noel Keywood  
e-mail: [publisher@hi-fiworld.co.uk](mailto:publisher@hi-fiworld.co.uk)

**Private & Trade Classified Ads**  
tel: +44 (020) 7625 3134  
fax: +44 (020) 7328 1844  
e-mail: [classifieds@hi-fiworld.co.uk](mailto:classifieds@hi-fiworld.co.uk)

**Subscriptions & Back Issues**  
tel: +44 (0) 1442 879097  
fax: +44 (0) 1442 872279  
e-mail: [hifiworld@webscribe.co.uk](mailto:hifiworld@webscribe.co.uk)

**News & Letters Email**  
e-mail: [diynews@hi-fiworld.co.uk](mailto:diynews@hi-fiworld.co.uk)  
e-mail: [diyletters@hi-fiworld.co.uk](mailto:diyletters@hi-fiworld.co.uk)

**WORLD AUDIO DESIGN**  
[www.worldaudiodesign.co.uk](http://www.worldaudiodesign.co.uk)

tel/fax: +44 (0) 1908 218 836  
e-mail: [info@worldaudiodesign.co.uk](mailto:info@worldaudiodesign.co.uk)

**Distributed by**  
Comag Magazine Marketing,  
Tavistock Road, West Drayton,  
Middlesex UB7 7QE  
Tel: +44 (0) 1895 444 055

**Printed by**  
Southern Print, Dorset  
Tel: +44 (0) 1202 628 300

**Our Agents in Malaysia**  
Millennium Hi-Fi & AV  
Simon Chang  
Showroom & office, 500-1-3 First Floor  
Wisma Indah (Shen Court), Jalan Tun Razak  
50400 Kuala Lumpur, Malaysia  
Tel: 603 9283 8171 Fax: 603 9281 3762  
e-mail: [info@millennium-audio.com](mailto:info@millennium-audio.com)

All unsolicited submissions and goods are at the owner's risk. We accept no responsibility for such submissions, nor do we undertake to return them.

No material may be reproduced from this magazine without the publisher's written permission.  
© Audio Publishing Ltd

# DIY supplement contents

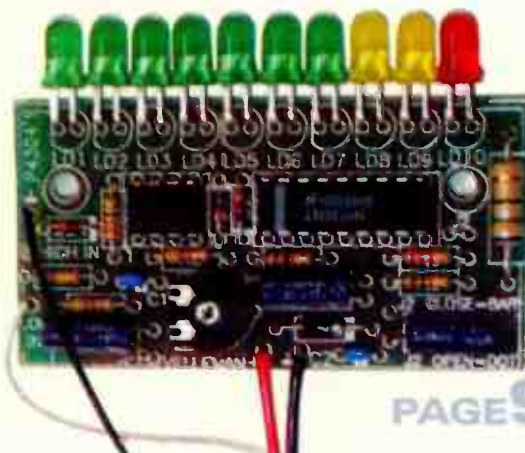

**NEWS** 93  
All the latest from the weird and wonderful world of DIY hi-fi.

**LED STEREO VU  
METER KIT** 94

Mike Ballance warms up his soldering iron and test kit to try out Maplin's 10 LED Stereo VU meter.

**POLE POSITION** 96  
Clive Meakins revisits his Williams Hart Phono Stage

**ALL NEW PSU** 99  
Neville Roberts plugs into the new Origin Live Ultra Turntable Power Supply.

[www.worldaudiodesign.co.uk](http://www.worldaudiodesign.co.uk)

**HI-FI WORLD**  
SUITE G4, ARGO HOUSE  
KILBURN PARK ROAD  
LONDON, NW6 5LF

# Falcon Acoustics Ltd

Falcon Electronics, Basically Sound  
<http://www.falcon-acoustics.co.uk>

Full Price List and Focal details on Web Site

DRIVE UNITS: by FOCAL & seas, and a pick of the best from other manufacturers.

100+ CROSSOVER NETWORKS: - Active & Passive, Components, Accessories,  
 New LS3/5A type Crossovers  
 COMPONENTS

SOLENE Polypropylene capacitors. 0.1mFd. to 100mFd.

Polyester and Polycarbonate Film Capacitors. 0.1mFd. to 10mFd.

ALCAP Reversible Electrolytic Capacitors (Non-Polar); 50v, 100v & Low Loss. 2mfd. to 600mFd.

FALCON Custom-wound Inductors.

FERRITE:- Standard, High Power, Super Power, Super-Super Power

AIRCORED 0.56 - 1.25mm wire; IRON DUST. 1mm wire

TAPPED INDUCTORS:- 0-10mH in 1mH steps & 0-1mH in 0.1mH steps

AUDIO AMATEUR PUBLICATIONS

Back year sets of Speaker Builder, Audio Amateur & Glass Audio, plus the Audio Anthology Set.

Altogether 50+ books and Audio Amateur's magazine year sets.

2001 & 2002 year sets on CD-R only

**FOCAL**® 'State of the Art' Units & Kit Designs'

Focal Unit Range

as pioneered in the Utopia range of systems.

Price List & Unit Specs FREE on Web site - available in .pdf format

5W4211 6W4311 7W4411 8W5411 10W6411

Plus: Audiom 6 WM

7K6411 (replacement for Audiom 7K-/7K2)

TC120TD5 - TC90TD5 & TC90TD5B

All normal stock items

SUPPLIERS TO THE TRADE SINCE 1972

Send for our FREE price list PL31: Just send a large S.A.E. (46p stamp) or US\$2 bill overseas, Europe US\$1 bill or 3 International Reply Coupons (IRC) to:-  
 (Dept HFW) Unit 12 Damgate Lane Industrial Estate, Damgate Lane  
 ACLE, Norwich, Norfolk, NR13 3DJ Tel: 01493 751100

Rediscover  
 the beauty of  
 pure sound....

NEW!  
 Visit our web site at  
[www.chelmervalue.com](http://www.chelmervalue.com)  
 to view our entire valve  
 catalogue and buy on  
 line!



We have been supplying tubes to the audio market for over 40 years. Only valves that pass our stringent in house QC tests are used for the CVC Premium brand, and our no fuss guarantee ensures your complete peace of mind. When available, we also stock the justifiably famous brands such as Brimar, GEC, Mullard, RCA Telefunken etc. So why compromise? Our sales and technical staff are just a telephone call away. To put it simply.....

YOUR NEEDS...OUR BUSINESS.

**CVC** Chelmer Valve Co Ltd

The Stables, Baddow Park, Great Baddow,  
 Chelmsford, Essex CM2 7SY

Tel: +44 1245 241300 Email:sales@chelmervalue.com  
 Fax: +44 1245 241309 [www.chelmervalue.com](http://www.chelmervalue.com)

audioXpress... It Just Sounds Better

Your Favorite Audio -  
 One New Magazine!

- PROJECTS
- REVIEWS
- THE NEWEST TECHNOLOGIES
- AUDIO CLASSROOM
- and Much More!



Subscribe To This  
 Great Monthly  
 Publication Today!

Only \$59.95 US  
 for 12 Issues!

audioXpress • PO Box 876 • Peterborough, NH  
 03458-0876 USA • Phone: 603-924-9464

Fax: 603-924-9467 • E-mail: [custserv@audioXpress.com](mailto:custserv@audioXpress.com)

ORDER ONLINE AT: [www.audioXpress.com](http://www.audioXpress.com)

# WHITE NOISE

AUDIO KITS, MODULES, COMPONENTS

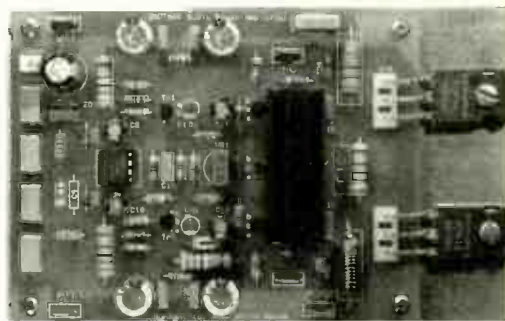

PRODUCTS INCLUDE:- Power Amplifiers 30-250W, Preamplifiers, Phono stages, Active Crossovers, Power Supplies, Buffer Amplifiers, Balanced line drivers / receivers, Stepped attenuators, Gold plated connectors, Cables, Capacitors, Resistors, Semiconductors, Transformers, Subwoofers, Loudspeaker drive units

WHITE NOISE  
 11 STATION ROAD  
 BEARSDEN  
 GLASGOW  
 G61-4AW

Web:- <http://www.wnaudio.com>  
 Email:- [david.white38@ntlworld.com](mailto:david.white38@ntlworld.com)  
 Tel:- 0141-942-2460 (until 9pm)  
 Fax:- 0141-587-7377

# diy news

## LINKS GALORE

The London Live DIY Hi-Fi Circle is a big site with many pages. Members meet in a convenient pub and discuss ways of improving ordinary hi-fi without spending the much larger sums that would be



necessary to replace their kit with top models. There's

many home-made designs here, including big power amps and electrostatic speakers, driven directly from the anodes of the valve power amps. Scary stuff.

The Links page is excellent. One takes you to a site with more circuit diagrams, including another phono stage using the OPA637, but with completely different values for the RIAA EQ components.

[www.londonlivehi-fi.com/](http://www.londonlivehi-fi.com/)



## FROM RUSSIA WITH LOVE

An e-mail from Vladimir in Moscow came with an attached circuit diagram of a power amplifier with no gain. No, this is not an April Fool's Day joke. The circuit is basically an emitter-follower (cathode-follower for you valve fans). There are two of these circuits, each being rather more complicated than the simple theory, having as they do several transistors of each polarity. The gain? Ah yes, that is provided by a step-up transformer between the

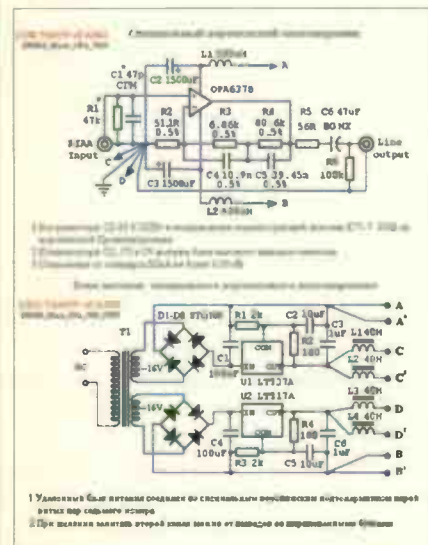
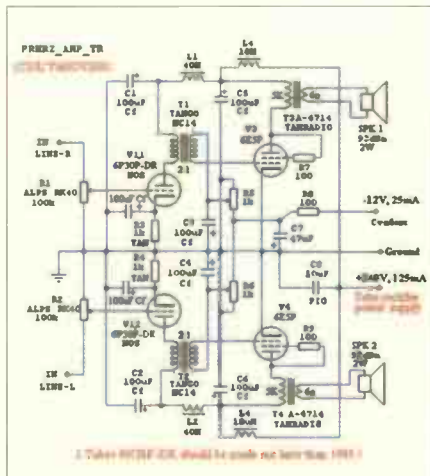

two circuits. With enough voltage gain in the transformer, the amplifier needs no feedback. A very clever design.

There's more interesting stuff on his website -

[www.fishnet.ru/~vovk/](http://www.fishnet.ru/~vovk/) which is partly in English and partly in Russian. The English part warns of copyright, but that does not stop the author from showing the reader several interesting designs. There's a phono stage using a single OPA637B op-amp and, of course, there are several valve amp circuits there too. You knew I was going to say that, didn't you!

## DECIBEL DUNGEON

Here's a site that also has many sections to it. From starting in hi-fi, through modifying hi-fi, building hi-fi and upgrades, it also includes hints and tips on installation and various mods and upgrades to specific items of hi-fi kit.

[www.decudun.fsnet.co.uk](http://www.decudun.fsnet.co.uk)

## BULL ELECTRICAL

Be careful of the print button at this site, it gave me 17 pages of valves with prices and the ability to add a quantity to the cart. Types include many CV numbers, but mostly don't state the manufacturer. You can get an EF86 for £3.85 but who made it? An EL84 is only £2.74 which might be a bargain, but all valves are described as "generally in original cartons and sold as-is", so caveat emptor rules here. The picture is of a big transmitting valve, made by ITT and yours for just £88. [www.bullelect.co.uk/hi-fi/valves.html](http://www.bullelect.co.uk/hi-fi/valves.html)



# LED stereo VU

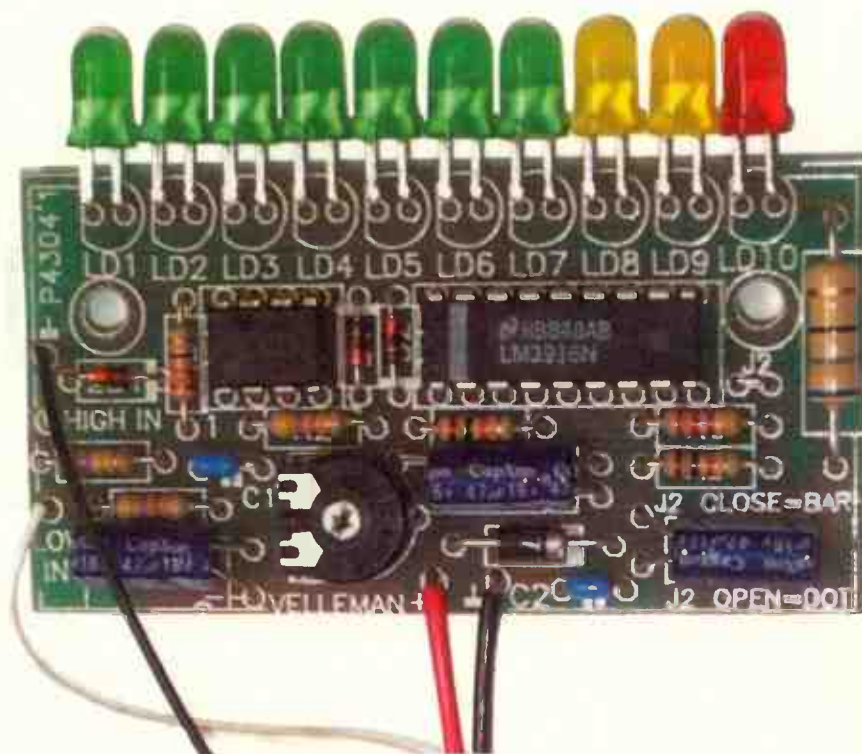

Mike Ballance warms up his soldering iron and test kit to try out Maplin's 10 LED Stereo VU meter.

Velleman offer a number of kits, including a well-specified FM tuner and even a couple of valve amps, but here we're looking at something rather smaller.

Their kits are available in the UK from Maplin, the mail-order company that now has around eighty shops around the country. Guaranteed to be bad for the wallet if you live near one! The Velleman part number for this stereo VU meter kit is K4305. It becomes part number VF91Y in the Maplin catalogue and the cost is £19.99 inc VAT. There is also a mono (single channel) version at £14.99 and a bigger version with 15 LEDs per channel for £29.99.

A neat little addition to any amplifier, or mixing desk for that matter, the unit includes two circuit boards with ten LEDs on each, and the associated circuitry. The industry standard display driver for this type of circuit is the LM3916 (the LM3914 and LM3915 are similar) but it seems they are becoming harder to buy on their own. The circuit is reproduced

in the instruction book that comes with the kit. The signal passes through one of two resistors, 47k for the 'low' or higher sensitivity input and 470k for the 'high' or low sensitivity input. After that it passes through an op-amp with diodes in the feedback loop to present a DC output that corresponds to the audio peaks. This signal then supplies the LM3916 display driver chip and then the ten LEDs. There are seven green LEDs, two yellow and one red.

## CONSTRUCTION

In addition to the two inputs, there is also a small potentiometer mounted on the board. This can be used to adjust the input sensitivity. With this control in mid-position, an input of 450mV (rms @ 1kHz) or -5dB is needed to switch all ten LEDs on. There is an option for the display to be dot more or bar mode, meaning that you can either have a single LED glowing at any one time, or a bar which gets longer with more signal strength. This latter is the more usual approach, so I soldered a link in place

to achieve this. It's easy - leave out this link if you want the bar mode.

The manual runs to many pages in a small booklet. It starts off with the colour code for resistors, so even if you've never made a kit before, you will find all the information you need here. The next page explains the technique of correct soldering. This is followed by a few pages on which each component is shown. There is a small check box to tick when that component is in place. It's obvious that Velleman have been making kits for a long time - they really have thought of everything. Naturally, special note is made of diodes and electrolytic capacitors, those components which must be inserted the right way round.

When all components are installed, the manual goes on to show how the units can be mounted. The board has two holes for fixing. No mounting kit is included, leaving users to make their own choices in this area. Dimensions are given for a fixing bracket, should you need one.

# meter kit

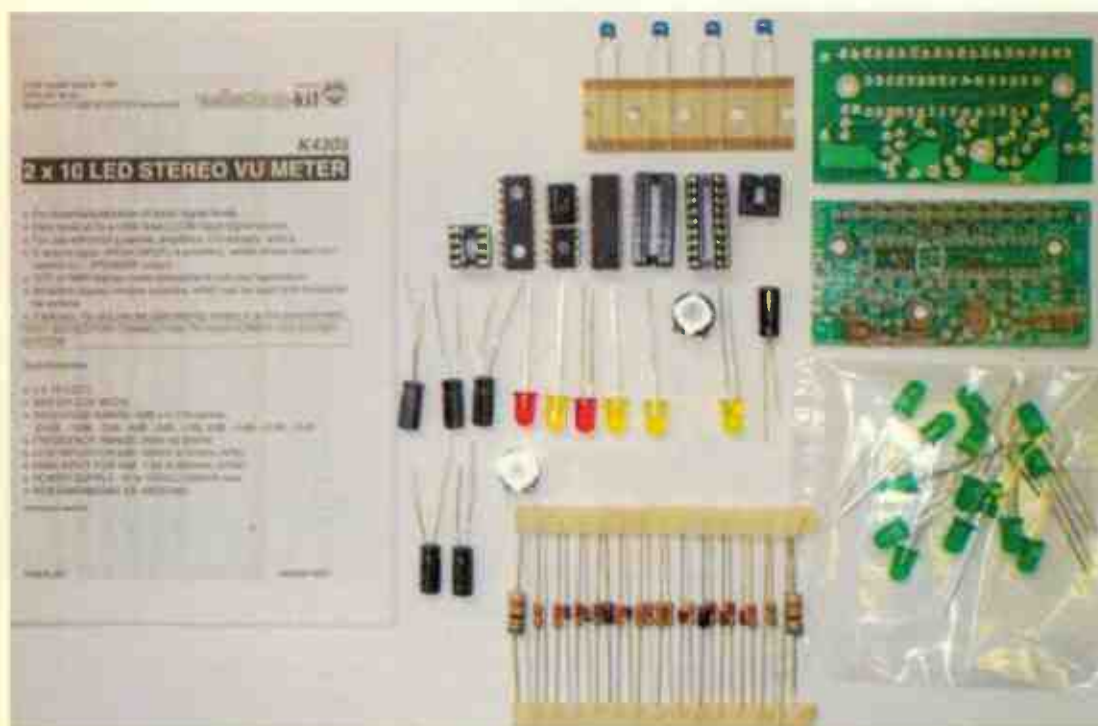

The descriptions of possible mountings run to several pages. The only criticism I have here is that the adjustment potentiometer will probably be difficult to access once the boards are fixed in place. Setting up is therefore best done before final assembly.

An important requirement is a power supply. You will need a supply of between 10V and 15V DC with a maximum current requirement of 250mA. I used a 12V supply for the measurements given below. Help is to hand here as well, with circuit diagrams of methods of obtaining this supply from the mains. The instruction book explains that you can either use a transformer with 2 x 12V secondaries, two diodes and a 1000mF capacitor, rated at 25V, or a transformer with a single 12V secondary, 4 diodes (or a bridge diode) and the same capacitor. It's perhaps not as obvious as it should be that you don't need both of these supplies!

The book explains that the 'high' input is for use with speakers and the 'low' input is for use at line level, in other words the output of tuners, CD players, etc. Although it is safe to connect this unit to speaker outputs, you are warned not to connect it to

high power car amplifiers as these often use bridged outputs in which neither speaker cable is connected to the car ground. Doing this would short out the amplifier and probably destroy it, so if you intend to use it in a car, do check the type of amplifier very carefully first! It should be safe to use this unit in a home system, even one with bridged amplifiers, since being powered from the mains, it will be safe, just so long as you never connect any part of the display unit to anything else, other than the mains input to the transformer and the audio coupling. Don't try to get the DC supply for this unit from within the amplifier, as the same problems will arise. In fact it is best from an audio point of view to have a completely separate supply, as noise spikes from the display unit could get into the audio system, increasing background noise levels.

## TEST MEASUREMENTS

The claimed frequency response is 20Hz to 30kHz and this was indeed met, although the unit was -3dB at 20Hz and -1.5dB at 30kHz. What this means is that an extra 3dB of input was needed at 20Hz to get the same display as at 1kHz. This is most unlikely to have any noticeable effect

- after all, we're not listening to these units! The maximum sensitivity available was 130mV, or -13dB, for all the green LEDs to be illuminated. This figure increased to 220mV, or -11dB, for all ten LEDs to be on. Considering that a CD player has an absolute maximum output of 2V (ie, 2000mV) this is much more than adequate, giving a very wide range of adjustment in use. A small quibble - the instruction book claims, under "indication range" that 0dB = 0.775mV rms. Ahem. Actually 0dB is 0.775V, or 775mV - only a typo, but don't let it confuse you.

## IN USE

Like all good meters for audio work, this display has a fast attack and slow decay. In other words when a peak of sound comes along, the meter responds quickly. However the lights don't extinguish as quickly for two good reasons. The first is you might not notice a very quick flash, or the diode might not respond to one, and the second is that in music some sort of averaging is more helpful in determining sound levels. All things considered this is an excellent little addition to any hi-fi system, tape recorder or mixing desk for recording use.

# Pole Position

Clive Meakins revisits his Williams Hart Phono Stage

It can be tough if you play records. Some wonder if you're so poor that you have to buy old cast off LP's. Other's think you must have a hearing problem. As for saying you're into vinyl, well this can get you into a lot of trouble as most people won't realise you are talking about records!

Once those shiny bird scarers, normally known as CD's had established themselves it was clear that an outboard phono stage was the way to go. Trying to combine a good amp with a good phono stage was bound to reduce one's options. Enter the Linsley Hood designed phono stage. John Linsley Hood designed various hi-fi circuits and has often been published in the sober but exalted journal, *Wireless World*. John's designs are very much an engineer's, there are no boutique or voodoo components but nonetheless where there are good measurable reasons for using an advanced component, this is advocated. A current designer of a similar ilk is Bruce Rozenblit, though what John Linsley Hood would have to say about Bruce's use of valves instead of much more 'sensible' silicon, I can only imagine.

JLH designed this phono stage using discrete components, not an opamp to be seen as for casework, it's available in one or two-box setups. It's over ten years since I built this phono stage so why am I writing about it now? Most importantly it is still available today, a good sign so it's still a current product. It has seen me through a considerable upgrading of my record playing equipment. The fact the I've always been able to hear the improvements from my newer equipment suggests the phono stage is not holding me back.

When I built the kit I was using a Systemdek/Linn LVX with a Linn K9 MM cartridge. I originally road tested the phono stage with a much better deck an cartridge using Naim amplification and was not disappointed. I have now progressed to a Michell Gyro SE with Orbe platter, HR power supply and



Internal view of assembled kit.

Ortofon Kontrapunkt B MC cartridge. The arm is a new acquisition, Michell's latest TecnoArm(a), it sounds every bit as good as it looks, it not better. The Williams Hart phono stage still delivers, letting me appreciate the front-end improvements I have made. This demonstrates that it must be doing something right.

Surely the technology has developed over recent years? In fact Williams Hart have needed to make

only minor changes to the kit. The transistors have been replaced by new versions but these are to all intents and purposes the same as the originals. The other changes comprise lower ESR electrolytic capacitors along with improved regulators. I decided to upgrade my phono stage with the latest capacitors and regulators to bring it up to what is pretty much the latest spec. The first few hours of use were a very graphic example of how



Power supply section as supplied.





**Phono section, as supplied.**

much components develop as they burn-in. At first I thought I'd made a dreadful mistake. This turned out not to be the case.

The kit comprises two pcb's, black painted aluminium casework and all the components you need. The resistors are metal film, non-polarised capacitors are polycarbonate, the power transformer is thoughtfully a fully shielded affair. There are two 15 volt

are a whopping 670mV and 60mV. This is of course very important for vinyl. Very short duration, high magnitude spikes caused by dirt or scratches can upset a phono stage without a good overload margin. MC loading is set at 100 ohms/0.01uF and MM at 47k/220pf. Of course you can using whatever loading you prefer.

How do the different cases look? The two case version looks very functional, if I were to be a little brutal I'd use the word 'agricultural' but it's by no means unpleasant. The one box case is similar to the Williams Hart Power amp. It's still black but this time rather more professional looking. At £236.69 for the two box and £250.99 for the single box their can be no complaints whatsoever about value for money.

The big question is whether the Williams Hart phono stage is good value not only for the parts count but in terms of its sound. I've

there are compromises between clarity, detail and atmosphere. There's no easy answer to this balancing act, it comes down to your personal preference.

Overall I would say that the Williams Hart is an exemplar of how good design triumphs over the use of exotic components in poorer designs. There is of course scope for experimentation, you could try polypropylene or paper-in-oil coupling capacitors according to your preference. The single box version gives more space for such tweaking. Replacing the electrolytics with Black Gates should be a considerable improvement but at some considerable cost. Schottky diodes in the power supply would be worth a try and finally some really good voltage regulators, sometimes referred to as super-regulators could potentially be big win. Such a fully tricked-up version would be interesting to hear. Clearly the costs

involved would be high. I reckon the design justifies this, mind you the version I have is really very good indeed and is without question very good value. In fact it's so good I'm intrigued to understand just how high-end this design can be made.

Ultimately £250 for a phono kit that delivers such good sonics can only be described as a bargain.



**Populated phono PCB.**

regulators in the power supply and two 5 volt regulators for the front end of the phono circuit. The regulators are of the 78xx, 79xx variety. The power supply board has a ground lift option via a movable internal link. MM and MC sensitivity is set by flicking a toggle switch. There are AC and DC inputs, AC is for MM cartridges where you might be concerned to block some dc voltage. The DC input does not have this extra dc blocking capacitor and typically sounds better, use it if you can.

The Williams Hart phono stage is a little unusual in that it uses shunt feedback, not the more normal series feedback. The justification is that it is said this circuit topology exhibits a much higher overload characteristic. So what are the specs? MM input sensitivity is 3.7mV and MC is 0.34mV, gain being 134 and 1460 times respectively. Overload margins

already said that this phono stage has seen me through significant record deck upgrades. This suggests that resolution is good, otherwise I wouldn't have heard the benefits of my upgrades. Bass can only be described as deep and tight. There is very good clarity and there is no hint of harshness, maybe this is the payoff from the high overload margin. Fine nuances are easily heard, it's crisp but smooth and detailed. I would describe soundstaging as good, perhaps imaging is not as strong but still respectable. To achieve excellence in imaging and impressive atmosphere you might need to consider a valve phono stage. Then again you might find

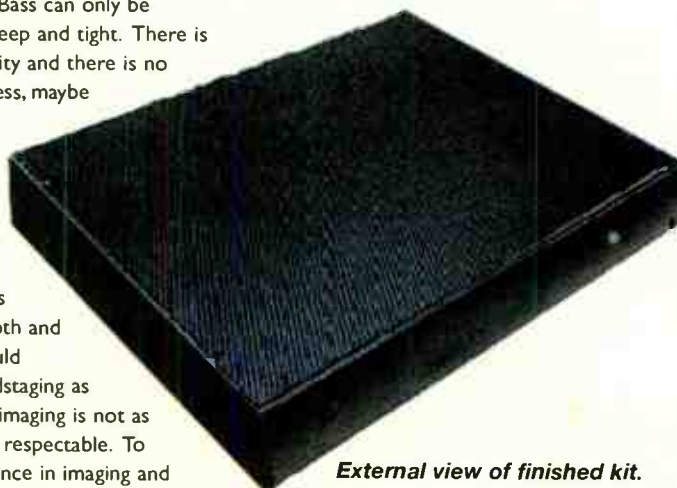

**External view of finished kit.**

Williams Hart Electronics  
 ☎ +44 (0)1678 520757  
 www.williamshart.com



[www.soundspares.co.uk](http://www.soundspares.co.uk)

capacitors (630v)



• 0.01uF Copper Foil .....	£15.29 each £55.00 set of 4	• 1uF Aluminium Foil ..	£19.99 each £71.95 set of 4
• 0.1uF Aluminium Foil .....	£12.50 each £45.00 set of 4	• 1uF Copper Foil .....	£41.23 each £148.43 set of 4
• 0.1uF Copper Foil .....	£18.27 each £65.77 set of 4	Other values and versions available - Please Call	
• 0.22uF Aluminium Foil .....	£14.51 each £52.24 set of 4	<b>Jensen 4 Pole Electrolytics*</b>	
• 0.22uF Copper Foil .....	£22.02 each £79.28 set of 4	• 47000uF - 16v.....	£21.40 ea
• 0.47uF Aluminium Foil .....	£16.61 each £59.80 set of 4	• 33000uF - 25v.....	£21.40 ea
• 0.47uF Copper Foil .....	£28.94 each £104.18 set of 4	• 22000uF - 40v.....	£21.40 ea
		• 10000uF - 63v.....	£21.40 ea
		• 6800uF - 100v.....	£23.44 ea
		• 220uF - 385v.....	£23.44 ea

\* Read our report on these fantastic capacitors at [www.soundspares.co.uk](http://www.soundspares.co.uk)

Valve Amplifier Parts

• EL34 Monoblock amp chassis.£43.00	• Alps Blue Audio Dual Pot 50k.....	£13
• 30w Mains Transformer	• Alps Blue Audio Dual Pot 20k.....	£13
410-0-410v / 5v / 6.3v.....	• DACT CT2 Attenuator Dual 100k.£115	
• 30w Mains Transformer	• DACT CT2 Attenuator Dual 50k...£115	
375v / 5v / 6.3v.....		
• PP 30w Output Transformer.....£49.00		
• HT Choke 200mA 7H.....£21.00		

Eichmann™ - Bullet Plugs\*

• Bullet plug - 4 pack.....	£ 30.00
• Silver Bullet Plug - single.....	£ 18.49
• Silver Bullet Plug - 4 pack.....	£ 74.99
• eXpress 4 interconnect RCA 1m*.....	£ 79.99
• eXpress 6 interconnect RCA 1m*.....	£144.99



Prices include VAT & UK Delivery

\*Alternative lengths available on request

01245 450 658

[sales@soundspares.co.uk](mailto:sales@soundspares.co.uk)

# High End Cable

## Just a few examples

Transparent Speaker cable	
2.44m pair Music Wave Plus	£329 SH
3.05m pair Music Wave	£329 new
3.05m pair The Wave	£259 new
Van den Hul 5m pr CS122 hybrid	£77.90
Van den Hul 5m pair Clearwater	£49.90
Transparent Interconnects	
Music Link 1m 3 pack	£189 new
7.6m pair Balance Music Link Ultra	£1299 SH
HDL 1m high performance coaxial	£69 new
Kimber KCAG Hyper silver RCA	£329 SH
Van den Hul Optocoupler Mk 2	£39 new

Many more deals on offer.  
14 day home trial available,  
Call **01775 761880**

Please visit website for latest stock position.

[www.highendcable.co.uk](http://www.highendcable.co.uk)

## The Digital Advantage

HW2

### Absolute High End Class D Amplifier

Can be used as a stand alone monoblock amplifier or fitted into existing loudspeakers to make them active

- Compact design due to switch mode P.S.U.
- 90% Efficient high switching frequency
- Small size, fits in a 110mm x 92mm opening
- Neutrik® Combi input balanced / unbalanced
- Output fully protected
- Status LEDs - Presence / Clip / Protect
- 600W / 2 Ohm - 500W / 4 Ohm - 300W / 8 Ohm
- All powers in R.M.S.
- Volume control. Input sensitivity 775mV
- Freq. Response 2Hz-20kHz
- Light weight 3kg
- Stunning performance

For further information please look at our website at [www.bkelec.com](http://www.bkelec.com) and click on the modules and hybrids button



Special quantity pricing and customised artwork for OEM's.

Price £281.12 Inc Vat Each or £499.00 Per Pair when quoting this advert  
Carriage UK Mainland Only £8.00



**B.K. Electronics**  
Unit 1, Comet Way, Southend-On-Sea, Essex SS2 6TR  
Tel:- 01702 527572 Fax:- 01702 420243  
Web:- [www.bkelec.com](http://www.bkelec.com) - email:- [sales@bkelec.com](mailto:sales@bkelec.com)



## NEW PRODUCTS FOR VALVE PRE AMPS

Full range of Mumetal input and output transformers for balanced and unbalanced pre-amps, microphone amps, equalizers etc.



For the true "valve sound" and elimination of hum and interference in your own or vintage designs. A new range and custom service for low power transformers to complement our power amplifier products. Transformers built to order 2-4 weeks delivery. Full technical support. Free catalogue. Visa, MasterCard, JCB etc.

E A Sowter Ltd  
PO Box 36 IPSWICH  
IP1 2EL England  
Tel: (+44) (0) 1473 252794  
Fax: (+44) (0) 1473 236188

E-Mail: [sales@sowter.co.uk](mailto:sales@sowter.co.uk)  
[support@sowter.co.uk](mailto:support@sowter.co.uk)  
Call or visit our Website for catalogue and information  
<http://www.sowter.co.uk>

# All new PSU

Neville Roberts plugs into the new Origin Live Ultra Turntable Power Supply.

**T**he latest offering to emerge from the vinyl gurus at Origin Live (<http://www.originlive.com>) is a top-of-the-range power supply to power their improved DC turntable motor that I have reviewed previously. Modestly titled the Ultra Turntable Power Supply, this builds on the success of their Advanced Power Supply as a 'no expense spared' design using the latest and best components currently available.

As with Origin's Advanced model, the Ultra is supplied as a kit that includes the DC motor and standard mains transformer, but with an enhanced price tag of £570 that reflects the design principles of this unit.

Obviously, the Ultra can cope with changes in input voltage from the mains, as well as the back EMF from the motor itself, which is used to control speed accurately. This minimises wow and flutter - a problem not just confined to tape transport mechanisms. As with the Advanced model, the Ultra incorporates a load compensating design that can compensate for the increased load on the motor caused by stylus drag.

However, the Ultra design incorporates features that compensate for the momentary slowing of the motor under sudden changes in load during, say, load bursts of music. Although this effect is very small, the cartridge can amplify this effect 100,000 times resulting in, according to Origin's literature, a loss of dynamic impact, particularly in the bass region. The circuit makes use of low impedance, low leakage capacitors, high power diodes and paralleled and closely matched transistors. All this technology is encased in a sleek, black case and finished off with a blue LED power indicator.

An upgraded transformer is also available for an additional £160 and this is also reviewed here to compare it with the standard offering that comes with the kit. The question is:

can a power supply costing in excess of £700 for a turntable really be worth the expense, or would the money be better spent elsewhere in the audio chain?

The kit is supplied with detailed instructions on how to upgrade virtually any turntable, with a separate section on upgrading the Linn LPI2. It also includes some washers and screws, a 2mm Allen key for use with Linn turntables, and a 'cut out and keep' strobe disc, with the centre hole pre-punched, for setting the motor speed.

I had already built an Advanced power supply into my turntable plinth (the subject of a previous article). The Ultra PSU and the associated mains transformers are housed in totally separate enclosures with the only connection to the deck itself being the output DC feed to the motor. This afforded me the opportunity to rapidly switch between supplies by rigging up a temporary switch on my turntable to connect the motor to either the existing internal supply or the new Ultra external unit.

As I had both the standard and the upgraded transformers available, I was also able to quickly switch between these units by plugging the appropriate transformer into the socket on the rear of the Ultra unit.

The Ultra has a 3-position switch on the front to select Off, 33 and 45 rpm speeds. The unit is designed to be powered continuously from the transformer and therefore the attractive blue LED remains lit, even when the motor is switched off. The actual speeds are set via 2 potentiometers accessed via a small hole drilled into the underside of the unit. The 45 rpm position can be set to provide 78 rpm by appropriate adjustment of the potentiometer if desired, although I would not be tempted to let your prize Hi-Fi cartridge anywhere near a 78!

Incidentally, while I had the unit upside down ready to set the motor speeds, I couldn't resist peering inside to see what components had been used. I was very pleased to see a large Rubycon electrolytic nestling at



Figure 1. The Ultra Kit and the Upgraded Transformer



Figure 2. The Ultra PSU



Figure 3. Rear view of the Ultra showing AC Input and DC Output Connections

the far end of the circuit board. As a convert to the delights of Rubycon Black Gates in my amplifiers, I was fully aware of the range of capacitors they manufacture specifically for use in high performance power supplies. When I discussed this with Origin Live, they told me that they had based their choice of the Rubycon on the fact that they simply sounded the best from their trials, rather than other factors. What better reason could there be for their selection?

The new PSU needs to be left to run in for a minimum period of 3

# LANGREX SUPPLIES LTD

DISTRIBUTORS OF ELECTRONIC VALVES, TUBES AND SEMI-CONDUCTORS AND I.C.S.

1 MAYO ROAD • CROYDON • SURREY CRO 2QP

24 HOURS EXPRESS MAIL ORDER SERVICE ON STOCK ITEMS

E-MAIL LANGREX@AOL.COM

PHONE  
020 8684 1166

FAX  
020 8684 3056

A selection of our stocks of **New Original Valves/Tubes.**  
Many other brands available

STANDARD TYPES		SPECIAL QUALITY TYPES						
ECC83	E.I	4.00	A2900/CV6091	GEC	17.50	12BY7A	GE	7.00
ECC85	RFT	12.00	E82CC	SIEMENS	7.50	5687WB	ECG	6.00
ECC88	BRIMAR	6.00	E83CC	TESLA	7.50	5814A	GE	5.00
ECC88	MULLARD	10.00	E88CC/CV2492	BRIMAR	15.00	6072A	GE	10.00
ECH81	MULLARD	3.00	E88CC GOLD PIN	TESLA	8.50	6146B	GE	15.00
ECL82	MULLARD	5.00	ECC81/CV4024	MULLARD	6.00	6201	GE	6.00
ECL86	PHILIPS	10.00	ECC81/M8162	MULLARD	7.50	6336A	RCA	35.00
EL36	MULLARD	5.00	ECC81/6201	MULLARD	10.00	6550C	SVET	20.00
EL37	MULLARD	30.00	ECC82/CV4003	MULLARD	15.00	6922	ECG	6.00
EZ81	MULLARD	10.00	ECC82/M8136	MULLARD	17.50	7027A	GE	25.00
EZ80	MULLARD	5.00	ECC83/CV4004	MULLARD	40.00	7308	SYL	5.00
GZ33/37	MULLARD	25.00	<b>AMERICAN TYPES</b>			<b>OTHER TYPES</b>		
GZ32	MULLARD	25.00	5R4GY	RCA	7.50	E88CC	TESLA	4.00
5Z4G	BRIMAR	7.50	5U4GB	SYLVANIA	15.00	ECC81	RFT	3.00
6V6GT	BRIMAR	7.50	5Y3WGT	SYLVANIA	5.00	ECC82	RFT	6.00
12BH7	BRIMAR	12.00	6BX7GT	GE	7.50	ECC83	RFT	8.00
12E1	STC	10.00	6B4G	SYLVANIA	22.00	EF86	USSR	5.00
13E1	STC	85.00	6FQ7	SYLVANIA	7.50	EL84	USSR	3.00
807	HYTRON	7.50	6L6GC	GE/SYL	20.00	EL34	SVETLANA	7.50
811A	USSR	10.00	6L6WGB	SYL	20.00	EL34	E.I	6.00
6080	MULLARD	10.00	12AX7WA	SYLVANIA	6.00	6SL7GT	USA	7.50
						6SN7GT	USA	7.50

THESE ARE A SELECTION FROM OUR STOCK OF OVER 6000 TYPES. PLEASE CALL OR FAX FOR AN IMMEDIATE QUOTATION ON ANY TYPES NOT LISTED. WE ARE ONE OF THE LARGEST DISTRIBUTORS OF VALVES IN THE UK. SAME DAY DESPATCH VISA/ACCESS ACCEPTABLE. OBSOLETE TYPES A SPECIALITY.

CREDIT CARD MIN ORDER £10.00.

OPEN TO CALLERS MON. - FRI. 9AM - 4PM. CLOSED SATURDAY

U.K. P&P 1-3 VALVES £2.00, 4-6 VALVES £3.00 ADD 17.5% VAT TO TOTAL INC P+P O'SEAS P & P PLEASE ENQUIRE

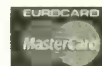

## Watford Valves

7 DAYS A WEEK 9AM - 9PM The Audiophiles Choice  
All output valves multi-tested and digitally matched  
Full no quibble guarantee. Expert advice on all valve amps

### SPECIAL OFFERS

ECC81	Telefunken	£15.00	300B	JJ Tesla	£68.00
GZ37	Mullard	£18.00	ECL82	A.E	£4.00
ECC83	E.I.	£3.83	5B255M	S.T.C	£4.00
2A3	Sovtek	£18.00	GZ32	Philips	£18.00
ECC83/5751	G.E	£10.00	6922	Philips	£5.00

### QUAD II REVALVE SPECIAL OFFER

The Harma KT66 has become the industry choice as the closest in performance to the G.E.C. KT66 in these classic amps. This month you can revalve and revitalise your quad at a fraction of the normal cost.



4x Harma KT66, 2 x Harma GZ32 & 4 Svet EF86  
only £130 The set plus carriage and v.a.t.

#### ATTENTION ALL 6C33 USERS & GRAAF OWNERS

We are renowned for supplying the high grade military version of the 6C33C. We have selected items which have been matched on plate current & transconductance at the special offer price of £22 each.  
Also PC900 Philips on special at £8.50 each.

### SVETLANA 6550C SPECIAL OFFER

Original (new old stock) 90's production 6550C with tri plate anode and precision gold wound grids. This tube obtained a rave review in Vacuum Tube Valley iss 6. All 6550C are rigorously tested and then dual matched on anode current and output. Special selected sets are available for AR, Conrad and World Audio Amplifiers at only £20 each.



### WORLD AUDIO DESIGN UPGRADES

KIT 6550 & KAT 6550 Upgrade

KIT 34 & KAT 34 Upgrade



4 x 6550C Svetlana matched  
2 x ECF80 GE  
2 x 5U4G Russian

KIT6550

£99 the set + vat & carriage



KAT6550



4 x EL34 Svetlana matched  
2 x ECF80 GE  
2 x 5U4G Russian

KIT34

£60 the set + vat & carriage



KAT34

MAIL ORDER OR  
ORDER ON LINE

Fast mail order/next day delivery/World Wide shipping  
1000's more valves stocked. Prices exclude VAT and carriage.



01923 893270

Fax: 01923 679207

www.watfordvalves.com



hours, according to the instructions, and about 8 hours of running to sound its best. However, I would recommend leaving it running for at least 24 hours – all of us who have installed Black Gates in our amplifiers will be familiar with them suddenly 'popping' into sounding good after a few hours of sounding rather flat and I didn't want to take any chances with the Ultra. Setting the speed is simply a matter of illuminating the strobe disc from a mains powered light source, preferably fluorescent, and turning the appropriate potentiometer until the correct ring of lines on the strobe disc appears stationary. This should be carried out while playing a record at about half way in to allow for stylus drag. To put all this in perspective, speed variations on most decks is around plus or minus 2% and the Advanced supply provides 0.3%, but the Ultra offers accuracy of about 0.1%.

With the new unit properly calibrated, it was time to conduct the all-important listening trials. Would there be any discernible difference between the supplies and, more importantly, would the Ultra actually sound better?

I started off by installing a copy of "Lincoln Mayorga & Distinguished Colleagues – Volume III", Sheffield Labs SL5/SL6, on the turntable. This is a 'direct to disc' recording and is the closest one can get to a live recording as the disc was cut directly during the recording session in November 1973. When switching between my original Advanced power supply and the Ultra, it was immediately apparent that the imaging and accuracy of placement of the instruments was significantly better with the Ultra. Staying with the Ultra and plugging in the upgraded transformer resulted in a further tightening of the bass. What was particularly surprising was that the percussion was also clearer with the upgraded transformer. The first track on side 2, "You are the Sunshine of my Life", positively sparkled and reverting to the standard transformer was like throwing a cloth over the performers! Going back to my original power supply caused the various instruments to somehow lose their precisely allocated spot on my living room floor!

Switching to a half-cut master recording of "Money" from "The Dark Side of the Moon" (the term 'half-cut' refers to the master disc being cut at half speed, not the alcoholic state of the recording engineer!) confirmed the effects of the Ultra. The bass guitar was more tuneful and the cash registers glittered with clarity! The

vocals were altogether cleaner and their slight raspiness was much better reproduced.

Moving into the classical arena, my recording of Stravinsky's The Firebird Suite (The Atlanta Symphony Orchestra - Telarc digital recording DG-10039) demonstrated the improved clarity with the Ultra with the bowing of the strings more discernible in the opening section. Again, the bass was tighter, especially with the upgraded transformer, and the sound seemed richer, more mellow and open as compared to my original Advanced power supply. The harmonics of the solo harpsichord of J. S. Bach's Partita No. 2 (Trevor Pinnock on Archiv 415 493-1) were somehow more separate and you were more conscious of the strings actually being plucked with the Ultra with its standard transformer. Replacing the standard transformer with the upgraded unit added detail and somehow made the performance more effortless.

I was very convinced of the improvements with the Ultra, but I felt the need to consult with an independent and unbiased listener who has not been bitten with the Hi-Fi bug like me – my wife! I am pleased to report that she too immediately noticed the improvements I had found with the Ultra in a 'blind' test, even when I switched between the supplies and not saying which was which.

Although the Ultra clearly sounded better, this left me with the question of why on earth a power supply for a turntable motor should have such an effect on sound quality. The Ultra is able to respond rapidly to sudden changes in load caused by increased stylus drag on loud passages and thereby keeping the record speed constant. This, in theory, will result in more accurate timing of the various components of the signal from the cartridge, with a consequential reduction of errors, leading to more accurate reproduction. The importance of longer-term speed stability (although I am still referring to fractions of a second) should not be overlooked as this minimises wow and flutter, which will clearly have a beneficial effect on bass response. Given all the amplification of these errors from stylus tip to loudspeaker cone, it is therefore very understandable that minimising these could result in the improvements that were heard.

Having finished the listening tests, it was time to remove the original power supply from my deck and complete the conversion to the Ultra



Figure 4. Motor Speed Setting Potentiometers



Figure 5. Setting the Motor Speed



Figure 6. Before (left) and After (right) – Spot the Differences?

external power supply. One of the holes on the plinth that accommodated the original speed control switch was put to good use and I fitted a spindle adaptor for large centre 45s that had been lying around in my Hi-Fi drawer for many years. The remaining holes were blanked off with squares of black plastic that I rebated into the wood beneath the metal cover.

To summarise, this power supply offers a performance that easily rivals top-flight power supplies from other manufacturers costing twice as much. To put this into context, you may spend considerably more on a cartridge, but risk 'cramping its style' by ignoring the record transport. If you want to get the best from your vinyl collection, you should not overlook the importance of the turntable motor and power supply. Incredible as it may seem, it really does make a very noticeable difference. Go for it!

# kit & component suppliers

## COMPONENT SUPPLIERS

### Audio Synthesis

PO Box 50 Nottingham  
NG9 1DX.

Tel. 01159 224138 Fax. 01159 229701.

Email [salesinfo@audiosynthesis.co.uk](mailto:salesinfo@audiosynthesis.co.uk)

Website [www.audiosynthesis.co.uk](http://www.audiosynthesis.co.uk)

VISHAY BULK FOIL RESISTORS - unquestionably the world's finest resistor for audio applications. Thousands of VSRJ 0.3W 300V 5ppm 1% values in stock at the lowest possible prices eg. values up to 20K at £3.50+vat. HIGH PURITY SILVERWIRE - Teflon insulated >99.99% purity, 0.6mm and 1.0mm diameter. Ideal for internal wiring, interconnects or speaker cables.

### Audio-Links

7 Fairmont Crescent,  
Scunthorpe,  
North Lincolnshire DN16 1EL

Tel: 01724 870432

Fax: 01724 875340

Email:

[audiolinks@ntlworld.com](mailto:audiolinks@ntlworld.com)

Extensive stock of specialist audiophile components for valve and solid state enthusiasts. Supplier of the largest range of high-end audio volume controls in Europe. 30 page catalogue - Free via e-mail or £3.00 posted.

### White Noise

11 Station Road, Bearsden,  
Glasgow G61 4AW

Tel: 0141 942 2460

Fax: 0141 587 7377

Email:

[david.white38@ntlworld.com](mailto:david.white38@ntlworld.com)

[www.wnaudio.com](http://www.wnaudio.com)

Supplier of the widest range of standard and audiophile kits for solid state preamplifiers, power amplifiers, headphone amplifiers, power supplies, MM/MC phono stages, active crossovers, balanced i/o modules, and stepped attenuators; more kits in the pipeline. All kits use the highest quality, glass fibre, solder masked, silkscreened, PCBs. We also supply a wide range of active (esp. Japanese transistors and Exicon mosfets) and passive components, gold plated connectors, and silver plated wires. Write, phone or email for a free catalogue. Mail order only.

### Audiocom Int. Ltd

Unit 14 Pier Road  
Pembroke Dock,  
Pembrokeshire, SA72 6TR

Tel: 01646 685601 Fax: 01646 685602

Web: [www.audiocominternational.com](http://www.audiocominternational.com)

E-mail: [info@audiocominternational.com](mailto:info@audiocominternational.com)

Extensive range of audio grade passive & active components, which including brands & manufacturers DACT, Black Gate, OS-CON,

Neotech, Vishay, Intertechnik, Elna, etc. We are the manufacturers & distributors of the highly acclaimed Superclock 2, plus Q-power & Super-regulator. Visit our website store today for pricing & information. Secure online ordering available.

## LOUDSPEAKER KIT SUPPLIERS

### IPL Acoustics,

Chelsea Villa, Torrs Park, Ilfracombe, North Devon,

EX34 8AY

Tel/Fax: 01271 867439

Please visit website for full catalogue of products:

[www.iplacoustics.co.uk](http://www.iplacoustics.co.uk)

IPL supply a range of 7 high quality transmission line speaker kits, and a full range of Hi Fi and AV speaker kits, including 2 active subwoofers. Drive units are available from Audax, Seas, Morel, Legend (Ribbon Tweeters), and IPL custom built metal coned drivers. IPL also supply; quality capacitors, inductors and cabinet accessories, including Silver Plated PTFE insulated cables.

### WILMSLOW AUDIO

50 Main Street, Broughton Astley,  
Leicester LE9 6RD

Tel: 01455 286603

Fax: 01455 286605

Email: [sales@wilmslowaudio.com](mailto:sales@wilmslowaudio.com)

Website: [www.wilmslowaudio.com](http://www.wilmslowaudio.com)

Contact us for a copy of our FREE Full Colour Catalogue or visit our Website with secure online ordering.

The UK's largest supplier of loudspeaker kits, drive units and components.

We also have a range of subwoofer kits and amplifier modules available.

Official UK distributor for ATC, Morel, Peerless, Scan-speak, Seas, Vifa and Volt. Beware of imitations, we only stock drive units made by the genuine manufacturers. We offer a full repair and upgrade service on most makes of loudspeakers.

## VALVE AND OUTPUT TRANSFORMER SUPPLIERS

### Watford Valves

3 Ryall Close, Bricket Wood,  
St. Albans, Herts AL2 3TS

Tel: 01923 893270 Fax: 01923 679207

Specialist in new old stock and current production valves. Sole UK distributor of the Harma Diamond range selected for their superior performance. Huge range held, stockists of Mullard, GE, Philips, National, Brimar, Sylvania, Telefunken, RCA, MOV and many more. All valves are new boxed and guaranteed. For free price list and specialist advice call or fax Derek Rocco, Watford Valves.

### Chelmer Valve Company Ltd

The Stables, Baddow Park  
Great Baddow, Chelmsford, Essex  
CM2 7SY

Tel: 01245 241300

Fax: 01245 241309.

Email: [sales@chelmervalue.com](mailto:sales@chelmervalue.com)

Web Site: [www.chelmervalue.com](http://www.chelmervalue.com)

Premium range of audio valves, tested/selected for low noise, hum, microphony; power valves burnt-in. Huge stock of valves/tubes of all type, audio valves (inc. NOS types), industrial etc. Also large stocks of semiconductor. Many obsolete types.

### Billington Export Ltd.

1E Gillmans Trading Estate,

Billingshurst,

West Sussex

RH14 9EZ

Visitors by appointment only please

Fax: 01403 783519

E-Mail: [sales@bel-tubes.co.uk](mailto:sales@bel-tubes.co.uk)

Website: [www.bel-tubes.co.uk](http://www.bel-tubes.co.uk)

Specialists in guaranteed new/old stock, current production valves & tubes. Also CRT for audio, hi fi (as well as industrial uses). A vast archive of vintage and obsolete types including limited quantities of Mullard, GEC, Sylvania, Philips, Brimar, Telefunken, RCA and others. Large stocks of Chinese, Russian, EI and Tesla etc. A 50-page valve catalogue is available on request. Major stockists of the excellent Billington Gold brand. Contact us for quotations - attractive price on larger orders.

## MODIFICATION SERVICES

### Audiocom Int. Ltd

Unit 14 Pier Road,

Pembroke Dock,

Pembrokeshire, SA72 6TR

Tel: 01646 685601 Fax: 01646 685602

Web: [www.audiocominternational.com](http://www.audiocominternational.com)

E-mail: [info@audiocominternational.com](mailto:info@audiocominternational.com)

SpCD, SACD & DVD modifications to all manufacturers & models. Modifications include the 'Superclock 2' ultra-low jitter master clock for re-clocking CD, SACD etc, analogue & digital power supply upgrades, plus analogue filter & output stage upgrades. (Dave Robinson, Editor - Positive Feedback Magazine - This is a slam-dunk no-brainer, amigos. If you're thinking about modifying your SACD player... if you do only ONE modification... then the Superclock 2 is it.) Prices start from £100 - £1000+. For further information visit our website, or call us now to see how this service can be adapted to suit your requirements.

email: [advertising@hi-fiworld.co.uk](mailto:advertising@hi-fiworld.co.uk)

# market place

specialist products and services

For all your advertising requirements please call  
Mike Ballance on 01908 616116  
or email: [advertising@hi-fiworld.co.uk](mailto:advertising@hi-fiworld.co.uk)

## Sound Investment

If you have invested expertise and money in building up a sound system to your own unique specifications, then why compromise with indifferent housing units?

Fi-Rax offers a new dimension in audio visual racking - from a range of standard designs to the flexibility to custom create a unit to suit your particular sound system and lifestyle.

- \*High quality aluminium construction.
- \*Finishes available to your choice.
- \*Fully adjustable 6mm glass shelving.
- \*Sound isolation on shelving/feet.
- \*Custom created to suit your system.
- \*Free delivery throughout the UK.

Fi-Rax - a sound investment for those who want the best from their equipment.

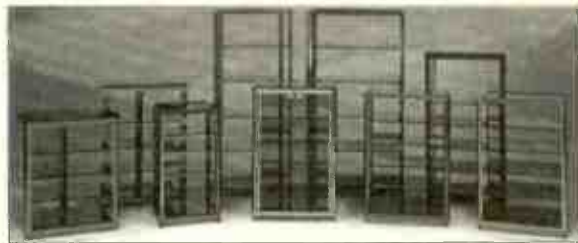

Audio Visual Furniture

For further information or a free brochure contact: JEM Distribution, Springfield Mills, Spa Street, Ossett Wakefield WF5 0HW. Tel: 01924 277626 Fax: 01924 270759

## RETRO Reproduction

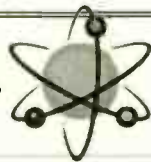

**New web address : [www.retroreproduction.com](http://www.retroreproduction.com)**  
28a Haddington Place Edinburgh EH7 4AF Phone/Fax 0131 558 9989  
Open 11.00am - 5.30pm - closed Monday & Sunday

Used equipment for sale			
<b>Amplifiers</b>			
Audiolab LX integrated amp boxed as new	£295	Beaumont B2 loudspeakers x-dem	£1500
Audionote M1 Valve Pre Amp with Phono Stage	£395	Celestion Dutton 44 3 way speaker	£195
Audio Innovations 1000 monobloc hard wired	£995	Gale 301 speakers	£125
Audio Research SP9 Pre Amplifier	£795	Impulse Horni speakers new	£1300
Arcam 290P power amp	£195	JM Labs 905 bookshelf spks stereophile recommended	£795
Croft EPOC Pre Amp	£595	JM Labs Micro Utopia speakers with matching stands boxed mint new	£3995
Denon P0A4400A monoblocs Class A (x4)	each £225	Linn Isobank	£1795
Denon DAF 2500	£95	Musical Fidelity MC2 Bookshelf Speakers	£395
EAR 834P Valve Phono Amp	£295	Martin Logans Aenusa last and best version boxed mint	£195
EAR 834L Valve Line Stage	£325	OLN Spiffified Signatures	£1495
Leak TL12 monobloc fully serviced excellent sound quality	£475	Quad ESL57 refurbished	£895
Linn Cairn pre amp with mc phono stage boxed as new late edition	£595	Sonus Faber Guinari Homage	£595
Linn UK140 power amp 95wpc mint boxed	£595	Tennys corner Lancaster with 15" Monitor	£2495
Leoson Pre Amplifier and matching Power Amp	£495	Gold's 1968 as new condition	
Marantz PM 66 K1 Sig Int Amp	£245	Spendor BC1 Speakers	£POA
Meridian 1C3D pre power combination	£295	Wilmslow Audio transmission line speakers with volt drive units Hi-Fi News recommended	£175
MicroMega Tempo 1 Integrated Amp remote control with great phono stage new	£800		£395
Moth 100W Monoblocks			
Naim NAP50 Power Amp		<b>CD Players, BACs</b>	
Quad 303 Power Amp		Audiolab 8000 DAX F serial number Tag McLaren	£595
Quad 405 Power Amp boxed		built HDCD mint boxed	£195
Rega EXS Power Amp		Arcam Alpha 6 new	£225
Rotel RB872BX Power Amp		Arcam CD6: 24 bit text CD Player mint boxed	£95
Rotel RB85 Stereo Power Amp can be bridged		A&R wedge shaped CD Player mint boxed	£795
Rotel RC99: BX remote control Pre Amp: £400 new		Marantz CD17 KI Signature mint	£486
Sugden A43 integrated Amp		Marantz CD63 top loading CD Player	£295
		Meridian 604 series transport	£195
		Meridian 604 CD DAC	£75
		Mission DAD5 CD Player boxed mint	£595
		Mission DAC7 boxed mint	£595
		Musical Fidelity A3 upsampling DAC as new boxed	£595
		Roksan Atessa top loading cd player £1500 new	£495
		Sony S55 champagne finish battleship build quality	£595
<b>Turntables</b>		<b>Tuners, Reel to Reel, Cassette Deck, misc</b>	
Michell 77: SM with 774 tonearm	£295	Cyrus-original Tuner	£150
Michell OrtoB Tumbletable	£1295	Leak Troughline Tuner 3 various ...from	£50
Michell Gyrodec gold finish mint condition boxed	£695	Mend an original shoebox tuner	£150
Michell Focus 1 turntable	£195	Quad FM3 Tuner (boxed mint)	£145
Original classic turntable acrylic platter	£395	Quad FM3 Tuner	£95
QC power supply phase II model	£295	Quad FM4 Tuner old style	£225
SME 309 T tonearm boxed	£495	Revox G36 Open Reel Mint	£395
System Desk II turntable ..UPGRADE YOUR REGA from	£150	Sansui TU555 Tuner round dial	£95
STD with Mission 774 tonearm	£195	Tascam 22/2 Open Reel	£395
Various Garrard turntables with granite wood marble plinths available	POA		
		<b>Due In</b>	
<b>Speakers</b>		Quad II Monoblocks	1250
ATC SCM 10 Active 10 ex dem new	£1750	ATC SCA2 Flagship pre amplifier	£2300
ATC Active 20s ex dem new	£2700	EAR S9 monoblocs	£394
ATC SCM 10's Walnut finish		EAR Q88 Pre Amplifier	£395
B&W CDM' Rosewood finish		Griffin 85 Active Speakers	£395
Audiophysik: Spark MK3 latest edition new	£1850		

**\*NOW DEMONSTRATING\***  
**The Fantastic EAR 890 and 899 70 watt per channel Class A amplification (SPECIAL offer trade in your existing amplification for full market value against any EAR products.**

**ATC SCM 7, 12, & 35 SPEAKERS PROBABLY THE FINEST SPEAKERS AVAILABLE - PRICES START FROM £480**

**Ear 869 single ended triode integrated amplifier**  
Improved version of the classic 859 with revised output transformers modified input stage with the addition of a extra signal valve which has allowed an increase to 15watt of single ended power, also the 869 can be used as a power amp. Don't be fooled by its modest power output this amp drives real world speakers. price £2498.00

**Ultimate Ear Phono Stage**  
This is the ultimate esoteric Phono Stage as used in the world wide acclaimed Ear 312 Control Centre - Pre Amp. This has to be the ultimate Vinyl Replay purchase. price £2095

**\*\* FOR A LIMITED PERIOD ONLY \*\***  
**Full value Trade in on Ear Phono Stages and other selected models.**

**WE ARE PROUD TO ANNOUNCE THE NEW BEAUHORN B2 HORN LOUSPEAKERS IDEAL FOR LOW POWERED SINGLE ENDED VALVE AMPS**

**ALSO DEMONSTRATING THE NEW GRAHAM SLEE PROJECTS RANGE OF AFFORDABLE PHONO STAGES**

**"DRAGONS TAILS CABLE"**  
**SPECIALLY DESIGNED FOR VALVE AMPLIFICATION PHONE FOR DETAILS!**

**There are now four models in the EAR lineup:**  
The classic 834P uses the same circuit architecture as its more expensive brothers, and shares the same high quality sound through MM type cartridges, it is enclosed in a tough, rigid metal case and is fully "CE" type approved. price £495.00  
The signature builds on the Classic 834P specification by adding a superb moving coil (MC) input stage, as well as the so-extra-price option of a high quality volume control. price £590.00

Top to the range, the Deluxe 834P comes in stunning chrome and gold cabinet, and has extra attention and quality control. With different moving coil input options, this unit will fit the most demanding of audiophile systems. For the true vinyl enthusiast. price £895.00

MC3 - The ultimate stage for MC matching with 3 fixed transformer taps to cover all types of moving coil cartridges, and separate left/right grounding. MC3 in used in the new £10,000 312 pre. price £630.00

**Selected products from: ATC, Audio Physic, EAR Yoshino, Nottingham Analogue, Dynavector.**







The Hi-Fi Company's

# Trading Station

www.hifitradingstation.com

## EX-DEMONSTRATION & DISPLAY ITEMS NOW AVAILABLE FOR SALE

We work closely with several high-end retailers and can offer you great savings on their top quality ex-demonstration and display items. All stock listed here is offered in 'as new' condition unless otherwise stated, complete with boxes, instructions and full manufacturers warranties. Some excess stock items are new, in unopened boxes.

The Trading Station

35 Cowgate Peterborough PE1 1LZ

Phone: 0870 608 8211

email: info@hifitradingstation.com

Business Hours: Tues - Sat: 10am - 5.30pm CLOSED MONDAYS

ALL MAJOR CREDIT CARDS ACCEPTED\*

\*NEXT DAY DELIVERY SERVICE

COMPETITIVE FINANCE TERMS FOR PERSONAL CALLERS

<b>APOGEE</b> Mini Grand GS Speakers £7598	<b>£4057</b>	<b>MARTIN LOGAN</b> CLS II Limited Edition £6700	<b>£4776</b>	<b>PS AUDIO</b> Ref Link Pre/DAC £4549	<b>£1997</b>
<b>ARIEL ACOUSTICS</b> Mod 8 + stands XD £5679	<b>£2996</b>	<b>MERIDIAN</b> DSP33 Digital Speakers £2595	<b>£2076</b>	<b>QUAD</b> ESL988 (Antique) £3750	<b>£2996</b>
<b>AUDIO ANALOGUE</b> Puccini, manual silver £595	<b>£397</b>	<b>MARTIN LOGAN</b>		<b>REGA</b> Naos (Cherry) XD £998	<b>£694</b>
<b>AUDIO ANALOGUE</b> Maestro Amp £2900	<b>£1797</b>	Theatre Centre Channel Speaker £2998	<b>£1597</b>	<b>REGA</b> ARA (Cherry) XD £255	<b>£214</b>
<b>AUDIOGRAM</b> M81 Amp £489	<b>£267</b>	<b>MARTIN LOGAN</b> Cinema Spk £1698	<b>£897</b>	<b>REGA</b> Cursa Pre Amp £548	<b>£334</b>
<b>AUDIOGRAM</b> M82 Integrated Amp £599	<b>£317</b>	<b>McINTOSH</b> MC122 Power £1249	<b>£796</b>	<b>REGA</b> Moia £498	<b>£294</b>
<b>AUDION</b> Silver Knight 3008 Intgrtd XD £1125	<b>£876</b>	<b>McINTOSH</b> MC7108 8Ch Pwr £2549	<b>£1496</b>	<b>REGA</b> Jupiter CD £998	<b>£694</b>
<b>AUDIO RESEARCH</b> DAC5 D/A £2335	<b>£1297</b>	<b>McINTOSH</b> MX135 AV Cntrl Cntr £7990	<b>£2996</b>	<b>SME</b> 10A with 309 Tone Arm XD £3410	<b>£2896</b>
<b>AUDIO RESEARCH</b> VT200/2 Pwr XD £11982	<b>£9586</b>	<b>McINTOSH</b> LS320 Speakers XD £1998	<b>£996</b>	<b>SONUS FABER</b> Amoti Homage XD £11850	<b>£9996</b>
<b>AUDIO RESEARCH</b> LS25 Mk2 XD £5795	<b>£4636</b>	<b>McINTOSH</b> LS340 Speakers XD £4798	<b>£2496</b>	<b>SONUS FABER</b> Concertino XD £599	<b>£529</b>
<b>AUDIO RESEARCH</b> DAC 120 £3498	<b>£697</b>	<b>McINTOSH</b> CS36 Centre Speaker £2495	<b>£1326</b>	<b>SONUS FABER</b> Extrema Speakers £6499	<b>£3497</b>
<b>AUDIO RESEARCH</b> 100.2 Amp £3690	<b>£2467</b>	<b>McINTOSH</b> MGT100 £5490	<b>£3996</b>	<b>SONUS FABER</b> Electro Speakers £1789	<b>£1197</b>
<b>AUDIO RESEARCH</b> LS8 Pre Amp £1499	<b>£997</b>	<b>McINTOSH</b> C46 Pre £4495	<b>£3496</b>	<b>SPENDOR</b> S6 £1299	<b>£894</b>
<b>AUDIO RESEARCH</b> Ref600 MkIII £42998	<b>£25797</b>	<b>McINTOSH</b> MC402 Power £5490	<b>£3996</b>	<b>SPENDOR</b> S8 Cherry - Slight cabinet damage £1700	<b>£1195</b>
<b>AUDIO RESEARCH</b> VT50 Valve Amp £4379	<b>£2997</b>	<b>MERIDIAN</b> DS568.2mm£4305£3296		<b>SPENDOR</b> S9 £2499	<b>£1696</b>
<b>AUDIO RESEARCH</b> M300 mkII monos £11996	<b>£5997</b>	<b>MERIDIAN</b> DSP5000C (Dig Centre) XD £1995	<b>£1594</b>	<b>TDS</b> Audio Transformer £349	<b>£266</b>
<b>AUDIO RESEARCH</b> VT100 MkIII Amp £6400	<b>£4267</b>	<b>MICHELL</b> Gyro SE XD £870	<b>£740</b>	<b>THETA</b> Cosonovo Pre XD £4478	<b>£2496</b>
<b>B&amp;W</b> THX System XD £4975	<b>£1496</b>	<b>MICHELL</b> Delphini Phono LPSU XD £895	<b>£738</b>	<b>THETA</b> Oreadnought5 Ch Amp £7498	<b>£5297</b>
<b>CALIFORNIA AUDIO</b> Alpha DAC £1808	<b>£847</b>	<b>MICHELL</b> Delphini Phono SPSU XD £998	<b>£798</b>	<b>THETA</b> Carmen II CO/OVO Trans £3998	<b>£2937</b>
<b>CALIFORNIA AUDIO</b> Delta CD Trans £1099	<b>£587</b>	<b>MISSION</b> 78C (Centre) XD £350	<b>£274</b>	<b>THETA</b> Jitter Buster £228	<b>£177</b>
<b>CALIFORNIA AUDIO</b> OX1 £852	<b>£457</b>	<b>MONRIO</b> Asty PH55 W.line + phono silver £650	<b>£397</b>	<b>THETA</b> DavidII DVD Player £5998	<b>£4397</b>
<b>COPLAND</b> COA277 CD + HDCD £1649	<b>£1097</b>	<b>MONRIO</b> Asty ST, remote volume silver £600	<b>£447</b>	<b>TRIANGLE</b> Zays Ambre £1295	<b>£897</b>
<b>COPLAND</b> CDA288 CD + HDCD £1998	<b>£1337</b>	<b>MONRIO</b> Asty-Player (24/96) silver £750	<b>£527</b>	<b>TRICHORD</b> Pulsa Series One DAC £1900	<b>£1298</b>
<b>COPLAND</b> CSA303 Pre Amp £1349	<b>£797</b>	<b>MONRIO</b> HP-1 (120 watts power amp) silver £895	<b>£597</b>	<b>UNISON RESEARCH</b> Unico 1 £775	<b>£597</b>
<b>COPLAND</b> CTA301 Pre Amp £1298	<b>£587</b>	<b>MONRIO</b> 188.2 (DAC) silver £595	<b>£227</b>	<b>UNISON RESEARCH</b> S2 £1295	<b>£697</b>
<b>COPLAND</b> CTA504 Amp £1999	<b>£1197</b>	<b>MONRIO</b> Bitmatch CD-player/transport silver £695	<b>£297</b>	<b>UNISON RESEARCH</b> Power 35 £1500	<b>£897</b>
<b>EAR</b> 834P Valve Phono Stage XD £549	<b>£436</b>	<b>MONRIO</b> MC-25 power amp silver £900	<b>£447</b>	<b>UNISON RESEARCH</b> Feather One £895	<b>£447</b>
<b>GOLDMUND</b> Mimesis 6 Amp £2899	<b>£1547</b>	<b>MONRIO</b> MC-200S power amp silver £1350	<b>£497</b>	<b>UNISON RESEARCH</b> Feather One Remote £995	<b>£527</b>
<b>GOLDMUND</b> Mimesis 6B Pre Amp £2584	<b>£1377</b>	<b>MONRIO</b> MP1 mono 110 watts £600	<b>£417</b>	<b>WILSON BENESCH</b> Full Circle £1995	<b>£1496</b>
<b>GRAAF</b> 13.5 BII Pre XD £3950	<b>£2746</b>	<b>MONRIO</b> MP1 mono 135 watts £700	<b>£457</b>	<b>WILSON AUDIO</b> Cub (Black Laminated) XD £5495	<b>£3496</b>
<b>GRAAF</b> GM20 OTL XD £2950	<b>£2356</b>	<b>MONRIO</b> MP2 2-channel x 135 watts £950	<b>£697</b>	<b>WILSON AUDIO</b> Cub (Gloss) XD £6890	<b>£3996</b>
<b>GRAAF</b> Venticinque £2250	<b>£1197</b>	<b>NAGRA</b> PLL Pre XD £5395	<b>£3996</b>	<b>WILSON AUDIO</b> Sophia (Black) XD £11992	<b>£9596</b>
<b>GRAAF</b> VTS.35.5 (five ch power amp) £2500	<b>£1397</b>	<b>NAIM</b> Intro 2 £865	<b>£694</b>	<b>WILSON AUDIO</b> Cub Wilson Gloss £6890	<b>£4397</b>
<b>JADIS</b> Orchestra CD Player £1298	<b>£957</b>	<b>NAIM</b> NAC 112 £660	<b>£524</b>	<b>WILSON AUDIO</b> Cub-II Wilson Gloss £8248	<b>£6047</b>
<b>KEF</b> XQ1 £999	<b>£744</b>	<b>NAIM</b> Nail 5 £845	<b>£674</b>	<b>WILSON AUDIO</b> Witt 2 Speakers £10995	<b>£6997</b>
<b>KEF</b> XQ5 £1999	<b>£1494</b>	<b>NAIM</b> NAP 150 £795	<b>£634</b>	<b>WILSON BENESCH</b> Orator XD £2900	<b>£1794</b>
<b>KRELL</b> KPS28 CD Player XD £8998	<b>£5996</b>	<b>NAIM</b> CDS/XPS Mk2 XD £6265	<b>£3994</b>	<b>WILSON BENESCH</b> Actor XD £3999	<b>£2496</b>
<b>KRELL</b> KCT Pre-amp XD £9998	<b>£6996</b>	<b>NAIM</b> Creda XD £1425	<b>£794</b>	<b>WILSON BENESCH</b> Discovery £5495	<b>£4496</b>
<b>KRELL</b> KAV250P Pre Amp £2398	<b>£1597</b>	<b>OPERA</b> SP1 (Cherry) XD £525	<b>£426</b>	<b>WILSON BENESCH</b> Act-1 XD £6999	<b>£3996</b>
<b>KRELL</b> KSL Pre Amp £2345	<b>£1037</b>	<b>PATHOS</b> Twin Towers XD £3250	<b>£2596</b>		
<b>KRELL</b> CD Player with DSP £3789	<b>£1517</b>	<b>PIONEER</b> DVR7000 DVD Recorder XD £1299	<b>£696</b>		
<b>LINN</b> LP12 / Linga / Akita (black) £2699	<b>£1994</b>	<b>PIONEER</b> SD-T 5000 50" Projection TV £3999	<b>£1496</b>		
<b>LINN</b> Classik Movie XD £1995	<b>£1596</b>	<b>PIONEER</b> PDP 503 HDE (50") Plasma £6995	<b>£4495</b>		
<b>MARTIN LOGAN</b> Aeon Speakers XD £3148	<b>£2646</b>	<b>PS AUDIO</b> Ulink 2 HDCD DAC £2590	<b>£1037</b>		

MANY ITEMS DON'T EVEN MAKE IT TO THIS LIST - LET US KNOW WHAT YOU'RE LOOKING FOR!



# AUDUSA

## AUDUSA EUPEN CSA 2.5 AUDIO AC MAINS CABLE

**GNLM 05/04 and GNLM 05/2.5 ( CSA 2.5) Cable with FERRITE TECHNOLOGY** - A polymer material mixed with a considerable quantity of homogeneously fine high quality ferrite powder is extruded around the copper conductors. As a ferromagnetic material, it will go through hysteresis loops whenever it is under influence of an alternating magnetic field. Consecutively magnetizing and demagnetizing the material will cause considerable losses of high frequency energy.

This energy is absorbed in the ferrite grains and converted into heat. The GNLM cables which in addition to the above described ferrite technology is further protected with a foil shield and a drain wire and specifically manufactured for High End audio use. **Said by some to be the most neutral sounding audio ac mains cable on the market.**

Fitted with IEC (Martin Kayser) and MK Tough plug Cable can be supplied fitted to our all steel 4, 6 and 8 way distribution blocks. We can rewire the distribution blocks with Eupen cable as an extra cost option. Refer to our web site for details.

**AUDUSA - OOM Silverlink OCC balanced speaker cable** - stranded, silver on OFHC plus three strands of OCC (Ohno Continuous Casting - single crystal copper) for improved bass performance. Mylar infill and with designed in protection against RF and EMI. conductor of 3mm diameter (approx 8 gauge). Cable Overall Dimension: 14.72 mm.

### GNLM 05/2.5 (CSA2.5)

£48 for 1.0m, £58 for 1.5m, £68 for 2.0m. Off the reel £30 for 1st meter, £20 per m thereafter.

Eupen GNLM 05/2.5 (CSA 2.5) shown with Maringo IEC 320 will be fitted at extra cost.

### GNLM 05/04

£58 for 1.0m, £72 for 1.5m, £86 for 2.0m. Also available of the reel.

Both GNLM cables are available for export.

### SILVER SILVER - upgrade the cable with silver plated contacts on IEC and and MK plug for £6. AUDUSA

- Eupen and LAT AC-2 mains cable available with 16 amp IEC ( for certain models of amps by Krell, MF, Levinson etc), Maringo/Wattgate IEC 320, Figure of eight, Bulgin, Hubble, European Schuko, French, Australian, Swiss, Danish, Neutrik and other plugs see our web site for IEC's, MK plugs RCA and Banana connectors with silver plate contacts and other audio and ac mains connectors

## LAT International AC-2 AUDIO AC MAINS CABLE

We have developed a cabling (weaving) pattern along with an unusual shielding/filtering system that gets rid of the garbage that contaminates your components. The difference you hear with our cord is astounding. Our power cord takes advantage of silver in its design through use of our proprietary Silverfuse conductors. The conductors are 10 gauge and with PTFE, the best insulation available. Fitted as standard with IEC / MK Toughplug. . 60cm £62, 90cm £75, 1.2m £88, 1.5m £101, 1.8m £112 etc Other lengths available and off the reel. **4,6 and 8 way all steel mains distribution blocks fitted with UK, Schuko or USA sockets.** CE tested & approved mains distribution units manufactured of heavy gauge steel, finished in black and fitted with high quality 13amp sockets. It has no filters, circuit breakers, surge protection, transformers, resistors, capacitors, LED's, on/off switches, chokes, regulators, just fitted with 1m of AC-2 mains cable. From £166 for 4 way, £198, 6 way, £229 for 8 way.

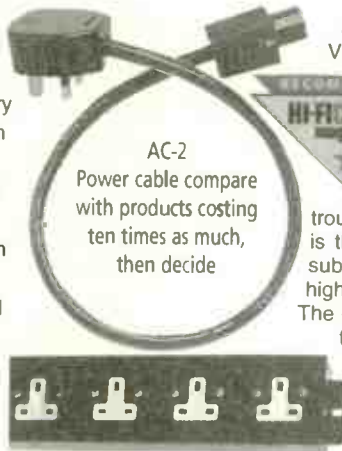

### SILVERFUSE

is a near alloy of silver and copper. IT IS NOT SILVER PLATED OR SILVER CLAD. Plating (or clad, which is the same thing as plating) causes a dioding effect when signal is passed through resulting in brightness and distortion. The Silverfuse process starts with seven nines OFHC copper wire with a diameter that is slightly larger than the required size. It is then pulled through a trough of molten silver. The wire with a silver deposit, is then forced through a compacting die where it is subject to tremendous pressure. The silver and the high purity copper are fused together into a near alloy. The compacting fusion also reduces the wire diameter to the desired size. No dioding subsequently occurs with this process. The result provides for the benefits of silver; which are excellent definition and clarity, with the high purity copper benefits of warmth and mellowness.

LAT INTERNATIONAL Inc USA - Analogue, Digital and Video interconnects and Speaker cable better than most others at double the price.

## SUNFIRE CORPORATION - Snohomish USA

**New for 2003 Sunfire Ultimate - world's most powerful home cinema Receiver. 7 x 200 watts, Cinema Seven power amps, 7 x 200 and 7 x 400 Signature True SubWoofers 13 inch cube True Sub MKIV 11 inch cube and Junior Sub Woofer 9 inch cube -all with two drivers, to as low as 16hz, 116 SPL and 360 cu ins of air movement, 1200 or 2700 watt patented amp technology. Solid state power amps 2 channel (2 x 300 and 2 x 600) and 5 channel (5 x 220 watts and 5 x 430 watts patented amp technology (no heat sinks), Classic tube preamp and Theatre Grand III processor preamp**

[www.audusa.com](http://www.audusa.com)

T: 020 8241 9826, 020 8264 0249 F: 020 8241 0999 E: [sales@audusa.com](mailto:sales@audusa.com)



**CD players DACs & Transports**

	Was	Now
Arcam FMJ CD23 Silver S/H	1200	699
Audio Research CD2 S/H	3499	1795
Audio Research CD3 x-demo	4999	4249
dCS Elgar 24/192 Non Firewire S/H	8500	3999
dCS Purcell Upsampler Non Firewire S/H	2999	1695
Krell KAV280CD x-demo	3999	3250
Mark Levinson No 360s x-demo	7495	4995
Musical Fidelity Pre 24 CP Player S/H	2000	1199
Naim CD2 Player S/H	1989	995
Theta Carmen CD/DVD Transport S/H	3499	1995
Theta Data Basic Transport S/H	2397	995
Theta Generation V Balanced S/H	6290	2799
Thule Sprit CD balanced O/P x-demo	1200	649
Wadia 830 CD Player S/H	3000	1995
Wadia 301 CD Player S/H	3650	2499

**Turntables Tonearms & Cartridges**

Densen DP0 2 MC Phono Stage S/H	499	275
Gryphon Legato SAP Phono Stage x-demo	7895	5999
Kuzma Stabi/Stogi S Turntable New& Boxed	1295	1099
Lehmann Audio Black Cube SE New& Boxed	650	449
Michell Gyro SE DC Turntable S/H	875	699
McCormack Phono Stage New and Boxed	650	399
Rega RB600 "origin live" Tonearm S/H	460	299
Roksan Artexerxes X MC/MM Phono Stage S/H	450	299
Roksan Cognoscenti Xerxes Piano lacquer /Tabrizi /Corus Black S/H	2700	799
Well Tempered Ref/Reference Arm "Fountainhead" S/H	6500	3999

**Preamplifiers**

Conrad Johnson Premier 16 " Mini Art" S/H	8000	3999
Electrocompaniet EC 4.7 Preamplifier x-demo	1295	995
Gryphon Sonata Allegro 2 box preamplifier x-demo	9739	5995
Naim Audio NAC62 (old style) with phono stage S/H	N/A	175
Naim 72 k Preamplifier S/H	789	349
Roksan L2 preamplifier S/H	1295	299
Spectral DMC12 Line New&Boxed	4250	2999
Spectral DMC12 s Phono x-demo	4750	3299

**Amplifiers**

Audio Research D100.2 x-demo	3690	2799
Cyrus Straightline Amplifier S/H	549	175
Denon AVC A10SE Amplifier Processor DTS/7.1 S/H	1800	999
Graaf GM100 Valve Power Amplifier x-demo	4500	3250
Gryphon S100 Class A power amplifier S/H	6000	2500
Gryphon Calisto 2200 integrated S/H	4800	3299
Linn LK140 power amplifier S/H	799	499
Naim Audio NAP140 (old Style) power amplifier S/H	N/A	299
Naim Audio NAP180 S/H	1199	599
Spectral DMA100s Power Amplifier x-demo	4750	3499

**Loudspeakers**

Avalon Eclipse Maple x-demo	9800	6995
Definitive Technologies 2002 Centre S/H	599	349
Indigo Model Two Centre Channel Cherry S/H	199	99
JM Lab Micro Utopia be Classic 6 months old S/H	4300	3399
Living Voice Avatars OBX-R Ebony x-demo	4000	2499
Martin Logan CLSII Anniversary Electrostatics 7 months Old S/H	6700	4995
ProAc Response 1SC Cherry S/H	1299	850
Sonus R4 Stands S/H	329	199
Verity Audio Fidelio Piano Lacquer x-demo	7995	4999

**Cables & Accessories**

Acoustic Zen Silver Signature Balanced 12ft S/H	2700	1499
Argento Copper 1m RCA-RCA new&boxed	199	119
Cardas Neutral Reference 1m RCA-BNC S/H	550	375
Cogan Hall EM-D 0.6m S/H	199	99
Finite Elemente HD02 MR 3 Tier Reference Table S/H	2300	1499
Madrigal CZ Gel 1.5m Balanced new&boxed	599	299
Madrigal MDC 1pro 1m AES/EBU		
Digital cable new&boxed	319	159
Madrigal MDC 2 1m Fatboy Digital cable new&boxed	319	159
Madrigal MDC 20.5m Fatboy Digital cable new&boxed	279	139

Nordost Red Dawn 2x3m Speaker cable S/H	920	599
Opera Lux 3 Tier Table Clear/Stainless x-Demo	950	449
Sitech SQ58G3 2x4m Balanced Interconnect x-demo	2370	1499
Sitech LS38G3 2x4.75m Silver speaker cable/WBT S/H	1752	999
Tara Labs RSC Air 0.6 Digital AES/EBU new&boxed	398	199
Transparent Music Link Ultra Balanced 7.26m S/H	2349	1499

**Tuners & Tape Decks, Power Supplies**

AKG C1000 Condenser Mic S/H	241	110
Magnum Dynalab FT-R Remote Switcher for FT101A/Etude (New&Boxed)	450	279

**Bargains Under £100**

Arcam Alpha II CD Player S/H	N/A	99
------------------------------	-----	----

Midland Audio X-change is looking for:-

Audio Research

Krell

Mark Levinson

Naim Audio

Dcs

Wadia

cash paid call John Roberts: 01562 731100

*Suppliers and installers of High Quality Audio Systems*

- 47 Laboratory
- Accuphase
- ATC
- Audio Physic
- Audio Research
- Avalon Accoustics
- Avid
- bel canto
- Benz Micro
- Cardas
- Clearaudio
- Conrad Johnson
- dCS
- Densen
- DNM/Reson
- Electrocompaniet
- Finite Elemente
- Graaf
- Gryphon
- J M Labs
- Krell
- Kuzma
- Lavardin
- Mark Levinson
- Martin Logan
- Michell
- Nagra
- Primare
- ProAc
- Rega
- Sitech
- Sonus Faber
- Spectral
- Nordost
- Sugden
- Transparent Audio
- Verity Audio
- Wadia

**MAX has moved..**

[www.midlandaudiox-change.co.uk](http://www.midlandaudiox-change.co.uk)

call John Roberts Tel 01562 731100

or Fax 01562 730228

The Old Chapel • Forge Lane • Belbroughton  
Worcestershire • DY9 9TD

e-mail [sales@midlandaudiox-change.co.uk](mailto:sales@midlandaudiox-change.co.uk)

Fax 01562 750246 Mobile 07721 605966



**01376 521132**  
**07802 483698**  
 CHELMSFORD, ESSEX  
 E-MAIL: [soundstage@netlineuk.net](mailto:soundstage@netlineuk.net)  
**BY APPOINTMENT ONLY**

**PRE-OWNED EQUIPMENT**

ARCAM ALPHA 75E CD PLAYER BOXED AND IMMACULATE	£249
ARCAM ALPHA 8 TUNER NO REMOTE AND MARKED HENCE	£149
ATC SCMS0A ACTIVE WALNUT WITH STANDS-BUYER COLLECTS-IMMACULATE	£3495
AUDIO INNOVATIONS SERIES 800 4-BOX VALVE PRE/POWER	£1495
CASTLE HARLECH CHERRY FLOORSTANDERS	£649
COUNTYPOINT SA100 POWER AMP VALVE/TRANS HYBRID BLACK BOXED	£649
CYRUS PRE PRE AMP NO REMOTE	£299
DEFINITIVE TECHNOLOGY PRO SUB 80	£249
DENON AVC-A11SR LATEST AV AMP BRAND NEW BOXED BLACK-NEW	£1700
DENON DVD1000 BLACK MULTI REGION DVD PLAYER AS NEW	£1295
DENON DVD300 BLACK AND SUPERB-CURRENT MODEL-£1000 NEW	£279
EPSON ES12 LIGHT CHERRY BOXED AND SUPERB	£595
KELF 104/2 ROSEWOOD + WALNUT CLASSIC FLOORSTANDERS EACH	£299
LFD PA2 POWERSTAGE POWER AMP MARBLE FRONT LOVELY LOOKS AND SOUND	£595
LINN SONDEK LP12 NORTON AIR POWER ITTOK TROIKA WALNUT SUPERB	£695
LOEWE ACONDA 32" FLAT WIDESCREEN SILVER + LOEWE GLASS STAND	£1295
M & K SS150 THX TRI-POLE SURROUND SPEAKERS-1300 NEW-BLACK	£1495
MARANTZ CD5000 GOLD BOXED AND IMMACULATE	£795
MERIDIAN A500 BLACK ASH LOUDSPEAKERS BOXED LOVELY CONDITION	£129
MERIDIAN 200 TRANSPORT + 209 PANEL REMOTE CONTROL-SUPERB	£399
MERIDIAN 605 MONO BLOCKS BLACK	£249
MICROMEGA STAGE 5 CD PLAYER BOXED AND IMMACULATE	£995
NAIM NAP 200 2002 MODEL BOXED AND IMMACULATE	£349
NAIM INTRO BLACK ASH BOXED AND SUPERB	£2795
NAIM AV2/NAP 175 2002 MODEL BOXED AND IMMACULATE	£179
NAKAMICHI BX-2 CASSETTE DECK JUST BACK FROM SERVICE	£795
ONIX OA35/OA1200 PRE/POWER AMP BLACK LOVELY	£995
ONIX OA35/OA801 x 2 PRE-MONOBLOCKS STUNNING	£595
PRIMARE D.20 24 BIT CD PLAYER	£249
REGA RADIO R REMOTE READY TUNER BLACK BOXED AND IMMACULATE	£299
REGA CURSA LINE LEVEL PRE AMP BLACK BOXED AND IMMACULATE	£299
REGA MAIA POWER AMP BLACK BOXED AND IMMACULATE	£449
REGA XEL WALNUT FLOORSTANDING LOUDSPEAKERS-OVER 1K NEW	£299
REGA JURA FLOORSTANDING LOUDSPEAKERS CHERRY	£299
REGA PLANET ORIG TOP LOADING CD PLAYER IN BLACK	£1295
ROKSAN DPI ATTESSA DA2 ATTESSA DS5 3-BOX TOP LOADING CD PLAYER	£995
ROKSAN XERXES ROSEWOOD TABRIZ ZI ORTOFON MC20 SUPREME	£2495
ROKSAN L1.5 DS1.5 S1.5 PRE/POWER SUPPLY/POWER AMP BLACK	£1595
ROKSAN XERXES BLACK ASH ARTEMIZ LYRA CLAVIS D.C. VDH MODDED	£349
RUARK SCRIPTURE NATURAL OAK BOXED AND MINT	£229
RUARK EPILOGUE YEW FINISH	£179
SONY SCX-X1670 SACD MINT BOXED JUST A FEW MONTHS OLD	£229
THORNS TD160 BLACK REGA RB250 GOLD DRING MM 1006	£599
TRIO KT917 TUNER SILVER HEAVYWEIGHT-SUPERB	£995
WADIA 3200 CD TRANSPORT WITH REMOTE AND INSTRUCTIONS	

PROFESSIONAL RECORD CLEANING SERVICE - KEITH MONKS MACHINE -  
 PLEASE RING FOR FURTHER DETAILS AND PRICES  
**THREE MONTH WARRANTY ON ALL ITEMS**  
[www.sound-stage.co.uk](http://www.sound-stage.co.uk)

**WILLIAMS HART**  
 ELECTRONICS

HART ELECTRONIC KITS TRADED FOR OVER 30 YEARS



Mosfet Monoblock Power Amp Kits

ONE OF THE BEST AMPLIFIERS YOU WILL HEAR! Regardless of price  
 REVIEWED IN HI-FI NEWS AS "...EXCEPTIONAL...  
 SELF EVIDENTLY CORRECT



Single Ended Class A Valve Sound  
 15Watt Power Amp modules

FOR THOSE WHO WANT THAT VALVE  
 MIDBAND BUT BASS AND TREBLE TO MATCH



ACTIVE R/Control SUBWOOFER MODULE £177.30



Speakers Designed & Built to Order

Advertise your Hi-Fi on my website (FREE)

Also, Award Winning Phono Stage Kit, Active Crossover Modules, Speaker Drive Units,  
 M Cap Capacitors, Caddock Resistors, Remote Control Volume and much more.

WEB SITE: [www.williamshart.com](http://www.williamshart.com) e-mail: [sales@williamshart.com](mailto:sales@williamshart.com)

Tyn-Y-Coed, Lidiardau, Bala, Gwynedd, LL23 7SG Tel/Fax for catalogue 01478 520757.

PERSONAL VISITORS SHOULD PHONE FIRST TO AVOID DISAPPOINTMENT

Run by former Technical Director of Wilmshlow Audio

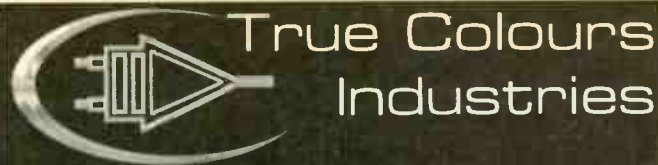

True Colours  
 Industries

Five Star Products  
 from Hi-Fi to Home Cinema



TCI Cobra  
**WHAT HI-FI**  
 ★★★★★

TCI Adder  
 Component  
 ★★★★★  
 Home Cinema  
 Choice



HI-FI INTERCONNECTS

CUSTOM VIDEO LEADS

MAINS POWER LEADS

SPEAKER CABLES

New Catalogue  
 Available Now

AVAILABLE From

- Anglia Audio  
Tel. 013 5927 0212
- Audio T (Brentwood)  
Tel. 012 7726 4730
- Audio T (Epsom)  
Tel. 013 7274 8888
- Audio T (High Wycombe)  
Tel. 014 9455 8585
- Doug Brady Hi-Fi  
Tel. 019 2582 8009
- Eastern Audio  
Tel. 014 7321 7217
- Hi-Fi Studios  
Tel. 013 0272 5550
- Kronos Hi-Fi  
Tel. 028 8775 3606
- Lyric Hi-Fi  
Tel. 028 9038 1296
- Thame Audio  
Tel. 018 4421 5431
- The Listening Rooms  
Tel. 020 7244 7759
- The Right Note  
Tel. 012 2587 4728
- Walrus Systems  
Tel. 020 7724 7224

And other good HI-FI Dealers

True Colours Industries  
 Unit 17  
 Lisburn Enterprise Centre  
 Ballinderry Road  
 Lisburn  
 BT28 2SA  
 Tel 077 1019 6949  
 Fax 087 0120 5923  
 Email [support@true-colours.com](mailto:support@true-colours.com)

Music Without Compromise,  
 Cables without Equal

[WWW.TRUE-COLOURS.COM](http://WWW.TRUE-COLOURS.COM)





# SUSSEX SURPLUS

Oak Farm, Goose Green Lane, Thakeham, West Sussex, RH20 2LW

Telephone: 01798 817496 Fax: 01798 817560

ECC81 MULLARD	£8	SR4GY STC	£25	2UF 600V DUB	£8	<b>TRANSFORMERS</b>	GRESHAM O/F	PARMEKO O/F
ECC82 MULLARD	£22	511E12 STC	£20	2UF 1000V TCC	£12	PARMEKO O/F	PRIMARY 200-250 50CS SCRNM	PRIMARY 200-250 50CS SCRNM
ECC83 MULLARD	£35	0443 GEC	£15			PRIMARY 115-230 50CS SCRNM	SECONDARYS	SECONDARYS
H8162 MULLARD	£8	4080 USA	£10	<b>AXIAL CAPACITORS</b>		SECONDARYS	400-350-0-350-400 150MA	450-400-0-400-450 250MA
H8136 MULLARD	£18	6166 USA	£30	25UF 500V DUB O/F	£10	380-0-380 176MA FWR	400-350-0-350-400 250MA	COM: 4-6.3-4A (x2)
H8137 MULLARD	£42	6166 STC	£45	.5UF 1000V DUB O/F	£10	150-0-150 7MA FWR		COM: 4-5-3A
6V66 BRIMAR UK	£22	5881 USA	£35	.1UF 500V TCC O/F	£6	3.2-0-3.2 3A (x2)		COM: 4-6.3-3A
6V66 USA	£15	5881 RUSSIAN	£35	.25 UF 500V TCC O/F	£6	6.4V 2.3A (x2)	PARMEKO O/F	
ECC31 MULLARD	£35	4033L STC	£125	.1UF 1500V TCC O/F	£6	3.2-0-3.2 1.2A	PRIMARY 115-230 50CS SCRNM	
ECC32 MULLARD	£100	12A07 BRIMAR	£12	8UF 500V HUNTS	£4		SECONDARYS	GARDENERS POTTED
ECC33 MULLARD	£45	G232 PHILIPS	£25	0.1UF 350V TCC O/F	£5	GRESHAM O/F	450-400-350-0-350-400-450	PRIMARY 115-230 50CS SCRNM
ECC34 MULLARD	£40	L57 GEC	£60	0.01UF 1000V TCC O/F	£3	PRIMARY 115-230 50CS SCRNM	380MA DC (CH)	SECONDARYS
ECC35 MULLARD	£40	6550AGE USA	£35	0.25UF 500V PLESSEY	£5	SECONDARYS	240MA DC (CO)	350-300-0-300-350 100MA
EZ80 MULLARD	£10	504GB RCA	£20	0.5UF 350V TCC O/F	£5	500-450-0-450-500 240MA		6.3 1A 6.3 3A
EZ81 MULLARD	£13	G233 MULLARD	£30	1.7UF 1000V SPRAUGE	£5		PARMEKO O/F	0.5-6.3 2A
EZ81 BRIMAR	£12	0ET25 GEC	£125	1UF 400V ICW POLY	£3	GRESHAM O/F	PRIMARY 200-250 50CS SCRNM	GARDENERS POTTED
EZ80 BRIMAR	£9	EL84 MULLARD	£10	.68UF 400V ICW POLY	£3	PRIMARY 115-230 50CS SCRNM	SECONDARYS	PRIMARY 115-230 50CS SCRNM
ECL86 TESA	£10	5B255M STC	£15	0.1UF 2000V EIRIE O/F	£10	SECONDARYS	350-300-0-300-350 120MA	SECONDARYS
KT66 CLEAR GEC	£70	5B254M STC	£15	0.22UF 630V WIMA	£3	350-0-350 200MA	COM: 4-6.3-3A	350-0-350 70MA
KT66 GREY GEC	£85	6P25 MAZDA	£10	1UF 400V WIMA	£2	0-250 400MA	COM: 4-5-3A	3.15-0-3.15 3.5A
KT66 SHOULDERED GEC	£130	163 GEC	£15	0.22UF 400V MULLARD	£3	0-6.3 3A 0-5 3A	COM: 4-6.3-4A	700 10 MA
KT61 GEC	£30	2116E USA	£125			0-6.3 2A		
KT88 GEC	£160	EL86 MULLARD	£10	<b>CHOKES</b>		£60	PARMEKO O/F	PARMEKO O/F
GZ30 MULLARD	£10	EF184 BRIMAR	£5	20H 120MA PARM O/F	£50		PRIMARY 200-250 50CS SCRNM	PARMEKO O/F
GZ34 MULLARD	£45	807 USA	£10	10H 250MA PARM O/F	£50	PLESSEY O/F	SECONDARYS	PRIMARY 200-250 50CS SCRNM
GZ32 MULLARD	£35			10H 150MA PARM O/F	£40	PRIMARY 115-230 50CS SCRNM	SECONDARYS	SECONDARYS
GZ37 MULLARD	£35	<b>BLOCK PAPER CAPACITORS</b>		10H 120MA PARM O/F	£40	SECONDARYS	450-400-0-400-450 120MA	COM: 4-5-6.3-3A (x2)
GZ37 COSSOR	£50	0.25UF 1000V TCC	£15	5 H 500MA PARM O/F	£50	365-0-365 215MA	COM: 4-5-3A	
ECC88 PHILIPS	£15	0.1UF 3000V DUB	£20	5 H 250MA PARM O/F	£40	57-0-57 60MA	COM: 4-6.3-3A	
EB8CC MULLARD	£30	0.25UF 1700V TCC	£20	5 H 180MA PARM O/F	£40	6.5 3A 6.5 3A 6.5 2A	COM: 4-6.3-5A	
CEASIE MENIS	£40	0.1UF 5000V DUB	£20	5 H 100MA PARM O/F	£35	6.5 400MA		
EF37A MULLARD	£15	1UF 1500V TCC	£20	50H 50MA PARM O/F	£50	PARMEKO O/F	PRIMARY 115-230 50CS SCRNM	SECONDARYS
EF86 MULLARD	£25	0.5UF 1000V TCC	£15	2 H 300MA PLESSEY O/F	£20	SECONDARYS	150-0-150 89MA	PARMEKO O/F
EL34 MULLARD	£80	8UF 200V TCC	£10	6 H 250MA PLESSEY O/F	£35	275-0-275 40MA		PRIMARY 115-230 50CS SCRNM
EL37 MULLARD	£80	0.5UF+0.25UF 350V	£7	16H 30MA PLESSEY O/F	£30	6.4 600MA 6.5 2A	PARMEKO O/F	SECONDARYS
EL156 TELEFUNKEN	£175	12UF 350V DUB	£12	45H 5MA PLESSEY O/F	£20		PARMEKO O/F	COM: 4-5-6.3 3A
U178/20 GEC	£30	8UF 600V DUB	£15	10H 120MA VARNISHED	£30	PARMEKO O/F	PRIMARY 115-230 50CS SCRNM	COM: 4-5-3A
FW4-500 MULLARD	£20	8UF 1000V DUB	£20	5 H 250MA VARNISHED	£30	SECONDARYS	150-0-150 89MA	COM: 4-6.3 3A (x2)
ML4 GEC	£25	0.5UF 800V TCC	£15	10H 150MA VARNISHED	£45	PARMEKO O/F	PRIMARY 115-230 50CS SCRNM	SECONDARYS
ML6 GEC	£25	1UF 1500V DUB	£18	10H 75MA VARNISHED	£20	SECONDARYS	400-350-0-350-400 60MA	0-2.5-5-6.3 2A (x4)
65A7 BRIMAR	£30	1UF 600V DUB	£8	10H 150MA VARNISHED	£30	6.4 1.5A		
65A7 USA	£20	4UF 600V TCC	£12	10H 150MA VARNISHED	£30			
12AX7 WAGE	£25	1UF 600V DUB	£10	16H 120MA VARNISHED	£30			
EZ90 MULLARD	£12	4UF 800V DUB	£15	50H 25MA POTTED	£45			
6X4 GEC	£70	4UF 1000V DUB	£18	15H 120MA POTTED	£40			
504G GEC	£70	4UF 1500V TCC	£20					

P&P £5 PER ORDER TRANSFORMERS AND OVERSEAS POSTAGE AT COST  
ALL ITEMS SUBJECT TO AVAILABILITY

## Connoisseur Audio

VISA

CALL FOR GREAT DEALS ON 'EX-DEM' AND 'B' STOCK ITEMS!

Choose From:

AUDIO ANALOGUE \* AUDIO PHYSIC \* CROFT BLUENOTE \* DIAPASON \*  
DYNAVECTOR \* EAR \* FINAL \* GRAAF \* LYRA \* OPERA \* PATHOS ACOUSTICS  
STAX \* SUMIKO \* TRIANGLE \* UNISON RESEARCH \* AUDUSA \* ANALYSIS PLUS  
ECOSSE \* KEMP ELEKTRONICS \* PS AUDIO \* AUDIOPAX  
MANLEY LABS \* CLEARLIGHT \* ASPEKT RDC \* PERPETUAL TECHNOLOGIES

\*\*\*\*\* OUR GUARANTEE \*\*\*\*\*

- TO BEAT ANY GENUINE PART EXCHANGE OFFER YOU HAVE BEEN MADE
  - 2 YEAR WARRANTY ON ALL NEW EQUIPMENT
  - 6 MONTH WARRANTY ON ALL PRE-OWNED EQUIPMENT
  - CUSTOMER CARE- BEFORE & AFTER YOU BUY

[www.connoisseuraudio.co.uk](http://www.connoisseuraudio.co.uk)

Tel: 0845-166-1249

[info@connoisseuraudio.co.uk](mailto:info@connoisseuraudio.co.uk)

MAXIMISE YOUR PREVIOUS INVESTMENT WITH OUR UNBEATABLE PART EXCHANGES

# Oxford Audio Consultants Ltd.

OUR SUPERB SERVICE IS THE SAME REGARDLESS OF PRICE



## Now Demonstrating



Ex-Demonstration & Previously Owned Equipment

### SALE LIST

Audio Analogue Paganini CD Player	£595	SH
Roksan Caspian 5 channel power amp	£695	SH
Vienna Acoustics Mahlers	£3000	SH
Marantz RC5200 remote control	£250	SH
Tag McLaren AV32R bp192 processor silver	£1795	SH
Naim NAP300 ex dem	£3750	XD
Musical Fidelity Trivista CD mint	£2995	SH
Audio Analogue Maestro amplifier	£1795	SH
Krell 300i amplifier	£1395	SH
Audio Analogue Maestro CD	£895	SH
Martin Logan SL3 speakers	£1795	SH
NAIM CD5 CD Player ex dem	£950	XD
NAIM NAIT 5	£650	XD
GM Audio BCD table half price	£675	XD
Conrad Johnson PV10B preamp	£P.O.A.	
Naim NAP500 power amp	£9250	XD
Krell FPB200 power amp	£3995	SH
Audio Physic Calderas	£P.O.A.	SH
Transparent Reference XL 20ft bal interconnect	£4750	SH
Krell KAV300iL	£2295	SH
Sim 2 HT300 projector ex dem	£5995	XD
Krell FPB200c power amp	£4995	SH
Martin Logan CLS11z mint	£P.O.A.	
Tag McLaren T32 tuner with DAB module	£1495	XD
Tag McLaren DVD32R DVD Player ex dem	£2995	XD
Denon DV5000 DVD Player	£ 695	SH
Onkyo TX DS 989 AV amplifier	£1295	SH
Krell FPB600	£6495	SH
Wilson System 6.1 Ferrari Grey	£9995	SH
Krell 250p preamplifier	£995	SH
dCS Delius	£2500	SH
Martin Logan Aeon ex dem	£2295	XD
Graaf 13.5 preamplifier	£1695	SH
Onkyo Integra system - our dem models	£5995	XD
Veritas P400 Power Amplifier as new	£1995	XD

SH - Second Hand XD - EX Demonstration

0% interest free credit

Licensed Credit Broker

REFER TO OUR WEBSITE FOR THE LATEST UPDATED SALE LIST.

Agencies include: Acoustic Energy, Alphason, Atacama, Audio Analegus, Aiff, Research, Beyer, BOSE, Castle, Chord Company, Copland, Crenson, Denon, Diapason, Dwin Electronics, Fujitsu, GM Audio, Heiling, Graaf, Integra Systems, IXDE, Jado, Jarno, Kef, Koetsu, Krell, Leston, Living Control, Loewe TV/Video, Linn Klipsch, Lyra, Marantz, Martin Logan, Michels, Musical Fidelity, NAD, Naim, NEC Gas Plasma Screens, Nakamichi, Nordost, Onkyo, Opera, Ortofon, Parasound, Pioneer, ProAc, Project Turntables, QED Multiroam, Quad, Quadraspire, REL Subwoofers, Sennheiser, Sharp LCD TVs, SME, Sonus Faber, Sonus Systems, Soundstyle, Stands Unique, Star, Stewart Screens, Tag McLaren, Tannoy, Teac, Theta, Transparent Union Research, Van den Hul, Vibe Acoustics subwoofers, Videologic, Vienna Acoustics, Wilson, Yamaha

TAX-FREE EXPORT SERVICE  
MAIL-ORDER AVAILABLE ON MANY ITEMS

Cantay House, Park End Street  
Oxford OX1 1JD

Telephone: Oxford (01865) 790879

Facsimile: Oxford (01865) 791665

E-MAIL: oxford.audio@btinternet.com

WEBSITE: www.oxfordaudio.co.uk



V.A.T. No.  
729580013



QUALITY USED  
EQUIPMENT,  
BOUGHT, SOLD,  
PART EXCHANGE

TEL/FAX  
0121 747 4246



URGENTLY REQUIRED  
LINN, NAIM,  
MERIDIAN, QUAD,  
CASH WAITING

	RRP	NOW £
ADVANTAGE A300 POWERAMP	2600	995
ADVANTAGE SI CD	3150	1995
ALOIA PST11 OI WITH PHONO	2765	1395
ATC 20ASL TOWER ACTIVE ROSEWOOD	5600	2495
AUDIO RESEARCH D130	2000	995
AUDIO RESEARCH VT130 SE	8500	2995
AVANTEGARDE SOLO SILVER	4700	2395
BALANCED AUDIO TECHNOLOGIES 6200/6 CHANNEL NEW	9450	5795
BALANCED AUDIO TECHNOLOGIES 300X	4000	2495
B & W 805 NAUTILUS CHERRY	1500	895
BEL CANTO EVO2	3000	1995
BOULDER 1012 PRE DAC PHONO	12995	7995
BOULDER 1060 POWER	16500	10995
BURMESTER 001 CD	9500	4995
BURMESTER 956 MK 3	6500	3795
CHORD CPA 3200 E	4800	2495
CLEARAUDIO REFERENCE, TQ1 ARM	6020	3995
CLEARAUDIO SINATURE M/C LOW HOURS	1755	895
CLEARAUDIO SIXSTREAM 1.5 MTR PHONO CABLE	505	295
CLEARAUDIO MAXIMUM SOLUTION, TQ1 LINEAR ARM	7575	4795
CLEARAUDIO STYLUS GAUGE	300	175
CLEAR AUDIO STROBE KIT	100	65
CLEARAUDIO MAJIX 4 AVAILABLE	175	95
CONRAD JOHNSON EV1 VALVE PHONO	1700	995
COPLAND CSA 14	1500	695
DYNAVECTOR L200	1500	995
DYNAVECTOR HX75	2300	1495
EAR V20	2995	1995
GAMUT D200	3995	1995
HOVLAND HP-100 + M/C PHONO	5750	3995
HOVLAND SAPHIRE POWER AMP	7000	4495
HOVLAND RADIA	7995	5995
JM LABS MICRO UTOPIA + STANDS	3500	1795
KRELL KPS 28C	9000	5995
KRELL KAV 300IL	3698	2495
KRELL KAV 300 I	3000	1295
LAVARDIN IS REFERENCE	2295	1495
LUXMAN K-351 CASSETTE DECK	N/A	195
LINN KOLEKTOR PRE	550	350
LINN CLASSIK MOVIE SILVER NEW SEALED BOX	2000	1295
MARANTZ SC12SI SACD DVD CD EX DEM	3500	2295
MARANTZ CD17 KI SIG MK11 GOLD	1200	595
MARK LEVINSON NO36 DAC	4000	1495
MERIDIAN 562 WITH PHONO BOARDS	900	395
MERIDIAN 518	900	450
MERIDIAN 507	200	795
MICHELL QC P/S	440	250
MUSICAL SURROUNDINGS PHONOMENA WITH BATTERY P/S	1200	695
NAIM HICAP	N/A	295
NAIM 32.5 72 UPGRADES	N/A	95
NAIM CDX	2500	1495
NAIM CDX2	2650	1895
NAIM 250	1800	1095
NAIM 102	1200	695
NAIM NAPSC	225	150
NAIM FLATCAP 2	500	350
NAIM 180	1220	695
NAIM 140	750	395
NAIM 62 MM PHONO OLIVE CASE	400	150
NAIM 72	N/A	295
NORDOST SPM REF I MTR RCA	900	495
ORACLE CD TRANSPORT SPECIAL EDITION	9500	3995
PASS ALEPH P REMOTE	4750	1495
PROAC TABLET REF 8 CHERRY	750	450
QUAD 989 ANTIQUE NEW	5000	3795
SOLILOQUY S10 SUB ROSEWOOD	1600	595
SOUNDLAB MILLENNIUM 3 NEW	8295	4995
SPECTRAL DMC10 PRE	2000	595
SPECTRAL MIT 330 I MTR INTERCONNECT	500	295
SPECTRAL MIT 350 MK 1 I MTR INTERCONNECT	1200	495
SPECTRAL 770 MK1 2X 10 FT SPEAKER CABLE	3000	995
SUGDEN MASTERCLASS POWER AMP	3300	2195
TAG McLAREN DVD32 FLR SILVER	3495	995
TAG McLAREN CD20R	1250	695
TARGET R4 STANDS	450	250
TEAC T1 TRANSPORT	650	295
THETA PROGENY	1100	395

OPEN MON-SUN 10.00 TO 8.00  
Website: www.centralaudio.co.uk  
E-mail: tony@centralaudio.co.uk

ALSO AGENTS FOR

Advantage, Balanced audio technologies, Boulder, Burmester, Egleston, Hovland, Kharma, Lumley, Pass labs, Sound lab, VTL.

HEATHERDALE PRE-OWNED GUARANTEED EQUIPMENT EXPORT FACILITIES AVAILABLE

**SPEAKERS**

Wharfedale Diamond III Speakers £90  
B+W DM4 Speakers in Rosenut £995  
Martin Logan Odyssey Speakers £5450  
Tannoy Arden Loudspeakers £395  
Harbeth LS12A Monitors £395  
Eltax Floor Standing Liberty 5+ Speakers £140  
Revel Salon Speakers Ex Demo Black Gloss Rosewood Side Panels (C15995) on offer for £3995  
Revel Studio Speakers Ex Demo Black Gloss Rosewood Side Panels (C10495) on offer for £3995  
Teac LS-X7 Satellite Speakers £50  
Orchid LWO Speakers Ex Demo £2495  
Epos ES12 Speakers £375  
B+W COM1 Speakers £350  
B+W matrix 1 Speakers £295  
Mirage M3 S1 Speakers £1495  
Mission 782 (Stand Mount Model) (Black Ash) Just Reduced From £250 £395  
Audio Physics Tempo speaker £190  
Revel Revel LE1 Sub Amp Plus 2 Sub 15's £995  
Eltax Symphony floor standing speakers £99  
Orchid PLL1 Speakers x demo £3495

**PRE AMPS**

Conrad Johnson PV14L Pre Amp £1595  
Naim Nac 92 Pre Amp £350  
Exposure 11 & 12 Pre Amp & Power Supply Just Reduced from £900 £650  
Adcom GTP 450 Tuner/Pre-Amp £350

**AMPLIFIERS**

Mark Levinson 383 Int Amp £4495  
Conrad Johnson MF2500A Amplifier £1595  
Boulder 102 AE Power Amp £1595  
Mark Levinson Ref 33 Mono Blocks Ex Demo £17995  
Chord 1200 Mono Blocks £2995  
Krell KSA 50s Power Amp £2195  
Lentek Integrated Amp rare classic £495  
Meridian 605 Mono Blocks £395  
Musical Fidelity P190 Power Amps With MF3a Pre Amp & PSU £395  
Naim NAP 903 power amp £695  
Revel LE1 Sub Amp Plus 2 Sub 15's £5995  
Audionote Nereo Mono amps £5995  
Nakamichi PA 5 Status Power Amp Cost New £1150 £395  
Adcom GFA 5300 Power Amp £350

**CD PLAYERS & TRANSPORT**

Classe CD GTP5 (HDCD) £995  
Mark Levinson 37 Cd Transport £2750

**MISCELLANEOUS**

Nakamichi Dragon Superb Condition £1200  
Audio Note (Kondo) KSI-AK2 Mains Cable (new & boxed) 1mtr £350  
Audio Note (Kondo) 2mtr pair interconnect £1650  
Shunyata Ex Demo 1m Aries rca interconnects with locking connectors normal retail £350 our price £425  
Shunyata Ex Demo 1.5 Aries rca interconnects with locking connectors normal retail £300 our price £495  
Shunyata ex Demo 3m Lyra Speaker C/W Spades with locking connectors normal retail £1500 our price £995  
Transparent 1.5 mtr digital interconnect £195

Pioneer Elite DVD/CD/Video Cd player, Region 1 DVD £895  
Yamaha DVD Player S795 £145  
Nakamichi Tr-Tracer 1000 Cassette Deck £395  
Nakamichi 680 3 Head Cassette Deck £395  
Sansui TU-D99X Tuner £55  
Madrigal C2 Gek 1mtr Balanced Interconnect £275  
Stax 40/40 Headphones £850  
1mtr Kondo Ksi Lp Interconnect (Normal Price £2000) £995  
Yamaha CI-810 Am/Fm Tuner £125  
Nakamichi b2z cassette deck £195  
5 mtr hovland bi-wire speaker cable £395  
Stax S8007 omega ref (SR117 head phone & SRM007 dual trope) Normal Retail £2995 £1995  
Audionote (kondo) 3mtr pair SP2 speaker cable £1995  
Audio Note (kondo) ksil-LP Silver Iitz interconnect 1 mtr pair £850

**TURNABLES, CARTRIDGES & TONEARMS**

Audio Note ANS7 Transformer £2995  
Koetsu Urushi Gold Unused BARGAIN £700  
Koetsu Red Unused BARGAIN £700  
Michell gyrodeck with dc power supply £995  
Lumley sphere turntable (gold plated) with dedicated stand & large power supply £2995  
Verder Ebony Wood arm board Normal Retail £800 £425  
Ortofon Jubilee Cartridge £995

**DACS**

Mark Levinson 365 Dac £1995  
Krell Studio Dac £350  
CEC DX51 MK2 DAC with CEC TL51 Transport NEW £2295  
CEC DX71 MK2 DAC NEW £1595

ALL USED CARTRIDGES ARE CHECKED UNDER A MICROSCOPE BEFORE BEING OFFERED FOR SALE.

VISA - SWITCH - MASTER CARD - AMEX - DINERS CLUB WELCOME.  
WE TAKE PART EXCHANGE ON NEW & USED STOCK and buy in for cash

## HADCOCK GH242 & GH228 TONE ARMS

For the finest sound with any cartridge



**G.F.C HADCOCK**  
Audio Division

Langley House Highwood Road Uttoxeter Staffs ST14 8BQ  
Tel/Fax 01889 569166

## AVI PLUS AVON

I referred last time to the superb little Alon Napoleon speakers which with their Thunderbolt subwoofer make a great full range speaker setup for £2.4k. Add the AVI laboratory integrated amp (£1400) and matching CD player (£1200), and few systems will match it. Obviously the various AVI speakers will also sound great, but they don't have a subwoofer and will be more difficult to match. However if you want to hear the difference do ring for a unique demo.

### SALE OF EX-DEMO/P.E. EQUIPMENT

ATC 20SL (PERFECT) + STANDS	£1300
ATC SCM50 SL PASSIVE (EX DEMO BLACK)	£2500
ATC SCM50 SL PASSIVE (AS NEW - ROSEWOOD)	£3000
AVI PRE + 2 MONOBLOCKS	£1400
INFINITY PRELUDE MTS SPEAKERS (£8K)	£6500
ALON LOTUS ELITE (NEW) (£4.4K)	£3500
(TO MAKE WAY FOR SIGNATURE)	
ESLAB DX-S4 DIGITAL POWER AMP (£2.5K GOLD)	£1200
ALON LOTUS (FOR VALVE AMPS) SPEAKERS	£1200
RUARK SOLSTICE SPEAKERS (OAK-£4K+)	£2000
ELECTROCOMPANET EC4.7 PRE + AW60 POWER	£1800
IAS BEAULIEU SPEAKERS (BEST WITH VALVE AMPS)	
3 WAY LARGE SPEAKERS	£500
ATC SCM 10's (WALNUT) + ATC STANDS	£600
BEARD 30 W/CH 2 BOX INTEGRATED VALVE AMP (MODEL BB101)	£1000
LINN SONDEK LP12 MISSION MECHANIC ARM/KIESICKI BLUE DC MOTOR	£1800

**V'audio** HI-FI Consultants

36 Druid Hill, Stoke Bishop, Bristol BS9 1EJ  
Tel/Fax 0117 968 6005

## IAN HARRISON HI-FI TEL: 01283 702875

HIFI AT DISCOUNT PRICES. FREE NATIONWIDE DELIVERY

### MASSIVE SALE!

TRADE IN YOUR OLD MOVING COIL CARTRIDGE & SAVE UP TO 60% OFF THE RRP.

CARTRIDGES & STYL	HIFI FURNITURE	HEADPHONES	DVD
DENON	CUSTOM DESIGN	BEYER	SONY
SHURE	OPTIMUM	STAX	MINI DISC
AUDIO TECHNICA	ASH DESIGN	SENNHEISER	SONY
GOLDRING	APOLLO	SONY	LOUDSPEAKERS
SUMIKO	SOUND STYLE	AKG	OPERA
TRANS-	SOUND	GRADO	TRIANGLE
FIGURATION	ORGANISATION	AUDIO-	FINAL
LONDON (DECCA)	ALPHASON	TECHNICA	ELAC
GRADO	CABLES	DAT	HARBETH
ORTOFON	BLACK RHODIUM	TASCAM	EPOS
RESON	TRANSPARENT	SONY	ORELLE
CLEAR AUDIO	QED	CASSETTE DECKS	AMPLIFIERS
KOETSU	ORTOFON	PIONEER	CREEK
SHUN MOOK	NORDOST	SONY	HALCRO
TONEARMS	ARGENTO	TUNERS	MOTH
GRAHAM	AUDIO	DENON	C.A.T.
MOTH	SUPRA	SONY	GAMUT
CLEAR AUDIO	WIREWORLD	CREEK	ALOIA
HADCOCK	CD PLAYERS	PHONO STAGES	EAR
MICHELL	MONRIO	TRICHORD	AUDIO VALVE
TURNABLES	GAMUT	MOTH	ACCUSTIC ARTS
GOLDRING	SONY	CREEK	GRAAF
MICHELL	CREEK	NAD	ORELLE
CLEAR AUDIO	CREEK	EAR	MONRIO
	ORELLE	TOM EVANS	AUDIO ANALOGUE
		CLEAR AUDIO	PATHOS -
			ACOUSTICS
			UNISON -
			RESEARCH

PLEASE PHONE TO CONFIRM PRICE & AVAILABILITY PRIOR TO ORDERING.  
ALL GOODS ARE BRAND NEW & BOXED WITH FULL U.K. GUARANTEES.  
NO EX. DEM OR EX DISPLAY GOODS. NO GREY IMPORTS. GOODS ARE NOT  
SUPPLIED ON APPROVAL. SOURCE: NO GENERAL CATALOGUES. PLEASE PHONE  
OR WRITE FOR SPECIFIC REVIEWS, BROCHURES OR PRICES.  
SUPPLIER OF HIFI PRODUCTS & ACCESSORIES SINCE 1986  
MAIL ORDER ONLY FROM: IAN HARRISON, 7 MILL HILL, REPTON,  
DERBY, DE65 6GQ. TEL: 01283 702875. 9am - 9pm INCLUDING SUNDAYS.

# diverse vinyl

10 charles st newport south wales np20 1ju  
01633 259661/256261 sales@diversevinyl.com

## NEW ON DIVERSE RECORDS

Dolly Varden - Dumbest Magnets £16.90

### NEW RELEASES

Aimee Mann	Lost In Space (Mob Fid)	£TBC
Caravan	Unauthorized Breakfast	£15.90
Einar Orn	Bank (Double 10")	£10.90
Electrelane	The Power Out	£13.90
Franz Ferdinand	Franz Ferdinand	£13.90
Joss Stone	The Soul Sessions	£15.90
Lambchop	Aw C'Mon/No You C'Mon	£16.90
Mountain Goats	We Shall All Be Healed	£13.90
Oneida	Secret Wars	£11.90
Red Hot Chili Peppers	Greatest Hits	£29.90
Scissor Sisters	Scissor Sisters	£12.90
Sia (Zero 7)	Colour The Small One	£15.90
Snow Patrol	Final Straw	£12.90
Stereolab	Margarine Eclipse	£15.90
Terry Hall & Mushtaq	The Hour Of Two Lights	£13.90
Various	Talkin Loud 1990 - 1994	£17.90
Von Bondies	Pawn Shop Heart	£15.90

### ALBUM OF THE MONTH

NORAH JONES "Feels Like Home" £18.90

Ltd vinyl pressing from EMI

### NEW REISSUES:

Aaron Neville	Warm Your Heart (Classic)	£TBC
Birmingham Sunday	A Message From (Akarma)	£15.90
Bob Dylan	Bob Dylan (Sundazed Mono)	£16.90
C,S,N,Y	Déjà vu (Classic Records)	£26.90
Cedric Im Brooks	And The Light Of Saba	£13.90
Duke Ellington	1st Time (Count Meets Duke)	£TBC
Fred Neil	Everybody's Talkin	£10.90
Henry Mancini	Music From Peter Gunn	£19.90
Isaac Hayes	Hot Buttered Soul	£TBC
John Lennon	Imagine (Mobile Fidelity)	£TBC
Jonathan Richmon	Best Of Modern Lovers	£17.90
Locomotive	We Are Everything You See	£15.90
Peter Gabriel	Plays Live (Classic Records)	£TBC
Pretty Things	SF Sorrow	£15.90
Yardbirds	Live Blues Wailing (1964)	£16.90

## JAPANESE BEATLES LPs - NOW IN STOCK

16LPs in total £25 each (doubles £35) very limited!

## DISCO ANTI STAT LP CLEANER

Probably the most economical LP cleaning device on the market

Only £41.95

Call for details

Call for a catalogue of over 3500

brand new LPs, or visit



[www.diversevinyl.com](http://www.diversevinyl.com)



## SALE LIST

	PRICE NEW	SALE PRICE	
KRELL KAV 500i Int Amp	£4,995.00	£2,295.00	D
CYRUS DVD7	£1,000.00	£599.00	D
CYRUS 5 AMPLIFIER	£500.00	£329.00	D + N
CYRUS 7 AMP	£700.00	£479.00	D + N
CYRUS AV MASTER - PROCESSOR		£100.00	D
AUDIO RESEARCH LS16 PRE AMP - BLK	£3,500.00	£2,195.00	D
ARCAM DV88 DVD PLAYER	£1,000.00	£679.00	D + N
ARCAM DIVA A75 AMP	£470.00	£309.00	N
ARCAM ALPHA 7R AMP	£280.00	£189.00	D
ARCAM FMJ A22 Inc DAVE AC3/DTS processor	£1,850.00	£999.00	N
TAG MCLAREN DPA32R (Digital pre inc DAB)	£1,990.00	£1,189.00	D
TAG MCLAREN 5R - 5 CHANNEL POWER AMP	£2,995.00	£1,799.00	D
MARTIN LOGAN AEON	£3,148.00	£2,195.00	D
MARTIN LOGAN SCENARIO	£2,498.00	£1,629.00	D
CELESTION C1 - Compact speakers	£199.00	£114.00	D
CELESTION - C2 - Floorstanders	£499.00	£299.00	D
LINN MAJIK - INT AMP	£650.00	£399.00	D
LINN KAIRN - PRE AMP	£1,400.00	£595.00	D
LINN 5140 - FLOORSTANDERS approx.	£2,400.00	£799.00	D
LINN KABERS -BLK		£395.00	D
MERIDIAN 556 - 2 CH POWER AMP	£995.00	£649.00	D
MERIDIAN 596	£2,750.00	£1,925.00	D
MERIDIAN 598 DVD Player smartlink (as new)	£3,195.00	£2,395.00	D
MERIDIAN 561 Surround Controller	£2,995.00	£2,095.00	D
MERIDIAN 562v.2 Controller	£1,500.00	£995.00	D
MERIDIAN 556 Power amp	£995.00	£595.00	D
MERIDIAN 588 CD	£2,100.00	£1,495.00	D
MERIDIAN 507 CD	£1,195.00	£879.00	D
MERIDIAN 568.2 mm Smartlink (as new)	£4,305.00	£2,995.00	D
VIENNA BEETHOVEN Speaker (Beech)	£2,500.00	£1,495.00	D
VIENNA MOZART Speakers (Beech)	£1,500.00	£995.00	D
VIENNA WALTZ centre Speaker (Beech)	£500.00	£350.00	D
VIENNA MAHLER	£5000.00	£2995.00	D
PROCEED AVP PROCESSOR.VGC/LIGHT USE	£4,700.00	£2,579.00	D
PROCEED PMDT DVD PLAYER.VGC/LIGHT USE	£5,495.00	£2,995.00	D
MUSICAL FIDELTY XA100R - INT AMP	£900.00	£599.00	N
MISSION 780 - ROSEWOOD	£300.00	£219.00	D
MISSION 783 - BEECH (Good condition)	£1,000.00	£599.00	D
MISSION 78 AS Active sub (new)	£700.00	£450.00	D
MISSION 773 E (new)	£399.00	£199.00	D
ROTEL RB985 5 Channel amp (new)	£599.00	£349.00	D
NAKAMICH MB10 5-disc multi CD	£500.00	£200.00	D
REDROSE Valve system (amp & speakers) 1yr old	£10,000.00	£3,995.00	SH

Hi-Fi Multiroom and home cinema  
PLEASE SEE OUR WEBSITE  
FOR LATEST OFFERS!

## THE LISTENING ROOMS LTD

161 OLD BROMPTON ROAD LONDON SW5 0LJ

TEL: 020- 7244 7750/59 FAX: 020 - 7370 0192

[www.thelisteningrooms.com](http://www.thelisteningrooms.com)

E-mail: [tlr@btclick.com](mailto:tlr@btclick.com)

Mon-Sat 10-6pm

# private ads

www.hifiworld.co.uk  
**hi-fi**  
 WORLD  
 & computer audio

Dealers must not advertise in the Private Classified section. Monthly consecutive insertions will be considered Trade advertising. The Publisher reserves the right to judge submissions.

**SPECIAL OFFER - Book a Private Classified Advert - Get One FREE!  
 Plus one months FREE Internet advert. See Page 129 for order form  
 This offer is only open to Private Classified advertisers**

**LINN KABER** Floor standing speakers, Linn Klassik CD-amp, Linn LK85 power amp (two). All immaculate Quad tri-wired speaker cables included. Tel: 0151 709 4540 (h), 0151 709 7706 (office) £1600. (May/1)

**HERTFORDSHIRE/NORTH LONDON** Audio/Record Fair. Sunday 25th April 2004. 11.00 to 4.00. £3. 9.30am early entry £10. At Cuffley Hall, Maynard Place, Cuffley, Herts. 5 minutes from M25 Junction 25. Tel: 07944 909 209 for details (Apr/1)

**DALI ROYAL Menuet II** boxed immaculate £199. (£399). Dali SC5 centre £75 (£150). ATC SCM10 walnut £275 some marks. NAD T770 boxed, immaculate (£699) £150. Two pairs Menuets available. Tel: 020 7237 4475 (Apr/1)

**TANNOY AMESBURY** (pair). 152 HPD. Big and go deep. £475. Sony FM stereo tuner 5950 SD, with Dolby NR £85. JBL L50 Speakers, dynamic sound, £250. Sony digital tuner. FM MW LW £30. Tel: 01983 247593 (Apr/1)

**ROGERS AUDIONOTE** improved F40A valve amp, 3 years old, Audionote revalved & coolers 12 months. Excellent, boxed £450. Tel: 01522 558 137 (day), 01522 694 871 (evenings/weekend) (Lincoln) (Apr/1)

**LOUDSPEAKERS FOR** discerning listeners. Two pair D'Appolito Configuration £200, pair large floorstanders £300. Recently built and custom designed. Superior to comparable mass produced and kit products. Seriously good! Tel: 01943 468 835 (West Yorks) (Apr/1)

**MISSION 78DS** dipolar surround speakers, black ash finish, bi-wireable, mint condition, boxed £175 including delivery within the UK. Contact: magurry@supanet.com (Apr/1)

**VADIS OUTPUT** transformerless power amplifier, excellent condition, new valves, super quiet, lovely sound. Upgrading again. £1300 ovno. Tel: 01208 872 316 (May/1)

**KEF REFERENCE 105's** £295. Early Kef Duets £85. Ariston RD80, Basik LVV arm £100. Single Tannoy Dorset £40. Musical Fidelity A100 £150. Goodmans Midax horn £40. Wanted: Lowther PM6C. Tel: 01362 687 615 (Apr/1)

**LINN LK140** £425, Kolector £275, Keilidh (walnut) £375. All new in 2000, as new condition. Tel: 01322 436 097 or 07802 265 786 (North Kent) (Apr/1)

**HEYBROOK HB100s** £60, stands £30, Leak Troughline 3 Stereo £85, Leak Varislope III £30, Leak Mono pre-amp £30, Leak Point One Plus £30. Tel: 01322 436 097 or 07802 265 786 (North Kent) (Apr/1)

**MISSION 753** floorstanding loudspeakers in rosewood finish, excellent sound, original packing. Can demonstrate. £325. Tel: 01308 459 443 or Email: mikehounsell@compuserve.com (Dorset) (Apr/1)

**INCATECH CLAYMORE** integrated with VG phono £130. Faulty Nakamichi BX-1 (No FFwd or reverse but plays and records fine) Offers. Tel: Adrian 020 8699 3252 or Email: buddam@screaming.net (Apr/1)

**QUAD ELS 63's**, good working order, boxes. Look good £500 ono. Tel: 01323 737 850 answerphone (Eastbourne) (Apr/1)

**THORENS TD160**, Ortofon M20 Super cartridge, Thorens plinth and cover including manuals, in very good original condition £120. Tel: 01273 307 995 (Brighton) (Apr/1)

**CAMBRIDGE AUDIO** amplifiers. C70 preamp. Two A70 power amps. Used as monoblocs. 90wpc, vgc, excellent sound. £250 ono. 0114 234 4200 (Sheffield) (Apr/1)

**QUAD 33/303** pre and power amps, FM3 tuner, excellent condition, original boxes, manuals. £200. Tel: 01953 601 939 evenings (Norfolk) (Apr/1)

**ATC SCM20 SLT**, vgc, boxed, £1995. Meridian 508 20bit £795. AVI monos latest spec £750. Shanling CDT 100 £1100. Tannoy Stirling HE £1695. Wanted: Cello Etude Passive Pre. Tel: 07947 700189 (Apr/1)

**AUDIO INNOVATIONS** Series 1000 monoblocks, new Billington Gold tubes. Requires attention, boxed, £500. Linn Kairn pre-amp + phono, boxed, £500. Ruark Accolade loudspeakers, £500. Tel: 0117 909 6025 (Bristol) (Apr/1)

**SPENDOR SP2/3E** rosewood, mint, boxed, hardly used, £850. Quad ESL57's, black pair, £375. Lumley Ref120 monoblocks, triode switchable, mint, boxed, revalved, £1100. Tel: 0113 257 7793 (Apr/1)

**KRELL KSA 80B** power amplifier, immaculate, complete with box and instructions, £1395. Audio Research LS2 balanced pre-amp, excellent condition, box and instructions, £795. Tel: 07973 242 975 or Email: hifibri@hotmail.com (Eastbourne, East Sussex) (Apr/1)

**COPLAND CTA 505** power amp, new, matched 6550C's and input valves. Triode mode. Spare 6550B's. Fully serviced 2003. Mint (25kg!) condition, boxed, £1000 ovno. Tel: Chris 020 8543 5531 evenings (Apr/1)

**RB300 INCOGNITO** rewired tonearm, four stainless steel spacing washers, spanner, with all setting up instructions, vgc, £180. Tel: 01642 456 228 any-time (Cleveland) (Apr/1)

**NAIM AUDIO CD3.5** £500. NAC102/NAPSC £800. Flatcap x3 £150ea. HiCap £350. NAP135 x2 £1400pr. Headline amp £200. Credo's (cherry) £650. Mana Sound Frame £130. All boxed, excellent condition. Tel: 01934 511 803 (Apr/1)

**FURUTECH FP202** angled locking banana plugs. Rhodium plated, screw fixing - no solder. 3 sets of 4. Mint. Superb. £24 (£50) per set. Tel: 01752 773 369 (Apr/1)

**YAMAHA NS1000-M**, Orbe DC-NC, boxed. Garrard 301, SME 3009-imp, mint condition. Thornes TD-124, SME 3012-R, excellent. Oracle Delphi - Mk1, good condition. Rega RB-300, ESL-57. Audio Research VT100. Thorens TD166-VI. Tel: 0117 955 6555 or 07979 514 450 (Apr/1)

**NAIM CDX** £1300. Naim 82 £1200. Naim 180 £600. Naim Hi-Cap £300. PMC 0B1 speakers £2000. All in mint condition with manuals and boxes, leads etc. Tel: 020 8270 9393 (Apr/1)

**TANNOY EDINBURGH** Prestige loudspeakers, 40" x 26" x 18". Big, bold, dynamic plus crafted cabinets. Expanding family forces reluctant sale. Happy to demo. Looking for 2K. Tel: 01245 251 235 (Apr/1)

5 MINS FROM M25

# MATRIX HI-FI

VALVE AMP  
REPAIRS

**RECORD DECKS**

NEW IN STOCK, GOLDRING GR1, WITH RB150 ARM AND GOLDRING ELECTRA CART BRILLIANT £139.00  
EQUINOX HEAD AMP POA £150.00  
MC HELIOS ARM MK1 £299.00  
ROKSAN XIRNES, SME CUT £660.00  
HI END POWER SUPPLY, BLACK ASH £650.00  
AUDIOJOTT T1, ORIGIN LIVE RB300 £199.00  
SYSTEM DECK 1IX WITH LINN LVX ARM THORINS S1150 £70.00  
LINN LP12 BASIC PLUS ARM IN M PLINTH VOYD RECORD DECK, ORION ARM IN ROSI WOOD PLINTH, THREE MOTORS - BEAUTIFUL MANTICORE WITH ARM & AUDIO TECHNICA CARTRIDGE, BLACK ASH £299.00  
NAD 5130 - NEW GOLDRING ELAN CART £125.00

**PRE-AMPS**

AUDIO RESEARCH LS7 LINE PRE £699.00  
BURMISTER GERMAN QUALITY BOXED Croft Micro - one of the first £199.00  
RAPPORT - Russ Andrews modified £199.00  
BALANCED AUDIO TECHNOLOGY VK31 £999.00  
GATE VALVE PRE NEW £649.00  
GATE TOP END PRE MM VALVE STAGE USED £599.00  
HAILER PRE £130.00  
MATISSE ATOM LINE VALVE PRE-AMP £499.00  
TAG MCCLAREN F3 PA10 - MC & MM £399.00

**POWER AMPLIFIERS - VALVES**

AUDIO RESEARCH CLASSIC 60 - MINT COND £1,599.00  
AUDIO INNOVATIONS 500 £449.00  
AUDIO INNOVATIONS SERIES 1000 MONO BLOCKS £999.00  
KORA EX DEMO EL34 INTEGRATED was £2,000 £1,499.00  
ROGERS CADET II CHASSIS WITH PRE £199.00  
ROGERS CADET III No1 £150.00  
ROGERS CADET III No2 £299.00  
SCOTT 200 B INTEGRATED VALVE AMP £499.00  
AUDION STERLING EL34 STEREO S/S WOOD £75.00  
ROGERS RAVENSBROOK £599.00  
ROGERS MASTER FACIL LINT £499.00  
QUAD II MONO BLOCKS GPC KT66s £2,500.00  
GATE 300B PUSH PULL SIT WEB

VAA70MKII - EL34 PUSH PULL INTEGRATED ARION ELECTRA SHANLING POWER AMPS (SEE WEB SITE) £399.00 £399.00 £2,000.00

**POWER AMPLIFIERS - SOLID STATE**

QUAD 33 £50.00  
CRIMSON 630 MONO BLOCKS & PRE AMP £1,199.00  
KRILL KSA50 IN VERY GOOD COND £749.00  
ARCAM 75 WITH REMOTE VGC 1.75.00  
QUAD 306 VGC £199.00  
MUSICAL FIDELITY E10 - EXCELLENT £150.00

**TUNERS, CASSETTE DECKS ETC.**

YAMAHA KX480 CASSETTE DECK £80.00  
YAMAHA KX500 CASSETTE DECK £85.00  
YAMAHA CT710 TUNER £45.00

**CD/HDCD/SACD/DVD PLAYERS**

ARCAM CD72 - MANUAL & BOX £299.00  
MARK LEVINSON No. 35 DAC WITH HDCD £1,299.00  
TOM EVANS 'EXIOS PRECISION' CD WITH SUPERATI POWER SUPPLY - AWESOME £1,999.00  
DPA ENLIGHTENMENT CX32 £299.00  
PINK TRIANGLE ORIGINAL DAC £299.00  
MICROMEGA DRIVE 2 AND DAC - MINT - BOXED £749.00  
HELIOS CD2 £499.00  
CALIFORNIA AUDIO LABS TUBE ANALOGUE PROTECTOR DAC £349.00  
SHANLING SCD T100 HDCD (SEE WEB SITE) £1,650.00  
SHANLING SCD T200 SACD (SEE WEB SITE) £2,150.00  
SUGDEN CD21 - MINT - REMOTE £599.00  
MUSICAL FIDELITY A3 CD PLAYER £450.00  
MUSICAL FIDELITY E60 CD PLAYER £150.00  
PHILIPS CD960 PRE-DECESSOR TO CD94 £199.00  
SONY MDS JA201S MINI DISK RECORDER £199.00

**SPEAKERS**

AUDIO NOTE ANJ TEAK £899.00  
DECCA LONDON WITH CAST IRON HORNS £650.00  
LINN KANN'S NEW CHERRY £299.00  
REGA ELA BLACK £199.00

**CAILES**

VARIOUS IN STOCK PLEASE PHONE

WWW.TUBE-WAREHOUSE.COM

## NEW

SEE OUR NEW TUBE  
WEB SITE - MAIL  
ORDER TUBES AND  
ACCESSORIES  
DISCOUNTED  
PRICES

GOLDEN DRAGON, SVETLANA, NOS ETC,  
OUR OWN "PRESTIGE" HAND PICKED FOR  
SOUND QUALITY PHONE 01322 281787

NEW HIGH QUALITY HIFI ● VINTAGE HIFI FOR SALE AND WANTED  
● DEM ROOM AVAILABLE VALVE AMP REPAIRS

SEE OUR WEB SITE FOR THE LATEST STOCK

SHANLING, MICHELLE, CELESTION, QED, AUDIOQUEST, SOUNDSTYLE, ETC...

PHONE : (01322) 281700/292391 FAX: (01322) 229908

E-MAIL: [info@matrixhi-fi.co.uk](mailto:info@matrixhi-fi.co.uk) WEB: [www.matrixhifi.co.uk](http://www.matrixhifi.co.uk)

FREE EASY PARKING

SHOWROOM

65 DARENTH ROAD  
DARTFORD

KENT DA1 1LU

Origin Live Recreating the Original Sound

[www.originlive.com](http://www.originlive.com)



**KIT TURNTABLES**

"...this vinyl front end had my jaw heading towards the floor with the solidity and transparency of the music it was making...Overall a deeply impressive deck...brilliant value for money... component quality is superb and the build process is a doodle."  
**Hi-Fi World**

"One of the most enjoyable and musically involving turntables I have ever heard regardless of make or reputation."  
**Audiophile**

Now you can own a professionally built, high performance turntable at a fraction of the normal cost. All OL turntable kits are supplied in various forms:

- A Standard Kit of Parts to enable you to build your own plinth at **£282**
  - The Complete Non-suspended Standard Kit offered with a pre-drilled & finished plinth at **£349**
  - The Complete Ultra Kit comes in two options. The Ultra Kit Classic offering a truly high end suspended sub-chassis turntable with beautifully finished solid wood plinth.
  - The Ultra Kit Modern offers the performance of the Ultra Kit Classic combined with the modern day skeletal styling.
- Both options available at **£538**



**TURBOCHARGING YOUR REGA ARM**

"Nothing less than total dynamite"  
**Hi-Fi World**

If you are the proud owner of any Rega tonearm, you are now in the enviable position to transform its performance into the league of super arms with our modifications. The OL structural modification at £75 will enable your Rega to perform at a level exceeding that of arms costing over £1500!! High performance rewiring with high grade litz wire is also offered at an additional £70 and external rewiring is also £70 further increasing the performance.

"I have to say the Rega modifications turn this humble arm into a real giant killer. Gone is the rather grey, sterile sound of the cooking Rega. Instead, tonal colour is fresh, dynamics have great speed and impact, and the sound stage is huge."  
**Hi-Fi World on structural modification**

What Hi-Fi? gave this modification 5/5

- Structural Modification - **£75**
- Internal Rewiring - **£70**
- External Rewiring - **£70**

For arm modifications we normally return your arm within 2 - 3 days



**UNIVERSAL TURNTABLE MOTOR KIT**

"It's value is nothing short of tremendous."  
**Listener Magazine**

"The single most important upgrade you can ever make to any record deck concerns the motor drive...nothing can prepare you for the shock of going DC. In a word, gobsmacking."  
**Common Ground Magazine**

"...if you are thinking of upgrading your system... the OL DC Motor Kit should be high on your list for consideration."  
**TNT Audio**

Designed as a drop in replacement for almost all turntables, the OL upgrade DC motor kit offers vast improvements to all versions of Linn, as well as: Rega, Systemdeck, Roksan, Rock, Oracle, Michelle, VPI, Clearaudio, Accoustic Signature, etc. The kit consists of a high grade DC motor, aluminium electronic control box and offboard power supply. All this provides an extremely cost effective route to truly high-end audio and is significantly superior in performance to PS upgrades at three times the price.

- OL Power Supply & Motor Kit - **£339**
- OL Ultra Power Supply & Motor Kit - **£570**
- Upgrade Transformer - **£175**

Origin Live, Unit 5, 362b Spring Road, Sholing, Southampton, SO19 2PB, UK  
Tel/Fax: +44 02380 578877 [www.originlive.com](http://www.originlive.com) email: [originlive@originlive.com](mailto:originlive@originlive.com)

# private ads

**hi-fi**  
WORLD  
& computer audio

Dealers must not advertise in the Private Classified section. Monthly consecutive insertions will be considered Trade advertising. The Publisher reserves the right to judge submissions.

**SPECIAL OFFER Book a Private Classified Advert - Get One FREE!**  
Plus one months FREE Internet advert. See Page 129 for order form  
This offer is only open to Private Classified advertisers

TANNOY T225 loudspeakers, 10" dual concentric, glass tops, fine example of Tannoy engineering. Max spl 111dB. So possible studio/home use. Good condition. £250. Tel: 01245 251 235 (Apr/I)

MCINTOSH 6450 integrated amp, 3 years old, mint condition, boxed (£2250) £1200. Rega Radio, mint, boxed, 3 years old (£300) £150. Tel: 0117 305 2563 (work), 07974 176 634 (mobile) or Email: Ray.hamilton@kone.com (Apr/I)

**MUSICAL FIDELITY**  
XP100. Bought April '02. Occasional use, excellent condition, virtually half price £375. Boxed as bought. Will pay transit cost for sending this preamp. No time wasters please. Tel: 024 764 16979 (Apr)

SUGDEN MASTERCLASS integrated amp. Class A, 34 w.p.c. R/control. Seductive, full bodied sound with a wonderful midband. Cost new £3150, asking £2250. Tel: 01296 437 314 (Aylesbury, Bucks) (Apr/I)

NORDOST VALHALLA interconnect, 1m, phono terminated. Asking £1400. JPS, Superconductor+ biwire, 5 foot pair with gold w.b.t. banana locking plugs. Asking £550. Tel: 01296 437 314 (Aylesbury, Bucks) (Apr/I)

QUAD ESL 63 plus stand and deliver stands £799. Quad 606 Mark I £325. Rel Strata III £299. Croft Supermicro upgraded to Epoch £299. Meridian DAC 203 £90. Tel: 01706 351 962 (Apr/I)

LINN BASIK turntable with Akito tonearm and Reson Mica cartridge £290 ono. Ring Graham after 6pm 01482 641 261 (Apr/I)

NAIM CDS Mark I £1100. Naim 135's silver £1200. Naim 135's olive £1400. Naim SuperNaxo 3-6 crossover £299. Townsend Rock Mark I, Merlin power supply, Rega RB250 £399. Tel: 01706 351 962 (Apr/I)

NOTTINGHAM ANALOG turntable, 12" Anna arm, Tracer 4 cartridge, PSU, £3200. Croft Absolute pre-amp £1500. Posselt Albatros loudspeakers £1300. All mint condition. Tel: 01604 404 499 (Northampton) (May/I)

ACTIVE LINN System, 6 years old, as new condition. Karik, Numerik, Wakonda with Sneaky tuner, 3x LK100 power amps, Keilidhs on granite base. £4000. Tel: 01305 776 932 or Email: c.cooknell@tiscali.co.uk (Weymouth) (Apr/I)

A.V.I. SERIES 21 MC4 Reference CD player, boxed, mint condition, only 2 years old. No remote. £450. No offers. Tel: 01502 518 938 (Apr/I)

CLASSIC ACTIVE system. Nytech CTA 252 XD, MM phono. Spare CTA 252 XD MC phono. Active CXA 252 XD. Arc 101 speakers. All boxed. £199. Tel: 01474 702 939 (Dartford) (Apr/I)

A AND R (ARCAM) SA 200, 100 watt amplifiers. 3no, two bridged £100 each. C200 pre-amplifier £75. Minim AD10 ambisonic decoder £100. Tel: 01642 559 078 (Stockton) (Apr/I)

QUAD ESL63, brown, excellent condition £1150 ono. Upgraded to 988. also JBL 4311 Control monitors, walnut, fair condition £250 ono. Plus Target spiked stands £25. Tel: 07970 575 547 or 01525 371 730 evenings (Apr/I)

**NAIM CDS II/XPS Flash**  
R/C, immaculate, low usage, boxed, can dem, £2900. Tel: 0121 553 1121 or Email: rp.stop@ukgateway.net (Midlands) (Apr/I)

FOR SALE Kef 107/2 speakers in walnut, excellent/mint condition with boxes, manuals and Kube equaliser, £1100 ono. Wanted: Kingston speakers. Tel: 020 7480 7964 or 07932 063 335 or Email: thewaldons01@tiscali.co.uk (Apr/I)

NAIM HI-FI System Sale, CD2 CD player, NAC 82 pre-amp, Hi-Cap power supply, NAP 250 power amp, SBL loudspeakers (cherry), QLN Projekt equipment rack (cherry). Complete system purchased new from Grahams HI-FI in December 1997. Mint condition, very low usage, boxed with manuals. For prices please ring Mark 01708 224 319 or 07813 332301 (mobile) (Essex) (Apr/I)

MUSICAL FIDELITY A3-2 amplifier £499, A3-2 CD player £499. Half price! As new, boxed, and hardly used. Tel: 01335 390 529 (Derbyshire) (Apr/I)

KIMBER SPEAKER cable 4TC 4.5 metres £140 ono. Kimber Classic PowerKord with Wattgate 320 IEC plug £45 ono. Yello power cable £17 ono. Tel: George 01262 606 089 or 07890 933 787 (East Yorkshire) (Apr/I)

NAIM CDX, 18 months old, mint condition, box, manual, remote, £1650. Naim 282 pre-amp, 3 months old & new Hi Cap 9 months £2800. Naim 250 £800. Arcam DAB 10 £320. Contact Richard 07956 594 104 or Email: richard.jones87@ntlworld.com (London) (Apr/I)

LOWTHER ACOUSTAS with remounted PM6A drivers, original plywood cabinets, sound but scruffy. Non-matching pair. £185 ono. Tel: 020 8677 8183 (Apr/I)

MICHELL ORBE full size QC. Black clear silver. As new, boxed, instructions. Upgrading. £925 ono. Tel: 07958 944 424 (Cleveland) (Apr/I)

**EXPOSURE 7-8 Pre and Power plus Expander £200.**  
Thorens TD 124 II, SME S.3 £200. Sony STR-DB 940 D.T.S. surround receiver 6.1 - 110w per channel, mint, £200. Tel: 01273 454 108 (Apr/I)

TAG MCLAREN DPA 32R D and A preamp with DAB (£2500) £1400 ono. G.Tee Oct 05. Myryad MP100 pre £250. Musical Fidelity A300cr power-amp (£2300) £1150. Audiolab 8000 DAC £220. All mint with boxes. Tel: 0121 742 1270 (Apr/I)

MUSICAL FIDELITY A1 amplifier £125. NVA A80 monoblocks £300. Infinity Kappa Reference 5 speakers £225. Marantz CD94 £225. Rotel RCD965BX £90. Manticore Mantra turntable £175. Marantz ST50L tuner FM.AM.LW. Tel: 01224 646 473 (Apr/I)

**MERIDIAN 507 CD player,**  
two months old, £600. Aloia PST II.01i pre-amp plus power unit. Aloia 15.01i power amp plus power unit. Amp power 60 + 60 watts. £2000. 4 box system. Tel 020 8531 5979 (May/I)

QUAD ELS 63's, good working order, boxes. Look good £500 ono. Tel: 01323 737 850 answerphone (Eastbourne) (Apr/I)

# AUDUSA

## AUDUSA EUPEN CSA 2.5 AUDIO AC MAINS CABLE

**GNLM 05/04 and GNLM 05/2.5 ( CSA 2.5) Cable with FERRITE TECHNOLOGY** - A polymer material mixed with a considerable quantity of homogeneously fine high quality ferrite powder, is extruded around the copper conductors. As a ferromagnetic material, it will go through hysteresis loops whenever it is under influence of an alternating magnetic field. Consecutively magnetizing and demagnetizing the material will cause considerable losses of high frequency energy.

This energy is absorbed in the ferrite grains and converted into heat. The GNLM cables which in addition to the above described ferrite technology is further protected with a foil shield and a drain wire and specifically manufactured for High End audio use. **Said by some to be the most neutral sounding audio ac mains cable on the market.**

Fitted with IEC (Martin Kayser) and MK Tough plug Cable can be supplied fitted to our all steel 4, 6 and 8 way distribution blocks. We can rewire the distribution blocks with Eupen cable as an extra cost option. Refer to our web site for details.

**AUDUSA - OOM Silverlink OCC balanced speaker cable** - stranded, silver on OFHC plus three strands of OCC (Ohno Continuous Casting - single crystal copper) for improved bass performance. Mylar infill and with designed in protection against RF and EMI, conductor of 3mm diameter (approx 8 gauge). Cable Overall Dimension: 14.72 mm.

## LAT International AC-2 AUDIO AC MAINS CABLE

We have developed a cabling (weaving) pattern along with an unusual shielding/filtering system that gets rid of the garbage that contaminates your components. The difference you hear with our cord is astounding. Our power cord takes advantage of silver in its design through use of our proprietary Silverfuse conductors. The conductors are 10 gauge and with PTFE, the best insulation available. Fitted as standard with IEC / MK Toughplug. . 60cm £62, 90cm £75, 1.2m £88, 1.5m £101, 1.8m £112 etc Other lengths available and off the reel. 4,6 and 8 way all steel mains distribution blocks fitted with **UK, Schuko or USA sockets.** CE tested & approved mains distribution units manufactured of heavy gauge steel, finished in black and fitted with high quality 13amp sockets. It has no filters, circuit breakers, surge protection, transformers, resistors, capacitors, LED's, on/off switches, chokes, regulators, just fitted with 1m of AC-2 mains cable. From £166 for 4 way, £198, 6 way, £229 for 8 way.

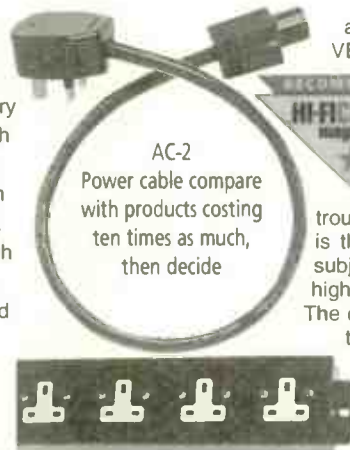

### SILVERFUSE

is a near alloy of silver and copper. IT IS NOT SILVER PLATED OR SILVER CLAD. Plating (or clad, which is the same thing as plating) causes a dioding effect when signal is passed through resulting in brightness and distortion. The Silverfuse process starts with seven nines OFHC copper wire with a diameter that is slightly larger than the required size. It is then pulled through a trough of molten silver. The wire with a silver deposit, is then forced through a compacting die where it is subject to tremendous pressure. The silver and the high purity copper are fused together into a near alloy. The compacting fusion also reduces the wire diameter to the desired size. No dioding subsequently occurs with this process. The result provides for the benefits of silver; which are excellent definition and clarity, with the high purity copper benefits of warmth and mellowness.

### GNLM 05/2.5 (CSA2.5)

£48 for 1.0m, £58 for 1.5m, £68 for 2.0m. Off the reel £30 for 1st meter, £20 per m thereafter.

Eupen GNLM 05/2.5 (CSA 2.5) shown with Maringo IEC 320 will be fitted at extra cost.

### GNLM 05/04

£58 for 1.0m, £72 for 1.5m, £86 for 2.0m. Also available of the reel.

Both GNLM cables are available for export.

### SILVER SILVER - upgrade the cable with silver plated contacts on IEC and and MK plug for £6. AUDUSA

- Eupen and LAT AC-2 mains cable available with 16 amp IEC ( for certain models of amps by Krell, MF, Levinson etc), Maringo/Wattgate IEC 320, Figure of eight, Bulgin, Hubble, European Schuko, French, Australian, Swiss, Danish, Neutrik and other plugs see our web site for IEC's, MK plugs RCA and Banana connectors with silver plate contacts and other audio and ac mains connectors

LAT INTERNATIONAL Inc USA - Analogue, Digital and Video interconnects and Speaker cable better than most others at double the price.

## SUNFIRE CORPORATION - Snohomish USA



**New for 2003 Sunfire Ultimate - world's most powerful home cinema**

**Receiver. 7 x 200 watts, Cinema Seven power amps, 7 x 200 and 7 x 400**

Signature True SubWoofer 13 inch cube True Sub MKIV 11 inch cube and Junior Sub Woofer 9 inch cube -all with two drivers, to as low as 16hz, 116 SPL and 360 cu ins of air movement, 1200 or 2700 watt patented amp technology. Solid state power amps 2 channel (2 x 300 and 2 x 600) and 5 channel (5 x 220 watts and 5 x 430 watts patented amp technology (no heat sinks), Classic tube preamp and Theatre Grand III processor preamp

[www.audusa.com](http://www.audusa.com)

T: 020 8241 9826, 020 8264 0249 F: 020 8241 0999 E: [sales@audusa.com](mailto:sales@audusa.com)



# private ads

**hi-fi**  
WORLD  
& computer audio

Dealers must not advertise in the Private Classified section. Monthly consecutive insertions will be considered Trade advertising. The Publisher reserves the right to judge submissions.

**SPECIAL OFFER - Book a Private Classified Advert - Get One FREE!  
Plus one months FREE Internet advert. See Page 129 for order form  
This offer is only open to Private Classified advertisers**

FROM MARCH 2004 ISSUE

**AVANTGARDE UNO** Horn loudspeaker £3500. Musical Fidelity Tr-Vista SACD Super Audio CD player, mint, boxed, £3000. Tel: 020 8531 5979 or 07903 265205 (Mar/I)

**KIMBER SELECT 1011** inter-connect cables. 2 pairs £200 each (£367). 1 Russ Andrews Purifier Block, 8 outlets RA Powercord £300 (£500). Tel: 01604 410726 (Northampton) (Mar/I)

**QUAD 988** CEVintage, finish, purchased August 2003, with extended warranty. £2500 (£3750). TacT M2150 digital amp, purchased September 2003, £2300 (£3800). Cardas Golden Cross 0.5m with Eichmann Bullets £300. Tel: 0131 225 9002, Email: S.Hussain@ed.sac.ac.uk (Mar/I)

**SNELL J2** speakers (walnut) on 'Pirates' stands. Recent new AudioNote silver drivers - nice! £475. Musical Fidelity X-Dac (HDCD) as new, boxed £150. Both ono. Tel: 07941 923 881 anytime (Sussex coast) (Mar/I)

**CASTLE HARLECH** floor-standers with plinths, yew finish, mint condition and boxed, £620 ono. Audioquest Indigo+ speaker cable 2x 3.5 metres, offers. Tel: 0 858 462 061 or 525 463 evenings (Market Harborough) (Mar/I)

**KRELL KRC3** pre-amp mint £1495. Theta Carmen CD/DVD transport mint £1395. Sonus Faber Signums mint £695. Teac VRDS7 fully Trichord modded £295. Tel: 0121 744 9733, mobile 0775 996 9324 (Mar/I)

**COPLAND SYSTEM, CDA266** HDCD CD player, Copland CSA28 amp special order black with Russ Andrews PowerChords, boxed as new with remote control. Cost £3000, sell £1400 ono. Tel: 01224 596 076 (Mar/I)

**NAIM AUDIO** system. Pre-amp, NAC82 monoblock, NAPI35 x2 Super Hi-Cap, speakers Dynaudio Contour 3.0, all boxed and mint condition, reasonable offers. Tel: 01293 886 832, mobile 07977 115 446 (Mar/I)

**LP12 (BLACK ASH)**, lttok LVII, K9 £450 ono. Naim NAPI40 £200 ono. Naim NAC 62N £225 ono. All boxed, good condition. Tel: 07931 142 693 (Mar/I)

**PAIR QUAD** ESLs on matching Gradient subwoofers. Excellent condition, magnificent sound, £2500 ono. Tel: 01227 752 438, Email: BriKelsey@aol.com (Mar/I)

**TDL's RTL4's** speakers, boxed, manuals, rewired, excellent condition £205 ono. Buyer collects. Pioneer F-91 tuner, boxed vgc £210 ono. Tel: 01934 813 666 after 6pm or Email: jpmc@supanet.com (South Bristol) (Mar/I)

**JBL Ti5000** speakers, 3 years old, black, perfect condition £1800 (£4000). Tel: 07773 788 317 (Mar/I)

**C.R. DEVELOPMENTS** Romulus integrated valve amplifier, 30w per channel, s/steel/black/gold (£1300) £600. Meridian 506 24bit CD player £600. Spendor Prelude speakers £80. Tel: 01205 750 314 (Mar/I)

**PRIMARE PHONO** Stage pre-amp, Model R-20, vgc, £250. Tel: 01224 483 642 evenings or Email: barmonte@aol.com (Mar/I)

**IPLS3TL TRANSMISSION** Line loudspeakers. Built from kit (mahogany). Details of model on IPL website. Good condition, excellent sound, £160 ono. Contact Gary 0141 942 9240 or 07789 527 028 or Email: mrwilson24\_7@hotmail.com (Mar/I)

**LINN SYSTEM** for sale. Ikemi, Kudos, Kolektor, two LK140, Aktiv Ninkas. Mint condition. Black. Original packaging etc. £2800. Tel: 07941 175 025 6-7pm only or Email: linnsale@hotmail.com (Kent) (Mar/I)

**J R 149 BI-WIRED** Speakers £100. Tandberg Series 15 machine £50. Aiwa P22 power amp £25. Crimson 610 pre amp £25. Tascam M106 mixing desk £100. Chilton M12-4 mixing desk £100. Revox G36 £200. Revox A77 £200. Yamaha KX380 cassette deck £30. Aiwa AD F360 cassette deck £25. Marantz CD75 player £45. JVC DD66 3-head cassette deck £45. 7 inch tapes £3. 10 inch NAB tapes £5. Revox NAB hub adaptors £25 pair. Revox A77 acrylic cover £35. Tel: 07710 828286 anytime (Mar/I)

**MERIDIAN M60C** centre speaker. Black, perfect condition, boxed, two years old. £500. Meridian S41 ProLogic pre-amplifier, £200. Tel: 07976 350 204 (Cardiff) (Mar/I)

**MUSICAL FIDELITY F22** valve pre-amplifier, lovely sound, as new, mint brushed aluminium fascia, £550. Tel: 01424 431 536 (Mar/I)

**TLC MAESTRO 70S** stand-mount speakers. 8 ohm 50watt bi-wireable. Solid cabinets in excellent condition and very musical. Two years old. Paid £300 will accept £200. Tel: 0113 273 3744 (Leeds) (Mar/I)

**NAIM SBLs**, black, boxed, current spec, immaculate, £900. Cyrus tuner, remote, alloy case, £100. Mission PCM 7000 CD, remote, £100. Thorens 160s, Linn LVV, P77, £170. All boxed, will demonstrate. Tel: 01722 334 694 (Mar/I)

**LOWTHER FIDELIO** speakers, gloss black finish, fitted with PM5A drive units in perfect condition, £1200. Tel: 01293 824 667 after 6pm or Email: JLC@beeb.net (Mar/I)

**OFFERS INVITED.** Homebound American selling two superb matched James Lansing 2-way speaker systems. Attractive pine finished JBL bass reflex enclosures. Inches 24x19x16 ono. Other components available. Tel: 020 8406 1666 (Mar/I)

**MERIDIAN 551** integrated amplifier, Meridian 506 CD player. £650 the pair. Mission 732 speakers, as new condition £65. Tel: 07778 895 257 or 01252 332 097 (Hampshire) (Mar/I)

**CASTLE SEVERN 2SE** in cherry veneer plus speaker cables £295. Little used as brand new, sale due to new room furniture and decor. No offers. Tel: Tony 020 8743 5690 (Mar/I)

**RUSS ANDREWS** power block (eight sockets) with 3' Reference Powerkord £175 ono. Tel: 01249 821 288 (Calne, Wilts) Tel: 01249 821 288 (Mar/I)

# Sound & Music

93-95 Nantwich Rd., Crewe, Cheshire.  
Telephone : 01270 214143

- Audiolab 8000 M... Amplifier (SI1) - £450
- Audiolab 8000 M... Amplifier (SI1) - £750 Pair
- Cast... Speakers (Wal... ) - £400
- ... Speakers (Oak... ) - £400
- ... 4500 - AV H... ) - £400
- ... pa 400 - Sp... ) - £400
- ... 6 - Speaker... ) - £400
- ... lassik Mov... ) - £400
- ... 50 - Power... ) - £1500
- ... n Keleidi... ) - £300
- ... inn Trikan... ) - £350
- ... Linn Siz... ) - £650
- ... eridian M... ) - £1100
- ... eridian 505... ) - £1100
- ... Mer... Amplifier (S... ) - £1100
- ... Amplifier (S... ) - £1100
- ... Subwoofer... ) - £1100
- ... Speakers (B... ) - £1100
- ... The Pream... ) - £1100
- ... - Power... ) - £250
- ... XP100 - Pre... ) - £400
- ... T752 - Rec... ) - £300
- ... RPM6 Turn... ) - £300
- ... 211 - Spea... ) - £450
- ... Quad 22L... ) - £50
- ... Quad 6... ) - £450
- ... Caspian... Amplifier (XD) - £650
- ... Rotel RB 985... Amplifier (SI1) - £450
- ... Tannoy... (Maple/XD) - £650
- ... Tannoy... (Rosewood/XD) - £300
- ... Wharfed... (Maple/XD) - £250
- ... Wharfed... Speakers (XD) - £400

Agencies include : Linn, Musical Fidelity, S.M.E., Origin Live, Monitor Audio, Castle, Quad, Wharfedale, Harman Kardon, Creek, Meridian, Tannoy, Infinity, Loewe, Sanyo, Ortofon, VDH, JBL, Pro-ject, Roksan, QED, Cable Talk, Michell, Arcam, Trichord, PMC,

## PINEWOOD MUSIC of Winchester and Taunton

### COPLAND CSA29

Good sound isn't necessarily good music, but hook your favourite speakers to this beautiful hybrid integrated and you'll feel instantly connected to your music - and probably lose that unsettling urge to upgrade. There's also a phono board option!

### COPLAND CDA822

And what better digital source for the CSA29 than this? One of the nicest CD players at any price, this device represents superb value for money and will wring all the emotion from your recordings.

*Ex-demonstration and part-exchange sale:*

Krell KAV-300il integrated	£2250
Sonus faber Signum	£ 750
Sonus faber Grand Piano Home	£1350
Transparent XL cables	£ POA

#### THE PINEWOOD MUSIC COMPANY

Winchester: 01962 776808  
Taunton: 01460 54322  
e-mail: brianriv@mac.com

Our agencies include: Krell, Sonus faber, Martin Logan, Copland, Transparent and finite-elemente

### CLASSIQUE SOUNDS.(LEICESTER) INC ONE THING.

VINTAGE HIFI & VALVE SPECIALIST TEL 0845 123 5137 (local rate)(UKonly)

WANTED Vintage and modern hifi eqpp. Part exchange welcome

#### FOR SALE.PR./POWER AMPLIFIERS

- Quicksilver Mono valve power amplifiers x 2. 60 watts uses 6550 tubes in push pull. With cages. Chrome tops £ 899 pr
- John Bowers (Musical Fidelity) pre-amplifier. Special edition. MM & MC + aux and CD.Excellent. Boxed Rare £ 175
- Marantz PM80 pure class A amplifier. 2 X 25 watts £ 225
- Audio Research PH11 valve phono stage. £1700.BXD £ 895
- Quad 606 mk1 pwr amplifier. Good condition. £ 399
- Musical Fidelity "The pre amplifier". MM & MC £ 149
- Sugden A28/11 class A integrated. Mint. Boxed. £ 250
- Audiolab 8000A integrated amplifier. Boxed. £ 199
- Audionote valve amplifier 10W/ch.K4. Revalved £450
- Linn LK100 power amplifier. Excellent condition. £ 395
- Golden tube Audio SE-40 single ended valve amplifier.Complete with Bias adjust tool.40 watts of valve power £ 495
- Sugden AU51 power amplifier. Boxed. £ 650
- Rotel RB970 BX power amplifier. Bridgeable. £ 125
- Marantz PM66SE KI signature integrated amplifier £ 199
- Naim Nap 90 & Nac 92 pre/power.New cases £ 495
- Pair Leak TL12 + valve amps Grey. Rebuilt by me. £ 599
- Crimson Electrik 510/520 pre/power amplifier.Bxd. £ 249
- Tube Technology Unisys valve pwr amp. Mint bxd £ 995
- Rogers Cadet integrated tube amplifier. 10W £ 175
- CR Developments Carmenta Line valve pre-amp. £ 450
- Harmon Kardon HK1400 line amplifier.Mint/boxed £ 199
- Hart 1100RSA integrated amplifier. 80W.Superb. £ 375
- Kenwood KA660D integrated amplifier. Black. £ 60
- Sugden A25 amplifier. Excellent condition & instr £ 200
- Naim NAC 92 pre amp. SNO 161840. Mint. Boxed £ 299
- Meridian Modular pre/power amplifier. Ex cond. £ 249
- Magnum MP.125 pre amplifier with MM/MC. £ 250
- Quad 77 integrated amplifier. Mint. Boxed. Instr. £ 399
- Quad 77 remote control for amplifier etc. Cost £300 £ 149
- Musical Fidelity B1 integrated amplifier. Good cond£ 125
- Naim Nait 3R integrated amp & remote.Mint.Bxd £ 495
- Linn LK1 pre-amp and remote. Good condition. £ 249
- Linn LK2 power amplifier. Good condition. £ 299
- Copland TASA01 power amplifier. Valve. £1800 £799
- Naim Nap 180 power amplifier. Mint. Boxed. £ 799
- Quad 11s in various condition and prices £POA
- Pioneer A400 integrated amplifier. Good cond. £ 125
- Leak Stereo 20 valve power amplifiers from..... £ POA
- Harmon Kardon integrated valve amp.110V. V rare £ 299
- Quad 303 power amplifiers from ..... £ 125
- Arcam Alpha 2 amplifier. Mint. Boxed/Instr £ 95
- Nakamichi CAS pre-amplifier. Ex cond. Cost £750 £ 375
- Nakamichi PA5 100W/CH power amp. Cost £1300 £ 650
- NVA A80 mono power amplifiers X 2. Good cond £799
- NVA A60 stereo power amplifier. Good condition. £ 295
- Musical Fidelity Pre-8 pre-amplifier. Mint. Boxed £ 150
- Arcam Alpha 3 amplifier. Mint.Boxed/ Instructions £ 100
- Arcam Zeta 1.Pro logic Cinema amp. Cost £999.00£ 450
- Quad 33 pre-amplifiers. From..... £ 75

#### TURNTABLES

- Thorens TD-135 turntable and arm. Like a 124. £ POA
- Thorens TD-2001 turntable and arm.Cost £700.Bxd £ 349
- Garrard 401 with SME 3009 arm. £ 295
- Thorens TD125 with thorens tone arm. £ 125
- Transcriptors 1/hydraulic reference/Decca arm.Mint£ POA
- Garrard 301/401 chassiss in various condition from £ 125

#### SPEAKERS

- Quad ELS63' Prus Black. Serviced as new. Mint. £1599
- Kef Cresta 2's. Cherry. Standmount.Mint & boxed £ 80
- Pair Quad ESL57 spkrs. Fully rebuilt by One Thing Axoid. Black cloth fronts.5 star review in Hifi World. Mint. £1599
- Quad ESL57 speakers.All fully serviced with full 3 months warranty.Hear what ESL57s should sound like From£900 pr £ 750
- Quad ESL57's nice condition. Bronze finish. £70/pr
- Tannoy Lancaster with 12" monitor golds. £ 199
- Roksan ROK-ONE speakers. Black. Mint. Boxed. £ 295
- Mission 773 floor standers. Mint/boxed. Half price £ 199
- SD Acoustics SD3 loudspeakers. Piano finish £ 275
- Rogers LS55 speakers. Rosewood. Boxed. Exc cond £ 199
- Heybrook Heylites. Black. Boxed. Ex condition £ 199
- Celestion SL600 speakers. Good condition. Bi wire £ 375
- Tannoy Chatsworth with 12 inch monitor golds. £ 169
- Meridian Short MS201 pearl. Brand new. Black £ 69
- B&W DM4 speakers. Black finish £ 85
- Castle Kendall speakers. Good condition. £ 69
- Magnepplaner MG 1.4. Boxed with £400 oak stands £ 999

#### OTHER ITEMS

- EAR 834P MM/MC valve phono box. £61500 new! 395
- Marantz CD63 top loader cd player. Collectable. £ 125
- Michell Iso. Very late model with see through case. £ 250
- Cyrus DAD3 Cd player with remote. Ex condition £ 275 Trio
- KT880L synthesiser tuner.AM/FM. Black. £ 75
- Rotel RCD 965 BX CD player. Mint. Boxed £ 149
- Arcam Delta 150 nciam stereo tuner and remote. £ 95
- Marantz CD50 Cd player. Ex condition. £ 79
- GEC PX4 valve. Brand new. £ 100
- Decca London international tone arm. New. Boxed. £ 175
- Arcam Delta 170.3 CD Transport.Mint.Boxed.£800 £ 399
- Leak Troughline 3 Mono valve tuner. Fully serviced £ 195
- SME 3009 tonearms from..... £ 125
- Rotel 950 CD player. Ex cond. Boxed. £ 100
- Quad 77 RDS FM tuner. Mint. Boxed. Instructions £ 399
- Nakamichi CDP 2E CD player. Ex condition. £ 250
- Naim 42.5 pre-amp. MM boards fitted. £ 125
- Phillips 101 top loading cd player. Collectable. £ 125
- Marantz SD275 twin cassette deck. Dolby B/C £ 49
- Technics SL-PG440A Mash CD player/remote. £ 75
- Alwa AD-5750 Dolby B-C-SHX pro cassette deck £ 75
- Technics SL-PS620A CD player/remote. £ 75
- Linn Tuner. Mint.Boxed. Very unusual. Cost £549 £ 249
- Quad FM3 tuner in excellent condition. £ 99

#### QUAD ESL57 & ELS63 PANELS/SERVICING ETC

NEW-- B&W DM70 Electrostatic panels now undertaken. Price for one panel is £150.00

Reconditioned Quad ESL57 speakers from only £900.00.pr.Why spend £4000+? **Have your ESL57 SPEAKERS STANDARD SERVICE £375.PR.** Ring for info.  
Exchange/recon ESL57 bass panel £130.Treble £90. ESL63 panels £ 100 refurbished.  
ELS63/ESL57 speaker stands, available in black or woodgrain @ £175.00 a pair.  
New socks for ELS63s £38 pr. Many other spare parts available. Please ring.  
"Classique Sounds servicing restores the Quads to a position where they can hold their head high", Jon Marks. HIFI WORLD. April 1999.Full servicing facilities available.

Troughline 3 tuner service & realignment £150.00. (excludes valves. Rarely needed).  
One thing stereo decoder (back in stock ) £175.00 Ex review Hifi world.

#### TRANSLUCENT. (somewhat of a bargain) Hifi World. Jan 1999

PURE SILVER INTERCONNECT CABLE  
99.99% pure silver conductors. Quality gold plated RCA phono plugs.  
Half Metre terminated £70.00 One metre terminated £90.00. Available with Eichmann plugs + £30  
New Translucent ULTRA + Heavy duty. 99.99% pure silver (4N). Eichmann Solid silver plugs  
£249.M Or £199.00 per half metre. 7 day money back guarantee if not better than existing cable

NEW. 1.0MM 99.99% Pure silver wire @£15m. 0.5mm pure silver wire @ £6.00m  
Translucent pure silver mains cable. 3 amp. £129.00 13 amp £249  
One Thing Mains cables. RFI suppressed. Silver plated conductors.Voltage spike protection.only...£70.00.

#### NEW EAR/YOSHINO EQUIPMENT

- Ear 834P MM/MC phono stage with/without volume. Brand new. Boxed at only £615
- Ear 834M MM phono stage. No volume control. Brand new Boxed at only £489
- Ear 834L Line only valve pre-amplifier.Amazing. Brand new. Boxed at only £549

TEL. 0845 123 5137 (Calls charged at local rate anywhere in the UK)  
Tel 0116 2835821 or 07802 213740 (Mobile). Callers by appt only.  
Opening times 10.00am-6.00pm Mon-Friday.10.00am-2.00pm Saturday.  
61 Aylestone drive, Aylestone, Leicester, LE2 8QE. Email classique\_sounds@yahoo.co.uk

# private ads

**hi-fi**  
WORLD  
& computer audio

Dealers must not advertise in the Private Classified section. Monthly consecutive insertions will be considered Trade advertising. The Publisher reserves the right to judge submissions.

**SPECIAL OFFER - Book a Private Classified Advert - Get One FREE!  
Plus one months FREE Internet advert. See Page 129 for order form  
This offer is only open to Private Classified advertisers**

CAMBRIDGE R40 loudspeakers, 2 pairs. £200/£250. Revox A77 2 track £125. Cambridge T55 tuner £50. Nakamichi 480 cassette £100. A&R A60 amp £50. All vgc, need space. Tel: 01442 389 952 or Email: mbond@makethedifference.net (Mar/I)

LEAK TL12+ amps, refurbished pair, excellent valve sound £475 ono. Helius Chameleon speakers HC1000 walnut finish including dedicated stands £275 ono. Tel: 01304 823 121 ask for Roger. Email: rog.rem@btinternet.com (Mar/I)

SNELL A LOUDSPEAKERS, sensational sound quality (£5000) £1250 ono. Pioneer 565 CD player, Trichord modified, Clock 4 superb sound, giveaway £500. Miller Kreisel MX125 MkII subwoofer (£1500) £850 ono. Money back guarantee. Tel: Allan 0117 952 1341 (Bristol). (Mar/I)

MAGNUM AMPLIFICATION, P200 preamp, moving coil phono stage, four line inputs, CD monitor, separate power supply (£2400) £950 ono. A200 stereo power amplifier, 300 w.p.c. outperforms Krell (£2400) £950 ono. Money back guarantee. Tel: Allan 0117 952 1341 (Bristol) (Mar/I)

LINN KAJRN phono £425. Linn LK-85 £350. NAD 3020B amp £65. Rotel RT-830L tuner £75. Rogers DB-101 speakers (opal finish) £110. Linn interconnects (x3) £25 each. Tel: 01226 211 740 evenings (Mar)

QUAD 33 pre-amp, mint and boxed. Quad 303 power-amp, excellent condition including leads £250. Tel: 020 8783 1250 or Email: anthonymurphy@blueyonder.co.uk (Mar/I)

4 GOOD USED GEC clear glass KT66 £150. 3 Good used Mullard GZ32 £30. 3 good used EF86 (Z729) £20. GKD Huntingdon cabinet £10. Garrard 4HF turntable/arm £50. Wharfedale Isodynamic headphones £20. Leak TL10 with pre-amp £250. Pair Super 8RS/DD in LNB cabinets £75. Axiom 10 £25. Tel: 0773 309 7673 or Email: nnh@dmu.ac.uk (Mar/I)

QUAD IIL speakers, piano black, little used, boxed, mint (£379) £299. Could deliver E. Midlands. Tel: 0115 960 3934 (Mar/I)

QUAD ESL988 electrostatic speakers, as new £2200 ono. Buyer collects. Tel: 01522 720 389 or Email: nuline.ellis@tiscali.co.uk (Mar/I)

AUDIO RESEARCH CD2, boxed, manuals, factory condition, superb sound, upgrading, £2250 ono. Tel: Keith 07811 272 378 or 07793 388 397 day or evenings (Black)(£3495) (Mar/I)

QUAD ESL63, brown with wood trims and stands. Mint condition £950 ono. Thorens TD150 base, cover, Thorens arm £85. Wanted: Rogers Master Mk One pre-amp. Tel: 07976 904 381 (Mar/I)

MERIDIAN 206B CD player £325. Exposure XX integrated amplifier £250. Rotel RQ970BX MM-MC phono amplifier £45. All items mint condition and boxed. Tel: 01483 855 603 (Mar/I)

MISSION 752 speakers, high gloss black ash finish, mint £235 ono. Origin Live DC turntable motor with custom power supply and oversize transformer £150. Tel: 01244 660 946 (Chester) (Mar/I)

HI-FI SYSTEM, Naim Audio NAC 82 preamplifier, Naim Audio input boards, Naim Audio HiCap power supply, Naim Audio NAPI80 power amplifier, Naim Audio CD1 CD player, Naim Audio SBL loudspeakers, Naim Audio Paxo passive crossover for above, Yamaha DSP E800 processor. (current valuation £4450 ono) Tel: 020 8300 3265 (Mar/I)

KLIPSCHORN CORNER speakers, superb, awesome (£6200) £3000. 1980's B&O system, tuner/amp, cassette deck, record deck, fourway speakers, £200. Bargain. Croft Duo mono preamplifier, recent service £200. Tel: 01202 388 688 or Email: terrymason.innerpeace@cwcrv.net (Mar/I)

MONITOR AUDIO Studio 20 SE speakers, piano black gloss finish, superb condition £850 (£2500) Tel: 07815 153 172 or Email: stephenadolphus@yahoo.com (Mar/I)

RGD 1046, GEL050 EL34 monoblocks. Leak ST60. Troughline, Rogers Cadet2. Quad 33/303, FM3/AM3. Thorens TD124/2 JR149 NOS valves wanted Pye HF25, PF91, Radford MA15/3, vgc, will sway above equipment. Tel: 01842 812 895 (Mar/I)

LINN KABER Floor standing speakers, Linn Klassik CD-amp, Linn LK85 power amp (two). All immaculate Quad tri-wired speaker cables included. Tel: 0151 709 4540 (h), 0151 709 7706 (office) £1600. (May/I)

JBL Ti5000 speakers, 3 years old, black, perfect condition £1800 (£4000). Tel: 07773 788 317 (Mar/I)

AUDIOLAB 8000A late model, vgc, £200. Rotel RCD991 AE, excellent £250. Meridian 207 DAC, vgc, £150. MF X-Act DAC, vgc, £80. Tel: 07887 527 397 (Staffs) (Mar/I)

KIMBER SELECT 1011 interconnect cables. 2 pairs £200 each (£367). 1 Russ Andrews Purifier Block, 8 outlets RA Powercord £300 (£500). Tel: 01604 410726 (Northampton) (Mar/I)

QUAD 988 CEVintage, finish, purchased August 2003, with extended warranty. £2500 (£3750). TacT M2150 digital amp, purchased September 2003, £2300 (£3800). Cards Golden Cross 0.5m with Eichmann Bullets £300. Tel: 0131 225 9002, Email: S.Hussain@ed.sac.ac.uk (Mar/I)

SNELL J2 speakers (walnut) on 'Pirates' stands. Recent new AudioNote silver drivers - nice! £475. Musical Fidelity X-Dac (HDCD) as new, boxed £150. Both ono. Tel: 07941 923 881 anytime (Sussex coast) (Mar/I)

J R 149 BI-WIRED Speakers £100. Tandberg Series 15 machine £50. Aiwa P22 power amp £25. Crimson 610 pre amp £25. Tascam M106 mixing desk £100. Chilton M12-4 mixing desk £100. Revox G36 £200. Revox A77 £200. Yamaha KX380 cassette deck £30. Aiwa AD F360 cassette deck £25. Marantz CD75 player £45. JVC DD66 3-head cassette deck £45. 7 inch tapes £3. 10 inch NAB tapes £5. Revox NAB hub adaptors £25 pair. Revox A77 acrylic cover £35. Tel: 07710 828286 anytime (Mar/I)

PRIMARE PHONO Stage pre-amp, Model R-20, vgc, £250. Tel: 01224 483 642 evenings or Email: barmonte@aol.com (Mar/I)

**CD players DACs & Transports**

	Was	Now
Arcam FMJ CD23 Silver S/H	1200	699
Audio Research CD2 S/H	3499	1795
Audio Research CD3 x-demo	4999	4249
dCS Elgar 24/192 Non Firewire S/H	8500	3999
dCS Purcell Upsampler Non Firewire S/H	2999	1695
Krell KAV280CD x-demo	3999	3250
Mark Levinson No 360s x-demo	7495	4995
Musical Fidelity Pre 24 CP Player S/H	2000	1199
Naim CD2 Player S/H	1989	995
Theta Carmen CD/DVD Transport S/H	3499	1995
Theta Data Basic Transport S/H	2397	995
Theta Generation V Balanced S/H	6290	2799
Thule Sprit CD balanced O/P x-demo	1200	649
Wadia 830 CD Player S/H	3000	1995
Wadia 301 CD Player S/H	3650	2499

**Turntables Tonearms & Cartridges**

Densen DP0 2 MC Phono Stage S/H	499	275
Gryphon Legato SAP Phono Stage x-demo	7895	5999
Kuzma Stabi/Stogi S Turntable New & Boxed	1295	1099
Lehmann Audio Black Cube SE New & Boxed	650	449
Michell Gyro SE DC Turntable S/H	875	699
McCormack Phono Stage New and Boxed	650	399
Rega RB600 "origin live" Tonearm S/H	460	299
Roksan Artexerxes X MC/MM Phono Stage S/H	450	299
Roksan Cognoscenti Xerxes Piano lacquer /Tabrizi /Corus Black S/H	2700	799
Well Tempered Ref/Reference Arm "Fountainhead" S/H	6500	3999

**Preamplifiers**

Conrad Johnson Premier 16 "Mini Art" S/H	8000	3999
Electrocompaniet EC 4.7 Preamplifier x-demo	1295	995
Gryphon Sonata Allegro 2 box preamplifier x-demo	9739	5995
Naim Audio NAC62 (old style) with phono stage S/H	N/A	175
Naim 72 k Preamplifier S/H	789	349
Roksan L2 preamplifier S/H	1295	299
Spectral DMC12 Line New & Boxed	4250	2999
Spectral DMC12 s Phono x-demo	4750	3299

**Amplifiers**

Audio Research D100.2 x-demo	3690	2799
Cyrus Straightline Amplifier S/H	549	175
Denon AVC A10SE Amplifier Processor DTS/7.1 S/H	1800	999
Graaf GM100 Valve Power Amplifier x-demo	4500	3250
Gryphon S100 Class A power amplifier S/H	6000	2500
Gryphon Calisto 2200 integrated S/H	4800	3299
Linn LK140 power amplifier S/H	799	499
Naim Audio NAP140 (old Style) power amplifier S/H	N/A	299
Naim Audio NAP180 S/H	1199	599
Spectral DMA100s Power Amplifier x-demo	4750	3499

**Loudspeakers**

Avalon Eclipse Maple x-demo	9800	6995
Definitive Technologies 2002 Centre S/H	599	349
Indigo Model Two Centre Channel Cherry S/H	199	99
JM Lab Micro Utopia be Classic 6 months old S/H	4300	3399
Living Voice Avatars OBX-R Ebony x-demo	4000	2499
Martin Logan CLSII Anniversary Electrostatics 7 months Old S/H	6700	4995
ProAc Response 1SC Cherry S/H	1299	850
Sonus R4 Stands S/H	329	199
Verity Audio Fidelio Piano Lacquer x-demo	7995	4999

**Cables & Accessories**

Acoustic Zen Silver Signature Balanced 12ft S/H	2700	1499
Argento Copper 1m RCA-RCA new & boxed	199	119
Cardas Neutral Reference 1m RCA-BNC S/H	550	375
Cogan Hall EM-D 0.6m S/H	199	99
Finite Elemente HD02 MR 3 Tier Reference Table S/H	2300	1499
Madrigal CZ Gel 1.5m Balanced new & boxed	599	299
Madrigal MDC 1pro 1m AES/EBU		
Digital cable new & boxed	319	159
Madrigal MDC 2 1m Fatboy Digital cable new & boxed	319	159
Madrigal MDC 2 0.5m Fatboy Digital cable new & boxed	279	139

Nordost Red Dawn 2x3m Speaker cable S/H	920	599
Opera Lux 3 Tier Table Clear/Stainless x-Demo	950	449
Sitech SQ58G3 2x4m Balanced Interconnect x-demo	2370	1499
Siltech LS38G3 2x4.75m Silver speaker cable/WBT S/H	1752	999
Tara Labs RSC Air 0.6 Digital AES/EBU new & boxed	398	199
Transparent Music Link Ultra Balanced 7.26m S/H	2349	1499

**Tuners & Tape Decks, Power Supplies**

AKG C1000 Condenser Mic S/H	241	110
Magnum Dynalab FT-R Remote Switcher for FT101A/Etude (New & Boxed)	450	279

**Bargains Under £100**

Arcam Alpha II CD Player S/H	N/A	99
------------------------------	-----	----

Midland Audio X-change is looking for:-

Audio Research

Krell

Mark Levinson

Naim Audio

Dcs

Wadia

cash paid call John Roberts: 01562 731100

*Suppliers and installers of High Quality Audio Systems*

- 47 Laboratory • J M Labs
- Accuphase • Krell
- ATC • Kuzma
- Audio Physic • Lavardin
- Audio Research • Mark Levinson
- Avalon Accoustics • Martin Logan
- Avid • Michell
- bel canto • Nagra
- Benz Micro • Primare
- Cardas • ProAc
- Clearaudio • Rega
- Conrad Johnson • Siltech
- dCS • Sonus Faber
- Densen • Spectral
- DNM/Reson • Nordost
- Electrocompaniet • Sugden
- Finite Elemente • Transparent Audio
- Graaf • Verity Audio
- Gryphon • Wadia

**MAX has moved..**

[www.midlandaudiox-change.co.uk](http://www.midlandaudiox-change.co.uk)

call John Roberts Tel **01562 731100**

or Fax **01562 730228**

The Old Chapel • Forge Lane • Belbroughton  
Worcestershire • DY9 9TD

e-mail [sales@midlandaudiox-change.co.uk](mailto:sales@midlandaudiox-change.co.uk)

Fax **01562 750246** Mobile **07721 605966**

# trade ads

Dealers must not advertise in the Private Classified section. Monthly consecutive insertions will be considered Trade advertising. The Publisher reserves the right to judge submissions.

**Special Internet offer see page 129 for details**

**hi-fi**  
WORLD  
& computer audio

VINYL COLLECTORS FAIR. CD's Banned. 21/3/04 - BP House, Cromwell Road, London, SW7. (Vinyl Fairs also at Bristol Temple Meads 13/3/04, Reading Rivermead 9/4/04 - Some specialist CD's allowed here.) All Fairs 10 - 4pm. Tel: 020 7831 8577 www.tvfairs.co.uk (Apr1)

**CLASSICAL VINYL** Records bought and sold. Collections large and small always wanted. Phone or email Geoff in Bedfordshire 01525 237 693, classical\_records@hotmail.com To buy our records go to: www.classical-records.8m.com /SALE%20may2.HTM (May1)

PURE EARTH and dedicated mains (electrical) circuits design and installation service. Contact MainsDoctor 07989 200 961, Email: mainsdoctor@yahoo.co.uk Website: www.mainsdoctor.co.uk We install for all audio and video applications (Feb051)

VINTAGE WIRELESS COMPANY LONDON Website: www.vintagewirelesslondon.co.uk Buy-Sell-Exchange. Vintage wireless and classical audio. Repairs, spares, restoration, modification to all valve equipment. Quad II, Leaks etc, shipped worldwide, best prices, call us at 17 Bell Street, London, NW1 5BY. Tel: 020 7258 3448 Fax 020 7258 3449 Email: vwirelesslondon@aol.com (Dec041)

BRILLIANCE CUSTOM-MADE Audiophile Cables. Synergy interconnects from £45. "The sound per pound ratio is superb" HFW Jan04. Equally capable digital A/V interconnects and speaker cables available. Contact Mike 07963 117 341 or Email: brilliance@ntlworld.com (Apr1)

AUDIOQUEST OPAL Truth RCA, 1.0 mtr (£260) £170. QUAD 989 Brand new, cancelled order (£4600) £3900. Naim NAC 32.5 pre, with phono stage, mint condition £230. Telephone Jules on 01792 280061, Email info@sounddrjuleshifi.co.uk Web: www.sounddrjuleshifi.co.uk (Apr1)

AUDIO RESEARCH M300 Mono Blocks MkII status (£12000) £3400. Tom Evans the Groove, phono stage, 2yrs, (£1800) £1200. Basis Debut Gold Standard Turntable, inc custom dust cover, (£8,500) £3490. Koetsu Red Signature \*, 20hrs, (£2200) £1250. All mint, boxed. Telephone Jules on 01792 280061, Email: info@sounddrjuleshifi.co.uk Web: www.sounddrjuleshifi.co.uk (Apr1)

TRANSPARENT ULTRA Bi Wire 12ft, WBT Bananas (£3440) £1700 Siltec Arm cable, Icheman bullets RCA's 1.5mts (£400) £250. Siltec 1.0 mtr RCA-RCA (£300) £170. Audiolab 8000CDM trans/DAC, excellent condition (£2500) £650 ono. Telephone Jules on 01792 280061, Email: info@sounddrjuleshifi.co.uk Web: www.sounddrjuleshifi.co.uk (Apr1)

LINN CD 12 , Aug 02, mint, boxed as new, (£12000) £8800 Linn Klimax Twin Power amp, 8 months old, as new (£6000) £4700. Linn Kellidh's, black ash, active cards, passive (£1000) £450. AudioTechnica OC9 cartridge brand new £270. Telephone Jules on 01792 280061, Email: info@sounddrjuleshifi.co.uk Web: www.sounddrjuleshifi.co.uk (Apr1)

AUDIONOTE M3 Pre amp, includes very good phono stage, excellent condition, ex-dem, fully guaranteed. (£4650) £2100 Mark Levinson ML383 integrated amp (as new) (RRP £6000) £4200. Wadia 16, 4yrs, mint (£7450) £3100. Telephone Jules on 01792 280061, Email: info@sounddrjuleshifi.co.uk Web: www.sounddrjuleshifi.co.uk (Apr1)

AMAZING CABLES! Solid silver interconnects from £110, with air / teflon insulation and WBT plugs. Solid silver / teflon speaker cables from £250. Fantastic performance, refund guarantee. 0115 982 5772 after 7pm, email bob@skydivers.co.uk (Jun1)

NEW VALVE Amps; powers £260; matching preamp £190; other valve related goodies at www.audioclassics.co.uk or telephone 01942 257525 for more information. Dealer enquiries welcome. (Apr1)

AUDIOPUBLIC, 78 Otley Road, Headingley, Leeds, 0113 217 7294. Yorkshire's newest Hi-Fi retailer, stockists of Naim Audio, Rega Research, Conrad Johnson, Sugden, Dynavector, (cartridges and amplifiers) and many more. Please call for advice. (Apr1)

MICHELL ORBE £1800. Orbe SE £1600. Tom Evans Groove £1450. Vibe £2100. Transfiguration Temper V £1800. Spirit3 £750. All brand new, full guarantees. Ian Harrison Hi-Fi Sale. Tel: 01283 702 875 (Apr1)

CLEARAUDIO REFERENCE £3250. Insider £4500. Accurate £2250. Koetsu Black £800. Jade £4450. Orelle CA100 £795. Orelle SPI00 £795. All brand new, full guarantees. Ian Harrison Hi-Fi Sale. Tel: 01283 702 875 (Apr1)

WORTHING AUDIO True Sound Series Crossoverless monitors 96dB efficiency, single 8" driver, perfect for low powered tube (S.E.T.) and solid state. Dynaudio Crafts, immaculate, boxed, with Dynaudio stands £1250. Musica Collins loudspeakers by Bernard Thiel & Partners (German) £1000. Tel: Worthing Audio 01903 212 133 or 07900 918 382 (Apr1)

EAR PRODUCTS on permanent demonstration, from the wonderful 869 to the rest of the range. Kora Explora 60 watt hybrid £450. Dynaudio Contours 1.3's Mk2 £699. Harbeth Super 5's £1499. Restek Challenger £600. Omega speaker systems TSR IR £1199. H-Cat P12 £2499. Kora Equinox pre-amplifier MM £995. Kora Hermes 96-192 valve DAC £1199. Tel: Worthing Audio 01903 212 133 or 07900 918 882 (Apr1)

SILVER ARROW 4N plus - Pure flat silver foil air interconnects and speaker cables. RDC Aspekt 3 tier in black, Editors Choice Hi-Fi Plus, £340. Audio Note CD Zero transport plus 1x Signature deck in silver £650 combo. Mains leads, Experience Filtration £75 per lead, £150 four way block. Tel: Worthing Audio 01903 212 133 or 07900 918 882 (Apr1)

REVEL PERFORMA F50 loudspeakers, new £4995. Revel Performa M20 loudspeakers, ex-dem £1495. Revel Ultima LE1 amp & 2 Sub-15 subwoofers, ex-dem £4995. Proceed BPA3 3 channel balanced power amp, new £2495. ESLab DX-S4 200w digital power amp, new £1795. ESLab DX-S8 300w digital power amp, new £1995. Quad ESL 63 loudspeakers £995. Horsham Hi-Fi. Tel: 01403 272 931 (Apr1)

# UK SUBSCRIPTION £36

VISIT OUR WEBSITE: [www.hi-fiworld.co.uk](http://www.hi-fiworld.co.uk)



**YES!** I want to subscribe to Hi-Fi World for:-

£36.00 for 12 months

**Your Details**

Title \_\_\_\_\_ Initial \_\_\_\_\_ Surname \_\_\_\_\_

Address \_\_\_\_\_

Post Code \_\_\_\_\_

Daytime Tel: \_\_\_\_\_

Start Issue \_\_\_\_\_

Delivery Address (if different) \_\_\_\_\_

\_\_\_\_\_

\_\_\_\_\_

\_\_\_\_\_

I would like to pay by cheque made payable to Audio Publishing Ltd.

Please debit my VISA  MASTER  SWITCH  AMEX

Security No:  (last three digits printed on the signature strip)

Switch card issue No:  Expiry Date: \_\_\_\_/\_\_\_\_/\_\_\_\_

Cardholder Signature: \_\_\_\_\_



**Please choose service:-**

**ZONE 1** USA, Canada, Africa

**ZONE 2** Australia, Japan, Korea, China, Middle East & South East Asia

**ZONE 1** Airmail £60.00

**ZONE 2** Airmail £70.00

**Send this form to:**  
 Hi-Fi World, Subscriptions Department  
 PO Box 464, Berkhamsted, Hertfordshire  
 HP4 2UR

## SPECIAL INTRODUCTORY OFFER!

£36.00 for 12 months plus 1 additional issue free. That's a saving of 40p per issue and includes **FREE postage & packaging.**



**Get your issue of hi-fi world straight to your door!**

**Get to our amazing classified ads first and grab a bargain!!**

- > Run by dedicated hi-fi engineers and enthusiasts.
- > Hi-Fi World has become famous for its informative reviews and radical kit designs.

## NEW NUMBERS

**Hotline**  
**+44 (0) 1442 879097**

**Fax No:**  
**+44 (0) 1442 872279**

**email:**  
**hifiworld@webscribe.co.uk**

**For Back Issues enquires please contact the above numbers**

# trade ads

Dealers must not advertise in the Private Classified section. Monthly consecutive insertions will be considered Trade advertising. The Publisher reserves the right to judge submissions.

**hi-fi**  
WORLD  
& computer audio

**Special Internet offer see page 129 for details**

MARK LEVINSON No.334 amplifier £3250. Martin Logan Aeons £2350. ATC SCM 35 loudspeakers £1695. Theta David II DVD/CD transport £2500. Gamut C2R preamplifier £995. IMF TLS 50 loudspeakers £295. Revox B26 FM tuner £395. Horsham Hi-Fi. Tel: 01403 272 931 (Apr/1)

ROGERS LS5/8 £350. Amcron PB-One £500. Fostex D20 DAT £650. Technics SP10 MkII £300. Nagra 4-Stereo £1400. Studer B67 VU £750. A62 £600. A80 VU £950. Revox B710 MkII £450. PR99 MkIII £950. PR MkII £750. Tel: 01246 275 479 (Apr/1)

FARADAY TOWER low density concrete cabinet floorstanding loudspeakers. Sublime sound and looks, see faradaysound.co.uk for full spec. Perfect condition, ABR bass, black, reluctant sale, £700 ono. Delivery possible. Tel: 01603 766 668 (Apr/1)

**THE MISSING LINK.** We are proud to announce our new family of no-compromise 5n Pure Silver Cryogenically treated Ltz Loudspeaker Cables and Interconnects ... Designed and Made in England by Music Lovers for Music Lovers. A limited number of Demo Cables are available by arrangement... Visit [www.the-missing-link.net](http://www.the-missing-link.net) for information and reviews or phone Mark on 0115 877 9089 (Jun/1)

VINYL COLLECTORS FAIR. CD's Banned 21/3/04 - BP House, Cromwell Road, London, SW7. (Vinyl Fairs also at Bristol Temple Meads 13/3/04, Reading Rivermead 9/4/04 - Some specialist CD's allowed here.) All Fairs 10 - 4pm. Tel: 020 7831 8577 [www.tvfairs.co.uk](http://www.tvfairs.co.uk) (Apr/1)

**CLASSICAL VINYL Records** bought and sold. Collections large and small always wanted. Phone or email Geoff in Bedfordshire 01525 237 693, [classical\\_records@hotmail.com](mailto:classical_records@hotmail.com) To buy our records go to: [www.classical-records.8m.com](http://www.classical-records.8m.com) /SALE%20may2.HTM (May/1)

**WANTED: DAMAGED** or non-functioning Krell power amplifiers. Telephone Nick Sheldon 07947 245 651 or Email: [nick\\_sheldon@yahoo.com](mailto:nick_sheldon@yahoo.com) Cash waiting, will collect. (Apr/1)

**NEW VALVE Amps;** powers £260; matching preamp £190; other valve related goodies at [www.audioclassics.co.uk](http://www.audioclassics.co.uk) or telephone 01942 257525 for more information. Dealer enquiries welcome. (Apr/1)

VINTAGE WIRELESS COMPANY LONDON  
Website: [www.vintagewirelesslondon.co.uk](http://www.vintagewirelesslondon.co.uk)  
Buy-Sell-Exchange. Vintage wireless and classical audio. Repairs, spares, restoration, modification to all valve equipment. Quad II, Leaks etc, shipped worldwide, best prices, call us at 17 Bell Street, London, NW1 5BY. Tel: 020 7258 3448 Fax 020 7258 3449 Email: [vwirelesslondon@aol.com](mailto:vwirelesslondon@aol.com) (Dec04/1)

REVEL PERFORMA F50 loudspeakers, new £4995. Revel Performa M20 loudspeakers, ex-dem £1495. Revel Ultima LE1 amp & 2 Sub-15 subwoofers, ex-dem £4995. Proceed BPA3 3 channel balanced power amp, new £2495. ESLab DX-S4 200w digital power amp, new £1795. ESLab DX-S8 300w digital power amp, new £1995. Quad ESL 63 loudspeakers £995. Horsham Hi-Fi. Tel: 01403 272 931 (Apr/1)

## GUIDELINES FOR BUYING AND SELLING SECOND-HAND EQUIPMENT

### FOR THE BUYER

1. Not everyone is honest - Buyer Beware!
2. **Don't send cash!**
3. Accept no verbal guarantees.
4. Have you heard the item or something similar? If not, why do you want it?
5. Don't pretend to have knowledge - it's your fingers that will get burnt!
6. Is it working? If not, why not?
7. Has it been modified and, if so, have notes been kept?
8. Was it any good in the first place?
9. **Don't send cash!**
10. If you are in the slightest doubt, arrange an audition (see point 5). If it's too far, wait for another time.
11. Either buy it or don't: vendors are excusably impatient with 'consultation' exercises.
12. **Don't send cash!**

### FOR THE SELLER

1. Not everyone is honest - Seller Beware!
2. Make no verbal guarantees.
3. Even 'nearly new' is still second-hand. If the manufacturer's guarantee is no longer in force, your price should reflect this.
4. There is very little intrinsic value in second-hand hi-fi; it's only worth what some one will pay for it.
5. The best guide to pricing is last month's Classifieds: that a 'classic' was worth £xxx a year or two ago is no guide. Values fall as well as rise.
6. Amateur second-hand dealing is not a big money game: you win some, you lose some.
7. Be prompt with despatch. If in doubt about buyer's bona-fides, either wash out the deal or send C.O.D.
8. There will always be time-wasters; be tolerant within reason!

**DEADLINE FOR MAY 2004 ISSUE IS 4TH MARCH 2004**  
**MAY 2004 ISSUE ON SALE 31ST MARCH 2004**

**DEADLINE FOR JUNE 2004 ISSUE IS 7TH APRIL 2004**  
**JUNE 2004 ISSUE ON SALE 30TH APRIL 2004**

The most important and expensive components of a valve amplifier are valves and transformers. £200 or £500 for a pair of huge "push pull" output transformers produces good bass + lots of "inter leaved" windings for better high frequency and "stability". Huge £150 mains transformers gives a less "processed" sound. Selected "matched" set of valves cost £50 or £160. If we could achieve the same quality of sound with £10 volume control, £10 wires, £10 capacitor, we could have saved a lot of money!!!

Money back guarantee (less £30 UK or £100 overseas) that you prefer :-  
 £850 or £1,000 or £1,250 or £1,450 "KT88 Triode Connection" amplifiers to most transistor amplifiers, most transistor / valve hybrid amplifiers, most Single Ended valve amplifiers, most Ultra Linear valve amplifiers selling for £2,000 to £20,000

£850 "KT88 Triode Connection" + high quality £350 "3 way" speakers to "ultra linear" valve amplifiers + £600 "2 way" and "2.5 way" speakers

£700 EL34 valve amplifiers (40 watts + 40 watts) to most transistor amplifiers and transistor / valve hybrid amplifiers costing £1,000 to £2,000

£500 EL34 valve amplifiers (40 watts + 40 watts) to most £700 amplifiers.

Telephone 01634 268662 anytime or 01634 373410 for Mr Andrew Everard's review in Gramophone Magazine and Summary of 21 testimonials from satisfied customers. [www.affordablevalvecompany.co.uk](http://www.affordablevalvecompany.co.uk)

[www.affordablevalvecompany.com](http://www.affordablevalvecompany.com)

**Buy direct & save £££**

Shop prices are expensive because of rent, rates, wages

**Free UK delivery**

Subsidised £50 UPS delivery to overseas countries.

4 years of proven reliability.  
 2 years guarantee.



KT88 valves are more expensive than 6550 valves  
 £1,250 Triode Connection  
 £1,400 Ultra Linear £1,050 £1,150



KT88 valves are more expensive than 6550 valve  
 £850 Triode Connection  
 £1,000 Ultra Linear £650 £750  
 Properly matched famous Svetana EL34 valves  
 40 watt + 40 watt  
 Upgradeable to £1,000 KT88 amplifier +£50 carriage +£50 for used valves £600 £700



# WITHDRAWN

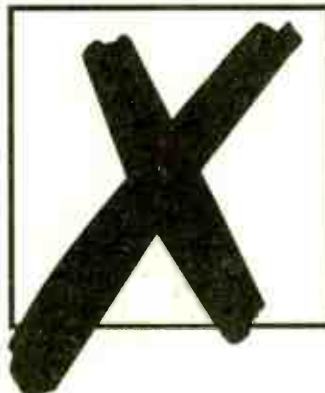

**If an ad misleads, we're here to stamp it out.**

Advertising Standards Authority

2 Torrington Place London WC1E 7HW 020 7580 5555 [www.asa.org.uk](http://www.asa.org.uk)





# classifieds ads order form

## RATES - ALL ADVERTS MUST BE PRE-PAID

Maximum length per advert is 30 words, each additional word is 50p extra. Telephone numbers and E-mail addresses are treated as one word. Model numbers are treated as one word i.e. Quad 303 = two words. Please tick the box for the advert required

In a rush to get your advert published? Why not use our Instant Internet Advert to get on our website immediately. Only £15 per week (7 days)

Dealers must not advertise in the Private Classified section. Monthly consecutive insertions will be considered Trade advertising. The Publisher reserves the right to judge submissions

## SPECIAL OFFER!!!

Book a private classified advert, and get one free, plus one months \*FREE internet advert  
**THIS OFFER OPEN TO PRIVATE ADVERTISERS ONLY!**  
 \*FREE internet adverts are published three weeks AFTER the magazine has been published

Instant Internet Only Advert Private or Trade published immediately	£15 per week	<input type="checkbox"/>
Private magazine advert plus *FREE internet advert	£10 per month	<input type="checkbox"/>
Private magazine advert display black box plus *FREE internet advert	£15 per month	<input type="checkbox"/>
Trade magazine advert plus *FREE internet advert	£10 per month	<input type="checkbox"/>
Trade magazine advert display black box plus *FREE internet advert	£15 per month	<input type="checkbox"/>
Please tick here if you <b>DO NOT WANT</b> your FREE internet advert <input type="checkbox"/>		

Please write or type your advertisement copy in block capitals with one word per box.

Please continue on a separate sheet if necessary.

WE WILL ACCEPT PHOTOCOPIES OF THIS FORM

1	2
3	4
5	6
7	8
9	10
11	12
13	14
15	16
17	18
19	20
21	22
23	24
25	26
27	28
29	30

Name \_\_\_\_\_  
 Address \_\_\_\_\_  
 Post Code \_\_\_\_\_  
 Daytime Tel: \_\_\_\_\_

Please debit my VISA/MASTER/SWITCH Card No. (Switch card issue No \_\_\_\_\_)

Expiry Date: \_\_\_\_\_ Cardholder Signature: \_\_\_\_\_

I enclose a cheque/postal order for £ \_\_\_\_\_ Made payable to: Audio Publishing Ltd.

Send in your private classified ads with our NEW Freepost service. No need for a stamp!

Send this form together with your payment in an envelope marked:

**Hi-Fi World, FREEPOST LON3478, LONDON NW6 6YR**



## PRIVATE & TRADE CLASSIFIED ADVERTS COPY DEADLINES

MAY 2004 ISSUE - 4TH MARCH 2004

JUNE 2004 ISSUE - 7TH APRIL 2004

## ADVERTISERS INDEX

AAudio Solutions	IFC
Absolute Sounds	90
Advertising Std. Agency	128
Affordable Valve	128
Audio Venue	60
Audusa	108
Beauhorn	10
Billy Vee	82
Border Patrol	60
Central Audio	114
Choice Hi-Fi	80
Classique Sounds	109
Connoisseur Audio	113
Custom Cable	107
DefinitiveAudio (Notts.)	60
Diverse Vinyl	116
Hadcock	115
Heathcote Audio	107
Heatherdale Audio	115
Hi-Fi Sounds	112
Hi-Fi Trading Co.	104,105,106
Ian Edwards	82
Ian Harrison	115
Icon Audio	90
Jem Distribution	103
KJ West One	52
LC Audio	10
Linn	6
Mantra Audio	90
Matrix	118
Michell Engineering	56
Midland Audio Exchange	110
Mission	BC
Musical Fidelity	IBC
N.V.C.F	112
Origin Live	36,118
Oxford Audio	114
Pinewood Music	109
Retro Reproduction	103
Sevenoaks	27,28,29,30,31,32,33,46
Sound of Music (Crewe)	109
Soundstage	111
Sussex Surplus	113
The Chord Company	14
The Listening Rooms	116
The Right Note	14
Trichord	36
True Colours	111
Tube Shop	82
UKD	56
V*Audio	115
Walrus	16
Weald Audio	112
Williams Hart	111
Wilmslow Audio	62

## DIY SUPPLEMENT No.78

Audio Xpress	92
BK Electronics	98
Chelmer Valve	92
Falcon Acoustics	92
Hi End Cable	98
Kit & Components	102
Langrex	100
Sound Spares	98
Sowter Transformers	98
Watford Valves	100
White Noise	92

# "Chanting The Mantra"

**Vinyl's all the rage right now, but it's still very much a hobbyist thing. The eighties was analogue disc's last stand as a mass music carrier, and spawned a variety of affordable and interesting turntables such as Manticore's Mantra. Dominic Todd remembers it...**

**T**he fact that there is nothing outstanding about the Manticore Mantra might make you wonder the reason for its inclusion here. After all, there was nothing ground-breaking, sonically or in engineering terms, about the Mantra when introduced in the mid 1980s. Yet, despite its very ordinariness, it was important at the time.

During the late '80s, turntable sales were still reasonably strong, and there were various stalwarts already well established. Essentially, if you were on a budget you'd get a NAD 5120, Ariston Q-Deck or Dual CS505. A little more would get you a Rega Planar 2 or 3. If you were really into your vinyl then, likely as not, you'd be demo-ing a Linn LP12, Roksan Xerxes or Michell GyroDec. The trouble here is that there was something of a gap between these two latter market sectors, and it's here where Manticore stepped in. Yes, there was the Systemdek IIX and Linn Axis, but neither was really a great step up from the Regas.

The Mantra's construction was

totally conventional. The real wood veneered plinth covered a steel subchassis, isolated by three springs. The Nylatron sub platter sat on a standard, but finely made bearing. On top of this was a glass platter and felt mat. Things didn't get a great deal more exciting with the motor. The Airpax (Philips) 24-Pole AC synchronous motor was standard fare at the time, however it could be upgraded. Indeed one of the best aspects of Manticore ownership was the stream of Linn LP12-like improvements that could be made - for £120 the upgraded motor unit featured improved mountings and was encased in Acetal to reduce vibration and promote smoothness.

Another upgrade centred around the power supply. For £220, Manticore would supply you with a 'pure synthesised' 50Hz outboard, twin speed, power supply in its very own veneered box, just like the big boys! Unlike most other decks though, the beauty of the Mantra was that the PSU upgrade could be just plugged in without any further modification needed. This was a

user friendly upgrade in a very user friendly deck. Yet, don't for one moment think that this meant average in terms of sound quality. True, the standard Manticore couldn't match the LP12, Xerxes or GyroDec, but it came closer than you might think. With a Rega RB250 or 300 arm the sound was neutral and

detailed. It was only really in the frequency extremes that the Manticore became a little ragged and even then, compared to the brash Linn Axis, was sweetness itself.

Moving to the matching Musician tonearm sweetened the sound still further, yet not in an overly euphonic way. This beautifully made arm was something of a bargain at the time, retailing for just £170 in 1989. The Linn type cut out makes it adaptable to many decks, and today its anonymity makes it, on its own, a used bargain. It shouldn't cost much more than a Rega RB250, yet offers so much more in terms of detail. Feeling a bit flash? If you really couldn't stop upgrading your Mantra, then there was always the Magician arm. At £575 it was far more than the deck itself yet, with its polished silver finish, looked gorgeous. The van den Hul cabling did its bit and this was a very tidy sounding tonearm, but then at nearly £100 more than an SME 309 of the time, it needed to be!

Needless to say a fully spec'd Mantra could happily trade punches with a basic LP12, Xerxes or Gyro. There really was very little criticism that was levelled at it at the time, and its unassuming manner made it a beguiling bit of kit to listen to. I happily lived with one during the late eighties, and was sad to see it ousted by the more 'reviewer friendly' (i.e. taut and precise) Xerxes/Artemiz combo that replaced it in 1992. Yet because it never had the image, Mantras now go for less than their true worth. Get a good basic one for under £200, and you've a decent step up from the Rega standard. If you manage to track one down with all the bells and whistles, then you're in for a real treat, in fact at its likely price now, an exceptional one.

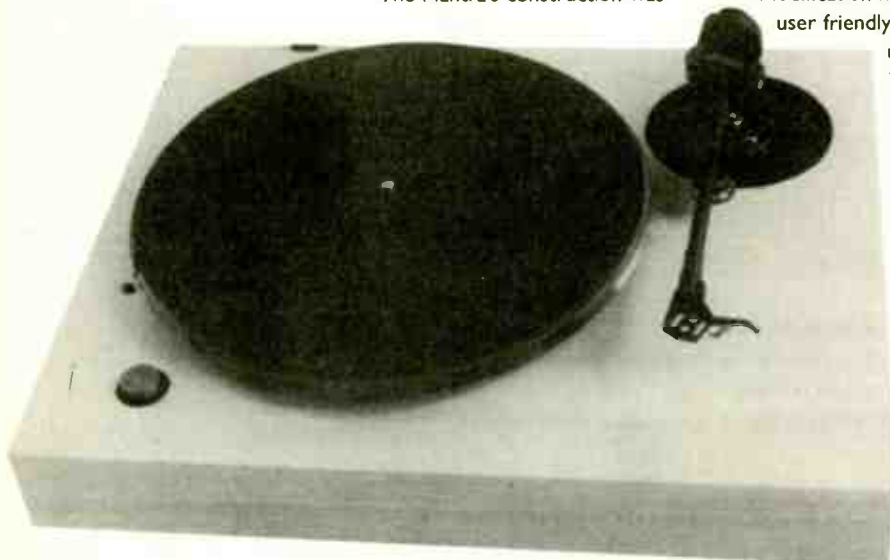



A3.2 SERIES.

MACHINED, MIL-SPEC ALUMINIUM FRONT PANEL.  
PLATINUM PLATED FITTINGS. REMOTE CONTROLLED. PHONO STAGE.  
POWERFUL, ROBUST, BUILT.



# v63 - European Loudspeaker of the Year 2003/2004



Simple Perfect Sound

**volare**

**MISSION**

Tel: +44 (0) 1460 423700  
[www.mission.co.uk](http://www.mission.co.uk)

Base stands not supplied with bookshelf speakers  
Also available in Cherry finish



