

Only
£2.00

HIFI WORLD

JUNE 1994 £2.00

**REVOLUTIONARY TANNOY
ELECTRONIC SUBWOOFER**

SCOOP!

**NEW TUBE
TECHNOLOGY
GENESIS VALVE
AMPLIFIER**

SCOOP!

**DIY
SUPPLEMENT
No. 8
banded to
this issue**

**SIX BUDGET
AMPLIFIERS ON TEST
LINN KLYDE CARTRIDGE**

**LATEST
MARANTZ
CD-63
CD PLAYER**

**COMPETITION - FIVE PAIRS OF TOP
KEF LOUDSPEAKERS TO BE WON
KEF REFERENCE 105/3 (1pr), REFERENCE 101/3 (4prs).**



The truth,
the whole truth,
and nothing but the truth . . .



. . . so help me DPA!

It is a truth universally acknowledged, that clarity of sound allows true involvement with music.

Recognised Hi-Fi critics throughout the world have consistently praised DPA's products for their unrivalled clarity and transparency of sound reproduction. This inevitably leads to more profound musical experiences.

After years of development, the 200S pre and power amplifiers have been perfected. The amplifiers share the technology that has so inspired reviewer's praise in the past. The 200S combination at £1,250 gives state of the art performance at a reasonable price.

If you crave musical truth, contact DPA so we can help.

dpa

DPA Digital Ltd., Unit 7, Willowbrook Tech. Units, Crickhowell Rd., St. Mellons, Cardiff CF3 0EI Tel (0222) 795621 Fax (0222) 794267



EXPERIENCE MUSICAL TRUTH



45 High Street, Hounslow, Middx.
TW3 1RH
Tel: 081 569 5802
(Also at Edgware, Middx,
Tel. 081 952 5535)



34, Buckingham palace
Road, London SW1W ORE
Tel: 071 - 233 0774
Fax: 071 - 233 7226

audible difference

Scole, Diss, Norfolk.
IP21 4DX.
Tel : 0379 740227



Chantry Walk,
16/18A Eldon Street,
Tuxford, Nr Newark,
Notts NG22 OLH.
Tel: 0777 870372

SHROPSHIRE HI-FI

St. Michael's Street,
Shrewsbury,
Shropshire SY1 2ES.
Tel: 0743 232317



NEW 200S PRE POWER £1250

Doug Brady Hi-Fi

Kingsway Studios,
Kingsway North,
Warrington.
Tel: 0925 828009
(Also at Liverpool, London
and Otley, Nr Leeds)



Tel/Fax: 0252 377952

Audio Suite

42 St. Andrews Street,
Aberdeen AB1 1JA.
Tel: 0224 625 635



152A High Street,
Bloxwich,
West Midlands.
Tel: 0922 493499



41 Victoria Road,
Cambridge.
CB4 3BW.
Tel: 0223 68305

ZEUS AUDIO

2/4 Great Victoria Street,
Belfast BT2 7BA.
Northern Ireland.
Tel: 0232 332522



KJ WEST ONE

26 New Cavendish
Street,
London W1M 7LH.
Tel: 071 486 8262



93 Hobs Moat Road,
Solihull,
W. Midlands
Tel: 021 742 0254

Oxford Audio Consultants

Cantay House,
Park End Street,
Oxford OX1 1JE
Tel: 0865 790879
Fax: 0865 791665

PJ Hi-Fi

3 Bridge Street
Guildford,
Surrey.
Tel: 0483 504801

AT OUR KEY DEALERS

dpa digital ltd

Unit 7, Willowbrook Technical Units,
Crickhowell Road, St. Mellons, Cardiff CF3 OEF, Wales, UK
Phone: 0222 795621 Fax: 0222 794267



Cover Photograph by
Paul Hartley Studio 071- 482 3768

THIS MONTH'S REVIEWS

AMPLIFIERS

TUBE TECHNOLOGY GENESIS 14
Noel Keywood asks whether this stunningly finished valve amplifier can also offer state of the art sound.



BUDGET AMPLIFIER TEST 27
With the budget market as competitive as ever, we listen to the latest offerings from the UK and Japan to find out who's in front.

PIONEER A-300X
DENON PMA-350 II
NAD 304
ROTEL RA-935BX
AURA VA50
ARCAM ALPHA 5

HARMAN/KARDON SIGNATURE 64
Is Sidney Harman's signature enough of an endorsement for this pre/power amp. Simon Cooke finds out.

COMPACT DISC

MONARCHY 24
A high quality CD convertor and transport from the States. Do the Americans, with their chip manufacturers, have a lead? Dominic Baker takes a long listen.



MARANTZ CD-63 48
Dominic Todd listens to the latest player in a long line of successful budget machines from this respected Japanese company.



**AMERICAN
and
CANADIAN
SUBSCRIPTIONS**
- see page 60

LOUDSPEAKERS

TANNOY 625ALF ACTIVE SUBWOOFER 19
Tannoy apply feedback to a subwoofer for better bass control. We test the first one ever.

ROGERS STUDIO 5 42
The new medium sized monitor building on a pedigree founded in broadcasting.

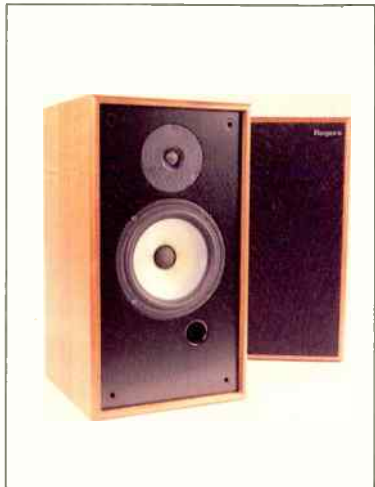

SENTEC AURORA 56
Scandinavian high-end. Do these large and unusual speakers make enough music to satisfy British ears?

TURNTABLES

LINN KLYDE 50
A new moving coil cartridge from the influential Scots, fully tested by our team.

TUNERS

MAXVIEW PROFILE ANTENNA 53
Here's a new indoor aerial designed specially for FM use. But does it give good enough reception for real hi-fi use? We apply some tough tests.

REGULARS

NEWS 8
New products and the latest gossip from around the hi-fi scene.

LETTERS 40
More alternative views on hi-fi from our ever expanding postbag.

Editor
Noel Keywood

Assistant Editor
Dominic Baker

Production Editor
Ferewini T. Michael

General Manager
Mark Winfield

Marketing Manager
Richard Johnson

Advertising Director
Caroline Knott
Advertising Tel: 071-266 0969

Design Engineer
Andy Grove

Technical Assistant
Nick Lucas

Contributors
Eric Braithwaite
Richard Brice
Giovanni Dadomo
Peter Herring
Simon Hopkins
Dominic Todd

Cartoonist
Freddy Ahmet

Distributed by:
COMAG, Tavistock Road, West
Drayton, Middlesex, UB7 7QE
Tel: 0895 444055

Origination by:
Ashford Scanning
2 Norfolk Drive,
Fairwood Industrial Park,
Ashford, Kent TN23 2PB
Tel: 0233 622042

Printed by:
Southernprint, Poole, Dorset.
Tel: 0202 622226

AUDIO PUBLISHING LTD.,
64 Castellain Road, Maida Vale,
London W9 1EX.
Tel: 071-289 3533
Fax: 071-289 5620
Queries cannot be answered
by telephone.

MAIL ORDER
Tel: 071-266 0461 (24 hours)

Subscription Rates:
UK: £22,
Overseas Surface: £29, Airmail:
£42 (Europe & Middle East),
£62 (Australia, Japan & China).

No material may be reproduced
from this magazine without
the publisher's written
permission.
© Audio Publishing Ltd

Q&A 115
Some of the most extensive and knowledgeable answers in the business from a range of experts, including our in-house team.

COLUMNS 61,63,69,71
This month's outlook on some important issues from the regular team.

NEXT ISSUE 60
Will July's scorching hot issue fulfil all your midsummer nights dreams?

SUBSCRIPTIONS 68
Make sure you receive your copy of Hi-Fi World every month.

ACCESSORIES 97
Hi-fi tweaks that work.

DIAL-A-DEALER 89
Want to get in touch with your local hi-fi emporium? All the info is here.

WORLD AUDIO DESIGN 81
Valve amps, and more from our expert design team.

MEET YOUR MAKER 84
Manufacturer listings

WORLD FAVOURITES 110
A selection of the finest products reviewed in the magazine.

CLASSIFIEDS 125
Second-hand bargains

ADVERTISER'S INDEX 130

FEATURES

ROTTING CDs 36
Does all the media attention surrounding the latest CD scare story warrant concern? Noel Keywood investigates.

TRACTRIX HORN LOUDSPEAKERS 58
A look at an early but much admired horn loudspeaker, the Voigt Tractrix. We picture a unique model recently recovered from a dance hall.

DIY SUPPLEMENT

Featured in this month's DIY Supplement:

Letters

Build the 101 mini-monitor from the Speaker Co.

13 woofers tested by Dominic Baker

A 211 bedside lamp for sweet dreams

An unusual compensated passive preamplifier

DIY Queries

New product news

Book reviews

MUSIC

Our guide to some of the best new releases.

ROCK RECORD OF THE MONTH:

Pulp : His 'N' Hers

CLASSICAL RECORD OF THE MONTH:

Wolfgang Amadeus Mozart: Die Zauberflöte (The Magic Flute)

ROCK AND POP 73

CLASSICAL 85

JAZZ 93

COMPETITION

COMPETITION 66
For this month's competition we raided KEF's warehouse. Into the swag-bag went one pair of floorstanding Reference 105/3s worth £2395, plus no fewer than four pairs of bookshelf Reference 101/3s, at £549 a pair. So this month's competition will net no fewer than five lucky winners.



CONTENTS

PHILIPS INVENTS

The Digital Compact Cassette

When it comes to sound quality, for Sting "good" just isn't good enough. He demands that his music is reproduced perfectly. That's why he is so impressed with Philips latest invention. DCC.



A digital cassette with the pure sound quality of a compact disc and the convenience of a compact cassette. There's a complete range of equipment, so you can play your DCC anywhere, in the home, in the car or on the street. And don't worry

about your collection of ordinary compact cassettes, the beauty of the DCC system is that it will play them too. DCC is already a big hit with the major record companies with hundreds of titles already available. So don't make a mistake, choose DCC. For details of stockists and further information telephone 081-665 6350.



DCC 600 Player/Recorder



FW 91 DCC System



DCC 130 Portable



DCC 811 In-car



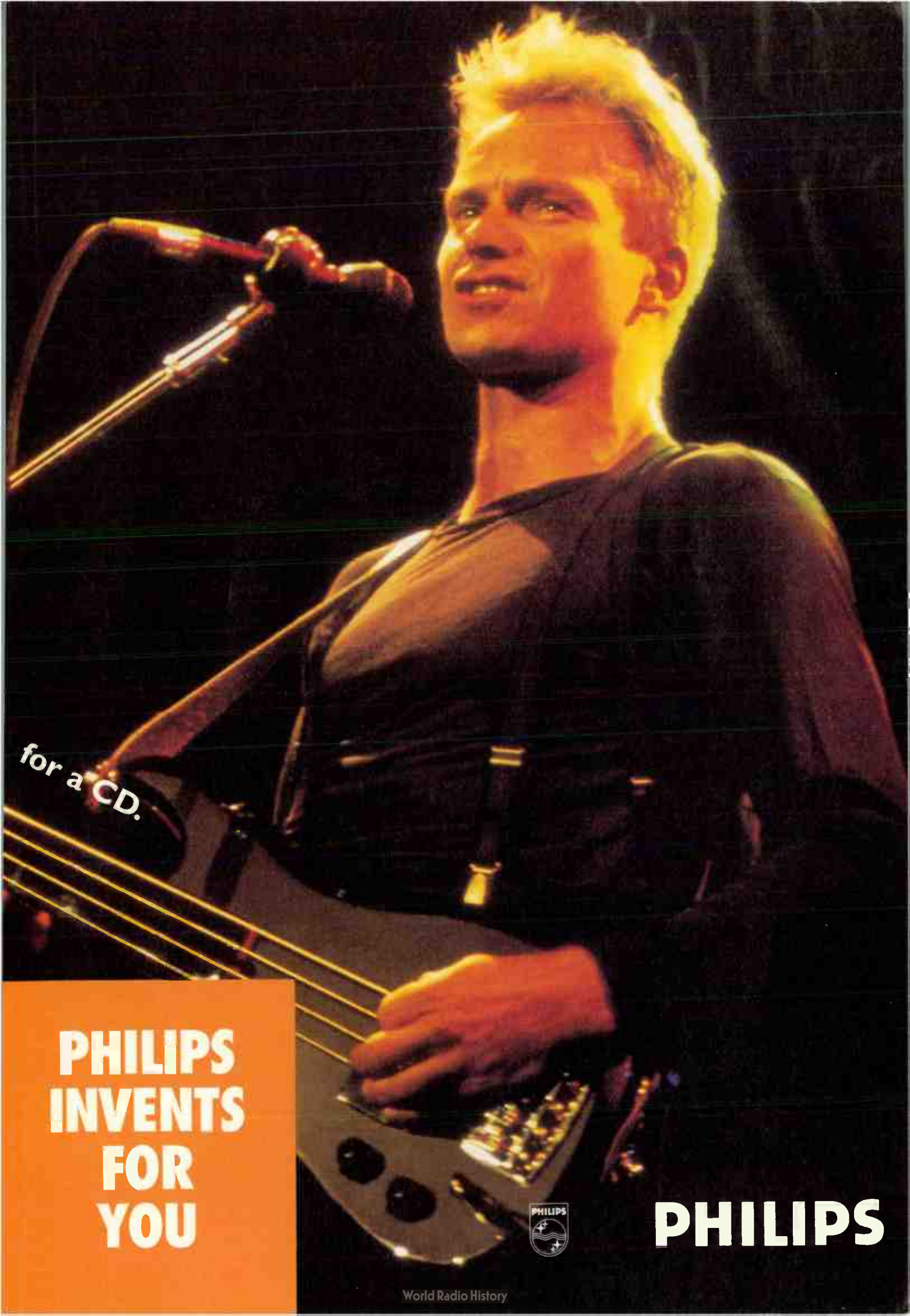

for a CD.

**PHILIPS
INVENTS
FOR
YOU**



PHILIPS

TANNOY GET ACTIVE IN THE BASS

Tannoy has just launched a fascinating new subwoofer which uses active sensing to provide feedback correction, so ensuring deep and uniquely clean bass. Aware that the boffins at Hi-Fi World have been experimenting with motional feedback subwoofers, to date putting numerous cones into orbit, Tannoy decided to show us how it should be done - we've got one for review in this issue, see p19.

TANNOY
Rosehall Industrial Estate
Coatbridge
Strathclyde ML5 4TF
Tel: 0236-420199

RECORD COMPANIES GET BEHIND MD, SONY SAY.

More than a thousand titles are now offered by Sony for its MiniDisc format. With 440 titles represented in Europe from 50 major record companies, including all the majors except Polygram (guess who owns that label) Sony is pushing the portability of the medium for the youth market. Prices of prerecorded discs remain high, however, averaging £13.49, HMV (Oxford Street) told us. They had information on 206 titles and reported a steady but not large sale from their Central London store.

The new MZ-E2 Walkman player is ultra-compact in size, being significantly smaller than the previous model. Weighing in at 205g (with battery) and measuring 74x18x107mm, the new portable is about the same size as a cassette tape case.

Sony promise longer battery life through new rechargeable Lithium-ion batteries. They give 7.5 hours of continuous play and are included in the player price of £349.99.

Sony is making an assault on all the major potential markets for MD by producing an in-car MD player and a full width hi-fi deck as well, the latter being expected to retail at £799.99.

SONY UK LTD
Sony House,
South Street,
Staines,
Middlesex, TW18 4PF.
Tel: 0784 467000

HMV Oxford Street
Tel: 071-629-1240



FASTER SOUND FROM CHORD COMPANY

With research and development originated by NASA, the latest speaker cable to be marketed by The Chord Company, Flatline, promises to be very high-tech.

It utilises Teflon surrounded oxygen free copper strands in a flat ribbon less than 1mm thick. According to the Chord Company, the signal travels through the Flatline cable faster than in any other cable and, being a 'low loss' cable with apparently impressive technical specifications, it can be used in long runs without compromising sound quality.

Three styles are available: Flatline Gold at £8.50 per metre, Flatline Twin for bi-wiring at £15.50 per metre and for the well-heeled audiophile, a silver stranded version, named Blue Heaven retailing at £58.50 per metre which can also be used as an interconnect.

THE CHORD COMPANY

30a Sarum Business Park,
Portway,
Salisbury,
Wilts, SP4 6EA.
Tel: 0722 331674

SENNHEISER FREEDOM

The 'freedom to walk, talk and listen' is the slogan under which Sennheiser is marketing its new infra-red cordless headphones.

The £149.95 IS 450 system is claimed to give exceptional audio performance, as well as having all the electronics, sensors and batteries built into a lightweight headset.

With the use of powerful output diodes the light transmission is said to flood a 400 square foot room with the IR signal.

Over 5000 installations worldwide use Sennheiser IR technology, for example Rock Circus, the Royal Festival Hall and a majority of West End theatres.

SENNHEISER UK
12 Davies Way,
Knaves Beech
Business Centre,
Loudwater,
High Wycombe,
Bucks, HP10 9QY
Tel: 0628 850811



MORE POWER TO GARRARD

With almost every major turntable manufacturer now

producing special power supplies to improve the performance of vinyl replay, Loricraft Audio has introduced a new supply for the venerable Garrard 301/401.

The PSU II is a low distortion active and isolated power supply retailing for £379 (or £399 with a meter) which improves on Loricraft's original PSU, although this is still in production at £149.

For those

Garrard addicts out there Loricraft produces a lubrication kit for the main spindle bearing and motor at £11.50 and will also supply high quality reprints of the original 301 instruction manual for £12.50.

LORICRAFT AUDIO

4 Big Lane,
Goose Green,
Lambourn,
Berks, RG16 7XQ
Tel: 0488 72267

SOLID RESPONSE

Rock Solid Sounds Inc have released the Centrale. This multi purpose monitor is aimed at Home Cinema and hi-fi system users who require a stylish product that can be mounted in a number of ways.

The design, by Morten Warren, is backed by B&W's

acoustic engineering expertise to produce a cabinet with a low distortion front panel and a multi-radiused two-part construction that gives an enclosure with no parallel surfaces. The Centrale is claimed to have a sensitivity of 89dB and uses a 5 inch long-throw woofer combined with a 1 inch fluid-cooled soft-dome tweeter, all of which are fully magnetically shielded. Solid have made the Centrale available for sale as a single unit for use in Home Theatre surround sound systems. Prices are £149.95 for a single unit and £299.95 for the pair.

ROCK SOLID SOUNDS INC.
B&W LOUDSPEAKERS (UK)
LTD
Marlborough Road,
Churchill Industrial Estate,
Lancing,
West Sussex, BN15 8TR.
Tel: 0903 750750

D E S E R V E S
C L O S E R I N S P E C T I O N



NAD 302. European Amplifier of the Year '93-'94

“An amazing design which can bring true Hi-Fi performance to those unable, or unwilling, to spend a fortune.”



BRITISH BY DESIGN

NAD MARKETING LTD. NAD BUILDING, 401-405 NETHER STREET, LONDON N3 1QG. TELEPHONE 081-343 3240

NEW ENTRY-LEVEL FROM TEAC

Priced at just £149.95, TEAC's new V-600 cassette deck is styled to match the rest of the range. Featuring a logic controlled, centrally mounted tape transport and a hard permalloy record/playback head, the V-600 also makes use of Dolby HX Pro as well as

B and C type noise reduction.

A comprehensive display has an electronic tape counter and level meters with peak hold. Tape selection is automatic.

TEAC UK LTD
5 Marlin House,
The Croxley Centre,
Watford,
Herts, WD1 8YA
Tel: 0923 819630



GOLDRING PRODUCE PERFECT SOUND

The Perfect Sound brand, the name under which Goldring market accessories, has produced a high grade interconnect cable. It uses an OFC copper conductor with foam PE insulation coupled to 24 carat gold plated plugs which have an alloy shell for extra shielding.

The interconnect will be sold in 1.2 metre lengths for £24.95.

GOLDRING PRODUCTS LTD

8 Greyfriars Road,
Bury St Edmunds,
Suffolk, IP32 7DX.
Tel: 0284 701101

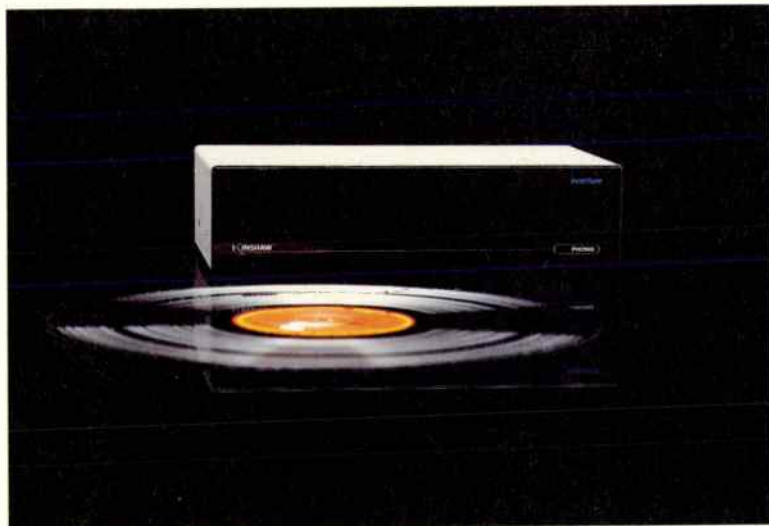

The Overture integrated amp offers 45watts per channel and accepts inputs at line level only. Kinshaw say it will retail for £435.

KINSHAW ELECTRONICS LTD
84 Pendarves Street,
Tuckingmill,
Cambourne,
Cornwall, TR14 8RE.
Tel: 0209 715878

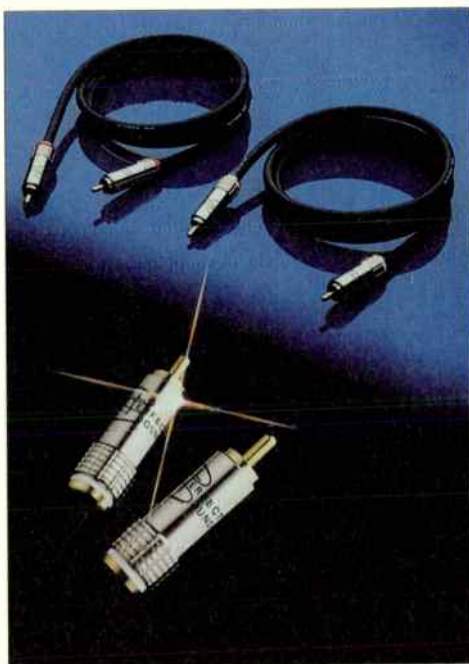

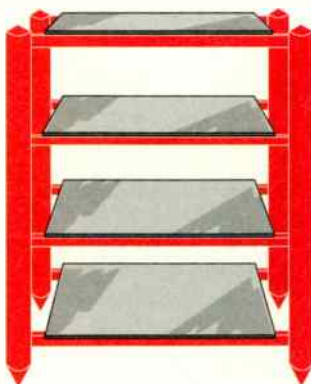
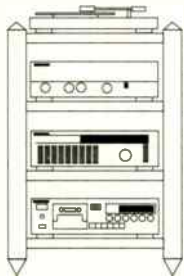
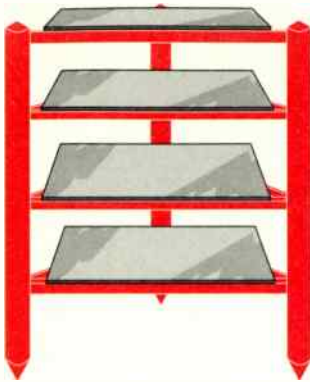
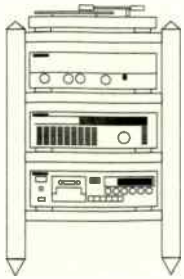

A Masterpiece in Colour

THESE DAYS THE SELECTION OF A HI-FI SYSTEM IS NOT ONLY RELATED TO SOUND QUALITY. VISUAL APPEAL IS ALSO A HIGH PRIORITY. **SOUNDSTYLE** AUDIO FURNITURE WILL ADD A DASH OF COLOUR AND EXCITEMENT TO ANY LISTENING ROOM. AVAILABLE IN SIX RICH COLOURS, THE **SOUNDSTYLE** RANGE PROVIDES SOUND SUPPORT FOR YOUR HI-FI COMPONENTS AND LOUDSPEAKERS. COLOURS RANGE FROM ROCK RED, OPUS GREEN, SONATA BLUE, SYMPHONY GREY, CONCERT BLUE TO CLASSIC BLACK. THE CHOICE IS ALL YOURS.

SOUNDSTYLE - MATCHING GOOD LOOKS WITH SOUND QUALITY FOR TODAY'S DISCERNING LISTENERS.

"...THE ICING ON THE CAKE... CAN HELP MAKE YOUR HI-FI PERFORM CLOSER TO ITS TRUE POTENTIAL... VERY SMART INDEED."

WHAT HI FI? APRIL 1993

"EASILY THE BEST SUPPORT TESTED... A HIGHLY EFFECTIVE UPGRADE."

WHAT HI FI? JUNE 1993

"...ADD A SPLASH OF COLOUR TO YOUR LISTENING ROOM...INDIVIDUALITY AND STYLE..."

AUDIOPHILE AUGUST 1993

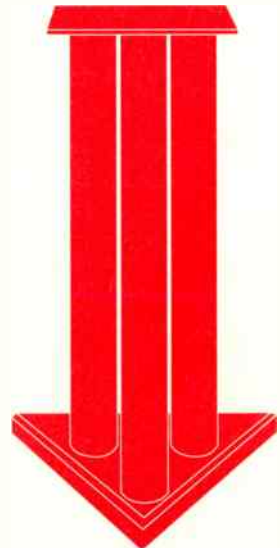
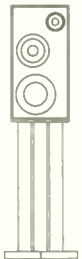

SOUNDSTYLE
AUDIO FURNITURE

SOUNDSTYLE, 8 GREYFRIARS ROAD, BURY ST EDMUNDS,
SUFFOLK IP32 7DX TEL . 0284 701101 FAX . 0284 750040

PLEASE SEND ME THE **SOUNDSTYLE** COLOUR BROCHURE, PRICE LIST AND THE NAME OF MY NEAREST DEALER.

NAME _____

ADDRESS _____

POST CODE _____

AUDIO INNOVATIONS FULLY BUILT

Due to demand for the Classic 25 valve amp kit produced by Audio Innovations, they have decided to offer the design as a fully completed product.

The line level integrated amp comes in the 'enclosed valve' casework that is common to Audio Innovations' pre-amps and features four line inputs and a tape loop.

Power output is rated at 25 watts per channel in class A and is the Classic 25 is available for £899.

AUDIO COMPONENTS LTD

Albany Court,
Albany Road,
Granby Industrial Estate Weymouth,
Dorset, DT4 9TH.
Tel: 0305 761017



SILVERADO, HOME ON THE RANGE

Selling direct to the customer and avoiding dealer mark-ups is how Silverado hope to offer high-end speaker performance at down-to-earth prices.



This new manufacturer is producing two different loudspeaker models aimed at either end of the market. The Raider comes as standard in a gorgeous piano black lacquer finish for £349.95. This small two-way design uses Morel drive units and high quality components, each speaker weighing 8 kgs.

The £1500 Silverado model is aimed at such high-end 'super' speakers as the Sonus Faber Extremas and Wilson WATTS. Using Dynaudio drive units and audiophile components in the crossover, the speaker features an overkill enclosure weighing in at 60 kilos per pair and is presented in a glorious hand-painted marble finish.

SILVERADO

128 Clitherow Avenue,
Hanwell,
London, W7 2BX
Tel: 081 567 0260

PLINTH PROBLEM

Dominic thought it looked better without one, KEF prefer it with one - the Q50 plinth, that is. So, after our plinth-less picture of the Q50 loudspeaker last month, here's the officially recognised version complete with plinth.

KEF AUDIO (UK) LIMITED

Eccleston Road,
Tovil Maidstone,
Kent, ME15 6QP.
Tel: 0622 672261





A Valve Testament

From Tube Technology come the Prophet pre-amplifier and Genesis power amplifier, reviewed by seer and sage Noel Keywood.



The fascias are solid alloy plates of 5mm thick brushed aluminium, with a black anodised finish. Most of the steelwork is deeply chromed - and so are the custom-machined control knobs, with their neat brass-dimple insert. They have a reassuringly stiff and solid feel to them. Tube Technology remain little known in Britain, yet they build and finish to a standard approaching that of SME. The Prophet preamplifier and Genesis power amplifier reviewed here glistened and glinted in our listening room and their shapes were intriguing: they have an alluring presence in the home.

In a world of black boxes, valve amplifiers like this are scene stealers, appreciated more in the East than

anywhere. That's why Brits who, by and large think that all hi-fi is made by Sony, don't often get to see Tube Technology. "I exhibited at Live 93", founder Zia told us, "and most people couldn't work out what they were. They'd never seen a valve before! So I'm happy selling nearly all my products in the East, but they demand really high standards of finish."

The new Genesis monoblock power amplifiers are relatively compact, but they turn out no less than 100watts apiece our tests showed, easily enough to make insensitive loudspeakers go very loud. And, of course, compete with solid-state amplifiers. Each unit is built onto a sturdy mild steel chassis, heavily chromed for a deep, lustrous shine and fitted with a machined alloy face plate. Etched brass

Tube Technology badges and brass cap nuts add to the visual interest and provide an aura of heavy engineering reminiscent of Victorian times. Then, metals were cast, hammered and hewn so that form not only reflected function, but emphasised it too. That's how it is with the Genesis.

Each Genesis power amplifier has a mains transformer and output transformer at rear, a brace of four Golden Aero EL34S output valves that stand tall and glow brightly, plus two 12AT7 (ECC81) preamplifier valves up front. With an input sensitivity of 800mV they must be used in conjunction with an active preamplifier capable of providing gain.

The Prophet preamplifier comes in two-box form. The lower unit possesses a solid state power supply. Above it sits the valve preamplifier, with inputs for CD, tuner, tape, aux and phono (moving magnet only). There is a balance control, but no tape monitor switch, nor a headphone outlet.

One of a few criticisms I have about this amplifier combination concerns its switch-on antics. In a curiously inconsistent way, Tube Tech. fit the power amps with switch-on delay, but not the preamp, which needs it. To prevent heart-stopping thumps through the loudspeakers, the preamplifier must be switched on and off when the power amps are off, since it generates sizeable and prolonged thumps. It's inconvenient to be forced to remember this; it means the uninitiated cannot be allowed near and, of course, one day you'll forget. . .

In light of this it is surprising to find that just such a delay circuit has been fitted to the power amps to prolong valve life, switching the HT in - to the accompaniment of a resonant thrum from the mains transformer - after the heaters have lit. This can prolong life by 8-10% or so, not an enormous amount and generally considered important only with expensive output valves, like 300Bs. However, our Genesis amps came fitted with Golden Aero EL34S valves - and they are quite expensive. Tube Technology advise that the amplifier is best switched off when not in use, to preserve valve life.

The mains transformers gave just a very slight mechanical buzz, inaudible from more than a foot or two away; electrical hum from the speakers was negligible.

Like most powerful valve amplifiers, this one uses 'fixed-bias'. In consequence, the output valves must be balanced using some form of metering system when they are replaced. Tube Technology can supply a meter for this purpose and four potentiometers, one per valve, are accessed with an insulated screwdriver (supplied) through a side vent with a neat filigree screen over it. Potential owners should be aware of this requirement and take it seriously, because fixed-bias amps will go off song if the output stage goes out of balance, for whatever reason.

Art Audio

MAESTRO

"They are just so stunningly gorgeous and open to listen to, I can barely imagine anything more alluring"

NK Hi-Fi World, June '91

Valve amplifiers from £750 to £4150.

Cables from £27 to £1700

Select Audio
Glasgow (041) 226 4268

Audio Venture
Banbury, Oxon (0295) 261863

K.A.I (UK) Ltd
Folkstone (0303) 245005

Doncaster Hi-Fi Studios
Sunnyfields (0302) 731387

The Hi-Fi Consultants
London (071) 380 0866
Evenings (071) 482 0003

The Hi-Fi Consultants
Nottingham (0602) 232450

Paul Green Hi-Fi
Bath, Avon
(0225) 316197

Audible Difference
Diss, Norfolk
(0850) 983233 or
(0379) 740227

Impulse Audio Consultants
Westcliff-on-sea, Essex
(0831) 616426 or 0374 277736

Hazelmere Audio
High Wycombe, Bucks
(0494) 437892

Sound Academy
Bloxwich, West Midlands
(0922) 473499

New A4 brochure containing full details of our amplifier and silver cable range contact
Art Audio (UK) Ltd.
130 Main Street, Calverton,
Nottingham, NG14 6LU
England
UK Tel. 0602 - 653604
Fax 0602 - 637795

Name:
Address:
.....
.....
Code:

LIVING VOICE LOUDSPEAKER SYSTEMS

Audio signals can be of infinite complexity.

Their content is prone to corruption during any part of the processes of recording and reproduction.

Given that it is possible to store and recover this information with some degree of accuracy, (a debatable but necessary starting point) audio engineering's prime concerns are with the electronic amplification of that information and its conversion back to mechanical energy in the form of sound.

Both the amplification and the transducer used for the conversion will inevitably distort the signal. The art of good audio design lies in minimising the amount of distortion that occurs.

In each stage of amplification some distortion will be introduced, although most arises as a by-product of the output device's attempts to control an uncooperative loudspeaker. The ease with which the loudspeaker can be controlled varies depending on both frequency and level. It therefore makes good sense to employ the most load tolerant output devices possible in the amplifier whilst keeping the number of gain stages of an absolute minimum.

Simple low powered amplifiers that fulfil these criteria have become more widely available over the past few years. Until now, the full benefits of this simplicity have not been readily apparent as all commercially available loudspeakers are too difficult to control accurately.

Loudspeaker drive units operate by passing a varying signal through a coil which is suspended in a magnetic field. The coil is usually coupled to a diaphragm and moves backwards and forwards following fluctuations in the input signal. As it is difficult to arrange a magnetic field that remains constant over a large area, the accuracy with which the coil and diaphragm follow the signal deteriorates as the excursions become larger.

If a loudspeaker drive unit can be constructed whereby the coil and diaphragm assembly can



move a great deal of air easily for a very small excursion then it will not be necessary to use as much power to generate a required amount of sound. A technique that achieves this more effectively than any other is "Horn Loading" and involves coupling the diaphragm to the air by using a flared horn. By arranging that the horn opens out at an optimally calculated rate, very effective coupling can be achieved with minimum distortion.

The loudspeaker can then be said to be an efficient transducer and will be easier for our idealised simple amplifier to control.

The AIR PARTNER & TONE SCOUT Loudspeakers use the principle of full range horn loading to optimise their efficiency. Both are 3-way systems with crossover points at 500 Hz and 10 KHz.

LIVING VOICE has worked closely with SECOMAKVITAVOX and other EC based manufacturers on the development of proprietary

Bass and Midrange drive units.

The Bass drivers have straight-sided, undoped, paper cones mounted in sturdy cast baskets attached to a huge magnet assembly. The decay of the Bass unit's response is very smooth and does not present significant problems in the octave above crossover.

The Bass horn is constructed entirely from High Density Birch Ply and is veneered using only "Crown-Cut" veneers.

The Mid-range units are pressure drivers featuring a rigid aluminium dome driven by a 75mm diameter coil operating in an intense magnetic field. The dome and coil former are of one piece of 50 micron thick, chemically stiffened aluminium. With the coil wound directly onto the dome there is direct drive - no intervening adhesive joint - and damping of eddy currents. The magnetic field is powered by a heavy ring magnet of Titanium, Nickel and Cobalt alloy.

Once again, the high frequency performance of the driver must decay smoothly and this is achieved by a phase corrector in the centre pole of the magnetic circuit. A complex arrangement of precision machined, tapered plugs form three concentric air channels angled to joint each other in the heart of the unit.

These drivers are directly coupled to a genuine, multi-cellular high frequency horn formed as a single piece aluminium casting. The assembly is encased in a matching, veneered cabinet.

The extreme treble response of both designs are handled by smaller horn loaded pressure drivers.

The astonishing efficiency of both the AIR PARTNER & THE TONE SCOUT allows them to reproduce all types of music with an appropriate sense of scale and ease. When used with suitable ancillary equipment they offer a level of resolution and realism that can truly be described as adequate.

SOUND QUALITY

We tend to think of the Mullard EL34 output pentode as having a warm, cuddly sound, of a sort that many valve-heads yearn for. It lacks stridency, giving a full, rounded tone.

That's a generalisation. In the Genesis the EL34, in high-anode-dissipation S form, provides a bright, clear sound possessed of a balance much more like that of a solid state amplifier. There's a sheen in the treble, one that highlights coarseness in recordings, whilst at the same time delivering strong, yet sweet highs. The Prophet and Genesis in combination provide the sort of deep insight into music and clearly defined image forms that valve amplifiers are valued for, especially across the mid-range of course, where vocalists like Angelique Kidjo were conjured up with vivid presence. She was a little further back on the stage and a mite less fuller in body than with some designs, I fancy, but full of voice and quite obviously exercising a superb vocal range.

Tube Techs do as a breed tend to offer a tighter rendition of music than is common from glowing bottles. It was in this amplifier's bass tightness, depth and speed that it pulled ahead of so many of its thermionic rivals. Walking bass lines in particular came across beautifully, their progression and intent were so clearly discernible. The ever difficult 'Break Every Rule', by Tina Turner, highlighted this strength of the Genesis, one that will be appreciated by anyone used to the low frequency power and control of a good solid state amplifier. Those massive output transformers help keep deep bass tight and clean.

There was a little less rosin on violin strings perhaps, and a little less stage depth with orchestras than some valve amps would have and here those that yearn, or perhaps expect to revel in the silky glow of shimmering strings might wish to ask some questions. The Tube Techs lie diametrically opposed to the 'warm and cuddly' sound - they're tight and fast, taking no prisoners. I would say they place more emphasis on pace and power than on variation of tonal textures, yet at the same time, good valve amplifiers always manage to excel across their midranges in this area - always a plus point easy to discern on demonstration.

I ran a Goldring 1042 cartridge through the disc stage and noticed that the Prophet made it sound brighter than usual, giving LPs a hard-etched clarity, with strong detail rendition and superbly tight, fast bass. There was no doubt that the 1042, which has a warm balance (but at the same time has superbly detailed treble due to its stylus), sounded a little brighter and more forward than usual, due I believe to the high frequency lift in the disc stage (see Measured Performance). Quite what I heard depended upon the record being played. For example, Tracey Chapman's Bridges,

having an innately warm balance, sounded very clear; Big Youth's A Luta Continua came over as a little harsh at the top end (I played Reggae to put strong bass through the amplifier - it held up well). The Prophet is best suited to warm-sounding cartridges and Goldring moving magnet types are amongst the most suitable.

Explosive bass dynamics, a midrange clear as a bell and shimmering treble mark out this Tube Technology combination. From valves there's also that wonderful lack of graininess and clear reproduction of vocalists to revel in.

Beautifully built and finished, the Prophet and Genesis form a captivating combination that will attract attention in any home ●

Genesis Monoblocks £2599
Prophet £1310
Tube Technology,
Hatch Farm,
Chertsey Road,
Addlestone,
Surrey, KT15 3EH
Tel: 0932 850361

MEASURED PERFORMANCE

The Genesis power amplifier is a fixed-bias design. This technique is used to give maximum power output and it allows the Genesis to turn out no less than 100watts - a very high figure for four EL34 output valves in parallel-push-pull. Yet the Genesis runs fairly cool and has a relatively compact mains transformer, helped by running the EL34s at low standing current. This means it is a Class AB design run substantially in Class B. The transformer is configured for 8Ω loudspeakers only; it has no 4/16Ω taps. This power amplifier will run even insensitive loudspeakers up to high volume levels, but it will not be at its best with low impedance speakers.

Tube Technology achieve a very wide bandwidth of 4Hz-116kHz from the CD input of the Prophet preamp through to output of the power amp. Noise was low at -92dB, with little hum.

The disc stage (moving magnet cartridges only) similarly had a wide bandwidth of 8Hz-35kHz, treble output rising slowly up to 60kHz. This could well give a bright sound. There was no warp filter either, something I feel is especially unwise with valve amps because 5Hz warp signals saturate output transformers at around 5watts of output. Sure enough, the Genesis went into premature output overload when fed a 5Hz signal. This is less of a problem with medium-compliance moving coil cartridges than high compliance moving magnets, yet the Prophet only has an MM input. I'd suggest it is used with MCs only, with an intervening step-up transformer or preamp, or that Tube Technology fit the Prophet with a high rate (-12dB/octave) warp filter at 50Hz, as do Linn and Mission with their disc stages, for example.

Distortion levels were set by the power amp, not the preamp, I found. At low signal levels of a few watts, innocuous sounding second harmonic distortion of around 0.05% dominates. As power increases above 5watts or so, third harmonic dominates, rising from 0.2% up to 0.6% in the midband. Run at high output levels, I would expect this to give the Genesis a bright, clear sound, but one that may be a trifle hard etched. At high

frequencies, distortion reached 1% at full output (-1dB), but in this case it comprised second and third harmonic in equal part.

Bearing in mind that the EL34 is not an especially linear valve at high outputs, these figures are low, suggesting good basic design and high quality transformers.

Switch-on pulses from the Prophet preamp measured 200mV, and at switch-off 400mV - enough to drive sensitive power amps to full output. As Tube Technology warn in their handbook, the Prophet must in consequence be turned on well before the power amplifier.

The Prophet and Genesis in combination offer high power and wide bandwidth. They measure well. Care is needed to avoid possible problems from LP warps and switch-on thumps, however. **NK**

TEST RESULTS

Power	100watts
CD/tuner/aux.	
Frequency response	4Hz-116kHz
Separation	72dB
Noise	-92dB
Distortion	0.05%
Sensitivity	190mV
dc offset	none
Disc (MM)	
Frequency response	8Hz-35kHz
Separation	68dB
Noise	-67dB
Distortion	0.05%
Sensitivity	1.8mV
Overload	150mV

Distortion

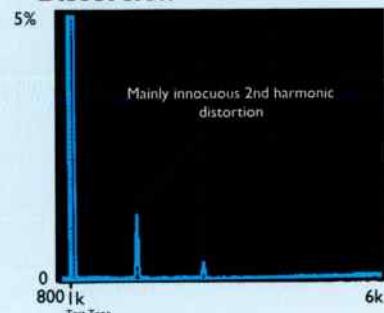

analogue replay

Project
Michell
Townsend
Wilson Benesch
Basis
Pink Triangle
SME
Sumiko
Lyra
Transfiguration

digital replay

TEAC
Pierre Lume
Micromega
Counterpoint
Mark Levinson
Audio Alchemy
Pink Triangle

valve amplification

Audio Innovation
Trilogy
Audionote
Lectron
Conrad Johnson
Lumley Reference
C.A.T
Copland
Sonic Frontiers

solid state amplification

Rotel
Aura
Jeff Rowland

D I V A

a u d i o f i d e l i t y



Experience just how good your LPs and CDs really can sound by listening to them through one of our hifi systems. from £50,000 to £500 we put together the finest hifi to suit every budget.

Our demonstration room is available for booking anytime day or evening from Monday through to Saturday; alternatively, we will demonstrate systems in your own home if you wish. We install both single and multi-room remote control systems, and can put together the finest in audio-visual home cinema. Call us or pop in to arrange a musical experience you'll never forget.

**Workshop 30, Royal Victoria
Patriotic Building, Fitzhugh
Grove, Wandsworth
Common, London SW18**

0 8 1 8 7 5 9 5 9 3

Counterpoint
Audiogram
Primare
Mark Levinson

loudspeakers

Charios
Monitor Audio
Proac
B & W
Martin Logan
Triangle
Audionote
SD Acoustics
Impulse
REL
Audiostatic
Thiel
Klipschorn
Sonus Faber

cables & accessories

XLO
Audioquest
Audionote
Cogan Hall
Silver Sounds
Seismic Sink
Tripod
Framworks
Leider

audio-visual

Harman
Lexicon
JBL



TAKING THE BOOM OUT OF THE BOX

Tannoy have successfully designed an 'electronic' subwoofer, one that uses motional feedback to give super bass quality. Dominic Baker - master of the lows - takes a listen.

Subwoofers have always been regarded by audiophiles as crude boom boxes and not real hi-fi - with justification. To get bass from a small cabinet they are made to boom and, aware of this I suspect, their manufacturers don't take them seriously. You want bass from a small box? We've got it - boom...boom...boom.

Richard Lord at REL changed all this a couple of years back by developing a

small range of high quality, powered subwoofers that didn't require an active crossover and second power amplifier, as do the complex, up-market Celestion and Gradient subwoofers, for example. The RELs were fitted with rugged and powerful drive units capable of reproducing realistic levels of bass down to 20Hz. They weren't room and position dependent like the dipole Celestion and Gradient and, with some effort, could be tuned to work with just

about any loudspeaker. But until the more affordable £495 Strata came along recently, they were still out of the financial reach of many music lovers.

Now Tannoy have joined the fray with something different and a bit revolutionary, if not totally unique. Hoping to leap in at the top of the league in terms of bass quality, they have employed motional feedback. In simple diagrammatic terms, this is how it works, and why it's so special.

TURNTABLES tonearms & cartridges FOR THE LOVE of music

To hear the dynamics and explosive power of Tchaikovsky's 1812 Overture, your HI-Fi system comes from Audiofreaks. For your final choice of analogue front end components we have selected a few of the very best.

VPI turntables and record cleaning machines, the unsurpassed WHEATON Tri-Planar IV tonearm, BENZ-MICRO state-of-the-art moving-coil cartridges and the latest wonder - EXPRESSIVE TECHNOLOGIES SU-1 step-up transformer with matching interconnect cables IC-1 and IC-2. The first and only MC transformer that works.

AUDIOFREAKS

15, Link Way, Ham, Surrey TW10 7QT.
Tel: 081. 948 4153 Fax: 081. 948 4250.



KLIPSCH High efficiency Loudspeaker
for

Full Performance Sound

FORTE 11 MODEL £1490 per pair
(reviewed by M. Colloms C.Eng M.I.E.E)



UK Distributor - 021- 430 7817

HORN LOUDSPEAKERS

Klipsch®

MAYPOLE LANE, BIRMINGHAM, B14 4PE.

Tesseract Audio.

We make them
the way they said
you just can't make
them anymore.

For full details of the Tesseract range of head amplifiers, pre-amplifiers, power amplifiers, turntable power supplies and dealer list contact: Tesseract Research Ltd, Sutton Business Centre, Restmor Way, Hackbridge Road, Wallington, Surrey, SM6 7AH Telephone: 081-669 0011 Fax: 081-773 0406

 **TESSERAC AUDIO**
The Best of British High End

A MANTRA AUDIO		• CARTRIDGES AND STYLUS • MAIL ORDER DIRECT 1-10 DAYS • COMPETITIVE PRICE inc P&P • 10% DISCOUNT ON STYLUS QTY 2+				
TYPE	SWISS QUALITY DIAMOND STYLUS	PRICE	MAKE	MODEL	CARTRIDGE	STYLUS
AOC	RK 8, RQ 4 QLM 30, RL 3/5	£8.00	Arcam	C 77	£27.00	£15.00
	R20 XE, QLM 32/34/36, XLM III	£12.50		E 77	£45.00	£33.00
Alwa	AN 5/6/7/10/11/30/35/8745	£800		P 77	£55.00	£45.00
	AN 2/50/70/77D/4932/8743	£10.00		P 77Mg	£65.00	£49.00
Akai	APN 2/5, RS 33/35/38/63	£8.00	Audio	AT 95 E	£21.00	£12.50
Audio	ATN 3401/3472P/3600/360	£8.00	Technica	AT 110 E	£25.00	£16.00
Technica	ATN 72/105/3451/3452-E	£12.50		AT 412 EP (T4P)	N/A	£13.50
Denon	OSN 24/28/39/44/47/57/66	£8.00		AT402 E	£36.00	£24.00
	DSN 50/54/60/65	£12.50		AT DC 3	£92.00	£64.00*
Dual	DN 140/236/237/245	£10.00		AT DC 5	£125.00	£86.00*
	DN 145/155/165 E, DN 149S	£12.50	Denon	DL 110 MC	£65.00	£52.00*
Goldring	G 800/820/850	£8.00		DL 150 MC	£85.00	£68.00*
	G 800 Super E (D110E)	£12.50		DL 304 MC	£180.00	£150.00*
JVC	DT 35/45/55/60, DT Z 1 S	£8.00	Goldring	ELECTRA	£24.00	£16.00
Kenwood	N32/33/47/48/52/60/61/66/72	£8.00		1006	£44.00	£29.00
(Trio)	N35/36/43/45/56/62/67/69/71	£10.00		1012 GX	£58.00	£38.00
Marantz	TT 333/443/551/553	£10.00		1022 GX	£76.00	£49.00
Nai Pan/	EPS 23/24/25/30/33/35/51 CS	£8.00		1042	£94.00	£61.00
Technics	EPS 270D, EPS 31/34/43 STSD	£8.00		Eroica (LX)/(H)	£90.00	£55.00*
	EPS, 30ES, EPS 202/270 ED	£10.00		Elite	£180.00	£117.00*
Ortofon	FF 15/VMS 10/20 EH, OM/P 10/20	£12.50	Nagaoka	TS 10	N/A	£20.00
Philips	GP 371/400/780/4001/III	£8.00		TS 11	£63.00	£33.00
	GP 330/401/401 II/412 II	£10.00		TS 12	£72.00	£38.00
Pioneer	PN 110/210/220/K65/250T/295T	£8.00		MP 10	N/A	£10.00
	PN 30/35/50/135/200/290T	£10.00		MP 11	£25.00	£12.50
Pickering	V15 AT/AD/AM/AT3, XV 15/50	£10.00	Ortofon	OM/P 10	£25.00	£18.00
	XV15 200/400, TL12	£12.50		OM/OMP 20 Super	£54.00	£31.50
Sansul	SN 10/27/28/37/41/50/80	£8.00		OM 30 Super	£72.00	£58.00
Sanyo	STG 8/9/10, ST 28/29 D	£8.00		OM N'CLUB S	£29.00	£18.00
(Fisher)	ST 35/36/37/40/42/55 D	£8.00		OM N'CLUB E	£33.00	£21.00
	ST 36/30/38/44/66 D	£10.00		CONC N'CLUB S	£50.00	£18.21
Sharp	STY 104/111/116/117/118	£8.00		CONC N'CLUB E	£54.00	£21.00
	STY 123/124/127/136/141/160	£8.00		510	£29.00	£19.00
Shure	N 75 6C N 70/91G	£8.00		520, 520P (T4P)	£49.50	£36.00
	N 75 ED/EJ T2, N 95 ED/EJ	£10.00		530, 530P (T4P)	£76.00	£57.00
	N 97 ED, VN 35 E	£13.50		MC 1 TURBO	£54.00	£45.00*
Sony	ND 133/134/150/155/200/300G	£8.00		MC 3 TURBO	£99.00	£82.00*
	ND 115/135/143/148/153 G/250 G	£10.00		MC 10 Super	£76.00	£65.00*
Stanton	D 5100 E5/107 A6/071A	£12.50		MC 15 Super	£99.00	£82.50
Tenorel	N 2001 D	£10.00		QUARTZ	£126.00	£105.00*
	N 2001 ED	£12.50		QUATTRO	£190.00	£160.00*
Toshiba	N 62, N 290 D, N 292	£8.00	Shure	ME 92 E (T4P)	£22.00	£15.00
	N 377/276/78 D, N 500	£10.00		ME 97 HE	£60.00	£42.50
				MC 35 MR (V 15 III)	£63.00	£43.00
				VN 45 MR (V 15 IV)	£90.00	£60.00
				V 15 V MR	£225.00	£130.00
MAKE	ACCESSORY		Stanton	500 AL DISCO	£30.00	£18.00
Shure	SFG 2 Stylus Force Gauge	£17.00		680 AL DISCO	£45.00	£32.00
Altal	Cartridge Alignment Protractor	£5.00				

* Exchange any MC ★★★ Other types available ★★★ Tel: (0757) 288652
Please state Stylus ident no/colour. Cartridge/ref on all orders/enquires - No credit cards
MANTRA AUDIO (HFV), 22 GARTH AVENUE, NORTH OUFFIELD, SELBY, NORTH YORKS YO8 7RP

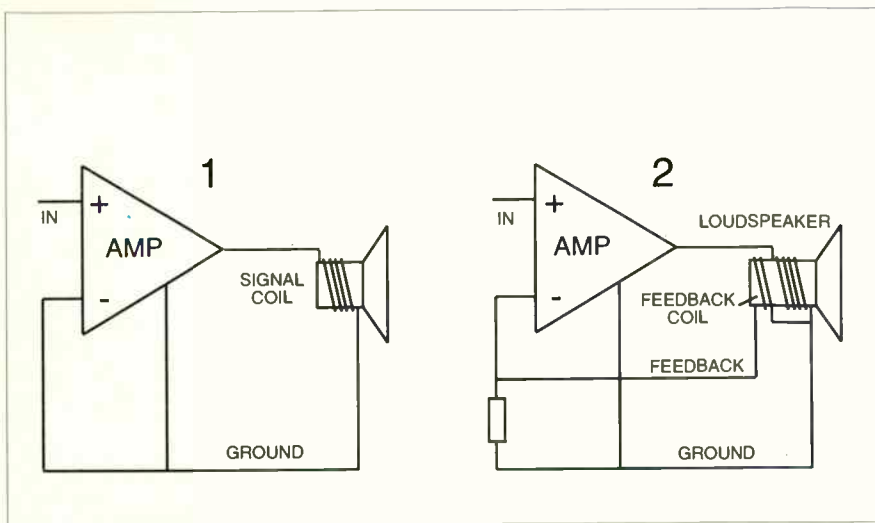

1. The in-built power amplifier drives the 12" bass unit with bass frequencies, as in a normal system. But the subwoofer doesn't behave linearly, and what you hear is the response of the bass unit in a cabinet interacting with the room.

2. The Tannoy system uses a second voice coil to provide a signal that describes what the drive unit is actually doing in response to the flat input signal. This signal is inverted and combined at the input of the subwoofer amplifier to correct for the distortion and give a flat bass response.

So, distortion is greatly reduced. But in addition, because the motional feedback corrects any disparity between what the power amplifier sends to the subwoofer, and what the subwoofer actually does, deep, powerful bass can be achieved from a relatively compact enclosure. In theory, a motional feedback system should produce clean, dynamic, fast and natural bass of a quality that conventional systems can't match.

Both Noel and I have experimented with motional feedback and the quality of bass it can provide is indeed fantastic, we found. Unfortunately, in both cases the system lasted around 30 seconds before a transient upset it and the drive unit destroyed itself. The problem we faced was that without a position transducer, the system had no reference position and was potentially unstable. The correction signal would drive the unit to its end stops with a loud crack, normally followed by smoke from the burnt out voice coil. We haven't stopped trying though: 30 seconds was enough to convince us that it's worth the effort.

But Tannoy have succeeded and the 625ALF is the result. And as the Tannoy literature says, "Dynamic, articulate and realistic deep bass reproduced in a natural way will set your foot tapping and bring a smile to your face as music is reproduced with a sense of limitless dynamic range". This sales talk certainly brought a smile to my face.

But all the same, there are a few things that Tannoy could have learnt from REL. Although complex, REL's two controls for accurately setting the upper limit of bass response enables their subwoofers to be accurately and smoothly integrated with just about any pair of stereo loudspeakers. Tannoy have chosen to fix their upper limit at 85Hz.

So unless your main loudspeakers roll off at exactly this frequency (unlikely), the result will either be a peak where they overlap, or a dip where they fail to meet. Noting that there is also an enhanced mode for home cinema use, I suspect that 625ALF has been designed more for bass reinforcement in such a system, than for being subtly integrated into a hi-fi system.



There is no adjustment for upper bass roll-off.

I wasn't about to give up though, the promise of superb bass driving me to find a way to integrate it to a pair of quality 'speakers. Here's where I'm lucky to have a large room. By pulling a pair of ProAc Studio 100s out far enough into free space I could adjust their bass to suit 'ALF quite well. Obviously, this isn't going to be all that convenient for most people, so if the quality of bass that the 'ALF produces is persuasive enough, pick a pair of small bookshelf speakers that won't have to be pulled quite as far into the room as the ProAc's had to be.

Another thing too. If you use a sensitive valve amplifier with efficient loudspeakers, as more and more people

are, 625ALF will not go loud enough to keep up with them. A little more gain would be useful for such situations.

So, after the palaver of swapping from valve amplifier to transistor, replacing the Quads with ProAc's and pulling them out into the room far enough to limit their bass so that the subwoofer integrated satisfactorily, I was ready to listen.

You're probably asking the same question as me at the time: was it worth the effort? Well, the quality is certainly there. 'ALF has a subjective speed and cleanliness in the bass that the RELs can't quite match. The new Stadium, which we have in for review at the moment, comes close, but is no real match for a motional feedback bass system.

It's not so much on fast punch and dynamic bass that you notice it though, more on those long thunderous, reverberant bass notes than can send lesser subs out of control. 625ALF stays firm and controlled to the end, with real room filling power to compliment it. In fact, I couldn't find a CD that really caused 'ALF any problems, even The Beloved's over emphasised electronic bass couldn't upset the tuneful and articulate manner with which it played each note.

A rapidly plucked bass guitar was no match for 'ALF's speed either; it managed to squeeze in each note with ease, and without slurring from one string to the next.

There's no doubt motional feedback is certainly one way forward for superior bass performance - and the best way so far, from what I've heard. It has the clarity and effortless dynamics of a dipole, without the complex room positioning problems.

As part of a hi-fi system, 625ALF isn't quite there yet though. Even after my efforts trying to integrate it as best I could with the ProAc's, there was still an obvious overlap. 625ALF looks to have been developed more for AV than hi-fi. Hopefully, Tannoy will produce a dedicated hi-fi version, one with adjustable roll-off and a little more gain in the very near future. As it stands though, I feel they've ignored a very important market, one where REL reign supreme. Let's face it, AV is

not so much about ultimate fidelity so much as the simple reproduction of effects. To produce a super low colouration, low distortion and neutral sounding subwoofer and then aim it at this market is a little contradictory I feel. So near, yet ●●●

625ALF
Tannoy Ltd,
Rosehall Ind Est,
Coatbridge,
Strathclyde.
ML5 4TF
Tel: 0236 420199

£595

ARJAY

ST 1
Capacity 600 LPs
price £272.00

ST 15
Capacity
66 Videos
price £207.00



ST 8
Capacity 90 CDs &
120 LPs price £149.00

ST 11
Capacity 270 CDs
price £200.00

All prices are ex-works and inclusive of VAT

THE PROFESSIONAL SOUND & VISION STORAGE SYSTEM DIRECT FROM THE MANUFACTURER

Whether your collection is records, cassettes, CDs or videos, the **ARJAY** system is for you. In fact, at many music studios, stores and libraries throughout the country, **ARJAY** is considered essential equipment. Its classic and original design makes the best possible use of available space to provide the ideal storage and display conditions.

You have a choice of the "**Record Collection**" the "**Compact Disc Collection**" or the "**Video Collection**" which consists of units in varying sizes designed specifically for your personal collection. Additionally, the "**Combination Collection**" has three different sized units, designed for your mixed collection of records, tapes and CDs. Either way **ARJAY** has designed a unit for your own requirements. We can also make units to customer specifications.

You couldn't put your music collection in better hands.

CONTACT CAROLINE ON: **081-390 2101** or send the coupon below to:-
TEAMPOINT Ltd, 54 Lower Marsh Lane, Kingston, Surrey KT1 3BJ.

Please send me THE **ARJAY** Sound Storage System brochure.

Name

Address

.....

Tel no.

SOUND ACADEMY

FOR THE VERY BEST IN AUDIO VISUAL

PURE HIGH FIDELITY
Telephone: 0753 680868

Quality, Clarity, Expertise, Choice...
and that's just the service!

- 3 Demonstration Rooms
- Home Cinema - In store
- Demonstration Theatre
- Evening demonstrations by appointment
- Home trials
- Mail Order available
- In-house service department



Sharing the ASDA Car Park with ample Free Parking
Off High Street, Bluswich, nr. Walsall, West Midlands
off M6 Junctions 10 and 11
Open 6 Days a week, 9a.m.-6p.m.
Fridays late night



Audio equipment from leading and specialist brands on two floors for you to listen and choose from

Telephone: 0922 473499/493499

ARCAM
AUDIOLAB
CHORD
DPA
EXPOSURE
MERIDIAN
MISSION
ROKSAN... and
many many more!

Great tracking

Ortofon is famed world over for the tracking capability of its cartridges. Cartridges which will breathe new life into a cherished LP collection, divulging detail as never before.

The cartridge is always the key factor in the reproduction of music from records and Ortofon has dedicated nearly 50 years to the manufacture of the finest pick-ups possible. Enjoying constant critical acclaim along the way.

So if you want to bring more out of your records than ever imagined, an Ortofon Cartridge will have you hot on the scent.



500 Series
Moving magnet
cartridges from £30-£100



MC Series
Moving coil cartridges
from £60-£110



Q Series
Moving coil cartridges
from £140-£500



1000 Series
Moving coil cartridges
from £800-£1500

ortofon

Ortofon (UK) Limited, Chiltern Hill, Chalfont St Peter, Bucks SL9 9UG.

Tel: 0753 889949.



Music Mill

At the Music Mill, we believe that buying hi-fi should be a pleasurable experience. We offer friendly professional service and advice in comfortable 'no rush' surroundings with the emphasis on your specific requirements. Excellence in hi-fi includes Nakamichi,

hear

Harman Kardon, DNM, Rehdeko, Audio Innovations, Nottingham Analogue, Pro-Ac, Systemdek, B&W, Cerwin Vega, Dal and Micromega.

The Music Mill - a fresh approach to hi-fi selection.

Access for people with special needs

Specialist hi-fi technical advice and service

here

The Music Mill (Scotland) Ltd
Bonnington Mill Business Centre
72 Newhaven Road
Edinburgh
EH6 5QG
Tel & Fax: 031-555 3963

NEW PRODUCT



BASE

VIBRATION ISOLATION PLATFORMS

Realise the full undistorted potential and accuracy of your high fidelity audio components with the latest concept in platforms.

Available as individual platforms, modular racking systems or hardwood enclosures built by craftsmen to suit your requirements.

Integral cable routing separates sensitive carriers from mains leads combining tidy appearance with elegant furniture design.



Audiophile



Audiophile Furniture Limited Telephone: 0342 826262



LOOKING TO REIGN

Could the new Monarchy CD convertor reign supreme? Dominic Baker assess the credentials of this new U.S. product.

Monarchy Audio have been very busy since we last took a look at their Model 22 CD convertor. They now not only have a transport, but a Digital Interface Processor that improves the signal on its way to the DAC. There's even a new convertor, the Model 33, complete with a Class A line pre-amp with inputs for two additional line level sources.

The new DT-40A transport is based on a laserdisc player, Monarchy claiming it is more stable than a conventional CD player. It is a little slow to use, since it looks for laser discs and CD video discs before looking for a music CD, the motor whirring busily whilst it tries each in turn. But once it has identified the disc, operation is fast and smooth.

It's strange how after getting used to

CD you find even a few seconds of delay irritating, the ceremony of playing an LP seeming so far away. You do get used to such a delay though, and it does give just enough time to get back to the sofa and get comfortable. Only Play, Pause, Stop, Track Skip and Search are provided on the thick alloy fascia, giving the DT-40A a purposeful audiophile look. It has both professional balanced AES/EBU digital outputs as well as the standard RCA electrical output, but no optical.

The transport is linked via the DIP (Digital Interface Processor) to the new Model 33 CD convertor. The DIP can be used between any transport and convertor and does a number of things to clean up and improve the digital signal. It re-clocks the signal from the transport and uses a special phase locked loop to

help suppress jitter. In addition, a custom transformer is used to isolate the DAC from the transport, reducing interference.

Last in the chain is the Model 33 convertor. At £1495 the Model 33 certainly isn't a budget convertor, but when you consider that it has the facility to act as a pre-amplifier with two additional auxiliary inputs available, things take on a different perspective. Monarchy use Burr Brown's PCM63P chipset and high quality OP275 op-amps to drive the convertor's line output. Analogue Devices' AD847s are used for the Class A pre-amp stage which makes a pleasant change from the common NE5534s, and component quality is generally high throughout.

I've been using the Monarchy

transport and DIP processor for several months now and they've driven a variety of different convertors. I must say that once you get over their little quirks, they form a formidable set-up. Whatever convertor is used, there's always been a powerful, dynamic and firm presentation of music. These units also sound remarkably smooth, having a similar lack of roughness in the upper midband to that of sync-locked convertors. I feel that a lot of this is attributable to the DIP, rather than the transport. In my experience there's not so much to choose between good transports. Sync-locking and digital signal cleaners seem to have a greater influence on the final sound.

Removing the DIP from the system robbed the sound of some of the fine detail and finesse it had, whereas, replacing the transport with a TEAC P500 made little difference. The effect of the DIP is not night and day, but it does give the sound a more cohesive, and expansive presentation. It puts things in order.

The Model 33 convertor, on the end of the DT-40A transport and DIP, sounded effortless. Bass was deep, full and firm, the midband had a sweetness and lack of grain that is uncommon even in convertors of this price and the treble was bright and articulate. It lost very little of this character through the built-in pre-amp, making it able to drive a power amp direct without any need for a

separate pre-amp. In fact, unless you were to spend upwards of £500 on a pre-amp, I'd say it'd be hard to better. A little richness is added and a sparkle in the treble, but these are aurally pleasant and certainly didn't detract from my enjoyment.

Inspirational Carpets' new album, complete with Hammond organ which is becoming increasingly popular with modern bands, had a large soundstage with reasonable depth to it - an area that CD players are traditionally weak in. There was plenty of atmosphere surrounding the performers as well, which helps to produce a more natural and realistic performance.

The crisp and open nature of the Monarchy CD system also suited Grant Lee Buffalo's acoustic country style, the briskly strummed guitar pushing forwards in the soundstage alongside vocals. The fluidity of the music was never strangled by the Monarchy, just allowed to breathe and open out to reveal the recording. It's this unconstrained delivery that made it enjoyable hour after hour; I never doubted that what it provided is what the recording engineer intended.

As I mentioned earlier, I've been using this CD player for several months now and it hasn't let me down. There is no area that I could strongly criticise. If I was being really picky, I'd suggest that just a little more body could be given to central images, and a little more depth to the soundstage, but this is a criticism that

could be levelled at almost all CD players regardless of price.

Of the three components, the DIP and the Model 33 convertor stand out as being best value. The pre-amp in the convertor is good enough to make it recommendable in its own right, and it's something of a bonus on top of an already very good DAC. The DIP should be auditioned by anyone already using a separate transport and convertor, especially if it doesn't have the facility to be sync-locked.

As a whole, this Monarchy set-up isn't cheap, but if you're looking for a solid, dependable sound, free from the slight coarseness in the midband that many convertors suffer, but with a big powerful presentation, it's definitely worth an audition. And you can always pass off the transport as a laserdisc player for the kids to justify some of the outlay ●

DT-40A transport £1595
Model 33 DAC £1495
DIP Digital Interface Processor £245

Wollaton Audio,
134 Parkside,
Wollaton,
Nottingham.
NG8 2NP
Tel: 0602 284147

MEASURED PERFORMANCE

The Monarchy Model 33 uses Burr Brown PCM63P convertor chips to good effect. Distortion was reasonably low at all levels. At -30dB, a level that represents a normal music programme, I measured 0.025% and, as you can see from the oscillogram, although the distortion harmonics are wide spread they are low in level. I would, however, expect to hear just a slight brightness due to the dominant odd-order 3rd and 5th harmonics.

The frequency response revealed a slight problem, possibly caused by a mis-terminated filter. The sharp peak just before the roll-off point is not so much of a problem in itself, being so high up the frequency response, but the steady lift up to the peak will add a brightness or sparkle to the treble. The peak was different on both channels as well, being 0.3dB up on the left and 0.7dB on the right, suggesting component tolerance to be the cause.

Elsewhere, the Model 33 measured well, with good channel separation and wide dynamic range. The output was extremely healthy too, measuring a high 3.27V, so in a demonstration the Model 33 will be considerably louder than most of its competitors. **DB**

TEST RESULTS

Frequency response	4Hz-21.5kHz	
Distortion %		
-6dB	0.005	0.005
-30dB	0.028	0.022
-60dB	0.56	0.45
-90dB	29.2	29.1
-90dB dithered	5.2	5.6
Separation dB	left	right
1kHz	98	98
20kHz	71	72
Noise	-99dB	
with emphasis	-101dB	
Dynamic range	108dB	
Output	3.27V	

Distortion

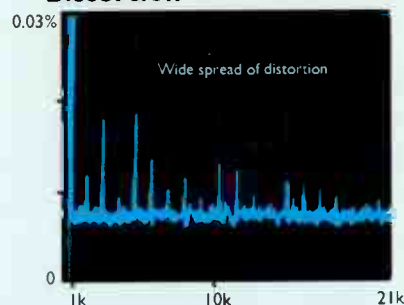

Frequency Response

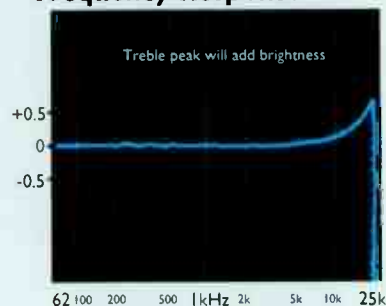



after sales service in a local market.

As the Oriental tide receded - and it has done significantly in hi-fi separates - some canny UK personnel realised that it was possible to improve the sound of many Japanese amplifiers, their weak area, whilst retaining all their strengths. Models like the Denon PMA-350 and Pioneer A400 were born. More importantly, however, they also thrived, helping to restore the reputation of Pioneer, for example, as an active player in the field.

But the fight isn't over. Arcam and Mission, to name but two British manufacturers, continue to do well and won't let the matter drop. Then there are relatively recent entrants like Aura, with the funds and expertise of B&W behind them, who have also gathered a reputation for producing an amplifier of good sound quality. So the competition in this field is tough. No one is prepared to give up too quickly.

Prospective buyers will find themselves confronted by variety. Denon offer tone controls on a big, black, chunky chassis, whilst Aura discard them in favour of an elegantly slim chromed case. Everyone offers an LP input, except Rotel, and there is power in abundance. So much of it in fact, with no less than 150watts peak

available from the NAD for example, that these amplifiers will all go plenty loud enough in the home - especially now that loudspeakers are getting increasingly sensitive. An output of 50watts will fill any room, except when insensitive loudspeakers (84dB SPL/watt) are to be run loud, in a large room. Then 80watts or more will be necessary.

Otherwise, choice can come down to facilities versus sound quality. It's unwise to place too much reliance on the former, since most tone controls are blunt instruments rarely able to apply the subtle changes usually needed to trim a system's subjective balance.

There's little else to consider. Balance controls can be useful to compensate for loudspeaker positioning and pickup cartridge imbalance, as well as listening position of course. Headphone outputs can also be useful. Otherwise, the best advice is to try and get some dealer demonstrations to see what you think of the differences we highlight, preferably with an understanding that if you don't like one amp you may be able to

Competitive Spirit

Competition between manufacturers has produced some fine budget amplifiers, as Robert Wilson and Noel keyword discover.

Fierce competition has brought some fine-sounding amplifiers to the marketplace. Once upon a time, Japanese manufacturers almost had it in the bag, offering consistently reliable and competitively priced products. Then UK

specialists like Mission and Arcam started to fight back, using modern production methods and tighter quality control techniques to meet the Japanese on reliability and consistency, whilst improving upon them in sound quality and



Cosmetically, this amp stood out from the rest, largely due to the optional bright chrome finish, but also because of its slim profile.

Switchgear on the Aura was elegant in its minimalism, with just four controls present on the front of the amp. Two solid black knobs control both volume and source selection, a small button placed between them switching in the tape circuit. The VA-50 has four line inputs and a moving magnet phono input for those of us still addicted to vinyl. A jack socket is provided for headphones, placed on the left side of the amp next to the on/off switch. Power-on is indicated by a bright green LED.

The rear of the Aura is as neatly laid out as the front, being dominated by the four large, centrally positioned, speaker outputs which accept 4mm banana plugs. Power comes to the Aura via a standard 3pin IEC mains 'kettle plug' socket.

Gold plating has been provided on the inputs for phono and CD, but other inputs of lesser importance must make do with standard RCAs.

SOUND QUALITY

This amp was excellent. From the first few bars of 'Roll With It' I knew that we were going to get on well. There was so much life to its performance, as well as a fullness that made the Aura stand out from the other models on test.

I found the VA-50's excellent bass quality made listening to rock a very satisfying experience; it has just the right amount of strength, weight and warmth, producing a cohesive portrayal of a rhythm section. Kick drum really did kick, and electric bass seemed to go down forever; this VA-50 had more apparent downward extension than any other model on test, it seemed.

The Aura knows how to drive a song. It had a mid-band with a natural texture and presence, one that captivated me. Allied to this was exact image placement across the plane of the

speakers, yet with tangible 3D imagery that injected plenty of space and body to the structure.

The ability of the mid-band to convey subtle nuances and inflections of tone and delivery made listening to vocalists such a pleasure. This was highlighted when I listened to Sade. The emotion and dynamic shading in her voice came over so naturally that I felt instinctively it was right. The harmonics were well filled out and the sound just seemed to possess more 'flesh and blood' compared to the others.

Treble had lots of energy and detail, never becoming obvious or intrusive, the decay of crash-cymbals on the Stranglers disc was quite stunning, hi-hat was razor sharp, and the slap-echo used on the rim shots was excellent.

Listening to some Pink Floyd on vinyl helped reinforce my belief in this amp's natural sounding midrange. However, the treble became slightly recessed and the bass a little dynamically compressed. The MM stage also produced a lot of cone movement due to record warps.

SUMMARY

Subjectively the Aura is a very complete package, appealing to the musical as well as audiophile senses.

Its bottom end is powerful and controlled, giving music solid rhythmic drive, without any resort to euphonic enhancement. The mid-band is expressive and detailed with good recovery of ambient acoustic information, while the top is spacious and lively with almost as much sparkle as that of the Pioneer A-300X ●

Aura VA-50
Aura Designs Ltd.,
Marlborough Road,
Curchill Ind. Est.,
Lancing,
West Sussex.
BN 15 8TR
Tel: 0903 750750

£349.95

MEASURED PERFORMANCE

The VA-50 uses a MOSFET output stage. Although robust (and expensive), MOSFETs do suffer distortion unless a lot of feedback is used, but this in itself can make an amplifier sound 'flat'. Aura have effected some curious balances to cope with this. The VA-50 has a high 0.24% distortion at 10kHz, with an extended harmonic structure - not a good sign. So to add apparent warmth and smoothness, treble output has been rolled off very early, reaching just 18.5kHz (-1dB) at all volume control positions. I've never measured such a limited bandwidth in a hi-fi amp, -0.5dB at 20kHz being the usual minimum. The impact upon sound quality can only be judged subjectively.

Power measures a healthy 60watts into 8ohms and 80 into 4ohms. The designer likes an extended subsonic response: CD reaches down to 4Hz, LP down to 11Hz. Warps are likely to cause cone flap on reflex speakers. Otherwise, the disc stage was well engineered, and so was CD/tuner/tape.

This is an unusual amplifier. **NK**

Power 60watts

	CD/TUNER/TAPE	DISC
Frequency response	4Hz-18kHz	11Hz-21kHz
Separation	70dB	66dB
Noise	-97dB	-79dB
Distortion	0.01%	0.01
Sensitivity	220mV	3.2mV
Overload		100mV
dc offset	8/4mV	

Distortion

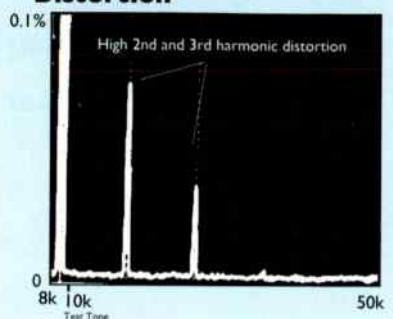



MEASURED PERFORMANCE

Frequency response through the 'flat' CD/tuner/aux inputs was wide at 4Hz-70kHz, with plenty of subsonic extension for CD, which with some discs does help show up some surprisingly low information. High sensitivity (170mV) makes it compatible with all sources, no matter how low their output.

Distortion was low across the mid-band, measuring 0.007%. It rose a little toward high frequencies, hitting 0.07% comprising odd order harmonics. I start to get worried when levels exceed 0.2% at 10kHz.

The disc stage has a warp filter at 50Hz, bass lower than this being attenuated. Equalisation was, otherwise, accurate right across the audio band, giving a flat frequency response, but I would expect some obvious lack of bass extension on LP. Sensitivity was high at 2mV and overload satisfactory at 105mV. Input capacitance measured around 180pF. The Alpha 5 measured well in all respects. **NK**

Power 55watts

	CD/TUNER/TAPE	DISC
Frequency response	4Hz-70kHz	50Hz-60kHz
Separation	72dB	48dB
Noise	-94dB	-74dB
Distortion	0.007%	0.008%
Sensitivity	70mV	2mV
Overload		105mV
dc offset	0/1mV	

Distortion

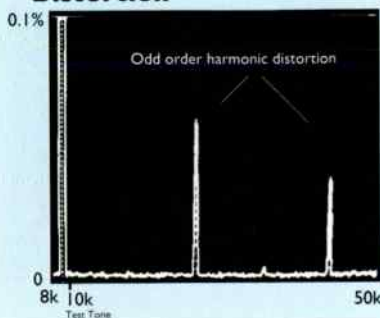

The first thing that is noticeable about the Alpha is the fact that it's right-hand drive in true British fashion, meaning that Arcam have chosen to place the power switch on the right of the fascia, one in the eye for convention.

As with all ergonomically correct amps the most prominent knob on the front is the volume control, which along with others on the Alpha has a small dimple on the surface to indicate the position.

Selection of the five inputs (four line, one MM phono) is by a rotary switch selector, whereas tape is selected by a button, although line out is only available for one machine. Another button is used to select the source-direct route, by-passing bass, treble and channel balance controls. The Alpha also has the ability to accept two loudspeaker systems as well as having an outlet for those of us who like to monitor on headphones.

Unfortunately, the Arcam budget didn't extend to the inclusion of a little gold plating for the RCAs, which would mean more to audiophiles than another set of speaker terminals (unless they were for bi-wiring).

SOUND QUALITY

Arcam appear to have taken the same approach to sound quality that Denon advocate, namely lots of life and dynamics.

The Alpha has a clear, concise and smooth presentation which projects the central image forward to a certain degree, making listening to vocals and prominent instrumentation very easy and enjoyable.

With the Stranglers' Dreamtime album I became aware of the vivacious presentation of the guitar solo during 'Always the Sun' which harmonised well with the tightly knit rhythm section, producing excellent timing between the kick drum, snare and bass. This ability to blend the musical information into a harmonious event was again evident with a Steve Winwood disc, which possessed

a fluidity that gave the band a believable presence. The ticking pulses on the hi-hat were very well defined, making it easy to determine when it was being played open or closed. Treble quality overall was very good, with a high amount of detail and a genuine degree of sparkle, personified by the gorgeous ride cymbal fills on 'Your Love is King' by Sade.

Mid-range detail, at times, was explicit with obvious examples being the reproduction of keyboard instruments and saxophone. This, in particular, had a rough and abrasive texture which left me in no doubt as to the timbre of the reed.

Bass went down a long way and was again fluid and dynamic, with a crispness that didn't leave the bass hanging around due to an excess of overhang that some amps like to portray.

With a moving magnet cartridge the Alpha really impresses. It has clean treble and bass with good weight and dynamics, leading to a lively, musical sound from the vinyl medium with very little background noise.

SUMMARY

The Alpha is a terrific little amp with lots of life. It produces music that is fluid and easy to follow and gives the listener a good deal of insight into the musical intentions of the piece. Dynamic expression is well maintained, making the Alpha very persuasive with piano recordings and good vocal renditions, especially those that have been captured with a large quantity of their dynamic shading still intact ●

Arcam Alpha 5
A&R Cambridge Ltd.,
Pembroke Avenue,
Denny Ind. Centre,
Waterbeach,
Cambridge,
CB5 9PB
Tel: 0223 440964

£229.90

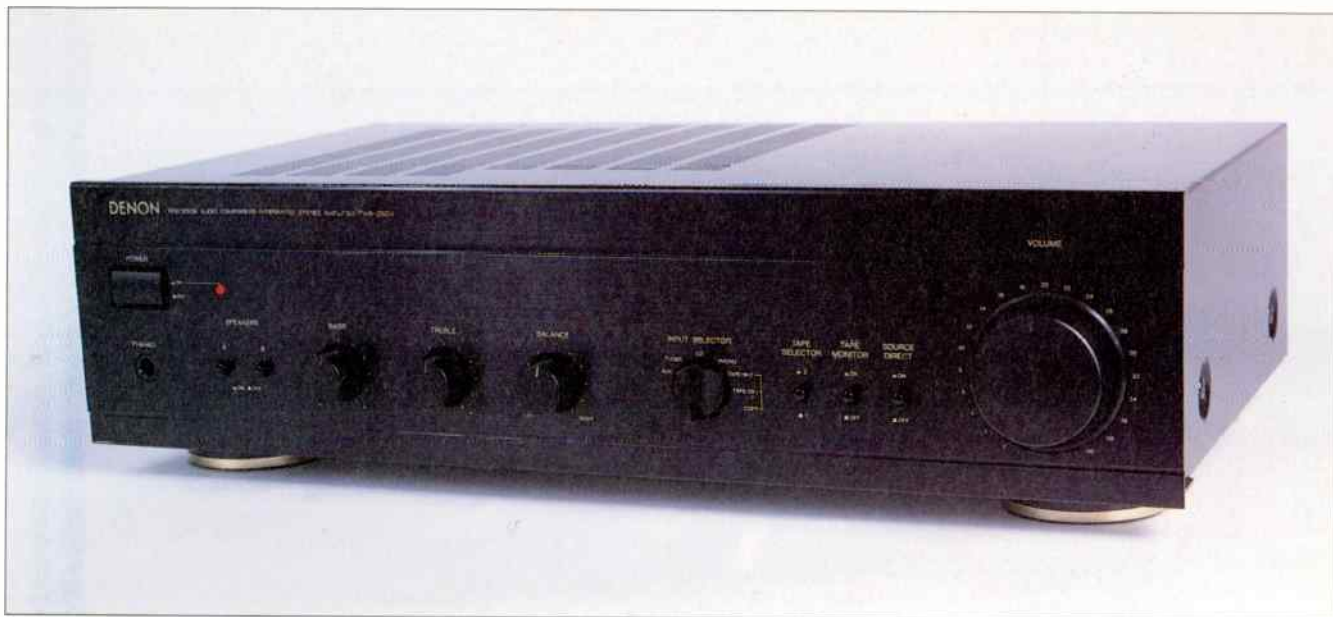

The Denon is presented in typical Japanese business-like fashion, everything in its place and a place for everything.

Two fluted channels across the top and bottom of the fascia frame the controls nicely, these being dominated by the presence of a large imposing volume control which feels good and makes volume setting easy and accurate, particularly at low levels.

Facilities are in keeping with the industry standard for this class of amp, three line inputs and one phono stage (MM only) as well as tape monitoring for two decks. Three small rotary knobs control the channel balance for the stereo image and also the bass and treble tone controls. However, Denon have the audiophile in mind and include a source direct button which by-passes all three controls.

Provision is made for the connection of two sets of loudspeakers which can be accessed independently using buttons located next to the headphone jack socket.

Around the back everything is neatly arranged, with speaker sockets able to accept banana plugs. However, there is a lack of gold plating on the RCA inputs, not important I know, but a nice touch all the same.

SOUND QUALITY

Especially after the mesmerising Pioneer, the Denon came as a bit of a culture shock, being a harder, punchier, more dynamic amp.

The sound was more immediate. With The Stranglers Dreamtime disc this amp's projection of the mid-range was involving, especially in the strong dynamic expression that the Denon resolves from the music. The amp also threw out a wide soundstage which remained solid at the outer extremes, but unfortunately this wide expanse of sound was quite flat, the Denon seeming to lack the depth and space that the Pioneer produced.

The drum beats and snappy

percussion on the intro to Winwood's 'Roll With It' really blasted out from the speakers, complemented by a tight, assertive bass which was fast, but a little dry. The Denon portrayed the lively, infectious quality of this song's arrangement very well. All the cymbals: ride, crash and hi-hat, while lacking the finesse and delicate touch of the Pioneer, were sharp and incisive, with their separate timbral characters intact.

This enthusiasm for the performance did have some drawbacks, which at times masked a little of the delicate internal structure of the music. While listening to Sade, I became aware of a cooler, more analytical aspect to her voice, although it still remained smooth. The amp placed more emphasis on the Fender-Rhodes piano that is present; it sounded excellent, the upper harmonic ringing of this instrument was reproduced with bell-like clarity.

The smooth, punchy sound of the Denon was also carried over to the MM input which had a lot of meat and weight at the bottom end, which I found very infectious on rhythmical music.

SUMMARY

Music reproduction with life and dynamics is the Denon's forte. This amp creates a wide expanse of sound that is both bouncy and exciting, with very good lower mid-range detail. The amp tends towards an up-front, analytical approach to some types of music, being slightly too clinical for warmer, more mellow styles of arrangement. However, Rock and powerful Blues sound great, particularly when listening to vinyl ●

Denon PMA-350 II £219.99
Hayden Laboratories Ltd.,
Hayden House,
Chiltern Hill,
Chalfont St. Peter,
Bucks. SL9 9UG
Tel: 0753 888447

MEASURED PERFORMANCE

The PMA-350II is a powerful beast. It produces no less than 84watts into 8ohms and can manage 132watts into 4ohms. This gives it plenty enough power to go really loud and the 350 will handle difficult (low impedance and reactive) loads with ease.

The 350II has low distortion across the audio band, plus a tightly band-limited frequency response that reaches up to just 23kHz (-1dB) via CD. This is thought to lessen transient distortions. It often results in a warm sound as well. The bass end reaches down to 8Hz, low enough to contribute toward good, solid bass.

There is a moving magnet (MM) phono stage, but no moving coil provision. British design input comes in again with a bass roll-off below 30Hz to suppress warps; Japanese amps rarely, if ever, possess this property. Sensitivity was correct, overload high and hiss low. Loading was correct at 47k//200pF.

The 350II has an impressive measured performance. **NK**

Power	84watts	
	CD/TUNER/TAPE	DISC
Frequency response	8Hz-23kHz	30Hz-20kHz
Separation	82dB	80dB
Noise	-96dB	-77dB
Distortion	0.004%	0.004%
Sensitivity	180mV	3mV
Overload		170mV
dc offset	2.5/2.7mV	

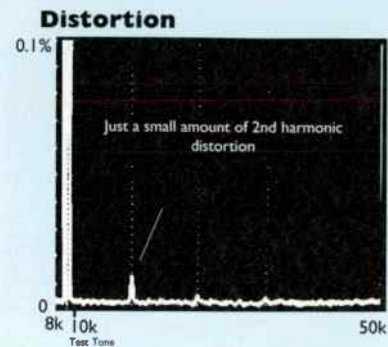



MEASURED PERFORMANCE

The 304 has an unusual short-term high power delivery system to cope with high level musical peaks that last one second at most. This means fast transients (e.g. a clash of cymbals), rather than sustained musical crescendos. It's a way of preventing overload distortion. At heart, the 304 is a 50watt amplifier (continuous power), but it can deliver a clean 150watts short-term. There's no problem with low 4ohm speaker loads: the figures rise to 70watts and 170watts respectively. So the 304 can go loud and avoid short term overload.

Distortion was low at all frequencies and levels, and comprised second harmonic only - a good sign. NAD limit bandwidth via CD (18Hz-40kHz) and fit a warp filter on the disc input. The disc stage was quietest of all the amplifiers, as always with NAD. Sensitivity was normal and the overload ceiling very high. This is a cleverly and thoughtfully engineered amplifier. **NK**

Power 50/150watts

	CD/TUNER/TAPE	DISC
Frequency response	18Hz-40kHz	30Hz-43kHz
Separation	70dB	70dB
Noise	-105dB	-70dB
Distortion	0.003%	0.0023
Sensitivity	200mV	3mV
Overload		240mV
dc offset	3/2mV	

Distortion

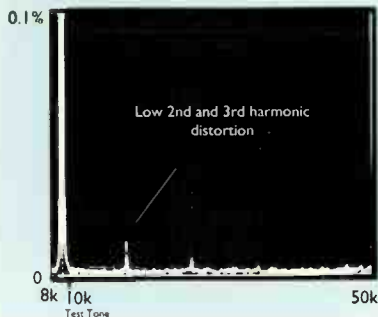

The 304 came to us in NAD's usual dark grey corporate colour scheme and it was styled in the their understated, functional manner. Here's an amp whose looks you'll either love or hate.

The 304 comes equipped with its fair share of facilities, including NAD's unique soft clipping circuitry. The largest control on the front panel is the volume control which has a lovely, smooth, well-weighted action. Source selection is provided by push buttons: a row of six is provided (including MM phono), plus one for tape monitor selection. Stereo balance, bass and treble are adjusted by rotary controls (no parametrics here) but those of us who don't believe in such frivolities can make use of a tone by-pass switch. A provision for switching between two sets of speakers is included, as is a headphone socket.

Around the back, everything is neatly set out, gold-plated RCA phono sockets being used for the phono and CD inputs. Two sets of sockets marked Pre-out/Main-in allow for the separation of the pre and power amp sections within by removing the metal jumpers that bridge them. Speaker terminals accept bare wire and 4mm plugs.

SOUND QUALITY

The NAD was a very rich-sounding amp, possessing a sound that had lots of body, but a darker tonal presentation than is usual.

On the Strangers CD, the NAD put lots of space around the rim-shot in 'Always the Sun', resolving the artificial reverb very well, but giving it a distinctly 'cuppy' timbre. This amp also placed importance on the dynamic content of the music signal, something I enjoy as it gives the music dimension and expression and, although the NAD wasn't quite as explicit as the Denon in this area, it made this amplifier a real foot tapper.

A marginal loosening of the bass could be detected with the Aye disc by

Angelique Kidjo where the full, rich character of the NAD tended to over-blow the bottom end slightly, but it still managed to maintain a solid drive to the rhythm. Percussion was very coherent, the NAD giving a good measure of snap to quick dynamic transients. Treble was refined, if a little restrained in comparison to that of the sparkling and airy Pioneer.

Vocal reproduction was very natural I felt, making lyrical content easy to follow and understand within the context of the song. The prominent lower mid-band did exhibit a discernible colouration, however the darkening of tone lent itself well to the definition of left hand notes played by Steve Winwood on a Hammond organ.

Imaging was good, producing, like the Denon, a broad, well-preserved picture of the musical event, though some more space and depth still needed to be resolved.

The NAD had a very quiet disc stage with a warm and engaging tonal character due to lots of presence in the bass and a sweet treble that made listening to vinyl very involving and communicative.

SUMMARY

In the 304 NAD have succeeded in producing a pleasantly musical amplifier, with a well engineered phono stage, one that has great body and weight, as well as a rich tonal texture that is quite inviting.

Good dynamic shading and bass definition create a sound that is faithful to the musician's performance, which makes for strong listener involvement.

Treble information is detailed without being offensive, but somewhat lacking in sparkle and openness against its rivals ●

NAD £239.95
NAD Marketing Ltd.,
Adastra House,
401-405 Nether Street,
London N3 1QG
Tel: 081 343 3240



Your pounds buy a large box from Pioneer, one that is held together by numerous copper-plated screws on the base plate and rear panel. This curious practice is meant to minimise eddy-current induction. The RCA phono sockets look dull plated, but in fact they have a special tin plating said to be better than gold. The speaker terminals accept 4mm plugs.

The A-300X has typical Japanese styling - it's large and intrusive - and while there is nothing wrong in that, it does look a little gross in comparison to the more aesthetically pleasing Europeans, at least, to my eyes.

The controls are a little on the large side, with a big dual-concentric volume control at right and two slightly smaller rotary controls for source and record selection. The Pioneer accepts three line level inputs and two tape systems, whilst vinyl is taken care of by an MM phono stage. A large chunky (and clunky) button controls power.

A fluted channel across the lower portion of the fascia helps to break it up a little visually, but the gold lettering and swirling script do make me a little wary.

SOUND QUALITY

This was the first amplifier up for listening, due to its position in the budget amp market as the one to beat and as a bench-mark against which all the others can validly be gauged.

It's easy to see where this amp got its reputation, as what issued forth was an airy, spacious sound with great mid-range projection and presence. Listening to the title track of Steve Winwood's *Roll With It* album, its easy-to-follow 'walking' bass line gave the music a good foundation, sounding gently rounded, but with a fair degree of punch which, coupled with the crisp and free treble, gave the sound a profound cohesion across the frequency band.

Vocals were very good, easily intelligible with excellent differentiation of the reverb content within the mix. Using

the *Lemon Trees* album, recorded with a lot of treble energy, showed how pure and sweet the Pioneer could be, managing to reproduce masses of detail without resorting to over-emphasis of sibilance. However, all was not perfect as some vocal transients did become a little hazy and breathy, although this could also be an aspect of the recording.

The amp constructed a fairly wide soundstage, though not a massive one, and the central image was well bolted down with lots of space around the main characters. The Pioneer revelled in the creamy textures of Sade's voice on the *Diamond Life* CD, along with its tight percussion which, while having crisp transients on crash cymbals also showed delightfully ringing decay on ride cymbals. With all this life and sparkle in the upper mid-band and treble it wasn't surprising that the bass was slightly withdrawn, although it never became disjointed or detached from the rest of the mix.

The Pioneer was a little let down by the phono input which failed to reproduce the same glorious treble, although it still possessed a free quality that many amps don't even hint at.

SUMMARY

The Pioneer A-300X likes the finer things in life, possessing a delicate nature with a beautifully maintained mid-band and treble. The spacious sound of this amplifier is very alluring and the bass also has a pleasantly warm character with a fair degree of speed, although dynamically it isn't what you'd term jaw dropping.

So, there it is, a very good amp with some outstanding qualities and a decent disc stage. It sets a high standard for others to follow ●

Pioneer A-300X £229.95
Pioneer Hi-Fidelity (GB) Ltd.,
Pioneer House,
Hollybush hill, Stoke Poges,
Slough, Berks. SL2 4PQ
Tel: 0753 789789

MEASURED PERFORMANCE

Although massively built, the A-300X turns out only 50watts, less than rivals, but still plenty enough to go loud, especially with today's sensitive speakers. It handles low and reactive loads without a murmur, so speaker matching will not be a problem.

This amplifier has a wide bandwidth on both CD/tuner/tape and LP. However, subsonic extension down to 7Hz with the latter will amplify warps strongly, leading to cone flap with reflex loudspeakers - not a good thing. I'd expect this Pioneer to have an open sound with solid bass from CD.

Distortion was very low at all frequencies and power levels, suggesting both good basic design, but also liberal use of feedback, which constricts apparent stage depth. There should be no treble roughness, however.

Sensitivity via CD was high at 170mV; the A-300X will match even low output items. Disc (MM only) was extremely quiet, sensitivity normal and overload threshold high. This is a well designed amplifier. **NK**

Power 50watts

	CD/TUNER/TAPE	DISC
Frequency response	5Hz-73kHz	7Hz-50kHz
Separation	80dB	79dB
Noise	-95dB	-83dB
Distortion	0.002%	0.002%
Sensitivity	170mV	2.7mV
Overload		150mV
dc offset	17/13mV	

Distortion

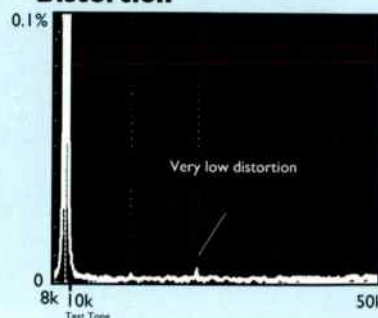



MEASURED PERFORMANCE

The RA-935BX produces 50watts into 8ohms and 80watts into 4ohms. It handles reactive loads well, so it is not loudspeaker sensitive. Rotel have engineered a wide bandwidth, joining Harman in this respect. Even though this practice runs contrary to current popular wisdom, it does not blight sound quality so much as give it a slightly different character, one that is open and clear, cool and sometimes a little bright. Precise character depends upon many other factors of course, so this can only be a generalisation.

Distortion was very low at all frequencies and power levels, always an interesting property. It suggests smooth treble free from harshness, but (possibly) compressed perspectives from heavy feedback. Only listening tests can be a judge of this, however. Sensitivity, at 250mV, was a little lower than usual these days, but adequate all the same.

The RA-935BX is a well designed 50watt amplifier, without a disc stage. **NK**

Power 50watts

	CD/TUNER/TAPE	DISC
Frequency response	8Hz-134kHz	none
Separation	60dB	
Noise	-103dB	
Distortion	0.005%	
Sensitivity	250mV	
dc offset	-21/-18mV	

Distortion

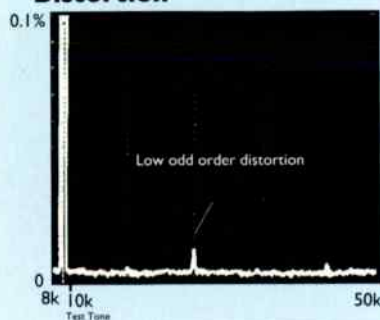

Definitely the most stylish amplifier in the group, this Rotel has an air of high-end minimalism about its design.

The fascia is well constructed, as is the rest of the amp, appearing solid, hefty and built to last. The brushed metal finish and fluted end caps add a touch of class. The front is dominated by a large centrally mounted dual-concentric volume control which allows channel balance to be adjusted, as well as output level. On the right hand side of the amp are two rotary selectors used for the selection of listening sources and recording sources.

Unfortunately, the Rotel has only three source inputs with no phono stage, so this is not much of a bargain for vinyl lovers, who would need a separate head amp. However, provision is made for two cassette decks.

The left side of the fascia has the power switch and the speaker selector; the Rotel can run two sets of loudspeakers and headphones too.

Rotel provide gold-plated socketry for the CD input. However, the other sources must do without such luxuries and both sets of loudspeaker terminals accept 4mm banana plugs or bare wire.

SOUND QUALITY

A striking, neutral mid-band was the Rotel's most obvious feature. This helped create a sense of space and tangibility to musical instruments, indicating that low level detail was being effectively recovered. In this respect the RA-935BX was similar to the Pioneer.

The bass had a fair amount of warmth and was rounded out nicely, but it lacked the rich, punchy quality of the NAD. The kick drum present on 'Agolo', a track from Angelique Kidjo's Aye album, certainly went deep, with a good softening of the transient's punch so that, although the bass had lots of presence, it lacked a little musical verve.

Jangling acoustic guitars prevail on

'The Way I Feel' by the Lemon Trees and these were superbly portrayed by the Rotel which captured the whole envelope of sound well, creating real snap to the strings, emphasising the percussive drive that the instrument gives to the song. The main vocal was solidly placed within the deep soundstage, although it was a little withdrawn in comparison to the projection of the Denon.

The Rotel was good at preserving the decay of notes such as on the sustained chords from a Hammond, or the sparkling ride cymbals used by the Lemon Trees, managing to hang on where other amps throw in the towel.

Dynamically, the RA-935BX was quite competent, with a pretty powerful rendition of the Toms that make such an impact towards the end of Dire Straits' 'Private Investigations'. This was carried over into the mid-band, which helped relay some of the emotion aroused by the varying attack on the playing of the acoustic guitar.

SUMMARY

A neutral mid-band with lots of ambient detail is what the Rotel is all about. The balance of the amp does tend towards that of the Pioneer, having the ability to reproduce upper mid-band and treble information with delicacy and sparkle.

Even taking this into account, Rotel haven't forgotten about the music; this amplifier has a fair share of dynamic ability, with a bass output that seems to go down a long way. Pace and excitement aren't quite in the NAD or Denon league, but the Rotel is still a long way from being bland ●

Rotel RA-935BX
Gamepath Ltd.,
25 Heathfields,
Stacey Bushes,
Milton Keynes,
Bucks. MK12 6HR
Tel: 0908 317707

£225.00

4240 Integrated Amplifier



* 40w per channel, Bi-wireable * Plug-in phono stage * Pre/Power connection
 5 line level inputs * Headphone output * Highly developed State of the Art Circuiting

Name : Address :

.....

..... Post Code :

CREEK AUDIO LIMITED

2 BELLEVUE ROAD FRIERN BARNET LONDON N11 3ES TEL 081 - 361 4133

WESTWOOD & MASON

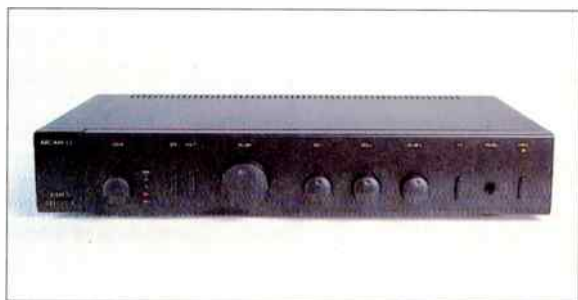

Compare for yourself!

**ARCAM ALPHA FIVE v CREEK CAS4240 v
 DENON PMA 350 II**

Westwood and Mason, hifi for the enthusiast and connoisseur, including : Tannoy Definition 500 and 700; Quad CD67 and 606; Naim CD3 Nait3 and 92/90.3; Rega XEL; KEF Q30 and Q70, Marantz CD63 and PM44SE; Mission 753,780SE,751 and 760ISE, Arcam Alpha Five CD and Delta 290; Monitor Audio 201 and 202 Epos ES14 and ES11 etc etc..

Westwood & Mason (Oxford) Ltd
46 George Street
Oxford
Oxford (0865) 247783 Closed Thursday
Demonstrations by Appointment.

Doug Brady Hi-Fi

"You really must hear this"



Tube Technology amplifiers sound as good as they look.

The Unisis integrated combines power and speed with sweetness and finesse.

We also have the Arcam, Creek, NAD, and Rotel amplifiers reviewed in this issue.

MAKE FRIENDS AT DOUG BRADY HI-FI

Kingsway Studios, Kingsway North, Warrington, Cheshire (0925) 828009 open six days. Fax: (0925) 825773	401 Smithdown Road, Liverpool L15 3JJ Merseyside (051) 733 6859 Closed on Wednesday.	14/18 Monmouth Street, Covent Garden, London WC2H 9HB (071) 379 4010 (071) 497 1346 Open seven days fax: (071) 497 9205	The Forge Cottage, 19 Crossgate, Otley, Leeds, West Yorks LS21 1AA (0943) 467689 Closed Sundays & Mondays.
--	--	---	--

CONCLUSION

This turned out to be a most enjoyable group test, during which I spent many days involved in the different perspectives that each amplifier gave to music. Using a system based around two very good sources, the Arcam Delta 250 CD transport sync-

although still smooth enough to prevent listener fatigue.

The Alpha is a real beauty sonically and visually. The finish and styling are very clean, and the phono stage is well engineered and sounds very good, especially as this facility seems to be

persuasive the longer you listen to it. Along with the Arcam, the NAD has a very quiet disc stage and runs neck and neck with the Alpha in sound quality produced from the vinyl medium.

The complete performer of this group is, for me, the Aura. I found this amp's ability to re-create the natural acoustic and complete timbral envelope of sound quite enthralling. The fullness of sound and tangible stereo images really stood out, placing the Aura in a class of its own. Bass extension was the best in the group and the quality of timing and dynamic punch was also very good.

All the budget amplifiers on test were very



locked to a Black Box 50 DAC and a Systemdek IIXE 900/SME 309/Goldring 1042 vinyl system, the amplifiers were listened to through a pair of Heybrook Sextets, which present quite an easy load, but are extremely revealing.

Broadly speaking the six tested can be grouped into three distinct classes. The first containing the Pioneer and the Rotel, as these two amps both have a delicate, sparkling treble and clear neutral mid-range. The Pioneer in particular is very sweet and possesses an upper mid-band that belies its solid-state origins and, although externally the Pioneer looks a little dated, sonically it's still up with the rest of the pack. Where the Rotel scores is its neutral mid-range and recovery of subtle ambient clues. This makes it an excellent amp if you like listening to minimalist acoustic recordings.

The dynamic ones are the Denon and Arcam, as both have an exciting and lively attitude towards recordings. The Denon really is an out-and-out power house with quite stunning punch on drums and percussion and wonderful presentation of vocals, which are forward and immediate,

becoming overlooked in this modern digital age. Sound quality overall is excellent, the Alpha having that rare ability to focus all the musical strands into a coherent, meaningful piece. Treble is detailed and informative, although not as

good. This test shows just how far the budget arena has progressed in the last couple of years or so. However, we should not get carried away here, as all these amps are easily bettered by slightly more expensive ones, such as Mission's



airy as the Pioneer and the mid-band has a presence and verve that really sings.

Both the Aura and the NAD can be defined as very natural sounding performers. Both have the ability to present vocals in a complete and eloquent manner with heightened emotional expression. The NAD, although being quite coloured in the lower mid-band, has a rich beguiling character which becomes more

Cyrus III and the Audiolab 8000A.

In spite of all the hype surrounding the so called Japanese 'super amps', to my ears they were not as musically interesting as similarly priced British alternatives. Therefore, although all six are certainly recommended, depending on your specific view on how reproduced music should sound, the ones that I would single out as particularly impressive are the Arcam Alpha 5 and the Aura VA-50 ●

PHILIPS COMPACT DISC

PURE, PERFECT SOUND-FOREVER.



NOT FADE AWAY

Are your CDs developing a pretty red hue? Hi-Fi World investigates the phenomenon of 'CD rust' with Philips Du Pont Optical, who have pressed disintegrating discs.

Perfect Sound - For Ever' - a wonderful slogan if ever there was one, so wonderful Philips have been pilloried for using it ever since! A frustrated executive once told me: 'We stopped using it a long time ago - it

caused too much trouble'.

The moral might be: don't make a promise you can't keep. CD never was perfect - few things are - and with distortion levels of up to 40% it wasn't difficult to prove. But when CDs started

'rusting' as well, even the second part of the promise began to look doubtful. Britain's tabloid press in particular waded in, suggesting that CDs may in due time rust away.

Nonsense? Our chance to investigate



◀◀

How a disc should look. This is our Level 42 control disc which has an even silver colour. A tissue over the disc helps highlight the property.

this phenomenon came about when a reader, Robert Jeapes, sent in two 'rusty' discs for us to look at. One was Johnny Mathis & Deniece Williams, That's What Friends Are For, unfortunately labelled 'Collectors Choice' by CBS. The second disc was Level 42's Running in the Family.

In truth, CDs cannot actually rust. The term seemed a little melodramatic when applied to these discs, because they had a smooth, reddish bronze hue, most pronounced on the label side, which the laser doesn't play of course. It plays the underside, from the inside outward. Undemeath, the discs had a faint red hue - it looked quite pretty! The question was: would this mild discolouration affect the laser sufficiently to be audible? Were the discs merely changing colour yet

▶▶

The reader's Level 42 disc which clearly has a red hue.



◀◀

The reader's Johnny Mathis disc strongly bronzed at the outside edge.

The expected Block Error Rate (BLER) for a good modern disc is 50. Philips Red Book Standard quotes 200 as a worst case maximum. Anything above this, PDO told us, was unacceptable and they would be prepared to replace such a disc. Both of Robert's discs exceeded the critical 200 figure near the edge of the disc, where the bronzing was heaviest. They were candidates for replacement.

Of our discs, the Johnny Mathis performance - the disc we bought new - had become effectively useless. It sent Philips' test equipment mad, as it had ours,

remaining playable, or were they deteriorating? And how could we tell?

Test them - that's how! Amongst our test equipment we have a Cambridge Audio CDI CD Quality Assurance unit, capable of measuring CD quality. All we needed were two new 'control' discs, to give us an idea of how a good disc should measure. That's where the fun and games started.

In a nutshell, one of the 'new' discs we bought off the shelf at Virgin Megastore in Oxford Street, Central London, was itself discoloured. But the real shock was that it

▶▶

Our Johnny Mathis control disc, purchased new April 94, strongly bronzed all over.



close your eyes and see

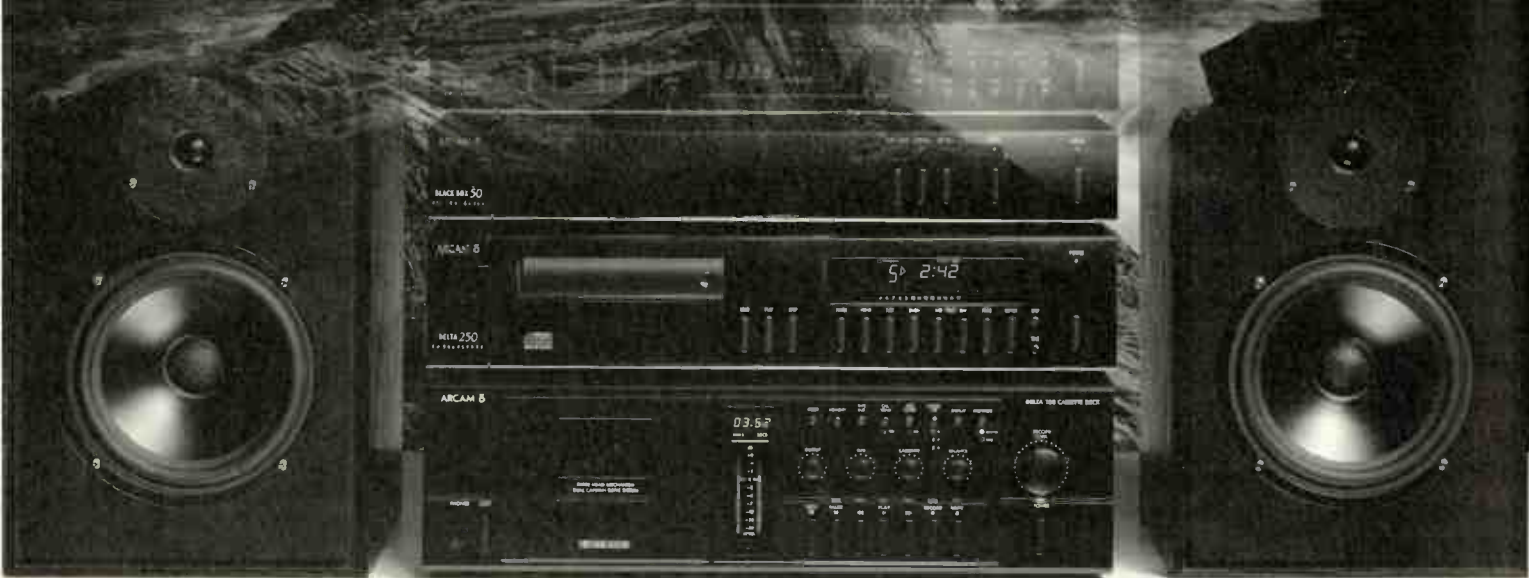

the Arcam Delta system

Close your eyes and see Arcam's Delta system of state-of-the-art hi-fi components.

Ignore the fact that the Delta 290 is our finest integrated amplifier, the recipient of a coveted Design and Engineering Award from the world's pre-eminent consumer electronics show, the Chicago CES. Don't be swayed just because the UK hi-fi press agree, giving it "a compelling and enthusiastic Recommendation"¹ and describing it as "an amplifier with real clout, able to deal with virtually any level of musical complexity".²

Next cast a jaundiced eye on the Delta 280 tuner. Again, disregard the pleasing aesthetics and the convenience of remote control*. Don't even be led by reviews revering its sound as "lucid", "warm" and "attractively open".³

Then, visit your scepticism on the Delta 270 CD player. "Solidly built", it "strikes a balance between smoothness and punch" to gain a class leading, 5 star recommendation.⁴

If that's not enough, take a sideways look at our remarkable two-box CD player, the Delta 250 CD transport and Black Box 50 DAC. "To justify their significant cost, two-box systems really have to offer that little bit extra in terms of sound quality; but Arcam's combination does just that - and more".⁵

Next, move on to the Delta 100 cassette deck. Try to dismiss once again its 1992 Chicago CES award and the reviewer who gushed, "In the beginning, I called for a round of applause for Arcam's bravery in producing a British-made cassette deck. At the end, I'm asking for a standing ovation".⁶

Finally, muster up your best disinterest for the "extraordinarily well engineered"⁷ Delta 2 loudspeakers, "a firm, positive sounding design with bold bass and mid and a firm grip on the musical architecture".⁸

In fact, ignore everything anyone else tells you. Ignore even what your eyes tell you is true. Just let your ears decide.

Just listen. Close your eyes, open your mind, and see the light.

1. Hi-Fi Choice, March 1993. 2. Audiophile, February 1993. 3. Audiophile, April 1993. 4. What Hi-Fi? Awards issue 1993. 5. What Hi-Fi?, November 1993. 6. Hi-Fi World, April 1992. 7. What Hi-Fi? Awards 1991. 8. Hi-Fi News Buyers Guide, November 1993. * CIR2000 System Remote Control handset to operate all the electronics listed here is an optional extra.

ARCAM

For your free copy of our brand-new 'Soundscapes' brochure with full details of the Arcam Delta range and the name of your nearest dealer, complete and return this coupon to us. In addition, if you would like independent reviews of any of our hi-fi equipment, please state which products and we'll be happy to send you the relevant material. Arcam, Pembroke Avenue, Waterbeach, Cambridge CB5 9PB. Or telephone: (0223) 440964 (24 hours) HFW 1-94

I am interested in reviews on (please state product(s)): _____

Title _____ First Name(s) _____ Surname _____

Address _____ Postcode _____

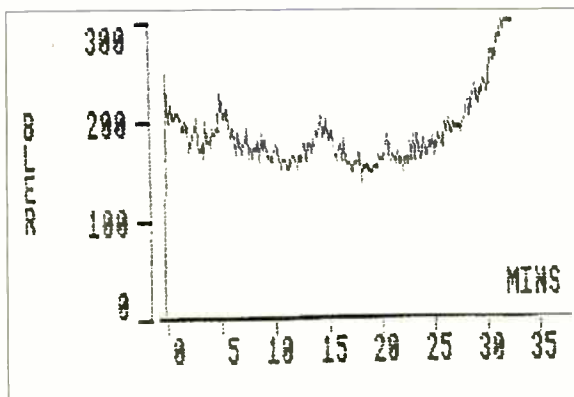
JOHNNY MATHIS & DENIECE WILLIAMS**That's What Friends Are For****READER'S DISC**

Appearance - bronzed,
mainly at outside edge.

Mean BLER - 168

Max BLER - 360

PDO Comments -

Outside specification at
edge

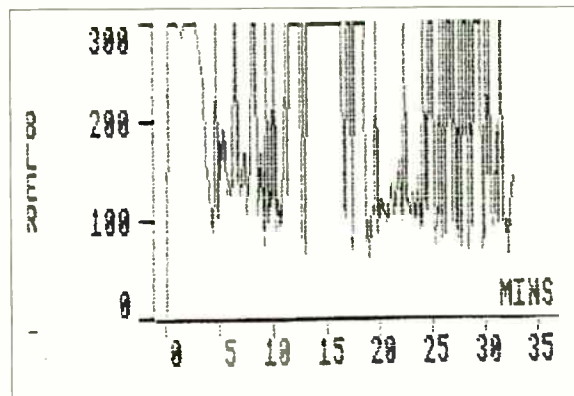
**HI-FI WORLD****'CONTROL' DISC**

Appearance - uniform
level of bronzing

Mean BLER - 1098

Max BLER - 1415

PDO Comments -

Outside specification
throughout disc

**NOTE: BLER = Block
Error Rate. Discs are
outside specification
when BLER exceeds 200.**

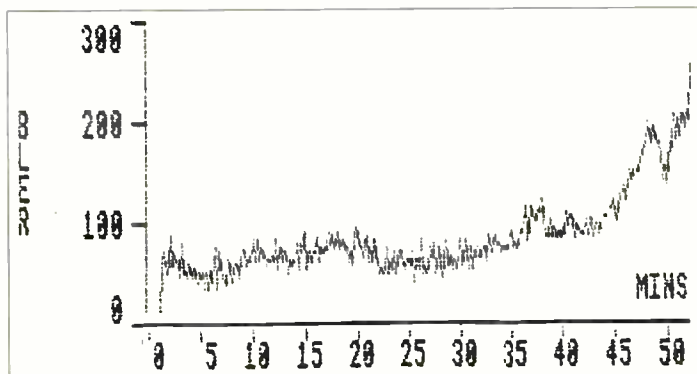
LEVEL 42**Running In The Family****READER'S DISC**

Appearance -
severe bronze
effect at outside
edge

Mean BLER - 71

Max BLER - 258

PDO Comments

- digital errors
above
specification at
outside edge

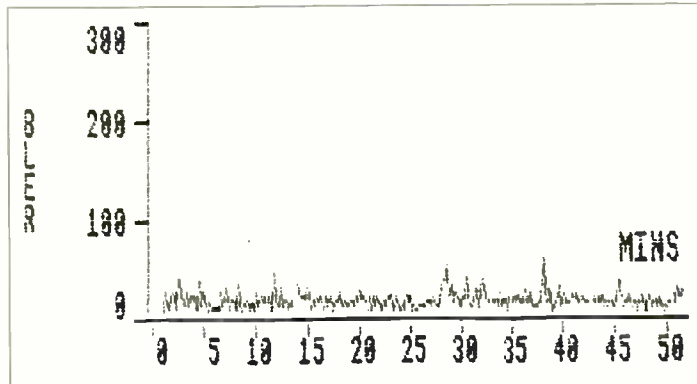
**HI-FI WORLD****'CONTROL' DISC**

Appearance -
no defects

Mean BLER - 13

Max BLER - 65

PDO

Comments -

within
specification

with a BLER of over 1000. It too was a candidate for replacement. Our Level 42 disc was in fine condition, however, having a mean BLER of 13.

So three out of the four discs sent to PDO were, on their own admission, sufficiently below standard to warrant replacement. A 75% failure rate seemed serious. I asked Dave Wilson at PDO for an explanation.

"The rusting problem affects only discs manufactured at PDO Blackburn over a certain period", he told me. Their explanation was that the nitrocellulose laquer they once used reacted with sulphur in the packing sleeves of singles, tamishing them. However, not one of our discs was a single, and all were packed in the usual plastic jewel case, so this explanation doesn't hold up. PDO do now admit that 'a small number of albums were also affected' too, which presumably includes all of ours. We can only hope this is so and that our sample was peculiarly unrepresentative.

New laquer

A new laquer, based on acrylics, is now being used by Blackburn, and it resists tamishing, PDO told me. However, a technical expert at another pressing plant said that some other plants had also used cellulose laquer, so not only PDO were to blame. Both Nimbus and EMI CD pressing plants assured me over the telephone that they had only ever used UV acrylic lacquers, which were harmless, so their discs could never suffer such a problem.

Is 'rusting' too strong a term? Hardly. The reflective coating does not just discolour, it steadily corrodes. So, as far as anyone can tell in the absence of very long term tests, discoloured discs are on their way out. The disc we bought must have been old stock: it had corroded to the point of being useless.

PDO told us that discolouration was highlighted by putting a tissue over the CD. This is a simple test owners can use. Good discs look white, discoloured ones are very clearly a buff colour. The tissue cuts down reflections and highlights differences of colour.

Our conclusion, at present, can only be that discoloured Compact Discs are in a state of corrosion and that, sooner or later, they will become unplayable. Furthermore, such discs are in the shops, corroding - and on sale. Contrary to what we have been told, cardboard sleeves are not necessarily to blame; all our discs were in normal plastic 'jewel' cases. It may well be that our small sample of four discs was unrepresentative. But the problem is real and it can be severe. What we don't know is how widespread it may be ●

**PDO have set up a Helpline for
worried owners.**

Call (freephone) 0800-387063



World

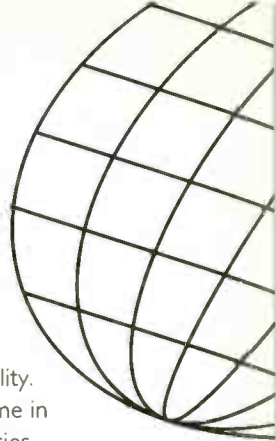

THANKS FROM THE COLONIES

I wish to thank you so very much for such a fine magazine. We look forward to each issue, although it takes rather a long time to arrive over here.

In the December 1993 issue (page 55) Mr. Baker makes the statement: "a CD input is no different from a tape, or tuner, input". This is not entirely correct! In an integrated amplifier I built in 1990 (designed by the staff of Electronics Australia in 1988) a separate CD input was offered. This input (as originally designed) takes only 250mV (as do all the other inputs). However, provision was made (on the circuit board) to add resistors so that the "normal" 2V output of a CD player could be reduced to 250mV. So you see, my amplifier has a dedicated CD input!

Anyway, thanks again for such a fine magazine. We particularly like the

construction projects as there is not a great deal to do over here in the Colonies, but "play radio" and listen to the B.B.C. (as short-wave reception permits!).

**Terry Robinson
Victoria,
Australia.**

Many thanks for spotting my error. I can see how my comment could have been misleading. What I actually meant was that the signal from a tape deck or tuner, like CD, needs no equalisation to give a flat frequency response. As you point out CD has a much higher output level than most other sources. There is good reason to attenuate its signal - and some designers do this with a resistive attenuator network. The idea is to eliminate sudden volume level changes when switching between sources **DB**

CLASSICAL PROBLEM

Before the advent of rock and pop music, almost all purchasers of expensive, specialist equipment were classical music and opera enthusiasts who required something special to replace the ubiquitous radiogram. They wanted something that would reproduce in the home a convincing representation of a symphony orchestra in the illusory acoustic of a concert hall, or the spacious realism of a live opera performance. The emphasis was always upon

sound quality. Stereo came in the late fifties, separating orchestral instruments and performers to enhance the impression of realism.

Equipment reviewers of the time concentrated upon the finer degrees of instrumental and vocal timbre, texture, delicacy and overall sonority, and also the degradation of nuances of sound caused by enclosure colouration and various forms of distortion. Stereo imagery

WIN HI-FI WORLD INTERCONNECT CABLES

OR PERFECT PITCH'S FRANCINSTIEN CD

ENHANCER

The writer of the most interesting or funniest letter will receive a choice of either: a free set of Hi-Fi World's silver plated copper interconnect cables, worth £69.95, or a Francinstien CD convertor enhancer worth £150.



Letter of

SUCCESSFUL TWEAKS

I was particularly inspired by the February letter of the month from Simon Linton.

I am much in the same position as Simon, having purchased a system several years ago (Quad FM4/34/405-2, KEF C80, Thorens TD166 and Philips CD104).

My hi-fi appeared to be suffering from depression (dull and withdrawn!). I was reluctant to throw it all away and start all over again, because the products may come back into fashion (like early Quads, Leaks etc.) and it has all been very reliable.

I was therefore inspired to try some of the newer speaker cables and interconnects. On visiting my local dealer (Northwood Audio of Aylesbury) we came up

with a sensible shopping list of upgrades. These were:

- 1 - Cable Talk Concert 2 for the speakers
- 2 - Gold plated solder-type banana plugs for speaker and amp.
- 3 - New interconnect cable for CD to pre-amp, and pre to power amp.

Could I tell the difference? Yes! The sound is definitely more up-front and sweet.

I was very sceptical at first since, having been trained as an electronics engineer, I can appreciate the need for lots of copper and good low resistance connections, but I'm still not so sure about skin effect at audio frequencies and cable direction.

So at the end of the day I have spent well under £100 and have seen some good results. Even though my equipment is fairly long

Send your letters to Hi-Fi World Letter Page,



writes

was never mentioned or considered, because it was of less relevance to the reproduction of the sound of a large and dispersed orchestra.

The introduction and popularisation of pop and rock music has brought radical changes to the perception of hi-fi, though whether these were intended by designers or have been made in response to exhortations by reviewers and others, or simply evolved,

is not known. At demonstrations by dealers and manufacturers of loudspeakers the sound of modern equipment, even before CD, often seems stark and lacking natural instrumental tonal colour. It has more affinity with synthetic, electronic music than natural instruments. CD and some modern cone materials may have further widened the gulf between 'natural' and synthetic.

That departure from the original concept of hi-fi has

been marked by other changes, especially the replacement of sound quality by stereo imagery as a mark of excellence. This has brought about a change in the method of loudspeaker placement, from wide separation with acute toe-in, to a relatively narrow separation of barely six feet with minimal toe-in.

These changes have been gradual and surreptitious, and as a result, a system which obviously favours the more popular types of music has

been imposed upon all, regardless of whether it was appropriate for, or detracted from, the enjoyment of classical music.

Widely separated and acutely angled 'speakers were first advocated by Hugh Written, in an article published many years ago and could offer several advantages. Orchestral instruments are more separated and therefore, more clearly defined; there is an increased sense of spaciousness the stereo listening area may be appreciably enlarged and remove the necessity for a central position and the 'speakers may be out of view and less distracting when listening to music.

Regular readers of loudspeaker reviews are rarely left in any doubt that the majority of reviewers concentrate upon their suitability for rock and pop music, while the interests of classical music receive only perfunctory attention. Most reviewers now seem to be obsessed with stereo imagery, dynamics and clarity, but fail to mention sonority and instrument tone as though of no consequence to the enjoyment of music.

**G A Jolly
Essex.**

(edited for reasons of length)

Reviewers, including myself, do tend to concentrate more on rock music than classical. But then there is some justification: 70% of music sold is in the former category. Furthermore, over the last decade or so there has been a strong

the Month

in the tooth, I do regularly attend hi-fi shows, but am holding back like many others on DAT, DCC, Mini-Disc etc, since I've had my fingers burnt by Betamax and BSB equipment. Although technically better than its rivals, the public did not buy 'en masse' and they were therefore doomed to failure.

What's the next purchase? I keep looking at the new Quad CD player, but as my Philips CD104 is still working well, and now I have a wife who is keen to change only when things go wrong, wear out or there are major differences, I guess I shall keep on looking in the windows.

**A.D.Ralph,
Aylesbury,
Bucks.**

I'm glad of your new found enjoyment with your system. All to often quality

equipment such as yours is thrown on the scrap heap without even a thought, yet often what has just been ditched may have been better than the new midi system it has been replaced with. There are a few other things though that you could usefully do to your system to further enjoy the music, especially as you confess to being an engineer.

Make sure that you have a good multi-element aerial, preferably roof mounted so that radio reception is at its very best. The FM4 is an excellent tuner and it'd be a shame if you weren't using it to its full potential.

You don't mention what arm or cartridge you have with your Thorens TD166, but if you haven't already done so, pop along to Northwood Audio and get them to check out the

stylus under a microscope. If it is worn, replacement will bring about a faster, crisper more lively sound from vinyl.

Now, as you are an engineer, and have heard the difference good cables can make, I'd suggest you do a little work on the KEFs. Just replacing the internal wire with good quality speaker cable, silver soldered instead of crimp on terminals, will bring about an improvement. Whilst you're at it, you could replace the capacitors in the treble arm of the crossover with polypropylenes. Solens sound especially smooth and sweet, and will definitely improve detail and openness. Solen capacitors are available mail order from Falcon Acoustics, Tel: 0508 578272. We'll make a tweaker out of you yet! **DB**

64, Castellain Road, Maida Vale, London W9 1EX.

continued on page 45... ▶▶

From the first few opening bars of Primal Scream's new album, *Give Out But Don't Give Up*, I knew that I was going to get on well with Rogers' new Studio 5s. Big Jet Plane had a suitably large and open soundstage with a deliciously detailed and sweet treble. The

bass was a little too dry, but I hadn't even started experimenting with positioning, so I was confident that there was more to come from these new £699.90 stand mounters.

Moving them around, I found the balance that best appealed to me was

with them positioned around two feet from the rear wall; in this position they didn't have especially deep bass, but it was full and solid all the same. It certainly suited the acoustic guitar on *Free*, which had a wonderfully reverberant, woody bloom to it and Denise Johnson's vocals

A Studious Approach



Dominic Baker finds Rogers have put a lot of thought and care into their new Studio 5 loudspeaker.

were so rich and silky smooth she could have been auditioning for a chocolate advert.

The Studio 5s are extremely fast and detailed, not in an intense or forceful manner, but with a deftness of touch that makes them musically involving and enjoyable. They don't image particularly well, members of the band could tend to drift a little, but they do conjure up a large and free soundstage with plenty of atmosphere and ambience.

Sad and Blue was relaxing and open, with good depth and dimension to the soundstage. The Studio 5s can really open up a recording, and rarely sound closed in or stifled, even with poorer quality recordings. In this respect they have an almost cold clarity to them, the midband is very clean, free from the artificial richness or warmth that many two-way polypropylene coned loudspeakers can suffer from.

Moving on to Magnapop and their Idiot Song, the cleanly plucked electric guitar leapt out of the mix and into the room. This ability is normally commendable in a loudspeaker of the price, but in this case it leapt a little too far to be realistic. This highlighted something I'd been suspicious of earlier: the Studio 5s are forward, perhaps a little too far forward for certain types of music. I must say though that I didn't have a problem with this and in most cases they added a spaciousness and crispness to music that was refreshing to hear, and certainly far better than the other, enclosed sounding extreme.

Linda Hopper's vocal chords were in fine form on Emergency, with the 5s having a crystalline clarity to them,

impressive considering the mediocre quality of the recording (good music though). In this respect the transparency of the Studio 5s is a great attribute, one that many listeners will fall for, I suspect. I

“They are fast, crisp and musically very expressive, with an open and spacious soundstage.”

can imagine them suiting most types of acoustically recorded music extremely well, but perhaps becoming a shade too hard with electronic pop.

Rogers have made a very cohesive loudspeaker in the Studio 5. These speakers hold a piece of music together well, all in sync, bass in time with the rest. This speed and tunefulness in the bass I suspect is partly due to the Studio 5s being a tightly ported design. I'm also sure they benefit from the soft dome tweeter, which forms a more seamless combination with the custom designed polypropylene bass unit than the metal dome tweeter used in the LS range does, good as it is.

Interestingly the Studio range are bi-wired as well, Rogers adopting single wired terminals in the more affordable LS

range to free up funds for better crossover components.

Finally into the draw of the CD player went The Blue Aeroplanes new album Life Model, which once again fared well. There was just a hint of polypropylene colouration which revealed itself as a richness in the upper bass, combined with a little boxiness from the quite lightweight cabinets, but nothing too severe. The crispness and their snappy, lively presentation tended to draw my attention quickly away from this though, so the Studio 5s certainly shouldn't be dismissed for this small blemish.

In summary, the Studio 5s are all about a tonally neutral midband and treble. There is a firm and punchy bass underlying it all, albeit not a very deep one, but enough to give balance to the sound. They are fast, crisp and musically very expressive, with an open and spacious soundstage.

This loudspeaker has competitors though. The TDL RTL3 offers much deeper bass and greater attack, the ProAc Studio 100s a more precise image. But if you want a musically enjoyable performance, don't miss deep bass or the preciseness that the ProAc's offer, the Studio 5s provide a relaxing and open presentation. They're a highly enjoyable listen ●

Rogers Studio 5 £699.90
Swisstone Electronics,
310 Commonsides East,
Mitcham,
Surrey.
CR4 1HX
Tel: 081 640 2172

MEASURED PERFORMANCE

Rogers loudspeakers are always well engineered, or at least the ones I've measured recently have been. Designed by Andy Whittle, the Studio 5s are no exception to this. They display a very flat frequency response, and more importantly, any lifts and falls in the response are well positioned to give good subjective results. Down at low frequencies there is a slow lift which will add speed and power to the bass, the small lift in the upper mid-band will push vocals forwards out of the box and the slight dip in the treble should ensure a smooth sound, free from harshness.

As with most British designed and built loudspeakers, the Studio 5s have a high overall impedance. I measured 11.7Ω, so they will demand relatively little current from an amplifier. The impedance curve is reasonably smooth as well, but the dive in impedance in the treble may produce a slightly warmer sound than usual from low,

or zero feedback amplifiers. Any modern transistor design should have no problem at all driving them though.

In addition the Studio 5s are quite sensitive. Using a nominal watt (2.83V) of pink noise they produced 86.5dB at 1m, a little higher than average. This, combined with their high overall impedance, makes them suitable for amplifiers of 20-30watts or more.

Rogers' Studio 5s are a well thought out and engineered loudspeaker. They will work well with most amplifiers, but for the final verdict, subjective tests still reign supreme. **DB**

Frequency Response



An even, flat response

Impedance

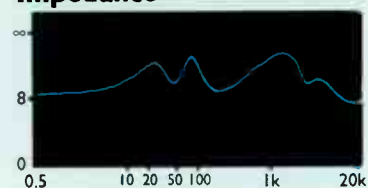

High overall impedance

EXPENSIVE TUNER??

THEN HAVE THE AERIAL IT DESERVES

You spend many hours and quite a lot of money choosing that new tuner, so don't ruin the whole effect by fiddling with bits of wire or old aerials. Have the full benefit of the multipath-free, clean signal which only a well designed and properly installed unit can achieve. If D.X. is your scene, then go for the ultimate in rotating high gain narrow beam systems like our G.23 with 19dB Forward gain, 38dB F. to B. and Acc. Ang. down to 15 Degrees or have a "one off" special built, up to 32 elements.

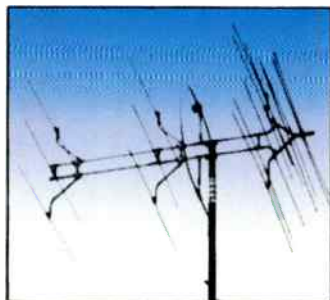

GALAXIE CIRCULAR 17-ELEMENT STEREO
GAIN 15.9dB F. TO B.33.7dB. L.74"

WE DESIGN, MANUFACTURE, SUPPLY AND FIT

- ★ FM arrays from 4 to 23 Elements. TV from 10 to 92 Element.
- ★ British-built and designed to withstand our weather.
- ★ Interested D.I.Y. advice freely given, backed by our complete range of masts, brackets, rotors, cables and aerials. Systems available for chimney, loft, wall, or through roof mounting.
- ★ Professional installation service available within a nominal 200-mile radius of LUTON. Full details of this service available on receipt of a large S.A.E. which will bring you our complete "Aerial Guide" which is more than just a list of our products and prices, and carries details of all our services, including MAIL ORDER and site surveys.

CONTACT US ON 0582 36561 or WRITE To:

RON SMITH AERIALS

98, ASH ROAD, LUTON, BEDS, LU4 8AQ

Personal Callers: Shop Hours Mon. Fri. Sat. 9.00 to 6.00. Lunch 12.30.1.00

Tuesday & Thursday 9.00 to 10.30 Wednesday Closed

(On Tue/Wed/Thurs/ we are often available: Phone to check. Mon/Fri/Sat we are always open).

NAIM AUDIO U.K. RECOMMEND OUR FM AERIALS AND THEIR DEALERS CAN OBTAIN YOUR CHOSEN MODEL WITHIN 48 HOURS, OR SUPPLY EX STOCK.

Standens

92A HIGH STREET
TONBRIDGE 0732-353540

We stock:-

**NAD 304,
CREEK 4240,
MARANTZ CD63**

(see reviews this issue)

ALL QUAD PRODUCTS STOCKED

**WE'VE BEEN GIVING
SOUND ADVICE FOR
OVER 50 YEARS**

Infidelity

indecently good hi-fi



Buying hi-fi should be fun, we guarantee to make it so. Listen to a well chosen selection of quality hi-fi equipment in our comfortable and relaxed listening room. Bring along your own records or CDs, we'll provide the coffee, and hear the difference we can make to your enjoyment of music.

MICROMEGA's fantastic new STAGE CD players now on demonstration

ARCAM, EPOS, HEYBROOK, MICROMEGA, NAIM, NAKAMICHI, NEAT, REGA, ROKSAN, ROTEL, ROYD, TEAC and YAMAHA

9 High Street, Hampton Wick, Kingston upon Thames, Surrey KT1 4DA
Telephone: 081-943 3530. Open: Tues - Fri 10.30am - 7pm, Saturday 10am - 6pm.

Listen Inn

HI-FI SPECIALISTS

Linn, Naim, Epos, Heybrook, Arcam,
Mission, Royd, Audiolab, Creek,
Cyrus, Quad, Denon, Rotel, NAD,
Marantz, Kef, Chord Company
(Naim and Epos Northampton only).

LISTEN INN Northampton
Appointed REGA Agent

32 GOLD STREET, NORTHAMPTON
TEL: 0604 37871
6 HOTEL STREET, LEICESTER
TEL: 0533 623754

...continued from page 41

demographic shift in consumer spending as post war 'baby boomers' who grew up in the sixties and seventies continue to pursue their musical interests. They're now affluent, active and continue to want music - mainly rock music. The old notion that family, house mortgage, children, etc killed off such interests has all but evaporated. The rump of our readers lie in the 25-45 age bracket.

However, I have to say that I still believe a good loudspeaker should be able to reproduce rock and classical with equal ability. As you fear, many modern loudspeakers and amplifiers do seem to be optimised to reproduce pace and rhythm at the expense of tonal colour, making for an arid sound. It's also true that certain ardent rock listeners like this sort of presentation, but equally, many do not, because whilst it handles the rhythmic side of things well, an imperative found only in rock, it doesn't compliment vocals or the many acoustic instruments often used in rock. We're sceptical about it too, but World appeals to a broad church; I feel we should be able to review such amps and describe their properties clearly and succinctly.

The rising interest in valve amplifiers is testament to people's appreciation of tonal colour. I feel we all sympathise with your fears about hi-fi systems that sound "stark and lacking in tonal colour". But it isn't necessary for us all to go back to mono to maintain a balance in these matters, only make sure we keep a wide and balanced view of what is required of an amplifier or loudspeaker. **NK**

MEASUREMENT SPEAKS

Regarding Kaleidoscope in the February edition on one of

the big questions in audio, that of the correlation between objective measurement and subjectively perceived sound quality, I would like to put forward a personal opinion on this matter from the other side of the fence, that of a consultant loudspeaker designer.

My experience has been that if a loudspeaker is judged to have a subjective fault, e.g. a colouration, I have always been able to reveal an engineering reason for it, using instrumentation. Therefore I believe that the concept of objective audio measurement as a predictor of subjective quality is not itself specious, but it is in the way measurements are made, interpreted and presented which can lead to a lack of correlation with subjective impression.

In other words, the question that designers, reviewers and informed purchasers need to ask is: which measurements correlate with subjective impression of sound quality, and how? Here are just a few of the guidelines to which I work with loudspeakers.

The most common measurement made and published is the frequency response curve, in the dB versus log. frequency form. When evaluating a frequency response curve, it is necessary to take into account how it was arrived at, as, for example, averaging the response can smooth the curve, masking a lot of detail which may be very audible indeed. It has been accepted for many years that very high Q anti-resonances dipping tens of dB can be entirely inaudible on programme material, yet high Q resonances which are just 1 dB above the average level can be very audible. Also, a shelf in the frequency response of as little as 0.25 dB across a bandwidth of an octave or more can completely change the timbral balance of the sound. An argument can be

made that smoothness of response is very important, as it can infer an impression of clean sound, but not always.

At this point, I would strongly recommend that Hi-Fi World change from showing third-octave curves to either true swept sinewaves, FFT'd impulse response or at least 1/12th octave resolution, with a more precise published frequency scale. This should cost you no more, it will allow readers to reach a much more informed opinion of the loudspeaker and many reasons for reviewers' subjective impressions will be evident.

Time domain measurements can also help predict subjective impressions. A very useful measurement of a loudspeaker is the impulse response, as this can be used to derive a quasi-anechoic frequency and phase response, it can reveal delayed resonances and reflections inside drivers, cabinets and at cabinet discontinuities.

The area of non-linear distortion has been heavily researched, and it is accepted that minimizing all forms of harmonic and intermodulation distortions is a worthy goal. Harmonic distortion measurements, however, give misleadingly low results when the distortion is of a low-level, modulated spiky nature, such as crossover distortion in early solid-state amplifiers, and quantization noise. Research is on-going into the audibility of this type of distortion.

In conclusion, I agree that objective measurements do not always correlate to perceived sound quality, but I believe that this is because we as reviewers and designers may not be making enough of the right measurements in the right way, and more research needs to be done in this area. After measuring my designs I listen, for weeks, on all types of material, using solid-state equipment and valves, and I

get opinions from everyone I know.

Having possibly committed professional suicide, I will leave any designers reading this with a valedictory warning: several years ago, the owner of a very large loudspeaker manufacturing company once said to a colleague of mine 'Oh, we don't bother listening to our loudspeakers any more, our computer systems tell us everything there is to know'. The company went bust.

M.J. Lawrence M.Inst S.C.E.

Selly Oak, Birmingham. (edited for reasons of length)

Conventional measurements do have their uses, but the point I was trying to make is that they have on the whole been devised to describe behaviour in a world of largely linear electrical and mechanical models that engineers use to understand and describe functional behaviour, so that they can design a better product. Attempted correlation to the human listening experience is retroactive and often of dubious value. Some measurements correlate well (e.g. frequency response) whilst others - like channel separation - have a psycho-acoustic impact quite opposite to that expected. Bizarre!

The same can be said for distortions - some are horrid in small doses, some benign in large doses. So what use are distortion measurements as indicators of sound quality, unless they are hopelessly wrought about with explanations and qualifications? Otherwise they can be positively misleading.

I'd suggest that to better understand and develop audio equipment we need a better understanding of what

continued on page 47...

SYSTEM LOUDSPEAKERS

"EVEN A SHORT LISTEN TO THESE WELL BUILT SPEAKERS FROM
THE SCOTTISH COMPANY BEST KNOWN FOR TURNTABLES
WILL TELL YOU THEY'RE SPECIAL"

WHAT HI-FI? February 1994

SYSTEMDEK LTD. IRVINE KA12 BLD SCOTLAND U.K. TEL 0294 271251 FAX 0294 277095

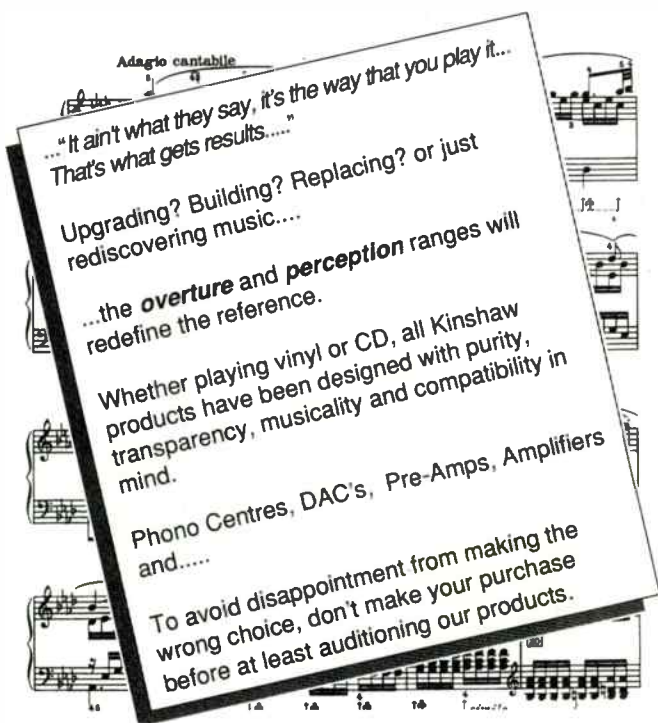

Adagio cantabile

... "It ain't what they say, it's the way that you play it...
That's what gets results...."

Upgrading? Building? Replacing? or just
rediscovering music....

...the *overture* and *perception* ranges will
redefine the reference.

Whether playing vinyl or CD, all Kinshaw
products have been designed with purity,
transparency, musicality and compatibility in
mind.

Phono Centres, DAC's, Pre-Amps, Amplifiers
and....

To avoid disappointment from making the
wrong choice, don't make your purchase
before at least auditioning our products.

Contact your nearest retailer for
an audition or for more information....

U.K. agent;
Ortofon (UK) Ltd.
Chiltern Hill
Chalfont St. Peter
Bucks. SL9 9UG
Tel: 0753 889949
Fax: 0753 889836

Overseas agent;
Kronos Distribution
35 Fariough Road
Newmills, Dungannon
N. Ireland BT71 4DU
Tel: +44 (0)8887 48632
Fax: +44 (0)8887 48281

KINSHAW

Conceptual Design - Sound Engineering

Kinshaw Electronics Ltd. 84 Pendarvas Street, Tuckingmill, Camborne, Cornwall TR14 8RE Fax: +44 (0)209 711839

PROGRESSIVE AUDIO



DIGITAL BY; SUGDEN, MERIDIAN, MARANTZ, MICROMEGA,
PROCEED, AUDIO ALCHEMY, ORELLE AND AUDIOMECA

ANALOGUE BY; MICHELL, PINK TRIANGLE, SME, VPI, BASIS,
VOYD, PROJECT, SYSTEMDEK

ARMS AND CARTRIDGES BY; LYRA, MICROBENZ,
TRANSFIGURATION, KOETSU, SUMIKO, GOLDRING, AUDIO
TECHNICA, DECCA, SME, GRAHAM, REGA, EMINENT AND
KUZMA

AMPLIFICATION BY; LFD,
AUDIO INNOVATIONS,
AUDION, SUGDEN, CHORD,
MOTH, LEVINSON, CONRAD
JOHNSON, CONVERGENT,
LUMLEY REFERENCE,
MICHELL, TUBE
TECHNOLOGY

SPEAKERS BY; PROAC,
AUDIONOTE, SNELL, IMPULSE
TDL, JPW, DALI, ORIGIN LIVE,
AUDIOSTATIC, RUARK,
SOUND LAB, DIAMOND
ACOUSTICS, TOWNSHEND,
MONITOR AUDIO, UKD,
ALCON

ACCESSORIES CABLES BY; QED, STRAIGHTWIRE, LOGAN
HALL, AUDIOQUEST, SILVER SOUNDS, AUDIONOTE, KIMBER,
L.F.D., AND VAN DEN HUL, STANDS BY; TARGET, TRIPOD,
FOUNDATION, GOLDRING, HEADPHONE BY STAX, SEISMIC
SINKS BY TOWNSHEND

HOME DEMONSTRATIONS A PLEASURE
PHONE DAVE ON MEDWAY 0634 389004

HOME DEMORECORD CLEANING SERVICE, SECOND HAND
EQUIPMENT AND RECORDS. PHONE DANNY ON: 0634 580763
DONSTRATIONS A PLEASURE
PHONE DAVE ON MEDWAY 0634 389004

...continued from page 45

we should be measuring and why. Measurements need to be devised that are specific to this end, instead of being adapted imperfectly from engineering modeling.

My fascination with Sensaura and OM3D was the way that they did just this - that is, rely on psycho-acoustic research. Both use complex phase and amplitude cues to 'fool' the brain. And look at the results - complex in some areas (e.g. signal processing), amazingly simple in others (just two speakers needed for surround sound). I suspect that this is the way forward for audio if it isn't just to buzz around in circles, like a bee in a jar.

Moving on to your observations about our published loudspeaker test results; they are consistent with my own reservations on measurement in this regard. I have rejected showing high definition impulse convolutions because they are far too complex for readers to interpret. We use such analyses to measure frequency response and delayed resonances whilst developing our own loudspeakers, but revert to third-octave analyses within the magazine to better illustrate simple trends.

These analyses might convey less to the trained engineer's eye, but in effect, by being understandable, they convey more to the typical reader's eye. **NK**

ORTOFON SPU

Disappointed was I with NK's response to Gerald Sartin's excellent letter in February's magazine.

Noel, what do you have against the glorious Ortofon SPU? What has this heavy weight transducer done to you? I think we should be told.

I don't know if the sample you had was faulty or by

accident it was plugged in to the wrong arm. After all the key to taming an SPU is to use a very heavyweight arm. I do not believe Mr Sartin is operating his cartridge 100% in a series II SME. He should try to find an earlier Mk I arm, sometimes referred to as the 'prototype'.

My own front end is based around an SPU Gold Reference in a Fidelity Research FR64S arm mounted on a Garrard of course. I have never had any of the problems you have had Noel.

In my opinion Hi-Fi World is the most open and free minded of all the major hi-fi press. So I was really disappointed to read Noel's prejudiced response based on a distant meeting.

I demand a re-trial of this most glorious cartridge. You can keep your Ortofon MC2000, as good as it is. It can in no way provide the authority the SPU can.

After all, how long was your 401 stuck up in the loft?
Haden Boardman
Wigan,
Lancashire.

Wow! No 401 jibes below the belt please! At least I kept my 401, in the firm belief that one day it would run properly and prove itself - as it did. But on to Ortofon's SPU.

Many moons ago, on a visit to the Ortofon factory in southern Denmark, I was presented with an SPU as a reminder of the length of time Ortofon had been in the business of manufacturing serious cartridges. But a senior engineer quipped that whilst it was revered by some enthusiasts, it really wasn't so good. This comment set up doubts.

I seem to remember unbolting mine from its massive headshell, putting it into an ADC magnesium shell, measuring it and then using it. Tracking was so-so and tip mass resonance

occured at around 10kHz I seem to recall, a low value. The treble was very sweet. However, suspicion about its abilities and fear of damage to my record collection from mistracking took a hold and persuaded me to part with it. This was Decca London paranoia setting in - I feared encountering another fantastic sounding cartridge that would desecrate my records. So the spiders in the loft never got to hear an SPU, even if they did do the Fandango on my Garrard.
NK

PAST CREATURES

Thank you for publishing my letter in the February issue. However, the note of scepticism in Noel Keywood's reply suggested that the SPU, although fine in its time, is a creature of the past, and, in his opinion, should stay there. I don't intend to challenge Mr Keywood's personal appreciation of this cartridge, but would just like to point out that this is not the view of Ortofon themselves. Not only is the SPU the only hi-fi product that has been in continuous production since 1958, but there is a range of SPU cartridges (marketed in Asia) from Classic, Gold, to Reference. The manufacturer still evidently considers the SPU a state-of-the-art product, with a price to match. The SPU Gold, the only model available in the UK, has a suggested price of £600. Not just for the romantics then!

The resonance Mr Keywood cites was probably due to the head shell. I have noticed a marked improvement to the performance of my SPU when I pushed black tack around the cartridge between the head shell to eliminate any sympathetic resonance. Current SPUs come encased in non-resonant solid head shells.

Perhaps this extra information will help convince

that all of those out there with obsolete Garrard 301s and 401s, 12 inch SMEs and Leak valve amps aren't straying towards soft headed nostalgia if they went so far as to try out an SPU!

Gerald Sartin
Paris,
France.

Alright, you win. We'll review an SPU as soon as possible! **NK**

PUTTING BACK THE INTEREST

Having become a new reader of your magazine it was a pleasure to see, for me, a refreshing approach to hi-fi was taken, in that old equipment holds an equal priority with new equipment.

I have a deep love for music and gradually building up and upgrading my system to what it is today has given me much enjoyment over the past couple of years. My system as it stands is a Marantz CD 52 MkII SE CD player, a Marantz 6100 turntable, a Marantz PM50 amplifier, a Nakamichi BX100E cassette deck and B&W DS4 twin drive speakers with Supra cable. An interest of mine has always been to build my own valve amplifier as I have had twelve KT88 valves in my possession for some time and I now have the opportunity to do this by coupling the idea with my University project, I am studying Electrical and Electronic Engineering specializing in electrical machines, it could provide an interesting comparison to the Marantz !

I plan to design a power transformer for the supply stage by determining the necessary core size and constructing my own primary and secondary windings. Due to a little early research, as my project is not until the next year of my course, it has become apparent that a

continued on page 55...

Marantz have been renowned for their budget and mid range CD players almost from the conception of compact disc itself. The CD-63 follows in a long and illustrious line of forebears. Effectively it replaces the hugely successful CD-52, which itself was preceded by Marantz's first budget bitstream player and rather unsuccessful CD-41. If you go back still further the multi bit CD-50 and CD-65 were, rightly or wrongly, legends in their own lifetimes, especially in souped up Special Edition (SE) form.

An SE version of the CD-63 is promised for the near future, but here we take a look at the standard model priced smack in the middle of the cut throat £200-£300 market, at £249.00.

Marantz may have an excellent reputation for value and sound quality, but their cheaper machines' aesthetics have often left something to be desired. In

an effort to rid themselves of this stigma, they have developed an entirely redesigned range known as "Softline", which runs alongside the flat fronted models.

Being from the Softline range, the CD-63 is slim at only 8.5cm high (in part due to the CDM-9/12 transport shared with other anorexics such as the Aura CD-50) and has a rounded front panel. Otherwise it's fairly lightweight, with gold buttons ringing overtones of tackier Japanese brands. Another break from tradition for Marantz is that the player is actually made in Japan rather than being of Dutch origin as previous budget machines have been.

Being Japanese usually means a surfeit of features, and here the CD-63 is no exception. Electrical and optical digital outputs, a thirty key remote handset, automatic music search, A/B repeat, a numeric key pad, editing features for

recording, and a remote volume control for the output and headphones are all there. Many of these features are unnecessary, and it did make me wonder how much the technical merit of the player would suffer as a consequence.

The internals are, sure enough, Philips based and pretty unexceptional. But proudly announced on the front panel are the initials (in gold of course) HDAM. HDAM transpires to mean high quality audio grade op-amps, rather than the nasty 20p jobs that are usually found lurking at the back of CD players. Its aims are similar to Rotels' Discrete output (reduced noise and harshness), but without going to the extent of building a discrete output stage.

With the four stage dimmer set to its minimum setting, I connected the CD-63 up to my system with a selection of interconnects (but definitely not with the bits of "string" provided). Whatever my

SOFTLINE SUCCESS

Will Marantz's new Softline CD-63 be able to follow on from the success of the CD-52?

Dominic Todd and Robert Wilson look for the answer.

MEASURED PERFORMANCE

With their well established reputation in CD players, Marantz can be expected to tread carefully - and they have with the CD-63. It has a sensibly flat frequency response that rolls off gently at high frequencies (see our response analysis), which will avoid sharpness in the sound.

Distortion was low at all music levels. The distortion spectrum analysis clearly shows a complete absence of distortion harmonics - a fine result for a budget player. Only lower down in the dynamic range did distortion rise a little above the norm., but this is unlikely to be of great consequence. A dithered -90dB signal generated around 10% second harmonic, whereas rival Sony players, for example, manage around 2%. However, low level distortion does not have a major affect upon the sound of player.

Channel separation was high and output normal, at approximately 2.3volts. Both spurious outputs above 21kHz (aliasing products), and high frequency distortion proved low for a budget design. Dynamic range was a satisfactory 105dB.

The CD-63 is very well engineered,

being essentially blemish free. Low distortion and a smooth frequency response in particular suggest a smooth sound is likely. **NK**

TEST RESULTS

Frequency response	3Hz-21kHz	
Distortion %		
-6dB	0.005	0.005
-30dB	0.007	0.007
-60dB	0.6	0.6
-90dB	40	37
-90dB dithered	15	10
Separation dB	left	right
1kHz	133	134
20kHz	127	128
Noise	-116dB	
with emphasis	-116dB	
Dynamic range	-105dB	
Output	2.28V	

Distortion

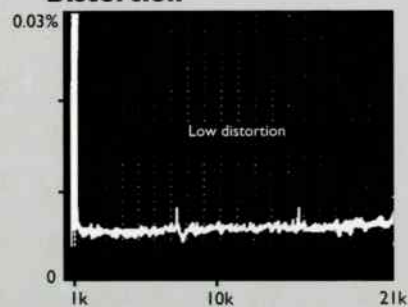

Frequency Response

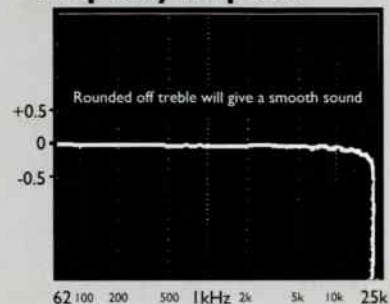



reservations about the new styling, the sound quality more than makes up for it.

I was immediately struck as to how much cleaner at the top end the player was than budget Marantz of old. Suzanne Vega's "99.9°" was tightly focused with her vocals kept firmly under control. Excessive sibilance and splashiness, that could grate with previous CD-52/-72s, were notable by their absence.

Those who enjoyed the Marantz vigour and upbeat presentation can rest assured though. The CD-63 still has all the Marantz hallmarks of good dynamics and fine detail in the treble. However, the latter of these talents does come somewhat at the expense of treble integration, which can sound detached and forward from the rest of the mix. This is emphasised more by poorer recordings and brighter sounding loudspeakers so, unlike many other budget machines, careful system matching is required.

With Fraser Chorus' "Cloud 8" the Marantz compounded the impression of control still further by showing a bass quality that was a match for the treble in terms of clarity, with useful bass extension and depth for the price. This was tainted, though, by a hardening at higher volumes that could become uncomfortable to listen to. Sympathetic interconnects, such as solid core DNMs or even pure silver cables, help, but don't totally alleviate the problem.

An old favourite of mine, Steely Dan's "Haitian Divorce" demonstrated another change of tact for Marantz. This is the first bitstream budget Marantz player I've heard with which piano doesn't come across as hollow and synthesized. Instead it was produced with realism and a greater degree of solidity, although still not quite in the league of, say, the Rotel 965 which really majors here. Other than this there was very little to carp at; the track had all the punch and vitality it should.

Clannad's "Sirius" was given sufficient Celtic atmosphere and warmth. The sound stage was only average in width and depth, but had surprisingly good height, and was open enough to be free from cloudy colourations, allowing vocals to sear from the loudspeakers.

It's rare for any CD player, regardless of price, to combine truly exceptional sound quality, and combine it with solid build quality and desirable looks as a complete package. The Marantz CD-63, like most machines of this price range, is flawed. The greatest disappointment has come with the new style casing which offers no ergonomic improvement on previous models (track and speed advance are still easy to mix up, for example), and dubious aesthetics. Despite being built in Japan, where the solidly built CD-72 originates from, there also seems to be no gain in build quality or finish over the Dutch built CD-42/-52.

Crucially, the sound quality has taken a step forward though, which is no mean feat when you consider Marantz's high standing in the first place. Whether or not this is to do with the new HDAM op-amps is impossible to say, but it seems quite likely seeing as the rest of the components are pretty straight forward.

The CD-63 still upholds the Marantz tradition in sounding lively, exciting and, above all, involving, but in this case is usefully smoother and more refined, especially at higher frequencies. This does fall apart at higher volumes and the refinement still can't match that of a Rotel or even a Denon. Clearly, if you seek an easy going, inoffensive machine, look elsewhere. If it's realism and excitement you seek, though, the CD-63 only has two real problems. The first is the NAD 501 at £180, and the second is Marantz's own Special Edition model which, if past experience still holds true, will be well worth the wait. Roll on the CD-63SE!

ROBERT SAYS

When listening to heavily structured polysynth rhythms which form the basis of Trevor Horn's production work with Grace Jones' "Slave to the Rhythm", the Marantz reconstructed the rigid sequencer patterns well, maintaining machine-like order to percussive arrangements. However, listening to a more natural arrangement, like Steve Winwood's title track from the album "Roll with it", the Marantz lost some of the music's looseness and feel, allowing less of the creative spirit to shine through.

Treble detail is initially impressive, being bright, but reasonably well controlled. It coped well with the excessively sibilant mix of the Lemon Trees album very well, it's just that the budget limitations of the CD-63 could be found when listening for the finesse and clarity of detail that prevails in well recorded cymbals, for instance the initial crash and metallic ring.

The most noticeable facet of the Marantz's balance was the dry bottom end, which I felt took some body away from the overall sound. The midrange is very clear and articulate, with good stage width that remains solid and stable through to the outermost edges, even if this is offset by an unfortunate compression of the actual image depth.

For a budget CD player, the Marantz is very good. It has a lively, clear and concise mid allied to a top end that can be impressive. However, the lack of richness and dynamic shading may not be to some peoples liking, although it could calm down some of the overblown speakers that are around ●

Marantz CD-63 £249
Marantz Hi-Fi UK Ltd.,
Kingsbridge House, Tadbury Oaks,
575-583 Bath Road, Longfield,
Middx. UB7 0EH
Tel: 0753 680868

BUILT ON THE KLYDE

Scots wae an LPI 2 - and love it - now have a new cartridge, the Linn Klyde, to consider. Sassenachs Eric Braithwaite and Noel Keywood take an interest as well.

The new Klyde moving-coil cartridge is likely to warm the cockles of Linnies' hearts. All those with £449 to spare will latch on to this one with the enthusiasm of monster spotters sighting Nessie.

It plays tunes. Or, at least, it plays what I call tunes, which I suspect may

involve more than the Linn definition, especially when it comes to classical music. When it comes to Lenny Kravitz or Tony Remy, the Klyde's wonderful power-driven bass end is tight, fast, and bruising on the solar plexus. It leaves the listener breathless.

At least when it was tracking well: it faltered noticeably heading towards the inner groove on Remy's GRP 'audiophile'

DMM-mastered Boof, as in fact it did on a couple of Alto's heavyweight Decca SXL re-pressings. When this happens, it doesn't interrupt the Formula-1 speed, which is truly exceptional, nor Klyde's supreme rhythmic clarity, but adds a kind of subdued crackle underneath the music, which is mildly disconcerting to those, like me, used to drier, more damped bass from a cartridge.

The Klyde's great strength is its road-holding; it takes the fast corners of music,

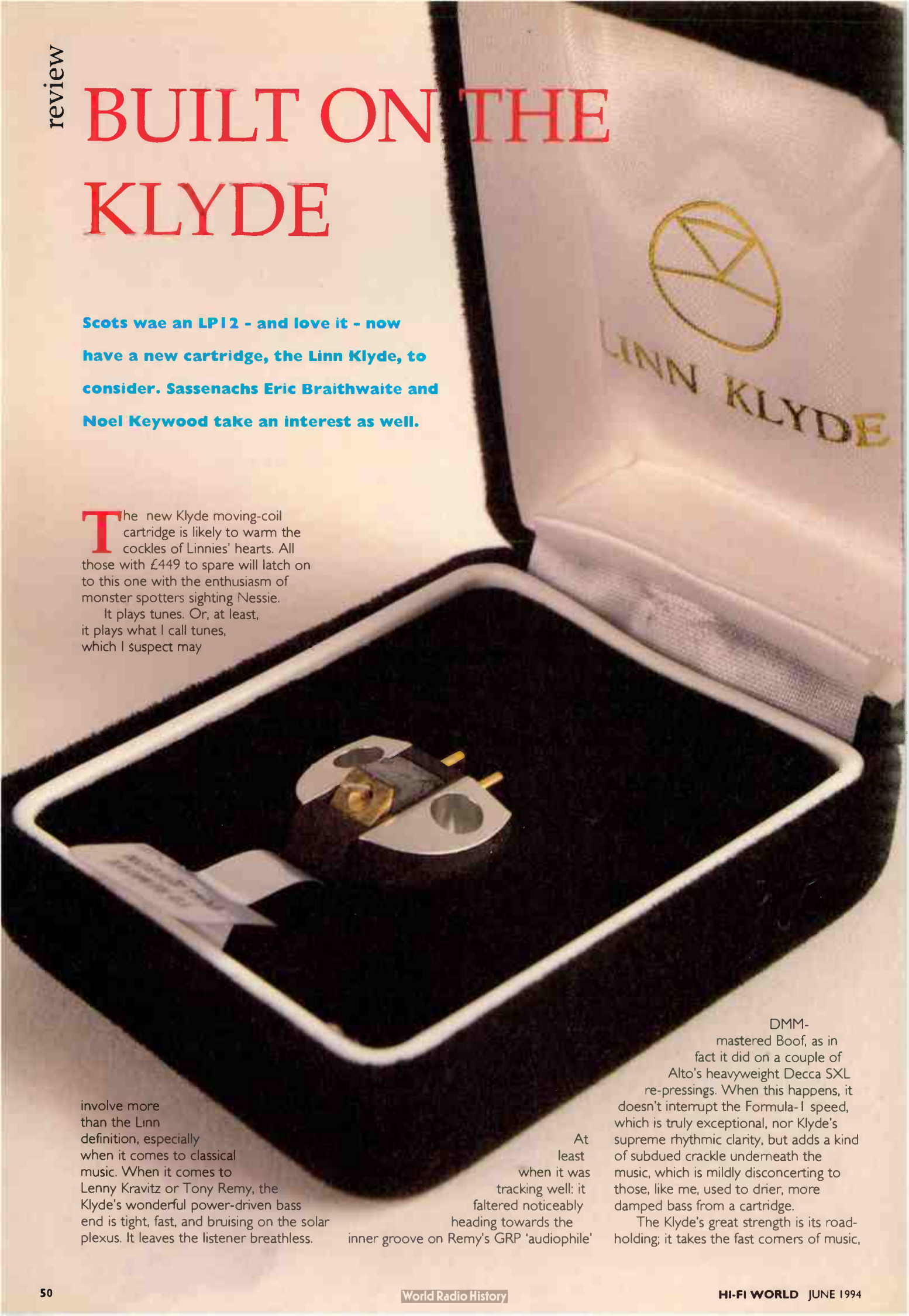

like serious bass or rhythm-guitar-picking, with consummate ease, weaving through the chicanes of drumming with the spot-on clutch changes that, until they were banned recently, racing drivers needed an on-board computer to manage.

Acoustic guitars, for example, have an unusual 'bigness', an endearing body, well to the fore of the Klyde's rivals. And none of this is achieved at the expense of the kind of insight to be expected at £450. Backing vocalists slot in from a deathly silence as another track is patched in through the mixing desk; instrumentalists and vocalists take up a defined space between the speakers, although

sometimes with a less expansive or more constricted width than the Ortofons or Lyras reproduce at this price level. But it doesn't half concentrate attention on the rhythm.

Where I was much less happy was playing Elgar's Violin Concerto or Ravel's Tzigane.

Neither Perlman's violin in the former on DGG, nor Ricci's on Alto-Decca SXL in the latter, soared in the upper reaches of the score. Like cymbal work, the harmonics were there, but truncated. Tzigane should sound Gypsy-ish and in Ricci's hands, a virtuoso piece. It came across more as a clever, but unimaginative test-piece out of a Suzuki school demonstration. DGG's downright ordinary recording quality was, on the plus-side, laid horribly bare; but on the minus side dulled further so as to make Elgar's violin writing near-anonymous. It was only on replacing the Klyde with my Morch da Capo (a Lyrac-clone) that a visiting listener said 'Ah, Elgar'

Beethoven's Triple Concerto (with the equivalent of a Williams team, Oistrakh, Rostropovich and Richter) had a strong piano below Middle C, but a touch boxy and recessed; plenty of air, space, surprising depth and recorded ambience, but while the piece was eminently recognisable, the distinctive playing of the individuals in this threesome was much less so, the subtlety that makes up the style somewhat dissipated.

A mixed bag, this one. Through my Iso, the treble was, by comparison with the superb bass and clear midrange, simply anaemic. With 100 ohm loading (via a Sota head-amp, the only one I could lay my hands on that gave me the option) the gap between the extremes was smoothed over; most of my listening was done with this loading. There lies the rub. The Klyde conforms to Linn's

stated aims in music reproduction in a way no other cartridge can match. But others are more equably balanced. Linn owners: go and buy! The Klyde is likely to complement an LPI 2 supremely well. Others: listen and compare first. **EB**

NOEL SAYS -

Having greatly enjoyed using Asakas in the past, I looked forward to getting hold of a Klyde, Linn's new 'budget' moving coil cartridge. By budget, I mean £449, which to most of us is quite a lot of money of course, even if it does pale into insignificance against esoterica like the Kiseki Lapis Lazuli, van den Hul

Grasshopper and such like. Generally though, the Linn moving coils could be relied upon to deliver rock music with superb dynamics: tight, thunderous bass, a super-clear midband with great projection and satisfactory treble, if not of the sweet, sonorous variety that comes from some upmarket MCs. Could the Klyde bring back this magic? Would it blow my socks off?

Presented in a compact grey carton, from which slides a neat clamshell container finished in black velour, the Klyde looks striking. Its distinctive semi-circular body appears to be hewn from a solid lump of metal - and it feels like it too. Finished in camera chrome, with black Linn logo, this body does, however, possess two minor drawbacks. It doesn't have a headshell alignment face, unlike straight-sided Ortofons for example, and the fixing screws must be inserted from below, putting the nuts and protruding screw threads on display above the headshell, which is ugly rather than anything else.

The Klyde body is, however, compact, arm compatible (it weighs a normal 8gms) and very rigid. I'm sure Linn would like this last point emphasised, because it does contribute to sound quality. However, I suspect it is not the only feature to give the Klyde its dynamics - others are more hidden.

Whilst the Klyde will fit most arms and they will, in turn, be able to balance out its 8gms weight, output proved so low that only very low noise preamps should be used. Stick to Linn, Michell, DPA and Audiolab amplifiers for this purpose; the MC stages available on some budget amps often hiss badly and will not be suitable.

Another unusual point worth bearing in mind is that the Klyde needs a load

greater than 50Ω. I found even 40Ω upset its performance slightly, but 100Ω would be ideal. This means it may well not suit step-up transformers - I'd advise a listening test first.

I installed the Klyde into an SME 309 sitting on a Systemdek IIXE900. Although my own preference of head amp is an EAR834P it seemed not to like an Ortofon MC7500 the other day, which surprised me. Wary of the fact that on MC the 834P has input transformers and that the Klyde may not suit, I kicked off using an Audiolab 8000C preamp for its high quality MC stage, feeding our own 300B feedbackless valve amplifier in final prototype form (it'll be in production soon!), driving sensitive Heybrook Quartet loudspeakers. This was a fabulous set-up, it turned out, just right for the Klyde. The Quartets have a lot of bass weight and plenty of vigour in their sound, plus a clear midband and easy treble.

I found the Klyde's great strength almost straight away by putting on 'The Hunter Gets Captured by the Game', from Grace Jones' Warm Leatherette. Sly Dunbar's drums slammed out of the speakers with such impact and so much resonance to their body I was taken aback. Jones snarled powerfully from centre stage - I was struck by the forcefulness of the sound, by its dynamic power and pace. The Klyde showed it had a tight, controlled and muscular presentation, but one without tizzy or searing treble. And without sibilance, I began to notice - and without much high treble at all, it slowly dawned on me as listening continued. Cymbals would crash, but they would not ring. Generally, metallic percussion instruments like

“Linn moving coils could be relied upon to deliver rock music with superb dynamics”



The Klyde's solid metal body takes screws from below. The cantilever is short and stiff.

triangles, hi-hats and cymbals lacked sonority, sounding a little bleak in their harmonic structure.

With a fine bass and midrange performance, the Klyde showed it suited classical music well, picking out individual instruments clearly and reproducing tonal colours nicely. It's a cartridge without brightness or thinness in its sound: violins

didn't shriek, yet timpani thundered. The cartridge brought its reproduction of dynamic contrasts as much to the orchestra as it did to the rock studio, lending weight and authority, whilst at the same time always sounding smooth and rich. Although Linn products are more associated with rock music than classical, I felt the Klyde was actually more impressive with the latter, although it gives a perspective a little more distant than is true.

With rock music, however, I was aware that the Klyde, whilst not sounding dull, certainly lacked sparkle. This balance was acceptable in light of the cartridge's strengths, except where it became severe on inner grooves where, I felt, the Klyde often became just too dull. Fleetwood Mac's 'Go Your Own Way' highlighted the problem; the whole performance sounded positively muffled.

Changing preamps had little effect. The Klyde didn't really benefit from the 834P's laid back fluidity of presentation.

It sounded more balanced tonally feeding a Linn Majik amplifier, although this inevitably lacked the sheer neutrality of a 300B amplifier, but this is only to be expected from a production solid-state unit against a highly specialised valve design. I feel that the Klyde best suits the bottom end welly and top-end brightness of solid-state amplification and can see how it is best complemented by a Linn system.

If there's anything that underscored the sheer control and scale of the Klyde's sound, it was a listening session with the Ortofon MC10/20/30 Supremes conducted at the same time. Whilst these cartridges consummately outperformed the Klyde in measured performance, the Klyde's show of sonic strength had them quaking in their boots. It's a remarkable cartridge subjectively, and certainly one that will light the fire of any Linnie; the Klyde made CD sound comparatively weak and anaemic.

My test results might appear to suggest this cartridge is enhanced, being all bass and no treble, but I suspect there's more to it. The cantilever is short, stiff and heavily damped. All these things are likely to enhance dynamics, at the expense of tracking and vertical tracking angle, so the Klyde may not measure well because of its strengths.

Personally, as much as I found myself in awe of the Klyde's sound, I wished for a just a little more treble. I think Linn could usefully tease just a little more out of it. At the same time it would be churlish to say anything other than this cartridge is a stonker - listen to it ● **NK**

LINN KLYDE £449.00
Linn Products Ltd.,
Floors Road,
Waterfoot,
Eaglesham,
Glasgow G76 0EP
Tel: 041 - 644 5111

MEASURED PERFORMANCE

The Klyde possessed an unusual measured performance. Nearly all pickup cartridges, especially moving coils, have a treble peak caused by tip mass resonance, where the effective mass of the tip acts in conjunction with the compliance of the record vinyl. Because moving coils do not have innately falling treble caused by generator loss, this peak can loom large. Audio Technica's OCS and Goldring's Elite are two MC cartridges that come to mind as obviously bright-sounding because of the phenomenon.

In contrast - and unlike most other MCs - the Klyde possesses no treble peak whatsoever. As our frequency response analysis shows, its output falls steadily from around 600Hz to become -2dB down at 12kHz. Above this frequency output falls away, especially on inner grooves, where tracing loss of the 'Vital' caused treble to measure -4db at 12kHz. These sort of treble losses will certainly be audible as a warming of the sound at least. On inner grooves I'd expect obvious dullness.

Tracking was mediocre at low frequencies and in the midband; the Klyde was easily bettered by moving coil Goldrings and Ortofons in this respect, at any price. Distortion was acceptably low on centre-stage images (lateral modulation) at 0.75%, mainly third harmonic. The cartridge's vertical tracking angle measured a high 30 degrees, producing no less than 6% second harmonic on vertical modulation, which will affect left and right images. Luckily, second harmonic only lightens timbre so, subjectively, its presence is not easily discerned.

Channel separation was unbalanced, indicating a misaligned generator assembly. By tilting the cartridge heavily, I found I could lessen this, but it's not a solution, because the tip does not then contact the groove properly. Our Klyde needed more

careful assembly I suspect. Output was very low at 0.25mV at 5cms/sec rms; Ortofon moving coils manage double this, for example.

The square wave performance of the Klyde showed a well damped cantilever, and the mediocre tracking figures suggest likewise. I wonder whether Linn have optimised the cartridge to sound well damped and tight in the bass, at the expense of much else. **NK**

TEST RESULTS

Tracking force (gms)	1.55-1.75
Weight (gms)	8
Vertical tracking angle (degrees)	30
Frequency response (2dB)	20-12k
Channel separation (dB)	24
Tracking ability (300Hz)	
lateral	60µm
vertical	45µm
lateral 1kHz (cm/sec)	15
Distortion,	45µm (%)
lateral	0.75
vertical	8.5
Output, 5cms/sec rms (mV)	0.25
Channel imbalance (dB)	0

Square wave



Absence of overshoot and ringing on a square wave shows that the Klyde cantilever is mechanically well damped.

Frequency Response

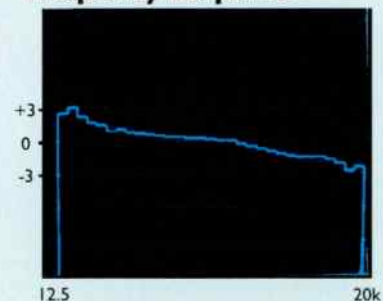

Frequency response on outer grooves exhibits steadily falling treble.

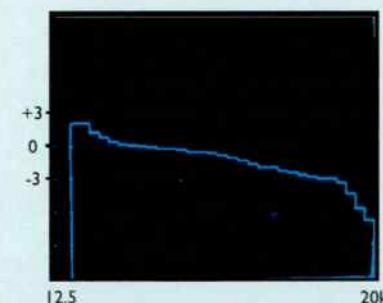

Frequency response on inner grooves exhibits strong upper treble loss.

Distortion

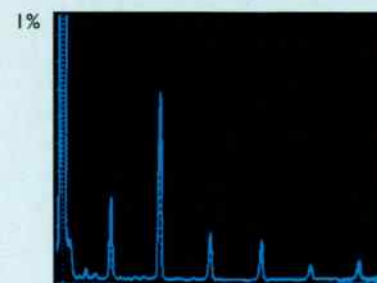

Third harmonic distortion dominates, measuring 0.75% at 45µm, 300Hz here.

Indoor aerials are commonly offered as a cheap technological fix for a minor ailment - poor reception - in the same way the Victorians peddled their potions and lotions. The bad news is - they're usually no more successful. Indoor aerials possessed of magic powers are nothing other than electronic hokum, at present at least. But then, you never know when someone might succeed; after all, the ferrite aerial used on medium wave seems magically small compared to its ideal equivalent, a long length of wire strung down the garden. So when Maxview recently released a new, powered indoor aerial exclusively for FM radio, I was keen to review it.

The Profile FM antenna takes the form of a slim, dark grey plastic case measuring 26cms high, 21cms wide and 5cms deep (max). Although it can free-stand on its narrow base, it has been designed to fix unobtrusively to flat surfaces like walls and windows. Maxview supply fixing screws and masonry plugs, suction pads for glass and 2 metres of lead, but no batteries. It takes two size AA batteries of the sort used in Walkmans to power its internal amplifier and they have a life of 1000hours,

or 41 days, if the device is left on. It can be switched off, however, from a front panel button and, when on, a little red LED flashes every ten seconds or so as a warning. Price is a mere £19.95, pretty reasonable considering there's even a signal amplifier inside.

It's common to test an aerial against a benchmark reference dipole type, noting how much better or worse is the unit under test. I use a rigid aluminium dipole bought for a tenner a few years ago and made by - guess who - Maxview.

This reference and the Profile were in turn used with a Hitachi FT5500MkII tuner possessing a digital readout of signal strength in dBs. The site of the tests was Central London, an area of mediocre signal strength.

Starting down at the bottom end of the VHF band I tuned into Radio 2 at 89.1MHz. There was some hiss, modulation distortion and birdies on stereo with the Profile, but the programme was intelligible; signal measured 50dB. The dipole gave noticeably less hiss, no birdies and good reception; signal measured 38dB. The dipole was clearly better, no matter how I arranged the Profile.

Up a little at 91.3MHz, with Radio 3, the situation reversed. The Profile put up its best performance here, with 55dB of signal and a very quiet, birdy-free background (i.e. no warbling). I listened for hours and noticed only occasional bursts of static interference.

That Radios 2 and 3 should differ was a little unexpected, because both come from London's distant Wrotham transmitter, South East in Kent. In contrast, GLR on 94.9MHz comes from Croydon, which is closer and due South. Both the Profile and the dipole gave good, quiet reception from GLR, but its signal was strong, the dipole showed, so any aerial should have worked well.

Tuning around at the bottom end of the band I found generally that with major stations or weak community radio signals the two aerials were broadly matched in their ability to provide low hiss reception, providing for the Profile was optimally positioned. The dipole was obviously less position sensitive. The Profile did show a tendency to produce birdies too - warbling or whistling on stereo. Its amplifier is likely to be the cause.

The situation changed at the top end of the band, around and above 100MHz. On Jazz FM the Profile was hissy and poor, whilst the dipole was reasonably quiet. Classic FM on 100.9MHz whistled with the Profile and was hissy, but it came in well on the dipole. Melody on 104.9MHz was hissy and suffered birdies on stereo with the Profile, but was quiet and stable with the dipole. Distant and weak BBC Three Counties radio on 103.8MHz came in well with the dipole, with the tuner switched to mono, but the Profile was unable to capture it in useable form.

What these tests show is that the Profile is tuned to the bottom end of the FM band, where it favours traditional BBC stations. I wasn't surprised to find that here it could not convincingly improve upon Maxview's own simple alloy dipole. Its advantage lies not in improved reception, but in convenience, particularly small size and ease of placement.

At the top end of the FM band, the Profile proved unimpressive, giving significantly poorer reception with all stations than a normal dipole.

So the Profile offers no magic improvement in reception, I'm sorry to say. Flat dwellers should instead rely upon ingenuity to get better results. For example, the Profile could be made to score if it was fitted with a longer lead and positioned up high, or perhaps at the other side of the building, if it faces the transmitters there. Then the internal amplifier will earn its keep by compensating for lead losses. Otherwise, it just amplifies noise and weak stations equally, giving a higher indication on a tuner's signal strength meter, whilst offering no improvement in reception quality. In fact, frequent birdies on stereo appeared to be a problem with this aerial. The magic indoor aerial capable of curing poor reception has yet to be invented ●

Aerial Magic

Can Maxview's new Profile indoor FM aerial cure reception problems? Noel Keyword looks for the magic.



Lumley Reference

"FOR REAL MUSIC LOVERS"



'ST70 STEREO'



'M120 MONOBLOCKS'

WE MAKE THE BEST STANDS IN THE BUSINESS,
'LUMLEY' MAKE THE BEST AMPLIFICATION. COME HEAR THE COMBINATION.

M.A.F

STANDS FOR QUALITY

BURTON ON TRENT STAFF

0283 30550

0283 38882 EVENINGS

Michell - Symbol of Precision

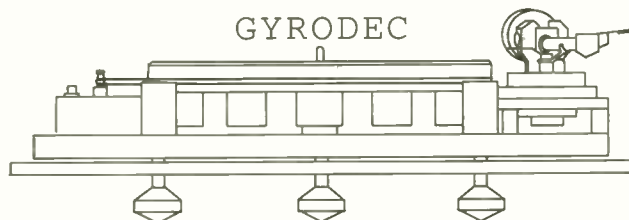

ALECTO

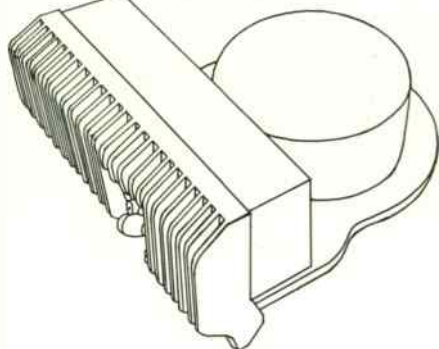

1S0



ALECTO

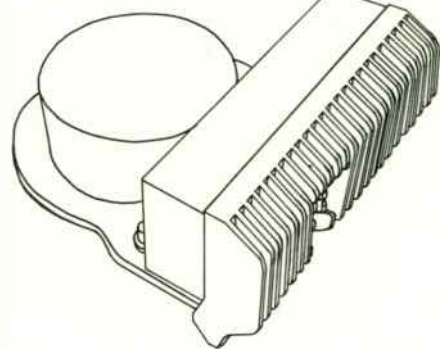

ARGO

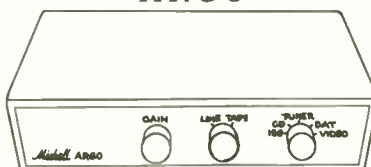

Information on our full range of products available from:-

J.A.Michell Engineering Ltd., 2 Theobald Street, Borhamwood, Herts WD6 4SE

Tel: 081 953 0771

Fax: 081 207 4688

...continued from page 47

circular cored transformer has significant advantages in sound quality over the conventional square cored versions. Please could you be of assistance in three areas? Do you know of any supplier of transformer core laminations that vary in width and thus would stack together to give a circular core? What would be the specifications of the secondary windings in terms of voltage and current requirements? And do you please know of any circuit diagrams for the KT88 valve? I know that a 6.3V secondary is needed for the heater element and a stepped up secondary for the anodes, but that is about all!

Any assistance that you may be able to give would be very much appreciated.

**David Cope
Salford,
Manchester,**

A mains transformer is a critical component in any item of electronic equipment because effectively it is the only thing between you and the National Grid. Any mistakes can have disastrous results. For this reason I recommend you speak to your lecturers and research the subject thoroughly before even considering winding a mains transformer. Unfortunately it is very difficult to get non standard laminations, the reason being that the standard "waste free" E-I laminations are very hard to beat, giving a large core area for a given external dimension. I am not sure if, when you say "circular core" you mean a toroidal transformer or a stack of E-I laminations of varying sizes to give a circular core cross section. Toroidals can suffer from insufficient core volume and to build an E-I stack into a circular cross section needed for a KT88 amplifier would require about 250 laminations of 125 different

sizes and it would have a far greater external size than the standard E-I for the same V.A. rating. **AG**

HAPPINESS IS A WARM 5-20

Well, I finally finished my Mullard 5-20 amp after many months of trying to locate the perfect parts, tweaking, etc. I decided to do it from scratch rather than starting with your kit as I wanted to make it operate in parallel push-pull, and wanted to put it all on one chassis. I also wanted to have the pleasure of hand picking all the components, although it turned out to be quite a chore to find everything. The final weight ended up at 25kgs!

I used oil-filled motor-run capacitors (large, they barely fit inside the case) for the power supply, figuring that they would have a lower internal impedance for better bass response. They seem to work very well, don't heat up, and sound good, so I think that was a good choice.

It was also necessary for me to wind my own mains power transformers as I couldn't find the proper ones to use. I think I made a bit of a mistake here (in addition to not realizing the agony involved) in that they run hot, while only giving me 320V AC (360V DC out of the 10H choke). I may decide to replace these at some point if I can find better ones that will give me something closer to 450V DC. I'm not sure if the low voltage is causing the tubes to operate in a non-linear region, but the sound is fine, so I figure probably not. As for brand names, I used the Sovtek 5881 and 12AX7 tubes.

I live a couple of blocks from some radio towers and was getting a lot of interference. After getting rid of a number of ground loops (I had wrongly used the chassis as my ground) by changing to a star-configured ground, I was able to cut the interference

down, but not get rid of it completely. I then put an RC filter on the input grid of V1, an LRC filter at the input jack, and shielded cable on a number of the more sensitive lines. The radio is still slightly audible if you put your ear right up to the speaker, but it is very tolerable and inaudible under normal listening circumstances.

As for the visual touches, the case is aluminium (painted black), and the front plate is polished copper. Lights on the two switches are the old red jewel type. It took me a while to locate a nice volume knob, and I finally found a company that was nice enough to send me a sample. Since I only needed one, that was that. Engraving the front plate finished it off.

I measured the frequency response with a test CD & oscilloscope, and it is as close to perfectly flat as can be seen on the display. I tried several configurations before deciding on the final one: with and without overall negative feedback, with and without the 0.1uF input capacitor, with and without the RF filters, etc. The best response, and best sound, was with negative feedback, and without the input capacitor (since my only sources are CD & tuner); I'm very happy with it.

I use my amp with some old AR-2a speakers that I like, but am not quite sure if I'm missing something. I think that I'll probably stick with these speakers, but have some concern that I'm just deluding myself into thinking that they sound good.

Anyway, thanks for providing the excellent DIY articles, opinions, etc, and although I decided to stick with the original pentode input/ultra linear design rather than the modified triode input/low-feedback one, thanks to Dominic Baker for providing the phone help and sending me his latest schematics for the amp.

**Steve Safarik
Seattle, WA
USA.**

P.S. I read Peter Qvortrup's letter several months ago about his opinion on various amplifier designs, and I honestly don't see how he can get any sleep at night.

The 5881 and EL34 are quite different valves; the 6L6/5881 beam tetrodes give a brighter, clearer sound than an EL34. However, many people like the superbly soft, easy sound of the latter in ultra linear operation. If you look at the graphs of the two valve's characteristics it can be seen that the 6L6 has a sharper "knee" than the EL34 and in this respect it behaves quite like an ideal pentode, while the EL34 "knee" is less well defined and the curves gather up at low anode voltages. We are looking here at conditions with the screen voltage at 250V; the gathering effect gets worse as the screen voltage goes up when going for extra power. This means that when used as plain pentodes and optimally load matched the 6L6 will produce less odd order harmonics and generally lower distortion than the EL34. For example, with similar supply voltages and at 55W output EL34s produce 5% distortion while 6L6GCs produce 1.8%. When comparing the two graphs take note that the grid voltage of the 6L6 is shown up to +15V, a region which is not normally used, only the lines up to 0V are relevant. In the 5-20 application your 5881s will work with the output transformer, but may need re-biasing to keep the dissipation within limits. Check the anode currents and change the cathode resistors if necessary. Also get a proper mains transformer or you may come home one day to find charred remains where your house used to be! **AG**

Products from Scandinavia do seem to possess an assured solidity. Take automobiles for instance. They conjure up images of that much maligned brick out-house. Hence the characteristics of these Swedish Sentec Aurora speakers, admittedly reviewed here in battered post-demonstration guise. Finished in an extremely hard-wearing light grey epoxy (they are also available in wood veneer) and tipping the scales at 22 kilos, the Sentecs emanate from the 'solid' school of loudspeaker design thinking.

Their weight is largely due to the use of 25mm MDF throughout the enclosure, this measuring 840 x 230 x 280mm (hwd) and being bass-reflex loaded by a fairly large diameter rear port. Experience suggested that these speakers would need to be placed in free space away from walls. The main reason for the sizeable bulk of the boxes is the need to be able to accommodate the three drive units that Sentec employ for each channel. These are a one inch, coated fabric, soft dome tweeter placed within a tuned chamber and two 6.5 inch cast magnesium chassis, polypropylene bass/mid drivers. The designer has made use of thick felt matting, installed around the tweeter to minimise diffraction problems.

Sentec quote a 92dB measured sensitivity rating and a 4 ohm impedance which should enable them to work well with a decent valve amp using a four ohm output tap.

To gain an initial impression of the Sentecs, they were wired up to the resident Audiolab monoblocks in order to run them in a little.

The first thing that hits you about the sound is the bass, and I do mean that literally. These Sentecs pack a punch that you really feel in the mid-riff as they reproduce bass with a menacing grumble.

The second immediately noticeable quality occurs in the image presentation which was squashed and low down, indicating that these speakers need to be raised about 6 inches, so that the centrally mounted tweeter is positioned at ear level.

Before the listening session began in earnest, I decided to use the Sentecs with a pair of World Audio Design K5881 valve monoblocks. This seemed to be the logical thing to do, as the speakers are a very sensitive design and the 5881s have a gloriously tight and fluid bass. I hoped this would tame a little of the Sentecs' low frequency exuberance and add some more definition to the overwhelming bass grumble that was noted earlier.

With the title track of Steve Winwood's album *Roll With It* an exciting, if not strictly accurate

room.

The sound varied quite considerably, the vocal projection was much better defined and the top end took on a sweeter nature. However, the bass, while being more restrained and balanced with respect to the rest of the frequency range, still tended to be marginally diffuse and at times difficult to pin down.

Michael Stipe of REM was positioned tangibly in the room and the music became livelier in character due to the treble being blessed with the ability to resolve transient information much more

quickly. In fact, it really began to sparkle in some instances. 'Everybody hurts' from *Automatic For The People* produced guitars with a warm, rich tonal quality, the organ also sharing this full-bodied sound. The use of an acoustic guitar to add a percussive element into the track was very obvious, the

sound of the plectrum 'clicking' on the strings crisp and dynamic. From an engineers point of view the positional differentiation of Stipe's main vocal from his rendition of the backing part was excellent, panned slightly to the right and pushed back a few feet into its own space within the soundstage.

John Paul Jones' string arrangement on the track was beautifully fluid, ebbing and flowing with the emotions expressed in the music and in complete contrast to the sharp snap of the snare drum.

The sweeter treble that the Sentecs had gained due to the change in environment was evident with Peter Gabriel's 'Mercy Street' from the acclaimed *So* album. This song uses a simple but incredibly effective triangle fill which tingled brightly with the Sentecs, as did the use of ride cymbals on other tracks. Vocal projection was explicit, if a little overblown and slightly darkened.

'Salisbury Hill', another Gabriel track, is one I know can really move along at a pace. This seemed a little lack-lustre with the Sentecs, again probably due to the lack of tight, rigid bass which gives the track its rhythmic drive. The DPA amps

“ Although these speakers aren't perfect, they are seductive. ”

presentation was observed. The drum intro was packed with power and energy, but the speakers couldn't quite define the timbral characteristics of the 'skins' as impeccably as the Heybrook Sextets that I had heard the K5881s with originally. During the track there is a subtle mix on the snare, which layers it with a hand-clap and a tambourine beat. This was difficult to ascertain using the Sentecs as they tended to mask the mid-range in their desire to encapsulate the room in copious amounts of bass, which caused both myself and the sofa to resonate in sympathy.

Using other music, such as Pink Floyd's *The Wall*, confirmed the wonderfully rich quality that the Sentecs give to the sound, the deep bass being matched by an equally deep soundstage. Although these speakers aren't perfect, they are seductive, this being the reason why I decided to take them round to Dominic's flat and give them a chance in his larger listening room which seems to accommodate bulkier loudspeakers quite well.

Raising the Sentecs by about 9 inches brought the tweeters to the right height for listening to in this different

Northern Light

Robert Wilson test drives a Scandinavian heavy weight and finds it a safe bet.

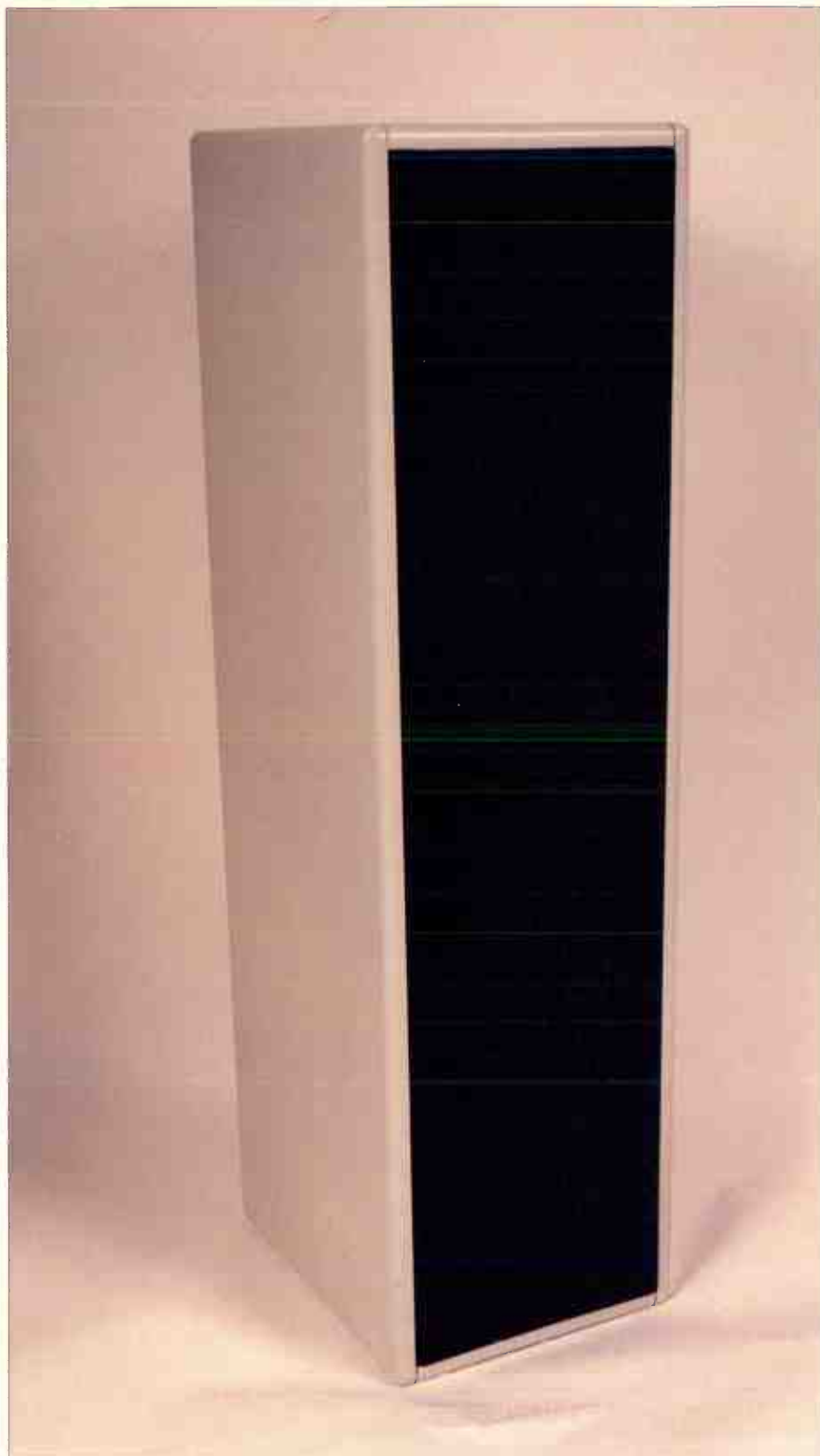

that Dominic uses are notable for their excellent neutral quality and lack of euphonic enhancement in the bottom end, suggesting that the Sentecs need an amp of amazing quality to regulate the bass drivers.

This final statement, luckily, goes without saying, as anyone contemplating an investment of £1500 in a pair of loudspeakers should already possess a system with excellent capabilities. At this end of the market, system synergy is extremely important and only the purchaser will be able to determine the Aurora's true worth within a specific location. If you have a very large listening room and are looking for a big sound

with loads of presence, then the Sentecs are worth searching out. They are a solid, well constructed design with an equally solid performance and go about their business with a genuine lack of pretension. To use an automotive analogy, a bit like a Saab Turbo ●

**SENTEC'S AURORA
MAG AUDIO (UK) Ltd.,
43 Henneker Point,
133 Leytonstone Road,
Stratford,
London, E15 3TV
Tel: 081 - 555 122**

£1500.00

MEASURED PERFORMANCE

The Sentec Auroras are an interesting loudspeaker. They use two small polypropylene bass drivers mounted either side of a SEAS soft dome tweeter. The three units are time aligned, so the tweeter sits back in a recess where its voice coil is in the same plane as that of the bass units. The hard edges of its recess would degrade image sharpness because of reflections, so the designer has packed layers of soft felt around the tweeter to absorb them and partially overcome the problem.

The frequency response shows good engineering; it is flat and very well tailored. The lower bass does, from the oscillogram, appear to be at a lower level than the rest of the response, but when positioned on the floor within a listening room this will be bolstered up.

Measuring sensitivity with a nominal watt of pink noise, I thought some trickery was going on. I measured 91dB, and knowing the units that Sentec have used quite well, I was surprised. Looking at the impedance curve explains this unusually high figure though: the speaker's have an overall impedance of 5Ω so, although sensitive, they are not efficient, demanding twice as much current from an amplifier as a typical British loudspeaker. The impedance curve itself is quite well mannered, and good results may be possible using the 4Ω tap on a valve amplifier.

As I said at the start, the Sentecs are an interesting loudspeaker. They measure flat, demand a lot of current to drive, implying the need for a good amplifier, and are sensitive. **DB**

Frequency Response

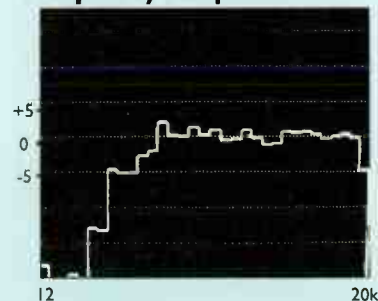

Impedance

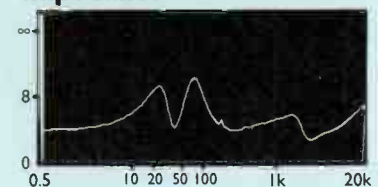

The VOIGT LOUDSPEAKER

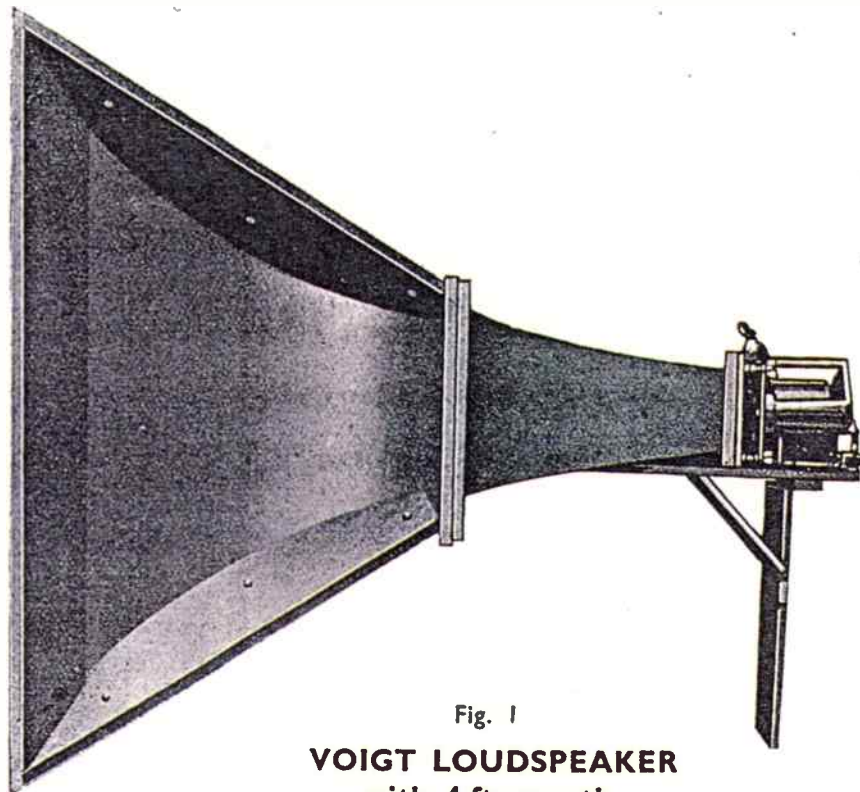

Fig. 1
**VOIGT LOUDSPEAKER
with 4 ft. mouth
STRAIGHT "TRACTRIX" HORN**

August, 1936

I got a call from a chap telling me there were a couple of horn loudspeakers in a dance hall in Selsdon and was I interested, because otherwise they'd be thrown out". The British Vintage Wireless Society grapevine was working well. Enthusiast John Howes didn't know it at the time, but he was about to encounter something to make his heart beat faster - very fast - a rare version of the Voigt Tractrix horn.

Like many BVWS members, John has a great affection for the past and its pioneers. This includes a reverential and well documented knowledge of Paul Voigt and his many audio inventions and designs, including the massive Tractrix horn loudspeaker. John already has a standard pair, played at every BVWS meet at Southboro Town Hall. The second pair made came with a 'bass bin', a square forward-firing tunnel that nestles

undemeath the main horn, as our pictures show.

The Tractrix was an early straight horn meant for cinema and dance hall work. Voigt, Klipsch and others produced folded horns later on as music moved into the home, today's equivalents being the Tannoy Westminster and Living Voice Air Partner. However, back around the turn of the century tiny electrical or acoustical signals were amplified (efficiently



◀ ▶
Rear view of the horn, showing construction and the configuration of the bass tunnel.

▶ ▶
Voigt's own twin diaphragm drive unit with sturdy forged iron frame.





The newly discovered Tractrix horn being readied for use. It has a four foot square mouth and this version also has an additional forward firing bass tunnel slung underneath.

transmitted in fact) by straight or gently curved horns, usually in public address applications. Remember that sound reproduction in the home hardly existed then, a crystal radio with headphones being most common. Television and hi-fi reached the public at large only after World War II.

Horn theory was first expressed mathematically by Webster, a U.S. mathematician, around 1920. Until Voigt developed the Tractrix flair shape in 1926 by geometric means (rather than pure maths), exponential and conical horns were used. The Tractrix flair gave a shorter horn with better dispersion at the mouth. In its time it was acknowledged,

by those who knew about it, as unusually effective. So Voigt, a Briton born in 1901 of German parents and educated at Dulwich College, South London, helped pioneer the horn loudspeaker, amongst many other things in audio, bringing to it a very effective form of flair. Curiously, the Tractrix remains little known or written about, even today.

Given plenty of space to breathe in Southboro Town Hall, and driven by a replica Williamson 0.1 valve amplifier (designed in 1947), the rescued Tractrix was in fine fettle according to our ears. Like all good horns, it was able to reproduce large dynamic changes in an easy, effortless fashion, quite beyond that

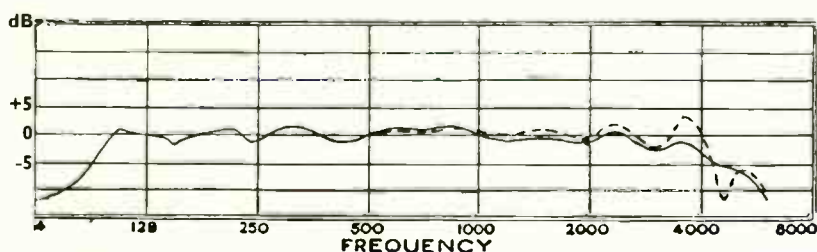

Characteristic curves of Voigt Loudspeaker with 4 ft. mouth wood horn and standard diaphragm.

of normal loudspeakers. With relatively crude early drive units designed and fashioned by Voigt, it may not have displayed quite the frequency range we are used to nowadays, but yet this hardly mattered in view of its other great qualities.

The horn itself is fashioned from curved plywood panels, bolted together with wing nuts, for easy assembly and disassembly; later versions were fashioned from metal. Like all true horns, the Tractrix is very efficient, needing just a few watts of power to fill a small hall, a great benefit in the days, prior to World War II, when valve amplifiers had difficulty producing much more than 15 watts or so. Voigt produced his own electro-magnet and permanent magnet drive units for the Tractrix and in fact filed a patent application for the moving coil principle of working just two months after Rice and Kellogg, in 1924. He was disappointed to find that these U.S. engineers, working for General Electric, had just beaten him to it, the patent being refused as a result. The Tractrix was patented, however, in 1927 and Voigt went on to start his own company, Voigt Patents Ltd, situated in Sydenham, South East London, in 1933. With a staff of nine people the company produced the Tractrix and, later, went on to make the Voigt corner horn for domestic use; it stood five feet high!

PATENT SPECIFICATION
 Application Date July 5, 1926. No. 16,794/26. 278,098
 Complete Left: March 2, 1927.
 Complete Accepted: Oct. 5, 1927.

PROVISIONAL SPECIFICATION.
Improvements in Horns for Acoustic Instruments.

1. I, JOHN HOWES, of "Borden House", 121, Honor Oak Park, London, E.H. 23, British subject, do hereby declare the nature of this invention to be as follows:—

This invention relates to horns for loud speakers, gramophones and the like. According to this invention, the main shape of a straight circular horn is as nearly as possible such that the distance between any point on the surface and the axis measured along the tangent at that point is constant. This gives a curve known as the "Tractrix".

At the flare this tangent becomes the radius. The flare diameter is therefore twice the tangent length.

If the horn is to be square, I prefer to make the square so that it will fit over the imaginary circular horn, touching it along the middle of each side.

If the horn is not required to project sound downwards, as for example in a table gramophone, only the upper half may be used, a flat surface forming the lower boundary, this flat surface should be continued in front of the flare if possible.

For convenience near the small end, the horn may be merged into a greater section of the same area at the previous section would have had at that point.

In practice it is nearly always necessary to bend the horn. At all bends the inner radius should be large compared with the width. If a sharp bend has to be made where this is impossible, the sound travelling round the inner radius will be out of phase with that travelling round the outer radius. This kills the wave front, and reduces the sound intensity near the inner radius.

These defects may be overcome by dividing the horn into several parts, each of the same length, which are joined together after the bend.

For example in a cabinet gramophone with a reasonably long mouth the 90° bend up to the tone arm may have to be so sharp that a considerable phase difference is produced. In such a case, I would divide the bend into, say, two parts: one, the inner path being of one third the original width and the original inside radius, while in the outer path the inner radius is now greater than before and the width is two thirds. Thus the ratio of inside radius to width is increased in both cases.

Each path should be separately tapered (as if it was a "lamination" of a straight horn bent up). The inner path should be bent round further than 90° and then joined back so that the extra length due to the loop equals the reduction due to the shorter path in the bend. The length of both paths is thus made the same and the phase difference becomes negligible.

Dated the 3rd day of July, 1926.
 P. G. A. H. HUGHES.

So it is likely that the wooden Tractrix horns John Howes rescued had been in use for sixty years. Listening to one of them, I noticed only a lack of top end sparkle as an obvious point of difference against today's loudspeakers and, interestingly, its published response curve does show a roll off in output above 2.5kHz (-10dB at 6kHz). Otherwise the response curve stays within 5dB limits right down to 80Hz, below which bass rolls off - not bad for the 1930s!

Needless to say, John was pretty excited at the prospect of listening to a stereo pair of Tractrix horns. His estate agent must equally be excited at finding a house big enough for both of them as well - or was that a bed in one corner of Southboro Town Hall?

definitive audio nottingham

Tel / Fax (0602) 813562

Import/Export

AUDIO INNOVATIONS • WADIA • VOYD • EMT • MICROMEGA • SME
HORNING • LOWTHER • VITAVOX • PIONEER • DALI • MIRO • IMPLUSE
GOLDRING • J.P.W. • SOUND ORG • HUYGENS • SYSTEMDEK

AUDIO INNOVATIONS	LINN
S 300 INTEGRATED *380500	KAIRN PRE (8 MONTHS).....950 1,398
S 200 PRE AMP *220350	AXIS - AKITO.....350
S 200 POWER AMP *250500	KABER LS 500.....700 1,298
S 1000 M.C. TRANSFORMER *130.....300	LP 12 / SME 3009.....450
2ND AUDIO 15w. TRIODES:	LK 400 S/CABLE.....4080
6B4G/88 *1,450 3,000	INDEX / KU STONE.....185370
2A3/82 *1,950 3,000	WADIA 6 INTEGRATED CD *2,800 3,950
NAIM	REVOX B215 S * 11,000 1,850
62 PRE190	AUDIO NOTE
72 PRE250	I.O. CARTRIDGE.....1,000 1,500
140 POWER250	AN J SILVER / OAK *600 1,000
90 POWER200	J 4 HUYGENS SUPPORT *200300
HI CAP150	AN E COPPER / OAK *750 1,400
LEAK TL10 *600	E 4 HUYGENS SUPPORT *200300
KELVIN LABS INT.....300	
NVA PHONO STAGE.....180	

ALL PRICES EXCLUDE CARRIAGE WARRANTY ON PRODUCTS MARKED *.

VITAVOX COMPONENT PRICES	
RH300 MID RANGE 4-CELL DISPERSIVE	253.80
S2 MID RANGE PRESSURE DRIVER	719.10
S5 MID RANGE PRESSURE DRIVER	479.40
AK 157 BASS UNIT 15"	554.60
LOWTHER COMPONENT PRICES	
PM 6A	180.00
PM 7A	220.00
PM 2A	240.00
PM 4	420.00
PM 6C	130.00
PM 2C	160.00

studio

82 The High Street
Harpenden
Herts AL5 2SP

82

HARPENDEN LTD

naim audio



NAIM NAIT 3



NAIM CD 1



NAIM TUNER 03



Agencies:

ARCAM ATC AUDIOLAB AURA AVI BANG &
OLUFSEN BLAUPUNKT B&W CASTLE
DENON EPOS HARBETH MARANTZ
MISSION NAD NAIM -AUDIO
NAKAMICHI
PANASONIC QED ROBERTS
RADIO TARGET TDL



IN THE JULY ISSUE

Spring is here! Outside your window the sun's shining and lambs are bouncing. Our July issue will be breathing new air onto the bookshelves too! We hope to have -

DPA PDM Ten Twenty-Four 1024 CD convertor.

Yep - we've promised it before, but this complex £6000 top technology convertor is now definitely ready, and fate permitting, will appear in our July issue.

Linn Majik amplifier

A new remote-control amplifier from Linn that has attracted diverse comment. We apply extended tests to discover the truth.

Ortofon Supreme moving coil cartridges

No fewer than three new, high quality cartridges from Ortofon, for all those with a treasured vinyl collection.

Professional Monitor Company TBI loudspeaker

Designed by ex-BBC engineers and supplied to broadcasters, the TBI claims to be a super high quality monitor. But is

it a good value hi-fi monitor too? We measure and listen.

Bookshelf Loudspeakers

Short of room? Dislike intrusive cabinets? Then buy a high quality bookshelf speaker instead. We look at the theory then measure and listen to six models.

Mission CD player

Better late than never! At last we get the new Mission CD player, complete with PSX power supply upgrade. We measure and listen to a fine piece of engineering.

Metal Tapes

Cassette is still alive and recently many new metal tapes have appeared. Hi-Fi World reviews a group of the best to see just how far cassette has been improved.

Hi-Fi World is still only £2, but with more editorial than most rivals. With the most enthusiastic and expert editorial team in hi-fi journalism, can you afford to miss it? Make sure you don't by filling in this order form and handing it to your newsagent.



Please reserve/deliver* Hi-Fi World on a regular basis, commencing with the next issue, until further notice.

Name: _____

Address _____

Signed: _____ Date: _____

• Delete as appropriate

Distributed to the news
trade by



Although the common perception would have it that Britain doesn't make hi-fi any more, it does - and there's a healthy amount of business going on at this moment, between Britain and the East. In the long term, if it can be built upon, it could benefit us by focusing attention on the need for valuable vocational training, sharpening up our educational syllabus and providing jobs that prove valuable and secure.

There might appear to be great disparities between Britain and the East. We industrialised in the nineteenth century, building our might on coal and steel, forging railways, ships and arms to help establish Empire. And that empire stretched its tentacles through the East, to Singapore, Hong Kong and parts of China.

It seems a pity that, on relinquishing power after the war, we did not leave much behind that could contribute directly or immediately to the future prosperity of the countries occupied. Basic government structure perhaps, a few colonial schools also, mining by foreign companies and rudimentary local agriculture. But no shipyards, aircraft factories, car factories, technical colleges or, of course, electronics factories.

Whilst Britain wasn't the only colonial power in the region, it did have a powerful defence and consumer electronics industry after World War 2, some of which may well have been transferable in basic form at least. But, that's history. Britain had its own problems after WW2.

Under MacArthur and American oversight Japan re-built after 1945, but it didn't re-arm. The Japanese turned instead to electronics, amongst other things, the first we knew of it being the arrival of intriguing miniature radios in the Sixties. As the book *Setmakers* relates, it was all over by the late Seventies. The British consumer electronics industry had

been decimated by Eastern ingenuity which, amongst other things, brought much needed reliability.

An alternative view, one I have a lot of sympathy for, and strongly hinted at in *Setmakers*, is that our industry collapsed as much through its own stupidity as anything else. Perhaps we should blame the Cold War and the projects it spawned, like Blue Steel, TSR-2 and the disastrous Nimrod airborne early warning system. Not only did they funnel national wealth down an open drain, they may well have robbed



Reflections from Noel Keywood kaleidoscope

industry of the managerial and engineering skills it needed to perform efficiently in a changing and modernising world, a world that was turning to computers and information technology, as Macluhan predicted.

I do know from my own experience that during the Seventies, when Sony amplifiers worked perfectly and were taking over, we could barely design and build such things - at least, not competitively. What a sad indictment, and what an irony too. If Britain had taken its technologies eastward, everything might have turned out differently. Instead the East, led by Japan, has largely found its own way forward in this field, leaving us struggling to catch up.

Now, industrialisation in the East is creating wealth and markets. Interestingly, they're also markets more sensitive to, and knowledgeable about electronic products than ours. Singaporeans are aware of hi-fi and electronics in a way Britons are not. "You should set up your magazine here" some have told us. I know why.

Meanwhile, competition

plus recession in Britain has left companies lean and mean, if not yet in a state to be declared unequivocally fit. Britain's hi-fi manufacturers export more than they sell locally. They've survived the Japanese onslaught and that, I believe, is now receding, as prices go up under pressure from the rising Yen and as Japanese audio technology starts to stagnate. British companies have learnt the hard way, they're still alive and they are slowly, but inexorably re-grouping and re-building.

So what's going on now between us and the East? Whilst Japan remains effectively a closed market, the other countries do not. There are good links with Singapore, Hong Kong, Malaysia, Taiwan and the like, and those countries are open and receptive to our products. The demands of industrialisation, the apparent metamorphosis of China into a market-led economy and the hand over of Hong Kong are all having an impact.

Demand for quality hi-fi products in the East is healthy and has helped UK companies to ride out the

recession at home. Wealthy Hong Kong businessmen are shrewdly transferring their wealth out of Hong Kong in case the hand over to China goes awry; KEF and Celestion were bought in the blink of an eyelid by Gold Peak batteries, for example. And recently I learnt that Tomei, another Eastern electronics giant, has a substantial share in Verity plc, who own Mission, Cambridge, Leak, Wharfedale and many other well known names. How is it that Mission have one of the most advanced hi-fi factories going, and that

Wharfedale can be resurrected so quickly and forcefully? Part of the reason is down to confident and substantial inward investment from the East.

Happily, the trade here is bi-directional (whereas with Japan it is uni-directional; why do you think Clinton's giving them hell?). Wharfedale, with all their knowledge, are now helping set up a loudspeaker manufacturing plant in China.

And, whilst I'm listing these links, let me not forget ground-breaking NAD, who back in the Seventies decided to design in the West (Finchley!) and build in the East, where their senior engineer spends much of his time. It is no coincidence, I'm sure, that the man who started NAD, Malcolm Blockley, was recently asked to head up Wharfedale. What goes around, comes around.

Britain's hi-fi industry might be small, but it is tenacious and talented. As the country pulls out of recession I believe it will grow, bolstered by these strengthening links with the East. For those who know their business, the outlook is good ●

Hi-fi for as little as £50,000.

[And more. Or less.]

If you take your hi-fi seriously – and we do mean seriously – this should sound familiar.

One, you'd like totally unbiased advice on all the available options.

Two, you're not prepared to settle for less than the best your money will buy.

Three, you feel you deserve a professional to tailor a one-off system to your personal requirements.

Four, you expect to test drive equipment – at length – before you decide.

And last, but not least, you'd love to have your own expert on permanent call.

In short, you want Serious Kit.

Simply ring 061-707 4823 for access to all the above.

Plus, most of the world's finest names in top-end equipment. And all the experience of the UK's top talent in hi-fi system design.

Serious sound. Serious sense. Serious service.

Serious Kit.

Music to your ears.

SERIOUS KIT

SERIOUS KIT · 21 ALGERNON STREET · MONTON · ECCLES · MANCHESTER M30 9QA · TELEPHONE 061-707 4823.
THE TOP NAMES. THE TOP EQUIPMENT. ACCUPHASE · ALCHEMIST · APOGÉE · AUDIO INNOVATIONS · AUDIOLAB
AUDIO RESEARCH · COPLAND · COUNTERPOINT · EPOS ACOUSTICS · GROOVE TUBES · HEYBROOK LOUDSPEAKERS
IMPULSE LOUDSPEAKERS · JADIS · KRELL · LYRA · MAGNEPAN · MARTIN LOGAN · MICHEL · MICRO-MEGA
PINK TRIANGLE · P.S.AUDIO · ROKSAN · SONUS FABER · SUGDEN · SYSTEMDEK · TEAC · THETA · THIEL · WILSON AUDIO

World Radio History

The fashion of minimalism in audio electronics might be neatly summarised as the principle of seeking to ensure the precious audio signal passes through as few electronic stages as possible on its journey from the microphone to the loudspeaker. Since every electronic circuit must inescapably introduce distortions of one sort or another, the aim is laudable enough and is a view with which I have a great deal of sympathy. Nevertheless, in the field of professional audio, it is often the case that, of necessity, there is a long and circuitous route from microphone signal to final master tape, where minimalism must take a metaphorical back-seat.

An example of this is a recording I made a couple of years ago as a result of a commission to produce a dance piece for children for the Rainforest Foundation. The recording involved spoken word, a children's choir, sound effects and backing involving a standard rock-band plus, amongst other things, pan pipe samples and Spanish guitar. The piece, *Hey Bulldozer* is based on a two-bar musical quote (and I mean a quote, not a sample!) from the fade out of *Hey Bulldog* by The Beatles. This two-bar ostinato underpins the whole thing whilst other ostinato phrases build up on top, first four-bar, then eight-bar and finally sixteen-bar.

The problem was, none of the pieces' component parts - the choir, the band, the narrators etc. - seemed to be able to be at the same place at the same time! Genuine sound effects were promised from South America, but these arrived only just in time for the final mix and then on a standard analogue cassette. The narration excerpts and pieces of choral annunciation were recorded in a dance studio in central London (complete with a very live acoustic and traffic noise) and arrived on un-edited quarter inch

analogue tape recorded at 15 inches per second. The skeleton of the backing tracks were prepared as MIDI tracks and therefore existed only on floppy discs and the choir were rehearsed and waiting somewhere in deepest Surrey. It began to look as if personally lying in front of the bulldozers might be a simpler way of saving the rainforest!

Once the realisation set in that the whole project would have to be put together "collage" style, the first step involved making a



recorded message

Left by Richard Brice

gash mix from the original MIDI files and dubbing this onto a multi-track tape as a working cue track. The multi-track was then loaded into the back of the car along with an array of microphones, mixer, power amps and fold-back speakers, then driven down to the choir. The children recorded several different "takes" whilst listening to the backing via several fold-back loudspeakers carefully set so that they were loud enough to be heard, but not so loud as to cause too much "spill" of this signal onto the final choir microphone signals.

Back at another recording studio a week later, after the final tweaks to the MIDI sequencer data and samples were finished, the complete vocal track was formed by selecting the best bits from the various "takes". The narrated speech and choral speaking excerpts were then carefully edited and "topped and tailed" using a trusty razor-blade and splicing block (yes, some of us can still do this) and

spun-in to a track on the multi-track by hand. The two acoustic guitar tracks were then added, then the electric guitar track and then a backwards electric guitar which involved turning the multi-track tape over on the deck and having the guitarist play along to the other tracks running backwards - something you can do only with an analogue multi-track machine.

After that, all that was left was to add the sound effects, which involved a combination of real jungle sounds (from cassette - arrgh!) and library FX. Oh, and the mix down: sixteen tracks of MIDI, four guitars, four stereo-pairs of choirs, two of narration, four of sound effects. Not having the budget for a studio with fader automation, it took me six goes, but I got it in the end.

It still intrigues me when I listen to the finished song that the children who say, "Leave the forest alone" and the children who sing, "Don't let them bulldoze the

rainforest away", immediately afterwards are not only different children, but were recorded twenty miles and a month apart. It's a tribute to modern parametric equalisers, noise gates and digital reverberation equipment that the choir, recorded direct to master tape with spaced omni microphones in stereo, doesn't sound too different from the chorus who were recorded in a noisy London location in mono onto analogue quarter-inch tape with different microphones.

So there we are. The whole track turned out to be about as minimalist as a Midi-System, but I believe - in this case - the end justified the means. Despite its tortured genesis, I am really proud of this track. It starts with an eerie prediction from an Indian chief which still sends a shiver down my back.

There is so much smoke, all the animals are being killed, the rivers too. My spirit is warning me that when the forest is all destroyed there will be no shade, there will be very strong winds, the sun will get very hot and it will be difficult to breathe. Then everybody will die, not just the Indians - everybody will die. I am warning you - leave the forest alone.

Hey Bulldozer received several performances during the summer of 1991 and has been performed several times since in different versions. Sadly, since then, the destruction of the rainforest has continued apace ●

For the first time in six years, Harman Kardon have launched a new range of pre and power amplifiers, in the form of the AP2500 pre-amplifier and the PA2100, 2200, and 2400 power amplifiers. The lowest-powered amplifier of the series, the 45watt per channel PA2100, was the one we chose to test with the AP2500 pre-amp as it is the combination which - at £849.98 - is the most affordable.

Although marketed as the 'Signature' series, only the pre-amplifier bears a facsimile of Sidney Harman's signature on the fascia. Strangely, the power amplifier does not share the same graphics or carry Sidney's inscription; maybe he wasn't so impressed with the power amplifiers and chose not to re-ink his pen!

The pre-amplifier is a well-specified beast, having MM and MC phono, CD, video, aux, tuner, and two tape monitors, as well as two sets of outputs, all gold-plated. The front panel has just three knobs, for volume, source, and tape monitor, and two buttons, for power and gain, which can be used to attenuate signals from high output CD players.

The rear panel of the power amplifier has, apart from the input sockets and cheap-looking 'speaker binding posts, a switch for bridged mono operation, another for defeating the 'auto standby' mode, and another for selecting 4ohm or

Signing On....

Simon Cooke goes autograph hunting for the 'Signature' series of pre and power amplifiers from Harman Kardon.

8ohm impedance 'speakers. The front panel is bare except for the power button.

The chunky, matt black fascias of these amplifiers are designed to impress the ruggedness of the beasts upon the owner, the design team seemingly wanting a kind of sophisticated, muscled look for what are, effectively, just the usual thin black pressed-steel fabrications. The feel of the controls enhances the illusion, since they are all well-weighted and comfortable to use, and do not feel 'tacky' in the least.

The sound quality was not, in fact, the expected grind and graunch that the look of these amplifiers had led me to expect. If anything, my first impression of the sound was one of an almost delicately effete quality, since the amplifiers seemed warm, verging on slow, without any real slam in the bass.

Take 'Roland the Headless Thompson Gunner', for example, From Warren Zevon's latest Learning to Flinch album, which starts out with helicopter-mimicking

MEASURED PERFORMANCE

The PA2100 power amplifier turns out a goodly 72watts into 8ohms and nearly double into four ohms, or 132watts. This is typical of Harman's approach to power amplifiers, fitting a walloping power supply with good regulation, able to shrug off the extra load imposed by low impedance loudspeakers. Perhaps it is due to the fact that they design as much for the U.S. market, where 'speakers commonly have a 4ohm nominal impedance. Such 'speakers reach down to 2ohms, so a pulse power test into this low impedance is valid. As expected, the AP2100 handled this situation well, producing 11amps with a tone burst, so peak current delivery is very high. All this means the PA2100 should go loud with any speaker, regardless of its impedance characteristics.

Harman consistently design their amplifiers to have a very wide bandwidth, reaching down to subsonic bass frequencies and up almost to Long Wave radio frequencies. This combination was no exception; I measured a -1dB response of 4Hz-142kHz. In my experience, wideband amps do sound clear and clean if well engineered in all other areas. To me, wide bandwidth is more an indicator of basic character than a yardstick of goodness. These days, amplifiers are more commonly band limited in fact, since there are good theoretical arguments for doing so, putting the Harman combo into a minority grouping.

It was reassuring to see the distortion content comprised second harmonic, since this should be subjectively innocuous. The maximum level I measured was 0.03% for full output at 10kHz, a small amount that should not be problematical; it can be seen in the distortion analysis.

The preamp has a peculiar sensitivity button that at 'Normal' setting gives a very high sensitivity of 90mV, but at '-10dB' gives a more normal 300mV. Irrespective of the setting used, however, input overload remained higher than 3V, a satisfactory condition, since the maximum likely output in practice will be 2.5V or so from CD.

Both MM and MC disc stages were wideband too, which is less sensible, since by reaching down to 4Hz they amplify warp signals. An optional warp filter should have been fitted. The MC stage was hissy too. I suspect that Harman have incorporated the simplest stage possible here and that too

much should not be expected of it.

This amplifier is wideband, powerful and capable of driving any loudspeaker to high volume levels. LP lovers should beware of the disc stages though, for hiss on MC and warps through MM and MC. **NK**

TEST RESULTS

Power 72watts

CD/tuner/aux.
 Frequency response 4Hz-142kHz
 Separation 72dB
 Noise -94dB
 Distortion 0.01%
 Sensitivity 90mV
 dc offset -1/57mV

Disc (MM)

Frequency response 4Hz-76kHz
 Separation 73dB
 Noise -70dB
 Distortion 0.01%
 Sensitivity 4.5mV
 Overload 55mV

Disc (MC)

Frequency response 5Hz-92kHz
 Separation 69dB
 Noise -63dB
 Distortion 0.01%
 Sensitivity 0.3mV
 Overload 10m

Distortion

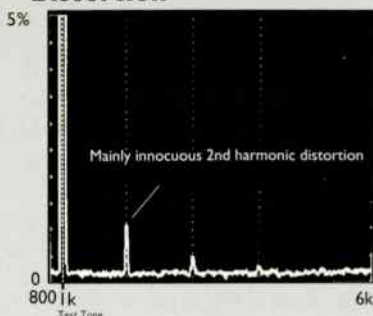



percussion, falling into a dark, brooding, Teutonic piano line. Through the Signatures, the percussion was more 'Thomas the Tank Engine' than Bell Huey, and the lower notes on piano failed to really resolve into the solid stomp that I had expected. I skipped a few tracks on the CD and tried 'Worrier King', but the grind and graunch of the steel guitar just wasn't there.

Some of the dirtiest, low-down blues I know was emasculated and tossed casually back by the Signatures. I toyed with a little Tom Waits, but he almost sounded musical and rounded. I threw down the gauntlet with Eberhard Weber's latest double bass extravaganza 'Pendulum', but the lowest bass tones just fell out of the bottom of the image, and the heart-rending squeak and squeal which starts 'Delirium' was just too bland for words. I threw in the towel.

Yes, I stopped looking for that exciting 'edge' which I always like in a

product, and tried listening to what the Harmans were actually playing. For all that, there was little really deep bass to boast of, and what there was in the upper bass seemed rather slow and confused. The Harman Kardons had a nice, rounded tone which suited mainstream jazz and classical works down to the ground. They won't slam a bass line out at you, because they're just that bit too polite. Instead you can look forward to hours of warm, cosy, listening, and you might even doze off

every now and then. It's a very comfortable, and comforting, sound.

The midrange frequencies were as rounded as the bass and, in not being forward, integrated well with both the bass and treble. The detail here could still be a little fuzzy at times, although this again was due to the lack of real speed rather than an inability to deal with complex pieces of music, which it did in the most flattering manner possible. It had warmth enough to mask problems in a recording, and yet never really became overly soft in tone, due mainly to a very slight graininess in the midrange and treble. For instance, Scott

Hamilton (Scott Hamilton Quintet in Concert) retained all the breath and air usually associated with his work, and his instrumental tone was impeccable, but just a little lacking in excitement, and not as raw as he would sound in reality. Riggs' drumsticks, on the solo that I've mentioned in other reviews, sounded as though they really were moving through air between striking each other. There was

atmosphere in plenty on every track played through the Harmans. Very civilized.

Up in the treble, the Signatures really did start to sing. The roundness of tone prevented the treble becoming overly astringent, and detail in alto and treble lines held and decayed with awe-inspiring liquidity. From the delicacy of plainsong to Talitha MacKenzie's haunting vocals on Mouth Music's eponymous album, the upper ranges were the domain of impressive detail and atmosphere. The

only time the treble let me down was when I was tempted to try the glass harmonium on Tom Waits' Swordfishtrombones album. A bad idea, since the sound was simply muffled and washy, floating vaguely around the soundstage rather than consolidating into a believable image.

The soundstage did seem impressive on 'civilized' classical and mainstream jazz music, but it fell apart with raw and jagged-edged live recordings, where the audience seemed confined to the edges of the image, rather than washing out forward of the 'speakers to engulf the listener. 'Raw' musicians such as Waits, Zevon, and Weber, all became ephemeral beings, seemingly loose and undefined in space. Give the Harmans the North German Radio Symphony Orchestra playing Brahms' 'Hungarian Dances', however, and they pinned the stage out admirably well, perhaps not defining all of the instruments perfectly, but staging solidly enough to be believable.

Strange to say after this, I liked the Harman pre/power. Perhaps they were a touch too warm in their presentation, and they were definitely unable to cope with dissonance and syncopation adequately, but they had an easy, comfy sound, that could really appeal. If you like easy, neat, but not entirely unchallenging hi-fi, and something relaxing to listen to, these are almost ideal amplifiers. They just don't like my music, that's all!

HK AP 2500 Pre Amp £499.99

HK PA 2100 Power Amp £349.99

Harman Audio,

Harman International Industries Ltd.,

Mill Street,

Slough, Berks. SL2 5DD

Tel: 0753 576911

*“ Detail in alto
and treble lines
held and decayed
with awe-
inspiring
liquidity.”*

£4590 worth of KEF

KEF are one of the UK's longest standing audio manufacturers. They've been in business for 33 years now, and with substantial research and development facilities their loudspeakers are renowned throughout the world. That's why we've chosen to offer FIVE pairs of their top-of-the-range Reference Series loudspeakers as competition prizes.

The lucky winner of the first prize had better have a large room though, for the £2395 Reference 105/3s, beautifully finished in American Walnut, are large, three-way floorstanders

capable of producing gut wrenching bass.

The four runners up will also receive KEF Reference Series loudspeakers, the £549 compact, standmounting 101/3s.

Both the 105/3s and 101/3s use KEF's unique Uni-Q drive units. These have the tweeter mounted in the centre of the bass unit, the aim being to produce a drive unit that closely emulates a point source, improving their ability to conjure up a believable image.

The 105/3s use the Uni-Q driver with similarly sized lower mid-range drivers positioned either side. The baffle

they are mounted on protrudes from the main cabinet, giving a narrow and deep profile, which again helps them to image well. The main cabinet houses two powerful deep-bass units, that work together in KEF's coupled-cavity arrangement. This ensures good, deep, powerful lows.

The 101/3s are based around a single Uni-Q driver in a small ported enclosure. Their compact size and high performance make them ideal for a high quality system in a moderate size listening room. Although the bass isn't quite as powerful as that of the 105/3s, it is firm and punchy and through the midband and treble the same strengths of the Uni-Q drive unit still shine through.

Both the 101/3s and 105/3s are masters of their class. With so much engineering expertise behind them, you can expect these speakers to perform well in almost any system.

To enter this fabulous competition for five pairs of KEF Reference loudspeakers, simply complete the questions opposite.

Please send your entry on a POSTCARD, or the back of a SEALED ENVELOPE, and completed in block capitals, to arrive no later than Tuesday 7th June 1994 to:

**KEF Reference Competition
Hi-Fi World Magazine,
64 Castellain Road,
Maida Vale,
London. W9 1EX.**

Don't forget to include your name, address and a telephone number - we like to contact the winners promptly.

In the event of more than one entrant submitting all the correct answers, the winner will be picked by the Editor from the tiebreaker. We will endeavour to publish the results in the August 1994 issue. Purchase of the magazine is not a precondition to entry.

No correspondence about this competition will be entered into and the Editor's decision is final.

No employees of Audio Publishing Ltd. or any of the companies associated with production or distribution of the prizes may enter ●

COMPETITION ENTRY QUESTIONS

1) For how many years have KEF been making loudspeakers?

- | | |
|-------|-------|
| A. 11 | B. 22 |
| C. 33 | D. 44 |

2) How many drive units does the 105/3 use in total?

- | | |
|------|------|
| A. 3 | B. 4 |
| C. 5 | D. 6 |

3) The 101/3 is part of which KEF series?

- | | |
|-------------|-----------------------|
| A. Q series | B. Constructor Series |
| C. C series | D. Reference Series |

4) What kind of bass loading is used in the 105/3?

- | | |
|-------------------|--------------------|
| A. Bass reflex | B. Isobarik |
| C. Coupled Cavity | D. Infinite baffle |

THE TIE BREAKER (OBLIGATORY)

It's from Tovil, Kent, KEF make their case
with Reference Series and super bass
The thunder from that town rolls out
swamping all the peasants about
They may be yours, if your home is strong
and if you woo the wife along
.....

We will endeavour to publish the results in the May 1994 issue. Purchase of the magazine is not a precondition to entry.

No correspondence about this competition will be entered into and the Editor's decision is final.

No employees of Audio Publishing Ltd. or any of the companies associated with production or distribution of the prizes may enter.

loudspeakers to be won

competition

APRIL ISSUE COMPETITION - PINK TRIANGLE DA CAPO CD CONVERTOR

Only one lucky winner out of the thousands that entered will take home one of the very best CD convertors available today. That lucky winner is:

Mr Andrew Stowell of Brighton, who's now the envy of everyone in the office here at Hi-Fi World. Many thanks for such an excellent response to all of you who entered, and please keep trying.



I've always felt it a great shame that so many good books of the past are nowadays unavailable to the majority of hi-fi enthusiasts. There are numerous books on valve amplifiers for example, most written between 1930 and 1965, that can only be found second hand, and even then in limited supply. The Radio Designers Handbook is a good example. This is possibly the definitive book on valves and their practical application. But as people become aware of such books, their supply diminishes. The Radio Designers Handbook is reportedly now so rare, that latest edition copies are changing hands for anything up to £200. I'm glad I got mine a few years back from a second hand bookshop for £9, but saddened that anyone now wishing to purchase a copy has to have a considerable amount of money with which to do so.

Other examples are the Mullard Audio Amplifiers book (- the one with the 5-20 and 5-10 amongst other designs in it), Electrostatic Design and Construction, an amazing book that actually goes through the steps of constructing your own DIY Electrostatic loudspeaker, and Gilbert Briggs' Loudspeakers - The Why and How of Good Reproduction, which is a must for anyone interested in constructing their own loudspeakers. So, when I found out that there was a company in the States that reprinted some of these unique titles, an idea we'd been toying with, but hadn't had the time to implement, I knew we had to make them available to you.

This month sees the start of the Hi-Fi World library. We've selected a range of books, some reprints, some new, covering electronics - valve and solid state, loudspeakers - including electrostatics - and a general audio book that covers most areas in enough detail to get the mind ticking. For a full list of what's on offer see page 15

of the Supplement.

There are still many books not being reprinted at present. The Radio Designers Handbook and Scroggie's Second Thoughts on Radio Theory to name but two, but we'll be working on that. For now, we've selected nine books that we believe to offer unique and authoritative views in the areas they cover.

Two modern books selected are The Art of Electronics and The Art of Linear Electronics. The former is a general electronics book, but it



Dominic Baker

dB on the level

offers a very thorough insight into solid state electronics. The first chapter is a foundation chapter which explains all of the basic components, how they work and their symbols. Also in this foundation is an explanation of voltage, current, power etc. The book then continues with transistors including FETs and their operation right through to digital electronics and microprocessors. Each chapter starts at a very basic level and finishes with suggested circuit applications for what you have just learnt about.

This is just the kind of approach to electronics needed for the beginner. I used this book throughout my A-level and Degree course and still use it today as a valuable reference book. However, for the complete novice, the practical side is also very important. If you are keen to learn though, I'd suggest using this book in combination with simple electronic kits from Maplin. So, as you finish the chapter on Transistors, have a go at

building a circuit that uses a transistor. Maplin provide kits that are quick and easy to build, and putting the theory into practice is where you really start to learn and understand about electronics.

Even if you never manage to design a circuit yourself, it will at least teach you enough to build circuits published in our DIY Supplement and those found in other publications. It isn't as hard as you think, and it's very rewarding to be able to build something that works and sounds good, let alone saves

you money.

You might have noticed that we are trying to encourage people to have a go at building things. The Cable Compensated Passive pre-amp in this Supplement uses very simple components and is free from danger of electric shock. It sounds good too, so just because it's not complex, it doesn't mean that it's not worthwhile. The 211 lamp is another easy one to build, and a bit of fun as well. This does expose the builder to mains voltage, so don't have a go unless you're experienced

enough to attempt it, but it is extremely simple to build.

We'll be doing more of these easy-to-build projects in future Supplements, but don't worry, they'll also be plenty more loudspeakers and amplifier projects too. Hopefully, if you read some of these books, and build up simple circuits to test your knowledge, pretty soon you'll be able to have a go at a valve amplifier or something of similar complexity. The satisfaction of building something yourself is well worth the effort ●

EDITORIAL ASSISTANT

Getting busier and busier daily, we are looking for another editorial assistant. A good background of experience in hi-fi is needed, plus respectable educational qualifications, particularly in English. We want someone who can listen and write, as well as organise. If you can handle a professional camera, so much the better. In the first instance, please write, enclosing CV and/or details to

EDITORIAL ASSISTANT VACANCY
HI-FI WORLD
64 CASTELLAIN ROAD,
MAIDA VALE
LONDON W9 1EX

The new Audiolab 8000CDM Compact Disc Transport



The Audiolab product range:
8000A Integrated Amplifier
8000C Pre-amplifier
8000PPA Phono Pre-amplifier
8000P Stereo Power Amplifier
8000T FM/AM Tuner
8000M Monobloc Power Amplifier
8000DAC Digital-analogue Converter
8000CDM Compact Disc Transport

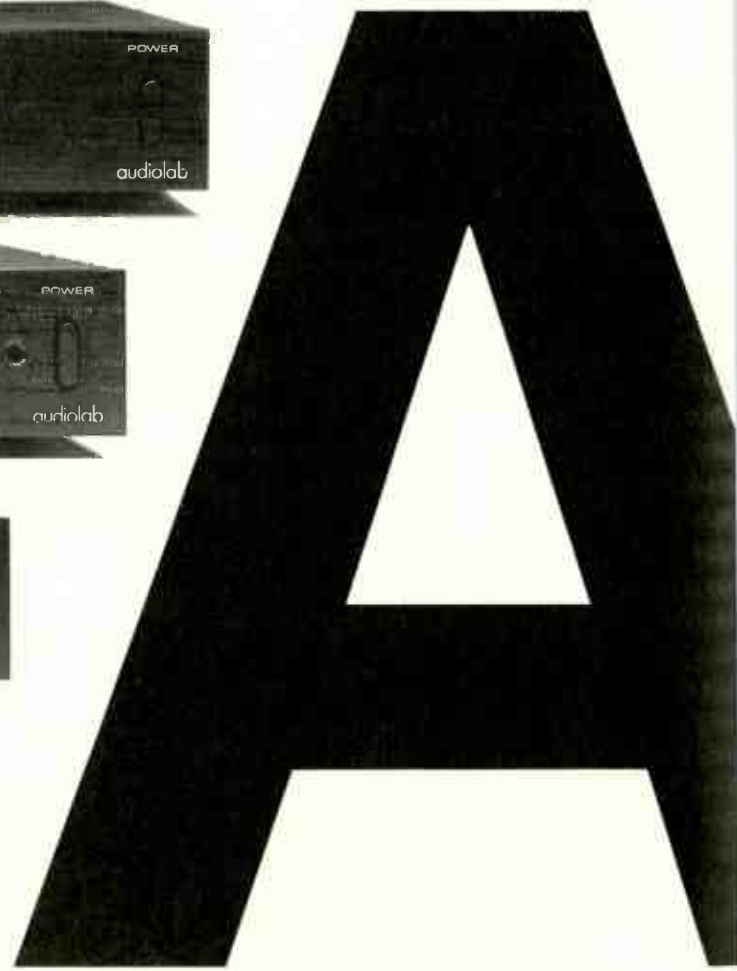

AUDIOLAB

Cambridge Systems Technology Limited, Spitfire Close, Ermine Business Park, Huntingdon, Cambs. PE18 6XY. Tel 0480 52521

World Radio History

Hardly a week goes by without us being questioned about 'speaker positioning. What would appear to be one of the simpler sides of hi-fi is in fact fraught with variables, and further investigation into the subject reveals there's more to 'speaker positioning than meets the eye. It's simply not possible to cover the entire subject, in detail, in a thousand words or so, but here's a rough guide.

The first concern has nothing to do with the speakers themselves, but the room in which they are placed. Very few people are fortunate enough to have a dedicated room for hi-fi, but fine results can be obtained by spending a little time in an ordinary domestic environment.

The 'speakers need to be placed on a firm surface. A concrete or quarry tiled floor is ideal, but not always available. If you're stuck with wooden floor boards there are a few tricks that will help alleviate the bass bloom that can result. The room may have a concrete fire surround, if not (or if it's too small) then placing the 'speakers on a stone or concrete slab can help.

An alternative for those with springy wooden floors is to insert screws into the floorboards and place the 'speaker, or 'speaker stand directly on top. Also, note in which direction the floor boards run. It's advisable to have the floorboards running in parallel with the front of the speaker. In this way, sensitive electronic components and turntables placed between the speakers are less likely to be affected by bass resonances through the floor boards.

For the best bass response, the loudspeakers really need to be placed near an outside wall rather than an internal one. There is no ideal size of room, as it varies from 'speaker to 'speaker. Something to consider if you're buying a transmission line speaker, though, is that they work differently from

conventional speakers in that they actually pressurise the air in the room. Therefore, too large a room can leave smaller transmission lines struggling to produce bass, whilst too large a 'speaker in a small room has the reverse effect. The obvious conclusion is to try before you buy.

Once you've found the best place to position your speakers, try to arrange the furniture so that they have plenty of space between and around them. Furniture should also be



Fair Views

- from Dominic Todd, our man in Scarborough

placed roughly symmetrically in the room and of balanced densities around the room (try not to have all the soft sofas on one side of the room and hard wooden furniture on the other, for example). Also, place a rug or some form of soft material on the wall behind the listening position to damp standing waves caused by hard surfaces. This will help create an even and balanced sound stage. Room acoustics can be optimised by using test discs with frequency sweeps and flutter echo tests, leaving further fine tuning down to experimentation.

The huge variety of speakers available on the market dictates that there's no hard and fast rule to speaker positioning. However, for the majority of box speakers (i.e. not panel speakers such as the Quad ESL which are a law unto themselves) there's reasonable uniformity.

Speakers should be placed between six to ten feet apart and parallel to the same rear wall. This last point may sound

obvious, but it never ceases to amaze me how many people still position their speakers across a corner. The distance apart is dictated somewhat by the distance the listener is from the speakers. The distance between the speakers should be between one and two thirds that of the speakers to the listener.

The distance from the wall is down to the individual speaker. Most are happiest at between one to two feet out from a wall, but some prefer to be placed right against a wall. Start with the speaker about a foot out from the wall, and adjust distance to create the best balance between bass weight and imaging. Pulling the 'speaker away from the wall will usually mean losing a little bass, but the trade off will be a wider and "freer" sound stage. One point often overlooked, is that the speakers should be the same distance from the side walls (sometimes difficult in smaller rooms with chimney breasts or bay windows).

Toe the 'speakers in, so that from the listening seat (hotspot), neither side of either 'speaker is visible. You may find you prefer the sound with the speakers firing straight down the room, or even toed in to a greater extent so that the axes cross in front of the listener. In general, however, toeing in the 'speakers so that they directly face the listener lends an extra degree of body to images in the stage, compared with the straight firing position, whilst avoiding the muddle

sometimes caused by toeing in the speakers too much.

Tilting the 'speakers rearward via use of stands or spikes is also beneficial. This subtly throws the sound stage upwards and reduces the chances of vocalists sounding as though they're singing on their knees! The high frequency unit (tweeter) should already be at about ear level when you are seated. To adjust the tilt from here, tilt the 'speaker backwards until the top is no longer visible. Hence the front panels of either speaker should be the only faces visible.

Finally, ensure, with a spirit level, that both speakers are perfectly level (adjustable via the spikes) in the side to side plane. Tighten the spikes firmly, and check that, if the speaker is supported via a speaker stand, it's squarely located with spikes, or Blue-tac. Upper spikes can give a slightly faster bass, whereas Blue-tac tends to increase bass presence. The correct fitting is, yet again, dependant on the speaker. Happy fiddling!

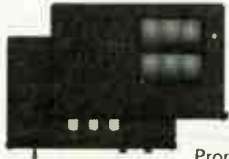
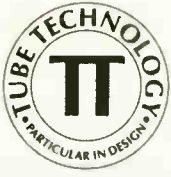

Prophet



Genesis

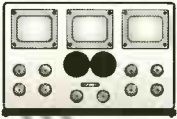

Unisis

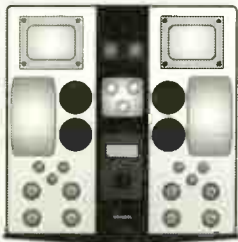

Synergy

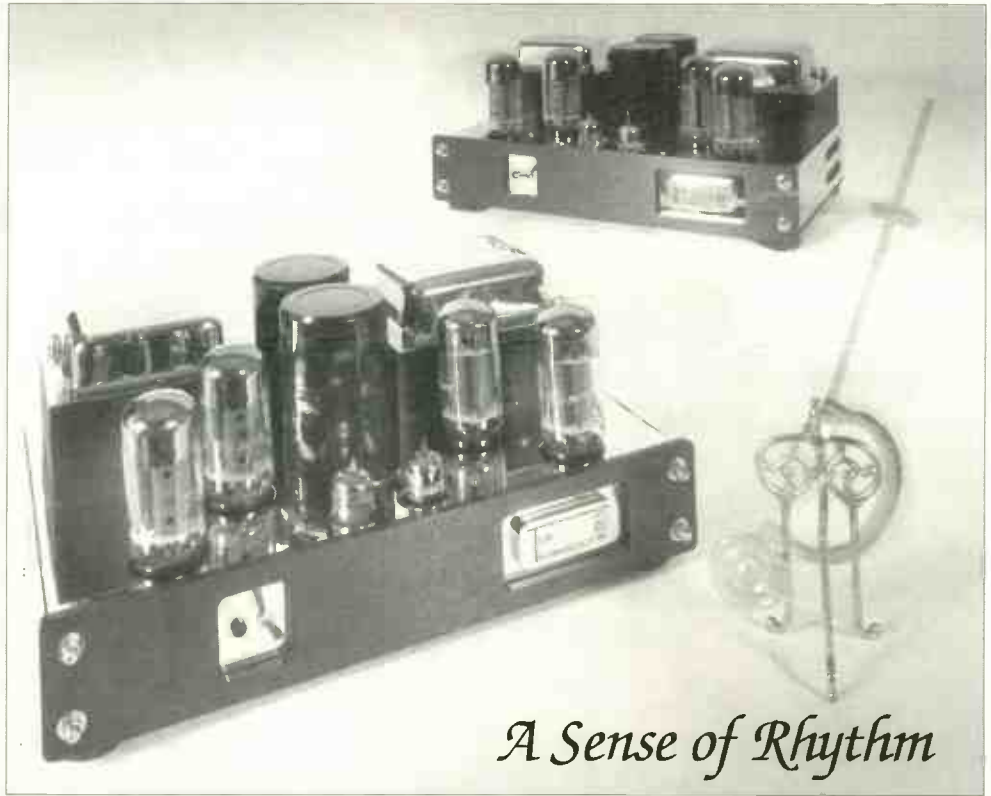

A Sense of Rhythm

Tube Technology, Design & Manufacturers of High Quality Tube Amplification & Distributors of Gold Aero Vacuum Tubes. Please enquire for further information on our range of amplifiers and Vacuum Tubes. ~ Hatch Farm, Chertsey Road, Addlestone, Surrey, KT15 2EH, England.
Tel: 0932 850361 Fax: 0932 850354 ~ Pictured; *The Genesis 100 watt All Tube Monoblocs.*

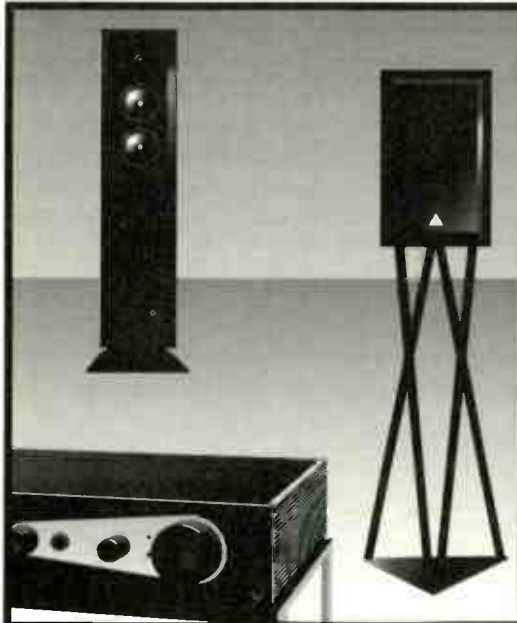

TRIANGLE

ELECTROACOUSTIC

FRENCH SPEAKERS

...as reviewed by English speakers...

"The Alicante's big, fluid, wide-ranging and open presentation lets the music speak for itself."

Jonathan Kettle. *AUDIOPHILE*. November 1993

"The Titus E has an absolutely riveting sound with openness and rhythmic drive."

WHAT HI-FI?. March 1993

"The Icaries are fast and enthusiastic: there's nothing twee or laid-back about their presentation of music - whether reserved classical or high energy rock."

WHAT HI-FI. October 1992

AND AS FOR THE AMPLIFIER...

"The Triangle TE60...has very clean treble...separation is first class...bass is outstanding...an excellent product. A super little amplifier, nicely styled and beautifully finished."

Jimmy Hughes. *AUDIOPHILE*. March 1994

THE ROMANCE OF FRENCH HI-FI

Berks
THE AUDIO ROOM
3 Little brook Avenue
Burnham, Slough, Berks
0628 - 668112

Cornwall
RJF AUDIOVISUAL
84 Pendarves Street
Tuckingmill, Camborne
0209-710777

Dublin
ACOUSTIC DIMENSION
16 Idrone Mews, Idrone Lane
Black Rock, Co. Dublin
0103531 - 2884612

Norwich
SOUND APPROACH
161 Unthank Road
Norwich
0603 - 622833

London
DOUG BRADY HI-FI
(See Dial-A-Dealer)
071 - 379 4010

Liverpool
DOUG BRADY HI-FI
(See Dial-A-Dealer)
051 - 7336859

Warrington
DOUG BRADY HI-FI
(See Dial-A-Dealer)
0925 - 828009

London
DIVA
Workshop 30, Royal Victoria
Patriotic Bldg., Wandsworth
081-875 9593

Otley
DOUG BRADY HI-FI
(See Dial-A-Dealer)
0943 - 467689

Scotland
HI-FI EXCELLENCE
293 Union Grove
Aberdeen
0224-322520

Triangle loudspeakers cost from as little as £265; TE60 Integrated Amplifier £549 - for more details phone Ortofon UK (0753-889949) or Kronos (08687-48632)

Giovanni Dadomo



INDEX

RECORD REVIEWS

ROCK & POP73
Giovanni Dadomo

CLASSICAL85
Peter Heming

JAZZ93
Simon Hopkins
Smon Cooke

FRANK BLACK
Teenager of the Year
4AD DAD 4009 CD

● Frank Black got some rather cool reactions with his first solo LP last year. Heaven knows why – I thought it was brill and sounds just as good, and still gets played a lot, today. But then, maybe he needed to get a caning for breaking up The Pixies, a great band who made two, maybe three solid gold classic albums. That's a lot to live up to, and even Frank's old band couldn't always match some of their own best efforts. But so what? After all, nobody's brilliant all the time.

Anyway, the prolific gentleman's career continues apace with this 22-song double set, culled from more than thirty new Black compositions recorded over

the past year, a veritable feast for confirmed FB fans.

What I liked best about the old band was that, although they were wildly inventive in their playing and structures, their best work – 'Bone Machine', 'Monkey's Gone To Heaven', oh too many to mention – combined loopy inventiveness with muscular tunes that stuck in the head. Ditto Frank's solo career. On this outing he includes such mad delights as a song about a headache ('Headache' it's called, for some reason) to the dribbling madness of 'Whatever Happend To Pong?', pensive ballads, even one item – 'Calistan' – that sounds like a bastardised Dire Straits'. The guitaring, abetted by ex-Pixie Joey Santiago, among others, is as wildly inventive as ever, ditto the vocal performances and lyrics, some of which are as delightfully DaDa as anything ever dished up by the good Captain Beefheart.

Maybe twenty two cuts might be too much for some folk – there's always the possibility of indigestion with so-called feasts of entertainment. But, that's what programme buttons were invented for. Considering the sheer quality and staying power of the 'Frank Black' disc, the odds are good that 'Teenager Of The Year' can only continue to yield its many and varied pleasures with continued listening. I'd buy it – and I just love the title. I mean, have you seen Frank Black lately? But then he could hardly have called it 'Fat Balding B....d of the Year', now could he? Well...

RECORD OF THE MONTH

PULP
His 'N' Hers
ISLAND CID 8025

● Some of the more pointy-headed music jourmos have been driving about a Seventies revival, supposedly lead by Suede, and into which oh so convenient albeit hugely idiotic bin this Sheffield-born quintet have also been chucked. And I say, Yeah? But which Seventies - Bowie/Bolan? Sweet and the rest of the Chinnichap crowd? Buzzcocks, powerpop etc? And so on.

But I say, who gives a damn? Because, what we have here is a sublime pop disc, one that ties up sundry influences and inflections to produce something delightfully fresh and very exciting.

The songs are tight, wittily lyrical, and delivered with huge panache from all concerned. Pulp are led

by vocalist/wordsmith Jarvis Crocker, easily the most unique and charismatic frontman to have crossed my TV screen in a good month of Sundays. Crocker has the look of a slightly debauched young dandy, an image that could make him look just at home popping pills with

Brian Jones in The Speakeasy in 1968, or biting delicate necks a century before along-side one of Ann Rice's elegant vampire gents. More importantly, he can and really does SING, stretching his tonsils every which way, from plangent agony, across deep throat passion, to

drums etc., and Steve Mackey on bass. It's a very bright, joyously innocent sound, poppy in the nicest, cleverest way - Ms Doyle, for example, entertains us with everything from rink-dink Farfisa to grand piano and even the humble Stylophone, while drummer Banks' credits include a fire extinguisher, would you believe.

Pulp have been together for almost a decade, and it shows in the sheer quality of their songs, arrangements and performances. His 'n' Hers is just so goddam tight, classy and catchy, it sounds like a Greatest Hits package. The opening 'Joyriders' is a witty ditty about naughty boys who take cars; it also contains the first of many great lines from Crocker - "Hey you in your Jesus sandals / Wouldn't you like to come over and watch some vandals?" Then comes 'Lipgloss', with its sublimely irresistible chorus, ditto 'Babies' and many more.

If Pulp have any flaws it's a tendency to wallow in the sort of high melodrama exemplified by the Ultravox of 'Vienna'. But thankfully such moments of bathos are few and far apart. Primarily this is a stunning, all but impeccable disc. English - so very English there's even a song about tea drinking! - Pulp do their country proud. Gold star stuff.

PULP. HIS 'N' HERS.

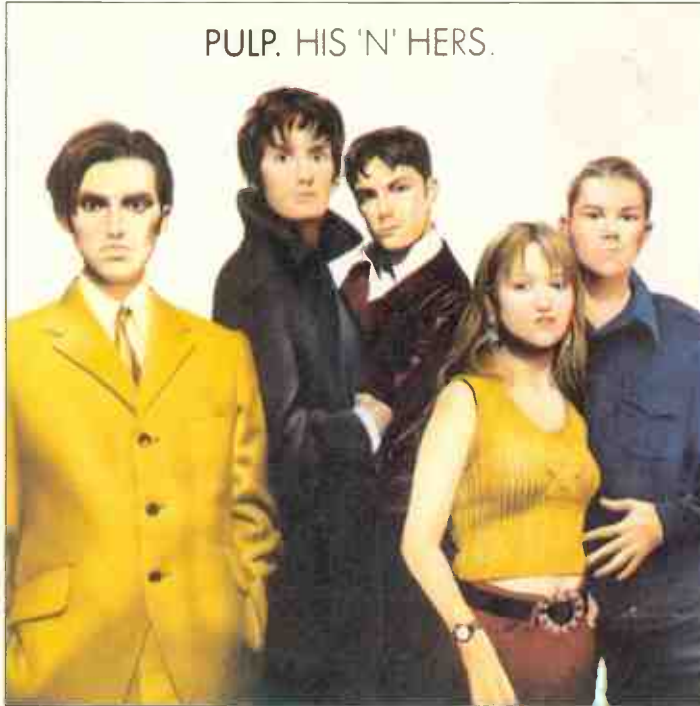

joyous hiccups of pure sensuality.

All this takes place over a broad sound canvas of guitars, courtesy of Russell Service, and keyboards, from the brilliant Candida Doyle, with a taut underlay of rhythm from Nick Banks,

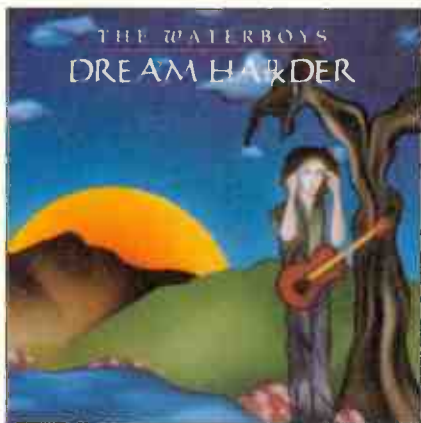

THE WATERBOYS
Dream Harder
GEFFEN GED 24476

● It's long been a mystery to me that Mike Scott (who, to all intents and purposes is The Waterboys) isn't a bigger star. He's been making great records for

some fifteen years now, and his best work - 'Whole Of The Moon', 'The Return Of Pan', to name but two - has an epic quality that's joyful, uplifting, universal.

Well, this album, made principally in America with the usual shifting line-up of latter-day Waterboys recordings sounds like he's finally decided it's make or break time. Gone are the gentle, almost cottage industry Celtic sounds of Scott's 'Fisherman's Blues' period. Instead the bulk of this latest record is Scott in expansive mood, all thundering guitars, shiny-shiny production values (Scott with Bill Price) yet without entirely relinquishing the man's penchant for a touch of the mystical. 'The New Life' or the aforementioned 'The Return Of Pan' are the kind of songs and performances that seem guaranteed to seduce the Americas.

At his best Scott sounds like a fresh-faced inheritor to the most inspired moments of the young Dylan, Lennon or

Phil Lynott, giants one and all. It's more than obvious here, as on the soaring 'New Life', while Scott retains a gentler side - the delicate 'Corn Circles', the playfulness of 'Spiritual City', with its backwards guitars, forwards sitars and vocal assistance from Billy Connolly - which reassures us that if at times he sounds like an FM programmer's dream, there's no reason to suspect he left his integrity or imagination at the studio door. Can't you just see him back on the cover of 'Melody Maker' under the inevitable 'MM' headline, 'GREAT SCOTT'? They could be right for once.



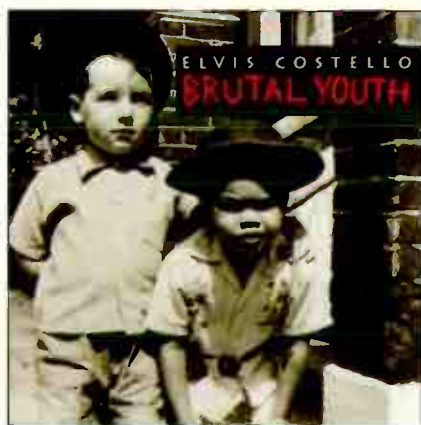
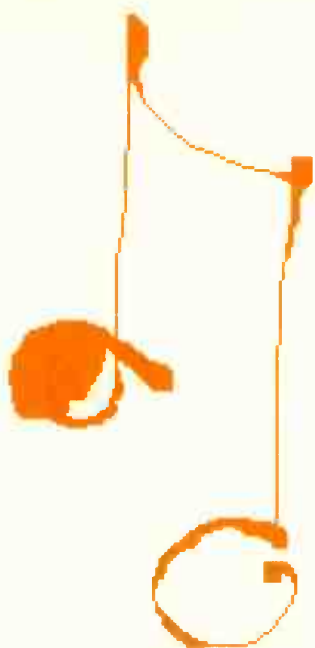

ELVIS COSTELLO
Brutal Youth
WARNER BROS 9362-45535-2

● Thank God Elvis Costello's been to the barber's – he may have taken the odd wrong step in a primarily glorious career, but none as misjudged as growing that awful beard and hair. Having doffed the Rasputin look, Elvis is back doing what he does best and re-united with the people he does it best with, namely The Attractions and his old bass buddy Nick Lowe. 'Brutal Youth' sounds – as you might expect – like a great lost Elvis album recorded between, say, 'This Year's Model' and 'Armed Forces'. There are even a couple of things made partly at the tiny Pathway Studios in Islington, home of many early Stiff classics, Costello's earliest works included.

So it's all here: the dense, sharply wry lyrics, the acid-tinged (as in biting, not tripped-out) vocal phrasings, all set to snub-nosed rhythms that are poised against Steve Neive's majestically soaring organ (Oo, er, missus).

There's only one question and it's that famous old saw, what's the point? Does the world really need another classic Costello album? Well, considering some of the alternatives (2 Unlimited, Take That, 'new', Punk) I'd say yes indeedly, it surely does.



BECK
Mellow Gold
Geffen GED 34634

● Billed as a sort of weird youth prodigy cross between rap and a resurrected young Dylan, this young Yank sure is verbose. Some of it may be drivel, but it's inspired, amusing drivel. To my mind the man has more in common with the spoken word-meets rock tradition that traces back, via Jim Carroll and Lou Reed, all the way to the Beats.

But hey man, that's cool, and it's real cool when allied to thundering rhythm cuts, as on 'F...in' With My Head'. And, sure, there are times when it all gets too precious and pretentious for words. "She can talk to squirrels," Beck tells us in an awed whisper during 'Whiskeyclone – Hotel City, 1997'. But then a little pretension never hurt Jim Morrison or a thousand others. This is a fascinating debut. Hell, some of it's even catchy. He may talk dirty, but Beck's a cool dude, no mistake.



THE DYLANs
Spirit Finger
Beggars Banquet BBQCD 144

● No-one enamoured of the 'Nuggets' sound of commercial '60s pop-psychadelia (Electric Prunes, Seeds etc) or contemporary 'revivalists' The Fleshtones will be able to resist the dirty sweet sound of the Dylans' second album. Tongue firmly in cheek maybe, but 'Children of the Flame' is a fine stomper while 'Just One Big Plastic Hassle' has to be my Song Title of the Year.

MORRISSEY
Vauxhall and I
Parlophone 7243 8 27797 2 8

● He may never have got whisky, but Moz has taken the odd U-turn since The Smiths bit the dust.

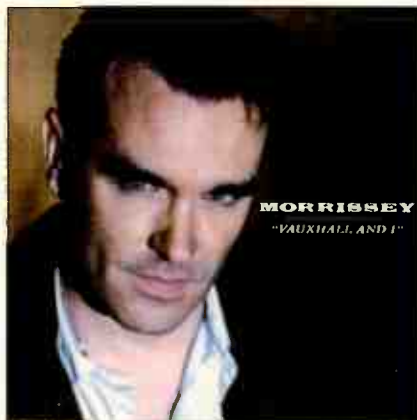

This is his Smith-iest-sounding solo disc yet, except the words are cleverer, subtler, and the singing takes bigger risks. Does the world really need another Smiths LP though? See Elvis Costello review...



DIE, MONSTER, DIE
Withdrawal Method
Roadrunner RR 9025-2

● If you like your girls riotous, then this hard-playin' group of young ladies from NYC could just be your cup of meat. Too raggedly desperate at times to bear much repeated listening – especially in a seated position. But, as we used to say in '77, they have bags of energy and enthusiasm. Bet they cut the mustard live, too.





Experience live music

in your home.

Experience a personal service second to none.

At Sound Gallery we will help you tailor a hi-fi system that sounds exactly the way you want it, not the way you've been told it should sound.

Experience the options in the neutral conditions of our demonstration room, and the professional home installation of your desired system.

**FOR A SOUND EXPERIENCE
AND SOUND ADVICE, CALL**

▶▶ **THE SOUND
GALLERY**

0494 531682

65 CASTLE STREET • HIGH WYCOMBE • BUCKS HP13 6RN

World Radio History

Specialist Hi-Fi Dealers

SOUTH

SOUND GALLERY

BUCKINGHAMSHIRE'S PREMIER HI-FI DEALER

Arcam, Denon, Linn Products, Naim Audio, Meridion, Rotel, Yomoho, NAD, Quod, Tripod, Nokomichi, Rego, Creek, Epos, Mordount Short, Celestion, Morantz, Mission, Cyrus, etc. ...

65 Castle Street, High Wycombe, Buckinghamshire.
Open Monday - Saturday
0494 531682 / 464670

WORTHING AUDIO

20 Treville Gate, W.Sussex. BN11 1UA
(0903) 212133

The friendly shop with the best sound system in the South. Friendly advice

• 3yr guarantees • easy parking

Open Mon.-Sat. 10am-6pm Late night Wed. 7.30pm
Agencies include: Arcam, Exposure, Kinshaw, Naim Audio, Marantz, Ruark, Audio Technica, Target, Tripod, IPW, TDL, Orelle, and many more....

the powerplant

BRIGHTON'S LEADING HI-FI SHOP

Cyrus, Roksan, Micromega, Audionote, Audiolab, Rega, Arcam, Exposure, Aura, Epos, Thiel, Ruark, Rotel, Marantz and other fine equipment.

66 Upper North Street, Brighton
Telephone 0273 775978

STATION SOUNDS

FOR A SELECTION OF VALVE AMPLIFIERS AND OTHER OLDER QUALITY EQUIPMENT

Valve amplifiers (combos and hi-fi) overhauled at sensible rates.
Audio Note speakers and used Audio Innovations amplifiers stocked.
Valve and other equipment always wanted.

Mike Pointer 0903 239980 (including Fax)

DOWN PLATFORM WORTHING STATION SUSSEX

Stockists of: ARCAM • CREEK • EPOS
HEYBROOK • MICROMEGA • NAIM AUDIO
NEAT • REGA • ROKSAN • ROTEL • ROYD
TEAC • YAMAHA

Infidelity

indecently good hi-fi

9 High Street, Hampton Wick, Kingston upon Thames, Surrey KT1 4DA. Tel: 081-943 3530
Open Tues - Sat 10.30am - 7.00pm.

CHICHESTER HIGH FIDELITY

7 ST. PANCRAS, CHICHESTER, WEST SUSSEX
CLOSED ALL DAY MONDAY
Tel: (0243) 776402

Appointed stockists of: A+R Cambridge, Castle Acoustic, Creek, Dual, Goldring, Linn Products, Monitor Audio, Naim, Nakamichi, Quad, Rega, Rogers, Royd Audio, Sendor



Near Norwich
Norfolk
Tel. (0508) 570829

Basically Sound of Norfolk

SEEK BEST VALUE LEADING HI-FI

Arcam, Naim, Audiolab, Epos, Denon, Nakamichi, Acoustic Energy, Heybrook, Micromega, Rotel, TDL, The Chord Company, Sound Style etc...

LONDON & SOUTH EAST

"One of the 5 best hi-fi shops in the world"

GRAHAMS HI-FI

Canonbury Yard, 190a New North Road
London N1 7BS, ☎ 071-226 5500
Ring for a chat, an appointment and a map!



For the great sound of sound :

The Comflake Shop
37 Windmill Street London W1P 1HH
071 631 0472 Fax. 071 436 7165

We stock ATC, Arcam, Meridian, Naim, Rega, Royde, Roksan, AVI, Monitor Audio, DNM; as well as offering a marvellous mail-order worldwide service • Crunch •

The Hi-Fi Shop

GUILFORD'S SPECIALIST SINCE 1950

We are at:
3 BRIDGE STREET, GUILDFORD
(By the traffic lights - next door to Alfred Marks)
0483 504801 • 0483 304756

Access • Visa • Switch

Open Monday-Saturday 9am-6pm (later by appointment)

volume one

Tel : 081 304 4622

Alchemist, Alphason, Arcam, Audioquest, Audio Technica, Beyer, B&W, Cabletalk, Canon, Celestion, Chord Co., Micromega, Michell, Moth, Musical Fidelity, Nakamichi, Neat, Ortofon, Pink Triangle, QED, Rotel, Royd, Ruark, Sennheiser, SME, Sonic Link, Sony

41 UPPER WICKHAM LANE,
WELLING, KENT

AUDIO CONCEPTS

27 BOND STREET, EALING
LONDON W5 5AS
TEL. 081 - 567 8703

AMC, Acoustic Energy, Aura, Audiolab, Audio Innovations, B&O, B&W, Cannon, Castle, Cyrus, Denon, Dual, Evolution, JPW, KEF, Marantz, Micromega, Mission, Monitor audio, Musical Fidelity, NAD, Nakamichi, Onix, Onkyo, Quad, REL, Rogers, Rotel, Systemdek, Target, Teac, Thorens, Van den Hul.

10 - 6 pm Mon., Tues., Friday, & Sat.
Late night Thur., closed Wed.

Two demonstration rooms.
Free local delivery and installation.
Repairs and Services

World Radio History

studio 99

79/81 Fairfax Road
Swiss Cottage
London NW6 4DY
071 624 8855/6
Mon-Fri 10-7 Sat 10-6

SURREY HIFI

SPECIALIST HI-FI OUTLET
DEMONSTRATION ROOM - PARKING

- QUAD • AUDIOLAB • REL • TUBE TECHNOLOGY •
- TDL • TANNOY • KEF • DENON • NAKAMICHI • THORENS •
- TARGET • MAGNUM • ROTEL • MARANTZ • MICHELL •
- SENNHEISER • BEYER HEADPHONES • JPW •
- SOUND ORGANISATION • SOUNDSTYLE TRIPODS •
- VAN DEN HUL CABLES • BOSE • MUSICAL FIDELITY • SEISMIC SINK •

'HOME CINEMA NOW ON DEMONSTRATION'

Just 2 minutes off Junc. 6 M25, (A25)

GODSTONE 0883 744755
45 High St., Godstone, Surrey RH9 8LS

Spaldings

ESTABLISHED IN SOUND

☎ 081-654 1231/2040

352/4 LOWER ADDISCOMBE RD.,
CROYDON, SURREY

HI-FI & COMPONENTS

84 Battersea Rise SW11 1EH

WHAT HI-FI?
BEST BUYS
in stock
as well as those hard to find
accessories and stylis

Established 29 years

Tel & Fax No:
071 - 223 1110

All major Cards accepted

SICKEST

DENON •
TANNOY • NAD •
ROTEL • BOSE •
DUAL • QED •
WHARFEDALE •
CELESTION •
KENWOOD •
ORTOFON •
INFINITY • SHURE

IC NAVELETTA FLEW

MIDLANDS

W. OWEN EST 1911

Audio/Video Specialists

Pioneer • Reference Point • Kenwood •
Sony • Akai • B&W
Free Installation and Home Delivery

58 Market Street, Oldengates
Telford, Shropshire
Tel: 0952 613818

13 Stratford Street
Newport, Shropshire
Tel: 0952 810876

STRATFORD HI FI LTD

AV AND LASER DISC IN STOCK

You can come and visit us at:
25 HENLEY STREET,
STRATFORD CV37 6QW

Contact Dirk or Jamie on:
Tel/fax No. 0789 414533
We are stockists of the leading
Hi-Fi brands including:

ARCAM, SONY, PANASONIC, NAKAMICHI, B&W, PIONEER, TECHNICS, DENON, NAD, KEF, MARANTZ, ROTEL, MUSICAL FIDELITY, MONITOR AUDIO, MISSION, TANNOY, QUAD, TDL & SENNHEISER, YAMAHA, CELESTION, ACOUSTIC RESEARCH, AUDIOQUEST, MONSTER, TARGET, BEYER, SYSTEMDEK.

2% Finance is available on selected products and all major credit cards accepted. We also have a Demonstration Room and Service Facilities.
Monday to Saturday 9.30-5.30. Late night Wednesday
"WHERE FRIENDLY SERVICE STILL COUNTS!"

Specialist Hi-Fi Dealers

MIDLANDS

MUSIC MATTERS

THE AUDIO SPECIALISTS

for the most exciting range of equipment available in the Midlands which includes:

Arcam, Aiwa, Alchemist, Alphason, Apollo, Arcam, Audiolab, Audioquest, Audio Innovations, Audio-Technica, Aura, Beyer, Cambridge Audio, Canon, Celestion, Chord, Cyrus, Deltec, Denon, Dual, Epos, Exposure, Heybrook, Impulse, Infinity, KEF, Luxman, Marantz, Meridian, Michell, Micromega, Mission, B+W, Mordaunt-Short, Michaelson Audio, Monitor Audio, Monster, Musical Fidelity, Nakamichi, NVA, Panasonic, Pink Triangle, Pro-Ac, Revox, Rogers, Roksan, Rotel, Royd, Ruark, Sansui, Sennheiser, Straitwire, Systemdek, Target, Technics, Thorens, Wharfedale, Yamaha etc.

OPENING TIMES:
Tues-Thurs 10.30-6.00
Friday 10.30-8.00
Saturday 10.00-5.00
Demonstration by Appointment

351 HAGLEY ROAD, EDGBASTON, BIRMINGHAM B17 80L
Tel: 021-429-2811

156/7 LOWER HIGH STREET STOURBRIDGE, WEST MIDLANDS OY8 1TS
Tel: 0384 444 184

INTEREST FREE
(for Ltd Period) APR 0%.
Written details on request.
Licensed Credit Broker.
Switch card accepted

THE MOST EXCLUSIVE INDEPENDENT HI-FI STUDIO

The internal atmosphere and easy access make it so much more exciting choosing your hi-fi from the finest audio products available.

Just off the High Street, Bloxwich, nr. Walsall, West Midlands.
(Ample free parking)
(OFF M6 JUNCTION 10)

TEL: (0922) 493499 - 473499

Open 6 days a week, Mon - Sat
All major Credit Cards accepted
Part Exchange enquiries welcome

ALBARRY • ACOUSTIC ENERGY • ARCAM • ART AUDIO • AUDIOLAB • AUDIO QUEST • B&W • BOSE • CABLE TALK • CHORD • CYRUS • DPA • DYNAUDIO • ENSEMBLE • EPOS • EXPOSURE • JPW • KEF • REFERENCE • MARANTZ • MERIDIAN • MICROMEGA • MISSION • MOTH • MUSICAL FIDELITY • NAKAMICHI • ORTOFON • PROSPECT • PROJECT • QUAD • ROKSAN • ROGERS • ROTEL • SONICLINK • SYSTEM DEK • TDL • THORENS • TRIANGLE • TOWNSEND • TUBE TECHNOLOGY • VAN DEN HULL • YBA •

CHRIS BROOKS AUDIO
SPECIALIST HI-FI DEALER

"We stock Linn Magik"
(see review this issue)

LINN • EXPOSURE • REGA • ROTEL • ROKSAN • ION SYSTEMS • ROYD • CREEK • AIWA • RAD-FORD • Q.E.D. • ETC.

WARRINGTON
29 GASKELL STREET, STOCKTON HEATH, WARRINGTON WA4 2UN
TEL 0925 261212

THE ULTIMATE IN SOUND ADVICE

EAST

The Audio File

27 HOCKERILL STREET, BISHOP'S STORTFORD, HERTS.
TEL: 0279 506576
2 FOUNDRY WALK, MARKET HILL, ST. IVES, CAMBS.
TEL: 0480 66123

THE ULTIMATE IN SOUND ADVICE

ARCAM, ROYDE, AUDIOTECH, CELESTION, APOLLO

MUSICAL APPROACH

Surround sound systems available for demonstration

STAFFORD WOODINGS YARD 0785 55154
ALDRIDGE 97 HIGH STREET 0922 57926

LINN, ROTEL, MARANTZ, HEYBROOK, TARGET

Single speaker demo rooms free expert installation

ignals

- audio innovation • fuller's audio • goldring • heybrook • impulse • jpw • lyra • michell • micromega • qed • soniclink • sumike • alphason • apollo • audioquest • ixos • projekt • soundstyle • sterling • townshend • • trichord • sugden • and many more

Monday to Saturday 10-6

MARTLESHAM HEATH • IPSWICH
(0473) 622 866

MIDLAND STUDIO

PHONE/FAX OR WRITE FOR OUR LATEST LIST OF EXDEMONSTRATION OR SECOND HAND EQUIPMENT FROM LEADING ESOTERIC MANUFACTURERS

MIDLANDS HI-FI STUDIO
WULFRUNA STREET
WOLVERHAMPTON WV1 1LX

TELEPHONE 0902 771774 FAX 0902 380083

CREATIVE AUDIO

9 DOGPOLE, SHREWSBURY, SHROPSHIRE
Tel: (0743) 241924
Closed Mondays

- Comfortable listening rooms
- Home demonstrations available
- Part exchange welcome
- Free home installation
- Interest Free credit

Authorised retailer for:
A & R ARCAM, AUDIO LAB, CELESTION, CYRUS, DENON, DUAL, MERIDIAN, MISSION, MONITOR AUDIO, QUAD, REVOLVER, ROKSAN, ROTEL, YAMAHA, EPOS, NAIM, KEF, RUARK

EIRE

Acoustic Dimension

AVI • ATC • AUDIO INNOVATIONS • ACOUSTIC ENERGY • MICROMEGA • AUDIO NOTE • LFD • REF 3A • IMPULSE • JPW • TDL PROJECT • PRO AC • TRIANGLE • RUARK • ROTEL • MARANTZ • DPA • APOLLO

Now ex demo equipment.
Credit card accepted.

THE STATE OF THE ART....

- EXPERT ADVICE
- CREDIT FACILITIES
- PART EXCHANGE WELCOME
- REPAIRS

Come and hear - NAD • B&W • NAKAMICHI • BOSE • QUAD • BEYER-DYNAMIC • SENNHEISER • AURA - and lots more in our listening room.

Tel. 0743 - 355166



AVON Hi-Fi Limited
12 Barker St. Shrewsbury
Plenty of parking - park and ride buses stop outside!

Peter Ellis Audio

A wide range of audio products always in stock including:- Quad, Denon, Stax, Marantz, Arcam, Creek, Sugden, QED, Castle, Rogers, Celestion, Tannoy, Nakamichi, Yamaha

- * Home Cinema available *
- * Demonstration Room *

29, Kirkgate, Newark, Nottinghamshire NG24 1AD
0636 704571

Advent, Albarray, AKG, Alphason, AMC, AR, Arcam, Audioquest, Audio Technica, Beyer, Bose, Castle, Chord, Denon, Dual, Goldring, Meridian, Michell, Monitor Audio, Nagaoka, Nakamichi, Ortofon, QED, Quad, Revox, Sennheiser, Sequence Design, Spondor, Target, TDK, TDL, Thorens, Wharfedale, K. Monks Record Clearing Service.

Five Ways Hi-Fidelity., (Est.1972)
12 Islington Row
Edgbaston, Birmingham B15 1LD
021-455 0667 (Closed Mondays)

We Never Compromise On Quality

CLONEY Audio

Meridian Arcam Classe Philips Rogers Epos B&W Naim Audio

55 Main St Blackrock Co Dublin
Tel 2889449/2888477 Fax 2834887
Open Tue/Sat 10AM-6PM. Thur/Fri 'till 9pm - Closed Monday

FRANK HARVEY

Hi-Fi EXCELLENCE

163 Spoon Street. Coventry. CV1 3BB Tel : 0203 525200.
Mon to Sat 9.30 till 5.30. Closed Thursday

MUCH MORE THAN HI-FI
WE ARE A BADA DEALER

Audiolab • Audio Alchemy • Arcam • Alphason • Bose • Bang & Olufsen • Celestion • Cyrus • Denon • Dual • Foundation • Kef • Marantz • Monitor Audio • Mission • Musical Fidelity • Nakamichi • Nad • Quad • Rega • Rogers • Rotel • Target • Tpod • Tannoy • Thorens • Van Den Hul • Yamaha

MAILORDER • EXPORT • HOME TRIALS

3 Floors. 3 Dem rooms. 3000 sq feet in the pursuit of Hi-Fi Excellence
World Radio History



Peter Dand & Company Ltd
Established 1963

Bang & Olufsen, Quad, KEF, Thorens, TEAC, and many more!
2 Demonstration Rooms
2 Year Guarantee

111 Clonskeagh Road, Dublin 6
Tel. 01035 31 269 4433

Specialist Hi-Fi Dealers

WEST & WALES

ENGLISH audio **3ADA**

CYRUS CENTRE
 PINK TRIANGLE-AUDION-SYSTEMDEK-HEYBROOK MICH-
 KEF REFERENCE MICROMEGA-NAKAMICHI-CHORD-ARCAM-
 MUSICAL FIDELITY-ROGERS-NAD-ROTEL-DENON-TANNOY-
 MARANTZ-MISSION-STAX-DUAL-TDL-ALBARRY-JPW-CELESTION-
 IXOS-SME-RUARK-MOTH-AUDIO TECHNICA-AND OTHERS
Free installations. Credit Facilities. Service Department.

M. S. 10 6
 95 W. ... 841 ... (0432) 355081

audio excellence

WHERE THE MUSIC MATTERS

Bristol **Cardiff**
 65 Park Street 134/6 crwys Road
 Bristol BS1 5PB Cardiff CF2 4NR
 (0272) 264975 (0222) 228565

Gloucester **Swansea**
 58 Bristol Road 9 High Street
 Gloucester GL1 5SD Swansea SA11LE
 (0452) 300046 (0792) 474608

TUESDAY - SATURDAY 9.00 - 5.30
CLOSED MONDAY

NORTH WALES

ACTON GATE AUDIO
 THE HI-FI CENTRE IN
WREXHAM

Aiwa, Albarr, Arcam, B&W, Canon, Celestion, Cyrus, Mastler,
 Marantz, Michell, Mission, NAD, Nakamichi, Quad, Radford, Rega,
 Rogers, Rotel, Huark, Spendor, Teac, Tannoy, Thorens,
 Wharfedale, Yamaha,
 "Yamaha cinema DSP club authorised dealer"

4 RUABSON ROAD, WREXHAM
 TEL. 0978 3645000

NORTH

ASTON AUDIO HI-FI SPECIALISTS

ARCAM • MERIDIAN • MISSION •
 CYRUS • AUDIOCAB • B & W •
 NAKAMICHI • AURA • DENON •
 QUAD • YAMAHA •
 KEF • MARANTZ •
 ROKSAN • NAD • MF • AIWA •
 DUAL • CELESTION • ROGERS •
 AUDIOQUEST • TECHNICS •

WEST STREET • ALDERLEY EDGE • PLUS HOME CINEMA •
 CHESHIRE • TEL 0625 582704 •
 INTEREST FREE CREDIT • DISCOUNT CD & TAPE • BADA •

THE HI-FI STUDIOS

HEYBROOK MONITOR AUDIO, ART AUDIO VALVES, DUAL,
 SUGDEN, ALPHASON, TDL, MICHELL, ACOUSTIC ENERGY, TEAC,
 A&R, AURA, ORIGIN LIVE, SYSTEMDECK, EPSILON, SHURE,
 AUDIO TECHNICA, GOLDRING, ALBARRY AND OTHERS FROM
 THE COMPANY THAT CARES FOR CUSTOMERS.
 DEMONSTRATION IN OUR LISTENING ROOMS OR AT HOME

SUNNYFIELD, DONCASTER
 Tel: (0302) 781387

AUDIO COUNSEL
 HI-FI SPECIALISTS

LINN, NAIM, REGA, ARCAM, ROTEL, ROYD,
 SHAHINIAN, DYNVECTOR, EPO, MARANTZ,
 NAKAMICHI, MICROMEGA and many more....
 "Time spent with staff may prove to be a particularly wise investment"

Audiophile
 12/14 Shaw Road, Oldham OL1 3LQ
 Tel. 061 633 2602

Cheshire Music
 Hi-fi systems for music lovers.

ATC Loudspeakers AVI Electronics.
 Clearly the best at any price.

For further details or a demonstration contact
 Roy Parrish on 061-439 0082

Retailers of Fine Audio Equipment

► EPOS
 ► ONIX
 ► DENON
 ► LINN
 ► AUDIO ALCHEMY
 ► ARCAM
 ► B&W
 ► NAKAMICHI
 ► ROYO
 ► TARGET
 ► TRIPOD
 ► LOUSY COFFEE

SUPERB OEMO FACILITIES

FULL INSTALLATION & HOME OEMO SERVICE

OPEN 6 DAYS A WEEK
 OTHER TIMES BY
 APPOINTMENT

0260 297544

1/1A Duke St Congleton Cheshire CW12 1AP

Swift
 THE HI-FI SPECIALISTS

ST ANN'S PARADE (ON A34) WILMSLOW, CHESHIRE
(0625) 526213

● 2 YEAR GUARANTEE ● EASY PARKING
 ● DEM ROOM ● PART EXCHANGE

Aiwa Audio Lab - Aura -
 B & W - Castle - Denon - Cyrus
 Celestion - JPW - Kenwood -
 Marantz - Mission - NAD -
 Pioneer - Rotel - Systemdek -
 Tannoy - Technics

Alan H. Goodrick Ltd
 Co. Durham's Premier Hi-Fi Dealer

★ Leading brands stocked -
 Technics, Marantz, Rotel, Kenwood,
 Denon, Mission, Mordaunt-Short
 ★ Demonstration Room Available
 ★ Our Own Qualified Service Dept.
 ★ Free Local Delivery & Installation

310-314 North Road,
 Darlington, Co Durham DL1 1EW
 Tel: 0325 - 465822

ACTION ACOUSTICS

Products Include: Acoustic Energy,
 Albarr, Croft, Denon, Harman Kardon,
 Michell, Pink Triangle, Revox, Rogers,
 TDL, Thorens etc.

Demonstration and Credit Facilities
 available

155-157 High St., Redcar, Cleveland.
 Tel: 0642 480723

REPAIRS/DIY

Chelmer Valve Company
 for
 Audio Valves

Buy CVC PREMIUM Hi-Fi valves direct from us. All valves
 processed for improved performance. We also have Stock
 of MAJOR BRAND types including: MULLARD, GEC,
 BRIMAR, RCA, GE, etc

130, New London Road, Chelmsford, Essex, CM2 0RG
 Tel: 0245 265865 Fax: 0245 490064

RATA
 Edge Bank House, Skelmergh, Kendal,
 Westmorland, LA8 9AS
 Telephone: 0539 823247

If you like the Hi-Fi equipment you have but want a better
 performance, don't change it

UPGRADE IT!

You can build better than you can buy and we offer kits,
 ports and instructions for anything from simple component
 upgrades to complete rebuilds plus kits to build high end
 equipment from scratch

New Upgrading Service.

If you are daunted at the prospect of taking the lid off your
 prized possession, send it to us and we can do the upgrade
 for you: We will advise on feasibility and cost before starting
 work and upgrade to the level of performance you require
 and can afford. We have a secure, low cost collection and
 delivery service within the UK.

Upgrades to: Audio Research, Celestion, KEF, Krell, Linn,
 Marantz, Meridian, Naim, Nytech,
 Pioneer, Quad, Leak, Radford, Rotel etc....

Send now for full details and a copy of our 1993 Audiophile
 Components Catalogue No. 2.
 To cover postage Europe 5 x IMCs, World 9 x IMCs, or
 quote your credit card number (Visa or Mastercard only).
 UK - free.

BANDOR
 MINIATURE LOUSPEAKERS
 DESIGNED AND MANUFACTURED BY MINIATURE
 LOUSPEAKERS AND SYSTEMS

Drive Units - 2" module with 1.3gms. mms. + 6" 8"
 & 15" ALUMINIUM CONED DRIVERS. Flat pack
 TRANSMISSION LINE KIT and NEW BANDORA -
 MORA semi-active complete loudspeaker system.

Free technical sheets etc.
 11 Penfold Cottages, Penfold Lane,
 Holmer Green, Buck. HP15 6XR
 (0494) 714058

**LOOKING FOR REAL HI-FI or HOME
 CINEMA IN SWINDON**

Audio Technica, Acoustic Energy, Audio Innovations (valve Amp), Beard
 (Valve Amp), Cerwin Vega, Impulse, Red/Acoustics, and many more....
 We also stock quality ex-demonstration and secondhand hi-fi
 Quality car Audio, new, used and secondhand, also available Repair and
 refurbishment classic equipment.

52 Audio Exchange 52

52 Morse St., Swindon Tel. 539008
 (Off Commercial Road, Swindon) Open 10am - 6pm, Mon - sat

VINTAGE AND VALVE HI-FI

Haden Boardman buys, sells, modifies & repairs all vintage hi-fi equipment.

Always quality hi-fi available, new and secondhand
 Advice is free, phone if just for a chat. Credit cards
 accepted. New equipment by Croft, E.A.R., Richard Allen
 + more coming soon!
 Quick worldwide delivery, callers by appointment
 Sorry but we are unable to answer queries in writing

GARRARD 301/401 Audio Classics 8 Lowe Mill Lane,
 IN STOCK Tel: (0942) 57525 Hindley,
 7 days a week Fax: (0942) 525861 Lancs WN2 3AF

Lockwood Audio
 Tel: 081-207 4472 Fax: 081-207 5283

**WE BUY AND SELL
 NEW, USED AND VINTAGE
 SPEAKERS, DRIVERS, CABINETS, PARTS.**

**SPEAKER REPAIRS
 THE
 Authorised TANNÖY Specialist**

MAJOR CREDIT CARDS WELCOME
IMPERIAL STUDIOS,
MAXWELL ROAD,
BOREHAMWOOD, HERTS. WD6 1WE

Audio Solutions Limited

Manufacturers of amplifiers and speaker system
 with Differential Error Correction, the only
 amplifiers with virtually zero distortion and no
 output DC offset. Send for information Installation
 & Maintenance of Hi-Fi equipment. Acoustic measurement and design
 of listening environments. Recording studio design and installation. Sole
 concessionaries of service and spares for 3M professional recording
 equipment Contact: Clive Kavan

Phone +44 (0)81 998 8127, (0)860 519 748,
 or Fax +44 (0)81 997 0608
 9b, Ashbourne Parade, Hanger Lane, Ealing,
 London, W5 3QS.

Specialist Hi-Fi Dealers

SOVTEK VALVES

6550WA. 6L6WGC/5881. 6L34G.
12AX7WB/7025. 6F86/6267

Over 1000 different types of valves stocked S.A.E. for list
DEPT. HFV

Wilson Valves, 28 Banks Ave, Golcar,
Huddersfield, West Yorks, HD7 4LZ
Tel: 0484 654650/420774 Fax: 0484 655699

Mail order only, Visa etc.

SOUNDS AROUND

Professional Service Repairs
and Accessories
Agent for Golden Dragon Valves

146 Clarendon Park Road, Leicester
Telephone : 0533 702442

AERIALS

ANDY'S AERIALS

• TV & FM AERIALS SUPPLIED & INSTALLED
• MULTIPOINT SYSTEMS REPAIRS
• DIY SALES FULLY INSURED COMPETITIVE PRICES
• ALL WORK GUARANTEED FREE SITE SURVEYS

7 DAY SERVICE Areas Covered

HARROW, RUISLIP, NORTHWOOD, EALING, ACTON, HAYES,
SOUTHALL, HEATHROW etc

CALL US FOR A PROFESSIONAL & RELIABLE SERVICE

061864 4890 OR 0660 830283

SHOWROOM AT: 345c NORTHOLT RD., (OPP SAINSBURY'S)
SOUTH HARROW, MIDDXX. OPEN 9am-5.30 MON-SAT

OVERSEAS

Sum of the parts.

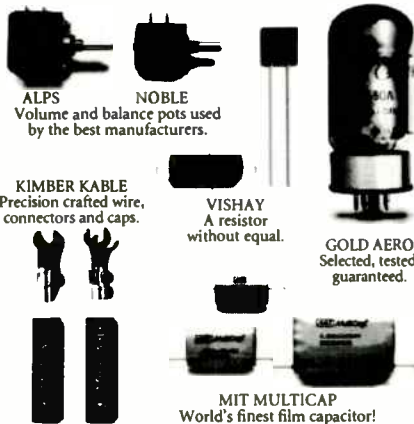

ALPS
Volume and balance pots used
by the best manufacturers.

NOBLE

KIMBER KABLE
Precision crafted wire,
connectors and caps.

VISHAY
A resistor
without equal.

GOLD AERO
Selected, tested,
guaranteed.

MIT MULTICAP
World's finest film capacitor!

The very best in audio grade parts,
upgrade/mod kits and complete kit products.
Call, write or fax for our catalogue.

SONIC FRONTIERS
INCORPORATED

2790 Brighton Road, Oakville, Ontario, Canada L6H 5T4
Telephone (905) 847-3245 - Fax (905) 847-5471

MIT MultiCap • Wonder Cap • Kimber Kap • Solen • Siemens
Hovland MusiCap • Wima • Holco • Draloric • Vishay • Caddock
Mills • Matsushita • Noble • Kimber Kable • Cardas • Discovery
Audioquest • Alps • Bourns • Shalco Attenuators • Electroswitch
Elma • CTS • Elna • Nichicon • Gold Aero • RAM • N.O.S. Tubes
Linear Technology • Burr Brown • Analog Devices/PMI • Motorola
Edison Price • Pearl • Tube Sockets • WBT • Neutrik • Kits

SCOTLAND

RIVERSIDE AUDIO

South West Scotland Tel: 0475 631 066
Argyll and Bute Tel: 0700 504845

The mystique of valve amplification demonstrated in the
comfort of your own home. Art Audio, Concordant
Valve Amplification, Atacama Audio Supports, J.P.W.
Speaker Systems, Fullers Audio Loudspeakers.

ANCURUM ELECTRONICS

YOUR LOCAL HI-FI SHOP

PIONEER, TECHNICS, PROLOGIC AMPS + LASER
DISC FOR HOME ENTERTAINMENT
TEL: (0382) 480030
39 GRAY ST., BROUGHTY FERRY DUNDEE

SERVICES & CONSULTATIONS

R. J. F. 84 Pendarves Street,
Tuckingmill, Camborne.
Cornwall TR14 8NJ
Tel: (0209) 710777

Dealers for: Albarr Audio Technica B&W Breyer, Cerwin Vega,
Denon, Dynavector, Exposure, Foundation Audio, Goldring, Harman
Kardon, JBL, Marantz, Michell, Micromega, Musical Fidelity, Nakamichi,
Ortofon, Perception, Pink Triangle, Project, QED, Sansui, SD Acoustics,
Sharp, SME, Tannoy, Target, TDL, Technics, Townshend, plus more!
Much second hand equipment available plus repairs to all brands



MUSIC ETC...

QUANTUM AUDIO IMPORTED LPs & CDs

Discover the recording reviewers & manufacturers use for their
standard references.
Listen to high definition compatible digital. Hear awesome & historic
performances, premier recordings, classics, opera, jazz and much more:
on: Athena, DCC, Fono, Klavier, Mark, Origaku, Reference recordings,
Sheffield Lab, VTL & Wilson.
These CDs & LPs are available from good hi-fi & record dealers in the
event of difficulty or for literature & prices call
Quantum Audio Ltd, P.O. Box 26, Kilmarnock KA3 7JA
Tel: (0563) 71122 Fax: (0563) 71133

STAFFS & DERBY

HOW TO SAVE £100 ON YOUR HI-FI

Choosing the right Hi-Fi and saving money is a difficult
task, make it easy on yourself.

To get your copy of "Guide to Buying Hi-Fi"
just telephone

FREEPHONE 0800 373039

We will send you one Free of Charge together with our
Fact Pack and see how you can save £100 on
recommended Hi-Fi Systems.

Active Audio

12 Osmaston Rd. 29 Market Street, 95 Stafford Street,
The Spot, Tamworth Hanley,
Derby Staffs, Stoke-on-Trent.
Tel: 0332 380385 Tel: (0827) 53355 Tel: 0782 214994

CLEAR SOUND

* HIGH END HI-FI EQUIPMENT SERVICED OR REPAIRED *
* VINTAGE & MODERN VALVE EQUIPMENT A SPECIALITY *
* QUAD AND LEAK VALVE TUNERS SERVICED & ALIGNED *
* KIT BUILDING SERVICE *
* VERY COMPETITIVE PRICES AND OVER 25 YEARS
EXPERIENCE *

ALSO DEALER FOR ATC, AVI, AUDIOLAB, AMESON COOPER,
GROOVE TUBES, SPENDOR AND KLIPSCH

**SPECIAL OFFER. ONE PAIR ONLY ATC SCM100A PIANO
BLACK 3750 NEW BOXED AND 6 YEARS WARRANTY**

PHONE RHYL (0745) 343 060 AFTER 6PM WEEKDAYS OR
AFTER 12 NOON AT WEEKENDS

WANTED URGENTLY

QUAD FM2 8FM3 & QUAD 11 VALVE POWER AMPS ALSO
LEAK THROUGHLINE 3 (STEREO) TUNERS AND STEREO 20
POWER AMPS
EQUIPMENT DOESN'T HAVE TO BE WORKING BUT MUST BE
ORIGINAL AND COMPLETE

L.G.S. AUDIO SERVICES.

Quality Audio Equipment and Hi-Fi Systems
Repaired and Serviced at Reasonable Cost
2nd Floor, Forest Mills, 133 Alfreton Road,
Radford, Nottingham NG7 3JL

Tel: 244443

HI-FI WORLD SPECIALIST DEALER DIRECTORY ORDER

**BOOK 12 MONTHS FOR A 30% DISCOUNT!!
OR 6 MONTHS FOR A 20% DISCOUNT.**

I wish to be included in Hi-Fi World's Specialist Dealer
Directory starting the _____ issue for a total
of _____ insertions.

Please find enclosed my artwork/copy details.
I wish to book _____ column centimetres at £12.50 per
col. Cm.

Name _____

Company _____

Address _____

Postcode _____ Telephone No. _____

Please return to Caroline Knott,
Hi-Fi World,
64 Castellain Road,
London W9 1EX

WORLD DESIGNS

by Mail Order

world audio design mail order

K5881 KIT

£395 ▼



Here's a superb, Class A, 20watt stereo power amplifier that uses the inexpensive Russian 5881 output valve, a military version of the regarded American 6L6, designed for low distortion audio work. It has super-quality output transformers (4/8/16Ω selected internally) to minimise distortion and the input stage uses triode working. A rugged, sixteen-gauge, all-welded steel chassis is provided, together with protective bottom plate for safety.

Designed for long life, low running costs and excellent sound quality, K5881 is sensitive enough to be used with a simple passive pre-amp. or our own line-drive pre-amp, and it matches modern loudspeakers well. There is a choke-regulated power supply and the channels can be paralleled to turn it into a 40W monoblock if desired.

K5881 costs just £395 as a kit of parts and £595 fully built from our own build service. The U.K./Europe version has a 240/220V transformer but 120/110V can be supplied as an alternative - see Overseas details on Order Form.

SPECIFICATION

Power	20watts/ch.
Frequency response	16Hz-40kHz
Distortion	0.02%
Separation	60dB
Noise (CCIR)	-103dB
Sensitivity	240mV
Dimensions (mm)	400w,300d,180h
Supply	110/120V or 220/240V, 220W
Weight	16kgs(34lbs)

VALVE LINE LEVEL PRE-AMPLIFIER

£295 ►

Constructed from heavy gauge steel with an aluminium anodised and polished front panel. This new chassis comes with the complete kit of parts necessary to build the valve line level pre-amp.

The components are all high quality and include a special screened toroidal transformer, Military Spec. Russian valves, Alps potentiometer, metal film resistors, polypropylene signal capacitors, silver plated copper wire etc.



◀ HIGH DEFINITION LOUDSPEAKER

£295

The High Definition loudspeaker is ideal for low power, high quality amplifiers, transistor or valve. It goes very loud with just 1-5watts, having an enormous sensitivity of 94dB - that's 8dB more than most other speakers. It is also a very easy load for valve amps (8ohms) and it gives a terrifically dynamic and fast sound. This speaker is also unusually suited to low powered vintage amplifiers, such as Quad IIs, Radfords, Pye Mozarts and such like.

The High Definition loudspeaker is available in two forms; as a drive unit pack containing two bass units and two tweeters modified and tested, or complete with all crossover components, gold plated bi-wire terminal dishes, silver plated copper wiring and long haired wool.

KLS2 LOUDSPEAKER

Drive Unit & Crossover kit etc	£195
Drive Unit Pack	£145

See page 83 for order form...

WORLD DESIGNS

by Mail Order

300B VALVE AMP KIT

£750 ▼



This is a specialised amplifier based on the highly linear 300B triode valve. Our 300B runs in Class A, giving one of the most sweet, open and neutral sounds possible today. Matched with good loudspeakers, it is unsurpassed.

The kit comprises a strong 16-gauge mild steel chassis, fully

punched, welded and ground smooth. Finish is a durable 'powder coat' black. A protective bottom plate is provided for safety. Output terminals (one pair) take 4mm plugs axially and radially for bi-wiring, or heavy gauge bare cable. Output options of 4/8/16Ω are selected internally at the transformer. A small circuit board carries most of the components. 240/220V and 110/120V versions available. Can be monoblocked for 60watts.

All parts are included in the kit, except valves since different 300B makes are available.

A fully built version from an approved build service is also available.

SPECIFICATION

Power	28watts
Frequency response	5Hz-36kHz
Distortion	0.2%
Separation	54dB
Noise (hiss/hum)	-100dB/-72dB
Sensitivity	240mV
Dimensions (mm)	405w,295d,175h
Supply	110/120V or 220/240V, 220W
Weight	20kgs(44lbs)

4W SINGLE-ENDED VALVE AMP KIT

£385 ▼



The 4W Single-Ended amplifier kit is a line level integrated amplifier. It comes with three line level inputs and a tape output. High quality components are used throughout, including polypropylene signal capacitors, Alps volume control, custom C&K gold plated selector switch etc. Valves are included.

SPECIFICATION

Power	4watts	Noise (hiss)	-100dB
Freq. Response	9Hz-64kHz	(hum)	0.7mV
Distortion	1.3%	Sensitivity	180mV
Separation	74dB		

DEMONSTRATIONS!!

By the time you read this we hope to have our K588I 20W valve power amplifier, KLP-1 valve pre-amplifier and 4W single-ended on demonstration at Hi-Fi Confidential, 34 Buckingham Palace Road, Victoria, London. Phone the patient and understanding Luigi on 071-233-0774 to check availability. He's a valve afficianado, knows Tim de Paravicini and is still sane, and stocks plenty of good products - including World Audio Design.

4W SINGLE-ENDED TRANSFORMERS

£190

A set of transformers (8kgs) for our single-ended amplifier (December '93. Supplement No 6).

- 1) Mains (1 off) Secondary: 0-210V a.c. at 150mA, 6.3V centre tapped. Primary: 220/240V or 110/120V - please state which on order form. Drop through fixing.
- 2) Output (2 off) High quality transformers with grain orientated silicon steel laminations. Secondary tapped 4/8/16Ω. Drop through fixing.
- 3) Choke (1 off) Compact 1.2H/150mA choke for under-chassis fixing. Frame mount.

6080 valves - double-triode power valve for the single-ended amplifier - **£15.00**

K588I (20W CLASS A) TRANSFORMERS

£220

There are four transformers in all, weighing 12kgs.

- 1) Mains (1 off) Secondary: 0-360, 1 x 6.3V centre tapped. Primary 220/240 or 110/120 - please state which on order form. Drop through fixing.
- 2) Output (2 off) These transformers use high quality materials, laminations of thin and best quality grain orientated silicon steel. Output tapped 4Ω, 8Ω and 16Ω. Drop through fixing.
- 3) Choke For smoothing of the H.T. line to provide best sound quality, a 5H choke that fixes under the chassis. Frame mounting.

300B (28W CLASS A) TRANSFORMERS

£430

Seven transformers in all, weighing 16kgs (35lbs)

- 1) Mains (1 off) Secondary: 230V-0-230V, 5 x 5V, 1 x 6.3V. Primary 220/240 or 110/120 - please state which on order form. Drop through fixing.
- 2) Output (2 off) Designed for low distortion and broad load compatibility from the 300B. Cores with centre-hole fixing to avoid corner flux concentrations; laminations of grain orientated silicon steel. Output tapped 4/8/16Ω. Drop through fixing.
- 3) Intervolve/phase splitter (2 off) frame mounting.
- 4) Chokes (2 off) For smoothing of the H.T. lines, two 3H chokes that fix under the chassis. Frame mounting.

Meet-Your-Maker

A reference guide to Britain's Manufacturers and Distributors.

ACOUSTIC ENERGY, 3a Alexandra Road, London W13 0NP. Tel. 081 840 6305. Acoustic Energy manufacture the award winning Reference Series AE1 and AE2 loudspeakers and the new Aegis Series Model 1, all of which feature the unique AE metal cone drive units. The AE distribution division offers superb high end products from WADIA, GRYPHON, ENSEMBLE and TARA LABS.

ALCHEMIST PRODUCTS, 4 Rosebury Mews, London N10 2LG. Call us for a list of our dealers in many areas including:- London, Kent, Hampshire, Wilts, Milton Keynes and N. Ireland and for product information on the Kraken, Freya, Bragi, Odin, Genesis and more.

ALEMA UK LTD., 25 Montifore Road, Hove, BN3 1RD. Tel. 0273 202637. Audion * Edison * Andersson * (Trade enquiries welcome for our newly extended range).

APPOLLO, The UK based designers and manufacturers of high quality speaker stands and equipment racks have now added to their comprehensive range a modular system ideal for housing audio visual products and CD storage. Please send for our free brochure to Zenith Crown Ltd, Tipton Rd, Dudley, West Midlands, DY14 Tel. 021 520 5070. Fax. 021 522 2055. - All export trade enquiries welcome.

ARCAM, Pembroke Ave, Denny Industrial Centre, Waterbeach, Cambridge, CB5 9PB. Tel. 0223 440964 or Fax. 0223 863384. Manufacturers of the Delta 290 Amplifier and the Delta 280 Digital FM Tuner. The two together produce a sound that has been described as "subtle and intriguing" and that provide "real clout" - discover this for yourself. For information on not only these products but also the Arcam CD Players, Speakers, Cassette Decks etc., 'Phone or write in to request a brochure - The pleasure is all yours!

AUDIONOTE CO, Unit 1, Block C, Hove Business Ctr. Fonthill Road, Hove BN3 6HA. Tel. 0273 220511. Audionote supply a range of very high quality and very expensive audiophile components including valve output transformers.

AUDIO SYNTHESIS, 99 Lapwing Lane, Manchester, M20 0UT. Tel. 061 434 0126. Audiophile design, development and distribution. Please contact us for details of: PASSION the passive controller everyone's talking about. SILVERBLUE pure silver interconnect cable and the ultra analog based dac - DSM.

AVONDALE AUDIO, Tel: 0246 200096. Exploit the full potential (and more) of the Linn LP12 Turntable for only #568.00 inc. (Cost much less than a Lingo) with Avondale's very naughty but STUNNING convertor. For a chat...the above number, please.

BANDOR, Studio II, Penfold Cottages, Penfold Lane, Holmer Green, Bucks. HP5 6XR. Tel. 0494 714058. Aluminium anodised cone drivers with only 1.8 gm moving mass giving full detail to sound covering 2/3 of the frequency spectrum.

BANDRIDGE LTD are the premier suppliers of quality audio and video leads, connectors and speaker cables in the UK. In addition to probably the widest range available, including PROFI GOLD, SUPER GOLD and SUPER +, offering a level of quality that meets the needs of the most exacting specification. Bandridge of London Ltd, Premier House, Deer Park Road, Wimbledon SW19 0N1 543 3633.

CABLE TALK PO Box 413, Woking, Surrey, GU22 8YZ. Telephone 0483 750667. Fax 0344 360866. Designers and manufacturers of British made high quality, value for money, interconnect and speaker cables. Phone or fax for a free full colour brochure on our What Hi-Fi? 5 star rated products.

CAMPAIGN AUDIO DESIGN, Llandudno Road, Cardiff CF3 8PG. Tel. 0222 779 401. Supplies / manufacturers mailorder, high purity silver interconnects, loudspeaker cables, internal wires and bespoke mains cables. Generous two week trial period.

CHORD ELECTRONICS, 3 Bower Mount Road, Maidstone, Kent. Tel. 0622 764874. Audition the Chord SPM 1200 at any of the following branches: Doug Brady Hifi - Liverpool/Leeds/London/Cheshire, Audio Reflections - Leeds, Music Matters - West Midlands and many others. Please call us for details.

CONCORDANT PREMIER TUBE, 14 Glyn Close, Barwell, Leicester, LE9 8GL. Tel. 0455 843752. The Excelsior - Designed for the analogue enthusiast. The Exhilarant - Designed for the line enthusiast. The Exquisite - Designed for the analogue and line enthusiast.

The Exhilarant Power Amp fitted to Quad II Hardware.
DBS AUDIO, PO Box 91, Bury St. Edmunds, Suffolk, IP1 0NF. Tel: 0284 828926. Fax: 0284 828026. The DBS6 loudspeaker kit, as designed by Dave Berriman

and featured in Hi-Fi News Feb/Mar 92, is still available - only from DBS Audio. To find out what these comprise, cost and how to order plus any other information on DBS products please telephone, fax or write in to the above address and numbers.

DPA DIGITAL, Unit 7, Willowbrook Technical Units, Crickhowell Road, St Mellons, Cardiff, CF3 6EF. Why do reviewers across the world rave about DPA products? Listen to DPA's DACs, transports, amplifiers and cables and discover for yourself.

IAN EDWARDS, The Old Chapel, 282 Skipton Road, Harrogate, Yorks. Tel. 0423 500442. Somebody Somewhere must make better storage units for CDs, Music, LPs, HiFi, Books, etc. than Ian Edwards. BUT until he appears, why not send for the brochure showing a selection of HAND MADE units. To do this please send 3 x 2nd class stamps.

E J JORDAN DESIGNS, The Oak, Manor Bier, nr Tenby, S Pembrokeshire, SA70 8QR. Tel. 0834 871 209. or Fax. 0834 871 770. Curvilinear metal cones loud speakers were first developed by Ted Jordan in 1963.

EJ Jordan Designs are now World leaders in foil cone technology. First and foremost.

ELECTROMAIL, PO Box 33, Corby, Northants, NN17 9EL. Tel. 0536 204 555. The branch of the well known R.S. Components trade mail-order business that deals with the public. They have a huge range of components - and catalogues to match.

EMF, 2a Bellevue Road, Friem, Barnet, N11 3ES. Tel. 081 361 6734. Manufacturer of Sagem 50w integrated amplifier and the Crystal D2A converter. Please write in for details.

FALCON ACOUSTICS LTD., Tabor House, Norwich Road, Mulbarton, Norwich, Norfolk, NR14 8JT. Tel. (0508) 78272. U.K. distributors of FOCAL drive units and SOLEN (chateauroux) polypropylene capacitors and the largest inductor manufacturer in the U.K. Comprehensive range of DIY Speaker Parts and Kits, Sub-Bass and Electronic Filters.

"Everything but the wood"
FARADAY SOUND, 248 Hall Road, Norwich, NR1 2PW. Tel. 0603 762967. Loudspeakers in CONCRETE: the ultimate enclosure. Now you can build your own low density concrete cabinet enclosure Faraday FS1, Siren, FS5, FS10 or a design of your own choice. Stunning sound and reviews. Simple DIY skills only. Full instructions including cabinet construction for only £10. Includes reviews, photos etc. and at least £10 discount off any further products purchased from us e.g. ready made cabinets. Also £25-£150 off any complete loudspeakers!!!

FOUNDATION AUDIO, 53 Beecroft Way, Dunstable, Beds. LU6 1EE. Tel. 0582 477550 or Fax. 0582 604001. We have long been acknowledged as the market leader in sonically superior stands and major in 'specials'. Send for our brochure and details of your nearest stockists.

FULLERS AUDIO, 20 Tunbridge Road, Southend on Sea, Essex SS2 6L. Tel. 0702 612116. Fuller's Audio produce a range of loudspeakers priced from £329 to £2499 and a complementary Pre and Power amp combination (electronic)
GRANITE AUDIO STANDS - The ultimate solution to problems of resonance and tonal accuracy. For 'bespoke' designs consult NORLSTONE, West Dean Road, West Thyerley, Salisbury. SP5 1QG. Tel. 0980 862253.

J E SUGDEN & CO LTD., Valley Works, Station Lane, Heckmondwike, West Yorkshire, WF16 0NF. Tel. 0924 404088. Manufacturers of hand crafted audio products. "A world of Music". Call or write in for information on our SDA-1 Digital to Analogue Converter, SDT-1 CD Player, A21a Class 'A' Amplifier, A25B Integrated Amplifier, A48 Integrated Amplifier, Au51c Pre Amplifier, Au51p Power Amplifier and more.

JORDAN WATTS ACOUSTICS LTD. Cyntra Place, 201 Mare Street, Hackney, London E8 3QE. Tel. 081 985 1646. Jordan Watts Acoustics for Sight AND Sound.
KEWICK AUDIO RESEARCH, 54 Coach Road, Outwood, Wakefield, W Yorks, WF1 3EX. Tel/Fax 0924 870606. "I'd say that the Figaro is the best miniature speaker I have heard" Audiophile March 1993. Write in or call for details on our full product range and your nearest stockist.

KRONOS DISTRIBUTION, 35 Farlough Road, Dungannon, N. Ireland. BT714 DU. Tel: 0868 748632. Fax: 0868 448281. Kronos is the UK distributor of some of the finest Hi Fi products in Europe. These include Audiomeca digital products and turntables; Lieder speaker pre and interconnect cables; Project turn-tables and amplifiers; Triangle speakers and

electronics; and YBA amplifiers. We also handle Frameworks equipment tables; Arion valve amplifiers and mains filters and Essex Audio digital products from the UK. Please telephone or write for product details and dealer lists.

LANGREX SUPPLIES LTD, 1, Mayo Road, Croyden, Surrey. CR0 2OP. Tel: 081 684 1166. Fax: 081 684 3056. We are one of the largest stockists and distributors of electronic valves, tubes and semiconductors in the UK. Over 6,000 types in stock. We specialise in obsolete types including original UK and USA made audio valves. Telephone or fax for an immediate quotation.

LECSDN SYSTEMS LTD., Unit 19, Nuffield Rd. Ind. Est., St. Ives, Huntingdon, Cambs, PE17 4LD. Tel: 0480 498211. Call for info on our range of integrated and four channel integrated bi-amplifiers. Stereoplus, Quattra and Quattraplus analogue and digital interconnects and loudspeaker cables. As a compliment to the LFD range of accessories GOLD plated mains 13A plugs and sockets now available.

LYNWOOD AUDIO, Imperial Studios, Maxwell Road, Borehamwood, Herts, WD6 1WE. Tel. 081 207 4472/
LODICRAFT AUDIO, 4 Big Lane, Goose Green, Lambourn, Berks. RG16 7SQ. Tel. 0488 72267.

Specialist restoration of 301's and 401's using genuine spares and re-manufactured parts to original pristine standards in our newly built work shops designed primarily for these purposes.

LYNWOOD ELECTRONICS, Coley Lane Farm, Wenthworth, Rotherham, S62 7SQ. Tel. 0709 873667. Lynwood Electronics is famous for manufacturing the only range of audio mains cleaners that really work. A complete range is now available to suit every system and every pocket.

MARANTZ HIFI UK LTD., Kingsbridge House, Padbury Oaks, 575-583, Bath Road, Longford, Middlesex UB7 0EH. Tel. 0753 680868 or Fax. 0753 680428. Marantz is a manufacturer of Hi-Fi separate components, including CD, DCC, cassette decks, amplifiers, tuners, receivers and speakers. Also now active in Home Cinema with Pro-Logic amplifiers and receivers, plus Nizam VCR and video projector.

MAY AUDIO MARKETING U.K. LTD. 83 Main Street, Burley in Wharfedale, North Yorkshire. LS21 7BU. Tel: 0943 864930. Distributors of High Quality audio products from Duson Electronics, Totem Loudspeakers, Jeklin Float Headphones and quality recordings from Proprius, Prophone, Opus, MAP and Swedish Society. IF ITS MUSIC YOU LOVE, TELEPHONE OR WRITE FOR LITERATURE.

MICHELL, 2 Theobold Street, Boreham Wood, Herts, WD6 4SE. For full information on our full range of excellent products including the Gyrodec, Alecto, Iso, Argo and others please telephone us on 081 953 0771. Michell - Symbol of Precision

PEAR AUDIO, 3 Northumberland Mews, Alnmouth, Northumberland, NE66 2RS. Tel. 0665 830862. A wide range of products including Shahinian Loud Speakers - Super ells, ARCs, Obelisks, Hawks and Diapasons. Dynavector amps and cartridges and Bedini amongst others.

PERFECT PITCH MUSIC, Hanworth Trading Estate, Hampton Road West, Feltham, Middlesex, TW13 6DH. Tel: 081 893 8662. Fax: 081 893 4318.

We manufacture the Franciscan CD enhancement system, The Dacula DAC and Perfect Digital and Analogue interconnects. Perfect Pitch also provide freelance design, manufacture, prototyping and test, also valve and solidstate specials. Trade enquiries welcome.

QUANTUM AUDIO LTD. PO Box 26, Kilmarnock, Ayrshire, Scotland, KA1 1BA. Tel. 0563 71122. Audiophile CD's & LP's. The UK's largest specialist: FONE, REFERENCE RECORDINGS, SHEFFIELD LAB, WILSON AUDIO, KLAVER 7 V.T.L. etc. Write or phone for full listings and prices.

REL ACOUSTICS, Unit 2, New Street, Bridgend Ind Est. Bridgend, Mid Glamorgan, CF31 3UD. UK. Tel. 0656 768 777, international +44 656 768 777. Fax. 0656 766 093, international. +44 656 766 093. The UK's only specialist sub-bass speaker manufacturer. "The only one that works". Get your dealer to give you a home demo and find out what the fuss is all about.

RICHARD ALLAN AUDIO, Bradford Road, Gomersal, Cleckheaton, W Yorks. BD19 4AZ. Tel. 0274 872442. Fax 0274 869935. Manufacturers of very high quality loudspeaker enclosures and drive units. Examples being the £270 RA8 series 2 as supplied to the BBC and the 5" reviewed Minette 2 at £120.

SAMBELL ENGINEERING LTD. Winston Avenue, Croft, Leicestershire, LE9 6GQ. Tel 0455 283251.
ATACAMA AUDIO SUPPORTS from Sambell

Engineering Ltd. We are the sole manufacturers of the 'SE' range of speaker stands, consisting of an 8", 12", 16", 20" and the award winning 24" high stand. Also three specialist models for the Tannoy 'sixes' Loudspeakers.

SEQUENCE DESIGN LTD. 24 Brook Street, Mayfair, London W1Y 1AE. Tel. 071 495 0775. Fax 071 495 0281. Slim loudspeakers which stand close to a wall or hang like pictures. "Likely to cause a glint in the audiophile's eye" (Audiophile); "the answer to a prayer....a bargain in the extreme" (HiFi News). Available with light or dark grilles and various solid wood finishes. From £199.95 a pair. Call or write in for an information kit and reviews re-prints.

SHEARNE AUDIO, PO Box 22, Stevenage, Herts, SG2 8HF. Tel. 0438740953. Following the success of John Shearn's Phase 1 pre power combination, reviewed in an earlier issue of HFW, newly launched John Shearn's Phase 2 integrated amp with many of the design features of the Phase 1. R.R.P. £495, 50 wpc & same finish as Phase 1 pre power also option of phono stage for Phase 2 £95.

SLATE AUDIO, makers of 'THE FINEST SPEAKER SUPPORTS IN THE WORLD' have never had a bad review, our reputation is legendary. Contact us now for details on our CUSTOM STANDS, as well as our solid marble GARRARD 301/401 PLINTH SYSTEM (Hi-Fi World Dec 93) THE GLASSMAT platter mat and the very special SME GARRARD 401 CELEBRATION ARMS. 47 Gemini Close, Leighton Buzzard, Bedfordshire, LU7 8UD. Tel: 02525 384174.

THE SPEAKER COMPANY, Unit 9, Waterside Mill, Waterside, Macclesfield, Cheshire, SK11 7HG. Tel. 0625 500507. The Speaker Company are a new company offering a wide range of loud speaker units from Audax, Celestion, KEF, Morel SEAS and many more. Also a wide range of speaker accessories the keen builders.

THE TDI GROUP, Unit 1 Summerlea Court, Alton Road, Herriard, BASINGSTOKE, Hampshire. RG25 2PN. Tel: 0256 381 514. Fax : 0256 381 692. Electronic Components distributors specialising in: Mains Power Connectors, Jack Plugs and Sockets, 4mm Connectors, Din and Mini Din Connectors, Phono Connectors, DC Connectors, XLR Connectors, Rotary Potentiometers, D Type and IDC Type Connectors, Co Axial and BNC Connectors, Switches, LEDs, Diodes, Bridges and Rectifiers, Fuses and Thermal Tips. - Have you got one of our new 1994 General Product Catalogues?

TARGET AUDIO PRODUCTS PLC, Britannia House, Leagrave Road, Luton, LU3 1RJ. The Audio equipment, rack and speaker stand specialist. For information on our products please telephone or write. **TRICHRD RESEARCH LIMITED** Following on from the highly acclaimed CO clock oscillator modifications the Pulsar Series One digital to analogue converter. This unique design is part multibit and part bitstream to give absolute linearity over an extremely wide dynamic range. Switchable between 18 or 20 bit resolution this converter will become the standard for CD replay. For details telephone (0684)573524

WOLLATON AUDIO, 134 Parkside, Wollaton, Notts, NG8 2NP. Tel/Fax. 0602 284147. Trying to bring imported high end down in price with Wollaton is the UK distributor of the following products: XLO interconnects and loudspeaker cables - "The best in the world". Clements loudspeakers; ribbons and/or moving coil drive units in outstanding value loudspeaker systems. Monarchy Digital: transports and converters (including the model 33 D to A with built in high quality preamp) to match the best at a fraction of the price.

WILMSLOW AUDIO LTD. Wellington Close, Parkgate Trading Est. Knutsford, Cheshire, WA16 8DX. Tel. 0565 650605. Extensive range of drive units and over 30 different designs of self-assembly kits. Everything required for the loudspeaker builder and four dem rooms to listen to the kits in built-up form.

To Advertise in this section, please contact Caroline Knott on: 071 266 0969

Peter Herring

**Magical Mozart, delightful
Dvorák, romantic
Rachmaninov, memorable
Martinu and, if that wasn't
enough to whet the appetite,
it's a happy new year from
Richard Wagner!**



ANTONIN DVORÁK
Piano Quintet No2 in A Major
Op81 (B155)
BOHUSLAV MARTINU
Piano Quintet No2
Peter Frankl, piano; Lindsay String
Quartet
ASV CD DCA889 (DDD/69.51)

● The Lindsay Quartet's 'Bohemians' series simply goes from strength to strength. This is the sixth volume and each has been a triumph, whether it has been devoted to the quartets of Janacek

or Smetana or the diverse chamber compositions of Dvorák. I hope that, eventually, the series gets the accolades due to it, not just for its consistency of playing and recording, but for the sheer enterprise in bringing this wonderful music to a wider audience. Even the designer of those gorgeously colourful and intriguingly detailed CD covers deserves some sort of prize!

Here, for the first time in the series, we encounter the chamber music of Bohuslav Martinu, his Second Piano Quintet. It was a work new to me, but one whose acquaintance I am delighted to have made. Even on first hearing, the substance of the piece, its wealth of ideas, its ingenious development of them, the depth and range of its emotional undercurrents, are evident. Subsequent playings uncover yet more of a work which Martinu wrote while in exile in the United States in 1944. In his booklet note, Jan Smaczny recalls that Martinu was physically and emotionally exhausted at the time, yet the music never suggests any want for energy or passion. It is also richly melodic but it is the often surprising variety with which Martinu exploits these ideas, especially in the intensely involving slow movement, that makes the Quintet so compelling.

There is abundant melody, too, in Dvorák's Op81 Piano Quintet, one of the greatest of his chamber compositions. It is music of radiant good-heartedness and the poignant theme of the andante is beguiling even by the standards of the master tunesmith that Dvorák was.

The Lindsay Quartet is joined here by that most underrated of pianists, the Hungarian-born Peter Frankl, and the understanding between them is evident from the start. Both performances have the energy and spontaneity that you usually encounter at a concert, but without the unwanted distractions. The recording was made in a concert venue that will be familiar to Radio 3 listeners, St George's Brandon Hill in Bristol, and the production team of Alexander Waugh and Andrew Hallifax – a new name to me – have obtained first-rate results there. This is music-making at its best, engaging and enriching, polished without being precious; an early contender for chamber music recording of the year, dare I suggest?

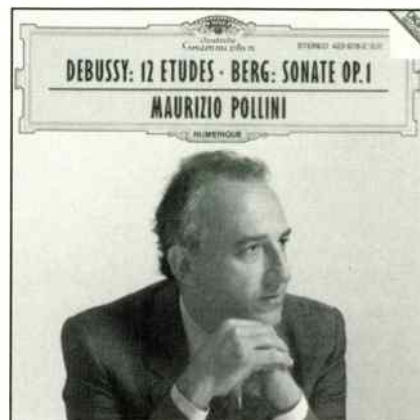

CLAUDE DEBUSSY
Twelve Etudes for Piano
ALBAN BERG
Piano Sonata Op I
Maurizio Pollini, piano
DEUTSCHE GRAMMOPHON 423 678-2
(DDD/52.16)

● Debussy and Pollini. It looks an irresistible combination but the result is curiously disappointing. To me, Pollini either misses or ignores the subtle sensuality and poetry in these remarkable pieces. The Twelve Etudes were Debussy's last major composition for solo piano and reflect his admiration for Chopin. Yet they are anything but wistfully reflective; more, this is Debussy at his most musically exploratory and his most abstract, eschewing descriptive or programmatic titles for straightforward pedagogic headings.

The music, though, is far from straightforward with its finely-shaded textures and delicate interweaving of melody. Too often, this eludes Pollini whose air of nervous agitation is at odds with the music's inner mood. At one point in the Second Etude, *Pour les tierces*, he ignores Debussy's instruction to play softer and actually plays louder. The brilliance that you might expect in the faster music is also lacking and Pollini is wary of the exuberance which is surely implicit in some of the more extrovert pieces. It is a competent enough performance but one short on imagination, lyrical vision and rhythmic flexibility. The close, rather boxed-in sound doesn't help. Of the modern versions of the Etudes, that by Mitsuko Uchida on Philips remains the front-runner.

However, Pollini does offer the attractive and unusual bonus of Alban Berg's opus one, his only published piano work. Lasting some ten-and-a-half minutes, it is music of great density and

Multi-layered allegory replete with masonic, even revolutionary, sub-texts, or a colourful collage of quasi-mystical hocus-pocus. Whatever interpretation you place on Emanuel Schikaneder's bizarre plot for *The Magic Flute*, there is no denying that, in Mozart's hands, it miraculously metamorphosed into a truly wonderful opera, or – to be more exact – singspiel. Mozart composed three types of opera: opera seria, opera buffa (or comic opera, *The Marriage of Figaro* being the finest example), and the Singspiel. The last, too, was essentially light-hearted and included spoken dialogue as well as sung arias and choruses. It was also, as the name implies, performed in German rather than Italian.

Mozart completed *The Magic Flute* in the last year of his life, 1791, but those seeking portents of impending doom in the work, rather as in the *Requiem* K626, are badly misguided. Sadly, it became Mozart's last opera, but that was unknown to him when he was composing it.

WOLFGANG AMADEUS MOZART

Die Zauberflöte (The Magic Flute) KV620

Kristin Sigmundsson (Sarastro); Kurt Streit (Tamino); Sumi Jo (Queen of the Night); Barbara Bonney (Pamina); Gilles Cachemaille (Papageno); Lillian Watson (Papagena); Martin Petzold (Monostatos); Håkan Hagegård (speaker); The Drottningholm Court Theatre Orchestra and Chorus; conductor, Arnold Östman
L'OISEAU-LYRE 440 085-2 (2 CD SET) (DDD/155.56)

● Although he uses period instrument forces, there is nothing especially radical about Arnold Östman's view of *The Magic Flute*. Yet it is clearly a deeply-considered performance, with a refreshing clarity and lightness of texture and a firm grasp of rhythm and flow. Like Norrington on EMI, Östman acknowledges the essentially light nature of the Singspiel idiom; *The Magic Flute* as an apotheosis of the eighteenth century rather than a precursor of the nineteenth and all that implies. Norrington's tempos are generally very

Being generous, given its absurd plot – symbolism or no symbolism – *The Magic Flute* is best described as a superior pantomime. It is Mozart's music which elevates it to the status of a masterpiece. The writer and music critic, Compton MacKenzie compared the two arias of the High Priest, Sarastro, to the great speeches of Prospero in Shakespeare's *Tempest*. The music of Papageno, the bird-catcher, is lighter and an opportunity for any baritone to prove his worth. Indeed, all the characters are given opportunities to dazzle, not least the Queen of the Night who has two of the most difficult of all coloratura arias in all opera, music that delights and disarms with its heavenly beauty.

Recordings of *The Magic Flute* are legion: over twenty are in the catalogue, beginning with the 1938 performance under Sir Thomas Beecham which is currently available in first-class transfers on both the Pearl and Nimbus labels. There have been several other legendary

recordings of the work, not all in retrospect living up to their reputations. How ponderous Klemperer's exceptionally slow speeds now seem, for example; and the sonic jiggery-pokery of Marriner's version on Philips is now merely irritating, despite a star-studded cast. Karajan's 1950 Vienna recording – better than the 1980 Berlin digital taping – is a glorious reminder of the Viennese Mozart tradition. Haitink's 1981 recording on EMI has much to commend it, principally the voice of the late-lamented Lucia Popp, and – along with Solti's 1990 performance on Decca – is arguably the safest recommendation among what might be described as 'traditional' interpretations. But *The Magic Flute* has also benefited from the attentions of 'authenticists', Roger Norrington and – most recently – Arnold Östman among them. And, for me, it is Östman's Drottningholm performance which deserves to join the ranks of the great *Zauberflöten*.

fast, which can be either alternately exhilarating or exhausting. It can sound rushed and the cast can best be described as adequate. Östman – I think

a weak link, and it isn't much of one, it is the Sarastro of Kristin Sigmundsson and, on the technical side, the spoken dialogue is sometimes not as audible as one would wish. Otherwise, the recording, made in Stockholm in August 1992, is a model of clarity and balance, displaying the many qualities of the Drottningholm orchestra to the full. The choir, too, is in fine voice.

Above all, this Oiseau-Lyre production succeeds as a performance, a satisfying sum of its parts. Which cannot be said of many a more starry line-up. The fact that it was recorded over a ten-day span rather than a ten-month one, and in one location, doubtless contributed to the cohesion and unity of the interpretation. There are times when it can seem that there is a surfeit of recordings even of a work of the stature of *The Magic Flute* and it is unquestionably a distinguished list that stretches back to Beecham almost sixty years ago. But Östman's is a recording full of distinguished performances that deserves its place among the handful of great interpretations at the head of that long list.



wisely – opts for slower speeds, which brings a welcome spaciousness to the proceedings and, overall, he has the stronger cast, with Sumi Jo quite splendid as the Queen of the Night. Hear her in the act two aria, *Der Hölle Rache kocht in meinem Herzen*, and I'm sure you will be bowled over. If there is

inner tension, awash with yearning chromatic lines. As it moves inexorably towards its central climax, Pollini is heard at his commanding best.

Berg was just twenty-three when he

wrote the *Sonata* and the influence of Schoenberg is evident, with all the material being driven from a few motivic cells voiced at the start. It is a fascinating piece and – as far as I am

aware – unavailable on any other recording. So Pollini's superb execution of the *Sonata* is doubly welcome, but doesn't compensate for the distinctly lack-lustre Debussy.



WAGNER GALA
Excerpts from Tannhäuser,
Lohengrin, Die Meistersinger
von Nürnberg and Die
Walküre

Cheryl Studer, soprano; Waltraud Meier (mezzo-soprano); Siegfried Jerusalem, tenor; Bryn Terfel, baritone; Berlin Philharmonic Orchestra; conductor, Claudio Abbado

DEUTSCHE GRAMMOPHON 439 768-2
(DDD/76.29)

● Vienna has its new year's day gala, but in Berlin they go to hear the city's famous orchestra at its home, the Philharmonie, on new year's eve. It sounds an eminently civilised tradition, one which Karajan – although he did not found it – steadfastly maintained. Now the onus is on Karajan's successor, Claudio Abbado, and for the past three years he has elected to devote the occasion to the music of just one composer. He began in 1991 with Beethoven and followed with Richard Strauss; last year it was the turn of Richard Wagner, not a name readily associated with Abbado. In the event, as this recording amply demonstrates, it proved to be an inspired collaboration. Mind you, Abbado did line up four of the finest of current Wagner singers to assist him: the American soprano, Cheryl Studer; the German-born mezzo, Waltraud Meier, who has been associated with the Bayreuth Festival for over ten years; the superb Siegfried Jerusalem, often described as the ideal Wagner tenor of this generation; and the young Welsh baritone, Bryn Terfel, who demonstrates the breadth of his vocal talents by tackling the two quite different roles of Wolfram in *Tannhäuser* (a glorious performance of the evergreen *Song to the Evening Star*) and Hans Sachs in *Die Meistersinger*.

The Berlin orchestra gets the chance to enjoy itself in three of the best-known Wagner orchestral excerpts, the *Overture to Tannhäuser*, the *Prelude to act one of Die Meistersinger* and – as a rousing conclusion – the *Ride of the Valkyries*. But the highlight of this gala concert has to be a more substantial excerpt from *Die Walküre*, the intensely powerful act one duet between Siegmund (Siegfried Jerusalem) and Sieglinde (Waltraud Meier). Both are in glorious voice, as in Cheryl Studer who

takes on the roles of Elisabeth and Elsa in the *Tannhäuser* and *Lohengrin* excerpts respectively.

I'm normally no great fan of this kind of gala recording, feeling that it must have been wonderful to have been there at the time but that the impact dulls in the cold light of listening at home. Here, however, I couldn't but enjoy a feast of fine Wagner singing, orchestral playing and – for that matter – conducting. Will the experience tempt Abbado to tackle one of the operas? I'd be intrigued to hear what he would make of *Tristan* or *Parsifal*. The sound from the Philharmonie, I should add, is a product of DG's 4D system which I don't pretend to understand but which produces – given the 'live' conditions – a richly-textured and full-blooded result. Wholly appropriate, in fact.



SERGEY RACHMANINOV
Piano Concerto No2 in C
minor Op18; Piano Concerto
No3 in D minor Op30

Howard Shelley, piano; Royal Scottish National Orchestra; conductor, Bryden Thomson

CHANDOS CHAN 9193 (DDD/75.08)

● A generous coupling (I know of no other current recording which offers both these concertos on one CD) and a somewhat perplexing one. The recording details list the tapes as having been made in the Caird Hall, Dundee, in December 1989 and April 1990, and the sleeve offers a first publication date of 1990, where upon the CDs of all four concertos (Nos 1 and 4 were taped as well) appear to have been abruptly deleted.

Howard Shelley is one of the finest of contemporary Rachmaninov interpreters, witness his superlative series of recordings of the solo piano music for Hyperion. This Chandos issue shows that he is just as sympathetic to the concertos.

Rachmaninov's Second Piano Concerto is probably second only in popularity to Tchaikovsky's First; indeed, it is probably the quintessential romantic piano concerto. Inevitably Shelley faces formidable competition in this work, from for example Ashkenazy (the LSO/Previn version) and the classic Van Cliburn/Reiner recording on RCA/BMG; there is also the thrilling Earl Wild interpretation, with the RPO and Jascha Horenstein which also happens to be on Chandos.

Howard Shelly offers a scrupulous, thoughtful performance which avoids the mawkish sentimentality and self-indulgence that colours so many interpretations of this work. Yet his playing – like the Chandos recording – is brilliant and full-blooded. Unfortunately, Bryden Thomson does not prove the most imaginative of accompanists, though the playing of the Scottish orchestra is full of commitment.

The Third Piano Concerto, completed in 1909, displays greater compositional mastery than its predecessor, both in terms of structure and in the use of the orchestra. It is also decidedly more demanding of the soloist than the Second Concerto, so much so that the dedicatee, Josef Hoffmann, never played the work. Even Rachmaninov, one of this century's greatest concert pianists, complained about the technical hurdles he had given himself! Howard Shelley takes these hurdles in his stride in what is an eminently cogent performance, yet not one without panache. He responds eloquently to the music of the *adagio* and offers vigorous and commanding playing in the outer movements. All round, this is probably the better of the two interpretations and, again, the weighty Chandos sound is wholly consistent with the essence of Rachmaninov's score, and the balance between soloist and orchestra is nicely judged. A welcome addition – if a belated one – to the crowded ranks of the Rachmaninov discography.

Classical



KJ WEST ONE

- the only place to buy your hi-fi !

*Better Choice * Better Advice * Better Service

+ BETTER DEALS !

We may be located in the West End of London but our customer base is nation wide. We can advise and supply by mail wherever you live in the UK. Whether you call-in or deal with us by mail or telephone you get the same deal. We charge no extra for carriage and you can still get INTEREST FREE credit.

These KJ "better deals" are available for a limited period. Don't delay - ring us today!

BRANDS STOCKED

* Accuphase * Acoustic Energy * Albarry * Apogee * Arcam * Audio Alchemy * Audio Innovations * Audion * Aura * Audiolab * Audio Research * B & W * Chord * Croft * DPA * Epos * Gradient * Impulse * KEF * Krell * Lexicon * McIntosh * Marantz * Martin Logan * Meridian * Michell * Mission * Musical Fidelity * Nakamichi * Nitty Gritty * Orelle * Pink Triangle * Proac * Quad * Rogers * Roksan * Rotel * SME * Sonus Faber * Stax * Spondor * Systemdek * Tannoy * Theta * Thiel * Wadia *

2 YEAR GUARANTEE

KJ extend the normal 1 year warranty to a full 2 years covering both parts & labour

DEMONSTRATIONS

We have 3 dem studios - 2 for hi-fi and one dedicated to AV/Home Cinema. Generally we arrange dem's by appointment. We recommend you ring us before travelling any distance.

PAYMENT OPTIONS

We can accept payment by Mastercard, Visa or American Express credit cards, and in-store only using switch and Connect debit cards. Cash or cheque payments are still welcome.

AMPLIFIERS (INTEGRATED)

ARCAM	ALPHA 5	£230
	ALPHA 6	£330
	DELTA 290	£450
	PP1	£400
ALBARRY	KRAKEN	£399
ALCHEMIST	500 (Class A)	£999
AUDIO	INNOVATIONS 700	£999
AUDIOLAB	8000A MK2	£450
AURA	VA100	£300
MERIDIAN	561	£695
MUSICAL FIDELITY	A1 MK3	£329
	A120	£549
	A1000	£1399
PIONEER	A300X	£230
	A400X	£300
ROTEL	RA930AX	£175
	RA935BX	£225

AMPLIFIERS (PRE/POWER)

ALBARRY	AP4 PRE	£350
	S508 PWR	£500
	AP2 PRE	£1500
	M408 PWR	£850
	M1008 PWR	£1100
	L1 PRE	£299
AUDIO INNOVATIONS	800 PWR	£849
	1000 PWR	£1499
	L2 PRE	£699
AUDIO RESEARCH	LS3 PRE	£1599
	LS2 PRE	£2798
	LS5 PRE	£5295
	D200 PWR	£2800
	D240 PWR	£3391
	V35 PWR	£3355
	V70 PWR	£4480
AUDIOLAB	8000C PRE	£450
	8000P PWR	£650
	8000M PWR	£1400
AUDION CHORD	300B PWR	£1995
	SPM 800 PWR	£1985
	SPM 1000B PWR	£2415
	SPM1200B PWR	£3385
	SPM2000 PWR	£4600
DPA	DSP 200S PRE	£499
	DPA 200S PWR	£750
KRELL	KS2 PRE	£3000
	KSA 100S PWR	£5290
MERIDIAN	501 PRE	£595
	555 PWR	£595
	605 PWR	£1850
MICHELL	ARGO PRE	£699
	ARGO HR	£1300
	ALECTO PWR	£1880
	ISO HEAD AMP	£399
	ISOHR HEAD AMP	£850
	THE PRE AMP	£220
	TYPHOON PWR	£349
MUSICAL FIDELITY	MAGS PWR	£950
	F22 PRE	£999
	F15 PWR	£1899

McINTOSH	MC275 PWR	£3595
QED	VECTOR REF PRE	£399
QUAD	34 PRE	£388
	86 PRE	£863
	306 PWR	£350
	606 PWR	£690
ROTEL	RC 970BX PRE	£150
	RB 970 BX PWR	£225
	RC 980BX PRE	£350
	RB 980BX PWR	£450

CD EQUIPMENT

(CDP = CD Player; CDT = CD Transport
DAC = D to A Converter)

ARCAM	ALPHA 5 CDP	£450
	DELTA 270 CDP	£800
	BL/BOX 50 DAC	£450
	DELTA 250 CDT	£750
AUDIO	DAC IN A BOX	£200
ALCHEMY	DDS2 CDT	£795
AUDIOLAB	8000D DAC	£750
AURA	CD50 CDP	£400
DPA	LITTLE BIT 2 DAC	£450
	BIGGER BIT DAC	£695
	T1 CDT	£895
MARANTZ	CD52 MK2 CDP	£230
	CD52 SE CDP	£300
MERIDIAN	506 CDP	£795
	500 CDT	£975
	563 DAC	£695
	508 CDP	£1350
MICROMEGA	STAGE 1 CDP	£450
	STAGE 2 CDP	£600
	STAGE 3 CDP	£800
	CDT CDP	£519
MUSICAL FIDELITY	FCD CDP	£1499
ORELLE	CD160.2 CDP	£749
	CD10T CDT	£799
	DA180 DAC	£599
PINK TRIANGLE	ORDINAL DAC	£790
QED	DACAPO DAC	£1450
	DIGT DAC	£139
	DIGITAL OPTICAL	£169
QUAD	67 CDP	£825

ROKSAN	DF2P CDP	£1495
	DF2 CDT	£1295
	DA2 DAC	£549
ROTEL	RCD965BX CDP	£300
	RCD965 DIS' CDP	£375
	RCD965SE CDP	£425
TEAC	VRDS 10 CDP	£770
THETA	DATA BASIC CDT	£1990
	DATA MK2 CDT	£3290
	COBALT DAC	£699
	PRO PRIME DAC	£1449
	PULSAR 1 DAC	£1195

SPEAKERS

A/ENERGY	AE1	£764
	AEGIS 1	£450
APOGEE	CENTAUR MINOR	£1345
AURA	SP50	£399
B & W	MATRIX 805	£845
CASTLE	CHESTER	£650
	HOWARD	£995
EPOS	ES11	£395
	ES14	£585
IMPULSE	H6	£1350
	H2	£2250
KEF	REF 103.4	£1199
	REF 105.3	£2295
MARTIN	AERIUS	£2222
LOGAN	SEQUEL 2	£3222
MISSION	760i	£130
	760i SE	£150
	780	£200
	751	£300
	753	£699
MONITOR	MA 201	£250
AUDIO	MA202	£400
PROAC	TABLETTE 3	£479
	STUDIO 100	£699
	STUDIO 200	£1850
	RESPONSE 3	£3069
QUAD	ESL63	£2860
	SV63 WOOFER	£1650
ROGERS	STUDIO 3	£499
ROKSAN	OJAN 3	£895
SONUS	MINUETTO	£898
FABER	MINIMA AMATOR	£1498
SPENDOR	LS35a	£539
TANNOY	605 MK2	£170
	607 MK2	£200
	609 MK2	£295
	611 MK2	£430
	D100	£650
	D500	£1470
	D700	£2100
THIEL	CS 1.2	£1219
	CS 2.2	£2679
	CS 3.6	£3809

If you didn't find what you are looking for in the above listings, then please ask for a quotation for any item from any of the brands listed in the left hand column of this advert.

10% VOUCHER

Whatever hi-fi equipment you purchase from KJ West One before 31st May 1994, will entitle you to a voucher for 10% of the purchase value to be redeemed in exchange for tape, CD's & Accessories before 31st August 1994.

(This voucher cannot be redeemed for cash or used as a substitute for deposit payments)

Please clip this coupon and present it when making your purchase

KJ/HFW

KJ WEST ONE

26 New Cavendish St
London W1M 7LH

TEL: 071- 486 8262/63
FAX: 071- 487 3452

LOCATION: We are situated about 50 yards from Marylebone High Street. Roughly 10 minutes north of Bond Street tube station or 10 minutes south of Baker Street underground station

OPEN: Monday - Saturday 10am - 6pm
Thursday open until 7pm

0% APR INTEREST FREE CREDIT

6 Months Scheme - Minimum order value £400 Deposit 50% of order value plus 6 monthly payments by Direct Debit

10 Months Scheme - Minimum order value £1000 Deposit 50% of order value plus 10 monthly payments by Direct Debit

18 Months Scheme - Minimum order value £2000 Deposit 50% of order value plus 18 monthly payments by Direct Debit

Hi-Fi World Dial-a-Dealer

AVON

AUDIO EXCELLENCE 'Where the music matters', 65 Park Street, Bristol BS1 5PB. Tel. 0272 264975 Fax. 0272 251327. Great Hi-Fi carefully selected and demonstrated by friendly enthusiastic staff. Home installations and check-ups. Two year warranty from our own service department. Open 9.00-5.30 Tuesday - Saturday closed Monday.

PAUL GREEN HI-FI LTD. Kensington Showrooms, London Road, Bath. Tel. (0225) 316197. Musical Fidelity, Krell, Creek Rogers, Quad, Cust. car park. Best selection in the West.

YAUDIO, 36 Druid Hill, Stoke Bishop, Bristol, B59 1EJ. Tel. 0272 686005. ATC, Acoustic Energy, Ruark, AVI, Exposure, Pink Triangle, Wadia, Audio Innovations, SME (incl 20A), Chord Amps, Michell, AMC, Analogue Electronics, Cadence Valve, Jamo, LFO, REL, Sansui, Sonic Link, Stax, Townsend, Audio Technica, Goldring, Ltra, Ortofon, Sumiko. Demos by appt only. home trial facilities, free install. service facilities.

BEDFORDSHIRE

WENTWORTH AUDIO, 83 High Street North, Dunstable, Beds. NU6 1JJ. Tel: 0582 6633 83. Marantz, Pioneer, Rotel, Audiob, Mission, Cyrus, Moth, Sony, HK, NAD, Pink Triangle, Yamaha, Systemdek, Tannoy, etc. Free installation & delivery. Home dems. Part exchange. Interest free credit -6, 9, 12, 18 & 24 month terms. Free car parking at rear of shop. Free refreshments (alcoholic or otherwise!) Open 10-6pm Tues-Sat

BERKSHIRE

NEWBURY AUDIO, 2 Weavers Walk, Northbrook Street, Newbury, Berks, RG13 1A1. Tel. 0635 33929. Linn, Creek, Epos, Denon, Nakamichi, Shahinian, Marantz, Micromega, JPW, Ruark. Single speaker dem room. Appt. necessary. Home trial facilities, free install. service dept, late appts. Access/Visa, interest free credit subject to status. 6 days 9.30am - 6.00pm.

ARC AUDIO, 9 Oukes Ride, Crowthorne, Berks, RG1 16L2. (0344) 762201. Denon, Harman Kardon, JPW, Marantz, Monitor Audio, Onyx, Rogers, Tannoy, Thorens, Yamaha. Demonstration facilities, no appointments necessary, home trial facilities, free installation. Access, Visa, Diners. Open Mon-Sat 9-6pm (closed Wed at 1pm)

READING HI-FI CENTRE, 4 Queen's Walk, Reading RG1 7QF. Tel. 0734 585463. "The best equipment, advice and service from Berkshire's premier Hi-Fi emporium". Products include: Arcam, exposure, Audiob, Meridian, Rotel, Sony, sennheiser, Top Tape Centre, and many more.

ASTLEY AUDIO, Wallingford, 0491 839305. See our entry under OXFORDSHIRE

BUCKS

O.L. CHITTENDEN LIMITED, 59-61 The Broadway, Chesham, Bucks, HP5 1BX. (Opposite Boots). Tel: 0494 784441. Philips, Denon, Kenwood, Canon Audio, Koss, Wharfedale, Mitsubishi, Target, Grundig, QED, Mordaunt-Short, Toshiba, Dolby Pro-Logic Systems, Nicon TV and Video, Surround Sound, AV Systems. Showroom Demonstrations from expert and friendly staff. No appointments necessary. Service Department. Credit facilities available. Open 8.30 to 5.30 Mon-Sat.

DEJAC HI-FI Consultants, 21 the Broadway, Old Amersham, Bucks, HP7 0HL. Tel. (0494) 433173. ARC, Arcam, Bose, Meridian, Quad, Denon, NAD, Tannoy, Mission, TDL, 2 dem rooms, Appts necessary, Free installation, Tricity finance, instant credit, open 9.30-5.30 pm. including Saturdays.

NORTHWOOD AUDIO II, 98 Cambridge St, Aylesbury, Bucks HP20 1BA. Tel. 0296 28790 (A/P). Selected sounds from Alchemist, Aura, Boston, B & W, Cabelatik, Castle, Celestion, Denon, Exposure, Gyrodec, Harman Kardon, Heybrook, Marantz, Micromega, Monitor Audio, Moth, NAD, Nakamichi, Rose, Rotel, Royd, Ruark, Systemdek, Tannoy, TDL, Thorens etc. Export orders welcome. 2 Dem rooms. Credit facilities available.

CAMBRIDGE

CAMBRIDGE HI-FI, 1-3 Hawthorne Way, Chesterton, Cambs. CB4 1AT. Tel. 0223 67773. Kenwood, Pioneer, Ariston, Kef, Technics, Yamaha, Marantz, B&W, AR, Mordaunt-Short, Bose. Single speaker dem room. Tues-Sat 9.30-5.30pm. Closed Monday. Free install, service dept. Vis/Access credit facilities.

STEVE BOXSHALL AUDIO, 41 Victoria Road, Cambs. CB4 3BW. Tel. 0223 68305. 10.00-6.00pm 6 days. 3 dem rooms. Denon, Rotel, Yamaha, Mission, Nakamichi, Tannoy, Audiob, Marantz, Krell, Martin Logan, Magneplanar, Wadia. Home trial facilities.

HI-FI WORLD JUNE 1994

Appointments preferred. Free install. and service dept. Access/Visa.

CHESHIRE

SWIFT HI-FI, St. Annes Parade, Wilmstow. 0625 526213. Aura, B&W, Denon, Kenwood, Marantz, NAD, Pioneer, Rotel, Systemdek, Tannoy, Revolver, J.P.W., M. Short, Mission, Celestion, Technics, Audiob, Castle. Open 9.30-6. Dem room. No pressure. BADA member.

THE HI-FI SHOWROOMS, 12A West Str, Congleton, Cheshire (0260)280017. 1 Stanley St, Leek(0533)383780, Celestion, Creek, Exposure, Marantz, Musical Fidelity, Pink Triangle, Project, Rotel, Ruark, Systemdek, Tannoy, Technics. 5 Dem Rooms, Noappts necc, Home trial, Free install, Service dept. Access, Visa, Lombard Tricity. Open 9-5.30, Closed Wed.

HALE HI-FI, 2 Bold St, Hale Road, Altringham, Cheshire WA14 2ER. Tel: 061 929 0834. Open Mon - Sat 10am-6pm & later by appointment. Specialising in equipment by: Naim, Quad, Royd, NAD, Denon plus selected others. Large range of quality accessories. On site service department. Installation & delivery. Home demonstrations a pleasure

ASTON AUDIO, 4 West Street, Alderley Edge, Cheshire. Tel. 0625 582704. Products include: Celestion, Creek, Yamaha, Monitor Audio, B&W, Aiwa, Aura, AKG, Musical Fidelity, Tannoy, Sennheiser, Marantz, Dual, Denon, Quad, Sansui, Technics, Spendor, Mission, SME, Nakamichi, Audiob, Rogers, Audioquest, Mordaunt-short, Meridian, Deltac, Roksan, Arcam, Kef, NAD, Cyrus and others. Discount CD and tape. Extended guarantee, interest free credit and written details on request.

CHRIS BROOKS AUDIO, 29 Gaskell Street, Stockton Heath, Warrington, Cheshire, WA4 2UN. Tel (0925) 261212. Tues-Sat 10.00-6.00. 2 dem-rooms. credit facilities. All credit cards. Established 1978. Total absence of bulls "t"

CONGLETON HI-FI, 1/1a Duke St. Congleton, Cheshire, CW12 1AP. (0260) 297544. Acoustic Energy, Arcam, B&W, Denon, Epos, Linn, NAD, Nakamichi, Onix, Royd, Target, etc. Superbly appointed single speaker demo facilities. No appointments necessary, home trial facilities, free installation. 2 year guarantee on all equipment. Access, Visa. Open Mon-Sat. closed Weds.

DOUG BRADY HI-FI, Kingsway Studios, Kingsway North, Warrington, Cheshire, WA1 3NV. (0925) 828009. "Largest choice of specialist hi-fi in NW. All credit cards 3 dem rooms. Fair demonstrations and home trial facilities. Open 6 days.

CLEVELAND

GILSON AUDIO LTD., 172 Borough Rd., Middlesbrough. (0642) 248793. Linn, Exposure, Arcam, Mission, Cyrus, Denon, Marantz, Rotel, Pioneer, Audiob, Tannoy. Demonstration facilities in main shop and one demonstration room. Appointments necessary. Home trial facilities. Free installation on request. Service department. Access, Visa, H.P. 10-5-6 days.

ACTION ACOUSTICS, 155-157 High Street, Redcar, Cleveland. TS10 3AN. 0642 480723. Audio Innovations, Denon, Harman Kardon, JBL, Michell, Musical Fidelity, Pink Triangle, Revox, Rogers, Thorens, etc. Dem room. Appointments nec. Home trial facilities, free installation, service dept. Access, Visa & HP. Open 9.15-5.30.

CORNWALL

RJF AUDIO VISUAL, 84 Pendarves Street, Tucking Mill, Camborne, Cornwall. TR14 8NJ. 0209 710777/612260. TDL, Michell, Musical Fidelity, NAD, Nakamichi, B&W, SME, Micromega, Pink Triangle, Pro-ject, Perception, Harman Kardon, Triangle. Integral dem/showroom and special home dems. Appts nec. home trial, free install, service dept. All cards Switch and Transax. Open Mon-Sat 9.30-5.30.

CUMBRIA

MISON'S SOUND & VISION, 11 Warwick Road, Carlisle CA1 1DH Tel (0228) 22620. Bang & Olufsen, B & W, Castle, Sonic Link, Quad, NAD, Yamaha, Sony. Demo Suite. No appts nec. Home trial facilities. Free installation. Service Department 9 - 5.30 Mon - Fri, Thurs 9-1, Sat 9 - 5.

DEVONSHIRE

THE HI-FI ATTIC, 58 New George St., Plymouth, Devon. PL1 1RR. 0752 669511. We stock most leading brands including Linn, Arcam, Denon, Pioneer, Musical Fidelity amongst others, and have an expert enthusiastic staff. Premises include attractive hi-fi and home cinema demonstration rooms. We offer free installation and

credit facilities (written details on request) also a fully equipped service department. We can also provide a mail order service for all your LaserDisc requirements. We accept Visa, Access, Amex.

CHELSTON HI-FI, 38 Walnut Road, Chelston, Torquay, Devon TQ2 6HS Tel.(0803) 606863. Denon, Marantz, Rotel, Musical Fidelity, Acoustic Energy, NAD, Castle, Heybrook, Celestion, JPW etc. Two dem rooms. Home trial. Free installation. Access, Visa, Amex, Diners, HiFi Markets Chargecard. Credit facilities. 9.30-7.30 Mon-Fri, 9.30-6.00 Sat.

DERBY

STRAD TRADITIONAL AUDIO, 29 Meadowfield, Whaleybridge, nr Buxton, Derbyshire. SK12 7AX. Tel. 0663 733383. We construct custom made reproductions of classic 1950's loudspeaker enclosure designs using authentic blueprints. These have never been bettered for valve amplification. Requests for specific designs considered and researched. Superb new speaker units from Richard Allan and Lowther are used.

ACTIVE AUDIO, 12, Osmaston Street, The Spot, Derby. Tel: 0332 380385. Fax: 0332 385185. We have three studios including a dedicated Audio Visual studio for the demonstration of quality equipment from the largest range in the Midlands. Open six days per week. Own service department. Free local delivery, home trial facility. Current special offers and buyers fact pack and quotation on request.

DORSET

DAWSONS, 23 Seamoor Road, Westbourne, Bournemouth, Dorset. 0202 764965 B&O, Castle, Canon, Jamo, JBL, Pioneer, Sony, Target, TDL, Technics. No appts necessary. Free installation. Service dept. Various credit facilities available. Open 9-5.30 6 days a week.

SUTTONS HI-FI, 18 Westover Road, Bournemouth, Hants. Tel. 0202555512. Linn, Arcam, Mission, Quad, Audiob, Rotel, Yamaha, Denon, etc. 2 single speaker listening rooms. Home demonstrations and free installation. Mon-Sat 9.00-5.30. Call for details.

ESSEX

BRENTWOOD HI FIDELITY, 2 Ingrave Road, Brentwood, Essex. CM15 8AT. Tel: 0277 221210. Audio Innovations, Aura, AVI, Castle, Chord Electronics, Denon, DNM, EAR, Impulse, John Shearne, Kenwood, Marantz, Micromega, Mission, NAD, Nakamichi, Pink Triangle, Pioneer, Pro-ject, Quad, Rotel, RuArk, SME, Systemdek, Tannoy, TDL, Townshend Audio, Yamaha plus many more. Single speaker dem rooms, home trials, dems and installations. Mon-Sat 9.30-5.30. Access, Visa, service facilities. Simply THE place to visit if you're serious about music.

PRO MUSICA, 6 Vineyard Street, Colchester, Essex. Naim, Roksan, Rega, Arcam, Audiob, Creek, Systemdek, Rotel, Marantz, Denon, Shahinian, Micromega, Neat, Aura, Heybrook, EPOS, RUarc, Monitor Audio, Tripod, Sound Organisation, Lots of records, 2 dem rooms. No appts necessary. Service dept, Part exchange, Finance available. 10-6 Mon-Sat.

TWENTY 20 AUDIO VISUAL LTD. Unit 205 Lakeside Shopping Centre, West Thurrock, Grays, Essex. 0M16. Tel. 0708 891818 Fax. 0708891300. For your total home entertainment requirements. From a 2" Casio to a 50" Pioneer screen. Dolby surround specialists with three dem rooms dedicated to pro-logic, laser disc software in stock, from Harman Kardon. Pro logic from Yamaha, Marantz, Pioneer, Technics, Kenwood and B&O.

RAYLEIGH HI-FI, Chelmsford, 216 Moulsham St. 0245 265245. RAYLEIGH HI-FI, Rayleigh, 44a High Street. 0268 779762. RAYLEIGH HI-FI, Southend, 132/4 London Rd. 0702 435255

Over 21 years experience of supplying the best. "The best dealer, the best Hi-Fi equipment, the best service" Carefully selected Hi-Fi from: Arcam, Audiob, Cyrus, Denon, Epos, Linn, Meridian, Mission, Naim, Nakamichi, Quad, Rega, Roksan, etc. etc. 3 years guarantee on Hi-Fi systems. 0% credit facilities.

AUDIO T, 442-444 Cranbrook Road, Gants Hill, Ilford, Essex, IG2 6LL. (081) 518 0915. Fax (081) 554 8463. Great Hi-Fi from Arcam, Audiob, B&O, Bose, Cyrus, Denon, Kef, Marantz, Meridian, Mission, Micromega, Nakamichi, Rotel, Sony, Yamaha & many more. Mon-Sat 10-6 3 year guarantee on Hi-Fi. Free delivery & installation. 30 day free upgrade scheme. Home demonstrations. Part exchange. 2 listening rooms. Home Cinema specialists. BADA Bonded.

GLOUCESTERSHIRE

AUDIO EXCELLENCE 'WHERE THE MUSIC MATTERS', 58 Bristol Road, Gloucester, GL1 5SD. Tel. 0452

300046 Fax. 0452 310680. Great Hi-Fi carefully selected and demonstrated by friendly enthusiastic staff. Home installations and check-ups. Two year warranty from our own service department. Open 9.00-5.30 Tuesday - Saturday closed Monday.

AUDIO T, 40-42 Albion Street, Cheltenham, Gloucestershire, GL52 2RQ. (0242)583960. Fax (0242) 226435. Great Hi-Fi from Arcam, Audiob, Denon, Epos, Linn, Marantz, Meridian, Mission, Quad, Rogers, Rotel, Yamaha, & many more. Mon-Fri 10-6. Sat 9.30-5.30. 3 year guarantee on Hi-Fi. Free delivery & installation. 30 day free upgrade scheme. Home demonstrations. Part exchange. Single speaker listening room. BADA Bonded.

HAMPSHIRE

AUDIO GALLERY, Near Petersfield, Hampshire. Mana, Castle, Alchemist, Albany, Audio Innovations, Wadia, Deltac, Tube Technology, Denon, Pioneer, Alphason, Tripod, NAD, Teac, Audio Alchemy, Klipsch, AMC, Proac, JPW, Moth, Pink Triangle. Mail order cabinets supplied to order in any size, wood & hand painted finishes, stone-granite-marble shelving. For a demonstration with home comforts call us for an appointment on: 0730 895194.

HOPKINS HI-FI, 'FOR THE BEST SEAT IN THE HOUSE' experience home cinema sound with Technics, Denon and Kenwood. Award winning products. Now on demo at HOPKINS HI-FI. 38-40 Fratton Road, Portsmouth, Hants, PO1 5BX. Tel. 0705 822 155, Fax. 0705 830 753

HAMPSHIRE AUDIO LTD., 2-12 Hursley Road, Chandlers Ford, Hants SO5 2FU. (0703) 252827/265232. 3 hiifi and 2 home cinema/surround sound dem studio's. Thurs late evening, closed Mondays (except in December). Service dept on site (2 yr guarantee). Large free car park - junctions 4 (M27/M3), 5 (M27), 12 (M3) and 13 (M3) all within 3 miles, est. 1969.

AUDIO T, 4 Feathers Lane, Basingstoke, Hampshire, RG21 1AS. (0256) 24311. Fax (0256) 24430. Great Hi-Fi from Arcam, Audiob, Denon, Linn, Meridian, Mission, Naim, Rotel, Sony, Yamaha & many more. Mon-Sat 9.30-5.30. 3 year guarantee on Hi-Fi. Free delivery & installation. 30 day free upgrade scheme. Home demonstrations. Part exchange. Single speaker listening room. BADA Bonded.

HEREFORDSHIRE

ENGLISH AUDIO, 95 Whitecross Road, Hereford, HR4 0DG. (0432) 355081. Musical Fidelity, Arcam, Castle, Ruark, Rogers, JPW, Micromega, Chord, Audio, Systemdek, Heybrook, Kef, Stax, Pink Triangle, Denon, Marantz, Mission-Cyrus, A.I., Rotel, NAD, Nakamichi, TDL and others. Single speaker dem room, home trial facilities, free installation, service dept, Access/Visa, Credit arranged. Open Mon-Sat, 10-6pm. BADA members.

GOSPEL MUSIC AUDIO, 32a High Street, Kington, Herefordshire, HR5 3BJ. (0544) 230254. Alphason, Allison, Revolver, Luxman, Yamaha, QED Audio, Systemline.

ACOUSTIC ARTS LTD, 101, St. Albans Rd., Watford, Herts. 0923 245250. Fax 0923 230798. Absolute Sounds, Adcom, Acoustic Energy, Audiob, Chord, Denon, Marantz, Meridian, Orele, S.M.E., T.D.L. 3 dem rooms, multi-room & home theatre. Expert installation. Credit facilities available, Tues-Sat 10-6.

STUDIO 82, 82 High Street, Harpenden, Herts AL5 2SP. 0582 764246. Fax 0582 467022. ATC/AVI, Arcam, Aura, Audiob, B&O, Denon, Epos, Mission, Cyrus, Naim Audio, Nakamichi, Quad, NAD etc. Quiet single speaker dem room. Appts nec. Home trial, free installation. Service dept. Visa, Access and finance terms. 9-5.30 (Mon-Sat) Closed Weds.

THE AUDIO FILE, 27 Hockerill St., Bishop's Stortford, Herts. CM23 2DH. Tel. 0279 506576. Fax 0279 506638. Linn, Naim, Roksan, Quad, Rega, Mission, Arcam, ProAc, Marantz, Sony etc. 4 dem rooms, installation service. Min 3 year warranty, 0%, BADA.

HERTFORD MUSIC. We want you to feel good when choosing your system in our 3 demonstration rooms (and bar!). Systems from budget to £15,000. Products include: CR Developments, Micromega, REL Acoustics, Acoustic Energy, Michell, Magnum, Diamond Acoustics, Beard, Lumley, Renaissance, etc. AAccess, Visa. Mail Order. Please telephone: 0992 442425.

RAOULET AUDIO, 141 Watling Street, Radlett, Herts, WD7 7NQ. Tel. 0923 856497. Mark Levinson, Proceed, Proac, Magnepan, Martin Logan, Tube Technology, Teac, Roksan, Audiob, Stax, Systemdek, Jarris, Copland, ATC, Audio Alchemy, AVI, EAR, Sumiko, Quad, Sonus Faber, Home trial facilities, free installation, Service Dept. Visa/Access 9-5.30 Mon-Fri 10-5.30 Sat.

REVOX Service & Repairs, Suite 10, Smuogak Business Centre, Lye Lane, Brickwood, Herts. AL2 3UG. Tel 0923 893711. Seventeen years experience. ex

Hi-Fi World Dial-a-Dealer

Bauch. Authorised agents for Revox products, sales and spares. All repairs carried out are guaranteed. Fast turnaround. Any enquiries telephone: 0923 893711.

KENT

ELECTRICAL DISCOUNT CENTRE, EDC, 138 Pelham Road, Gravesend, Kent DA11 0JH. Tel: 0474 569601. Pioneer, Marantz, Technics, Akai, JVC, Jamo

ELECTRICAL DISCOUNT CENTRE, EDC, 109 The Broadway, Bexley Heath, Kent DA6 7JH. Tel: 081 298 7880. Pioneer, Marantz, Technics, Akai, JVC, Jamo

PROGRESSIVE AUDIO, 2 Maryland Court, Rainham, Nr Gillingham, Kent. ME8 8QY. Tel. 0634 389004. Agencies include: Audio Innovations, Audion, Audionote, Audiostatic, Audiotechnica, Chord amps, Cogan Hall, Conrad Johnson, Convergent, DALI, Decca, Eminent Technology, Goldring, Impulse, Koetsu, Levinson, L.F.D., Lyra, Lumley Reference, Meridian, Michell, Micromega, Moth, Origin Live, Pink Triangle, ProAc, Proceed, Ruark, Silversounds, S.M.E, Sugden, Sumiko, Systemdek, Snell, Target, T.D.L., Transfiguration, Townshend, Tube Technology, Voyd, V.P.I., etc. etc... Demonstrations by appointment please.

JOHN MARLEY HI-FI CENTRES, 2 Station Road, West Canterbury (0227)769329. Also at Dover - 0304 207562. Arcam, Aura, B&W, Heybrook, JPM, Proac, Pioneer, Rotel, Ruark, Tannoy, Technics. Dem rooms and home trial facilities. Mon-Sat, 9-5.30 clos. Thurs. Free install. Credit to #1,000. Access, Visa and credit charge. Service Dept.

VOLUME ONE, 41 Upper Wickham Lane, Welling, Kent, DA16 3AD. 081 304 4622. Arcam, Dual, Epos, Expanse, JPW, Marantz, Micromega, Nakamichi, Pink Triangle, Rotel, Ruark, Royd, Sony, Systemdek, Alchemist, Celestion, B&W. Large dem room, no appts necessary, Evening dems in shop by appt. Home trial facilities, free delivery and installation. Access/Visa. 10.00-6.00pm Mon-Sat.

KIMBERLEY HIFI, 193 Broadway, Bexleyheath, Kent. Tel: 081 3043272. Pioneer, Technics, Kenwood, Marantz, Denon, NAD, Aiwa, Tannoy, Mission, Rotel, Wharfedale, Castle. Separate dem room, no appt necessary. free installation, service dept, instant credit facilities. no early closing.

V.J. HIFI, 29 Guildhall Street, Folkestone, Tel. 0303 256860 Mon-Sat 9-6. NAD, Yamaha, Marantz, Sony, Tannoy, Denon, Kenwood, Rogers, Musical Fidelity, Quad, Aiwa, Aura, Heybrook, Castle, Mission, Yamaha, REL, JBL, Polk. Dem rooms in both stores. free install. Credit facilities available., specialists in home theatre, Amex, Diners, Visa, Access, Service Dept.. We are BADA dealers.

THE WESTGATE HI-FI, 2 Station Road West, Canterbury, Kent. 0227 769329. Suppliers of quality hi-fi equipment including : Arcam, Akai, Aura, B&W, Denon, Jamo, JPW, Mordaunt Short, NAD, Panasonic, ProAc, Quad, Rotel, RuArk, TDL, Technics, Tannoy. Part exchange. Listening room. Service and repairs. Credit facilities. Access/Visa. Open 6 days 9-5.30.

DOVER HI-FI, 43 High Street, Dover. Tel: Dover 207562. Suppliers of quality hi-fi equipment including : Arcam, Akai, Aura, B&W, Denon, Jamo, JPW, Mordaunt Short, NAD, Panasonic, ProAc, Quad, Rotel, RuArk, TDL, Technics, Tannoy. Part exchange. Listening room. Service and repairs. Credit facilities. Access/Visa. Open 6 days 9-5.30.

LANCASHIRE

AUDIO CLASSICS, 8 Lowe Mill Lane, Hindley, Wigan, Lancs. WN2 3AF. Sorry but we are unable to answer queries in writing. I buy, sell, modify and repair all vintage and valve hifi equipment. Advice is free. New equipment by EAR, craft, Ortofon and more soon. Phone if just for a chat. Credit cards accepted. Quick worldwide delivery, callers by appointment. Tel. 0942 57525 or Fax: 0942 525861. 7 days a week.

ROMERS HIFI CENTRE, 94-96 High Street, Rishton, Blackburn, Lancs. Tel 0254 887799. Stockists of: Sony Espirit HiFi, Technics, Marantz, Musical Fidelity, Pioneer, Kenwood, Rotel, Tannoy, Mission, Ruark, B&W and many others. Dem room, service dept, free delivery and installation (local area) Access/Visa and Switch.

LEICESTER

LEICESTER HIFI COMPANY, 6 Silver Walk, St Martin's Square, Leics. LE1 5EW. Tel. (0533) 539753. Fax (0533) 626097. Acoustic Energy, Arcam, Marantz, Micromega, Mission/Cyrus, Musical Fidelity, Nakamichi, Meridian, Rogers, Roksan and

"oodles more" 2 dem rooms, home trial arranged, free install, service dept. Credit facilities, Access/Visa/Diners/Amex. 6 days. 9.30-5.30

THE LISTENING ROOMS, 6 Hotel Street, Leicester. Tel. 0533 623754. fax. 0533 623758. Linn, Audiolab, Arcam, Tannoy, Definition, Denon, Rotel, Nad, Heybrook, TDL etc. Open 10.00-5.30 (Six days.)

STEREO SHACK, 1-3 Guildhall Lane, Leicester, Tel. 0533 530330. Aiwa, A.R. Denon, Kenwood, Jamo, Mission, NAD, Philips, Pioneer, Home Cinema specialists. Free installation. Open 9.30-5.30 6 days. Credit available.

LINCOLNSHIRE

BOSTON HI-FI CENTRE, 65a Wide Bargate, John Adams Way, Boston, Lincs PE21 6SG. Tel: 0205 365477. Quad, Nakamichi, Arcam, Marantz, NAD, Castle, Tannoy, Rogers etc. Separate demonstration studio inc. home cinema. Free installation. Access, Visa, Tues-Sat 9-5 pm.

COTTAGE AUDIO, 17 Bridge Street, Saxilby, Nr Lincoln, LN1 2PZ. Tel. (0522) 702834. Evenings: (0522) 696708. ATC, AVI, Chord amplifiers, Harbeth, LFD, Michell, Origin Live, QED, Royd, Sansui. Sequence, Something solid, Sonic Link, etc. Demonstration rooms. Home trial facilities. Free installations and above all a personal, friendly service.

LONDON

ANALOG AUDIO, 849 High Road, Finchly, N12. (081) 445 3267 For friendly service and advice. AR, AKG, Allison, AT, Cerwin, Vega, Denon, Dual, Harman Kardon, Jamo, Infinity, Marantz, NAD, Pioneer, Rotel, Revolver, Sonab, Teac, Thorens, Tannoy, Wharfedale, Yamaha. Speaker cables and accessories. Free installation. Service

AUDIO CONCEPT, 27 Bond Street, Ealing, W5 SAS. Tel: (081) 567 8703. Acoustic Energy, Audiolab, Aura, B&O, B&W, Boston Acoustics, Canon, Castle, Denon, Dual, Evolution, Infinity, JPW, KEF, Marantz, Mission, Monitor Audio, Musical Fidelity, NAD, Nakamichi, Onix, Quad, Revox, Rogers, Rotel, Systemdek, Target, Teac, Thorens, Van den Hul. Two dem rooms. Interest free credit. free local delivery & installation, service department.

'Hi-Fi Specialists without the attitude'

BABBER ELECTRONICS, 158 Uxbridge Road, West Ealing, London, W13 8SB. (081) 579 6315. Akai, Aiwa, A.R. Celestion, Dual, Goodmans, Harman Kardon, JBL, JVC, Kenwood, Marantz, Panasonic, Sennheiser, Sony ES range, Tannoy, Technics, Wharfedale, Yamaha.

THE CARTRIDGE MAN - Front end problems? It doesn't have to cost an arm and a leg to get the best listen to my Koetsu - and - Decca - Eater. Also agents for Croft, Sugden, Thorens, Pentachord Speakers and Notts Analogue. (Plus a cartridge re-tipping service. Tel. 081 688 6565.

OIVA AUDIO FIDELITY: For the finest in real HiFi, AV and Multiroom systems. Accuphase, Audio Innovations, Audio Note, Audiostatic, Aura, Chord, Conrad Johnson, Impulse, Klipschorn, Levinson, Lumley, Lyra, Michell, Micromega, Monitor Audio, Primare, Rel, Rotel, S.M.E, Triangle, Trilogi, XLO. Call us or pop in for a musical experience you'll never forget. Open 10-6, Mon-Sat at Workshop 30, Royal Victoria Patriotic Building, Fitzhugh Grove, Wandsworth Common, London SW18. Tel/Fax: (081) 875 9593. Also see our full page advertisement on page 18 of this issue.

DOUG BRADY HIFI, 18 Monmouth Road, London WC2H 9HB. Tel. (071) 379 4010 or (071) 479 1346. Fair demonstrations and home trial facilities. Wide range of top specialist hifi from Britain, America and Japan. Open 6 days.

GOLF ELECTRONICS, 311 Kentish Town Road. NWS 2TJ Tel 071 482 2518. Fax 071 284 3381. Authorised dealers for : Sony, Panasonic, Aiwa, Akai, Mitsubishi, Philips, Grundig, Bose. We carry an extensive range of hardware from Walkmans to camcorders, including a wide range of TV and video equipment. Free local delivery & installation on selected items. Open 10-6 Mon-Sat. We regularly have special offers on different products. A visit to GOLF ELECTRONICS could save you £££s

HIFI & COMPONENTS, 84 Battersea Rise, London, SW11 1EH. (071) 223 1110. Denon, Tannoy, NAD, Rotel, Bose, Dual, QED, Wharfedale, Jamo, Celestion, Kenwood, Ortofon, Infinity, Shure, to name but a few! Established over 29 yrs. Appts necessary. Service dept. 10-6 (closed Weds)

HIFI EXPERIENCE, 227 Tottenham Court Road, London W1. 071 580 35535. Arcam, Audiolab, Mission, Cyrus, Quad, Celestion, Kef, Meridian, Rogers, Tannoy, Yamaha, TDL, Thorens, Marantz, Nakamichi, Musical Fidelity and many more. Open 10.00-7.00 Mon-Fri. 9-6 on Sat. Service dept, Credit facilities, delivery and free installation.

THE HIFI SURPLUS STORE, 62 Weymouth Street, W1 Tel. 071 486 9981/071 935 7582. Stock a full range of goods including: Aiwa, Akai, B&W, Bose, Dual, JVC, Jamo, Kenwood, Marantz, Mordaunt-Short, Mission, NAD, Pioneer, Rotel, Sony, Technics, Teac, Thorens, Tannoy, Wharfedale. Full range of "Target" speaker stands always on stock. All goods are brand new in sealed cartons with full 1 yr guarantee. We guarantee you can not buy cheaper elsewhere. Give us your genuine quote and we will beat that price by £10 (goods must be in stock) Access/Visa welcome. Open Mon-Sat 9.30-6pm. Late night 'til 6.30 Thurs.

KAMLA ELECTRONICS, 251 Tottenham Court Road, London W1P 9AD. Telephone. 071 323 2747. Fax. 071 637 2690. Acoustic Research, Aiwa, Akai, Albary, Alchemist, Alphason, Audio Alchemy, Audio Innovations, Audio Technica, Audioquest, Aura, Audiostatic, B&W, Cerwin Vega, Conrad Johnson, CopenHagen, Furukawa, Goldring, Infinity, IXOS, JPW, JVC, KEF, Kenwood, Kuzma, Lynwood, Maxell, Micromega, Mitsubishi, Monster, Mordaunt Short, Moth, Nakamichi, Oracle, Ortofon, Panasonic, Pioneer, Project, QED, Rotel, Ruark, Sansui, Stax, TDK, and many more!!!!

K J WEST ONE, 26 New Cavendish St., London W1M 7LH. 071 486 8262/63. Fax 071 487 3452. Two hi-fi & dedicated home cinema dem studios. Appts pref. Home trial. Installation by arrangement. Service dept. Major credit cards. Interest free credit on selected items. Major brands stocked: Acoustic Energy, Arcam, Audio Innovations, Audion, Aura, Audiolab, Audio Research, B&W, Chord, DPA, Epos, Impulse, Krell, Martin Logan, Meridian, Michell, Musical Fidelity, Nacamichi, Nitty Gritty, Orelle, Pink, i, ProAc, Quad, Roksan, Sonus Faber, Stax, Tannoy, Theta, Open 6 days.

BILLY VEE SOUND SYSTEMS, 248 Lee High Road, London SE13 (081) 318 5755. Arcam, Linn, Naim, Quad, Creek, Cyrus, Marantz, Nad, Rotel, Rega, Denon, Yamaha, Tannoy, Mission, Micromega, Heybrook, etc., 2 dem rooms, instant free credit, Access/Visa. Closed Thursdays

CONNECTIONS, 13 John Prince's Street, London W1M 9AH. Tel. 081 348 5676. Dealers in : Absolute, Audio Note, Audioquest, Deltac, Harmonix, Kimber, Mandrake, MIT, Siltech, Symo, Van den Hul, WBT and others.

THE LISTENING ROOMS, 161 Old Brompton Road, London SW5 0LJ. (071) 244 7750/59. Fax (071) 370 0192. Linn, Quad, Meridian, Nakamichi, Arcam, Audiolab, Acoustic Energy, S.M.E, Audio Research, Krell, Wadia, Theta, Apogee, Martin Logan, Pioneer, Tannoy, Systemdek, Stax, Pink Triangle, Michell,

Monitor Audio, Yamaha, Marantz, Kef, Bose, Celestion, Epos, Mission, Denon, Neat Petite. Mon-Sat 10-6pm.

STUDIO 99, 79-81 Fairfax Road, Swiss Cottage, London, NW6 Tel 071 624 8855 or Fax 071 624 5315. Linn, Naim, Meridian, Rega, Quad, Nakamichi, Mission/Cyrus, Kef, B&O, Yamaha, Creek, etc. 2 single speaker dem rooms. Appts necessary. Home trials, free installation, Visa/Access, 10-7pm Mon-Fri, 10-6pm Saturday.

THE CORNFLAKE SHOP, 37 Windmill Street, London W1.(071) 631 0472 (domestic), (071) 323 4554 (multiroom). Fax.(071) 436 7165. Tues-Sat 10-7 Rega, Roksan, Naim, Monitor Audio, Arcam, Nakamichi, Rotel, Epos etc. 3 dem rooms (incl. home cinema) Friendly professional service. Home trial facilities, appts preferred. Full delivery and repair service. Multiroom specialists. Access & Visa.

MUSICAL IMAGES, 173 Station Road, Edgware, Middlesex. Tel. (081) 952 5535. See advert under Middlesex for more information.

MUSICAL IMAGES, 45 High Street, Hounslow, Middlesex. Tel.(081) 569 5802. See advert under Middlesex for more information.

AUDIO T, 190 West End Lane, West Hampstead, London, NW3 1SQ. (071) 794 7848. Fax (071) 431 3570. Great Hi-Fi from Adcom, Arcam, Audiolab, B&W, Denon, Epos, Marantz, Meridian, Michell, Mission, Philips, Rotel, Proac, Micromega, Nakamichi, Yamaha, & many more. Mon-Sat 10-6. 3 year guarantee on Hi-Fi. Free delivery & installation. 30 day free upgrade scheme. Home demonstrations. Part exchange. 2 listening rooms. BADA Bonded.

ALPHABEC, 392 Finchley Rd, London NW2 2HR. Tel:071 431 9133. Denon, Yamaha, Jamo, Hecco, Alphason, JVC, Nakamichi, B&W, Quad, Soundstyle, Stand Design, Boston Acoustics, Thorens, AMC, Grundig, Musical Fidelity and many more. Home Cinema Products. Free installation & delivery. Open Mon-Sat 10-6pm. Thurs 10-1pm.

GREATER MANCHESTER

THE AUDIO COUNSEL, 12 Shaw Road, Oldham, Manchester, OL1 3LQ. Tel. 061 633 2602. Linn, Arcam, Naim, Yamaha, Creek, Nakamichi, Denon, JPW, Marantz, Royd, Lexicon. 3 dem rooms, free install, Visa/Access. Licensed credit brokers up to £1,000 instant credit. Full multi-room & A.V. installation. 10.00-5.30pm Mon, Tues, Wed, Sat, 10.00-7.00pm Thurs & Fri.

HALE HI-FI, Tel 061 929 0834. See our main entry under Cheshire,

BILL HUTCHINSON HIFI, 50-52 Deansgate, Manchester M3 2FE. (061) 8321600. For the largest selection of HiFi and audio visual equipment in the North West. Specialist A.V. demonstrations of the highest quality. Best prices guaranteed. Minimum 2 year warranty and an optional 5 yr guarantee

TO FIND YOUR AREA
Use our
COLOUR REFERENCE



To Advertise in this section, please contact Caroline Knott on:

071 266 0969

Hi-Fi World Dial-a-Dealer

available. Instant credit and mail order service on offer throughout the U.K. Pioneer, Denon, Kenwood, Yamaha, Technics, Marantz, Mission, Tannoy plus many more.

MERSEYSIDE

DOUG BRADY HIFI, 401, Smithdown Road, Liverpool, L13 3JJ. (051) 733 6859. Fair demonstrations and home trial facilities. All credit cards. Largest choice of specialist hi-fi in N.W. Closed Wednesdays and lunch 1-2.15pm.

P & A AUDIO (BIRKDALE) LTD. 31 Liverpool Road, Birkdale, Southport (0704) 68373. Arcam, Cambridge, Creek, Denon, Michell, Mission/Cyrus, Mordaunt-Short, NAD, Pink Triangle, QED, Revolver, Rogers, Rotel, Royd, Tannoy. 3 Single speaker demo rooms and Naim surround sound dem room. Free delivery, installation (Merseyside) Service dept. Mon-Sat 9-5.30 Half day Tues. Access, Visa, Lombard.

MIDDLESEX

HARROW AUDIO, 27, Springfield Rd., Harrow, Middlesex. Tel: 081 863 0938. Open Mon-Sat 9.30-5.30. Most brands available - see our regular advert for full range including Audioblab, Arcam, Audioquest, Apogee, Aura, B&W, Cyrus, Denon, Epos, Krell, Marantz, Mission, Nakamichi, Tannoy, Target, Yamaha etc. AV Specialist including installation. Interest Free Credit - ask for details. The largest range of accessories for miles around. 2 dem rooms. Plus Carriage Free Mail Order.

AUDIOCRAFT, 18 Hillingdon Road, Uxbridge, Middlesex, UB10 0AD. (0895) 253340. Unbelievable but true you can audition these brands here. Audion, Proac, Michell, Erle, LFD, Lumley, Levison, Lurne, Triangle, Sentec, Mag Audio, Teac, VHD, Silversounds, YBA, Stax, Theta, Monitor Audio, Fuller Audio, Trilogy, Lyra, Sumiko, Ortofon, Decca, Target, Project, Moth, Kelvin, Townshend, Edison, Audio Alchemy, Kesiki, Musical Fidelity.

MUSICAL IMAGES, 45 High Street, Hounslow, Middlesex. Tel: (081) 569 5802. Fax: (081) 569 6353.

MUSICAL IMAGES, 173 Station Road, Edgware, Middlesex. Tel: (081) 952 5535. Fax: (081) 952 5535. Most brands available - see full page advert. Interest free credit, ask for details. Demo rooms. Repairs & Service. Sunday opening - Open all week. A Home Cinema Specialist. Mail order. Part exchange.

AUDIO T, 159a Chase Side, Enfield, Middlesex, EN2 0PW. (081) 367 3132. Fax (081) 367 1638. Great Hi-Fi from Adcom, Arcam, Audioblab, Celestion, Denon, Marantz, Meridian, Micromega, Mission, Philips, Rotel, Yamaha, & many more. Mon-Fri 10-6. Sat 9.30-5.30. 3 year guarantee on Hi-Fi. Free delivery & installation. 30 day free upgrade scheme. Home demonstrations. Part exchange. 2 listening rooms. Home Cinema specialists. BADA Bonded.

NORFOLK

BASICALLY SOUND, The Old School, School Road, Bracon Ash, Norwich, Norfolk, NR14 8HG. Tel: (0508) 570829. Arcam, Heybrook, Chord Co. Rotel, Sound Style, TDL, Royd, Denon, Naim, Spendor, Sound Organisation, Audio Technica, Creek, Epos etc. 2 comprehensive dem rooms, home trial facilities, free installations, Visa/Access, HP facilities. Tues-Fri 9.30-1.00pm, 2.00-5.30pm. Saturday 9.30-5.30pm.

PROTECT-A-DISC, Unit 4, Elvin Way, Sweetbriar Industrial Estate, Norwich, NR3 2BB. Tel: 0603 482193. Producers and suppliers of finest quality car record and CD sleeves with taped edges, poly-lined or unlined, mailers and cruciforms etc. Please send SAE for full current price list. Trade enquiries welcomed. Tel: 0603 482193.

NORTHAMPTON

LISTEN INN, 32 Gold Street, Northants NN1 1RS. Tel: 0604 37871. Fax 0604 601430. Naim, Linn, Rega, Audiolab, Arcam, Cyrus, Royd, Nakamichi, Mission, Denon, Rotel, Nad, Heybrook, Marantz, Chord Co. etc. etc., Open 10.00 - 5.30 (Closed Thurs)

NOTTINGHAMSHIRE

DEFINITIVE AUDIO, Tel: (0602) 813562. For a carefully considered approach to building a true high fidelity audio system with components derived from the following manufacturers: Audio innovations, Wadia, Micromega, Deltec, E.M.T., Horning, Voyd, Systemdek, SME, Revox, Impulse, Ortofon, Pioneer. Also the remarkable Living Voice Air Partner loud

speaker system. Demos by appt. Please phone for further details, install. free of charge. Mon-Sat 10.00-7pm. Closed Wed a.m.

PETER ELLIS AUDIO, 29 Kirkgate, Newark, Notts NG24 1AD. Tel: 0603 704571. QUAD, Castle, Arcam, QED, Sugden, Tannoy, Threns, Marantz, Denon, Teac. Demo room, free install, Service dept, Access, Visa. Mon-Sat 9-5.30. Closed Thursdays.

CHANTRY AUDIO, 18-18a Eldon Street, Tuxford, Nr Newark, Notts, NG22 0LH. Tel: 0777 870372. Pink Triangle, DPA, Rotel/Michell, Micromega, NVA, Alchemist, Michell, Monitor Audio, Lumley, SME, Audion, and much more! Three dem rooms, home trial, free installation, service department. Access & Visa, credit facilities, Mail order, Mon-Sat 9.30-6.00, Sun and evenings home dem by appointment.

OXFORDSHIRE

AUDIO T, 19 Old High Street, Headington, Oxford, DX3 9HS (0865) 65961. Fax (0865) 60415. Great Hi-Fi from Arcam, Audioblab, Cyrus, Denon, Epos, KEF, Marantz, Meridian, Mission, Musical Fidelity, Rotel, Sony, Yamaha & many more. Mon-Fri 10-6. Sat 9.30-5.30. 3 year guarantee on Hi-Fi. Free delivery & installation. 30 day upgrade scheme. Home demonstrations. Part exchange. 2 listening rooms. Home Cinema specialists. BADA Bonded.

WESTWOOD & MASON, 46 George Street, Oxford. Tel: 0865 247783, Creek, Marantz, Naim, Arcam, Rotel, Rega, Epos, Tannoy, Mission, Nakamichi, Denon, Aiwa, Quad, Yamaha, Monitor Audio. Open 9.30-5.00pm. Dem room. Closed Thursdays.

ASTLEY AUDIO LTD, 3 Marketplace, Wallingford (3 miles from Berkshire border). 0491 893005. Aura, B&W, Technics, Panasonic, Pioneer, Kenwood, Sony, Yamaha, Denon, Dual, Marantz, Mission, Tannoy. 1 listening room. Home trial, free installation. Service department. Access, Visa, Amex, Diners. Instant credit. Tues-Fri 9-5.30, Sat 9-5. Records & CDs stocked.

SHROPSHIRE

AVON HIFI, 12 Barker Street, Shrewsbury, Shropshire, SY1 1QJ. Tel: 0743 355166. Aiwa, Beyer-Dynamic, NAD, Quad, B&W, Mordaunt-Short, Kenwood, Bose, Nakamichi, Onkyo, Teac, Sennheiser. Dem room. Home trial. Free install. Service dept. Access/Visa. £1,000 instant credit. Mon, Tues, Wed, Fri, Sat 9 - 5.30.

SHROPSHIRE HIFI, St Michael Street, Shrewsbury, Shrops. SY1 2ES. Tel: 0743 232065. Stockists of Musical Fidelity, Mordaunt Short, Sony, Kenwood, Pioneer, Rotel, Denon, B&W, Proac. Audio Visual. Products available. Open 9.30 - 5.30pm Mon-Sat.

SOMERSET

MIKE MANNING AUDIO, 110 Middle Street, Yeovil, Somerset, BA20 1NE. Tel: 0935 79361. Fax: 0935 32923. Mobile 0850 325965. Naim, Roksan, Pink Triangle, A&R (Arcam) ION, NAD, Pioneer, Rotel, Denon etc. Dedicated listening lounge, for relaxed and unpressured demos. Appts not necessary but best to telephone first. Home trial facilities on request, free installation and service dept, Instant credit, Access/Visa etc. 9-5.30, closed Mondays.

STAFFORDSHIRE

ACTIVE AUDIO, 95, Stafford Street, Hanley, Stoke-on-Trent, Staffs. Tel: 0782 214994. Fax: 0782 283346. We have four studios including a dedicated Audio Visual studio for the demonstration of quality equipment from the largest range in the Midlands. Open six days per week. Own service department. Free local delivery, home trial facility. Current special offers and buyers fact pack and quotation service on request.

MUSICAL APPROACH, Unit 7, Woodings Yard, Bailey Street, Stafford, Tel: 0785 55154. Also branch at 37 High Street, Aldridge, nr Walsall. Tel: 0922 57926. Linn, Rega, Arcam, Rotel, Royd, Heybrook, Marantz, Teac, Celestion, Apollon, Target. Mon-Sat 9.30-5.30. Home cinema equipment stocked. 2 single speaker dem rooms. Service dept and free install. Credit facilities. We are now agents for Rega products. Stafford branch only.

ACTIVE AUDIO, 29, Market Street, Tamworth, Staffs. Tel: 0827 53355. Fax: 0827 59513. We have two studios including a dedicated Audio Visual studio for the demonstration of quality equipment from the largest range in the Midlands. Open six days per week. Own service department. Free local delivery,

home trial facility. Current special offers and buyers fact pack and quotation service on request.

SUFFOLK

AUDIO IMAGES, 7 All Saints Road, Pakefield, South Lowestoft, Suffolk, NR33 6JL. Tel/fax: 0502 582853. Quad, Triangle, Arcam, Castle, Rotel, Moth, JPW, Finlux, Audio Innovations, plus the amazing RDTWELL range. Separate dem room, no appts nec. 10-6.30 Tues-Thurs, 7pm Fri. 6pm Sat.

SIGNALS Martlesham Heath, Ipswich. Tel: (0473) 622866. Audio innovations, Fuller's Audio, Goldring, Heybrook, Impulse, JPW, Micromega, QED, Sonclink, Sumiko, Alphason, Apollo, Audioquest, Ixos, Project, Soundstyle, Sterling, Townshend, Tricord, Sugden and more!
Monday to Saturday 10 till 6

BURY AUDIO, 47 Churchgate Street, Bury St Edmunds, Suffolk, IP33 1RG. Tel: 0284 724337. Arcam, Audio Alchemy, Heybrook, Marantz, Michell, Meridian, Nakamichi, Pink Triangle, Quad, Rotel, Sonus Faber, Stax., Tube Technology., Single speaker dem room. Free install. Credit facilities. Mon-Sat 9.30-6.00, closed Wed.
Evening dems by appointment.

EASTERN AUDIO, 41 Bramford Road, Ipswich, Tel: 0473 217 217. Fax 0473. 215705. Quad, Arcam, Audioblab, Meridian, Mission, Denon, Rotel, Marantz, NAD, Sony, Rogers, Nakamichi, Systemdek, Technics, Celestion, B&W, Tannoy, Morel Thorens and Top Tape. Also stock a wide range of accessories. usual credit facilities. A BADA dealer.

SURREY

SPALDINGS HI-FI, 352-4 Lower Addiscombe Rd., Croydon, Surrey. 081 654 1231/2040. 3 dem rooms and home dem. Free installation/credit.
Linn, Naim, Quad, Arcam, Audioblab, Cyrus, Marantz, Denon, Ruark. Mon-Sat 9-6, Tues 9-8, Closed Wed. Service dept.

PJ HIFI, The Hifi Shop, 3 Bridge Street, Guildford, Surrey GU1 4RY. Tel: (0483) 504801. 9-6 Mon-Sat. Linn, Meridian, Rega, Arcam, Quad, Revox, Musical Fidelity, Rotel, NAD, Nakamichi, Marantz, KEF, Reference etc.

ROGERS HIFI, 13 Bridge Street, Guildford, Surrey, (0483) 61049. Aiwa, Creek, Denon, Dual, JPW, Marantz, Onix, Pioneer, Systemdek, Ruark, Tannoy, Teac. Dem facilities available, no appts necessary, free installation, service dept. Access/Visa. Instant credit upto £1,000 subject to status. Monday-Saturday, 9.30-6pm, later by appt.

SURBITON PARK RADIO, 48 Surbiton Road, Kingston-upon-Thames, Surrey. (081) 546 5549. QUAD, Castle, Denon, Dual, Kenwood, Mordaunt-Short, JBL, Rotel, Pioneer, QED, B&W and Tannoy. Demo fact. Access, Visa and Switch. 9.30-5pm.

SURREY HIFI, 45 High Street, Godstone, Surrey, RH9 8LS. (0883) 744755. Specialist HiFi outlet, demonstration room and parking available. Quad, Audioblab, TDL, Tube Technology, Rel Acoustics, Nakamichi, Kef, Thorens, Magnum, Rotel, Marantz, Denon, Michell, Furukawa, Van den Hul, Musical Fidelity, Tannoy, Target, JPW. Lumley Reference in stock. Single speaker dem rooms. Free installation service dept, Access/Visa/Mastercard. Open 9-6pm. Closed all day Wednesday.

SUSSEX (EAST)

THE POWERPLANT "Brighton's Leading HiFi Shop". 66 North Street, Brighton, Tel: 0273 775978. Comfortable listening rooms. Knowledgeable and approachable staff. Roksan, Micromega, Exposure, Audioblab, Epos, Rotel, Marantz, Cyrus, Regal, Arcam, Mission and more.

WORTHING AUDIO, 20 Treville Gate, W Sussex, BN11 1VA. Tel: 0903 212133. "The friendly shop with the best sound systems in the South". Friendly advice, 3 yr guarantees, easy parking, open Mon-Sat 9-6pm. Late night Wed. Arcam, Exposure, Naim Audio, Marantz, Ruark, Restek, Clear Audio, Audio Technica, Target, Tripod, Sennheiser, AR and many more.

CHURCHERS HI-FI, 154 Montague St. Worthing, Sussex. BN11 3HH. Tel: 0903 821595. All major well know brands of Hi-Fi stocked. Please call for details.

SUSSEX (WEST)

AUDIO DESIGNS, 26 High Street, East Grinstead, West Sussex, RH19 3AS. Tel: 0342 314569. Friendly understanding Hi-Fi specialists. Audioblab, Arcam, Cyrus, Epos, Linn, Marantz, Mission, NAIM, NAD, Neat, Quad, Rotel, Sony, Stax, Tannoy, Target, Thorens, Yamaha. Dem rooms, free installation, service dept, credit facilities, mail order, credit cards, 9.30-6.00 6 days a week.

BOWERS & WILKINS Ltd. (est. 1945). 1 Becket Buildings, Little Hampton Road, Worthing, Tel: (0903) 2 64141. Top names in HiFi and audio visual including B&W, Nakamichi, Castle, Denon, Philips, Quad, Technics, Aura, Teac, Sugden, Mission Thorens and many more. 4 dem rooms (budget-high end.) expert friendly advice, service dept, local installations free. one minute from A24 & A27, free local parking, Access/Visa, Instant Credit up to £1,000 subject to status. Open 6 days.

CHICHESTER HIFI, 7 St Pancras, Chichester, W Sussex. PD19 1SJ. Tel: 0243 776402. Linn, Naim, Rega, Creek Nakamichi, A&R, Denon, Roksa, Epos, JPW, Ruark, Rotel, Quad, Spendor. Evening appts available.

JAYSOUND AUDIO, 5 Waterloo Square, Bognor Regis, Tel: 0243 826355. Aiwa, B&W, Beyer, Denon, Dual, Goodmans, Heco, Jamo, JVC, Marantz, Mitsubishi, Pioneer, QED, Samsung, Sennheiser, Sharp, Shure, Teac, Wharfedale. Free local delivery and install. Part exchange welcome, licensed credit broker, Repairs on all makes of HiFi & TV/Video. Open 9am-6pm. Cl. Weds.

TAYSIDE

J.O. BROWN 28-36 Castle Street, Dundee DD1 9NZ. Tel: (0382) 26591. Rotel, Denon, Pioneer, Technics, Aiwa, Mission, Castle, Mordaunt-Short, Monitor Audio, Bose, Infinity. All equipment ready for demonstration. No appt. nec, free installation/service dept. Open 9.30-6pm six days a week, (close 5pm Sat).

TYNE & WEAR

BILL HUTCHINSON HIFI, 87a, Castle Street, Newcastle-upon-Tyne, (091) 230 3600. For the largest selection of HiFi and audio visual equipment in the North East. Specialist A.V. demonstrations of the highest quality. Best prices guaranteed. Minimum 2 year warranty and an optional 5 yr guarantee available. Instant credit and mail order service on offer throughout the U.K. Pioneer, Denon, Kenwood, Yamaha, Technics, Marantz, Mission, Tannoy plus many more.

WARWICKSHIRE

STRATFORD HIFI, 25 Henley Street, Stratford-upon-Avon, CV3 0W. Tel: 0789 414533. Pioneer, Technics, Denon, Marantz, NAD, Rotel, Musical Fidelity, Monitor Audio, Mission, Tannoy, Quad, TDL, Sennheiser, 0% finance is available on selected products and all major credit cards accepted. Dem Rooms, Service facilities, open 9.30-5.30pm. Late night Thursday until 8.00pm.

WEST MIDLANDS

FRANK HARVEY HI-FI EXCELLENCE, 163, Spon Street, Coventry, CV1 3BB. Tel: 0203 525200. The Midlands first choice for specialist Hi-Fi. Audioblab, Audio Alchemy, Arcam, Audio Quest, Alphason, Bose, Bang & Olufsen, Celestion, Cyrus, Denon, Dual, Foundation, Kef, Reference, Marantz, Monitor, Audio Mission, Musical Fidelity, Nakamichi, Nad, Rega, Rogers, Rotel, Quad, Systemdek, Target, Tripod, Tannoy, Thorens, Van den Hul, Yamaha, 3 floors, 3 demonstration rooms. Open 9.30 till 5.30. Closed Thursday. All credit cards incl. Amex & Diners. Instant credit and interest free facilities. Home trials. Free installation, home cinema AV floor. We are a BADA dealer.

MILANO VALVE HIFI, Specialising in true fidelity systems built around valve amplification:- Audion 300B Silver Nights, Audio Innovations, Impulse, Audio Note, KAL, Townsend Audio, Ortofon, Voyd, Micromega, Edison, Stax, Apollo, Dynavector, Seismic Sink, Valves. Home demonstrations and part exchange. Also vintage: Leak, Quad, Croft, Radford, etc. Flexible opening 7 days. phone Gary 021 722 2317.

Hi-Fi World Dial-a-Dealer

MUSIC MATTERS, 351 Hagley Road, Edgbaston, Birmingham, B17 8DL. Tel 021 429 2811. Roksan, Nakamichi, Arcam, Audiolab, Kenwood, DPA, Tannoy, Royd, Heybrook, Michell, Panasonic, Aura, Celestion, Musical Fidelity, Mission/Cyrus, Meridian, Kef, Monitor Audio, Pink Triangle, Ruark, Epos, Exposure, Pioneer and many, many more! 2 single speaker dem rooms. Appts necessary. Home trial facilities and free install. Service dept. Access/Visa/instant credit upto £1,000. Interest free credit available also. Tues -Thurs 10.00-6.00pm, Friday 10.30-8.00pm, Saturday 10.00-5.30pm. Check out the new branch in Solihull - Phil works there so it can't be bad! 021 724 0284.

COVENTRY HI-FI, 126, Church Lane (off Walsgrave Road), Coventry, CV2 4AJ. Tel: 0203 440529. Quad sales & service agent, Pioneer Reference Point, Kenwood, Aiwa, T.D.L. B&W, Tannoy etc. Private listening room. 2 year guarantee on all new hi-fi. Open 9.30-5.30 Mon-Sat. Closed Thursdays.

ELECTRO CENTRE, 244 Soho Road, Handsworth, Birmingham, Tel. 021 554 1878. Full range of HiFi, Pioneer, Technics, Kenwood, JVC, Sony, Aiwa, Akai, "Guaranteed the lowest price in the UK" 24 hour mail order facility available.

ELMDON AUDIO, Tel 021 784 8765. Reference Imports Lumley, Alon etc. Esoteric Audio Research 834 integrated on demonstration. Home demonstration can be arranged. Top part exchange prices, lots of used bargains. Quad, Leak, etc. Valves and valve testers, new GEC KT66s available.

FIVEWAYS HI-FIDELITY LTD. 12 Islington Row, Edgbaston, Birmingham, B15 1LD. 021 4550667. Advent, Albary, AKG, Alphason, AMC, AR, Arcam, Audioquest, Auditechnica, Beyer, Bose, Castle, Chord, Denon, Dual, Gold Ring, Meridian, Michell, Monitor Audio, Nagaoka, Nakamichi, Ortofon, QED, Quad, Revox, Sennheiser, Spendor, Target, TDK, TDL, Thorens, Wharfedale. K Monks Record Cleaning Service. Closed Mondays.

MUSICAL APPROACH, 37 High Street, Aldridge, nr Walsall. Tel 0922 57926. Linn, Arcam, Rotel, Royd, Heybrook, Marantz, Teac, Celestion, Appollo, Target, and others. Mon-Sat 9.30 - 5.30. Closed Thursdays. Home Cinema equipment stocked. Dem rooms, service dept. Free installation and credit facilities. Free parking at rear of shop.

SOUND ACADEMY, Just off the high Street, Bloxwich, Walsall, W. Midlands. (Ample free parking). Tel. 0922 493499. Alberty, Art Audio, Acoustic Energy, Arcam, Audiolab, Audioquest, B&W, Bose, Chord, Cyrus, Cable Talk, DPA, Ensemble, Epos, JPW, Kef, Reference, Marantz, Meridian, Mission, Monitor, Musical Fidelity, Nakamichi, Ortofon, Project, Quad, Roksan, Tube Technology, Triangle and many more. Open 6 days a week. Mon-Sat. All major credit cards taken. Part exchange, enquiries welcome.

AMADEUS SOUND & VISION, 10 Boldmere Road, Sutton Coldfield, West Midlands. Tel. 021 354 2311. Audio Innovations, B&O, Castle, QED, Wharfedale. Single speaker demo, appts preferred, service available, installations, B&O link install, home trials. Access/Visa, interest free credit available subject to status. 9.30-6.00pm 6 days.

GRIFFIN AUDIO, 94 Bristol St., Birmingham, Tel. 021 622 2230/021 692 1359. Tues-Sat 10 a.m.-6 p.m. Enjoy music at home with a system from Griffin Audio. We demonstrate and install the very best hi-fi, with systems from £500 to £25,000. Ask for Bob, Tim or Alex. Linn, Naim, Shahinian, Quad, Arcam, Rega, Denon, Marantz, Rotel.

WILTSHIRE

THE AUDIO EXCHANGE, 52 Morse Street, Swindon, Wiltshire SN1 5QP. (0793) 539008. Acoustic Energy, Audio Innovations, Beard, Cerwin Vega, C.R. Developments, Impulse, Magnum, Micromega, Michell, REL, Sequence. AV and single speaker demo room. Home trial facilities, free installation, service dept. Mon-Sat 10-6.

AUDIO T, 60 Fleet Steet, Swindon, Wiltshire, SN1 1RA (0793) 538222. Fax (0793) 487260. Great Hi-Fi from Arcam, Audiolab, Denon, Linn, Marantz, Meridian, Mission, Rotel, Sony, Yamaha & many more. Mon-Sat 9.30-5.30. 3 year guarantee on Hi-Fi. Free delivery & installation. 30 day free upgrade scheme. Home demonstrations. Part exchange. 2 listening rooms. Home Cinema specialists. BADA Bonded.

WORCESTERSHIRE

SPAINS HI-FI, 2 +2a New Rd., Bromsgrove, Worcs. Tel: 0527 872460. Aura, B&W, Beyer, Denon, Heco, JVC, Kenwood, Marantz, Mission, Monitor Audio,

NAD, Nakamichi, Pioneer, Rotel, Sennheiser, Soundstyle, Sony, Systemdek, Tannoy, Target, Thorens. Integral demo room/showroom for instant comparisons on Hi-Fi & AV equipment. Free installation. Part exchange welcome. Service department. Access, Visa, 0% finance on slcted products. Mon-Sat 9.00-5.30 pm. Closed Thursdays.

WEST MIDLANDS

WEST MIDLANDS AUDIO, 158 Ombersley Road, Worcester WR3 7HA. Tel 0905 458046. Fax. 0905 457585. Naim, Rega, Rotel, Marantz, Nakamichi, NAD, Audiolab, Roksan, Meridian, B&W, Audio Research, Krell, Martin Logan, Arcam. 9-5.30 Mon-Sat, eve's by appt only. Free

YORKSHIRE (SOUTH)

HIFI STUDIO'S, Sunnyfields, Doncaster, Tel 0302 781387 TDL, Sugden, ProAc, Ruark, Teac, Impulse, Systemdek, Alphason, Target, Albary, Heybrook, Monitor Audio, JPW, Totem, Harbeth, Keswick Audio Research, Michell Engineering, AMC (CD and Valves), CR Developments (Valves), Art Audio (Valves), Rel Acoustics, Projekt, Origin Live, Dual, Yamaha plus home Cinema pro-logic dems. Listening room demo's. Home trial, free install, licensed credit broker, 2 yr guarantee on all equipment, service available. Access/Visa. 10-8pm 6 days. *phone for further information and free fact pack.

TRC HIFI, 3 Kings Cross Street, Halifax, HX1 (0422) 366832. Agents for Kenwood, Denon, Castle, Rotel. Demonstrations and advice a pleasure. Call at any time to audition some of the best HiFi and pro-logic systems. Delivering and installation free within 20 miles. "The family firm where the customer matters most."

YORKSHIRE (NORTH)

AUDIO CLINIC, 22 Lord Mayors Walk, Yorks, YO3 7HA. Tel. (0904) 646309. Revox- Qed- Audio Innovation-Allison-Celestion-Yamaha-Teac-Revolver-JPW-Kenwood-Bose-Thorens-Mission-Snell-B&W-Heco-Cannon-NAD-JVC-Musical Fidelity-Wharfedale-Micromega-Ruark-Heybrook. Surround sound and demo rooms, free installation. Service Dept. Credit facilities on request. Access, Visa, Open 10am - 5pm 6 days a week.

SCARBOROUGH HIFI, 14 Northway, Scarborough, North Yorkshire YO11 1JL. Tel. 0723 374547. Albary, Aura, B&W Matrix, Cyrus, Pioneer, Philips, Marantz, Cabasse, Bose, Tannoy, DCC wide screen and lazer vision. Home trial facilities and free installation, service dept, Access/Visa, Credit charge, £1,000 instant credit/ Amex/Diners.

THE SOUND ORGANISATION (YORK) 2b Gillygate, York, YO3 Tel. (0904)627108. Linn, Meridian, Micromega, Naim, Rega, Arcam, CREEK, Nakamichi, Mission, Denon, Epos, Royd, Rotel. 3 single speaker dem rooms, appts. preferred, home trial facilities, free install, service dept. Credit facilities on request. Access/Visa. 10.00am-5.30pm. Tues-Sat. Sony dealer award nominated '86, '87 and '88.

VICKERS HIFI, 24 Gillygate, York. (0904) 629659. Audiolab, Harmon Kardon, Marantz, Musical Fidelity, Pink Triangle, Quad, Systemdek, Tannoy, Technics, and lots more. 3 dem studio's. (2 by appointment). Superb showrooms. 2 yr guarantee on all hi-fi products. Appts. as above. Home trial facilities, free install. service dept. Qualified and experienced staff, over 25 yrs experience. 12 mths interest free credit. 10.30-5.30 Mon-Sat.

YORKSHIRE (WEST)

AUDIOVISION (YORKSHIRE) LTD. 5 Bethel Street, Brighouse, W.Yorks. HD6 1JR. Tel. (0484) 713996. 1 mile from junction 25, M.62. THE NORTH'S LARGEST RANGE OF TECHNICS HIFI SEPARATES AND SYSTEMS. Yamaha Cinema DSP - Hi-Fi dealer for West Yorkshire. Panasonic Nikam TV, VCRs and camcorders. Philips widescreen TV, CD-1 and laserdisc players. Sky satellite, Bose, Castle, Cerwin-Vega, Mordaunt-Short, TDL, Aiwa, & Pioneer. AV and LD player. Six home Cinema/ Dolby Pro-logic systems on continuous demonstration. Access/Visa and Credit charge.

BILL HUTCHINSON HIFI, 26-28 Woodhouse Lane, Leeds (0532) 427777. For the largest selection of HiFi and audio visual equipment in the Yorkshire. Specialist A.V. demonstrations of the highest quality. Best prices guaranteed. Minimum 2 year warranty and an optional 5 yr guarantee available. Instant credit and mail order service on offer throughout the U.K. Pioneer, Denon, Kenwood, Yamaha, Technics,

Marantz, Mission, Tannoy plus many more.

DOUG BRADY HIFI, The Forge Cottage, 19 Cross Gate, Otley, West Yorks, LS21 1AA. Tel. (0943) 467689. Naim, Arcam, Rotel, Pink Triangle, Meridian, Epos, Castleg, Two dem rooms, fair demonstrations and home trial facilities. Access/Visa. Open 10.00-6pm Tues-Sat.

SCOTLAND

EDINBURGH

BILL HUTCHINSON HIFI, 43 South Clark Street, Edinburgh. (031) 667 2877. For the largest selection of HiFi and audio visual equipment in Lothian Specialist A.V. demonstrations of the highest quality. Best prices guaranteed. Minimum 2 year warranty and an optional 5 yr guarantee available. Instant credit and mail order service on offer throughout the U.K. Pioneer, Denon, Kenwood, Yamaha, Technics, Marantz, Mission, Tannoy plus many more.

ABERDEEN

HOLBURN HI-FI, 441 Holburn Street, Aberdeen. Tel: 0224 585713. Arcam, Audiolab, B&W, Celestion, Denon, Dual, Epos, Heybrook, ION, Kenwood, Creek, Marantz, Meridian, Mission, Cyrus, M.S., NAD, Nakamichi, Pioneer, QED, Quad, Revox, Rotel, Ruark, Tannoy, Technics, Wharfedale, Yamaha. 9.30-5.30 Mon-Sat.

HI-FI EXCELLENCE, Hi-Fi innovators & product designers with 15 years experience. Very much in the business for the music. Musical Fidelity key dealer. Largest Rotel retailer in the area. Particularly keen to make the buying of Hi-Fi a fun experience. Situated in the West End away from the bustle of the City centre - the perfect environment to enjoy quality Hi-Fi. Full time service engineer. Open Mon-Tues 10-6, Wed 10-1, Thurs 10-7, Sat 10-5 or later by appointment. Hi-Fi Excellence, 293 Union Grove, Aberdeen. Tel: 0224 322520

AYRSHIRE

LASER AUDIO, Now at new premises : 1 St Marnock Place, Kilmarnock KA1 1DT. Tel: 0563 40292. Audiolab, Aiwa, Celestion, Cyrus, Denon, Dual, Marantz, Mission, Philips, Pioneer Systemdek and Tannoy. 2 demonstration rooms, AV dem room. Appointments preferred, home trial facilities. Free installation, service facilities. Access, Visa and written credit. Open Tues- Fri 10-5.30 Sat 9.30-5.30.

GLASGOW

STEREO STEREO, 278 St Vincent Street, Glasgow, Scotland. Tel 041 248 4079. Closed Tuesday. Installations throughout Scotland. Credit facilities available.

BILL HUTCHINSON HIFI, 43 Hope Street, Glasgow, (041) 248 2857. For the largest selection of HiFi and audio visual equipment in South West. Scotland Specialist A.V. demonstrations of the highest quality. Best prices guaranteed. Minimum 2 year warranty and an optional 5 year guarantee available. Instant credit and mail order service on offer throughout the U.K. Pioneer, Denon, Kenwood, Yamaha, Technics, Marantz, Mission, Tannoy plus many more.

INVERNESS

THE MUSIC STATION, 49 Church Street, Inverness, IV 1DR. Tel. 0463 225523. Beyer Dynamic, Celestion, Denon, Jamo, Kef, Kenwood, Mission, Pioneer, Rotel, Sony. Listening room, service department, free local delivery, part exchange, full range of credit facilities.

IRELAND

DUBLIN

ACOUSTIC DIMENSION, 67 Mountjoy Street, Dublin 7. Tel: 305633, Fax: 305839. (from UK + 0103531). Stockists for speakers : ATC, Acoustic Energy, JPW, Triangle, ProAc, Ref 3A, RuArk, Heybrook, Polk Audio, TDL, Impulse, Chario, Audio Static. Amps by : Albary, AVI, LFD, NVA, Alchemist, Marantz, Audio Innovations, Rotel, CR Developments, EAR, Kinshaw. CD Players and DACs by : AVI, Pierre Lurne, Micromega, Kinshaw. Turntables by : Project. Tables/Stands: Apollo. Cables: Straightwire, Ixos, VLS, Eagle. Credit cards and mail order.

CLONEY AUDIO, 55 Main Street, Blackrock, Co Dublin. Tel. 2889449/2888477. Fax. 2834887. Products include: Arcam, Classe, Philips, Rogers, Epos, B&W, Naim Audio, Meridian and others. Open Tues/Sat 10am-6pm. Thurs/Fri till 9pm. Closed Mondays.

PETER DAND & CO LTD. 111 Clonskeagh Road, Dublin 6. Tel. 0103531 2694433. Products include: B&O, Quad, KEF, Thorens, TEAC & many more! 2 demonstration rooms and 2 year guarantee.

BELFAST

LYRIC HIFI, 163 Stanmills Road, Belfast (0232) 381296. Linn, Naim, Rega, Arcam, Denon, Rotel and more. Mon-Sat, 10.00-6.00pm. Late night Thurs.

ZEUS AUDIO, 6 Hope Street, Belfast, (0232) 332522. Audio Innovations, Pink Triangle, Roksan, Marantz, Celestion, Meridian and more. Mon-Sat 10.00-5.30pm. Late night Thursday.

COUNTY DOWN

ASTON AUDIO, Unit 8, Kings Road Shopping Centre, Kings Road, Belfast. (0232) 402220. Akai, Technics, JVC, Samsung, Toshiba, Panasonic and many more. Demos. Open Mon-Frid 10-8pm Sat 10-5pm.

LONDONDERRY

ZEUS AUDIO, 23a Kingsgate Street, Colrairie, BT52 4LB. Tel. (0265) 56634. Marantz, Mission Cyrus, Aiwa, Akai, Alphason, Sony, Pink Triangle, Celestion, Rotel. Mon-Sat 10-5.30pm. Closed Thurs.

WALES

ACTON GATE AUDIO, 4 Ruabon Road, Wrexham, North Wales, Tel. 0978 364 500. Arcam, B&W, Marantz, Mission, NAD, Quad, Rega, Rotel, Tannoy, Yamaha, etc. Dem facilities, A.V. on dem. Mail order. No appts nec, home trial fac. Free install, Service Dept. Access, Visa. 9.30-5.30 closed Weds pm.

ELECTRO TRADER, 19 Colwyn Crescent, Rhos on Sea, Colwyn Bay, Clwyd, Wales, LL28 4RN. (0492) 548932. NOW APPOINTED SUGDEN DEALER FOR THE NORTH WEST. Rotel, Yamaha, NAD, Harman, Kardon, Teac, Alphason, Heco, Infinity, KEF, JBL, Suggden, Tannoy, Rotel Michi, Heybrook, Acoustic Research, Ruark and Soundstyle tri-pod racks etc. Dem room appts preferred. Home trial. Free install. Access, Visa, Open 9.30 - 1.00, 2.00 - 5.30 Mon-Sat.

AUDIO EXCELLENCE ' WHERE THE MUSIC MATTERS', 134-6 Crwys Road Cardiff CF2 4NR, Tel. 0222 228565 Fax. 0222398201. Great Hi Fi carefully selected and demonstrated by friendly enthusiastic staff. Home installations and check-ups. Two year warranty from our own service department. Open 9.00-5.30 Tuesday - Saturday closed Monday.

AUDIO EXCELLENCE ' WHERE THE MUSIC MATTERS', 9 High Street, Swansea, SA1 1LE. Tel. 0792 474608 Fax. 0792 645087. Great Hi Fi carefully selected and demonstrated by friendly enthusiastic staff. Home installations and check-ups. Two year warranty from our own service department. Open 9.00-5.30 Tuesday - Saturday closed Monday.

I&H GRIFFITHS & SONS, 313 High Street, Bangor LL57 1YA. 0248 370655. Yamaha, Tannoy, Teac, Sony, B&W, Wharfedale, Rotel, JVC. Home trial facilities, free installation, service dept. After hours dems by appointment. Access, Visa, Lombard credit charge. Mon-Sat 9-5.30, Wed 9-1. Audio Visual Specialists.

TOP TAPE, 1 Crystal Way, Elm Grove Road, Harrow, Middlesex, HA1 2RJ. Tel: 081 427 1404. The UK's oldest and largest Tape Mail Order Service. TDK, Maxell, Sony, Ampex audio cassettes plus Fuji, JVC, Konica, Memorex, Scotch & TDK video tapes. Send for complete list of latest prices and offers including Video 8, VHS-C, S-VHS, DAT, MiniDisc and Open Reel and tape accessories including Allisop. Local Dealer Listing available. Telephone orders on 081 427 1404 Mastercard, Visa & Switch accepted.

Surman on soprano and baritone saxophones, bass clarinet and synthesizers.

In many respects, the record carries all the hallmarks of one of Surman's own beautiful, elegaic, pastoral solo records, but Phillips' compositions (and as with the Motian set, Journal Violone feature entirely leader-written material) are shot through with a crystalline iciness a million miles from Surman's essential warmth. This is fabulous stuff though, and its austere exterior easily rewards repeated in-depth listening.

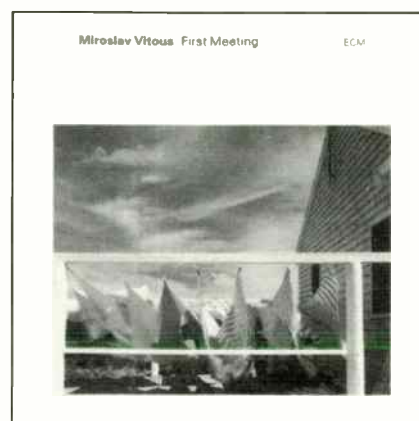

MIROSLAV VITOUS
First Meeting
ECM 519 280-2

● Another bassist-led set, and again dating from 1980, First Meeting has many of the romantic-melancholy-pastoral leanings of the Phillips set, but is nonetheless far more conventionally jazz-ish in its approach to similar material (which, with the exception of a single group improvisation - the title track as it happens - is, again, entirely leader-composed).

The record features a more regular jazz quartet for a start: Vitous himself, one-time member of fusion superstars Weather Report and a bassist who easily melds rhythmic drive and abstract lyricism; drummer and percussionist Jon Christensen, another ECM mainstay and veteran of sessions with contemporary jazz legends like Jan Garbarek and Keith Jarrett; once again John Surman, here on just soprano sax and bass clarinet; and American pianist Kenny Kirkland, a fine and swinging improviser, if a tad staid for my own liking.

If the tundric harshness of the Phillips sets and the spontaneous abstraction of the Motian are still a hint alien for you, First Meeting ably bridges the gap between these extremes and more conventionally accessible contemporary jazz, a kind of bridge which I reckon is still one of the most lasting and significant bequests of the first half-dozen Weather Report records. Vitous may only have been with the group a short while, but he learned at least this from Zawinul and Shorter. A highly enjoyable listen.

accessibility with unfettered, searching self-expression, he represents the very best that ECM has had to offer for over twenty years.

Le Voyage was recorded in 1979 and features a fine trio of Motian himself, bassist J.F. Jenny-Clark and the masterful Charles Brackeen on tenor and soprano saxophone. The album features five of Motian's own compositions and they're so perfect - in conception and performance - that it's hard to believe that Motian - bandleader, drummer and composer - kept on getting better and better, but he surely did, and remains one of all current jazz's finest, if most underrated talents. All of these ECM reissues are worthwhile and enjoyable, but Le Voyage is essential.

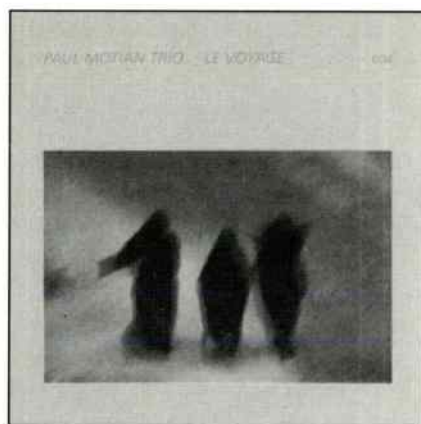

PAUL MOTIAN TRIO
Le Voyage
ECM 519 283-2

● First up this month, a quartet of CD reissues from the German ECM label. Pick of the bunch for my money is almost certainly the Paul Motian Trio's Le Voyage. Drummer Motian has been an ECM stalwart from the label's earliest days, both as a sideman and as a leader. His approach to both composition and playing has almost been the perfect summation - certainly the finest example - of the label's style and aims. He balances abstraction and romanticism perfectly, with pieces that range from driving post-bop to hypnotic tone poem, from achingly lovely folk tune to intense Free Jazz. In balancing virtuosity with carefree experimentation, and

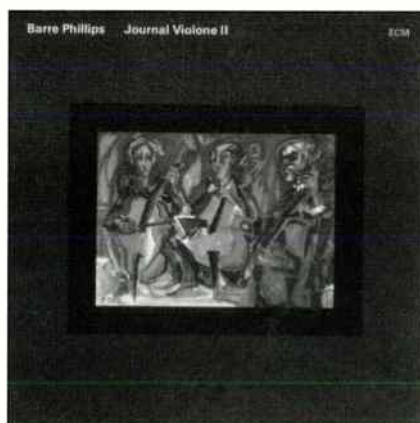

BARRE PHILLIPS
Journal Violone II
ECM 847 328-2

● If Le Voyage's bass-drums-sax line up is an unconventional one (though one which Motian has employed, always successfully, over and over), Barre Phillips gathered a - for him - characteristically odd group together for 1980's Journal Violone. The record features the leader on bass, of course, singer Aina Kemanis and the West Country's own superb John

Simon Hopkins

Hi-End Hi-Fi in the heart of East Anglia.

For the best in Hi-End hi-fi Bury Audio is a must. All the names stocked are individually chosen to complement one another to give the best sound in their class. To get the best from CD there are DAC's like **Pink Triangle - Da Capo** or **Ordinal**. Great sounds now can mean good looks too thanks to **Michell - Iso, Argo, Alecto**. Now, Gyrodec sounds better still with the **Tesserac - Tags psu**. Valves from **Tube Technology - Unisis**. For fanatics, **Musical Fidelity - F22** and **F15**. Open natural sounds from **LFD - PAO, LSO, MMO**. Stunning to look at and to listen to the new **Ruark - Equinox**. These are just a selection of the impressive sounds on demonstration now. Why not come in and have a listen to the best sounds in East Anglia.

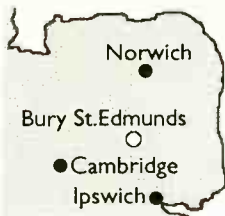

Bury Audio

47 Churchgate Street,
Bury St. Edmunds, Suffolk IP33 1RG
Tel or Fax : 0284 724337

TABULA RASA LOUDSPEAKERS



"It is a rare experience to play a track that you have known for the better part of, say, twenty years and suddenly, to hear new details and information."

(Hi-Fi World - Dec '93 on CT77 loudspeaker kit)

With the increased popularity of "do it yourself" hi-fi, Tabula Rasa are offering an extensive range of quality loudspeaker kits and car audio kits from top German manufacturer Mainhattan Akustik.

All loudspeakers kits are simple, fun to build, and at prices to suit all pockets. Each kit comprises drivers, filters, connections, terminals, and all the necessary fittings needed to complete your chosen loudspeaker, and every kit is available with or without cabinets. Furthermore, each kit comes with a 10 year warranty as standard and will be delivered within 14 days of confirmation of your order. For a catalogue (including price lists and a brief guide to speaker construction) please send £2.00 (refunded after first kit purchased) and a self addressed A4 envelope to:

Tabula Rasa, 136 Kilnwood, Walters Ash, High Wycombe,
Buckinghamshire, HP14 4UR, Tel 0494 565116

Cheques and postal orders should be made payable to Tabula Rasa.
Trade prices available on request.
30 days money back guarantee offered
on all drivers & kits.

Wilmslow Audio

THE ULTIMATE HI-FI EXPERIENCE

Arcam Aiwa Audiolab B&W Castle
Denon Dual Heybrook Kef Marantz
Monitor Audio Mordaunt-Short
Nakamichi Qed Revolver Rogers
Tannoy Target Teac . . .

*Britain's leading loudspeaker kit
and drive unit suppliers*

Catalogue of our full range £2.00

Four demonstration rooms

Wellington Close, Parkgate Trading
Estate, Knutsford, Cheshire WA16 8DX
(Dpt HFW)

No appointment necessary Closed
Monday

Telephone (0565) 650605

Fax (0565) 650080

LOOKS LIKE
NO OTHER...
SOUNDS LIKE
NO OTHER...
SOUNDS LIKE
NOTHING
AT ALL.

THE BEST IN
THE WORLD.



Interconnects and
Speaker Cables.
Made in USA

Available exclusively
from Wollaton Audio and
selected dealers.

WOLLATON
A·U·D·I·O

tel/fax: 0602 284147
Dealer enquiries welcome.

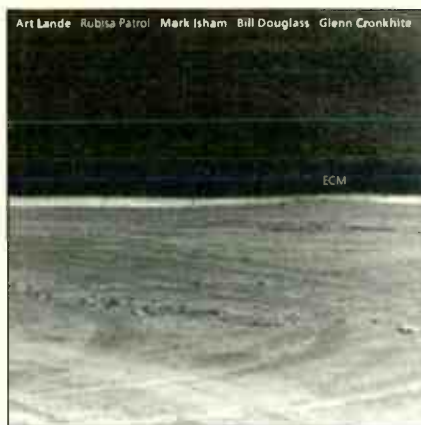

ART LANDE
Rubisa Patrol
ECM 519 875-2

● But even more straightforwardly enjoyable - and perhaps the most straightforwardly enjoyable of all these ECM reissues - is pianist Art Lande's Rubisa Patrol, recorded and originally released in 1976. The record features a quartet of Lande, trumpeter Mark Isham (doubling here on Flugelhorn and soprano saxophone), drummer-percussionist Glenn Cronkhite and bassist Bill Douglass (who also turns in some fine flute, including some pretty gorgeous oriental bamboo flute).

Opening up with a stirring rendition of a traditional Chinese melody which unfolds delightfully into a cracking piece by Isham, the band work their way through a bunch of compositions by the leader, Isham and Cronkhite. They also bash out a driving, take-no-prisoners arrangement of a mind-numbingly complex, odd-metre Bulgarian folk tune, which in terms of sheer "did-you-hear-that?" potential is the album's stand-out track. A good dozen years before any marketing dunderhead dreamt up the odious term "world music", this group were among several weaving together indigenous ethnic musics and jazz improvisation in a highly accessible manner. Not groundbreaking stuff by any means, but you'd have to be a sour old sod not to enjoy this record a good deal.

tracks derived from that sax-driven amalgam normally found on American sitcom themes, but it's well played; just the thing to get you in the mood for the real jazz that comes next, as we enter an easy, modernist album including nods to jazz greats such as Gillespie, Hawkins and - stone the crows! - a Glenn Miller - on acid riff on track six!



Track seven's the disappointment, as Mintzer hasn't the guts in his sax to do slower mainstream jazz well, and I found Kennedy's cymbal-work too forward and irritating at times, but I have no real complaints, as there's a better range of talents, styles and instruments on show than you normally get on MOR-jazz albums. Recommended.

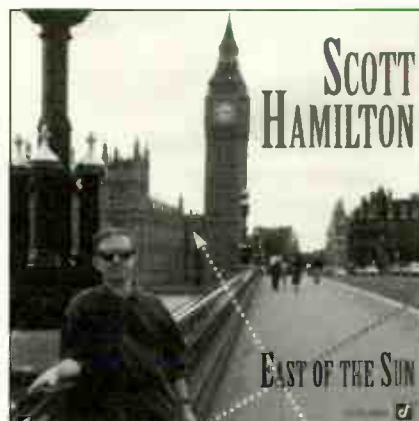

SCOTT HAMILTON
East Of The Sun
(CCD-4583)

● Concord jazz continue their work with another album of well recorded Jazz from Hamilton, who consistently finds fresh, new ways with half-forgotten tunes. Some tracks in this selection - Carmichael/Parish's 'Stardust', Cahn/Styne's 'Time after time' and Hammerstein/Kern's 'All the things you are' - were recorded by the Scott Hamilton Quintet in Tokyo in 1983, and make for interesting comparison.

The intervening decade has barely touched Scott's playing. Perhaps the sound is easier, more mature now but that may be because the frisson of a live recording is absent on this studio

set. What shines through is Scott's masterful touch, a living, breathing line to classic jazzmen from the golden age who have long since fallen silent

Here, Scott is playing alongside three of Britain's finest; Brian Lemon on piano, Dave Green on bass, and Allan Ganley on drums. This group compares well with the Scott Hamilton Quintet as Scott's Zelig-esque ability to play in any setting is reciprocated by this excellent trio. It's been a long time since I have heard a group which bounces phrases around with such ease and confidence.

If you thought that the days of swing were gone - beautiful tunes and easy rhythms with tonal quality preferred to prestidigitation - then it's time you discovered Scott Hamilton. For those in the know this is up there with Scott's best. That should be recommendation enough.

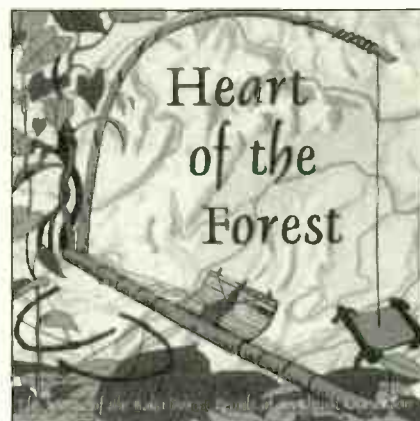

HEART OF THE FOREST
The Music of the Baka Forest
People of Southeast Cameroon
(HNCD 1378)

● So called "World music" rather than jazz, but as close as you'll get to the roots that spawned jazz, blues, and the whole gamut of modern music.

This CD presents a good slice of weird and unearthly Baka music, atmospherically recorded, and with instructive notes. If you want to know where jazz came from, hear this. It may be your last chance before the Baka become 'civilised'.

Simon Cooke

YELLOWJACKETS
Run For Your Life
(GRP 97542)

● This album looks derivative, even down to the sub-Zappa facial hair, shaved chromedome and 'serious muso' dress code on the group photo inside. Run for your life? Surely these guys never even had to run for the bus! The thanks list even begins 'All our families' and ends with 'the memory of Richard Tee'. Can the music really be as formulaic as the album looks?

Hell, no! it begins with a couple of



The thrill of hi-fi is often hearing the most delicate and subtle aspects in a recording. Today's CD technology can present an astonishing amount of information, but getting it all into your system is not quite that easy.



The more you put in

INPUT

It's here that Audio Technica's micro engineering skills can help, starting with the **AT6078 CD Lens Cleaner**. Deep

inside your player the lens attracts dust, smoke and other debris, an industry acknowledged problem.

A 10 second session with the unique eight brush disc safely returns optimum performance, greatly reducing tracking error for higher fidelity. **AT6078**

contains CD control codes for fully automatic operation (in car **AT7121**). As an improvement to all machines but especially those 'budget' models **AT674 CD**

Stabiliser is a carbon-fibre disc which helps reduce servo motor movement and aid error correction. Finally there's our magic green damping rings

AT6079 which fit to the edge of individual CD's to absorb stray laser light. The result is a smoother, more integrated sound and added disc edge handling protection.

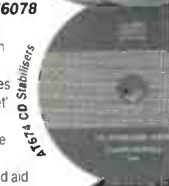

& OUTPUT

The better it comes out

From the wide A-T headphone range we can offer **ATH308** (and sister model 309), the perfect

mid-size headphones. High sensitivity, low weight and extreme comfort make them stand out from the crowd.

Our 900 Series offer a 'larger than life' sensation courtesy of large diameter drivers and copper clad aluminium voice coils. Top of this range **ATH911SV**

is packed with sound enhancing features including 'High Energy' Neodymium magnets.

For ultimate audiophile listening **ATH9000** is a very special headphone/transformer combo which sits in a direct

line between your amplifier and loudspeakers. Its electret

condenser system is at the leading edge

of high fidelity to re-create the very sense of 'being there'.

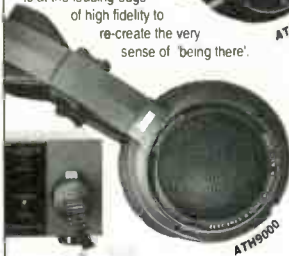

audio-technica®

INNOVATION PRECISION INTEGRITY

Technica House, Royal London Industrial Estate
Old Lane, Leeds LS11 8AG

Tel: 0532 771441 Fax: 0532 704836

SEE THEM AT GOOD HI-FI STORES

"ASTOUNDING"

DIGIT THE DAC

QED'S Bitstream Digital to Analogue Converter

"... It really is the most cost effective upgrade ever... For twice its price it would be superb, at what it costs, it's outstanding." (Hi-Fi World May 1992)

Send a 1st Class Stamp for a copy of the full review and our NEW 32 PAGE AUDIO CATALOGUE.



QED

QED AUDIO PRODUCTS LTD, RIDGEWAY HOUSE, RIDGEWAY CLOSE,
LIGHTWATER, SURREY, GU10 5XU, ENGLAND

**CAMBRIDGE
HI-FI LTD**

**NATIONAL HI-FI
DEALER OF THE
YEAR - 1987/88**

1-3 HAWTHORN WAY,
CAMBRIDGE
CB4 1AT.
TEL. 0223 67773
FAX. 0223 353741

BOSE, KEF,
PIONEER,
MARANTZ,
KENWOOD,
B&W, TECHNICS,
JAMO,
MORDAUNT
SHORT, YAMAHA

*AV Prologic
Separates &
Systems
40" Pioneer
projection screen
on AV Demo*

**WIDE RANGE OF
LASER DISC
SOFTWARE
LATEST
AMERICAN &
BRITISH TITLES**

**1/2 PRICE LASER
DISC PROMOTION
NOW ON**

AUDIO ACCESSORIES

SME Garrard Celebration Arm



GARRARD 401 CELEBRATION SME IV TONEARM

A special version of the SME IV cast magnesium alloy tonearm, dedicated to the Garrard 401. The SME IV is precision engineered to be fully adjustable, making set-up easy and precise. If you want to get the best from your Garrard 401, this is a fantastic tonearm, sympathetically styled to form a perfect combination.

GARRARD 401 CELEBRATION SME IV TONEARM£847.15



BUG AUDIO

A fascinating little device no larger than a hand-held remote which allows the user to adjust bias on any cassette deck perfectly for any tape. You can check the state of your cables and connections with it, too! Supplied with a cassette test tape and full instructions. (See review, Nov. 1992 issue.)

BUG AUDIO£59.99

SOUND SWIVEL

A rotating, upright, double-sided, storage cabinet with space for up to 160 Compact Discs, including 8 double jewel-cases. Mounted on an all-steel turntable, it swivels smoothly through 360 degrees giving easy access to the storage compartments either side. Manufactured in durable MDF with a Black Ash effect finish, the Sound swivel comes packed for self assembly with full instructions.

SOUND SWIVEL£49.95



AUDIO ACCESSORIES

HI-FI WORLD SOLID SILVER INTERCONNECTS.

Constructed from strands of solid core silver wire and silver soldered to Neutrik Profi phono plugs which are probably the best available. These line level

interconnects offer the ultimate in transparency, openness and detail. The plugs are bonded to the cable with adhesive heatshrink to ensure that the cable has a long life without

fatigue occurring at the plug join. Available exclusively through Hi-Fi World Mail Order

HI-FI WORLD SOLID SILVER CABLE.....£139.95/1M PAIR.



HI-FI WORLD SILVER PLATED COPPER INTERCONNECTS.

A similar construction to our solid silver cables, but using silver plated copper and standard Gold Phono plugs. Because the majority of the audio signal passed

through the skin of a cable these can approach the quality of silver one but at cost a normal high quality copper cable.

HI-FI WORLD SILVER PLATED COPPER INTERCONNECTS £69.95/1M PAIR.



HIGH QUALITY MAINS CABLES.

Supplied to Hi-Fi World by Campaign Audio Design these mains cables are screened to reduce Radio Frequency and Electromagnetic Noise. They also come with a VDR fitted which protects equipment from mains spikes. The MK plugs have a silver plated fuse and holder for the cleanest supply. Available with IEC or Figure eight (Marantz/Philips CD players) equipment plugs or with a hard wired, soldered 4-way mains block.

1M WITH IEC PLUG.....£19.20
1M FIGURE 8 PLUG£15.75
1M 4-WAY BLOCK.....£31.95

RECORD STORAGE CUBE

Designed to hold about a hundred LPs, with an internal width of 37cm, height of 32.5cm and depth of 32cm. The cubes can be stacked or placed alongside each other - and are even strong enough to be used as seats! Made from 15mm MDF (Medium Density Fibreboard) with a smart durable black paint finish, the

cube is supplied in flat-pack form ready for home assembly.

RECORD STORAGE CUBE£45 EACH

SIX CUBES FOR THE PRICE OF FIVE £225.00

EIGHT CUBES FOR THE PRICE OF SEVEN!.....£315.00



MICHELL ENGINEERING PLUGS

Craftsmanship marks out Michell Engineering's range of gold and rhodium plated plugs from the competition.

GOLD-PLATED SIDE ENTRY BANANA PLUGS (4)£10.00
GOLD-PLATED SURE-LOC BANANA PLUGS (4)£14.95
RHODIUM-PLATED SURE-LOC BANANA PLUGS£18.95
GOLD-PLATED SPEAKER CABLE CONNECTORS...£10.00

GOLD PLATED 4MM BANANA PLUGS

Heavy-duty, gold-plated banana plug with a unique type of axial solderless connection for loudspeaker cables. The cable is stripped back and pushed into a clamping collar which is then screwed down tight, accepting cable up to 6mm external diameter and 4mm core diameter. Supplied in sets of four.

BANANA PLUGS (4)£8.00

Hi-Fi World

AUDIO ACCESSORIES

AUDIO-TECHNICA RECORD CLEANING SYSTEM

Removes both dirt and static; a tiny amount of cleaning agent in the handle removes fingerprints, oil and film, while a pad lifts off dust. Pad brush and fluid are supplied.

AUDIO-TECHNICA RECORD CLEANING SYSTEM £10.50



AUDIO-TECHNICA COMPACT DISC LENS CLEANER

A disc the size of a CD, with fine brushes - one of which is dampened with cleaning fluid. As the disc spins in the player, the brushes clean the laser lens. It may not suit all machines.

CD LENS CLEANER£16.25



KONTAK

An effective cleaning solution that removes contaminants from electrical connections. After application, a system regains its original life, sparkle and vigour.

KONTAK£19.00

HI-FI WORLD DRY STYLUS CLEANER

Keep your stylus sharp and bright for perfect tracking without using fluid. Cut a strip about the size of a matchbox striker off this sheet of card and draw it gently under the stylus from back to front. One sheet of this card, with its aluminium-oxide micro-abrasive coating, should be enough to clean your stylus at least forty times.

DRY STYLUS CLEANER ..£1.95

GOLDRING EXSTATIC MAT

For vinyl users, the Goldring Exstatic is a felt mat made with fine carbon fibre strands. This helps to reduce positively charged static electricity that builds up on the surface of records.

GOLDRING EXSTATIC MAT £7.50



SUPER EXSTATIC CARBON FIBRE DISC CLEANER

Effectively removes dust and grime from record grooves, this cleaner is a combination of one million carbon fibre filaments and a soft velvet cleaning pad.

EXSTATIC CARBON FIBRE CLEANER £9.95

EQUIPMENT SUPPORTS

FrameWorks is an innovative range of versatile hi-fi supports whose high standard of strength and rigidity results from their 'triangulate' design. The shelves are supported on struts of thin cross-section and four sturdy corner columns, to reduce resonances.

Versatility is guaranteed by two or three shelf options, an additional isolation shelf and a stacking unit to expand the system as the hi-fi grows. All you need to do is add components as and

when you feel the need.

FrameWorks stands come with attractive 10mm thick toughened smoked glass shelves, supported on rubber-damped spikes to reduce vibration and lessen the tendency for the glass to slide. Metal parts are finished in a hardwearing satin black powder coat.

FrameWorks stands will extract the best out of any equipment.

FrameWorks' excellent hi-fi equipment stands are now available through our Mail Order Department.

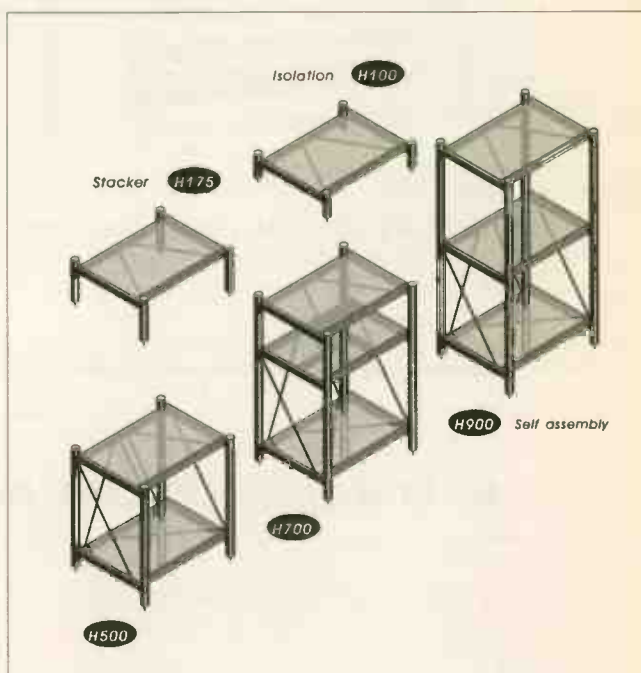

PRICES FOR FRAMEWORKS EQUIPMENT STANDS ARE AS FOLLOWS;

CODE	HEIGHT	PRICE
H100	100MM	£109
H175	175MM	£119
H500	500MM	£205
H700	700MM	£275
H900	900MM	£305

ALL FRAMEWORKS SHELVES ARE 550MM WIDE BY 450MM DEEP. All prices include VAT & p+p for UK only.



H100 ISOLATION TABLE

AUDIO ACCESSORIES

LASAWAY GREEN PEN

When red laser light hits the reflective surface of a CD, some of it can be scattered off the edges of the disc, causing optical interference. Applying this green coating, formulated by Japanese company Mitsubishi, to the inner and outer edges of the CD reduces this interference, improving sound quality.

LASAWAY GREEN PEN£8.50



ANTI-STATIC RECORD SLEEVES

Translucent sleeves, treated to reduce static and dust attraction, supplied in packs of fifty.

They will fit inside ordinary printed inners.

LP SLEEVES (50) PRICE £8.15



MILTY TRIPLE A

Suitable for all types of cassette players including auto-reverse, the Milty Triple A wipes clean single/dual capstans and pinch rollers with a non-abrasive cleaning action.

MILTY TRIPLE A £6.50

MILTY MAGNET IX

The Milty Magnet IX comes complete with battery. It requires approx one second to de-magnetise the heads removing magnetic charge build up. Recommended after every 30 hours of playing time.

MILTY MAGNET IX £10.50

HI-FI WORLD SPECIAL AUDIO ACCESSORIES ORDER FORM

Please send me:

- Audio Technica CD Lens cleaner.....£16.25 each
- Audio Technica Green CD Ring Stabilizers.....£6.50 (Pack of 5)
- Audio Technica Record Cleaning System.....£10.50
- Automatic CD Cleaner.....£21.95
- Bug Audio Biasbug.....£59.99
- CD sound swivel.....£49.95
- Garrard 401 Celebration SME IV Tonearm.....£847.15
- Gold plated 4mm plugs.....£8.00 (4)
- Goldring Exstatic Mat.....£7.50
- Goldring Super Exstatic Carbon Fibre Disc Cleaner.....£9.95
- Hi-Fi World Silver Plated Copper Interconnects (1m pair).....£69.95
- Hi-Fi World Dry Stylus Cleaner.....£1.95 per sheet
- Hi-Fi World Solid Silver Interconnects (1m pair).....£139.95
- Kontak cleaning fluid.....£19.00each
- Lasaway Green Pen.....£8.50 each
- Laserguide.....£14.95
- Michell Gold-Plated Side Entry Banana Plugs (4).....£10.00
- Michell Gold-Plated Speaker Cable Connectors.....£10.00
- Michell Gold-Plated Sure-Loc Banana Plugs (4).....£14.95
- Michell Rhodium-Plated Sure-Loc Banana Plugs (4).....£18.95
- Milty Magnet IX.....£10.50
- Milty Triple A.....£6.50
- Nagaoka Anti-static record sleeves.....£8.15 (50)
- ON Stylus Cleaning Kit.....£2.50
- Pixall MkII Record Cleaner.....£10.75 each
- Pixall refill roller.....£2.75each
- Record storage cube.....£45.00 each
- Screened Mains Cable With 4-Way Block (1m).....£31.95
- Screened Mains Cable With Fig 8 Plug (1m).....£15.75
- Screened Mains Cable With IEC Plug (1m).....£19.20

All prices are exclusive of postage & packing, please add £1.00 for postage in the UK and £2.00 for postage overseas.

I enclose cheque/PO for £.....made payable to
World Audio Publishing Ltd.

I wish to pay by Visa/Access, please debit my account no:

--	--	--	--	--	--	--	--	--	--	--	--	--	--	--	--	--	--	--	--

Expiry date:

--	--	--	--

Name.....

Delivery Address.....

N.B. If delivery address is different to the credit card holder's address please supply both.

Tel:.....

Please send completed order form together with your cheque/PO to:

HI-FI WORLD,
64 Castellain Road,
Maida Vale,
London W9 1EX.



Credit Card Orders
Telephone 071 - 266 0461
24 hour Mail Order Answerphone

Please allow 28 days for delivery

4/94

Try me & see For the very best DEALS for 1994!

**on any current Hi-Fi, A/V,
Home Cinema unit or VCR-
AND all Award Winners**

AMAZING PRICES GUARANTEED

**PHONE NOW—you'll get first-class
service, savings and support.**

- ▶ Budget, Regular and Esoteric Equipment.
- ▶ Insured Overnight Delivery, anywhere in the U.K.
- ▶ Major Credit Cards, Switch/Connect accepted.
- ▶ All goods carry full Manufacturers' Warranty.
- ▶ TMS Warranty covering collection and delivery provided FREE.
- ▶ Extended Warranties up to 5 years available.

*You can always buy from TMS with the complete confidence that we will never let you down.
We ever put our customers first and constantly upgrade and update our systems in order to improve our service.*

081-563 0003
Fax 081-563 0300

**Try Me & See Ltd,
5 Rocks Lane, Barnes,
London SW13 0DB**

The SPEAKER Company

For all your needs in DIY speaker and crossover construction

We offer a large range of speaker chassis and crossover components for hi-fi, car audio, public address & studio uses. The Speaker Company also offers a range of specialist services.

Hi-Fi chassis speakers, crossover's, cabinet kits, cable, cabinet damping materials, spike kits etc

Car Audio chassis speakers, crossover's, sub bass cabinets and amplifiers.

Public Address chassis speakers, crossover's, mixers, amplifiers, cabinets, microphones and stands.

Plus a comprehensive range of accessories

Chassis speakers by

Audax, Seas, Morel, Rcf, Kef, Elac, Rcl, Richard Allan, Fane, McKenzie, Celestion, Eminence, Peerless, Volt, Altai, Soundlab, P.H.L. Please phone or post for a copy of our free comprehensive catalogue and price list which includes hints and tips on DIY loudspeaker construction.

Unit 9, Waterside Mill, Waterside
Macclesfield, Cheshire SK 11 7HG

Tel: 0625-500507

Fax: 0625-500508

All goods dispatched within 24 hours subject to availability

Open 9 am to 6 pm Monday to Friday & 9 am to 5 pm Saturday

The North West's
Big New

 naim
audio

Dealer

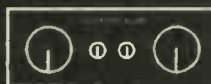

NAIM, RUARK, ROGERS, EXPOSURE, MF,
TANNOY DEFINITION, CREEK, MARANTZ, ROTEL,
TECHNICS, CASTLE, PRO-JECT, TEAC, PINK TRIANGLE.
5 Demonstration rooms.

Open: Mon-Sat 9.00am - 5.30pm
Closed: Wed.

The
Hi-Fi
Showrooms

12a West Street, Congleton,
Cheshire, CW12 1JR.
Tel (0260) 280017

EXPLOIT THE FULL POTENTIAL (and more) OF THE LINN LP12 Turntable

For Only
£568.00 inc.

(Cost much less than a Lingo)

with
Avondale Audio's
Very Naughty (but Stunning) Conversion

For a chat
Tel: (0246) 200096

Please note that we are no longer able to reply to enquiries in writing.

Transformers

Input and Output Transformers designed and manufactured to your requirements, at our OEM prices...

KT66 Single ended valve mono block power amps... **£250.00 pair**

Valve phone stages **MM.. £100.00**
MC.. £135.00

Valve phono stage design sheet, parts and price list.
UK - £3.00 cheque or PO.
Overseas - US \$5.00 in \$ bills only

The Garrard 301/401 power supply 100/130 volt setting.... **£64.45**

All units are fully assembled and tested.
Prices include delivery and VAT
2 week money back guarantee

SAE for data sheets

F&S Trading
31 Brooks Road
Sutton Coldfield
West Midlands B72 1HP
Tel/Fax: 021 - 321 3357

Are you tired of getting ONLY what you pay for?

Call me and see how different it can be.

For the Best of British...

DPA Digital, LFD, Michell, Orelle, Pink Triangle

And the Best of the Rest...

**Classé, Copland, Linaeum, Magnepan,
Sonus Faber, Van den Hul**

'Phone or fax me anytime, 9am - 10pm, any day including weekends on:

0252 - 377952

0385 - 317952

Mike Harvey's

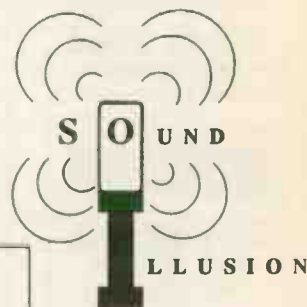

Part Exchange/Ex Demo equipment:

Acoustat Model 3 electrostatics £1500, Musical Fidelity A370 £1000, Sonus Faber Electa £1350

Major credit cards accepted

HALE HI FI



We stock:-

**ROYD, NAIM, LINN, DENON, CREEK,
ARCAM, QUAD, YAMAHA etc....**

A wide range of accessories always available.

Full demonstration facilities - no appointment necessary - full service department.

Free delivery and installation

2 Bold Street, Hale Road Altrincham, Cheshire

WA14 2ER

Telephone: (061) 929 0834

Inaccessible accessories by post.

If you can't get to us, we'll get our accessories to you.

CARTRIDGES: Arcam, A.T., Denon, Dynavector, Goldring, Lyra, Ortofon, Sumiko. **CABLES:** Audioquest, Cable Talk, Ixos, Kimber, Ortofon, Sonic Link, Van den Hul. (including the new carbon cables.) **STANDS:** Alphason, Sound Organisation, Stands Unique, Target. **HEADPHONES:** Beyer, Sennheiser, Stax. **ACCESSORIES:** Allsop, BIB, Discwasher, Hunt, Kontak Last, Michell, Milty, Nagoaka, Pixall, QED. **LP's/CD's:** Audioquest, DCC, Fone, Klavier, Naxos, Opus, Proprius, Reference Recordings, Sheffield Labs. **Plus** a full range of quality equipment available.

Bury Audio

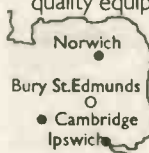

47 Churchgate Street, Bury St. Edmunds, Suffolk IP33 1RG.

For a full catalogue or to order telephone or Fax. 0284 724337 or telephone 0850 565693.

Access, Visa, Diners Club, American Express.

Relatively Speaking, GOLD AERO TUBES

give Music
more Sense of
Space and Time.

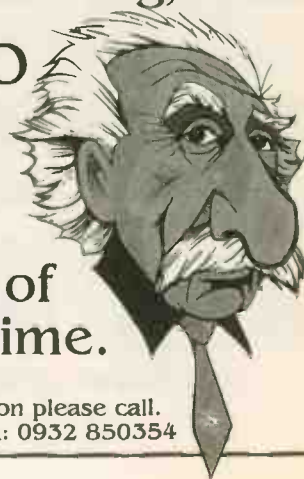

For further information please call.
Tel: 0932 850361 Fax: 0932 850354

Spring Specials at Sevenoaks Superfi.

<p>AMPLIFIERS</p> <p>Arcam Alpha 5 Great delivery and vivacity Claim 3 year warranty Free £229.95</p>	<p>AMPLIFIERS</p> <p>Audiolab 8000A Transparency and power, notably neutral Claim 3 year warranty Free £449.95</p>	<p>AMPLIFIERS</p> <p>Aura VA100 Big sound, open shimmering tone Claim 3 year warranty Free £299.95</p>	<p>AMPLIFIERS</p> <p>Kenwood KA3020 Controlled delivery with plenty of dynamic tension was £169.95 £149.95</p>	<p>AMPLIFIERS</p> <p>Marantz PM44SE Power and subtlety, an absolute bargain Claim £20 CD voucher Free £199.95</p>
<p>AMPLIFIERS</p> <p>Musical Fidelity A1.3 Sweet string tone and warm bass Claim £20 CD voucher Free £329.95</p>	<p>AMPLIFIERS</p> <p>Technics SUA600K Excellent mid range and bass, good value was £199.95 £179.95</p>	<p>CASSETTE DECKS</p> <p>Aiwa ADF410 Great sound from this award recommendation was £119.95 £99.95</p>	<p>CASSETTE DECKS</p> <p>Aiwa ADF810 Stable and sure footed with plenty of punch was £229.95 £199.95</p>	<p>CASSETTE DECKS</p> <p>Nakamichi DR3 Sound quality with ambience and presence was £399.95 £339.95</p>
<p>CASSETTE DECKS</p> <p>Sony TCK511S Dolby S-3 head an absolute steal was £279.95 £219.95</p>	<p>CASSETTE DECKS</p> <p>Sony TCK611S Excellent sound, facilities and value for money was £329.95 £259.95</p>	<p>CASSETTE DECKS</p> <p>Yamaha KX360 High performance deck with vibrant sound was £199.95 £139.95</p>	<p>CD PLAYERS</p> <p>Arcam Alpha 5 Exciting presentation, fluid bass and fine treble Claim 3 year warranty Free £449.95</p>	<p>CD PLAYERS</p> <p>Arcam Delta 70.3 Precise, stable stereo imaging was £699.95 £449.95</p>
<p>CD PLAYERS</p> <p>Aiwa XC300 Great presence for the price was £149.95 £119.95</p>	<p>PRICE PROMISE</p> <p>We always try to ensure our prices are competitive. In the unlikely event of a product being available from an <i>authorised</i> dealer at a lower price - WE WILL BEAT THAT PRICE BY UP TO £20. Values: £110 to £500 = £10. £501 to £1000 = £15. £1001+ = £20.</p>			<p>CD PLAYERS</p> <p>Aiwa XC750 Placing sonic purity before sonic thrills was £199.95 £149.95</p>
<p>CD PLAYERS</p> <p>Denon DCD595 Punchy, dynamic and larger than life sound quality Claim 3 year warranty Free £179.95</p>	<p>CD PLAYERS</p> <p>Marantz CD52II Probably the best budget player on the market was £229.95 £199.95</p>	<p>CD PLAYERS</p> <p>Marantz CD52IISE The sound simply bubbles with energy and vitality Claim £30 CD voucher Free £299.95</p>	<p>CD PLAYERS</p> <p>Marantz CD63 5 star stunner from Marantz Claim £10 CD voucher Free £249.95</p>	<p>CD PLAYERS</p> <p>NAD 502 Sensibly equipped accommodating player Claim £30 CD voucher Free £229.95</p>
<p>CD PLAYERS</p> <p>Teac VRDS10 This player sounds big and beefy Claim £30 CD voucher Free £769.95</p>	<p>CD PLAYERS</p> <p>Technics SLPG440AK High grade, MASH, 4 DAC was £169.95 £159.95</p>	<p>CD PLAYERS</p> <p>Yamaha CDX870 An audiophile component user was £329.95 £199.95</p>	<p>TUNERS</p> <p>Audiolab 8000T Fantastic performance, once heard never forgotten Claim 3 year warranty Free £699.95</p>	<p>TUNERS</p> <p>Denon TU260L Warm sound for cold evenings Claim 3 year warranty Free £119.95</p>
<p>TUNERS</p> <p>Sony STS311 User friendly design, clear and involving sound was £199.95 £179.95</p>	<p>TURNABLES</p> <p>NAD 5120 inc cart Seriously good sound at a super low price was £119.95 £89.95</p>	<p>TURNABLES</p> <p>Project 0.5 inc cart Hallmarks of audiophile design at a budget price outstanding value at £144.95</p>	<p>TURNABLES</p> <p>Project 6 inc cart A tweakers delight and best turntable title holder old price held £399.95</p>	<p>TURNABLES</p> <p>Technics SL1210II The professional DJ's turntable was £399.95 £349.95</p>
<p>SPEAKERS</p> <p>JPW Minim Nicely finished with pleasantly detailed presentation was £79.95 £59.95</p>	<p>SPEAKERS</p> <p>Mission 751 Big, fast bass plus open midband and treble free stands & cable £299.95</p>	<p>SPEAKERS</p> <p>Mission 760i SE Enjoyable 3D music with hefty bass free stands & cable £149.95</p>	<p>SPEAKERS</p> <p>TDL NFM Small but powerful, superb speakers old price held £99.95</p>	<p>MINI/MICRO SYSTEMS</p> <p>At least 10% and up to 25% off all mini/micro systems in stock. (7 Oaks only.) excluding Denon Min 10% off</p>

Sevenoaks Superfi - There's no better place to buy Hi Fi.

THIS ADVERTISEMENT IS VALID TO AT LEAST 30TH APRIL 1994.
ADDED VALUE OFFERS ARE NOT AVAILABLE ON PRICE BEAT SALES. PRICE BEAT CONDITIONS ON LISTINGS PAGE.

C•H•U•R•C•H•E•R•S

8 WESTERN ROAD HOVE & 154 - 179 MONTAGUE STREET WORTHING



WE STOCK MOST
BRANDS OF WELL
KNOWN HI FI,
INCLUDING ROTEL'S
935BX BUDGET AMP

8 WESTERN ROAD HOVE & 154 - 179 MONTAGUE STREET WORTHING

WORTHING 0903 230558

AUDIOJUMBLE

SALE OF VINTAGE AND MODERN
AUDIO EQUIPMENT AT
THE ROYAL VICTORIA HALL
SOUTHBOROUGH,
TUNBRIDGE WELLS, KENT.
SUNDAY 17TH JULY
10.30AM - 4.30PM
ADMISSION £1.00
STALLHOLDERS £15.00

ALL ENQUIRIES:
0892 - 540022

REFRESHMENTS AVAILABLE

SLATE AUDIO

HI-FI Design & Cable Services



THE SPEAKERSTAND Custom made to suit any loudspeaker. Solid slate, supremely rigid & totally stable. P.O.A.

"Immaculately finished, sublimely rigid, on a par with the best stands I've used."
Ken Kessler, Hi-Fi News/RR March '89
An astonishing degree of instrumental separation, stable and holographic, with great precision and remarkable poise. The ultimate in high fidelity supports."
David Prakel, Hi-Fi Answers Sept. '89
Superbly finished, the sound quality was considered to be first rate."

"The sound quality when using the Slate Audio stands proved to be a revelation, something special."
Martin Colloms, Hi-Fi News/RR May '90
"The finish is excellent, the sound quality magnificent and breathtaking."
Paul Messenger, Hi-Fi Choice, May '91

"Tom Bryant, The Telegraph, June '92"

The Finest Speaker Supports In The World

GARRARD 401/301 PLINTH SYSTEM With 20 years of experience, we are the leading experts on the 401/301. Our solid marble plinths transform these decks into world class beaters.

(Free servicing and fitting) £349 + £25 p/p

THE GLASSMAT A dedicated platter mat for the Garrard 301/401 that also works with all other turntables. Sensational, unbelievable, brilliant! £49.95 + £2 p/p

SME 309/312/IV/V With special graphics "Garrard 401 Celebration" £568.39 £660.93 £827.20 £1232.49

THE TURNTABLESLAB Solid slate spiked turntable platform, can be placed anywhere with remarkable results. Size 17" x 14" £175.00

THE TABLESLAB Solid slate shelf which replaces any other shelf normally fitted to equipment racks, dramatically improving your turntable's performance. Slate size £125.00

THE SPIKEKIT Specially developed to fit directly to floor standing loudspeakers or any wooden support. Adjustable and very simple to fit. £20.00

THE STONESET Spike kit for use with stone, slate or marble only. Fully adjustable. £20.00

ALL PRICES INCLUDE PACKING AND FREIGHT UNLESS OTHERWISE STATED.

(U.K. MAINLAND)

I ENCLOSE A CHEQUE/P.O. for £ _____ made payable to SLATE AUDIO

Name: _____

Address: _____

Tel: _____

47 GEMINI CLOSE, LEIGHTON BUZZARD, BEDFORDSHIRE, LU7 8UD. TEL 0525 384174



SAVE
£450

IMPULSE H6 SPEAKER SYSTEM SPECIAL PURCHASE

A unique opportunity to purchase this well reviewed speaker at a massive reduction. Normal retail is £1350.00.

This horn loaded speaker system is at its most comfortable in a room corner or against a rear wall; this can be a substantial benefit when space is limited. The foot print is also quite small - only 7.5" wide and 14" deep.

The H6 has the dynamic realism, the power and the authority of a true horn speaker. The low frequency horn gives the speaker a dynamic bass response which is astonishing for the size of enclosure.

(Specification: 88 - 89db sensitivity; 100 watts power handling; 8ohm impedance).

We have a limited number of pairs available in black finish offered on a first come first served basis.

Shipping by mail £15 extra.

K.J. WEST ONE
26 New Cavendish St
London W1M 7LH
TEL: 071-486 8262/8263
FAX: 071-487 3452



JUST
£899

FOR THE BEST

ADVICE
INSTALLATIONS
DEMONSTRATIONS
AFTER SALES SERVICE

SPALDINGS

The South East's Leading Hi-Fi Specialists
352-354 Lower Addiscombe Road Croydon Surrey CR0 7AF

081 654 1231/2040

V' audio

Hi-Fi Consultants

SYSTEM SYNERGY

As I constantly keep mentioning, the vital aspect of getting a system to sound superb is matching the various components. We spend hours checking what works with what, and sometimes the results surprise even us. An interesting case occurred this week while trying out the ISO and perception phono stages for a customer who used an Ortofon MC3000 II + AVI pre-amp + ATC 50's in active form. As it happened my 50's were in passive mode and my trusty old Denon 103D was in the arm, so I carried out a test and the perception won. Having then mounted an Ortofon MC3000 and put the ATC's into AC/VE and repeated the test - the ISO won - it was close, but it is so important to evaluate the right system.

Talking about passive ATC 50's, these really do sound superb; it's strange that in general everyone only seems to consider them as active speakers. I know there are some ATC dealers who have never even listened to a pair of passive 50's, but they should. They are more tolerant than the actives and if you've got good amplification well worth considering, but anyway work well with AVI or Heybrook amplification, at a similar cost to actives.

The AUDIO MECA MEPHISTO transport and TRICHORD RESEARCH PULSAR are now on PERMANENT DEMONSTRATION

36 Druid Hill, Stock Bishop,
Bristol BS9 1EJ.
Tel. Bristol 686005

NB-2000™

active noise reduction headset

NB-2000 can reduce annoying noise by 50-95%, while leaving desired sounds, such as speech, music and warning signals clearly audible.



Use NB-2000 in conjunction with your portable audio equipment or in-flight entertainment system to reduce environmental noise, and enjoy better audio quality.

Use the comfortable, lightweight NB-2000
- in the plane, car, bus, truck, boat, train, tube, city, home, office
- with lawnmowers, vacuum cleaners, home power tools, computers
- and in many other everyday situations where noise is a nuisance.

How does "active" noise reduction work ?

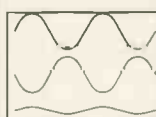

Microphones in both headset earcups listen to the offensive noise, feed that information to the NB-2000 electronic controller where it is analysed, and an anti-noise wave is generated.

The anti-noise meets the offensive noise, that noise is reduced.

£139.99 + £5.00 P&P. To order, send a cheque or postal-order made payable to "Don Fordy Ltd." for £144.99 to :

For further information,
Tel 0792-588862 or
Fax 0792-588865



Don Fordy Ltd., 4 Abertawe House, Ystrad Road,
Fforestfach, Swansea, West Glamorgan, SA5 4JS



The
Audio Room
Pure Sound



For High End Hi-Fi

0784 458176 / 081 893 1074

You can audition any of these products in your own home or in any of our three permanent demonstration rooms.

Audio Note Oto SE	Micromega T/Dac, T/Drive
Audio Note Soro SE	Ortofon cartridges
Audio Note DACs	Project Turntable
Audio Note speakers	Townsend Rock III
Arion valve amps	Transfiguration Cartridge
Audio Innovations Alto	Triangle T60 amp
Audio Innovations valve range	Triangle Alcante, Icare, Scalene
Audiomeca Mephisto/Kreatura	Trilogy 958 monos, /stereo/ pre
Basis turntable	Wilson/Benesch turntable/arm
Graham Tonearm	YBA amps, CD players
Impule H2, H5, H6, H7 speakers	Apollo stands
Kinshaw amps, phono, DAC	Base stands/platforms
Lumley Reference 120s/ST70	Frameworks stands
Lumley Monitor speakers	Seismic Sink
Magnum Dynalab FT101 Etude	Cables: Audio Note, Cogan Hall,
Micromega Stages	Silver Sounds, Lieder, XLO

Ex-dem & p/ex bargains:

Item	Sale
Jadis JP80 MM	3200
Audio Innovations L2 preamp	499
Audio Innovations 2nd Audios	1999
Manley 350 monoblocs	2999
Pink Triangle PIP2 c/w battery pack	1599
YBA 3 Power/2 pre	1999
Trilogy 858 100w monoblocs	1799
Trilogy 901 preamp	599
Trilogy 902 preamp	1099
Lumley 120s	2499
Apogee Scintillas (4/1 ohm)	999
Kef 107/2 as new	1799
Kef 105/3 as new	1499
Ensemble PA1 ref. (Piano Black)	2199
Snell Type E's	599
Impulse H1	1699
Triangle Icare	1199
Triangle Alcante	850
Triangle Scalene	550
YBA CD2 player	2150
T/Dac T/Drive	1999
Audiomeca Kreatura player	999
Proceed PIP PDT2	2200
Theta DS pro-prime (as new)	850
Gyrodec Zeta arm	625



Don't let your
LISTENING ROOM
spoil his performance.

With the help of

Room Acoustics Services
you can achieve near concert hall realism,
in harmony with your home decor.

Full details, reviews etc, of our computerised postal
Hi-Fi room acoustics consultancy available from:-

ROOM ACOUSTICS SERVICES

3, Queen Elizabeth Way, BARTON-upon-HUMBER,
South Humberside, DN18 6AJ. Tel: (0652) 635523



LOVE HERTZ

"You pays your money and you takes your choice"
but our pure silver cables and quality mains interconnects will
improve your Hi-Fi system or we will give you your money back.

- ★High Purity Silver interconnects with PTFE
- ★Silver tone arm wires & digital interconnects
- ★Silver speaker cables & mains leads

"We will improve your Hi Fi or give you your money back!"

Campaign Audio Design
Llandudno Road (HW) Cardiff CF3 8PG

Tel: 0222 779401

TRADE & INTERNATIONAL ENQUIRIES WELCOME

THE AUDIO GALLERY

For a Fine Selection of High Quality Audio Equipment

Tube Technology - Audio Innovations - Audio Note - Wadia
Audio Alchemy - DPA - TEAC - Micromega - Alchemist
Martin Logan - ProAc - Klipsch - Acoustic Energy - TDL
Heybrook - JPW - Impulse - Pink Triangle - SME - Denon
Moth - Audio Synthesis - NAD - Pioneer - Alphason - Tripod
Replacement Valves by Gold Aero

Demonstrations by Appointment Only.

Please call 0730 895194 Hampshire, Nr. Petersfield

Credit Cards

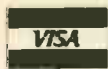

Open: 10 - 6pm Mon-Sat
10 - 9pm Thursday
World wide tax free export

Welcome
24 hrs. delivery service

071 - 233 0774

ENJOY THE MAGIC OF VALVES

Pure Natural Sound

0%

**INTEREST FREE CREDIT
ON SELECTED ITEMS**



**Audio Innovation, E.A.R,
Lumley Reference, Tube
Technology, Conrad Johnson,
D.D. Audio, Hi-Fi World Kit**

We Offer

- 24hrs. delivery services
- Part x-change
- Free three years warranty on selected product
- Home load
- Home installation
- Interest free credit
- We are located very new to Victoria main line underground station. One minute walk & open late 9pm (Thursday)

We have in stock:
Spendor • Quad • Royd • Triangle • KE •
Tannoy • Proac • Castle Speakers
Please ASK for our special offer list

CD Player From:- Quad • Micromega • Teac • Marantz • Rotel • AMC •
Pioneer • Orelle Musical Fidelity
Cassette Decks from:- Aiwa • Denon • Sony • Nackamichi • Harman • Marantz
Amps From:- DPA • Orelle • Quad • Alberry • Musical Fidelity • Alchemist
• John Sheam • Aiwa • Pioneer
Turntables From:- Pink Triangle, Thoren, Alphason, Townsend Rock

DACS from
Pink Triangle • DPA • Kinshaw
Orelle • Musical fidelity • Teac

HI-FI CONFIDENTIAL LTD

34 Buckingham Palace Road, London SW1W 0RE (Victoria Station) Phone 071 - 233 0774 Fax. 071 - 233 7226

The NORFOLK/SUFFOLK High End Dealer audible difference near DISS, NORFOLK

Audio Research	Audion (Alema)	ART Audio
ATC	Audio Innovations	Audio Note
AVI	CHORD	Copland
Croft	DAWN AUDIO dpa	
EAR	Impulse	Kinshaw Perception
Linaeum	Lyra	LFD Audio
Magnepan	Micromega	neat
Orelle	Pink Triangle	ROKSAN
Sumiko	SME	Sonus Faber
SUGDEN	Tube Technology	van den Hul

At this level of equipment we believe that the highest level of service should be offered.
We will book only three demonstrations a day to ensure that you have ample time to evaluate the option YOU chosen,

**DEMONSTRATIONS IN OUR LISTENING ROOM OR
YOUR HOME EQUIPMENT LOAN SERVICE
AVAILABLE**

Tuesday to Friday, 12 to 9 pm
Saturday 9 to 5 pm
PLEASE RING FOR AN APPOINTMENT

0850 983233 OR 0379 740227

VINYL & CDs

FROM THE RECORD CONNOISSEUR

WE CARRY THE FOLLOWING GREAT LABELS:

ALTARUSLP	KING SUPER ANALOGUELP
ALTOLP	KAMEI.....CD
ANALOGUE	MAPLESHADECD
PRODUCTIONS.....LP/GOLD CD	MOBILE FIDELITY...LP/GOLD CD
ATHENALP	ORIG. JAZZ CLASSICSLP
AUDIOQUEST.....LP/CD	POP/ROCKLP/CD
BLUE NOTE (JAPAN)LP	PROPRIUS.....LP/CD
CHESKY.....LP/CD	REFERENCELP/CD
CBS MASTERSOUND ..GOLD CD	RYKOLP
CONCORD AUDIOPHILELP	SHEFFIELD LAB.....LP/CD
DCC.....GOLD CD	VITALLP/CD
DECCA (180 GM HQ)LP	WATER LILLYLP/CD
ENJA (180 GM HQ).....LP	WILSONLP/GOLD CD
GRP JAZZLP	
JAPANESE PRESSINGSLP	SUMIKO & LYRA CARTRIDGES
JAZZ IMPORTSCD/LP	NAGAOKA SLEEVES

For a Free 40-page Catalogue send 28p SAE to PO Box 132,
Wokingham, Berks, RG11 4NG.



Free to overseas customers
Tel./Fax **0344 780262**



RECORDS WANTED

Paying up to £100 each for Classical LPs on Decca SXL, EMI ASD Columbia Sax, Mercury SR, RCA SB. **Top prices paid for** Mobile Fidelity, Nimbus Supercuts, Nautilus, 1/2 Speed Master, Japanese Pressings, Rock, Pop, Jazz, Folk, Blues & more.

World favourites

COMPACT DISC PLAYERS

NAD 501	£180	A break from the MASH tradition, the Philips powered 501 gives excellent results.	Apr'94
DENON DCD 890	£270	Exciting and forceful sounding player, but slightly characterful	Nov'92
ROTEL RCD965 DIS	£350	A smooth and easy sound make this one of the best value players around.	Jan'94
QUAD 67	£790	A new breed of Quad. Lacking nothing in verve or excitement.	May'93
SUGDEN SDT 1	£850	Airy and spacious with a rare quality of ambience.	Mar'93
NAIM CDI	£1598	Single box, 16 bit player. Close to the two box CDS, has vital 'tingle factor'.	Apr'92

COMPACT DISC TRANSPORTS

DPA DIGITAL T-1	£795	Superbly detailed sounding transport when sync-locked to DPA's converters.	Jan'93
ORELLE CD10-T	£799	Very involving, unforced and natural when used with Orelle's DA-180 DAC.	Feb'94
M'MEGA DUO CD.2	£1850	Seriously priced, serious CD using Philips' CDM-9 PRO mechanism. Exemplary.	Apr'93

DIGITAL TO ANALOGUE CONVERTERS

QED DIGIT/OPTO	£139/169	Excellent value, with no rough edges. Now with optical input (Opto).	May'92
DACULA	£376	This little devil from Select Systems really gets its fangs into the music.	Dec'93
DPA DACS	£450-2K	The current masters of DAC-7, their DACs offer superb performance at a range of prices.	
ORELLE DA-180	£599	'Analogue' sounding converter, best with matching transport.	Feb'94
P. T. ORDINAL	£695	Pure sound, smooth and free from harshness. One of the best at any price.	Jul'93
M'MEGA DUO PRO	£1050	Spacious and dynamic presentation, with a detailed and informative manner.	Apr'93
P. T. DA CAPO	£1450+	Pink Triangle's own one bit DAC reaches new standards in digital. One of the very best. Even better with DC supply and new filter options.	Mar'94

TURNTABLES

PRO-JECT 6	£350	Great involvement and rhythm. Comes with Ortofon MC15 for £399	Dec'93
MICHELL MYCRO	£397	In between the Syncro/Gyrodec, the Mycro has superb midband clarity and poise.	Apr'92
TOWNSHEND ROCK III	£799	The MkIII has a fabulously stable, solid image and terrific bass.	Feb'94
P. T. ANNIVERSARY	£1200	Very neutral turntable. Excellent imagery and detail.	May'92
SME MODEL 20	£2495	The last great turntable, bettered only by the £11,000 Model 30.	Oct'92

TONEARMS

REGA RB 300	£139	Simple and superb; dynamic with solid bass.	
SME 309	£568	Based on IV and V: Aluminium armtube and detachable headshell.	Jan'93
SME IV	£850	Looses little to the fabulous V, possibly the best value for money SME.	Dec'93
SME SERIES V	£1232	A masterpiece of precision engineering, with a cohesive sound.	May'92

CARTRIDGES

GOLDRING 1012 GX	£60	Rounded bass, slightly forward midband, clean transients. A bargain.	Jul'93
GOLDRING 1022GX	£80	Extra degree of dynamic range and speed over the 1012GX	Jul'93
SUMIKO BLUE POINT	£100	The Blue Point casts a romantic charm over all types of music. Robust too.	Oct'92
ORTOFON MC15	£100	Moving coil cartridge at a moving magnet price. Has a tight grip on rhythm.	Jun'92
GOLDRING 1042	£100	A reference to all other MMs regardless of price	May'92
GOLDRING ELITE	£200	British made moving coil. Good value, smooth and detailed.	Apr'92
ORTOFON MC2000	£650	We came across this one by accident; used on a Garrard 401 with an SMEIV it gave one of the best results we've ever heard.	Dec'93

CASSETTE RECORDERS

SONY TC-K61 IS	£330	A Dolby S bargain. All the gadgets necessary to produce great recordings.	Feb'94
NAKAMICHI DR2	£500	Worth every penny, pushes recordings to the limit and remains unflustered.	Feb'94
NAKAMICHI DRI	£780	Nakamichi sound quality, and manual head azimuth adjustment.	Jun'93
NAKAMICHI CR-7	£1500	No Dolby 'S', but auto tape tuning and motorised head. The Best!	Aug'92

TUNERS

NAD 402	£160	Stunning budget tuner, with a warm and open sound. Can compete with the best.	Jan'94
AURA TU-50	£230	Superb FM-only tuner. Produces a delightful, three-dimensional sound. A cracker.	May'92
YAMAHA TX-950	£260	Fine all-rounder, with good AM section.	Jul'92
MISSION CYRUS FM7	£299	Clear and lucid sound. One of the best, regardless of price.	Apr'94

World favourites

H/K TU9400	£300	Fairly basic facilities, but sound which beats most at the price.	Jul'93
QUAD 66FM	£490	Among the very best in terms of tonal colour and imagery. Remote controllable.	Nov'92
NAIM NAT 03	£500	Warm and easy sound with a good sense of atmosphere. Good value.	Sep'93
NAIM NAT 01	£1377	The best solid state tuner currently available. For better radio, live in the studio!	Mar'92

INTEGRATED AMPLIFIERS

H/K HK6150	£159	Good sounding starter amplifier. Great dynamic range, excellent bass.	Jun'92
NAD 302	£160	Lots of insight and detail, but could sound a little rough in the wrong system.	Jan'93
PIONEER A-300X	£200	Exceptionally sweet mid and treble, plus the superb dynamic range of the A400.	Dec'92
DENON PMA-350II	£220	Powerful and with deep rhythmic bass drive.	Sep'93
H/K HK6550	£349	Thoroughly refreshing, tonally neutral amplifier with a realistic price tag	Nov'92
AUDIOLAB 8000A	£430	Very neutral and superbly built. Good bass, great imagery, but can be sterile.	Apr'92
J.SHEARNE. Phase2	£495	Gorgeous looks, even better sound. Tight, quick bass and valve-like mid and treble	Dec'93
MISSION CYRUS III	£499	Superb engineering, a solid cast chassis and a clear and spacious sound.	Apr'94
SUGDEN A21a	£639	Class A transistor amp. Sharp, crisp, deep, tight, and it images well too.	Feb'94
AUDIONOTE OTO	£1250	12w Valve amplifier. More in tune with music than hi-fi. Superb dynamic range.	Jun'92
EAR 834	£1295	Valve integrated amplifier with a sweet, open and detailed sound.	Feb'93

PRE-AMPLIFIERS

EAR.834P	£290	MM/MC phono stage. Uses valves to create a rich sound with tremendous depth.	Jan'94
A. Innovations. LI	£299	Valve line level preamplifier. Outstanding results with vdH carbon interconnect.	Feb'94
A. SYNTH. PASSION	£475	Or £275 for the kit version. Unrivalled transparency from a passive pre-amp.	Aug'93
ROSE RV23-S	£495	Valve/Transistor hybrid. Smooth and clean, rich and spacious.	Nov'93
DPA DSP 200S	£495	Not quite the 50S, but there's still nothing to match it at the price.	Jun'93
MICHELL ISO HR	£850	Impossible not to recommend. What more does your vinyl want?	May'93
NAIM NAC82	£2000	Remote control preamp. The NAC82 thrusts detail forwards in true Naim fashion.	Apr'94

POWER AMPLIFIERS

ROSE RP-190	£495	Used with the Rose pre-amp it gives 70 watts of smooth relaxing sound.	Nov'93
SUGDEN AU41P	£530	100 Watts of smooth, detailed, full bodied sound. And at a bargain price.	Apr'93
QUAD 606	£675	140W powerhouse. Smooth and civilized, with the legendary Quad back-up.	Aug'93
DPA DPA 200S	£750	Not as cold as the 50S. Better than anything else at the price.	July'93
MICHELL ALECTO (S)	£1300	Valve like transparency, big warm easy going sound.	Sep'93.
MICHELL ALECTOS	£1800	The Alectos have a lucidity and three dimensional realism that is rarely attained.	Dec'92
NAIM NAPI80	£898	Partner to NAC82. Has real drive and grip on loudspeakers.	Apr'94
CHORD SPM 1200	£2995	Massively powerful, dynamic and detailed sound. Among the best of solid state.	Mar'93
E.A.R. YOSHINO	£25,000	Single-ended valve design. Noel is still suffering withdrawal from this product.	Jul'93

LOUDSPEAKERS

R' ALLAN MINETTEII	£120	Fast and lively sounding, competent bass.	Sep'93
GLL MAXIM	£120	Replacing the Maxim 3; not as tight in the bass but still one of the best at the price.	Aug'93
MISSION 760ISE	£150	One of the best miniatures around, very musically involving.	Jan'94
HARMAN LS 0300	£200	Glass fibre woofer gives a forward and open mid with good bass kick	Nov'93
TDL RTL 2	£250	Bass on a budget. Solid, vibrant and spacious sound.	Dec'93
SYSTEMDEK 93 I	£300	Poor man's LS3/5a? Coherent and involving, these little gems really sing.	Mar'94
HARBETH HL-P3	£400	There probably isn't a more neutral sounding design anywhere near the price.	Feb'93
ROGERS LS8a/2	£449	Big, enjoyable, room filling sound from this 2-way floorstander.	Feb'94
REL STRATA	£499	REL's Strata offers excellent bass depth and power.	Mar'94
H'BROOK QUARTET	£555	Sensitive enough to work with low power valve amps. Fast and detailed sound.	Jul'93
JPW RUBY I	£500	Metal driver 'speaker with an exciting and lively presentation.	Aug'93
TANNOY D100	£650	Believable 3D images produced by this small dual concentric speaker.	Jan'94
PROAC Studio 100	£699	Excellent monitors with detailed, natural sound and plenty of atmosphere	Feb'94
SPENDOR SP2/3	£769	Smooth sounding speaker with a superb mid-range. Very easy to listen to.	Feb'94
PROAC RES I S	£918	Small box design. Can convey the spirit, drive, and passion of music.	Jul'92
TANNOY D700s	£1970	Dynamic and powerful. Needs a good clean power amplifier for best results.	Sep'93
TANNOY GRFM	£3500	Giant loudspeakers. Capable of awesome sound. Need good valve amplification.	Jul'92

HAD A BETTER QUOTE?
THEN PHONE US AND SEE
WHAT WE CAN OFFER YOU!!

R.S. AUDIO MAIL ORDER CENTRE

071 255 1403 / 071-255 1503

10-12 HANWAY STREET
LONDON W1P 9DD
1st left from Tottenham Court
Road Tube Station

**KENWOOD
DP7050
£279**

**MARANTZ
CD-52II
£199**

**MARANTZ
CD-52II SE
£255**

**KENWOOD
KA3020
£135**

**NAD
302
£142**

**PIONEER
A-400X
£229**

**KENWOOD
KRV6060
£295**

CD PLAYERS

AIWA	XC-300	£129
KENWOOD	DP2050	£195
	DP3050	£199
	DP5050	£215
	DP7050	£279
	DPM6660	CHEW
MARANTZ	CD52II	£199
	CD52II SE	£255
	CD63	£215
	502	£195
NAD	505	£249
PIONEER	PD102	£122
	PD202	£139
	PD502	£199
	PD5602	£230
	PD5702	£245
	PD5802	£285
	PD5901	£409
	PD5902	£409
SONY	CDP311	£140
	CDP411	£175
	CDPC335	£250
	CDP711E	£250
	CDP811E	£280
	CDPX303ES	£480
TECHNICS	SLPG340	£190
	SLPG440	£149
	SLPG520	£157
	SLPS620	£193
	SLPS740	£205
	SLPS900	£285
	SLPS840	£340
	SLPS2000	£310

AMPLIFIERS

KENWOOD	KA1030	£110
	KA3020	£135
	KA3020 SE	CHEW
	KA4050R	£165
	KA4050R	£220
	KA5050R	£250
	KRA4050DR	£195
	PM44SE	£199
MARANTZ	302	£142
NAD	304	£190
	306	£278
PIONEER	A-102	£105
	A-202	£139
	A-300X	£175
	A-602	£295
SONY	TAF211B	£190
	TAF242B	£175
	TAF442B	£219
	TAF542E	£280
TECHNICS	SUVZ220	£110
	SUVZ230	£135
	SUA600K	£165
	SUA700K	£205
	SUA800K	£270
	SUA900K	£235

CASSETTE DECKS

AIWA	ADF410	£105
	ADF810	£199
	ADWX828	£220
	ADWX929	£199
KENWOOD	KX-3050	£135
	KX-5530	£175
	KX-5050	£165
	KX-7050	£235
	KX-7050-S	£215
	KX-9050 S	£439
PIONEER	CTS-220	£199
	CTS-320	£165
	CTS-420	£205
	CTS-520	£230
	CTS-620	£299
	CTS-920	£315
SONY	TCFX211B	£37
	TCK311B	£130
	TCK411B	£175
	TCK511S	£240
	TCK611S	£279
	TCW435B	£160
	TCWR535B	£175
	TCWR635S	£280
TECHNICS	RSBX404	£155
	RSBX646	£187
	RSBX747	£245
	RSTR232	£155
	RSTR333	£199
	RSTR515	£210
	RSTR777	£245
	RSTR979	£300

MINI SYSTEMS

AIWA	NSX270	£249
	NSX340	£265
	NSX500	£310
	NSXD707	£405
JVC	UXA3	£250
	UXA5	£210
	ADAGIO S2	£210
	ADAGIO S3	£235
	ADAGIO S4	£265
	ADAGIO S6	£305
	ADAGIO G7	£370
	ADAGIO G9	£340
KENWOOD	UD-301	£265
	UD-351M	£299
	UD-501	£460
	UD-551M	£329
	UD-701	£399
	UD-751M	£349
	UD-901	£310
PIONEER	N-33	£230
	N-33M	£265
	N-63	£425
	N-53M	£465
SONY	MHC-510CD	£339
	MHC-710CD	£399
	MHC-2800CD	£485
	MHC-C50CD	£440
	MHC-C70CD	£330
TECHNICS	SC-CH404	£419
	SC-CH550	£460
	SC-CH650	£419
	SC-CH655	£379
	SC-CH750	£789
	SC-CH950	£839

**MISSION
760i
£109**

**MISSION
760ISE
£129**

**BOSE
AMS-II
£585**

**SONY
STS311B
£175**

**NAD
402
£135**

**AIWA
ADF810
£199**

**SONY
TCK611S
£279**

10-12 HANWAY STREET, LONDON W1 9DD
1st left from Tottenham Court Road Tube Station

PRICES SUBJECT TO CHANGE WITHOUT NOTICE

THE MIDLANDS FIRST CHOICE FOR SPECIALIST HI-FI FRANK HARVEY HI-FI EXCELLENCE

THREE FLOORS - THREE DEMONSTRATION ROOMS
3000 SQ FEET IN THE PURSUIT OF HI-FI



For people who
like Quad

THE FIRST CHOICE FOR THE
BEST HI-FI SET AMIDST THE
ELEGANCE OF OUR 14TH
CENTURY SHOWROOMS

ON OUR FIRST FLOOR WE ARE
NOW SHOWING THE LATEST
DOLBY PRO-LOGIC AND SOUND
PROCESSING PRODUCTS
AVAILABLE FOR AUDIO-VISUAL
SYSTEMS

CAREFULLY SELECTED PRODUCTS

AUDIOLAB - AUDIO ALCHEMY - AUDIO -
TECHNICA - ARCAM CAMBRIDGE - AUDIO
QUEST ALPHASON - APOLLO - BEARD - BOSE
- BANG AND OLUFSEN - CELESTION - CREEK
- CYRUS - DENON - DUAL - FOUNDATION -
GOLDRING - HEYBROOK - KEF - MARANTZ -
MERIDIAN - MONITOR AUDIO - MISSION -
MORDAUNT SHORT - MUSICAL FIDELITY -
NAKAMICHI - NAD - PHILIPS - PIONEER -
QUAD - REGA - ROGERS - ROTEL -
SENNHEISER - SYSTEMDEK - TARGET -
TRIPOD - TANNOY - THORENS - VAN DEN
HUL - YAMAHA HOME THEATRE ETC

FROM CAREFULLY SELECTED AGENCIES

OUR PRICE PROMISE GARANTEE ENSURES
THE BEST DEAL AT THE LOWEST POSSIBLE
PRICE

MAKE FRIENDS AT FRANK HARVEY OUR KNOWLEDGABLE AND ENTHUSIASTIC STAFF ARE
ALWAYS AVAILABLE TO ADVISE ON YOUR HI-FI REQUIREMENTS. AS MEMBERS OF THE BRITISH
AUDIO DEALERS ASSOCIATION WE REALLY DO CARE. WE BELIEVE IN THE PRODUCTS WE STOCK
AND THE AFTER SALES SUPPORT WE GIVE. WE BELIEVE THAT YOU OUR CUSTOMER ARE OUR
MOST VALUABLE ASSET.

FREE CARRIAGE UK MAIL ORDER
EXPORT SERVICE AVAILABLE

PART EXCHANGE SERVICE 2 YEAR
FULL GUARANTEE FULLY EQUIPPED
SERVICE FACILITIES 5 YEAR
EXTENDED GUARANTEES AVAILABLE

FRANK HARVEY HI-FI EXCELLENCE

165 MEDIEVAL SPON STREET TEL 0203 525200
FAX 0203 631403 COVENTRY CV1 3BB
ALL MAJOR CREDIT AND BANK
CHARGE CARDS ACCEPTED

INTEREST FREE CREDIT ON
SELECTED PRODUCTS

(WRITTEN DETAILS ON REQUEST)

APR 0%

FREE INSTALLATION AND DELIVERY SERVICE OPEN
MONDAY TO SATURDAY 9.30 till 5.30 CLOSED ALL
DAY THURSDAY



**THE PAST &
THE PRESENT**

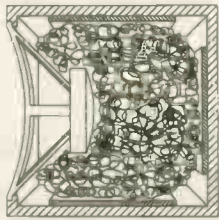

Inside a Typical Cabinet

**LISTEN TO
THE FUTURE**

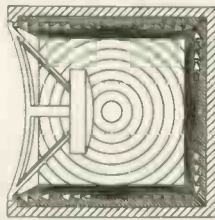

Deflex Panels Fitted

**GET THE MUSIC OUT OF YOUR SYSTEM, AND LET
YOUR SPEAKERS BREATHE!**

Replaces the existing damping material inside your loudspeakers – quick and easy to fit. Available for any loudspeaker.

Deflex acoustic panels have excellent performance characteristics. The polymer is specially formulated to absorb shock and vibration, thus minimising cabinet resonances.

The surface emulation has been carefully designed to eliminate standing waves

The energy inside the enclosure is controlled – **NOT ABSORBED**, as in other cabinets.

Independent tests on MLSSA show energy gains over 50%.

DEFLEX® A.P.T. ACOUSTIC PANEL TECHNOLOGY

PURPOSELY DESIGNED HI-TECH SPEAKER LININGS
NOT BY-PRODUCTS FROM ANY OTHER INDUSTRY

"NEW APPROACH STUNS THE EXPERTS"
"BIGGEST BREAK-THROUGH IN 20 YEARS"
"RESULTS NEVER ACHIEVED BEFORE"
**"THE MUSIC IS FASTER, BRIGHTER,
CLEANER, WITH DEEP, CONTROLLED BASS"**

U.K. DISTRIBUTOR

The
SPEAKER
Company

UNIT 9,
WATERSIDE MILL,
WATERSIDE,
MACCLESFIELD, CHESHIRE
SK11 7HG
Phone 0625 500507

CURRENT PRICES

Standard Panels
@ £7.95 each

Sub-woofer Panels
@ £11.95 each

Adhesive from
£3.50 (200ml)



scarborough hi.fi

14 northway, scarborough, n. yorks yo11 1ji
phone: (0723) 374547
15 commercial street harrogate, n. yorks hg1 1ub
phone: (0423) 504274



**LUMLEY REFERENCE,
MUSICAL FIDELITY, ORELLE,
CASTLE, RUARK,
TANNOY DEFINITION RANGE,
ALCHEMIST, ONKYO,
PERFECT PITCH, KINSHAW,
PERCEPTION, CABASSE,
YAMAHA, ALBARRY and
PRO-JECT TURNTABLES**

amongst other fine hifi products.

We also offer a re-wiring and sound upgrading service on selected products.

Call us for details.

IAN HARRISON DISCOUNT HI-FI

* BRAND NEW GOODS WITH FULL UK GUARANTEES * NO EX-OEM GOODS * NO GREY IMPORTS * REVIEWS & DETAILS ON REQUEST (0283) 702875

DENON	ORTOFON	AUDIO TECHNICA	SENNHEISER	GOLDRING	DENON AUDIO
DL304	MC7500	HD 1000	HD 1000	DUAL RING FPS	DT911
DL103D	EPOA MC5000	HD580	HD580	LAPIS FPS	IR8790
DL 103	E75 MC3000H	AT-ART1	HD560H	EMERALD FPC	DT901
DL160	E70 MC2000H	AT-OC30	HD250H	RUBY FPC	DT990P
DL110	E55 QUASAR	AT-OC5	HD540H	TOPAZ OFHC	DT811
	QUATTRO	AT-OC3	HD530H	TURQUOISE OFHC	DT801
SHURE	QUARTZ	AT110E	HD520H	PHONE FOR PRICES	DT511
V15VMR	MC15SH	ATH9000	HD340		DT431
VN35MR	E199 MC10S	ATH811	HE90		DT311
TEST DISC 117	E55 T3000	ATH810	HEV70		
	E15 T20H	ATH8082			
DAT	QED	HI-FURNITURE	DENON AUDIO		
AIWA XDS1100	E750	APOLLO	TECHNICAL TEST CD		
GOLDRING		SOUND ORGANISATION	£12.99 POST FREE		
EROSCA		SOUND FACTORY TRIPOD	HARRISON MULTI-PURPOSE TEST		
EXCEL GS		SOUNDSTYLE TRIPOD	CASSETTE £20 POST		
EXCEL		GOLDRING - BLACK SATIN	FREE (SUPPLIED WITH FREE TELARC SAMPLER CD)		
ELITE		(Brochures available)			

ARCAM, ADA, OPERATE A MACHINE, OIL EXCHANGE, 7 PM PLUS. PHONE FOR DETAILS AND PRICE. NO LENOVO. YOU DON'T WORK. JUST PHONE. GOODS ARE BRAND NEW WITH FULL UK GUARANTEES. NO EX-OEM EQUIPMENT. PLEASE PHONE OR WRITE FOR DISCOUNT PRICES. CD, TDK, MAXELL, SONY, AMPEX. RASF DISCOUNT AUDIO & VIDEO TAPE. AUDIOQUEST, SONIC LINK, REVOK, QUAD, DISC WASHER, TELARC, BIS, ATC, SPENDOR. DELIVERY CHARGE IS £5.

IAN HARRISON DISCOUNT HI-FI (MAIL ORDER ONLY), 7 MILL HILL, REPTON, DERBY, DE65 6GQ 9am - 9pm

KIMBERLEY HI-FI

A Sound Investment

• SEPARATE DEMONSTRATION ROOM •
 BRANDS STOCKED: DENON • TECHNICS • KENWOOD •
 AIWA • NAD • DUAL • CASTLE • GOODMAN'S •
 MARANTZ • MONITOR AUDIO • HECO • ROTEL •
 PIONEER • REFERENCE POINT •
 SOUTH LONDON'S & NORTH KENT'S ONLY



LARGE RANGE OF ICE INC PIONEER & KENWOOD

193 BROADWAY, BEXLEYHEATH, KENT
 081 - 304 3272



CHOOSE

the powerplant

BRIGHTON'S LEADING HI-FI SHOP

REGA and ARCAM products now on demonstration

Roksan, Micromega, Audiolab, Rega, Arcam, Aura, Exposure, Rotel, Marantz, Ruark, Epos, Thiel and other fine equipment

66 Upper North Street Brighton 0273 775978



HUDDERSFIELD

ARCAM,
 AUDIOLAB, AUDIO
 QUEST, B&W,
 CASTLE,
 CELESTION,
 DENON,
 FOUNDATION,
 GOLDRING,
 KENWOOD, MARANTZ, MERIDIAN,
 MICHELL ENGINEERING, MISSION,
 MUSICAL FIDELITY, NAKAMICHI,
 ORTOFON, QUAD, REVOLVER,
 ROGERS, ROTEL, SENNHEISER,
 SPENDOR, STAX SYSTEMDEK,
 TANNOY, TARGET, TDL, THORENS.



2/4 CROSS CHURCH STREET,

HUDDERSFIELD 0484 544668

LORICRAFT AUDIO

Turntable Repair and Record Cleaning Service

Sale and Repair of Classic Hi-Fi Specialising in Garrard and Thorens

Manufacturers of high quality plinth systems. Review (copy available)

Electronic low distortion power supply and active power supply for Garrard 301/401 Thorens TD124

Re-manufactured spindle bearing and correct lubrication kit. Specifically designed for this type of bearing

Loricraft specialist services start at £5.00 for platter damper rings

New Catalogue now available

4 Big Lane, Goose Green, Lambourn, Berks. RG16 &XQ. Tel. 0488 72267

See us with Art Audio at Chesterfield

Audio Physics

CleanLine - Modification for the NAIM HICAP

Would you believe that the already excellent sound of your NAIM equipment could be further improved?

If you use a HICAP to power your NAIM pre-amp we believe it can. By replacing the IC regulator in the HICAP with our special low noise CleanLine discrete regulator module.

By doing this our customers have found substantially improved clarity and transparency.

The CleanLine is £125 inc p&p, with a guarantee for 12 months and a full 30 day refund if not completely satisfied.

Phone Geoff Mead on 0895 637846 for full details



readers' queries

BASS DOWN UNDER

To all experts at Hi-Fi World -

Re: REL Strata (Aussi \$2,000 - my limit) versus The Purpose Built Gradient S.W.57

1. I have a chance to buy a pair of 23 year old ESLs but I can't live without some bass! (though I don't feel a need to rattle the walls).

2. Hate Heavy Metal - love the rest

3. Ancillaries - mid-range stuff, mostly old: - Quad 405, 66 pre & CD. KEF R104 ABs, Thorens I45, Shure VI5.3, but it likes me (you're right, I'm no tinkerer - sorry).

4. My ears roll off sharply after 13kHz (but I'm only 40! -

Write in with your problems to Hi-Fi World, 64 Castellain Road, Maida Vale London W9 1EX. Our panel of experts will endeavour to solve them or at least offer some practical advice

Hey, what did you say?

5. I would love a Quick Flick around the office on the following basis:

Name, Vote, Reason.

6. It's bloody dark down here when it comes to pommie hi-fi stuff, but a little light comes filtering down once a month - albeit two months late - but thanks anyway.

**Bill McIvor
McIvor Architects,
Brisbane,
Australia.**

Name: Dominic Baker
Vote: REL Strata

Reason: There are several reasons for my vote, however, the most relevant one for you is that the Gradient SW-57 is around twice the price of the Strata before you even think about the extra power amplifier it's going to need - putting it beyond your budget. The REL has its own built-in power amplifier, can be positioned anywhere within a room and has a lovely rich bass quality to it. The SW-57 on the other hand can also sound very good, but it will almost certainly sound best facing in a different direction to the ESLs, so they won't be able to stand neatly on top (it's a dipole and therefore needs to be acoustically aligned with the room. This normally means that it must face into the corners, not towards the listener). In addition, the Gradient active crossover is a rather cheap affair and does tend to add a little

coarseness to the Quads which are otherwise oh-so-smooth.

Name: Noel Keywood

Vote: REL Strata as well

Reason: I've spent months developing a subwoofer crossover for the Quad and rejected, even before

starting, the notion of using yet more silicon chips in the signal path, as Gradient do.

To me, upping the chip count in a system with speakers of the Quad's lucidity is a contradiction in terms and smacks of uncritical engineering inappropriate to the aims of the high fidelity. Couple this with the fact that no-one who uses the Gradient box likes the way it is engineered, and you have my firm vote against it. Some day we'll get around to publishing my own Quad crossover circuit in a universal form, hopefully soon in the DIY Supplement.

I have used the REL and, like just about everybody else it seems, was mightily impressed. REL subwoofers deliver real subsonics - earthquake stuff. However, they do need careful tuning to match them in or they can sound boomy. You need to set gain at a minimum and crossover frequency at its



The REL Strata gives good results wherever it's positioned.

Continued on page 117...

Valves Mostly UK. Makes

Type	Price
KT66 G.EC	£65.00
EF86 G.E.C	£9.00
ECC81 MULLARD	£5.00
ECC82 MULLARD	£5.00
ECC83 MULLARD	£10.00
12AX7 MULLARD	£6.00
5R4GY	£4.00
6080	£10.00
E810F MULLARD	£10.00
E180F MULLARD	£6.00
G337 MULLARD	£3.00
EL84 MULLARD	£6.00
13D3 (CV4068)	£4.00
6SN7GT	£4.00
DA42 G.E.C	£15.00
U19 RECTIFIER	£15.00
6X4 RECTIFIER	£3.00

Valve Sockets

Type	Price
UV4 CERAMIC	£2.00
OCTAL CERAMIC	£4.00
B9A P.T.F.E	£2.00
B7G PAXOLIN	£1.00
Pre-Amp attenuator switches gold plated, solid silver studs British made	
P.O.A.	
P.T.F.E silver plated wire, various sizes and colours	
50p per metre ceramic stand-off tag strips various sizes. P.O.A..	
P+P. Free on orders over £20.00. Under £20.00 Add £5.00 to order.	
VAT at 17.5% to be added to all orders.	

Oil Filled H.T Transformers

Primary	Secondary
230/240V	612V-0-612V 430 MA
115/230V	1250V-0-1250V 310MA 4.6V 100 MA
115/230V	210340 MA 170V 40 MA 290V 90 MA
115/230V	400V-0-400V 300 MA 30V 100 MA.C.T
230V	275V-0-275V 100MA 6.3V 2.5A 6.3V 1A 5V 2.5A

Oil Filled Choices

Price	Inductance	Price
£25.00	10H 25MA	£8.00
	2.5H 250MA	£8.00
£35.00	5H 250MA	£12.00
	5H 200MA	£12.00
	5H 120MA	£12.00
£15.00	5H 350MA	£18.00
	5H 400MA	£20.00

Oil Filled Paper Capacitors

£18.00	2MFD 500V	£6.00
	2MFD 600V	£6.00
£18.00	4UF 600V	£6.00
	8UF 100V	£12.00
	8UF 800V	£10.00
	8UF 100V	£12.00
	1UF 600V	£5.00
	.5UF 100V	£4.00

Heater Transformers

115/230V	6.4V 3A X2	
	2.5V-45V-6.4V 3AX2	£15.00
115/230V	6.4V 10A	
	10V 650MA	£15.00
	26V 650MA	
115/230V	2.5V-5V-6.4V	£15.00
	2A XE	
115/230V	6.4V 5A X3	£20.00

All items in this advert are made to mill spec.

All items in this advert are made to mill spec.

COURT & SPARK

RHODIUM PLATED MK MAINS PLUG FOR A LONGER LASTING CLEAN CONTACT. SUPERIOR TO GOLD RHODIUM WILL LAST TEN TIMES LONGER!!

13 Amp £12.95
15 Amp £14.95

Wall Socket
Single £20.95
Double £30.95
I.E.C. Plug 9.95

(p+p included)



TO ORDER SEND CHEQUE/POSTAL ORDER WITH NAME AND ADDRESS MADE PAYABLE TO:

T. WESTERMAN
41 GREVILLE STREET
HATTON GARDEN
LONDON EC1

TEL. 071 - 242 2329

SOCKET 'n' SEE!

.... Continued from page 115

lowest then slowly adjust both upward. Matched in properly, a REL subwoofer with Quads can sound awesome, for the together they measure fairly flat from 10Hz right up to 20kHz - and it sounds like it.

TUNING IN TO A NEW SYSTEM

I have just sold my system through your magazine. With some of the money I would now like to buy a tuner based system. I have made a selection of products from your magazine, i.e. Pioneer A-300X amp., Rotel RT-950BX tuner, Rogers LS2a2 speakers - all highly recommended as individual products.

It would be difficult to find a shop with all three units to have an audition. With your expert knowledge, as you have reviewed all these products, could I ask you to give your verdict as a complete system in terms of sound quality compatibility. I want easy, warm, relaxing listening that only good hi-fi can give, even at a budget price.

Also, would you please let me have the company name and address of the shop in the December issue P.47 Audio Jumble.

**A Brooksban
London W12.**

The Pioneer A-300X and Rogers LS2a2s are a good combination and you have chosen well here, but there is an alternative to the Rotel tuner you have picked which may better give the warm and relaxing sound you are pursuing. The NAD402 at around £160 takes some beating. All here agree that it is one of the best tuners available below £500.

Remember that to get the very best from a quality tuner you will need a good aerial. Your closest transmitters are Wrotham in Kent for BBC stations and Croydon for commercial radio. This means that for good signal strength,

i.e. enough to provide full quieting and high fidelity sound, a four element aerial will be essential.

The shop to which you refer is Howse of Southboro, Kent, and sells TVs, Radios and Hi-Fis, but not vintage equipment. John Howse is a vintage audio enthusiast who organises events such as the Audio Jumble (17th July 1994). For details on the next gathering, 'phone John on 0892 540022. **DB**

LOST IN THE SPEAKERDOME

I want to change my speakers, but am lost in the maze of

exciting but refined with a no-fatigue factor, as these speakers will have to last me many years to come. All of this I wish to attain within the limitations of my amplification and a sensible budget, as funds are tight, but I would rather wait than buy cheap, if positive benefits are to be found.

I listen to music both quietly and loud, so good sensitivity would be a virtue. Below is a diagram of my room layout and there is no alternative (I am married - need I say more) so speakers that work well very close to a near wall are essential.

My musical tastes

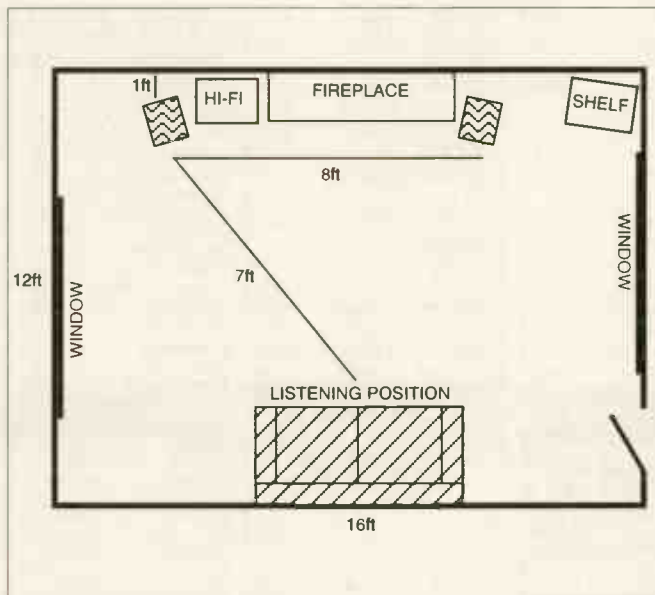

Alan Scott is looking for new loudspeakers to suit his system and room.

speakerdom! My system comprises Arcam Alpha 5 CD, Cyrus II + PSX, Tannoy 605s Mk1 on sand filled dedicated stands bi-wired with QED Gold and Audioquest Quartz cables. The midrange transparency and instrumental separation is quite good, but I am not happy with the performance of the cheap metal dome tweeter which is too harsh and overpowering on brightly recorded CDs.

I also need a better balanced, clearer, punchier and more realistically tuneful bass that does not get lost in the background so much (although many recordings are partly to blame for this). I love a very detailed sound, dynamic and

encompass light rock, blues, acoustic rock and others, but not classical, soul, dance and jazz.

My room size and acoustic has a profound effect upon the speaker's performance and the more I read, the more confused I have become. I have considered "monitors" but their low sensitivity and apparent below-par bass performance have made me unsure. I would appreciate your suggestions and comments so as to make a short list of possibilities.

**Alan Scott
Hemel Hempstead,
Herts.**

I agree that metal dome

tweeters can sound a little unnatural, but I think that it would be unfair to Tannoy to lay all of the blame at their feet. Both the Arcam Alpha 5 CD player and Mission amplifier have a bright and lively sound that may be exciting the Tannoys just a little too much. This is a system mis-match. However, as you have recognised the cheapest and most effective solution would be to go for a more refined loudspeaker. I'd recommend either the TDL RTL2s or 3s, whichever you prefer of the two. Both combine high sensitivity, really good bass dynamics and control, a nice, sweet, soft dome tweeter and a good clean midrange, so they'd appear to fit your needs quite nicely.

The only other loudspeakers that may suit your system are Rogers' LS8a2s. These use their own in-house designed bass/mid-unit which has a lovely neutral quality to it and a metal dome tweeter - don't frown, it's a very good one that will behave itself well in the company of Mission amplifiers.

Whilst you're auditioning new loudspeakers, I'd suggest you try using some of Ortofon's SPK loudspeaker cable; it may help to clean up the sound a little and improve definition. **DB**

WEIRD

Enclosed are details of my systems and a drawing of my living room. OK, I know its weird but the basic idea of the main system is to fill the room with sound without strain, which it does well. Also the IMFs provide a good, solid, nicely controlled bass, with the Snells providing the treble beautifully; they work well together.

I know valves are supposed to be low powered, but this system goes very loud without strain such that a friend who plays in a rather

Continued on page 119... ▶▶

HI-WAY HI-FI LTD

CAR STEREO • HI-FI • VIDEO

EST '78



CLEARANCE BARGAINS

Yamaha CDX-370

Was £239
Now £129

CD PLAYERS	WAS	NOW
Akai CD-73	£449	£299
Kenwood DP-X9010	£499	£369
Philips CD-940	£279	£179
Philips CD-910	£129	£99
Pioneer PD-201	£199	£139
Rotal RCD-9511X	£230	£185
Rotal RCD-9511E	£329	£269
Technics SA-PS520	£199	£129
Yamaha CDC-635	£299	£249
Yamaha CDX-670	£290	£239
Yamaha CDX-660	£249	£199

CASSETTES	WAS	NOW
Kenwood KX-5530	£220	£159
Kenwood KX-3510	£119	£89
Kenwood KX-W 8050	£170	£125
Kenwood KX-W 6080	£200	£149
Rotal RD-1000	£149	£125
Rotal RD-9000X	£199	£165
Yamaha KX-260	£160	£129
Yamaha KX-360	£199	£169
Yamaha KX-W262	£199	£169
Yamaha KX-W362	£250	£199

FM TUNERS	WAS	NOW
JVC FX-343	£129	£99
Philips FT-920	£139	£99
Pioneer F-676	£190	£149
Pioneer F-757	£279	£209
Rotal RT-9000	£149	£125
Technics ST-GT630	£199	£139
Yamaha TX-470	£159	£125

JVC AX-442	WAS	NOW
2 x 75 Watts	£199	£129

AMPLIFIERS	WAS	NOW
Kenwood DA-9010	£599	£449
Philips FA-920	£199	£129
Rotal RA-9400	£199	£165
Rotal RA-9000	£129	£105

YAMAHA DSP-A1000
Was £899
Now Only **£699.00**
All Stock New & Guaranteed

For the Best Deals in Town - and that's a Promise!!

We will Match or Beat any Price from an Authorised Dealer for Goods in Stock. Clearance Lines, Special Offers, Ex-Display Equipment Excepted.

Mail Order Hot Line 071 723 5251

AMPLIFIERS

DENON (2 Yr Guarantee)		
PMA-25011	30wpc	£160
PMA-35011	50wpc	£220
PMA-480R	50wpc	£220
KENWOOD		
KA-1030	65wpc	£125
KA-3050R	45wpc	£180
KA-4050R	70wpc	£250
KA-5020	80wpc	£205
KA-5050R	95wpc	£315
KA-7050R	100wpc	£450
PIONEER		
A-102	30wpc	£115
A-202	40wpc	£150
A-300X	40wpc	£205
A-602	80wpc	£315
A-502R	70wpc	£270
A-400X	60wpc	£270
A-351R	70wpc	£170

TECHNICS		
SU-A600	40wpc	£170
SU-A700	45wpc	£225
SU-A800	55wpc	£280
SU-A900	80wpc	£389
SU-V220	30wpc	£115
SU-V320	45wpc	£150

AMPLIFIERS & RECEIVERS

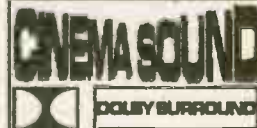

PRO-LOGIC		
DENON (2 Yr Guarantee)		
AVC-3530	110wpc	£999
AVC-1530	70wpc	£479
AVC-3020	80wpc	£729
KENWOOD		
KA-V8500	55	£649
KA-V7700	100wpc	£549
KR-A4050	60wpc	£205
PIONEER		
VSA-D802S	55wpc	£540
VSA-A701S	55wpc	£450
VSA-452	50wpc	£360
SONY		
TA-AV370	70wpc	£360
YAMAHA (2 Yr Guarantee)		
DSP-A2070	3 Chn	£1099
DSP-E200	3 Chn	£369
DSP-A970	7 Chn	£799
RX-V470	50wpc	£399

FM TUNERS		
DENON (2 Yr Guarantee)		
TU-260	"Winner"	£120
TU-580	RDS Sys	£220
KENWOOD		
KT-2050	3 Band	£135
KT-3050	RDS Sys	£165
TECHNICS		
ST-610	24 Mem	£119
ST-G70	3 Band	£225
ST-G470	39 Mem	£130
ST-GT550	Rem Con	£175
ST-GT650	RDS Sys	£210

CASSETTES

AIWA		
AD-F410	Hx-Pro	£99
AD-F810	3 Head	£199
AD-WX828	Twn A-Rev	£179
DENON (2 Yr Guarantee)		
DRM-540	Hx-Pro	£160
DRM-710	3 Head	£260
DRS-610	Hx-Pro	£200
DRS-810	3 Head	£300
DRW-760	Hx-Pro	£250
KENWOOD		
KX-3650	Hx-Pro	£150
KX-5030	3 Head	£205
PIONEER		
CT-S420	3 Head	£225
CT-S620	3 Head	£299
CT-W420R	A/Rev	£180
CT-W620R	Hx-Pro	£225
CT-W820R	Rem Con	£270
SONY		
TC-K611	Dolby S	£299

TECHNICS		
RS-TR333	Hx-Pro	£180
RS-TR515	A/Rev	£225
RS-TR979	Tw Rec	£340
RS-BX404	Hx-Pro	£160
RS-BX646	3 Head	£205
RS-BX747	3 Head	£270

FM TUNERS		
DENON (2 Yr Guarantee)		
TU-260	"Winner"	£120
TU-580	RDS Sys	£220
KENWOOD		
KT-2050	3 Band	£135
KT-3050	RDS Sys	£165
TECHNICS		
ST-610	24 Mem	£119
ST-G70	3 Band	£225
ST-G470	39 Mem	£130
ST-GT550	Rem Con	£175
ST-GT650	RDS Sys	£210

FM TUNERS

AIWA		
LCX-09	10wpc	£315
NXS-270	16wpc	£250
NSX-340	20wpc	£250
NSX-D707	35wpc	£450
NSX-D909	35wpc	£585
ZD-7000M	40wpc	£720
AKAI		
MX-92	25wpc	£270
DENON (2 Yr Guarantee)		
D-250	50wpc	£930
D-65	30wpc	£570
D-90	40wpc	£670
D-110	40wpc	£800
JVC		
Adagio G7	50wpc	£720
Adagio G9	55wpc	£790
Adagio S30	NEW	£360
UX-A4	15wpc	£315
UX-T1	8wpc	£270
W-50CD	50wpc	£450
KENWOOD		
UD-951M	42wpc	£999
M-28MG	40wpc	£549
M-97MG	85wpc	£1699
PIONEER		
N-65T	37wpc	£495
N-93M	66wpc	£945
J-10	49wpc	£495
J-20	50wpc	£585
J-40	102wpc	£900



FANTASTIC SAVINGS ON MIDI & MINI HI-FI SYSTEMS

SAVE £150 ON THIS **SONY MHC 2800CD**

Was £549.99
Now **£399.99**

MONEY SAVERS	WAS	NOW
AIWA Z650	£369	£349
Hitachi AX-12	£349	£298
Hitachi AX-15	£449	£380
JVC Adagio S2	£369	£315
Kenwood M47G	£749	£620
Kenwood M77MG	£999	£900
Kenwood M57MG	£849	£705
Kenwood UD551M	£649	£585
Sony 759CD	£1099	£935
Sanyo DCMS1	£299	£255
Technics CDX120	£699	£595
Technics SCCH750	£799	£679
Technics SCCH950	£999	£849
Pioneer J30	£749	£599
Pioneer J50	£1149	£919
Pioneer N33	£379	£300
Pioneer N93M	£1049	£839

HI-FI SYSTEMS

AIWA		
LCX-09	10wpc	£315
NXS-270	16wpc	£250
NSX-340	20wpc	£250
NSX-D707	35wpc	£450
NSX-D909	35wpc	£585
ZD-7000M	40wpc	£720
AKAI		
MX-92	25wpc	£270
DENON (2 Yr Guarantee)		
D-250	50wpc	£930
D-65	30wpc	£570
D-90	40wpc	£670
D-110	40wpc	£800
JVC		
Adagio G7	50wpc	£720
Adagio G9	55wpc	£790
Adagio S30	NEW	£360
UX-A4	15wpc	£315
UX-T1	8wpc	£270
W-50CD	50wpc	£450
KENWOOD		
UD-951M	42wpc	£999
M-28MG	40wpc	£549
M-97MG	85wpc	£1699
PIONEER		
N-65T	37wpc	£495
N-93M	66wpc	£945
J-10	49wpc	£495
J-20	50wpc	£585
J-40	102wpc	£900

And MANY MANY More

THE CAR HI-FI SPECIALIST

JVC
KS-RX770 + XL-MK500
CD Changer System
Was £499 **£349.00**

PIONEER
KE-2730 Radio/Cass 4x7 Watts
Was £145 NOW £129
KE-3730 Radio/Cass Dolby B NR
Was £185 NOW £145

ALPINE
7980M In Dash 3 Tray CD/Tuner
Excluding Power Amps
Was £699 NOW £529

KENWOOD
KDC 86R CD/Tuner RDS-BON
Exc. Power Amps
Was £699 NOW £390

SONY
DJ 704 CD System
4x25 Watts XR 7041 Radio/Cass
+CDX 70 10 CD Changer
Was £499 NOW £365

PIONEER
SPEAKER BARGINS
TS-E1066 Was £37 NOW £27 pair
TS-E1399 Was £77 NOW £56 pair
TS-E1688 Was £66 NOW £48 pair
TS-G1033 Was £37 NOW £25 pair
TS-F1385 Was £37 NOW £27 pair

1994 PIONEER RANGE - NOW IN STOCK -

WE OFFER A FULL FITTING SERVICE FOR CAR HI-FI, ALARMS AND MOBILE TELEPHONES

318-324 Edgware Rd



Please supply the following goods:

I enclose Cheque/PO for £.....
or debit my Access/Visa/Amex Card No

Expiry date.....

Name.....

Address.....

Post Code.....

Day Time Tel..... HFW/694

HI-WAY HI-FI LTD
318-324 Edgware Rd
London W2 1DY

Also AT
242 Tottenham Crt Rd
London W1 9AD

Tel: 071 723 5251
Fax: 071 724 6101

Opposite Paddington Green Police Station
Near Edgware Rd (Bakerloo) Tube

Tel: 071 636 5974
Fax: 071 323 4159

FREE DELIVERY On UK Mainland

We offer a Fast and Efficient Mail Order Service CARRIAGE FREE* in Mainland UK

*Price Match & Clearance Lines Excepted

E & OE

.... Continued from page 117

noisy band keeps shouting at me to turn it down when he comes round. The system will also play low beautifully.

Alright, so overall I'm happy with the system, but I would like your advice on some upgrades. Whilst happy with the Cambridge I feel it's holding the Leaks and Snells back. Could you suggest a

or can you suggest something else, MC or MM? Also suitable interconnects and speaker wires, again I hope to get another Rogers Cadet and bi-amp the Missions and maybe change the stands to Atcoma ones.

Apart from the queries mentioned, do you have any suggestions for other upgrades or comments generally.

Finally thanks for a great

quite an effective preamplifier, even if it does look a little basic mechanically against some of today's better preamps. You'd only better it with a Rose RV-23S, an Audio Innovations P2 or a line-level pre-amp like our own kit design, KLP-1. We'd only recommend a preamp upgrade if your Leak TL12+ valve power amps and Stereo 20 are in first rate condition though. Otherwise, whilst their sweetness might be obvious, their lucidity could well be improved, since ageing components can compromise sound quality in this respect. Graham Tricker of GT Audio is the man to contact about Leak restoration. He can be contacted on 0895-833099. Kits of components are available for restoration purposes.

We favour silver

plated and pure silver interconnects, producing our own of course. So you could well try experimenting with the Maplin cable; it should give good results.

For the PD-S801, get a DPA Little Bit. It's one of the best upgrade convertors around for this purpose.

You may well be able to split the IMF crossover into low pass and high pass sections for bi-amping, but do not try to alter or redesign it. Crossovers are highly specific to the drive units and cabinets they work in conjunction with. The best you can do is to upgrade the components (e.g. change electrolytics to polypropylenes of the same value) and internal wiring. And remember that Quad IIs turn out a measly 12watts or so - nothing like enough for a TLS80, which was designed for high power solid state amplifiers. So don't expect to drive them too hard.

The Sumiko Blue Point

cartridge is a fine high output moving coil that will feed any moving magnet preamp, including a Hart. The Moth arm (a Rega RB250) would be a good upgrade for the old SME3009 II; fit another Sumiko or try a Goldring cartridge, MM or MC (all Goldrings are decent).

Check out Ortofon loudspeaker cables (Dominic and Eric swear by them).

Many people have recommended the Rogers Cadet to us. Other readers might like to take note; car boots have been known to yield up such wondrous devices early on Sunday morning, before the gannets arrive. We will hopefully get around to reviewing this amplifier; must remember to get out of bed early.

Any other suggestions? What about a pair of Stax Electrostatic headphones for the cat. **NK**

GOOD BYE OLD FRIEND

I am about to change my old friend, a very early ('85) Mission Cyrus I amplifier. The rest of my system consists of an Axis/Akito/K9 on Mana sound-frame, Arcam Delta 2 speakers - on stands of course, Ixos hardcore cable and a Denon 710 tape. I've two amps in mind of totally different nature.

I'm a vinyl nut, so obviously a phono stage is of greatest importance. Basically, do I play safe with my first choice of a Naim 92/90 or go for the new Alchemist Kraken Anniversary integrated amplifier with off-board power supply which I'm rather taken with? Although Alchemist offer a phono-board for an option (£45) would this do my records and the amp justice?

I was considering an off-board head-amp. I've read your report on the EAR 834P valve phono preamp, but at £290 it's fairly costly. Could you recommend a suitable

Continued on page 121....

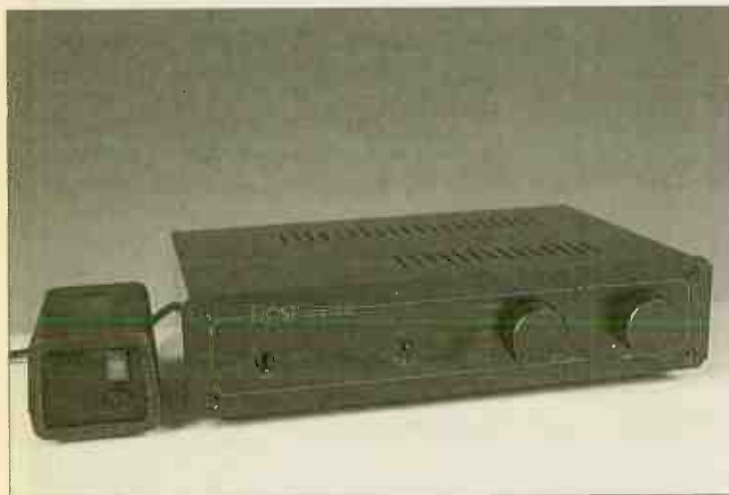

The Rose RV-23S valve pre-amp with solid state MM and MC inputs.

suitable replacement, remembering they only need 125mV input?

I wonder what interconnects I could replace the Tandy with (and the others), or is it financially worth it? Also, what about speaker wire? Maplin do a silver plated wire for £3.95 a metre.

I plan to get a DAC for the Pioneer PD-S801. Could you recommend anything?

I am intending to rewire the IMFs and have the crossovers re-built and converted, to allow me to get another set of Quad IIs to bi-amp them.

Also a friend has a Hart phono amp which sounds good. I'm thinking of getting one for the 401.

Regarding the bedroom system, again I'm mostly happy with this, apart from the SME/Supex. I intend to change to a Moth and wonder about a suitable cartridge under £100. Do you have any comments on the Denon 110

magazine which encouraged me to listen to valves, e.g. the Rogers, as well as seek out the rest of my older equipment. PS. If you get a chance listen to a rebuilt Rogers Cadet, when I got mine it was after listening to a couple of Audio Innovations which didn't sound as good. A friend got rid of his Audio Innovations and turned down a Meridian after he bought and rebuilt a Cadet III.

**Davies McGuire
Newfoundpool,
Leicester.**

Weird? We'd be euphemistic and say it was 'imaginatively constructed'; you get full marks for effort! Connecting a Quad 44 preamp to Quad II valve power amps is hardly for beginners, and getting no less than two Garrards up and running takes some effort as well. We like the lodger's turntable - the Japanese would reckon he gets the best deal, since they rate the 301 most highly.

The Cambridge C70 is

RING
FOR
DETAILS



UXBRIDGE,
MIDDLESEX
(0895) 253340

Unbelievable but true you can audition all these brands here. Audion, Proac, Michell, Lumley, Levison, Lurne, Triangle, Teac, VHD, Silversounds, Stax, Monitor Audio, Trilogy, Lyra, Sumiko, Ortofon, Decca, Target, Project Moth, Townshend, Edison, Sudgen, Trichord Research, Cadence, Kinshaw, SD Acoustics, Totem.

7 days a week 10am - 7pm
RING FOR DETAILS
UXBRIDGE, MIDDLESEX
(0895) 253340

G T AUDIO

At G T Audio we pride ourselves on selling an excellent range of sound reproduction equipment, backed up by first-class after sales service. From the vast range of quality audio equipment available we have chosen that which we feel offers the best sound at very competitive prices with a high degree of reliability. We have extensive servicing facilities to cater for all types of equipment whether new or old.

CROFT, NOTTINGHAM ANALOGUE, ANALOGUE TRACER, POSSELT, UKD CALLAS, MONARCHY AUDIO, XLO ELECTRONIC, MATISSE, GROOVE TUBES, GOLD AERO, TOWNSEND SEISMIC SINKS, G T AUDIO CABLES, ATACAMA supports, CLEMENTS, METAXUS, ZIKRO AUDRO are available on demonstration.

WE CAN OFFER A COMPLETE RESTORATION SERVICE AS WELL AS SUPPLYING AUDIOPHILE COMPONENT KIT FOR UPGRADING ALL LEAK, QUAD, RADFORD, PYE and QUICKSILVER amplifiers. P.O.A

G T Audio is situated on the outskirts of London, 5 minutes from junction 16 of the M25/M40 Motorways.

FOR DEMONSTRATIONS OR BOOKING IN EQUIPMENT TO OUR SERVICE CENTRE contact Graham Tricker.

TELEPHONE 0895 833099

(DEMONSTRATIONS STRICTLY BY APPOINTMENT ONLY)

DAN DULEY Hi-Fi

Ultra High Quality Negus System :- Comprising Passive pre-amp active crossover, 3 matched Stereo amplifiers, Power pack, 3 way active loudspeakers and all interconnects. This system gives unrivalled clarity and realism at the price of £1800 fully installed.

Video Companion: Anyone who has connected a V.H.S video to Hi-Fi equipment will know about hiss.

The Dan Duley Video Companion successfully reduces hiss by 12-14 dB using a dynamic filtering system. An essential piece of equipment for video lovers at £90.

Handbuilt Equipment:- Constructed on an individual basis. Amplifiers from 50wpc (rms) to 1Kwpc. All equipment is tailor made and installed to the clients requirements.

Tape Machine Alignment: Carried out using test tapes and an oscilloscope, rather than "set by ear", for the very best results. Very reasonable rates for all tweaking and tuning work.

For full details of any of the above items either write or telephone Dan Duley Hi Fi at:
15 St. Georges Square,
Forest Gate,
London E7 8HN
Telephone: 081 470 9795



Chord Electronics Ltd
3 Bower Mount Road
Maidstone ME16 8AX

Tel. 0622 764874/692000 Fax. 0622 764506

Chord UK Dealers

Cottage Audio	0522 702834
KJ Leisuresound, London W1	071 486 8262
Acoustic Arts, Watford, Herts.	0923 245250
Brentwood Music Centre, Brentwood, Essex	0277 221210
Progressive Audio, Gillingham, Kent	0634 389004
Doug Brady Hi-Fi, London WC2	071 379 4010
Doug Brady Hi-Fi, Warrington, Cheshire	0925 828009
Doug Brady Hi-Fi, Liverpool, Mersyside	051 733 6859
Doug Brady Hi-Fi, Leeds, Yorkshire	094 346 7689
Photocraft Hi-Fi, Ashford, Kent	0233 624441
West Midlands Audio, Worcester, West Midlands	0905 58046
The Reference Studio, Heathfield, Sussex	0435 868004
Paul Green Hi-Fi, Bath, Avon	0225 316197
Eastbourne Audio, Eastbourne, Sussex	0323 25828
Surrey Hi-Fi, Godstone, Surrey	0883 744755
Sound Academy, Wallsall, West Midlands	0922 493499
English Audio, Hereford, HR4	0432 355081
Hi-Fi Experience, London W1	071 580 3535
London Hi-Fi Services, London	071 263 1015
Diva Audio Fidelity, London SW11	071 924 5286
Music Matters, Birmingham, West Midlands	021 429 2811
Music Matters, Dourbridge	0384 444184
Vaudio, Stoke Bishop, Bristol	0272 686005
In Hi-Fi	031 225 8854
Audio Reflections	0532 528850
Audible Difference	0379 740227

... Continued from page 119

head-amp, preferably of I.C. design, or do you consider that the purchase of a head-amp is unnecessary in my outfit? Would I be better off plumping for the Naim pre/power and dismissing the idea of the Kraken as being fanciful?

Please advise, I need your professional opinion, not one of a sales-person which I always regard as having ulterior motives, "irrelevant" to the customer needs. I've always shopped with my ear - now I need your opinion.

David Musgrove
Lillington,
Warwickshire.

Right, you want advice, so here it is.

1) Ditch the K9 and replace it with either an Arcam P77 or the Goldring 1042. This will give you a much sweeter and more detailed sound from vinyl.

2) Go for a really top flight integrated amplifier with a good phono stage, like Sugden's superb A21a. These will both offer a considerable improvement over your ageing Cyrus 1. You should hear much tighter, more powerful bass dynamics and the whole sound will be more detailed and richer.

3) Get rid of the Arcam 2s and replace them with something a little cleaner and more revealing. Epos ES1 Is should do the trick on their own open frame stands. These are reasonably sensitive, so should go well with the A21a, and have a very detailed and musical presentation.

If you don't get on with these speakers, it might be worth listening to Castle's new Durham 900s. These claim 90dB sensitivity, so they should have a detailed and energetic sound. They also come as mirror image pairs with the tweeters offset to one side, so they should image well also.

I seem to have planned

your upgrades for the next year or so, but it'd be worth finding a dealer who can let you hear the whole lot, so you know what you're aiming for and can confirm it is to your taste. **DB**

QUAD MAKE A STAND

I found your latest supplement very interesting and useful as I have a pair of Quad ESL63 Pro. electrostatic loudspeakers. One of the reasons I bought the Pro was because it doesn't have the downward facing grills, hence the sound can easily 'get out' without resort to tilting, and increased height or grill change etc.

Is it still necessary to get stands for the Pro which, from your article, would seem in this case to offer a trade off of 'not losing too much bass', to possible greater clarity.

I very much like the Stand and Deliver stands as they blend in very nicely with the loudspeaker and come with spikes instead of wheels.

If you advise that stands are still going to give a good improvement then I will start running around like a headless chicken trying to locate a pair.

My system consists of Roksan Xerxes, Artemiz, AT-OC30, Hi-Fi News step-up, Concordant Excelsior feeding Leak TL50+ power amps with ESL63 Pro.

Changes planned/dreamt of:

- Speaker stands
- VDH Cobar interconnect and speaker cable
- EAR step up
- Leak TL50+ rev amp (already underway)
- Innovative (cheap) efforts at isolation and tweaking

As a last thought, how about some comparative reviews of transformer step-up devices to include EAR, Audio Innovations and the smaller manufacturers. Also, what a shame not to have tested the Concordant Excelsior phono stage with a really good step-up transformer and

interconnect - how might this have compared with the Michell Iso you used instead? NB: Listening room 15 x 18 feet

Donald Naismith
Scotland.
(address withheld)

Start running, 'cos Stand and Deliver stands do improve the Pros in our opinion. But you'll only get as far as a headless chicken, because at present they don't exist. In response to your query, Quad told me, however, that they do hope to start making their own stand in the near future, now

acknowledging the steady demand for such an item, as well as its innate worth.

Sitting on the floor, Quad ESL63s - including Pros - have rather boomy bass. Raising them up by about 10-12in lessens this problem. Raising them any higher makes them bass light. You can easily check the effect of this by raising the speakers up on boxes first. It would be possible to make stands from wood; I suggest you try a solid front baffle. As you say, the Pros do not suffer downward beaming, so improvements in this area will be less obvious.

VDH cable would be fine, but don't forget inexpensive Quad cable (yes - even Quad have become believers - albeit reluctant ones at the altar of Mammon!).

The EAR834 and 834P work very well with Quads, although the insensitivity of these speakers limit volume (we measure 83dB Sound

Pressure Level for 2.8V, or a nominal 1watt, whereas most speakers give 86dB or more nowadays). They'll still go loud with an 834 and I'd say this was a symbiotic match in sound quality terms.

Leak amplifiers can be restored, or parts supplied,

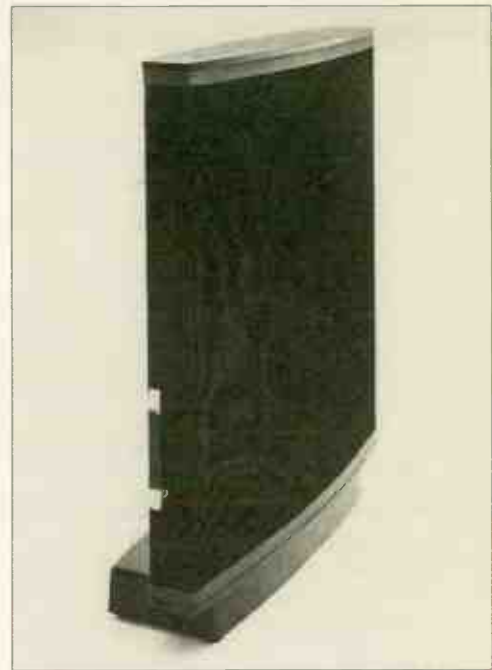

The Quad ESL 63 Pros will benefit from good stands.

by Haden Boardman of Audio Classics ('phone 0942-57525) and Graham Tricker of GT Audio ('phone 0895-833099).

My experience of Concordant in the past has shown measured performance to be a bit - er - open to question, but sound quality was liquid, warm and smooth - definitely beguiling.

You must know by now that I continually recommend removing the metal fronts of Quads as a tweak, albeit with the proviso that this is potentially dangerous, since it exposes lethal (2500V) voltages. Do be very careful about this - you must know what the dangers are and whether they are acceptable. Dominic, myself and Martin Colloms, to name but three, choose to use ESL63s with the grilles off, but the usual advice is to avoid this where fried budgie doesn't feature on the menu (or where children are, or might be present). **NK**



FOR STATE OF THE ART HI-FI

STUDIO ONE

Our dedicated 'Absolute Sounds' Studio. We have on permanent demonstration the following equipment:
APOGEE - from Centaur Minor to Diva
AUDIO RESEARCH - including the LS2b, LS3b & D200
CLASSE - 30, 70, DR4, DR5, DR6, DR10, DR15
KRELL - amplification and digital, now on dem the new KSA50s
MAGNEPLANAR - from SMGa to MG3.3
P S AUDIO - complete range including the Lambda transport
SONUS FABER - Minima Amator, Minuetto, Electa
THETA - Data Basic, Pro basic, Pro prime
WILSON AUDIO speakers

STUDIO TWO

Our new purpose built audio visual room
ADCOM processors
CELESTION shield speakers
CELESTION HT3 package
DENON av amplifiers
LEXICON processors

STUDIO THREE

ACOUSTIC ENERGY
ADCOM
AUDIOLAB
CHORD ELECTRONICS
KEF REFERENCE
MICHELL
MICROMEGA
ORELLE
PROFESSIONAL MONITOR COMPANY
ROKSAN
SME
TANNOY
TDL

Call us or drop in for a chat or to arrange a demonstration. We stock a complete range of speakers from £109 including B&W, CELESTION, HEYBROOK, KEF, SEQUENCE & TANNOY and separate components from £119 from DENON, MARANTZ, SONIC LINK and THORENS all available for audition in **STUDIO FOUR**

A wide range of accessories, headphones and equipment supports available.

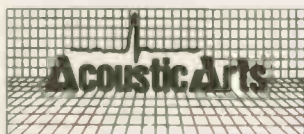

Tel: 0923 233011 Tel: 0923 245250 Fax: 0923 230798

Acoustic Arts Ltd

101 St Albans Rd, Watford WD1 1RD
 Opening hours: 10am - 6pm Tues to Sat
 100 yards from Watford Junction Station

Classic Hi-Fi & Video



NAD • MARANTZ
• ROTEL •
HEYBROOK •
AURA • SUGDEN
• YAMAHA •
PIONEER • LFD •
KEF • JPW •
ROGERS •
MONITOR AUDIO
• CELESTION •
KENWOOD • TDL
• CASTLE •
ONKYO •
KESWICK AUDIO
& MORE



Classic Hi-Fi & Video
 School Lane, Kettering, Northants.
 Tel: 0536 - 515766



hi Best prices for new, xdem & s/h equipment fi

Audio Research D115	mint s/h	£995	Marantz CD 12	mint s/h	£1495
Trilogi 958/902 pre/pwr	as new	£2495	Arcam Alpha Plus	mint s/h	£260
Musical Fidelity P270	min s/h	£700	Sony 502/702	mint s/h	£1195
NVA A40/50	mint s/h	£250	Meridian 602 Trans.	mint s/h	£895
Musical Fidelity P140/P3A	vgc	£295	Quad 67 CD	as new	£595
Krell KSA 50	mint s/h	£895	Roksan Xerxes/Tabriz-zi	as new	£995
Musical Fidelity Typhoon/the pre	mint s/h	£295	Alphason Sonata/Zeta	mint s/h	£495
Krell KMA 100 MKII	mint s/h	£1795	Micell Gyrodec/RB300/PSU	vgc	£550
Croft 4SA	mint s/h	£350	Roksan TMS/Artemiz/Shiraz/XPS3	as new	£2750
Audiolab 8000 P/C	mint s/h	£650	Ortofon MC 3000/T3000	as new	£795
Beard BB100 MKII	as new	£750	London Jubilee	as new	£650
Audio Research LS2	mint s/h	£1600	Burmester 838 phono	mint s/h	£595
Meridian 601 DSP+DAC	mint s/h	£1500	Pioneer HZ1 phono	as new	£1295
Roksan L2/S1 pre/pwr	as new	£1595	Quad 66 Tuner	as new	£395
Audio Note OTO	as new	£895			
Mod Squad Deluxe L.D.	mint s/h	£495			
Quad 66/606	as new	£1050			
Sonus Faber Electa	mint s/h	£1050			
Monitor Audio Studio 10 +stds	mint s/h	£695			
Apogee Callipers	vgc	£895			
Martin Logan Sequel II	mint s/h	£1295			
Monitor Audio Studio 20 SE	as new	£1495			
Roksan DP1/DA1/DS4	as new	£1495			
EAD T 7000 TRAN/DAC	mint s/h	£1595			

PLEASE CALL WITH YOUR SPECIFIC REQUIREMENT
 (081) 568 8808

hi CHOICE fi

Equipment bought or part exchanged
 Full demonstration facility - by appointment
 Major credit cards accepted
 Open 7 days 9.30am - 8.00pm

CLEARAUDIO, S.M.E., AUDIO RESEARCH, KRELL, CHORD

HEATHERDALE AUDIO LTD.

Tel. 0903-261213 or 0860-660001

we are pleased to take your calls from 9am to 9pm
 7 days a week.

CLEARAUDIO

PREMIUM PHONO CARTRIDGES FOR SUPERIOR MUSIC REPRODUCTION.

... the Clearaudio Gamma S equals the best when it comes to sheer competence - the ability to translate strongly groove into music without added hiss or drama. Bally or not this is quite a cartridge ...
 Jimmy Hughes, Audiophile April 1991.

This Month's Bargains:		
Krell 508 (ex demo)	£2795	Martin Logan Veritas (ex demo)
Krell 100S (ex demo)	£1295	Theta Basic CD transport (ex demo)
Graham L51 (oncam) (ex demo)	£1195	Sonus Faber Minuetto's (ex demo)
Jadis Def seven (used mint)	£3495	Audio Research D100 (ex demo)
Lumley Reference 12h		Audio Innovations 300 int. amp (used)
Triode Pent. (ex demo)	£2895	Audio Innovations 200 pow. amp (used)
Avd/SME 4 (ex demo)	£1495	Audionite AN2 speakers (front)
Martin Logan Quest (ex demo)	£3995	Audionite ANF speaker (front)
		Sony 702FS Dac (used and rare)

MAGNEPLANAR, MARTIN LOGAN, SONUS FABER, AUDIONOTE

THE SPECIALIST'S SPECIALIST

PETER TYSON



OF
CARLISLE

WE GIVE YOU

KNOWLEDGE IN DEPTH



OUR STAFF ARE ALL HI-FI ENTHUSIASTS THEY ALL KNOW THE DIFFERENCE BETWEEN A PUSH PULL ELECTROSTATIC DIAPHRAGM AND A SOFT DOMED TWEETER - AND THEY'RE HERE TO HELP YOU.

WE GIVE YOU.....



1 SCORE YEARS AND SEVEN
IN THE HI-FI BUSINESS STEADILY BUILDING A REPUTATION AS A REGIONAL CENTRE OF EXCELLENCE IN PRODUCT KNOWLEDGE, SERVICE AND COMMITMENT TO QUALITY.

THE BIGGEST
INDEPENDENT
HI-FI
SPECIALIST
IN CUMBRIA
AND
THE BORDERS

WE GIVE YOU.....



SPACE

YOU CAN COME AND 'TEST DRIVE' THE VERY LATEST KIT IN OUR DEMO LOUNGE - RELAX IN COMFORT AND ENJOY THE FINEST HI-FI SYSTEMS AND EQUIPMENT WELL AWAY FROM THE SHOP FLOOR AND ALL THE USUAL DISTRACTIONS

WE GIVE YOU



DISTANT PARTS

OUR MAIL ORDER DEPARTMENT OFFERS A UK WIDE DELIVERY SERVICE ON SPECIALIST COMPONENTS AND ACCESSORIES - YOU CAN PHONE OR FAX YOUR REQUIREMENTS WITH COMPLETE CONFIDENCE BECAUSE YOUR ORDER WILL BE PROCESSED BY EXPERTS.

The
NAME
you can
TRUST

Peter TYSON

ABBEY STREET CARLISLE CUMBRIA CA3 8TX TEL. (0228) 46756 FAX. (0228) 49253

AMADEUS SOUND & VISION

Aura, Audio Innovations,
Bang & Olufsen,
Castle Acoustics, Micromega,
Mordaunt-Short,
Musical Fidelity, Nacamichi, NAD,
Pioneer, Quad, Spendor, Technics.

10 BOLDMERE ROAD
SUTTON COLDFIELD
WEST MIDLANDS

Tel: 021-354-2311

SEQUOIA DESIGN

Does your CD player sound dull, lifeless, fatiguing? Are you tired of the sound of your amplification system? If so, then you need a musicality injection!

Sequoia Design can provide an upgrading service for your whole system or individual separates.

CD upgrades from £161, amp upgrades from £149 pre-power combinations, cassette decks, loudspeakers all catered for.

All work is carried out by a highly qualified electronics design engineer with a passion for high quality music reproduction. All modifications are fully guaranteed and all money refunded if you are not satisfied.

WRITE FOR DETAILS TO : JOHN CHEADLE
SEQUOIA DESIGN, CEFN-YOFA,
NEWBRIDGE-ON-WYE POWYS, LD1 6HT

"WHERE SERIOUS MUSIC BEGINS"

PIONEER

BEST PRICES GUARANTEED

KENWOOD

TANNOY

LICENSED CREDIT BROKERS ASK FOR DETAILS

LICENSED CREDIT BROKERS ASK FOR DETAILS



MISSION

DENON

YAMAHA

ALL BILL HUTCHINSON HI-FI SHOPS ARE DEDICATED AUDIO VISUAL CENTRES

ALL BRANCHES ARE MAJOR LASER DISC STOCKISTS



Bill Hutchinson

Hi-Fi • CD • Audio Visual Centre

THE PROFESSIONALS

When you purchase from Bill Hutchinson you're buying the best names in Hi-Fi from the best name for Hi-Fi.

Our Product Guarantee and Pricing Policy ensure you obtain an excellent deal.

My staff and I look forward to being of service to you.

Bill

YAMAHA DSP-A2070



PRICE PLEDGE

Should you find any local dealer offering a better price for goods currently in stock at Bill Hutchinson and the alternative quoting retailer, we will better that deal.

- MARANTZ CD52 MKT15E - CD PLAYER - AWARD WINNER '93
- MARANTZ PM44SE - AMPLIFIER - AWARD WINNER '93
- MISSION 751 - SPEAKERS - AWARD WINNER '93
- SONY TCK-6115 - CASSETTE DECK - AWARD WINNER '93
- SONY STS 311 - TUNER - AWARD WINNER '93
- AIWA NSX-360 - MINI SYSTEM - AWARD WINNER '93
- TECHNICS SC-CH950 - PRO-LOGIC SYSTEM - AWARD WINNER '93

THE LARGEST SELECTION OF QUALITY HI-FI AND AUDIO VISUAL SYSTEMS

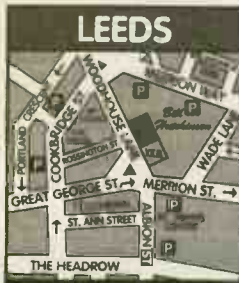

26 28 WOODHOUSE LANE
0532-427777

OPEN MONDAY - SATURDAY
9.30AM - 6.00PM
THURSDAY LATE OPENING

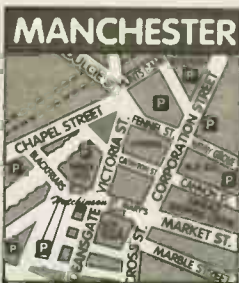

50-52 DEANSGATE
061-832 1600

OPEN MONDAY - SATURDAY
9.30AM - 6.00PM
THURSDAY LATE OPENING



87A CLAYTON STREET
091-230 3600

OPEN MONDAY - SATURDAY
9.30AM - 5.30PM
THURSDAY LATE OPENING



43 HOPE STREET
041-248 2857

OPEN MONDAY - SATURDAY
9.30AM - 6.00PM
THURSDAY LATE OPENING

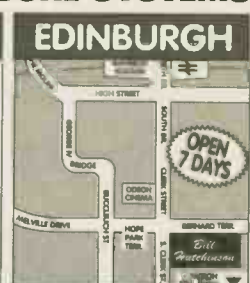

43 SOUTH CLERK STREET
031-667 2877

MON - SAT 9.30AM - 6.00PM
SUNDAY 11.00AM - 5.00PM
THURSDAY LATE OPENING

AKAI

PHILIPS

SONY

TECHNICS

ROTEL

ALL WITH 2 YEAR GUARANTEE

AIWA

AUDIO INNOVATIONS Series 300 Class A Valve Amp (Integrated) £250.
Sony PS 4750 Direct Drive Turntable £65.
Kirk Revolution Mountain Bike, Magnesium Alloy. Looks great in purple £235. 0983-291197.

LEAK TL25A Power Amplifiers, plus two matching Variopole III Pre-amps, all new components and valves, circuit diagrams supplied, power amps; are 1957 vintage, very rare. Can be heard. £400. Tel: 0386-553942.

FURUKAWA FS-2T35P Speaker Cable - 4 x 2 MTR Bi-wired lengths with connectors £50. Also standard Seismic Sink £90. 0483-275389 Malcolm for details.

CASTLE WINCHESTER Speakers c/w floor stabilisers. Yew wood veneered, as new. Too large for new location. £1,150 buyer collects, ferry costs refunded. Tel: 0983 (I.O.W.) 565849.



NAIM IBL Speakers £425. Beyer Dynamic Headphones DT-311 £25 (cost £45) new and boxed. QED Headphone adapter £20 (cost £35). Tel: 0473-271033.

FOR SALE. Counterpoint Electronic Systems SA-7 Dual Channel Pre-amplifier. One owner £250 o.n.o. Tel: 0425-480221 evenings. (Hampshire).

AUDIO RESEARCH SP 15. Pre-amp black facia. Mint condition & exquisite sound quality. R.R.P. £6,400 - £3,000 o.n.o. Please phone: 0792-280061.

TOWNSHEND GLASTONBURY II's, boxed! £875. Townshend Rock £275. Xenon (MCS Spec) £79. ATOCS9, little used £79. Kelvin MM-MC pre-amp, P.S.U., M30 Monoblocks £349. Inexpensive carriage possible. Also selling records. 091-4144221.

NAD 502 CD Player NAD 302 amp. Mission 763i Loudspeaker all boxed all guaranteed mint condition £610 (new £800). Tel: (0986) 893959 can be heard.



CONCORDANT EXCELSIOR Valve Pre-amp. Perfect working order. Slight scratch on wooden case hence £450. Tel: 0694-771278 or 0939-234170.

MERIDIAN 206 Delta Sigma. £795. Quad 34/FM4, £575. AKG 1000. £325. Tascam Portatone Tape Deck, £295. Dual CS701, Shure V15 + spare, £50. All boxed/mint (0533) 532513 Leicester.

AURA VA100 Evolution Amplifier, as new, £250. Tel: 0703 328573 (Soton) eyes.

NAKAMICHI CR7E. Just serviced. Perfect. Offers. Also Pioneer CT95 Dolbys to top of the range cassette deck. Two weeks old. Offers to Mr Moss 081-203 4411.

RHYL, NORTH WALES. Guest House established 36 years. Two minutes to promenade and sun centre. Parking. TV lounge. TV's and tea-making facilities in bedrooms. BB & EM. Excellent food. Moderate terms, reductions for children. Crest Villa, Beechwood Road. Tel: 0745 334733.

AUDIO RESEARCH Pre and Power Amps. Last of the many tube type. 5F-8 (£750) and D-701 (£800). Both look like new; boxes and instructions. Tel: Brighton 0273-6884424.

RADFORD STA15 Valve Amp, SC3 Control Amp. £300 Leak Stereo 20 Valve Amp. Vanscope Control Amp £200. All excellent condition. Any demonstration. Superb valve sound. Tel: Barry 0472-871199.

Beautiful Garrard 301, Heavy Plinth. Linn Ittock Arm £350 (may split) two re-built Leak TL50+ £450. Integrated Armstrong Valve Amplifier £60. Leak Stereo 20 £180. 0709-555403 evenings.

WANTED: 50 Watt Valve Monoblock by Magneta (B.V.C.) Ltd. Leatherhead, Surrey also information about this equipment. Telephone: 0392-469242 evenings please.

LINN INDEX Loudspeakers plus KU-Stone Stands. Excellent condition £230. Tel: (0780) 53079 (eves/weekends).

MICHELL ISO/HERA £275.00. Concordant Exhilarant £400.00. Concordant Modified Quads £300.00 (per pair). Groove Tubed. Audio Technica at OCS £30.00. Denon DL304 £50.00. Tel: Dean 0902-788648 or work: 0384-262470.

LINN LP12 Lingo, Trampolin, Akito, Klyde (2 years old). £850. Audio Innovations 200 pre-amp (MM/MC) and power amp £200 each. Linn Pretek pre-amp £200, Epos ES11 speakers with stands £275. All in pristine condition. Tel: 0904 631515.

FOR SAI F: Linn Ittock LV2 boxed £175; Quad II Stereo Tuner (valves) £65; Audio Technica ATH70 Electret Headphones boxed £100; Thorens TD160/SME3009, wood plinth £65. Tel: 081-989 6434.

KL51 SPEAKER Cabinets built by furniture-maker. Finished in satin black simulated woodgrain with chamfered front baffles. £150 o.n.o. or swap Creek/Cyrus amp. 0787-374399. (W. Suffolk).

WANTED: Roksan latest spec record deck, prefer rosewood. Also large Denon monoblock power amplifier. Tel: Dave 0455-616932.

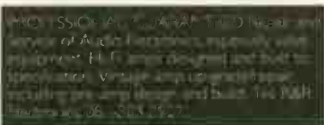

ACCUSTAT 1100's £600.00, Revox A77, serviced, remote booklet, £300. Elite Townshend pre/power monoblocks M/C M/M £250.00. Audio Research STC-70 power-amp. Offers? Electrocompact 25W Class A, £225.00. Thorens TD 125 MKII. Lots more. 0932-849849.

MICROMEGA MICRODAC, nearly new, £250 (£350). Wilmslow Crossover and Tweeter up-grade for KEF Concertos/Kelkat 3's. £80 (£135). Wanted: Leak Stereo 20 for re-building. Phone 0283-820818 eves.

TOWNSHEND ELITE Rock MKII Moth Arm (Rega RB250) AT-OCS M/C £335 o.n.o. Tel: 0243 568627.

LINN LP12. Black, Valhalla. Ittock LVII, A.T.5. £375. LK1 Pre-amp, inc. XLR's, latest spec. £275. Meridian component integrated amp, CD, Aux, Tape and moving magnet inputs. £150. Tel: Banbury (0295) 272925.

HAFLER XL600 Power-amp and Hafler D110 Pre-amp excellent condition £850. Tel: Steve 0229-827980 (Cumbria).

MERIDIAN 206B CD Player (DAC 5). Excellent condition £550. Tel: 041-639 7036 (Glasgow).

HEYBROOK POINT Five Series 2 Loudspeakers. Approx 20 months old. As new, boxed. £1100. Tel: Rugeley (0889) 575655.

MAGNEPLANAR: White Electrostatic Loudspeakers, Slimline (50 x 120 x 5cm). Great sound and brilliant imagery. As new. £430 o.n.o. Southend (0702) 470633.

WANTED: Quad FM4, in exchange for Meridian 203 B.S.C., as new. New set of matched valves for Quad II Amps £500.00. Tel: after 6.00 pm 0455-617784.

TANDBERG RECEIVER TR2025MB, FM, Long, Med and short wave, presets, £110. Technics turntable SLQ3 Quartz Direct Drive Auto £70. Sony Single Tape Deck TC-FX420R, Dolby, Autoreverse. £70. Tel: 0606-782556.

LINN LP12/EKOS/LINGO power supply / AT-F5 Cartridge excellent condition. New £2,455.00. Will sell for £1,000.00. Tel: 081-964 8356 (after 6.00 pm).

QUAD Q3 Pre-amp and 405 Power-amp. Recent QUAD service. Offers. Pair Sony Speakers SSE 30, 50 watts. 12" W x 24" H 11" D. Offers. 0782-395797 (Staffs).

PINK TRIANGLE Turntable, Helius Scorpio and Audio Technica AT-F5, recently serviced, boxed, little used, unmarked deck, £380. Tel: Haywards Heath (0444) 413660.

CHURCH DONATION SALE: Quad 303/FM4/44. SME Series II/Shure V15 Type V. Garrard 401. Marantz SD35/CD54. Sennheiser 2000 ES Phones. Lowther Acoustics. Inclusive offers please; details. 0293 532825.

WANTED: Keith Monks Record Cleaning Machine must be in good working order. Tel: Paul (0533) 553176.



NAIM NAIT 2. Great sounding amplifier. Very good condition. Box and manual. £190 o.v.n.o. Tel: Andy (0753) 825928 Slough.

ARCAM ALPHA plus CD: Alpha 3 amplifier; Alpha 3 Tuner, Mission 780 Speakers; Cyrus Stands; Sound Organisation Rack; Linn-Chord leads: 1 year old, boxed. £699. Tel: 0494-873487 (South Bucks).

LEAK TROUGHLINE 3 Stereo Tuner, working order, original condition £150 o.n.o. Phone: 0270 68500.

ACOUSTAT SPECTRA 1100 Electrostatic Hybrid Loudspeakers. Very good condition £600 o.n.o. MOD SQUAD Line Drive £200. Tel: 0843 584030 eves or days (answer phone).

PIONEER A400GTE. NAD CD T.L. Cassette Deck. Clearwater Speakers and Stands £325 - boxed. Tel: 0639-701104. Anytime.

AUDIO INNOVATIONS 600 Valve Pre-amp £240. Leak Stereo 20 Sugden re-build £230. Linn KANS and KANII Stands £320. All o.n.o. Tel: 0209-820066.

HELP! Sage Amplifier Module wanted. Supermos 100 watt, others considered if in pairs. Desperate. Tel: 0482-470961.

LINN LP12, EKOS, Troika (all '91). Naim 32.5/SNAPS/250. EPOS ES14, tables, stands. Yamaha K-340 deck. £2,400 o.n.o. Tel: 081-547 1264.

SUGDEN, SDA-I DAC, latest spec, superb sound, £475. Sugden, SDD-I transport, £450. Oracle Delphi MK3, Turbo supply, Randall Tonearm Terminator, Sumiko MDC800 "The Arm", £995. All mint and boxed. Tel: 0273-775302.

J.E. SUGDEN Power Amp P51, control unit CS1, stereo F.M. tuner R51. Including instruction leaflets (circuit diagrams). Celestion Ditton 55 speakers, all in good working order. Sensible offers, (0865) 390884 (Oxon).

NAKAMICHI CR7 - The ultimate cassette deck. Automatic record Bias/Azimuth. Manual playback Azimuth control. Auto Fade. Remote control. cost £1,995 new. Reluctant sale £1,150 o.n.o. Tel: 0895-258193 (Uxbridge).

LS3/5a SPEAKERS on customised heavyweight stands offered in exchange for a pair of bronze Quad Electrostatics or £295. A & R T21 Tuner £80. HFW silver plated Interconnect (fun-used) £50. Tel: 0202-735987 (Poole).

LINN SONDEK LP.12 Lingo, Ittock MK3 21/2 years old, boxed and in mint condition, approx 400 hours use. Tone-arm to be retained hence price £750 o.n.o. Any demo welcome. Tel: 021 558 1248

ACOUSTIC ENERGY AE-1 (Rosewood) boxed pair only 2 months old £695 o.n.o. or swap for mint Nakamichi cassette plus cash. Target T-20 stands 10" boxed pair £30. Tel: 081-778 6174.

WANTED: SONY TAE - 1000 ESD, DSP Pro-logic Pre-amp. Cash waiting. For sale: Nakamichi Receiver 1; top of range; 80w/p channel; audio/video inputs/outputs; remote will operate two NAKAMICHI decks and CD player. Excellent condition. 1 year old. R.R.P. was £800 will sell for £300. Reason for Sale: up-grading. Contact Leonel on 0483-771731 (Home - Days) or 0483-32791 (work-evenings).

MICHAELSON ODYSSEUS Integrated Valve Amplifier. Recently re-valved, line level. Art-Deco Style, 45 watts. Boxed can demo. £450 (£999new). Tel: Rochdale 0706-357804.

LINN ISOBARIKS, Walnut Finish, including stands, panels, 1987 model, sounds great with Naim amps. Lovingly cared for example. Mint condition. £850 o.n.o. Tel: 0524-381389.

Pair Wharfedale Teesdale speakers, reproduction style cabinets, with new drive units. Very little used £110. Tel: (0535) 671427.

ION NEXUS System. SP1 Pre-amp (MM & MC). X-Pak 2 power supply. SAM 40 Power-amp. FMT1 Tuner. TCI Speakers/Crossovers. 4 x 6M Kimber Cable. Target Table. £1,150. Arcam Alpha CD Player £250. All mint. Tel: 051-342 8463.

LINN AXIS Turntable, AKITO K9 as new. £250. Mana Acoustics Sound Shelf - mounts to wall - was £150 new. £70 (081) 428 7201.

CHORD SPM 1000. 250 watts into 8 OHMS. Black front with black ash sides. As new, boxed £1,250. Birmingham 021-472 8746 after 6.30 pm.

NAKAMICHI CR-7E cassette deck. New, with unopened remote control unit. Now £1,995, will accept £1,300 or v.n.o. Tel: 0424-220171 (eve).

HELIUS SCORPIO Tonearm, Audionote re-wired £75. Koetsu Rosewood, mint £160. Supex SD900 cartridge, boxed. Mint £65. Rogers Ravensbrook amplifier £45. JPW Minims, mint £45. Wanted: Nakamichi 480 cassette. Tel: 0280-701145.

TANNOY 15" Dual Concentric DU386 speakers, complete with crossovers, all fixings and technical manual and enclosure construction guide with or without Tannoy York Cabinets £480 call any evening after 6.00 pm. 34c. Gintra Park, Norwood, SE19 2LQ.

QUAD II AMPS 22 and FM2 with stereo decoder (fault on tuner) £275. Garrard 301 £20. Femograph valve reel to reel model 482U £80. May part-ex FM4, Nakamichi. Tel: 051-734 0965.

LEAK TL25 PLUS £85 o.n.o. Rogers Cadet 3 £50 o.n.o. Both in perfect working order. Telephone: 0302 885742 after 4 p.m. (Doncaster).

PINK TRIANGLE LPT GT1 Turntable with Rega RB250 arm. Excellent condition, boxed with purchase receipt. GT1 board still under B.A.D.A. warranty. £350 Tel: (0204) 68455 (Lancs).

ARCAM BLACK Box 3 DAC £150 Pioneer F4D1L Tuner £95 both boxed and perfect condition three target audio wall shelves £40 or £15 each. Phone: Steve 0625-619076.

KEF CR 200's Flush mount wall speakers, black, new unused. Cost £360. Accept £230. Tel: 0963-350844 Somerset.

GOOD-SOUNDING Equipment-built to last! Original model KEF105 speakers. AKAI GX95 cassette deck. Marantz PM84/2 amplifier (Class A). Telephone offers to Horrocks on 021-429 9143 or leave message.

ALPHASONI SONATA Turntable, Zeta Tonearm & Madrigal Carnegie Cartridge (MC) very low use £800 (list £2,000). Audio Innovations Series 800 Power Amplifier also hardly used £420. Both items in mint condition. Tel: 081 878 1127

Aria. A new way to look at hi-fi support.

Introducing the Aria Modular Hi-Fi Support System. It can change the way you look at your components.

Build up separate vertical shelves. Or link units side by side. Either way, Aria lets you vary shelf heights to suit your components. Start with a Base Pack and go from there.

There's no limit to the number of ways you can build it up.

Not only does Aria give you more flexibility than any other hi-fi support system, it also provides positive sound deadening and decoupling benefits. With black tubular steel legs. Grey tinted glass or black MDF shelves.

And adjustable carpet-piercing spikes.

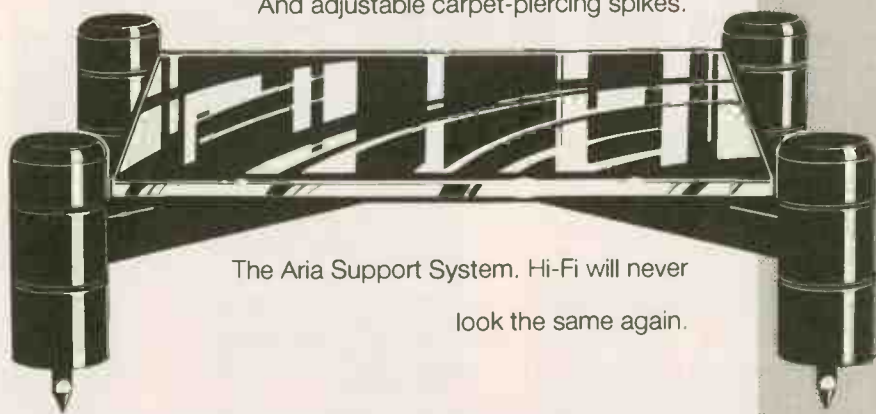
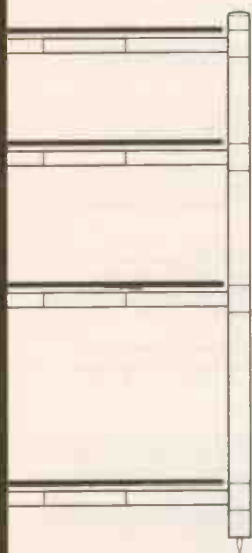

The Aria Support System. Hi-Fi will never look the same again.

I want a good look at the Aria system. Please send me a brochure.

Name

Address

Post code

APOLL
HI-FI FURNITURE

Our components improve yours

Zenith Crown Ltd., Tipton road, Dudley, West Midlands, DY1 4SQ Tel: 021 520 5070/1432

PRIVATE

MANA ACOUSTICS Isobank speaker stands £250 - 'Soundstage' reference tables for Isobank stands £120 - 5 tier amplifier stand £250 - all under 1 year old. COD delivery via UPS. Tel: 01049-7243 67582.

2 PAIRS OF 8 metre interconnect by Avondale Audio. Gold RCA plugs. £50.00 each. 1 pair Audioquest live-wire clear - 2 metre. Gold Spades £150.00 Kimber KCAG Diglink 1/3 metre. £30.00. Tel: 0253-872402 evenings.

R50 TRANSMISSION Line Speakers. Rosewood & Black. Professionally built (units £497.00 from Wilmslow Audio). Too large for New House. Tel: 0270-589322 or 0246-290049.

LEAK STEREO 20 Fully Re-built Kimber Caps and New Valves fitted beautiful open sound £200. Audio Research 5P8 unmodified and new valves fitted £250. Quad Stereo FMZ & Pre-amp £50 pair. Grants valve pre-amp £120 Leak mono valve tuner £30. Tel: Alan 0661-852874.

FOR SALE: AVI S2000A POWER Amplifier 250w/CHA. £950. Trilog 948 Valve Stereo Amp 50w/CHA £850. Audio Synthesis PAS-02 Passive/Pre £150. Phone 081-531 5979.

TDL MONITOR Reference Speakers, excellent condition £1,095, Mendian 203 DAC £195, Pioneer F737 Tuner £95. Tel: 0869-278249.

VALVE AMP LITERALS. Beard P1004 MKZ. 100WPC £475. Radford STA15 £300. Leak Stereo 20 (Croft re-built) £200. Rogers Cadet Pre-power £100. Also Tannoy Cheviots £220. Phone or Fax 0903-200705 (Sussex).

LEAK STEREO 20 Valve Amp £120. PROAC Tablette EBT Loudspeakers with Foundation Stands £95. IPL M2 Loudspeakers £95. Tel: 0895-637 846.

PINK TRIANGLE PTT00 RB300 Ortofon Quasar mint boxed £350. PROAC Studio Towers Prototype Mint £1,600. Nakamichi MR2 Pro Tape Deck Mint Boxed £200 LINX Stratos Pre-power mint boxed £200. Felixstowe 282838.

AUDIO INNOVATIONS Senes 500 Amplifier. Golden Dragon Valves. Good condition boxed. £450 Tel: Joe (0609) 779739 N. Yorks. (Shift worker - days/evenings).

QUAD ELS black, pr. Overhauled, protection circuits fitted. £450. Audio Innovations S800 Power-amp £375. Audio innovations S300 Integrated amp £225. Tel: 0883 349298 (Surrey).

WANTED: Leak TL 12+ and Stereo 20 or Leak TL10 and Stereo 20 or Leak TL 12+ and TL10 in exchange for: AVIS2000A Power Amplifier 250WPC. Phone: anytime 081-531 5979.

EQUIPMENT CLEAROUT. Meridian 205 mono blocks, excellent condition, including remote control, priced to £1,000. £500. Also in offer only tuner, ML7, etc. Tel: 01786 81010.

FOR SALE VINTAGE HI-FI. Quad 22 Control Unit, pair Quad II's amps. 10 spare valves, Garrard 301, Tandberg reel-to-reel, Wharfedale speakers, Wharfedale crossover, all very good condition. £500. Telephone: 0446-700875, after 6.30pm.

2005 mono blocks, excellent condition, including remote control, priced to £1,000. £500. Also in offer only tuner, ML7, etc. Tel: 01786 81010.

1960's HI-FI. MAIN UNIT. Tandberg 64 tape deck, Quad FM and AM tuners, Quad 22 amp. Garrard 301 turntable, teak cabinet. Also two speakers, own teak cabinets. Offers: 0734-476167.

LINN AXIS TURNTABLE + K9 Cartridge, excellent condition, £225. Or exchange for Nakamichi deck. Tel 081 852 8155

ARCAM ALPHA CD player £180 ono. Target CD/turntable stand (single, low shelf) £20. AudioQuest Sorbothane feet (large) £25. Or all 3 items for £200. A formidable combination. 081-686 3850.

AT OC7 CARTRIDGE £125 (£260) never used. OC7 replacement but up-graded instead. Mendian component amp (MM, MC, CD, Aux, Tape) can use as pre-amp only £150 (£630). Stoke: 0782-839807.

AUDIO INNOVATIONS 400 integrated valve amp £350. A selection of 25watt amps from £350. Why bother to build? Small amps from £150. Many other items available. Station Sounds 0903-239980.

AUDIO INNOVATIONS S800 valve power amplifier, triode coupled, boxed. £395. Magnaplanar MG1.4 panel speakers, superb sound, bargain £475 (new £1,100). Ortofon T-5 step-up transformers £35. Will post/deliver. 0449-676335.

AUDIO RESEARCH D100A solid state pre-amp, recently fully serviced, superb sound £695. AudioQuest Emerald solid core interconnect 1m £100 (£220). 4544 2003 0548 3738.

AUDIO PRO TA150 tuner amp 120watt DIN, good working order. Clean (selector L.E.D. faulty). Offers phone: 0539-721995, 9.30 - 5.00pm Wednesday-Saturday.

CASTLE CLYDE SPEAKERS £80. Micromega Logic CD player, £175 Bang & Olufsen 4400 receiver 45w/ch. £50. Musical Fidelity B1 amplifier, £50. All in mint condition. Phone 0252 870861 after 6.00 pm.

CHORD SPM 1200 250 x 250 watt amplifier, hardly used. Cost £3,000, bargain £1,500; Snell Type 'C' speakers. Audio Note silver wired, 91 dB efficient, pirate stands, stunning sound £1,250; stereo metre Mandrake Ultimate Interconnect, W.B.T. phones: retail £600, nearly new £420. Torlyte stand £60, Seismic Sink, new £95; 'Mana' style 1-off heavy duty precision made equipment stand, 3 granite shelves. Cost £350 - £190, surt 'Ongaku', LP12 etc; 2 G.E. VT211 valves original 1942. Telephone: 0932-349314.

CONCORDANT EXCELSIOR valve pre-amp (separate power supply), wooden sleeve, one year old, barely used £850. Worcester (0905) 21464.

DIY BARGAIN, IAS Beaulieu 811 Loudspeakers, excellent review in Hi-Fi Answers, cost new £1,000+, need recovering, spiked stands included, £195 ono. Telephone: 05035-679 (Loose).

DPA BIGGER BIT (DAC 7) DAC. £375.00. 0.5m DPA White Slink interconnect £45.00. Excellent condition. Offers considered. 0670-590395 after 6.00 pm.

DYNAVECTOR 23RS Ruby Karat £55. Lentek Moving Coil amplifier (with separate power supply) £25. Offers for both. Telephone: 0953-717546 (Norfolk).

EPOS ES11 Speakers with stands, still top of the class. £290. Martin Ronaldson. Telephone: 0837-840438.

FOR SALE VINTAGE HI-FI. Quad 22 Control Unit, pair Quad II's amps. 10 spare valves, Garrard 301, Tandberg reel-to-reel, Wharfedale speakers, Wharfedale crossover, all very good condition. £500. Telephone: 0446-700875, after 6.30pm.

GARRARD 401 turntable with SME 3009 arm on plinth. Offers: 081-646 6793.

GYRODEC with PSU £495. Celestion 700SE £675. 4 x Magnum A50 monoblocks P200 pre-amp and PSU £1,950. Everything must go, no reasonable offer refused. Fidelity Research FRX. Wanted: 64 tone-arm. Telephone: 0272-257048.

LEAK TROUGHLINE stereo tuner, Vanslope 2 stereo pre-amplifier and Stereo 20 power amplifier. System serviced by Haden Boardman, requires further attention. Manuals and additional valves £350. Telephone: 061-430 3749.

LEAK Troughline III FM mono £125, Stereofetic £115, ST-30MK1 £35, ST-30+ £45, Delta-30 £40, 2030 AM-LW-FM £40 EMI Stereoscope integrated valve amp, faulty £50. Garrard TPA-12 arm + Goldring 600 Mono £40. 071-372 3724.

LINN KAN II speakers and stands. Bi-wireable. Immaculate condition £275. Naim Snaps power supply £50. Telephone: 0444 - 248424.

LINN LK1 Pre-amp plus Dirak and Remote £325. Telephone: 0344-484 038 evenings.

LINN LP12 Basik II/9 £285, Avic Basik+ £265, SME 3009/3s + extra tube £130, Shure V15II + extra stylus £45, Lenco GL-72 £45. WANTED: SME 3021, SME parts, Goldring Erica, ADC Phase IV. 071-625 8966.

LINN LP12 black, Ittok, Karma, Lingo, Trampolin, £995. Albany PDM1, dual mono pre-amplifier and power supply £400. Telephone: 0992-464320

LINN LP12 with Ittok arm and Troika. Perfect condition £600. Telephone: 081-802 1736.

MAGNEPLANAR SMG-a loudspeakers mint - £295.00. Audio Alchemy DAC. DDEv1.0 as new, £189 (£420 new). Audio Alchemy Clearstream Digital Interconnect £30 (£70 new). Marantz CD63 as new, £180.00. WANTED: headphone amplifier, preferably class A with valves.

MERIDIAN 203 DAC £175, Celestion SL6i speakers £145, Celestion SL600si speakers £600 (up-grading to 700's). All very good condition. Telephone: Shrewsbury (0743) 364369 (evenings).

MICHELL MYCRO Moth arm, Goldring 1012. Two years old. Mint condition, original packaging, receipts etc. £350 ono. Telephone: 061-707 7007 daytime, ask for Bame.

MINT GARRARD 301, African Mahogany plinth, SME Arm, Shure V15, £495 Harman-Kardon Pro turntable, pivoted tangential arm, mint £120. Hitachi FTS500 MK2 tuner (Awards Winner 1988) £95. Telephone: Coventry 0203-679165.

MUSICAL FIDELITY MC-4 loudspeakers complete with Target stands, mint condition. £325.00. Telephone: 0204-365104 (Bolton).

MUSICAL FIDELITY pre-amp 3A and PI40X power-amp. Both excellent and little used. £395 (£800+ new). Sony CDP333 ESD CD player, excellent sound and condition. £275 (£600 new). Telephone: 0455-633350.

MUSICAL FIDELITY The Pre-amp 2a, excellent condition £150.00, Perreux of New Zealand PMF2150B power amp 200wpc mint, boxed £700.00. Acoustic Energy AEI speakers with matching stands, excellent £650.00. Carlisle 0228-21533.

NAIM IBL SPEAKERS boxed, as new £375. Tannoy M20 Gold MKII speakers, teak veneer, bi-wireable, boxed, V.G.C. £100. Telephone: (0902) 752535 (Midlands).

NAIM NAC 72-Hi Cap (new style) £780. Naim NAP 250 £695. NAC A-5 cable 2 x 6m £20. 2 x 9m £30. Mahogany (52") Hi-Fi cabinet £40. Telephone: 0903-756582.

NAIM NAC42 Pre-amp mm £130 (£350). Naim Nat £179; Pioneer A300X £129; JPW's £60; Rogers LS7's, stands £250 (£502); TD160B/Grace/Arcam P77 £150. Or exchange IMF TLS/TDL. Audiolab. 0206-861457 Jim.

NAIM WANTED. CDS, CDI, 1355, 250, 82, 02, Hi-Cap, new style only. Private buyer, cash waiting. Telephone Dave on 0803-555401 South Devon.

ORACLE DELPHI turntable £180. Mendian 103 + 105 power amps. Not in cases. Ring for details. Blyth 0670 354726.

PAIR BLACK QUAD ESL-63s with open stands, bargain at £950. Must sell due to space problems. Delivery etc. mutually arranged. Peter Brown 0467-643872 (Scotland).

PRIVATE SALE: Naim 42.5 pre-amp, pair 110 amps, power supply, all Avondale improved. £600; Naim IBL speakers, £350. Musical Fidelity PRE3A pre-amp, pair MASO amps, £595. All superb - 0872 572397 (Cornwall).

QUAD ESL63 PROS. Latest specification £1,750.00 ono. Gale G5401A + stands £300.00 ono. Mendian CD Player MCD £150.00. Thorens TD160S + SME Senes III S Arm £150.00 ono. Telephone: 061-624 3075 (evening).

REVOX A77 MARK III, mint and boxed, Swiss, light amateur use at home, miles of tape £550. Linn Sondek/Ittok/Karma, walnut. Vihalla, glued sub-hassis arboard etc. £700. Can demonstrate. Telephone: Derby 0332-763150.

SILVER WIRE with hybrid dielectrics, beats VDH carbon. Fat!! Only £4 mtr, the best for peanuts, enthusiast's surplus, limited supplies. Wanted Naim 250, 135, will buy full amplifier. Paul 0642-532696.

SILVER WIRED loudspeakers: Audio Note K/SP, black with Huygens K4 stands (ideal with valve amps) £625. Telephone 081-572 2504 (Midddx).

SINGLE SPEAKERS: Lowther Mini Acousta, Leak Sandwich 600, Tannoy 15" Red chassis, Goodmans Axiom 300, offers or buy your single. WANTED: Single Chatsworth (empty/loaded) or any empty pair Tannoy 12/15" cabinets. 071-372 3724.

SUMMO POLARIS AMP. Sumo Athena pre-amp. Sumo Aurora FM/AM Tuner, audiophile American equipment, cost £2,100. Also Michell power supply for GyroDec turntable. All in mint condition. Offers and demo's - 081-651 5711.

TANNOY 611s complete with dedicated plinths, 13 months old £200. Arcam Alpha CD, mint. £175. WANTED: EPOS ES11s. Contact: Mark 0952-619536, evenings.

TASTY TREATS for valve lovers: British Acoustic Films Cinema monoblocks (pair). 1940's: 4 x KT66 Tnode connected, oil caps, ultra-reliable, very impressive looks and sounds, rare opportunity. Telephone: 0707-328515.

TDL STUDIO 1 Transmission Line Speakers with TDL Stands, Black Ash veneer, as new condition with boxes. £395. Telephone: 0734 869789 (home), 0635 506620 (work) Berkshire area.

TDL STUDIO 1 transmission line speakers, walnut finish, complete with stands, excellent condition, boxed. £400. Telephone: 0784-457332.

Oxford Audio Consultants

HI-FI SPECIALISTS



Our superb service is the name,
regardless of price.

SONUS FABER GUARNERI

The nearest thing to a musical instrument
you've ever heard!!

NOW DEMONSTRATING

DPA 200 SERIES PRE/POWER AMPS - A very nice small package.
 MICROMEGA STAGE - the new concept in upgradeable CD players
 AUDIO RESEARCH D200 POWER AMPLIFIER -
 BOSE LIFESTYLE SYSTEM
 RUARK EQUINOX LOUDSPEAKERS - Superb British craftsmanship.
 TDL RTL SPEAKER RANGE
 SME 20 TURNTABLE - top notch analogue built to last.
 TEAC VRDS 7 - a snip at £599
 MICROMEGA T DRIVE AND DAC - tremendous value for money
 MUSICAL FIDELITY F SERIES including the fabulous new CD PLAYER
 HEYBROOK SEXTETS AND QUARTETS on dem!
 COPLAND CTS14 - a bargain at £999
 AUDIO VISUAL SYSTEMS including PIONEER, LASERDISC, DENON, NAD, ROTEL
 AUDIO ALCHEMY DAC IN THE BOX - unbelievable value for money.
 AUDIO RESEARCH LS5 - earth shattering!
 AUDIO RESEARCH CDT TRANSPORT - Simply brilliant.
 KRELL DSP CD PLAYER and STUDIO DAC - give them a go!
 THETA BASIC CD TRANSPORT - excellent value
 TEAC P700 2 BOX COMBO -brill!
 MARANTZ CD 10 -The latest MARANTZ heavyweight
 MICHELL GYRODEC -Try the latest power supply
 KRELL KSA 100S & KRC 2 (remote control) - Fabulous
 AUDIO RESEARCH LS2B & LS3 PREAMPS & V70 POWER AMP
 SONUS FABER - THE COMPLETE RANGE; WE LOVE THEM ALL!
 MARTIN LOGAN AERIUS -Stunning looks and sound
 REL STADIUM STRATA SUBWOOFERS
 VAN DEN HUL CABLES -including The First, Second and Revelation

EX DEM & P/EX BARGAINS

STAX QUATTRO CD PLAYER...£1595
 LUXMAN D500X CD PLAYER £2250
 SEQUERRA MET 7 SPEAKERS NEW £495
 STAX LAMBDA SIGNATURE/SRM T1 £1115
 STAX LAMBDA PRO/SRDX PRO £595
 ORELL CD 160 CD PLAYER £495
 RUARK TEMPLAR EX DEM £375
 RUARK SWORDSMAN PLUS EX DEM ££225
 WADIA 6 CD PLAYER £2995
 AUDIO RESEARCH V70 EX DEM £3495
 AUDIO RESEARCH DAC 1-20 £1995
 ACOUSTIC ENERGY AE 1s EX DEM £550
 KRELL CD DSP CD PLAYER EX DEM £3495
 KRELL STUDIO DAC £3495
 THETA DS PRO PRIME £995
 NEAT PETITE SPEAKERS ££395

Please ask for details or our current list

Agencies include: Accuphase, Acoustic Energy, Air Tangent, Apogee, Audio Alchemy,
 Audio Research, Audio Technica, Basis, B&W, Castle, Copland, Denon, Denon
 Cartridges, DPA, Dual, Goldring, Harmonix, Heybrook, HPW, Kimber, Koetsu,
 Krell, Lyra, Magneplanar, Magnum, Mandrake, Marantz, Martin Logan, Michell,
 Micromega, Music Fidelity, NAD, Nakamichi, Onix, Orelle, Ortofon, Pioneer, Proceed,
 PS Audio, QED, REL Subwoofer, Revox, Rogers, Roksan, Rotel, Ruark, SD
 Acoustics, Selsim Sink, Sennheiser, Sequence, Sequerra, Slate Audio, SME, Sonus
 Faber, Stax, Target, TDL, Teac,
 Theta, Thorens, Van den Hul, Wadia, Wharfedale

TAX-FREE EXPORT SERVICE
 MAIL-ORDER AVAILABLE ON MANY ITEMS
 Open Mon-Sat 10am-6pm

Oxford Audio Consultants

Oxford Audio Consultants, Cantay House, Park End Street OX1 1JE
 Telephone: Oxford (0865) 790879 Facsimile: Oxford (0865) 791665

ROTHWELL ENGINEERING

Rothwell are pleased to announce the revised edition of
 the highly acclaimed passive pre-amp. Now full size and
 very attractive, even more attenuations and full gold-
 plated inputs.

Trade enquires welcome, particularly overseas.
 All enquiries to: Audio Images, 7 All Saints Road,
 Lowestoft, Suffolk NR33 0JL. Tel: 0502 582853

ROTHWELL, THE REFLECTION OF PERFECTION

AUDIO IMAGES
 7 All Saints Road, South Lowestoft
 Tel (0502) 582853

Specialists in Quality Hi-Fi and Advanced Finlux C.T.V.s

QUALITY, SOLID TIMBER CD STORAGE



At last an alternative to cheap
 plastic or chipboard storage
 furniture for your Cd collection.
 Send now for our full colour
 information leaflet showing the
 range of craftsman built
 furniture, featuring our unique
 swivelling action system.
 Telephone 0462 670505 or 0438
 720102 (eve) or write to Unit 10,
 Shaftesbury Ind. Est., Letchworth,
 Herts. SG6 1HE.

Transfiguration, Wilson Benesche,
 Magnum, Dynalab, Graham,

M.J.S. HI-FI

We at M.J.S. Hi-Fi are dedicated in the quest for excellence
 in the reproduction of recorded music.
 You can be assured that we are not influenced by reviews and
 all the hype in Hi-Fi magazines. We devote time and
 patience when auditioning before we recommend and stock
 the product.
 We feel very sad about the way in which most Hi-Fi
 equipment is chosen and sold. We offer a refreshing
 alternative to the norm:-

- * EXTENDED AUDITION TIMES
- * HOME AUDITIONS
- * HOME VISITS
- * OPEN DISCUSSIONS
- * TUNING SUGGESTIONS
- * EVENING AUDITIONS

AND ABOVE ALL COMMITMENT TO YOU AND YOUR MUSIC.
 For More Details, Please Phone:

M.J.S. HI-FI
 80 Stapleton Lane, Barwell, Leicestershire
 LE9 8HE
 Telephone: (0455) 846977
 BY APPOINTMENT ONLY

Lumley Reference, Nottingham Analogue, Townshend,
 L.F.D, Helius, Silver Sounds, Cogan Hall

John Shearne, Concordant, S.D. Acoustics,
 Diamond Acoustics, Origin Live, Basis, S.M.E

Ortofon, CAT, Unistar, Sonic Link,
 Pearl, Gamma, Moth

Advertisers Index

MAIN ISSUE					
ACOUSTIC ARTS	122	HI-FI CONFIDENTIAL	109	TESSERAC	20
AMADEUS SOUND & VISION	123	HI-WAY HI-FI	118	THE AUDIO GALLERY	108
APPOLLO	126	HUDDERSFIELD HI-FI	114	THE AUDIO ROOM	108
ARCAM	38	IAN HARRISSON HI-FI	114	THE HIFI SHOWROOMS	102
ART AUDIO	16	INFIDELITY	44	THE MUSIC MILL	23
AUBIABLE DIFFERENCE	109	J.E. SUGDEN	I.B.C.	THE POWER PLANT	114
AUDIO CRAFT	120	JOHN CHEADLE	123	THE RECORD CONNOISEUR	109
AUDIO IMAGES	128	K.J. LEISURE	106,88	THE SPEAKER COMPANY	102,113
AUDIOJUMBLE	106	KIMBERLEY HI-FI	114	TRIANGLE	72
AUDIOLAB	70	KINSHAW ELECTRONICS	20	TRY ME & SEE	101
AUDIO PHYSICS	114	LISTEN INN	44	TUBE TECHNOLOGY	103,72
AUDIO TECHNICA	96	LORICRAFT	114	V'AUDIO	107
AUDIOFILE FURNITURE	23	M.J.S.	128	WEST MIDLANDS	
AUDIOFREAKS	20	MANTRA AUDIO	20	RADIO SUPPLIES	46
AVONDALE AUDIO	102	MICHELL ENGINEERING	54	WESTWOOD & MASON	34
BILL HUTCHINSON HI-FI	124	NAD	10	WILMSLOW AUDIO	94
BURY AUDIO	103,94	ORTOFON	22,26	WOLLATON AUDIO	94
C.M.F. SHELVES	128	OXFORD AUDIO			
CAMBRIDGE HI-FI	96	CONSULTANTS	128		
CAMPAIGN AUDIO DESIGN	108	PETER TYSON	123		
CHOICE HI-FI	122	PHILIPS	6,7		
CHORD ELECTRONICS	120	PROAC	O.B.C.		
CHURCHERS HI-FI	106	PROGRESSIVE AUDIO	46		
CLASSIC HI-FI	122	Q.E.D.	96		
CONNECTIONS	26	R.S. AUDIO	112		
COURT 'N' SPARK	116	REFERENCE IMPORTS	54		
CREEK	34	RON SMITH AERIALS	44		
DAN DOOLEY	120	ROOM ACOUSTIC SERVICES	108		
DEFINITIVE AUDIO	16,60	SCARBOROUGH HI-FI	113		
DIVA	18	SERIOUS KIT	62		
DON FORDY	107	SEVENOAKS HI-FI	104,105		
DOUG BRADY HI-FI	34	SLATE AUDIO	106		
DPA DIGITAL	I.F.C.,3	SOUND ACADEMY	22		
F&S TRADING SUPPLIES	102	SOUND GALLERY	76		
FRANK HARVEY HI-FI	112	SOUND ILLUSION	103		
G.T. AUDIO	120	SPALDINGS	107		
GOLDRING	12	STANDENS	44		
HALE HI-FI	103	STUDIO 82	60		
HAMPSHIRE AUDIO	26	SUSSEX SURPLUS STORE	116		
HEATHERDALE AUDIO	122	SYSTEMDEK	46		
		TABULA RASA	94		
		TEAM POINT	22		

SUPPLEMENT

AUDIO NOTE	10,11
B.K. ELECTRONICS	20
BANDOR	22
BILLINGTON EXPORT	4
CHELMER VALVE CO.	I.F.C.
HALCYON ELECTRONICS	4
HART ELECTRONIC KITS	I.B.C.
IPL ACOUSTIICS	8
LANGREX SUPPLIES	8
LOCKWOOD AUDIO	26
P.M. COMPONENTS	18
Q.E.D.	20
RUSS ANDREWS	O.B.C.
S.J.S.	4
SEAS	20
SONIC FRONTIERS	22,26
SOWTER TRANSFORMERS	4
TABULA RASA	26
THE SPEAKER COMPANY	16
VINTAGE VALVES	22,26
WILMSLOW AUDIO	22
WOLLATON AUDIO	4



SUGDEN

HAND CRAFTED ■ FAIT À LA MAIN

DESIGNERS & MANUFACTURERS OF HI-FI & AUDIO EQUIPMENT

J. E. SUGDEN & CO. LTD.

Valley Works,

Station Lane, Heckmondwike,

West Yorkshire WF16 0NF

Tel. Heckmondwike 0924 404088/9

Fax No. 0924 410069

World Radio History



SCALING NEW HEIGHTS.

There's a new tower on the block – the Studio 200.

And it's going to make you think again about how much loudspeaker you should get for your money.

Innovative cabinet construction, critical driver offset placement and state-of-the-art componentry combine to bring you a new sophistication in high-end listening experience.

The Studio 200 can now be auditioned at selected dealers. Contact us for details.

 **ProAc**
Perfectly Natural

130-132 THIRSK ROAD
BOREHAMWOOD
HERTS WD6 5BA
TEL: 081-207-1150
FAX: 081-953-8933