

HI-FI CHOICE

THE WORLD'S NUMBER ONE GUIDE TO BUYING HI-FI

JULY 1989 £2.95

FREE SUPPLEMENT

A COLLECTOR'S
GUIDE TO
100 GREAT ROCK
ALBUMS



ASPIRATIONS

LOOKS AT TWO
SUPERB HI-FI SYSTEMS
IN THE HOME

The Collection

REVIEWS ON SOME
OF THE FINEST HI-FI
IN THE WORLD

THE CHOICE DIRECTORY

THE DEFINITIVE
BUYER'S GUIDE
WITH SUMMARIES
ON OVER 900
HI-FI PRODUCTS



KRELL

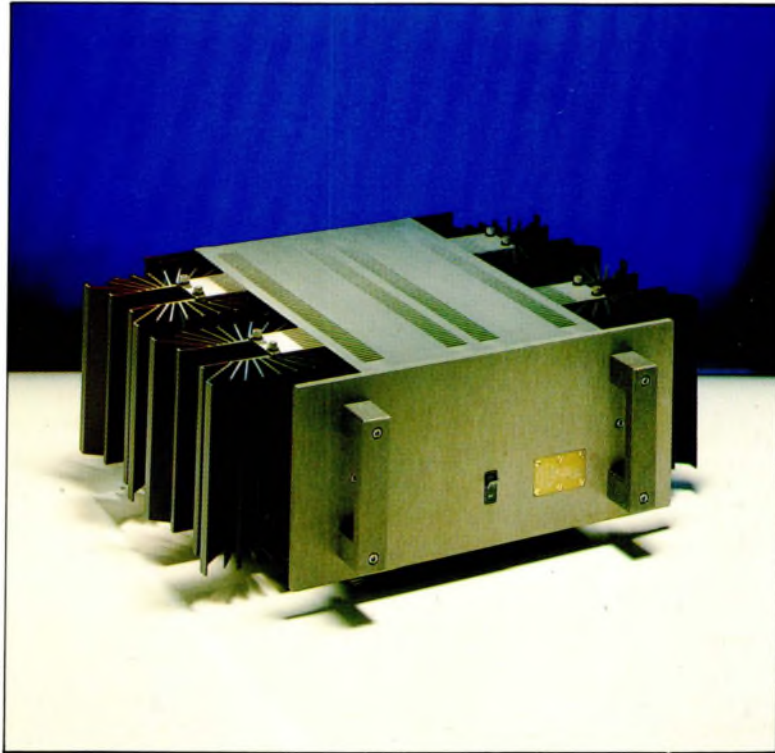

PAR EXCELLENCE

Krell amplifiers have the rare ability to impart a sense of unlimited power and musical authority. While other manufacturers aspire to this complete mastery of the musical signal, only Krell achieves it. In under a decade Krell has ascended to the top of the high end ladder, providing the amplifiers of choice for audiophiles and reviewers around the world. With the latest generation, Krell has further strengthened its claims, the new KSA-80 inspiring Hi-Fi Answers to write, 'The Krell is all about making music, carriage class'. Krell amplifiers; power with finesse.

Write or phone for perceptive advice and details of nearest dealer



Absolute Sounds 318 Worples Road Wimbledon London SW20 8QU
Tel: 947 5047 Telex: 894800 Absol G.

Air Tangent, Apogee, Audio Research,
California Audio Laboratories,
Counterpoint, DMP, Duntech, Entec, Goldmund,
Kinergetics, Koetsu, Krell, Madrigal,
Mandrake, Magneplanar, Micro-Seiki, PS Audio,
Randall Research, Wilson Audio, Sonus Faber

'I have the simplest of tastes . . .
I am always satisfied with the best'
Oscar Wilde

THE WORLD'S No. 1 GUIDE TO BUYING HI-FI
HI-FI CHOICE
ISSUE NUMBER 72: JULY 1989

EDITOR:

John Bamford

CONSULTANT EDITOR

Paul Messenger

ASSISTANT EDITOR

Jane Hadley

STAFF WRITERS

Daniel Houston, Jason Kennedy

CONTRIBUTORS

Chris Bryant, Martin Colloms, Roy Gregory,
Paul Messenger, Alvin Gold, Paul Miller

PHOTOGRAPHY

Chris Richardson

ART EDITOR

Kerry Gormley

ADVERTISEMENT MANAGER

David Reynolds

ADVERTISEMENT EXECUTIVES

Miriam Young

Heidi Bopst

ADVERTISEMENT PRODUCTION MANAGER

Kathryn Balchin

ADVERTISEMENT DIRECTOR

Alistair Ramsey

PRODUCTION MANAGER

Judith Middleton

MARKETING MANAGER

Bryan Denyer

ASSISTANT MARKETING MANAGER

Katrina Edmonson

CIRCULATION CONTROLLER

June Smith

PUBLISHING DIRECTOR

Marianne McNicholas

FINANCE DIRECTOR

Colin Crawford

MANAGING DIRECTOR

Stephen England

CHAIRMAN

Felix Dennis

PUBLISHED by Dennis Publishing Ltd,
14 Rathbone Place, London W1P 1DE. Tel: 01-631 1433.

Telex: 8954139 DENNIS G. Fax: 01-436 0350

Company registered in England.

REPRO: Graphic Ideas.

TYPESET by: Time Graphics Ltd.

PRINTED by: Riverside Press.

DISTRIBUTED by: SM Distribution,
6 Leigham Court Road, Streatham, London SW16 2PG.

Tel: 01-677 8111.

A



PUBLICATION

Enquiries regarding the content of this journal should be made in writing to *Hi-Fi Choice* Editorial, 14 Rathbone Place, London W1P 1DE. We regret enquiries cannot be dealt with by telephone. While every care has been taken in the preparation of this journal, the publishers cannot be held responsible for the accuracy of the information herein, or any consequence arising from it. Readers should note that all judgements have been made in the context of equipment available to *Hi-Fi Choice* at the time of review, and that 'value for money' comments are based on UK prices at the time of review, which are subject to fluctuation and are only applicable to the UK market. This edition © 1989, Felten productions. ISSN No. 0955 111 5.

MENU

Welcome to this year's *Collection*, our annual high-end extravaganza where we go for broke and indulge ourselves in some of the most exotic audio gear money can buy.

Needless to say *The Collection* is something we look forward to every year. What better excuse for a reviewer to drop out of the real world and get to borrow some state of the art hi-fi products for a few weeks? Some of the components featured in the pages that follow almost defy description; if you feel a twinge of envy when reading our contributors' descriptions of the audio bliss they've been enjoying, console yourselves with the thought that packing the gear into cardboard cartons and waving it goodbye when the writing is finished and the suppliers call to take it away is a tortuous experience!

Having experienced this first hand, bidding farewell to such exotica as the Conrad-Johnson *Premier Seven* preamplifier and massive Duntech *Crown Prince* loudspeakers, I couldn't help but spare a thought for hi-fi dealers who make a living travelling to people's homes to demonstrate such products. Listening to high-end high fidelity is a joy, but man-handling heavyweight boxes in and out of living rooms is no fun whatsoever. Still, it has to be done. You don't get a great system simply by throwing money at expensive components; various combinations have to be carefully considered and auditioned to see how they 'gel' in your listening room. The co-operation of a sympathetic and experienced hi-fi dealer is a vital element of the selection process at this level of audio.

The business of 'system synergy' is a topic which features strongly in next month's *Choice*. We've put together a selection of systems made up of good quality separates – turntable, CD player, amplifier and speakers – and set Alvin Gold the task of trying them out to gauge their worth. The systems range in price from £500 to £5,000, and full reports follow next month along with tests on a selection of 'yuppie blasters', up-market portables (most of them including a CD player) ideal for taking on holiday.

Come to think of it, I don't suppose many *Choice* readers will be wanting to spend money on a holiday this summer. Not after having acquired a taste for the best in high-end audio from reading *The Collection*!

As an added bonus this month we include the first of our free Collector's Guides to great music – *100 Choice Cuts*. Volume 1's *Top 100 Rock Albums* kicks off the series, with Jazz in our September issue, Classical (November) and more to follow. So get collecting!

John Bamford



Cover photograph of the
Micro Seiki CDM100 (see
page 69) by Chris
Richardson.

CONTENTS



THE FRONT END

6

UPDATE

What's happening on the hi-fi scene? Our reporters bring you the freshest news on products, technological advances and events.

20

CHOICE SESSIONS

This month JB discovers that he can't live without a mega TV, and we get some diverse reactions to high-end products from Roy Gregory and Paul Miller.

32

MARKET RESPONSE

DMH investigates the audiophile marketplace and finds out which products sell and why.

ASPIRATIONS

14

THE ABSOLUTE STATEMENT

High-end guru, Ricardo Franassovici opens the doors of his listening room, and reveals one variation of his ever evolving gramophone system.

26

HORNS OF PLENTY

The dynamic duo, Houston and Richardson, visit a somewhat more down to earth dwelling, kitted out with an unusual and exotic audio system.



Two aspirational hi-fis are featured this month with some absolutely outrageous Absolute Sounds' kit (above left) and the rare Impulse H1 putting some oomph into the above set-up. All round home entertainment (left) shouldn't be this good.

THE COLLECTION

37

INTRODUCTION

A rundown of the high-end products in this year's *Collection*.

39

TURNTABLES AND TONEARMS

Seven of the best-cookin' vinyl players and arms reviewed by AG, JB and JK.

53

CARTRIDGES

Paul Miller puts his alignment gauge to good use and evaluates a bunch of expensive needles.

99

TUNERS

Broadcast news: Chris Bryant tunes in with three audiophile radios.

104

LOUDSPEAKERS

Blown away: the low-down on some substantial loudspeakers.

115

HEADPHONES

In the can: JK and AG wrap their lugs around some costly 'phones.

61

CD PLAYERS

The digital alternative: the *Choice* team sample some of the world's finest compact disc players.

75

AMPLIFIERS

Eight preamps without tone controls and nine high-class power amps are put through their paces.



THE DIRECTORY

118

SELECTED DEALER DIRECTORY
Regional dealer listings to help you find the best hi-fi in your area.

122

THE CHOICE DIRECTORY
Our unique buyer's guide, packed with information on all the currently available equipment that we've reviewed.



CHOICE MATTERS

12

WBT ACCESSORIES OFFER
Hi-Fi Choice offers state-of-the-art WBT plugs and connectors at a discount.

13

COMING UP
Next month Alvin Gold reviews ten complete vinyl and CD systems made up with separate components. And JK cruises through Chelsea with ten yuppie blasters in his GTI convertible (well he might've if he had one), and Richard Black kicks off with part one of a feature on the rebuilding of an analogue masterpiece – the Studer C37 reel-to-reel tape recorder.

35

DMP COMPACT DISC OFFER
Hi-Fi Choice and Absolute Sounds bring you the DMP audiophile Jazz CDs at £5 below retail price.

114

BACK ISSUES
Missed an issue, or want to read up on a previously reviewed product? Fill in this page for back copies.

152

PERSONAL MESSAGES
Paul Messenger, having recovered from his recent stint of loudspeaker reviewing, examines some of the dichotomies of the process.

The temple of audio exotica (above left): taking the wraps off this year's high-end line-up to bring you the best-sounding collection ever, such as the Sony R1 (above) and the Pluto arm (below). Martin-Logan's Statement on the art of sound reproduction (below left): it doesn't come cheap.



SUMMER

RICHER Sounds

CLASSICS! A few examples from our exclusive range of highly reviewed top-notch hi-fi.

The UK's hottest hi-fi deals are here... With dozens more scoops and bulk-buys in-store if you're adventurous enough to visit us...

FREE GIFT! on this item with coupon

FREE on these Classics, with this coupon.

TOP QUALITY SCANDINAVIAN SPEAKER STANDS
 or ORTOFON RECORD CARE SYSTEM KIT
 or DECCA CARBON FIBRE RECORD CLEANING ARM
 ONE FREE GIFT PER ITEM PURCHASED e.g. 3 ITEMS = 3 FREE GIFTS OF YOUR CHOICE.

£59⁹⁵

DUAL CS410 Turntable Brand-new to the UK, this high performance low priced Dual brings new standards to budget turntables! •(Cart £5 extra.)
 Gift voucher may be used on any item of our large range of Dual stocked.

FREE GIFT! on this item with coupon

£99⁹⁵

ARISTON Q Deck Turntable What Hi-Fi? magazine's 'Turntable of the Year' and Hi-Fi Choice mag's 'Best Buy' the sound on this 'Q' will blow your mind with fidelity!! While stocks last... (Quality Ortofon cart only £10 extra)

FACTORY REPACK

FREE GIFT! on this item with coupon

£69⁹⁵ Pr.

NAD 3020E SPEAKERS Laser-analysed computer-aided research has been utilised to produce an amazing 60 watt per channel compact classic.
 •W210xH340xD190

Gift voucher may be used on any item of our large range of NAD stocked.

FREE GIFT! on this item with coupon

£109⁹⁵

ROTEL RA820BK2 Amplifier One of the finest quality audiophile amps currently available. This clean-drive classic boasts impressive performance and no-nonsense styling.

Gift voucher may be used on any item of our large range of Rotel stocked.

FREE GIFT! on this item with coupon

£69⁹⁵

MARANTZ AV251 Whether you're dubbing videos, mixing mics or simply trying to enhance the quality of a grotty picture this versatile AV controller is just the trick.

Gift voucher may be used on any item of our large range of Marantz stocked.

FREE GIFT! on this item with coupon

£119⁹⁵

NAD 3020E Amplifier: The legendary 3020 in an improved 'E' form. This 20 watt stunner speaks for itself. Need we say more?? •420x91x270

Gift voucher may be used on any item of our large range of NAD stocked.

You can get some amazing bargains
 What Hi-Fi? Magazine

FREE GIFT! on this item with coupon

£84⁹⁵

AIWA ADF270 Cassette Deck The professional's choice, for price and quality this deck's a winner: featuring Dolby B&C, fine bias control and auto tape select.
 Gift voucher may be used on any item of our large range of Aiwa stocked.

FREE GIFT! on this item with coupon

£169⁹⁵

DECCA FM7D5500 Tuner Containing award-winning circuitry a mind-blowing specification and 16 touch presets this tuner's knockout performance takes care of itself! Only while stocks last.

WAS £169.95

FREE GIFT! on this item with coupon

£89⁹⁵

YAMAHA T09 Tuner Crystal clear, to your ear, this sleek, highly desirable digital tuner features 2 wavebands and sixteen touch presets •435x72x237

Gift voucher may be used on any item of our large range of Yamaha stocked.

FREE GIFT! on this item with coupon

£169⁹⁵

MARANTZ CD833 COMPACT DISC This fresh new addition to the Marantz range wins again, offering the same impeccable spec as the CD873, complete with FREE remote control. (Also CD6511 £249.95, CD6511SE £299.95)

Gift voucher may be used on any item of our large range of Marantz stocked.

WE GUARANTEE TO BE THE CHEAPEST

SPECIALS

BARGAINS!

Some of this season's specials on scoop purchase and end-of-line product, all at our world renowned prices.

INTEREST FREE CREDIT available on most goods. Ask for details.

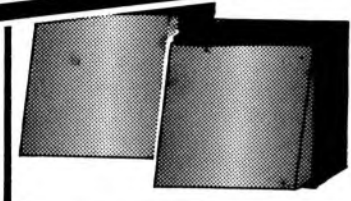

FISHER STEM77R
Amazing value surround/extension speakers handling 15 watts per channel

£9⁹⁹ Pr.

HALF PRICE 3 YEAR EXTENDED WARRANTIES

available on Turntables, Amplifiers, Cassette Decks, Tuners, Receivers and Equalisers
ONLY £9.99 for items up to £100
£14.99 for items over £100

Phone your nearest store for your FREE copy of our 16 page FUN BUMPER CATALOGUE/PRICE LIST

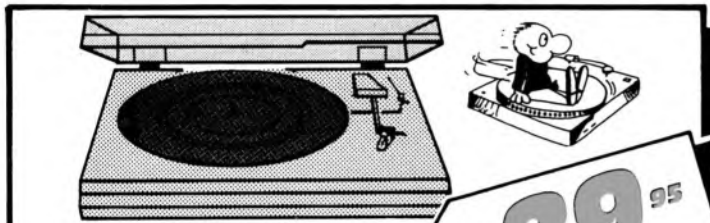

FIDELITY RD200 Turntable Sleek, low profile turntable featuring a DC servo motor and static balance tonearm for increased performance. Cart £5 extra.

£29⁹⁵

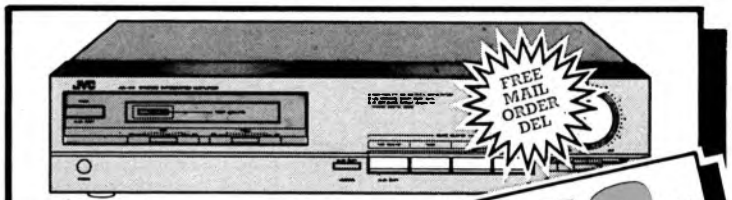

JVC AX111 Amplifier With internal 30wpc twin-amp high fidelity configuration and a low impedance direct power supply what more could you wish for?

£69⁹⁵

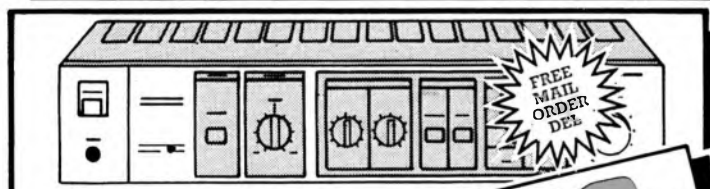

SANYO JA220 Amplifier 20 watts of music power! Featuring bass/treble controls, tape monitor and a respectable THD of only 0.9%, what more could one desire??

£39⁹⁵

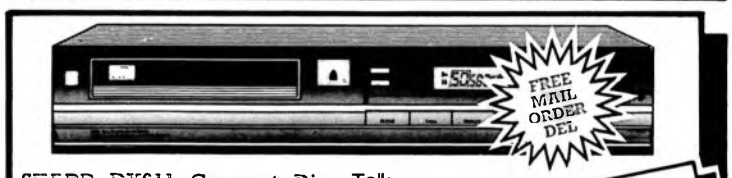

SEARP DX611 Compact Disc Talk about price crash clearance! Grab 'em while you can, this tremendously popular player has £££s knocked off its normal price!
(Also DX620 £179.95, DXR700 £199.95, DX6010 multi £229.95)

£119⁹⁵

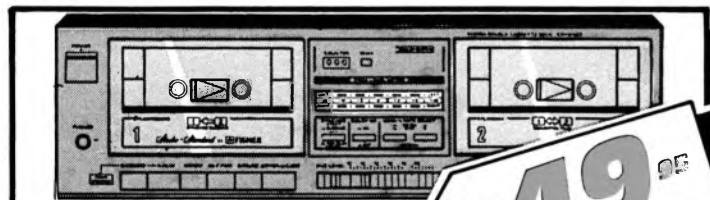

FISHER CRW35 Cassette Deck This unbeatable value separate has all the bits for half the price! Twin cassette, touch controls and Dolby NR D.C. Voltage. (Also CRW890 £199.95, CRW891 £199.95)

£49⁹⁵



KENWOOD DPM97R Compact Disc. Sophistication is the name of the game here. A classy 6-disc remote control multiplayer boasting a cool crisp sound. In a word... Unbeatable!

£149⁹⁵

WHERE TO FIND US:

- BIRMINGHAM** 10 Smallbrook Queensway, B5 4EN. Tel: 021 643 1516
- BRISTOL** 20 Cotham Hill, BS6 6LF. Tel: 0272 734397
- CARDIFF** 5 Central Square. Tel: 0222 383311.
- EDINBURGH** 1B Chambers Street, EH1 1HR Tel: 031 226 3544
- LEEDS** 55 The Headrow, LS1 6LR. Tel: 0532 455717

- LIVERPOOL** 69B Church Street, L1 1DN. Tel: 051 708 7484
- LONDON CENTRAL** 2 London Bridge Walk, SE1 2SX. Tel: 01 403 1201 (10 lines) 01 403 4710
- LONDON NORTH** 25 Northways Parade, College Crescent, NW3 (Bottom of Fitzjohns Ave) Tel: 01 722 3359
- STOCKPORT** 4 Wellington Street, SK1 3RN. Tel: 061 480 1700
- YORK** 6 Feasegate, YO1 2SQ. Tel: 0904 645535

WE ARE OPEN: 10-6pm Mon-Fri and 10-5pm Sats except London 10-7pm Mon-Fri and 10-5pm Sats.

WE WELCOME: Access, Visa, Cheques (up to of £1000 subject to status) and Part Exchange. Also VAT export (handling charge £2.50)
All goods brand new in sealed boxes unless otherwise stated. inc. VAT and g'teed 1 year. E&OE. All stores have a clearance corner full of ex-display & secondhand bargains and browsers are definitely welcome! Don't forget if you see our hi-fi cheaper anywhere else within 15 miles of your local branch we'll happily beat that price on the spot by £3. (Must be in stock elsewhere at time of purchase)

FREE MAIL ORDER available from our Stockport branch (where indicated)



UPDATE



TECHNOLOGY

PYE EYED

The winning design for a 'Personal Entertainment System of the Future' competition looks like a wristwatch and a pair of sunglasses. The Pye Prize, run by the electronics giant and the Design Council was won by 18-year-old Sam Barlow, from Castle Douglas, Scotland. His innovative idea presents a combined portable CD and CDV player designed to hang on a belt and be operated remotely by a wristwatch-size control unit which also tells the time. A screen and headphones set looks like a pair of sunglasses and would also be remotely controlled. Inside the 'glasses' is a LCD screen which focuses the picture on the eyes.

Over 80 entries were considered for the competition which was open to UK students aged 16 to 18. Sam's prize was a trip to Disneyland and £1,000. A spokesman for Pye judged the competition a success and said the plan was to make it annual but with different topics such as 'the TV of the future'. "The brief was as open as possible but we

did say that the designs should be marketable," he said. "Who knows, some of these things could be around in a few years' time." Non-working mock-ups of some of this year's winning entries were made at Pye's behest and displayed at the Design Centre in London.

DAT KILLER?

A new development from Dolby Labs, Dolby S, could herald the death of DAT when (and if) it is introduced on domestic cassette players next year. The technology derives from Dolby SR (Spectral Recording) – a successful analogue 'noise reduction' system used in some recording studios during the last three years. If Dolby engineers can condense the SR technology onto a couple of chips we could see it used on certain cassette decks in 1990 (though apparently licences will only be granted for models which meet stringent standards – those which allow user azimuth adjustment, for example).

Although less sophisticated than SR, Dolby S should be capable of delivering noise performance to compare with DAT (digital audio tape), yet it

has all the advantages of using the established compact cassette medium. Given the fact that domestic DAT appears to be in the hands of Mexicans (mañana factor 10) this analogue alternative could ensure the future of compact cassette and bury its digital rival. *Choice* carries a full report by Paul Messenger next month.

SIX NINES

Soldering iron-wielding audiophiles may be interested in a highly pure copper cable recently introduced to the UK. Stress free *6-Nines Copper* (so called because it is 99.9999 per cent pure copper) is made and marketed by the Nippon Mining Company which bills it as a replacement for the hitherto industry standard 99.99 per cent pure copper. The resulting sonic advantages of using *6-Nines*, which claims 100 times less impurities than conventional 4-Nines, will make it a must for those who want to improve the internal cabling of their equipment, and it's also available in loudspeaker and interconnect cable packages. Nippon Mining UK is based in Gresham St, London EC2. Tel: (01) 796 3345.

ULTIMATE AUDIO

Bespoke high-end systems with custom-built furniture are being offered by The Final Upgrade, a recently established dealer in New Barnet, North London. Personal visits to evaluate a customer's needs, and home demonstrations allow for (hopefully) the right choice of equipment in a relaxed manner. Stocks include SME, Voyd, Pierre Lurne, Ensemble, Clearaudio, Bel, Matisse, van den Hul and Audioquest products. Apparently this is also the only place to review the Ensemble *Primadonna* loudspeakers (see products' story) at present. Secondhand equipment is also available. The Final Upgrade, Tel: (01) 440 2588.

PRODUCTS

MONITOR MAKES IT METAL

Monitor Audio has introduced metal dome tweeters on its budget *R100* and *R252* loudspeakers in a move which totally embraces metal dome technology for the firm. The use of 19mm aluminium dome

Entertaining shades (above left) are a future possibility, while Monitor Audio's all-metal line-up (below) is a certainty.



drivers in the upgraded models is claimed to give them better power handling with a sensitivity rating of 89dB and 90dB for the £170 100 and £200 252 respectively. Impregnated paper cones are used for the bass/mid drivers. The models are finished in black vinyl and will now carry the 'MD' suffix.

OUT OF BEDSIT LAND

Nakamichi has announced four models in a new tuner-amplifiers range proving that the comeback of receivers isn't just confined to the bedsitting generation. Simply dubbed *TA1*, *2*, *3* and *4* the tuner-amps offer an ascending array of features and power outputs to match their price points of £395, £595, £895 and £1,195 respectively. *TA1* is described as an 'entry' model providing Nakamichi sound quality; *TA2* comes with a remote control unit compatible with Nakamichi CD players and cassette decks, while *TA3* and *4* are also *AV* compatible with three video inputs and two outputs. *TA4* offers the most features with eight audio inputs and is billed as having the flexibility to cope with a complete home entertainment system. All models have digital tuning with ten presets for FM and AM stations.

ANTIPODEAN LINKS

UK production of Linx products has begun with the £399 *Theta* analogue FM tuner (reviewed in this issue). Linx components had been imported from New Zealand but Linx Audio UK bought the name last year and imported the original design team of Gavin Morris and Gordon Taylor to establish production of the range of electronics here.

The products will be marketed by The Musical Design Company – a new member of the Linx group which is also responsible for Micromega CD players, Audioplan loudspeakers and Eminent Technology products in the UK. Musical Design Company, tel: (0268) 590789.

BACK IN THE REAL WORLD . . .

We couldn't resist teasing *Collection* readers with news of Binatone's latest 'CD compatible' midi system – at £89 a gargantuan price leap downwards from some of the kit you'll see on later pages.

System *Midi 310* is finished in grey with matching loudspeakers and comprises belt drive turntable, five band graphic equaliser, twin high-speed dubbing and continuous playback

cassette deck, plus amp and auto-frequency control three-waveband stereo tuner. Proprietary sockets cater for add-on CD player and stereo microphone. For another tenner Binatone's *Midi 360* offers remote control.

SIX PACK CD

Goodmans is offering its new six-disc CD multiplayer with a pair of 'active' *Maxamp* loudspeakers for a premium of £329. The *GCD555* CD player can also be bought on its own for £219. It comes with a six-disc magazine and is remote controllable allowing listeners to grow roots into their armchairs. With the *Maxamps* it offers an alternative, compact CD-only system.

EAR IN GOLD

EAR 509 power amplifiers finished in gold-plate are now available priced £2,298 a pair, which is £600 more than the 'standard' chrome version. These highly regarded all-valve monoblocks are built in Huntingdon and designed by Tim de Paravacini who said that the new finish was purely cosmetic. "Nothing else has changed; they don't need any upgrading," he swanked.

HIGH-END COMPACT

Sonic purity and reliability are the touted properties of the new Conrad-Johnson *DF1* combined CD player and preamplifier just arrived from Virginia, USA. The remote controlled £1,799 *DF1* boasts CJ's own DAC, filters and audio circuitry and only uses Philips' mechanical parts. The heavy steel chassis, damping and disc clamp promise minimal vibration which in turn reduces disc reading errors "offering harmonic integrity, ambience retrieval, focus and soundstaging

not approached by any other CD player", according to the importer Audiofreaks. The by-passable FET preamplifier section has a volume control and inputs for auxiliary and tape with tape-out (but no phono stage) making *DF1* eminently suitable for use with active loudspeakers, say.

Also available from the Audiofreaks stable is the all-valve Conrad-Johnson *PV10*

preamplifier which at £1,149 is the cheapest in C-J's range. However, *PV10* boasts circuitry developed for the outrageously priced *Premier Seven* (reviewed this month) and is described as "a worthy successor to the *PV5*". One phono and five line-level gold-plated inputs are offered as well as a tape loop, and the amp has a bypassable balance control. *PV10* is finished in 'champagne gold' anodised aluminium.



A must for the bed-bound: Goodmans' endless music pack (top). Midas-touched amps from EAR (bottom).

HOW MUCH MONEY WILL YOU SPEND ON HI-FI BEFORE YOU HEAR THE MUSIC?

We don't wish to worry you, but had you realized just how many audio components there are around that will never really let you hear the music, no matter how many naughts they have on their price tags.

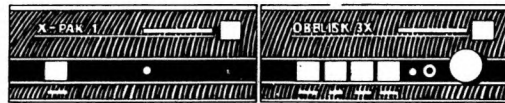
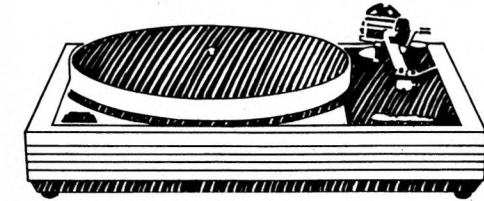

At Chris Brooks Audio, we work by one simple rule: if it doesn't play music we won't sell it!

That means that any music system or component you buy from us, at whatever price point, will always satisfy this fundamental requirement.

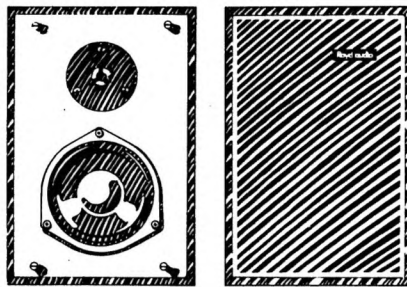

It also means that when you choose from our carefully selected range of quality hi-fi, you'll be able to hear exactly why Charlie Parker is regarded as a genius or Miles Davis such an innovator. Why Itzhak Perlman is a master of the classical violin. You'll be able to hear the skill of John Williams, the soul of Bobby

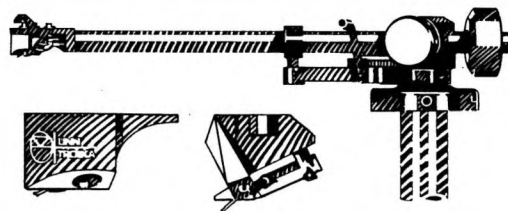

Womack. Musical ideas, emotions and techniques.

If these things are important to you, then why not call and talk to us. Book a demonstration in one of our three studios; we're conveniently situated close to the motorway network. Bring some of your favourite music; relax and listen.

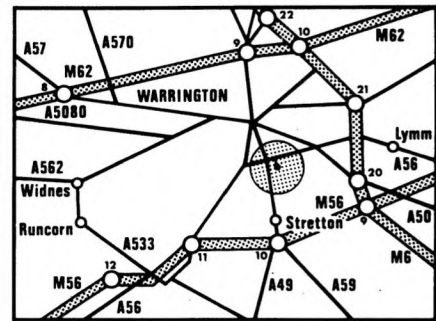

If you decide to make a purchase, it will be properly installed for you free of charge if required, covered by our 2 year parts and labour guarantee and backed by our in house servicing facility.

Most of all however, you'll have the means to enjoy music, pure and simple.



CHRIS BROOKS AUDIO, 29 GASKELL ST., STOCKTON HEATH, WARRINGTON, CHESHIRE. TELEPHONE: 0925 61212.

LINN ▶ NAIM ▶ EXPOSURE ▶ REGA ▶ ROKSAN ▶ ION SYSTEMS ▶ ROYD ▶ CREEK ▶ A & R CAMBRIDGE
▶ BEYER ▶ AKG ▶ SENNHEISER ▶ RUARK ▶ AUDIO TECHNICA ▶ QED ▶ DUAL ▶ P.W.B.

Open 10am to 6pm, Tuesday to Saturday. All major credit cards accepted. Credit terms available, written details on request.

VITAL'S FIRST LADY

Just £5,500 will buy you the new *Primadonna* loudspeakers from the Ensemble stable. Like other prima donnas the floor-standing speaker is visually striking with a curved front, but unlike most of them it is only 115cm tall and will apparently 'work' in most listening rooms. The two-way system boasts an efficiency rating of 92dB making it easy to drive with low power amplifiers. Its striking Bacofoil-like 130mm mid/bass driver is instantly recognisable as Ensemble's hallmark and *Primadonna* has a custom-made tweeter.

The *Primadonna* is so far only available for auditioning at The Final Upgrade in New Barnet, North London.

ICE ON THE ROAD

Roadstar, the Swiss In Car Entertainment company, has set up a subsidiary in the UK. The complete range of Roadstar equipment is to be made available with prices from £50 for simple cassette players, to £350 for compact disc units. Amplifiers, antennas and equalisers are also available. Many of the products have a Radio Data Service (RDS) facility for up to date travel information and all have quick release mechanisms for easy servicing and theft prevention. Two in-car speaker ranges, the budget *Rallye Line* and *Digital Sound* range, feature a host of models priced from £20 to £100.

Roadstar already has existing sales outlets in Europe, Japan and America and the move has been made in anticipation of the Common Market proper in 1992.

NEW TUBE LINE

The new range of Grant amplifiers has been launched with a valve pre and power combination selling for less than £1,000. The Portsmouth-based manufacturer has produced a new £690 stereo power amplifier (*G50A*) and a £287 preamplifier (*G43P*) which have been designed for use together. An existing model, the £224 *G100P* preamplifier, has been upgraded to include fully regulated HT supplies and a redesigned front-end, but is described as sonically slightly less capable than the physically larger *G43P* and, for instance, lacks a tape monitoring facility. Three valve monoblocks priced between £900 and £2,500 make up the rest of the range.

BUSINESS

TOMORROW'S MARKET

TV and video giant Ferguson, now owned by French multinational Thomson, has just published its second annual report on the UK consumer electronics market. As with its predecessor, the slim 16 page booklet contains a wealth of fascinating detail on the trends which are operating in the whole area of 'brown goods', which includes all but the more esoteric hi-fi equipment. High quality colour graphics can make even marketing data interesting, while the fact that the 'consumer intentions' research was carried out as recently as February this year means that it takes account of reactions to the current credit squeeze.

This has already had a substantial effect upon sales of

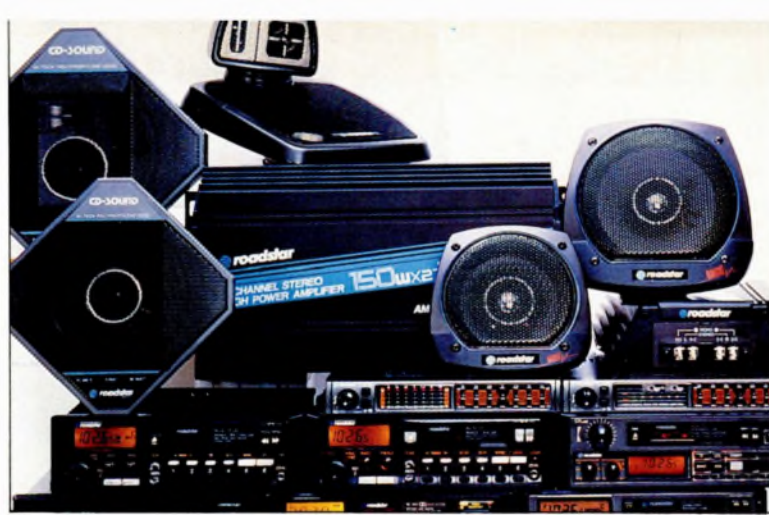

New buggy boogie packs from Roadstar.

electrical goods, which are probably running at 15 per cent below last year, and the caution of consumers is reflected in the small percentages registered as intending to purchase different items during 1989, plus the comparatively high percentages prepared to postpone such purchases if necessary.

However, all is not gloom. The 'hi-fi/stereo/CD player' sector comes out better than all the other brown goods categories with seven per cent intending to purchase, beaten by cars, washing machines and cookers but comfortably ahead of TVs, VCRs and satellite TV systems.

More detailed analysis of the market for domestic hi-fi and audio, with figures for 1987 and '88 plus projections for '89, show the slow but steady percolation of CD through the marketplace, and indicate that the market for one-piece and component systems is expected to continue growing in 1989, at least in volume terms, though not at the high rate experienced in 1988.

However, the market for standalone CD players would appear to have peaked at around 300,000 units, while that for players in complete systems seems to be starting to flatten off at around 600,000. Most of the growth of CD is now expected to be in one-piece 'music centre' midis where CD is still only featured in 25 per cent of systems sold, and in personals and portables which have hitherto grown slowly in the UK.

Over 80 per cent of households now have hi-fi/audio systems, but only 13 per cent overall have so far embraced the CD format – a figure which splits out at five, five and three per cent for those with music centres, separates and rack systems respectively. However, both CD and music centres are strongest amongst the youth market, 16-24 year old householders registering 24 per cent and 62 per cent ownership respectively.

IN BRIEF

Bandridge, which markets Eurochannels, Monitor PC and Laserline accessories as well as Cobra aerials, has moved address to Premier House, 18 Deer Park Road, Wimbledon, London SW19 3TU. Tel: (01) 543 3633.

Grahams Hi-Fi has moved to new specially designed premises at Canonbury Yard, 190 New North Road, London N1. The 60-year-old specialist retailer has built five listening studios in the ground and basement floors of a Victorian warehouse, offering the very latest in hi-fi demonstration techniques with the added advantage of on-site parking. Tel: (01) 266 5500.

DNM Distribution Ltd is a new company set up to deal with UK sales of DNM amplifiers, cables and accessories, and Rehdeko loudspeakers in the UK. DNM Design will continue to operate as the research and design arm of the company whose products are made by Karlev Audio in Switzerland. DNM Distribution, Brentwood, Essex. Tel: (0277) 227355.



Central heating variants (1): a Grant pre/power combo.



Goldring has replaced its 1010 moving magnet cartridge with a new £40 model the 1012. 1012 uses a fine line Gyger III diamond stylus, and a rigid glass reinforced polyester body which can be tightly bolted to the headshell.

R O K

San

STAY AT HOME AND
listen to your records,

a major contribution
to road safety.

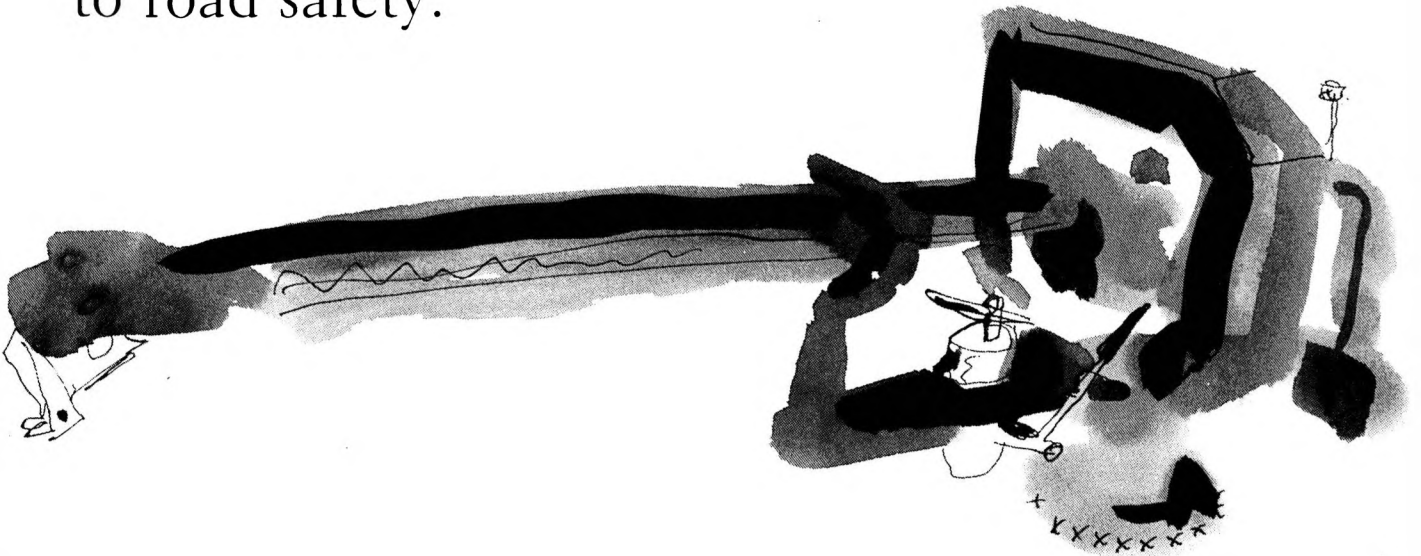

The Roksan Artemiz and Shiraz

The Cornflake Shop

37 WINDMILL ST. LONDON W1P 1HH

01 631 0472

WBT HI-FI ACCESSORIES OFFER

Get the best from your hi-fi and save £s with high quality connectors.



Ever felt like making up your own interconnects or improving the quality of the plugs and sockets around your system? Now's your chance to do it and do it properly. *Hi-Fi Choice* in conjunction with Absolute Sounds are offering you the chance to buy the very best audio connectors at a discount.

The German WBT company produces a comprehensive range of high quality gold plated plugs and sockets, which includes two varieties of phono plug, loudspeaker plugs and an array of sexy accessories.

The WBT-0101/0150 lockable RCA phono plugs are for soldered connections and come in two sizes, for up to 9mm and 11mm diameter cables respectively. The alternative is the WBT-0108 which has screw terminals and should be used with WBT-0425 endsleeves for best results. These gold plated tubes are crimped onto the cable ends and ensure an airtight connection without the fiddle of soldering. And for a really professional look to your home-made cables, you can finish the leads off with spiral sleeves. (Note: you don't use spiral sleeves with cables exceeding 7.3mm diameter.)

If you want to improve your loudspeaker terminals and feel confident with a Black & Decker in your hands, look no further than the beefy WBT-0700 4mm pole terminals. These are designed to accept any form of speaker connection from bare wire to banana plugs and can be fitted to virtually any loudspeaker.

Perfect for all loudspeaker connections, the WBT-0600 4mm lockable 'banana' plug fits cables ranging from 2.5 to 16mm², so no more effort with large cable cross sections. For thinner cables use the WBT-0570 spiral sleeve. The 0600 can either be crimped or soldered – just as you wish.

The WBT-0200 is a top quality phono socket, just the job for cabinet mounting, for casing-wall thicknesses ranging from 0.5-6.0mm.

WBT supplies audiophile solder too (WBT-0800), and once you've perfected your connections put your cable-jungle in order and label your cables with the WBT-0500 labelling card. These sticky-backed labels are marked 'CD', 'Tape', 'Video' etc and can be wrapped around cables and connectors to make identification easy when wrestling at the back of your audio gear.

WBT products are designed to make DIY connection upgrades a painless – even, dare we say it, fulfilling pastime. We suggest you check 'em out!

TO ORDER WBT ACCESSORIES

(Tick selections)

	Recommended Retail Price	Our Price
<input type="checkbox"/> WBT-0101 RCA Male for 9mm cable	£12.95	£10.95
<input type="checkbox"/> WBT-0108 RCA Male for 9mm cable crimp-type	£15.50	£13.50
<input type="checkbox"/> WBT-0150 RCA Male for 11mm cable	£17.50	£14.95
<input type="checkbox"/> WBT-0200 Chassis mount RCA Female	£12.95	£10.95
<input type="checkbox"/> WBT-0425 Strand end sleeves for WBT-0108	£ 1.95	£ 1.60
<input type="checkbox"/> WBT-0500 Labelling card (only available with minimum order of £5.75)	£ 1.95	£ 1.60
<input type="checkbox"/> WBT-0550 Spiral sleeve (5mm cable entry)	£ 1.95	£ 1.60
<input type="checkbox"/> WBT-0560 Spiral sleeve (6.2mm cable entry)	£ 1.95	£ 1.60
<input type="checkbox"/> WBT-0570 Spiral sleeve (7.3mm cable entry)	£ 1.95	£ 1.60
<input type="checkbox"/> WBT-0600 4mm Banana plug (lockable)	£16.75	£14.25
<input type="checkbox"/> WBT-0700 4mm Pole Terminal	£16.25	£13.75
<input type="checkbox"/> WBT-0800 Silver solder (0.9mm x 10 metre)	£ 6.75	£ 5.75

PAYMENT

I enclose cheque/PO made payable to Dennis Publishing for _____
(£5.75 minimum order)

Please charge my Access/Visa
(delete as appropriate)

Credit card number _____ Expiry date _____

Signature _____

Name _____

Address _____

Postcode _____

(HFCT2 WBT)

Please send order form with payment to:
Hi-Fi Choice Mail Order, PO Box 320, London N21 2NB.

All our prices are inclusive of postage, packing and VAT. Please allow 28 days for delivery. Available to UK readers only.

The Sound Room of Norbury

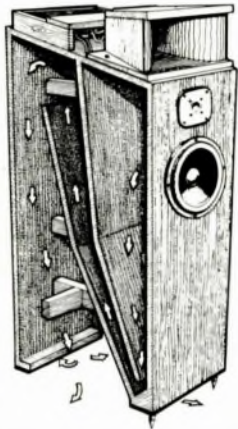

WE ARE THE FIRST UK DEALER TO HAVE ON PERMANENT DEMONSTRATION THE FABULOUS ROCK REFERENCE. PLEASE PHONE FOR AN AUDITION.



Townshend Rock

Custom built State of the Art Horns. Introducing the awesome new Impulse H1 full range horn loaded loudspeakers. Lows that go down to the bowels of the earth. Highs that sing sweetly and a midrange that flows with an effortless freedom.

AGENCIES INCLUDE:

ORACLE · BEARD AUDIO · ESOTERIC AUDIO RESEARCH · KISEKI-MILLTEK · AUDIO INNOVATIONS · ZETA · SNELL · MICHELL GYRODEC · THE VOYD · VALDI · HIGHPHONIC MCA 3 · IMPULSE H4 · AUDIO NOTE · HELIUS AUDIO · STATIC · MDM · SPICA · VECTEUR JECKLIN · DECCA · GARROTT P-77 · GOLDRING GRANT · SAE COMPACT DISC · ALPHASON VAN DEN HUL · INFINITY · KUZMA · COPLAND FOUNDATION · ELITE ROCK · AUDIO TECHNICA GLANZ · GRADO · NAGAOKA · ORTOFON SHURE · STAX · TARGET · DNM

SOUND ROOM SPECIALS

EX DEMONSTRATION

	Retail Price	Sale Price
SNELL TYPE E WITH STAND 3 MONTHS OLD	£1200	£795
SONUS FABER	£1200	£995
ORIAOE SPEAKERS NEW	£865	£865
INCATECH CLAYMORE	£345	£225
BEARD P35	£795	£395
KRELL KMA100	£5900	£3195
VTL STANDARD PREAMP	£550	£345
VTL DELUXE PREAMP	£995	£475
BEARD 506 PREAMP	£1195	£795
KUZMA TONEARM	£395	£250
KRELL KSA50	£2550	£1250

OPEN 7 DAYS AND EVENINGS
DEMONSTRATIONS BY APPOINTMENT ONLY

PHONE 01-764-9295



DON'T MISS NEXT MONTH'S ISSUE OF

HI-FI CHOICE

PACKED WITH IN-DEPTH REVIEWS!



10 SYSTEMS ON TEST

We assess 10 separate systems ranging in price from £500 to £5,000. Plus MUSIC ON WHEELS: an aspirational Porche with Soundstream in-car electronics.

AND...

JASON KENNEDY CHECKS OUT A HANDFUL OF THE LATEST YUPPIE BLASTERS FOR GOOD SOUNDS ON THE MOVE.

PLUS...

NEWS, VIEWS, AND MUCH, MUCH MORE.

HI-FI CHOICE

AUGUST ISSUE ON SALE JULY 7th



ASPIRATIONS

Sometimes described as the UK's high-end guru, Ricardo Franassovici is well on the way to audio nirvana with his current system. Dan Houston and photographer Chris Richardson, went to visit.



The Absolute Statement



At last we had a date to visit Ricardo Franassovici, the French-born doyen of UK high-end audio who single-handedly took on the establishment in the late '70s importing exotic equipment from Japan and the States in a bid to prove to audiophiles that there was life after the British 'best'.

Ricardo lives in a large house with his wife and two children. And crunching over the gravel drive the first thing you see is the black Ferrari 400i – only a recent acquisition and testimony to the fruits of a

decade's labour (he somewhat shyly assures). The wood-panelled hallway with its antique vases and tables, and the adjoining sumptuously decorated dining and drawing rooms reflect a taste for Regency style; his wife is an interior designer and the home wouldn't look out of place in any of the 'interior' magazines. But we had come to see his music room, situated at the back of the house with views over a spacious (but not uncontrollable) garden. One of his two pointers was patrolling the perimeter.



This light and airy room used to be his company's operational base and is still used for auditioning new equipment. A large table in one corner supports an ever-trilling telephone, computer and impossible piles of correspondence. Elsewhere sports car magazines and art books are piled on shelves and model Ferraris clutter a mantelpiece, but the arresting sight is of the huge converted bookcase containing some 5,000 records and the massive Martin-Logan loudspeakers that transduce their content. These latter were just days

old at the time of our visit and at £38,500 are among the most expensive in the world!

The record collection is no less impressive. Much of it is made up of collectable first pressings with a high content of soul and blues music from the '60s and '70s. Ricardo could be described as a compulsive buyer of such material – he recently took it upon himself to scour the country for old Blue Horizon releases, and has ended up with all but about three records of the label's entire output. "I really like

these because they're such pure recordings," he explained, "and many great musicians started with the label; I've got some early Clapton, Paul Kossof, Fleetwood Mac and the Yardbirds." For Ricardo (a serious collector since he came to live in England in 1977) the first pressing is all important, like a first edition book, and he would rather scour second-hand record shops and fairs than buy the new records which have since been re-released.

There is also a shelf for singles, some of which are kept for use in his restored 1958

American Musical Instrument Company 'Stereo Round' *Continental* juke box. And the keen-eyed will notice a pair of Australian Duntech loudspeakers flanking this working piece of art deco, but it would be absurd to wire it through them . . . wouldn't it? Before anyone loses faith in Ricardo's system matching ability, it would – the Duntechs were redundant, having just made way for the Martin-Logans.

On the back wall of the room hangs an early painting of Rolling Stone Keith Richards, anonymously executed but apparently by one of his girlfriends (which hardly narrows it down!) and balancing that on the other side is a Ronnie Wood lithograph of David Bowie, Johnny Rotten and Rod Stewart entitled *Decades: 70s*. The gorgeously pink Vivai del Sud sofa and chairs are from Italy.

Another music system (a Nakamichi 600 stack) stands in the fireplace alcove like a piece of industrial art. The 600 range was the only rack system produced by the cassette deck specialist. However, the focus of the room is the main system, set up behind and between the enormous loudspeakers, offering a visually awesome taste of what was to come aurally. Indeed this equipment doesn't look so much like hi-fi as an array of electronic orchestral instruments with each item dedicated to one area of re-making the musical experience.

The musicality of equipment is all important to Ricardo who chose this (and the rest of his imported range) on the criteria that it is well-built by an established manufacturer, will last a long time and that it is "musically correct". "Many products have one or two of these criteria but my equipment must have all three," he says. The most difficult side of the triangle to judge is that of musicality and Ricardo says he makes his decisions on equipment intuitively, listening to the whole "envelope" of the sound rather than picking out the characteristics of bass, image, treble and the like.

He cites his long involvement with live music as qualification to make the right judgement. Before he arrived in England he had been A&R man for WEA, Ariola and RCA in France and had run a jazz club (the Black Horse) in Rio de Janeiro for ten years. He also ran a promotion business in (then fascist) Portugal, organising concerts featuring the likes of Procul Harem and Vinegar Joe in the late '60s and early '70s. He speaks four languages.

Absolute Sounds was started from this listening room in 1977 with a working capital of just eight Dual Tone cartridges. But



the company was founded almost by accident. "I came over from France to take a job with a record company and then found out it was not all it was supposed to be," he explained. Since I was here, and I had always been hi-fi system conscious I naturally drifted into it. I realised that some of the components I had been able to get in France were non-existent here. And for us in Europe, England has always been a country that traditionally has been able to absorb quality goods. For instance it was accepted here that you could spend £20,000 on a Rolls-Royce, £5,000 on a good watch or £2,000 on a nice camera. But audio wasn't considered important. It was Linn, Rega and housewife regulated. People thought a top system would cost £1,500."

In the light of this approach it's not surprising to hear Ricardo say that his main inspiration came from Enzo Ferrari rather than anyone in the audio field. "He was a genuine bloke, I can tell you; I often quote his saying: 'I build my cars for people to reward themselves for an intense labour.' And in the same way I wouldn't like anyone to buy high-end audio for the wrong reasons; we have never been caught selling something just because it is expensive."

Getting Absolute Sounds to where it is today with "15 loyal dealers" is remembered as a challenge and uphill struggle;



dealers were originally very sceptical having just got used to a new heirarchy based on British brands. The business breakthrough came in 1980 with Koetsu cartridges, by which time Ricardo was offering audiophiles his alternative high-end system. This fronted with the Canadian Oracle turntable, Sumiko arm, Beveridge and Threshold valve amplifiers and Beveridge Cylindrical Tower loudspeakers. "I have always been very system conscious," he continued, "things have to sound well together. It's like putting a



The alternative orchestra plus toy (left) features some of the best players in the business with (clockwise) Nakamichi's thumping classic, Jadis, Goldmund and Martin-Logan crossovers.



Porsche engine on a Lamborghini chassis, you have to try things together before you know they work."

Synergy of components within a system context is something Ricardo gives European audiophiles credit for rather than Americans. In the early 1980s there was no system awareness in the States, he claimed.

One of the first things one notices about this system is the lack of CD player (the same can be said for most of the audiophiles we visit). Ricardo does import CD

players for customers who want one but he is unequivocal about their performance capabilities so far. "There is no comparison with analogue," he states sweepingly, "they are fundamentally wrong in essence; by asking your brain to numerically sample all those signals... well you just can't do it. I always say that the people who like CD players don't really know music. Even some musicians have fallen into a commercial trap by liking it. With a digitally recorded signal you lose the envelope, you instantly lose the reverberation and the

sense of timbre of the music.

"Let me relate something. I was recently at the house of a very famous patron of the arts in Geneva and we played a Fitzwilliam Quintet record of Schubert which sounded absolutely gorgeous on his high performance system. At the time Carlos Paita, the famous Argentinian conductor was in the room and he had a CD of the same music by the same quintet that he had recorded himself and which he wanted to demonstrate on this superb system. So he stood between the speakers and conducted the imaginary musicians. I was completely off axis but I turned round and said: 'this is wrong'. He stamped both feet on the ground and said: 'I know!' He even told me that now he tells musicians not to follow the score but to carry on playing a little bit to fill out the envelope so as not to give a chopped effect to the music."

While this story may be amusing, especially Ricardo's impersonation of the Latin maestro's frustration, it is also worrying when one considers the continued hype over CD, with several record companies ditching vinyl altogether in favour of this (expert's) non-favourite. Not that a record deck is the best of all sources in Ricardo's eyes. For him, the ultimate is an analogue tape machine on which to play the original master tapes. "If I was a record company magnate I would truly love to have a tape



M A R A N T Z.
N O T F O R T H E
C A S U A L
L I S T E N E R.

You don't buy Marantz hi-fi to hear music. You buy it to listen. To appreciate every aspect, every subtlety of sound in a musical piece. Thirty years ago Saul Marantz said, 'for us the realistic reproduction of music is the essential premise'. These words set the standard that continues to this day.

That's why Marantz still uses its own custom components and technologies throughout the entire hi-fi range. Because it's still the only way to achieve pure high fidelity. After all, there is just one ultimate test of musical perfection – listening.

marantz
PURE HIGH FIDELITY

PM 95 Reference Standard Digital Class A Amplifier.



based system," he dreamily aspires.

But wow! If this system isn't the best thing going for this man then he's hard to please. Lost somewhere *on axis* in the Vivai del Sud it was certainly hard to believe that this was hi-fi we were listening to. Prince stepped out from behind the right hand *Statement* and started his slow and painful rendition of *Black Monday*... and yes, he seemed to be wearing a trenchcoat and little else.

Ricardo fussed over the open crossovers with a penknife screwdriver blade and started (would you believe it) to apologies for not having had time to have the system running just so. "I'm afraid these speakers are only doing about 45 per cent of what they should. I'll ask you back in a couple of months when they're run in," he said. It worked; we were impressed.

The session continued with classical and soul offerings sounding equally live and deep. One of the strange things that I've encountered obviously only once before for *Aspirations*, was the true sense of stage and reality (perhaps unreality) from the loudspeakers in this room context. They immediately disappear, allowing you to listen through to the positions of the different performers. Even when you're staring at the massive diaphragm and cabinet of four bass drivers it is impossible to tell that they are providing this room-full of music you're hearing.

The non-tweaked bass, powered by the squat black Krell *KSA 200* and using the same flat-silver high current Symo speaker cable that the amp uses internally, was unnoticeable as such. As were the outlandish Jadis *JA80* valve monoblocks which were powering the higher frequencies to the electrostatic panels using Siltech *Silver Ribbon* cable.

As previously mentioned, Ricardo's great love and the majority of his collection consists of soul and early British Blues

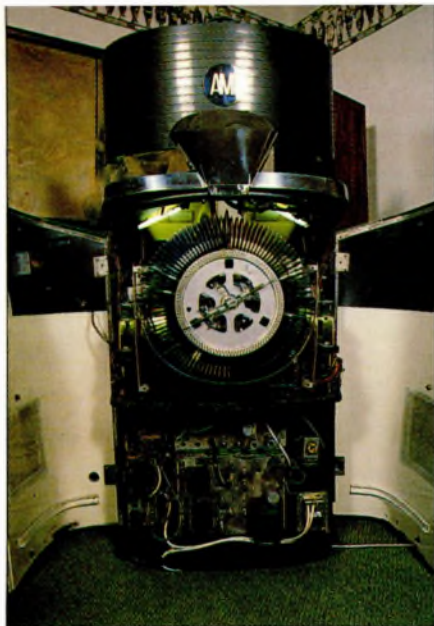

The innards of a jukebox (above) provide an alternative valve sound to that of the gramophone (below).

music. Most of these are secondhand and have probably previously been played using a stylus that is the hi-fi equivalent of a chisel! And perhaps aware of this as much as of the unparalleled tracking abilities of his Goldmund *T3F* and Koetsu *Gold* tonearm and cartridge, Ricardo was leaving the records scattered on the carpet – destroying the sanctimonious image of an audiophile tenderly preserving his beloved black vinyl. These records are kept to be played, not molly-coddled, and the system presents them with a boogie factor that is impossible to resist.

A 1968 recording of Otis Redding at the Whiskey A-Go-Go (Ricardo has around 30 OR records) had the soulster singing *Papa's Got a Brand New Bag* in a similarly live way to Prince, swaying from side to side right there in the centre of the imaginary stage with his backing group standing around, defined by their instruments' posi-

tions. Sadly we didn't get to hear the Marantz *10B* valve tuner or the Sumo-size Nakamichi *1000ZXL* cassette deck. Both these models have been superseded by supposedly better models but Ricardo doesn't think so. He has had the 20-year-old FM classic for the past decade and believes there is still nothing to match it.

Ricardo's future business aspiration is to get back into record production once Absolute Sounds is more established. This would be under the AS name and in the tradition of the company would be dedicated to "musical correctness", and would (of course) produce only vinyl records of the highest quality. That is the future. For now it was revealing to hear what can be achieved with hi-fi knowhow once you take away the price tags.

Driving away our photographer referred to the price tag which of course might be a small factor to an aspiring audiophile. "For that money," said Chris, "I'd want to hear the voice of God speaking to me." But maybe when Ricardo gets his own record company he'll be able to make a suitable recording.

The Kit:

Koetsu <i>Gold</i> Cartridge	£1,600
Goldmund <i>Reference</i> Turntable	£19,500
Goldmund <i>T3F</i> Tonearm	£3,950
Audio Research <i>SP15</i> Preamplifier	£6,350
Jadis <i>JA80</i> Power Amplifier	£3,200 each
Krell <i>KSA200</i> Power Amplifier	£5,050
Nakamichi <i>1000 ZXL</i> Cassette Deck	n/a
Martin-Logan <i>Statement</i>	
Loudspeakers	£38,500
Marantz <i>10B</i> Tuner	n/a
Mandrake <i>Solid Silver</i>	
Interconnect	£250/m
Siltech <i>Silver Ribbon FT12</i>	
Loudspeaker Cable	£85/m
Symo Cable (bass only)	£49/m
	Around £85,000





CHOICE SESSIONS

This month we discover cinema for the home, dissect the Cello Etude and enthuse about a Blackheart.



FULL FRONTAL

Somewhat bleary eyed, John Bamford reports on a TV/video projector which has had him watching movies late into the night.

In retrospect it was a bad idea. Borrowing the Thompson *TVP 3000* projection system from Cheltenham's Amark Video Designers when I should have been writing up reviews for *The Collection* was asking for trouble.

When Amark called to install the system they also came armed with two Pioneer CDV combi players (one PAL, one NTSC) and a carrier bag full of blockbuster movies on 12-inch discs. And once the news got out, everyone and his uncle wanted to call in to check out this cinema-in-the-home experience. Late the other night, for example, I had the entire staff of the *Choice* office (and others besides) around for a *Top Gun* party! Never has so little sleep been had by so many...

We first came across the *TVP 3000* in the Amark demonstration room at last year's Penta hi-fi show. What makes it different from other projection systems – and ideal for home installations – is Thompson's on-board microprocessor-aided convergence system which allows you to optimise the colour convergence alignment in just a few minutes via the remote handset. Installation of TV projectors is usually a highly specialised business, and should the projector or screen ever be accidentally nudged out of position you need to employ the services of an engineer (probably the person who sold you the projector) to set the whole thing up again by making internal adjustments to the projector to re-align the guns so that they converge accurately at all points on the screen.



Cinema in the home made easy by Thompson's microprocessor-controlled TVP 3000.

When they don't, you soon know about it. The effect is a little like 'ghosting' on a TV with a poor aerial, except that what we're talking about here is the colours being out of register. Suddenly people's heads gain a red or blue halo – and when the images on the screen are larger than life any anomalies are all too obvious.

And TV projectors have a habit of drifting out of tune. So, as with your central heating boiler, your projector usually needs a periodic service to keep it working satisfactorily, which makes ownership a costly and fairly troublesome exercise.

The remote control digital convergence system is what makes the Thompson *TVP 3000* such an attractive proposition. A ten minute demonstration was all I needed to learn how to set the thing up myself. The 'brain' of the *3000* divides the projected image into 182 zones, any one of which can be accessed to make tube alignment perfect.

But what's really clever is the Automatic Convergence Mode: pressing the relevant keys on the remote handset presents a grid

on the projection screen to ensure that the image is square, and 17 points on the screen (preselected out of the 182) can be checked and readjusted. At each of these 17 points a cross is projected on the screen which should appear white; if there's a red or blue 'shadow' cross you use cursor keys on the handset to move the shadows left and right, up and down, until the images converge to give a properly focused cross. Pressing 'Auto' memorises the alignment at each point on the screen, and once alignment has been set at each of the 17 points the convergence alignment is made for the total image thanks to the on-board microprocessor. It's all done from your armchair, and the whole procedure takes no more than four or five minutes.

Other important features of the *TVP 3000* include multistandard capability for PAL, SECAM and both NTSC formats (the projector automatically senses what's what), and four different video inputs (2 BNCs, RGB analogue and Euroconnector) allow connection of TV, VCR, camera, videodisc and satellite systems. Of particular interest to some parties will be the fact that the projector is also computer ready (IBM based systems) with both the Euroconnector and RGB input which can be connected to home computers. This would make things like flight simulation games really wild – but more importantly the *TVP 3000* is ideal for educational and training purposes. Used as a whiteboard, the projection screen can show displays of data to large audiences.

What the *3000* doesn't have is an on-board TV tuner. Normally you'd connect it to the output of a video recorder, of course – and with a NICAM equipped Hi-fi VCR and a high quality hi-fi system you can enjoy a magnificent cinematic experience off-air or via video tapes. Thing is, you can't watch one TV channel while recording another, so you'll probably still want to hang on to your TV set. Mind you, after a few days with the *3000* you'll find watching a minuscule TV screen a singularly uninspiring experience.

In a way, a TV projection system is the ultimate home entertainment experience. What does it cost? Well, it's not cheap, but at £4,365 the *TVP 3000* is cheaper than many lesser projection systems. Add to this £86 for the ceiling mounting brackets – and, of course, the cost of a screen. The one I used was an ordinary slide projector screen, worth around £80, with a 'gain factor' of zero. It worked OK, but the image faded considerably in high ambient lighting and closing the curtains to watch *Grandstand* on a Saturday afternoon is hardly civilised practice. Parabolic screens are available with a gain factor as high as nine, but parabolics are expensive and too 'permanent' for most home installations. Amark has recently sourced a new type of screen from America which looks much like an ordinary screen but has a gain factor of three and is only around 20 per cent more

costly. This is the one I'd go for. In fact, as my living room is set up predominantly to accommodate a hi-fi system, I'd probably budget for a motorised screen (around £400) which could disappear into the ceiling at the touch of a button.

It all adds up to a lot of hay. But, as we commented to each other the other evening after our senses had been bombarded by *Top Gun*, it's a lot more fun than a Mini Metro! If we'd had the 3000 a few days longer I'd like to have tried a complete Dolby Surround set-up. Now that would have been really mind blowing!

Amark Video Designers, Anchor House, Warwick Place, Cheltenham, Glos GL52 2NP. Tel: (0242) 570131.

NO THANKS

Has high-end audio gone mad? Can a passive control unit really be worth £795? Paul Miller studies the Cello Etude...

Founded by Mark Levinson as a personal statement on 'state-of-the-art', Cello electronics has already carved itself a niche in audio folklore. One of its least expensive (though no less outrageous) products is the *Etude*, a calibrated stepwise attenuator designed to sit between a line level source (such as a CD player) and power amplifier. The attenuator is then adjusted, just like a volume control, to moderate the output of the power amp without recourse to a fully fledged active preamplifier.

In essence the *Etude* is little more than a glorified potentiometer, yet with a heady retail price of £795 it's some 15-20 times more expensive than the likes of the QED or RTJ passive control units. On the face of it the *Etude* does offer greater flexibility, a second knob routing one of four possible line inputs to the stepped attenuator. However, though each of the signal and return (ground) lines are switched independently, the input and output phono sockets are grounded on a common, bright nickel plated brass busbar. Nor are the joints properly soldered, a gold-plated thread and nut sufficing to make the ground connection.

Externally the *Etude* looks very purposeful if a trifle utilitarian. The standard of construction is excellent but Cello has made life difficult for itself by fashioning the brushed alloy case from individual sheets of lacquered metal. Nevertheless, the corners of the alloy fascia are chamfered to obtain a smooth finish which complements the two matching control knobs that grace the front of the box. To the left lies the four position (ITW) input selector while to the right lies the attenuator itself.

Opening the lid of the *Etude* reveals about as much fresh air as you generally find in a cheap pork pie (see pic). The bank of input and output phono sockets are heavily gold-plated and the silver-plated multi-strand wiring is insulated with a hard PTFE dielectric. The input cabling is actually a fine coaxial which offers a modicum of shielding, though the 10.7kohm input impedance will not prove problematic for the vast majority of CD players.

At the heart of the *Etude* is Cello's hand-built attenuator which features two layers (L + R) of 58 one per cent tolerance metal film resistors soldered onto gold plated PCB

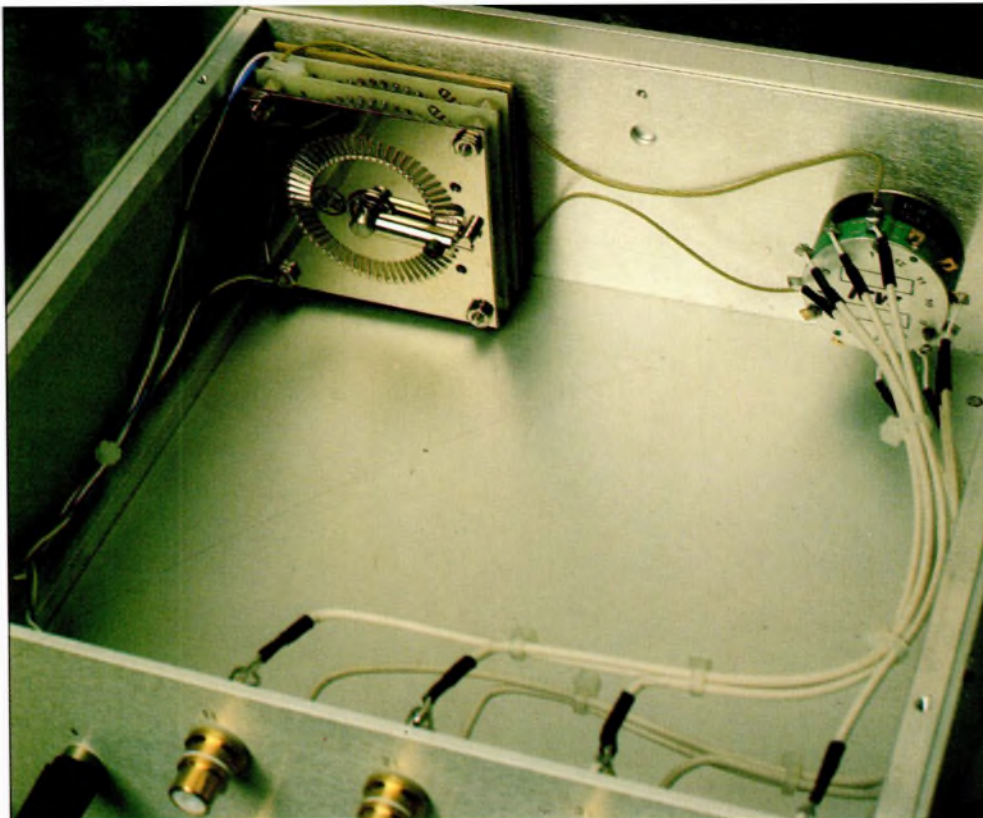

Inside the Etude: a stepped attenuator, some silver plated wire and much fresh air.

tracks. However, when dismantling the attenuator I discovered at least four individual brands of resistor. To my mind using one component type would make more sense and, in this instance, Holco or Vishay Bulk Foil resistors would at least go some way towards justifying its high price.

The two L/R wooden wiper arms each have two palladium alloy contacts that connect each resistor, and therefore the audio signal, to the main output. However, Cello has configured each of these resistor networks in series so the signal is required to pass through a maximum of 58 resistors and some 118 soldered joints. So much for reducing the number of passive components in the audio path!

The positive detent action felt when rotating the calibrated dial is not achieved with the L/R signal wipers. This is facilitated using a third, auxiliary wiper arm with an inset ball-bearing that locates into 59 separate slots cut radially into the surface of a nickel-plated back plate.

So what is the technical prowess of this passive attenuator? Well, the control offers 59 positions (= 58 discrete steps) with 0dB to -50dB covered in increments of 1dB; the step accuracy and L/R channel balance falling within ± 0.015 dB. The subsequent five steps provide a further attenuation of 10dB, or 2dB each, within a tolerance of ± 0.02 dB. Finally, the last two steps are graduated in 5dB per division (± 0.035 dB), while the final position offers an additional cut of 41.2dB (L) and 42.5dB (R). Ignoring this last (mute) position the *Etude*'s maximum attenuation is 70dB (3162:1) with an accumulated error over this range of just -0.05dB (R) and -0.02dB (L). With the final step taken into account the full attenuation is equal to 111dB.

All good stuff so far. However, because the *Etude*'s output is unbuffered its output impedance varies with attenuation, reaching a maximum of 2.6kohm at -6dB. This will be a popular setting for it represents the point

where the peak output of a CD player will drive most power amps close to full output. Unfortunately this is also where the *Etude* will be most sensitive to interconnect cable (the effective RC network causing a roll-off of extreme HF signals) in addition to hum and noise. Furthermore the stereo separation fell to 116.9dB (100Hz), 95.1dB (1kHz), 69.2dB (20kHz) and just 61.4dB (50kHz) at this -6dB attenuation.

Employing the *Etude* attenuator in conjunction with an amplifier such as the Audiolab 8000P did tend to sweeten the treble and reduce any incipient graininess, probably by dint of its low pass filter action which effectively curtails any in-line RF noise. Amplifiers that are less sensitive or almost immune to RF noise, such as the Deltec DPA-50S, did not react so favourably to the introduction of this passive attenuator. Here there was a subliminal loss of control, stereo focus and an increase in treble 'splattering'.

The musical soundstage seemed more expansive than that noted via the buffered unity-gain output of the Pink Triangle Pip II preamplifier, but this was attributed to a similar increase in the level of hum and noise. Experiments conducted many years ago proved that a surreptitious increase in



The Kenwood KX-5010



After a review that says it all,
a chance to hear it like it is.

It is undoubtedly welcome to read that Hi-Fi Choice has accorded the Kenwood KX-5010 the accolade of Best Buy cassette deck.



But it is better even to experience the truth for yourself.

Ring the number given below and we'll be happy to point you in the direction of the nearest Kenwood dealer.

There to trust your own senses as you sample the finer qualities of the KX-5010.

TEL: (01) 575 6030

TRIO-KENWOOD, BRISTOL ROAD, THE METROPOLITAN CENTRE, GREENFORD, MIDDX UB6 8UP



KENWOOD
HOME Hi-Fi ■ CAR Hi-Fi

the noise floor of a system could prompt many listeners to perceive an improvement in openness and stereo depth. In this case any such 'improvement' must be traded against hum that was audible during silent passages...

Compared to my own stepped attenuator which uses gold-plated high-pressure contacts and paralleled Holco resistors, the *Etude* was singularly unimpressive. Neither did it approach the inherent neutrality and compatibility of a buffered unity-gain output such as that incorporated in the *Pip* preamp. In truth the Cello *Etude* suffers both technical and subjective shortcomings that clearly thwart any possible justification for its outrageously high price.

KISEKI BLACKHEART

Roy Gregory gets heavily involved with the poor man's *Lapis Lazuli*.

One of the nicest things about being in the hi-fi trade is that it gives you the chance to experience equipment which would normally remain nothing more than a name on a page. Occasionally, just occasionally, you come across a product which rearranges your sensibilities – changes your expectations of hi-fi systems as a whole. Such products are rare, and normally, but not always, expensive.

When I heard a Kiseki *Lapis Lazuli*, it didn't so much rearrange my notions of hi-fi performance, as leave them in shreds. And yet, when people ask me why it's so good, it's extremely difficult to explain. Playing the *Lapis* to hardened hi-fi cynics is a joy. The first few bars of a track from a 'Hi-Fi Standard' record, and their jaws drop. The nearest I've got to summing it up is to say that it sounds like people, not like a cartridge. Pardon? Well, let me put it this way: when you listen to the *Lapis* you listen to a performance rather than a recording. You simply forget the cartridge – the whole system really. Is it an accurate cartridge? Accurate tonally, no; but accurate musically, in spades! It's true to the sense, the life and the spirit of music – it involves you in the very reasons which separate music from noise, and that's what I mean by "sounding like people".

I know and admire Kiseki cartridges, having owned both *Purpleheart Sapphires*, and *Agate Rubies*. The *Lapis* is so far ahead of either of these that it's difficult to believe that they're related – but then at £3,500 I guess that should be the case. Imagine my excitement when around a year ago Kiseki announced a new cartridge to bridge the gap, claiming to offer near *Lapis* levels of performance at a more "sensible" price (£1,595 looks almost cheap in comparison). Could it, I wondered, be a *Lapis* on the cheap?

I have to say that first impressions of the *Blackheart's* appearance at least, were disappointing. Used to the imperial splendour of the *Lapis* and the multi-coloured hues of the *Agate*, the *Blackheart* presented a very sober appearance. A bleak stained body, otherwise outwardly identical to the *Purpleheart* offers a slightly drab face to the world, looking rather like a poor cousin to its purple stablemate. Having said that, the wooden body makes for a lighter cartridge which is more compatible with my favoured air bearing arms than either the *Lapis* or the *Agate*.



Kiseki's £3,500 *Lapis Lazuli*, as pictured on the cover of last year's *Collection*. Now there's the *Blackheart* which is almost as good at less than half the price.

The cantilever is also quite 'normal' when set beside its gemstone toting siblings, being an aluminium/boron overlay. So much for appearances, the *Blackheart* has the usual Kiseki characteristics of a large, flat top plate with threaded holes which take standard Allen bolts; which combined with the long, parallel sides and level baseplate make setting up a doddle. It tracks, like its whole family, at a heavy 2.1 – 2.2grams but this affords a sense of poise and security which is welcome, and is combined with exceptionally low surface noise.

Once set up, the *Blackheart* flows through whatever music you throw at it with equal gusto. Large scale romantic works, jazz trio, original instruments Baroque, Cheap Trick live (yes, even Cheap Trick!) were presented with a sense of poise and 'connections' appropriate to each in turn.

So is it a dressed down *Lapis*, or a dressed up *PHS*? Definitely the former, but with qualifications. I rather think it's a *Lapis* but not quite, and that's why I find it so fascinating. Here is a cartridge which does indeed offer much of the performance of its illustrious elder, and yet in its shortcomings it begins to suggest why the *Lapis* is so special.

The first thing which strikes you about the *Blackheart* is that of a sense of life that I referred to earlier. But here the naturalness of the presentation suffers the occasional flaw. This cartridge lifts an enormous amount of detail from a record, and yet it doesn't sound like an overtly detailed performer. What it succeeds in doing is integrating that detail into a precisely proportional sonic picture – every element properly related to the others. Take any attribute desirable in a cartridge and the *Blackheart* excels. Speed? This is a very quick cartridge but again, this manifests itself as a sense of correctiveness – in other words, it's fast enough to allow, and does allow, things to happen at their own

individual pace. It is this sense of overall cohesion which brings performances to life. Stereo perspectives seem just so, not wide or deep but just right. In fact, if forced to listen to parameters instead of music, the stage is slightly forward, with a mild exaggeration of depth at the expense of width.

Yes, where it falls behind the *Lapis* is in the integration of its virtues. It has a very slightly obvious quality, a tad bright in the treble, a shade heavy in the bass, but a tremendous source of power. The *Lapis* triumphs by balancing its virtues perfectly, so much so that there seem to be no cracks in its sonic pictures, just complete entities. There is no way to penetrate and separate the elements of its artistry. The *Blackheart* is in many respects just as technically competent as the *Lapis*, but runs just far enough toward the vivid and vibrant to provide the odd crack – a handle to get hold of.

Where the *Blackheart* throws a beautiful image of a female singer, showing you her movements relative to the stage microphone, her slithering feet and breathing, and sense of all these disparate clues, the *Lapis* places her on the stage as a whole, in a complete acoustic along with the other musicians.

Bear in mind that the *Blackheart* is well under half the price of the *Lapis*, so to have got so close with such a saving is remarkable. Its minor blemishes reduce it to being a superb cartridge instead of an Audio Narcotic. Expensive to buy, it's comparatively cheap to run, with a long life and a '45 per cent of retail value' exchange scheme.

The *Blackheart* has provided me with many hours of pleasure and I would unhesitatingly recommend it to anyone who owns and values a record collection, and has a turntable to accept it.

Am I going to put my money where my mouth is and buy one? Well... no, but only because I'm saving for a *Lapis*!

SEVENOAKS HI-FI & VIDEO

This advertisement is valid until at least 30th June 1989. Please note: Beckenham, Chatham and Woolwich close all day Wednesday.

SUGGESTED SYSTEMS

The suggested systems priced below all include the popular Dual CS503/1 turntable, but an alternative turntable or CD player is available at extra cost. Please see 'OPTIONS' list below for further details.

SPEAKERS
All system prices include 100Watts
Dual CS503/1
AMPS

Rotel RA820A

Rotel RA820BXC

Nad 3020E

Nad 3130

Rotel RA840BXC

Marantz PM35

Rotel RA810A

QED A240CD II

Yamaha AXC300

Arcam Alpha II

Rotel RA8708BY

Yamaha AXC400

Nad 3225

Marantz PM45

Kenwood KA550D

Dennon PMX250

Cambridge 840

M/Short MS250 II

A/Research 22

88W DM550

Celestion DL6 II

Monitor Audio R17

Celestion DL4 II

F/Book P4 S

Rotel RA850

Tannoy E11

JMW P1

A/Research 112

M/Dele Sound III

Celestion 5

Rotel RA870

JMW Sound

Goodmans Spring P4.3

Box A1

Mission 101

M/Short MS10 II

Goodmans Maxim II

W/Dele Data 30

Mission 101

274.95

309.95

269.95

299.95

299.95

249.95

319.95

249.95

309.95

429.95

299.95

289.95

339.95

279.95

354.95

314.95

449.95

319.95

284.95

329.95

309.95

359.95

314.95

369.95

299.95

319.95

389.95

324.95

389.95

314.95

359.95

319.95

379.95

339.95

399.95

339.95

389.95

314.95

434.95

389.95

449.95

549.95

434.95

424.95

419.95

409.95

474.95

419.95

474.95

409.95

474.95

419.95

474.95

409.95

474.95

419.95

474.95

409.95

474.95

419.95

474.95

409.95

474.95

419.95

474.95

409.95

474.95

419.95

474.95

409.95

474.95

419.95

474.95

409.95

474.95

419.95

474.95

409.95

474.95

419.95

474.95

409.95

474.95

419.95

474.95

409.95

474.95

419.95

474.95

409.95

474.95

419.95

474.95

409.95

474.95

419.95

474.95

409.95

474.95

419.95

474.95

409.95

474.95

419.95

474.95

409.95

474.95

419.95

474.95

409.95

474.95

419.95

474.95

409.95

474.95

419.95

474.95

409.95

474.95

419.95

474.95

409.95

474.95

419.95

474.95

409.95

474.95

419.95

474.95

409.95

474.95

419.95

474.95

409.95

474.95

419.95

474.95

409.95

474.95

419.95

474.95

409.95

474.95

419.95

474.95

409.95

474.95

419.95

474.95

409.95

474.95

419.95

474.95

409.95

474.95

419.95

474.95

409.95

474.95

419.95

474.95

409.95

474.95

419.95

474.95

409.95

474.95

419.95

474.95

409.95

474.95

419.95

474.95

409.95

474.95

419.95

474.95

409.95

474.95

419.95

474.95

409.95

474.95

419.95

474.95

409.95

474.95

419.95

474.95

409.95

474.95

419.95

474.95

409.95

474.95

419.95

474.95

409.95

474.95

419.95

474.95

409.95

474.95

419.95

474.95

409.95

474.95

419.95

474.95

409.95

474.95

419.95

474.95

409.95

474.95

419.95

474.95

409.95

474.95

419.95

474.95

409.95

474.95

419.95

474.95

409.95

474.95

419.95

474.95

409.95

474.95

419.95

474.95



ASPIRATIONS

Our second Aspirations this month features a young Doctor whose main hobby in life is hi-fi. Words: Dan Houston, pictures: Chris Richardson.



The pathologist at play (left); the system (right) fronts with 'Sapphire' and SME V on a re-jigged Voyer deck and custom power supply, transduced through the 'horns'.

Horns of Plenty

This system would work in a room four or five times as big as this; we're just tickling it at the moment," stated Gary Burley of The Sound Room, who supplied this collection of esoteric equipment. We were listening to hi-fi belonging to Doctor Stephen Sampson, a 26-year-old trainee pathologist who lives in Orpington, Kent. The large horn loudspeakers were doing their stuff in the living room of this first floor flat, and even "tickling" them we could hear that the occupant downstairs had turned her television up to full volume in response. The rare, though raved about, Impulse *H1* horn loudspeakers are new in the doctor's system which he has been upgrading seriously since he graduated from medical school.

The first pair to be built, they are designed to work in corners and sit snugly either side of the rest of his set-up which occupies one end of his living room and which is the visually dominant feature of the room. The television for instance, is kept in the kitchen.

Hi-fi is Stephen's main hobby (apart from tennis) and he describes himself as "a tweeker", taking time to get the best from his system. "I've just begun to dabble around with a soldering iron," he said, "I've started to think about hard-wiring some components or bypassing fuses . . . that sort of thing." Stephen chose most of his hi-fi from The Sound Room, because he liked Gary Burley's approach. "He's an audiophile and comes out at odd hours to

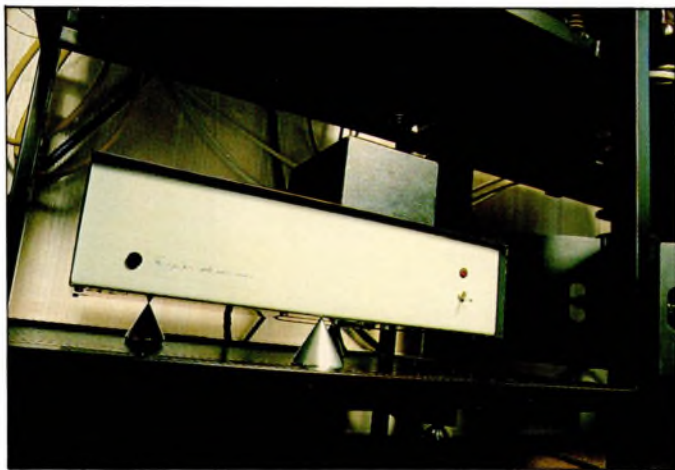

give the service that he would have liked as a customer." The hi-fi has been collected piece by piece, upgrading first one component and then another, so this is not a complete system that has been bought outright.

Stephen graduated through a Pioneer system in his first year at medical school, to a Linn and later the Voyd which he preferred to all the other turntables he listened to. "I didn't think the *LP12* was much better than the *Axis*, but the Voyd did everything as far as I was concerned; I could set it up myself and I could see what Guy Adams (the designer) was trying to achieve with the three motors for instance."

Above everything the hi-fi here is purist;

there is no tuner, no cassette deck, and certainly no CD player. It has all been chosen for "reality of sound" though Stephen believes truly lifelike sound reproduction is impossible. Experience of live music is necessarily limited at present; he's at that stage in a medical career when doctors find themselves working a 75-hour week, but says he gets out to jazz clubs and classical concerts when he can. "I also go to church every Sunday which is a good place for live music," he told me. In choosing his equipment Stephen said: "firstly I listen to the overall sound and ask myself whether I like it and whether it sounds like music, and could I live with it. Once I've established those things I start to dissect the sound, listening to the bass, treble,

hardness and other specific areas to try and pick up the deficiencies."

The only deficiency with this system is an external one and caused by poor power supply according to Stephen, who said he can hear the power surge through the system. "I think I'm on the end of the line here or something, it sounds like the amp is going down, the power goes and then surges back up again sometimes. So I need a fully regulated back-up power supply."

The system fronts with a Kiseki *Purple-heart Sapphire* cartridge, SME *V* tonearm and a *Voyd* turntable which has been tweaked to make it two thirds a *Reference*. This has been done by adding a *Reference* bearing, platter, chassis, suspension and power supply. The record player sits on a

COVENT GARDEN RECORDS

AT

84

**CHARING CROSS ROAD
LONDON WC2H 0JA**

Tel: 01-379 7635/7427

Fax: 01-836 1345

Open Mon - Sat 10.00 am - 7.30 pm 2 mins from Leicester Sq Tube

**THE COMPLETE SERVICE TO ALL MUSIC LOVERS
AT LONDON'S FINEST COMPACT DISC CENTRE**

NEW RELEASES

Classical full price new releases only £9.95 and mid price £6.95 per CD for the first 30 days after issue: Decca, DG, Philips, EMI, CBS, RCA and selected others.

LISTENING FACILITIES

Not only the cheapest new releases in town but also full individual listening facilities - listen before you buy.

7,000 CDs IN STOCK

A continually updated and growing stock of the best classical, jazz and popular compact discs.

SECONDHAND

Secondhand CDs bought and sold, on sale from £5.99.

TOKEN SCHEME

Unique scheme of one token for each CD you buy (value £10.95 and over) entitles you to a free CD when you have collected ten to the value of £10.95.

SPECIALISTS IN CD PLAYERS

Over 45 CD Players in stock and on demonstration. From £149 to £2,000.

QUALITY AUDIO

We stock an excellent range of some of the best audio equipment and loudspeakers available from famous names such as B&W, Quad, Meridian, Mission, Cyrus, Arcam, Rogers, Sony, Nakamichi, Sennheiser, Denon, Rotel, Marantz, Pioneer, Revox, Monster Cable, Yamaha, Technics, Celestion and more.

DELIVERY AND INSTALLATION

Free delivery in the London area on selected Hi-Fi systems. Installation service provided. Orders actioned within 24 hours subject to stock availability.

DEMONSTRATION

Two private demonstration rooms to audition your future purchase. Demonstration room can be prebooked. Just phone to make an appointment.

SERVICING

Full up-to-date department for servicing and CD Player up-grading by qualified technicians.

DAT

Digital Audio Tape on demonstration.

CDV

**COMPACT DISC VIDEO NOW ON SALE AND DEMONSTRATION
PHILIPS, MARANTZ AND PIONEER IN STOCK
FULL RANGE OF 5", 8", AND 12" CDV FROM £4.99**

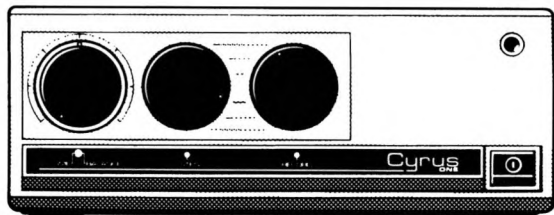

**COVENT GARDEN RECORDS
PRESENT**

NOW IN STOCK AND ON DEMONSTRATION

MISSION ELECTRONICS

New range of Mission loudspeakers now in stock and on demonstration. Also stockists of full range of Mission speakers from the 761 to 765.

PCM 2 CD Player
Cyrus 1
Cyrus 2
PSX Power Supply

£499.00
£199.00
£299.00
£229.00

The superb new CD Player, the PCM2 and the improved Cyrus 1 and 2 amplifiers. These outstanding products set new standards for reproducing music as it was performed.

**£50
OFF**

WHEN YOU BUY A CD PLAYER

Bring this coupon in during
JUNE/JULY
and get £1 off your next
50 CDs over £6.99 this year
Also available on Audio
Components over £500.

Sale & Special offer goods excluded Valid until end of JULY 1989

HFC 07/89

**£6
OFF**

ON PURCHASE OF 5 CDs OVER £9.95

84 Charing Cross Road, London WC2
No Tokens Given
Valid to end of JULY 1989

HFC 07/89

**£1
OFF**

ON PURCHASE OF 1 CD OVER £9.95

84 Charing Cross Road, London WC2
No Tokens Given
Valid to end of JULY 1989

HFC 07/89

RATA isolation table with spiked feet, one of which rests on a coin. This is one of the free PWB Audio ideas which are said to improve sound quality, and Stephen has used some of the theories with resulting slight differences in sound quality, although he hasn't spent money because the "effect wasn't that marked".

The horns are the first *H1*s to be built and incidentally, are the same model reviewed by Jimmy Hughes, the first audio journalist to take up the PWB cause and who treats equipment he listens to with Belt products. Here, the famous little sticky foils were still in evidence on the tweeters so we were listening to a 'semi-Belted' sound. PWB products purport to change the listener's perception of sound by affecting adverse "electrical" currents in the equipment environment. They have been embraced by some audiophiles, denigrated by others and remain largely an unsolved mystery. While the claims of much-improved sound remain unsubstantiated, few claim the products actually make hi-fi sound worse, and like little green spacemen, they have made many people laugh, which is certainly no bad thing.

The *52* is a valve preamp (using 50 rather than 52 valves) which is isolated on its table using a piece of home-hewn slate suspended by four car valve springs from a Hillman Imp! The *52* uses *MIT 330* interconnect between its two boxes and Deltec Black Slink cable to feed the two *EAR 519 II* monoblocks. These then power the all valve sound (car or otherwise) to the *H1* horns using Vecteur *9040* loudspeaker cable to tri-wire the bass, midrange and tweeter units. The *EAR* monoblocks are isolated using Torlyte Amplat slabs, again supported using Hillman Imp car valve springs. So why a Hillman Imp's springs? "They have flat tops, so the board stays stable," explained Stephen.

Listening to a variety of material on this system was another great pleasure in this month of two *Aspirations* features. The 'horns' breathe the music bringing a natural and neutral sound with superbly developed bass even in this (fairly small) room. The eight-and-a-half inch SEAS bass unit moves air through about ten feet of internal funnelling, appearing through the open base of the cabinet. Gary Burley told me, and I think his hand was on his heart, that the speakers' bass response went to

below 20Hz. It certainly goes low, at one point the floor started to resonate with some drum music we were playing so we were listening through our feet as well. A four-and-a-half inch SEAS driver is used for the midrange which is on top of the cabinet using another flare, and a French Focal tweeter on the cabinet face provides the high frequencies.

One of the stunning realities of the *H1* was with voices; the introductions on *The Young Person's Guide to the Orchestra* by Benjamin Brittan sounded extremely clear and lifelike although the musical instruments sounded a little distant. This seemed to be a fault with the record rather than system, as other classical music and an American Reference recording of *Dafos* (the drums) had the system showing off brilliant separation and clarity with musical instruments. Stephen said that when he first had this system set-up he felt it was "a bit too much" but that he had got used to it now.

"It's now reached the stage where the only way I can improve on this system would be to spend another ten or twenty thousand pounds." In fact for the moment his aspiration is to have a bigger listening room rather than more hi-fi. "The limiting factor is probably the size of the room, but as we all know houses cost far more than hi-fi." One gets the feeling that he would rather it was the other way around; here the house is almost incidental to the hi-fi and it's a sobering thought to recall that less than a decade ago most people would have thought of this system in terms of mortgage values.



More interestingly Stephen has doctored his *Voyd*, taking away the bottom board and using strips of Sorbothane stuck underneath the top plate to damp out any resonances. The sound had "slightly improved" he said. The *Voyd's* split phase power supply is also a 'one-off' and uses Kimber cable and Holco resistors internally. This is positioned (on *Tiptoe* cones) on a Target table next to the turntable underneath the awesome *EAR Professional 52* two box preamplifier. Our photograph shows a Hi-Fi News Flux Dumper (more magic), on top of the power supply, which unfortunately broke when I picked it up. (You just can't get the quality these days.)



Ear's favourite: the golden twin-box 52 preamp dominates the system while yet more boxed-valves take up floor space (bottom).



The Equipment:

Kiseki Purpleheart Sapphire cartridge	£695
SME V tonearm	£1,206
Voyd turntable	£999
Voyd Reference bearing and platter	£352
Voyd Reference chassis, suspension and power supply	£1,000
EAR Professional 52 preamplifier	£6,000
EAR 519 power monoblocks	£2,450 (pair)
Impulse H1 Horn loudspeakers	£2,800
RATA turntable support	n/a
Target equipment table	approx £45
Torlyte equipment slabs	approx £40
Hillman Imp valve springs	£4.75 (set)

Installed by: The Sound Room, Norbury, London. Tel: (01) 764 9295.

STILTON AUDIO SYSTEMS

Simply better hi-fi

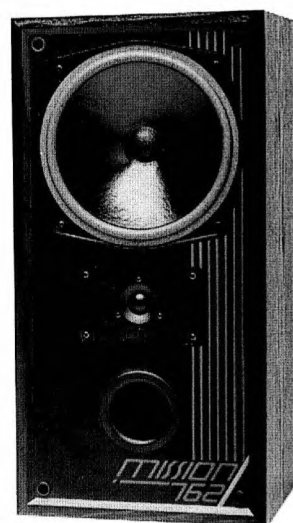
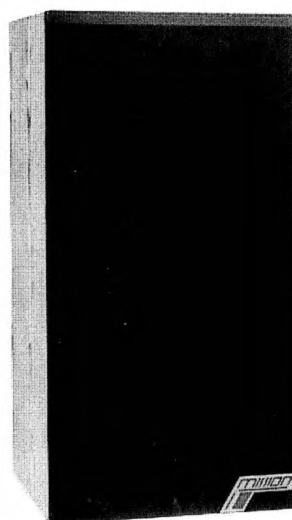
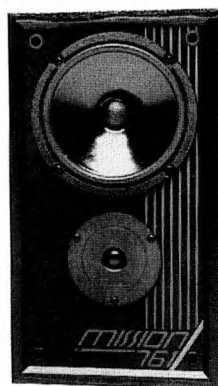
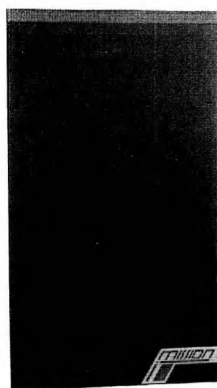

MISSION 761

MISSION 762

MISSION
ELECTRONICS

**ALL MISSION PRODUCTS AVAILABLE
ON INTEREST FREE CREDIT
TELEPHONE US FOR DETAILS**

We are stockists of A&R — Audio Technica — British Loudspeakers BLQ — Dual — Harman Kardon
— Inca Tech — kuzma — Linn Products — Mantra — Mission — NVA — Revolver — Wharfdale
Yamaha

STILTON AUDIO SYSTEMS, 489 LINCOLN RD., PETERBOROUGH PE1 2PE. TEL: (0733) 558838.



MARKET RESPONSE

Dan Houston talks to dealers in the high-end audio market asking them about selling super-systems.

In this survey we look at the esoteric system market from the point of view of the relatively few dealers who stock such equipment. As a loose guide we have categorised high-end systems as those selling above the £5,000 mark. Of course, relatively few audiophiles can afford to spend this kind of money outright and the normal aspiration is to gradually piece together a super-sounding set-up, upgrading a component at a time. With that in mind we have asked dealers what are their best-selling source components, amplifiers and loudspeakers, and hopefully will be providing some distillation of their experience in this field, covering matters such as reliability.

Dealers approached for this survey rely on high-end sales for anything between five and 100 per cent of their income with an average figure of just under 40 per cent. Most said sales were financially very important to them, although one pointed out that the amount of money he invested in loan and demonstration stock and the time spent visiting customers' homes to audition and set-up equipment meant that he certainly wasn't in it for the money. Indeed the prestige element of offering systems which both cost and sound far above the norm was quite common among these dealers.

In Britain high-end audio still hasn't taken off in the way it has in the States for instance. One of the reasons dealers cite for this is that there's still no general

public acceptance of the fact that one can spend proportional amounts of money on hi-fi as on other luxury goods from a mink coat to a diamond watch. The notion of actually having the King's College choir in one's living room just hasn't caught on yet.

During a similar survey last year many dealers felt that expensive equipment was on the verge of taking off as an established desirable item and that they were about to break the mould of mostly selling to audiophiles who also had the necessary disposable income. This year the feeling is more conservative; "we're still doing well with high-end sales but we're not up on last year as much as we had hoped," was an almost universal comment.

Several dealers felt that the economic climate was affecting high-end sales but Derek Aston-Darker, of Aston Audio, said: "high-end customers are not affected by interest rates. Rising interest rates have affected the mid and lower end sales but the fundamental problem is that in Britain we're not as well off as other countries. Exchange rates make it seem as if we're better off but our spending power is less. This causes resistance among customers who know the prices of equipment abroad. I know many people who could afford exotic equipment but who are put off because of outrageous prices."

High-end audio was put on the map in the UK by Ricardo Franassovici, who founded Absolute Sounds in 1977. AS now has 15 dealers and several competing firms, many of whom have come onto the scene in the

last year or so. Even established household names like Rotel, Sony and Marantz are now offering esoteric gear with stuff like the reviewed *R1* and *CD12* from the two latter firms while Rotel set up the high-end line-up of Oracle turntable, Jeff Rowland amplifiers and Infinity loudspeakers through its Gamepath distribution company.

With all this activity in the past 12 months it was surprising to hear dealers say their takings were not booming; ten years on in monetarist Britain the high-end audio market is still very limited. For example one dealer estimated that less than 100 Krell amplifiers were sold per year here. SME told us that while they exported 900 *Series V* tonearms a year, they only sold 70 on the home market (and some of these might be leaving the country with foreigners buying from British dealers).

Doug Brady summed up the market by comparing the situation with motorcars. "It's like a triangle; the high-end is similar to Rolls-Royce which produces 2,500 models a year, then you have the Linn and Naim area which is like BMW which makes 500,000 models a year, and finally the Amstrads which are like Ford - it makes five million cars a year."

Another perceived resistance to high-end equipment seems to be with people getting used to their existing sound systems. The advances in terms of sound quality get smaller and smaller with every mega cheque you write and several dealers mentioned customers being sceptical about the performance capabilities of a system they were auditioning during the first part of a demonstration.

TROUBLE AND STRIFE

"Yes, we sold a £3,000 system to a female doctor recently," replied one dealer to the question 'have you ever sold high-end hi-fi to a woman?' Without doubt high-end audio is the preserve of the male of the species and the proof of the rule lies in its exceptions as implied by the above statement. Several reasons for this trend were given from "women don't like music so much, they can live without it" to "the ladies are put off by the tweeky nature of high-end equipment".

One dealer even told us that a couple of his customers had come close to divorce when the distaff side of the household discovered the price of the hi-fi. "It was quite serious," said our fly-on-the-wall dealer, "one chap bought his wife a car to appease her." Another reason given was that the looks of hi-fi were off-putting to anyone with taste. "The aesthetics (*cf hi-fi*) need to be worked at," opined Derek Jenkins of the Sound Organisation, "take the Exposure amp, it looks like a biscuit tin. No wonder people say 'I don't care what it sounds like'. Looks are very important - no-one wants half an oil rig in their front room."

However, while dealers said that the initial interest was mostly on the part of men they also noted that women often influenced the decision to buy if they were demonstrating equipment to a couple. And Doug Brady, who is actively trying to reverse the trend (by employing female sales staff for example) told us: "women's ears are often better than men's, and they're not at all impressed with the techno guff. Often it's just a case of being confident with your gut reactions. We're very keen for them to make the decisions; our role is to see where they want to go and then guide the demonstration." *Hi-Fi Choice* is an equal opportunities magazine and none of the above comments are intended to the audiophile sorority. We merely, sadly, recognise that in this area the activity is predominantly male oriented.

WHO BUYS IT?

So who buys it? We asked dealers for a customer profile (do high-end audiophiles have large ears

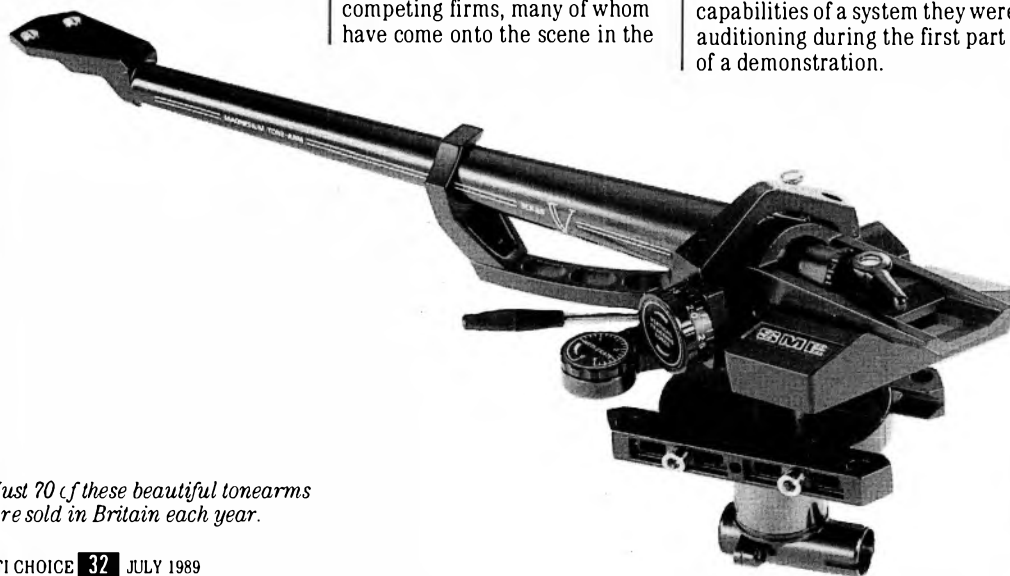

Just 70 of these beautiful tonearms are sold in Britain each year.

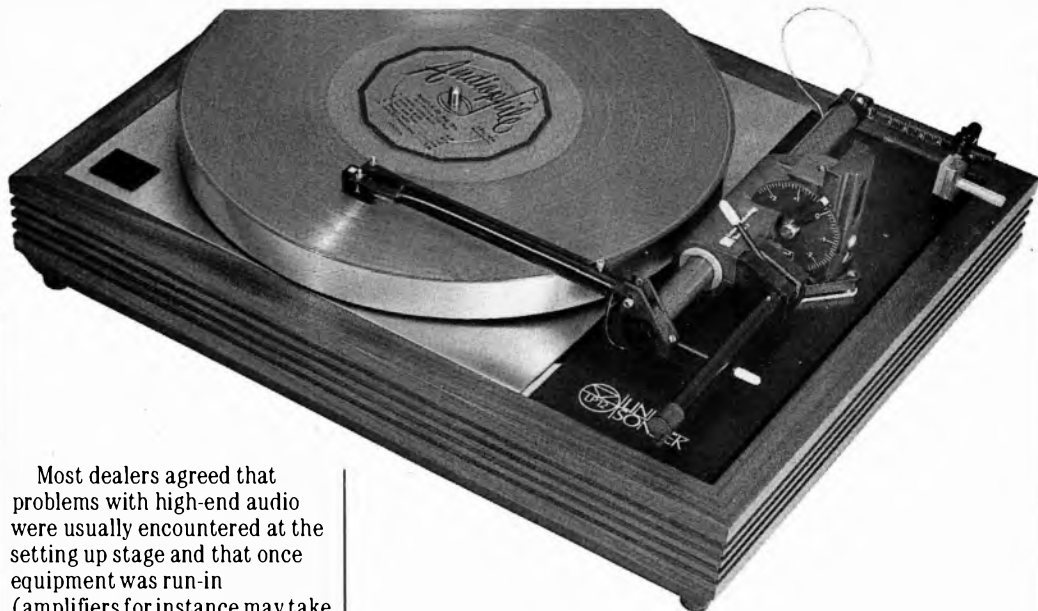

and bad eyesight?) and discovered that apart from the male orientation there is no 'type'. Doug Brady told us: "firstly customers tend to have a sincere and powerful love of some kind of music, it can be any kind, even MOR. Secondly, they like to have quality articles which are well made and perform excellently. But they come from all walks of life and sometimes we'll visit a guy who doesn't live in a nice house with beautiful furniture; but he does have a huge record collection and great hi-fi. It's his one centre of excellence and he can put on a record and forget the screaming kids or his job. I really like that, it's very healthy to be at the top of the tree in something."

Several dealers voiced similar points of view but it was also noted that for the non-passionately audiophile customer expensive hi-fi was usually an add-on after the other more established desirables in life. In this sense high-end gear is seen as a prestige item to complement a lifestyle, but we heard almost universally that it was not being bought for hollow reasons. Therefore it was not surprising to hear dealers saying that many of their high-end customers became personal friends, sharing the common goal of recreating the musical experience.

RELIABILITY

Dealers are particularly aware of their reputation when it comes to selling expensive gear. So when you buy high-end audio you also buy superlative service and the whole question of reliability changes. Most of the people we spoke to would bend over backwards to ensure a customer was satisfied and that the system was not only operating to his satisfaction but to theirs as well. In fact Brian Rivas, of Pinewood Music told us that he would rather not sell a piece of equipment if he knew the system context in which it would be sited would not allow that equipment to operate at its best. But once the equipment was installed Brian said: "all this stuff is totally reliable, it has to be. If I've sold something to someone who lives 200 miles away I don't want to have to go out there repairing things."

Most dealers agreed that problems with high-end audio were usually encountered at the setting up stage and that once equipment was run-in (amplifiers for instance may take weeks to burn in and start sounding their best) it was very reliable. The tubes on valve amplifiers were said to blow occasionally but most customers would replace valves themselves.

Paul Tam, of KJ Westone, put it this way: "we expect some problems with high-end stuff. Five to ten per cent of our valve amplifiers come back but it's the nature of the beast. We find most people don't mind if you're efficient about it; there's a kind of masochism involved - people don't mind suffering for their art."

Opinion was too divided to be able to name regular faulty brands and some dealers seemed to have bad experiences with makes while others sang their praises. Dealers also advised that valves last longer if they are left on all the time avoiding the harmful current surges when switching the system on. The valves' finite life is similar to a light bulb which also lasts longer if left burning. Apart from valve amplifiers, the only problem we heard concerned bass panels blowing on Apogee ribbon loudspeakers and even here we are talking very small numbers.

In any case dealers agreed that company back-up in this area was very efficient so breakdowns didn't constitute the hazard they might with a more run-of-the-mill system.

However, buyers should be warned that setting up equipment can take several visits and it's not in this beast's nature to simply be carried home and switched on.

THE BEST SELLING BRANDS

As previously mentioned the size of the market is limited but in order to get some idea of where the activity is taking place we asked dealers for their top selling components. Six years down the road CD players have made surprisingly little difference to

audiophiles and eleven dealers said they still sold more record players with an average ratio of 65:35. Only one dealer said he sold more CD players than record players, giving a ratio of 80:20. The thirteenth respondent sells equal numbers.

Tuners and cassette decks are considered inferior. Dealers did concede that CD players are "coming along" and were sounding better and we heard a few mentions for Micro Seiki and Kinergetics machines. The criticisms of CD sound are that it still sounds brash and bright and lacks the reality afforded by the best vinyl replay systems.

The best selling source according to our dealers is the Linn *LP12* turntable with an *Ekos* arm and *Troika* cartridge. This is followed by the Roksan *Xerxes* deck with a SME *V* tonearm and Koetsu *Red* or Audio Technica *OC9* cartridge. Voyd decks with Helius arms were the next most popular.

Popular preamplifiers are from Audio Research (*SP8*, *9* and *11*), Naim (*32-Hi-Cap*) and Audio Innovations *Series 1000*. The popular power combinations respectively are Krell (*KSA200*), Naim (*250*) and Audio Innovations (*Triodes*).

Apogee and Magneplanar loudspeakers are equally popular followed in order by Linn *Isobariks*, Snell and Naim offerings.

As far as synergy goes, the schools of thought link the likes of Linn and Naim together with a Linn source, Naim amplification and either company's loudspeakers. Other popular combinations are Voyd, Audio Innovations and Snell, or Audio Research preamps, with Krell amplifiers powering Apogee or maybe Magneplanar loudspeakers. There are of course, variations on these themes and dealers voiced their

loyalty to other brands and combinations.

Dealers said that they almost always sold proprietary loudspeaker and interconnect cable with a high-end system. A plethora of companies have sprung up selling variations from solid silver to multi-strand copper. Several dealers spoke of the importance in getting a cable to suit your system and that cable could be used as a final tuning touch in a system helping to brighten or mellow the sound. Popular brands are Absolute Wire and van den Hul followed by Symo and Rotel Supra.

Furniture for hi-fi comes in many shapes and sizes and is usually hi-tech in nature and hardly the thing to complement the Queen Anne desk. Half a dozen dealers said customers were choosing to have cabinets specially made (with vents for power amps for instance) which hid the offending sight of the equipment behind a 'period' facade. Apart from this, Sound Organisation and Target furniture was preferred with Pirate stands found necessary for Snell speakers.

PARTICIPATING DEALERS

Our thanks to the following dealers for helping us compile this survey:

Aston Audio, Alderley Edge, Cheshire.
Definitive Audio, Brighton, Sussex.
Doug Brady Hi-Fi, London, Warrington and Liverpool.
Elite Hi-Fi, Harrogate, Yorks.
Grahams Hi-Fi, N London.
KJ Westone, West London.
Pinewood Music Centre, Andover, Hants.
Radlett Audio, Radlett, Herts.
Studio 99, London.
Suttons Hi-Fi, Bournemouth.
The Cornflake Shop, Windmill St, London.
The Music Room, Glasgow.
The Sound Organisation, London Bridge.

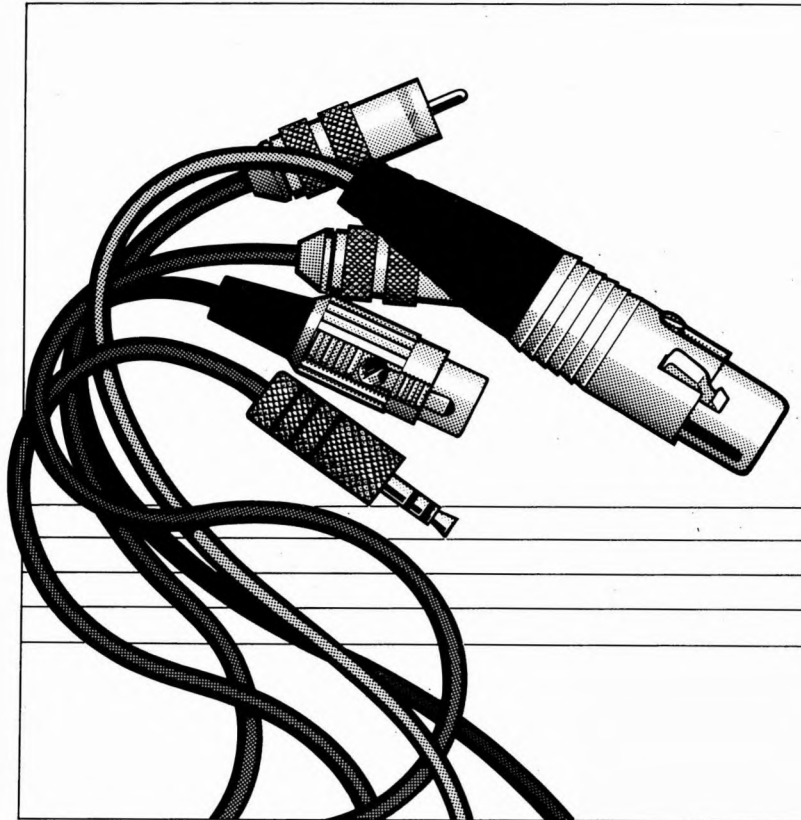

The best leads
come from having
the best
connections.

C H O R D
C O M P A N Y

19 St Marks Road Salisbury Wiltshire S91 3AY
Telephone (0722) 331674

T H E N A T U R A L C H O I C E

Rogers

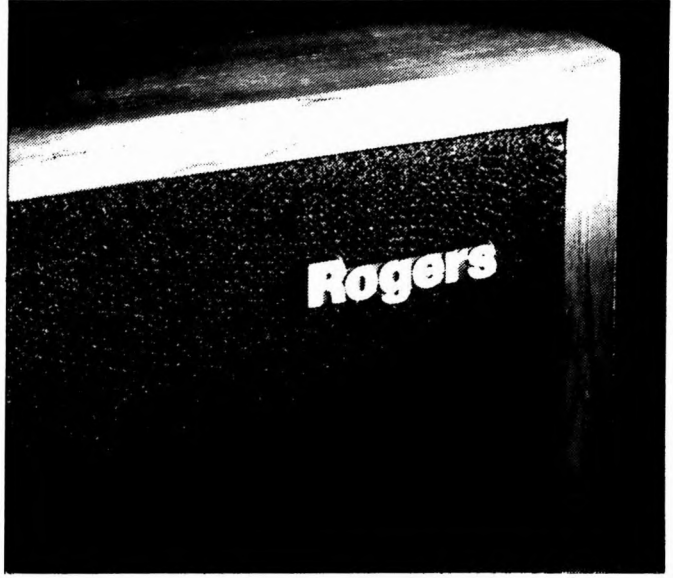

Manufactured by Swisstone Electronics Limited, 310 Commonside East, Mitcham, Surrey CR4 1HX, Tel No: 01 640 2172, Fax No: 01 685 9496, Telex: 893980 Rogers.
Distributed by Audio Influx Corp. N.J. USA, Plurison P.Q. Canada, Audio 2000 NSW Australia, Excel Hi Fi Hong Kong, Denco Audio New Zealand, Atlas Hi Fi Singapore.

DMP CD OFFER

Special offer to Hi-Fi Choice readers. Save £5 on DMP compact discs.

Digital Music Products is a CD-only jazz label imported from the USA by leading audio specialist Absolute Sounds. As an introduction to the superb quality of DMP CDs, *Hi-Fi Choice* is offering its readers DMP CDs at a special price of £13.00 each, £5 off the recommended retail price.

As part of its exclusive deal with *Hi-Fi Choice*, Absolute Sounds is offering automatic free membership of the DMP Club as soon as you place an order for a DMP CD.

Membership of the DMP Club entitles you to:

- Select any of the CDs in the DMP catalogue at special discount prices.
- First option on all new DMP releases.
- DMP's quarterly newsletter, which keeps you up to date on all the new releases, live tours, and forthcoming projects by DMP artists. The newsletter also features regular competitions in which you could stand to win any number of the hi-fi accessories distributed by Absolute Sounds.

CD-443: TriCycle, Flim & the BB's
Voted best jazz CD of 1985 by readers of Digital Audio in the US, combining pop melodies and jazz improvisation. Arguably the definitive DMP album, TriCycle has become a standard demo CD for stretching hi-fi loudspeakers to their limits.

CD-447: Tunnel, Flim & the BB's
Flim & the BB's second album for DMP voted best jazz CD of 1986 by readers of Digital Audio magazine. A collection of joyful, melodic songs superbly played and recorded.

CD-451: Incredible Journey, Bob Mintzer Big Band
A must for all jazz and big band lovers, Incredible Journey features Mintzer supported by some of America's finest jazz musicians – including Michael and Randy Brecker, Peter Erskine, Lawrence Feldman and Marvin Stamm.

CD-453: NY Cats Direct, John Tropea

Brilliant New York guitarist John Tropea plays bluesy, improvisational jazz which alternates between thoughtful, melodic passages and electrifying blues solos. Supporting musicians include Steve Gadd and David Spinozza.

CD-454: Big Notes, Flim & the BB's

Another tour-de-force from jazz quartet Flim & the BB's. Superb sound, joyous, uplifting music – and ... (yup, you guessed it) ... voted best jazz CD of 1987 by readers of Digital Audio magazine.

CD-455: Lighthouse, Billy Barber

One of the most popular DMP recordings, and rightly so – Barber's second album for DMP is full of beautiful melodies and heartfelt tunes. Barber's piano playing is stunning, accompanied throughout by an array of imaginative keyboard and synthesizer sounds.

CD-459: Braziliana, Manfredo Fest

Blind-from-birth jazz legend, Manfredo Fest returns to the world of recording with this stunning CD invested with the rhythms and melodies of Brazilian jazz. Fest's piano playing throughout is inspired, as are the pure vocals of Roberta Davis.

CD-460: Thom Rotella Band, Thom Rotella

DMP discovery Thom Rotella combines melodic acoustic guitar with funky electric solos on this mainstream jazz CD. Great sound – the recording was a prototype for one of the first Sony R-DAT demos.

CD-461: Spectrum, Bob Mintzer

Spectrum is still fired with the big band sound of Mintzer's earlier DMP albums, but also sees the acclaimed saxophonist and composer experimenting with quintet and quartet arrangements. A superb collection.

CD-462: The Further Adventures of Flim & the BB's, Flim & the BB's

The BB's fifth album for DMP and perhaps their best to date. Once

again the band's characteristic blend of dynamic jazz, driving rhythms and pop melodies combine to form a memorable collection of songs.

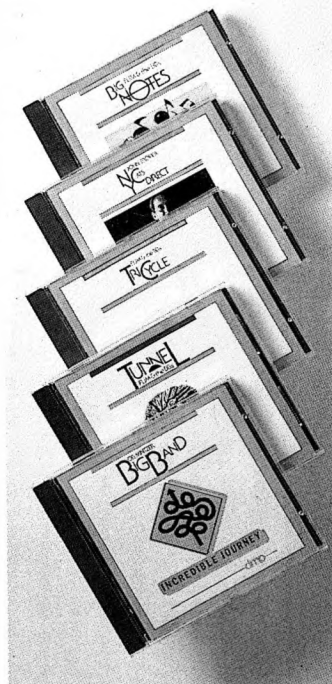

TO ORDER DMP COMPACT DISCS

(Tick selections)

- CD-443: TriCycle, Flim & the BB's
- CD-447: Tunnel, Flim & the BB's
- CD-451: Incredible Journey, Bob Mintzer Big Band
- CD-453: NY Cats Direct, John Tropea
- CD-454: BigNotes, Flim & the BB's
- CD-455: Lighthouse, Billy Barber
- CD-459: Braziliana, Manfredo Fest
- CD-460: Thom Rotella Band, Thom Rotella
- CD-461: Spectrum, Bob Mintzer
- CD-462: The Further Adventures of Flim & the BB's, Flim & the BB's

PAYMENT

- I enclose my cheque/PO made payable to Dennis Publishing for _____ selections at £13.00 each
Total _____
- Please charge my Access/Barclaycard/American Express/Diners Mastercharge (delete as appropriate)

Credit card number _____
 Expiry date _____
 Signature _____
 Name _____
 Address _____

 Postcode _____
HFC72

Available to UK readers only.
Please send order form with payment to:
Hi-Fi Choice Mail Order
PO Box 320
London N21 2NB

Music is Beautiful

Where elegance and science
transcend the machine and its function...

Where the subtlety and intimacy
of musical emotion is revealed...

Where the art of pleasing oneself
finds no greater self expression...

Where ownership
becomes an absolute privilege



ORACLE

Oracle UK, 25 Heathfield, Stacey Bushes,
Milton Keynes MK12 6HF,
Tel: (0908) 317707, Fax: (0908) 322704

THE COLLECTION

TURNTABLES AND ARMS

CRYSTAL REFERENCE	39
LINN EKOS	41
ORACLE ALEXANDRIA	43
ROKSAN XERXES/ARTEMIZ/SHIRAZ	44
THE VOYD TURNTABLE	46
WELL TEMPERED TURNTABLE	49
ZARATHUSTRA S4/PLUTO 5A PRESTIGE	50

CARTRIDGES

AUDIOTECHNICA ART 1	53
CELLO CHORALE	53
CLEARAUDIO SIGNATURE	55
EMPIRE BENZ MICRO MC2	55
GOLDRING EXCEL	57
KOETSU BLACK S	57
KRELL KC-100	59
VAN DEN HUL MC TWO	59

CD PLAYERS

DENON DCD 3520	61
MARANTZ CD12LE	62
MERIDIAN 207-PRO	65
MICROMEGA CDF1 CLASSIC	67
MICRO SEIKI CDM100	69
SONY CDP-R1/DAS-R1	70
STAX QUATTRO II	73

AMPLIFIERS

ARAGON 4004	75
AUDIO INNOVATIONS 1000/2ND AUDIO	76
AUDIO RESEARCH SP9/CLASSIC 30	78
CELLO AUDIO PERFORMANCE	80
CONRAD-JOHNSON PREMIER SEVEN	82
GOLDMUND MIMESIS 2	85
JEFF ROWLAND COHERENCE ONE/7	86
KRELL KSA-200A	88
KLYNE SK-5A	91
MUSICAL FIDELITY MVX/A370	92
SUMO ANDROMEDA II	95
YBA MODEL 3	96

TUNERS

LINX THETA	99
MAGNUM DYNALAB FT101	100
ONKYO T-9090II	101

LOUDSPEAKERS

APOGEE DUETTA SIGNATURE	104
DUNTECH CROWN PRINCE	106
ENSEMBLE PA-1	109
INFINITY 8 KAPPA	110
MAGNEPLANAR MG1.4	111
MARTIN-LOGAN CLS II	112

HEADPHONES

JECKLIN FLOAT ELECTROSTATIC	115
SONY MDR-R10	116
STAX LAMBDA SIGNATURE/SRM-T1	117





THE FINAL.....



PA1



REFERENCE

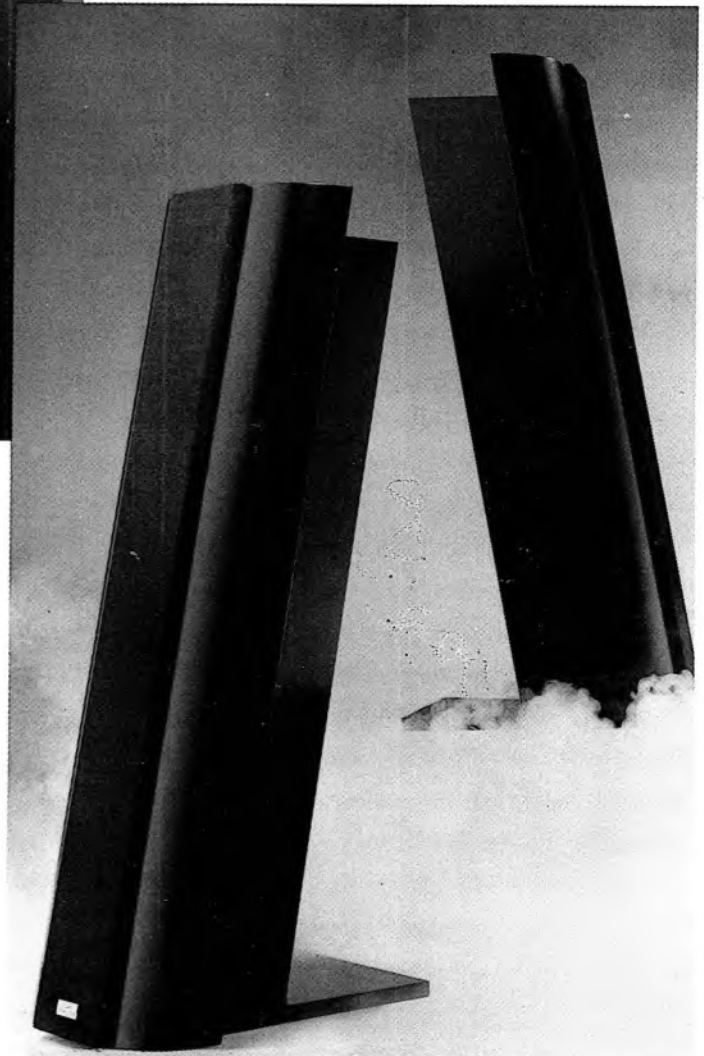

PRIMADONNA



UPGRADE.....

ON **PERMANENT** DEMONSTRATION . . . CLEAR AUDIO - VOYD - MATISSE - SME -
GYRODEC - B.E.L. - LURNE - vdH - TARGET - HELIUS - AUDIOQUEST - SLATE AUDIO . . .

THE **BEST** EQUIPMENT AVAILABLE WITH A PERSONAL SERVICE - S/H LIST AVAILABLE -
P/EX POSSIBLE

01-440 2588 - EASY ACCESS BY M25 OR TUBE (HIGH BARNET)

Oxford Acoustics was formed in May 1986, and has been trading successfully since that time selling limited quantities of turntables via a small coterie of specialist dealers, here and abroad.

The *Crystal Reference* is the mainstay product. There's a more expensive model which features an even more elaborate suit of clothes; predictably it's called the *Signature*. And there are now cheaper cut down models too, along with some add-ons which will soon be available for building into the turntables (either at time of sale or as retrofits) including an RIAA module and remote volume and headphone facilities.

A high level of information retrieval is a key claim for the design, and to this end the deck offers a well defined path for energy transmission, and a rigid but well damped structure achieved by using materials in intimate combination (eg bronze and acrylic for the platter, acrylic and aluminium in the armboard, Medite and aluminium in the sub-chassis, etc) – and lots of them.

There's a suspension of sorts, but it has a very high compliance in rotation, and even vertically it's so thoroughly damped it's scarcely noticeable under most circumstances. Everything else is bolted solidly together, even the 24volt Papst motor (as used in the *Gyrodec*), leaving platter inertia and belt compliance to flatten motor noise. The centre spindle is decoupled in the vertical plane only by rubber (think of Roksan) and is removable for centring, though not with the record in place. The round section belt rides on a machined black acrylic disc attached below the phosphor-bronze main platter. The platter is topped by an enormous acrylic top section which is slightly dished and has a centre label recess. A brass and acrylic clamp holds the record in place.

The main platter alone weighs 15kg/33lbs. The appropriately Herculean bearing is an inverted single point design, with a tungsten-steel ball running in a hardened steel thrust-plate, immersed in an oil bath.

The plinth section, which is skinned in Medite with steel top and baseplates, sits on adjustable feet (3 pads and one spike) and is heavily mass loaded with sand. It is also home to the quartz referenced two speed power supply, and provision has been made for other electronic modules.

LAB REPORT

Solid (eg concrete) floors are recommended, but I couldn't find any, and the optional wall mounting version was turned down for obvious reasons – Oxford Acoustics proposed taking the deck away after we'd tested it! Fortunately, however, my test area does have a concrete floor; it was not practical to float the *Crystal* free of its environment, and this will have adversely affected some of the measurements. So too will the lack of time for running in. Barely 24 hours could be spared for this, due to late delivery of the turntable; the massive bearing certainly requires a lot longer. Probably as a result rumble levels were higher than has been measured elsewhere using similar procedures.

The *Crystal* was also rather susceptible to low frequency vibration and acoustic breakthrough in the region below 100Hz or so. The

CRYSTAL REFERENCE

disc impulse response however was excellent, with very mild excitation which is quickly damped. The other plots too all suggested that the *Crystal* behaves in a linear fashion, with no sharp discrete resonances. Electrical noise is low too, with some mild effects noted mainly at 50Hz and 100Hz.

Speed accuracy was near perfect, with near zero drift and very little slowing under load, as expected. Weighted wow and flutter was just 0.06 per cent. The unweighted flutter contribution to this was essentially negligible, but low rate speed variations which show as wow were not especially low, though nothing audible could be directly pinned to this.

SOUND QUALITY

Oxford Acoustics mentions the Rega *RB250/300* as being particularly well matched. This would also make a good starter combination while saving up for an Airtangent, which seems to be the other favoured combination. The *Crystal* was tested with the latter, and the combination worked magnificently as well as looking a million dollars.

I had anticipated sound quality of some stature. In the event, the *Crystal* easily exceeded my expectations, managing to sound faster and yet less pointedly 'obvious' than many other heavyweights, but with all the power and drive that such turntables usually provide.

The most noticeable characteristic of the *Crystal* was its tantalisingly solid imaging. The soundstage was wide and deep, with very specific image placing combined with a spacious, free breathing quality. Clearly the Airtangent arm shares some of the credit for this, but equally plainly it's a joint effort.

The extraordinarily three-dimensional ability is accompanied by a range of qualities, including a tuneful and potent bass, utter consistency with changing volume levels, and an unobtrusive but still very clear-cut kind of presentation.

CONCLUSIONS

For the filthy rich, appearance alone should be good enough reason to buy the *Crystal*. And it should provide Rolls-Royce style pride of ownership – though more money can be spent even faster on a Goldmund. More to the point, the *Crystal Reference* is a winner musically, with wide ranging abilities in all key areas. A thoroughbred.

TEST RESULTS

Type	belt drive 2 speed turntable with integral stand
Platter mass/damping	15kg/excellent
Finish & engineering	excellent/excellent
Type of mains connection leads	3 core
Speed options	33/45rpm
Wow & flutter (DIN peak Wtd)	0.06%
Wow & flutter (Lin peak Wtd 0.2Hz – 6Hz/6Hz – 300Hz)	0.14%/0.04%
Absolute speed error	0.0016% fast
Speed drift 1 hour/load variation	negligible/0.06%
Start up time to audible stabilisation	11 sec
Rumble DIN B Wtd L/R Average/L + R (see spectrum)	–66dB/–65dB
Size (h x w x d)	72 (w/o lid) 55 x 45cm
Ease of use	excellent
Typical acoustic breakthrough and resonances	average/excellent
Subjective sound quality of complete system	excellent
Hum level/acoustic feedback	low/low
Vibration sensitivity/shock resistance	good/excellent
Estimated typical purchase price	£1995

Reprinted from issue No. 60

Reviewed by Alvin Gold

Oxford Acoustics Ltd, Unit 4, West End Ind. Est, Witney, Oxon
OX8 6UB. Tel: (0993) 771174.



WE'D LIKE



TO TAKE



A BOW...

*... following a survey among readers of
Stereophile magazine in 1988*

Customer satisfaction

91% of Magneplanar owners confirmed that if they were asked to consider another type of speaker, they would still buy Magneplanar.

8% said that they would probably buy Magneplanar, but would like to listen to other speakers first.

1% said that they would buy other speakers.

*... following a survey by Inside Track magazine
among a large number of US dealers*

Dealer satisfaction

Magneplanar's position was number one in terms of distribution, number two in terms of after sales service and number three in terms of the sales force rating.

Write or phone for perceptive advice and details of nearest dealer



ABSOLUTE SOUNDS
318 Worples Road, Wimbledon, London SW20 8QU
Tel: 01-947 5047 Telex: 894800 Absol G

Air Tangent, Apogee, Audio Research, California Audio Laboratories, Counterpoint, Davidson-Roth, Duntech Audio Limited, Entec, Goldmund, Jadis, Kinergetics, Koetsu, Krell, Madrigal, Magnepan, Martin Logan, Micro Seiki, PS Audio, Sonus Faber, Well Tempered Lab, Wilson Audio, Win Research Group

'I have the simplest of tastes . . .
I am always satisfied with the best'
Oscar Wilde

The cynic's view of the *Ekos* (from the French word *Ecosse*) is that it's a mildly souped up *Ittok* for more than twice the money. The second part of course is right – the *Ittok* sells for £429, the *Ekos* for £895 – but don't be fooled. Almost every component in the *Ekos* is new.

Linn says the *Ittok's* fundamentals were right, so why change them? Why indeed? So the *Ekos* has the same distinguishing features – a fixed headshell (with a third hole for the *Troika* cartridge), a wide armtube and strong(ish) bearings and so on. The arm is dynamically balanced; equilibrium is initially achieved by adjusting a stiffly decoupled counterweight, and then both bias and downforce are applied by spring.

The *Ekos* is the first arm Linn has actually built in-house from the outset. The claimed aim was to achieve something closer to the ideal of a stationary cartridge referred to the groove mean position, and the steps taken to achieve this include using stronger, more rigid materials, and joints with less give in them. An early decision was made not to follow the one piece arm/headshell bandwagon because Linn reckons that alloys with the required hardness can't be extruded or cast, or even machined without incurring a severe weight penalty.

To these ends, the *Ittok's* soft alloy headshell has been replaced by a solid machined item. The two armtube terminations are achieved with high technology glue (the *Ittok* is glued and screwed), said to make the *Ekos* 'more of a one piece arm than a one piece arm'(!) The armtube itself is a new ultra-hard alloy. The bearings have the same

LINN EKOS

geometry, but again they're much improved in specification and tolerances, and are claimed to be the best currently available in both respects. Other changes include a new metal output plug (*not* cable) which is said to have a significant sonic effect. The armrest is no longer separate, and the lift-lower device is damped in both directions to reduce the possibility of resonance. Build and finish are superb.

LAB REPORT

You won't find the secret of this arm in the lab test measurements. All they do is to suggest that no great errors have been made. Effective mass is a very reasonable 9g, friction in both planes is at the limits of measurement, and not only is there no discernible slack within the bearings, they also feel incredibly strong. Bias and tracking force adjustments are calibrated with absolute precision. The first arm breakup mode appears around 1.2kHz (probably a beam bending mode), and although the armtube quiets down quickly thereafter, there are some odd discrete resonances, including a high Q one apparently attributable to the fingerlift.

SOUND QUALITY

The *Ekos* was used mainly with the *Troika*, and on both Linn *LP12* and Pink Triangle

turntables, in all cases with truly excellent results. In the best possible sense, the *Ekos* is like a much improved *Ittok*. The feature I noticed first was that bass was reproduced in full, glorious stereo. The *Ittok* bass was always punchy and tight, but it often wasn't very deep, and true LF information tended to reproduce with spatial cues muted. Similarly treble reproduction is improved. The old slight but significant tendency to stridency has been somewhat ameliorated.

In a more global sense the arm is more obviously homogeneous and less obvious as a mechanical tool for reproducing music. For the first time in a Linn arm, I hear the subtle layering and stereo abilities of the Rega *RB300*, but with traditional (or better!) Linn style large scale dynamics and weight. In this one special respect *Ekos* does emulate the strengths of a one piece arm. The *Ekos* lifts the performance of the *LP12* to new, previously unrealised heights, ironically in the direction of other front runners, notably the Pink Triangle and Roksan *Xerxes*, both of which have demonstrated superior stereo and resolution with suitable arms.

CONCLUSIONS

The damped cue lift feature is a pain in the butt when used on a suspended player, but this apart the *Ekos* (like the *Ittok*) is the most practical and sensible of exotica. It takes Linn several steps further towards audio nirvana. Recommended.

TEST RESULTS

Arm	
Approx effective mass inc screws, excl cartridge	9g
Type/mass headshell	fixed/n/a
Geometric accuracy	excellent
Adjustments provided	height/overhang/lateral
Finish and engineering	excellent
Ease of assembly/set-up/use	very good
Friction (typical) lateral/vertical	<10mg/<10mg
Bias compensation method	dial
Bias force, rim/centre (set to 1.5g elliptical)	140mg/170mg
Downforce calibration error 1g/2g	0/0
Cue drift	negligible
Cue rate ascent/descent	3 sec/3 sec
Arm resonances	good
Arm damping method	none
Estimated typical purchase price	£895

Reviewed by Alvin Gold
 Reprinted from issue No. 67
 Linn Products Ltd, Floors Road, Waterfoot, Eaglesham, Glasgow
 G76 0EP. Tel: (041) 644 5111.



THE ART OF LISTENING

At Acoustic Arts standards continue to improve and it gives us great pleasure to announce that our premises have been redeveloped to offer you, our customer, the finest demonstration facilities we know of. Two new studios have been added to cope with the increase in our business one of which has been specially tailored to resemble the structure of a typical domestic living room. We feel strongly that we should recommence our own activities as the performance of new equipment has astonishingly continued to rise and our standards must rise with them.



Friendly staff in a friendly atmosphere

The most significant loudspeaker development must surely be the new Apogee Duetta Signature. We are all Apogee enthusiasts here but the improvement in sound quality with this model has amazed us. A true 'state of the art' product. Lower down the price range we must mention the new Magneplanar 1.4 which is a huge improvement in standards but amazingly costs no more than its predecessor at £1098. The P.S. Audio 4.6 with a new power supply is also a big improvement and at under a £1000 is probably the best pre-amp around at the price.

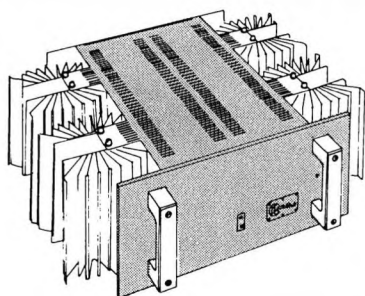

The landmarks this past year must surely be the new Krell range. The KSP-7B pre-amp and KSA-80, 200 and 160 power amps set new standards in being able to combine 'state of the art' sound quality with massive power delivery. Just put one of these amplifiers into your system and we guarantee it will transform it.

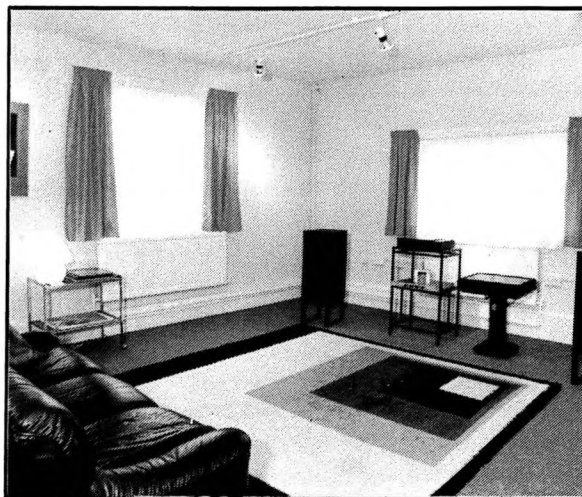

New Demonstration Room

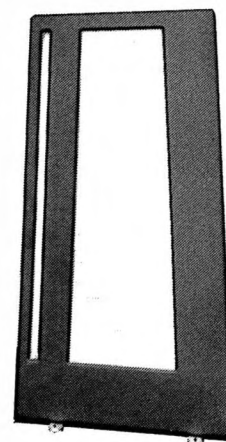

Come and hear these and many other fine new products at our new showroom. You owe it to yourself to discover why people continue to visit us from all over the country in ever increasing numbers.

Among the equipment we stock and love:
 A & R, ATC, Acoustic Energy, Air Tangent, Alexander, Alphason, Apogee, Aragon, Audiolab, Beard, Bryston, Castle, Celestion, Counterpoint, Crystal, Deltec, Denon, Dual, Ensemble, Gale, Goldmund, Heybrook, Incatech, Jadis, Koetsu, Krell, Linx, Magneplanar, Manticore, Marantz, Meridian, Micromega, Monitor Audio, Musical Fidelity, Orell, Pink Triangle, PS Audio, Quad, Quicksilver, Radford, Revolver, Revox, Robertson, Rogers, Roksan, Rotel, SD Acoustic, SME, Sonus Fabus, Spendor, Stax, Sumo, Systemdek, Source, TDL, Tannoy, Thorens, VDH, WTA, Wharfedale, Yamaha.



Acoustic Arts Limited, 101 St. Albans Road, Watford, Herts.

Telephone: Watford 245250

Open Monday-Saturday 9.30-5.30 p.m.

We cater for export orders.

To facilitate testing, the *Alexandria* was supplied with an SME Series IV arm, but arm bases are interchangeable to enable a range of other arm types to be used. Many of the design principles familiar from the better known *Delphi* appear in *Alexandria*, but this is no slavish copy. The deck looks more or less conventional, with a platter and arm base floated on a subchassis and a fixed, enveloping particle board chassis of standard proportions. The lid is an optional £125, on top.

The suspension is very close to the *Delphi* pattern. A massive, alloy subchassis is hung from three conical spring suspension units which can be adjusted from above, and which are normally covered by discreet black covers. The springs have different tensions, and can be changed to suit different weight arms.

The current *Mk III* version of the *Alexandria* is distinguished by a new low noise 12 volt DC motor, fed from an outboard supply. A high speed, small spindle design drives an inner rim on the one piece platter by flat belt. In a departure from tradition, the platter is of a synthetic composite material with a felt mat to which the record is clamped.

The clamp is a mild disadvantage, and so is the SME's awkwardly angled, stiff cueing lever which rocks the suspension. However, the row of three light touch controls for the two speeds and off is a delight; player finish is absolutely first class; the discreet Europeanised styling is a treat, as is the detailing and the 'piano gloss' black finish.

LAB REPORT

The *Alexandria* measures predictably well. Motor isolation is excellent and the rumble spectrum clean. The measured level of rumble is high on one channel, but this appears to be a measuring fluke caused by noise leakage in the test rig, rather than a real problem. This Oracle is largely immune from acoustic feedback, and coupling through the feet is highly effective, even in the context of high quality suspended decks. Excitation of the platter is quickly damped and there are no important resonances within the platter.

Wow and flutter measures reasonably low, but the level of linear wow is disappointing, though without obvious audible side effects. The deck has adjustable speed presets.

SOUND QUALITY

I was taken aback by the *Alexandria*. I already know the *Delphi* (and indeed the SME Series V) and expected something close but not as good. What I actually discovered

ORACLE ALEXANDRIA

was a pairing that could weave spells – the two suit each other almost ideally. Whereas the SME V can be difficult to match into many systems, perhaps because it has quite a strongly characterised sound of its own, this is certainly not a problem in this case with the IV.

There are no important weaknesses. Although it's true that the system doesn't have quite the resolving power of, say, the Roksan/SME, it has a very homogenous, poised delivery. The bass is firm and extended, the treble is discernibly less glassy than the *Delphi*, and midband information is layered and positioned to perfection. Stereo imagery always was a strong point of the *Delphi*, and the *Alexandria* continues this tradition. Finally, and this perhaps is the deck's most valuable (but also most subtle) feature, the deck has a perceived noise floor that is subjectively lower than almost any other. The 'blackness between the notes' during, say, the Gustav Leonhardt *Art of Fugue* (on Harmonia Mundi) provides a perfect illustration of an ability which is related to the perception of dynamic range.

CONCLUSIONS

Although both products were devolved from more illustrious parents, this combination has a naturalness and euphony that is quite new, along with superb stereo and dynamics. All this *and* superb good looks!

TEST RESULTS

Type	manual belt-drive motor unit
Platter mass/damping	2.5g/good
Finish and engineering	excellent
Type of mains connection leads	transformer in detachable lead
Speed options	33/45rpm
Wow and flutter (DIN peak Wtd)	0.12%/0.25%
Wow and flutter (Lin peak Wtd 0.2-6Hz/6-300Hz)	0.24%/0.052%
Absolute speed error	+0.06%
Speed drift 1 hour/load variation	+0.02%/–0.03%
Start up time to audible stabilisation	2.5 sec
Rumble DIN B Wtd L/R/L+R	–58dB/–80dB/–81dB
Size (h x w x d)/clearance for lid rear	15 x 49 x 37.5cm/7cm
Ease of use	average
Typical acoustic breakthrough and resonances	excellent
Subjective sound quality of complete system	excellent
Hum level/acoustic feedback	good
Vibration sensitivity/shock resistance	excellent
Estimated typical purchase price	£825-£995

Reviewed by Alvin Gold
Reprinted from issue No. 67
Gamepath Ltd, 25 Heathfield, Stacey Bushes, Milton Keynes
MK12 6HR. Tel: (0908) 317707.



Lovers of black vinyl have had quite a lot of bad news in the last year or two, in particular over the priority the record industry is placing on compact discs. Unpalatable as it may be, realism demands we recognise that within a year or so it won't be viable to consider vinyl as the primary source of music in any system drawing heavily from the new release lists. As releases increasingly become channelled into the compact disc and (perhaps) cassette format only, a lot of the life and vitality will vanish from the vinyl market – forever.

But while records may be well on the way to losing the war, nobody could call it a dishonourable defeat given the fact that even now in the year six of the digital revolution record reproduction continues to set the standards for excellence. Improbable as it may seem, much of this progress has been contributed by a healthy number of relatively small, lively outfits of which Roksan is just one. Mind you, it's not that small any more. Roksan quickly outgrew its London HQ and has now moved out west to a home in Wales, whilst the *Xerxes* has gone from strength to strength, making Roksan the second largest up-market turntable supplier in this country after Linn Products.

On previous occasions we've looked at Roksan's first and still best known product, which is the *Xerxes* turntable, and then at an early sample of the *Artemiz* arm, which turned out to be good but not wholly satisfactory in every respect. For this issue, the editor thought it would be a good wheeze to

ROKSAN XERXES/ ARTEMIZ/SHIRAZ



mark the release of the Roksan front-end, complete with *Shiraz* moving coil cartridge, by taking a look at the combination, particularly as the arm has shaken down nicely in production, invalidating much of the criticism made in the last report, and the *Shiraz* hasn't been covered at all. Naturally, the description that follows concentrates mainly, but not exclusively, on the *Shiraz* cartridge.

The turntable is a two-part design, consisting of a motor unit and a standalone power supply with on/off switching (on the back) and a 33/45rpm toggle switch. The supply itself is quartz driven and drives the player's synchronous motor through two Class A amplifiers, one for each phase of the motor. The player is belt driven and lacks a suspension in the usual sense, though a carefully contrived highly damped decoupling system is built in, doubling as a means of tuning the basic geometry of motor, belt and platter. The elaborate platter and bearing design have been covered previously; suffice to say that the thinking behind them is sophisticated, the standard of engineering is unusually high, but that little of this subtlety and excellence is apparent to the casual observer from the plain exterior aesthetics.

Following other recent arm designs like the SME IV and V and the Linn Ekos, which are all sleek curves and virtuoso engineering prowess, the *Artemiz*, like the Roksan itself I suppose, has the slightly austere air of the authentic audiophile product. Despite the rather primitive appearance of the area behind the pivot, there's some elegant engineering which results, for example, in a hanging unipivot counterweight offering a reduced inertia under acceleration, amounting to a reduction in apparent arm mass as seen by the cantilever suspension. This also gives a useful structural decoupling. The 'pyramid' bearing design is unusual if not unique, as it uses very low velocity metal-metal joints to reduce noise. The bearings are also unusual in that preloading is determined by the geometry of the arm when playing records. There's noticeable slack in the system when it's not being used. The arm works in a Rega cut-out, though the dimensions are not identical.

Finally, the *Shiraz* is a low output moving coil with a fixed stylus assembly in the classic mould. The generator is the EMT design which has been available for years under its own name, and is fitted with an alloy cantilever and a micro-linear stylus, an extended contact design optimised to cope with a fairly high 2.2gms recommended tracking force. Where the EMT arguably fell down was in the interface between generator and arm – the body in fact. Roksan has tackled this area by recourse to practices used elsewhere in the hi-fi chain (eg in its own *Darius* loudspeakers) but never so far to my knowledge with cartridges.

What Roksan has done is to design a complex solid alloy anvil-like mount incorporating three spiked mounting points which engage with the cage and generator to ensure a rigid final assembly. No glues are used, and no attempt has been made to hide the generator by using a cover which might cause its own structural resonance problems, so the appearance of the *Shiraz* is slightly odd. It's small, bright blue with all the innards exposed – rather like the new London Lloyds building when lit up at night. There are no output terminals and no terminal plate, just four captive trailing wires running from two loading capacitors, one each side of the cartridge. Wiring, as on the arm, is Roksan's own *Isoda* cable, a hybrid containing strands of brass, copper and aluminium.

SOUND QUALITY

The important point about the Roksan front-end is that as a system it demonstrates true synergy. Each of the three components, insofar as their audio properties can be separated from the others, appears to pull together giving the combination a kind of single minded consistency. It may not do everything quite as well as some of its competitors, but it tends to sound consistent and convincing even when it's wrong.

In fact it doesn't go far wrong. Although I've never thought of any Roksan component in quite these terms before, in a curious way the combination treads a middle ground between what its major competitors offer. However, this is not meant to imply that the combination is self-effacing, limp or anything that could be described in terms safe and neutered. Far from it.

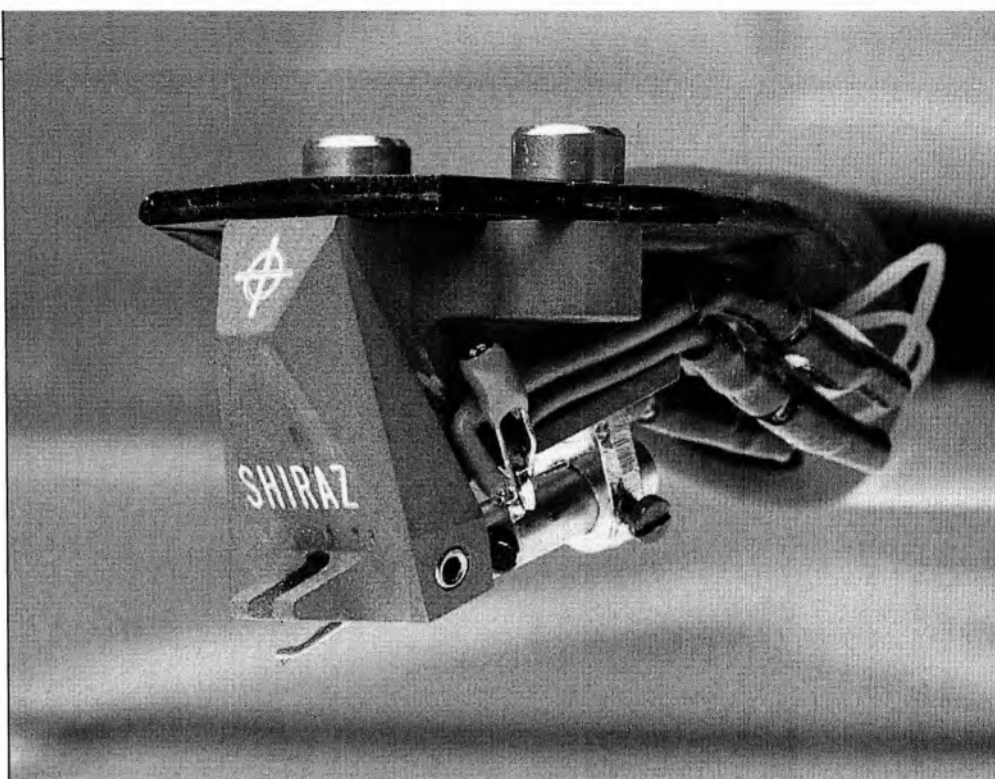

The turntable itself is now well known. Its primary attributes are very fine speed stability and excellent stereo imagery and subtlety, largely it seems due to a lack of overhang or any of the more usual smearing effects. Bass extension is deep and it has a tightly controlled, surefooted quality that leads the music to sound drier and a touch leaner than most decks. In this respect it falls between the euphonious glow of the Linn and the dry, sharply delineated and rather literal bass quality of the original *Elite Rock*. It has something in common with the Pink Triangle in the bass, though not elsewhere.

The first *Artemiz* sample I examined some months back was not as well built as this review one, particularly the bearings which had to be adjusted to the manufacturer's spec, a task I had no experience of. The current model also benefits from other individually minor running mods and wheezes of the kind that can be expected when bringing anything as complex as a pick-up arm – especially a first pick-up arm – on stream.

In its present form the arm sounds better controlled with a smoother high frequency performance and improved spatial differentiation, presumably because the unusual bearing design is working the way nature (and Roksan) intended. It blends almost imperceptibly with the turntable in a way that some other high class arms (the Linn range for example) don't when used on the same turntable, though the reasons for this remain obscure. The *Artemiz* has excellent definition, but without most of the pointing of detail and 'zing' that is present in the *Ittok* (toned down in the *Ekos*, thankfully). It also sounds better integrated, a property of the Roksan system as a whole by the way, but it would be claiming too much to suggest that the arm has been completely transformed. It's better, that's all.

The cartridge already has a distinguished pedigree from its EMT incarnation, and appears to have only gained from the transmutation. In fairness though, it's a long time since I heard an EMT so any comments I make should be treated as somewhere between just tentative and conjecture. Cer-

tainly compared to its modern peers the *Shiraz* is a first class cartridge, akin to a higher output version of a top Audio Technica – sharp, quick and very good through dense, complex passages, but with rather more 'balls' and a sweeter, more refined top end. There's nothing in the *Shiraz* to compete with the architectural solidity of some of the better Koetsus, but it's not lacking in bass either, and there's the same feeling of control and precision that is so prominent a component of the turntable and arm on their own. It tracks beautifully by the way, but demands careful setting up to optimise HF signal/noise and to focus the stereo soundstage.

The fact that the *Artemiz* doesn't use the Linn armbase fitting, which is now the de-facto industry standard, will not help its penetration of the arm market. It's the reason I haven't used it on other decks so far. One benefit however, is that it can go anywhere a Rega arm has been, and as such is perhaps the only genuine upgrade option available to Rega users, at least if they have a turntable of sufficient calibre.

CONCLUSIONS

The *Xerxes* has already proved its worth as a world class universal motor unit, and I'm satisfied from my tests that the *Shiraz* is very much in the same class. I haven't been able to prove any such thing of the arm yet for logistical reasons, but the three Roksan components together provide a level of performance of extremely high standard.

The Roksan front-end is one of the least coloured, most detailed and most consistent combinations I have ever used, with just a trace of top end 'presence' perhaps interpretable as emphasis, and a tuneful and beautifully controlled bottom end. It's an untemperamental system which provides music for the long term, rather than a glamorous sound or gimmicks for the short term. Setting up is not quite the easiest of tasks, but experience suggests that once done, it stays done.

Typical retail price inc VAT

£655, £450, £489
Reviewed by Alvin Gold
Roksan Engineering Ltd, 21 Ddole Road, Llandrindod Wells, Powys
LD1 6DF. Tel: (0597) 4911.

Reference power supply, which looks more like a power amplifier, drives the motors in series.

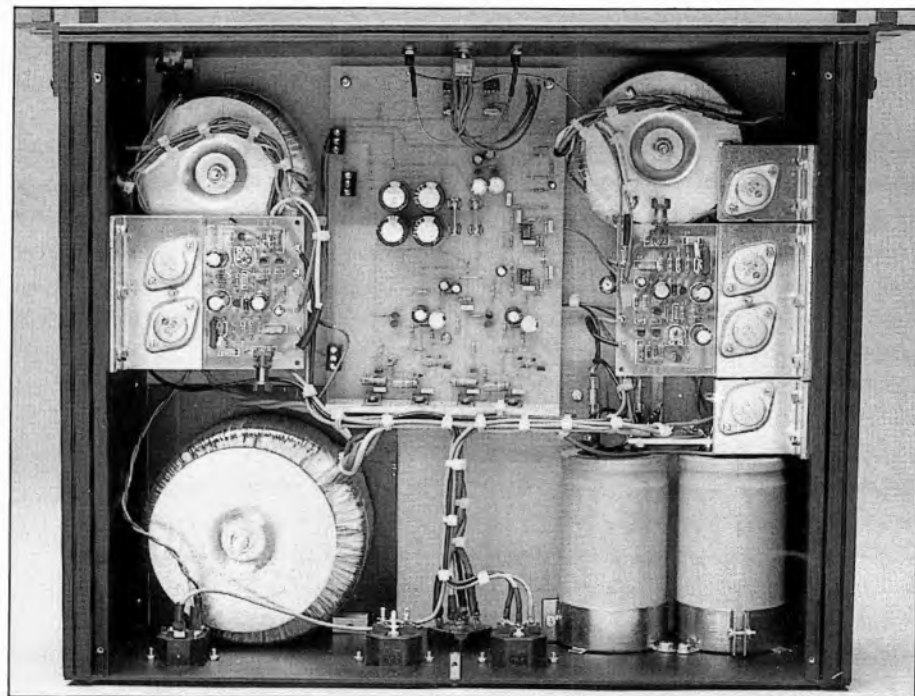

Voyd Turntables is a small Cheltenham-based outfit producing turntables of the highest quality. These start with the *Valdi* at £595, then there's *The Voyd* at £999 (or £1,199 with split-phase power supply), and finally a strictly limited edition *Voyd Reference* at a cool £5,000. The latter item is made to order and there's a substantial waiting time for delivery due to the fact that the motors used in this mega-deck are as rare as hen's teeth.

The turntable reviewed here is *The Voyd*, but with the addition of some optional extras which bring it some of the way towards being a *Voyd Reference*. Perhaps *The Voyd Plus* would be an apt name for it. Entry to the owner's club isn't cheap: the package supplied for auditioning comprised the *Voyd* motor unit (£895), *Reference* bearing and platter (£352) and *Reference* power supply (£1,275 inc. motor mass dampers), along with a Helius *Cyalene* tonearm (£1,066) and Audionote *IO* cartridge (£895). We'll leave you to do the sums . . .

Quality of finish is nothing short of superb. All Voyn turntables look the part, with gorgeous sculpted wooden plinths available in a variety of tree options. Three springs are used to suspend the subchassis, and a funda-

THE VOYD TURNTABLE

mental part of Voyn design is multiple motor drive – two motors in the cheaper *Valdi* deck, three motors in all others. Designer Guy Adams describes the action of the cartridge stylus acting as a brake as the walls of the record groove try to 'drive' it. The degree of braking depends, in part, on the amplitude (volume) and frequency (pitch) of the modulation (signal) in the groove. Low frequencies and transients are the most difficult

signals to get past the stylus.

When a transient occurs the motor in a conventionally driven sprung-subchassis turntable continues to turn at a constant speed, but initially it is easier for the motor to pull the entire record platter, the subchassis and the tonearm assembly towards itself than to pull the platter and record past the stylus. This dynamic instability is happening all the while a record is playing – and the result, says Guy Adams, is that we're not accurately retrieving all the information content of the record groove, especially in the areas of low level detail and dynamic attack.

All Voyn decks employ acrylic platters for good 'impedance matching' between record and platter (a controversial subject, this: it's one thing for unwanted vibrational energy to be effectively transferred from the vinyl disc to the platter, but then where does the energy go?); however, what we have on this deck as one of the optional upgrades is the platter from the *Reference* turntable. This is machined from highly expensive polycarbonate sheet (Lexan) which is claimed to improve upon acrylic by its ability to dissipate heat as energy more readily. This provides a more inert platform for the record, thus the attack and decay profiles are

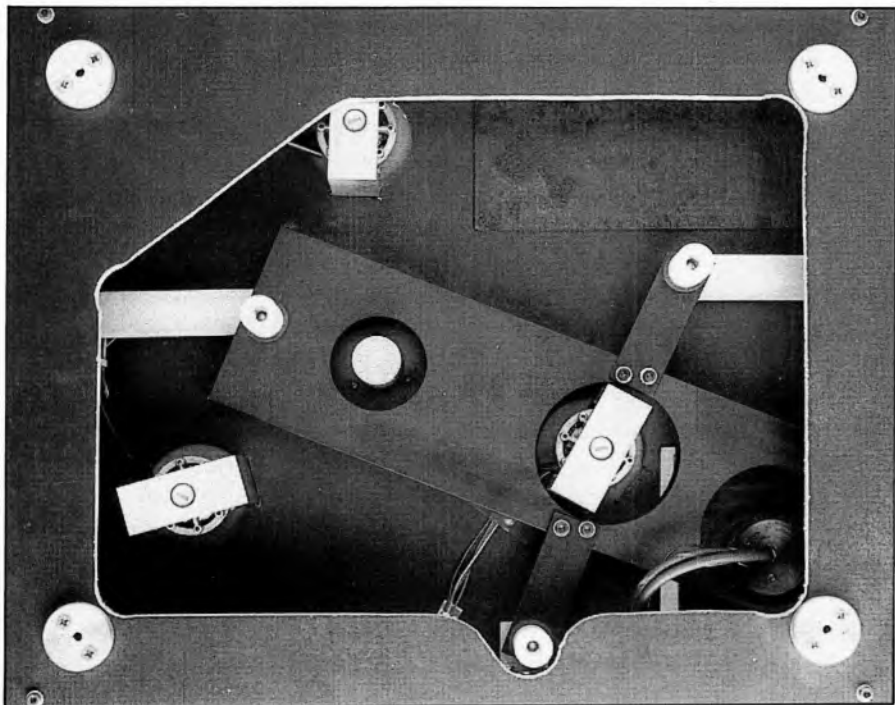

Worm's eye view shows the three Papst motors and the mass dampers which form part of the Reference power supply upgrade programme.



improved. The £352 buys not just the platter from the *Reference* deck but also an improved bearing to go with it. This has a diamond lapped thrust pad along with a tapered, hardened silver steel shaft to provide an exceptionally fine running clearance.

Then there's the *Reference* power supply. This unit, like the platter and bearing, is identical to that used in the *Reference* turntable. It's a high voltage (up to 150V RMS) 350VA twin phase unit, housed in a substantial rack mounting case – and at first glance it could easily be mistaken for a fairly meaty power amplifier! Front panel switches control power on/off and speed selection between 33⅓ and 45 rpm.

The designer describes the technology used in the power supply as 'state of the art'. The use of output transformers allows high voltages and power to be maintained accurately and reliably. The psu operates the motors at twice the speed that they run in the standard Voyn deck, giving the drive system four times the inertia. Also the motors can be run in series (they're in parallel in the standard deck), allowing several advantages: because the magnetic flux and hence torque is generated by current, when the motors are connected in series they are all forced to draw the same current and therefore the same flux is generated in the stator of the external rotor Papst motor. This application in a three-motor system, says Voyn, guarantees that all the motors 'pull' in exactly the same way and therefore the stability of the drive system is further improved.

Within the turntable plinth substantial motor brackets are used to provide a rigid mounting platform for the motors and to con-

trol unwanted energy by providing a region of high mass close to the motors. The fitting of these 'mass dampers' by the manufacturer is part of the *Reference* power supply upgrade package.

SOUND QUALITY

It takes little more than the first few bars of music to hear that the upgrades to the 'standard' Voyn provide a considerable improvement in sound quality. Late last year I auditioned a standard deck with *Cyalene* arm and *IO Limited* cartridge – and it didn't sound as vivid and well-focused as this review deck, despite the fact that this time around I was using a slightly inferior cartridge (the *IO Limited* cartridge is breathtaking, while the ordinary *IO* model is merely wonderful!).

Like the standard Voyn, only more so, this upgraded deck sounds powerful and authoritative, and in terms of its ability to track dynamic swings in music it is world class. What the upgrades appear to have done is improve bass control and 'slam' and improve soundstaging. Never before has my system produced such lifelike, out-of-the-box images, and the placement and perspective of sounds within the soundstage were explicit and extremely vivid.

Listening to this analogue front-end is always a rewarding experience. The musical performance is colourful and dramatic, and, unlike some decks which appear to throw detail and excitement at the listener, *The Voyn* never causes stress or fatigue. This deck is just the tonic for systems which sound bland and over-damped.

CONCLUSIONS

Aimed clearly at enthusiasts and music lovers who demand the best possible sound from vinyl records, *The Voyn* is a beautifully presented turntable which puts many British hi-fi products to shame. Not only is this a piece of furniture which you'd be proud to have in your home, but the sound it presents is first-rate too. And the upgrade options have pushed the performance onto a higher plane.

What's nice for existing Voyn owners is that the *Reference* upgrades are retrofittable. Also, enthusiasts may wish to start with a standard deck – perhaps with an inexpensive Rega arm and something like a Goldring *Eroica* cartridge – and then upgrade over the years to a deck which is not that far short of the full-blown *Voyn Reference*. It's good news for consumers because they're never left with an out of date product, and it's good marketing because it inspires strong brand loyalty from customers.

Turntable sound is a subjective business, and all magazine commentators have their favourite models. What is indisputable about *The Voyn*, however, is that it is clearly one of the finest turntables available anywhere in the world at any price. If the price ticket won't prove a stumbling block I strongly recommended you investigate further. Playing records on a turntable of this quality is a real treat.

Typical price inc VAT

Reviewed by John Bamford

Voyn Turntables Ltd, Anchor House, Warwick Place, Cheltenham, Glos GL52 2NP. Tel: (0242) 574528.

£2522

CAREFUL LISTENERS ONLY PLEASE



Audio Technica have built up a worldwide reputation on the quality of its transducer products ... those delicate components which turn soundwaves and mechanical movement into electrical impulses or vice versa. It's made us world leader in the field of cartridge technology and now the same micro-engineering expertise is at work in the 900 series 'phones.

The 'larger than life' sensation of our new ATH 909, ATH 910 and ATH 911 models comes courtesy of extra large diameter drivers with copper clad aluminium voice coils which produce a superbly natural sound right through to the critical high frequencies. Add good ergonomic design, soft-feel earpads plus a low overall weight to create a most impressive headphone.

Comfortable enough, you'll agree, for the most careful of listeners.

Audition the 900 Series soon at your specialist hi-fi store, local BADA member dealer or simply contact us directly for more information.

Hz 20 200 kHz 5 10 20

ATH 909 Open Back
ATH 910 Closed Back Monitor
ATH 911 Open Back PC-OCC

The only complete transducer family

● CARTRIDGE ● HEADPHONE ● MICROPHONE ● VITAL LINKS

audio-technica®

□ INNOVATION □ PRECISION □ INTEGRITY

Technica House, Lockwood Close, LEEDS LS11 5UU. Tel: (0532) 771441 Fax: (0532) 704836

AES
Sustaining
Member



Almost no feature of this player is as you'd expect. Even lifting it up is not for the unwary since the motor and a section of plinth associated with it stay behind, being totally separate. The platter is a dished acrylic item with a screw clamp. The synthetic flat peripheral drive belt certainly isn't as you'd expect, and neither is the complete lack of suspension. Instead structural control is maintained by a heavy composite chassis of Medite sandwiching about 14lbs of lead. The heavily weighted AC motor has a plastic drive pulley with steps for the two different speeds.

The well into which the spindle fits is massively oversized, and is filled with silicone fluid. The platter and inner bearing are restrained by plastic (PTFE?) studs inside the bearing well – and the drive belt.

If it's possible, the arm is even more idiosyncratic than the turntable. The aluminium armtube is unfashionably thin and the headshell a screwed-on cross member which offers a small area of contact to the fingerlift and only indirect contact to the armtube. The fingerlift can even be rotated to adjust the offset angle.

The real novelty, however, is the 'bearing'. The arm is literally suspended on a hoop of what appears to be fishing line, in a vice like arrangement that can be opened to vary the amount of twist which acts to provide bias compensation. An enormous paddle attached beneath the pivot sits in a well of high viscosity silicone fluid, and is heavily damped to say the least. The arm has very simple, quick methods of adjusting cartridge azimuth (as viewed from the front), VTA and several other parameters.

LAB REPORT

The first resonance of this otherwise well damped, low mass arm is a bending mode at the cartridge/arm mount, and this turns out to be a critical point. Merely adjusting the mounting screws is enough to place the resonance anywhere from 300-800Hz. Everything else is adjustable or peculiar: geometry is arbitrarily good, while friction doesn't exist at all in the formal sense.

The player is only slightly less odd. Speed stability is good and motor breakthrough moderate. The plinth acts as a somewhat uneven mechanical filter, being microphonic around 170Hz, and the platter tends to ring too, with several discrete frequency components identified by spectrum analysis.

WELL TEMPERED TURNTABLE

SOUND QUALITY

On audition, this deck possesses a lovely '3-D' quality. The treble is sweet and pure, the midband 'liquid', and the bass, perhaps surprisingly, is light and crisp. Timing is a strong point. The deck has a sharp attack, a clear sustain and releases quickly once the stimulus has passed. More striking than any of this, however, is the sense of quiet between notes – and on a grander scale, the extraordinary way the whole soundstage is laid bare.

For all this, the sound is slightly 'over-damped', and detail is not as explicit as with some competitors. But if asked to pinpoint a quality that is truly out of character, it is that the WT doesn't go quite far enough along the road the designer has mapped out. The arm especially sounds microphonic at quite high frequencies, and is responsible for an overlay of coloration on the sound. This can be shifted around a bit by tweaking the setting up, but not completely eliminated.

CONCLUSIONS

Those who love the sound of a good valve power amp ought to feel comfortable here. The Well Tempered combination is all about feeling comfortable with your record collection. It challenges dogma by breaking every tenet of traditional thinking, yet provides living proof that there is another way – and it works; Recommended.

TEST RESULTS

Motor section

Type	manual belt-drive player
Platter mass/damping	1.75kg
Finish and engineering	very good
Type of mains connection leads	captive, 2-core
Speed options	33/45rpm
Wow and flutter (DIN peak Wtd)	0.11%/0.14%
Wow and flutter (Lin peak Wtd 0.2-6Hz/6-300Hz)	0.14%/0.058%
Absolute speed error	-0.13%
Speed drift 1 hour/load variation	synchronous/-0.09%
Start up time to audible stabilisation	1.5 sec
Rumble DIN B Wtd L/R/L + R	-76dB/-79dB/-79dB

Arm section

Approx effective mass inc screws, excl cartridge	7.5g
Type/mass headshell	fixed
Geometric accuracy	excellent
Adjustments provided	tilt, overhang, lateral, height
Finish and engineering	very good
Ease of assembly/set-up/use	average
Friction (typical) lateral/vertical	n/a
Bias compensation method	twisted thread
Bias force, rim/centre (set to 1.5g elliptical)	130mg/150mg
Downforce calibration error 1g/2g	n/a
Cue drift	poor
Cue rate ascent/descent	n/a/1 sec
Arm resonances	below average
Arm damping method	very viscous fluid and heavy decoupling

System as a whole

Size (h x w x d)/clearance for lid rear	18 (to top of arm) x 48 x 39cm
Ease of use	average
Typical acoustic breakthrough and resonances	average
Subjective sound quality of complete system	very good
Hum level/acoustic feedback	good/below average
Vibration sensitivity/shock resistance	good
Estimated typical purchase price	£1690 (optional cover £75)

Reviewed by Alvin Gold

Reprinted from issue No. 67

Absolute Sounds Ltd 318 Worple Rd, London SW20 8QU

Tel: (01) 947 8160.



Somewhere in the highlands of Scotland lives a Buddhist whose passion is the creation of exotic record players. His name is Simon Yorke and the fruit of his labours is the Zarathustra turntable – a presumptive name for a presumptive machine. As the *S4*'s name suggests this is the fourth generation of Zarathustra, although there's also an *S5* version which is fundamentally the same but with a glass case and substantial slate plinth to keep the vibes and dust out.

The *S4* is a deceptively simple turntable, requiring little more than a flat surface to be got up and running. There's no complex set-up procedure or fine tuning and you don't have to be a wizard of the runes as is often the case with other turntables. Its simplicity of set-up has been achieved by carefully refining the design and keeping tolerances as tight as possible, thus the three suspension springs may be adjusted with shims to account for different arm mass but otherwise

need not be tweaked. Because of the high mass platter the springs are very stiff and the subchassis bounces in an incredibly even fashion compared to other sprung turntables. For the same reason, however, if the *S4* is on a table, walking close to it will cause it to move. This doesn't make it mistrack but means a knack has to be acquired for painless cueing.

With the exception of the bearing the Zarathustra uses entirely non-ferrous metal in its construction, to avoid stray magnetic fields which would affect the cartridge. In fact most of it is stainless steel – even the columns which have a very even finish resembling a matt metallic paint. This, I'm told, is achieved with nothing less than good old elbow grease. The free standing motor, which has the same finish, drives the platter at its periphery with an 'O' section belt and is positioned so as to exert minimum tension. This slightly slows down start-up, but it's no slower than many high-end players. The

motor has some decoupling to cut down on energy transfer to the support, and not surprisingly it has a preference for high mass shelves which soak up any extraneous energy.

The platter itself weighs a substantial 11kg, supports a thick, hard rubber mat and runs on a bearing consisting of a phosphor bronze shaft in an acetal plastic sleeve, the thrust being taken by two opposing balls in oil for minimal friction and wear. Construction is otherwise as seen, a Medite armboard with a counterweight on the opposite spring, the chassis has rubber 'O' ring feet and all the connections are made with stainless set screws – a nice touch that inspires confidence. Power in this case was supplied by the larger Zarathustra power supply, a £500 option with the *S4*, though usually a smaller single speed unit is supplied. This particular box is finished to Cello standards (no coincidence, given the company's past involvement with Cello) and has tasty toggle switches for

ZARATHUSTRA S4



speed and start/stop on the front, and a large heatsink and IEC power sockets on the rear.

Pluto tonearms are distributed in the UK by Zarathustra and painstakingly handmade by a Dutchman called Eddy who apparently spends 100 hours on each one, which accounts for their high price and superb build quality. The *5a Prestige* is, I believe, the most expensive tonearm he builds, being constructed almost entirely from titanium. The genus of Pluto arms appears to be the SME arms of the late '70s, but taken to the 'nth' degree of precision. For instance, the counterweight can only be slid onto its spigot with the aid of silicone lubrication, it's that tight. The bearings are extremely precise gimbals with no apparent play, whilst the string and weight bias correction is the most stylish and versatile I've come across. Three different weights are supplied and can be easily attached to the nylon thread. However, it's important to ensure that the subchassis is level before setting bias – if it's sloping this

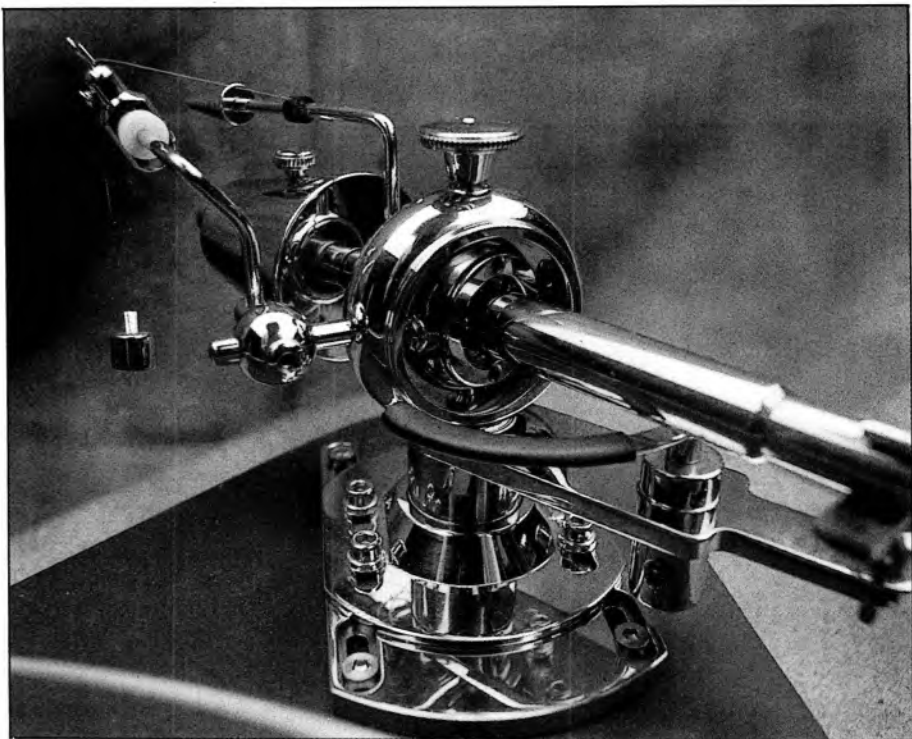

AND PLUTO 5A PRESTIGE

will have a greater effect than both the anti-skate and the cartridge's natural tendencies.

Setting up the Pluto is slightly more long-winded than with the turntable, as it can be adjusted in most every respect; even headshell angle can be altered (but not removed) although it's unlikely to be necessary. This means that with little difficulty the cartridge can be optimally aligned and VTA can be accurately set; although one point that proved a slight nuisance was the mass of the counterweight. The first cartridge tried was a Stilton *AT-F3*, which is lighter than usual at 5.75g, and required a little extra mass in the form of a blob of Blu-tack to achieve the correct statically applied tracking force of 1.65g. However, an *OC7* (7.8g) proved more suitable, but it's a point worth considering as many cartridges weigh in the region of 6g and need over 1½ grams of downforce.

The physical reasons for the £2,500 price tag are the phenomenal build and finish standards which is up in the Airtangent and SME *V* bracket, if not above. The *5A* has the sort of finish one associates with original art deco silverware – the styling is in the same vein and anyone who appreciates quality will really dig this tonearm.

SOUND QUALITY

Under the circumstances it proved impossible to review the arm and turntable separately which means the following observations are for the record player as a whole. The two cartridges mentioned were used to audition it through an Audio Innovations/Snell system.

Primarily, the sound of the *S4/5A* combination is the sound of the vinyl that it's given to transduce, or that's how it seemed as it has

less character than any turntable I'm conversant with. If a pressing had good bandwidth and was well recorded, without recourse to compression or other studio fidelity crushers, it sounded remarkably convincing. However, if the opposite were the case as is very often, then this is what came out of the speakers.

Quite a few rock albums revealed their true, bass heavy, rolled off and compressed colours, especially more recent ones from the likes of David Lee Roth and Def Leppard. Other discs revealed unattractive vocal compression and processing and became less appealing as a consequence. These included discs that in the past have been considered hi-fi dem records such as Prefab Sprout's *Steve McQueen* and Lloyd Cole's *Rattlesnakes*, the latter revealing varying degrees of vocal processing depending on the track.

Those are the instances where a better gramophone could be considered a drawback, but luckily in my collection at least, they were in the minority. I'm glad to say there were far more records which sounded considerably better in all respects. In fact many discs which had previously sounded drab and poorly executed on the manufacturing side became far more musically coherent and dynamic, for instance the Rolling Stones' *Black and Blue* – a purely analogue creation. Whereas certain records which have a reputation for sounding good actually lived up to expectations, Talk Talk's *Colour of Spring* for instance sounded devastating, as did The *The's Soul Mining*.

It soon became clear that this gramophone's strengths lay in its ability to accurately resolve information across the entire audio bandwidth, or as much of it as the Snell *III*

speakers could transduce, and an uncanny capacity to reveal the dynamic range of recordings.

What's more, it did this with a Stilton *AT-F3* which, while undoubtedly a good cartridge at the price, is hardly a match for its more expensive brethren. Changing over to the *OC7* brought about improvements in subtlety, bandwidth and articulation – Michael Hedges' guitar became mesmerising and *Soul Mining* became even more paranoid. I could go on ad infinitum but the final frontier looms – if you can handle fidelity to your vinyl then seek and purchase.

CONCLUSIONS

What the Zarathustra and Pluto manage to do is make records far more interesting, varied and entertaining. One is no longer distracted by the hi-fi qualities of the product and the tendency is to play all one's favourite records in turn, just to hear what's on them, to get into the ideas and textures inherent in different pieces.

After a while the room becomes awash in record sleeves. There is no time to put things back in order, all you want to do is get into the vinyl groove and find out what's really in it. Need I say more?

Typical Retail Price

S4/5A Prestige/power supply
£1500/£2500/£500

Reviewed by Jason Kennedy
Zarathustra Designs, Gosford Camp, Longniddry, East Lothian,
Scotland, EH32 0PX. Tel: (08757) 662.



Nigel Kennedy listens to Nigel Kennedy on Stax headphones

STAX

THE BEST HEADPHONES IN THE WORLD

Path Group PLC, Desborough Industrial Park, High Wycombe, Bucks HP12 3BG. Tel: 0494 459981. Telex: 837134 PATH G. FAX: 0494 461209

PATH
GROUP PLC

AUDIO TECHNICA ART1 & CELLO CHORALE

Launched to coincide with Audio Technica's 25th Anniversary, the *ART1* moving coil cartridge is claimed to 'push back the existing boundaries of analogue reproduction'. To this end AT has employed PCOCC6N copper (99.99996 per cent CU) for the coils which are wound onto an inverted V-shape armature. AT has also attempted to reduce all body resonances with a ceramic armature mould, a very rigid grey titanium shell and a lower skirt fashioned from a brown, rubber-like polymer. Even the lightweight boron cantilever is reinforced while AT suggests the exquisite micro-linear stylus has a lifetime in excess of 1000 hours.

LAB REPORT

THD and IMD were both exceptionally low and comprised equal 2nd and 3rd components – the SMPTE spectrum was the cleanest I have recorded so far. The compliance was a little asymmetric but tracking was fine and the stereo separation quite amazing with a maximum of 49dB at 3.2kHz! *ART1*'s output of 0.34mV was good in the light of its low 12ohm coil resistance and input loads above 100ohm are recommended.

SOUND QUALITY

In many respects this hi-tech moving coil is the natural foil for Ortofon's prestigious *MC3000*. It offered a similar feeling of tactility, groove stability and sharp stereo focus but was less prone to sounding hard or clinical, blending a rare sense of treble definition with an equally rare subtlety and refinement. There were occasions where the soundstage appeared a little flat and vocalists too reserved but, on the whole, it was very convincing.

Accurately aligned it was also singularly insensitive to surface noise, another related factor in its ability to retrieve very delicate, low-lying nuances. The *ART1* was not as forward nor as obvious sounding as the exciting Koetsu, yet it possessed a measured and seamless fluidity that set it apart from lesser cartridges.

CONCLUSIONS

ART1 is a radically different beast from the richer-sounding *AT-OC9* – up until now the top dog in Audio Technica's fine range of moving coils. The *ART1* is a cartridge that trades the vigorous slam of traditional MCs for a gentler and extraordinarily refined perspective. It's technically advanced and analytical, yet inherently smooth and delightfully musical.

Compliance, vert/lat	7.5cu/15.6cu
Tracking Force Range/Test	1.3-1.7g/1.6g
Tracking ability, L/R	>80µm/76µm
LF res, Vert/Lat	13Hz @ 9dB/9Hz @ 15dB
Output (1kHz, 5cm/sec, L/R)	332.5µV/350.6µV
Channel sep, L/R, 100Hz	25.7dB/26.9dB
3kHz	34.5dB/46.8dB
10kHz	24.8dB/28.3dB
Channel balance	0.46dB
Coil resistance	11.23ohm
Frequency dev 20Hz-20kHz	-0.2dB/+2.1dB
THD (300Hz, 1kHz)	0.29%, 0.82%
HF Distortion, (10.8kHz pulsed)	0.39%
SMPTE IMD (2nd/3rd Order)	3.2%/0.65%
Vertical Tracking Angle	25 degrees
Loading Requirements	>100ohm
Typical retail price	£800

Reviewed by Paul Miller

Audio Technica Ltd, Technica House, Lockwood Close, Leeds LS11 5UU. Tel: (0532) 771441.

CELLO CHORALE

One of Cello's least extravagant products, the longstanding and distinctive *Chorale* moving coil cartridge appears to be sourced from the same Japanese manufacturing base as the Krell *KC-100*. A similar, very low source impedance generator is mounted inside a thin-walled alloy cylinder that serves as the body for this odd-looking cartridge. A flat top-plate and suitably recessed mounting lugs enable a firm mate to be achieved with the partnering tonearm but the circular profile of the body makes accurate alignment a hit-and-miss affair.

Furthermore the high mass of the cartridge together with its unsymmetrical and high compliance renders it unsuitable for use with chunky, medium-to-high effective mass tonearms.

LAB REPORT

Yet another phase-inverting cartridge, the *Chorale* offered a very even and symmetrical stereo separation that reached a max of 34.8dB at 7kHz before falling to 23dB at 20kHz. Its response was boosted by a mild +0.5dB at 500Hz before dipping -1dB at 5kHz and then rising a full +2.8dB at 20kHz. *Chorale*'s ultrasonic output remained potent and +9.2dB at 41.7kHz will test the input headroom of many MC disc stages. THD was

kept to within 1.4 per cent throughout the midband though the 10.8kHz pulsed HF residual rose to 4.6 per cent when subject to RIAA eq. The low 2nd order SMPTE product (4 per cent) indicated a fair lateral alignment even though the poor 31 degree VTA incurred a vertical distortion of around 5.8 per cent.

SOUND QUALITY

Tracking at just 1.4g the *Chorale* offered a light, sparkling and fresh perspective of musical events. Strong bass lines sounded solid and taut but not particularly deep or powerful, the cartridge erring instead on the lean but very transparent side of neutrality. By contrast, the subtlest treble nuances were revealed with great dexterity and conviction, betraying no hint of sibilance or brashness.

CONCLUSIONS

Offering a similar overall tonal 'character' to the Krell *KC-100* but at a saving of some £110, the *Cello Chorale* would appear to be the better buy. However, general compatibility is not the forte of either design and a home dem is therefore recommended.

TEST RESULTS

Type, body mass	Low o/p moving coil, 13g
Stylus type	elliptical
Compliance, vert/lat	13.0cu/21.5cu
Tracking Force Range/Test	1.0-1.7g/1.4g
Tracking ability, L/R	>80µm/75µm
LF res, Vert/Lat	9Hz @ 12dB/7Hz @ 16dB
Output (1kHz, 5cm/sec, L/R)	292.6µV/266.2µV
Channel sep, L/R, 100Hz	27.5dB/26.8dB
3kHz	28.3dB/29.6dB
10kHz	31.2dB/32.9dB
Channel balance	0.82dB
Coil resistance	4.17ohm
Frequency dev 20Hz-20kHz	-1.0dB/+2.75dB
THD (300Hz, 1kHz)	0.29%, 1.37%
HF Distortion, (10.8kHz pulsed)	0.46%
SMPTE IMD (2nd/3rd Order)	4.0%/0.51%
Vertical Tracking Angle	31 degrees
Loading Requirements	>10ohm
Typical retail price	£590

Reviewed by Paul Miller

Aston Audio, 4 West Street, Alderley Edge, Cheshire. Tel: (0625) 582704.

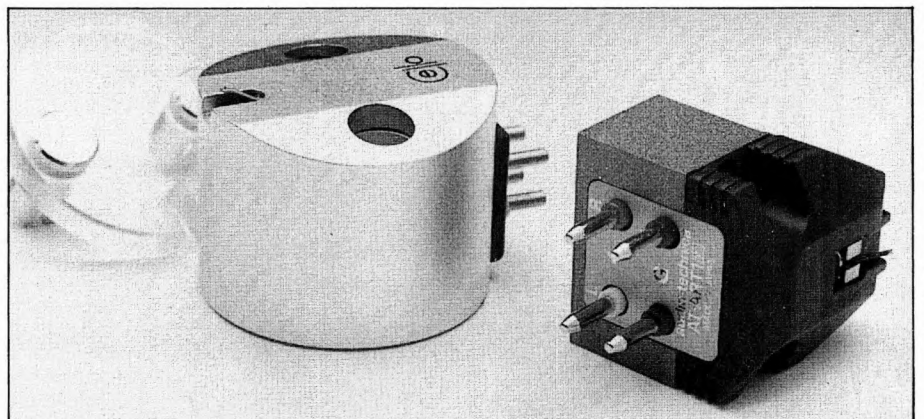

TEST RESULTS

Type, body mass	Low o/p moving coil, 9g
Stylus type	100µm square microlinear

music made live...

MISSION
ELECTRONICS



Bartlett's money saving recommended systems speakers

Turntable	Amps	Speakers					
		Wharfedale Delta 30 Goodmans Maxin	Heybrook Point 5 Tannoy E11 AR 112 Mission 761	AR 122 B & W DMS50 Gale GS210	Tannoy M15	Heybrook HBI AR 132	Tannoy M20B
Dual CS430	AR A03	279.95	314.95	339.95	356.95	382.95	407.95
Dual CS430	AR A05	314.95	348.95	373.95	390.95	416.95	441.95
Dual CS430	Il+ ARCAM Alpha	288.95	322.95	348.95	364.95	391.95	416.95
Dual CS430	Denon PMA 250	249.95	284.95	348.95	326.95	352.95	377.95
Dual CS430	Marantz PM 35	271.95	305.95	331.95	447.95	373.95	398.95
Dual CS430	Marantz PM 45	314.95	348.95	373.95	390.95	416.95	441.95
Dual CS430	NAD 3020E	246.95	280.95	305.95	322.95	348.95	373.95
Dual CS430	NAD 3130	288.95	322.95	348.95	364.95	389.95	414.95
Dual CS430	NAD 3240PE	356.95	390.95	415.95	432.95	458.95	483.95
Dual CS430	NAD 3225	271.95	305.95	331.95	447.95	373.95	398.95
Dual CS430	Rotel RA810A	254.95	288.95	314.95	330.95	356.95	381.95
Dual CS430	Rotel RA820A	279.95	322.95	348.95	364.95	391.95	416.95
Dual CS430	Rotel RA820BX3	322.95	356.95	382.95	398.95	424.95	449.95
Dual CS430	Rotel RA840BX3	419.95	454.95	479.95	496.95	522.95	567.95
Dual CS430	Rotel RA870BX	229.95	263.95	288.95	305.95	331.95	356.95
Dual CS430	Yamaha AX300	271.95	305.95	331.95	347.95	373.95	398.95
Dual CS430	Yamaha AX400	314.95	348.95	373.95	390.95	416.95	441.95

Free cartridge, cable, 2-year guarantee, carriage*

All systems supplied with cartridge, speaker cable and 2-Year Parts and Labour Guarantee. Carriage is FREE For UK Mainland*. Please phone for competitive carriage rates overseas.

Price guarantee

If you can buy cheaper - including leads, carriage and 2-Year Guarantee - we will match it.

Prices correct for the life of this magazine, but are subject to change.

Stockists of A & R, AR, Ariston, Audiolab, B & W, Denon, Dual, Exposure, Gale, Heybrook, Inca Tech, KEF, Linn, Marantz, Musical Fidelity, Mission, NAD, Nakamichi, Quad, Revalver, Rotel, Tannoy, Wharfedale, Yamaha.

Improved turntables (inc. cart)

Dual CS 505-1 Extra £21.00 Dual CS 505-3 extra £42.00
Ariston Q Deck Extra £50.00 Ariston Icon/Epic extra £124.00
AR EB101 Extra £119.00 Revolver Rebel extra £60.00
Revolver extra £93.00

CD instead of turntable front end

AR CDO6 extra £246.00 Denon DCD 610 Extra £93.00
Denon DCD 810 extra £136.00 Denon DCD 910 extra £179.00
Denon DCD 1520/2 extra £348.00 Marantz CD 583 extra £52.00
Marantz CD 65/2 extra £136.00 Marantz CD 65/2 SE extra £179.00
Marantz CD 75/2 extra £175.00 Marantz CD 75/2 SE extra £221.00
NAD 5220 extra £119.00 NAD 5240 extra £162.00 NAD 5320
extra £68.00
Rotel RCD 820B extra £102.00 Rotel RCD 820B x 2 extra £136.00
Yamaha CD x 630 extra £136.00 Yamaha CDX 710 extra £153.00
Yamaha CDX 810 extra £179.00

BARTLETTS

175 HOLLOWAY ROAD, LONDON N7. TEL: 01-607 2296/2148

Access, Visa cards accepted

CLEARAUDIO SIGNATURE & EMPIRE BENZ MICRO MC-2

After the *Gamma*, *Delta*, *Veritas*, *Pradikat* and *Accurate* the *Signature* is the latest Clearaudio cartridge to emerge from Peter Suchy's den in Erlangen, West Germany. Each of the cartridges features the same boron cantilever, 'trigon' stylus and proprietary generator which comprises four rare-earth magnets disposed in two pairs either side of the central pivot position. The generator is embedded in a coloured resin and fitted with the now characteristic 'hammerhead' frontispiece which supports the four gold-plated output pins.

Each generator assembly is then graded by audition and measurement before being equipped with a metal body and carrier befitting of its station. The *Signature* is deemed to exist between the *Delta* and *Pradikat* and, as a consequence, is fitted with a rhodium-plated lead-alloy mounting plate.

LAB REPORT

As usual, this Clearaudio offered a very even separation with a rising response that started 1dB down at 7.5kHz but clocked in +1.37dB at 20kHz and +3.2dB at 27.6kHz. Furthermore, the vertical distortion hit 6.5 per cent with a comparably weak lateral SMPTE IMD of 12.2 per cent. Output was some +2.8dB up on the *Accurate* - a good point.

SOUND QUALITY

As if to reinforce the contention that all Clearaudios are graded examples of the same generator, the *Signature* proffered a tightly detailed and punchy sound that placed it smack between the cheaper *Delta* and costlier *Pradikat*! Like others from the same stable the *Signature* did sound a little forward and bright in the first few hours of use, a property that gradually waned to be replaced by an altogether smoother and more transparent balance.

It sounded more refined in the treble than either the *Delta* or *Gamma* derivatives but it certainly did not afford the uncannily three-dimensional sound of the *Accurate*. Clearaudio's *Signature* extended high into the far treble but equally deep and resonant bass notes were curtailed by comparison.

CONCLUSIONS

The designer must still address the unnecessarily high VTA of these cartridges but is commended on achieving a healthy 0.65mV output, rendering it suitable for use with many good MM inputs. By offering a very uncluttered, fresh and uncompressed sound the *Signature* is likely to win new friends for Clearaudio.

Compliance, vert/lat	25.2cu/25.2cu
Tracking Force Range/Test	1.8-2.4g/2.2g
Tracking ability, L/R	77µm/75µm
LF res, Vert/Lat	7Hz @ 12dB/7Hz @ 13dB
Output (1kHz, 5cm/sec, L/R)	673.4µV/623.0µV
Channel sep, L/R, 100Hz	28.5dB/27.1dB
3kHz	32.6dB/31.5dB
10kHz	31.8dB/30.6dB
Channel balance	0.67dB
Coil resistance	47.53ohm
Frequency dev 20Hz-20kHz	-1dB/+1.4dB
THD (300Hz, 1kHz)	0.56%, 1.58%
HF Distortion, (10.8kHz pulsed)	0.49%
SMPTE IMD (2nd/3rd Order)	12.2%/0.98%
Vertical Tracking Angle	32 degrees
Loading Requirements	10-50ohm
Typical retail price	£995

Reviewed by Paul Miller

Vital Systems Ltd, 38a Meadow Way, Harrow Weald, Middx HA3 7BW.
Tel: (01) 863 8988.

EMPIRE BENZ MICRO MC-2

This cartridge bears more than a passing resemblance to the vdH *MC-Two* also reviewed in this issue and indeed both are sourced from Empire in Switzerland. The *Benz MC-2* is a lower output device but is also distinguished by its top-plate (with threaded lugs) and six reinforcing screws picked out in matt black. The remainder of the alloy body is anodised a rich gold colour.

The 0.27mm diameter boron cantilever is the same as that employed in the Empire *MC1000* and vdH *MC-Two* but the micro-edge stylus is particular to the *Benz* derivative, despite it being very close to the vdH1 profile. Empire has used a neodymium-iron magnet in the *MC-2*'s generator to boost its output to around 0.44mV though the compliance of the cartridge remains fairly high, suggesting it should be used with low/medium effective mass tonearms.

LAB REPORT

This cartridge is phase inverting and failed to track some 10µm off the top 80µm band with a downforce of 1.8g. A higher downforce did not improve its tracking prowess but did compromise sound quality, perhaps as a result of increasing the already high 26 degree VTA. THD hovered between 0.6 per cent - 1.4 per cent across the mid and treble and while a lateral misalignment resulted in

a high 10.6 per cent 2nd order SMPTE IMD, it was symmetrical about the sum and difference sidebands.

SOUND QUALITY

Bearing in mind the common heritage shared by both the vdH *MC-Two* and Empire *Benz Micro MC-2*, I wasn't surprised by the delicately detailed and wonderfully transparent 'family sound' shared by both models. The vdH was the lighter, more open and freer of the two but the *Benz* enjoyed a richer and warmer bass. Treble sounds were nicely differentiated without sounding bright or clinical just as well-recorded vocals possessed a realistic diction and stereo presence. The *Benz* seemed less able to recreate the width and depth achieved by the vdH though, in general terms, it was smoother and sweeter in tone.

CONCLUSIONS

If the lower output of this cartridge poses little inconvenience then the very measured and relaxing sound of the *Benz* may prove just the ticket. A trace of extra verve and treble sparkle would make all the difference for my tastes. However, the *MC-2* clearly warrants a Recommendation.

TEST RESULTS

Type, body mass	Low o/p moving coil, 7.5g
Stylus type	Micro-Edge, 3x80µm
Compliance, vert/lat	21.4cu/21.4cu
Tracking Force Range/Test	1.6-2.0g/1.8g
Tracking ability, L/R	70µm/68µm
LF res, Vert/Lat	8Hz @ 10dB/8Hz @ 12dB
Output (1kHz, 5cm/sec, L/R)	437.0µV/437.0µV
Channel sep, L/R, 100Hz	23.0dB/24.0dB
3kHz	34.7dB/32.7dB
10kHz	27.5dB/24.9dB
Channel balance	0dB
Coil resistance	20.4ohm
Frequency dev 20Hz-20kHz	+1.3dB/-1.4dB
THD (300Hz, 1kHz)	0.54%, 1.02%
HF Distortion, (10.8kHz pulsed)	0.56%
SMPTE IMD (2nd/3rd Order)	10.6%/1.3%
Vertical Tracking Angle	26 degrees
Loading Requirements	>10ohm
Typical retail price	£600

Reviewed by Paul Miller

Audiofreaks, 15 Linkway, Ham, Surrey TW10 7QT. Tel: (01) 948 4153.

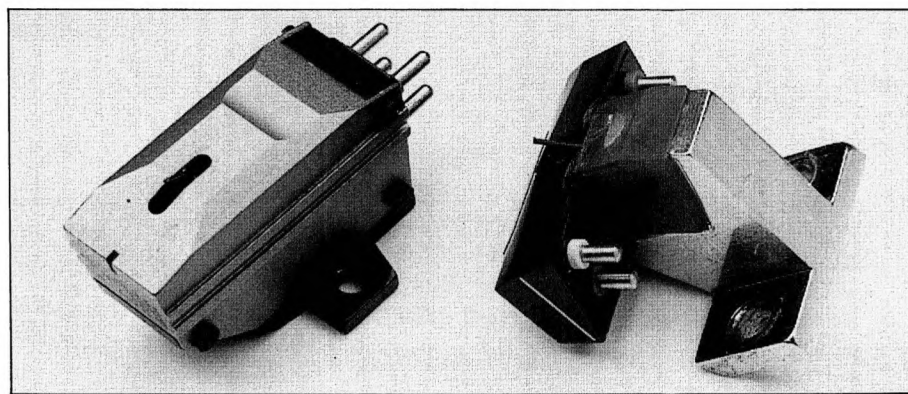

TEST RESULTS

Type, body mass
Stylus type

Low o/p moving coil, 9.5g
Trigon Parabolic, 5x35µm

VICTORIA AUDIO

3 Warwick Way
Victoria
London SW1



Tel: 01-630 9444
9.30am-6.30pm
Mon.-Sat.

**MAIL ORDER
FREE CARRIAGE
Anywhere in the U.K.**

ARISTON
Q DECK.....£139.00
ICOM.....£199.00

**AUDITION
THE NEW
'AVALON' TURNTABLE**
*The "Rock" Reference
Cube 1*

**NVA
HEYBROOK**

Denon
Rotel
Oracle
Jeff Rowland
Infinity
Sennheiser
Gale
Conrad Johnson

BOSE

101.....£139
205.....£199
301.....£269
401.....£399
AM5 Black.....£499
AM5 White.....£499

901 on special offer -
Free Sansui CDX 701



STOCKIST OF:

ALPHASON, AUDIO TECHNICA, A&R CAMBRIDGE, ARISTON, BOSE, B&W, BEYER,
CASTLE, DYNAVECTOR, ELITE, FOUNDATION, HARMAN KARDON, JBL, KUZMA,
MANTICORE MANTRA, NAKAMICHI, ONKYO, QED, TARGET, TOWNSHEND, VAN DEN HUL
and SME and CAMBRIDGE AUDIO

★ **SINGLE SPEAKER DEM ROOM** ★

Aylesbury Hi-Fidelity



The real Hi-Fi specialists in Buckinghamshire

MONITOR AUDIO MODEL R852 MDs
R352 MD/R300 MD
NOW IN STOCK.
CAMBRIDGE P40/CD2
DISC PLAYER IN STOCK
ARCAM RANGE OF
AMPS IN STOCK
ROKSAN
TURNTABLE IN
STOCK
MUSICAL
FIDELITY RANGE
OF AMPS IN
STOCK
CELESTION MODEL
3/DL4/DL6/DL8
IN STOCK

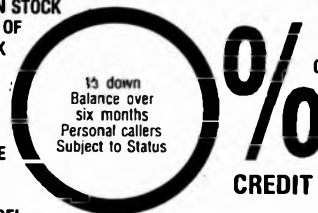

**7 DAY EXCHANGE PART EXCHANGE
HOME DEMONSTRATIONS
SERVICE FACILITIES.
EXPERT INSTALLATIONS.**

**MICHELL GYRODECK
ON DEM.**

**MARANTZ RANGE OF CD PLAYERS
IN STOCK.**

**DENON RANGE OF CD
PLAYERS IN STOCK**

**ONKYO RANGE OF
CD PLAYERS IN STOCK**

MANTICORE

**MANTRA IN STOCK
AUDIO TECHNICA**

**ATF3/ATFS/007/
OCD IN STOCK.**

**MAIL ORDER
AVAILABLE.
EXPORT SERVICES.
TURNTABLE SET
UP FACILITY**



Aiwa, AKG, Alphason, Audio Technica (CD Players also), ADC, AR, A&R, Beard, Boston, BLO, Castle, Celes, Celestion, Denon, Diecis, Dual, Exposure, Gale, Goldring, Goldring, Grado, Gyrodek, Heybrook, Harmon Kardon, KEF, Logic, Linn Arms, Monitor, Audio, Michell, Magnum, Mantra, Musical Fidelity, Meridian, Mission, Mordaunt, Short, Marantz, Monster, Myst, Nakamichi, Nagaoka, NVA, NAD, Ortofon, Paragon, Philips (CD only), P.S. Audio, Proac, Proton, Quad, QED, Rata, Rotel, Revox, Revolver, Rogers, Sennheiser, Something Solid, Sondex, Stand & Deliver, Spendor, Systemdek, Tannoy, Target, Teac, CD, Thorens, Trio, CD, Walker, Wharfedale, Yamaha, Zeta



98 Cambridge Street, Aylesbury, Bucks

HI-FI MARKETS (0296) 28790

TOP TAPE

OPEN 10am-6pm Monday-Friday, 9.30am-5.30 Saturday

The Sound Shop

Sound Advice, Sound Equipment, Sound Deals

**The Sound Shop
For:**

CHOICE HI-FI

**AIWA, A.R., ARISTON, AUDION, ALLISON, ALPHASON, B&W,
CASTLE, CELESTION, CONRAD JOHNSON, DENON, DUAL, HARMAN
KARDON, HELIUS, INCATECH, JPW, KUZMA, KENWOOD, LYNX,
MARANTZ, MONITOR AUDIO, MUSICAL FIDELITY, NAD, NAKAMICHI,
NVA, ONKYO, ORELL, PIONEER, PORTON, QED, REVOX, RUARK,
REVOLVER, SD ACOUSTICS, SYSTEMDEK, STAND DESIGN, TANNOY,
THATS, THORENS, TOWNSHEND, VECTOR, VAN DEN HULL,
WHARFEDALE, MONSTER.**

**58 THE BROADWAY,
MILL HILL,
LONDON NW7 3TE
Tel: 906-3364/3680**

GOLDRING EXCEL & KOETSU BLACK S

Craftsman built, the Goldring *Excel* is an aesthetic delight with its gold-anodised alloy body fronted by a richly textured strip of hardwood. Looking very much like an Audio Note cartridge, rigidity has played an important part in *Excel*'s design and conception, from the two ribbed alloy side cheeks which not only clamp the main generator in place but also ensure the all-important link with the headshell, via two threaded lugs. A powerful ferromagnetic magnet, proprietary pole-shoe and fine silver coil armature windings help develop a beefy 0.45mV+ output from a source impedance of just 7.6ohms – a feat indeed! This luxurious package is completed with an exquisitely finished VdH 1 diamond, a prerequisite at this price.

LAB REPORT

THD was principally 2nd harmonic at LF but the spectrum was more extended at higher frequencies. Tracking was acceptable, separation good but channel balance poor with a 1dB error between channels. More importantly a very sharp drop in vertical distortion at 22 degrees indicates the *Excel* will be extremely sensitive to VTA adjustment, and accurate lateral imaging is sure to depend on this.

SOUND QUALITY

As predicted, it was singularly sensitive to alignment. Both tracking force and VTA, though inextricably linked, proved critical to its tonal balance and stereo presentation. Tracking a mite over 1.7g, the *Excel* was hampered by a heavy and sluggish bass that succeeded in robbing all music of its natural zest and clarity. Backing off both the bias and tracking force freed its presentation from this obscuring warmth to reveal a delicately poised, naturally balanced and quite delightful source of music.

The edginess of metal-stringed guitars and rasp of brass was still reproduced with a slightly rose-tinted hue, and as a result the treble was not quite as pure as the Cello *Chorale* or VdH, yet it was beguiling and quite inoffensive. Driving bass lines were maintained with great aplomb, the *Excel* enjoying both the subjective speed and bone-moving slam of the elder Koetsus.

CONCLUSIONS

Though this is the most expensive cartridge Goldring has produced the price isn't unreasonable when compared to other exotic models. And the lucky few can justify the expenditure in the knowledge that the *Excel* is undoubtedly the best Goldring ever produced!

Compliance, vert/lat	20.3cu/20.3cu
Tracking Force Range/Test	1.5-2.0g/1.8g
Tracking ability, L/R	79µm/75µm
LF res, Vert/Lat	8Hz @ 12dB/8Hz @ 13dB
Output (1kHz, 5cm/sec, L/R)	507.6µV/451.6µV
Channel sep, L/R, 100Hz	22.8dB/24.6dB
3kHz	31.6dB/34.7dB
10kHz	28.5dB/27.0dB
Channel balance	1.02dB
Coil resistance	7.59ohm
Frequency dev 20Hz-20kHz	-0.1dB/+1.2dB
THD (300Hz, 1kHz)	0.48%, 1.02%
HF Distortion, (10.8kHz pulsed)	0.38%
SMPTE IMD (2nd/3rd Order)	6.3%/2.9%
Vertical Tracking Angle	22 degrees
Loading Requirements	100ohm/<500pf
Typical retail price	£500

Reviewed by Paul Miller
Goldring Ltd, 8 Greyfriars Road, Bury St. Edmunds, Suffolk IP32 7DX.
Tel: (0284) 701101.

KOETSU BLACK S

Launched without the usual blaze of publicity that accompanies the release of a new Koetsu, the *Black's* latest S version looks to be a very slick and professional product. Built by contractor in Japan the *Black S* still features the familiar *Black K's* shortened matt-black alloy body with gold coachlines but now includes a gold baseplate, bringing it into line with the costlier *Red's*. Koetsu has finally appreciated the exceptional rigidity of the *Black's* alloy body, and equipped the mounting flanges with reinforced lugs, similar to those on the *Red Signature*.

LAB REPORT

A pre run-in sample demonstrated an uptilted response, fairly flat to 1kHz it fell 0.7dB at 5kHz but rose +0.6dB at 10kHz, +4.6dB at 20kHz and peaked +6.7dB at 27.5kHz. Stereo separation hovered between 24-28dB to 2kHz but improved by 5dB till 16kHz where it deteriorated following a cantilever resonance. Suited to medium to heavy arms, the *Black S* managed a healthy 0.4mV output with only a 5ohm coil resistance. It was not terribly critical of VTA, vertical distortion seemingly fairly high as a matter of course.

SOUND QUALITY

If the earlier *Black K's* sound could be described as big 'n' beefy then by comparison the *Black S* sounded cool, fast and unerringly confident. This is an exciting cartridge that captures the drama and pizzazz of a musical performance without sounding, well, too over-the-top! It's brighter and sharper of focus than the older *Black*, though by addressing an alternative balance it's not necessarily going to sound 'better' in all systems. Indeed I noticed a trace of extra sibilance with some vocal material.

This is a polished Koetsu: less euphonic and more obviously accurate it builds a deep and forward-sounding stage populated with vital, energetic images of performers and instruments alike.

CONCLUSIONS

This OEM-sourced Koetsu has been conceived for the modern audiophile, successfully blending the speed and articulation of a good CD player with the relaxing sweetness offered by the best analogue sources. A Koetsu for the '90s!

TEST RESULTS

Type, body mass	Low o/p moving coil, 9.5g
Stylus type	Swept elliptical
Compliance, vert/lat	10.2cu/10.2cu
Tracking Force Range/Test	1.9-2.2g/2.0g
Tracking ability, L/R	71µm/79µm
LF res, Vert/Lat	11Hz @ 13dB/11Hz @ 18dB
Output (1kHz, 5cm/sec, L/R)	414.5µV/391.7µV
Channel sep, L/R, 100Hz	22.4dB/24.9dB
3kHz	28.7dB/24.8dB
10kHz	27.8dB/26.5dB
Channel balance	0.49dB
Coil resistance	5.02ohm
Frequency dev 20Hz-20kHz	-0.7dB/+4.6dB
THD (300Hz, 1kHz)	0.64%, 1.2%
HF Distortion, (10.8kHz pulsed)	0.41%
SMPTE IMD (2nd/3rd Order)	9.0%/0.67%
Vertical Tracking Angle	25 degrees
Loading Requirements	>10ohm
Typical retail price	£599

Reviewed by Paul Miller
Absolute Sounds Ltd, 318 Worple Road, London SW20 8QU.
Tel: (01) 947 8160.

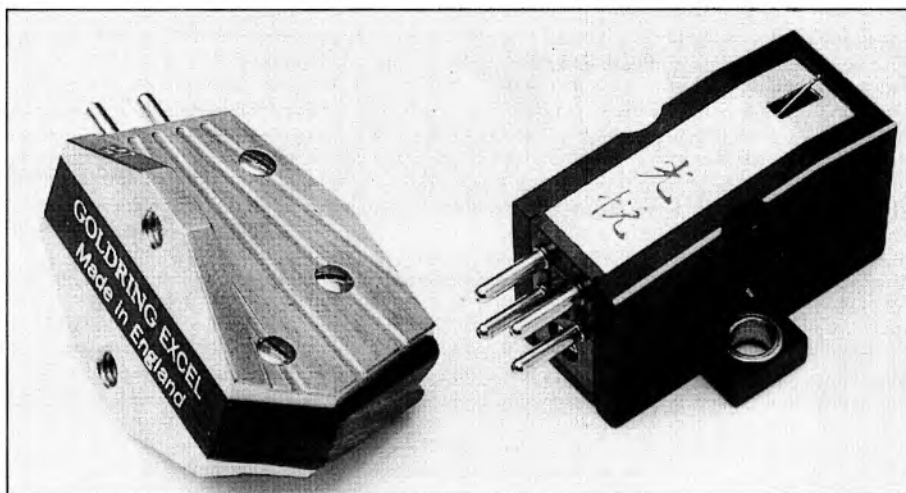

TEST RESULTS

Type, body mass	Low o/p moving coil, 8.5g
Stylus type	vanden Hul 1, 3.5x85µm

OGNI PIACER PIÙ GRATO

*A little rebellion
now
then you are in
for a surprise*

**ARCICI STANDS
GOLD AERO VALVES
GNP LOUDSPEAKERS
LECTRON AMPLIFIERS**

imported and distributed in the U.K. by

E L E C T R O A C T I V I T Y
shamint limited

#5, 11 MUSWELL AVENUE LONDON N10 2EB TELEFAX: 01 365 3614

PHILIPS CD VIDEO THE MOST ADVANCED CD PLAYER YOU CAN BUY

- ▶ Superb CD sound + pictures
- ▶ Fully remote controlled
- ▶ CDV 475 Plays all CD audio discs + 5", 8", & 12" CD video discs

Philips CD Video
Players available from:

KAMLA ELECTRONICS
251 TOTTENHAM COURT ROAD, LONDON W1P 9AD
TELEPHONE: 01-323 2747 (4 Lines)



HARP
ELECTRONICS LTD



237 TOTTENHAM COURT ROAD, LONDON W1. TEL: 01-436 4511/2. TELEX: 27768 MASON G
ACCOUNTS PHONE No. 01-436 7563

NOW YOU CAN SEE THE MUSIC

PHILIPS

PHILIPS

KRELL KC-100 &

VAN DEN HUL MC TWO

Apparently commissioned as an individual design from the same Far Eastern plant as the Cello *Chorale*, the Krell *KC-100* does at least come complete with some unique packaging. Held together with the same gold-plated screws that Krell uses for its huge Class A amplifiers, the *KC-100*'s box has to be seen to be believed! The cartridge is equally massive in construction and its milled alloy body is also better damped than the thinner case used for the *Chorale*. However, the recessed mounting lugs, crimped alloy cantilever and standard elliptical tip seem pretty much identical.

LAB REPORT

In common with the *Chorale* the Krell *KC-100* is phase inverting, offers a moderate 0.3mV output (at 5cm/sec) from a low impedance generator and is rather too compliant/under-damped for universal compatibility. Lower-medium effective mass arms are best suited for use with the *KC-100*. Both lateral and vertical misalignments were reflected in the high 14.8 per cent SMPTE IMD and 29 degree VTA while midband separation figures of around 28dB could also stand improvement. This MC's frequency response proved to be distinctly 'bright' for although it appeared flat to 10kHz the output had risen by +2.7dB at 20kHz followed by an abrupt peak of +8.3dB at 43.4kHz. Once again, any spurious ultrasonic noise could well upset the MC input of certain amplifiers.

SOUND QUALITY

Trading the mellow sweetness of 'traditional' moving coil designs for a slightly leaner but very open and 'airy' sound, the Krell *KC-100* was quite unruffled by complex musical passages. So, though the cartridge was by no means perfect - particularly in its resolution of punchy bass lines - it did offer a reliable consistency of sound almost regardless of the music in question. Vocals were usually expressive and pleasantly uncompressed while the most delicate percussion was revealed with a realistic, tremulous air.

CONCLUSIONS

It's difficult to justify the extra expenditure demanded of the *KC-100* simply in terms of better build quality, if only because the salient design features of this idiosyncratic MC are also shared by the Cello *Chorale*. It's for Krell fans who like their treble smooth but extremely detailed.

TEST RESULTS

Type, body mass	Low o/p moving coil, 13.5g
Stylus type	Extended elliptical
Compliance, vert/lat	16.1cu/28.7cu
Tracking Force Range/Test	1.7-1.9g/1.8g
Tracking ability, L/R	71µm/73µm
LF res, Vert/Lat	8Hz @ 12dB/6Hz @ 18dB
Output (1kHz, 5cm/sec, L/R)	313.3µV/293.4µV
Channel sep, L/R, 100Hz	25.4dB/25.9dB

3kHz	30.7dB/31.5dB
10kHz	27.8dB/28.6dB
Channel balance	0.58dB
Coil resistance	4.12ohm
Frequency dev 20Hz-20kHz	-0.6dB/+2.7dB
THD (300Hz, 1kHz)	0.97%, 1.58%
HF Distortion, (10.8kHz pulsed)	0.30%
SMPTE IMD (2nd/3rd Order)	14.8%/1.58%
Vertical Tracking Angle	29 degrees
Loading Requirements	>10ohm
Typical retail price	£700

Reviewed by Paul Miller

Absolute Sounds Ltd, 318 Worple Road, London SW20 8QU.
Tel: (01) 947 8160.

VAN DEN HUL MC-TWO

With the demise of Automation Sciences the distribution of van den Hul cartridges met with something of a brief hiatus in this country. Now under the protective gaze of Viper Ltd, an up-dated range of vdH MC's has been made available. Numbered amongst these are the popular *MC10* and *MC-One*, the latter subject to further revision in the form of a high output clone known as *MC-Two*. Externally, the *Two* can only be distinguished by the pink anodising, for the alloy body shell and threaded mounting lugs are identical to the Empire *Benz MC-2* and *MC1000*.

Remarkably, the extra coils added to the *MC-Two*'s armature have increased the source resistance to just 81ohm while the gain in output is measured at some 14dB - sufficient to preclude an entire amplifier stage. Otherwise the *MC-Two* is typical of all vdH/Empire stock, featuring a rigid boron cantilever and extended vdH *I* stylus profile.

LAB REPORT

With a 5cm/sec output of some 2.6mV the *Two* will happily drive any 47kohm moving magnet disc input without incurring too much of a penalty in noise or gain. Mechanically the cartridge was less impressive, particularly its asymmetric compliance and uneven tracking prowess. By contrast the Stylus's narrow profile ensured that tracing distortion was kept to within sensible limits, indeed THD was <1 per cent throughout the midband. Stereo separation and channel balance were all fine while, perhaps more

importantly, the cartridge was less influenced by ultrasonic resonances.

SOUND QUALITY

Given time to settle in this cartridge is perfectly capable of providing a very neutral and transparent performance. It combines just the right degree of treble sparkle with a taut and rhythmically secure bass. The remarkably tactile and yet ethereal nature of the earlier *MC-10/MC-One* is also embodied in this high output MC, guaranteeing that the most precious mid and treble details will be faithfully preserved. In no way did I find it sounding clinical or synthetic, simply very well integrated, fluid and musical. And the worry over noisy MC stages is a thing of the past!

CONCLUSIONS

The uninformed, or plain stubborn, may always contend that a high output moving coil will always represent some sort of subjective compromise. Perhaps the *MC-Two* is simply an exception that proves the rule: either way it has seen sterling service used for auditioning amplifiers in *Choice* and comes highly Recommended.

TEST RESULTS

Type, body mass	High o/p moving coil, 7.5g
Stylus type	van den Hul 1, 3.5x85µm
Compliance, vert/lat	16.9cu/27.9cu
Tracking Force Range/Test	1.4-1.7g/1.6g
Tracking ability, L/R	79µm/68µm
LF res, Vert/Lat	9Hz @ 10dB/7Hz @ 12dB
Output (1kHz, 5cm/sec, L/R)	2.67mV/2.54mV
Channel sep, L/R, 100Hz	28.4dB/26.1dB
3kHz	36.5dB/31.0dB
10kHz	32.7dB/29.7dB
Channel balance	0.45dB
Coil resistance	81.1ohm
Frequency dev 20Hz-20kHz	+1.2dB/-1.3dB
THD (300Hz, 1kHz)	0.54%, 0.91%
HF Distortion, (10.8kHz pulsed)	0.41%
SMPTE IMD (2nd/3rd Order)	7.71%/2.12%
Vertical Tracking Angle	26 degrees
Loading Requirements	200ohm-47kohm
Typical retail price	£799

Reviewed by Paul Miller

Viper, PO Box 13, London E18 1EG. Tel: (0268) 590788.

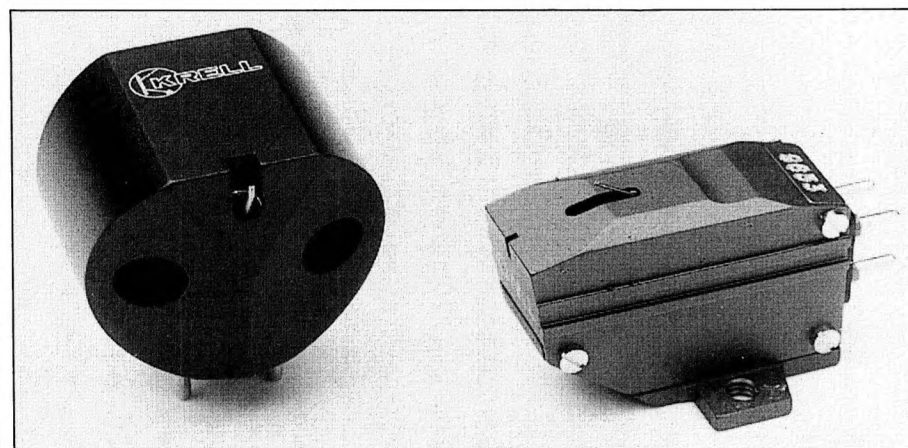

MISSION IN CHESHIRE

ELECTRONICS

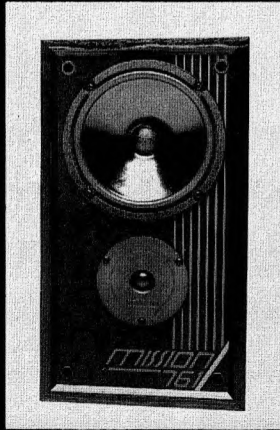

MISSION 761



MISSION 762



MISSION 763



MISSION 764

THE COMPLETE NEW MISSION RANGE IS IN STOCK AND ON DEMONSTRATION

We are also stockists for: MUSICAL FIDELITY, ALLISON, TARGET, AR, AIWA, ARCAM, AUDIOLAB, B&W, CELESTION, DENON, HEYBROOK, KENWOOD, MARANTZ, MONITOR AUDIO, MORDAUNT SHORT, NAD, PIONEER, OED, ROTEL, TANNOY.

★ FREE INSTALLATION ★ 2 YEAR GUARANTEE ON ALL HI-FI ★ FREE EASY PARKING



SWIFT OF WILMSLOW

St. Anns Parade, Parsonage Green, Wilmslow, Cheshire.
Telephone: 0625 526213

BADA
THE ULTIMATE IN
SOUND ADVICE

Bill Hutchinson

HI-FI, AUDIO & C.D. Centre

★ Sales ★ Service ★

ROTEL KENWOOD

marantz Technics

ARISTON Dual KFF AIWA

DENON **TANNOY** JVC

Mordaunt-Short **AR** PIONEER
YAMAHA ACOUSTIC RESEARCH MISSION

*Leading loudspeakers. Plus
all leading brands. Our aim is to provide the
highest level of service and value available in
Scotland*

43 SOUTH CLERK ST EDINBURGH

031 667 2877

43 HOPE ST GLASGOW

041 248 2857



NO 1 FOR
SERVICE
AND VALUE



**...Lend me
your ears...
and you'll hear music like
you've never heard it before.**

We are probably the only specialist Hi-Fi Dealers who record as well as listen to live music. With this expertise we can recommend equipment from the following manufacturers:-

Audio Innovations, Audionote, Audion, Ariston, B.L.O., Beyer, Decca, Denon, Foundations, Goldring, Helius, Jecklin-Float, JPW, JBL, Marantz, Nagaoka, Nakamichi, Ortofon, Pink Triangle, Pirates, QED, Revox, Rotel, The Rock, Sennheiser, Snell, Sony, Sugden, Suma, Supra, Systemdek, Torlyte Platforms, Target, Valdi, VOYD.

Audio South

"Professional record cleaning service now available"
Ex-Demonstration and Second Hand equipment available -
ring for details

5 Mead Lane, Farnham, Surrey GU9 7DY
Tel: (0252) 714555



Open Monday to Saturday 10-6 pm
Demonstrations by Appointment



Weighing in at a hefty 17kg this new top-of-the-range player from Denon also features its so-called 'Real 20-bit Super Linear Converter' together with a proprietary 8x oversampling filter. The beautifully finished casework comprises a laminate of alloy, steel and a visco-elastic polymer, while the disc mechanism is fashioned from an inert Bulk Moulding Compound (BMC). Standard track skip and fast music search transport facilities are provided and the comprehensive fluorescent display (with 20 track music calendar) can be disabled in two steps to reduce RF interference.

The lower half of the fascia withdraws to reveal a (motorised) variable output pot, digital output switches, index skip and a 0-9/+10 digit direct access keypad. Denon's *RC-213* IR remote adds single and all-repeat, auto space and auto edit functions to the list. Another excellent facility allows both the start and stop points of a selection to be specified in minutes and seconds.

Inside Denon has used two separate *PCM64P* 18-bit D/A converters (one per channel) together with an additional 2LSBs provided by discrete, peripheral circuitry. These simply define the final amplitude of the reconstructed waveform but any remaining mismatch between the respective current levels (due to misalignment or thermal drift) could result in non-monotonic conversion.

In theory, reconstructing a 16-bit (audio) data stream using the uppermost bits of a 20-bit DAC should improve the resolution of low-level details, a process further enhanced by Denon's use of external compensation for the four MSBs. Four adjustable presets are included for this purpose, ensuring that the machine is calibrated for least distortion and excellent linearity at and around the 16th bit.

LAB REPORT

In practice an amplitude linearity of 15.6-bits was implied by the positive error of +2.4dB at -90dB. As a result low level (-90dB) signals would emerge at 87.3µV instead of 66.1µV relative to the peak output of 2.09V.

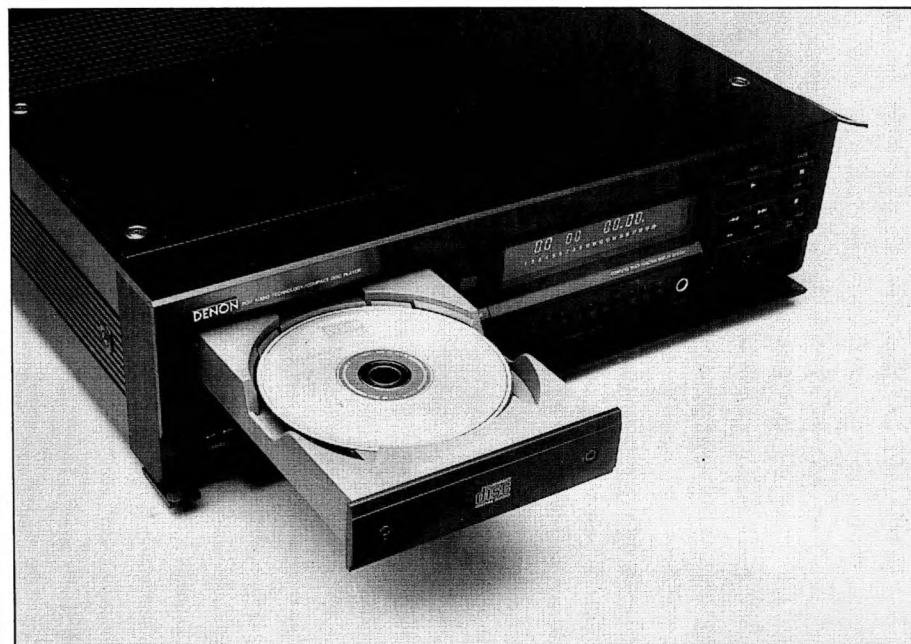

DENON DCD-3520

With subsequent adjustments the *DCD-3520* achieved a true 16-bit linearity with only a minute 0.02dB error at -90dB while distortion (-90dB, dithered) decreased from 8.2 per cent to 5.1 per cent. At 0dB THD was typically 0.002 per cent throughout the mid-band but increased to 0.046 per cent at 20kHz (CCIR IMD = 0.051 per cent) due to open-loop non-linearities in the integrating op-amp. The cheaper *DCD-1520* suffers from exactly the same problem.

Stereo separation bettered 100dB across the midband but the level of THD on the crosstalk channel usually approached 84 per cent. The exceptionally low noise of -117.4dB proved independent of de-emphasis and, in terms of S/N alone, is indicative of a 19-bit system. Aside from this the right channel produced around 10mV of RF noise centred on 38.5MHz, increasing to 25mV once the digital outputs were switched on.

SOUND QUALITY

Compared to the fine detail resolution demonstrated throughout the low bass and high treble, the *3520's* presentation of mid-band detail was just slightly softer and less prominent. However, it proved hard not to appreciate the player's excellent vocal diction and stability, the images of performers and instruments alike were both precise and sharply honed. There was an

analogue-like richness to the sound of many discs, almost as if the bright edges of sound recordings had been craftily ameliorated without compromising the inherent clarity and harmonic purity of the music.

Rather than being forcefully ejected the music drifted across in a carefree but controlled manner, a quality that made for many hours of comfortable listening. Other players will sound sharper, more immediate and perhaps more impressive in the 'hi-fi' sense but in the long term the *DCD-3520* is likely to possess a winning edge.

CONCLUSIONS

The *3520* offers a slightly fuller and richer sound than the cheaper *1520*, together with an exemplary quality of construction. However, at double the retail price it is clearly less competitive, even bearing in mind the subtle improvements in sound quality. Furthermore the ultimate quality of both players is very dependent on the adjusted accuracy of the MSB current trim pots. So, by introducing this variable into the equation the *DCD-3520* can only warrant a qualified Recommendation.

TEST RESULTS

	20Hz	1kHz	20kHz
Channel Balance	0.02dB	0.02dB	0.13dB
Channel Separation	119.5dB	104.1dB	81.3dB
L/R Phase Error at 10kHz			0°
at 20kHz			0°
De-emphasis Accuracy, 1kHz			0.0dB
5kHz			-0.05dB
16kHz			-0.16dB
S/N Ratio (A-wtd), w/o emp			117.4dB
w emp			117.4dB
THD (at 1kHz, L/R), 0dB			-93.7dB
-10dB			-85.7dB
-30dB			-70.8dB
-60dB			-43.8dB
-90dB			-12.1dB
Dithered -90dB			-21.7dB
CCIR IMD, 0dB			-65.9dB
SMPTE IMD, 50Hz/7kHz			-82.7dB
400Hz/7kHz			< -85dB
Suppression of stop-band IMD			-87.3dB
Resolution at -30dB			+0.01dB
-40dB			+0.03dB
-50dB			+0.07dB
-60dB			+0.18dB
-70dB			+0.41dB
-80dB			+1.13dB
L/R -90dB			+2.42dB
Peak Output Level, L			2.086V
R			2.090V
Output Impedance			295.7ohm
Track Access Time (99)			7.5 secs
Typical Retail Price			£1,000

Reviewed by Paul Miller

Hayden Labs Ltd, Hayden House, Chiltern Hill, Chalfont St. Peter, Bucks SL9 9EW. Tel: (0753) 888447.

The Marantz *CD12* is a two-box player; one unit contains the CD player transport and associated disc operating circuitry and controls, the other houses the digital processor. The styling is rather reminiscent of the *CD94/CDA94* units, but the *CD12* is finished in a fine champagne gold with a pink tinge.

Both chassis use thick copper-plated die-castings. Alloy extrusions make up the exterior and both units share the same dimensions and styling. Visible on the front panel of the player section are play/stop, track skip, open/close and power on/off buttons. The Perspex display window is the same size on both – on the convertor it shows what input is in use and at what sampling frequency it's operating. A flip down cover runs along the length of the machine and may expose the variable headphone socket and output selector rotary controls, covering the digital tape monitoring facilities. The back panel has balanced 600ohm Canon and standard phono socket analogue outputs. For

digital there are two coaxial inputs, two optical inputs, and digital tape monitoring connections – coaxial in/out and optical in/out.

Flipping down the matching front hinged panel on the other unit reveals a row of ten small round gold-plated track selector buttons, the standard track and index search, FTS, time display button, A-B repeat and pause. The standard Marantz programming facilities are also available. The display is the same as on the *CD85*, with a small 24-track calendar display, track and index numbers, several time modes, plus the normal flags confirming various operational states.

The processor has no fewer than three separate power transformers feeding the various analogue, digital and display sections. Each area is divided off from the others by copper-plated metal boxed sections. Even the outputs at the back have a copper plated cover. Digital acquisition and lock is improved by the addition of an extra phase lock loop (now two) to keep down the jitter rate. The audio power supply uses selected Elna supply caps of 6800 μ F capacity and

Cerafine audiophile electrolytics are found all over the board in coupling and decoupling applications.

The digital-to-analogue conversion path is a *TDA7220P/B* digital filter followed by an *SI* selected *TDA1541A* DAC. High grade film caps are used for current decoupling and the filter circuits use copper foil polystyrene types. Balanced 600ohm output is provided by transformer coupling.

The remote control handset is a bulky affair finished in the same pinky gold. It covers a whole entertainment system, not just the CD player, so some of the features are redundant in this context. Suffice it to say that the front controls are available here; an LCD display which automatically switches off when not in use is built in to help with operation.

The player section has virtually the same construction and uses a predominantly alloy transport mechanism which is smooth in operation. The interior has the various sections screened from each other by copper plated metal. There is only one transformer,



but extra care has been taken over the power supplies. Two coaxial digital outputs are provided along with one standard optical connection. Everything is held together by the familiar copper-plated screws.

Finally, the *CD12* comes with a bulky 'intelligent' remote control handset which can be programmed to control a whole entertainment system, not just the CD player.

LAB REPORT

Almost every test was passed without trouble and the *12LE* produced a generally excellent set of results. Points of note include the exceedingly good intermodulation distortion results, signal-to-noise ratio and ultrasonic spurious suppression. Error correction could have been better, but the 1mm capability shouldn't produce any problems. Stereo separation was exceptional at high frequencies but less good (though perfectly acceptable) at lower frequencies, which is the converse of most players. Low level linearity was very good right down to the noise floor below -110dB.



MARANTZ CD-12LE

SOUND QUALITY

This is the best Marantz I have yet heard, which must place it well up in the top ten of currently available players. The familiar high class Marantz sound found in the best of cheaper units is refined in every area, delivering more of everything wanted. Considering the price differentials involved, this refinement hasn't produced as large a change as might have been expected, and the law of diminishing returns is obviously at work. Compared to a *CD75/11SE*, the bass is just a little more tactile and agile, the mid develops detail and etches out the soundstage more cleanly with more precise edges and more authority. The treble is cleaner, more delicate, less grainy and just slightly more detailed.

The sound is more solid, losing some of the characteristic brashness of the cheaper models and underpinning every performance with authority, controlled articulation and weight. The total balance is excellent, not highlighting nor tempering any particular aspect of the fundamental neutrality. The soundstage is large in every dimension, creating realistic perspectives. Transparency is first rate and images are well formed right out to the edges and back of the stage.

When compared directly with the Sony *R1*, the *12LE* was found less good in the areas of treble and midrange focus precision and dimensionality, but it also put in the more balanced performance of the two.

CONCLUSIONS

This player is expensive and fairly large. It doesn't easily blend in with the majority of systems either, as the finish is designed to draw attention to itself. However, technical and sonic performance place it indisputably at the top of the exceptional Marantz range. Although well worth consideration, whether it's worth so much more than some of its cheaper family members will require some contemplation on the part of the prospective purchaser.

TEST RESULTS

Test resolution (L/R av)		15.9 bits	
Output level, source impedance		2.07V, 0.30dB, 58ohms	
Effective dynamic range		105dB	
Harmonic distortion	20Hz	1kHz	20kHz
Ref 0dB	-94dB (0.002%)	-88dB (0.004%)	-93dB (0.0022%)
Ref -70dB			-34.5dB
Stereo separation	102dB	110dB	122dB
Stereo balance L/R	0.01dB	0.02dB	0.03dB
Frequency response (20Hz to 20kHz)			±0.03dB
High frequency intermodulation			-106dB (0.0005%)
Electrical noise (CCIR ARM, 1kHz)			-112dB
Mechanical noise			very low
Ultrasonic noise			-109dB
Error correction			1mm gap
Shock/vibration resistance			excellent
De-emphasis			+0.04dB at 5kHz
Track finding speed (15, YEDS 2)			3 secs
White noise overload test			OK
Size (w x d x h)			45.5 x 35.0 x 10.1cms
Typical price inc VAT			£2500

First reviewed in issue No. 70 by Chris Bryant
Marantz Audio (UK) Ltd., 15-16 Saxon Way Ind. Est., Moor Lane,
Harmondsworth, Middx UB7 0LW. Tel: (01) 897 6633.

TEAC

Quality Comes As Standard



V-670 Stereo Cassette Deck



PD-470 Compact Disc Player

Outstanding sound quality –
that's what you get as standard with TEAC.
Two new models from TEAC come with even more of that quality.

The V-670 is a 3-head Cassette Deck which, with adjustable bias, guarantees optimum recording quality with all tapes. Dolby B and C with HX Pro reduces noise to a minimum with extended dynamics.

When it comes to Compact Disc players, the PD-470 offers more than most. 16 bit A/D converters with 4 times oversampling provide an exceptional clarity of sound. Comprehensive controls allow up to 20 selections to be programmed, with a remote control to put that operational variety at your fingertips.

Check out TEAC Sound Quality today
and hear what comes as standard.

TEAC®

TEAC UK Limited, 5 Marlin House, The Croxley Centre, Watford, Herts. WD1 8YA
Telephone 0923 225235

Y

es, we know that the Meridian 207 has been around for quite a while now and that *Choice* reviewed it in issue 66. However, having recently heard a new sample I suggested that the model required an updated review and that its position in the market made it *Collection* fodder.

Not only is it a CD player, but it's also a versatile line preamplifier and for a small extra cost can be equipped with plug-in cards to facilitate a disc input. The modular Meridian approach has spawned one of the most distinctive and best looking players on the market. It is a two-box design, but unlike other players which consist of a digital processor which will work with any CD transport, the Meridian is dependent on its other half. So, as it's really only a player in two boxes, it's not designed for the chop and change merchants. Also, it must be borne in mind that all its facilities, including volume, can be controlled from the remote, thus enhancing its versatility. Furthermore, it forms the heart of the new Meridian system. Matching monoblok power amplifiers and a tuner have now been joined by active (digital) loudspeakers which can be driven by the 207's digital output.

The 207 now uses a re-worked CDM-4 Philips laser transport, controlled by Meridian designed circuitry, with improved servos which have dedicated power supplies for enhanced inter-stage isolation. The disc transport is also Meridian's own design and is decoupled on Sorbothane mountings, linked to the control unit with a multiway cable.

The small and simple display is automatically switched to reveal what's happening as dictated by the user's commands. Even the function processor is unique to the device, and enhances the available facilities. The following functions can be accessed from either the front panel or the remote control: tape, aux, CD and LP (either moving magnet or moving coil gains available via on-board switches), plus there's a headphone socket mounted on the rear. The volume control has a decent 64dB range and because it uses FETs to switch discrete resistors the channel balance over the entire volume range is excellent. Finally, a neat touch, the player's phase can be changed from the remote.

In its latest incarnation the 207 uses the most recent 16 bit 4x oversampling Philips digital filter and digital to analogue convertor. This is followed by a discrete current to voltage convertor stage and passive output filtering and de-emphasis. If a phono stage is required it comes on its own board which plugs in at the back of the unit. This uses a single low noise operational amplifier around which the RIAA circuitry is placed in the feedback loop.

LAB REPORT

The full level fixed output is 2.34V which is up on the normal and comes from a 270ohm source impedance. Electrical and mechanical noise are both very low and ultrasonic spurious very well filtered.

The channel separation is asymmetric at the benchmark points of 20Hz and 1kHz, with only 64dB recorded for the left on right separation, as against 110/90dB respectively for the right on left. By 20kHz this asymmetry had disappeared. While 64dB is acceptable

MERIDIAN

207-PRO

the difference recorded shows some anomalies, perhaps of circuit layout, which the manufacturer may wish to investigate. On the other hand stereo balance was good and preserved over the entire frequency range.

Error correction is a solid 2mm for a single gap, but when asked to correct for two chunks of missing code on the same track its ability was reduced to 1.5mm. However, this should be good enough for all but badly damaged or particularly faulty discs.

The de-emphasised response on this sample showed a surprisingly high error over the whole operational range with a maximum error of 0.43dB at 5kHz though this was reduced to 0.33dB at 16kHz. It should have been more accurately set but it was near identical on both channels. Low level linearity has benefited greatly from the use of the latest chip set and is now practically error free all the way down to the noise floor.

SOUND QUALITY

I originally heard this player not knowing that any changes had been made since my last acquaintance. I admit to being a little perplexed at first as it appeared to deliver a standard of performance which I didn't remember it having. Must be my ears, I thought, but on checking it against several players of known quality my original impression was reinforced. It was better and by quite a large margin.

The treble is very clear, explicit and open. In this respect it rivals some of the very best for purity and natural tonal quality. It's devoid of sibilance, added grain or extra edginess. The midrange virtually equalled this performance with very good resolution and no accentuation or extra hardness.

Only in the bass did it fail to attain a top ranking. It's firm and articulate in so much as it can play complex passages and resolve individual strains of music, but on dynamic rock/pop material it sounds too slow. When compared with players which excel in this area this lack of pace probably means that it's more suited to classical than rock material. However, in saying that I must confirm

that even in this respect it's better than the vast majority of CD players.

Stereo imagery is wide and deep. Images are created with a special sense of realism that is only available from exceptional players. The soundstage is particularly stable which made long sessions of fatigue free listening interesting and rewarding.

The variable output isn't quite as good as the fixed one when it's used in a normal system with its own preamp. But of all the CD players I have yet heard it has the best variable output and direct connection to a power amplifier reveals its class.

CONCLUSIONS

A £1,000 price tag may seem a lot for a CD player, though it must also be remembered that you get a fully remote line amplifier thrown in, and it's only an extra £100 or so for the disc board (the sonics of which are also pretty good). It interfaces with other makes without fuss and forms the centre of the latest Meridian concept system. For the performance, style and facilities it looks something of a bargain.

TEST RESULTS

Test resolution (L/R av)	15.3 bits	
Output level, source impedance	2.34V, 1.36dB, 270ohms	
Effective dynamic range	104dB	
Harmonic distortion	20Hz	1kHz
Ref 0dB	-79dB	-79dB
	(0.011%)	(0.011%)
Ref -70dB	-36dB	-36dB
Stereo separation	64/110dB	90/64dB
Stereo balance L/R	0.12dB	0.12dB
Frequency response (20Hz to 20kHz)	±0.24dB	
High frequency intermodulation	-80dB (0.01%)	
Electronic noise (CCIR ARM, 1kHz)	-111dB	
Mechanical noise	very low	
Ultrasonic noise	-114dB	
Error correction	2mm gap	
Shock/vibration resistance	average/very good	
De-emphasis	+0.43dB at 5kHz	
Track finding speed (15, YEDS 2)	3.5 secs	
White noise overload test	OK	
Size (w x d x h)	16 x 32 x 10cm	
Typical price inc VAT	£1050	

Reviewed by Chris Bryant
Meridian Audio Ltd, Ecclestone Rd, Tovil, Maidstone,
Kent ME15 6GP. Tel: (0622) 672269.



griffin AUDIO

BIRMINGHAM

*Something
for
Spitting
Griffin!*

ROYD, MORDAUNT SHORT, ARCAM, LINN, MONITOR
AUDIO, EPOS, NAIM, MISSION, REGA, DUAL, ROTEL,
CYRUS, CREEK, NAKAMICHI, DENON, MARANTZ,
REVOX, QUAD

94 BRISTOL ST., BIRMINGHAM
692 1359, TUE-SAT 10am - 6pm

The decidedly exotic French-made Micromega players, of which there are presently four, topped by the two box *Digital*, are distributed in the UK by Linx, who also distributes van den Hul products and makes its own electronics.

The £1,400 *Classic* is one of three internally identical models, based on the Philips *CD-M4* transport mechanism. Externally they are styled to suit different tastes and the *Classic* is, I believe, one of the more conservative models in the range. However, by CD player standards it's a very distinctive machine, with a 6mm thick brass fascia and side panels of light coloured solid cherry wood. However, the most eye catching and unusual feature of the *Classic* is the large perspex lid, a 15mm thick, reddish brown tinted affair which covers the top of the machine and has a milled recess for the disc. The disc itself, which sits on top of the machine, is held by a brass puck in much the same manner as a record clamp. This puck is a hefty 50mm in diameter and 9mm thick, and without it the disc won't stay put as I found out the first and last time I forgot it!

The more familiar one becomes with the *CDF1* the more it looks like a CD player built on turntable principles. The transport controls are relatively basic as is the four digit display, the only high tech concession being a remote control but even that looks anaemic by current standards. The controls are entirely flat but they do give a reasonably tactile response and aren't as disagreeable as one might expect. They even use different labels like 'next' and 'prev' for track skipping, but most are intelligible and only the track programming requires a bit of user manual investigation. An LED display will show either the track or elapsed time with a preference for the latter.

In use it has one obvious difference to other players, in that if another track is selected whilst the disc is playing the machine doesn't immediately go to the selected track, but plays on for another couple of seconds. We understand that the only standard Philips component in this machine is the laser assembly – the transport and all the electronics are made by Micromega. One of the more interesting technical features is the use of a three-point suspension system for the laser transport. This uses rubber bushes in an attempt to isolate the mechanical part of the player much like a suspended subchassis turntable.

The *Classic* proved quite straightforward to use until the sun came out, then it stalled, bluntly refusing to play a disc! The cause turned out to be the optical disc detector which only allows the machine to operate when a disc is in place. However, strong light at the wrong angle can get underneath the disc and fool the machine. Under the majority of circumstances this is unlikely to be a problem and can be remedied with a bit of paper either over the sensor or on the lid!

The simple theme of this player continues with RCA phono output sockets which emit both digital and analogue signals, and an IEC mains lead is supplied.

SOUND QUALITY

The equipment used for this review was Audio Innovations triode amplification, Snell

MICROMEGA CDF1 CLASSIC



and Infinity loudspeakers and a Marantz *CD75IISE* CD player, with all cables by Audionote. And after a recommended 24-hour warm-up time the *Classic* was ready to roll.

My initial impression, using Berlioz *Symphonie Fantastique*, was of a player with remarkably sweet and extended treble, informative and colourful midrange and deep timbral bass. Violins retained their slightly woody feel and avoided the usual CD pitfall of sounding too fluid, whilst double basses were reproduced with good shape and depth.

Comparisons with the Marantz were very revealing, this highly rated machine sounding relatively crude next to the *Classic*. It has more time to present information and a better sense of timing, giving a lot more dynamic information, especially in the bass, in a more controlled manner. Basically it's very civilised and informative, but is still very revealing of the disc it's playing. Badly made discs (for whatever reason) become quite unlistenable at anything but low levels. One recording that really showed off the *CDF1*'s capabilities at LF was the Sheffield Labs Kodo drummers – Japanese drummers banging out primeval beats on very big drums and recorded without recourse to compression. The first beat makes you jump out of

your seat and goes down pretty low – the *Classic* managed to extract more of the dynamic range in the bass and consequently sounded deeper and revealed more timbral detail.

Another good disc proved to be a Mozart flute concerto, on the solos this instrument sounded remarkably realistic, but very high notes had a tendency to jar slightly. This may be a limitation of the (DDD) disc or it could be the player. The Marantz made the instrument sound smaller and less open but not quite so brittle, although it did get aggressive on the crescendos and was less delightful overall.

CONCLUSIONS

As a source component it doesn't compete with the better analogue alternatives. It still displays some noise at HF and doesn't have the dynamic capabilities of a well designed turntable. However, the Micromega *CDF1 Classic* is a very stylish and nicely made CD player; it is also very revealing and capable, and despite the high asking price it deserves Recommendation.

Typical price inc VAT
Reviewed by Jason Kennedy
Musical Design Company, PO Box 13, London E18 1EJ.
Tel: (0268) 590789.

£1,400

M U S I C I T H O U T B O U N D A R I E S

The Original Musical

Experience remains

bound in our soul

Surrender your pre-

conceptions about

music reproduction.

Experience

the performance.



JEFF ROWLAND
DESIGN GROUP

Exclusive United Kingdom distributor
Gamepath Ltd.
25 Heathfield
Stacey Bushes
Milton Keynes
Bucks. MK12 6HR
0908-317-707
Fax: 0908-322-704
Telex: 94016133 GAME G

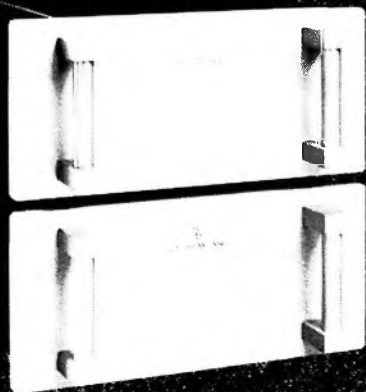

Model 7 Differential Mode™
Mono Power Amplifier

Micro Seiki is a Japanese company which only has a limited presence in the UK. Being distributed by Absolute Sounds, the *CDM-100* will be considered by many to be the only solid state digital machine worthy of inclusion in high-end systems. The styling, finish and build quality is totally extravagant and the player is immensely heavy.

The chassis is built into a traditionally crafted dark Rosewood frame which has an exceptional finish. Side panels of the same materials add extra quality. The player has a titanium grey front panel and a grey textured finish on the other metal surfaces. The chassis is a solid die-casting and even the lid is made from a cast alloy with good damping properties. Inlaid into the wood base is a gold plated, light tough on/off switch with a deep red MICRO legend etched into its surface. Unlike many modern CD players, which advertise heavily on their front panels the technical features within, the Micro is much more restrained leaving its fine styling, to tell its own story.

The loading draw glides in and out far more smoothly and silently than most, but needs an adaptor for 3-inch singles. The back panel's a little busier than most – additional balanced 600ohm cannon output sockets are provided and, unusually for a CD player, an earth terminal is included. Other facilities are high quality gold plated audio phono sockets, a coaxial digital output and a Toslink optical drive.

It sits on four rubber/hydraulic coupled vibration isolating feet which support the 22kg bulk. The reason for its immense weight is due to the quantities of lead sheet applied to the interior which are intended to damp out resonances. As a turntable manufacturer Micro Seiki knows the importance of keeping unwanted vibration away from the source, and it seems stability is as fundamental to CD sound as it is to vinyl. It uses a modified Philips transport, and control circuitry. The DAC/digital filter comes from Philips too, so it's a 4x oversampled 16-bit player. Great attention to detail has been applied to the interior with a large high quality transformer and separate regulators for each section.

The 600ohm balanced output is provided by carefully screened professional type output transformers, and indeed all sections are fully screened. Though much of the internal circuitry is similar to Philips some top grade audiophile bits have been added, including expensive Sideral polypropylene capacitors.

The plastic remote control is housed in a wooden frame just like the player itself. And the inset remote contains the full complement of controls normally associated with a top flight CD player. Key pad track and index access is prompted by pressing the required number followed by play – however, I prefer the method which gives you one (or two if track number is greater than nine) touch track access. AMS (automatic music scan) plays the first ten seconds of each track in turn and during this scan process pause and track search buttons still operate.

Continuous loop-play (A-B repeat) is included as well as normal repeat, which allows one track or the whole disc to be played repeatedly. Using the select play button in conjunction with the remote's ten-key numeric allows selection of track, index



MICRO SEIKI CD M-100

number, and the beginning point of the selection in minutes and seconds. In addition are the normal track skip, index and fast search keys. Full programming for up to 20 blocks on one disc is available – track numbers take one block, index numbers two blocks, and a selected section five blocks. There's full memory recall and memory can be accessed using the AMS function.

The fluorescent display uses light orange alpha numerics to reveal track, index and playing time, elapsed or remaining time. A 24-track calendar stretches along the bottom. Reminders are also present for recall, repeat, AMS, A-B repeat and time display mode.

LAB REPORT

The *CDM100* is loosely based on the Philips system, delivering a set of measured results which are very similar to machines from the top of that range.

The standard (unbalanced) output is exactly to the 2V industry standard from a low measured source impedance of 56ohms and absolute phase is correct. Harmonic distortion is low at full level and the down band product of a single full level 20kHz tone on the 19kHz and 20kHz intermodulation tones is well suppressed. Channel separation is constantly maintained over the entire audio spectrum at 112dB and the stereo balance is very good. The frequency response is typical of Philips players – flat, although de-emphasised responses showed a surprising error of 0.2dB at my standard check frequencies of 5kHz and 16kHz. Ultrasonic spurious are very well suppressed and in band the player is rated as having a 106dB dynamic range. Electrical and mechanical noise are both very low and resistance to shock and vibration is good. Track access time is a speedy three seconds. The fade to noise test revealed good linearity right down to below the –110dB noise floor with the worst errors occurring around –90dB. As these are only around –3dB it's little cause for complaint.

SOUND QUALITY

I auditioned the *M100* using equipment which matches the player's elevated price – namely the Pink Triangle *Pip II* preamp,

Krell *KSA 80* power amplifier, Celestion *SL700* and Apogee *Duetta Signature* loudspeakers, with silver cables used throughout.

The bass is firm and extended, but couldn't match the best in this department; it just isn't fast or agile enough. The *M100* is pretty articulate with good rhythmic integrity for a CD player, although not perhaps up to the top standards. When presented with complex, intricate bass lines it was unable to translate their structure completely coherently. The midrange is generally pleasant and clear, but given some slightly aggressive material it displays some leanness, sounding hard and thin. Detail is only good – it doesn't have the extra bit of magic that a high-end CD player should give. The treble is a touch lazy, exhibits a little grain and imprecision and doesn't reveal enough low level detail. Depth and ambience suffer as a result.

The *M100* does have a measure of transparency, but the soundstage is categorised merely as good by today's standards. It doesn't go back and lay out the performance or focus like the Sony *R1* or create the interest of the Marantz *CD12* or the Meridian *207*. Turning the display off does have a beneficial effect on sound quality, but improvement is small and not enough to change the overall ranking of the player. But it's a useful facility nonetheless.

CONCLUSIONS

This player is beautifully built and finished. Its styling is just a little idiosyncratic and your present system will determine whether it fits in or not. Facilities and lab performance are just about good enough, although by modern standards it does lack some of the more specialised facilities. Although firmly at the top of the good class, the sound quality is a little below the first division. At this price you wouldn't buy it for sound quality alone, but it's hard to quantify the merit which must be awarded for its undoubted charms.

Typical price inc VAT

Reviewed by Chris Bryant

Absolute Sounds Ltd, 318 Worple Rd, London SW20 8QU.
Tel: (01) 947 8160.

£3850

SONY

CDP-R1/DAS-R1

It's not every day that we get a £5,000 CD player to assess and, as it turns out, this one only came in for four days. The player is so interesting that writing about it could take up the space of four ordinary reviews, but for the time being a couple of pages will have to suffice.

It's a two-box player. The transport is designated *CDP-R1* and the *DAS-R1* digital processor covers three different sampling frequencies with automatic lock – 32kHz for DAT (32kHz mode) and DBS (direct broadcast satellite), 44kHz for CD, and 48kHz for DAT (standard mode). One benefit of this is that any noise and vibration interaction between the CD transport and the audio circuits is minimised.

Both units have high quality champagne finished alloy exteriors, with real walnut end caps. At the back of the *CDP* are twin link optical connectors, a coaxial digital output socket and the selector switch. The front panel has the bare minimum of facilities – open/close, play, pause, stop and track skip. Operation is best performed via the versatile remote control which has all the expected facilities (with the possible exception of a remote volume control). It has the normal functions available on the *ESD* range of players which are described in more detail in the review of the *CDP227* reviewed in issue No. 70.

The quite small display has all the required information with plenty of visual help when using the various functions. It's located under a centrally mounted loading drawer that has a super smooth action.

The *DAS-R1* has a front panel which is even simpler. There is a selector switch for three LED indicated digital sources, an orange 'on' LED, and three more to indicate the sampling frequency in use. The back panel has gold-plated line output phonos, two coaxial digital inputs and the twin optical link connector.

The signal is transferred by either a standard coaxial link or a dual optical fibre, the latter made from plastic clad silica glass with high light transmission characteristics. The dual optical fibre provides both a signal and return to ensure precise timing between the two. The crystal controlled oscillator is located in the processor section close to the DAC, and this minimises fluctuation in the phase components of the audio signal. A new servo system is fitted for high accuracy laser tracking, which minimises tracking noise.

The units are heavy and construction is immensely solid and rigid. Inside, everything is attached onto a lattice of girders. There are two rubber decoupled transformers in the player section which feed selected high value reservoir capacitors, and lots of regulators feed the digital acquisition and transport control circuitry. The processor uses

fairly standard chips for the digital side, but once again has two transformers and lavish regulated supplies for all sections.

Everything is shielded from everything else, and copper plated panels are used in both units. A Sony 8x oversampling digital filter drives a pair of dual Philips *TDA1541A* SI selected DACs, used in the same mode as in the *CDP227*; but here greater attention has been paid to the current to voltage conversion and the subsequent analogue filtering and output circuits. Fast, high precision operational amplifiers are used and the output circuits are Class A transistor stages. High quality audiophile grade film capacitors are much in evidence throughout all the circuitry.

LAB REPORT

This player didn't measure quite as perfectly as I had expected, but its performance is very good nonetheless. The full level output is higher than normal, so level matching is a must in making A-B comparisons. Stereo separation is excellent but stereo balance merely good. Total harmonic distortion figures are exceptional and the intermodulation products of the twin high frequency tones is well suppressed. Dynamic range is 107dB and both electrical noise and the audible mechanical noise was very low. Error correction is viable only up to 1.5mm, but resistance to shock and vibration is excellent. The –90dB sinewave showed some triangulation, and the spectrogram some harmonic distortion artefacts. Low level linearity is precise down to –80dB, but a positive kink in both channels causes a +3dB error at –90dB and more thereafter. The frequency response exhibits a mild treble rolloff, but the de-emphasis test reveals no error.

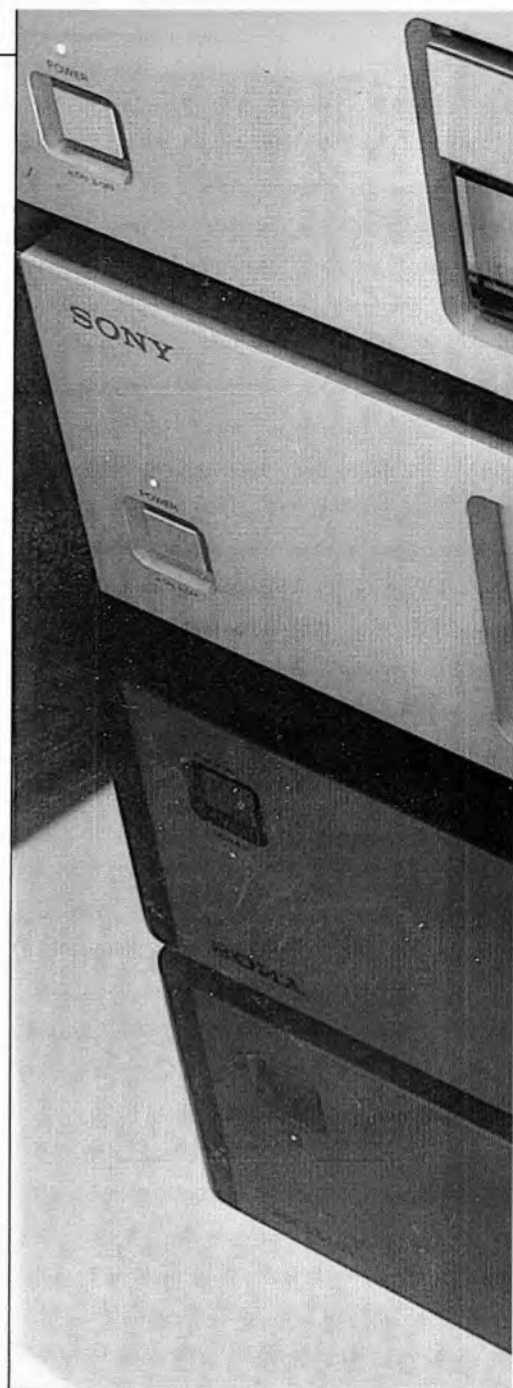

SOUND QUALITY

It's been 18 months since I heard the amazing Accuphase *DC80/DP81*, a machine unavailable in the UK but one which is sub-

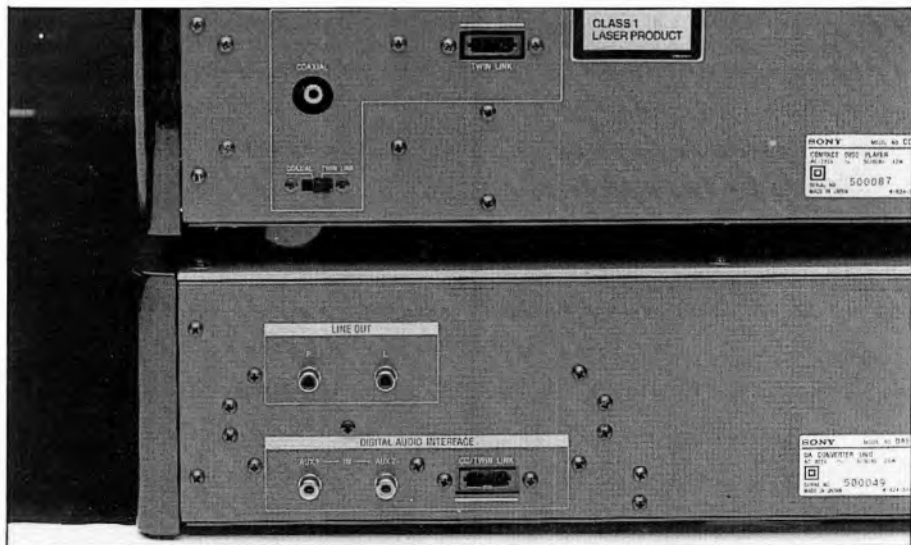



jectively yet to be beaten. The *RI*, however, goes quite some way towards achieving that milestone.

It has the most precise, detailed and natural treble I have heard from any player. Focus is nothing short of excellent, with sharp definition and shadings of texture revealed in minute detail. The bass is tight, able to produce a subtle, tactile portrayal of complex structures with excellent dynamic integrity, good extension and great speed. At first it seemed lighter in weight than ideal, but continued listening established its correctness.

Unfortunately the midrange didn't match the performance achieved in the other registers. Although this too is tightly controlled with an awesome clinical precision and ultimate clarity, it produces some upper mid tonal accentuation which put a sheen on bowed violins, and became a mite brittle on brass. The upper reaches of human voice sound hard and unnaturally tinged with an unexpected edginess, such that they lack the warmth and ease of presentation one would have expected (and some other players can deliver). When the player wasn't stressed in this area it sounded truly state of the art.

As far as the soundstage is concerned, width and depth are stunning, focus is exceptional and stereo images are precisely formed. The sound has immense scale and conveys a sense of rightness about the acoustic which surpasses lesser models – even those you thought were good can sound small in comparison. The soundstage is portrayed in the most realistic way available from any commercial CD player that has graced my system; concert orchestras are laid out on the most correct and natural perspectives.

CONCLUSIONS

If I had been allowed longer with this player I may never have finished the CD project I was working on at the time. After the panel had listened and left, I continued listening. It took great self restraint to drag myself away before I had finished reauditioning the whole of my CD collection in order to let Sony have its player back. I have listened to virtually all the CD players currently available at all price levels, and in some areas this is one of the very best. It may have its flaws, but what it did well, it did so well that it convinced me

how good CD really can be. Had the midrange been flawless it would be a difficult proposition for rich music lovers to resist.

TEST RESULTS

Test resolution (L/R av)		15.8 bits	
Output level, source impedance	2.7V, 2.6dB, 250ohms		
Effective dynamic range		107dB	
Harmonic distortion	20Hz	1kHz	20kHz
Ref 0dB	-96dB	-95dB	-95dB
	(0.0015%)	(0.0018%)	(0.0018%)
Ref -70dB			-35dB
Stereo separation	134dB	133dB	111dB
Stereo balance L/R	0.10dB	0.12dB	0.21dB
Frequency response (20Hz to 20kHz)			± 0.20dB
High frequency intermodulation			-97dB (0.0014%)
Electrical noise (CCIR ARM, 1kHz)			-11dB
Mechanical noise			very low
Ultrasonic noise			-107dB
Error correction			1.5mm gap
Shock/vibration resistance			excellent
De-emphasis			± 0dB at 5kHz
Track finding speed (15, YEDS 2)			2 secs
White noise overload test			OK
Size (w x d x h)		2 x 46.8 x 40 x 12.4cms	
Typical price inc VAT			£5000

Reviewed by Chris Bryant

Sony UK Ltd., Sony House, South Street, Staines, Middlesex.
Tel: (0784) 467000.



We have **STAX** headphones with full demo facility. Consult our expert – **Michael** or write for further information.

PRICE LIST

SR-34 (incl Energiser)	£139.95	SR-X/Mk-3 PRO	£289.95
SR-84 (incl Energiser)	£209.95	SR-LAMBDA	£289.95
SR-5N	£189.95	SR-LAMBDA PRO	£359.95
SR-GAMMA	£199.95	SR-LAMBDA SIGNATURE	£469.95
SR-GAMMA PRO	£295.95	SR-SIGMA	£459.95
SR-X/Mk-3	£229.95	SR-SIGMA PRO	£549.95

ENERGISERS

The following energisers are self biasing and require no connection to the mains. They are connected to the speaker terminals of integrated amplifiers/power amplifiers:

SRD-6SB	£99.95	SRD-7 Mk-2 SB	£184.95
---------------	--------	---------------------	---------

The following energisers are connected to the mains and run from any line level source, i.e. Pre amp output, Tape Monitor output, CD Player, Tape Deck or Tuner:

SRD-X PRO	£229.95	SRM-I Mk-2 PRO Direct Coupled	
SRM-I Mk-2 Direct Coupled		Mos-Fet Output	£635.00
Mos-Fet Output	£550.00	SRM-T1 Direct Coupled	
		Vacuum Tube Output	£895.00

EXTENSION CABLES

SRE-15N	£34.95	SRE 16 for high quality Pro	£62.50
---------------	--------	-----------------------------------	--------

p&p free within U.K. Overseas p&p £5-00

HI-FI CARE RETAIL LTD

**DEPT HIC 7,
7/245 TOTTENHAM COURT ROAD
LONDON W1P 9DP**

(MICHAEL) 01-637-0371 — 01-637 8911

**SRM-II & LAMBDA SIGNATURE
AVAILABLE FROM STOCK NOW**

**REAL HI-FI
HATCHES IN
HAVANT.**

For further information or to book a demonstration, ring us on the number below. Alternatively, visit our newly refurbished shop for helpful, professional advice.



THE HI-FI SPECIALISTS
27, Market Parade, Havant
Hampshire. PO9 1PY
Tel: (0705) 473952
OPEN: 10-6
(Mon 10-2, Thur 10-8)

COMPACT Music



Rupert maintains that holidays are all very well, but to ensure that you really enjoy yourself, endeavour to bring your Chew & Osborne equipment with you.

Chew & Osborne
HI-FI · TELEVISION · VIDEO
COMPACT DISCS · CASSETTES

... sounds outstanding

In the UK at least, Stax is best known for its pace-setting electrostatic headphones (Earspeakers), even though the company has dabbled in the manufacture of various electronics products. The *Quattro II* CD player represents one of the latter projects, superseding the Yamaha-based *Quattro I*. By way of contrast its *MkII Quattro* uses a rudimentary Sanyo transport mechanism, buried within an exoskeleton of plastic, alloy and black Medite casework.

The upper half of this substantial unit plays host to a variety of convenience features such as track and index skip, fast music search, repeat and 0-9 digit direct access keypad. Track location remains a two-step process but at least Stax has provided a comprehensive fluorescent display including, amongst other things, an obligatory 1-20 track music calendar. Smaller buttons cater for the 20-track random access memory and edit functions while the *RC-2* remote control adds auto space, A-B repeat, time search, random play and a ten second intro-search to the list of facilities.

Below this busy black fascia lies the heart of the machine. Here Stax has incorporated two 18-bit convertors (L/R) running at an increased sampling rate of 352.8kHz (8x), in conjunction with proprietary analogue filtering and transconductance circuitry. Separate power supplies are included for the digital, analogue and servo sections together with comprehensive regulation and decoupling. Separate buffer amps are included for the fixed and variable outputs, the latter situated immediately after two 10kohm ALPs potentiometers.

LAB REPORT

As with other CD players using 18-bit DACs (Burr Brown *PCM-64*) with external MSB correction, the *Quattro II* presented an error of some +5.3dB at -90dB, indicating a true amplitude linearity of some 15.1 bits. Such a positive error will increase low level detail from, say, 67.1µV at -90dB (ref 0dB = 2.121V) to 123.7µV thereby boosting subtle musical nuances. Maladjustment of the external presets, together with thermal variations within the DAC itself are the root cause of this reduced linearity; Philips' Dynamic Element Matching compensation scheme would undoubtedly help if only it could be implemented!

However, Stax does have other figures to crow about, including the superb separation (>123dB), noise (-113.5dB) and 24.1kHz stop-band rejection of -93.7dB. THD fell to around 0.0022 per cent at peak level in the midband though the spectrum was principally composed of odd harmonics. More importantly a broad-band spurious RF noise accompanied all signals above 5kHz (peak level) but was reduced by a factor of 20dB via the variable outputs, all other parameters being equal. Subjectively, this could have important consequences, especially if the partnering amplifier is susceptible to RF IMD.

SOUND QUALITY

Stax has contrived to achieve a rich and deep bass for its latest player, though this was less noticeable via the variable outputs, which by comparison sounded slightly reticent or

STAX QUATTRO II

damped. Via the fixed outputs it seemed able to reach down and grasp the very lowest bass notes even though this occasionally resulted in a sound that was dominated by its bass line or rhythm section. Nevertheless the most attractive aspect of the *Quattro II* remained its lush and seamless presentation of mid and treble detail.

Perhaps the sound was a little too detailed to be deemed strictly accurate but it proved difficult not to be captivated by its musical spell. The player suffers none of the harsh and fatiguing colorations that plague lesser units and this lack of strain leads to very relaxed and rewarding listening. Other players may offer slightly more tactile imagery, a better sense of stereo depth and technical accuracy but the *Quattro II* is simply that much more musical.

CONCLUSIONS

Stax has succeeded in demonstrating the critical role played by all post-DAC integrating analogue electronics and, as a result, its *Quattro II* is to my mind just about the finest integrated CD player currently available. However, its long-term flexibility is reduced by the lack of any digital output, for there's little doubt the future lies in separate CD transport/outboard DAC combinations.

TEST RESULTS

	20Hz	1kHz	20kHz
Channel Balance	0.0dB	0.0dB	0.1dB
Channel Separation	135.3dB	126.1dB	122.6dB
L/R Phase Error at 10kHz at 20kHz			0° 0°
De-emphasis Accuracy, 1kHz			-0.01dB
5kHz			-0.08dB
16kHz			-0.09dB
S/N Ratio (A-wtd), w/o emp			108.7dB
w emp			113.5dB
THD (at 1kHz, L/R), 0dB			-93.2dB
-10dB			-85.1dB
-30dB			-66.3dB
-60dB			-37.6dB
-90dB			-8.7dB
Dithered -90dB			-13.7dB
CCIR IMD, 0dB			-89.7dB
SMPTE IMD, 50Hz/7kHz			-86.2dB
400Hz/7kHz			< -90dB
Suppression of stop-band IMD			-93.7dB
Resolution at -30dB			+0.01dB
-40dB			+0.04dB
-50dB			+0.09dB
-60dB			+0.29dB
-70dB			+0.79dB
-80dB			+2.68dB
L/R -90dB			+5.32dB
Peak Output Level, L			2.121V
R			2.121V
Output Impedance			500ohm
Track Access Time (99)			2.5secs
Typical Retail Price			£2,995

Reviewed by Paul Miller

Path Group plc, Desborough Ind. Park, Desborough Park Rd, High Wycombe, Bucks HP12 3BC. Tel: (0494) 459981.



Uxbridge Audio

Dear Sir

Wembley Park,
Middlesex.

The EXCELLENT service, personal attention and professionalism I found with your staff, compels me to write this letter.

Having embarked on the daunting task of looking for the right music system I visited many Stores and purchased a lot of literature. I was attracted by your advertisement in What Hi-fi magazine. First class sound quality was my top priority and from another article in the same magazine I had made up my mind to purchase a system recommended therein.

A quick phone call to your Shop to find out whether you had them in stock and I was lectured on how a Music System should be purchased . . . "Have you listened to it? How do you know you will like it's sound? It isn't the same as buying a washing machine, when it has to be taken on faith that it will do the job as you want it. It is more like buying a musical instrument, where personal preference dictates. You do not need to be an expert, you only need to listen to it and decide for yourself . . ."

Not too keen on the lecture, I was, none the less, taken up by what he said, and decided to pay you a visit. This turned out to be QUITE AN EXPERIENCE! After listening to a few systems I had already decided I would be buying my own combination and not the one recommended in the magazine. A music system should, indeed, be listened to, before purchasing. In addition, the personal attention, friendly, untiring and "non pushy" attitude of your sales assistant, Jas, turned the daunting prospect of choosing the right hi-fi into a most pleasant experience.

When I first read the letter from a satisfied customer in your advert I didn't think it genuine. But after my experience I know just what he meant. I echo him in commanding you and your staff and I will not hesitate to recommend you. I, once again, thank you for the help in choosing my system and the excellent service and attention I have received at and since it's installation.

Wishing your Company every success

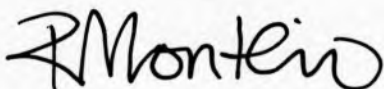

Mrs. F. Monteiro

TWO DEMONSTRATION ROOMS • 7 DAY EQUIPMENT EXCHANGE OR REFUND • UNBIASED ADVICE

MAIL ORDER ANYWHERE • 2 YEARS GUARANTEE PARTS AND LABOUR • FULL INSTALLATION SERVICE

0% INTEREST FREE CREDIT • TURNTABLES SET UP AND FULL REPAIR FACILITIES

BADA
THE ULTIMATE IN
SOUND ADVICE

UXBRIDGE AUDIO
278 HIGH ST. UXBRIDGE
MIDDX. Tel: 0895-30404 Multi-line
OPEN 10 TILL 6 – 6 DAYS A WEEK

*Music from the best
equipment at all
price levels*

ACOUSTIC ENERGY • A&R CAMBRIDGE • AR • ARISTON • CAMBRIDGE
AUDIO • CREEK • CYRUS • DENON • DUAL • EPOS • EXPOSURE
HEYBROOK • INFINITY • JPW • KEF • LINN PRODUCTS • MANTICORE
MARANTZ • MERIDIAN • MICHELL • MISSION • MONITOR AUDIO • NAD
NAIM • NAKAMICHI • QED • QUAD • REVOLVER • ROGERS • ROTEL
RUARK • SANSUI • STAX • TANNOY • THORENS • TRIO/KENWOOD
WHARFEDALE • YAMAHA



Conceived by Mondial and designed by Dan D'Astingno (Krell), the Aragon range of power amplifiers consists of two dual-mono models. Costliest of these is the 4004, rated at 200W per channel and built into an imposing black case complete with a 9.5mm thick alloy faceplate. Mondial has rejected the grab-handles usually associated with monster power amps in favour of a plain fascia characterised by a V-shaped swathe, cut from front to back. If nothing else the Aragon is sure to stand out amongst the rows of anonymous black boxes found in dealer's showrooms.

Furthermore, the notch also forms a 'chimney' for air circulating around the two cast alloy heatsinks beneath, each equipped with four pairs of TO-3 style output devices. Tiffany input sockets are provided though the 4mm loudspeaker cable binding posts are basic, nickel-plated terminals. At least Aragon has labelled the connections so that they may be read by peering over the top of the amp!

Two 600VA toroids form the heart of the power supply, together with four 10,000 μ F electrolytics and four separate bridge rectifiers for each of the positive and negative supply rails. Further, discrete, on-board regulation is provided by Toshiba/Motorola C2238/MJE150 A968/MJE150 bipolar transistor pairs while the main audio drivers are integrated into single 14-leg IC packages. Further MJE150 devices are used for thermal (bias) compensation, in addition to firing the 4-pole output muting relay which protects the speakers from high level continuous or transient LF signals.

LAB REPORT

While not offering the +3dB increase in power suggested by Aragon, the 4004 did achieve an increase of +2.28dB to 390W into 4ohm. The protection relay tripped below 8Hz at full power into 4ohm. Distortion was maintained to within the claimed limits of 0.06 per cent at OdBW = 1W but deteriorated from 0.014 per cent at 20Hz to 0.17 per cent at 20kHz at two-thirds power. Similarly the fine squarewave linearity of -86dB at 2kHz worsened to -77dB at 22kHz, though this is not necessarily a function of reducing feedback as the output impedance of the amp remained fairly constant at a low 0.05ohm from 20-20kHz.

ARAGON 4004

The input sensitivity of 2354mV indicates a moderate overall gain of +25dB, but in the light of its high power output (+32.7dBV) the S/N figure of 105.4dB is a trifle weak. Indeed, hum products (-61.8dB) were extraordinarily high in amplitude and extended in frequency, dominated by 100Hz rectifier pulses + harmonics to 1kHz. Aragon should redress the convoluted signal and P/S wiring used in the 4004.

SOUND QUALITY

When cold the Aragon sounded a little hard if not obviously bright. However, a smoother, silkier balance, took over once the unit had been powered-up for a day or two. Oddly enough I felt the final sound to be just too soft and relaxing. The 4004 retained a tight grip on the speakers, but much of the conviction and energy of the musical performance was dulled, softened and generally reduced in articulation and impact. Central vocal images were well represented, but both stereo width and depth were compromised by the focus of peripheral instruments which, by comparison, seemed slightly indistinct.

Clearly, the 4004 is an amp for those who prefer a laid-back and relatively innocuous sound. Its presentation was both unfatiguing and undemanding but, equally, it lacked the crisp vitality that should set a costly amp such as this aside from lesser designs. Nevertheless, the Aragon is a lusty performer undaunted by insensitive or low impedance loudspeakers, a fact that bodes well for general system compatibility.

CONCLUSIONS

The importer has refrained from loading the UK retail price of the Aragon 4004, so in material terms and £s per watt it represents fair value. The amp is also generally unaffected by bright-sounding CD players but its lush, sweet presentation may simply prove too forgiving for some listeners.

TEST RESULTS

Maximum Continuous Power Output, 4ohms	20Hz	1kHz	20kHz
	220.3W	230.8W	228.1W
Dynamic Headroom (IHF)	365.9W	390.4W	392.1W
		+1.36dB (315.9W)	
Output Impedance	0.048ohm	0.051ohm	0.051ohm
Damping Factor	168.4	155.7	156.4
Stereo Separation (OdBW)	60.7dB	60.5dB	59.6dB
Total Harmonic Dist. (OdBW) (1/2 power)	-67.1dB	-79.2dB	-67.3dB
	76.7dB	69.2dB	55.6dB
CCIR Intermodulation Distortion (OdBW)			-77.4dB
CCIR IM Distortion (1/2 power)			-66.9dB
Rise Time (@ 10kHz)			2.1 μ secs
Power bandwidth (<1% THD)			8Hz - 75kHz
Squarewave linearity			-86.3dB
Phase shift 20Hz			0°
1kHz			0°
20kHz			347°24'
Noise (A wtd, 20Hz-20kHz) OdBW			-85.3dB
(A wtd, 20Hz-20kHz) 1/2 power			-105.4dB
Residual noise (unwtd)			-61.8dB
Input Sensitivity (for OdBW) (for full output)			153.2mV
			2345mV
Input loading			21.4kohm
DC offset, left/right			+21.4mV/+14.8mV
Typical Retail Price			£1,795

Reviewed by Paul Miller

Path Group plc, Desborough Ind Park, Desborough Park Rd, High Wycombe, Bucks HP12 3BG. Tel: (0494) 459981.



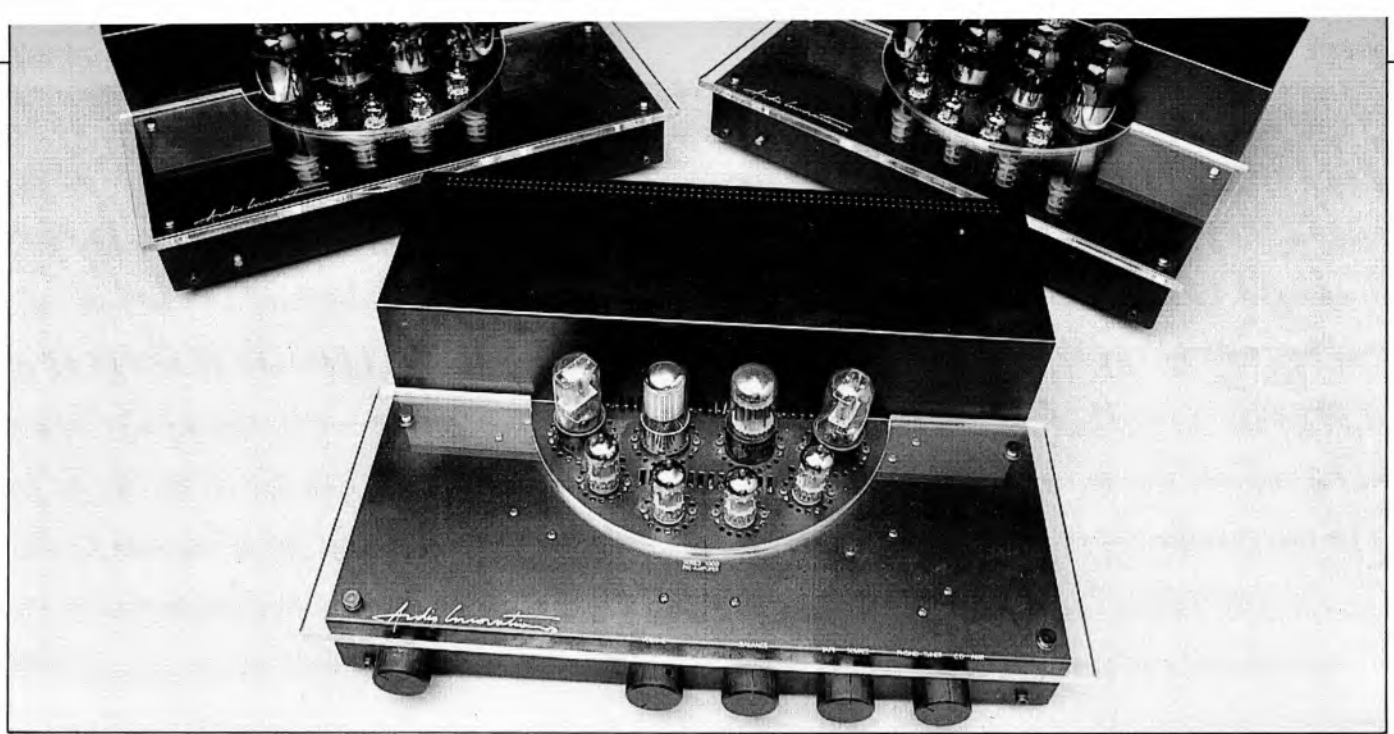

AUDIO INNOVATIONS

1000/2ND AUDIO

Audio Innovations is fast becoming one of the UK's biggest producers of valve amplifiers, with a prolific range of models ranging from the *Series 300* and *500* integrated models (£389 and £799) to this top-of-the-range pre/power combination.

The company is a subsidiary of Audio By Design Ltd which markets Snell loudspeakers (from the US) and Audionote cartridges and cables in the UK. Despite an ever-increasing profile in this country, the majority of 'Innovations amplifiers produced are exported; Denmark and Sweden are large consumers of the breed, and I understand that a growing market also exists in Taiwan.

The visual design of this combo is striking, with exposed valves glowing seductively and reflecting off the Perspex 'top plate' at the front. The *Series 1000* preamplifier has inputs for disc (phono), tuner, CD and aux, along with a proper tape monitor loop, while at the rear all socketry is gold plated and

there are two sets of output sockets to facilitate bi-amping in cost-no-object systems. A single ECC83 double-triode is used at the disc input, and passive disc equalisation is effected using specially selected polypropylene capacitors and tantalum film resistors. Independent solid-state rectification (valve regulation) is employed at all stages of the preamp, the chunky power supply employing no less than 18 430V/4 μ F Dubilier electrolytics in series/parallel to maintain the very high 485V HT rail.

The *2nd Audio Amplifier* (to give it its full name) is the company's top monoblok power amplifier at present, nominally rated at 15watts Class A. A smaller power amp is available called the *1st Audio Amplifier* which is a 7 $\frac{1}{2}$ watt stereo model priced £1,149. On the rear of each amplifier a row of four output binding posts provide a choice of 2, 4 or 8ohm taps, input is via a gold plated phono socket, and a simple push button on/off switch is at the front.

A high energy power supply featuring 2 x 220 μ F/400V BHC electrolytics is used in these 15watt monobloks with basic solid-state regulation. Two low-voltage ECC88 double-triodes form both input buffer and phase splitter, feeding a further two PCC88 triodes which are configured as push-pull drivers operating at a slightly higher voltage. A total of four 6B4G direct-heated single triodes comprise the paralleled, push-pull output stage.

This pre/power combination was first reviewed in last October's issue of *Choice* (issue No. 63), and I said at that time that there was further investigating to be done with these components. The manufacturer has been good enough to let me hang on to them all these months, during which time I've been using them as a reference amplifier in all sorts of system configurations – and recently I was supplied with a further pair of monobloks for bi-amping! Rather than simply re-print that original review in this year's high-end *Collection* I felt compelled to reassess my thoughts on these individualistic products.

SOUND QUALITY

Contrary to anything we might have expected from the full lab tests carried out on these amplifiers last October, these '15watt' triode amplifiers sound enormously powerful and dynamic on classical and rock music alike, coupled with very good transparency to the source and truly wonderful soundstaging. It has been accepted in hi-fi circles for many years that an amplifier can measure 'perfectly' on the test bench but sound awful when trying to reproduce a music signal, yet never before have we come across amplifiers which measure so abominally and yet sound

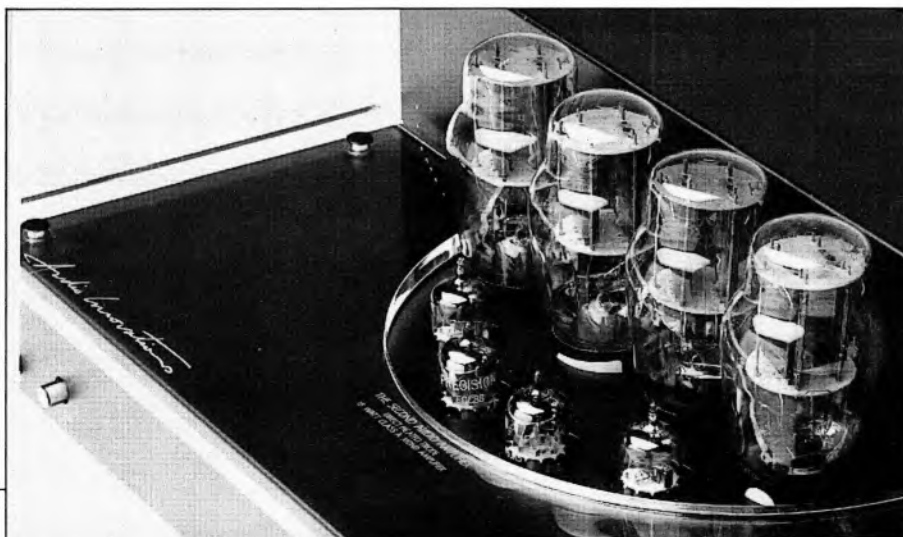

so vivid and 'alive'. (Adhering to a 1 per cent THD ceiling the power amp achieved just 3.89W at 1kHz and 4.16W at 20kHz!)

Where some listeners might criticise the sound of this combination is the feeling it gives of lacking 'grip'. Rather than sounding taut and controlled at frequency extremes, which is how one would describe the performance of many highly-respected amplifiers, these 'Innovations amplifiers have what can only be described as a 'free-breathing' and naturally 'open' quality, creating a soundstage that you swear you could walk into. In some ways this valve combination provides a unique listening experience, and its nigh-on impossible to describe its sound in conventional terms - just as it's obviously impossible to measure its performance on the test bench in the conventional way and get any kind of meaningful results. Using appropriate natural recordings, the sense of real musicians performing in real space is at times breathtaking.

What these amplifiers appear to do better than any other amplifiers I've heard to date is preserve the leading edges of transients and the natural timbre of instruments. Cymbals and other percussion instruments came across as especially lifelike, and if you regard the bass to be sounding loose and lacking in 'control' you're missing the point; there's remarkable transparency in the bass which allows bass sounds (kick drum and bass guitar, for example) to be clearly differentiated. The sound is less "hi-fi" and simply more real. This phenomenon applies not just to the amplifiers' bass performance but to the entire audio bandwidth. But there are

improvements to be made - the *Series 1000/2nd Audio Amplifier* combo is by no means the end of the road - and having spent many weeks comparing these components with other amplifiers I've detected a sense of muddling in the midrange which is restricting ultimate clarity. The sense of realism available from this combo is tremendous, and four monoblocks bi-amping Snell *Type C* and Duntech *Crown Prince* loudspeakers needs to be heard to be believed, but there are still some more veils to be removed . . .

Incidentally, the preamp and power amps need to be treated as a combination. The input sensitivity of the amplifiers is an abnormal 31.5mV, which normally leads to insurmountable noise problems when trying to use alternative preamplifiers, and if you do manage to find a preamp quiet enough to drive the monoblocks, you then discover that they are distinctly lacking in low bass. I've always thought that two wrongs shouldn't make a right, but the preamp's phono input displays +2dB boost at 20Hz which makes it sound 'just right' with its partnering amplifiers but rather bloated when used into different power amps.

CONCLUSIONS

I got into all sorts of trouble with the manufacturer last year when I said that these amps appeared rather expensive for what you get in physical terms. The point I was trying to make, perhaps too diplomatically, is that although the sound is firmly in the high-end, the rather utilitarian appearance of the metal casework and the plasticky control knobs lack that expensive 'feel' one normally

expects from a £3,000 amplifier. But I did say that if all you're interested in is good sound quality these amplifiers demand auditioning - and that was meant as a compliment, because you can spend much, much more than £3,000 on a pre/power combo and not get as good a sound as this.

I also got into hot water because I said that Audio Innovations makes much cheaper amplifiers which sound *almost* as good, implying that this combo is poor value for money. But the emphasis here has to be on the word 'almost'. You can buy a very good phono cartridge for £100, for example, but if you want one that's a little bit better you need to spend £200 and upwards; Audio Innovations makes excellent sounding amplifiers priced below £800, but if you demand the best possible high fidelity you'll need to spend larger sums in the pursuit of small improvements in sound quality. That's life!

Casting all that aside and concentrating purely on the performance, the *Series 1000/2nd Audio Amplifiers* can be regarded as something of an audio bargain. Used in a properly matched system, with appropriately sensitive loudspeakers, there's nothing I've heard that comes close to matching their ability to recreate the drama and excitement of a live musical performance.

Typical retail price inc VAT

Preamp £1,299

Power amps £2,250 (pair)

Reviewed by John Bamford

Audio Innovations Ltd, Level 5, New England House, New England Street, Brighton BN1 3JD. Tel: (0273) 203277.

ARJAY

ST2
Holds 480 records
price £162.00

ST1
Holds 600 records
price £192.00

ST5
Holds 120 records
price £50.00

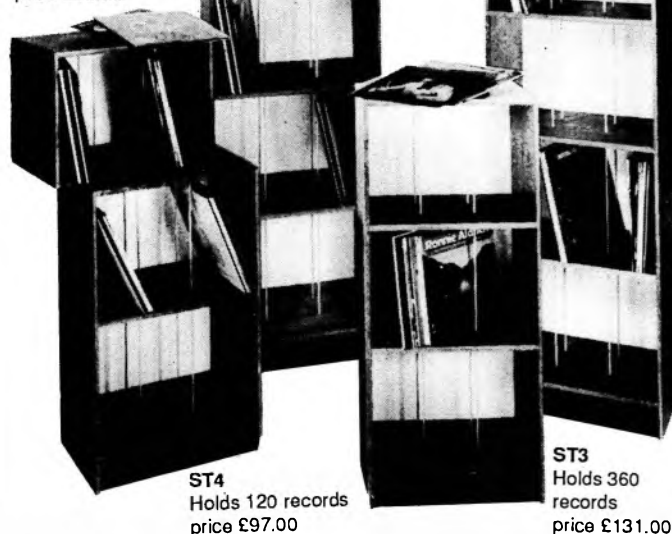

ST4
Holds 120 records
price £97.00

ST3
Holds 360 records
price £131.00

All prices are ex-works and inclusive of VAT.

The Professional Sound Storage System Direct from the Manufacturer

Whether your collection is Records, Cassettes or CDs the ARJAY system is just for you. In fact, at many music studios, stores and libraries throughout the country ARJAY is considered essential equipment.

Its classic and original design makes the best possible use of available space to provide the ideal storage and display conditions.

You have a choice of the "Record Collection" which consists of five different sized units, designed specifically for record only collections or "The Combination" which has three different sized units, designed for a mixed collection of Records, Tapes & Compact discs. There is a unit just right for you.

The ARJAY System is British made and is available in a choice of five functional finishes - Rosewood, Mahogany, Teak, Black or White - to look good wherever you choose to keep them.

You couldn't put your music collection in better hands or units.

Contact Sandra on 01-390 2101 or send coupon below to:-

ARJAY Ltd.

54 Lower Marsh Lane, Kingston, Surrey KT1 3BJ

Please send me The ARJAY Sound Storage System brochure.

Name

Address

..... Tel No

AUDIO RESEARCH SP9/

The American Audio Research Corporation continues to fly the valve flag, remaining at the high quality end of the hi-fi business on grounds of genuine sound quality, fine finish and build. The combination reviewed here comprises the established £1,700 *SP9* preamp plus the brand new *Classic 30* power amplifier (£2,250).

Both units are FET-valve hybrids, and the *SP9* enjoys a fine reputation as a reliable high quality preamplifier with low noise inputs to suit a variety of signal sources: moving coil and moving magnet pick-up cartridges, CD, tuner and tape sources can all be accommodated. Modestly priced (for ARC!) this tube preamplifier has shown above average reliability on account of its extensive use of FETs and only a few triode stages in uncritical positions. A single box unit, the *SP9* can be installed quickly and easily into a system, and will match a wide range of amplifiers and sources.

Rated at 30watts per channel, the *Classic 30* stereo power amplifier is built to an uncompromised standard and is intended for

high sensitivity speakers, and for use at moderate listening levels in moderate sized rooms. The delivery of loud rock with medium sensitivity speakers is not its forte. It uses a triode connected valve (tube) output stage, and triode-coupled drivers are also used, while the input and differential gain stages employ select differential FETs – solid state devices with 'tube-like' electrical characteristics.

You can buy much larger amplifiers for the money but I wonder whether you can buy better in terms of musical enjoyment. Componentry is first class, including top quality polypropylene film capacitors backed by extensive supply regulation.

LAB REPORT

ARC models usually perform exceptionally well in the lab, with very little of the usual valve weakness. When present, these can often give the reviewer scope to criticise and also identify effects associated with sound quality variations.

In areas where many valve amplifiers are weak such as peak current, rated power

response flatness and wide band distortion, most measurement results of the *Classic 30* were equal to or better than those for the best solid state designs. Into 8ohms the output was typically 40W with a fine power bandwidth and a healthy $\pm 6A$ peak current. The output impedance is fairly high at typically 0.6ohm so speakers may show some mild tonal balance change with this model.

On test, the *SP9* showed a very good signal to noise ratio, fine overload margins, excellently flat frequency responses and good RIAA equalisation. Distortion was at negligible levels via all inputs and measured over the standard frequency range. A mild +0.4dB treble lift remains on the analogue disc input, present from 5kHz to 20kHz.

SOUND QUALITY

The power rating may be a modest 30watts per channel, but the *Classic 30* could produce decent volume levels with the easier-to-drive loudspeaker models, such as those of 87-92dB/W sensitivity and ideally possessing straightforward 8ohm load impedances. Bi-wired designs are preferable, enabling the



CLASSIC 30

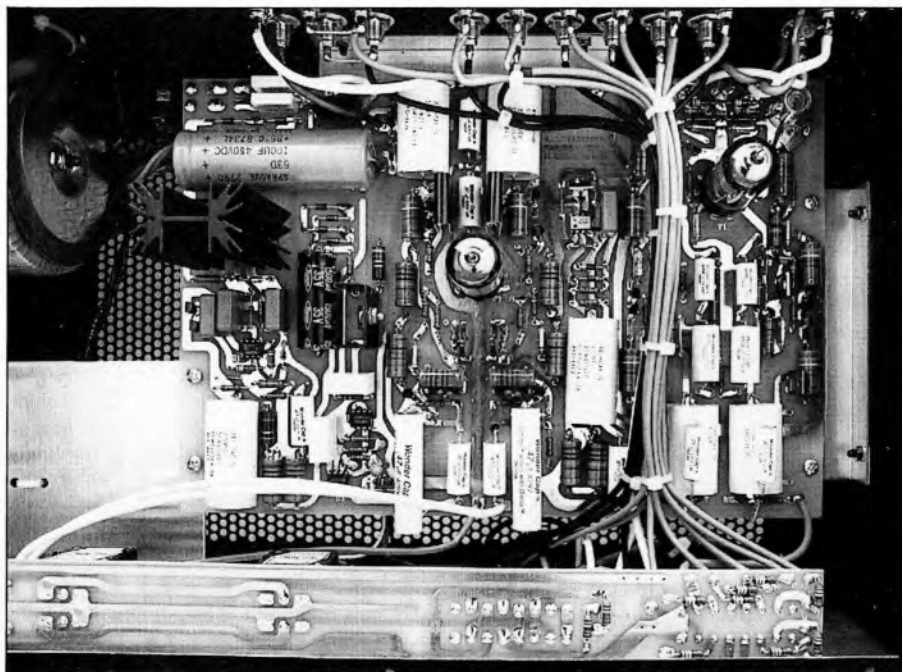

lifetime, and established as a class leader, the later introduction of the much cheaper *SP9* preamp led to some speculation that the smaller model would offer a good proportion of the *SP11* sound quality, which indeed has proved to be the case. Possessing typical Audio Research qualities, the *SP9* is a lively and open performer showing high levels of musical detail coupled with strong stereo image focus – while width, depth and ambience were all present in good measure.

Considered evenly balanced, the *SP9* showed a well considered blend of sonic qualities and no particular feature stood out as worthy of special criticism or exception. It worked well with the *Classic 30* but at the same time, was not quite in the same class.

CONCLUSIONS

While the *Classic 30* is not a big amplifier, the sound quality was truly exceptional, and given the right choice of speaker (offering good sensitivity, and a sensible load impedance) the result was not merely a taste of the high-end – it *was* high-end! The mid was exceptionally neutral and natural while the overall effect was one of transparency and life, fully justifying the 'high definition' slogan used by ARC. It is worth noting that another *Classic* model is also available offering twice the power (60watts per channel) and costing £3,150.

The *SP9* remains a fine example of the genre, and is a versatile all-rounder with decently low noise levels suitable for MC and MM cartridge types. I feel that its value base has been eroded over the past year or so, but not to such a degree that it could not be Recommended – its fundamentally good performance ensures it that assurance.

With care, a really fine system can be put together using these products, and although the *SP9* is a strong preamp, ideally matched in price, the *Classic 30* has the potential to satisfy some of the best preamplifiers currently manufactured, including my current favourite, the £2,600 Krell *KSP 7B*.

detail and transparency that this amplifier is capable of delivering to be more readily revealed.

Audio Research Corporation has produced very few duds in its extensive and evolving product range and the *Classic 30* proved to be no exception. This amplifier was right up with the best of today's designs, and by that I mean the *very* best. Apart from dynamic range or, more specifically, maximum loudness capability, the power amp made no concessions with regard to focus, transparency or clarity; indeed in areas such as low level detail and tonal purity, this modest amplifier excelled.

Its pedigree was unmistakable, recognised after the first few notes of music. Given a compatible speaker load, I cannot see how this amplifier could fail to please. Stereo images were presented on a decently large scale, strongly focused and with good perspective layering, fine width and exceptional depth. Musical dynamics were lively, the amplifier showing a very good sense of rhythm and pace. Bass lines were clearly and cleanly portrayed, understandably lacking the 'slam' of a solid state 'dreadnought' design. With some speakers the bass could sound less well damped with the *Classic 30*, yet the bass line timing remained comparatively undisturbed.

Singing voice was excellent – natural, articulate, alive and low in sibilance. In fact the whole midrange was excellent for programme ranging from violin to piano, sounding even and well balanced, smooth, natural and unforced. Likewise so little of the usual grain was present that it would be unfair to comment specifically on this matter. It played louder than the 30watt specification would suggest, and was so kind-sounding when overloaded that it performed more like a 60watt model.

With ARC's *SP1111* a legend in its own



TEST RESULTS

POWER AMPLIFIER			
Rated power into 8ohms, maker's spec	30W (= 14.75dBW)		
Power output/8ohm tap	20Hz	1kHz	20kHz
One channel, 8ohm load	15.4dBW	15.4dBW	14.3dBW
One channel, 4ohm load	11.9dBW	11.9dBW	11.7dBW
One channel, 2ohms, pulsed	—dBW	11.0dBW	—dBW
Instantaneous peak current	+6A		
Distortion			
Total harmonic distortion,	20Hz	1kHz	20kHz
at rated power	—52dB	—55dB	—40dB
Intermodulation, 19/20kHz, rated power	—57dB		
Intermodulation, 19/20kHz, at 0dBW	—67dB		
Noise 'A' wtd	—77dB (0dBW),	—91dB (rated power)	
DC output offset	0mV		
Output impedance (damp)	0.6ohm	0.59ohm	0.72ohm
Input data	socket type	sensitivity	loading
Power amp			
(to clip)	phono	72mV	94kohms 100pF
Typical price inc VAT	£1698/£2250		

Reviewed by Martin Colloms
Absolute Sounds Ltd, 318 Worple Road, London SW20 8QU.
Tel: (01) 947 8160.

Following Mark Levinson's departure from MLAS, he founded Cello, the right to the 'Mark Levinson' trade name being vested in MLAS. And with the able support of designer Tom Colangelo Cello has set out to produce a line of audiophile products. Appearing on the scene with a state of the art tone control called the *Audio Palette*, this superb design established Cello's credentials and led to the design of the *Audio Suite* mainframe preamplifier. This studio-inspired unit offers virtually any combination of inputs and outputs, over a range of qualities, with balanced or unbalanced connection. Input or output facilities plug into the mainframe to form the desired arrangement.

This top end range continues with the *Performance* amplifiers, presented in no less than four substantial aluminium cases for a stereo set. The power supplies have been separated from the active circuitry, which is an unusual feature for a power amplifier. With a high percentage of Class A operation the amplifier boxes run pretty hot internally, but are kept relatively cool by the use of two fans per box. On an original sample, (never supplied for review) the fans were too noisy, and due to their slightly different rotational speed produced a beating drone like a distant four prop airliner. It was therefore necessary to place these boxes outside the main listening room, although a temporary if short term listening solution was found in the form of a large duvet, arranged as an acoustically quiet tent over the amplifiers!

These are powerful amplifiers, capable of a considerable 200W per channel over a wide range of speaker loadings, including continuous duty with 4ohm types. Facilities are provided for balanced and unbalanced connection to the preamplifier if required, and Cello uses a special high quality audio connector made by Fisher which also comes with the special Cello *Strings* audio cable. Costly adaptors are available for phono plug connection.

Balanced drive can confer improvements in sound quality in some systems by producing a better signal to noise ratio, and freeing the source from ground loops and similar

CELLO AUDIO PERFORMANCE MONOBLOKS

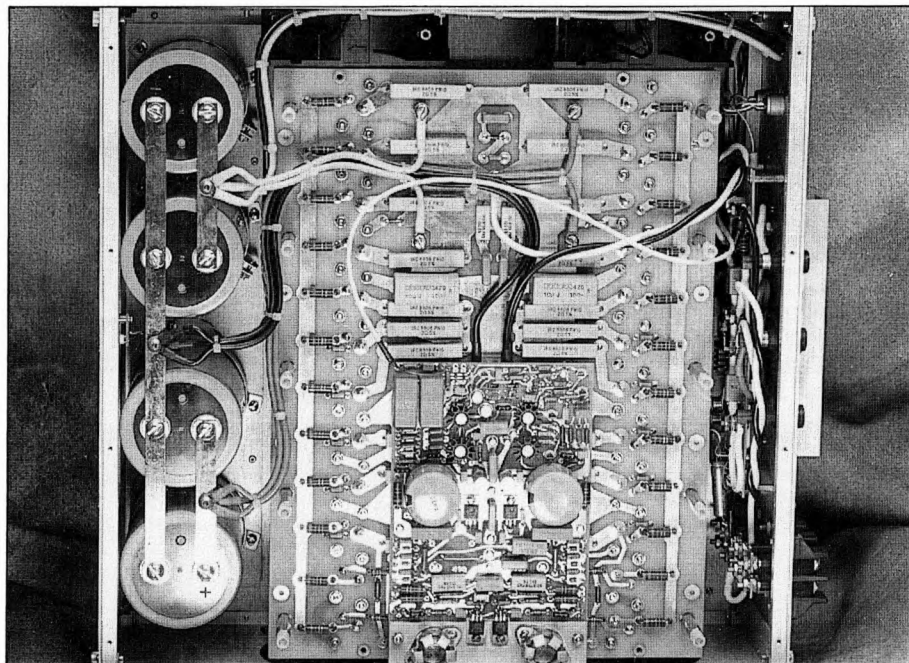

interaction with the destinations, in this case the preamplifier. An experienced dealer can advise on the need for balanced connection in particular cases, where the option is available.

Certainly the most radical feature of this no-compromise power amplifier system is the massive separate power supplies which incorporate choke input rectification, too

costly a practice for most designs but in theory capable of better supply line noise rejection and far better regulation stability than the usual capacitor input supply circuit. Of course, its double mono design is another obvious feature, conferring audible benefits in definition and stereo focus. It also allows the power amplifiers to be located adjacent to the loudspeakers and very short speaker

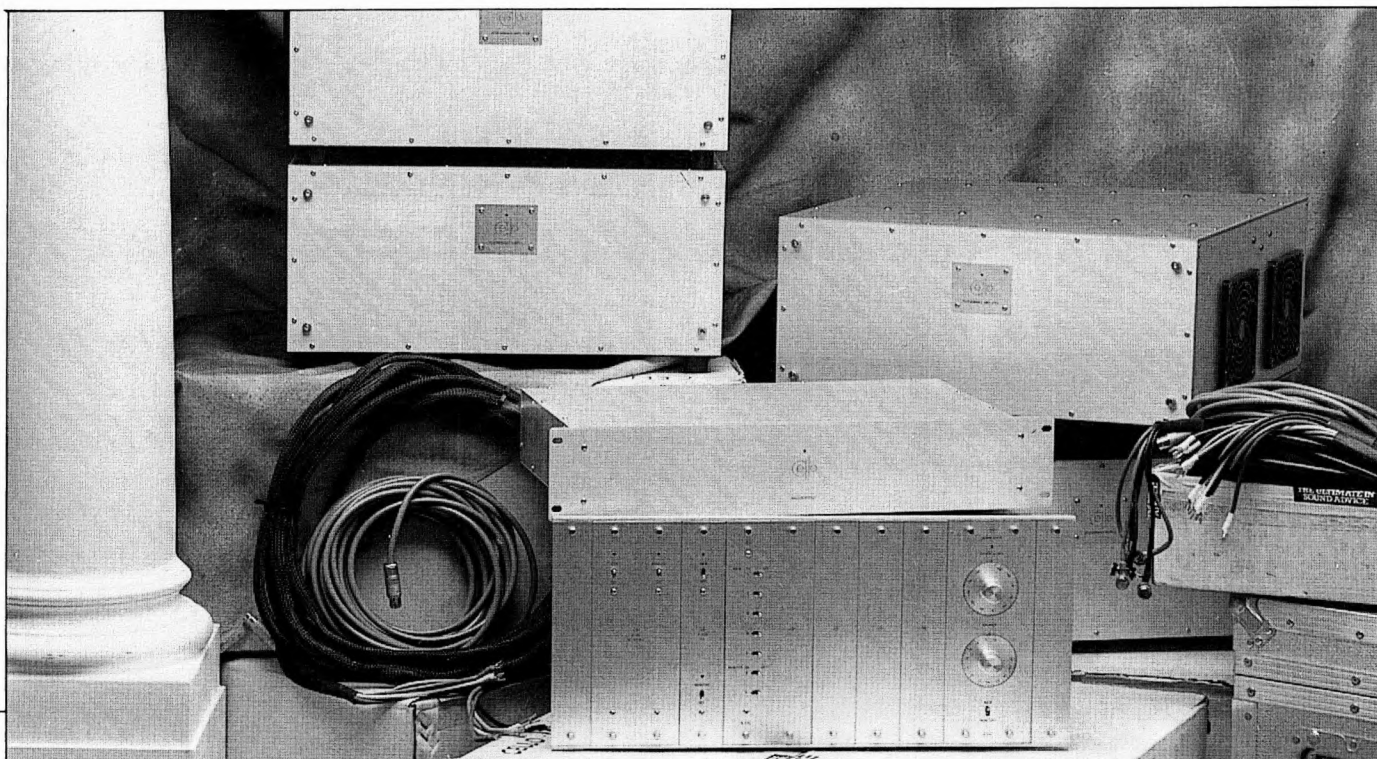

leads can be used, thus enhancing the directness of coupling between those two components.

The output stage of the *Performance* is solid state, fully complementary with a large number of paralleled devices for a massive peak current capability as well as high reliability. Starting up such an amplifier 'raw' imposes big surges on the mains supply and the *Performance* now has special start-up circuitry.

Hardly worth putting on the test bench, the *Performance* behaved as superbly as the *Audio Suite* did before it. Electrical noise levels were very low, and the distortion quite negligible, while the generous output characteristics mean that sufficient power and current is available for any sensible loading.

SOUND QUALITY

The *Performance* amplifiers were tried in several systems with both moving coil and large panel speakers and also with balanced and unbalanced drive. Using the *Audio Suite* 'Premium' grade control unit, there was no doubt concerning the components' mutual compatibility, both in terms of interfacing and their individual sound quality. If anything, the *Audio Suite* had a slight advantage on the *Performance* which is probably as it should be. In its current form, the *Audio Suite* with Premium plug-ins remains a reference quality design though its value is being eroded by more recent preamp introductions such as models from ARC and Krell – and, for that matter, even Cello. A new non-mainframe version of the *Suite* is available for much less money, and with at least as good sound!

The *Performance* scored high on the grounds of a superbly effortless power delivery and large scale of soundstage. Supremely generous, big amplifiers such as this have their own special quality, a feeling of total control and 'weight', and an ability to sound relaxed and yet fully secure in their ability to reproduce a magnificent dynamic range. The *Performance* threw real power into everything to which it was connected, and high quality/high current speaker cable is a necessity with these amplifiers if the powerful, tight bass is not to be compromised.

Focus was very good to excellent, except in the upper treble where image definition was not quite as sharp. Definition was very good as was image depth, while stage width was excellent; the fine sense of width was also maintained to the perceivable back stage. A strong recovery of recorded ambience was noted while the tonal quality was considered to be very close to neutral – unstrained, offering very good clarity and favourable in terms of listener fatigue. High sound levels can certainly be produced, and I have heard demonstrations with the Cello speakers where they provided naturally explosive sound levels on piano reproduction – a rare capability for any audio system.

When the *Performance* amplifiers were first introduced, they were comparable with some of the world's finest including the Mk1 ARC *M300*, and the Krell *KMA100* and *KMA200* amongst others. The latest Cello amps are a little improved, but the whole amplifier market has undergone a major revolution with the introduction of designs such as the ARC *D125* and the *Classics*, the new Krell *KMA* and *KSA* series – and, for that

matter, the Musical Fidelity *MA100*. These models have all considerably lifted the standard of musical performance in areas such as transparency and treble purity, the resolution of fine detail and the exposition of rhythm and dynamics. Revisiting the *Performance* amplifiers for this review, they were undoubtedly a major example of the high fidelity art, but in my opinion do not quite reach the present state of the art. This may be important to those who, for example, find that the last half second in a 0-60 sprint crucial, but it may not matter much in the context of a properly configured audio system.

CONCLUSIONS

Cello is all about system design where the careful and intelligent design of specific components results in an audio system where the sum of the whole exceeds that of the parts. This aspect should not be underestimated when comparing Cello prices with others. For the top of the range *Performance* power amplifier, and for the ancillaries, the sound quality standard was very high, and the arrangements foolproof. Fan noise, although still annoying, has been considerably reduced, while the build quality as well as the finish are commensurate with the price.

This is luxury audiophile equipment and deserves serious personal investigation by the well heeled, musically oriented enthusiast.

Typical price inc VAT

Reviewed by Martin Colloms

Aston Audio Ltd, 4 West Street, Alderley Edge, Cheshire SK9 7EG.

Tel: (0625) 582704.

(power amp set) £10,500

Excellence within reach . . .



– valve preamplifiers and power amplifiers (UK)

conrad-johnson – Full range of valve preamplifiers and power amplifiers (USA)



– moving-coil and moving-magnet cartridges (Switzerland)



– loudspeakers (Canada)



turntable, tonearms (Yugoslavia)



– solid state electronics from the designers of conrad-johnson (USA)

OAKLEY – valve preamplifier (Yugoslavia)

SOUND-LAB – the electrostatic speaker specialists (USA)

SONOGRAPHE™ CD player offering sheer musicality (USA)

AUDIOFREAKS

audio distribution & consultancy

15 Link Way, Ham, Surrey TW10 7QT. Tel: 01-948 4153. Fax: 01-948 4250

There's a danger when writing about a product such as the *Premier Seven* to reach for the Thesaurus in search of new superlatives. The product is out of this world, the price tag equally so, and only in *The Collection* could we indulge it fully in all seriousness and keep a straight face.

US designers William Conrad and Lewis Johnson have bared their souls in the design of the *Premier Seven*. Cliché or no, it can justifiably be claimed to be their personal statement on the 'state-of-the-art' in pre-amplifier design. And as if the high price wasn't enough to convince you, the merest glance at the product is enough to confirm that this is a preamp designed without compromise.

Of course, we're talking valves here. We're also talking dual-mono construction in extremis. The top two-thirds of the *Seven* system' (which in fact is one box styled to look like two boxes) comprises separate left and right channel preamps, with separate volume controls and separate rotary switch source selectors. I won't pretend this is a joy – because in day-to-day use it's a cause of considerable annoyance. (Oh, how we suffer, etc . . .) However, to avoid having to constantly turn the volume up and down when changing records or programme sources (which is a real pain when there are *two* gain controls), a 'mute' function has been included; but to have wired in a push-button common to both channels would have been too much of a compromise here, so – you guessed it – there are two mute buttons!

The box at the bottom is the power supply, and if you take a second look at the photograph you'll notice there are two on/off push-buttons. In fact, there are even two power leads which need two mains plugs. That's right; the bottom 'box' is two separate power supplies, one for each channel, held together by a common front plate for rack mounting (if desired).

The two volume controls are custom-built stepped attenuators which switch discrete pairs of resistors, and to ensure correct channel balance the level settings are displayed by two rows of 23 LEDs. A close look inside to study the attenuators reveals that each attenuator is actually two attenuators (!). The part which regulates signal level is physically separated from the part that controls the LED display. I did say this was a no compromise audiophile design . . .

Facilities include four line level inputs plus the phono input, separate Listen and Record functions (so that you can listen to a CD while recording a radio programme, or whatever), and a proper tape monitor loop. Sockets on the rear are all top quality Tiffany RCA phonos. There are two main outputs for bi-amped systems, and positioned next to each disc input socket is a gold-plated ear-

thing post and a small ten-position rotary switch to adjust input impedance between 70ohm and 47kohm.

The audio circuit is an all-valve design, using 12 single triodes in a "zero feedback configuration for superior transient properties". The deployment of a low noise nuvistor input valve means that relatively low output moving coil cartridges can be used straight into the *Premier Seven*. I found there was ample gain for both Koetsu *Red* and Audio Technica *AT-OC9* cartridges, no external step-up transformer was needed, and noise was commendably low. To absolutely isolate the preamp's individual gain stages (three per channel) each stage has its own discrete solid state regulated power supply (FETs). The lower box which houses all the supply components connects to the main preamplifier(s) via two umbilical cords.

Staying inside the preamp, all components appear to have been chosen with the utmost care. There are no electrolytic capacitors anywhere, Vichi resistors are employed in the critical phono stages, and internal wiring is 300 micron linear crystal solid silver cable. Rubber damping rings – 'tube dampers' – are positioned on the valves to reduce microphony, and C-J has taken this a step further by building the circuit boards which house the audio circuitry and associated power supply regulators onto springy rubber mounts. Yes, this is a valve preamp with a floating subchassis! The boards need to be secured with judiciously placed packing wedges before transportation.

The substantial front panels of the *Premier Seven* are exquisitely finished in champagne gold; the rest of the casework is mundane black but extremely solid nonetheless and the panels fit together perfectly – as you'd expect given the £7,669 price tag.

SOUND QUALITY

As must be patently obvious by now, the C-J *Premier Seven* is a gorgeous piece of kit. But like all high-end products you can't just throw it into a system and expect the system to be transformed. High-end audio is all about systems, not just individual components, and like any other preamplifier the *Seven* needs careful matching if the full performance abilities are to be enjoyed. However, given suitable ancillaries, the performance is breathtaking.

Where it really scores, and this took me somewhat by surprise, is in its extraordinary resolving power. The majority of listening for evaluation was with vinyl LPs, but these comments also equally apply to the preamp's performance with CD. The level of detail extracted from the source is quite unlike anything I've heard before, the layering of instruments and voices in recordings being nothing short of remarkable.

This high level of detail has implications

in soundstaging too. When I first encountered the *Seven* in a system comprising a C-J *MV100* power amplifier, Kuzma turntable and arm fitted with Empire *MC2* cartridge, and Energy loudspeakers (a system assembled by Branko Bozic, the boss of UK distributor Audiofreaks), the sound was so far removed from the speakers that it gave the well worn phrase 'out of the boxes' a whole new meaning. Having heard this system first without the *Seven*, what the preamp appeared to be doing was extending the per-

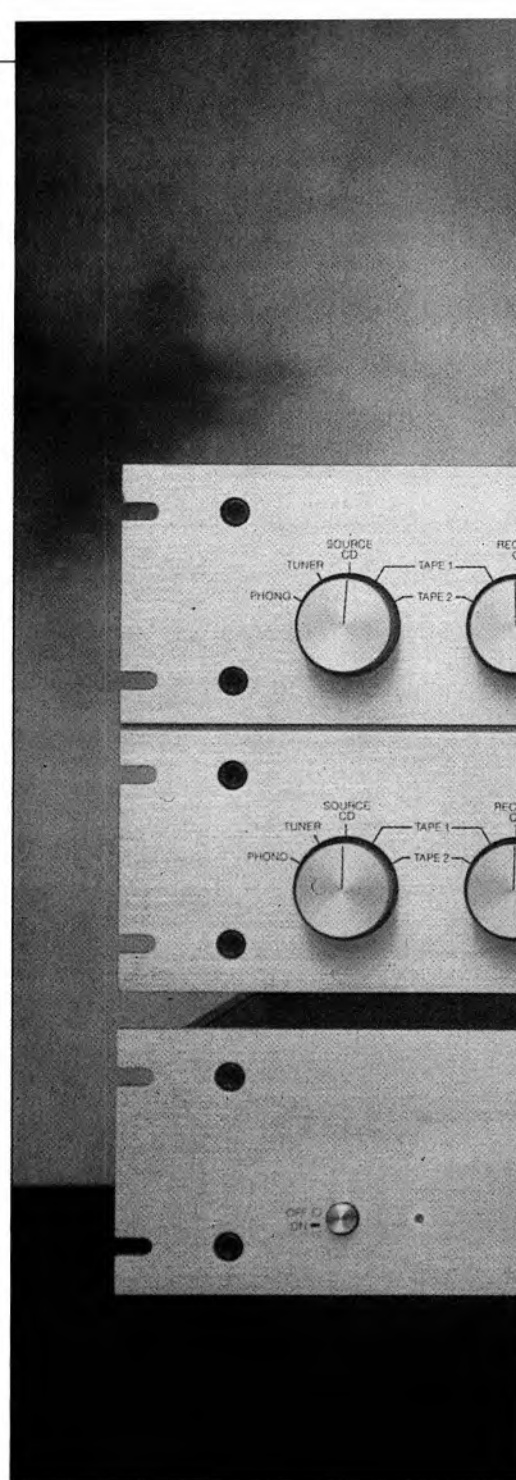

CONRAD JOHNSON PREMIER SEVEN



ceived bandwidth of the sound and projecting it into the room with unbridled power and exuberance. A brief report on this was featured in May's issue of *Choice*.

Having now had the opportunity to enjoy the *Seven* at home for a few evenings, and having experimented with different power amplifiers and loudspeakers (Audio Innovations, Audio Research, Snell, Townshend, Duntech, Ensemble), a fuller description of the preamp's sound is possible. The overriding character is still that of immense detail retrieval, but what's also apparent is a strong sense of poise and control. Compared to the preamp which normally resides in my system, the Audio Innovations *Series 1000* (almost budget gear in this company!), the sound of the C-J is less obviously dynamic and exciting, and it lacks a sense of 'colour' and sparkle. High frequencies can sound a touch 'feathery' and soft, while at the bass end the sound is quite dry and taut. The mid-range is exquisite.

What the *Seven* does is bring individual

voices and instruments into sharp focus and even the busiest and most cluttered multi-track recordings are tidied up and presented in an orderly and controlled fashion. Much of this might be down to the sense of space around the separate sounds which makes listening a stress-free and natural pastime.

CONCLUSIONS

Used in the right system the *Premier Seven* has you rediscovering recordings which you thought you knew intimately. It puts a new perspective on things and allows you to listen into the soundstage in an enthralling manner which you probably never thought possible from a hi-fi system.

It would be an oversimplification to say that the *Seven* sounds squeaky clean, like a high quality solid state device, though with the warmth and 'soul' of the best valve designs – but I can't think of any other way to describe it.

Like the Goldmund *Mimesis 2* preamplifier reviewed elsewhere in this issue, the

price is clearly ludicrous. After all, £7,000 buys a perfectly adequate family motor car! But if you're prepared to go this far in your search for audio nirvana, the Conrad-Johnson *Premier Seven* is undeniably a product which reflects the designers' labour of love – that of producing the most transparent and musical sounding component possible, regardless of cost – and any audiophile would be proud to own it given half a chance. Sadly, most of us can but dream . . .

GENERAL DATA

Size (height x width x depth)	(preamp) 7 x 19 x 16in (power supply) 3.5 x 19 x 15.75in
Weight	60lbs
Gain (phono stage)	40dB
(line stage)	29dB
Maximum output	20V RMS
Output impedance	<200ohm
Typical price inc VAT	£7,669

Reviewed by John Bamford
Audiofreaks, 15 Linkway, Ham, Surrey TW10 7QT. Tel: (01) 948 4153.



FOUNDER MEMBER

All good ideas radiate

With 5 totally segregated demonstration studios and with a range of quality chosen electronics to suit most budgets Hampshire Audio is best equipped to demonstrate the character and value of loudspeakers

Hampshire Audio Ltd

Kingfisher House
2-12 Hursley Road

Chandlers Ford, Hants SO5 2FU
Tel: 0703 265232/252827



SUCH AS
THE MISSION 761



We stock selected items for: Aloi, Audiolab, A&R, Audio Technica, B&W, Celestion, Celet, Cliff Stone, Creek, Cyrus, Denon, Dual, Gale, Goldring, Gyrodek, Heybrook, Hunt, Infinity, Jordan, KEF, Koetsu, Linn, Marantz, Mark Levinson, Maxell, Meridian, Michell, Mission, Monitor Audio, Monitor PC, Musical Fidelity, Nagaoka, Nakamichi, Ortofon, Perreaux, ProAc, QED, Quad, Revolver, Revox, Rogers, Rotel, Sennheiser, Snell, Stanton, Supex, Wharfedale, and others. Active systems on demonstration.

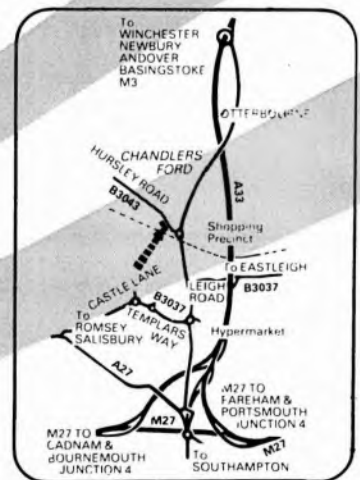

OPENING HOURS
10AM-6PM
(8PM THURSDAY)
CLOSED MONDAY
Except in DECEMBER



U pmarket electronics equipment from the Swiss-based Goldmund company usually comes in classy slimline packages - for example, the amazingly elegant *Mimesis 3* stereo power amplifiers: 130watts per channel, double mono in a rack width case just 5cm (2-inch) high. Long awaited, the matching preamplifier is now available, designated the *Mimesis 2*, costing a substantial £7,000 in the UK. The fine power amplifier is currently £4,750.

The *Mimesis 2* has been thoughtfully designed and incorporates some design features relevant to the Goldmund range as a whole, plus some others which could well benefit any system. In common with many high-end preamplifiers, the *2* has a front panel phase invert switch which may subtly improve the sound of some recordings in a system of sufficient quality. One special feature is the removal of the analogue disc section to a separate small box which may be remotely sited near the turntable - or, in the case of the Goldmund *Studio* record player, there is the option to fit it within the plinth. The associated special cabling (with phono plugs as alternatives) is connected directly to the Goldmund tonearm mounting. In this manner the delicate moving coil signal is transmitted to the active amplifier/equaliser circuitry with a minimum of loss and a maximum dynamic range. A top quality auxiliary signal cable is then required to link the remote box back to a line input of the preamplifier.

As a combination the total price is in the region of £7,000, with the line preamp alone costing £5,500. The latter unit offers a total of five line inputs (one for the phono preamp) and two tape monitor loops. Connections are all phono while a further set of connections are available to the all-important remote control. When obtainable, the remote facility will distinguish the *Mimesis 2* from most other audiophile designs. A further rear panel control allows the 'phase' of the mains connection to be switched. This, plus the flexible grounding arrangements, should cater for any system requirement.

The smoothly acting front panel controls include input select, tape monitor and tape dubbing, phase invert, mono, mute, balance, volume and power. I did not favour the action of the volume control as it didn't provide a uniform level distribution with rotation. Near zero, one channel dropped out, while at 1/3 rotation, there was a large 'step' increase in volume. Given the substantial line gain, this resulted in problems with a high level CD source when used with a medium sensitivity power amplifier. I would have expected better from a design at this price level. Notwithstanding this objection, the build quality and finish of this Swiss made design was first rate.

LAB REPORT

Very good performance figures are claimed and met for the *Mimesis 2*, save in one respect. The line output was perfectly flat over the 20Hz to 20kHz range (and beyond, eg -1dB at 200kHz) but the disc input showed an equalisation error under standard test conditions (6ohms source). Referenced to 2kHz, the response was perfectly flat to 50kHz (-0.2dB by 200kHz) with no ultra-

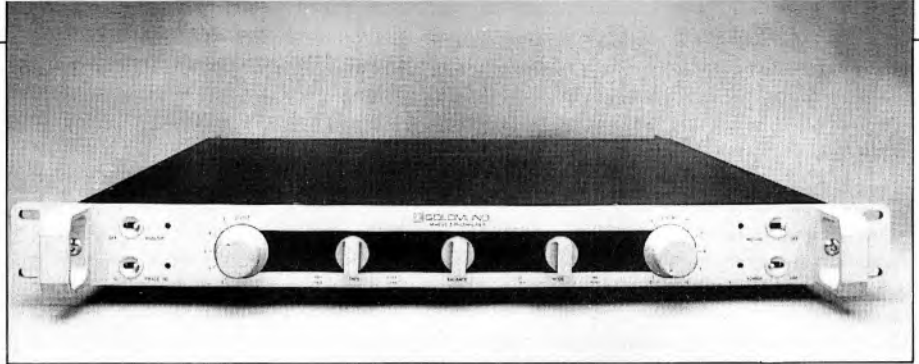

GOLDMUND MIMESIS 2

sonic roll-off, but it showed a +1.2dB shelf lift over the 20Hz to 300Hz range - definitely audible in terms of tonal quality. Referred to IHF input levels, the moving coil input noise was satisfactory at 67dB while the line inputs reached 83dB (CCIR ARM) DC coupled, no DC offset was present at the output connections. Mild intermodulation was observed via the MC input, which was considered harmless at -60dB, 0.1 per cent. Via line, an excellent -94dB was recorded. Harmonic distortion was negligible over 20Hz to 20kHz, typically better than 0.005 per cent.

SOUND QUALITY

Assembled as part of a high quality listening chain including bi-amped Apogee *Duetta Signatures* driven by Krell *KSA 80s* and, appropriately, a Goldmund *Studio* Turntable with *T4* arm and Koetsu *Red Signature* cartridge, the *Mimesis 2* performed very well. Working from extended personal experience with the *Mimesis 3* power amplifiers, it was obvious that the *2* was wholly compatible, and since it delivered a still higher standard, in keeping with the general character, it did not compromise the power amplifier performance in any way.

Holding up well in comparison with the current series of *SP1 Mk 2* and Cello *Audio Suite 'Premium'* preamplifiers, the *Mimesis 2* has its own blend of attributes and its own story to tell. Taking the line output first, this was judged to be close to neutrality, wide in frequency response and excellently taut and controlled over that range.

There was an air of Swiss precision about the sound, allied to a firm, stable soundstage, a level of focus bordering on excellent, and a clean, 'open' treble. Firm and articulate bass lines were evident, together with a very good degree of transparency and clarity, coupled with fine stereo soundstage width and depth. When compared with a direct line path the *Mimesis 2* could be heard to have a slightly 'dry' quality.

With analogue disc (the unit is self matching for a wide range of high and low output moving coil cartridges) the tonal balance shifted a little, showing a darker, richer effect, more so than the intrinsic difference usually observed between analogue and digital sources. Bass was powerful and deep, yet

retained that dynamic expressive quality. High levels of musical detail were present throughout and apart from the mild tonal difference the disc section sounded very similar to the line stage.

Only the most critical comparisons showed that the *2* possesses a touch of 'haze' in the treble, very slightly exaggerating sibilance and upper register transients. Audible grain was considered to be low - few other audiophile preamps match it, never mind exceed it in this respect. The sense of dynamics, rhythm and pace was very well presented, very satisfying in practice, even though a couple of competing examples such as the ARC *SP15* and the Krell *KSP7B* do offer a little more dynamic expression and pace.

CONCLUSIONS

Some minor anomalies were uncovered on test - unexpected considering the price and quality level involved. However, these were clearly not prejudicial to the sound quality, which was most definitely in the reference class, particularly when properly installed with the phono amplifier incorporated in a Goldmund turntable. The value is unexceptional, but the quality is very high and this is a worthy addition to the range of available audiophile preamplifiers.

TEST RESULTS

Total harmonic distortion, at rated power, aux/CD input	20Hz - 84dB	1kHz - 88dB	20kHz - 84dB
Intermodulation, 19/20kHz, rated power, aux input			- 94dB
Intermodulation, 19/20kHz, at 0dBw, disc (MC)			- 60dB
Noise			
Disc (MC) input (IHF, CCIR weighted)			- 67dB
Aux/CD input (IHF, CCIR weighted)			- 83dB
Residual, unweighted (volume control at min)			- 86dB
DC offset, preamp		left 0mV, right 0mV	
Input overload	20Hz	1kHz	20kHz
Disc (MC) input (IHF)	30dB	32dB	22dB
Aux/CD input (IHF)	> 28dB	> 28dB	> 28dB
Stereo separation			
Disc input (MM)	91dB	71dB	45dB
Aux/CD input	103dB	73dB	48dB
Channel balance, disc, at 1kHz			0dB
Volume/balance tracking	0dB	- 20dB	- 60dB
Aux/CD input	0dB	0dB	2.9dB
Input data		sensitivity	loading
Disc (MC) input		0.03mV	3.5ohms
Aux/CD input		26mV	52kohms
Typical price inc VAT			£7000

Reviewed by Martin Colloms
Absolute Sounds Ltd, 318 Worple Road, London SW20 8QU.
Tel: (01) 947 8160.

JEFF ROWLAND COHERENCE ONE/ MODEL 7

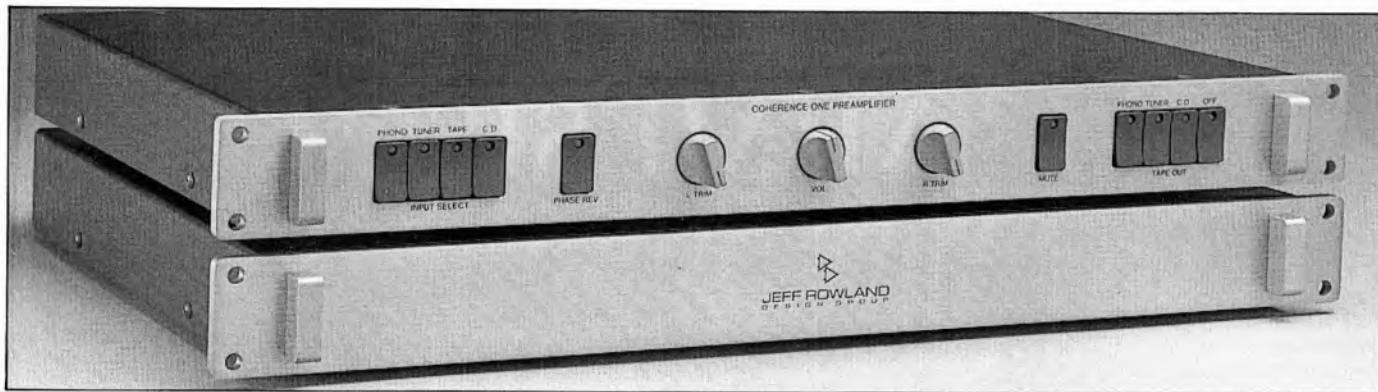

Now imported into the UK by Gamepath Ltd (the company behind Rotel), Jeff Rowland's impressive range of pre/power amplifiers are worthy competitors for established favourites like Krell and Musical Fidelity. Only one preamp is available, the two-box *Coherence One*, while the gargantuan *Model 7* monoblok power amps represent the pinnacle of JR's design work. The latter were first produced around 1984 and have steadily evolved into a very sophisticated design featuring both balanced and unbalanced inputs, a modular J-FET input stage (epoxy sealed), minimum nested feedback and a compound Class A output stage utilising no less than 26 200W ring-emitter output transistors.

The sides of each massive monoblok are flanked by huge alloy heatsinks which run very hot indeed – even the expansive alloy fascia with its chunky grab-handles starts to warm up after a few hours! JR's preamp is dwarfed by the *Model 7*s but still comprises two boxes, one containing the line and MM/MC disc circuitry, the other an outboard PSU. The control amplifier has a single volume control with two (L/R) trim pots that facilitate some 6dB of channel balance.

Two banks of switches are provided for phono, tuner, tape, CD input and rec-out, all of which are routed via local Aromat relays. Disc gain (x100, x320 or x1000) and disc loading is adjusted from within the preamp while disc equalisation is accomplished passively. A total of eight inverting and non-inverting gain blocks are used in the *Coherence One*, each fed from separately regulated supplies and potted in epoxy resin to ensure both thermal and mechanical stability.

Used in differential (balanced) mode, any induced noise or distortion common to both pre/power signal conductors (two per channel) is cancelled out as a function of the Common Mode Rejection Ratio. This is because the input diff amp only responds to

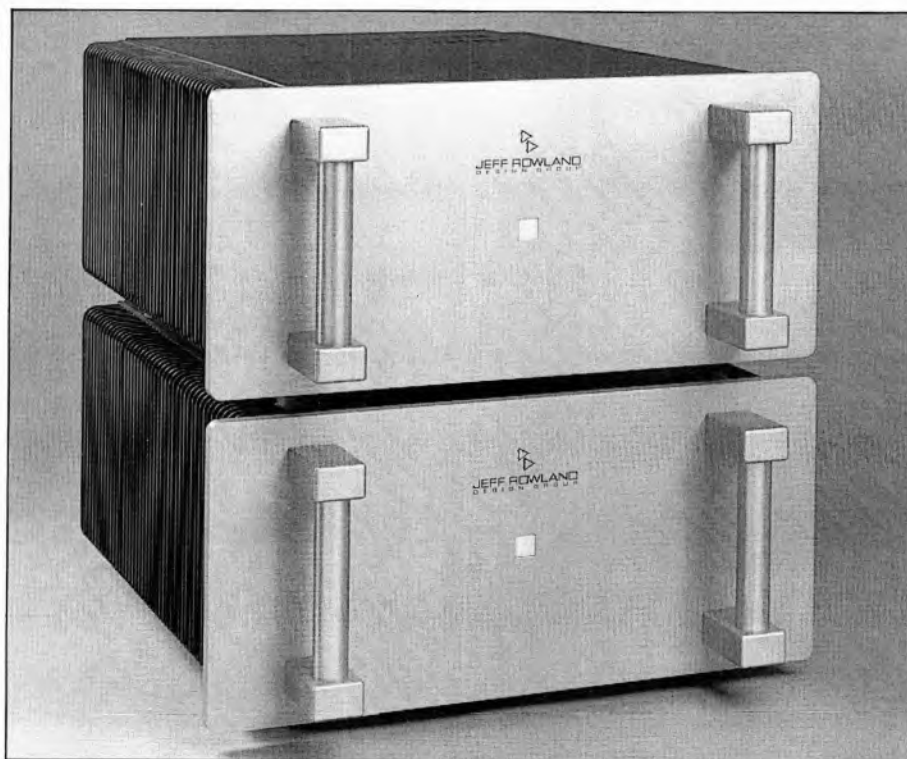

the difference between these two antiphase signals, rejecting signals (hum etc) common to both.

LAB REPORT

Jeff Rowland has succeeded in engineering a wholly second-order distortion characteristic for both line and disc preamp inputs. All harmonic and IM artefacts measured between 0.014 per cent – 0.017 per cent regardless of frequency or level (up to 21.5V out) though IMD in particular did show a greater frequency-dependence via the MM and MC disc input. The 2nd order CCIR IM product via MC popped up to 0.42 per cent though no trace of higher order distortions was visible. This is a contrived effect and one

that bodes well for good sound quality.

However, the preamp channel separation was maintained to 70dB at 20kHz but the channel balance proved rather weaker with an error of 2.7dB at –60dBV (line). Nevertheless this discrepancy is not uncommon with the exotic Penny and Giles pots used in the *Coherence One*, which are chosen primarily for their fine sound quality and not their tracking prowess! Noise was a low –75dB via the MC input while its 111µV input sensitivity should accommodate even the lowest output MC cartridges. Reducing the disc gain by 20dB to the MM input level of +40dB still yielded a 1V sensitivity of 811µV, sufficient for many medium output MC cartridges.

The matching *Model 7* monoliths bludgeoned the 8ohm test load with an output of 448W, rising a spectacular +2.48dB to 794W into 4ohms. The relay protection circuit tripped on the 20kHz full power tests, requiring the amp to be reset via the front panel, while the strict power supply regulation limited the instantaneous IHF dynamic headroom to +0.76dB or 534W into 8ohm. Unlike the preamp, the *Model 7*'s complement of distortion was principally odd-order at moderate to high power levels and varied from 0.0071 per cent at 0dBW to a worse case of 0.112 per cent at 20kHz (two-thirds power). More impressive (bearing in mind the vast 2.5kVA toroidal mains transformer) was the low -93dB hum and spectacular -128dB A-wtd noise (ref. two-thirds power), quite the widest S/N ratio I have ever measured.

SOUND QUALITY

This potent combination was at its most impressive via the CD input where it recreated highly tactile and stable images, both of vocalists and instruments, that were underpinned by a bass rhythm that was vice-like in its surety. Never bright nor boomy the *Model 7*s combined a delicacy of touch with seemingly bottomless reserves of power. However, they refrained from sounding forward or overly 'detailed', instead the soundstage was always appropriately balanced in a way that most convincingly reflected the acoustic of the recording venue.

A quartet huddled in a small room would be as accurately painted as the grandeur of an orchestra in full swing, the sense of depth and stage width simply fluctuated to accom-

modate the musical occasion. Nevertheless the natural ease of the line stage was progressively 'thickened' via the MM and MC inputs. The effect was not damning by any means but I felt the MC stage, in particular, was somewhat warmer and leaden compared to the mercurial swiftness and crystal transparency enjoyed by the line input. Clearly this is as much a testament to the resolution of the accompanying power amp as anything else, for the overall calibre of the *Coherence One* is matched by few other available preamps.

CONCLUSIONS

At a mite under £14,000 this heavyweight pre/power combination is as much a status symbol as domestic apparatus, though it does go a long way towards justifying this outrageous price with a remarkably solid and coherent subjective performance. When assessed via its flexible disc inputs the combination is only slightly less convincing, though I believe changes are afoot here. Meanwhile, as an exceptionally load-tolerant amp possessing great gusto and musical conviction the *7*s are as close as any to the status of 'ultimate amp' - perhaps the ultimate choice for the Herculean!

TEST RESULTS

PREAMPLIFIER			
	Aux/CD	MM	MC
Stereo separation (20Hz)	109.5dB	85.5dB	90.3dB
(1kHz)	94.6dB	87.4dB	92.5dB
(20kHz)	71.7dB	68.1dB	69.3dB
Channel balance (1kHz, 0dBV)	0.15dB	0.16dB	0.10dB
(-20dBV)	0.45dB	0.12dB	0.10dB
(-60dBV)	2.7dB	3.2dB	4.8dB

Total harmonic dist. (0dBV, 1kHz)	-75.6dB	-59.5dB	-59.1dB
(20kHz)	-76.8dB	-60.4dB	-54.0dB
CCIR intermod. dist. (1:1)	-75.4dB	-60.9dB	-47.5dB
Phase shift (20Hz)	0°	12°30'	8°12'
(1kHz)	0°	50°48'	49°30'
(20kHz)	0°	91°12'	82°0'
Squarewave linearity			-89.6dB
Noise (A wtd, 20Hz-20kHz)	-90.5dB	-72.8dB	-75.1dB
Residual noise (unwtd)	-86.7dB	-64.7dB	-63.3dB
Input sensitivity (for 0dBV)	105.5mV	81.0µV	110.9µV
Disc overload (20Hz)		19.5mV	2.25mV
(1kHz)		125.8mV	17.4mV
(20kHz)		1175mV	157.8mV
(50kHz)		2487mV	215.5mV
Preamplifier output (max)/impedance			21.5V/195ohm
Tape output (max)/impedance			16.5V (disc)/2.5ohm
DC offset, L/R			+3.5mV/+3.9mV
Retail Price			£3750

POWER AMPLIFIER			
	20Hz	1kHz	20kHz
Maximum Continuous Power Output - 8ohms	443.3W	448.4W	445.9W
- 4ohms	788.5W	794.2W	786.1W
Dynamic headroom (IHF)			+0.76dB (534.2W)
Output impedance	0.0287ohm	0.0276ohm	0.0356ohm
Damping factor	278.7	290.2	224.6
Stereo separation (0dBV)			N/A
Total harmonic dist. (0dBV)	-84.9dB	-83.1dB	-82.7dB
(½ power)	-66.4dB	-66.7dB	-58.9dB
CCIR intermodulation distortion (0dBV)			-84.5dB
CCIR IM distortion (½ power)			-76.8dB
Rise time (@ 10kHz)			2.1µsecs
Power bandwidth (< 1% THD)			5Hz - 95kHz
Squarewave linearity			-77.4dB
Phase shift 20Hz			0°
1kHz			0°
20kHz			343°48'
Noise (A wtd, 20Hz-20kHz) 0dBV			-105.5dB
(A wtd, 20Hz-20kHz) ½ power			-127.9dB
Residual noise (unwtd)			-93.1dB
Input sensitivity (for 0dBV)			135.9mV
(for full output)			2917mV
Input loading			100kohm/20kohm/3kohm
DC offset			+15.6mV
Retail price			£4950 (each)

Reviewed by Paul Miller

Gamepath Ltd, 25 Heathfield, Stacey Bushes, Milton Keynes MK12 6HR. Tel: (0908) 317707.

Audio Acoustics

RETAILERS FOR THE ULTIMATE IN FINE QUALITY AUDIO PRODUCTS

AUDIO ACOUSTICS are proud to announce we are the sole U.K. retailer for the unique "REFERENCE VOYD" turntable. It is on permanent demonstration and is the last word in accurate and neutral reproduction of music.

Hearing, is still not believing !!

But if you want the best and have heard the rest, we will let your ears decide!

THE VOYD - its not a reference but has proven to be a Musical Prodigy compared with all other turntables. Again, please don't take our word, come listen!

We also have the complete SNELL range of loudspeakers from TYPE K's ascending to the reference standard 'TYPE A'. These speakers have no match in terms of neutrality and musicality.

Read the reviews! Seen the silly specs!

Then come and hear the Audio Innovation Triode Amplifiers with their awesome dynamic range and musical accuracy. These Amplifiers have no equal; and in terms of value for money are unsurpassed.

AUDIOINNOVATIONS	AUDION	AUDIONOTE
GOLDRING	HELIUS	JPW
MICCHELL	PIRATES	RATA
SYSTEMDEK	VALDI	VOYD

Demonstration by appointment,
Tel: 01-998-9041
Mon-Sat 11am-9pm

AT LAST A WEST
EALING DEALER

THE MICHELL CONNECTION

"The ultimate connectors for all quality speaker cables"

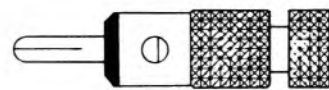

BANANA PLUG

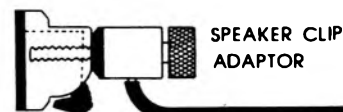
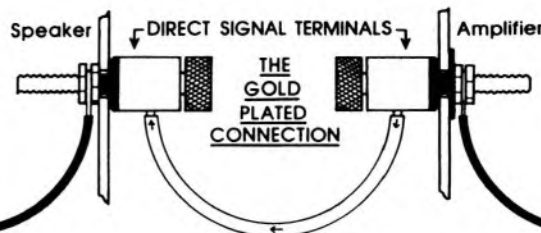

SPEAKER CLIP ADAPTOR

You ain't heard nothin' yet, folks! GET THE CONNECTION!

For details please write:

J A Michell Engineering Ltd
Dept NHS, 2 Theobald Street, Borehamwood, Hertfordshire, England
Telephone 01-953 0771

KRELL KSA-200A

The *KSA-200A* is one of Krell's relatively new range of so-called 'programmable' designs. It's a stereo Class A power amplifier and is rated at 200watts per channel. Both statements require qualification. Krell's power ratings have always been conservative, and considerably more than 200watts is available in practice. However, Krell certifies that 200watts of Class A power is available into an 8ohm load, any headroom above this figure driving the output out of Class A.

Furthermore, power output increases into low impedance loads. It's quite normal with big amplifiers to find that output doubles, or nearly doubles, as the load impedance value is halved, but the *KSA-200* goes well beyond that by continuing to double in output for every halving in load impedance down to 1ohm. Thus rated power output is 400watts/channel into 4ohms, 800watts/channel into 2ohms and 1600watts/channel into 1ohm – and there's still headroom to play with above these levels. Power indeed!

The '200' is also rated for continuous high power operations into sub-1ohm loads (Apogee *Scintillas*, busbars, car starter motors, the National Grid etc), but before it's used this way an adjustment must be made internally on the output protection circuit board. (Please note that this is a dealer-only adjustment.)

I can't help feeling a twinge of suspicion of the Class A claim. The amp does produce a lot of heat, and even after cutting off all central heating from the room it was tested in it was still too warm at times. But it still seems incredible that the amp dissipates enough to justify a 200W Class A rating knowing how

unapproachable even at 15watt Class A valve amplifier can become in the same situation. Nevertheless, Krell is insistent that the '200' is biased hard enough into Class A to provide the rated 200watt/channel into an 8ohm load. And, in fairness, the 1.5kW standing consumption of the amp lends some credence to the claims.

The protection circuitry eschews all fuses in favour of semi-intelligent circuitry which monitors the load and input signal (not to mention operating conditions within the amplifier itself), disconnecting the amp if it senses trouble. Resetting is achieved by turning the amp off and waiting a few seconds. The circuitry is said to be non-intrusive sonically. The protection circuit will normally trip at high levels into such loads unless the internal change is made – not, it seems, to protect the amplifier so much as to protect whatever it's plugged into.

This reconfiguration process for low-Z loads constitutes one important element in the 'programmable' part of the specification. But there is another. Programmable here also means that the *KSA-200* can be changed into a monoblok design with a 400watt/channel rating (8ohms). In this form it becomes – is – a *KMA-400*, which by the way is not a bridged version of the '200'. Each of the two input sockets then becomes an inverted version of the other, and the inputs are fully balanced. The reprogramming exercise is performed free of charge (apart from carriage) on request. They get you anyway, of course – you'll still have to pay the bill for an additional *KMA-400* monoblok. Unless you're heavily into Phil Spector, that is.

The new Krell amplifiers sport massive

convection cooling fins on each side, easily breaking the 19-inch rack mounting dimensions of the old models, but eliminating fans in the process. It's worth noting the size of this amplifier – 23 x 59 x 72cm (h x w x d) – and the weight: over 52kg.

The amplifier's internal circuit topology is Class A right the way back to the input, and the amplifier is DC coupled throughout. The front panel is home to a power switch and LED, the output being connected to the load via a relay for safety reasons. On the back panel there's a pair of phono sockets for the input, and two pairs of outputs – 4mm binding posts connected in parallel for bi-wiring purposes.

The inside story is one of sufficiency taken to excess. Separate power supplies are used for different circuit areas – indeed the story is largely that of its power supplies. Input impedance is 47kohm, which is ideal when running long leads from a low impedance source. Full rated output is generated with 1volt in, and although this sounds alright on paper, sometimes it was impossible to drive the amplifier hard enough when run direct from the output of some CD players using the player's built-in volume control or an outboard passive unit like the QED.

SOUND QUALITY

I have a couple of criticisms of the way the Krell is put together, notably that the large top plate is surprisingly resonant, a comment that applies equally to the heatsink vanes. I also feel the heatsinks constitute a hazard, especially to children, as there are many sharp corners. A mesh cover should have been included in the design.

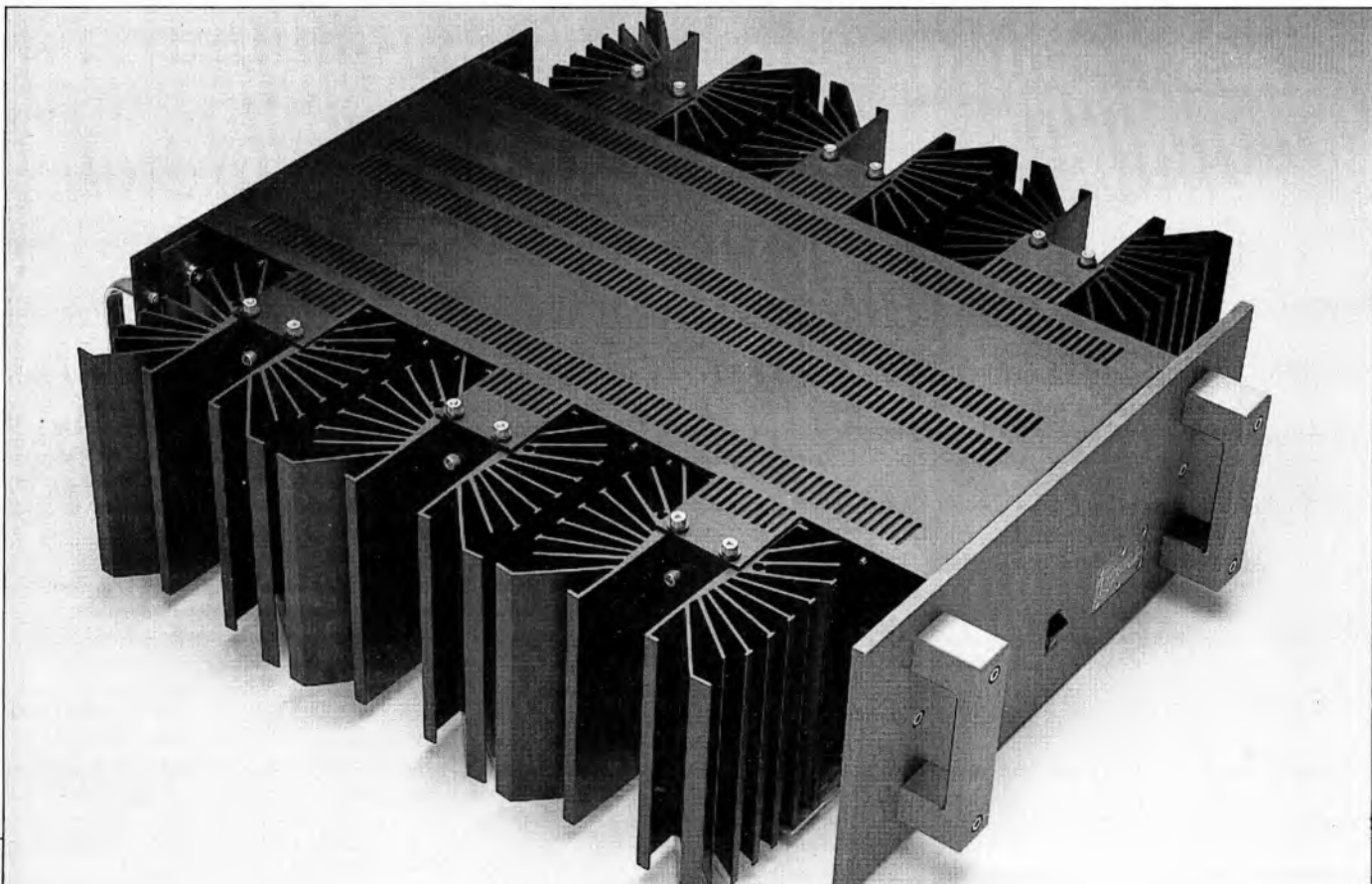

Warm-up is rapid and vice free. The Krell is audibly approachable even from cold and is nearly at its optimum within half an hour or so. It's also utterly silent in use, both electrically and also mechanically. There's no buzzing from errant transformer laminations to spoil proceedings.

It's been suggested in the past by valve devotees that Krell makes transistor amps that sound like valve ones. However, I've yet to hear a valve amp with the dynamics or vitality of this amp, and doubt if many others have either (*except triode users! - Ed.*). The 200 is essentially in a class of its own, though it makes a supremely unglamorous kind of sound that's not as seductive as many big amps.

I had the opportunity to run the Krell with several loudspeakers, including the Apogee *Caliper* and the Martin-Logan *CLS II*. However, the first loudspeaker I used was a Snell *Type E*, a largish two-way dynamic loudspeaker with a sensitivity approaching 94dB/watt/mtr - in other words the kind of speaker that could be driven decently loud by a 5watt amplifier, never mind one generating 200watts. A sledgehammer to crack a nut maybe, but it was impossible to ignore the understated authority and rock solid stability of this amp, even when played at modest volume levels. Yet there was never any trace of heavyhandedness.

The Krell worked consistently with each of the speakers used and always displayed the same basic set of attributes. In my experience the bass end in particular was quite unexcelled, being firm, deep and superbly controlled.

What might come as a surprise is the asto-

nishing subtlety and finesse with which the Krell approached its assigned role. It has a sharp, lively quality with exceptionally fine differentiation and some subtle layering of the stereo soundstage. This subtlety was something of a surprise since there is always the suspicion that when so much is achieved at the loud end of the dynamic range spectrum it must be at the expense of what happens at the quiet end.

Although I have heard more exacting small amplifiers (the DNM power amp is one example) none has had anything like the near universal capabilities or poise of the Krell regardless of the loudspeaker being driven, or the kind of music being played. And there are very few as good as the DNM either. My own Musical Fidelity *A370* held up well in these comparisons, but it offered a softer, more valve-like style of music making, and it didn't have quite the Krell's exemplary energy and vitality.

CONCLUSIONS

The *KSA-200* is an undeniably expensive amplifier in anybody's terms, but it's worth making the point that the real cost of ownership may not be quite as frightening as the raw price figure suggests. For one thing it's exceptionally well made, putting most esoteric amplifiers to shame. This of course implies a long useful life expectancy. Secondly it's backed by what is probably the best warranty in the business: five years parts and labour *including* shipping. This is also transferable to the next and subsequent owners. Those who have ever tried plastering the packaging of one of these amps with enough stamps to get it accepted by the Royal

Mail will realise that value of the last part.

Next, the ability to turn the 200 into a monoblok corresponding to the top of the line Krell amp provides the user with a guaranteed upgrade path for the future. Less tangible but equally important elements in the cost of ownership equation is that unlike many other fine amplifiers, the *KSA-200* should be suitable for any kind of loudspeaker you might consider using in the future, and this includes the fussiest, no matter how reactive, low in impedance (the *Scintilla* sets standards here of course) or insensitive.

I'm going to duck a final definitive statement on the value for money question. I've presented all the information necessary to make an informed decision in accordance with whatever requirements you may have. I have no such compunction about saying how the amp sounds, however. It has panache and finesse, consistency combined with a wide dynamic and tonal range, pinpoint imaging and a real sense of coherence, of wholeness. Most striking of all perhaps was the energy it imparted to the music, and the way it retained the independence of instruments and voices, even using some of the messier commercial recordings that infest today's release lists. However, what the *KSA-200* does not do is glamorise music.

Typical price inc VAT

Reviewed by Alvin Gold

Absolute Sounds Ltd, 318 Worple Road, London SW20 8QU.
Tel: (01) 947 8160.

£5050

The Pinewood Music Company

'Martins', Church Lane, Goodworth Clatford,
Andover, Hampshire SP11 7HL
Telephone: Andover (0264) 57536

Pinewood Music deals only with the world's finest and most exclusive equipment for reproducing music in the home. Some of it is reviewed in this publication.

Pinewood is dedicated to demonstrating and supplying systems that operate at the cutting edge of perfection to give long-term satisfaction and free you from the misery of constant upgrades.

For advice, demonstrations and a very personal service, telephone Brian Rivas at Pinewood Music.

Agencies include:

Apogee, Audio Research, Counterpoint, Goldmund, Jadis, Koetsu, Krell, Krell Reference, Magneplanar, Mandrake, Micro Seiki, MIT, PS Audio, Sicomin, Sonus Faber, Well Tempered Lab

Pinewood Music is a specialist dealer for ABSOLUTE SOUNDS

AT OVER £100 THIS COULD LEAVE YOU FEELING A BIT LIGHTHEADED.



How do we convince you and your wallet to part company with more than a hundred pounds for a set of headphones?

Well, not any old headphones, you understand. These are a bit special (at this price they have to be!)

Do we tell you that the Beyer DT 990 and DT 770 are compatible with compact disc players? Yes, but who doesn't?

Or, do we mention that you can listen to anyone from Mozart to McCartney, while someone else in the room is playing the organ? (an unlikely event, we admit, but you never know what turns people on.)

Perhaps we could persuade you that it will go nicely with other status symbols, like your Porsche.

Wait a minute, though, we haven't mentioned the most important thing, yet. The sound.

If we can blind you with science for a moment, here are just a few outstanding features that should help to convince you.

The DT 990 is an open headphone with an unbelievable frequency response of 5-35,000 Hz. The

unique technology used to achieve the very low mass of the diaphragm and moving coil assembly (only 20% of that found on a typical competitor's headphone), results in an exceptionally transient response and a reduction in the non-linear distortion, qualities normally found only in the best electrostatic headphone.

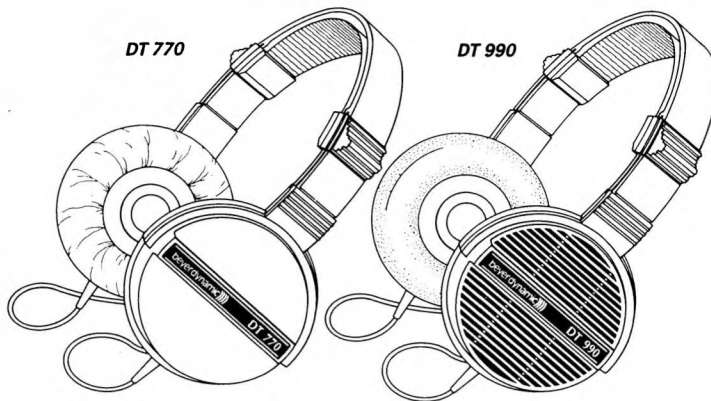

The DT 770 closed headphone combines the latest transducer technology with a unique bass reflex system. This achieves a superb bass response with well defined sound image, plus excellent pulse characteristics.

As you would expect they are both light, very light, and extremely comfortable.

You must hear them to appreciate their real value. You just can't compare them to anything else, simply because there's nothing else quite like them. So get down to your Hi-Fi specialist and listen to the new Beyer DT 990 or DT 770.



Expensive? Yes. Worth it? Yes. Every penny.

Need you hear more.

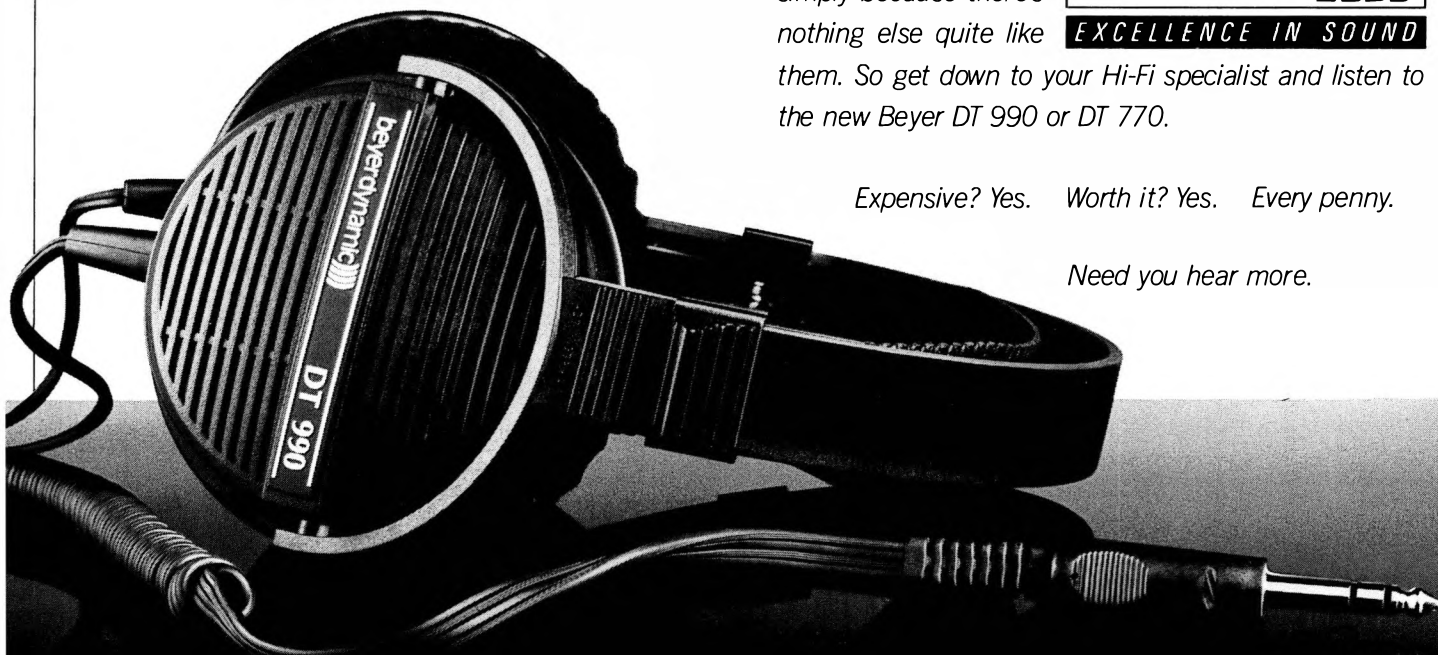

W

here high-end equipment is concerned the USA seems to provide a prodigious output of classy gear. The drawback, from the UK's point of view, is its high price. Import tariffs, exchange rates and high freight costs take their toll, so what may be a sonic bargain on the other side of the Atlantic doesn't always seem such a good deal over here. However, the size of the American market ensures that these companies have a strong commercial base which gives them a high enough turnover to facilitate highly professional research, production and finish.

The Klyne *SK-5A* looks like a classic preamp. It's not exactly minimalist but it doesn't have the regular bass and treble controls. It's a slim, full width, standard rack sized box with the front panel finished in light platinum gold. The metal case has well fitted panels and the sides are finished off with thick, dark stained oak. It sports five knobs and no push buttons – all selectors being rotary. The on/off switch is on the back panel, but this is no problem as the preamp's designed for continuous running. On the front panel are the source selector covering aux/tuner/phono, mode covering tape monitor/source/mono, balance and volume and phase/mute. The source and volume knobs are slightly larger than the other three, while all have the same raised centres to denote position and are luxurious in feel and finish. The single front panel light turns from red to green to denote operation status.

The back panel sports both normal and inverted outputs which are active at all times (for driving balanced power amps), the front panel phase invert switch inverting the phase of both outputs simultaneously. This also provides several other interesting options – driving a stereo power amplifier with one channel out of phase and reversing the phase of one of the speaker connections reduces the peak current drain on shared power supplies in the amplifier and creates a more even demand. Driving ordinary stereo amps in bridged mode without extra circuitry, providing it is suitable for such treatment, is also possible.

The *SK-5A* has been designed to give an exceptionally versatile interface/gain stage/equalisation for phono cartridges by providing a large number of preset variables set via internally located dip switches.

Input impedance values range from 150ohm to 47kohms in 12 steps covering most every sensible load, the capacitance from 110pf to 650pf in five steps, the gain of the MC disc stage from 22 to 34dB in four steps, the high frequency roll-over frequency from 12 to 50kHz in ten steps. Finally line amp gain can also be changed from -14dB to 20dB by plugging in appropriate resistor values (supplied) in the available sockets on the pcb. When high output cartridges are used the MC gain stage is bypassed.

The phono stage uses two hybrid gain blocks encapsulated in small modules, there using a mixture of passive and active components for the RIAA equalisation. The line amp is another of these encapsulated gain stages which is followed by a buffered DC coupled output stage. The printed circuit board is neatly laid out and really looks the part, so much so in fact that, as an optional

KLYNE SK-5A



extra, a clear Perspex lid is available to show it off.

LAB REPORT

Distortion of the line inputs is very low especially in the midband, and intermodulation is also pretty well suppressed. At minimum gain settings, with the MC module bypassed, the intermodulation distortion products are still well down at -65dB and not too bad at the maximum MC gain setting, with -54dB recorded.

Noise performance is good on the line inputs and acceptable on the MM setting. With the MC input set to maximum gain a figure of -62dB was recorded which while acceptable could be better. DC offset on both the tape and main outputs is negligible which is excellent, considering that DC coupling is used. Input overload is generous on all inputs and on all settings when gain is sensibly adjusted to input levels. Stereo separation on the line inputs fell at a rate of 6dB per octave over the audible frequency range, with some capacitive interactions between channels. However, at 20kHz this still measures a perfectly acceptable 52dB.

Disc input channel balance is excellent and volume control balance tracking is superb with no error noted whatsoever. The 600ohms output impedance is to specification and up to 10.2V is available before it clips. All sensitivities are variable with sensibly chosen ranges.

The frequency response on the line inputs is flat and extended and the RIAA was almost perfectly engineered on the 'flat' setting.

SOUND QUALITY

The system used to assess the Klyne comprised Krell *K5A 80* and Sumo *Andromeda II* amplifiers, a variety of top ranking CD players, van den Hul *MC-Ten* and *MC-Two* cartridges, Rega *RB300* tonearm, Linn *Sondek*, Apogee *Duetta Signature* and Celestion *SL700* loudspeakers with top quality cable.

On the line input the *SK-5A* attained a decent if not exceptional score. Comparisons were made with a couple of top audiophile preamplifiers namely the Pink Triangle *Pip II* and Musical Fidelity *MX*, both of which are at similar price points. From the CD driven line input the Klyne showed itself to

be well above the mainstream of sensibly priced units, but was unable to compete with the best British designs.

Tonally the *SK-5* proved to be generally well balanced. The midrange is quite fast and detailed but at the same time I detected some slight hardness in the upper ranges of the midband. The treble is detailed in its presentation of the main structure of the music played, but it lacked some measure of ambience and showed a hint of imprecision and grain. The bass is somewhat indistinct, lacking in slam and speed. Its ability to produce good rhythmic coherence is well above average, but not as tight in this respect as may be hoped for at this level.

On the disc input I used the high output van den Hul *MC-Two* to drive the moving magnet setting, avoiding the moving coil gain stage completely. Here the midrange has a lush musical texture devoid of the previously noted hardness, but in achieving this it's too rounded, losing attack and definition.

Although the stage created has good width and fair depth, it doesn't seem to have any ability to create acoustic space around performers. However, images are well located, in a conventional stereo sense, and its tonal balance is pleasant enough.

Using a low output moving coil cartridge (vdH *MC10*) the extra gain stage had to be switched in. In real terms, allowing for the change in cartridge, it displayed a similar performance to that reported above.

CONCLUSIONS

The *SK-5A*'s presentation and build quality is first class and its finish makes a pleasant change from black which is currently so prevalent. Technical performance lives up to expectation and its facilities make it much more versatile than most. The sound quality is very good and, up to only a short time ago, it would have been close to the best available. However, certain homespun products, as well as the best of the foreign competition, have set very high standards and it's up against stiff competition.

Typical price inc VAT

Reviewed by Chris Bryant

Audio Dimensions, 506 Upper Newtownards Rd, Belfast, N Ireland
BT4 3HB. Tel: (0232) 655135.

£2990

Of all the indigenous amplifier manufacturers, one has grown from nowhere to become one of the largest within a few short years. MF's growth has been achieved on the back of an extremely wide and still fast evolving product range based on designs which owe their fundamentals to errant genius Tim de Paravicini and their practical realisation to the boss, Antony Michaelson, who is well renowned for not suffering fools. Musical Fidelity was early to learn that its amplifiers should be packaged with a degree of professionalism previously associated only with the more prestigious imported brands, and it's against such yardsticks that the *A370* and *MVX* most readily compare.

The 40kg-odd *A370* is the penultimate power amplifier in the range, and in the company of brands like (say) Krell, Audio Research and Rowland, it carries a good deal of conviction, partly because a degree of parallel thinking is evident in the way they have turned out. But Musical Fidelity, which is based in the UK and not thousands of miles away, has the edge on pricing. The *MVX* is Musical Fidelity's most costly and exacting preamplifier, and a natural match for the *A370*.

If you're quick, you'll be able to buy an *A370.2*, the current version, for £2,299, as it's soon to go up to £2,499. The preamp costs £2,299 and should stay at this price for a while.

The *A370.2* represents a rejigging of the original *A370* in ways which have had quite a large effect on performance. The most impor-

tant changes have been made at the input, which in the old design consisted of an *LM110* op-amp, and is now a *LM318* with a long tail pair differential front-end, fed from a new constant current power supply. Electrically this is worth approximately 6dB extra on the signal/noise figure. Sonically the objective was to sweeten up the sound somewhat and to sort out the bottom end, which could be a little lacking in control under certain circumstances.

There's also been some tuning of the power supply, and although the output stage has a similar topology, power output has been reduced from in excess of 250watts to 150 watts/channel (but you'd never know), concurrently with a significant increase in standing current. The higher standing current means it dissipates more and runs hotter, providing a room heating effect equivalent to a small to medium size central heating radiator. The *A370* operates deeper into Class A than its predecessor.

The *MVX* preamp was conceived as a valve preamplifier executed using solid state devices, thus avoiding the usual valve problems – noise, unreliability, inconsistency, lack of longevity etc. The 'valve like' claim is a common one and usually spurious. It isn't here. The *MVX* uses FET gain stages almost throughout, and what amounts to a valve power amp using transistors in the line output stage which is coupled to the output through a line output matching transformer. Another very fine quality transformer is used in the MC input stage. Consequently the *MVX* has a very low output impedance and drives the line output in a form of balanced

operation. It seems largely oblivious to the types of interconnect used, as long as the copper is of reasonably high purity. However, line input impedance appears to be low, and this should be borne in mind when choosing source components.

Each stage of each channel has its own regulated power supply. The power supply section takes up much of the room inside and is more complex than the audio circuit itself. There's also a large, heavy outboard 'black box' supply which feeds power to the whole amplifier. The audio circuit is very simple, but there's evidence of careful choice of capacitors, potentiometers (Alps) and other components. The *MVX* really hasn't altered much since it was released, apart from changing component sources and other such matters of detail.

Power amp facilities are limited to a front on/off switch (there is no output relay, but DC offset levels are negligible, even at start-up), a pair of input phonos and output 4mm binding posts doubled for bi-wiring. The output terminals can be broken – I even managed to prove it on test. The preamp has inputs for MC and MM cartridges (switch selectable at the back, with parallel loading sockets for the MC input), tuner, auxiliary, CD and tape (with true off-tape monitoring). On the output side, there is a single output phono pair. Facilities in between include source switching, balance and volume control, and – usefully – a phase invert control. The power switch acts more like a standby switch.

Both items are exceptionally well built. The power amp carcass now consists of flat panels with angled edges which bolt to adjacent panels, with massive heatsinks clamped to each side. Fan cooling isn't needed. The front and (now) rear panels are fully engineered alloy slabs, and the whole amplifier is subject to a superb anodised black finish. The preamp follows a broadly similar pattern, and like the power amp resists 'ringing' when tapped. It has a similar presentation with solid matching rack mounting handles. In both cases the final effect is extremely luxurious.

SOUND QUALITY

The *A370.2* tested is the author's own, having recently been exchanged for one of the original opus. In its period of residence (around three months) it's been used extensively with many loudspeakers, including Apogee *Calipers* and Snell *Type Es*. The Apogee and Snells represent the extreme limits of what the power amp is likely to encounter in practice. The Apogee, a full range two-way ribbon design, is extremely low in sensitivity and has a low characteristic impedance with some reactive crossover elements. Its rather flowery bass quality demands the utmost control, but it reacts badly to the strangulation imposed by many solid state amplifiers. It needs room to breathe. The Snell, by contrast, is a highly sensitive and apparently straightforward load with a rather analytical nature that makes qualitative rather than quantitative demands, especially in the middle and upper reaches of the audio passband. Hardness in the system driving it is ruthlessly penalised.

The two Musical Fidelity products could have been purpose designed for either of

MUSICAL FIDELITY MVX/A370.2





these loudspeakers. Like most MF products, from the smallest integrated design (*A1*) upward, they share a warm and lucid bass end that contrasts with the dry sterility of many others. Although it had great stature and presence, the original *A370* sometimes appeared to lose the edge of control. This has been tackled positively in the current version which breathes naturally and still has an outgoing bass quality with a heartstoppingly deep, powerful delivery when the music really demands. However, any suggestion of loss of control or of rhythmic ability is firmly in the past. The easy, free-breathing LF capability is shared with the preamplifier, and is apparent through all inputs from moving coil to the line and tape stages.

The *A370* is improved elsewhere too. The lower noise floor is not immediately apparent since the last version was far from having an obvious noise problem, yet it was clear from the outset that the design gives a more contrasty and better differentiated style of music-making than before, abilities which were at their most notable with large scale works. Orchestral cellos and basses for example sound deeper and more sonorous, pianos are more obviously solid and the vocal sections of choral music (The DGG Alexander Nevsky/Abaddo recording was a test piece here) has altogether superior stature, separation and what can best be described as freedom from the means of reproduction.

Both pre and power amplifiers are remarkably free of glare or grain or any of the usual range of ills that amplifiers imprint on the music. I was particularly pleased by this since generally the bigger and more ambitious an amplifier, the more it tends to suffer

from such failings, even though other performance aspects may benefit. In this respect the claimed correspondence between (in particular) the *MVX* and a good valve preamp is quite believable.

I wish to draw attention to one other feature of the Musical Fidelity combination, one that applies to each item on its own to very much the same extent as it does to the combination. In ways which are not easy to pin down, I found the sound surprisingly unobtrusive. They offer a remarkably lifelike quality even with the volume turned down very low (I'd pick the preamplifier as being particularly impressive here). There's a generosity about the sound. Without sacrificing detail, there's nothing that could be described as hard edged, and systems built around them tend to be very easy to listen to. Yet the sense of tangibility was remarkably high.

It goes without saying that image placement is extremely good, as it often is with amplifiers costing the best part of £5,000. What is slightly more unusual is the generous image scale and presence and the excellent handling of the range of subtle clues that define the aural fingerprint of the recording venue. The Musical Fidelity components don't merely image well, they place the images in a believable context.

CONCLUSIONS

The pricing of both items, whilst high measured absolutely, is low measured against the natural competition. As far as I can judge, they are even good value on a materials cost plus basis, at least when compared to other

similar amplifiers. Both pre and power amps are now built to a standard that is compatible with their world class status for sound quality, and finish is almost in the same class.

If there are disadvantages, they lie in the traditionally excessively short model lifetime that tends to knock secondhand values for six. There has also been some talk of poor reliability and servicing, though not necessarily with these two products. I've had no problems with my own *A370*s though a colleague did have a problem with an early one, which was quickly cured. And I have no long term experience of the *MVX*.

Moving on to sound quality, the designer's stated aim was to produce something valve like, that would sound sweet and warm without aural harshness. The almost self-effacing *MVX* was not designed to be the world's most obviously dynamic amplifier, and in fact it sounds something like a superior *A1*, being particularly impressive at low levels with a deep, strong bass which however stops well short of dullness or 'bloom'. The power amp is very much in keeping with the same precepts, especially in its current guise, though it's perhaps a more neutral component on the whole. In both cases a lot of emphasis has been placed on getting the fundamentals right, and in my judgement both do just what is claimed. They are at the pinnacle of British high fidelity achievement in solid-state design, and can be confidently Recommended.

Typical price inc VAT

Reviewed by Alvin Gold

Musical Fidelity Ltd., Unit 16, Olympic Trading Estate, Fulton Road, Wembley HA9 0ND. Tel: (01) 900 2866.

£2299/£2299



Made to measure Hi-Fi

To get the perfect suit, you wouldn't walk into the first shop you see and buy the first one you saw.

And if you were discerning, and required a suit to fit you perfectly you'd probably try made to measure. Just as every human body is different, so is every human ear. That's why we believe the closest thing possible to Made to Measure Hi-Fi is the Hi-Fi Experience.

An incredible selection of the finest systems.

We've the greatest selection of the very best systems technology has to offer.

To measure you up for one, we'll sit you in one of our demonstration rooms where you can hear a system or any combination of separate pieces of equipment in private.

Free Fitting.

Most retailers will deliver a pile of cardboard boxes to your home, we won't! We have a team of trained installers who will not only deliver your system, they will also install it to your satisfaction before they go.

14 day exchange period.

We are 100% confident that you will be absolutely delighted with your system, so much so, that we promise you can exchange it without quibble, within 14 days if this shouldn't be the case.

2 year guarantee.

Finally, in addition to your statutory rights, we'll give you a full comprehensive two year guarantee regardless of any manufacturers guarantee.

We think you'll now agree, we're a very different type of hi-fi company. So if you have good vision, an ear for music and a nose for good value, call in to see us for the most sound advice.



HI-FI EXPERIENCE

You'll like the sound of us

LONDON

Tottenham Court Road, London W1
Lion House, 227 Tottenham Court Road
Tel: 01 580 3535

Open as usual during refurbishment.

Our Lion House branch is currently being extensively refurbished to be the hi-fi store for the nineties. Don't be put off by the scaffolding, most of the new stock is already in, and we're open for business as usual.

Alfred Place, London WC1

32/34 Alfred Place, Store Street Tel: 01 631 4917

Camden, London NW1

2/4 Camden high Street Tel: 01 388 1300 (round corner form Mornington Crescent tube)

YORKSHIRE

Bradford Rawson Square (near John St Market)
Tel: 0274 309266

MIDLANDS

Birmingham Superfi, 67 Smallbrook Tel: 021 631 2675
Leamington Spa 49 Park Street Tel: 0926 881500

SCOTLAND

Glasgow 145 Bath Street Tel: 041 226 4268

Sumo amplifiers are relatively new to the British hi-fi scene. While the UK has its own plethora of small manufacturers indulging in fierce competition, so it is in the States. UK sourced components are generally competitively priced, so by the time an importer has paid the freighting costs, import taxes and taken on the vagaries of currency exchange rates, the competitive edge of all but the best of USA output is lost.

However, those importers who are able to carefully select competitive products can, under the right currency exchange conditions, bring attractive products into the country. Sumo is 'budget audiophile' gear in the States and once the sterling transition has been made it's no longer budget equipment, but still offers value for money in terms of our domestic market. The comprehensive line-up of audio gear brought in by Acoustic Gold starts at almost affordable prices. The *Andromeda II* is one of the larger Sumo power amps rated at 200watts per channel.

The vision conjured up by audiophile power amplifiers with high output levels is of huge hernia inducing monsters, with prices which will rupture your bank balance, and styling and size which will disturb domestic harmony. Against this the Sumo seems almost unassuming. For one thing, as it weighs a mere 23kgs, you can move it about without a forklift truck. At £1,500 it's not expensive audiophilia and it won't put your average yuppie's bank manager's nose out of joint. It will even fit in with the domestic arrangements of 'normal' sized houses. So, even before review, the product has positive points, although these will come to nought if the little (comparatively) black box doesn't deliver the goods.

The casework all fits together nicely and is made from anodised sheet alloy with a fine grain finish, in a greyish black colour. The back panel is simple enough, although there are one or two extras. There are two gold plated RCA phono input sockets per channel and as in current American fashion there's also provision for balanced operation.

When connecting the unit to a conventional preamplifier the inverting inputs can be shorted using the plugs supplied. The amplifier will then work as normal. When balanced differential operation is called for the shorting plugs are removed and one pair of interconnects per channel are needed.

The amplifier uses full-wave balanced-bridged circuitry which means there are no common grounds except at the input. Where common earths are used, for instance headphone boxes and the like, this amplifier is unsuitable. Internally there are no protection circuits or current limiting; MOSFETs have a negative temperature coefficient so are self-limiting. However, circuit breakers are used in the line.

LAB REPORT

The intermodulation distortion results are exceptional with -100dB recorded at rated power. The response is perfectly flat from 10Hz to 20kHz and gently rolled off thereafter - a mere 2dB down at 200kHz. Harmonic distortion is very low in the midband, even at the rated power of 200 watts (23dBW), and still low at the frequency extremes. Channel separation is at worst



SUMO ANDROMEDA II

67dB at 20kHz and slightly better at lower frequencies. The CCIR/ARM 1kHz weighted signal to noise ratio is good with a figure of -93dB ref 0dB and -115dB ref full level. Channel balance is perfect whilst the input impedance is a reasonable 42kohms and low in capacitance. Input sensitivity is exactly to manufacturer's spec at 130mV RMS for 1watt output and 2.7V promoted programme clip.

The *Andromeda* proved exceptionally powerful, and exceeded manufacturer's spec by a commendable margin. A full 26.4dBW or 437 watts is available across the audio bandwidth into 8ohms with one channel driven and 26dBW is maintained into 4ohms. This is the equivalent of 800watts of unclipped sine-wave so it's a veritable power house of an amplifier for £1,500.

SOUND QUALITY

As the test results suggest the Sumo has immense power. It's capable of driving insensitive loudspeakers to very high levels and in this department is hard to beat for the money. It gives the impression of sounding big, loud and effortless, but it's not high definition in the way that Audio Research, Krell or indeed some other amps from the Sumo range are. The bass is just a little soft - it's perfectly respectable and reasonably articulate, but it doesn't have the grip, pace and sheer slam of some of its competitors.

The midrange is easy, with a relaxed, musical quality and good level of clarity and naturalness. It doesn't accentuate any one area, and tonally must be judged particularly well balanced. Perhaps it's just a little soft for its own good - I detected not only a loss of speed and attack, but also an inability to resolve the finest detail. The high frequencies are a tad splashy, but quite revealing. At no time did any of the listeners detect any harshness or unwanted edge.

With complex music the Sumo has a habit of modulating detail. By this I mean that if there are soft and loud instruments in the same passage, the louder one has a tendency

to mask the quieter one. Many amps do this, including some highly rated models, but there are some which manage to preserve all the detail without problem.

The *Andromeda*, however, is transparent with a big soundstage in all dimensions and it gives a good impression of scale. Generally it's a very pleasant sound and should be easy to live with.

CONCLUSIONS

The Sumo *Andromeda II* is exceptionally well made, and of surprisingly modest dimensions considering the large amount of power available. The lab performance showed that it easily achieves its specifications, and then some. If you need this sort of power then this amplifier is sufficiently neutral and proficient to make it recommendable.

Rated power 8ohms Measured power (at 240V AC 50Hz)	200W; 23dBW (level ref. 1W)		
	20Hz	1kHz	20kHz
Continuous 8ohms 1 ch.	26.4dBW	26.5dBW	26.4dBW
Continuous 4ohms both	26.0dBW	26.0dBW	26.0dBW
Burst 10ms 8ohms 4ohms	—	26.5dBW	—
Output impedance	n/a ohm	n/a ohm	n/a ohm
Harmonic distortion			
Rated power 8ohms at 0dBW 8ohms	-76dB	-84dB	-67dB
Channel separation	75dB	68dB	67dB
Intermodulation distortion (19/20kHz 1:1)	rated -100dB 0dBW -93dB		
Peak current via 1ohm 2.2µF 2m sec pulse	not measured		
Signal to noise ratio (full gain)	rel. 0dBW	rel. full level rated	
22Hz - 22kHz	-75dB	-97dB	
'A' wtd	-93dB	-115dB	
Channel balance	0.03dB		
Input impedance	42kohm	160pf	
Input sensitivity	128mV IHF, 0dBW		
DC offset, L,R	n/a mV	n/a mV	
Frequency response	-0.5dB <10Hz to 70kHz; -3dB <10Hz to >200kHz		
Typical price inc VAT	£1585		

Reviewed by Chris Bryant
Rating: Recommended
Acoustic Gold Ltd, 1 Orston Lodge, Old Farm Road, Hampton, Middx
TW12 3RD. Tel: (01) 941 6737.

Cheapest of the YBA amplifier range, the *Model 3* pre/power combination bears a superficial resemblance to the costlier *YBA 7* though both the external and internal design is simpler. Both pre and power amps are built into lightweight cases with matching blue/grey anodised fascias, each punctuated with a red 'on' LED (no mains switch is provided). The preamp features two detented volume controls (L + R) and a row of toggle switches labelled video, CD, tuner, phono and 'monitor' which route the appropriate input only when in the 'up' position.

These toggles do little for the preamp's aesthetic continuity, which is a pity bearing in mind the high quality alloy knobs employed for the two volume controls. Furthermore, YBA has only made provision for MM phono cartridges though it does manufacture a step-up MC transformer which can be plugged directly into the current phono inputs.

Technically both products are very simple though a thorough examination was hampered by YBA's use of black paint to obscure all component values and active device codes. As it is, I really doubt whether anyone else would wish to copy the design! Anyway, the power amp utilises a large and essentially unregulated power supply with 8 x 4700 μ F electrolytics bypassed with a series of ERO capacitors. A double differential input stage is employed together with two pairs of complementary output devices (per channel) bolted to a rear-facing heatsink.

The inductive/transformer coupled compensation network used in the *YBA 1* is absent in the *3* and emitter resistors are employed. The matching preamp features a similar number of power supply caps (!) while the disc and line gain stages are encased in sand-filled blocks in order to promote thermal and electrical stability.

LAB REPORT

YBA's use of paralleled solid-core internal wiring has endowed the preamp with a peculiar separation curve that peaks around 1kHz with a fine 90dB but deteriorates to 65-75dB

YBA MODEL 3

at the frequency extremes. The line input is phase-inverting so some experimentation with speaker cable polarity will prove worthwhile; noise and input sensitivity were both fine. The MM input was less sensitive at 4.75mV for 1V out, while the A-wtd noise was slightly high at -70dB. More importantly, although the disc headroom was an impressive +35.8dB at 1kHz it fell dramatically to just +16.2dB at 20kHz and +9.8dB at 50kHz due to premature slew limiting of the RIAA stage. Its disc response undulated slightly with a bump of +0.4dB at 15Hz followed by a -1.3dB droop at 120Hz and a further +0.9dB rise from 1-10kHz.

The power amp displayed a mix of 2nd and 3rd harmonic distortions (0.045 per cent - 0.13 per cent) while the preamp fostered subjectively innocuous 2nd order products via both line and disc inputs. Power output increased by a fine +2.0dB from 8ohm to 4ohm, while also offering a low -111dB A-wtd noise, excellent separation and suitably low output impedance.

SOUND QUALITY

Leaving this pre/power combination permanently powered up appeared to steady its recreation of a broad and satisfyingly deep stereo soundstage. A hint of grain and edginess was audible via the CD input due to the amp's RF sensitivity and though the treble did become a little smoother and sweeter with time, a trace of brightness always per-

sisted. In overall terms the balance may have erred on the lean side of neutral but strong bass rhythms still sounded convincingly taut and punchy.

Vocal articulation was both delicate and expressive despite the vocal images themselves lacking the last vestiges of focus and tactility. Images thrown up by the YBAs were ethereal, spectre-like rather than subjectively 'solid' as with the Rowlands, for example. Nevertheless this made for a very relaxing and see-through presentation. YBA's MM disc input sounded similarly fresh but, in general terms, proved to be the most 'comfortable' sounding of the available inputs.

Plucked strings and delicate percussion were both relayed with a flighty but crisp clarity without sounding coarse or unpleasantly bright. The sound was always balanced, honed and communicative, avoiding any undue thickening or slowness. Similarly, there was a fine sense of openness between and behind the speakers even though central images did seem to dominate at the expense of peripheral activity.

CONCLUSIONS

The overall quality of build and finish could do with a little tidying up just as the lively treble would benefit from some further refinement. However, the *YBA Model 3s* offer fair value at just under a grand a piece, particularly when partnered with high sensitivity loudspeakers.

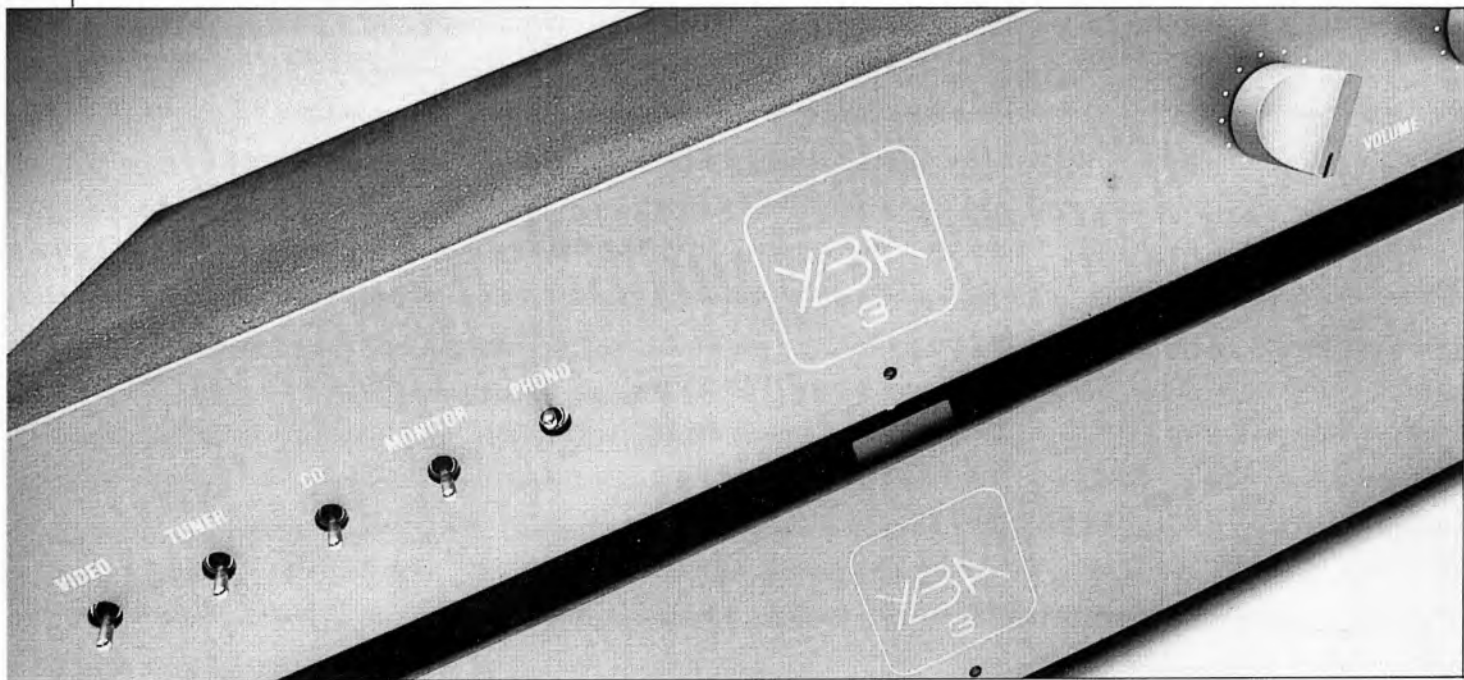



TEST RESULTS

PREAMPLIFIER

Stereo separation (20Hz)	Aux/CD	MM
(1kHz)	75.6dB	75.5dB
(20kHz)	90.1dB	85.3dB
Channel balance (1kHz, 0dBV)	0.03dB	0.09dB
(-20dBV)	0.48dB	0.35dB
(-60dBV)	2.62dB	2.38dB
Total harmonic dist. (0dBV, 1kHz)	-70.8dB	-69.6dB
(20kHz)	-69.7dB	-65.1dB
CCIR intermod. dist. (1:1)	-70.6dB	-66.7dB
Phase shift (20Hz)	180°	345°30'
(1kHz)	180°	316°48'
(20kHz)	180°	266°24'
Squarewave linearity		-89.9dB
Noise (A wtd, 20Hz-20kHz)	-92.6dB	-70.8dB

Residual noise (unwtd)

Input sensitivity (for 0dBV)

Disc overload (20Hz)

(1kHz)

(20kHz)

(50kHz)

Preamplifier output (max)/impedance

Tape output (max)/impedance

DC offset, L/R

Retail Price

POWER AMPLIFIER

Maximum Continuous

Power Output - 8ohms

- 4ohms

Dynamic headroom (IHF)

Output impedance

Damping factor

Stereo separation (0dBV)

Total harmonic dist. (0dBV)

(1/3 power)

-97.9dB

146.1mV

4.753mV

34.45mV

307.3mV

323.0mV

307.3mV

6.306V (disc)/28.3ohm

9.333V (disc)/34.0ohm

7.5mV/0.5mV

£995

20Hz

1kHz

20kHz

55.8W

56.3W

54.8W

86.1W

90.0W

89.3W

+1.39dB (77.6W)

0.067ohm

0.063ohm

0.074ohm

118.6

127.8

107.5

118.7dB

110.5dB

105.6dB

-67.7dB

-68.4dB

-59.6dB

-67.4dB

-68.0dB

-57.6dB

CCIR intermodulation distortion (0dBV)

CCIR IM distortion (1/3 power)

Rise time (@ 10kHz)

Power bandwidth (<1% THD)

Squarewave linearity

Phase shift 20Hz

1kHz

20kHz

Noise (A wtd, 20Hz-20kHz) 0dBV

(A wtd, 20Hz-20kHz) 1/3 power

Residual noise (unwtd)

Input sensitivity (for 0dBV)

(for full output)

Input loading

DC offset, left/right

Retail price

Reviewed by Paul Miller

Presence Audio Ltd, The Old Post House, Plummers Plain, Horsham, W. Sussex RH13 6NU. Tel: (0403) 891777.

-66.6dB

-68.6dB

4µsecs

10Hz - 50kHz

-88.9dB

0°

0°

345°36'

-96.8dB

-110.7dB

-83.5dB

106.7mV

812.4mV

29.1kohm

-77.4mV/-75.9mV

£995

GRANT AMPLIFIERS



High Art High Fidelity

The G200AMS MkIII is a valve amplifier of outstanding construction and performance regarded by many owners as the finest 200 watt monoblok presently available. Harry Pearson, in his article 'Transparency in Audio' described the G200AMS as a new experience. "What had been created was a system of the greatest transparency, in excess of anything I or the serious listeners invited in afterwards had ever heard..." We are pleased to confirm that many audiophiles agree with him.

The units are priced at £2,500 per pair and of course carry our usual two year warranty.

For details of the G200AMS and the rest of our range of pre and power valve amplifiers please write, phone or Fax to:

**Grant Amplifiers,
Sales and Administration,
145 Gladys Avenue, North End,
Portsmouth PO2 9BD. UK.**

GRANT AMPLIFIERS designed to sound better

THE COLLECTION...

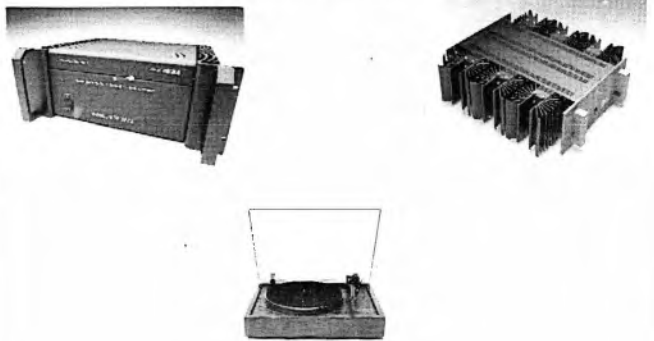

X-DEMO SALE - PHONE SHEFFIELD FOR DETAILS
MUSICAL FIDELITY MVT3 PREAMP£750.00
QUAD FM4 GREY TUNER£275.00
PERREAUX SM3/PMF 3150 PRE/POWER .£1,200.00
CELESTION SL-600 SPEAKERS£429.00

IN STOCK

- MAGNAPLANAR • CROFT • CYRUS • DUNLOP
- TOWNSHEND ROCK • ROGERS • ROTEL •
- SONUS • CAMBRIDGE • ALLISON • QUAD •
- MUSICAL FIDELITY • RUARK • VAN DEN HUL
- JPW • AUDIO INNOVATIONS • AR
- A&R CAMBRIDGE • AUDIOLAB
- MARANTZ • DENON • ORELL



NICE PRODUCTS • NICE PEOPLE!

FOR ALL THAT'S BEST IN HI-FI
MOORGATE ACOUSTICS LTD.

2 WESTGATE, ROTHERHAM (0709) 370666 •
 184 FITZWILLIAM STREET, SHEFFIELD (0742) 756048

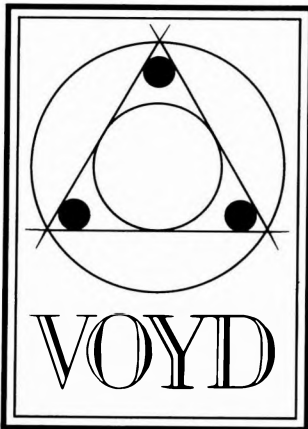

"... there's little doubt in my mind that, *the Voyd* is one of the world's finest sounding turntables."

John Bamford
Hi-Fi Choice
November 1988

Voyd Turntables Ltd.,
Anchor House,
Warwick Place,
Cheltenham,
Gloucestershire
GL52 2NP

Tel: (0242) 574528
Fax: (0242) 570131

O'BRIEN hi-fi

QUALITY EQUIPMENT ON DEMONSTRATION ON MOST OF THE BEST BUYS

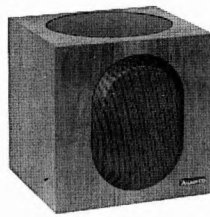

ALLISON CD6



MARANTZ CD75II

FAMOUS NAMES IN HIGH FIDELITY EQUIPMENT
FROM A&R (CAMBRIDGE) • AR • BEARD • CAMBRIDGE
AUDIO • CELESTION • DENON • DUAL • GLANZ
HADCOCK • HARMON • KARDON • HELIUS
HEYBROOK • HITACHI • KEF • LINN • LOGIC
MARANTZ • MICHELL • MORDAUNT-SHORT
MERIDIAN • MISSION • MONROSE • MYST
NAKAMICH • NYTECH • OAK • ORTOFON • PINK
TRIANGLE • QUAD • QED • REVOLVER • REVOX
• ROGERS • ROTEL • SONY • SUPEX • SYRINX
TECHNICS • THORENS • YAMAHA

95 HIGH STREET, WIMBLEDON VILLAGE, LONDON, SW19. 01-946 0331
• CREDIT FACILITIES (Trinity Finance APR. 38.4%. Written details on request)
• SERVICE FACILITIES • ACCESS/BARCLAYCARD
• FULL ORDER & EXPORT SERVICE • Opening Hours: Tues-Sat 9-5.30.

HIFI MARKETS

PROGRESSIVE AUDIO

Lessons in music...

Systemdek IIX/Helius Scorpio/Goldring 1010
Sugden A25 + JPW P1

Rock/Excalibur/ATF-5

Kelvin Labs Junior Pre/Power + Proac Super Tablettes

Valdi/Kuzma Stogi/Goldring Eroica
Audio Innovations Series 500 + Snell Type JII

Kuzma Stabi/Kuzma Stogi/Audio Technica OC-7
Kelvin Labs MC1/M30 + Proac Mini Towers

Michell Gyrodek/SME IV/Koetsu
Kelvin Labs MC1/M60 + Proac EBS

Voyd/Helius Cyalene/Audio Note
Audio Innovations 1000/2nd Audio Triodes + Snell Type C

We give you six of the best!

Progressive Audio is situated 5 mins. off the M2 at Rainham, Kent.
First class, no obligation demonstrations of these systems
or of the superb equipment listed below, with pleasure,
either here or in the comfort of your own home.

MICHELL VOYD SYSTEMDEK ROCK KUZMA STABI VALDI
REGA ARMS EXCALIBUR HELIUS SME KUZMA STOGI
AUDIO NOTE GOLDRING KOETSU ORTOFON AUDIO TECH. MILLTEK
ARIA ROSE AUDION AUDIO INNOVATIONS QUICKSILVER
SUGDEN ALBARRY INCA TECH MYST KELVIN LABS
TOWNSHEND GLASTONBURY'S PROAC SNELL SPICA JPW CELEF
MARANTZ CD PLAYERS KIMBER SUPRA VECTEUR PIRATES
COMING SOON! LATEST MODELS FROM CROFT AND TDL

PHONE: DAVE on (0634) 389004 or STEVE on (0634) 366216

£150 + £125 = £1000?

Add our £125 sub-bass unit to your £150-per-pair "Best Buys" and your system will sound as if it has LARGE (and expensive!) speakers. Although very compact, this ingenious Push-Pull design will fill-in that missing "Bottom Octave" and can be sited almost anywhere in the room—without affecting the stereo image. It can be connected directly into systems with medium sized speakers (87-90 dB sensitivity).

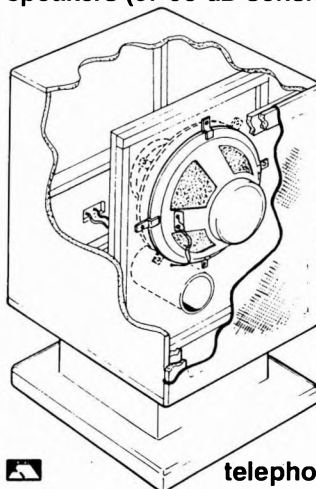

The Wilmslow Audio CPP sub-bass speaker kit contains 2 10" drive units, flatpack cabinet kit (inc. stand) machined from smooth MDF for easy assembly, low pass filters, grille fabric, reflex port etc.
Dims. (inc stand):
571x366x336mm
Amp. suitability:
20-120 watts
Impedance: 8 ohms
PRICE £125 inc. VAT
plus carr/ins £11

telephone credit card orders

WILMSLOW AUDIO LTD.

35/39 Church Street, Wilmslow, Cheshire
SK9 1AS Tel: 0625 529599

Call and see us for a great deal on HiFi
(Closed all day Mondays)

DIY Speaker catalogue £1.50 post free (expirt \$6)

The Linx company started life in New Zealand and its products were initially distributed in the UK by the HTS Group. The first Linx amplifier to appear in *Hi-Fi Choice*, way back in issue 44, was the *Stratos* pre/power combination. This fairly high power MOSFET unit was made distinctive by its unusual octagonal styling. Shipping low volume products from the other side of the world created a fairly expensive landed price which meant that although the Linx products sounded good they were unexceptional for the cost.

Not to be deterred by these distance problems the current UK distributor decided on a fairly unique solution. Instead of importing the products it decided to import the designers, managing to persuade Gavin Morris and Gordon Taylor to help set up a manufacturing facility in the UK. A year or so on, the fruits of this move are coming to realisation and a factory down on Canvey Island in Essex is now churning out a range of product which externally at least bears more than a little resemblance to those originally imported.

In a world crammed with lookalike metal boxes where almost the only visual difference between products is the name on the front panel, Linx rightly decided that to make any impression on the market styling as well as performance was of prime importance. To that end Linx has continued to use variations on the stretched octagon of its early products. It makes the box fabrication more costly but the results (at least in my opinion) are well worth it. Its approach to front panel design is also distinctive. With the exception of the tuning knob, the front panel is totally flat with no protruding buttons. Instead, rectangular slots narrowing at the bottom are carefully cut into the Perspex fascia. By not completing the cut at the narrow end, the bottom section is left intact and a row of light touch buttons are arranged behind the panel.

When the unit is connected to the mains via the IEC socket on the rear panel it's immediately in standby mode and the indicator above the power switch lights up. All the various functions are denoted by back lit red labels.

Although an analogue tuner, the display is digital with an LED frequency display. Immediately adjacent to this is a reminder that it's FM you're listening to and above is the stereo beacon. The signal strength meter is an 11 segment indicator, with tuning aid above. A central light which denotes 'tuned' is boarded on either side by two back lit arrows indicating which way to tune for optimum signal. Other functions available are inter station muting, AFC (automatic frequency control), narrow IF bandwidth and mono. Finally the tuning display can be used as a multi path interference detector.

LINX THETA

The aerial connection is a BNC socket rather than the usual coaxial type, but as a suitable BNC plug is supplied (complete with fitting instructions) to go on your aerial coax down lead this isn't a problem – simply fit and forget. And once installed it offers a more secure connection than normal. The only other back panel facilities are the phono output connectors, with no provision made for 300ohm balanced aeriels.

Internally the unit is configured with the front end of the tuner and IF strip in a screened housing at the end of the main printed circuit board. Decoding and analogue output circuitry follows (this board is brought in from Magnum Dynalab) and there is another circuit to drive the front panel frequency read out.

LAB REPORT

Sensitivity for a 50dB signal to noise ratio measured $4.8\mu\text{V}$ for mono and $22\mu\text{V}$ for stereo. This level is fine for hi-fi tuners and should prove more than adequate for most. Noise levels were a little higher than I would have liked when measured with a CCIR/ARM/1kHz ref weighted filter switched in. However, a spectrum analysis revealed the noise floor to be generally well down. The RF muting threshold is set at around $1\mu\text{V}$ which is a little low. On the wide setting alternate channel separation is 55dB and together with a capture ratio of 1.5dB represents a good compromise. The pilot tone rejection is good for the 19kHz tone and even better at 38kHz, however both these have slightly higher side bands; the worst artefact was recorded at 17kHz and 50dB down on a 1kHz fully modulated signal.

Stereo separation is asymmetric with the left on right channel measurements rather better than the right on left ones. Even the worst ones however, are just about acceptable. The stereo channel balance is very accurate and the output level is 720mV. The frequency response is almost perfectly flat through the midrange and into the treble, with a slight roll-off from 7kHz before falling away sharply after 16kHz. The signal strength meter is sensibly graded from $5\mu\text{V}$ up to an 8mV signal which had all the indicator lights lit.

SOUND QUALITY

Sweet, open, with plenty of detail just about sums up this product. The midrange has a smoothness not normally associated with tuners. It even seems to ameliorate some of

the chestiness on voice often associated with BBC broadcasts. On music the vocals were particularly well articulated, and as it doesn't get confused when there's a lot going on it preserves much of the original structure of the broadcast.

The treble is clean and fairly pure with plenty of air and a measure of sparkle and life, such that cymbals and bells, for instance, retain much of their delicate decay texture. Transients could use a little more power and authority but even these are pretty good in the context of the medium. The bass is good, perhaps not the best available as it could use a bit more slam and weight, but it differentiates well between instruments. Stage depth is rather good and it portrays fine stage width. A measure of transparency not often found on a tuner is also prevalent.

It obviously works best off a good strength signal and with RF signal above 2mV there is little to complain about. On this sample I wasn't bothered by any birdies or whistles and the whole design seems particularly competent. If you have to revert to the narrow setting the reproduction suffers to some extent – it loses some of the openness found on 'wide' and the staging isn't quite as good.

CONCLUSIONS

The *Theta* is a simple and unusually styled tuner which offers good off-air stereo. Although there are one or two technical details which could be improved upon, there are few tuners which compete with its performance in the midrange and treble and consequently, if sound quality is of primary importance, it's well worth a look.

BEST RESULTS

Sensitivity for 50dB signal-to-noise ratio	
Mono/stereo	4.8 μV /22 μV
Ultimate signal-to-noise (CCIR/ARM/1kHz ref)	
Mono/stereo	67dB/60dB
Muting threshold, R.F. level	1 μV
Alternate channel selectivity	55dB
Pilot tone rejection, 19kHz/38kHz	62dB/89dB
AM rejection	71dB
Capture ratio	1.5dB
Total harmonic distortion	
At 100% mod, 1kHz, mono/stereo	-44dB/-44dB
Stereo separation, 1kHz/5kHz/10kHz	48/34dB 37/26dB 28/21dB
Output level, 100% modulation	720mV
Channel balance, stereo	0.09dB
Dimensions (width, height, depth)	43 x 6.5 x 26.5cm
Typical price inc VAT	£399

Reviewed by Chris Bryant
Musical Design Company, PO Box 13, London E18 1EJ.
Tel: (0268) 590789.

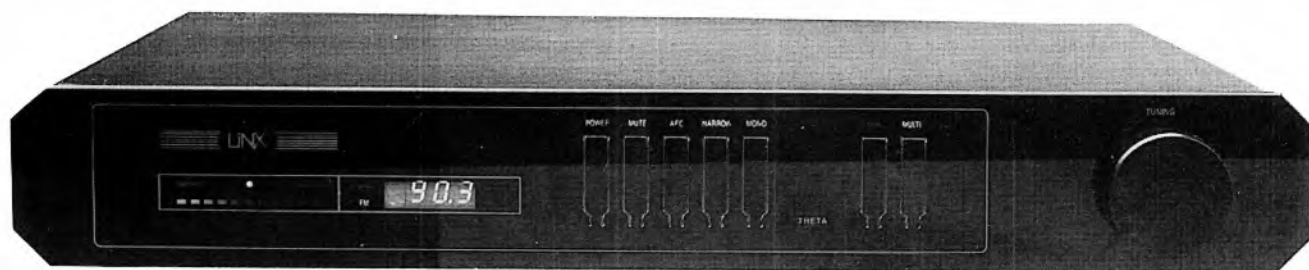

Magnum Dynalab is a small Canadian company based in Ontario which specialises in tuners. First launched in North America about four years ago the FT101 quickly gained a good reputation for performance at a reasonable price. On a recent trip to that continent Richard Hay, of Ion Systems, was so impressed with the product that he decided to import them.

The FM-only FT101 can be partnered by something called the 205 *Signal Sleuth* which increases the sensitivity and selectivity of signal capture. However, for most applications in the UK, the *Sleuth* is unnecessary and this review is restricted to the stand alone 101, but its availability is worth noting for people who live in problem reception areas or like DX-ing. Also of interest are the aerials available from this company. Accompanying the FT101 was an indoor antenna called the *Silver Ribbon*, a dipole which proved fairly effective with good strength signals. There's also the quite expensive ST-2 which is a half wave omni directional stainless steel whip aerial with a special load matching coil constructed into its base. Intended for outside installation it comes complete with 25ft of coaxial cable. The latter device was found to provide a perfectly acceptable level of performance for good signal areas and I used it in preference to my roof mounted one for a while.

The FT-101's styling is rather workmanlike with its line-up of three analogue moving coil meters and centrally located green LED digital frequency display. To some extent it reminds me of lab equipment, but as I used it more, its clear presentation of reception conditions and general ergonomics were actually preferred in some ways to the usual domestically oriented fare.

The rotary tuning knob is nicely weighted and following the pattern adopted by most tuners it sits on the right of the fascia. The right hand meter indicates signal strength, the central one centre tuning, and the left hand one reveals the presence and strength of multipath interference. A small red LED indicates stereo reception – and that's about it for the visuals.

The switches aren't flash either, they're just ordinary toggle switches arranged to function horizontally rather than vertically. These provide automatic frequency control, a wide/narrow intermediate frequency bandwidth option, inter-station muting, and

MAGNUM DYNALAB FT101

stereo/mono switching. There are no station presets so although it's very easy to use it's perhaps not as convenient as a digitally synthesised tuner for finding stations.

Internal circuitry is quite interesting. It uses discrete analogue circuitry and a MOS-FET front-end with three stages of amplification, followed by a 'group-delay' ceramic filter. Both wide and narrow IF stages are available, giving better reception of closely placed signals. Tuning is performed by a voltage controlled, local oscillator from which the frequency readout is taken. The analogue tuning method is said to have several advantages over the alternative frequency synthesis method. These include the ability to tune into stations with greater precision as frequency synthesis tuners tune in increments of 5kHz. The infinite resolution of the analogue system also means that fine tuning away from an interfering signal can be better accomplished. The other argument that supports this approach is that frequency synthesis relies on all broadcast stations being exactly 'on frequency'. While the expectation is that the parties concerned will get this right, with the help of the meters the Dynalab analogue system can be accurately fine tuned even if they don't.

Another interesting feature is the 'sequential blend' circuit which adjusts stereo separation in sympathy with the strength of the incoming signal.

The tuner's circuitry is housed on two boards, each with its own regulated supply. The main one houses the fully screened front-end followed by the multiplex circuitry, low pass filters and finally the audio operational amplifiers. The other board is used to drive the digital frequency display.

LAB REPORT

Sensitivity for a 50dB signal to noise ratio while not up to the standards of the most sensitive is very creditable, especially for stereo reception. Like the Linx *Theta* I found

the RF muting threshold level to be set at a too low $1\mu\text{V}$, but at the end of the day I suppose it's really just a matter of taste. The ultimate signal to noise ratio (CCIR/ARM/1kHz ref) is only 60dB in stereo and 70dB in mono, but a full spectrum analysis revealed the noise floor to be generally well down, excepting some spurious at around 9kHz. Alternate channel selectivity is good on the narrow setting and the capture ratio likewise on wide.

SOUND QUALITY

This tuner neatly paralleled the Linx in performance – listening off air it proved virtually impossible to tell the two apart.

Although the bass is a little subdued it's quite tuneful if light. Very good focus and ambience were fully apparent, both male and female voices being very well handled. The treble is open and quite airy and while it has fine texture and fine transient detail it loses just a little in the way of subtle harmonics. After a few weeks of on and off listening I felt that overall it was just a little soft which meant that rock and pop broadcasts lost some pace and excitement.

The FT101 created an exceptionally broad and deep soundstage which I hadn't really realised was available from the medium. It has a transparent, seamless quality when the programme is good which makes one listen to the radio more than before. The tuner seems more at home on good classical broadcasts than it is with rock and pop stations but that may just be a reflection on the quality of the broadcast material.

CONCLUSIONS

Magnum Dynalab makes fine tuners which may be accused of looking a little old fashioned because they're not festooned with facilities like some of their rivals. But the FT101 proved easy and satisfying to use. Few rivals can beat it for either RF or audio performance and although it's expensive the 101 certainly delivers the goods.

TEST RESULTS

Sensitivity for 50dB signal-to-noise ratio	
Mono/stereo	$5\mu\text{V}/25\mu\text{V}$
Ultimate signal-to-noise (CCIR/ARM/1kHz ref)	
Mono/stereo	70dB/60dB
Muting threshold, R.F. level	$1\mu\text{V}$
Alternate channel selectivity	65dB
Pilot tone rejection, 19kHz/38kHz	60dB/77dB
AM rejection	55dB
Capture ratio	1.5dB
Total harmonic distortion	
At 100% mod, 1kHz, mono/stereo	-46dB/-46dB
Stereo separation, 1kHz/5kHz/10kHz	30dB/27dB/27dB
Output level, 100% modulation	770mV (High)
Channel balance, stereo	0.04dB
Dimensions (width, height, depth)	48.3 x 9.5 x 28.5cm
Typical price inc VAT	£599

Reviewed by Chris Bryant
Ion Systems, Unit 28, Mochdre Ind. Est, Newton, Powys SY16 4LE.
Tel: (0686) 25266.

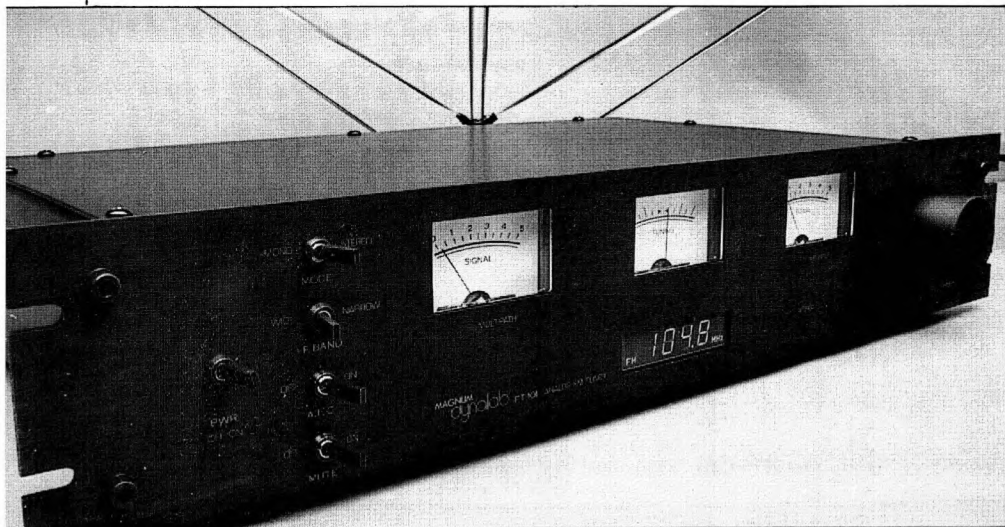

Like the other two tuners reviewed in this *Collection* issue the Onkyo T-9090II is an FM only design, but the similarity ends there, for it's a fully featured, multi function device stuffed with automatic circuitry. It is, of course, a computer controlled, quartz synthesised piece of luxury Japanese gear. Its design incorporates all the gadgets which are now associated with top tuners of this type and Onkyo has gone out of its way to include clever technology to ensure that the maximum performance is available at all times. The T-9090 is full of intelligently conceived circuitry to make life as easy as possible for the user, while ensuring the maximum in performance in the RF, IF and analogue parts.

There are a few tuners about which feature remote control and in the *Collection* last year the much liked Harman Kardon *Citation* was one such device. However, they are still rare enough to create some added interest and the Onkyo has one of the most comprehensive remotes available. Added to this the 9090 has a very good external finish and comes in ever popular black. The styling is entirely modern and although it breaks no new ground, its front panel is crammed with a multitude of features.

The T-9090II uses a comprehensive computer controlled system which Onkyo calls a five-mode APR (automatic precision reception) system. This monitors the quality of the FM broadcast being received and as its name suggests, juggles five variables to achieve the best parameter for each. These five modes cover either one of the two aerial inputs, DX or local RF mode, wide, narrow or super narrow IF bandwidth, hi-blend and automatic stereo mono switching. Once the optimum setting has been established they can be stored in the memory for that particular radio station. Another interesting facility is SFR (sonic noise filtering reception). Onkyo claims that acoustic vibrations can upset sound quality and has designed a circuit which electronically reduces their effect.

There are 20 preset channels available through 11 buttons running along the bottom of the fascia. Above these from left to right are the tuning level selector buttons which work sequentially to set the auto tuning level to 17, 27, or 37dB. Further buttons turn the signal strength level meter on and instigate preset scan.

There's also a whole bunch of tuning and programming buttons, plus a muting control, next timer program display, and timer program for use with an external timer.

The fluorescent display is likewise very comprehensive: with a bargraph type signal strength meter in units of 10dBf, a frequency readout, tuning level indicator, an optional readout of signal strength displayed numerically in dBf and the preset number in use. There's also a reminder for memory. A number of LED indicators denote the preset in use, and the current RF and IF mode.

The infra red remote control covers those front panel facilities which are used most often. These include volume, preset station select via a 20 key pad, preset scan, mute, preset sequential skip, RF mode, IF band, Hi-Blend, mode and antenna select.

The rear panel is fairly simple and features two sets of phono sockets for fixed and variable analogue outputs, another set pro-

ONKYO T-9090II

vides a monitor of multipath problems, and two 75ohm standard antenna sockets. There is no provision for a 300ohm aerial but just in case you want to use that variety two baluns (aerial connection converters) are included in the package.

Construction and build quality are in keeping with the price. The case is steel, with an anti-vibration base plate and an alloy front panel. It uses shielded casings for the digital and power supply sections, and all the terminals are gold plated. The RF, IF and analogue circuitry is laid out neatly on a single PCB. Good quality parts are used throughout.

LAB REPORT

The front-end's sensitivity is set reasonably high to ensure a 50dB signal to noise ratio; on the DX setting 2.0µV was required for mono and 20µV for stereo. Switching to local effectively halved the sensitivity. The ultimate signal to noise figures of 82dB for mono and 71dB for stereo are very good and no in-band artefacts were found by spectrum analysis. The muting threshold is set to 10µV, which is an eminently sensible figure and pilot tone rejection is simply excellent, with AM rejection also commendable. With the narrow settings the alternate channel selectivity was a more than useful 81dB while on wide the capture ratio was an equally impressive 1.5dB.

The frequency response is very flat and filtered sharply above 16kHz. Total harmonic distortion is exceptionally low for both mono and stereo reproduction and the stereo separation more than competent. Stereo channel imbalance is only 0.1dB at 1kHz and the output level available at 100 per cent modulation is higher than most tuners at 860mV, so it should suit modern equipment well. Finally, the signal strength meter is quite accurately calibrated and covers a sensible range.

SOUND QUALITY

Set to wide IF and local the tuner achieved full quieting before a 1mV signal strength was registered and there were no problems with birdies or whistles above about 100µV. It sounded lively, open and quick with good bass weight and articulation. The midrange is fine and detail and ambience are produced with an uncharacteristic naturalness for the

medium. It's not prone to sibilance and the treble is particularly pure, cymbals ring back in true hi-fi fashion and there is a distinct lack of grain and tizz. It etches colourful sonic pictures, but a slight veiling of the sound was detected, which means that it doesn't quite have the transparency of the very best designs. Stereo focus is sufficiently precise and the soundstage has fair width with well above average depth and image placement.

On the narrow setting there is a reduction in bass speed slam and timing. Drum and electric bass notes tended to muddle in a way which made following bass lines more difficult. The midrange became similarly confused and I felt that some emotion was lost from vocals. Midrange balance is fine but there is some thickening and a loss of detail and ambience. Transients and harmonic construction were reasonably preserved. The treble however, was still well liked and the soundstage retained some width and depth. On the super narrow setting the whole thing seems to clog up, the sound stage narrows and flattens and sound generally thickens.

CONCLUSIONS

This tuner may not offer the ultimate in RF sensitivity or sound quality, however on both counts it's up among the best available. Add to this ease of use, a myriad facilities and excellent build quality, and let's not forget the remote control, it turns out to be a very comprehensive package that for many will prove hard to beat. Definitely one for the short list.

TEST RESULTS	
Sensitivity for 50dB signal-to-noise ratio	
Mono/stereo	2.0µV/20µV
Ultimate signal-to-noise (CCIR/ARM/1kHz ref)	
Mono/stereo	82dB/71dB
Muting threshold, R.F. level	10µV
Alternate channel selectivity	81dB narrow
Pilot tone rejection, 19kHz/38kHz	90dB/91dB
AM rejection	72dB
Capture ratio	1.75dB wide
Total harmonic distortion	
At 100% mod, 1kHz, mono/stereo	-69dB/-65dB
Stereo separation, 1kHz/5kHz/10kHz	39dB/37dB/34dB
Output level, 100% modulation	860mV
Channel balance, stereo	0.10dB
Dimensions (width, height, depth)	46.6 x 9.9 x 38.0cm
Typical price inc VAT	£590
Reviewed by Chris Bryant	
Hi-Fi Markets Ltd, Axis 4, Rhodes Way, Watford, Herts WD2 4YW.	
Tel: (0923) 226499	

DEALER GUIDE

Hi-Fi Sounding Out of Tune?

System Attuning
Turntable Resetting Cassette Deck Re-biasing

Home Installations

(See Aspirations feature Hi-Fi Choice April '88)

Home Visits by Appointment

Robert King & Associates

The Audio Consultants

27 Old Gloucester Street,

London WC1N 3XX 01-274 8081



WHY DO YOU THINK IT IS THAT REVIEWERS WHO WRITE for Hi-Fi Choice · Hi-Fi Answers · New Hi-Fi Sound · and Hi-Fi News/Record Review · Use systems in their own homes that comprise

VOYD AUDIO INNOVATIONS SNELL ?

WHY IS IT THAT THESE SYSTEMS ARE REGULARLY CHOSEN by concert musicians, music teachers, and jazz and classical concert goers alike?

DEFINITIVE AUDIO NOTTINGHAM

HOME DEMONSTRATIONS THROUGHOUT NOTTINGHAM AND THE EAST MIDLANDS

For further information and appointments phone (0602) 813562 (10am - 9pm including Sunday)

Systemdek · Voyd · Valdi · Helius · Audio Innovations · JPW · Snell · Audionote · Goldring · Target · Pirate

Active Audio

sound systems

■ Alwa ■ AR ■ A&R Cambridge ■ Ariston ■ Bose ■ Celestion ■ Denon ■ Elite ■ Heybrook ■ KEF ■ Marantz ■ Mission Cyrus ■ Monitor Audio ■ Musical Fidelity ■ NAD ■ Onkyo ■ Pioneer ■ Rotel ■ Revox ■ Rogers ■ Sansui ■ Wharfedale ■ Yamaha

BRANCHES IN DERBY & TAMWORTH

Active Audio
12 Osmaston Rd
The Spot
Derby
☎ 0332-380385



Active Audio
29 Market St
Tamworth
Staffs
☎ 0827 53355



Appointed stockists of A&R Cambridge, Denon Castle, Creek Audio, Goldring, Linn, Naim, Quad, Rega, Rogers, SME, Monitor Audio, Nakamichi, Roksan, Royd, Spondor, Tannoy

7 St. Pancras, Chichester
Telephone 0243 776402
(Closed all day Monday)

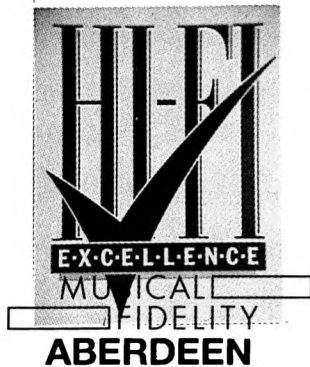

3/5 SKENE SQUARE (0224) 624408

MANDERS HI-FI LTD

For Nakamichi, Quad, Dual, Hafler, Luxman, Denon, Revox, Sansui, Harman-Kardon, A+R, Thorens, QED, Spondor, Monitor Audio, Rotel, Ariston, Revolver, Technics etc.

2 Edward St, Grimsby,
Humberside
0472-351391

ASHTON AUDIO VISUAL SPECIALISTS

TARGET, RUARK, THORENS, ARISTON, WHARFEDALE, TDK, THAT'S, SONY, ROBERTS, CELESTION, MORDAUNT-SHORT, TANNOY, KENWOODJVC, TOSHIBA, JBL, LINX, MONSTER CABLE, VAN DEN HUL, DENON, MARANTZ, PROTON, NAD, ROTEL, AR, NAKAMICHI, INCATACH, QUAD

6 HIGH STREET SOUTH, DUNSTABLE, BEDFORDSHIRE.
TEL: 0582 608003

Diner's Club - American Express - Visa - and Credit Brokers
Open Monday to Saturday 9.00am - 5.30pm (6 on Fridays)

BUY, SELL, EXCHANGE & REPAIR CENTRE FOR TV, VIDEO & HI-FI

- ★ NEW & RECONDITIONED EQUIPMENT
- ★ FULLY GUARANTEED
- ★ COMPETITIVE PRICES
- ★ TECHNICAL ADVICE GIVEN
- ★ EXPORT ORDERS WELCOME
- ★ FULL BACK UP AND REPAIR SERVICE
- ★ FOR PERSONAL & PROFESSIONAL SERVICE



CANAL BRIDGE AUDIO VISUAL

172 Caledonian Road, London N1 0SG



01-837-8741



DEALER GUIDE



Hi-Fi Specialists

- A&R
- Castle
- Dual
- Mordaunt-Short
- Musical Fidelity
- Pioneer
- Philips CD
- Quad
- Rogers
- Rotel
- Revox
- Sony
- Spondor
- Tannoy
- Technics
- Thorens
- Trio/Kenwood
- Yamaha
- Ariston etc.
- B&W
- Denon
- Marantz
- Monitor Audio
- Nakamichi

Two-year guarantee
Private listening room
Excellent comparator demonstrations

54 Chapel St., Chorley, Lancs.

Telephone (02572) 71935

AUDIOVENUE

24 CHURCH ROAD, CRYSTAL PALACE, LONDON SE19 2ET
TEL: 01-771 7787

Stockists of: Linn Hi-Fi, Naim Audio, Creek, A&R, Denon, Dual, Revolver, Marantz, BLQ, Yamaha, etc.

2 single speaker demonstration rooms, Instant Credit Facilities.

All equipment delivered & installed. Comprehensive turntable rebuilds etc.

Interest Free Credit. 2 year warranty.



Open 10-6pm - Closed all day Wednesday

SHROPSHIRE'S HI-FI CENTRE!

- Quad
- B&W
- Kenwood
- JVC
- Celestion
- NAD
- Onkyo
- A&R
- Nakamichi
- Beyer Dynamic
- Dual

AVON Hi-Fi Limited

12 Barker Street, Shrewsbury (0743) 55166

Analog Audio

First Class Separates from AR, Denon, Dual, Harmon/Kardon, Jamo, Kenwood, Luxman, Marantz, Mordaunt Short, NAD, Onkyo, Proton, Rotel, Teac, Thorens, Tannoy, Yamaha

FULL DEMONSTATION FACILITIES AVAILABLE

Access and Barclaycard Welcome.

ANALOG AUDIO

849 HIGH RD., LONDON N12. 01-445 3267

Hastings Hi-Fi CONSULTANTS

32 WESTERN ROAD, ST. LEONARDS. (0424) 442975

Selected Hi-fi from - EXPOSURE, MUSICAL FIDELITY, QUAD, NAKAMICHI, HARMAN KARDON, MONITOR AUDIO, ROGERS, TANNOY, CYRUS, NAD, REVOLVER, MANTICORE, GALE, MARANTZ, ROKSAN, ELITE, AUDIOLAB, CELESTION, HEYBROOK, & Many more.

- OPEN TUES-SAT 9.00-6.00
- FULL DEMONSTRATIONS - IN STORE & IN HOME



ROTEL



DENON



Norman H. Field

Hi-Fi

Technics

ALBANY HOUSE,
HURST STREET,
BIRMINGHAM B5 4BJ
Telephone: 021-622 2323

YAMAHA



6 ABBEY ST, CARLISLE. TEL: 0228 46756
(Hi-Fi & Service Centre)

Products we stock include:-

Linn-Acoustic Research-Mission-Cyrus-Technics
-Marantz-Kenwood-Aiwa-Denon-Dual-Pioneer-Akai-Ariston and Philips.

"Demonstration Facilities" "Part Exchange Welcome"
"Free Delivery & Installation" Access & Visa accepted
"Cumbria's Premiere Hi-Fi Centre"

SHROPSHIRE HI-FI THE HI-FI SPECIALIST

ARISTON, AUDIO TECHNICA, CAMBRIDGE AUDIO, CELEF, DENON, DUAL, HEYBROOK, INFINITY, ION, MANTRA, MORDAUNT SHORT, MUSICAL FIDELITY, MONITOR AUDIO, MARANTZ, NVA, PROAC, QED, ROTEL, TARGET, TEAC, TANNAY, ROKSAN

Demonstration Room, Free Parking, Free Installation, Repairs

CLOSED THURSDAY

**SHROPSHIRE HI-FI, ST. MICHAEL'S STREET,
SHREWSBURY 0743 232317**

SMC GROUP

Launched with a great fanfare some five years ago, the American Apogee organisation created a sensation by producing a full sized, three-way ribbon loudspeaker simply characterised by the company name of 'Apogee'. When the dust settled, it became clear that while this speaker contained elements of a truly stratospheric performance, the operating principle was not entirely clear; furthermore significant difficulties were encountered when driving it. Depending on the connection mode, very low impedances of down to 0.1ohm were present, and to cope with these Krell and other manufacturers designed experimental amplifiers.

Soon after this speaker was introduced, its smaller brother the *Scintilla* appeared. This

was closer to a two-way design and offered a more believable 4ohm impedance. Sensitivity was very low, requiring a minimum of 200W per channel. Later the *Scintilla* was relaunched with an improved sensitivity rating, but efficiency was still very low and the impedance now fell to 1ohm – which represents an extremely severe amplifier load.

For a year or two in hi-fi circles the main question directed to audiophile amplifiers was "Can it drive a *Scintilla*?" but since then further research and development has resulted in a new range of Apogee speakers which offer more moderate sensitivity and amplifier loadings, and for their size and performance rather better prices. These are currently (UK) the *Caliper Signature*, *Duetta Signature* and *Diva*. Having tried both the

Caliper and *Duetta Signature* models, the former can genuinely be regarded as a down-sized version of the latter, conceding very little in terms of coloration and transparency, and only compromised by maximum loudness power handling and low bass extension. The *Caliper* is £3,150.

Meanwhile, the *Diva* is an awesome three-way design which costs an equally awesome £8,600 and requires much dedication in terms of room and supporting audio system to obtain the best results. The dominant market position naturally falls to the *Duetta* reviewed here, now in its third incarnation, (*MkI*, *MkII* and now *Signature*.) I did not favour the first version; the second showed improvement, while the new *Signature* version certainly requires serious consideration.

APOGEE DUETTA SIGNATURE

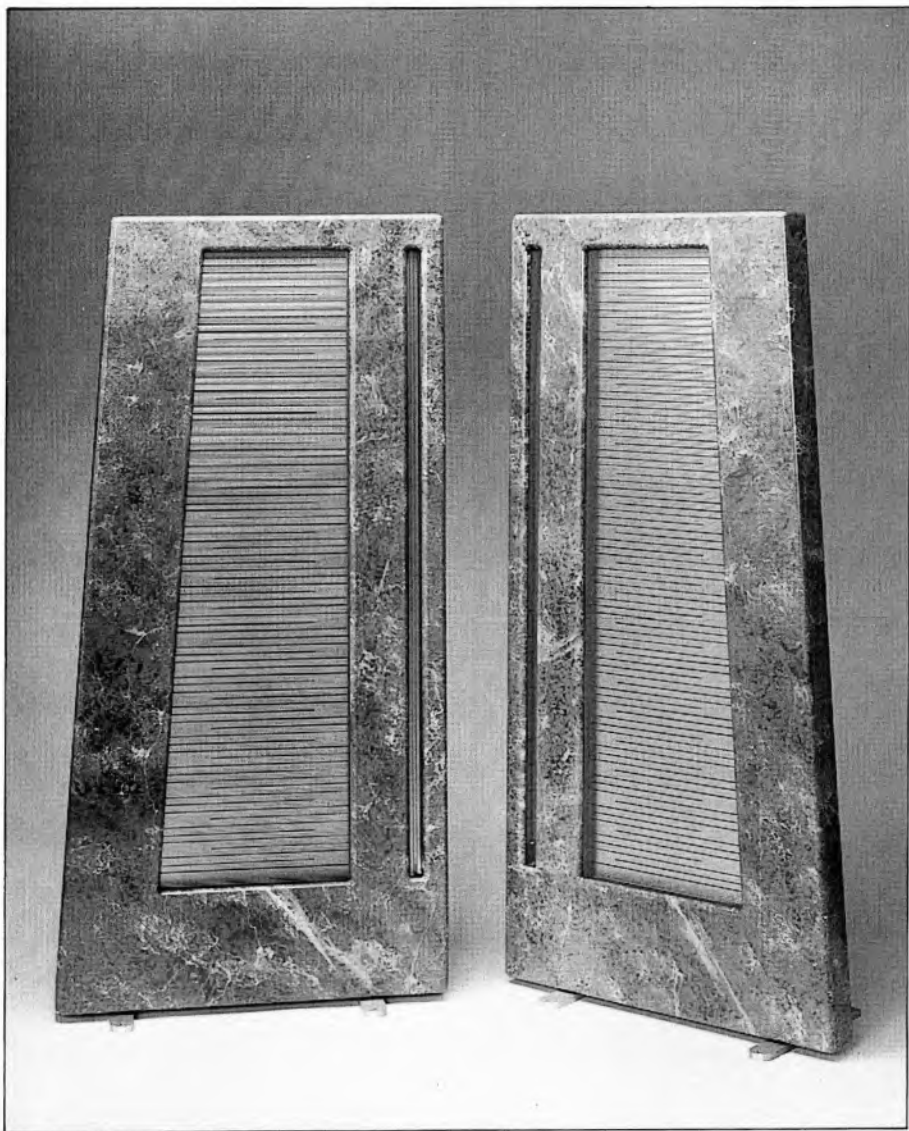

A tall, modernistic looking free-standing panel, it has provision for levelling using adjustable spiked feet. The sound-producing sector consists of a large tensioned membrane covering the bass and low midrange, and a full height vertical ribbon element offering a wide linear frequency response over the mid to treble range. A well designed ribbon has almost zero distortion, plus negligible self resonance and a superb transient response. It is implied by the literature that the Apogees are all-ribbon designs, but in fact the bass element, although pleated horizontally, is based on the isodynamic principle, used for example by Infinity and Magneplanar. Behind this active membrane is an array of bar magnets mounted on a thick steel plate which is extensively perforated to allow the rear radiation to pass through relatively unobstructed. This single sided drive method is less linear than a bi-directional or push-pull system, but given the large driven surface area, equivalent to several 12-inch bass units, the movement is very small and the resulting distortion is negligible.

The *Duetta Signature* may be bi-wired (strongly recommended) and must be used almost square on, spaced approximately 0.6 to 1.5 metres from the back wall. As close as 0.5m from the side walls is permissible and helps to expand stage width, this recommendation dependent on room size.

Measured in-room, the speaker delivered linear frequency responses on the listening axis, with good integration shown between the two drivers. No nasty spurious were found. Driven hard, some distortion was evident in the bass, mainly doubling, but this was only significant in context of the rest of the frequency range where the distortion was very low, much lower than in competing moving coil designs, for example. In fact the ribbon section has lower distortion than a number of

good power amplifiers.

Most important of all, in my well proportioned listening room the *Duetta Signature* delivered a superbly flat computer averaged frequency response over the listening area, this confirming the subjective findings. The impedance was quite uniform – close to 4ohms – and presented no problems, while the sensitivity assessed at the listening position was equivalent to an eminently useable 85-86dB/W. Maximum room sound levels of 104 to 105dB/A were possible from a stereo pair, enough for thrilling volumes on big classical works but still not enough for reliable 'disco' duty in large rooms.

SOUND QUALITY

For the listening tests the main power amplifiers were the Krell *KMA 160* (£10,000 a pair) but many others were also tried in order to investigate their compatibility, these including the ARC *DI25*, Musical Fidelity *A470* and *A370*, and the *KSA 200* and the *KSA 80*. Both MF models were man enough for the job, with the *A470* showing world class slam, while judgement on its sound quality must be reserved until a final production model is obtained. Of the less expensive models, the *KSA 80* was an unexpected find and, in the context of its price, power and sound quality proved to be very well matched to the *Duetta Signature*, the combination costing £7,200. The bigger Krells were better still, with a sonic reward roughly in proportion to price. At moderate sound levels the *DI25* was very fine but this ARC amplifier was straining to produce higher sound levels where even the *KSA 80* remained quite unperturbed.

Preamplification included a current ARC *SP11-II*, a Pink Triangle, *Pip II*, an upgraded MVX and a Krell *KSP7*. Sources were a Goldmund *Studio/T4/Koetsu Signature* and a refurbished Cambridge Audio *CD1*. A veritable high-end feast!

Where previous Apogee *Duetta* models sounded incomplete, brilliant in some respects but flawed in others, the *Signature's* balance of qualities proved entirely positive. Once properly aligned, and noting that vertical setting was quite critical, their performance was wholly believable on both rock and classical works. While it has often been said before about exceptional equipment, the effect of this *Signature* is simply the removal of a veil from the music. Its transparency and resolution of detail was extraordinary and was not just a midband phenomenon – it stretched across the whole audible frequency range.

The bass was well extended to 25Hz, and can be a mite too powerful in some rooms. Different to box speakers and partly as a result of the way it drives the room, the *Duetta* bass sounded 'right', with the transient edge, the slam and the weight all occurring in unison and with excellent pace and rhythm. On other gear bass sounds are often just 'notes', while the *Duetta* fully conveys the character of the instrument playing, and also *how* it is played. Never sounding congested, and devoid of compression, the *Duetta Signature* managed to separate out the fine strands of complex scoring in a most satisfying manner. Moreover it achieved all this without hardness or exaggeration, free from ringing, 'tizz', or 'boom'.

Stereo images are well focused once you have adjusted to their specific presentation, with a large scale soundstage including good height and depth. Listener fatigue is very low – a good sign, this.

CONCLUSIONS

At a substantial but a believable price, Apogee has demonstrated a remarkable level of design maturity in the *Duetta Signature*. It can be driven well by a number of suitable amplifiers and has a sensitivity that is sufficient for inputs of 100W per channel upwards. At this time, I favour bi-amped connection with a pair of *KSA 80s*, though a single amp used bi-wired also gave fine results. *KMA 160s* were also first rate.

With a wide frequency response (no need for sub woofers!) these elegant modern designs can produce decent sound pressure levels of very high quality and with low distortion – exceedingly low in the mid and treble ranges. In terms of tonal balance they are neutral, accurate, very low in coloration and their excellent transient performance gives them the ability to 'drive' on rock, and flow on classical material.

A true reference grade loudspeaker, the overall balance of this design is most successful, marrying theory, technology, build quality and finish to a first rate sound. As you may already have guessed, I bought a pair!

Typical price inc VAT

Reviewed by Martin Colloms

Absolute Sounds Ltd, 318 Worple Road, London SW20 8QU.
Tel: (01) 947 8160.

£4,250

DEALER GUIDE



THE HI-FI SPECIALIST

Single Speaker Dem Room

Appointed Stockists for:-

Akai · Aiwa · Ariston · B&W

Denon · Dual · Exposure · Heybrook · Incatech · JVC · JBL

Kenwood · Marantz · Nakamichi · Philips · Revox

Sony ES · Technics · Townshend · Systemdek · Yamaha

plus accessories

H. L. SMITH & Co. Ltd.,

287-289 Edgware Road, London W2 1BE

Telephone: 01-723 5891/7595 Fax: 01-724 6101

Access, Visa, Amex, Diners, Credit Charge Privilege Acc.

THE AUDIO CENTRE

AR, Bose, Denon, Duo, Goodmans, Iowa, Mission, Onkyo, Revox, Ross, Rotel, Sansui, Technics.

**84 Bridge Street,
Portadown, Northern Ireland.
0762 358059**

BUY! SELL! EXCHANGE!

We accept for cash or exchange ALL 2nd hand Audio & Video equipment.

Everything accepted in ANY condition – absolutely NOTHING refused!

MUSIC & VIDEO EXCHANGE
56 Notting Hill Gate, London W11
Open 7 days 10am-8pm
Tel: 01-727 0424

DOUGLAS SHOP

NOW OPEN

ON LOCH

PROMENADE

0624-815521

MARANTZ

AUDIO INNOVATIONS

MICHELL

BEYER DYNAMICS

LUXMAN

A&R

ISLAND COMPACT DISC & HI-FI CENTRE

WHARFEDALE

SUGDEN

CELESTION

TEAC

PHILIPS

JBL

ARISTON

SNELL

PARLIAMENT SQUARE

RAMSEY, ISLE OF MAN

MUSICAL FIDELITY

OPENING TIMES MON-SAT 9-5-00PM

DEM FACILITIES

TEL:
(0624)
815521

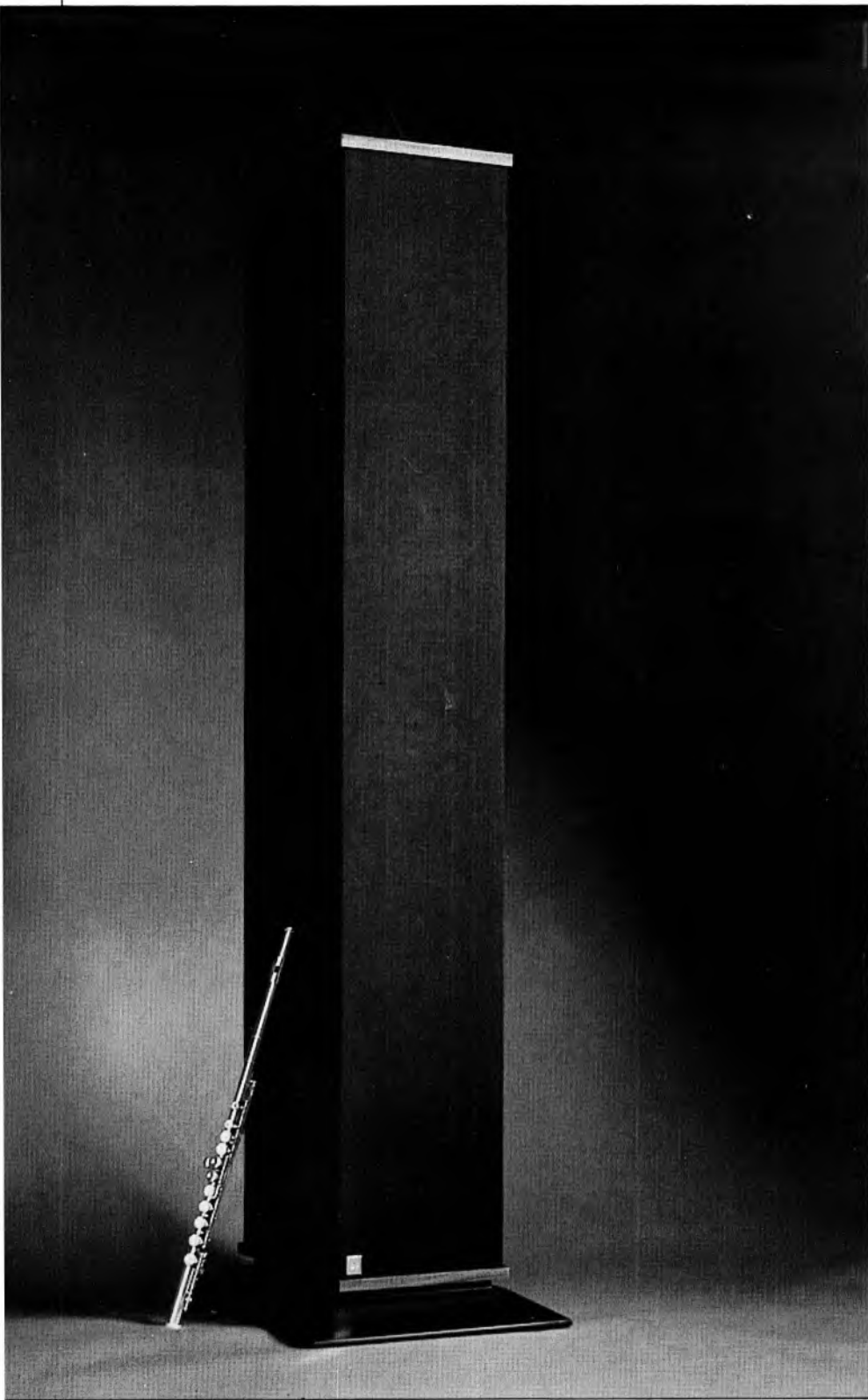

DUNTECH CROWN PRINCE

Duntech loudspeakers are a relatively new breed to the UK, high-end importers Absolute Sounds having only begun distributing the brand here last Autumn. Duntech is based at Technology Park, Salisbury, Adelaide in South Australia – and although the name might be new to UK audiophiles the company has a history dating back to the early '60s.

Before moving to Australia in 1981 Duntech International had already established itself as a world leader in antenna systems in the US. Between '63 and '72 it designed and made almost all of the National Aeronautics' and Space Administration's communications systems for such projects as the Mercury, Gemini and Apollo Spacecraft, as well as being involved in designing and manufacturing the US President's emergency communications system installed at the White House.

Duntech Audio is but one division of this huge company. Another division is reported to be working on a revolutionary air collision avoidance system which could be on the market within three or four years at between \$5,000 and \$10,000. (That's cheap.) Meanwhile hi-fi loudspeakers are the result of US-born engineer and physicist John Dunlavy's dream of producing a speaker that would be the nearest thing to 'being there' at a live musical concert. The dream became the *Sovereign 2001*, launched in '86 and the company's current flagship model which is priced here at £15,200/pr. Then in '87 a smaller and less expensive version of the *2001* appeared, the *PCL1000 Crown Prince*. Also in the range is the *PCL1100 Princess* (very similar to the *Crown Prince* but with heavier duty cabinet and more hefty price ticket), and the *PCL500 Marquis* (£3,500) which I enjoyed listening to at home a few months ago. (Report in issue 65, December 1988.)

Standing six feet tall, the *Crown Prince* weighs a back-breaking 55 kilos. The cabinet walls are $\frac{3}{4}$ inch thick, fabricated of laminates of high density fibreboard which are veneered top and bottom, and covered around the front, back and sides in a polyester grille cloth like a wrap-around 'sock'. The cloth is claimed to be 'acoustically transparent'; whether or not the speaker sounds better without it must be left to conjecture as it's not easily removed – and I wasn't about to go hacking into a pair of review speakers costing £6,000. For similar reasons, therefore, much of the information here has been gleaned from the comprehensive literature supplied with the speakers.

Driver complement comprises a centrally placed 28mm soft dome tweeter with two 100mm cone midrange drivers, one placed directly above and the other directly below the tweeter. Then above and below the midrange units are the two 240mm woofers. Each driver has its own sealed chamber within the enclosure, the inside surfaces of the woofer chambers being reinforced and braced for extra stiffness. Crossover frequencies are at approximately 500Hz and 5kHz.

Threaded inserts in the base of the speakers accept bolts for the base 'plinths' which add stability to these otherwise top-heavy columns. On the rear a handsomely engraved panel sports two sets of gold-plated terminals (bare wire or spade connectors only) for bi-wiring or bi-amping. For auditioning I used four (I counted 'em!) Audio Innovations

15watt triode monobloks for bi-amped operation; the *Crown Prince's* 90dB sensitivity allowed for ear-shattering sound pressure levels without any sense of strain or loss of control.

SOUND QUALITY

I guess it goes without saying that with speakers this size you get a real sense of scale to the musical performance happening in your living room. Musicians are lifesize, the image is deep and expansive, and the sense of power and weight achieved by the extended bass response does indeed give a feeling of 'being there'.

With speakers that go this low in the bass you can feel the air moving in the recording venue even during silent passages. It's always been my belief that to 'trick' one's mind into believing that a real musical event is happening, rather than an electronic reproduction thereof, you've got to extend bandwidth way above the limits of human hearing to preserve harmonic integrity, and way down into infrabass regions to 'feel' the air which is being energised by the vibrations emanating from musical instruments.

It would be easy to get over excited and proclaim that these speakers are the best I've encountered in terms of the way they create that 'live music' illusion. As it happens, it would be a true proclamation but such a statement needs qualifying. You see, the *Crown Prince*, as well as being the biggest speaker ever to have graced my living room, is also just about the biggest speaker that

could possibly grace my living room, period. And because of this, in my room it works just dandy.

A more lifelike sense of realism and scale is available from loudspeakers superior to the *Crown Prince*, of that I have no doubt because I've witnessed such sound elsewhere, but to experience them in the privacy of my own home... well, perhaps I'm going to need a bigger home.

So just what kind of sound does the *Crown Prince* make? In my 27 x 14ft room (approx) and with high class ancillaries (too numerous to mention here) the speaker presents a rich, deep bass with plenty of 'slam', warm midrange and laid-back treble. Perhaps a little too soft-sounding for some (at least one visitor to my home thought it was "all wrong") it is best described as 'polite' and understated. Imagery is top class, with excellent soundstaging throughout the frequency spectrum. The sound is never cluttered, the *Prince* seemingly taking everything well within its stride.

The *Prince* also appears to possess excellent dispersion characteristics. Toed-in just the right amount, there's no listening 'sweet spot' and you can enjoy good stereo well off axis. The front baffle sports an 'acoustic blanket', a sound-absorbing felt covering to eliminate cabinet corner diffraction effects, an idea seen elsewhere in countless speaker designs but one which Duntech itself patented in 1979.

If memory serves me correctly, the smaller *Marquis* has the edge on 'punch' and excitement, but the *Prince* shows finer breeding.

CONCLUSIONS

What I particularly enjoyed about the *Crown Prince* was its unfussy and forgiving nature. I could scurry around digging out hi-fi demonstration discs to show off the speaker's capabilities, and the system would make impressive noises, or I could watch the movie *2010* on the television via a NICAM-equipped VCR and be totally overwhelmed by the experience without once putting on my hi-fi buff's hat and complaining that the sound simply wasn't good enough. The Duntech *Crown Prince* has an uncanny ability to always make the best of a bad job.

Does this mean that the *Prince* isn't telling the whole truth? Maybe. But if you think it might fit the bill, allowing for the not inconsiderable size and the fact that to create a realistic image each speaker needs a good couple of feet of space all around, it can provide the final stage for a most enjoyable and fatigue-free high-end hi-fi system.

I really didn't want to part with them, but I know my bank manager wouldn't even entertain the idea - so there was no point in asking.

SPECIFICATIONS

Size (h x w x d)	180 x 30.5 x 43.5cm
Weight	55kg
Sensitivity (ref 2.83V @ 1m)	90dB
Nominal Impedance	4ohm
System bass resonance	42Hz
Typical price inc VAT	£6,120
<i>Reviewed by John Bamford</i>	
Absolute Sounds Ltd, 318 Worple Road, London SW20 8QU.	
Tel: (01) 947 8160.	

JOIN THE CROWD AT THE ... DOUG BRADY HI-FI SALE

APOGEE CALIPER £1995
APOGEE DUETTA £2950
MAGNAPAN MG3 £1895
MAGNAPAN MG2B £895
KRELL KSA 50/II (MINT) £1995

KRELL KSA 80 £3100
KRELL KMA 100 (pair) £3900
KRELL KSA 100/II £1999
AUDIO RESEARCH D115 £1890
AUDIO RESEARCH D125
(MINT DEMO) £3995

CELESTION SL700 £999
INFINITY KAPPA 8 £1495
ALPHASON SONATA £549
GALE 301 £199
ROTEL RL850 (PAIR) £99

Doug Brady Hi-Fi

Kingsway Studios,
Kingsway North,
Warrington, Cheshire.
(0925) 828009.
Open six days.

401 Smithdown Road,
Liverpool L15 3JJ,
Merseyside.
(051) 733 6859
Closed on Wednesday.

14/18 Monmouth Street,
Covent Garden,
London WC2H 9HB.
(01) 379 4010.
Open seven days.

DOUG BRADY'S THE MUSICAL EXPERIENCE!

SALE LIST continued

MONITOR AUDIO MA952 £499
LINX POWER I £650
MUSICAL FIDELITY MVT3 £1175
MUSICAL FIDELITY P172 £499
ACOUSTIC RESEARCH AR22BX
(PAIR) £130
B&W DM580 (NEW) £359
B&W DM570 (NEW) £224
B&W DM560 (NEW) £179

SOUND BEYOND THE FINAL FRONTIER

Audio
PROJECTS

45 HEADINGLEY LANE, LEEDS 6
0532 304565



g
the
sound
gallery

ALL CONSULTANTS ARE
THE SAME. AREN'T THEY?

THE SOUND GALLERY HAS
ESTABLISHED AN ENVIABLE
REPUTATION FOR ITS
PROFESSIONALISM IN THE
RECOMMENDATION AND
DEMONSTRATION OF DOMESTIC
HI-FI. WHATEVER YOUR BUDGET,
WE CAN PROVIDE YOU WITH THE
HIGHEST LEVEL OF MUSICALITY.

SO WHY COME TO US?
FOR SERVICE. IT'S FRIENDLY YET
INFORMATIVE. PROFESSIONAL
YET COST-EFFECTIVE. TRY IT!

65 CASTLE STREET
HIGH WYCOMBE, BUCKINGHAMSHIRE HP13 6RN
TELEPHONE (0494) 36682

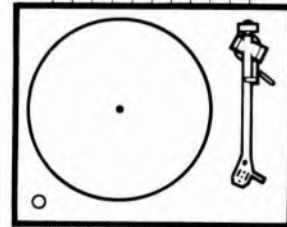
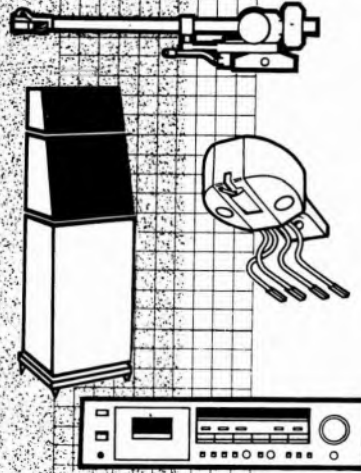

- ACOUSTIC ENERGY ■
- AUDIO AB ■
- A + R ■
- B & W ■
- CAMBRIDGE ■
- CREEK ■
- CELESTION ■
- DENON ■
- EPDS ■
- GOODMANS ■
- HEYBROOKS ■
- KEF ■
- LINN PRODUCTS ■
- MORDAUNT SHORT ■
- MARANTZ ■
- NAD ■
- NAIM ■
- NAKAMICHI ■
- REGA ■
- ROTEL ■
- SENNHEISER ■
- TANNOY ■
- WHARFEDALE ■
- YAMAHA ■



1st choice in East Anglia for Quality hi-fi . . .

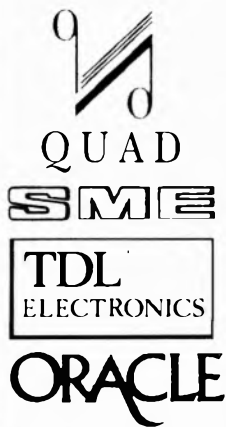

- | | |
|---------|--------------------|
| ROGERS | AUDIOLAB |
| ROYD | JPW |
| QUAD | PINK TRIANGLE |
| ARCAM | MISSION |
| ROKSAN | HEYBROOK |
| NAD | SYSTEMDEK |
| DUAL | WHARFEDALE |
| DENON | MICHELL ENG. |
| TDL | GOLDRING |
| ORACLE | SENNHEISER |
| SME | AUDIO-TECHNICA |
| ROTEL | CELESTION |
| SONY ES | BEARD |
| QED | MARANTZ |
| SPENDOR | SOUND ORGANISATION |
| AR | TANNOY |

- OPEN 9am to 6pm
MONDAY TO SATURDAY
(or by appointment)
- PROFESSIONAL INSTALLATIONS

- FULL DEMONSTRATION
FACILITIES AVAILABLE
- FREE CUSTOMER
CAR PARK OUTSIDE

Lyon Audio 
Hi-Fi Sound & Design Specialists

16 PEARTREE BUSINESS CENTRE
PEARTREE ROAD, STANWAY, ESSEX
Tel: COLCHESTER (0206) 560259

Credit Arranged - details on request



Sounds Exclusive

AUDIO CONSULTANTS

Agencies include:- Proac, Chesky Records,
Alphason, Y.B.A., Michell, Cambridge,
Vecteur, Albary, Sumo, Kiseki, Spica, Opus 3,
Voyd, London, Milltek, SME, Jecklin,
Alexander, Clear Audio, Quicksilver,
Gryphon, Finestra.

For an appointment or enquiry telephone
Guildford (0483) 276439
Open until 11 p.m.

The image of the Swiss as a nation obsessed with perfection is doubtless just as daft as the notion that folk living in Lancashire wear flat caps and breed whippets. Still, there's no denying that hi-fi products manufactured in Switzerland seem to reflect the same kind of dedicated skill and craftsmanship for which Swiss watches are so famous. The renowned Breuer tonearms are a perfect example, as are the luxurious cost-no-object hi-fi products of Goldmund.

Ensemble is the brand name for a range of loudspeakers made by Swiss company Pawel Acoustics, led by designer Harry Pawel. In addition to the *PA-1* there's a *PA-1 Reference* model (£2,995) which looks identical to the speaker reviewed here but features further refinements to the drivers and crossover components, and there's also a £5,500 floor-standing model which goes by the wonderful name *Primadonna*. Until just a few weeks ago Ensemble loudspeakers were handled by Vital Systems, the company best-known for distributing Quicksilver, Clearaudio and Pierre Lurine products in the UK. However, distribution has just been switched to a newly-formed company called Ensemble (UK) Ltd, based in Surrey.

Looking at a picture of the *PA-1* with its grille removed you might think it is using a metal-coned driver *a la* Jordan or Acoustic Energy *AE1*. In fact, the small 130mm bass/mid driver, which is custom-made for Pawel Acoustics, has a hardened synthetic foam diaphragm (which looks like it's covered in silver foil!) to make it lighter and more rigid than most common drivers. Pawel Acoustics claim the driver has very good linear extension, that much attention has been paid to the suspension, voice coil and magnet, and that together with the 19mm Focal soft dome tweeter these are the finest drive units money can buy.

Despite the diminutive size, this is no bookshelf loudspeaker. The entire rear face of the cabinet is taken up by a large elliptical passive bass radiator, the *PA-1* having been designed to operate in free space positioned somewhere between 1m and 2m out from the rear wall. Walk into a room where these loudspeakers are playing and you'd certainly wonder where all the bass is coming from – except now you know.

The cabinet is a sandwich construction of high density wood, finished in Brazilian rosewood veneer, or black or white satin lacquer (ours were black). The enclosure is tapered allowing 'time alignment' of the forward facing drivers, and feels extremely rigid and dead to the knuckle-rap test.

SOUND QUALITY

Used on the stands supplied, 24 inch tall Foundation *Designer* stands which cost a cool £299, the sound produced by the *PA-1* was much, much bigger in scale than it had any right to be. I'd been told in advance to position the speakers facing straight forward, and used as instructed the *PA-1*s are capable of creating an expansive soundstage which extends well beyond the boundaries of the enclosures, both in width and depth. The sound was free and open, quite lively and dynamic, with well-defined and tuneful bass and very good integration through the mid-band and treble. Stereo was good off-axis, and the *PA-1* proved to be a musically enjoy-

ENSEMBLE

PA-1



able loudspeaker which I grew to admire more the longer I listened. The grille covers are best left in place; without them the treble can sound a little 'peaky' and keeping them on seems to do nothing to the detriment of midband clarity and overall transparency.

CONCLUSIONS

Remarkable for its size, the *PA-1* produces a 'big' sound which is concurrently 'fast' and transparent. Bass is surprisingly weighty too, but it still lacks the extension which you'd expect to get from a larger floor-standing loudspeaker. "Well of course it does," go the cries. Yes, except this is a £1,700 loudspeaker (on a £300 stand) – and you can buy a lot of loudspeaker for that kind of money.

As this is a turbo-charged miniature, comparisons with models such as the Celestion *SL600Si*, *SL700* and Acoustic Energy *AE1* will be inevitable. Listeners who feel the Celestions too 'British' sounding, just a little too understated and over-damped, will prefer the extra vitality and sharper definition of the Ensemble *PA-1*. The *AE1* has this 'faster'

sound also, but it lacks the *PA-1*'s finesse and transparency. However, the *AE1* goes considerably louder before showing signs of running out of headroom.

In other words, it's all horses for courses. My preference would be for the Ensemble *PA-1*, but I can well imagine some listeners choosing differently. Which is all well and good, until it comes to the business of writing a cheque. And try as hard as I might, I can't imagine many customers – even those desiring high-end sound and appreciating that audio nirvana doesn't come cheap – being prepared to pay the asking price.

GENERAL DATA

Size (height x width x depth)	35 x 23 x 21cm (tapering to 15cm)
Weight (pair)	17.3kg
Sensitivity (ref 2.83V @ 1m)	86dB
Nominal impedance	6ohm
Maximum SPL (pair @ 2m)	104dBA
Typical retail price inc VAT	£1,695

Reviewed by John Bamford
Ensemble (UK) Ltd, Little Banks, Park View Road, Woldingham, Surrey.
Tel: (01) 948 4153.

The background to Infinity loudspeakers must be pretty common knowledge by now, the company having been represented by three different UK distributors in the last five years and consequently having received a fair amount of publicity. The current distributor Gamepath, which also handles Rotel, has taken on Infinity as part of its high-end range which includes Jeff Rowland amps and Oracle turntables. The *Kappa* series of loudspeakers represents Infinity's mid priced range and slots in between the affordable *RS* models, such as the Best Buy *RS2000*, and the megabucks *IRS* series.

The *8 Kappa* retails for £1,650 and stands an impressive four feet high and 20 inches wide. The enclosures supplied for review had santos sides and tops which are reddish in colour and give the speakers excellent perceived value and domestic acceptability. The fluted semicircular sides resemble a roll-top desk adding a certain distinction, as well as acting as an anti-diffractive boundary to the baffle. They are considerably shallower than they are wide, which means that the imposition made on the listening room is much more acceptable than one would expect of a unit with such a large frontal area.

Each enclosure is supported on a 38 x 29cm foot which tilts the speaker back by about 15 degrees; a slight drawback with this is that it's devoid of spikes or feet and is thus only suited to flat uncarpeted floors. However, Gamepath is working on some threaded inserts for spikes and in the meantime *Tiptoes*, aluminium cones, do the job quite adequately.

Removing the plastic framed grilles, a sonically preferable option, reveals an aggressive array of drivers mounted on a black carpet damped baffle. There are four

INFINITY 8 KAPPA

front firing units which start with a 12 inch graphite reinforced polypropylene woofer which can be switched for extended or normal operation. The sonic difference between these two settings is only a matter of 3Hz – it is claimed to extend to 32Hz – what's more important is that it changes the load presented to the amp. In extended operation impedance can drop to 1½ohms, a result of the bass extension requirement for such a low volume cabinet. Switching to the normal setting introduces a 1ohm resistor into the circuit and increases impedance by three quarters of an ohm. It may not sound like much but it's the difference between a Krell and a Rotel in current delivery terms.

The bass driver hands over at 80Hz to a *Polygraph* five inch lower mid unit, a large polypropylene dome reinforced with a spiders web of graphite which is somewhat vulnerable to stray fingers. The rest of the midrange is covered by the *Polydome*, a very soft three inch dome which covers the 800Hz to 4.5kHz range. Penultimately there is an *Emit* isodynamic tweeter – I say penultimately because there's another one of these on the back of the *8 Kappa*, which is intended to "provide enhanced spatial characteristics and imaging" – say no more.

In true Infinity fashion the crossover is

fitted with output adjusters for the two mid-range units and the front firing tweeter. These can be tweaked to adjust for frequency balance anomalies in the rest of the system or the room, or at least that's the idea, anyway. The connections are of the chunky three-way type and there are four per side to allow for bi-amping/wiring.

The *8 Kappa* prefers to be sited away from room boundaries with at least two feet at the side and with as much space as possible behind. The greater the distance to the rear wall the better imaging capabilities become.

SOUND QUALITY

A variety of ancillaries were used for the listening tests including Audio Innovations, Conrad-Johnson and Omtec amplification alongside Roksan and Townshend turntables and a Micromega *Classic* CD player. A pair of Snell *JIs* were used for reference purposes and my initial impressions of the *8 Kappa* are consequently the differences between the two speakers. These seem most obviously to be considerably more extended bass and a generally darker, less open presentation.

The *8K* is particularly strong in the bass and despite trying various amp combos and settings on the speakers, bass output seemed a little too high. With many recordings the effect is quite acceptable, even appealing, but with others LF can be a bit domineering. For instance quite raw, live sounding records like Green on Red's *No Free Lunch* lose some of their edge, but gain depth and start to image quite well. In fact this disc proved quite beguiling and it took considerable effort to stop listening and make notes.

But looking at it in a more analytical light one can't help wondering where the life and clarity that the *JIs* reveal had gone – the *8K* has a certain 'thickness' in the midrange that makes records sound slightly fluid. Transparency and dynamic range are the forté of Innovations/Snell systems and something that once discovered is hard to relinquish. The *K8* asks one to do that in exchange for imaging, extended bass and good looks, which is a high price.

CONCLUSIONS

The *8 Kappa*'s sonic strengths are great imaging, especially with powerful transistor amps in large rooms, good bass extension for its size and a wide sweetpot. It is a very attractive and highly enjoyable loudspeaker that is perhaps best suited to classical recordings, and is at home with the digital alternative.

Size (height x width x depth) 118 x 51.5 x 17.5cm
 Typical price per pair inc VAT £1,650
 Reviewed by Jason Kennedy
 Gamepath Ltd., 25 Heathfield, Stacey Bushes, Milton Keynes, Bucks
 MK12 6HR. Tel: (0908) 317707.



M

innesota's Magneplan is a dedicated but conservative company, so while it rarely introduces a new model it's even more unusual for it to phase out an established design. However, the launch of the new *MG1.4* also heralds the demise of the long-serving *MG1c*.

Neither the *MG1c* nor its successor incorporate the ribbon tweeter that distinguishes the top Maggies, but certain detailed modifications have been made to the *1.4*, without incurring a price penalty. The basic concept is very elegant: replace the cylindrical former and wound voice coil of a conventional driver with a planar former and voice coil. Here the Mylar former also doubles as the diaphragm which is strategically clamped at its edges to control any resonances inherent in such a structure.

The brass voice 'coil' is bonded directly to the rear of the diaphragm, covering its surface as a series of parallel vertical conductors about 10mm apart. One Mylar film is used per speaker with the bass section occupying some 2761cm² of its surface area and the treble strip covering about 439cm².

Just as a conventional driver's voice coil is set between the poles of a cylindrical magnet, the Magneplanar also requires a fixed magnetic field for the induced (audio) electromagnetic field around the diaphragm to 'work' against. This is achieved using a series of vertical bar magnets that take the form of a perforated sheet fixed to the front.

The magnetic sheet and stretched Mylar diaphragm are built onto a 19mm Medite frame which is then covered with an attractive off-white cloth. Magneplanar's proprietary 2nd-order crossover is also concealed behind the cloth grille and incorporates two huge air-cored inductors together with four high quality Seacor polypropylene capacitors.

In addition, the reinforcing oak side panels that accompany all Magneplanars have been increased in stature for the *MG1.4*. Furthermore, though their insubstantial L-shaped feet are still supplied to support the panel, at least the fixing screws are now located into metal bushes fixed tightly into the base of the frame.

LAB REPORT

The measured sensitivity of the *MG1.4* has been adjusted to 88dB at 2.83V in order to account for the deviation all dipole speakers take from the inverse-square law. Either way, its sensitivity is up on most Maggies and with a maximum input power of 200W is likely to develop a health 104dB SPL in a standard living room. Magneplanar claims the impedance to be both purely resistive and constant at 5ohm across the audio band. In reality the load varied between 5.4ohm at 100Hz and 4.9ohm at 10kHz with a very prominent panel resonance leading to a peak of 10.4ohm at a high 750Hz, just prior to the crossover point at 1kHz. In comparison, the LF system resonance of a conventional infinite baffle speaker will usually fall below 100Hz.

SOUND QUALITY

It's not uncommon for the bass to flesh-out

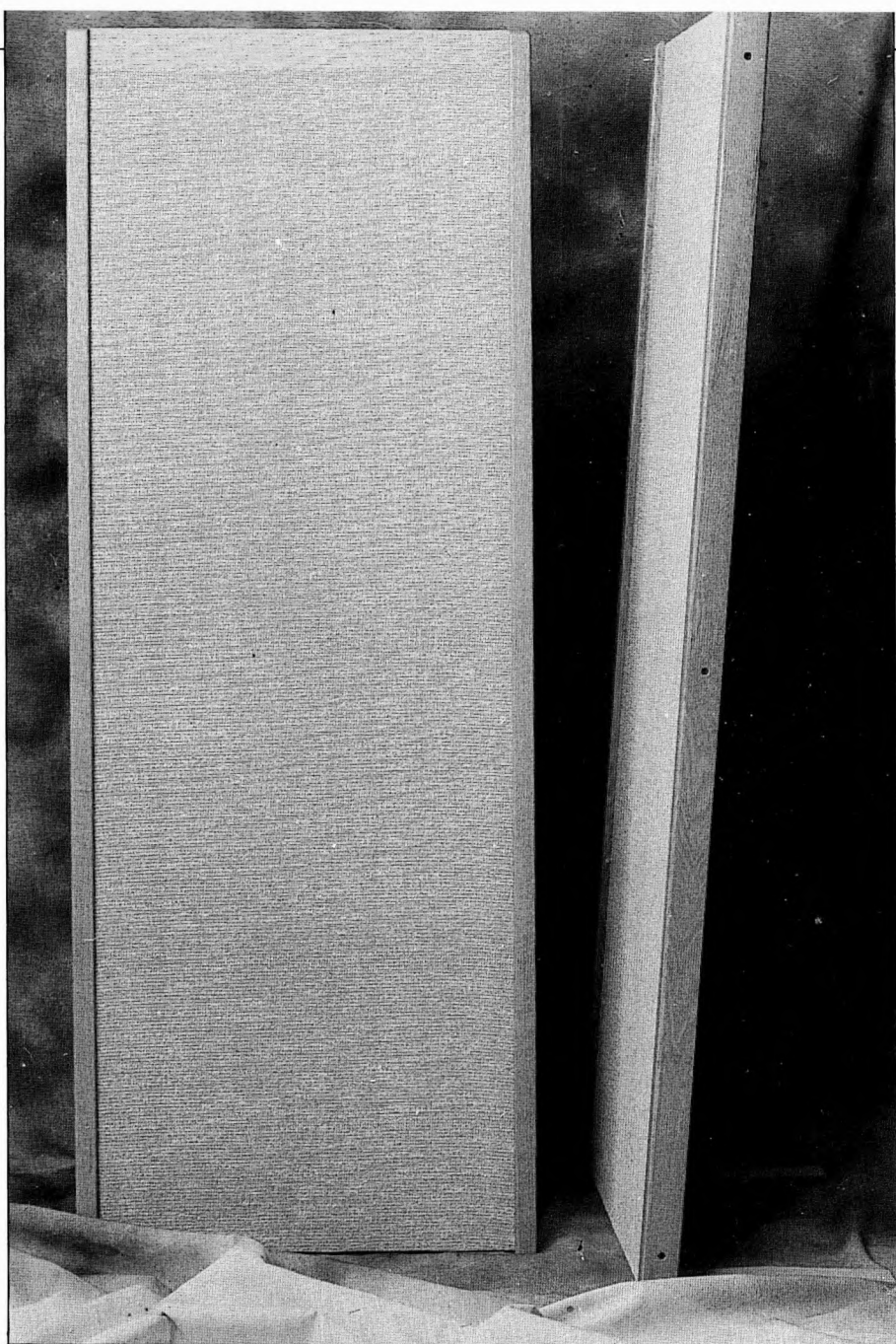

over a period of a few days when running in a brand new pair of Magneplanars and, indeed, the initial balance of these speakers was both tight and cold. Once run in the bass was clearly not as extended as it was with my usual *2.5Rs* despite it sounding exceptionally crisp and rounded in tone with a punchy and rhythmically solid bass line.

The treble panel did 'relax' after a time, helping the speaker to achieve a fine sense of projection, even if the imagery itself was slightly narrow. However, front to back imagery was very good indeed, the *1.4s* enjoying a pleasantly open and see-through midband free of the 'boxy' colorations that plague so many conventional loudspeaker enclosures.

Vocals were projected with a solidity and conviction that outstripped even the costly *MG2.5Rs* but there was undoubtedly an increase in sibilance together with a faint lispy coloration added to the most potent of performers. Reticent vocalists sounded very articulate, though I missed the tonal purity

of delicate percussion with these speakers.

The difference, say, between brush strokes and the patter of a high-hat was clearly differentiated but there was still some residual smearing that compromised the resolution of complex passages. This was a pity because the speaker sounded delightfully taut and articulate when reproducing simple pop or chamber works.

CONCLUSIONS

Magneplanar's *MG1.4* breathes new life into the older *MG1c* design, offering a wonderfully open and airy sound quality with suitable recordings. However, the ultimate success of this new Maggie will depend very much upon the musical tastes of the prospective owner, as the effectiveness of its musical 'spell' was less convincing with full-scale classic works.

Typical Retail Price

Reviewed by Paul Miller

Absolute Sounds Ltd, 318 Worple Road, London SW20 8QU.

Tel: (01) 947 8160.

£1098

MAGNEPLANAR MG1.4

MARTIN-LOGAN

CLS II

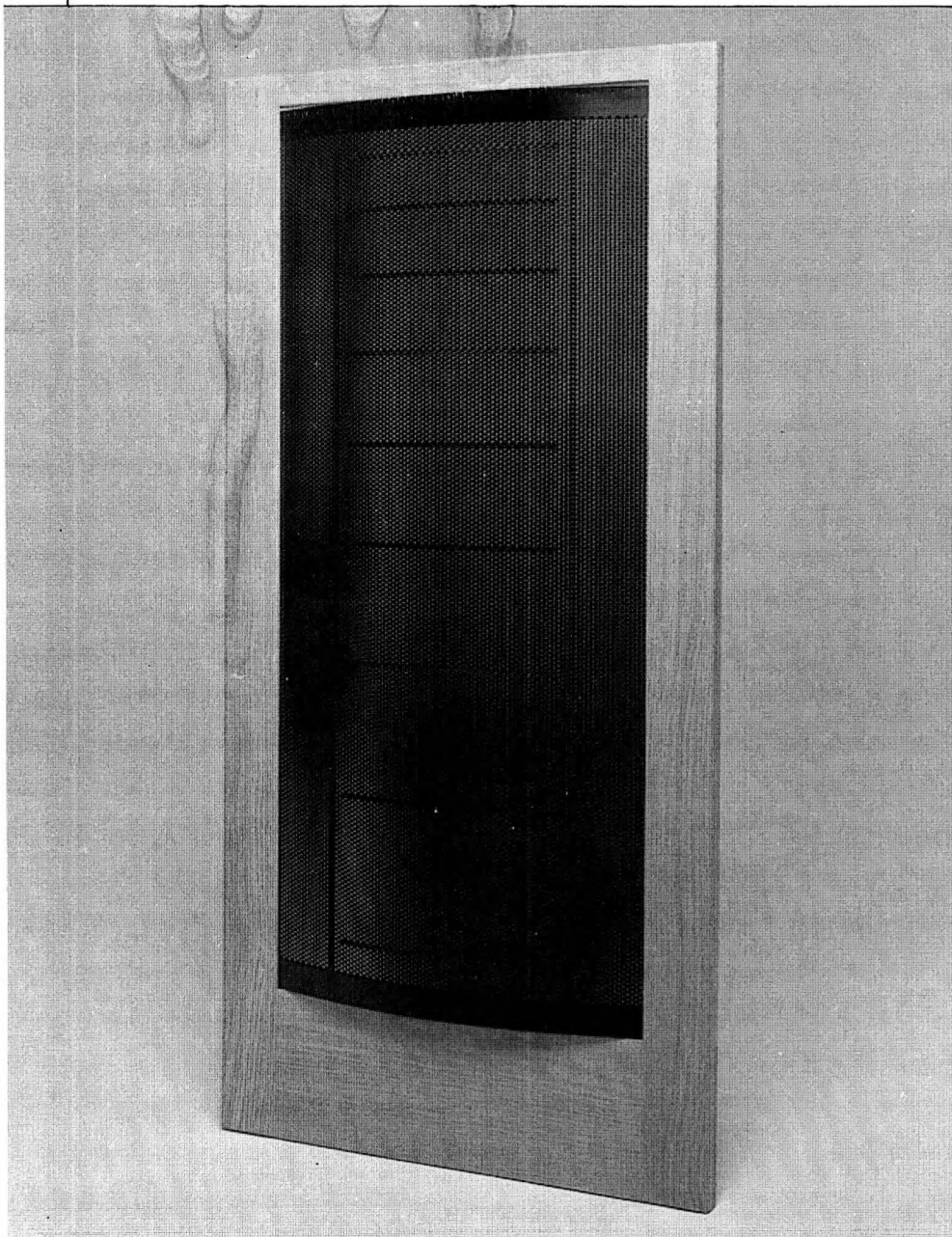

THE *CLS II* is a full range electrostatic loudspeaker of dramatic appearance, designed and made in the States, and now distributed in this country by Absolute Sounds.

The *MkII* version of the *CLS* consolidates various running improvements that were phased into the *CLS* programme, and adds a number of new ones in an exercise that makes something of a rough (and inconsistent) diamond into a more polished and rounded one – to match its appearance, you might say.

Surely one of the most distinctive loudspeakers in the world, it stands nearly 5ft tall on solid or spiked feet (both are supplied,

the latter a response to UK pressure) and consists of a solid wood frame surrounding two panels spaced to form electrodes with the electrostatic diaphragm suspended in between. The panels are curved in the lateral plane only and the frame is supported at its base by a large black metal box which protrudes from the rear. This very heavy item contains all the interface electronics for the speakers, much of the weight being due to two large transformers. Mains power is supplied to an IEC socket in each loudspeaker, and a switch rolls off the extreme HF a little, should that be deemed desirable – it wasn't on test.

The diaphragm is transparent, and no additional plastic or cloth covers are used.

Consequently the perforated mesh grilles constitute the only impediment to light which streams through the speaker almost as though it wasn't there. It's this quality, along with the general excellence of build and finish (the woodwork is truly superb) that makes the *CLS* so striking, not to say elegant.

That doesn't mean that I have no criticisms of the way the system is made. The one real problem with panel speakers is that they're intrinsically open to all kinds of bending and torsional modes as it's very difficult to make flat panels stiff. The base structure of the *CLS* is better than most panels at anchoring the system firmly to the floor, but M-L has missed a trick by failing to exploit the curvature of the radiating panel at the top and bottom – it's clamped at the two sides only. Tapping the centre of the panels reveals a complex of structural ringing modes which might have been at least partially damped with a better thought out frame.

As for the changes incorporated in the *MkII*, it seems that the interface circuit topology is radically different to the original *CLS*. The new power supply is a regulated design said to be indifferent to mains power variations and spikes, retaining a much more constant bias force. However, an internal switch allows the bias to be changed to cope with unusual climatic conditions – for example if you live half way up the Andes and suffer from discharging on louder passages. Changing bias voltage will generally effect a cure I was told, but at the expense of a dB or so sensitivity.

In contrast to the previous model, there are two basically similar transformers. These are used in such a way that in the low frequency area the system 'sees' both transformers in a series/parallel configuration, giving twice the turns ratio (200:1) in the bass. The low pass transformer is filtered out of the system, and above 500Hz or thereabouts only the other transformer is left. In effect, the system operates as a single full-range transducer but with a stepped up bottom end. All bipolar radiators operated in free air roll-off at 6dB/octave below a frequency determined by the panel size and wavelength. In effect the system becomes progressively less efficient, and M-L has compensated by progressively boosting output below about 200Hz.

The same goal was pursued in the old design, but it was done with a single transformer. The new circuit provides a much higher peak-to-peak voltage swing, and there's something like 6dB more field strength on the diaphragm. As a result there's more headroom, and a little more sensitivity. To help cope with these changes, the spacing between the electrode plates has been increased, allowing greater diaphragm excursions. Efficiency is not altered, but sensitivity is higher because the impedance is lower. Even so, we're talking 86dB/watt/meter, which is not exactly super efficient. Impedance is nominally 4-6ohms, but at high frequencies it drops to a low of about 0.8ohms at 20kHz. M-L claims that the *CLS II* is more resistive than reactive, but I found it amplifier sensitive and would not recommend taking chances.

The other significant change – which occurred just before the *MkI* was phased out – concerns the electrostatic panel itself. The old one had a carbon coating and was

renowned for being inconsistent and behaving hygroscopically, varying in performance with the weather and temperature. M-L now uses a 'plasma coated' diaphragm, in which copper oxide and palladium are vapour deposited *in vacuo*, giving a much more consistent diaphragm. The surface coating has a resistance of 10⁹ohms/cm sq and is said to hold its charge in a very stable manner. It doesn't pull enough dust from the air to need a dust cover (those who have heard a Quad stripped of its protective layers will know what a blessing this is), and there's insufficient charge to constitute any hazard to the user. The new design no longer needs a hair dryer to shrink it back to a proper operating tension as did the early *MkI* pair I reviewed some time ago.

SOUND QUALITY

I used a Krell *KSA-200* for most of the listening, a combination explicitly approved by the manufacturer. I also used a Musical Fidelity *A370*, which worked magnificently and would help keep system costs in check. For all its newly acquired user-friendliness, the system takes a considerable time to break in. I gave it three days and three nights playing Bernstein's new *Mahler 1* on auto-repeat. I didn't want to blunt its enthusiasm.

Dispersion is close to figure-of-eight, but is optimised with the narrow strip (see diaphragm) inside, and the speakers just barely toed in. The speakers should be pulled 1m or more from the rear wall, and used with spikes. In some circumstances they are said

to benefit from a little damping behind the speakers. The diaphragm is large and of low mass; it's highly transparent to rear room reflections. I tried varying the speaker/rear wall distance by small amounts, and applying damping using drapes. The sound varied, often quite dramatically even after apparently insignificant incremental changes. I can't say how it will work out in other situations, but in my listening room the system always sounded at its most natural, and gave the most cohesive imaging, when the minimum of damping was used around the loudspeakers.

I recognised a fine sense of speed and transparency in the older model, but was turned off by a poorly controlled LF, and a predisposition to coldness verging on brittleness which at the very least demanded sympathetic treatment by the system it was used with, but which often couldn't be controlled at all. Well, it no longer sounds that way. This new model has a tighter and better damped bass, and perhaps a marginally deeper one too, though nothing to compare with an Apogee of similar size. There is the same resolution and clarity so prominent in the old model, but it's more forgiving and a little sweeter too. The lower mid has been filled in a little, it's not as cool nor as lean in personality. The *CLS II* paints a broader canvas, and where the old model was inclined to sound unforgiving, the *II* is genuinely easy on the ear.

Buy a *CLS II* and you'll discover a thoroughbred, a transducer that has exceptional

speed and transparency, that reproduces an improbable amount of detail, and that on a typical recording offers a full, quite deep bass with a lightness of touch you won't find in a box speaker. There's real energy here, excellent projection (a characteristic of panel speakers), and a well resolved, sharply focused and properly distanced soundstage (many panel speakers sound a bit bloated and defocused). It goes loud too, tracking dynamics perfectly (another panel plus point), appearing to thrive on most of the power available from either test amplifier (see separate reviews). It's a powerful and engaging combination of virtues, only slightly marred by a rather 'busy' upper midband; a slight tendency to glare in the region often occupied by orchestral strings.

CONCLUSIONS

The first *CLS* gave an exciting but often bumpy ride, and there's a case for saying that it wasn't a truly dependable product. It was hard to predict how it would behave from system to system — even from day to day. Although it looks pretty much the same, the *II* is a much more polished, professional and consistent product. It's not for everyone, but it now comes much closer to standard UK tastes (particularly in bass/mid level, integration and damping), and is much less destructively interactive than before. Highly Recommended.

Typical price inc VAT

£3,750

Reviewed by Alvin Gold

Absolute Sounds Ltd., 318 Worpole Road, London SW20 8QU.
Tel: (01) 947 8160.

A MOVING EXPERIENCE

(with apologies to the reader)

The well-informed enthusiast will confirm that demonstration is a fundamental element in choosing the equipment that will give you lasting pleasure playing music in your home. Indeed the quality of dealer may be judged from demonstrations — how convincingly these back up what they say they think will suit you and suggest you ought to buy. A great deal 'tho, is due to the dealer's long experience in the setting up of systems for musical felicity.

The warmth of family business plus the skills that have been added over sixty years of trading have combined for Grahams Hi-Fi to make them most respect'd in the field of specialist dealers. In premises quite unfavour'ble (a warehouse site near Kings Cross)

our happy home has operat'd for nigh on twenty years; but the traffic's getting heavier (and some would say much louder) the parking's more congested, the dem rooms aren't that perfect e'en tho' they were among the first (not quite the best) to be set up here in England.

We're proud to make th'announcement that Grahams Hi-Fi's moving not far — about ten minutes — it's quite a quiet area with lots and lots of parking and the chance in our new building to do things even better — we'll have among the finest demonstration rooms in Europe; in all, the proper premises to complement a service (not to mention installation) which has earned our reputation both at home and overseas.

Our policy will continue of carefully selecting the best of all those items that are brought to our attention, equipment that is able to reproduce the message and communicate the essence, yea, the spirit of the music. It may well be for the first time (perhaps — we might be boasting) in the whole United Kingdom that appointments can be taken for any one of five new dem rooms, acoustically unrivall'd and specially designed to provide the vital background for easy relaxation. So please do dial our number and make yourself a booking, let's show you our new building can provide the perfect context for optimal selection of your choice in sound and music.

Visit Grahams! End your searching!

GRAHAMS HI-FI



GRAHAMS HI-FI, CANONBURY YARD, 190A NEW NORTH ROAD, LONDON N1 7BS PHONE: 01-226 5500

BACK ISSUES & BINDERS

TO ORDER BACK ISSUES:

Please tick issues you require

CD Midi Systems (Special Ed.)	Nov 86	<input type="checkbox"/>
Turntables, Arms, Cartridges (48)	Dec 86	<input type="checkbox"/>
The Best Buy Guide (Special Ed.)	Oct 87	<input type="checkbox"/>
Amplifiers & Tuners (50)	April 87	<input type="checkbox"/>
Compact Disc Players (51)	June 87	<input type="checkbox"/>
Cassette Decks & Tapes (52)	Aug 87	<input type="checkbox"/>
Loudspeakers (53)	Dec 87	<input type="checkbox"/>
CD Based Midi Systems (54)	Jan 88	<input type="checkbox"/>
Turntables & Arms (55)	Feb 88	<input type="checkbox"/>
Amplifiers (56)	March 88	<input type="checkbox"/>
Cassette Decks (57)	April 88	<input type="checkbox"/>
CD Players (58)	May 88	<input type="checkbox"/>
Loudspeakers (59)	June 88	<input type="checkbox"/>
The Collection (60)	July 88	<input type="checkbox"/>
One-Name Systems (61)	Aug 88	<input type="checkbox"/>
Amplifiers (62)	Sept 88	<input type="checkbox"/>
Cassette Decks (63)	Oct 88	<input type="checkbox"/>
Compact Disc Players (64) (inc. free CD)	Nov 88	<input type="checkbox"/>
CD Midi Systems (65)	Dec 88	<input type="checkbox"/>
Loudspeakers (66)	Jan 89	<input type="checkbox"/>
Turntables & Arms (67) (inc. free Elite Gauge)	Feb 89	<input type="checkbox"/>
Amplifiers (68)	March 89	<input type="checkbox"/>
Cassette Decks (69)	April 89	<input type="checkbox"/>
CD Players (70)	May 89	<input type="checkbox"/>
Loudspeakers (71) (inc free supplement)	June 89	<input type="checkbox"/>

Individual issues including postage and packing: UK £3.50,
rest of the world £4.25 (air service)

TO ORDER BINDERS:

Keep your copies of *Hi-Fi Choice* in prime condition with our 8-issue binder finished in black and gold. £5.95 (UK), £7.95 (air service) inc. postage and packing

PAYMENT

I enclose my cheque/Post Order made payable to *Dennis Publishing Ltd.*

Please charge my Access/Visa (delete as appropriate)

Credit card number _____

Expiry date _____

Signature _____

Name _____

Address _____

Postcode _____

(72)

Please send order form and payment to:

Hi-Fi Choice, Mail Order, P.O. Box 320, London N21 2NB.

The Collection

(of Presence Audio)

Some of the best British high-end hi-fi products (for which Presence is world distributor) and some of the best of the imports are listed below. Further information on these value-for-money products can be obtained by phone, fax, telex or letter at the address below.

ALBARRY-BRITAIN. Uniquely-styled, high-quality transistorised Pre-Amplifier plus 48watt and 100watt monoblok power amplifiers. These are for those who care about the looks as well as the sound.

ALEXANDER-BRITAIN. Uniquely-styled, steel-cased compact loudspeakers for enthusiasts with space/partner problems, to upgrade a rack/stack system or as extension speakers to the dining room, kitchen, conservatory or pool.

CADENCE-BRITAIN. Uniquely-styled, high-quality valve (tube) pre-amplifier (with switchable moving coil input) plus 60watt monoblok power amplifiers. Accurate 1990s valve sound with great presence (sorry!).

DECCA - SEE LONDON.

GLANZ-JAPAN. Outstanding value-for-money moving flux and moving coil cartridges all with replaceable styli.

INTERFACE-HOLLAND. Sound-improving mats for compact discs plus a record mat and clamp. They really do work.

KISEKI-JAPAN. Six of the best moving coil cartridges in the world, including THE best and most expensive. The exchange scheme means a Kiseki is always worth 45% of its replacement cost. Also step-up transformers.

MILLTEK-JAPAN. Made by Kiseki, these high-output, lower-priced moving coil cartridges offer sound value-for-money.

LONDON (DECCA)-BRITAIN. The world knows and buys the Decca-designed London cartridges and also the new Decca London International (Revised) tonearm. They may look dated - but have not yet reached their "sell-by date" by a long way.

ODYSSEY-HONG KONG. Can connectors affect the sound? Definitely! Odyssey's non-magnetic, gold-plated and insulated speaker and phono plugs make the difference.

OPUS 3-SWEDEN. Famous for its high-quality recordings on LP and CD, this company now produces a turntable and a range of five loudspeakers using a unique cabinet material - crushed marble and resin. Very unusual, very heavy and very good.

SAE-USA. Here's a range of transistorised electronics which have not only good sound and styling, but also the facilities that some owners still require - such as tone controls, speaker switching, tuner pre-sets, etc. More value-for-money.

SPICA-USA. The famous wedge-shaped speakers which amaze all who hear them. Plus their most unusually-shaped big brothers, the Angelus. Not box-like.

STERLING-BRITAIN. Is this the world's best-sounding interconnect and loudspeaker cable? Solid silver strands of 99.99% purity - not just plated - so you invest in precious metal! And it's not even the most expensive cable available.

TEAKWOOD-THAILAND. Uniquely-styled, roll-top storage cabinets for CD/Audio/Video Cassettes hand-made in real teak.

VECTEUR-FRANCE. Famous first for top quality LC/OFC interconnect and loudspeaker cable (and now a new single strand cable for amplifier and speaker internal wiring), Vecteur also produces some effective accessories such as a CD Cleaner, Les Cones and MC cartridge step-up Transformers. But a surprise is coming shortly!

YBA-FRANCE. Fast becoming world-famous, this range of top transistorised electronics includes three pre-amplifiers, three power amplifiers (50watt, 70watt and 85watt) and a line filter for the mains.

ZYP-BRITAIN. The last word in accessories - and at last a pair of speaker stands that look as good as they sound. Tell the wife!

For further information please contact Presence Audio, The Old Posthouse, Plummers Plain, Horsham, W. Sussex RH13 6NU. Tel: (0403) 891777. Fax: (0403) 891747. Telex: 87602 ANCR F G.

JECKLIN FLOAT ELECTROSTAT

Built using the same basic shell as the *Model One*, the *Electrostat* is the top model in the Jecklin range and differs from the others in using a mains powered energiser. This unit sits between the amp and speakers and features two sets of spring clip terminals to accommodate the incoming and outgoing signals. For the purposes of this listening test

I used DNM single strand cable.

The long (3m) flat lead terminates in a six-pin lockable plug that fits into the energiser. It is recommended that the 'phones are left plugged in to warm up before use, and this procedure was followed. The comfort rating is the same as for the less expensive *Model One* – good long term comfort after initial familiarisation. Apparently the *Float*

range was designed by a Swiss recording engineer for use in the studio, where long term comfort is an ergonomic (or even ergonomic) necessity.

Sonically quite exceptional, for my money these are the best headphones in the review (issue No. 55). Characterised by remarkable clarity and control over an impressively wide frequency range, they were more revealing than loudspeakers costing two or three times as much. Compared to the *Lambda Pros* reviewed in issue No. 55, the bass was much improved, and the presentation gave a significantly better impression of spaciousness, in some respects sounding quite unlike headphones. They also sounded more palatable at highish volume, and were very clean and solid.

The strength of the *Float* models lies in the openness created by the unusual ear to driver relationship, and they would be unsuitable for a noisy environment. However, under normal domestic circumstances they represent the state of the art in headphone design, and as such must be Recommended.



GENERAL DATA

Type	circumaural-ish, open-backed, electrostatic
Mass	480g inc. lead
Size rating	very large
Length of cord	3m
Comfort rating	good
Sound quality rating	excellent
Price	£399

Reprinted from issue No. 55

Reviewed by Jason Kennedy

Castle Acoustics Ltd, Park Mill, Shortbank Road, Skipton, W. Yorks BD23 2TT. Tel: (0756) 5333.

AD INDEX

Absolute Sounds	IFC	Kenwood	22
Acoustic Arts	42	KJ Leisuresound	121
Audio Acoustics	87	Lyon Audio	108
Audio Freaks	81	Marantz	18
Audio Projects	108	Moorgate Acoustics	64
Audio South	60	O'Brien Hi Fi	98
Audio Technica	48	Path	68
Aylesbury	56	Pinewood	89
Bartletts	54	Prescence Audio	114
Brady, W & A	107	Progressive Audio	98
Chew & Osbourne	72	Reading Hi Fi	11
Chord Co	34	Richer Sounds	4,5
Cornflake Shop	31	Rogers Swisstone	34
Compact Music	72	Rotel	36,52
Covent Garden Records	28	Sevenoaks Hi Fi	24,25
Final Upgrade, The	38	Shamint	58
Graham's Hi Fi	113	Sounds Exclusive	108
Grant Amplifiers	64	Sound Gallery	108
Hampshire Audio	84	Sound Room of Norbury	64
Harrow Audio	11	Sound Shop	56
Hi Fi Care	72	Soundtec Marketing	IBC
Hi-Fi Experience	94	Swifts of Wilmslow	60
Hutchinson Hi-Fi, Bill	62	Victoria Audio	56
Kamla	58	Voyd	98
		Uxbridge Audio	74
		Wilmslow Audio	98

SONY MDR-R10

The £2,500 *MDR-R10* is a labour of love. The development brief took four years to fulfil, and called for only the finest materials to be used irrespective of cost. But neither cost nor the time scale surprised me – what did was that the result of the protracted gestation process looks so orthodox, superficially at least. The *MDR-R10* is not an electrostatic, but a dynamic moving coil design with sealed ear units (!) and a standard lead and 6.3mm plug set. I posed the obvious questions to Sony's engineers, and was led to understand that people like the acoustic isolation of sealed headphones (where? In Japan?). On the moving coil question, I got no change at all.

The facade of conventionality doesn't sustain closer examination. Basically the *MDR-R10* story is one of tried and tested design principles taken to previously unheard of heights. Choice of materials is the single most remarkable feature, starting with where it all happens – the 50mm diaphragm, which is made of a bio-cellulose material ten times as rigid as paper, but with the transmissibility of aluminium or titanium (sic). Developed in co-operation with the Ajinomoto Corporation, it's made by an acetate bacteria.

The equally exotic outer housing is carved from solid 200 year old Aizu zelkova wood (a relative of elm) chosen for its lightness and hardness, amongst other structural properties. The shape is complex, and is internally stepped for sound diffusion purposes. To improve resistance to microphony the housing is decoupled from the earcushion. The deep, opulent circumaural earpads are

covered in soft Greek lambskin (one whole skin per headphone!).

The headband is a two piece type with an outer carbon fibre section and a soft leather inner with a self adjusting mechanism for location purposes. These are based on flat memory alloy springs which maintain near constant tension at widely different settings. The cable has a high purity Litz core structure, and a silicon and silk dielectric and covering. Even the plug is costly – 6.3mm sockets are by no means common on esoteric equipment, but Sony will be producing an accessory called the *DRC-R10*, a passive unit that is plumbed into the loudspeaker leads.

System impedance is 40ohms with a low but perfectly manageable sensitivity of 100dB/MW. More significantly, it's no featherweight. Without the cable it clocks in around 350gms, a fact suggested by its bulk. Finally, presentation is truly something special. The Sony comes packed in a high quality lock-up case, with a linen covered instruction book printed on fine paper. Finish of the headphone itself is simply beyond compare.

Short term wear comfort is utterly fabulous. The materials used have an opulent, silken feel and an absolutely even spread of pressure over the top and sides of the head, which is maintained at a minimum level consistent with security. The tension of the self adjusting headband was a little high for my taste, but this is a minor quibble. Having said all this, we're discussing a sealed headphone that is undeniably relatively heavy, and inevitably there comes a time (in my case after a couple of hours' straight use) when the brainbox cries out for relief. Sony has done nearly as good a job as was possible, but

it's inevitable that such headphones will make their presence felt, later if not sooner.

SOUND QUALITY

A word used more than once in Sony's literature is the apparently innocuous 'presence', which is a property the *R10* possesses in abundance. First impressions, determined partly by tonal balance, are of a very big, upfront yet spacious and highly detailed style of musical presentation, framed by a deep bass which is balanced on the warm side, and a smooth, sweet and slightly distant treble. I felt there was some confusion of spatial clues due to a contradiction between the close, forward mid and upper midband and the treble which tends to fall away, giving a more distant feel to upper woodwind and some strings and percussion. Overall, the Sony is extremely sophisticated. It gives a fine sense of tonal differentiation and explicit (though not pointed) dynamics in the context of an overall soundstage, intended to sound a little more diffuse and distant than many headphones. I suspect these observations are part of a deliberate 'humanising' of the archetypal over-explicit close-sounding headphone sound.

Courtesy of Jason Kennedy, I was able to make a short but illuminating direct comparison with the Stax *Lambda Signature* (with its optional valve energiser) and the comparison was far from one-sided. The Sony is significantly warmer and sweeter than the *Lambda*, which was probably the idea, but in the area of imaging and dynamics the *Lambda* was still crucially in the lead which I believe may be attributable to the *Lambda*'s lack of a sealed pressure cavity. Be that as it may, the *Lambda* gave a clearer idea of where instruments were positioned in a mix, the shape of the soundstage as a whole, and the scale of individual instruments and the way they interrelated. Soundstaging was more explicit and informative than with the Sony, though with commercial stereo recordings intended for reproduction via loudspeakers, neither can claim to tell the absolute truth.

CONCLUSIONS

Five hundred units a year will be made, half each for Japan and the rest of the world, but production rate is partly determined by availability of the raw materials. Lifetime is said to be in excess of ten years to the maker's specifications. Leatherwork in contact with the listener's head is replaceable.

Perhaps the most exclusive headphone ever made, and arguably the most desirable, the *MDR-R10* is a notable landmark in headphone design. It's surely the finest moving coil unit ever made, and is musically comparable to the finest headphones of any type – at a price. It has a distinctive character of its own, tending to favour the presentation of detail and timbre over the shape and scale of the soundstage. Ultimately, personal perceptions of what is and what isn't important will determine choice between the Sony and its very few rivals. Recommended.

Typical price inc VAT

£2500

Reviewed by Alvin Gold
Sony UK Ltd, Sony House, South Street, Staines, Middlesex.
Tel: (0784) 647000.



The Stax name has long been associated with high quality headphones, and despite quite a varied range of products, including 'humungous' power amps, the company will always be remembered for its cans. Its speciality is the electrostatic earspeaker, and the *Lambda Signature* is the top of the range semi-panoramic model. There's also a larger panoramic model called the *Sigma* which takes the panels further from the ear thus creating a totally different effect.

The *Signature* tag indicates that the electrostatic diaphragm is one micron thick which is half a micron thinner than the *Pro* version. Thus the diaphragm is lighter and therefore quicker at stopping and starting than lesser models in the range. It would have been interesting to directly compare a *Pro* model with the *Signature* to see exactly what difference this demi micron makes, but time did not allow and I had to get by on a comparison with AG's megabuck Sonys.

The *Signatures* are constructed in much the same fashion as other *Lambda* models – large rectangular phones with cast alloy shells are attached to a plastic frame that retains a wide, soft adjustable supporting strap. The phones themselves are open-backed and contain oval shaped diaphragms, the earpads are large, circumaural and upholstered in a very soft imitation leather. At the price the real thing would have seemed more appropriate and more conducive to long term comfort, however, I guess vinyl is easy to clean and this at least looks like leather. In true Stax tradition the *Signatures* are put together with a fanatical attention to detail and cannot be criticised on grounds of finish.

The *SRM-T1* uses dual FETs for the input stage and a pair of 6FQ7 twin triode output tubes to drive the phones, so it has at least got it half right, and in practical terms the use of FETs may well be a necessity. The instruction manual does, however, poo-poo the use of transformers on sonic grounds – our experience of such devices does not suggest that this is a wise presumption. On more neutral ground the *T1* has two pairs of phono sockets, paralleled up so that the incoming

STAX LAMBDA SIGNATURE SRM-T1

signal can be passed back to a tape deck and you don't lose your tape loop – it just gets longer. Controls consist of a ganged volume pot for balance adjustment, a preheat switch which keeps the tubes warm when it's not in use and an on switch. Apparently, these two switches should not be left on simultaneously.

Comfortwise the *Signature* is secure without exerting too much pressure on the head. I can't imagine them becoming unnoticeable, but given the fairly hefty 322g weight without the cord the imposition isn't too bad. In the long run the synthetic nature of the padding becomes noticeable and one's ears appreciate a break, but this is the case with most cans and is not a fatal flaw.

SOUND QUALITY

When Path's Nigel Crump brought round the 'phones he also brought some Stax CDs made with a dummy head microphone to show off the combo's capabilities. These really revealed the imaging abilities of the *Signature/T1* set-up, the most stunning track giving an incredibly realistic impression of being in the middle of a room with two people speaking and someone casually strumming an acoustic guitar. It's so believable that one is apt to turn around when the guy opens the door and shy away when he whispers in your ear – eerie!

However, in the real world music is rarely recorded in this fashion and the way the

combo deals with regular records is more pertinent. It does so in a way that reveals a lot of tangible information, ie details like lyrics and notes that other transducers brush over. To avoid deafening users it deliberately restricts dynamic range and this has other less appealing effects on music, but that would be to unfairly compare it with loudspeakers, for which no headphone can be a substitute.

The set-up is most at home directly connected to a good CD player. The balance seems to be very well suited to the digital medium as the phones manage to extract layers of previously obscured information and present them with uncanny clarity and depth. They don't exactly image in the traditional loudspeaker fashion but they do create a very believable effect of space around notes, which is similar to imaging. In my analogue system, which at present includes an Innovations *1000 Series* tube preamplifier, they didn't sit so happily. One got the impression that the midrange was being veiled and consequently music lost a lot of its life and spirit. For instance those lone wolves ZZ Top sounded warm and almost soft having lost transient edge definition and traded it in for a relaxed yet informative presentation. In fact with this particular preamp the impression I got was of the traditional valve sound, ie warm, euphonic and sweet which is far from the case with the *1000* under conventional circumstances.

Far better results were achieved round at Alvin Gold's den where we spent some time comparing these cans with a pair of two and a half grand Sony dynamic phones through a Musical Fidelity *MX* preamp. We played a selection of classical records which really showed off the nimbleness of the Stax combo. It recreated an excellent sense of life and drama and beat the Sony hands down when it came to transparency.

CONCLUSIONS

The *Lambda Signature* combined with the *SRM-T1* must rank as one of the best headphones currently produced and is truly worthy of that tired label 'state of the art'. Given that in some areas it equals if not better the world's most expensive headphones the high price can almost be justified. It's still a lot, but if you're dedicated to the medium it should be worth it.

Typical price inc VAT Lambda Signature/SRM-T1 £470/£895
Reviewed by Jason Kennedy
Path Group Plc, Desborough Ind. Park, Desborough Park Rd, High Wycombe, Bucks HP12 3BG. Tel: (0494) 459981.



SELECTED DEALER DIRECTORY

Choosing a good hi-fi dealer is the most vital step in acquiring the system that is right for you. This unique directory gives full information on dealers in your area.

AVON

ABSOLUTE SOUND AND VIDEO, 65 Park St, Clifton, Bristol. (0272) 264975. A&R, Apogee, Denon, Dual, Krell, Linn, Magneplanar, Mission, NAD, Quad, Roksan, Rotel, Yamaha, etc. (closed Weds). Customer car park. BADA MEMBER **3402**

PAUL GREEN HI-FI LTD, Kensington Showrooms, London Road, Bath. (0225) 316197. A&R, Creek, Dual, Heybrook, Linn, Musical Fidelity, Rotel, Systemdek, Wharfedale, Magnaplanar, Krell, Apogee. Customer car park. BADA MEMBER **3407**

RICHER SOUNDS, 20 Cotham Hill, Bristol BS6 6LF. (0272) 734397. City-centre budget hi-fi discounts; most popular 'majors' from A to Z and all points in between; monthly 'specials'. Facilities: expert advice; free 48 page Hi-fi Guide and monthly Newsletters; mail order; part exchange. Mon-Fri 10-6, Sats 10-5. Access, Visa, Richer ChargeCard.

BEDFORDSHIRE

ASHTON AUDIO, 6 High Street, Dunstable. (0582) 608003. AR, Cambridge Audio, Denon, Incatech, JVC, Kenwood, Marantz, Monster, NAD, Nakamichi, Proton, Sony, Thorens, etc. Credit to £1,000. Access, Amex, Diners, Visa. Service dept. Dem room facilities. Open 6 days, 9-5.30, 6p.m. Friday.

CAMBRIDGE HI-FI, 31 Cuthbert St, Bedford. (0234) 325035. Mission-Cyrus, Rotel, Kenwood, Pioneer, Manticores, Revolver, Ariston, ITL, KEF, Monitor Audio. Single speaker dem room. 9.30-5.30 6 days. Free installation. Service Dept. Visa. Access. Credit facilities.

BERKSHIRE

NEWBURY AUDIO, 2 Weavers Walk, Northbrooke Street, Newbury, Berkshire RG13 1AJ (0635) 33929. 6 days 9.30-6.00. Linn, Naim, Roksan, Exposure, A&R Cambridge, Ion Systems, Revolver, Ruark, SD Acoustics, Monitor Audio, Manticore, Nakamichi, Dual, Rotel, Royd. Dem room. Home trial facilities. Free installation. Late appointments. Interest free credit. Access, Visa.

READING HI-FI CENTRE, 4 Queen's Walk, Reading RG1 7QF. (0734) 585463. 'The best equipment, advice and service from Berkshire's premier Hi-Fi emporium'. BADA MEMBER **3423**

BUCKINGHAMSHIRE

AUDIO INSIGHT LTD, 53 Wolverton Rd, Stony Stratford, Milton Keynes. (0908) 561551. A&R, Audiolab, Heybrook, KEF, Linn, Mission Cyrus, Musical Fidelity, Nakamichi, Nytech, Rotel. BADA MEMBER **3432**

AYLESBURY HI FIDELITY, 98 Cambridge St, Aylesbury. (0296) 28790. Denon, Dual, Exposure, Heybrook, Marantz, Musical Fidelity, NAD, Roksan, Rotel, Systemdek. 2 Dem rooms, appointment reqd. Mon-Fri 10-6, Sat 9.30-5.30. Home trial, free installation, credit to £1,500. Access, Amex, Diner, Visa. Service dept.

CAMBRIDGESHIRE

CAMBRIDGE HI FI, 1 Hawthorn Way, Cambridge. (0223) 67773. Ariston, ITL, KEF, Mission Cyrus, Monitor Audio, Pioneer, Revolver, Technics, Thorens, Kenwood. All credit cards.

STEVE BOXSHALL AUDIO, 41 Victoria Rd, Cambridge CB4 3BW. (0223) 68305. 10-6 - 6 days. Denon, Rotel, Dual, Monitor Audio, Tannoy, Quad, KEF, Roksan, Nakamichi, Revox, SME, Audio Research, Krell, Magneplanar. 3 dem rooms, home trial, appointment preferred. Free installation and service dept. Access, Visa and credit facilities. BADA MEMBER **3434**

STILTON AUDIO, 489 Lincoln Road, Peterborough. (0733) 558838. A&R, Cyrus, Exposure, Harman Kardon, Linn, Meridian, Mission, Musical Fidelity, Roksan, Yamaha. Home trial, free installation. Credit facilities. Access, Visa, Amex. Mon-Fri 10-6. Sat 10-5.30. Service dept.

CHESHIRE

ASTON AUDIO, 4 West St., Alderley Edge. (0625) 582704. Wide selection of equipment in N.W. 2-year guarantee. 3

dem rooms. Tues-Fri 10-6, Sat 9-5. Closed for lunch 1-2. BADA MEMBER **3435**

DOUG BRADY HI-FI, Kingsway Studios, Kingsway North, Warrington. (Padgate 0925) 828009. 'Largest choice of specialist Hi-Fi in N.W.'. All credit cards. 3 Dem rooms. Open 6 days. BADA MEMBER **3436**

NEW DAWN HI-FI, 1-3 Castle St, Lower Bridge St, Chester. (0244) 24179. Linn, Quad, Technics, National Panasonic, Denon, Rotel, Dual, Meridian, Aiwa, Philips. BADA MEMBER **3437**

SWIFT OF WILMSLOW, 4-8 St Annes Parade, Wilmslow. (0625) 526213. A&R, Aiwa, Denon, Marantz, Mission, Monitor-Audio, Pioneer, Trio, Yamaha, NAD. Dem facilities. Tues-Sat. BADA MEMBER **3438**

RICHER SOUNDS, 4 Wellington St, Stockport SK1 3RN. (061) 480 1700. Cheerfully small store by BR station with virtually all major 'budget' names; many on special offer. Facilities: expert advice; free 48 page Hi-fi Guide and monthly Newsletters; part exchange. Mon-Fri 10-6, Sats 10-5. Access, Visa, Richer ChargeCard. Mail Order for all Richer Sounds stores from this branch.

CHRIS BROOKS HI-FI, 29 Gaskell St, Stockton Heath, Warrington. 0925 61212/3. Tues-Sat 10-6. 2 dem rooms. Credit facilities. All credit cards. Total absence of bull****. BADA MEMBER **3439**

CORNWALL

N.C.E. HI-FI, The Bridge, Boscastle, N. Cornwall (08405) 248. Ariston, Arcam, Creek, Denon, Dual, Gale, Heybrook, Incatech, Marantz, QED, etc. Dem room. Full credit facilities including interest free. Access, Visa.

DERBYSHIRE

ACTIVE AUDIO, 12 Osmaston Rd, The Spot, Derby. (0332) 380385. Arcam, Ariston, Celestion, Denon, Heybrook, Kef, Cyrus, Musical Fidelity, Marantz, Revox, Rotel, Rogers, etc. etc. Demonstration and home trial facilities. Account and credit cards. Ring for opening times and free 'Fact Pack'. BADA MEMBER **3440**

ESSEX

A.T. LABS, 442/4 Cranbrook Rd, Gants Hill, Ilford. (01) 518 0915. Mon-Sat, 10-6. Two single speaker dem rooms. Access, Amex, Visa. BADA MEMBER **3441**

RAYLEIGH HI-FI, 44a High Street, Rayleigh, Essex. (0288) 779762/747571. 216 Moulsham St, On-the-Parkway, Chelmsford, Essex. (0245) 265242. A&R, Audiolab, Beyer, BLQ, Cyrus, Celestion, Denon, DNM, Epos, Gale. Access, Visa. 3 years parts and labour guarantee on hi-fi systems. BADA MEMBER **3442**

BRENTWOOD MUSIC & HI-FI CENTRE, 2 Ingrave Rd, Brentwood. (0277) 221210. Alphason, B&W, Cambridge Audio, Denon, Harman Kardon, Marantz, QED, Quad, Yamaha. Dem and home trial facilities. Mon-Sat 9.30-5.30 (Thurs from 10am, Sat from 9am). Free installation, credit facilities. Access, Visa, Hi-Fi Markets. Service dept.

LYON AUDIO, 16 Peartree Business Centre, Peartree Road, Stanway, Essex CO3 5JN. (0206) 560259. Audiolab, Beard, Celestion, Oracle, Rogers, Denon, NAD, Rotel, J.A. Michell, Roksan, Marantz, Quad. Dem facilities. Mon-Sat 9-6. Installations. Credit facilities up to £1000. Access, Visa, Hi-Fi Markets, Eurocheque. Service dept available.

GLOUCESTERSHIRE

ABSOLUTE SOUND AND VIDEO, 40/42 Albion St, Cheltenham. (0242) 583960. A-R, Denon, Dual, Linn, Meridian, Mission, NAD, Rotel, Technics, Yamaha, etc. (Closed Wed). BADA MEMBER **3443**

AUDIO EXCELLENCE, 58 Bristol Road, Gloucester. (0452) 30046. Audio Research, Dual, Krell, Linn, Magneplanar, Naim, NAD, Yamaha and lots more. Closed Mon. BADA MEMBER **3444**

HAMPSHIRE

ABSOLUTE SOUND AND VIDEO, 4 Feathers Lane, Basingstoke, Hants RG21 1AS. (0256) 24311. A&R, Audiolab, Denon, Dual, Linn, Mission, NAD, Rotel, Technics, Yamaha. Dem and home trial facilities. Mon, Tues, Thurs, Fri 9.30-6, Sat 9.30-5.30. Closed Wed. Free instal-

lation. Credit facilities. Access, Visa, Connect, Amex, Diners. Service dept. BADA MEMBER **3445**

HAMPSHIRE AUDIO Ltd, 2-12 Hursley Rd, Chandlers Ford. (0703) 252827/265232. Quality CD and analogue agencies. 5 dem studios. Large free car park. BADA MEMBER **3446**

HOPKINS HI-FI, 38/40 Fratton Rd, Portsmouth PO1 5BX. (822155) 830753. Technics, Quad, Monitor Audio, Tannoy, Denon, Nad, Heybrook, Ariston, Onkyo, plus others. Dem facilities, appointments necessary. Access, Visa. 9-5.30. Open to 6 Thurs. Closed Wed. Service dept.

HERTFORDSHIRE

ACOUSTIC ARTS Ltd, 101 St Albans Rd, Watford, Herts. (0923) 45250. A&R, Audiolab, Denon, Magneplanar, Quad, Rogers, Meridian, TDL, Jadis, Krell. Mon-Sat 9.30-5.30. BADA MEMBER **3447**

THE AUDIO FILE, 40 Hockerill St, Bishops Stortford, Herts CM23 2DW. (0279) 506576. 9.30-5.30 6 days. Linn, Roksan, Rega, Naim, Denon, Mission, Cyrus, Marantz, Quad, Tannoy, Sony. 2 dem rooms. Home trial, free installation service dept. Interest free. Bada Charge Card. BADA MEMBER **3448**

ISLE OF MAN

ISLAND COMPACT DISC CENTRE, Parliament Square, Ramsey. (0624) 815521. Musical Fidelity, Sugden, Celestion, Harman Kardon, Teac, Castle Acoustics, Philips, A&R, JBL, Luxman, Bose, Sansui. Mon-Sat 9-5.00. Dem and home trial facilities. Free installation. Full credit, no limit. Access, Elite. Service dept.

KENT

JOHN MARLEY HI-FI CENTRES, 2 Station Rd West, Canterbury. (Canterbury) 69329. Also at Dover - (0304) 207562. B&W, Heybrook, Magnum, M.Y.S.T., Nakamichi, Pink Triangle, Rotel, Sansui, Technics, Quad. Dem and home trial facilities. Mon-Sat 9-5.30 closed Thurs. Free installation. Credit to £1,000. Access, Visa, Creditcharge. Service dept.

VJ HI-FI, 29 Guildhall St, Folkestone. (0303) 56860. Mon-Sat 9-6. NAD, Yamaha, Marantz, Cambridge Audio, Denon, Kenwood, Rogers, Dual, N.V.A., Quad. Dem and home trial facilities, free installation, credit to £1000. Amex, Diners, Visa, Access. Service dept.

PHOTOCRAFT HI-FI, 40 High St, Ashford. (0233) 624441. No. 1 in Kent for Linn, Naim, Rega, Roksan, Exposure, Onix, Epos, Royd, Creek. But before you choose equipment choose where to buy it. Dem room, appts. necessary. Home trial and free installation. Visa, Access, Bada Chargecard. 9-5.30 Mon-Fri (Wed & Sat to 5 only). Service Dept.

LEICESTERSHIRE

SOUND ADVICE, The Sound Factory, Duke St, Loughborough LE11 1ED. (0509) 218254. A&R, Creek, Linn, Epos, Mission, Cyrus, Naim, Rega, Roksan, Rotel, Yamaha. Dem facilities, appointment reqd. Mon-Sat 9.30-6. Free installation. Credit facilities. Access, Visa, Amex. Service dept. BADA MEMBER **3449**

ALPHA AUDIO, 1-3 Guildhall Lane, Leicester, LE1 5FQ. (0533) 518597 or 530330. Aiwa, Akai, Ariston, Bose, Cambridge, Celestion, Denon, Harman Kardon, Musical Fidelity, Rotel, etc. Mon-Sat 9.30-5.30. Free installation. Credit to £1,000. Dem facilities. Access, Visa.

MJS HI-FI, 80 Stapleton Lane, Barwell, Leicester LE9 8HE. (0455) 46977. The Rock, Audio Innovations, Kelvin Labs, Snell, Helius, Sugden, Ruark, Concordant, Valdi, JPW. Our main aim is for our customers to enjoy music. Dem and home trial facilities. Mon-Sat 9.30-7.00. Free installation and service dept. Visa, Access.

THE LEICESTER HI-FI CO, 6 Silver Walk, St. Martins Square, Leicester LE1 5EW. (0533) 539753. 6 days 9.30-5.30. A&R Cambridge, Heybrook, Marantz, Mission, Musical Fidelity, Nakamichi, QED Hi-Fi, Quad, Revox, Roksan "and oodles more". Largest selection in Leicestershire. 2 dem rooms. Home trial arranged + free installation. Credit facilities. Hi-Fi Markets, Access, Visa, Am. Exp. Service dept.

SELECTED DEALER DIRECTORY

LONDON

A.T.LABS, 159 Chase Side, Enfield, Middlesex. (01) 367 3132. Mon-Sat 10-6. Two single speaker dem rooms. Service dept, car park. Amex, Visa, Access.

BADA MEMBER **311**

AUDIO T, 190 West End Lane, London NW6. (01) 794 7848. Mon-Sat, 10-6. Two single speaker dem rooms. Access, Amex, Visa. BADA MEMBER **313**

CORNFLAKE SHOP, 37 Windmill Street (just off Tottenham Court Road), London W1. (01) 631 0472. Mon-Sat 10-7. DNM, Epos, Koetsu, Marantz, Naim, PS Audio, Rega, Roksan, SME, Yamaha. 2 dem rooms, full delivery and installation. Credit facilities. Access, Visa.

COVENT GARDEN RECORDS, 84 Charing Cross Road. (01) 379 7635/7427. Quad, B&W, Meridian, Mission, Yamaha, Sony, A&R Cambridge, Nakamichi, Rotel, etc. Dem facilities - no appointment reqd. Mon-Sat 10-7.30. Home trial facilities, free installation. Access, Visa, American Express, Diners Club. Service dept. BADA MEMBER **313**

DOUG BRADY HI-FI, 14-18 Monmouth St, London WC2H 9HB. (01) 379 4010. Wide range of top specialist hi-fi from Britain, America and Japan. 3 Dem rooms. BADA MEMBER **311**

GRAHAMS HI-FI, Canonbury Yard, 190a New North Rd, London N1 7BS. (01) 226 5500. 'FBA Dealer of the year 1985'. Linn, Naim, Rega etc. £300-£3,000-£13,000. BADA MEMBER **313**

H.L. SMITH & Co Ltd, 287-289 Edgware Rd, London W2 1BE. (01) 723 5891. Aiwa, B&W, Denon, Dual, KEF, Ortofon, Panasonic, Sony, Technics, Yamaha. Dem facilities. Mon-Sat 9-5.30, Thurs 9-1. Credit to £1,000. Access, Visa, Diners. Service dept.

KAMLA ELECTRONICS, 251 Tottenham Court Road, London W1. (01) 323 274. Amadens, Ariston, B&Q, Gale, Incatech, JPW, Linn, Mordaunt Short, SME, Systemdek, Thorens, Townshend, Ruark, Wharfedale.

KJ WEST ONE, 26 New Cavendish St, London W1M 7LH. (01) 486 8262/63. Fax (01) 487 3452. Dem's by ap't, installations arranged, open mon-sat 10-6. Design, plan and install of multi-room systems. Arcam, Apogee, Audio Research, Audiolab, Audion, Cambridge, Croft, DNM, Epos, Ear, Harbeth, Heybrook, Krell, Linn, Linn, Magnaplanar, Manticore, Martin Logan, Marantz, Meridian, Mus. Fidelity, Naim, Pink, PS Audio, Quad, QED, Revox, Rotel, Rogers, Stax, Sonus, SME, Systemdek, Tannoy, Voyd, Zeta. Major Credit Cards.

RICHER SOUNDS 2, 6 London Bridge Walk, London SE1. (01) 403 1988. Major names in esoteric hi-fi, unusually matched to discount offers and special end-of-line purchases. Dem facilities, expert advice, free local delivery & installation (£500+), plus 2 Yr G'tee. Hi-fi Guide and monthly newsletters; part exchange. Mon-Fri 10-7, Sat 10-5. Access, Visa, Richer ChargeCard. Service Department.

RICHER SOUNDS, 2 London Bridge Walk, London SE1 2SX. (01) 403 1201/4710. The original bargain hi-fi store, now refitted; 100s of regular and special discounts on most budget/mid price major names. By London Bridge. Facilities: expert advice; free 48 page Hi-fi Guide and monthly Newsletters; mail order; part exchange. Open Mon-Fri 10-7, Sat 10-5. Access, Visa, Richer ChargeCard. Service Department.

MIDDLESEX

A.T. LABS, 173-175 Station Rd, Edgware, Middx. (01) 952 5535. Mon-Sat 10-6. 2 single speaker dem rooms. Access, Visa, Amex. BADA MEMBER **311**

UXBRIDGE AUDIO LTD, 278 High St, Uxbridge, Middx UB8 1LZ. (0895) 30404 (Multi-line). A&R, AR, Ariston, Creek, NAD, Denon, Dual, JPW, KEF, Manticore, Meridian, Cyrus, Nakamichi, Quad, Rotel, Wharfedale, Yamaha, etc. 2 dem rooms. Mon-Sat 10-6. BADA MEMBER **313**

HARROW AUDIO, 27 Springfield Rd, Harrow. (01) 863 0938. Mon-Sat 9.30-5.30. A&R, Audiolab, Cyrus, Denon, Dual, Heybrook, Linn, Monitor Audio, Musical Fidelity, Quad, Rotel, Tannoy etc. BADA MEMBER **313**

MERSEYSIDE

W.A. BRADY & SON, 401 Smithdown Rd, Liverpool L15 3JJ. (051) 733 6859. 'Largest choice of specialist Hi-Fi in N.W. £100-£20K'. All credit cards. 3 dem rooms. Closed Monday. BADA MEMBER **313**

PURE SOUND - Birkenhead 051 645 6690 24hrs. Acoustic Energy, Aragon, Audio Technica, Beard, Celestion, Deltec, Denon, Michel, Cyrodec, Ortofon, SME. Home demonstration a pleasure, plus evenings and weekends (Sundays by appointment).

RICHER SOUNDS, 69B Church St, Liverpool L1 1DN. (051) 708 7484. Virtually every major 'budget' name - small store with big discounts and special offers. Facilities: expert advice; free 48 page Hi-fi Guide and monthly Newsletters; mail order; part exchange. Mon-Fri 10-6, Sat 10-5. Access, Visa, Richer ChargeCard.

NORFOLK

SOUND APPROACH, 161 Unithank Road, Norwich. (0603) 622833. Kuzma, Ariston, Castle, Denon, Exposure, Ion, Royd, NVA, QED, Roksan, Ruark, Revolver, etc. etc. Dem and home trial facilities. Mon-Sat 9-6.30. Free installation. Credit to £1,500. Visa, Access, Diners Club. Service dept.

NORTHAMPTONSHIRE

CLASSIC HI-FI + VIDEO, School Lane, Kettering, Northants. (0536) 515766. ADC, Marantz, Onkyo, Sansui, Teac, Harman Kardon, Pioneer, Proton, Ariston, Thorens, Mantra, Goodmans, Castle, JPL, Mordaunt Short, Seleco TV, Monitor Cable + others.

THE AUDIO SHOP, Coffee Tavern Court, High St, Rushden. (0933) 56651. Audio Technica, Denons, Goodmans, Rotel, Tannoy, Ion Systems, Thorens, Gale, BLQ, Royd. Dem room. Home trial and free installation. Mon-Sat 9.30-5.30 (Thurs 9.30-2). Service dept.

TECHNOSOUND, 7 Granville Square, Willen Local Centre, Milton Keynes. (0908) 604949. Bang & Olufson, Denon, Rotel, Technics, Yamaha. Selection of enthusiasts products. Multi-room hi-fi installations. Branches at Luton and Dunstable. BADA MEMBER **313**

NOTTINGHAMSHIRE

DEFINITIVE AUDIO, Nottingham. (0602) 813562. Voyd, Valdi, Systemdek, Helius, Audionote, Golding, JPW, Snell, Target, Pirate. Home demonstrations throughout Nottingham and East Midlands. Please telephone (0602) 813562 for further information.

WEST MIDLANDS

ALTERNATIVE AUDIO Ltd, 93-95 Hobs Moat Rd, Solihull. (021) 742 0254 (sales), 0248 (service). A&R, Audiolab, Denon, KEF, Marantz, Meridian, Mission, M.A., The Source, Philips. Tues-Sat 10-6, closed Mon. Home trial facilities, 3 dem rooms, free installation, instant credit. Access, Visa, Amex. Service dept. BADA MEMBER **313**

GRIFFIN AUDIO Ltd, 94 Bristol St, Birmingham. (021) 692 1359. Linn, Naim Audio, Rega, Creek, Denon, Nakamichi, Quad, Mission, Monitor Audio, Rotel. BADA MEMBER **313**

FRANK HARVEY HI-FI EXCELLENCE, 163 Medieval Spon St, Coventry. (0203) 525200. Linn, Musical Fidelity, Quad, Mission, Cyrus, Denon, A&R Cambridge, Rotel, Nad, Nakamichi etc. Three floors of carefully selected hi-fi amidst the eloquence of our 14th century showroom. Dem, home trial and credit facilities. Access, Visa, Diners, Am. Exp. Mon-Sat 9.30-5.30. Closed Thurs. BADA MEMBER **313**

HORTON ELECTRONICS (1987) LTD, 89 Lower Temple St, Birmingham B2 4JD. (021) 643 0972. Aiwa, Dual, Marantz, Goodmans, JVC, Mission, Sony, Technics, Wharfedale, Sennheisser. Dem facilities. Credit to £1000. Access, Visa. 9-5.30 Mon-Sat. Service dept.

RICHER SOUNDS 2, 12 Smallbrook Queensway, Birmingham B5 4EN. (021) 643 6664. Popular esoteric hi-fi for upgrades, monthly special offers. Dem facilities, expert advice, free local delivery/installation (£500+), 2 Yr G'tee. Hi-fi Guide and monthly Newsletters; part exchange. Mon-Fri 10-6, Sat 10-5. Access, Visa, Richer ChargeCard. Service Dept.

RICHER SOUNDS, 10 Smallbrook Queensway, Birmingham B5 4EN. (021) 643 1516. An A-Z of affordable, popular hi-fi, no-frills environment. Facilities: expert advice; free 48 page Hi-fi Guide and monthly Newsletters; part exchange. Mon-Fri 10-6, Sat 10-5. Access, Visa, Richer ChargeCard. Service Dept.

FIVEWAYS HI-FIDELITY LTD, 12 Islington Row, Edgbaston, Birmingham. (021) 4550667. Alphason, A&R, Denon, Meridian, Musical Fidelity, Nakamichi, Quad, Revox, TDL, Thorens, etc. Dem and home trial facilities. Tues-Sat 9.30-6. Free installation. Access, Visa. Service Dept. BRIDGE HI-FI, 3 Tudor House, Bridge St, Walsall. (0922) 640456. NAD, Dual, Yamaha, Kenwood, Technics, Pioneer, Mission, Celestion, Denon, Mordaunt Short. Appts required. Home trial and free installations. Access, Visa, Diners, Amex. Credit to £1,000. 9.15-5.30 Mon-Sat. Service dept.

OXFORDSHIRE

ABSOLUTE SOUND AND VIDEO, 19 Old High St, Headington, Oxford. (0865) 65961. A&R, Denon, Linn, Mission, NAD, Rotel, Yamaha. Also 256, Banbury Rd, Summertown. BADA MEMBER **313**

ASTLEY AUDIO LTD, 3 Market Place, Wallingford. (0491) 39305/34349. AR, Dual, Kenwood, Mordaunt-Short, Mission, Monitor Audio, Philips, Technics, Tannoy, Yamaha. Tues-Fri 9-5.30, Sat 9-5. Records, tapes, 1000+ CD's. Service Dept. Access, Visa, Diners.

WESTWOOD AND MASON, 46 George St, Oxford. (0865) 247783. Linn, Naim, Rega, A&R, Heybrook, Dual, Mordaunt-Short, Mission, Tannoy, Quad, etc. BADA MEMBER **313**

WITNEY AUDIO & VIDEO, 28 High St, Witney, Oxford. (0993) 2414. A&R, Aiwa, Akai, Bose, Denon, Dual, Goldstar, JBL, Mordaunt-Short, NAD, Pioneer, Sony, Yamaha. Dem facilities. Mon-Sat 9-5.30. Free installation, credit to £1,000. Access, Visa. Service dept.

OXFORD AUDIO CONSULTANTS LTD, Cantay Hse, Park End Place, Oxford OX1 1JE. (0865) 790879. Oxford Acoustics, Audio Research, Krell, Magneplanar, Apogee, Aragon, Stax, Marantz, Wharfedale, Cambridge Audio. Home trial and free installation. Instant Credit. Access, Amex, Visa. 10-6 Tues-Sat. Service Dept.

HORNS OF OXFORD LTD, 6 South Parade, Summertown, Oxford. (0865) 511241. Alphason, Ariston, B&W, Celestion, Marantz, Nakamichi, Pink Triangle, Quad, Sony, Technics. Free installation. Service dept. Access, Visa. 9-5.30. Closed Thurs. BADA MEMBER **313**

SHROPSHIRE

AVON HI-FI Ltd, 12 Barker St, Shrewsbury. (0743) 55166. A&R, B&W, JBL, Dual, NAD, Nakamichi, Revolver, Trio, Quad, Yamaha. Dem and home trial facilities. Mon-Sat 9-5.30, closed Thur. Free installation, credit to £1,000. Access, Visa. Service dept.

MID SHROPSHIRE AUDIO, 24 Peveril Bank, Dawley, Telford. (0952) 502828. Agencies include Alphason, Apollo, Ariston, Audio Innovations, Goldring, Ion Systems (full range), Marantz, Michell, Ortofon, QED, Royd, Ruark, Sansui, Sennheisser, SD Acoustics, SME, Target. Guaranteed used equipment also available. Free delivery nationwide. Mail Order. Access/Visa. Credit facilities. Part exchange.

CREATIVE AUDIO, 9 Dogpole, Shrewsbury. (0743) 241924. Marantz, Meridian, Linn, Naim, A&R, Mission, Nakamichi, Revolver, Castle, Audio Technica. Dem room. Home trial and free installation. Credit to £1000. Access, Visa. Tues-Sat 9.30-5.30. Service dept.

SOMERSET

WATTS RADIO - THE ENGINEERS, Jim Badman, 1 West Street, Somerton. (0458) 72440. Castle, Dual, Denon, KEF, Mordaunt-Short, Ortofon, Quad, Rogers, Thorens, Yamaha. Dem and home trial facilities. Mon-Sat 9-1, 2-5.30, Wed 9-1. Free installation. Credit to £1,000. Access, Visa. Service dept.

STAFFORDSHIRE

GRANGE HI-FI LTD, 153 Branston Road, Burton-on-Trent. (0283) 33655. Pink Triangle, Voyd Valdi, Marantz,

SELECTED DEALER DIRECTORY

Audio File, PH, Systemdek, Audio Innovations, A&R Cambridge, Quad, Rotel, Snell, Manticore, etc. 2 dem rooms. Mon, Tues, Thurs, Fri, Sat. 9-6. Closed Wed. Free installation. Credit facilities. Visa, Access. Service dept.
ACTIVE AUDIO, 29 Market Street, Tamworth, Staffordshire. (0827) 53355. Arcam, Ariston, Celestion, Denon, Heybrook, Kef, Cyrus, Musical Fidelity, Marantz, Revox, Rotel, Rogers, etc. etc. Demonstration and home trial facilities. Account and credit cards. Ring for opening times and free 'Fact Pack'. BADA MEMBER **3424**

SUFFOLK

EASTERN AUDIO, 41 Bramford Rd, Ipswich. (0473) 217217. Quad, Audio Lab, Denon, Dual, Marantz, Mission, NAD, Nakamichi, Technics, Arcam. Mon-Sat 9.30-6. BADA MEMBER **3424**

SURREY

AERCO AUDIO Ltd, 11 The Broadway, Woking, Surrey GU21 5AP. (04862) 4667. Roksan, Exposure, Ion, Royd, Systemdek, Thorens, Acoustic Research, Nakamichi, Monitor Audio and many more. 2 dem rooms. Appt's advisable. Home trial and free installation, part exchange. Access, Visa, Amex, Diners. Credit Facilities. Mon-Fri 9.30-6.00. Sat 9.00-5.30. Service dept. BADA MEMBER **3424**

ROGERS HI-FI, 13 Bridge Street, Guildford (0483) 61049. Ariston, Acoustic Research, Akai, Denon, JPW, Mordaunt-Short, Marantz, Onkyo, QED, Tannoy etc. Mon-Sat 9.30-6. Dem. facilities. Instant Credit. Access, Visa. Service dept.

SURBITON PARK RADIO, 48 Surbiton Rd, Kingston-Upon-Thames, Surrey. (01) 546 5549. Quad, Dual, Denon, Kenwood, Nakamichi, Rotel, Pioneer, QED, B&W, Tannoy, Mordaunt Short, Castle, KBL. Dem and home trial facilities. Access, Visa. 9.30-5.00 Tues-Sat. Service dept.

TRU-FI SOUND AND VISION, 2 Central Parade, Redhill, Surrey. (0737) 767400/766128. Akai, Aiwa, B&W, Nakamichi, JPW, Mission, Mordaunt-Short, Nagaoka, Sony, Technics. Dem. facilities. Mon-Sat 9.30-6. Free installation, credit to £1,200. Access, Visa. Service dept.

UNILET PRODUCTS Ltd, 35 High St, New Malden, Surrey KT3 4BY. (01) 942 9567. Mon-Sat 9-6. Thurs 9-7. Dem facilities. Large stock. Amex, Access, Diners, Visa.

SPALDINGS HI-FI, 352-4 Lower Addiscombe Rd, Croydon, Surrey. (01) 654 1231. A&R Cambridge, Audiolab, Denon, Linn, Marantz, Mission, Musical Fidelity, Meridian, Naim, Quad. 3 dem rooms and home dem. Free installation, credit facilities. Twice nominated Sony E.S. Hi-Fi Dealer of the Year. Mon-Sat 9-6, Thurs to 8. Closed Wed. Service dept. BADA MEMBER **3424**

TRU-FI SOUND & VISION, 10 Church St, Leatherhead, Surrey. (0372) 378780. Sony, Technics, Panasonic, Mitsubishi, Ferguson, Aiwa, Pioneer, Sanyo, B&W, Mission, Wharfedale. Free installation. Credit facilities. Access, Visa. 9.15-5.30 Mon-Sat. Closed Wed. Service dept.

SUSSEX (EAST)

DEFINITIVE AUDIO BRIGHTON, 30 Islingword Street, Brighton, East Sussex BN2 2UR. (0273) 672796. Voyd, Systemdek, Helius, Audio Note, JPW, Snell, Pirate Stands, Goldring, etc. Wed-Sat 11-7. Home dems throughout Sussex. Credit facilities. Visa.

JEFFRIES HI-FI, 69 London Rd, Brighton, East Sussex. (0273) 609 431. 2 dem rooms, closed Mon, late night Wed. Parking, bus route. Credit facilities.

BADA MEMBER **3424**
JEFFRIES HI-FI, 4 Albert Parade, Green St, Eastbourne, East Sussex. (0323) 31336. 2 dem rooms, closed Mon. Late night Wed. Parking, bus route. Credit facilities.

BADA MEMBER **3424**
HASTINGS HI-FI, 31-32 Western Rd, St Leonards On Sea. (0424) 442975. A&R, B&W, Mission/Cyrus, NAD, Nakamichi, Quad, Rotel, Systemdek, Tannoy, Yamaha. 2 dem rooms. Mon-Sat 9-6. Home trial facilities. Free installation. Credit facilities. Access, Amex, Visa. Service dept.

SUSSEX (WEST)

BOWERS AND WILKINS Ltd, 1 Becket Buildings, Littlehampton Rd, Worthing. (0903) 64141. B&W, Cambridge, Dual, JVC, Mordaunt-Short, Nakamichi, Philips, Shure, Quad, Sony, Technics. 2 dem rooms. Mon-Sat 9-5.30. Weds 9-1. Home trial facilities, free installation, credit to

£1,000. Access, Visa. Service dept.
CHICHESTER HI FI, 40 Little London, Chichester PO19 1PL. Tel: (0243) 776402. Linn, Naim, Rega, Creek, Nakamichi, A&R, Denon, Roksan etc. Tues-Sat, 10-1, 2-5-15 (closed Mon). BADA MEMBER **3424**

TYNE & WEAR

RED RADIO SHOP AND HI-FI CENTRE, 11 Olive St, (Off Park Lane) Sunderland. (Sunderland) 5672087. Bose, Castle, Denon, JVC (Hi-Fi and Portable TV), Luxman, Michell, Mordaunt-Short, Pickering, Tannoy. Dem facilities. Mon-Sat 9-5.30. Free installation, interest free credit. Visa. Service dept.

LINTONE AUDIO LTD, 7-11 Park Lane, Gateshead. (091) 477 4167. Linn, Naim, Rega, Musical Fidelity, Audio Lab, Quad, Cyrus, Denon, NAD, plus all leading Japanese manufacturers. Dem and home trial facilities. Free installation. Access, Visa, Amex, Diners. Credit to £1000. 9-6 Mon-Sat. Service dept. BADA MEMBER **3424**

WILTSHIRE

ABSOLUTE SOUND AND VIDEO, 60 Fleet Street, Swindon. (0793) 38222. A&R, Denon, Dual, Linn, Meridian, NAD, Rotel, Technics, Yamaha. (Closed Wed). BADA MEMBER **3424**

YORKSHIRE (NORTH)

ELITE HI-FI, 178 Kings Road, Harrogate HG1 5JG (0423) 521 831. Voyd, Valdi, Avalon, Systemdek, Helius, Audionote, Goldring, Audio Innovations, Sugden, Marantz, Mordaunt-Short, JPW, Infinity, Snell. Mon-Sat 9-5.30. Free installation. Service dept.

THE AUDIO CLINIC, 2A Brunswick St, Bishopthorpe Rd, York YO2 1ED. (0904) 646309. ADC, Allison, Hafler, JPW, Luxman, Proton, Quart, Studio Power, Systemdek, Thorens and more. Second hand hi-fi available. Appt's req'd, home trial and dem-facilities. Free installation. Access and Visa. 10-5 Mon-Sat. Service dept.

SCARBOROUGH HI-FI CENTRE, 53 Dean Road, Scarborough YO12 7SN. (0723) 374547. A&R, Bose, QED, Denon, NAD (incl. Monitor series), Thorens, Onkyo, Tannoy, Marantz, Ruark. Dem Room. Appts preferred. Home trial facilities. Mail order and part exchange. Visa, Access, Diners, Hi-Fi Markets, 6 months interest free credit. 10-6 Tues-Sat.

RICHER SOUNDS, 6 Feasegate, York YO1 2SQ. (0904) 645535. Probably the smallest hi-fi store in York; but stocks the A-Z of popular budget hi-fi at special discount prices. Facilities: expert advice; free 48 page Hi-Fi Guide and monthly Newsletters; mail order; part exchange. Mon-Fri 10-6, Sat 10-5. Access, Visa, Richer ChargeCard.

YORKSHIRE (SOUTH)

MOORGATE ACOUSTICS Ltd, 2 Westgate, Rotherham S60 1AP. (0709) 370666. South Yorkshire's leading specialist hi-fi dealer. Roksan, Meridian, Mission, Quad, Musical Fidelity, Rogers, Beard, Bryston etc. Single speaker dem facilities. BADA MEMBER **3424**

YORKSHIRE (WEST)

AUDIO PROJECTS, 45 Headingley Lane, Leeds. (0532) 304565. A&R, Audiolab, Creek, Heybrook, Linn, Musical Fidelity, Naim, Quad, Rega, etc. Tues-Fri 9.30-6, Sat 2.30-5.30. BADA MEMBER **3424**

ERRICKS, Hi-Fi Experience, Fotosonic House, Rawson Square, Bradford (0274) 309266. Dem facilities. Sales/service agents for A&R, Linn, Quad, Naim, Nakamichi, Mission etc. BADA MEMBER **3424**

HUDDERSFIELD HI-FI CENTRE, 4 Cross Church St, Huddersfield. (0484) 544668. B&W Loudspeakers, Kenwood, Denon, Dual, A&R Cambridge, Musical Fidelity, Quad, NVA, Audio Lab, Philips, etc. Dem facilities - appointment req'd. Mon-Sat 9-5.30, Thurs 9-8. Closed Wed. Free installation, credit facilities. Access, Visa.

IMAGE HI-FI Ltd, 8-10 St Annes Rd, Headingley, Leeds. (0532) 789374. AR, Audio Lab, Denon, Linn, Marantz, Meridian, Mission, Monitor Audio, NAD, Quad. BADA MEMBER **3424**

RICHER SOUNDS, 55 The Headrow, Leeds LS1 6LR. (0532) 455717. Affordable special deals on every big budget line from Akai to Yamaha; separates & systems. City centre store opposite Lewis's. Facilities: expert advice; free 48 page Hi-Fi Guide and monthly News-

letters; mail order; part exchange. Mon-Fri 10-6, Sat 10-5. Access, Visa, Richer ChargeCard.

SELECTIVE AUDIO, The Forge Cottage, 19 Crossgate, Otley. (0943) 467689. Exclusively handles Alphason, Roksan, NVA, ProAc in the area and other minimalist British designer products for the discerning listener. Dem facility. Member of the Cognoscenti. Mon-Sat 10-6.

IRELAND

CLONEY AUDIO, 34 Main St, Blackrock, Co. Dublin. 0001 889449. Linn, Naim, Roksan, Rega, Rogers, Spendor, Musical Fidelity, Cambridge Audio, Accoustat. Tues-Sat 10-6, Thurs & Fri til 9. Free installation. Visa, Access. Service dept.

SCOTLAND

EDINBURGH

RICHER SOUNDS, 1B Chambers St, Edinburgh EH1 1HR. (031) 226 3544. Discount hi-fi near the Royal Scottish Museum; affordable culture with monthly special offers on major names. Facilities: expert advice; free 48 page Hi-Fi Guide and monthly Newsletters; mail order; part exchange. Mon-Fri 10-6, Sat 10-5. Access, Visa, Richer ChargeCard.

BILL HUTCHINSON Ltd, 43 Clarke St, Edinburgh. (031) 667 2877. AR, Aiwa, Denon, Dual, JVC, Mission, Mordaunt-Short, Omar, Technics, Yamaha. Dem facilities. Mon-Sat 10-6. Free installation. Instant credit. Credit cards: Access, Visa. Service dept.

GLASGOW

RICHER SOUNDS, 24 Gordon St, Glasgow G1 3PU. (041) 221 9147. The affordable hi-fi alphabet in an unpretentious atmosphere; regular special offers. Facilities: expert advice; free 48 page Hi-Fi Guide and monthly Newsletters; mail order; part exchange. Mon-Fri 10-6, Sat 10-5. Access, Visa, Richer ChargeCard.

STEREO STEREO, 278 St. Vincent St, Glasgow G2 5RL. (041) 248 4079. Linn, Naim, Rega, A&R Arcam, Aiwa, Creek, Denon, Dual, Epos, Exposure, Heybrook, Mission, Revox, Rotel, Royd, etc. Mon-Sat 10-6. Interest free credit. BADA MEMBER **3424**

BILL HUTCHINSON Ltd, 43 Hope Street, Glasgow. (041) 248 2857. A.R., Aiwa, Denon, Dual, JVC, Mission, Mordaunt-Short, Omar, Technics, Yamaha etc. Dem facilities. Mon-Sat 10-6. Free installation, instant credit. Access, Visa. Service dept.

GRAMPIAN

HOLBURN HI FI Ltd, 441 Holburn St, Aberdeen (0224) 585713. Linn, Rega, Quad, Audiolab, Mission Cyrus, Rotel, QED, NAD, Krell, Nakamichi, Denon, Sony, KEF, Wharfedale, Monitor Audio, Kenwood, etc. 9.30-5.30 Mon-Sat. BADA MEMBER **3424**

WALES

GLAMORGAN

AUDIO EXCELLENCE, 134 Crwys Road, Cardiff. (0222) 28565. Audio Research, Dual, Krell, Linn, Magneplanar, Naim, NAD, Yamaha, etc. Closed Mon.

BADA MEMBER **3424**
AUDIO EXCELLENCE, 9 High St, Swansea. (0792) 474608. Audio Research, Dual, Krell, Linn, Magneplanar, Naim, NAD, Yamaha, etc. Closed Mon.

BADA MEMBER **3424**
RICHER SOUNDS, 5 Central Square, Cardiff CF1 1EP. (0222) 383311. From Akai to Yamaha on a budget - regular end of line special offers. Facilities: expert advice; free 48 page Hi-Fi Guide and monthly Newsletters; mail order; part exchange. Mon-Fri 10-6, Sat 10-5. Access, Visa, Richer ChargeCard.

GWENT

A. E. HUGHES & SONS LTD, 28 Clarence Place, Newport. (10633) 58851. Bang & Olufsen, Kenwood, Mordaunt-Short, Roberts Radio, Dynatron, Mitsubishi, Sheraton. Cabinets plus audio accessories. Dem and home facilities. Free installation. Access and Visa. 9-12.45, 2.15-5.30 Mon-Sat. Service dept.



NEW CAVENDISH STREET W1

CITY OF WESTMINSTER

The choice is yours!

Most equipment featured here has received a "Best Buy" or "Recommended" rating when reviewed in this magazine.

Send for our Tax FREE price list and general information on how to order.

Stereo in as many rooms as you want. Contact Paul Tam for more information about this service.

MUSICAL FIDELITY



B200

SPEAKERS

Apart from having the best selling range of amplifiers the MF range of speakers is fast establishing itself as a best selling brand.

MODELS/PRICES

Reference 2	£199
Reference 4	£399
MC 2	£299
MC 4	£499



AMPLIFIERS MODELS/PRICES

A1 (20w)	£269
B200 (80w)	£299
A100 (50w)	£459
PR3A Pre-amp	£379
P140 Power (70w)	£349
P172 Pre-amp	£599
P170 Power (85w)	£599
MV1 Pre-amp	£1199
P270 Power (135w)	£1299
MA50 Mono blocks	£875
MXV Pre-amp	£2299
A370 Power (185w)	£2299

ASK ABOUT OUR INTEREST FREE CREDIT

TANNOY

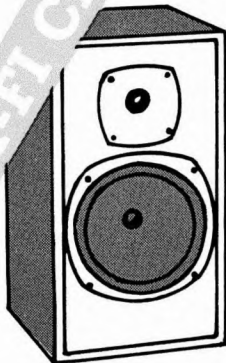

Two models in the Tannoy range have received 'Best Buy' awards in this magazine and it is not difficult to realise why. Their all-round versatility on a wide range of music means they integrate well into most systems. Good dynamics, clarity and firm bass sum up their best characteristics.

MODELS/PRICES

Eclipse	£119.90
Mercury 'S'	£159.90
M20 Gold Mk 2	£199.90

marantz

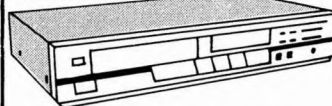

CD65 Mk 2 Special Edition

The current Marantz range of CD players keeps winning accolades from the press. The 'special edition' versions of the CD65 and CD75 have been 'tweaked' for extra refined performance. Indeed the CD65 Mk 2 SE was recently voted CD player of the year by What Hi-Fi magazine and enjoys a 'Best Buy' rating in this magazine. Through the range they are excellent machines and to be fully recommended.

MODELS/PRICES

CD65 Mk 2 SE	£299.90
CD75 Mk 2 SE	£349.90
CD 85	£499.90
CD94	£799.90
CDA94 D to A convertor	£799.90

HI-FI CHOICE RECOMMENDED

INTERCONNECTS Stereo pairs terminated gold plated RCA phono plugs

Description	0.5m	0.75m	1.00m	1.5m	2.0m	3.0m	Cable per metre
QED INCON	13.95	—	14.95	16.50	18.00	21.00	1.20
QED INCON (screened)	17.95	—	18.95	19.95	21.95	25.95	1.75
DNM Solid Core	22.90	23.90	25.00	27.25	29.50	34.00	2.30
DNM Solid Core (shielded)	23.50	25.00	26.50	29.50	32.50	38.50	3.00
Delttec Slink	29.00	30.50	32.00	35.50	39.00	46.00	—
Delttec Black Slink	126.00	139.00	152.00	178.00	204.00	256.00	—
Monster Interlink 400	24.00	27.00	30.00	36.00	42.00	54.00	—
Kimber PSB	30.60	33.70	36.80	43.00	49.20	61.60	—
Monster Interlink CD	33.00	39.50	46.00	59.00	72.00	98.00	—
AQ Livewire Ruby	37.00	41.00	45.00	53.00	61.00	77.00	—
Kimber KC1	39.25	46.70	54.20	69.00	83.95	113.75	—
Vecteur 8045	39.00	—	49.00	59.00	69.00	79.00	—
AQ Livewire Quartz	47.00	55.00	63.00	79.00	95.00	127.00	—
Van den Hul D102 Mk2	53.00	59.50	66.00	79.00	92.00	118.00	12.95
Monster Reference	62.00	—	88.00	114.00	140.00	192.00	—
AQ Livewire Emerald	68.00	83.00	98.00	128.00	158.00	218.00	—
Musical Fidelity Lifeline	43.50	46.25	49.00	60.50	72.00	95.00	11.50
Van den Hul Thunderline	89.00	114.90	139.90	189.90	239.90	339.90	—

SPEAKER CABLES Stereo pairs terminated 4mm plugs (state if other termination required)

Description	2m	3m	4m	5m	7m	10m	Cable per metre
AQ Livewire Type 2	49.80	23.70	27.60	31.50	39.30	51.00	1.95
AQ Livewire BC 4	20.00	24.00	28.00	32.00	40.00	52.00	2.00
AQ Livewire Type 4	26.80	32.70	38.60	44.50	56.30	74.00	2.95
AQ Livewire Brown	27.80	35.70	43.60	51.50	67.30	91.00	3.95
KIMBER 4TC	76.00	108.00	140.00	172.00	236.00	332.00	16.00
QED 79 Strand	12.50	14.30	16.10	17.90	21.50	26.90	0.90
QED 79 Strand (Flat)	13.70	16.10	18.50	20.90	25.70	32.90	1.20
QED 200 Strand (Flat)	48.50	22.50	26.50	30.50	38.50	50.50	1.95
NAIM NACA 4	19.95	24.42	28.90	33.38	42.34	55.78	2.24
LINN LK20	19.90	24.30	28.80	33.30	42.20	55.50	2.20
DNM Solid Core	19.70	24.30	28.90	33.50	42.70	56.50	2.30
MUSICAL FIDELITY Lifeline	56.00	79.00	102.00	125.00	171.00	240.00	11.50
SUPRA 2.5mm	16.95	19.95	22.95	25.95	31.95	49.95	1.49
SUPRA 4.0mm	20.95	25.95	30.95	35.95	45.95	60.95	2.49
SUPRA 10.0mm	41.00	54.00	67.00	80.00	106.00	145.00	6.49
Van den Hul CS122	37.00	48.00	59.00	70.00	92.00	125.00	5.50
Van den Hul CS352	67.00	93.00	119.00	145.00	197.00	275.00	12.95
VECTEUR 9040 (CV30)	35.00	45.00	55.00	65.00	85.00	115.00	4.99
VECTEUR 8120 (CV90)	49.00	—	—	199.00	—	389.00	—

BRANDS STOCKED: Air Tangent, Albarry, Alphason, Arcam, Apogee, Audloplan, Audiolab, Audio Research, Avance, Beard, B & W, Cambridge, Croft, Celestion, DNM, Denon, Dual, Epos, EAR, Foundation, Goldmund, Harbeth, Heybrook, Jadis, KEF, Koetsu, Kiseki, Kinergetics, Krell, Kuzma, Linn, Linx, Magneplanar, Martin Logan, Manticore, Marantz, Meridian, Michell, Milltek, Mod Squad, Musical Fidelity, NAD, Naim, Nakamichi, Nitty Gritty, Oracle, Pink Triangle, PS Audio, Quad, QED, Rata, Revox, Revolver, Rotel, Rogers, Stax, SD Acoustics, Sonus Faber, Spica, SME, Sumo, Slate Audio, Systemdek, Tannoy, Voyd, Wharfedale, Yamaha, Zeta.



K.J. WEST ONE Dept HFC7
26 NEW CAVENDISH STREET,
LONDON W1M 7LH

Telephone: 01-486 8262/8263
Fax: 01-487 3452

Open: Monday-Saturday 10am-6pm
Thurs until 7pm

MAIL ORDER - Post/Packing/Carriage
£1.65 per order (over £35 Post Free) UK
mainland only. Overseas and off-shore by
quotation. Telephone orders are welcomed if
customers are paying by credit card.



THE DIRECTORY

The *Hi-Fi Choice Directory* was conceived as a reference guide to all the audio products reviewed by *Choice* that are currently available. The products are split into suitable categories, each with its own introduction containing information about the product type and its applications. They are particularly relevant to the uninitiated first time buyer and help sort out the order of priorities when buying a piece of equipment.

Each product along with its retail price is placed in its respective category in alphabetical order. For instance the Acoustic Research *EB101* is presently at the beginning of the Turntables and Tonearms section; however, the Ariston *RD90 Superior* heads the Motor Units section as it is sold and was reviewed as a separate component – requiring a separate arm. Where there are several products with the same name but different model numbers these are in price ascending order.

Then come the ratings for the standard achieved in laboratory and listening tests, with the exception of certain product groups where lab tests were not carried out. One important point to remember is that they cannot be used to compare products from different categories – ie a cassette deck rated 'excellent' in sound quality will not usually offer the same standard of fidelity as a similarly rated

turntable or CD player (unless you can get hold of first generation copies of the master tape!).

The Comments column contains a potted summary based on the original review, emphasising the salient points of a product's character and sonic performance. The space available doesn't allow for great detail but in the 20 or so words we have attempted to put across the essence of the review, in some cases using quotes from the review itself. Obviously, important information on compatibility or auxiliary equipment used in the test cannot be included, and it is best to refer to the original review for this, of which more later.

The next column(s) varies from category to category but is usually either features or specifications, the former being facilities available on a cassette deck or amplifier or the type of drive system on a turntable.

Specifications vary with product type but usually relate to suitability or capability, for instance arm matching figures are given with the cartridges which tie in with the mass figures for the tonearms themselves, making it easier to avoid compliance/mass mismatches.

Perhaps the most influential letters in the Directory are those found in the Value column, the *Rs* and *BSs* denoting the Recommended and Best Buy ratings that are appended to products we consider meritworthy. The Best Buy tag means that a product not only offers good sound quality but is reasonably priced as well. With source components a price limit of approximately £300 is usually used as a

guide. Recommended means that either the performance of a product is particularly good irrespective of price or, alternatively that a good value standard is achieved but overall attainment falls short of Best Buy classification. An ideal situation would be to choose suitably priced Best Buy or Recommended products from relevant categories and create a Best Buy system, but, due to the variety in tonal balance that exists in much audio equipment (especially the electromechanical elements – ie cartridge and speaker) system building is not quite that simple. These ratings make a useful guideline for shortlisting components, but only experiencing the actual combination will tell you whether it works for you.

The final column contains a reference to the issue of *Hi-Fi Choice* which featured the complete review. If you wish to get a better idea of a product by reading the complete review it is possible to order a copy (if still in print) through our back issues department. Every *Choice* issue contains a Back Issues page for this purpose.

The Directory is constantly updated with the latest reviews and price changes as well as having discontinued products removed. If a listed product is updated to a 'mark two' form and the alterations are purely cosmetic or not too extensive we sometimes leave the product in with its current model number and an asterisk to denote that it has changed since our original review was published.

SYSTEM BUILDING

Pre-packaged one-make systems have been commercially very successful, with advantages like cosmetic consistency, competitive pricing, and (assumed) technical compatibility. However, despite the mass market clout of the consumer electronics giants, the hi-fi tradition of specialised separate components seems as strong as ever, and certainly represents the route taken by those who place sound quality ahead of other criteria.

Yet those who choose the separates route still have lingering doubts – usually completely unjustified – over the compatibility of components from different manufacturers. Gross incompatibilities are very rare nowadays, only likely to rear their heads amongst the most exotic components. Here the delicate art of 'supercompatibility' really takes over the major role and might be regarded as the key to 'real' hi-fi.

There are now three different pre-recorded music media competing for the attention of the hi-fi user, and to go for all three will either cost a lot of money or involve substantial compromises in the sound quality of each. For this reason many separates purchasers may start with just one source, adding others or a tuner when funds permit.

There will always be controversy over the relative qualities of LP, CD and cassette. LP is still the choice for ultimate sound quality – particularly for those prepared to spend a substantial sum on a good quality turntable system. Furthermore the vinyl repertoire is still the cheapest, largest and most varied.

Cassette has never really challenged vinyl's superior quality, but it is a multiple role format, offering 'go anywhere' flexibility, a uniquely useful recording capability, plus a broad catalogue of pre-recorded music cassette material. As a hi-fi medium cassette suffers from pre-recorded material which has been improving but is still patchy in quality, and can usually be bettered by a home recording. There is also the worry that a tape made on a specific machine usually replays best on that machine, which may cause aggravation when upgrading a few years hence. It is worth remembering that though such opportunities are rarely possible or practical, a live recording onto cassette using good quality microphones can be the hi-fi equal of any other source.

CD is the latest challenger to these two established media, using a digital instead of analogue storage format. The sound quality remains controversial, hailed as near perfect by its fans but derided by vinyl freaks, so it is probably fairest to say that CD is fine for most listeners, but may not suit everyone; certainly the lack of background noise, defects and deterioration over time are major strengths.

While there will always be arguments about the different music storage and transmission formats available to the hi-fi listener, there is also controversy over the relative importance of the different components which make up the system chain – by which is meant the source, the amplification, and the loudspeakers (and for the pedantic the room itself, though there's often little that can be done here).

For many years the 'weakest link' theory proposed that the loudspeakers needed the most attention, that amplifiers merely had to have sufficient power, and that turntables were pretty well perfect. However, this perspective has become steadily discredited by an alternative 'theory of precedence', which stresses that no subsequent component can make up for the inadequacies of its predecessors – all it can do is supply its own additional degradations. In such a context it is not uncommon to find more than half the system budget allocated to the record player, with scrimping and saving made on amplifiers and loudspeakers, even though these are used all the time whatever the source.

Choosing the components of a system is only part of the task of getting the system as a whole working as well as possible. Good turntables and loudspeakers both benefit to a surprising degree from proper support – from stands that enable them to give their best performance, whether floor-standing or wall mounted.

Siting of components within a room can play a significant role, as can the room itself. Some people may prefer an acoustically more 'live' room than others, but most will agree that the larger it is the better, because this tends to provide smoother and better extended bass reproduction. All rooms create reflections and standing waves, and the effects of these are more severe if all opposing walls are parallel, similar distances apart, and with hard reflective surfaces. Provided that the loudspeakers can be placed fairly symmetrically, slight asymmetry elsewhere in the room is usually helpful.

The loudspeakers are most critical of placement, because it is their job to create the stereo image, and it will be impossible to do this if the sound from each is not roughly similar at the listening position. Each loudspeaker should operate in a similar immediate acoustic environment, unencumbered by other furnishings and structure, and a similar distance from listener, nearby walls, and corners. Some loudspeakers are designed to operate close to a rear wall, others a metre or so out into the room, but all loudspeakers benefit from being closely mechanically coupled via proper stands to the floor.

There is some debate about the best form of fixing, however, adjustable spikes through to the

floor proper or seated into the tops of cross-head screws are generally regarded as the best solution in most circumstances. There is no need for paranoia about using spikes through normal pile carpets because the holes will be almost impossible to find when the stands are removed.

Most decent quality turntables are fairly immune to feedback from loudspeakers, so it should not matter too much if these items are sited fairly close to each other. Indeed it is debatable whether any advantages gained from keeping the turntable well away are not lost through the need to use longer connecting cables.

Mixing and matching the components of a record player to get optimum results can be something of a black art, over and beyond the fairly simple business of choosing a cartridge of roughly the right compliance to suit the arm effective mass. Certainly the combining of turntables and tonearms is not a simple matter, and this is where a good specialist dealer will come into his own, both in terms of recommending good combinations from the models he holds in stock, and then in correctly carrying out the sometimes tricky set up procedures which are often required to get the best results.

The key to getting the best results from a separates system lies in finding an experienced and skilled dealer in the first place, one who takes the trouble to find out what you really want and then demonstrate some likely alternatives, without trying to cram his own particular prejudices down your throat. To some extent the customer's task must be to discover for himself whether the dealer in question is competent or not. Membership of trade organisations like BADA can be a worthwhile pointer to a degree of professionalism, but the bottom line is whether the dealer in question can create a good sound in his own shop. If he can't, there is precious little chance of him doing so in your home. The best dealers should lay on demonstrations so you can hear the differences between components for yourself, and hear the sort of improvements which can be had at different price strata. You can then establish the sort of performance you are prepared to accept within whatever budgetary constraints you have set.

The Directory has been compiled so that it can be used by *Choice* readers as a buying guide. A guide in the sense that you should use the information in it to make a shortlist of equipment suited to your needs and budget, and then audition it at a dealer's before taking the plunge. Because tastes inevitably differ it would be unwise to buy purely on the basis of our recommendation and dealers are the most experienced people around when it comes to making systems work as a whole.

THE DIRECTORY

TURNTABLES & TONEARMS

The schizophrenic split between consumer electronics and 'real hi-fi' is most obvious amongst turntables. The former are supplied simply as a means of playing vinyl in a system context. Cheaply manufactured in the Far East, these are complete players with a variety of automatic facilities, sometimes tied into system remote control. But engineering compromises severely limit sound quality, cartridge choice may be P-mount restricted, and such machines are rarely stocked by specialist hi-fi dealers these days.

Specialist turntables offer big sound quality

improvements, but lack so-called convenience features (that practised users often find irksome). Such turntables at the cheaper end of the market (sub-£350) tend to be supplied with matching tonearm, and often include a 'starter' cartridge. Still better quality is found at higher prices amongst the separate motor units and tonearms. Careful partnering and set-up is essential for these individual components, but 'naturally sympathetic' combinations do exist, and the good dealer can help. Listed separately as integrated players and as turntable motor units and tonearms, our **sound**

quality rating is based on results achieved using a high quality system – but in point of fact the turntable is usually the limiting factor soundwise in any system. **Lab performance** summarises the speed stability, vibration generation and environmental isolation of turntables, along with the friction, alignment and adjustment of tonearms. The tonearm's physical characteristics also define a range of mechanically compatible cartridges (see cartridge listings).

Listed separately as integrated players and as

INTEGRATED TURNTABLES

NAME PRICE	LAB SOUND	COMMENTS	FEATURES ARM EFF. MASS	VALUE	BACK ISSUE FULL REVIEW
Acoustic Research EB101 £230	Good Good	This genuine high fidelity product offers an impressive package at a competitive price	Subchassis, manual, 13.5g	BB	48
Alphason Solo/Xenon MCS £365/£262	Average+ Good	The deck is warm and euphonious with high levels of clarity. Wow artefacts occasionally just audible.	3 point suspended motor unit, optional quartz PSU/speed change 13g		67
Alphason Sonata/HR-100S-MCS £695/£412	Excellent Very Good	Highly capable audiophile system with real resolution and control. Bass is powerful and dynamic ability unbridled	Manual, subchassis, belt drive, 10g	R	60
Ariston Q-Deck £150	Good Average+	Well engineered and good sounding low cost package which is both easy to set up and to use	Semi-auto, belt drive, solid	BB	67
Ariston RD60 £219	Good Good	With the Enigma arm, this balanced and communicative turntable falls only slightly short of the RD90 on sound quality	Manual, belt drive, subchassis, 11.5g	BB	48
Ariston Forte £350	Below Average Average	Heavy on engineering, short of soul? The Forte almost makes it, losing out only because of some residual pitch variations and a lack of bass power. The arm is modestly good	Manual 2-speed belt drive player and detachable arm, 10g		67
Dual CS430 £89	Average Below Average	Ragged, sometimes unpleasant cartridge mixes with a modest pleasing player in a very sharply priced package.	Belt drive, with cartridge, auto return, 5g	R	67
Dual CS503-1 £114	Poor Average	Stated as a replacement for the CS505, the 503-1 needs careful system matching to mask rumble and microphony, but is good enough to benefit from a better cartridge	Semi auto, belt drive, low mass arm	R	55
Dual CS505-3 £139	Very Good Good	Continuous steady improvements have kept this model at the forefront of the budget market. Practicality is excellent and the deck has excellent timing bass/mid and stereo imaging	Semi-auto belt-drive, 8g	BB	67
Dual CS5000 £200	Average Average+	The rare 78 facility may give grandma's collection a new lease of life but the player did not merit recommendation on price vs sound	Electronic, belt drive, subchassis, 10g		48
Goldmund ST4 £4,550	Very Good Excellent	The Studio turntable takes on a cheaper tonearm than the T3F, yet provides a similar reference standard objective and subjective performance at £2,000 less, in a neatly integrated though bulky package.	Solid subchassis, direct drive, parallel arm, detachable headshell	R	60
Heybrook T72 turntable & arm £349/£249	Average Good+	A gradual process of informed evolution and a sensibly designed arm combine to make this a good sounding middle of the road package. Well supported by dealers	Manual subchassis motor with arm, belt drive, 14g	R	67
JVC AL-FQ555 £170	Below Average Poor	Clear midband sound but woolly bass and crude treble. Ease of use however ranks highly, and there's little to go out of adjustment	Auto, direct drive, 5.5g		67
Kenwood DP-990 £300	Average Average	Smart, slick and massive player suitable for low compliance cartridges only. A good but not inspired performer.	Semi-auto 2 speed direct drive, 16g		67
Kuzma Stabi/Stogi £575/£349	Average+ Stabi: Good; Stogi: Excellent	Stabi is powerful, spacious but not sufficiently subtle. Stogi is an excellent all rounder with even spread of abilities.	Manual, belt drive, subchassis, 12.5g	Stogi: R	60
Linn Axis £379	Good+ Good+	Setting new performance-for-price standards this cleverly engineered and competent deck has many of the qualities of the Sondek LP12	Electronic, belt drive, semi subchassis, 13g	BB	48/Coil
Linn Sondek/Ittok (Troika) £509/£429 (£669)	Excellent Excellent	Superb sound – the best LP12 combination yet. The Troika gives the system real solidity and strength, stretching the deck and arm qualities to the full	Manual subchassis player, belt drive, 14g	R	60
Manticore Mantra £300/£330 (Arm)	Good+ Good+	Fitted with a Rega RB250 arm variant and AT95E cartridge the Mantra fared very well indeed with a fine midrange and good focus	Subchassis, 12g, manual	BB	48/Coil
NAD5120 £89	Average Average	A number of running improvements have given this player a range and tautness denied its lazier sounding antecedents.	Semi-auto belt drive, detachable armtube/weight, 9g	BB	67
Omega Point Silver/Black £895/£295	Good Good+	An avowedly stripped down turntable that lacks even an on/off switch, the Omega Point Silver offers fine midrange clarity and good stereo, but some HF compression and a lack of 'wellie'	Manual, solid, belt drive, unipivot, 11g		55
Opus 3/Decca London International (Revised) £399/£99	Poor Good	Heavyweight motor unit with many fine properties, but which needs further development. The idiosyncratic arm is a suitable (though not ideal) platform for the Decca cartridge. For all its faults though, the whole transcends the sum of the parts	Belt-drive manual, damped unipivot arm, 12g		67
Rega Planar 2 £155	Average+ Good	A remarkable product at the price, surprisingly articulate and confident	Integrated turntable, manual, 11.5g	BB	48
Rega Planar 3 £207	Good Good	A long time leader in its price category, the '3 (with its excellent RB300 arm) sounded nicely 'musical' in a balanced and coherent manner	Integrated turntable, manual, 11.5g	BB	48
Revolver Rebel £160	Below Average Below Average	Fat, assured and forward presentation, but ragged and subjective speed stability problems. With a little further development, it will be a winner	Manual, 2-speed belt drive inc cartridge, 13g		67
Revox B291 £660	Average- Average-	Sound quality ranks as below average. Subjective bandwidth is narrow and the music lacks grace and energy. Ease of use however is unrivalled	Automatic, remote controllable, direct drive parallel arm, prefitted cartridge		55
Sansui SR-222 Mk V £159	Average- Average	More than acceptable in most areas, the Sansui is detailed and positive, though a little muddled when stressed. Best suited to low compliance cartridges	Manual 2-speed belt drive, 16g		67
Systemdek IIX £248	Good Average+	Poised, clean sounding deck, forward and explicit in character. A good value deck under £250, and a relatively cheap and satisfactory suspended model	2 speed belt drive manual turntable and arm, 11g	R	67
Technics SL80-22 £90	Average- Average-	Not bad for the price and a great improvement on the L20, it performs reasonably when not stretched	Semi automatic, solid plinth, electronic, 6g P-mount	R	48
Technics SL-DD33 £110	Average Average	As with the DD33 though better value	Automatic, direct drive, solid plinth, 7.5g, P-mount	BB	48
Technics SL-L20 £115	Poor Average-	A rather lightweight parallel tracker achieving a poor overall rating, with little to recommend it unless you dig facilities	Electronic, solid plinth, 5g, P-mount		48

TO ORDER BACK ISSUES OF HI-FI CHOICE SEE PAGE 114

THE DIRECTORY

INTEGRATED TURNTABLES

NAME PRICE	LAB SOUND	COMMENTS	FEATURES ARM EFF. MASS	VALUE	BACK ISSUE FULL REVIEW
Technics SL-QD33 £140	Average Average	The quartz speed controlled version of the DD is short on sound quality but not features. But it did have fair focus and some depth	Automatic, Quartz, direct drive, solid plinth, 7.5g, P-mount	R	48
Thorens TD280 £150	Average Average	Extremely competitively priced package with a trace of lower-mid overhang, but it's very well behaved elsewhere	Semi-auto belt-drive 2-speed, 13g	BB	67
Thorens TD166 Mk II £179	Average Average+	A polished and professional design consisting of a first rate budget suspended subchassis turntable and a mildly disappointing arm	Manual 2-speed, 13g	BB	67
Thorens 160S Mk IV £249	Average+ Average+	Fine, familiar suspended player and arm. Faults are few, but include poor arm bearing adjustment. The arm can sound a little messy	Manual 2-speed, 7g	R	67
Thorens TD320 Mk II £349	Good Good	Good, consistent sounding deck with much improved (but not ideal) arm. A little expensive for performance offered	Semi-auto two speed belt drive, 14g		67
Well Tempered Turntable & Arm £1690	Average Very Good	Intriguing and challenging design. Musically it is not ideal, but it has a limpid quality and a lack of artificiality that sets standards as well as turning the ear, though it's not completely uncoloured. A charmer yet mainstream enough in its virtues to be viable	Manual 2-speed, damped, suspended arm, 7.5g	R	67

MOTOR UNITS

NAME PRICE	LAB SOUND	COMMENTS	FEATURES	VALUE	BACK ISSUE FULL REVIEW
Ariston RD90 Superior £900	Good+ Good	Good but slightly damped sound quality, with powerful and stable bass. The pro quo is a certain lack of pace, energy and resolution	Belt drive, subchassis, electronic		55
Michell Synchro £265	Good Good	A particularly happy blend of qualities endows the Synchro with a blend of subtlety and force – the mailed fist in the velvet glove. Easy on the ear in the best sense.	Manual, belt drive, suspended motor unit	R	67
Michell Gyrodec £595	Good Good	Sweet and natural sounding player, well exploited by the Rega RB300 arm. Aesthetics, and the acres of acrylic, are unique	Manual, belt drive, suspended motor unit		55
NVA Turntable £499	Average Good	A surprisingly fast and assured performer, but with lightweight bass and a little aggressive. Easy to set up, the price (necessarily includes stand	Manual, belt drive subchassis, stand, 33 $\frac{1}{3}$ rpm		60
Oracle Alexandria Mk III £825 – £995	Very Good Very Good	One of the most beautifully presented players made, and fully supported by superb separation, dynamics and a euphonious style of delivery.	Manual 2-speed belt drive	R	67
Oracle Delphi III £1450	Very Good Very Good	Stable imaging, good bass and refined detail, it's well made and consistent in service – but very expensive	Manual, belt drive, subchassis	R	60
Oxford Acoustics Crystal Reference £1995	Very Good Excellent	This big, open and powerful sounding turntable works beautifully with Airtangent arm to give superb 3-D imagery	Manual, belt drive, subchassis, stand	R	60
Pink Triangle PT 700 £650	Good Excellent	A state of the art player, easy to set up but extremely fussy about partnering equipment and state of tune. The test sample suffered flutter derived roughness (presumed not typical)	Manual 2-speed, outboard PSU	R	67
Rega Split Slab Modification Kit £74	Good Good	Clever and cheap upgrade kit that protects the initial investment and which adds clarity and environmental isolation to a fine but microphonic original	Conversion suspended chassis kit for Rega 2/3		67
Roksan Xerxes £655	Excellent Excellent	This unique design cuts a swathe through the conventions of turntable design, providing superb resolution and stereo. Setting up is critical, and for experts only	Manual, belt drive, solid/decoupled	R	67
SEE Revolver £135	Average Average	Nicely balanced, but unimpressive timing and lightweight bass made this deck rather average for the price. Manufacturer has since made several changes, but not re-submitted for review	Manual, belt drive, solid plinth		48
Source So £675	Good Good+	Now an extremely tidy sounding deck, the So has a grip and range at low frequencies that knows few peers, and is at least sufficiently good elsewhere. A successfully refined version of a promising original that didn't quite deliver	Manual belt-drive 2-speed, outboard PSU	R	67
Systemdek IIXE £248	Good Good	Fine, honestly specified and well built player which easily betters its closest stablemate, the IIX	Manual 2-speed, external PSU	R	67
Systemdek IV £495	Good Very Good	The level of wow is a theoretical concern at least, but elsewhere this player shines, combining euphony, information and imaging in a polished, untemperamental package	Two-speed manual belt drive	R	67
Thorens TD521 £629	Average Average+	Nice product. Unexciting, rather undynamic and insubstantial sound quality, but facilities such as ability to accommodate 12 inch arm compensate	Manual, belt, suspended motor unit, 78rpm, pitch control,		55
Townshend Avalon £299	Good Good	Some smear and coloration, probably due to structural shortcomings of the plinth, take the edge off this otherwise well turned out and well priced machine. Worth trying if you can't afford the full-blown Rock	Manual 2-speed belt drive	R	67
Townshend Rock £450	Good Good+ +	Tight, tidy sounding player which works with a wide variety of (non-tangential) arms, giving almost CD like precision and clarity. Good bass depth, dry balance – our Editor's favourite deck, in fact	Manual, belt drive, solid, arm damping, various optional extras	R	55

TONEARMS

NAME PRICE	LAB SOUND	COMMENTS	ARM EFF. MAS	VALUE	BACK ISSUE FULL REVIEW
Alphason Opal £110	Good Average	This is a straightforward adequate sounding low cost arm, priced just above where it rightly belongs	10g		55
Alphason Delta £165	Good Average+	A highly competent design from Alphason gives good sound quality but with slight blurring and treble fizz	16g	R	48
Alphason Xenon £210	Good Good+	A trimmed down HR100S, the Xenon has inferior bearings and a simpler finish, but sounds crisp and coherent. Fits any Linn cutout	12.75g	R	55
Alphason HR100S £395	Good+ + Very Good	This S-shaped arm sounds smooth, but nevertheless reproduces transients with fine attack	10g	R	48/Coll
Ariston Enigma £99	Average Average+	Good but not the best in its class: mid-band sounds a little uneven; treble a trifle "brash"	11.5g		48
Audio Technica AT1130 £186	Good Good	Well suited to most cartridges including high compliance ones, the AT is smooth and tonally neutral, if slightly lacking in 'balls'	8.5g	R	67
Decca International £49	Average+ Average+	This uni-pivot design gives a rather rich tonal balance and some bass muddling. Could be good with Decca cartridges, but not well built	12g		48Summary
Eminent Technology £1000	Good+ Good+ +	One of the best sounding tonearms around, the linear tracking Eminent delivers impressive stereo imagery, focus and transparent sound	9g (vertical)	R	48/Coll
Goldmund T3F arm £3950	Excellent Excellent	This complex parallel tracker created an "ear-opening" experience when tested with a (since updated) Goldmund Studio turntable	16.5g	R	Coll 2
Grace G707 £299	Good Good+	This venerable is still capable, if not competitive with modern alternatives	7g		48
Helius Orion 2 £490	Very Good Very Good	Very expensive but with a performance that merits recommendation	12g	R	48

THE WORLD'S NO 1 GUIDE TO BUYING HI-FI

THE DIRECTORY

TO NEARMS

NAME PRICE	LAB SOUND	COMMENTS	ARM EFF. MAS	VALUE	BACK ISSUE FULL REVIEW
Linn LV Plus £129	Good + Good	The fixed headshell provides an improvement over the LVX resulting in better clarity, detail and punch	13g	BB	48
Linn Ittok LVII £429	Very Good Very Good	Suitable for many turntables this top-quality arm performs best with the LP12, the combination exceeding the sum of both parts	13.5g	R	48/Coll
Linn Ekos £895	Very Good Very Good	Superb, state of the art design which builds significantly on Ittok's strengths	9g	R	67
Mission Mechanic £900	Good Good +	Nearly right, but inconsistency with level and vague imagery spoil what is otherwise a firm, powerful advocate for black vinyl	11g		55
Moth Arm £78	Good Good +	The ultimate budget arm? Refined, detailed, sweet and natural – performance improves in line with the rest of the system	12g	BB	60
Rega RB300 £115	Good + + Good + +	Despite its modest price this sets exceptional performance standards and could be used on a number of high-quality turntables	10-11g	BB	60
Roksan Artemiz £350	Average Good	Excellent but flawed arm which needs some development and refinement before it can be wholeheartedly endorsed. Watch this space. Fits Rega cutout	8g		67
SME 3009 Series IIS £165	Good Average +	A simplified less flexible (as regards adjustment) Series III with a similarly 'soft' sonic character	5g		48
SME 3009 Series III £229	Good Average +	Comprehensively adjustable and very well made, suited to MM and high compliance MC cartridges	5g		48
SME 3009R £291	Average + Average +	A higher mass version of the Series III designed for low compliance MC cartridges	12g		48
SME Series IV £810	Excellent Very Good	Superb engineering and finish with a finely balanced sound giving impressive stereo focus and low coloration	10.5g	R	60
SME Series V £1206	Excellent Very Good	Excellent in terms of design engineering and sound quality, this arm arguably sets a new reference standard regardless of price	10.5g	R	60
Souther Tri-Quartz £895	Average Good	A unique parallel tracking arm that makes up for what it lacks sonically in its unusual appearance	3-4g		48

CARTRIDGES

Very much the 'slave' of turntable and tonearm and to some extent undermined by the supply of free 'starter' cartridges on many turntable systems, the cartridge is still worth taking seriously. The quality of both the stylus itself and the cartridge's tracking performance are important in preserving that most important part of the hi-fi system – the record collection – and the cartridge also plays a significant role in determining the overall balance of a system.

Cartridges fall into two groups: high output models, capable of working directly into any amplifier, and more expensive low output models. Stereotypically, low output cartridges use the moving coil principle of operation, have better mechanical integrity and tighter tolerances, and give better performance but at much higher cost. Most under-£150 amplifiers and many valve designs need either an extra head amp or transformer to cope with the low output. **Cartridge/amplifier**

interfacing can be very subtle, but even basic high output moving magnet designs benefit in overall balance from optimised amplifier capacitance loading. Still more important, the mechanical cartridge characteristic of cantilever compliance ('springiness') needs to be considered in the light of the effective mass of the tonearm which will be used (see Turntable & Tonearm entries).

NAME PRICE	LAB SOUND	COMMENTS	ARM OUTPUT/TYPE	VALUE	BACK ISSUE FULL REVIEW
A&R C77 £20	Average + Average +	A sensible moving magnet package with good bounce at a competitive price	6-16g Normal, MM	BB	48
A&R C77Mg £30	Average – Average	Punchy sound quality with plenty of extra energy to liven things up. The solid body seems well worth the extra £10	4-8g Normal, MM	BB	67
A&R E77Mg £47.50	Average Average	Our sample had a disappointing stylus, but gave a coherent, rich and laid back sound, with good 'scale'	3-8g Normal, MM	R	48
A&R P77Mg £60	Average + Average +	Cautiously recommended, the P77Mg was preferred to its cheaper partner by virtue of a better tip. Channel balance could have been better	4-9g Normal, MM	R	48
Audionote I02VDH £795	Good Very Good	One of the best, giving 'an extraordinarily relaxing midrange clarity'. But it picked up a bit of surface noise and dust and needs a transformer	8-18g Very low (transformer), MC		43
Audioquest MC5 £200	Average Average	Offers high-output benefits but the drooping frequency response and severe VTA error preclude recommendation	10-20g Normal, MC		54
Audio Technica AT95E £17	Average – Average	Clear, dynamic if richly balanced, the magnetic '95E is a definite Best Buy	8-14g Normal, MM	BB	48
Audio Technica AT-420E OCC £30	Average Average	Better suited to pop recordings this MM bears some of the sonic hallmarks of the Linn K5	7-14g (damp) Normal, MM	R	67
Audio Technica AT-430E OCC £42	Average + Average	A rising high frequency response yields something of a treble sting, not a good all-rounder	3-7g Normal, MM		67
Audio Technica AT-F3/OCC LE £70	Average + Good	Though the 'limited edition' badge is a trifle tongue-in-cheek the 'F3 still offers excellent value	8-15g Low, MC	BB	67
Audio Technica AT-F5/OCC £100	Average + Good	Decent output, good channel balance and a thoroughly refined sound sets the standard at £100	9-20g Low, MC	BB	54
Audio Technica AT-F5/OCC LE £100	Average Good +	This latest sample demonstrated some technical weaknesses but its spacious, fluid sound quality still represents a benchmark at this price	4-10g Low, MC	BB	67
Audio Technica ATOC7 £250	Good + Good +	Technically and subjectively this cartridge represents a new dawn for AT, in the twilight of analogue audio	6-13g Low, MC	R	54
Audio Technica ATOC9 £400	Average + Very Good	Tonal colours were reproduced faithfully while stereo images were clearly isolated and focused despite contributing to a thoroughly integrated whole. Slightly less transparent than more costly MCs	6-14g Low, MC	R	60
Azden YM10VE £12.50	Average Average –	A good tracker. Sounds rather bunched-up but not totally incoherent – for very basic systems only	5-15g Normal, MM		54
Azden GM1E £30	Average – Average –	Of academic interest only, this high o/p MC is seriously flawed in sonic terms	8-18g Low/normal, MC		54
Azden GMP5L £108	Average + Average +	Although no P-mount system will do this cartridge justice, it can still be enjoyed in its universal mode. The subtle balance may prove irresistible to some	4-10g Low, MC	R	54
B&O MMC5 £24	Average + Average	Cheapest in the family – smooth treble and good focus, but the bass was left in the wings	5-15g Normal, MM		38 (Summary)
B&O MMC4 £43	Good Average +	Solid and well balanced in the midrange, the '4 lacks bass impact	5-15g Normal, MM		48
B&O MMC3 £57	Good Average	Slightly "laid back" sound quality but a good performer for the price. Best suited to B&O equipment	5-15g Normal, MM		48

TO ORDER BACK ISSUES OF HI-FI CHOICE SEE PAGE 114

THE DIRECTORY

CARTRIDGES

NAME PRICE	LAB SOUND	COMMENTS	ARM OUTPUT/TYPE	VALUE	BACK ISSUE FULL REVIEW
B&O MMC2 £87	Good Average+	Only a modest improvement on its cheaper brothers (and sisters)	5-15g Normal, MM		48
B&O MMC1 £112	Very Good Good	Great clarity and detail at high frequencies but a slightly plodding bass. It may appeal more to the classical enthusiasts!	5-13g Normal, MM		48
Cello Chorale £799	Good Very Good	Looking like a piece of NASA gadgetry the Chorale's transparent treble delicacy was without equal. A serious audiophile choice	4-10g Low o/p, MC	R	48/Coil
Clear Audio Gamma £295	Average Average+	Brimming over with enthusiasm, the unusual-looking Gamma is more than an audio oddity, but it lacks a little subtlety at times	4-11g Low, MC		54
Clear Audio Delta £450	Average+ Good	Midway between the Gamma and exotic Pradikat, the Delta sounds like neither! Nevertheless, it delivers the goods	6-17g Low, MC	R	54
Clear Audio Pradikat £1225	Average+ Very Good	Sounded absolutely glorious, creating a full sense of scale and a large well-focused soundstage – but watch for record wear	8-18g MC		Coil
Clear Audio Accurate £2,000	Good Excellent	A remarkable cartridge, not only by virtue of its effortless and highly neutral sound quality but also because this has been achieved with the same basic design as Clearaudio's cheapest MCs	4-11g Low, MC	R	60
Denon DL110 £69	Good Good	Firmly recommended as a fine all-rounder, this high-output moving coil model is likely to perform well in nearly all circumstances	6-16g Normal, MC	BB	48
Denon DL150 £89	Average+ Good	Although listeners just preferred the 110 its brother here proved a twin in lab tests and is still "thoroughly competent"	6-16g Normal, MC		43
Denon DL 103 £99	Average Good	This classic spherical stylus model gives a lively sound with powerful bass, and is popular in broadcast studios	6-16g Low, MC	R	48
Dynavector DV-50X £60	Good Average	A high-output MC model with impressive lab performance, but whose tip and sound quality both disappointed	6-14g Normal, MC		48
Dynavector DV10X IV £60	Average Average+	Fine sounding and realistically priced, damping is recommended to ensure successful tracking ability	8-18g Normal, MC	R	48
Dynavector DV23RS £150	Average+ Good	Sound quality was described as "shut-in", lacking energy and sparkle but with some "edginess" in high frequencies	10-22g Low, MC		28
Dynavector DV XX-1 £360	Good Good+	The XX-1 embodies a power and solidity rarely encountered amongst the breed, nevertheless it did exhibit a peculiarly suppressed character that will suit lively rather than wholly neutral systems	7-17g Normal, MC		60
Empire 800 Mk II £33	Good Average	This very high output MM appears to be based on the classic Ortofon VMS series. A trifle uninspiring overall	7-17g Normal, MM		67
Empire MC-5M £110	Average+ Good	A very low compliance renders this MC best suited to heavy tonearms while its sweet, non-aggressive sound quality earns it a recommendation	13-20g Low, MC	R	67
Glanz MFG 110EX £24	Average Average	A little bright but giving detailed bass and clear treble this was competitive at the price	6-16g Normal, MM	R	Systems
Glanz GMC-10EH £49	Good Good	The rising HF trend of this high o/p MC may cause problems in certain systems but with a favourable wind its seductive qualities will win out	8-14g Normal, MC	R	67
Glanz GMC-10LX £79	Average+ Average+	Bearing some of the hallmarks of the 10EH, the 10LX is still less competitive in the sonic stakes	7-15g Low, MC		67
Glanz GMC20E £129	Average Average	You could try haggling but we thought the makers of this number were demanding too much lucre for their product	3-6g Low, MC		48
Goldmund Clearaudio £1500	Average+	Something of a mixed bag overall, its sonic character bears a strong resemblance to the Pradikat though it shares some of the hallmarks of the more expensive Accurate	5-12g Low, MC		60
Goldring Elan £15	Average+ Average	A lightweight and frisky-sounding MM that appears to be based upon the same body as the Nagaoka mm4	7-15g Normal, MM	R	67
Goldring Epic II £23	Average Average+	An excellent budget choice though the limitations of the stylus are rather obvious at higher frequencies	5-12g Normal, MM	R	67
Goldring G1010 £36	Average Average	A bit fiddly to set-up but rewarding once accomplished. The big and bouncy sound belies its price. Sensitive to amp loading	10-20g Normal, MM	BB	54
Goldring G1020 £53	Average+ Average-	This one strutted finely onto stage but couldn't project to the "gods"	8-16g Normal, MM		43
Goldring G1040 £79	Average+ Average-	High frequency extension was improved by the van den Hul tip, nice looking model – no great actress	8-16g Normal, MM		48
Goldring Eroica L £95	Average Average+	Open and relaxed sounding, the L version is just that bit more refined than its high output brother	7-18g Low, MC	R	54
Goldring Electro II £149 complete	Average Average+	A pretty decent allrounder that did not excel sufficiently to warrant recommendation	8-16g Normal, MC		43
Grace F9E II £240	Good Good	For lively presentation, excellent separation and generally satisfactory sonic delivery – consider this model	5-10g Normal, MM		48
Grado XTE +1 £20	Average- Average	Bass and treble are a trifle coloured but the midband proved highly enjoyable. Ideal for budget systems	6-13g (damping) Normal, MM	R	54
Grado XF3E + £43	Average- Average	Downtilting balance disguises the brightness of this cartridge; bit of a mixed bag at this price	9-20g (damping) Normal, MM		54
Highphonic MCA3 £360	Very Good Good+	Exquisitely crafted by a group of ex-Denon engineers, this superb tracker had a sweet and seductive (if rather bright) treble	5-12g Low, MC		43
Kiseki Blue Silver Spot £395	Average+ Good	Solid performance from a very solid cartridge but lacks some of the magic of other Kisekis. Compliance too high	5-12g Low, MC		54
Kiseki Purpleheart Sapphire £695	Good+ Good+	Rare, beautiful to look at and sweet to listen to, our review of this high-flyer conjured up images of Japanese art	5-14g Low, MC		Collection
Kiseki Blackheart £1595	Good Good	This cartridge demonstrated refined poise and a delicate but at once potent security, however, the price did seem a little on the high side compared to other Kisekis	6-16g Low, MC		60
Kiseki Lapis Lazuli £3500	Good Very Good	Combining very sensible design concepts at a silly price, the Lapis Lazuli is best thought of as combining the detail of the MC3000 and the fluidity of the Clearaudios	4-12g Low, MC		60
Koetsu Red £896	Good+ Very Good	Named like a rare, and perhaps dangerous, little oriental fish this famous cartridge sounded "almost larger than life"	10-25g Low, MC	R	48/Coil
Koetsu Red Signature £1391	Good Excellent	Technically this cartridge suffers no faults whilst on a subjective level it offers rare musical insight	10-21g Low, MC	R	60
Linn K5 £30	Average Average+	Not as crisply focused as the costlier Linn magnetics, the K5 offers a smoother presentation	7-16g Normal, MM	R	67
Linn K9 £75	Average Good	Linn threw this model into the leading pack by beefing up the Basik's bodywork, adding a super stylus, and keeping the price fair	6-15g Normal, MM	BB	48/Coil
Linn Asaka £299	Good+ Good+	Disciples of Linn who are trying to realise their true "Karma" may find that saving money is not a short cut to heaven	9-18g Low, MC	R	48/Coil

THE WORLD'S NO 1 GUIDE TO BUYING HI-FI

THE DIRECTORY

CARTRIDGES

NAME PRICE	LAB SOUND	COMMENTS	FEATURES	VALUE	BACK ISSUE FULL REVIEW
Linn Karma £435	Very Good Very Good	A specialist which is strongly recommended for Linn-based systems; results may be less predictable in more general application	9-18g Low, MC	R	48/Coll
Linn Troika £669	N/A Very Good	Ex-Karma users have been seen with glazed expressions indicating smug self-indulgence the morning after fitting a Troika	8-18g Low, MC		Coll
London Maroon £109	Average Average+	Now manufactured under the London brandname this Decca cartridge is as iconoclastic as ever	9-20g (damp) Normal, MM		67
London Super Gold £248	Average— Good+	Sometimes a bit fierce in emphasising record surface faults, it is perhaps best at revealing the excitement and tension in music	8-20g + damping Normal, MM	R	48/Coll
Madrigal Carnegie One £685	Average+ Good	Looks like a duck but sounds much better, certainly worth auditioning. Compliance too high	5-11g Low, MC		54
Milltek Aurora £198	Good+ Good+	An overall feeling of relaxed ease characterised this clear and atmospheric Kiseki-built cartridge	8-16g Normal, MC	R	48/Coll
Milltek Olympia £298	Average+ Good+	Warm and detailed sound – packs the punch of the best MCs with high output as a bonus	12-20g (damping) Normal, MC	R	54
Mission 773HC £150	Good Good	A sufficiently well-balanced and competitively priced "old-timer" which still warrants recommendation	6-16g Low, MC	R	38
Monster Alpha 2 £479	Good Good+	In the final analysis this fine allrounder is insufficiently exceptional in any specific respect to justify fully its high price	6-14g Low, MC		Collection
Nagaoka MM4 £8	Average— Average—	Clear punchy sound that delivers the rudiments of a good performance	6-16g Normal, MM	R	54
Nagaoka MP10 £17	Average Average	High frequencies sounded "shut-in" with this spherical-stylus model, but mid and mass were energetic, bouncy and punchy	5-13g Normal, MM	R	48
Nagaoka MP11 Boron £38	Average Average+	Responding well overall in PM's equipment and listening room, this model was mildly criticised for low level and dynamic limitations	5-13g Normal, MM	BB	48
Nagaoka MP10SB £40	Average Average+	Stilton's mods have improved the fine detail resolution of this popular budget model	5-15g Normal, MM	R	54
Nagaoka MP11 Gold £45	Average— Average+	There were mild criticisms directed at most areas, but in general the sound was clear, open and even	3-8g Normal, MM	R	48
Nagaoka MP11 Gold SB £70	Average— Average	Excessive price loading for a blob of aluminium	2-6g Normal, MM		54
Ortofon OM5E £15	Average— Average—	The OM10 is a hi-fi cartridge – the OM5E is not	5-16g Normal, MM		43
Ortofon VMS5E II £14	Average Average	Sound quality was thought fair for the price, though a little 'untidy'	8-18g Normal, MM		38 (Summary)
Ortofon OM10 £20	Average Average	One of the leading "cheapies", this gives a fine level of sound quality for the price, with good matching compatibility	5-15g Normal, MM	BB	48
Ortofon VMS 10E II £21	Average— Average—	Some of its stablemates fared rather better, and showed less evidence of tracking problems to boot	Normal, MM		38
Ortofon VMS20E II £35	Average Average	One of the most popular cartridges ever, sound quality was a bit laid-back and tracking could have been better	3-10g Normal, MM		48
Ortofon OM20 £40	Average Average+	This turned out to be the listening panel's favourite among Ortofon's moving magnet models	5-16g Normal, MM	R	48
Ortofon 520 £50	Average Average+	Very sensitive to load capacitance this new Ortofon maintains the company tradition for a lively, effervescent SQ	7-16g Normal, MM	R	67
Ortofon X1 £50	Average Average	The cheaper X1 scored higher marks with our listening panel than the X3, but both were a disappointment	6-15g Normal, MC		48
Ortofon VMS30E II £52	Average+ Average	Rather an old soldier in relation to turntable technology, it will perform undemandingly in demanding circumstances	5-13g Normal, MM		38
Ortofon MC10 Super £70	Average Good	"What a delightfully sweet-sounding cartridge this is..." we said	5-15g Low, MC	BB	48
Ortofon X3 £70	Average Average	A lack of bass power, definition and a "zitty" top end makes this competent but uninviting	5-15g Normal, MC		48
Ortofon OM40 £80	Average Average+	Highly competent engineering, secure tracking and decent sound quality are major strengths. But it's a little cold, a little polite	3-8g Normal, MM		48
Ortofon 540 £100	Average— Average	Graced with an advanced FGII stylus our sample possessed too high a compliance for broad arm matching. It could also sound a little unforgiving	3-8g Normal, MM		67
Ortofon MC20 Super £170	Average+ Good+	An "inviting" sound quality; polite rather than exciting it approaches much more expensive models, but does not better them	6-15g Low, MC	R	48/Coll
Ortofon MC30 Super £250	Very Good Good+	Beautifully engineered and well-balanced, it was slightly criticised as bland, though some may appreciate the lack of rough edges	5-14g Low, MC		Coll
Ortofon MC3000 £800	Good Excellent	Quite simply, the most accurate transcription device yet created – not one for the faint hearted	6-16g V. Low, MC	R	60
RATA RP20 £22	Average— Average	Good integration, a clear dynamic midrange and the beginnings of fine stereo imagery merits clear recommendation	6-14g Normal, MM	R	48
RATA RP40 £44	Average Average+	The '40 did a good job of sorting out the layers and complexity of the mix, with good focus, excellent stereo spread and fine scale	6-15g Normal, MM	R	48
RATA RP70 £77*	Average Average+	Clearer and sweeter than the '40 this also seemed heavier and less lively. For £99 you can have a van den Hul stylus	6-14g Normal, MM		43
RATA RP70vdH £99	Average+ Good	Able to retrieve bags of musical detail (thanks to the vdH stylus), RATA's top cartridge ranks as one of the most articulate MM's available	11-18g Normal, MM	R	67
Rega Bias £34	Average Average+	Difficult to mount in some arms due to its shallow build, the bias offers a gentle, refined SQ that certainly makes it worthy of audition	4-10g Normal, MM		67
Rega RB100 £38	Average Average+	Remarkable mechanical performance in the right system context, but "try before you buy"	5-12g Normal, MM	R	48
Rega Elys £74	Good Good	Clearly superior to the Bias, despite their common heritage, the Elys is both more detailed, accurate and musically convincing	8-15g Normal, MM	R	67
Revolver £20	Average+ Average	This modified AT-95E enjoys a very lively mid and treble even if the bass is somewhat 'slower' in protection. A firm budget buy	8-16g Normal, MM	BB	67
Shure M92E £15	Average— Average	Though lacking depth, the overall sound quality was competent, but treble was not its forte	10-15g Normal, MM		43
Shure M99E £26	Average— Average—	Sister to the 92E this is a solid but not particularly exciting cartridge	5-10g Normal, MM		38 (Summary)

TO ORDER BACK ISSUES OF HI-FI CHOICE SEE PAGE 114

THE DIRECTORY

CARTRIDGES					
NAME PRICE	LAB SOUND	COMMENTS	ARM OUTPUT/TYPE	VALUE	BACK ISSUE FULL REVIEW
Shure ME75ED £24	Average Average-	Rather bright and splashy in the high frequencies but nevertheless a competent model	5-10g Normal, MM		38
Shure M104E £32	Average- Average	Capable in many ways, but giving no substantial improvement over the 92E in our view	5-15g Normal, MM		38
Shure ME97HE £44	Average Average+	It won't turn a sow's ear of a turntable into a silk purse, but will at least keep going and produce an acceptable result	8-20g Normal, MM	R	48
Shure M105E £45	Average Average-	A slightly 'spitty' sound lacking deep bass and dynamic contrast, but can be used in virtually every system where it will perform "unobtrusively"	5-12g Normal, MM		38 (Summary)
Shure M110HE £55	Average Average	Sound quality was thought eminently presentable, but not exciting; smooth clear high frequencies, but a loss of bass definition	5-10g Normal, MM		38 (Summary)
Shure M111HE £67	Average Average	Early reviews of this cartridge complained principally of the price - which has since come down	5-10g Normal, MM		38 (Summary)
Shure ML120HE £95	Average+ Average+	Quite decent sound quality and a generally fine balanced performance	6-18g Normal, MM		48
Shure ML140HE £120	Average+ Good	Qualitatively the treble of this well-balanced moving magnet model was a match for many moving coil cartridges	6-16g Normal, MM		43
Shure V15 VMR £195	Good Average+	Initial listening gave promising results, but extended familiarity gave the feeling of a lack of energy and a "shut-in" sound	5-12g Normal, MM		38
Shure Ultra 500 £452	Good Good	There was no doubting the accomplishments of what could well be the finest moving magnet cartridge around	6-14g Normal, MM		48
Stilton/AT-F3 £110	Good+ Good+	At a premium of some £40 this modified AT-F3 offers a startlingly refined performance and is strongly recommended	8-18g Low, MC	R	67
Supex SM100E £115	Average Average+	Delivers as much musical information as many moving coils - the bass in particular having an attractive bounce	6-15g Normal, MM		38
Supex SD900IV £350	Average+ Good+	The 900 is an inherently fine cartridge, but despite a recent update it is beginning to show its age	10-18g Low, MC		48/Coll
Supex SD901IV £375	Average+ Good+	This high output model delivered sufficient subjective and objective performance, plus good compatibility, to justify its price tag	8-18g Normal, MC	R	48
Supex SDX2000 £651 L £721 H	Good Good+	The high-o/p 2000 was preferred on listening tests to the low-o/p model, which even so has a unique place among the top designs	6-16g Either, MC		48
Van den Hul MC10 £699	Good Good+	A neutral balanced performer giving transparent midrange, fine depth and focus with firm extended bass. Gosh!	5-10g Low, MC	R	60
Van den Hul MC One £799	Good Very Good	This extended all the positive qualities of the '10 but added greater authority and scale - worth it for the extra money	6-12g Low, MC	R	60

AMPLIFIERS

The amplifier sits at the heart of the system, processing the outputs from all the various music sources as necessary and then driving the loudspeakers. These two (quite separate) functions are integrated into a single box at the low-to-middle price points; separated pre- and power amplifiers become increasingly common as one moves upmarket. At the upper end of the specialist market, valve amplifiers provide a popular alternative to the transistor types amongst enthusiasts.

There is a substantial difference between specialist (sound quality oriented) amplifiers and the consumer electronics style models. The former

are bleakly simple, avoiding all unnecessary features to provide the most direct signal path in the interests of best sound quality. The latter range from models with just basic tone controls and tape recorder switching, to those with elaborate facilities such as graphic equalisers, remote control (including volume), surround sound options etc. etc.

Lab measurement provides some useful data, particularly in regard to an amplifier's ability to drive a wide range of different types of loudspeakers, but this is only obliquely related to sound quality. We also include our measured power output (RMS, 8ohm load, 1 channel driven) - but

again, paradoxically, this doesn't necessarily correspond to the loudness capability of the amplifier, which has as much to do with the elegance of the overload characteristics within a given system (valve amplifiers invariably sound more powerful than their rating would suggest). The listing of features provides some indication to the complexity of an amplifier: many users prefer to retain the option of tone controls to 'shape' the overall sound according to taste; many others have found living without tone controls surprisingly easy, with additional benefits in terms of transparency.

NAME PRICE	LAB SOUND	COMMENTS	FEATURES	VALUE	BACK ISSUE FULL REVIEW
Acoustic Research A07 £280	Very Good Average+	Relatively smooth but ineffectual sound quality that lacks some weight and impetus at very low frequencies	75W, 4 line, 2AV and MM/MC inputs		68
ADC A-2080E £400	Good+ Average+	Clean and neutral sound but one that lacked depth and spaciousness; MM input favoured above MC or CD	108W, logic sw. for 5 line and MM/MC inputs		68
Akai AM-93 £550	Average Average-	Unfortunately Akai's on-board D/A converters were less successful than its conventional analogue CD input.	112W, coax and optical dig inputs. MM/MC		68
A&R Arcam Alpha II £160	Good Good+	Very confident, convincingly musical and punchy sound that sets the standard for other budget amps	41W, 4 line and MM inputs	BB	68
A&R Arcam Delta 60 £250	Good Good+	Very refined and highly detailed sound via MM and CD without any of the hardness noted via the MC stage	59W, 4 line, MM/MC inputs, no tone controls	R	68
A&R Arcam Delta 90 £350	Good Fair	Well balanced and sweet-natured in any given system with MC capability, but pricey	70W MM/MC 5 inputs tone controls		50
Albarray M408 II £649 pr.	Good+ Good+	Unusually styled transistor monoblok power amplifiers reintroduced with improved performance and sound quality. Needs good warm-up for best sweetness and clarity	40W Power amp only	R	56
Albarray M1008 II £899	Very Good Good	A larger version of the similarly styled M408II, fairly good all round but only of average quality for the price	80W, monoblok		62
Aria Acoustics Aria 12 £299	Poor Very Good	A plain looking valve power amp that's something of a wolf in sheep's clothing giving many dearer amps a run for their money	12W	BB	63
Ariston Amp £180-200	Average Average+	Slightly veiled and thin sound but proved suitably attractive in the listening tests	32W, full logic control, MM and 4 line inputs	R	68
Audio Innovations Series 300 £425	Poor Good+	Something of an anomaly the 300 is an integrated valve amp that looks awful in the lab but sounds remarkable in a system	10W, MM, 6 inputs	BB	63
Audio Innovations Series 1000/2nd Audio Amplifier £1199/1999	Poor Excellent	This valve combination offered awesome dynamic range with superb transparency and power to match. Compatibility with other brands is unpredictable	15W, MM, 6 inputs, monobloks	R	63
Audio Research SP9 £1698	Very Good Very Good	This new high performance valve FET hybrid preamplifier sets a high standard for versatility, build quality and sound	5 inputs, MM/MC	R	60

THE WORLD'S NO 1 GUIDE TO BUYING HI-FI

THE DIRECTORY

AMPLIFIERS

NAME PRICE	LAB SOUND	COMMENTS	FEATURES	VALUE	BACK ISSUE FULL REVIEW
Audio Research SP11 II £5250	Very Good Excellent	Current state of the valve preamp art. A reference point	Straight line MM/MC Disc + phase invert	R	60
Audiolab 8000C £325	Excellent Good	A well established preamp with a highly controlled sound, though it could do with more life and depth	MM/MC, 5 inputs, hdph, tone controls	R	62
Audiolab 8000A £350	Very Good Good	A long running and high dependable classic, versatile and consistent via all inputs	50W, MM/MC, 5 inputs, hdph, tone controls	R	62
Audiolab 8000P £495	Excellent Very Good	A dynamic powerhouse, load tolerant and sonically reliable	100W	R	62
Beard Audio CA35/P35mkII £595/£795	Fair + Very Good	Good build quality and a very smart finish combine with a characteristic valve sound to make a first class amplifier capable of giving hours of musical enjoyment	35W, MM/MC, 4 inputs	R	63
Beard 506 £1195	Good + Good +	A versatile valve preamp - the bass sounded lively if a touch softened while the treble was detailed but lacked a little sparkle and air.	4 inputs MM/MC		50
Beard M70 £1995 pair	Good Good +	A substantial British monoblok power amplifier, but not a great deal more impressive than the P35 at half the price	70W		50
Bryston 12B/4B Pre/Power £995/£1395	Good + Good	Bryston's massive 4B power amp stood out as the backbone of this combo, the preamp sounding a trifle unbalanced between MM and MC inputs	272W, bridgeable to 800W. 6 line, 2 disc inputs, subsonic filter		68
Cambridge Audio P40 £200	Good Good +	A very fine sounding integrated amplifier with simple facilities and MC cartridge capability	5 inputs 40W MM/MC straight line	BB	50
Cambridge Audio C75 £279	Good + Good +	Whilst not quite on par with its A75 companion this preamp provided excellent stereo imagery but was a touch "heavy" in character	MM/MC disc	R	50
Cambridge Audio P55 £290	Very Good Very Good	A grown up P40, the P55 suffers slight noise on the moving coil input but offers great sound for the money	55W, MM/MC, 5 inputs, hdph	BB	62
Cambridge Audio A75 £299	Very Good Very Good	This strong power amplifier sounded open and effortless, with fine bass drive and dynamics, albeit a touch grainy and harsh at high frequencies	100W	R	50
Cello Audio Suite £5280	Excellent V Good/Excellent	Cello's preamp represents a whole new ball game in flexibility and sound quality (or war of attrition on your wallet)	Optional inputs MC etc	R	50
Conrad Johnson MV50 £1699	Good + Good +	Coupled with the PVS, this CJ power amp performed well on audition	50W		Collection
Conrad Johnson Motif MC-8 £1995	Very Good Very Good	A cheaper alternative to the '7, this preamp is an undoubted success in maintaining the Motif sound but does not compare on sound quality	MM/MC	R	50
Counterpoint SA12 £1250	Good + Good +	A real power-house power amp, beefy and load-tolerant although like the SA7 a trifle untidy at frequency extremes	100W		Collection
Creek CAS 4040 II £179	Good Good	The Mk II has no problems and is a fine all rounder	30W, MM, 4 inputs, tone controls	BB	62
Creek CAS 4140 S2 £219	Good + Good	Redesigned for '88, this is a fine allrounder with good moving coil input, plain presentation	40W MM/MC 3 line inputs	BB	62
Croft Micro £150	Average + Good	A real upsetter, this excellent valve preamp put the cat among the pigeons proving good sounds can be made at budget price levels	4 inputs MM straight line	R	Collection
Croft Super Micro A £500	Average + Very Good	The looks are somewhat improved, while this 'hot rod' version with tuned components performed very well indeed. There is still no gain on the line inputs	4 inputs, MM, straight line	R	57
Croft Series IV(S) £730	Good Good	The original IV is still available now supplemented by the higher price and power (S); both are fine performers	40(60)W channel	R	57
Croft Series IVSA £1000	Good Very Good	Featuring tuned components chosen for their sound quality, the 'A' variant is an impressive example of Croft's technique in valve design	60W special supply regulation	R	57
Deftec DSP-50S DPA-50S Pre/Power £675/£825	Excellent Excellent	Remarkable pre/power combo based around the highly linear DH-0A32 hybrid op-amp. Unmatched detail resolution, control and transparency	63W, external feedback wiring, 3 line, MM/MC no tone controls	R	68
Deftec DPA 100S £2200	Very Good Very Good	A top-quality transistor power amp, sounding fast, articulate and well controlled, though maybe a touch clinical for some tastes	80W	R	50
Denon PMA 250 II £125	Good Fair	Despite a claimed increase in power this competent model now slips behind the competition on sound quality grounds	30W, MM, hdph, tone controls		62
Denon OAP-2500 POA-4400A Pre/Power £549/£599 pr.	Very Good Good	Denon's fully-fledged preamp also incorporates D/A converters that did not improve the sound of our £299 CD player. The power amps are brilliant!	172W, monobloks Opt/Coax dig + 2 tape, 4 line and MM/MC inputs		68
Denon POA-6600 £1,000/pair	Excellent Excellent	Delivers abundant high quality sound, solid engineering expertise and content clearly compensating for any compromising of purist audiophile principles	250W monoblok, remote power	R	60
DNM 3A From £1000	Good + Very Good	The DNM3 in its acrylic case is a remarkably revealing and neutral state of the art preamp	5 inputs MM/MC twin vol controls	R*	44
E.A.R. 802/509mkII £920/£1550	Average Very Good	Extremely well made and combining the sonic strengths of both transistors and valves this EAR combo warrants attention	100W, MM, 6 inputs, monobloks	R	63
E.A.R. 549 £3,000/pair	Very Good Very Good	A valve monoblok that measures like a solid state amp is itself an achievement, but exceptional power delivery and bass 'slam' is not fully matched by delicacy and transparency elsewhere	200W monoblok, bias setting		60
Exposure VII/VIII £360/£340	Very Good Good	Supplied as a combination without the separate preamp power supply, this pre power combination performed satisfactorily especially on the moving coil input	50W, MM/MC, 3 inputs, straight line		62
Exposure VI/VII Dual/VIIIS Pre/Power £449/£219/£379	Good Very Good	An established company like Exposure could do more to improve the 'look' of these amps which, nevertheless, sounded confident, dry and musical	63W, Super mod. 4 line and 2 disc inputs with full rec-out switching	R	68
Grant G60AMS £948 pr.	Good Very Good	This neat and compact 60W valve monoblok gave good sound on the 8ohm tap, better still on 4ohms. The midrange was particularly natural	60W monobloks 41 8ohms	R	57
Hafner DH120 kit form £295	Fair	We didn't build one; see below	60W		44
Hafner DH120 assembled £360	Very Good Fair	Sound quality results were decent enough, but this power amp won't set the world on fire at this price	60W		44
Harman Kardon PM635i £159	Good Good	An improved version of the classic PM635 amp which sounds typically dry and articulate. Price is frozen	49W, 4 line and MM inputs A/B speaker o/p	R	68
Harman Kardon 640 Vxi £225	Good + + Good	Moderately priced but built to HK's high standards; good value and good load tolerance	50W MM, 5 line inputs tone controls		55
Harman Kardon PM645Vxi £300	Very Good Good	Fits in well with the Harman Kardon series, giving a competent all round performance at a fair price	75W, MM/MC, 5 inputs, hdph, tone controls		62
Harman Kardon PM650vxi £369	Average + Good	A light and slightly over-damped sound lacks any essential warmth or richness. Reduced headroom on MC	71W, 6 line, MM/MC and true A/V inputs		68
Harman Kardon 655 Vxi £449	Very Good Good	Plenty of well built integrated amplifier for the money, with lots of power to drive almost anything, plus versatile inputs	100W MM/MC 6 line inputs tone controls		56
Harman Kardon PM665Vxi £699	Good Good	A versatile and meaty amplifier with high current capability, but sound quality lags behind certain home grown alternatives	150W MM/MC tone controls (switchable)		60

TO ORDER BACK ISSUES OF HI-FI CHOICE SEE PAGE 114

THE DIRECTORY

AMPLIFIERS

NAME PRICE	LAB SOUND	COMMENTS	FEATURES	VALUE	BACK ISSUE FULL REVIEW
Inca Tech Dirk £215	Good+ Good+	This tiny, minimalist model is effectively a power amplifier with volume control, providing inputs for CD player and tape recorder but not tuner!	50W, 2 line inputs, straight line		56
Inca Tech Claymore £396	Good+ Good+	Limited facilities but a strong, clear, well-focused sound results in auspicious <i>Choice</i> debut for this relatively young company	50W MM/MC 3 line inputs straight line	R	56
Inca Tech Claymore S £415	Fair Very Good	Rich, deep and captivatingly musical this amp prompted a very favourable reaction. Disc sens. too high	60W, CMOS logic controls 7 line and MM/MC inputs	R	68
Inca Tech Claymore 2 £515	Good Average+	Very similar to the well-received 'S' via CD our Claymore 2 had a dodgy disc input which ruined its showing	100W, CMOS logic, as 'S' but with more MosFets!		68
ITL MA-80 £169	Good Good	A promising start for this young company, the MA-80 gave a fine sound with CD but was less wonderful on the moving coil input	30W, MM/MC, 5 inputs	R	62
Jadis JP30/JA30 £7,425	Fair Excellent	Two-box preamp plus monoblok power amps, classic valve design gives stereotype valve sound. Beautiful build, nostalgic styling and delightful sounding midrange transcend limitations at frequency extremes, in lab, and re cartridge matching	30W 2-box pre-, monoblok power, MM-only, 4 line inputs	R	60
JVC AX-222 £110	Good Fair	Not very impressive, JVC need to pull their socks up if their budget amplifiers are to score	35W, MM, 4 inputs, hdph, tone controls		62
Kelvin Labs Junior/130 £295/£295	Good Good	Their heart is in the right place but the class A Junior combination is a bit expensive for what you get	20W, MM/MC, 5 inputs		62
Kenwood KA-550D £130	Very Good Fair	Having dropped its moving coil input, this latest version has British style dynamics and rhythm but is not first grade yet	35W, MM, 4 inputs, hdph, tone controls	R	62
LFD £2,995+	Very Good Excellent	Can set the subjective standards that others merely aspire to, but this outstanding if unconventional multi-box preamp needs careful matching to ancillary components (cartridge, power amp)	MC (with care), passive line extra	R	60
Linn LK1/LK280 Pre/Power £495/£645	Good Good—	A very modern, logic-controlled amp with distinctive and inoffensive sound quality. Its restrained sound could do with extra insight and zip.	84W, compact amp CMOS sw. for 2 tape, 2 line and MM/MC. XLR sockets.		68
Luxman LV100 £205	Good Fair	Nicely finished modern integrated amplifier, generally competent though not exceptional	45W MM 4 line inputs tone controls		56
Luxman LV105u £685	Very Good Good	This very well equipped and beautifully finished Japanese integrated amplifier has two valves in the early section of the power amplifier. Pleasant and musical it sets no value for money record here	9 inputs 80W, MM/MC tone controls		57
Magnum A100 £1995 pair	Good + + Good+	Given their massive power rating a pair of A100's make a fine stereo power amp; ideal for high levels and with a wide dynamic range for digital programme	320W		50
Marantz PM25 £125	Good Fair	Soft and sweet like the rest of the range, the PM25 is inoffensive and undemanding	25W, MM, 5 inputs, hdph, tone controls		62
Marantz PM35 £170	Very Good Good	This new generation Marantz is a good allrounder, and shows that extra care is being taken over sound quality; well equipped and versatile	45W MM/MC 3 line inputs tone controls		56
Marantz PM45 £200	Good+ Fair	Generally pleasant and polite with above average clarity; there was some softening in the bass, restricting dynamic output somewhat	40W MM/MC tone controls		50
Marantz PM-75 £400	Good Average	More successful than most amps with on-board DACs but still not as balanced as other Marantz products	136W, opt/coax dig inputs, 6 line + MM/MC		68
Marantz PM94 £1,000	Very Good Good	At 23kg the PM94 is no lightweight in either physical or sonic respects. A very powerful and comprehensively equipped amplifier	140W MM/MC tone controls (switchable)		60
Meridian 201/205 £599/£425 each	Very Good Good+	A fine preamp with additional luxury option of full system remote, plus competent and attractive monoblok power amplifiers with generally good performance	100W MM/MC 6 line inputs remote capable straight line	R/—	62
Mission Cyrus One £180	Very Good Good	A red hot class winner, which caused the whole issue to be re-rated! It's even well built – however, the headphone socket will only take a 3.5mm jack	30W, MM/MC, 5 inputs, hdph, straight line	BB	62
Mission Cyrus PSX £230	Very Good Very Good	The PSX does make the Cyrus Two sound better, and also improves the PCM II CD player giving more wallop and clarity	Auxiliary power supply	R	62
Mission Cyrus Two £300	Very Good Very Good	Also a top performer in its group with fine moving coil and compact disc sound. Again, only 3.5mm headphone socket	50W, MM/MC, 5 inputs, hdph, straight line	R	62
Mordaunt Short MS-A5000 £350	Very Good Good	With a recognisable pedigree, Mordaunt Short engineers have made a good job of this one. A musical all rounder	50W, MM/MC, 6 inputs, hdph, tone controls	R	62
Musical Fidelity A1 £269	Good Good+	Fine-ranking in terms of overall sound quality for money, the excessive heat output could be hazardous to your vinyl if you're careless	20W MM/MC 4 inputs straight line	BB	56
Musical Fidelity B200 £299	Very Good Good+	Running cooler than other MFs, the B200 delivered fine musical and dynamic sounds with plenty of power	80W MM/MC 4 line inputs straight line	BB	62
Musical Fidelity Pre 3/P140 £379/£349	Very Good Very Good	Delivering true audiophile sound quality well ahead of their price, both components shine in their own right	70W MM/MC 4 line inputs straight line	R	56
Musical Fidelity A100 £459	Good+ Very Good	This is another one recommended for fine sound with which you could keep your Chinese carry-outs warm	50W MM/MC 5 inputs straight line	R	62
Musical Fidelity P170 £599	Very Good Very Good	Acquitted itself well, later samples showing steadily increasing refinements	85W	R	50
Musical Fidelity MA-50 £875 pair	Good Excellent	An audiophile bargain. One of the best sounding power amplifiers made	50W, monoblok	R	62
Musical Fidelity MVT Mk 3 £1199	Very Good Very Good	The MVT preamp was "strong in its class", providing competition for £1500-plus amplifier systems, now rivalled by the MF3B	MM/MC 5 inputs	R	50
Musical Fidelity P270 £1299	Very Good Excellent	If the hot-box aspect is not a deterrent, this is something of a bargain. A big amplifier scale of sound which is just a little rough-edged	135W	R	50
Musical Fidelity MVX £2229	Very Good Excellent	Soundwise this preamp puts Musical Fidelity on terms with much more expensive exotics, with top class transparency, focus and dynamics	MM/MC, phase invert	R	60
Musical Fidelity A370 £2229	Very Good Excellent	Arguably the finest sounding power-amplifier manufactured in the UK	185W	R	50
NAD 3020e £120	Good Fair	A little light in balance and "weight" but superior to run-of-the-mill budget amplifiers	20W MM/MC 4 inputs	R	50
NAD 3220PE £140	Good Fair	Like the 3020E but with more peak power and loudness thanks to the 'power envelope'	20W, MM, 5 inputs, hdph		62
NAD 3225PE £150	Average+ Average+	Light and detailed if not as rich or weighty sounding as others. MM input sounds warmer than CD	42W + 70W dyn. headroom; soft-clipping, MM only	R	68
Naim NAIT 2 £322	Average+ Fair	Well built with good load tolerance the NAIT delivered a fully competitive sound in spite of its modest measured power output. Recent modifications as yet unchecked	15W pc MM 3 inputs	R*	50
Naim Separates £560-c£8,000	Very Good Good	A consistent and coherent series of 'building blocks' for conventional passive or active operation. Sound quality ignores conventional audiophile standards of presentation, but achieves fine musical communication	40-70W, MM/MC etc	R	60

THE WORLD'S NO 1 GUIDE TO BUYING HI-FI

THE DIRECTORY

AMPLIFIERS

NAME PRICE	LAB SOUND	COMMENTS	FEATURES	VALUE	BACK ISSUE FULL REVIEW
Nakamichi CA-5E £750	Very Good Good	A fine lab performance and high build quality but rather disappointing sound quality for a preamp of this price	MM/MC, 6 inputs, hdph, tone controls		62
Nakamichi PA-5E £1150	Very Good Good	A strong sound in several respects but one which ultimately failed to satisfy	100W		62
Nakamichi CA7E/PA7E £2500/£1700	Very good Good/Good+	Exceptional build and finish, plus good general performance, remote control and versatility, but expensive	200W MM/MC 6 line inputs, remote, tone controls		56
Nuance £795	Very Good Good	A subtle civilised pre-amp though a little lacking in resolution and detail; suited to some tastes but not top-drawer	4 inputs MC		50
NVA AP30mc £290	Average+ Good	Utilitarian in appearance but offers a very refined and beguilingly musical sound quality on MC and line	22W only. MC or MM options, 3 line inputs	R	68
Oakley Image £425	Poor Very Good	An interesting valve preamp from Yugoslavia, the Image on first impression needs a bit of tweaking to warrant <i>Choice</i> commendation but is a nice product nonetheless	MM, 5 inputs straight line		63
Orell SA-040 £359	Good Good+	This promising newcomer from a brand new company sounded pretty good and should improve as production settles	45W MM/MC, 4 line inputs, straight line	R	56
Philips FA960 MkII £299	Good+ Average	The MkII '960 still failed to grasp our listeners' attention but it remains a competent amp nonetheless	122W, 6 line & 2 disc inputs + tone controls		68
Pink Triangle PIP £2670	Excellent Excellent	This state-of-the-art preamp is one of the few truly high end products to come out of this country this year. It will most certainly worry the competition	MM/MC, 4 inputs, battery supply	R	62
Pioneer A333 £149	Very Good Fair	A rather average but nonetheless competent performer that is pleasant enough	55W, MM, 5 inputs, hdph, tone controls		62
Pioneer A-515 MkII £180	Good+ Average	The disc inputs sounded a trifle smoother than the CD stage which was harder and more aggressive	95W, 3 tape, 3 line and 2 disc inputs. Heavy		68
QED A240 CD II £169	Good+ Good	Latest 240CD is fine value for CD and has competent MM disc input as well	45W MM 5 line inputs straight line	BB	62
QED A240 SA II £219	Good + + Good+	Redesigned 240SA represents a significant allround improvement over its predecessor, and provides a good moving-coil disc input in a competitive price	45W MM/MC 5 line inputs straight line	BB	62
QED A270 £329	Good- Good+	Building on the strengths of the '240, the '270 sounds weighty, fast and dynamic. A bit 'lumpy' via MC	51W, 5 line and 2 disc inputs, pre-out	R	68
Quad 34 £285	Very Good Fair	This well-built durable preamp has useful filtering and above average tone controls but was found lacking in sound quality (viz: detail/dynamics)	4 inputs MM/MC tone controls		44
Quad 405 £349	Very Good Fair	Not an impressive power amp but easy on the ear if not pushed and very reliable	100W		44
Quicksilver Mono £1495	Good Good+	Moderately improved for '88 the Quicksilver still rates well despite up and coming competition	60W monoblok 4/8ohms		57
Radford SC25 £862	Very Good Very Good	A very fair price for a solid, well built valve preamp, combining good allround performance and a neutral sound	5 inputs, MM, straight line	R	57
Radford MA75 £977	Good Very Good	A fine quality valve monoblok with good load tolerance and a neutral accurate sound, offering significant gains in power and focus over the STA25	75W monobloks	R	57
Radford STA25 Renaissance £1115	Good Good+	Offering superb midrange performance if not quite as good at the extremes, the Renaissance valve power amp is a genuine audiophile product	25W	R	50
Revox B150 £875	Very Good Average +	Beautifully constructed but hampered by Revox's convoluted logic control. Open and smooth sound. Still costly.	117W, CMOS sw. for 3 line, 2 tape and MM		68
Revox B250 £1188	Very Good Good	With much improved sound over its predecessors plus amazing remote control facilities, this could form the heart of a round-the-dream-house system	150W MM/MC system/house remote tone controls		56
Robertson Forty Ten £987	Very Good Good	Here is a neat little power amp (60W) you can fit and forget; it proved most satisfying over long listening sessions	60W		Collection
Rose RV-23 £370	Average Very Good	A very attractive little British valve preamp with a sound that was rich, colourful and reasonably sharp via the CD input but was less impressive on disc	MM, 4 inputs, straight line		63
Rotel RA810A £100	Very Good Fair	As a cut price RA820AII this is a very successful little amp that loses little in sound quality to its predecessor. Excellent value	20W, MM, 5 inputs, hdph, tone controls	BB	62
Rotel RA820A £130	Good+ + Good	This A version of an established budget favourite delivers the goods sonically and is fine value for money	35W MM 4 line inputs tone controls	BB	56
Rotel RB/RC850 £150/£125	Good+ + Good+	Quality separate pre and power amplifiers at near budget integrated amplifier prices. A notable achievement	60W MM/MC 4 line inputs tone controls	BB	62
Rotel RA820BX3 £170	Very Good Good	The latest upgrade is not that impressive, but the BX remains a fine amplifier and now has a moving coil disc input	30W, MM/MC, 5 inputs, hdph, straight line	BB	62
Rotel RC-870BX/RB-870BX Pre/Power £199/£210	Excellent Good+	Reduced price makes the 870 combo better value but, despite mods to the preamp, it is the power amp that must take the lion's share of credit	128W or 208W in bridged mode. CD direct, 4 line, 2 tape and MM/MC	R	68
Rotel RA840BX3 £220	Very Good Good+	Requires a very long warm-up period but rewards with a refined sound that should suit 'lively' systems	59W, 2 tape, 2 line, MM/MC and A/V inputs	R	68
Rotel RA870BX £300	Very Good Good+	A powerful blockbuster with solid and well focused sound, good versatility and fine load tolerance	85W MM/MC 7 line inputs tone controls	R	56
Sony TA-F200 £130	Average- Average	Over-ambitious protection circuit is hardly in keeping with modern amp design. Lean but 'dead' sound quality.	74W, 2 tape, 3 line and MM/MC inputs		68

To Advertise in
this space ring Miriam Young
on 01-631 1433

THE DIRECTORY

AMPLIFIERS

NAME PRICE	LAB SOUND	COMMENTS	FEATURES	VALUE	BACK ISSUE FULL REVIEW
Sony TA-F400 £200	Good Average+	Some lack of integration across the frequency range but still offers a more open and detailed sound than the F200	76W, 2 tape, 3 line and MM/MC inputs. Rec-out		68
Sony TAF 500ES £349	Good+ Fair	Not too hot at the price, lacking in bass action, rating poorly on vinyl, and only marginally improving on CD	75W hdph tone controls MM/MC		50
Sony TAF 700ES £500	Good++ Fair	Scoring higher than the 500 but still not offering the sort of standards set by the competition. But many buttons to push	100W MM/MC tone controls		50
Sumo Nine+ £1200	Very Good Excellent	Macho styling of this class. A stereo power amp conceals a sonic subtlety that is exceptional for the price, limited by lots of waste heat and a noisy fan on our sample (being improved)	65W	R	60
Tanney SR-840 £1713	Very Good Good	A "muscle" power amp, capable of impressive levels into difficult loads while remaining quite subtle and revealing	250W		50
Vacuum State FVP £999	Good Very Good	This well thought out valve preamplifier is designed for optimum musicality and transparency, a goal which is handsomely achieved	5 inputs, MM, straight line	R	57
Yamaha AX-300 £100	Good Fair	A lively and dynamic performer, offering a credible if bright sound at a competitive price	30W hdph tone controls (MM)		50
Yamaha AX500 £200	Very Good Good	A well built versatile performer with generous power, decent sound	90W MM/MC 5 line inputs tone, var loudness		56
YBA 2 pre & pwr £1395/£1695	Good++ V Good/Excellent	Superbly finished French audiophile separates, with very good space and transparency, slightly softened bass. Needs extra transformer (£300) for MC cartridges	70W MM (MC extra) straight line	R	56
YBA 1 preamp £2895	Very Good Excellent	A front line French audiophile product. Great stereo and a fine Krell style finish	MM/MC, 3 inputs, straight line	R	62
YBA 1 power amp £2995	Good Excellent	This equally well finished power amp offers front rank stereo staging and transparency, and is capable of driving the most difficult loads	85W	R	62

LOUDSPEAKERS

Last item in the hi-fi chain, to some extent the loudspeaker is merely the slave of what has gone before, capable only of reproducing a signal as good as it is fed. Nevertheless the distortions (colorations and stereo effects) introduced by loudspeakers (and rooms) tend to be more immediately obvious than those anywhere else in the chain, so careful choosing according to taste is very important.

The average loudspeaker consists of a smallish enclosure, much of which may have begun life as

part of a tree, plus a couple of drive units hidden behind a removable grille. Inside the box lurks a simple electrical circuit known as a crossover, which divides the incoming (full range) signal into the right bits for the drivers to handle. Variations on the above formula are specifically identified in the entries. The designer's primary task is to balance the sensitivity of the loudspeaker (how loud it goes for a given electrical input) against the bass extension (how low does it go) for the given box size. After that such subtleties as coloration and

dispersion come into the equation.

Careful placement of the loudspeakers within the room is as important as the initial choice of model. For good stereo they need to be more or less the same distance from nearby walls, and preferably on similar rigid stands. The listener should be about the same distance from and listening angle to each loudspeaker. The ideal placement depends on the way a particular model has been balanced (not to mention a number of other factors), and our recommendation is given in the entries.

MODEL PRICE	LAB SOUND	COMMENTS	SIZE PLACEMENT	SENSITIVITY BASS FROM	VALUE	BACK ISSUE FULL REVIEW
Acoustic Energy AE1 £696	Good Very Good	To the author's knowledge, the most awesomely dynamic and articulate miniature ever made	29.5 x 18 x 25cm semi- open space	88dB/W 60Hz	R	59
Acoustic Energy AE2 £1138	Good Very Good	Dynamic, solid and lively, a great allrounder if a bit small considering the price. AE proves that metal cone/dome drivers really work.	39 x 23.5 x 29.5cm heavy stands in free space	88.5dB/W 45Hz	R	66
Acoustic Energy AE4 £1880 (stands £550)	Uneven Uneven	Magnificent but also seriously flawed, the AE4 possesses tremendous dynamic realism but a very mid-dominant balance. Large rooms and wallets only need apply.	54 x 32.5 x 44cm own stands in free space	90dB/W 40Hz		71
Acoustic Research AR112 £125	Average Average-	Nicely presented and engineered, but sounds a bit small and boxy without true coherence.	36 x 19 x 18.5cm stands near rear wall	87dB/W 75Hz		66
Acoustic Research AR122 £150	Average Average	Despite a promising enough list of ingredients, the 122 failed to excite real enthusiasm amongst the listening panel	38.5 x 19 x 22cm stands near rear wall	87dB/W 68Hz		68
Acoustic Research AR132 £200	Average+ Average-	Good presentation and detail engineering was not sufficient to counter bass heavy balance problems on auditioning	44.5 x 23 x 25.5cm stands 1ft from rear wall	87dB/W 50Hz		66
Alexander 566 £159	Good- Average-	Unusual shape, metal-jacket miniature that works well within limited dynamic range capability; needs free space siting.	40.5 x 11 x 16 narrow stands in free space	83dB/W 70Hz		71
Alexander Aurora £379	Average Good-	The unusual metal case and slim shape of this grown up miniature provide welcome diversity. It sounds pretty good too	42.5 x 14 x 19cm matching stands in free space	85dB/W 55Hz		66
Allison CD6 £290	Average Good-	An unusual cube-shaped model designed for wall mounting gives exceptional bass extension from a small box, though it's also a bit heavy, coloured and slow	28.5 x 28.5 x 28.5cm stands against rear wall	88dB/W 45Hz	R	71
Alphason Orpheus £800	Good Good+	Large hi-tech two-way features unusual, sweet-sounding isodynamic tweeter; well engineered and balanced if a shade odd in appearance	65.5 x 28 x 34cm stands near rear wall	87dB/W 43Hz	R	71
Apogee Scintilla £4990	Good Very Good	These take-me-to-your-leader speakers gave exceptional transparency and can achieve excellent results in a true audiophile system	145 x 88 x 9cm free space on floor	79dB/W 20Hz	R	46/Coll
A&R Arcam Three £149	Average+ Average-	Arcam's baby speaker did not delight our listeners, but it might do better in less expensive systems	34 x 18 x 23cm close to wall at head height	88.5dB/W 95Hz		53
A&R Arcam Two £270	Good Average	Most things to most men this compact is unlikely to disappoint with its lively "ballsy" character though lacking weight... a bit	38 x 23 x 28cm near wall shelf or 40cm stands	88dB/W 55Hz		59
A&R Arcam One Plus £359	Good Average	Provides a solid, weighty and rich sound, but is a little raw in the treble and indefinite in the midband	22.3 x 28.1 x 37.8cm open space, on stands	88.5dB/W 60Hz		59
Ariston Image £159	Good Average	Good engineering content at a reasonable price, the Image delivers fine stereo with low coloration, but sounded too bassy under our listening conditions	42 x 22 x 27cm stands in free space	87dB/W 55Hz		66
Audiostatic ES200 £1495	Average Average+	Sounding forward and unbalanced with limited bass power, these excelled in transparency and detail, and might suit some tastes	150 x 53 x 23cm low stands, free space	79dB/W 45Hz		46
Audiostatic ES300 £1995	Average+ Good	Marred by similar problems to its cheaper ES200 stablemate, this line source electrostatic was superb in the upper-mid and treble but lumpy in the bass	44 x 5 x 93cm free standing	82.5dB/W 30Hz		46
Audio Electronics TC10 II £599	Good- Good+	Oddball appearance is rescued by a respectable technical performance, interesting and impressive engineering and fine sound quality at a realistic price.	70 x 33.5 x 33.5cm low stands in free space	87.5dB/W 40Hz	R	68
Avance 120 £279	Average+ Average+	This unusual "after eighties" looking speaker has the recipe for success, but not quite the right seasoning yet	42 x 30 x 30cm 30cm from wall on 40cm stands	86.5dB/W 60Hz		53
B&W DM550 £149	Good+ Average-	Beautifully presented, well engineered near-miniature with precise sound but a distinct lack of 'wellie'. Ideal for considerate flat dwellers	35 x 20.5 x 22.5cm stands in free space	86dB/W 70Hz		71

TO ORDER BACK ISSUES OF HI-FI CHOICE SEE PAGE 114

THE DIRECTORY

LOUDSPEAKERS

MODEL PRICE	LAB SOUND	COMMENTS	SIZE PLACEMENT	SENSITIVITY BASS FROM	VALUE	BACK ISSUE FULL REVIEW
B&W DM560 £200	Average + Average—	Fine cosmetic presentation and good engineering for the price, overload protection may be handy but listening panel was underwhelmed	49 x 23.5 x 30cm stands in free space	88dB/W 55Hz		66
B&W LMI Mk II £249	Average + Average	Probably one of the best 'micros' ever made, worth considering for special applications (boats or vehicles). Upgraded since our review	24 x 15.5 x 20cm shelf or flush mount	86.5dB/W 80Hz	*	31
B&W DM1600 £369	Good Good	Crisp, dynamic loudspeaker with tight but not especially deep bass and a tweeter that sometimes sounds overcooked	49 x 23.6 x 30cm free space, open stands	87.5dB/W 60Hz	R	59
BLQ Q2 £275	Average— Average	Nearly a good loudspeaker, the basic balance is good, but the midband is very uneven and there are severe losses of resolution, 'space' and dynamics	43 x 25.1 x 24.5 semi open on stands	87.5dB/W 70Hz		59
Bose Interaudio 3000XL £140	Average Average—	Lots of perceived value and well enough balanced, but low cost cabinet and driver engineering results in a crude and unsubtle sound	46.5 x 29 x 23cm stands in free space	89dB/W 45Hz		71
Boston A4011 £120	Average Average—	Competent performance for size and price but below average relative to the UK competition	34 x 21 x 20cm on stands near wall	88.5dB/W 63Hz		41
Canton Karat 20 £300	Good + Average +	Very prettily finished and accomplished near-miniature, the bright-sounding '20's only difficulty lies in justifying its high price	34 x 22 x 20cm stands in free space	87dB/W 55Hz	R	71
Canton Karat 40 £550	Average Average	Pretty and compact three-way for those who mourn the passing of the loudness control — definitely errs on the boom'n'bizz side	50 x 27 x 27cm stands in free space	88dB/W 50Hz		71
Canton 60 Karat £630	Average + Good	Looks a bit of a throwback designwise, but is nicely presented and has a lively, dynamic and generous sound	58 x 31.5 x 31cm stands in open space	90dB/W 48Hz	R	66
Castle Clyde £149	Average + Average	A tidy little performer packing punch, but beginning to show its age in the light of new competition	37 x 21.5 x 22cm open space on stands	89.5dB/W 64Hz	R	46
Castle Durham £199	Average + Average	Listening results were encouraging, well engineered and finished, but lean on treble and a bit weak on bass: still recommended	41 x 21.5 x 25cm near rear wall	89dB/W 67Hz	R	46
Castle Pembroke £309	Good Average +	Comfortably recommended, a sweet smooth sound with good overall balance of engineering-based performance	55 x 37.5 x 30.5cm open space on stands	88dB/W 46Hz	R	31
Castle Warwick £169	Good Average—	Excellent presentation and fine engineering with overload protection, but a sonic disappointment in bass and dynamic qualities	46.5 x 25 x 23cm stands 1ft from rear wall	88dB/W 50Hz		66
Celef Cirrus £180	Average Good	It's nice to see Celef back in the UK, with this decent sounding small reflex box that seems unusually tolerant of siting	39 x 20.5 x 23cm stands in free space	84dB/W 60Hz	R	66
Celef CF2 Nimbus £230	Good— Good—	Nicely balanced overall but a little uneven with it, this lively and dynamic large bookshelf model came close to Recommendation	46 x 25.2 x 24cm stands in free space	88dB/W 55Hz		71
Celestion DL6 Series Two £149	Good Average	Good tonal colouring and plenty of bass for the enclosure size, the metal dome tweeter is excellent, but bass and mid lack clarity and 'bite'	45.4 x 24.5 x 26.2cm near wall, on stands	87dB/W 65Hz		59
Celestion DL8 Series Two £199	Very Good Good	A refined middle market speaker has a smooth but slightly dull quality, with good definition and deep, if slightly boxy bass	50 x 27.5 x 27.8cm open, stands	87.5dB/W 60Hz	R	59
Celestion SL12Si £580	Average Average	Careful setting up does reveal elements of fine sound quality, but this 'grown up' SL6 variation has a lumpy response alongside its improved power handling	53 x 20 x 27cm matching stands clear of walls	85dB/W 50Hz		66
Celestion SL600Si £799	Good + Good	This Aerolam high tech miniature has certain remarkable qualities that some will find irresistible, and which go a long way towards justifying the highish price. Needs careful system and room matching	27 x 20 x 23cm matching stands in free space	82dB/W 52Hz		68
Celestion SL700 £1349 inc stands	Good Good	Very sophisticated, mostly smooth and accurate transducer, with fast but not very deep bass and a rather bright treble	37.5 x 20 x 23.5cm free air on tall stands	83dB/W 45Hz		60
Celestion 6000 £1470	Very Good Very Good	A genuine fullrange audiophile quality speaker system — with Star Wars styling to suit a high tech environment	Complex, on floor in free space	82.5dB/W	R	60
Chameleon 500 £349	Average— Average—	Sounding badly coloured, dull and compressed, it is also amateurishly constructed, despite using good quality materials	38 x 25.3 x 31.3cm free, stands	89.5dB/W 75Hz		59
Energy 22 Pro Monitor £600	Good Good	Presentation is a bit rough for the price, but this Canadian entrant is an impressive sonic allrounder that will appeal to most listeners	62.5 x 27 x 30cm stands in free space	87dB/W 40Hz	R	66
Gale 301 £300	Average Average +	Of unusual, distinctive appearance this produced a mixed response, being lively but lacking depth	44 x 23.5 x 22cm on stands quite near wall	86.5dB/W 63Hz	*	46
Gale GS402 £700	Average + Average +	Clean but rich and powerful bass; stereo focus was not a strong point, but it is worth considering. (Recent revisions not yet checked)	61 x 35.5 x 28cm on matching stands near wall	88dB/W 48Hz	*	46
Goodmans Maxim Two £90	Average + Average	More wham-bam-thankyou-mam sound that imitates much bigger speakers when you let these babies yell. (A well-controlled yell)	26 x 17 x 19cm near wall on shelf or stand	86dB/W 85Hz	BB	59
Goodmans Point 3 £100	Average + Average—	Recommended as good value for money, but our listeners' differing opinions mean your ears should judge for themselves	47 x 25 x 20cm shelf/ high stand near wall	90dB/W 80Hz	R	53
Goodmans Sterling Point 5s £139	Good— Average—	Looks a remarkably good deal with apparently good engineering, but the room drive is mid-dominant and the sound is loud but not that likeable	56 x 29 x 26cm stands in free space	89dB/W 60Hz		71
Goodmans Point 7 £180	Average + Average	Basically competent performance—mix and a lot of speaker for the money, but a certain lack of refinement nonetheless	69 x 33 x 26cm free space on 35cm stand	89dB/W 47Hz		53
Harbeth LS3/5A £330	Good Average	Still a classic miniature, though not to every taste, and none the better for the recent update under our listening conditions. Limited dynamic range	30.5 x 19 x 16cm stands in free space	81dB/W 60Hz		66
Harbeth HL Compact From £499	Very Good Average	The clean and neutral sound lacks resolution and gives rather unsubtle though well differentiated stereo. Can be bi-wired to advantage	52 x 27.2 x 28.1cm open space, on high stands	87.5dB/W 65Hz		59
Heco Interior 430s £399	Good Good—	This tall floorstanding enclosure delivers an impressively even sound balance with good bass extension, if not the lively dynamics to satisfy enthusiasts	85 x 24 x 27.5cm free space	88dB/W 43Hz	R	71
Heybrook Point Five £129	Average Average	Disappointingly prosaic performance on listening tests, wooden and hollow, with restricted dynamics and 'space'. Earlier samples sounded better	37.5 x 23 x 23cm near wall, on matching stands	86dB/W 65Hz		59
Heybrook Point 7 £169	Average Average	Physically an attractive package, but not entirely convincing in lab or listening panel test; interesting for all that	40.5 x 23 x 23cm stands against rear wall	85dB/W 60Hz		68
Heybrook HB1 £189	Good Average +	No longer an over-bright character, a strikingly clear sound and fine transient performance now merits recommendation	47 x 29 x 23cm on stands near wall	88dB/W 61Hz	R	46
Heybrook HB100 £249	Average + Good	Well matched for wall siting, the HB100 is a lively and informative performer in the tradition of the popular HB1	47 x 26 x 28cm stands near rear wall	86dB/W 50Hz	BB	66
Heybrook HB200 £369	Average Average	This luxury successor to the HB2 is lively and informative, but sounded insufficiently balanced to convince our listening panel	46 x 23 x 26cm stands against rear wall	87dB/W 55Hz		66
Infinity RS2000 £130	Good Good +	Fast, detailed and assured miniature with quick but not very deep bass. The top end is detailed but sometimes jangly	36.2 x 22.5 x 20cm near rear wall, high stands	91.5dB/W 70Hz	BB	59
Infinity 6 Kappa £725	Good Good	Interestingly styled US loudspeaker has unusual high tech drivers and good neutrality, but the sound seriously lacks excitement	63 x 38 x 24cm stands, free space	85dB/W 35Hz		66
Jamo Concert 2 £240	Good Average—	A thoroughly respectable 'bookshelf' performer that needs free space siting but includes attractive cabinetwork and a neat grille	41 x 24 x 25cm stands in free space	85dB/W 48Hz		66

THE WORLD'S NO. 1 GUIDE TO BUYING HI-FI

THE DIRECTORY

LOUDSPEAKERS

MODEL PRICE	LAB SOUND	COMMENTS	SIZE PLACEMENT	SENSITIVITY BASS FROM	VALUE	BACK ISSUE FULL REVIEW
JBL TLX12 £149	Good— Average	This smart near-miniature has a 'boppy', lively bottom end, but beware of the fizz in its top	37 x 23 x 23cm stands 0.5m from rear wall	87dB/W 55Hz	R	71
JBL LX44 £340	Good— Average	This generously built model offers good power handling, bass extension and dynamic range, but suffers from the 'three-way syndrome', with middle muddle	58.5 x 30 x 29cm stands in free space	89dB/W 40Hz		71
JBL L 60T £449	Good+ Good	Well balanced and offering realistic value for money, the fine treble and extended bass make it suitable for larger rooms	78 x 30.5 x 26.5cm low stands or floor	88dB/W 40Hz	R	46
JBL L80T £649	Good Average	Large scale, dynamic if rather unwieldy sounding, this is a performer of integrity, if not much subtlety	85.1 x 35.6 x 30.3cm floorstanding, open space	89.5dB/W 55Hz		59
JBL 18Ti £599	Good+ Good	Beautifully engineered, well finished miniature with many good points, but unexceptional overall. Try the cheaper L20T	34 x 24 x 22.5cm 50cm from wall on rigid stands	85.5dB/W 53Hz		46
JBL 250Ti £3599	Good+ Good+	In general this speaker did not show the required level of dynamic presentation transparency and stereo depth expected of a pricey flagship model	132 x 57 x 36cm free space on floor	89dB/W 53Hz		46
JPW Sonata £99	Good Average+	Well balanced and integrated, this near-miniature offers fine sound if limited bass and dynamic range, plus real tree wood at a nearly silly price	32 x 23 x 20cm stands near rear wall	86dB/W 55Hz	BB	71
JPW P1 £125	Good Average+	Honest and basically articulate if not very sophisticated, resolution is good but it can sound a little wearing in bright systems or with rough sounding material	44 x 25.9 x 26.1cm free space on stands	89dB/W 60Hz	R	59
JPW AP2 £145	Good Average+	Few grounds for criticism but purchasers should check out the treble qualities to avoid hammering the ear anvils	46 x 26 x 25cm 40cm from wall on 45cm stands	89dB/W 65Hz	R	53
JPW AP3 £210	Good Average+	Pretty good stereo and well balanced overall it had its own character which is well suited to vinyl replay	52 x 25 x 29.5cm near wall on stands	90dB/W 57Hz	R	46
KEF C15 £99	Good Average	One of the tiniest around delivers a surprisingly 'big' and well balanced sound, with excellent stereo from free space siting	26.5 x 18 x 14cm stands in free space	85dB/W 60Hz	R	71
KEF C75 £349	Good Good	Compact floorstanding model's Uni-Q driver provides fine crossover integration, giving stable stereo and fine dynamic range within a slightly 'rich' balance	72 x 24.5 x 25.5cm floor in free space	90dB/W 45Hz	R	71
KEF R102 £365	Very Good Very Good	High class near-miniature with expressive, articulate midband and clean, accurate bass and top. The sound quality of the Kube circuitry, however, is suspect; what would an audiophile Kube sound like?	33 x 20.7 x 26.3cm near wall or open on stands	89.5dB/W 60Hz	R	59
KEF 103/3 £680	Good+ Good	Technically impressive, excellent bass/power handling for size, but not for the audiophile system. Better among cheaper components, and good in a large room	56 x 27 x 30cm supplied stands free space	90-95dB/W 35Hz		53
KEF 104/2 (inc KUBE equaliser) £895 (£994)	Very Good Good+ +	A reference point for dynamics, preferred without KUBE, suited to many rooms. Good stereo, high sound levels	90 x 28 x 41.5cm floor standing in free space	92dB/W 50Hz	R	60
KEF 107 £2025	Very Good Good+	A welcome sense of ease and lack of strain at most normal levels. Minor criticisms included a dulling in the extreme treble. Excellent bass extension	116.5 x 33 x 45cm on floor in free space	87.5dB/W 20Hz	R	60
Linn Helix £279	Average+ Good	Attractive presentation is coupled with an attractively lively sound which is more neutral if less committed than earlier Linn loudspeakers	51 x 25.5 x 28cm stands 1ft from rear wall	88dB/W 53Hz	R	66
Linn Nexus £379	Good Average	Good features include a solid, meaty bass plus good imagery and tonal balance. The catch is that Nexus lacks resolution and timing	49 x 23.5 x 30.4cm near rear wall supplied stands	89dB/W 60Hz		59
Linn Sara £795	Good Very Good	The new Sara is now much smoother and sweeter, with much better imaging. Bass power and dynamics are as good as ever, and the system is no longer as fussy as before	43 x 34.4 x 26.5cm stand mounting, near wall	88dB/W 50Hz	R	60
Magneplanar SM6a £675	Average— Average	Totally 'rich', in the right room it proved a satisfactory musical experience	122 x 48 x 4.5cm on floor clear of wall	85dB/W 56Hz		46
Magneplanar MC2.5R £1897		Offers the low coloration and profound musical insight of better electrostatic loudspeakers but without loss of low frequency extension	183 x 56 x 4.5cm Open space	83-85dB/W 35Hz	R	60
Magneplanar MG11a £2650	Good Very Good	Another excellent true-audiophile loudspeaker this American panel speaker helps to convey much of the original character of the music	180 x 62 x 38cm well clear of walls	84-86dB/W 35Hz	R	46
Marantz LD20 DMS £150	Average Average	Recommended more for CD users than vinyl keepers, soundly engineered and built but should be heard before bought	36 x 23 x 24cm free space on 45cm stands	86.5dB/W 55Hz		53
Marantz LD50DMS £200	Very Good Good—	Well behaved larger two-way has fine balance, stereo and integration with good bass extension, albeit with mild 'boxy', 'chesty' and 'fizzy' effects	42.5 x 27 x 28cm stands in free space	87dB/W 50Hz	BB	71
MB Quart 390 £469	Below Average Poor	An aggressive, messy sounding design whose uncouthness undermines the positive level of detail	52 x 31 x 30.5cm open space, on stands	89.5dB/W 60Hz		59
Meridian M30 £775	Average+ Average	Priced but easy on the ears and worth considering especially where space is at a premium	38.5 x 18 x 32cm free space on stands	Active 40Hz		46
Mission 761 £120	Average Good	One helluva speaker for the price, if a shade small and short of subtlety and refinement — should prove a worthy successor to the 70 and 700	38 x 21 x 21cm stands near rear wall	87dB/W 60Hz	BB	66
Mission 762 £180	Average Average—	Mission's 'bookshelf middleweight' offers high sensitivity and loudness capability, but at the expense of a somewhat untidy and rather 'heavy' sound	50 x 25 x 27cm stand, experiment advised	91dB/W 55Hz		66
Mission 763 £280	Average+ Average+	A very artful combination of generous volume and good bass extension at a modest price. Works well in the listening room despite a few rough edges	77 x 25 x 32cm near rear wall	86dB 40Hz	BB	68
Mission Cyrus 782 £340 (stands £80)	Good— Good—	Lively, articulate and beautifully finished, this compact wall-mount model with twin main drivers has good integration but a rather rich, 'Loudness' balance	50 x 25 x 32.5cm Cyrus stands near wall	90dB/W 50Hz		71
Mission 764 £400	Good Good—	Large floorstander has fine bass extension but limited dynamic range, and sounds 'lazier' than Best Buy 763	86 x 25 x 32cm 0.5+m from rear wall	86dB/W 43Hz		71
Monitor Audio R100 £159	Average+ Average—	Totally quite neutral, but with small box character, negligible low bass and a rather 'hard' midrange	40.5 x 25 x 21cm free space on stands	87.5dB/W 70Hz		46
Monitor Audio R300/MD £250	Average Average—	An attractive 'large bookshelf' model that's handicapped by poor crossover and integration between paper cone bass and metal dome tweeter	47.5 x 25 x 30.5cm stands in free space	88dB/W 50Hz		71
Monitor Audio R352/MD £299	Average+ Good	A good value large box that sounds more engaging than subtle, providing a good compromise between bandwidth and sensitivity	64 x 25 x 32cm stands in free space	89dB/W 45Hz	R	66
Monitor Audio R452/MD £399	Average Average	This big, efficient, dynamic sounding loudspeaker has a clean, open treble but a pinched, two-dimensional midband. Can be tiring in the long run	64 x 25 x 31.8cm open space, low stands	89dB/W 55Hz		59
Monitor Audio R852/Gold MD £449	Good Good	Luxury build and 'high tech' tweeter or not, this compact model offers good refinement and detail on an open soundstage	45 x 25 x 26cm stands in free space	86dB/W 50Hz	R	66
Monitor Audio 1200 Gold MD £799	Average Average+	This smooth and civilised slimline floorstanding loudspeaker is well built and nicely presented. But it is also expensive	94 x 20 x 26cm in free space	85dB/W 48Hz		68
Mordaunt Short MST0 II £90	Average Average—	One of the best miniatures around. A borderline Best Buy because of the bass limitations, which may depend on your taste	29 x 20 x 17cm wall bracket	86dB/W 75Hz	R	53
Mordaunt Short MST00 £189	Average+ Average+	A 'mid forward' tonal balance is its main drawback but other aspects such as ambience, transparency and stereo depth compensate	32.5 x 22.5 x 21.5cm stands near wall	85dB/W 80Hz	R	46

TO ORDER BACK ISSUES OF HI-FI CHOICE SEE PAGE 114

THE DIRECTORY

LOUDSPEAKERS

MODEL PRICE	LAB SOUND	COMMENTS	SIZE PLACEMENT	SENSITIVITY BASS FROM	VALUE	BACK ISSUE FULL REVIEW
Mordaunt Short 45Ti £230	Good Average	A sensitive tandem-bass number that can be driven loud but loses its balance a bit and can be unsuitable	63 x 26 x 30cm low (20cm) stand near wall	90.5dB/W 52Hz		53
Mordaunt Short MS300 £319	Average+ Average+	Not considered particularly competitive in its class, though it has good power handling and stereo focus	54 x 22.5 x 25cm on stands near wall	89dB/W 65Hz		46
Mordaunt Short 442 £1150	Good+ Good++	A resounding success with the listening panels. Make sure your room can accommodate the bass	95 x 26 x 38cm floor standing in free space	87.5dB/W 40Hz	R	60
Musical Fidelity Reference 2 £199	Good— Good—	This compact wall-mount design with advanced drivers has good dynamics, balance and stereo, plus flashy styling and some midband 'boxy' coloration	38 x 25 x 20cm stands near rear wall	88dB/W 50Hz		71
Musical Fidelity MC-2 £299	Very Good Very Good	This exceptionally clean and clear design offers real subtlety and finesse. Bass quality is light but exceptionally clear; the treble is smooth if slightly shallow	48.5 x 25.5 x 16.5cm open space and stands	87.5dB/W 65Hz	BB	66
Musical Fidelity MC-4 £499	Very Good+ Very Good	Achieving a very high standard, the MC-4 sounds detailed and coherent like the MC-2, but with more bass depth and solidity, and large image scale	56.5 x 26.9 x 29cm open space on stands	87.5dB/W 60Hz	R	59
NVA Cube 1 £600 (stands £200)	Good— Good+	Attractive, cube-shaped semi-omni is very sturdily built, and gives an idiosyncratic but unusually open, spacious and informative sound	33 x 32 x 32cm own stands c0.5m from wall	85dB/W 52Hz	R	71
Opus 3 Capella £495	Good Good	The sound of this Scandinavian curiosity certainly benefits from the crushed marble enclosure, though presentation is strictly DIY	32 x 40.5 x 26(ave)cm amongst books in bookcase	86.5dB/W 45Hz		66
Quad ESL-63 £1538	Good+ Good++	With its unusual but subtle characteristics this classic electrostatic may not be punchy in the bass, but has strengths that some cannot live without	92 x 66 x 27cm open stand well clear of wall	84dB/W 34Hz	R	60
Richard Allan CD5 £242	Average— Average—	This neatly presented small reflex design can sound engagingly communicative, but is flawed sonically and technically and quite expensive too	38 x 19 x 23cm on rigid stands	88dB/W 80Hz		68
Rogers LS7t £399	Good+ Good+	A fine combination of classic qualities at reasonable price produces the "R" tag, but try to get a pair home on approval to check for bass 'heaviness'	56 x 27 x 28cm free space on 40cm stands	88.5dB/W 48Hz	R	59
Rogers Studio 1a £565	Very Good Good—	The classic BBC monitor style sound sensitively updated—transparent and natural with fine stereo, but a touch 'heavy' in balance	63.5 x 30.5 x 30.5cm stands in free space	87dB/W 36Hz	R	66
Roksan Darius £1265	Average Poor/Very Good	A controversial speaker which when set up right can deliver impressive performance, but with a far from neutral balance	98 x 31 x 51cm integral stands near side walls	88dB/W 50Hz		53
Rotel RL850 II £130	Average+ Average+	Strongly recommended. Well-balanced, clear, with decent focus and fine stereo, but tendency to 'heaviness' needs decent stands and space	44 x 25 x 24cm free space on 40cm stands	86.5dB/W 50Hz	BB	59
Royd A7 Series 11 £99	Average+ Average	Lively clear sound; good upper bass and dynamics, but treble "ramp" made vocals sound shut in. Try before you buy	31 x 20 x 17cm shelf or 50cm stands near wall	86dB/W 75Hz	R	53
Royd Eden £235	Average Average+	Delightful mid/treble speed and transparency but determinedly bass light, this oddball miniature threatens cult status but could use a sweeter tweeter	31 x 20.5 x 18.5cm stands close to rear wall	87dB/W 85Hz	R	66
Ruark Swordsman £200	Good Average	Very attractively styled and finished, the Swordsman is a well built 'small bookshelf' model that delivered better test than listening results	38.5 x 20 x 27.5cm stands 0.5m from wall	84dB/W 50Hz		71
SD Acoustics OBS £695	Average Good+	Large but unusually pretty, needs a big(fish) room and has a sting at the top, but the transparent dipole midband provides an unusually open and dynamic sound	102 x 35 x 25cm spiked, in free space	86dB/W 45Hz	R	71
SD Acoustics SD1 £1150	Average Very Good	A large scale, airy and unusually detailed system with excellent dynamics. Balance is light and bright, and the original model could upset some systems/listeners. Current model has more civilised top-end and warmer overall balance	123.5 x 38.2 x 31.9cm free standing, away from walls	90dB/W 50Hz	R	60
Shan Shimna £280 (stands £75)	Average+ Good—	Pretty little miniature in cast mineral/plastics has limited dynamic range and could sound smoother, but integration is good and box effects slight	31 x 16 x 17cm stands near rear wall	84dB/W 65Hz	R	71
Sony APM-101ES £99	Good Average	Big hearted sound from small bookshelf successor to BB '10ES, sounds a little untidy at frequency extremes, so suits CD better than vinyl	39.5 x 22.5 x 23.5 stands in open space	86dB/W 52Hz	R	71
Sony APM 10ES £100	— Average	An obvious Best Buy at its highly competitive price point, it can do justice to a good hi-fi system of Sony or specialist origins	40 x 25 x 20cm, 40cm stands 40cm from wall	87dB/W 55Hz	BB	59
Sony APM 22ES £249	Good+ Good	Sounding notably clear, the 22ES scored well on listening tests was easy to drive and achieved high sound levels	51.5 x 29 x 30cm free space on 40cm stands	88.5dB/W 46Hz	R	46
Sony APM-181ES £300	Very Good Average	Big and beefy but also somewhat fat and bass heavy, this well engineered three-way has notable strengths but lacks transparency and sounds better at lower levels	57.5 x 29 x 36cm stands in open space	87dB/W 40Hz		71
Sony APM 66ES £700	Average+ Average+	Powerful heavyweight sound with a brilliant midband—clear articulate and transparent. But the bass is on the boomy side and the treble can sound grainy	66 x 38 x 36.5cm open space, low stands	89dB/W 60Hz		59
Spendor SP2 £470	Very Good Good+	Conceding little to the SP1, this 30 litre model displayed good tonal balance with a highly articulate midrange, only slightly marred at frequency extremes	50 x 25 x 30cm free space, stands	87dB/W 45Hz	R*	59

DAT FROM PLAYBACK

THE WORLD'S SMALLEST DAT RECORDER

THE COMPLETE
PLAYBACK PACKAGE
THE CASIO DAI
THE AFFORDABLE
PORTABLE AT
£645 + VAT



CASIO DAI

- * 4 hour rechargeable battery pack
- * AC adaptor * Fixed angle stand
- * Free tapes and carrying case worth £60

15 Percy Street, London W1P 9FD. Tel: 01-631 0939
Fax: 01- 636 5011

PLAYBACK

LOUDSPEAKERS

HI-FI CHOICE

THE DIRECTORY

LOUDSPEAKERS

MODEL PRICE	LAB SOUND	COMMENTS	SIZE PLACEMENT	SENSITIVITY BASS FROM	VALUE	BACK ISSUE FULL REVIEW
Spendor SP1 £710	Very Good Good	A very subtle and musical performer that works particularly well with digital material. An exceptional allrounder	63.5 x 29.5 x 30.5cm stands in open space	87dB/W 41Hz	R	60
Spendor SA3 Passive £1500	— Good+	Same as Spendor SA3 active	85 x 38 x 46cm low	89dB/W 32Hz	R	46
Spendor SA3 Active £2900	Good+ Very Good	Substantial speakers designed to deliver high sound levels and killer bass. Suited to larger rooms and power hungry ears	85 x 38 x 46cm low rigid stands in free space	89dB/W 32Hz	R	46
Spica TC50 £595	Good— Good	This triangular-profile 'grown up' miniature is a shade boxy and laid back but has good rhythmic and musical integrity	40.5 x 33 x 29cm stands in open space	88dB/W 55Hz		71
Spica TC50SE £795	Good— Good	A heavily UK-modified TC50, the SE sounds less boxy and more spacious, but lacks some of the urgency of the standard model	40.5 x 33 x 29cm stands in open space	88dB/W 55Hz		71
Spica Angelus £1195	Good Average	A little bass shy and soft in the bass and lower mid, the Angelus is otherwise tidy, extremely lively and fluid, if uneven overall	116.8 x 53.3 x 26cm free standing away from walls	86.5dB/W 50Hz		60
Studio Power Sapphire £130	Poor Average—	Balance difficulties are improving, though still prevent the potential of this interesting metal-cone new miniature from being fully realised	30 x 20 x 19.5cm stands near rear wall	85dB/W 70Hz		66
Tannoy Eclipse £120	Average+ Good	Although a little bright, the essentials are right: hear-through clarity at all frequencies, good dynamics, firm bass	38.8 x 22.6 x 21cm semi open on stands	87dB/W 65Hz	BB	59
Tannoy Mercury S £160	Good Good	A fine budget allrounder in the now established Mercury tradition; good balance and reasonable refinement will ensure wide appeal	49.5 x 25 x 21.5cm stands in free space	87dB/W 50Hz	BB	66
Tannoy DC1000 £199	Average Average—	The smaller of two DC models with dual concentric drivers, the '1000 is much less well balanced than the larger, floorstanding '2000	50 x 24 x 25cm	91dB/W 53Hz		71
Tannoy M20 Gold £200	Good Average+	Luxury version of Mercury S with real wood and bi-wire frills doesn't necessarily sound any better overall, but still fine value	49.5 x 25 x 21.5cm stands in free space	87dB/W 50Hz	R	68
Tannoy DC2000 £300	Good Good	Remarkably high sensitivity from unique dual concentric driver that has an involving but characteristic sound. Bass could be better	68.5 x 26 x 27cm floor in free space	93dB/W 55Hz	R	66
Tannoy Westminster £3400	n/a Good+	These awesome horn loaded speakers are remarkably controlled and impressive, if only suited to a few pockets and rooms	Huge, flat against rear wall, away from corners	96dB/W (manuf.)	R	Coll
TDL Monitor £1600	Very Good Very Good	Fine solidity and good accuracy, with enough bass extension to satisfy even organ freaks. Needs a big room and can sound a bit lazy and a shade tinkly	118.5 x 30 x 47cm 0.5m from walls	85dB/W 28Hz	R	66
Technics SBC 250 £130	Average+ Average—	Despite a fairly even tonal balance, the 250EK sounded muddled in the midrange and dull in character	36.5 x 23.5 x 20.5cm free space, stands	86dB/W 60Hz		46
Technics SB-RX50 £500	Very Good Average+	With its unique coaxial drive unit the RX50 proved a smooth and well balanced loudspeaker, its minor weakness being a mildly excessive low bass	48 x 30 x 26cm free space on 40cm stands	86dB/W 40Hz	R	46
Toshiba S33-M £90	Average Average	Providing a benchmark for budget loudspeakers, this Toshiba-inspired but UK designed and manufactured model is a lot of loudspeaker for the money, if a shade on the cheap	40 x 26 x 21.5cm stands in free space	86dB/W 55Hz	BB	68
Wharfedale Delta 30 £79	Good Average	Very clear and surprisingly neutral for the price, with good dynamics and stereo within limited volume ceiling	37.9 x 20 x 16.9cm near wall on high stands	88.5dB/W 80Hz	BB	59
Wharfedale Delta 50 £99	Average+ Average—	"There's nothing obviously wrong, but it seems a bit mundane," is what we said when the Delta 50 was £129. But since then the price has dropped by 30 per cent, making it great value	48 x 27 x 19cm near wall on 40cm stands	88dB/W 55Hz		53
Wharfedale Diamond 111 £99	Below Average Average—	This latest version of the long running Diamond sports a better tweeter, but bass, though deep, is soft, and the midband is indistinct and uneven	24 x 18.5 x 20.5cm near wall, stands	86.5dB/W 75Hz		59
Wharfedale Super Diamond £139	Average Average—	Although there are improvements on the basic "legendary" model, listening panelists did not get airborne about this upgrade	24 x 19 x 19cm close to wall at head height	88dB/W 57Hz		53
Wharfedale 504/2 £139	Average Average	Not strictly accurate, this musically involving miniature sounds unusually coherent and well integrated, if a shade dull in balance	29 x 18.5 x 19cm stands against rear wall	84dB/W 60Hz	R	68
Wharfedale 505/2 £169	Average Good	This lively Wharfedale provides plenty of speaker with unusual refinement for the money, and should be fairly tolerant of room siting	44 x 25.5 x 24cm stands 1ft from wall	86dB/W 55Hz	BB	66
Wharfedale 510.2 £299	Average Average—	Even in its latest guise, this loudspeaker still sounds hard, cluttered and lacking innate clarity. The bass is uneven and midband coloured	61.5 x 28 x 29.6cm near wall, high stands	89dB/W 50Hz		59
Yamaha NS 1000M £900	Good Good+	Living up to its monitor label, and tonally well suited to digital material, the NS 1000M is superbly crafted and capable of high levels	67.5 x 37.5 x 32.5cm 30cm from wall, stands	90dB/W 40Hz	R	46

* rating refers to original, tested model.

CASSETTE DECKS

The bad odour of copyright theft hangs around the compact cassette, but there is no doubt it is the world's most versatile and ubiquitous music storage medium. Hi-fi buffs may wrinkle their noses pointedly, but are still happy to use cassette decks to make up tapes for the car or personal — at the same time complaining loudly about the quality of pre-recorded material. (In fact the very best decks can do a surprisingly good job with musicassettes.)

There is no problem in connecting a cassette deck to any normal amplifier, but some care needs

to be taken in choosing the best tapes for a specific machine. (Trial and error is one effective technique, but many decks have manual bias adjustment and some match up to the tape automatically.) Lab performance and sound quality often go hand in hand, and are frequently somewhat dependent upon factory alignment. The mechanical integrity of the mechanism itself is another crucial factor, that is often reflected in the asking price.

All modern hi-fi decks have Dolby B and the majority have Dolby C besides; the very worthwhile

HX Pro system is becoming steadily more widespread. Remote control remains rare, though sometimes it is available as a system option. Three-head recorders allow simultaneous checking of the recording being made. Auto-reverse is a useful convenience feature, but usually with some mechanical compromise, while double-mechanism 'dubbing' decks of dubious quality are fashionable at the bottom end of the market. The welter of different 'music search' systems available is some indication of their frequent ineffectiveness.

NAME PRICE	LAB SOUND	COMMENTS	FEATURES	VALUE	BACK ISSUE FULL REVIEW
Acoustic Research RD-06 £280	Average Average+	Acceptable middle market player with very simple facilities and cramped control section, but unusually good looks	Dolby B/C HX Pro, fine bias, counter memory, repeat		
Aiwa AD-F370 £130	Average Average	Adequate but uninspiring recorder with detail shortcomings but good control layout and successful sounding with recorded musicassettes	Dolby B, C, HX Pro, bias adjust		63
Aiwa AD-R470 £150	Average Good	For once, an auto-reverse deck with the performance of a decent unidirectional one at a similar price. The Aiwa is modern in concept and execution, and has good, transparent electronics	Dolby B/C/HX Pro, auto reverse, cue & review, bias adjust	BB	69
Aiwa AD-WX707 £180	Poor Average	Not bad value for a twin deck, but marginal from the high fidelity viewpoint. The review sample was poorly set up	Dual deck, auto-reverse, Dolby B & C, bias adjust		57
Aiwa AD-F880 £300	Good Very Good	Modern sophisticated deck which manages to include some very sound under the skin development work in a rather ordinary (if well polished) exterior	Dolby B/C/HX Pro, 3 head, remote, manual tape calibration	R	69
Aiwa XK-007 Excelia £400	Good Good	Downmarket version of XK-009 with simplified bias/equalisation adjustment section and more forgiving but less informative sound. Still good, but less exciting than XK-009	Dolby B, C, dbx, HX Pro, 3 Head, tape alignment		63

THE DIRECTORY

CASSETTE DECKS

NAME PRICE	LAB SOUND	COMMENTS	FEATURES	VALUE	BACK ISSUE FULL REVIEW
Aiwa AD-WX909 £400	Good Good	Convenience meets sound quality, and both win. An essentially clean, positive recorder which works alongside an auto-reverse player of lower standard – a sensible compromise	Dual deck, auto-reverse, track search, Dolby B/C/HX Pro, bias adjust, 3 Head	R	57
Aiwa XK-009 Excelia £550	Very Good Very Good	Excellent detail, stable articulate midband and slightly obvious treble. The most interesting Aiwa for yonks	Dolby B, C, dbx, HX Pro, 3 Head, tape alignment, CD direct	R	63
Akai GX-32 £200	Average Poor	Constrained and smeared sum this deck well. It has poor bass and treble definition alike, though it proved well aligned for prerecorded cassettes	Dolby B/C, variable bias, headphone out, track search		69
Akai GX-52 £249	Very Good Very Good	Well finished and a pleasure to use this well specified deck sounds clean and defined with all tape groups, with or without Dolby	Dolby B, C, HX Pro, track locate features	BB	57
Akai GX-6 £350	Good Good	There is a strong sense that someone has really thought this one through; it has an indefinable 'specialness'	Real-time counter, track search, Dolby B, C, bias adjust	R	52
Akai GX-95 £400	Good Very Good	Well designed and finished cassette deck with features well judged to please the audiophile – especially switchable Dolby HX Pro and switchable panel display. The calibration system is simple and effective, and the deck sounds great	Dolby B/C/HX Pro, 3 head, manual tape set-up	R	69
Denon DR-M07 £125	Poor+ Average	There were several problems with the test player that render it an unsafe purchase. This is a pity since despite the antiquated control system, the deck is capable of refined sound quality	Dolby B/C, fine bias adjust		69
Denon DR-M10HX £180	Good Good	Very well laid out, a sensible range of features and smooth cam-operated transport. Replay-only sound quality suspect, but the deck is successful as a recorder – clean, precise but slightly 'grainy'	Dolby B, C HX Pro, memory counter, bias adjust	R	63
Denon DR-M12HX £220	Good Good+	Well constructed and pleasant to use, a lack of true pitch constancy kept it from sounding superb	Track search, Dolby B, C, HX Pro, bias adjust	R	57
Denon DRW-750 £229	Good Good	Polished and articulate, the only significant shortcoming is poor performance with prerecorded material	Dolby B/C/HX Pro, twin unidirectional, one records	R	69
Denon DR-M24HX £290	Good Good+	This deck will slot into many high grade systems without disgracing itself – or the cassette medium. Very presentable high resolution sound with good stereo with or without Dolby	Dolby B, C, HX Pro, bias adjust, 3 Head	R	60
Denon DR-M34HR £320	Very Good Good+	Prerecorded cassettes sounded grey and dull, but this may have been a sample fault. As a recorder, the DR-M34 is refined and detailed – and good value	Dolby B, C, HX Pro, 3 Head, manual tape calibration, memory counter		63
Denon DR-M44HX £400	Excellent Excellent	A well designed deck that also performed fine sonically, working very well with ferric and metal tapes	Real-time counter, Dolby B, C, HX Pro, tape alignment adjust, remote control, 3 Head	R	60
Dual CC8010 £110	Average Average+	The only limitation worth noting is a slight opaqueness; the Dual otherwise sounds stable and effective. An excellent low-cost design	Dolby B & C, microphone input	BB	63
Goodmans GSW-5200 £90	Poor Poor	Musically unimpressive but at least it's cheap!	Dolby B, twin, one records		69
Grundig Fine Arts CCT-903 n/a (system component)	Good Good-	(Competent part of complete Grundig system). Solid and well engineered deck with small but significant problems preventing it scoring highly. Basic design generally – and transport specifically – are excellent	Dolby B/C, twin auto reverse, one records		69
Harman Kardon CD491 £695	Good Good+	Excellent audio engineering and tremendous flexibility make this an audiophile cassette deck 'par excellence'	Real-time counter, auto reverse, track search, Dolby B, C, HX Pro, bias adjust	R	52
JVC TD-R411 £180	Poor Poor	Transport irregularity, especially flutter, and poor set-up lead to a sound that although sharp is lacking in body and detail. However, the quick auto-reverse mechanism is nice to use	Dolby B/C, auto reverse		69
JVC TD-W444 £190	Average Average	The 444 offers a satisfying blend of cost and facilities, but musically it is lacklustre, lacking detail, dynamics and grip. Fair value though	Dolby B/C, twin deck, unidirectional play deck, auto-reverse record deck		69
JVC TD-V711 £380	Very Good Excellent	This is a complex recorder which is built on the back of some important ideas with audiophile roots. It has a (mostly) superb technical performance and is very capable, if not always strictly accurate	Dolby B, C, HX Pro, 3 Head, variable bias, track search, 3 line inputs	R	63
JVC TD-W222 £150	Below Average Below Average	Well endowed but somewhat user-hostile twin deck. Sound quality is very tape dependent, but offers tolerable stability with considerable loss of resolution and scrappy musical presentation.	Dual deck, auto reverse, Dolby B/C		63
Kenwood KX-440HX £140	Average+ Poor	Uneven, unstable sounding player with limited resolving power, but good control layout and finish	Dolby B, C, HX Pro, intro scan		63
Kenwood KX-660HX £170	Good Good	Well designed control system with useful search aids. Sound quality is positive and detailed	Dolby B, C, HX Pro, track & blank search, intro-scan, bias adjust	R	63
Kenwood KX-5010 £269	Very Good Excellent	This important new middle price deck is a well thought through and thoroughly developed design which eschews gimmicks for the sake of musical excellence	Dolby B/C/HX Pro, auto tape calibration, track/intro search	BB	69
Luxman K-105 £349	Average Average	Rating quite well for an auto reverse deck, and featuring complex track search facilities, it was not sonically competitive on price	Auto reverse, track search, Dolby B & C, remote control		52
Luxman K-112 £349	Average Average	Build quality is not truly consistent with the price. Nor is sound, which veers on the warm, lousy side of neutral	Dolby B, C, HX Pro, bias adjust, 3 Head		57
Marantz SD-35 £150	Good Good+	Rock steady tape transport gives very competitive sound quality for the price, but the slightly bright replay may not appeal to some	Dolby B & C, bias adjust	R	52
Marantz SD-45II £200	Good+ Good+	Well built and dynamic sounding player, working better as a recorder than with musicassettes	Dolby B & C, bias adjust Auto selection	R	52
Marantz CP230 £300	Average Average	This is a competitively priced portable recorder though not suited to replay of musicassettes	Dolby B, bias adjust	R	52
Marantz SD585 £300	Average Average-	Sound quality is a little sat upon, and control ergonomics are somewhat opaque, though the twin auto-reverse/recording capability makes this a powerful machine	Dolby B/C, twin auto-reverse & record, parallel recording etc		69
Marantz SD-55 £349	Good Very Good	Slightly tacky feel and restricted signal/noise performance are the main shortcomings of an excellent sounding piece of kit	Real-time counter, track search, Dolby B/C/HX Pro, bias adjust, 3 Head	R	57
Memorex SCT-84 £200	Average+ Average+	The playback only transport is a little disappointing, but the record one is a quality item and the deck works well. Ergonomics are good, but styling and control feel are decidedly tacky.	Dolby B/C, fine bias, twin with auto-reverse record, unidirectional play	R	69
NAD 6300 £550	Very Good Very Good	Solid and homogeneous sound quality and very good replay compatibility thanks to 'play trim'. Distinctive, musical – and costly	Dolby B, C, HX Pro, 3 Head, bias adjust	R	63
Nakamichi CR-1E £345	Very Good Good	Modestly equipped by any standards, the CR-1E stands or falls by its build quality, which is high, and sound which is highly competent	Dolby B & C		57
Nakamichi CR-2E £395	Very Good Good+	Ordinary to look at, in some respects rather awkward to use (tape switching especially), the CR-2E sounds very slightly better than the CR-1E, and therefore ranks well. But it doesn't come cheap	Dolby B & C, bias adjust, remote control	R	57
Nakamichi RX-202E £545	Good Very Good+	Fine, clear and articulate sounding player. Excellent with prerecorded material, but idiosyncratic and sometimes obstructive control system	Auto reverse, Dolby B, C, 2 Head	R	63
Nakamichi CR-3E £595	Very Good Very Good	The user interface is a little clumsy, though conceptually straightforward. Sound quality approaches the CR-4E, and is amongst the best at the price.	Dolby B & C, bias adjust, remote control	R	57

TO ORDER BACK ISSUES OF HI-FI CHOICE SEE PAGE 114

THE DIRECTORY

CASSETTE DECKS

MODEL PRICE	LAB SOUND	COMMENTS	FEATURES	VALUE	BACK ISSUE FULL REVIEW
Nakamichi CR-4E £745	Very Good+ Very Good+	High class deck with a reasonably full range of features and superb sound at a slightly unlikely price	Dolby B & C, bias adjust, remote control, 3 Head	R	57
Nakamichi CR-5E £995	Excellent Excellent	A slightly simplified version of the all-conquering CR-7, the CR-5 has a very similar standard of audio performance – the best	Dolby B/C, fine bias, 3-head	R	69
Nakamichi CR-7E £1500	Excellent Excellent	Remarkably this deck is not only ergonomically but also sonically superior to the Dragon, particularly on record/replay	Real-time counter, track search, Dolby B & C, tape alignment adjust, bias adjust, remote control, 3 Head	R	60
Nakamichi Dragon £1750	Excellent Excellent	Previous to the birth of the CR-7E, this machine stood head and shoulders above the rest. It is still the ultimate for musicassette replay	Auto reverse, Dolby B & C, tape alignment adjust, bias adjust, remote		60
Dnkyo TA-2120 £130	Average+ Good	Clear, vivid sound with good timing and resolution when using Type II tapes without Dolby. The controls are less inspiring – the meters in particular are plainly inadequate	Dolby B/C, auto tape sensing, block/side repeat	R	63
Onkyo TA 2130 £160	Average+ Average+	Rating fairly well on both pre-recorded and record/playback, ergonomics were a little poor but overall performance was generally consistent	Track search, Dolby B & C, bias adjust		52
Philips FC566 £179	Average+ Average+	Mostly well equipped, though some tape search facilities fail to exploit the auto-reverse capability. Sounds clean and stable – with prerecorded tapes too	Auto reverse, track search, Dolby B & C		57
Philips FC567 £279	Average Poor	Well equipped but ergonomically substandard; sound quality is messy and lacking in clarity and dynamics	Dual deck, auto reverse, track search, Dolby B & C		57
Pioneer CT-443 £180	Average Good	Structurally sound and subtly musical recorder. Sophisticated, mildly damped sound quality	Dolby B & C, fine bias adjust, track search	R	63
Pioneer CT-737 £300	Average- Average-	Interesting design and a pleasure to use with rather too many rough edges to really work properly	Dolby B, C, HX Pro, 3 Head, bias adjust, memory counter		63
Pioneer CT-939 £450	Excellent Excellent	High grade and easy to use cassette deck featuring a state of the art transport. The audio amplifiers are not quite in the same class, but fail to seriously damp enthusiasm for an excellent package.	Dolby B/C/HX Pro, 3 head, real time counter, variable bias	R	69
Proton AD-200 £140	Poor Poor	Sound quality is essentially on a par with many portables, and has nothing to do with high fidelity. The main problems are an unrelenting hardness and an almost total lack of detail	Dolby B & C		57
Proton AD-300 £200	Average- Poor	High levels of flutter give sound a roughness and coarseness that rules it out for high quality work. The record and replay electronics certainly deserve better	Auto reverse, Dolby B & C		57
Revox B215 £1461	Good Average+	Superb engineering and good sound, but lacking the subjective qualities that characterise the very best hi-fi equipment	Real-time counter, Dolby B & C, tape alignment adjust, remote control		52
SAE C102 £549	Average+ Good	Looking most unlike a cassette deck designed in the States and proving competitive in its price group. Not sonically that outstanding, however	Real-time counter, track search, Dolby B & C		52
Sansui D-X301i £150	Average+ Good	Lively, informative and well equipped basic deck, if rather obscure operationally	Dolby B/C/HX Pro, variable bias, track search	R	69
Sony TC-FX 150 £90	Average+ Average+	Recording and playing back on this deck itself gave acceptable results, whereas prerecorded stuff was a joke. But it's a good £90 worth	Dolby B & C		52
Sony TC-W300 £150	Poor Poor	Deeply unimpressive and messy sounding deck with bloated quality and poor pitch integrity. Dubbing performance substandard	Dual deck, Dolby B & C		63
Sony TC-RX50 £180	Average- Poor	Terminal inability to play at a steady pitch, or (on prerecorded material) in tune spoiled this simple but otherwise attractive design	Auto-reverse, Dolby B/C/HX Pro		63
Sony TC-WR500 £200	Poor Poor	In many ways a curiously old-fashioned package which lives up (down?) to stereotypes about twin cassette decks	Twin Dolby B & C, 1 records, both auto-reverse		69
Sony (WMD6C) ProWalkman £249	Good+ Excellent	"One of the finest sounding cassette decks on the market today. A mandatory Best Buy, which also fits in your pocket"	Dolby B, & C	BB	60
Sony TC-RX60ES £250	Average Average	For once a stable sounding auto-reverse deck but sound quality is rather 'dirty' and compressed, especially with Dolby C	Auto-reverse, Dolby B/C/HX Pro, auto tape recognition		63
Sony TC-RX80ES £350	Average+ Good	Clean, powerful and detailed sound, especially without Dolby C. Stable pitch – but prerecorded cassettes sounded disappointing	Auto reverse, Dolby B/C/HX Pro, bias/level adjust	R	63
Sony TC-K700ES £499	Excellent Excellent	Firmly in the esoteric league, this is easy both to operate and to listen to. Best points: first class imagery, focus and stability	Track search, Dolby B & C, tape alignment adjust	R	60
Teac V-250 £89	Average Average	Ultra-basic design which works quite well. Lack of pitch integrity is the main shortcoming, but it wasn't always noticeable	Dolby B	R	63
Teac V-270C £109	Average- Average-	Not quite cheap enough to compete solely on price, the V-270C is a rather messy and unstable sounding deck	Dolby B & C, bias adjust		63
Teac V-570 £199	Average+ Good	Metal tapes are not exploited well by this deck, and prerecorded tapes sounded very disappointing. But the underlying sound quality sets a very high standard, assisted by clean electronics and an excellent transport	Dolby B/C/HX Pro, fine bias adjust	R	69
Teac V-670 £249	Average Average	This deck is worth considering, but much has been sacrificed for the third head, both musically and in the range and type of features included. Worth considering	Dolby B/C/HX Pro, fine bias, 3 head/off tape monitoring		69
Teac R-515 £299	Average+ Average+	Expensive, this deck is basically a competent but pedestrian performer which will not fully satisfy the critical user	Real-time counter, auto reverse, Dolby B & C, bias adjust		57
Teac W-460C £299	Good Average	Musically this deck is a little lacking, given the price and despite a notably fine transport section. Nevertheless well worth considering if the programming options appeal.	Dolby B/C, twin unidirectional, one records. Programme memory		69
Teac V-870 £399	Good+ Good	Cut-down V-970X for the proletariat. Expensive and carefully engineered with mostly very good but slightly cold sound quality	Dolby B, C, HX Pro, 3 Head, manual tape calibration	R	63
Teac V-970X £499	Very Good Very Good	An excellent sounding deck with useful features (tape calibration etc) that fully justifies the price	Real-time counter, track search, Dolby B/C/dbx & Dolby HX Pro, bias adjust, remote control, 3 Head	R	57
Teac W-990RX £499	Good Good	A mess with dbx, but taut and articulate otherwise. The 990, though expensive, has a powerful range of features, making it one of the few really ambitious decks to successfully straddle both sets of requirements	Dolby B/C & dbx, dual auto-reverse/record, parallel & sequential recording, remote	R	69
Technics RS-T230 £160	Average- Average	Satisfactory with prerecorded material but otherwise unexceptional, the main features of this deck are its excellent user interface and value for money	Dual deck, Dolby B/C		63
Technics RS-B355 £140	Good Good	Good sound let down by inadequate meters and poor prerecorded replay only sound quality	Dolby B, C, microphone inputs, cue and review	R	63
Technics RS-B505 £160	Average+ Average+	Neatly made recorder with Dolby HX Pro that sounds precise and stable, though sometimes a little processed and grainy too	Track search, Dolby B/C/HX Pro		57
Technics RS-B605 £180	Good Average+	Mixed but generally good sound. Weakest points are dbx and prerecorded sound, best are Type IV (metal) recordings which sound sharp and precise	Track search, Dolby B/C/HX Pro & dbx		57
Technics RS-T330R £200	Average+ Average+	One of the very few dual cassette decks with any real pretensions to audio quality, the RS-T330 is a considerable success musically as well as being a pleasure to use	Dual deck, Dolby B & C	R	63
Technics RS-B705 £250	Average Average-	3 heads for the price of two, but not the sound quality to go with them	Track search, Dolby B, C, HX Pro, bias adjust, 3 Head		52
Technics RS-B905 £350	Good Good	Good, well set up cassette deck with a clean, accurate sound but some compression. dbx circuit sounds poor	Dolby B, C, HX Pro, dbx, bias adjust, 3 Head		57

THE DIRECTORY

CASSETTE DECKS

MODEL PRICE	LAB SOUND	COMMENTS	FEATURES	VALUE	BACK ISSUE FULL REVIEW
Technics RS-T80R £400	Poor Poor	Flexible and pleasant to use but poor transports led to poor sound on our latest sample	Dual deck, auto reverse, track search, Dolby B, C, dbx		52
Yamaha KX-200 £120	Good— Good	Cheap, well-equipped and workmanlike with the sound quality less obviously processed than most – the whole is more than the sum of the parts	Track search, Dolby B & C, remote control	R	52
Yamaha KX-300 £150	Average+ Average—	Uncommonly well equipped and adequately made and presented, this model turned out to be a disappointingly uncertain proposition on audition	Track search, Dolby B, C, HX Pro with 'play trim', bias adjust, remote control		57
Yamaha KX-400 £200	Good Good+	A highly commercial package with every widget under the sun. Happily it sounds good too.	Auto reverse, track search, Dolby B, C, HX Pro, remote control	R	52
Yamaha KX-500 £210	Very Good Very Good	An accomplished performer, strongest in the areas of pitch and spatial stability, but slightly rough around the edges	Real-time counter, track search, Dolby B/C/HX Pro with play trim, bias adjust, remote control	R	57
Yamaha KX-800 £330	Good Average	The present Yamaha range seems oddly inconsistent. This sophisticated model sounds fine (almost) but came a clear second best to the KX-500	Real-time counter, track search, Dolby B, C, HX Pro with play trim, bias adjust, 3 Head		57
Yamaha KX-1200 £500	Excellent Average+	A veritable rats' nest of buttons and dials, albeit well laid-out. This is nearly a great recorder, but lacks simplicity of sound	Real-time counter, track search, Dolby B, C, dbx, HX Pro, bias adjust, remote control		52

DAT RECORDERS

NAME PRICE	LAB SOUND	COMMENTS	FEATURES	VALUE	BACK ISSUE FULL REVIEW
Aiwa Excelia XD-001 £1300	Very Good Very Good	Clear and very listenable recorder roughly comparable to but slightly sweeter sounding than the Sony DCT-1000ES – but with an inferior front panel design	Track ID and search, remote	R	63
Grundig Fine Arts DAT-9000 n/a (system component)	Good Good	Conventional DAT recorder offering standard facilities. The deck is well made and equipped, and is engineered to a satisfactory quality standard. It performs to an acceptable standard, though it is not state of the art	2/4 hour recording, mic inputs, digital in/out		69
Luxman KD-117 £1499	Good Good	Slightly soggy, earth-bound sound quality, this model trails the other DAT decks tested so far	Two analogue inputs, remote twin address		63
Pioneer D-1000 n/a	Excellent Excellent	Fine, clear, colourful and consistent sounding deck. The Pioneer is lavishly (uneconomically?) constructed and equipped. It shows what is possible, but will probably never go on sale	Many search and memory facilities	R	63
Sony DTC-M100 £799	Very Good Very Good	Clean, clear sounding 2nd generation model with most of the features and sound of the DTC-1000ES	Mid-width, alpha-numeric display, remote, optical interfaces	R	63
Sony DTC-1000ES £1299	Very Good Very Good	Fine, consistent performer with accomplished tape handling and good build quality	Standard track ID and search, remote	R	63

CD PLAYERS

This all-digital music source is well established, despite still high disc prices and the opposition of many hi-fi enthusiasts. Compact Disc's strengths over conventional vinyl are complete freedom from surface noise with automatic and programmable play, plus track skip and fast music scan – frequently under full remote control. However, many vinyl enthusiasts find CDs sound less involving than

top quality vinyl replay.

Introduced five years ago at around £500, CD players now average less than half that price, and for the main offer improved performance besides. Even cheaper players may have the latest decoding chips and the most useful play features; extra money can buy remote control, remote volume control, audio 'tweaks', plus improved build and component

quality control.

Compared with many hi-fi components, CD players give impressive lab performance, though there are differences between players nonetheless. Sound quality variations are even more marked, particularly in a good quality system. As it behaves very like a preamp, there are no problems connecting a player to a normal amplifier.

MODEL PRICE	LAB SOUND	COMMENTS	FEATURES	VALUE	BACK ISSUE FULL REVIEW
ADC CD 2000E £330	Good+ Fair+	One of the slimmest players in the business but nothing special inside. Nice ergonomics but overpriced	Remote, timeshared 16 bit		64
Aiwa DX-M45 £149	Fair Fair	Cutdown Philips technology, but results are quite good for this British made machine	Manual	R	64
Aiwa CD-001 £300	Good Good	Pretty close to Recommendation, delivering a respectable sound quality and lab performance from an ergonomically attractive package, but ultimately failed to excel in any particular respect.	Track entry/volume remote, direct recorder connection etc.		58
Aiwa XC-007 £499	Very Good Good	Creditable sound despite inverted output, high tech engineering with very good lab performance. A worthy contender but not cheap	Remote, keypad, timer, digital output, pseudo 20 bit, dual DAC		64
Akai CD-52 £249	Good Good	A nice surprise from Akai, genuinely good sound from this mid-priced model. Better linearity will help further	Remote, digital output, headphone socket	BB	64
Akai CD-62 £330	Fair Very Good	Looks, build quality and the technical specification are right up to date. As it stands it sounds very good but if the indifferent lab performance could be improved, it would probably sound even better.	Remote, programme, hdph, comprehensive display etc	BB	70
Akai CD-73 £450	Good Average	A little uneven musically, the Akai tends to smother fine detail, but has first class dynamics and stereo imagery. Worth auditioning	Track entry keypad remote, menu display (switchable)		62
Akai CD93 £700	Good Very Good	Undoubtedly a CD player of real class in build, presentation, lab performance and sound quality, but also a shade expensive for formal Recommendation – though that's not to dissuade lovers of black lacquer wood finish.	Track entry remote, menu display etc.		58
Arcam Delta Black Box £250	n/a Very Good	This rich, powerful and articulate sounding DAC transforms the majority of medium price CD players	Needs D-out CD players	R	60
Arcam Delta 70 £500	Good Very Good	This solidly built British player has attractively understated presentation with straightforward, simple ergonomics. The very good sound quality shows a steady improvement over earlier samples.	Simple remote, headphone socket etc.	R	58
Cambridge Audio CD2 £650	Fair Very Good	The finest midrange in digital audio is sufficient grounds for Recommendation, though there remains a tinge of disappointment that the CD2 didn't get closer to big brother elsewhere, notably in the bass.	16x oversampling, remote control	R	58
dbx DX5 £640	Good Poor	Sound quality proved a single disappointment, though it's refreshingly unique in providing semi-pro post-production facilities that some users will undoubtedly relish.	Track entry/volume remote, compression, impact recovery, ambience etc.		58
Denon DCD 610 £200	Good+ Fair+	Lots of Denon player for the money, well equipped with good all round performance	Remote, versatile programming 2x O/S	BB	64

THE DIRECTORY

CD PLAYERS

NAME PRICE	LAB SOUND	COMMENTS	FEATURES	VALUE	BACK ISSUE FULL REVIEW
Denon DCD 810 £250	Very Good Fair+	A good value allrounder bettered on sheet value by the 610 and 910; power volume could sound better	Remote, 4x oversampling, programming	R	64
Denon DCD 910 £300	Very Good Fair+	A well equipped deck of impressive appearance and solid sonic and lab performance	Remote volume, programming, 8x O/S digital output	BB	64
Denon DCD-1500II £500	Very Good Very Good	The extra build quality over cheaper Denons is justified in terms of sound quality and lab performance, while the feature list is comprehensive and quite nicely presented.	Track entry/volume remote, menu display etc.	R	60
Denon DCD-1520 £500	Very Good Very Good	High tech, high profile, high gadget content, good sounding player at an almost affordable price.	Programme, hdph socket, remote, track entry, optical digital output	R	70
Denon DCD 1700 £650	Good+ Very Good	The overall sound was strong and coherent approaching reference standards. Fine build quality and facilities make this a firm contender	Remote, skip, scan, headphone socket, programmable	R	58
Denon DCD-3300 £1200	Good+ + Very Good	Sounding tight and coherent though not significantly better than the cheaper 1700. Very well built and comprehensively equipped	Remote control, with volume, keypad programme, scan, search, headphone		51
Dual CD 1030 RC £170	Fair Fair	An up and down performance on test but it is hard to deny the overall value for a machine that includes remote control at this price	Remote, headphone socket, 2x O/S, timeshared 16 bit	R	64
Ferguson CD007 £130	Good Fair	The cheapest recommendation in the test group; don't expect the earth but the value is good	Manual, digital output, headphone socket	R	64
Ferguson CD008 £150	Fair Fair	Not as strong as its relatives, sample fault perhaps? Though performance is fair enough overall	Remote, midi digital output, 2x O/S, timeshare 16 bit		64
Goodmans GCD300 £129	Average Average	It may be adequately made, but with cheap good sounding players available this particular Goodmans isn't quite good enough	Programmable, skip, search, repeat		70
Goodmans GCD550 £199	Average+ Fair+	A slow autochanger with a weakish lab performance but the sound is fair enough, the features good and the price is low	Remote, 6 disc autochanger, 2x O/S	BB	64
Grundig CD9000 £1000	Good Good	Aimed at a market which puts external styling above sound quality. Although this player is of slightly above average competence in most departments it is expensive	Remote, programme, hdph socket, calendar display etc		70
JVC XL333 £170	Good Good	This player provides lavish facilities at a budget price (no remote though) and it produces a good sound and performed well in the lab	Track key entry, 32 track memory, comprehensive display	BB	70
JVC XL-Z444 £255	Good Fair+	An average performer, unremarkable though well equipped and fair value for money	Full feature remote, digital output, headphone socket		64
JVC XL-M400 £300	Good Fair	JVC has produced a competent autochanger which works well. Average sound quality doesn't create any great enthusiasm	Autochanger, key pad remote, hdph socket, multi disc programming		70
JVC XLZ 555 £350	Good Fair	The display is something else, but the rest of the player, although displaying fine build quality is too average everywhere	Keypad track select, comprehensive display, optical digital output etc		70
Kenwood DP-660SG £180	Below Average Below Average	Build quality and ergonomics are good, and the range of features far exceeds the price norm. However, sound quality is messy with a soft bass, recessed mid and sometimes spiky top.	Remote control, calendar/menu display, keypad, 20 track memory		62
Kenwood DP-880SG £250	Very good+ Fair+	A fine CD transport for the price, fine sound, very good lab results, good for a decoder?	Remote volume, programming, headphone socket	BB	64
Kenwood DP-990SG £400	Very Good Good	Falling just short of the required subjective standard for Recommendation at this price level, this is a doughty player nonetheless, with a build quality and technical performance that arguably justifies its premium price.	Track entry remote, menu display, sprung feet etc.		58
Kenwood DP-8010 £449	Good Fair	Top build quality and novel technological features seem to achieve little success here. While the technical performance is fine, the sound quality doesn't match its competitors	Track entry remote, memory display, sprung feet, optical digital output etc		70
Kenwood DP-1100SG £450	Very Good Good	Something of a high tech flagship, this model doesn't quite make the grade on sonic grounds but is well built	Full remote, optical and coax digital outputs, headphones		64
Luxman D-90 £300	Fair Good	Despite technical ingredients that do not seem particularly inspiring, this is a nicely judged package that is ergonomically neater than most, with decent sound quality for the price and distinctive finish and presentation.	Track entry remote, programming etc.	R	58
Marantz CD583 £150	Very Good Good	Devoid of all but the CD essentials it makes up for in sound quality what it lacks elsewhere	Memory, track skip, search, etc	BB	70
Marantz CD65HSE £300	Very Good Very Good	Scorching sound quality from a competitively priced player, which is the new middle market reference	Remote, programming, digital output	BB	64
Marantz CD75HSE £350	Very Good Very Good	Remote volume version of the 65 SE with an optical digital output as well. A sonic superiority complex in a cheap plastic box	Remote volume, hdph socket, FTS, optical output etc	BB	70
Marantz CD85 £550	Very Good Very Good	This player may just miss a top sonic rating but it's well made and has plenty of features befitting a Marantz heavyweight	FTS, key pad remote, comprehensive display, programming, optical output etc	R	70
Marantz CD94 £800	Good+ + Very Good	Clearly the best Marantz CD player, with high build quality and good objective and subjective performance	10 digit keypad, headphone socket, favourite track selection, remote	R	58
Marantz CD94/CDA94 £1600	Very Good Excellent	Taking its logical place at the top of the Marantz CD hierarchy, this two-box combination delivers reference standard lab and listening test results, albeit at a price which seems a little steep. Very refined	Favourite track selection, remote, balanced output etc	R	60
Marantz CD12LE £2500	Very Good Very Good	This may be very expensive but it is very well made. Technical performance is very good and the sound is the best from Marantz yet	Two box, digital processor, FTS, optical connection, hdph socket, comprehensive display, balanced output etc	R	70
Meridian 207 £1050	Very Good Excellent	Not only arguably the prettiest model around, but also one of the best sounding and most versatile - on-board preamp now accepts vinyl disc for an extra £100, and Meridian plans round-the-house future-readiness	On-board preamp, remote (inc volume)	R	64
Mission PCM2 £500	Good+ Good	A matured design with good features it is the best sounding power volume player available, it even tests well. It accepts the £200 PSX power supply option	Remote volume, display and phase invert	R	64
NAD 5220 £230	Average- Poor	Conforms sonically to a stereotype of the medium that most players have grown out of. Hard, thin and raw sound with poor stereo and resolution.	Time/track display, memory		62
Nakamichi OMS-1E £395	Good Good	This neat enough player doesn't really follow the Nakamichi tradition of providing exceptional sound quality while at the same time perpetuates that of selling at an above average price	Simple remote etc.		58
Nakamichi CDP-2E £495	Very Good Good	It's ergonomically superior and has above average sound, but it isn't cheap. The standard of build quality and finish is first class which isn't quite matched by the sound quality	Programming, hdph, remote track entry, digital output		70
Nakamichi DMS-3E £995	Good Good	Superbly built and presented this expensive machine was a bit of a "stuffed shirt" when it came to sound quality	Remote control, skip and scan, headphone socket		51
Nakamichi OMS-4E £1200	Very Good Very Good	Solidly controlled and comparatively simple this clearly represents one of the major benchmarks for CD sound quality, though the midrange sounded a touch thin	Skip and scan, headphone socket		51
Nakamichi OMS-5EII £1500	Good+ Very Good	"... delivers near state of the art performance and build quality in a deliberately starkly functional package, but at a very high price..."	Skip and scan, simple track programming, manual control		51
Nakamichi OMS-7EII £2000	Good+ Good	The only serious criticism here is of the price. And in our not always humble opinion you can get better sound quality for less elsewhere in Nakamichi's range	10 digit track entry keypad programming, headphones		51
Onkyo DX-1500 £170	Average Fair	Ruled out on the grounds of its poor DAC filter, but it's not so bad really given the price	Manual, 2x O/S, timeshared 16 bit		64

TO ORDER BACK ISSUES OF HI-FI CHOICE SEE PAGE 114

THE DIRECTORY

CD PLAYERS

MODEL PRICE	LAB SOUND	COMMENTS	FEATURES	VALUE	BACK ISSUE FULL REVIEW
Onkyo DX-3500 £250	Very Good Fair	It offers a lot of facilities and fine build quality for the money. Lab performance is very good but the sound quality doesn't inspire	Key pad remote, memory, hdph socket, comprehensive display etc		70
Onkyo DX-7500 £450	Good Very Good	This comes close to the state of the art performance in many areas. It has lots of facilities and is well made too.	Key pad remote, memory, hdph, very comprehensive display, optical digital output etc	R	70
Philips CD582 £200	Very Good Good	Build quality and finish are only adequate but in every other respect it's more than competitive	Simple remote, programming, large display, hdph socket	BB	70
Philips CD473 £229	Good Good	In the forefront as regards sound quality, this is one of the best sounding Philips players yet; we were unable to catch it out on classical through Jazz program	Favourite track selection, remote control with volume, headphones etc	BB	58
Philips CD782 £230	Very Good Good	In the present market this Philips offers an amazing performance in all areas at a most affordable price. The styling is a little bland	Versatile volume remote, FTS, variable headphone socket etc	BB	70
Philips CD880 £500	Very Good Very Good	The '880 is an impressive blend of luxury build quality and features at a far from extravagant price, and also delivers the subjective goods.	Volume remote, FTS, menu display etc.	R	60
Pioneer PD4100 £170	Fair Good	It's not perfect in the lab, the facilities are few, but the sound quality sets it apart	Programmable, skip, search, repeat	BB	70
Pioneer PD5100 £220	Fair Fair	It's well made and has good facilities. The lab performance is generally fine, but it's only average for sound quality	Remote, volume, programming, hdph socket, etc		70
Pioneer PD-6100 £249	Good Good	A budget audiophile player; fine sound even if its lab performance seems a little uneven	Full feature remote, digital output, variable hdph	BB	64
Pioneer PD-M500 £269	Good Good	A high performance autochanger for the money, good value all round and generously featured specification	Full remote, digital output, variable hdph	BB	64
Pioneer PD7100 £300	Good Good	External build quality is fine, the level of facilities are lavish, but the sound it produces only just takes it into the good category	Remote, volume headphone socket, versatile programming, faders etc		70
Pioneer PD-M700 £400	Very Good Fair+	Top class autochanger, surprisingly fast, high specification and a good allrounder	Remote, optical digital output, headphone socket		64
Pioneer PD-91 £800	Excellent Excellent	Close to state of the art in nearly all areas - soundstaging, clarity and simple lack of artificiality. A well made and sophisticated player	Track entry remote, calendar display, index search, etc.	R	64
Revox B126 £649	Very Good Good	Made in Switzerland so the build quality and technical performance is high but then so is the price and the sound quality is only good	Programming, Revox remote system compatible		70
Revox B226 £756	Good+ Good	The traditional Revox house style is combined with the fine Philips 16 bit chip set, but this player doesn't really offer sound quality to match the price	Infra-red remote control, full search, scan, programming		51/Coll
Rotel RCD820B £210	Good+ Fair+	A budget Philips based player of dependable sound quality and offering very good value. Build is a touch lightweight	Remote, basic facilities	BB	64
Rotel RCD820BX2 £250	Good Very Good	Start with a good base and then make it sound better, the '820BX2 CD player maintains the reputation established by its namesakes, and comfortably deserves Recommendation.	Direct track entry remote etc.	R	58
SAE DT02 £700	Good Good	Considering the high price of this player, most of the innards seem fairly prosaic. Sound quality and lab performance are both respectable enough, but hardly justify the price premium involved, though styling is unusual.	Remote (inc volume), skip, scan etc.		58
Sansui CD-XM510M £299	Average Fair	Not designed to appeal to the audiophile, but with its 12 disc facility it's ideal for background music or as a second player for the kids	12 Disc, 2 magazine autochanger, comprehensive remote, programming etc		70
Sansui CD-X501i £300	Fair Fair	Weak dynamic range for an upmarket player which shows in both lab and listening tests	Remote, programmable, digital output, headphones		64
Sansui CD X701i £449	Good Good	A stylish attractive player which sets itself apart from mainstream mediocrity by means of its external appearance. It works well too, has plenty of facilities and good sound quality.	Remote, key pad track access, digital output, variable headphone socket etc	R	70
Sharp DX150 £129	Fair Fair	This is a none oversampled player which is rather outclassed for technical and sonic merit by the vast majority of the competition. Pretty enough but would you want to put discs in it?	Programmable, skip, search, repeat		70
Sharp DX750 £179	Fair Fair	It has a remote control but it's too like the 150 which is rather outclassed for technical and sonic merit by the vast majority of the competition	Remote, programmable, skip, search, repeat		70
Sharp DX-620 £200	Good Good	A surprising achievement but it shows what can be done. Another high value budget package	Remote, headphone output, 2x 0/S, timeshare 16 bit	BB	64
Sharp DX-R700H £225	Average- Poor	A workmanlike player that does not offer exemplary lab or sound quality but which is well-built with good facilities and should perform well in use	Remote control, track selection keypad, skip, scan repeat programming		53
Shure Ultra D6000 £495	Average+ Fair	Ergonomically well thought out with full function remote control, but not really scoring sonically considering its price	Remote control (full function inc volume)		51
Sonographe SD1 (by CJ) £799	Good Very Good	Distinctive with oak end-cheeks, using Philips based 14 bit x 4 oversampling, Conrad Johnson electronics make this a musically rewarding player	Full search programme and timing	R	51/Coll
Sony CDP-M35 £170	Fair Fair	There is no disguising the lightweight plastic construction of this player, but the technical performance, sound quality, aesthetics and ergonomics all deliver more than one has the right to expect for £170.	Skip, scan, programming etc.	R	58
Sony CDP-350 £180	Fair Fair	A fairly basic machine. The lab test showed up some faults and it didn't do particularly well sonically	Programming, skip, search, repeat, hdph socket		70
Sony CDP-M55 £190	Fair Fair	£20 buys a remote control handset to operate your M35. Sony call it an M55 (see CDP-M35 review).	Simple remote, skip, scan, programming etc.	R	58
Sony CDP-550 £200	Good+ Fair+	Another dependable Sony, it doesn't have a digital output but at the price who's complaining? Fit and forget	Full remote headphone output, 4x 0/S	BB	64
Sony CDP-M75 £230	Good Good	This midi version of the '750 saves £20 on the price (see CDP-750 review).	Track entry remote, menu display ect.	BB	58
Sony CDP-750 £250	Good Good	A seductive blend of fine presentation and solid performance, all at a very realistic price that should ensure its success.	Track entry remote, menu display etc.	BB	58
Sony CDP-C50M £250	Fair Fair	The Sony concept of an autochanger is interesting and executed with characteristic thoroughness. The lab and sound test results reveal it to be of only average quality	Carousel autochanger, remote, multi disc programming, variable hdph socket		70
Sony CDP-M95 £280	Very Good Fair+	Very well equipped mid sized player fine build and finish, incorporating Sony's custom file disc labelling	Remote, programmable, variable hdph output	R	64
Sony CDP227ESD £400	Good Good	The cheapest of the ESD range offers plenty of ergonomically arranged facilities. It performed well in both the lab and on the listening tests, and its reasonable price makes it hard to miss	Remote, keypad track access, volume, hdph, comprehensive display, FTS, custom index, etc	R	70
Sony CDP-337ESD £550	Good Very Good+	Well built, high grade player with excellent if undemonstrative sound. Excellent resolution, dynamics and bass weight, though arguably not control	Random access remote, calendar display, FTS, memory	R	61
Sony 557ESD £1000	Excellent Good+	Superbly built flagship model that produced excellent lab results and very good sound. Many luxury features though not that good value	Full remote, disc directory, digital output, power volume, 8x 0/S, 18 bit		64
Teac PD135 £180	Fair Fair	Particularly easy to use, this lags a little behind the pack when it comes to sound quality, but it still represents a valid alternative for those who find the presentation attractive.	Skip, scan, programming, repeat.		58
Teac PD470 £250	Fair Good	Pleasant sounding though unexciting, ergonomically functional though predominantly plastic. It doesn't achieve the sonic status required in a hotly contested market segment	Remote, track key pad, autospace, comprehensive display, hdph socket		70

THE DIRECTORY

CG PLAYERS

NAME PRICE	LAB SOUND	COMMENTS	FEATURES	VALUE	BACK ISSUE FULL REVIEW
Teac ZD880 £450	Good Fair	Decent enough in most respects with a very good build and finish. Its sound isn't competitive enough to inspire any real enthusiasm	Remote, track key access, auto space, comprehensive display, hdph socket etc		70
Technics SL-P350 £250	Very Good+ Good	Nicely built, good features and fine sound, what more do you want for £250?	Remote, digital output, variable hdph output	BB	64
Technics SL-P770 £350	Excellent Good	Sophisticated, high resolution player, but inconsistent with level with some coarseness and compression during loud passages	Remote, 18 bit, rotary cue wheel, comprehensive display	R	61
Technics SL-P990 £450	Excellent Good	An obvious technical tour de force, with ample engineering and build quality to justify the price, but some subjective reservations nonetheless	Track entry remote, menu display, search dial etc		58
Technics SL-P1200 £800	Good+ Good	Looking more like a desk workstation than a stackable component, this will appeal to the creative recordist and semi pro user. Sounded pretty good	Headphones, remote control, search dial cueing, etc		51
Toshiba XR-9318 £150	Good Fair+	A basic Philips based player perhaps but just look at the price/performance equation	Remote via system, manual, non oversampled, 16 bit	BB	64
Toshiba XR-9128 £190	Very Good Good	A well equipped Philips clone with a very good performance for the price	Remote, programmable, digital output, hdph	BB	64

CD MIDI SYSTEMS

So you want a hi-fi, but you don't want to make a fuss about it. A pre-packaged system with everything matching up and no aggravator may not rank with carefully chosen separates on sound quality, but there's no denying the attractiveness or popularity of this approach – the market for pre-packaged component hi-fi systems is at least as big as that for separate items, even ignoring the vast numbers of low-cost single unit stacker systems.

The arrival of compact disc led to a new fashion for shelf-standing compact systems, or 'midis' as

they are known in the trade, as a replacement for earlier floor-standing rack systems (themselves the upmarket development from music centres). Only some 330mm wide, midis can more or less match full-size (430mm) rack components for performance, and are certainly cheaper to make, ship, sell and buy.

Whereas specialist hi-fi is moving steadily towards ultra-simple 'no frills' components, midi systems tend to be sold on a feature count at a price point, usually with little opportunity for

demonstration and comparison. Our test programme includes extensive auditioning and lab testing, while making allowance for the different aspirations of designers and expectations of users. Key features valued highly by customers include system remote control, automatic switching, double 'dubbing' cassette decks, and elaborate equaliser tone controls. And the top end of the market is developing with surround sound audio/video-ready packages.

NAME PRICE	LAB SOUND	COMMENTS	FEATURES	VALUE	BACK ISSUE FULL REVIEW
Aiwa X-55 £380	Average Average-	The turntable was slightly better than usual, the cassette deck highly limited, but the dreadful loudspeakers are the clincher	Combined cassette tuner-timer/amp, dedicated T/T speakers, & optional CD		65
Aiwa X-78 £550	Average+ Good	Good. The loudspeakers are disappointing and the turntable is excessively microphonic, but the rest of the system works well	Auto reverse cassette/tuner/amp & timer, T/T and CD	R	65
Aiwa V1500DX £999	Good Good	Remarkable features level even includes independent record feeds to each cassette. High class build, satisfying sound, but best without loudspeakers	Separates system, twin auto-reverse cassette, full remote, timer	R	54
Akai M.50CD £550	Poor Poor	Cassette lacks Type II compatibility, general sonics mediocre or less	Devolved from M.80 but simplified, part remote		65
Akai M.80CD £800	Good Good	Good all rounder with minor ergonomic shortcomings but generally practical layout	Separates based, twin auto-reverse cassette	R	65
Goodmans 5300CDM £400	Average- Average+	Crisply styled system with gutsy amplifier and sophisticated speakers. CD player works well, other sources are variously mediocre	Combined cassette/tuner/amp, plus T/T and CD with remote	R	65
Goodmans Maxim-Midi System £520	Average Average+	De-luxe version of 5200 system – very good value for money and readily upgradeable. Sonics rough but OK and speakers good. CD crude	All separates with twin cassette	R	54
JVC Midi-W900CD £1000	Good Good+	A competent allrounder, with important convenience related features and powerful linked recording facilities. Less strident speakers would be appreciated	Separates system, equaliser, auto-reverse cassette	R	65
Marantz MX583 £750	Below Average Poor	The system has potential in an A/V context, but is patently lacking in a purely audio one. Only the CD excels	Component system with A/V amp, no speakers		65
Marantz MX673CD System £900	Average+ Average	Tremendously flexible audio/visual system. Sound quality is satisfactory at best and ergonomics a mess	Various A/V inputs, remote, speakers optional		54
Philips F777 £850	Good Good	Excellent CD player, tuner and amplifier, offset partly by poor cassette deck and turntable	Separates system, optional remote, no speakers		65
Pioneer System 300 £1000	Very Good Very Good	Sharp, articulate and powerful system that works. The turntable is a weakness as usual, but the only real weakness in an uncommonly sophisticated package	Remote separates system, optional multi-disc CD	R	65
Proton AI-3000 £550	Good Good	There are a host of minor problems, including no LW, but the unit is attractively packaged and can be made to sound very good despite a woolly sounding amplifier	One piece CD, cassette, tuner and amp, remote	R	65
Sanyo System 22 £350	Average Average+	Some careful detail design has given this system sound quality out of keeping with ordinary appearance. More than the sum of its parts	Single piece, plus speakers	BB	65
Sanyo W40CD £380	Average Average	Low cost, no options package with attractive displays, cassette had high wow and flutter, but the rest worked OK	Semi auto T/T, auto record start, twin cassette	R	54
Sanyo System 33 £400	Average Average+	Similar to the 22, and better when extended, but the price (and value) advantage is dissipated	As 22, separate T/T, remote	R	65
Sharp SA-CD800H £700	Average Average-	A superficially high grade, high spec system, the SA-CD800H actually sounds clean but a little 'synthetic'	One-piece, 6-disc CD, no T/T		54
Sony Compact 350CD £480	Average- Average-	Visually stunning appearance hides very basic audio attributes. The turntable and cassette deck suffering severe pitch related shortcomings. CD is too expensive in this company	Integrated one piece, (ex CD), 5 disc non-cartridge player		65
Sony Compact 500CD £550	Average+ Average+	Impressive visuals are matched to electronics which in audio terms lack inspiration. The speakers are particularly poor	Combined amp/cassette, 36 preset tuner, T/T component CD		65
Sony Compact 700CD £700	Average+ Good	Loudspeakers and (to a lesser extent) turntable spoil a fine sounding and stylish – if rather costly – package	Separates system, auto reverse cassette, 36 preset tuner		65
Sony Series 1000CD £1500	Very Good Excellent	Very sharp, articulate sounding system from CD and FM. Cassette deck good and flexible, turntable as usual is not in keeping	Separates system, twin auto-reverse cassette, amp with DAC	R	65
Technics X900CD £470	Average Average-	Good build and mostly good sound is offset by mediocre amplifier and loudspeaker and some operational oddities	Main cassette/tuner/amp, separate T/T and CD		65
Technics X950 System £850	Good Good	Fine sound from CD, FM and AM radio and cassette. The record deck is a little better than normal too, but the loudspeakers are disappointing	Component based, CD, twin auto-reverse cassette, tuner, auto T/T, amp and speakers	R	65
Technics X9900 System £1250	Good Very Good	Powerful, flexible and well built system – loudspeakers apart. Even the turntable is on the rough side and the loudspeakers should be changed if possible. The rest of the system is AI	Twin deck, programmable T/T, amp, CD, speakers	R	65
Toshiba V17CD £370	Average Average+	Loudspeakers are the weak link, with cassette and turntable also indifferent. Tuner and CD worked well though, so reasonable value for money	Twin cassette, semi-auto T/T	R	54
Toshiba V18CD £400	Poor Poor	Neat and simple to use basic system with good CD but poor elsewhere and abysmal loudspeakers	Integrated amp/cassette deck, other components separate but dedicated		65

THE DIRECTORY

TUNERS

TUNERS

The radio medium operates at a much lower profile than TV, but in areas outside pop music the BBC service is the envy of the world. Live Prom concerts can rival all other sources from a hi-fi perspective. Only the FM (VHF) bands give stereo hi-fi sound, though AM (MW & LW) are useful for receiving certain transmissions in the UK.

Something of a hi-fi afterthought, tuners are often selected merely to match a chosen amplifier

cosmetically. However, the task they carry out is far from simple (or cheap), combining the skills of RF (reception) and audio (signal processing) engineering. The importance of the former will depend on local reception conditions, but money invested in a high quality outside aerial system is well spent.

Tuners come in two basic types. Analogue models tune gradually (and usually manually) across

the bands, and can have analogue or digital displays; they are often preferred for sound quality, and are certainly best for AM bands. Digital tuners offer convenient automatic tune facilities and hold many station positions in pre-set memories.

(The Lab and Sound results for models tested in issue No. 65 refer to FM only. For AM results see under Comments.)

NAME PRICE	LAB SOUND	COMMENTS	FEATURES	VALUE	BACK ISSUE FULL REVIEW
Akai AT-52L £150	Very Good Very Good	Holds its own on FM against many much more expensive tuners, but AM is very poor	All bands	BB	65
Akai AT-93L £250	Good+ Good+	By AM standards presentable (good) while FM delivers the goods	All bands, aerial switch	R	65
A&R Arcam Alpha £149	Good Average+ +	Attractively classic British analogue tuner with sound quality comfortably better than most	FM/AM Analogue	BB*	50
A&R Arcam Delta £270	Very Good Very Good	Hi-fi sound on FM, good on AM, a dependable British all-rounder	6AM, 6FM presets. FM/MW. LW display manual tune	BB	55
Denon TU 450L £130	Average+ Average+	Poor AM sound quality may be a deterrent but the FM performance fully merits recommendation	FM/AM Digital MW/LW	R	50
Harman Kardon TU920 £299	Good Average	Rather weak sound quality for the price despite good lab test results	16 presets, AM/FM, digital auto scan, active tracking		55
Harman Kardon Citation 23 £559	Good Very Good	Fine performance, interesting features and ease of use are this tuner's forte, and the sound quality is top notch	FM/AM seek/manual adjustment muting 16 presets remote control	R	60
Hitachi FT-MD 5500 £200	Excellent Good+ +	A powerful, good sounding tuner with versatile facilities	16 presets, FM, AM, MW auto scan digital, signal meter	BB	55
Kenwood KT-660L £130	Fairly Good Fairly Good	You get your money's worth of gadgets and the radio's basically sound although programming is complicated. AM - fairly good	Timer, clock, all bands	R	65
Kenwood KT-1100D £300	Good+ Good+	Behind a gaudy and rather useless display the radio is much better than you might first think. AM - good	Firework display. FM/MW bands only	R	65
Marantz ST35L £125	Good+ Average-	It works well enough but the sound could be better for the money	16 presets, AM/FM, digital auto scan, active tracking		55
Meridian 204 £525	Good+ Good	Pleasant sounding with a fine finish but does not make the grade at this price	FM only, auto scan, digital, remote, clock timer		55
Musical Fidelity TI £300	Good+ Very Good	Top class FM stereo sound on good signal strengths from this audiophile model. Watch out for local CB!	FM only, analogue box dial, manual tune, signal meter	R	55
NAD 4020B £139	Good Average+	Not the quietest or most sensitive tuner tested, it still provided good sound for the money, being "musical and ambient"	Analogue FM/AM	BB	50
Naim NAT 01 £1098	Very Good Very Good	There may be better sounding tuners in the world, but we have yet to hear one	No presets. Two box, flywheel tuning FM only, Analogue	R	50
Nakamichi ST-7E £750	Good+ + Good+	Exceptionally good for weak-signal areas, and good all round	16 AM/FM presets, Schotz enhanced sensitivity, auto time digital		55
Pioneer F551L £100	Good+ Good+	High value budget tuner, very little to argue about (includes long wave)	12 FM, 12 AM presets, auto scan, digital and signal strength meter	BB	55
Pioneer FT 443L £130	Poor Poor	The pretentious 'computer controlled' features don't amount to much. AM - very poor	All bands		65
Pioneer F-737 £230	Good+ Good+	Terrific separation and selectivity on FM, but AM still lacking. AM - fair	FM/MW only	R	65
Pioneer F91 £350	Excellent Good+ +	Easy to use, this model has excellent RF performance and scored very high ratings on the listening tests	FM/AM 24 presets	R	60
Proton AT-300 £199	Good Good	The AT-300 is pretty on the outside, orthodox on the inside and rather dear. AM - poor	FM/MW only	R	65
Quad FM4 £289	Very Good Good+	Fine sound, excellent ease of use, good build and finish and a more than satisfactory technical performance	7 presets. Digital	R	50
Revox B260 £918	Excellent Very Good	Sophisticated and expensive, the B260 is ideally suited to the rest of the Revox range and should also work well in other systems	FM - virtually everything	R	60
Rotel RT-830AL £110	Good+ Good	Fine sounding budget audiophile material, no frills, no fuss	Manual dial analogue, FM, MW, LW	BB	55
Rotel RT-850AL £160	Good+ Good+	Scoring well on listening tests and one of the best sounding tuners at its price level, it was a bit let down on AM but RF performance was good	FM/AM, digital	BB	50
SAE T-102 £449	Good+ Good+	Expensive for all the radio you get, but sounds interesting. AM - Poor	FM/MW only	R	65
Sansui TU-D99XL £249	Very Good Good+	This slimline compact model gave good FM sound quality and strong RF performance. But the AM sounded unpleasant	FM/AM, 16 presets	R	50
Sony ST-S300L/ ST-S100L £140/£100	Good Good	A reasonable entry point, not for difficult areas. AM - Poor	All bands	R	65
Sony ST 500ES £200	Good+ + Average-	Disappointing sound quality but good lab performance. (Includes long wave)	10 AM/FM presets, auto scan digital		55
Sony ST-S 700ES £299	Very Good Very Good	First class in every respect including FM sound quality. Even AM was well above average	FM/AM, 10 presets, digital scan	BB	60
Yamaha TX-L400 £130	Good+ + Good+	Good FM sound, let down by poor AM but otherwise good value	16 presets, auto scan, digital, FM, MW, LW	BB	55
Yamaha TX-500 £150	Average+ Average	Under a gaudy coat, this sensitive tuner gave reasonable stereo results. However, the AM had again been thrown down a well	20 presets (10 buttons) digital		50

THE WORLD'S NO 1 GUIDE
TO BUYING HI-FI

HI-FI CHOICE

THE DIRECTORY

HEADPHONES

There are a variety of different approaches to headphone design, and examples of each turn up in this group. Amongst the more expensive esoteric models, electrostatic drivers are used in square open-backed phones such as the Jecklin and Stax models. The majority of these come with some form of transformer which takes the signal initially from the speaker terminals on the amplifier. The actual speaker cables then travel from this unit via a

bypass switch to the loudspeakers.

The more down to earth models feature dynamic drivers in circular open-backed designs. The advantage of open backs seems to be a correspondingly open sound and a less claustrophobic feel to the music. One can also of course hear external noises and irritate people on public transport.

The third category are closed-back designs,

which are useful in situations where it is necessary to block out background noise.

Another means of distinguishing different types is the way they sit on your head or ears. There are three styles: circumaural models enclose the ear and rest on the side of the head; supra-aural designs press on the outer ear (pinna); and intra-aural types rest inside the ear and are popular amongst users of personal stereos.

NAME PRICE	SOUND COMFORT	COMMENTS	TYPE	VALUE	BACK ISSUE FULL REVIEW
Aiwa HP-X8 £49	Good Very Good	Very slick Walkman oriented phones which are tonally well balanced and go loud without becoming painful	Supra-aural, closed-back, dynamic	R	63
Aiwa HPEX-200 £90	Good Good	Modern looking and well finished the Excelsias, as they are dubbed, had meaty bass and sounded reasonably open for the type	Circumaural, closed-back, dynamic		63
AKG K135 £35	Fair Poor	Despite a very appealing design the K135s don't live up to the usual AKG standards, though they do have the ability to reproduce rhythm well	Supra-aural, semi-open, dynamic		63
AKG K240 Monitor £60	Good Very Good	Something of a classic these AKGs are very user friendly in all respects; sonically on the warm side of neutral	Circumaural, semi-open, dynamic	R	63
AKG K280 Parabolic £110	Very Good Good	A very revealing and unusual twin driver design that uses the same principle as a satellite dish to beam sound into the ear	Circumaural, open-backed, dynamic	R	63
Audio Technica ATH 909 £55	Average Average	Quite impressive in the treble though a bit bass shy, the 909s worked well at highish levels	Circumaural, semi-open, dynamic		55
Audio Technica ATH 910 £65	Good Average	The closed-back 910s are an improvement on the 909s with a nice rhythmic quality rarely found with headphones	Circumaural, closed-back, dynamic	R	55
Audio Technica ATH-911 £75	Very Good Very Good	Nicely finished dynamic headphones with all the trimmings, plus a very clean and subtle sound	Circumaural, open-backed, dynamic	R	63
Beyer DT 325 £30	Fair Very Good	Lightweight in more ways than one, the 325s may be a little bright for some systems and tastes but will suit duller sources	Supra-aural, open-back, dynamic	R	63
Beyer DT330 Mk II £45	Poor Good	Not the most revealing phones encountered, the 330s were nevertheless enjoyable and rarely offended	Circumaural, semi-open, dynamic		55
Beyer DT550 £69	Good Good	On their own the 550s sound articulate with a slightly 'gritty' treble and 'keen' midrange, not suitable for headbangers!	Circumaural, semi-open, dynamic		55
Beyer DT880 £90	Good Good	Well made cans with a warmish sound but fairly solid midrange, though they're not that informative for the price	Circumaural, semi-open, dynamic		63
Beyer DT990 £119	Very Good Very Good	The 990s are definitely a significant pair of dynamic headphones; they have a smooth and yet revealing, neutral sound that is hard to criticise.	Circumaural, open-back, dynamic	R	55
Jecklin Float Model One £79	Very Good Good	Whilst very unusual in appearance the Floats give remarkable sound quality and openness at a reasonable price	Circumaural-ish, open-back, dynamic	BB	55
Jecklin Float Model Two £99	Very Good Good	Helmet shaped and pretty unflattering but open sounding and comfortable in the long term. Note lack of adjustment means you should try before you buy.	Circumaural-ish, open-backed, dynamic	R	63
Jecklin Float Electrostatic £399	Excellent Good	One version of the state-of-the-art, these electrostatics have an openness of sound rarely found in the breed, with good dynamic range to boot	Circumaural-ish, open-back, electrostatic	R	55
Koss K/6X Plus £30	Poor Fair	'Sixties-style' phones from the good ole US of A, their sonic style is unique and can make a system sound quite different	Supra-aural, closed-backed, dynamic		63
Quart Phone 30 £40	Fair Good	Whilst not as seductive as their PMB25 predecessor the 30s are reasonably neutral and do improve on some of the competition - though not stunning	Circumaural, semi-open, dynamic		63
Quart PMB 25II £40	Good Good	Despite a somewhat unconventional suspension system the 25s put in a convincing and enjoyable performance with warm yet lively balance	Circumaural, open-back, dynamic	BB	55
Quart Phone 70 £70	Good Good	Competent performers that were hard to criticise but lacked the life and sparkle of which some of the competition are capable	Circumaural, closed-back, dynamic		63
Quart PMB 65 £70	Good Good	Quite revealing and neutral albeit with the usual closed back sound, this competes well with more established models	Circumaural, closed-back, dynamic	R	55
Quart PMB 85 £90	Very Good Fair	These more expensive Quarts bear a striking resemblance to the Jecklin Float models and use two drivers per ear. Sound is a bit bass heavy but not bad overall	Circumaural, open-backed, dynamic		63
Ross RE-2760 £35	Fair Poor	Stylish white cans from the only British firm in the business. Unfortunately sound quality is not up to par in this price range	Supra-aural, closed-back, dynamic		63
Sennheiser HD30 £13.50	Poor Good	Built specifically for the personal stereo market these small and light Sennheisers have a slightly synthetic sound, but are an upgrade on the average Walkphones	Supra-aural, semi-open back, dynamic		55
Sennheiser HD450 £27	Fair Good	Modern, simple and lightweight phones that are remarkably robust and which turned in a relaxed if weighty performance that was at worst pleasant	Supra-aural, semi-open, dynamic	R	63
Sennheiser HD480 £37	Fair Good	Using the same shell as the 450s, the 480s were a little softened and unrevealing by comparison with their competitors	Supra-aural, semi-open, dynamic		63
Sennheiser HD420SL £47	Good Good	The 420s gave a full and tangible quality to instruments and voices; whilst not the most revealing headphones around they would suit slightly brash sources	Supra-aural, open-back, dynamic		55
Sennheiser HD540 Ref Gold £160	Very Good Good	The 540 Golds prove that dynamic headphones can be subtle, informative and capable of creating a remarkable sense of space	Circumaural, open-back, dynamic	R	55
Sony MDR V3 £30	Good Fair	Portable stereo oriented phones that are very nicely made and combine clarity with a pleasant lack of distortion	Supra-aural, closed-back, dynamic	BB	63
Sony MDR V6 £70	Good Very Good	A lot more civilised and dynamic than the V4s, these were pretty good for their type and fold up to boot	Circumaural, closed-back, dynamic	R	55
Sony MDR V7 £70	Very Good Very Good	Classy sounding cans that are very slick and work well with all types of music, setting the standard in their price range	Circumaural, closed-back, dynamic	R	63
Stax SR34 £140	Very Good Fair	The least expensive Stax headphones around, the SR34s are lively and rhythmic with good tight bass and a sweet midrange	Supra-aural, open-back, electret		55
Stax SR84 £210	Very Good Very Good	The stepping stone between dynamics and full electrostatics, these electret phones are revealing, open and highly enjoyable	Supra-aural, open-backed, electret	R	63
Stax Gamma pro/SRD-X pro £296/£230	Excellent Very Good	The Gamma pros are like a stethoscope for your hi-fi, revealing subtleties that many loudspeakers fail to resolve	Circumaural, open-backed, electrostatic	R	63
Stax SR Gamma £299 (inc. SRD-6 Adaptor at £100)	Very Good Very Good	The next model down the Stax range from the Lambda, the Gamma is an excellent headphone with little to criticise but the price.	Circumaural, open-back, electrostatic	R	55
Stax SR Lambda Pro £545 (inc. SRD-7SB Mk 2 Adaptor at £185)	Excellent Very Good	A bit of an industry reference the Pros are frighteningly revealing, bringing across more information than loudspeakers costing twice as much	Circumaural, open-back, electrostatic	R	55

THE DIRECTORY

PERSONAL STEREO

Whilst not exactly hi-fi components, personal stereos probably play more music to more ears than all manner of domestic systems and as such demand some attention. Now that personal CD players have joined the ubiquitous Walkman in the market, the variety and standard of sound quality is huge, with obscurely named cassette players practically falling out of your cornflakes packet and Discmen going for £300.

Despite their diminutive size personals attempt to incorporate as many gimmicks and features as

possible, cassette players often incorporating tuners, graphic equalisers and Dolby noise reduction. CD players are still relatively expensive and don't tend to vary that much on the features front, rather the amount and quality of accessories differs. Most models come with a mains adaptor and some include remote control.

Sound quality on the cassette front seems to have a proportional relationship to price and integrity of construction – wow and flutter being quite obvious on the cheaper models. CD players

become less noisy as they get dearer and also reduce in size; one drawback of the latter seems to be that immunity to shock suffers as a consequence. Cassette players do, on the whole, seem better suited to the outdoor life than their digital counterparts, as does the software. Bear in mind that the sound and lab ratings given below cannot realistically be compared to those in other categories or between cassette and CD personals.

PERSONAL CASSETTES

MODEL NAME PRICE	LAB SOUND	COMMENTS	FEATURES	VALUE	BACK ISSUE FULL REVIEW
Aiwa HS-G35 MkII £30	Poor Fair	A reasonable player for the price but not well suited to classical material and let down by the headphones	Autoreverse, graphic EQ, types I & II		56
Aiwa HS-J36 £89	Good— Average	Comprehensive facilities and reasonable sound are no mean feat for the price.	Dolby, autoreverse, types I, II & IV, AM/FM, recorder	R	56
Aiwa HS-PX101 £149	Average— Good	A very slick little number with soft touch controls and remote control headphones	Dolby B, C, autoreverse, types I, II & IV R		56
Ferguson 3T46 £35	Very Poor Poor	Not particularly subtle but having reasonable speed constancy, it's OK with most material but can get painful	Autoreverse, AM/FM		56
Philips D6658 £30	Very Poor Poor	The low price limits sound quality, and this is not a spectacular machine, but it does a reasonable job nonetheless	Graphic EQ, AM/FM		56
Saisho PS90R £40	Poor Poor	A bit of a jumble of features and gadgets, the PS90R has on-board speakers, an extending aerial and even records, but sound quality is dubious	Graphic EQ, types I, II & IV, AM/FM, recorder		56
Sanyo MGR-77 £35	Very Poor Very Poor	Rather a basic machine with a raw edgy sound, not helped by poor speed stability	Graphic EQ, AM/FM		56
Sanyo MGR-87 £50	Very Poor Fair	The 87 came up with a slightly fast but rhythmic sound. Although lacking in finesse, it worked OK with pop material	Autoreverse, graphic EQ, AM/FM		56
Sanyo MGP 600D £50	Average+ Average—	With styling aimed at the fairer sex the 600D sounded a little better than the similarly priced MGR-87. Lacking in clarity, it was still quite endurable	Dolby, autoreverse, graphic EQ, types I, II & IV		56
Sanyo JJ-P4 £100	Poor Good	Claimed by its makers to be the world's smallest personal stereo the JJ-P4 is a tasty looking object that's capable of good sounds to boot	Dolby, autoreverse, tape types I, II & IV, rechargeable		56
Sony WM-34 £40	Poor Average	This straightforward no frills Walkman makes pretty plausible sounds at a reasonable price and apart from the Walkman Pro was the only model to earn a Best Buy rating	Dolby, types I, II & IV	BB	56
Sony WM-F63 £100	Average— Average—	This attractive Sports Walkman is nicely built but sonically flawed by rather hissy intra-aural headphones	Dolby, autoreverse, types I, II & IV		56
Sony Walkman Pro £249-£289	Good+ Excellent	One of the finest sounding cassette decks on the market today. A mandatory Best Buy, it takes other personals to the cleaners (except on weight and power consumption)	Dolby B, C, types I, II & IV, record, line BB in/out, varispeed		52/56
Toshiba KT-4027 £35	Very Poor Very Poor	Not a very wonderful machine, the 4027 sounded pretty appalling with all but the most unsubtle music	Graphic EQ, AM/FM		56
Toshiba KT-4047 £60	Average Average	This model proved capable of making the most of better recordings, and sounds reasonably tuneful	Dolby, autoreverse, graphic EQ, types I, & II, AM/FM	R	56

PERSONAL CDs

MODEL NAME PRICE	LAB SOUND	COMMENTS	FEATURES	VALUE	BACK ISSUE FULL REVIEW
Goodmans GCD-10 £120	Average— Poor	Cheap, flashy and not short on accessories the GCD-10 is a rather noisy player that left a lot to be desired on the sound quality front	13.5 x 3.7 x 18cm, 478g, mains adaptor		66
Kenwood DPC-77 £270	Good+ Very Good	Very chunky and well made, the DPC-77 is the only player to include a digital output and sounds very good through its analogue output – a suitable domestic alternative	12.8 x 3.5 x 14.5cm, 750g, digital output, mains & in-car adaptors	R	66
Philips D6800 £130	Average Average—	A competitively priced and reasonably attractive looking player whose sonic performance is somewhat marred by a rather grainy top end	13 x 4 x 17.5cm, 516g, 3" ready, twin hdph sockets		66
Sanyo CP-12 £260	Fair Good+	Sonically amongst the more enjoyable personal CD players and capable of revealing the musical aspects of a disc in an interesting and entertaining fashion	12.5 x 2 x 12.7cm, 380g, wired remote, mains adaptor	R	66
Sony D-20 £150	Average+ Fair	Not bad for a machine at this price, it's nicely designed and reasonably robust, with reasonable sound quality	13.8 x 3.8 x 15cm, 450g, mains adaptor	R	66
Sony D-40 £200	Fair Good	A 'largish' but attractive player that works well as a Discman being fairly immune to shock and capable of making a good job of reproducing the discs it's given	13.6 x 3.7 x 14.7cm, 480g, mains adaptor, slinky case	R	66
Sony D-88 £300	Average— Fair+	A stylish and 'cultish' object, the D-88 is very small and has an adjustable disc drive for three and five inch discs. Sound quality doesn't quite match appearance	9.4 x 3 x 9.8cm, 300g, 3" ready, mains adaptor, no line out		66
Sony D-150 £300	Fair+ Very Good	One of the most enjoyable machines encountered, sounding informative and sweet and looking very tasty to boot. Comes complete with a tough carrying case	12.6 x 2.1 x 13.5cm, 420g, 3" ready, R mains adaptor		66
Toshiba XR-9458 £250	Average+ Good—	Accompanied by a plethora of accessories including a meaty plinth and infra red remote, the Toshiba didn't quite make it on the sound quality front but is worth considering	12.6 x 2.4 x 12.9cm, 460g, 2 remotes, mains adaptor, 3" ready etc		66
Xenon CDP-03 £180	Average— Fair+	A well made and competitively priced machine that is ergonomically spoilt by flat slightly unresponsive buttons. Sound quality ain't too bad but a trifle boring	12.6 x 2.7 x 12.6cm, 560g, high frequency filter, key lock		66

To Advertise in
this space ring Miriam Young
on 01-631 1433

THE DIRECTORY

CD PORTABLES

CD Portables or Yuppie Blasters as we classified them are basically portable stereos gone digital, ie a compact disc player is included alongside the usual AM/FM radio and single or double cassette deck. Compact disc is a novelty that seems to add a fairly hefty premium onto the price of the standard ghetto blaster, but the improved sound quality over standard cassettes may justify this for some. In virtually every case a CD output socket is

fitted which means that it's possible to play silver discs through a domestic amplifier and loudspeakers, thus they are some sort of substitute for standalone mains machines (as are the personal CD players). One drawback with having a CD player on board is that batteries are gobbled up even quicker than usual, up to ten batteries being required in some cases. Neither are the units particularly light, the heaviest weighing eight kilos!

However they do all run off the mains too, and come with an appropriate lead for this purpose. Other useful features common to most are spare input sockets to record from an external line source such as a preamplified vinyl disc signal, and microphone sockets for recording live events (although the usual lack of record level adjustment is a nuisance).

MODEL PRICE	SOUND	COMMENTS	FEATURES	VALUE	BACK ISSUE FULL REVIEW
Ferguson RCD02 £300	Poor	A large, slightly tinny midi system-esque unit with removable speakers and a slightly brash sounding CD player	Twin cassette, graphic equaliser, spare input (DIN)		53
Fisher PH-D473F £300	Average	The Fisher is quite a neat and compact player which is nice to use but doesn't offer particularly great sound quality	Autoreverse, AFC		53
Hitachi CX-W800 £300	Average+	This meaty Hitachi lives up to Blaster expectations, its super woofer bass speaker giving maximum street credibility	Twin cassette, graphic equaliser, phono input	R	53
Memorex CD-3300 £280	Average	A little bit tacky, the Memorex put in a plausible if unenthralling performance, and will work with external speakers	Spare input		53
Panasonic RX-FD80L £300	Average-	Shiny in a glitzy way, this Panasonic features a reasonable cassette deck but a below par CD player with tiny transport controls	Autoreverse, spare input		53
Sharp WQ-CD15 £250	Good	A reasonably compact machine with a quite impressive CD player and a novel twin cassette mechanism	Twin cassette, graphic equaliser, spare input	R	53
Sony CFD-66L £350	Good	A very attractive player in the true yuppie mould of white plastic with silver details, it even sounds OK	Spare input, shuffle play, AMS (tape search system)	R	53
Toshiba RT-7096 £250	Poor	Quite a large box for the money, the Toshiba isn't too special when it comes to sound quality but does have partly wooden detachable speakers	Twin cassette, graphic equaliser, spare input		53

STANDS AND SUPPORTS

It's becoming more and more apparent that all the components in a hi-fi system benefit from being placed on the right kind of support. It is already acknowledged that performance of electro-mechanical transducers, such as turntables and loudspeakers, can be greatly improved by using highly rigid supports. This notion has been expanded to include electronics such as amplifiers and compact disc players, and inevitably a broad range of stands and supports have been produced to cater for this requirement.

With loudspeaker stands there seems to be two

broad schools of design. The most common is the open frame type which uses square section steel tubing (usually less than an inch square) made up to form a tripod or quadropod stand usually fitted with spikes top and bottom to ensure good coupling to both floor and cabinet. However, for reasons of domestic harmony this latter option is often not pursued as eagerly as perhaps it should be. The alternative approach is to use mass. Larger section (approximately 3 inch x 2 inch) tubing is welded between square top and bottom plates and filled with sand and/or lead shot. Again, this type uses

spikes at the base but Blu-tack or the like for coupling with the speaker cabinet. Equipment supports generally place isolation quite high on the list of priorities and usually use a lightweight steel frame to support an MDF platform. Once again spikes are used to minimise contact with the platform and ensure good coupling to the floor. Minimising weight without compromising rigidity seems to be the aim with turntable supports but those designed for electronics often employ some form of damping to kill vibration, sometimes in the form of mass.

LOUDSPEAKER STANDS

MODEL PRICE	TYPE FINISH	COMMENTS	TOP PLATE SIZE HEIGHT	VALUE	BACK ISSUE FULL REVIEW
Appolo A820 £40	4 leg Fair	A light open-framed budget design slightly lacking in rigidity and subjectively superceded by other stands costing £10 more.	19 x 19cm 53cm		58
Appolo A10 £47.25	4 leg Fair	A robust and lightweight model, it would make an ideal upgrade for those still happy with the big boxes of old.	19 x 19cm 44cm	R	58
Foundation Fred £65	2 leg Average	With sand filling the Freds made speakers sound tight and coherent with a more even balance.	19 x 19cm 36/43/59cm		58
Foundation Maggi £159	Pair Very Good	Made for Magneplanar and other similar panel speakers they seem to have a healthy effect on the sound quality thereof.	50 x 2cm 2cm	R	58
Foundation Pi £250	2 leg Very Good	Overpriced in material terms the Pi nevertheless has a very positive effect on the low frequency performance of conventional speakers.	20 x 20cm 25/38/46/53cm	R	58
Heybrook Point 5 £50	3 leg Very Good	An unusual triangulated open frame stand that can help certain speakers sound more transparent and fluent - a good value stand	23 x 21.5cm 47cm	BB	58
Heybrook HBS1 £75	4 leg Very Good	With its new aluminium base frame the HBS1 fared very well in the listening tests. It allowed much of the speakers own 'sound' to remain intact.	23 x 21cm 47cm	R	58
Linn Kan II £79	4 leg Very Good	Built to support Linn's Kan speaker this stand is well suited to the task, but is less successful with other loudspeakers.	19 x 16cm 59cm		58
Linn Sara £85	4 leg Very Good	The Sara exhibits some odd properties so its use other than with the Sara loudspeaker should be viewed with caution.	25 x 21cm 53cm		58
Monotrak Engineering M1 £58	1 leg Good	The M1 gave the mid and treble a commendably smooth and detailed presentation but bass sounded rather lacklustre and muddy.	19 x 18.5cm 48cm		58
Monotrak Engineering M4 £58	4 leg Very Good	Begging comparison with Heybrook's HBS1 the M4 maintained much of the openness and forthright detail of that model.	23 x 21.5cm 53cm	R	58
Monotrak Engineering M4S £58	4 leg Very Good	Its stature and stability would seem to mark it out as most suitable for smaller, lighter cabinets. The M4S possessed an open midband and clear treble.	20 x 17.5cm 53cm		58
Mordaunt-Short IS1 II £45	3 leg Good	Suited to low mass speakers, preferably using spikes to effect coupling, they sounded slightly 'jazzed up' but the overall sound was quite unuddled.	18 x 15cm 56cm	R	58
Origin Live £117	3 leg Good	An unusual tripod stand devoid of top plate and taking up more floor space than normal, subjective and technical performance was exemplary.	(support area) 22 x 17.5cm 52cm	R	58
Partington PP4 £50	1 leg Good	The PP4 offers a rather mixed performance, though when damped with sand infill it was less ready to embellish the overall sound and low frequencies became tauter and quicker.	18 x 16.5cm 48cm		58
Partington Dreadnought II £120 (filled)	1 leg Very Good	Ideal for systems on the light/bright side of neutral, the Dreadnought IIs nevertheless still need some careful re-examination by Partington.	17.5 x 16.5cm 63cm		58
QED TS22 Tristand £50	3 leg Very Good	Most tracks sounded uplifted or buoyant, never thick nor coloured. It worked well with most of the speakers tried and encouraged a fluid and revealing midband.	19 x 17cm 45/50/58cm	BB	58
RATA Torlyte £190	2 panel Excellent	Suited to low mass speakers, these unusual stands are hardly discreet but offer transparent and clean sound - much like the Torlyte table!	25 x 21cm 48cm	R	58
Target HS20 £53	1 leg Excellent	This monopod stand can be used either filled or unfilled and encourages different characteristics in the sound accordingly.	19 x 16.5cm 53cm		58
Target HJ15/3 £83	3 leg Very Good	Sound quality was basically very good though without the sand infill some loudspeakers may sound a little unbalanced as both bass and treble regions are subjectively exaggerated.	28 x 28cm 40cm	R	58

THE DIRECTORY

EQUIPMENT SUPPORTS

MODEL PRICE	TYPE FINISH	COMMENTS	SIZE (H x W x D)	VALUE	BACK ISSUE FULL REVIEW
Audioquest Sorbothane Feet £10 each	Feet Good	These large gundrops are very useful for damping vibrations in amplifiers and especially CD players.	6.5 x 2.5cm (circular)	R	57
Cornflake TCS5 £50	Table Very Good	A little too close to the ground for comfort, perhaps, but this novel and stylish little table is certainly worth seeking out.	29 x 43 x 33cm	R	57
Cornflake TCS6 £50	Shelf Good	A squat and rigid frame supports a Medite top board with four adjustable spikes, better suited to suspended sub-chassis turntables.	43 x 23 x 33cm		57
Deltec Isolation Base £135	Platform Good	Designed for all CD players, amplifiers and separates, but not suspended sub-chassis turntables, the isolation is second to none.	50.5 x 40cm	R	57
RATA Model A £125	Table Very Good	A three-legged Torlyte turntable support that has become something of an industry reference.	46 x 46.5 x 38.5cm	R	57
RATA Amplat £40.25	Platform Very Good	A lightweight and rigid Torlyte slat with spikes for floor or shelf mounting, it works well in conjunction with the Target TT2.	4 x 44.5 x 35cm		57
Sound Organisation Table £55	Table Very Good	A deceptively simple structure that just happens to be engineered in a thoughtful, and ultimately successful manner.	37 x 45 x 35cm	BB	57
Sound Organisation Wall Stand £40	Shelf Very Good	The first of its ilk and still amongst the best, this simple framework represents a vast improvement over standard furniture shelves.	27.5 x 43 x 35cm	BB	57
Target TT1 £46.50	Shelf Excellent	This rigidly braced shelf offers both good sound quality and material value for money.	26 x 46.5 x 35.5cm	BB	57
Target TT2 £47.50	Table Very Good	Standing up to the best in most areas, the TT2's only real foible concerns a slight loss of bass 'slam'.	52 x 46.5 x 35.5cm	BB	57
Townshend Suspension Base £145	Platform Fair	Designed to complement the Rock turntable, this platform will bring subjective improvement to a wide range of electronics.	43 x 36cm	R	57

CABLES AND CONNECTIONS

Although cables and connections are sometimes thought to be the least important items in an audio system there has been a growing awareness in recent years that they have a significant effect on sound quality. To this end there is now a vast array of exotic cables and interconnects available to those interested in experimentation. The key observation on cables is that they are much more than mere accessories. Carrying the audio signal, just as an amplifier does, it's really not too surprising that they can influence the quality of that

signal. The characteristics of any cable are determined by the materials and topologies utilised in its construction. The purity of the conductor, nature of the insulator dielectric, mechanical construction, physical geometry, RF characteristics, efficiency of screening and finally the connectors themselves, all play vital roles in the sonic character. These factors tend to vary more with interconnect cables which are used to carry the signal between active components like pre and power amplifiers. The

interconnects summarised here were tested in 1m terminated lengths and therefore the results and prices relate to that length - some cables may well perform differently when used in longer lengths.

The features column contains information on the material make-up of the different cables with the following abbreviations: OFC - oxygen free copper, OFHC - oxygen free high conductivity (Audionote define the HC as high crystal), PC-OCC - pure copper by ohno continuous casting, LC-OFC - linear crystal oxygen free copper.

INTERCONNECT CABLES

MODEL PRICE (per metre)	LAB SOUND	COMMENTS	FEATURES	VALUE	BACK ISSUE FULL REVIEW
Apature LSD N/A in UK	Poor Fair	Faint resonant boom was audible at very low frequencies, but otherwise this cable sounded remarkably neutral.	Silver plated copper, PTFE dielectric		59
Audioquest Reference 2 £29	Good Fair	Ultimately Reference 2 simply damped much of the atmosphere and emotional charge of a musical performance.	OF copper		59
Audioquest Livewire Topaz £29	Good Fair	Sounding 'bigger' and faintly richer than Reference 2, Topaz was also slightly grainy at the top end.	Gold-plated plugs, OFHC copper		59
Audioquest Livewire Ruby £45	Fair Good	Smother sounding than the Topaz, the extended crystal Ruby is less grainy and coarse, better able to resolve complex passages.	FCL copper twin axial	R	59
Audioquest Livewire Quartz £65	Good Good	Quartz has an ideal, neutral balance that embodies sparkling clarity without the drawbacks of harshness or compression.	3 piece plugs, PTFE dielectric	R	59
Audio Technica AT6115 £50	Very Good Fair	This cable sounds somewhat 'quieter' than the original LC-OFC interconnect, but is also less transparent and three dimensional.	PC-OCC copper coaxial		59
Audionote Copper ANC £35	Fair Good	ANC sounded punchy with a faintly lean but tightly-focused bass character. This crystalline precision waned slightly at higher frequencies.	OFHC copper twin-axial	R	59
Audionote Flexible Silver ANS £85	Fair Good	ANS scored a hit with its transparent midband and revealing but quite unforced treble quality. Bass transients were slightly softened.	Silver signal & Copper screen	R	59
Audionote Silver ANV £140	Poor Fair	Fair weightier-sounding than the flexible ANS, ANV interconnect also possesses a fair degree of treble clarity and sparkle.	21 strand silver Litz		59
Aural Symphonics N/A in UK	Poor Good	This cable enjoyed an open and transparent midband and sounded remarkably neutral and faithful to the source.	OF copper PTFE dielectric	R	59
Budget Patch Cords see text	Fair Poor	As thrown in gratis with cassette decks and the like - frequency extremes were restricted and performances were veiled.	Thin coaxial		59
Budget OFC circa £7	Fair Fair	Subjectively, this cable did lift much of the aural fog experienced with scrawny standard hook-up leads.	OFC		59
Deltec Slink £32	Good Very Good	Ideally used in lengths of under 4 metres, it errs on the lean side of neutral but has an uncommon transparency in the midrange.	4 silver plated OFC strands PTFE dielectric	BB	59
Deltec Black Slink £152	Excellent Excellent	Inherently neutral the cable faithfully reproduced broad and deep stereo soundstages with precise focus and a sense of tactility.	8 silver plated OFC strands PTFE dielectric	R	59
Denon LC-OFC N/A separately	Very Good Fair	Supplied with Denon's dearer CD players this cable introduced a peculiar 'twangy' coloration at high frequencies, and a slightly soft bass.	LC-OFC, non-magnetic gold plated plugs		59
DNM Solid-core £15-£25	Fair Good	Transparent in the midband and full of sparkling detail in the treble, low bass was slightly curtailed (unterminated price £2.30 per m.)	Single strand nickel-plated copper. Unshielded	R	59
Kimber Kable PSB £32	Very Good Very Good	An exceedingly transparent midband but slightly 'clanky' treble. It always managed to sound remarkably uncluttered and open.	OFC, PTFE dielectric	BB	59
Kimber Kable KC-1 £47	Very Good Fair	Tonally faintly leaner and brighter than the more open-weave PSB, KC-1's treble detail was just too sharp and grainy.	Multi-gauge PTFE dielectric		59
Kimber Kable KC-AG £375	Good Very Good	Treble detail resolution was perceived in a slightly abrupt if wholly controlled fashion. Depth re-creation and lateral separation were excellent.	Multi-gauge silver, PTFE dielectric	R	59
MDM Interconnect £14.95	Good Fair	The subjective performance of MDM did appear a little imprecise at the frequency extremes, but a worthwhile upgrade on budget interconnect.	Coaxial, solid core, gold plated plugs		59

TO ORDER BACK ISSUES OF HI-FI CHOICE SEE PAGE 114

THE DIRECTORY

INTERCONNECT CABLES

MODEL PRICE (per metre)	LAB SOUND	COMMENTS	FEATURES	VALUE	BACK ISSUE FULL REVIEW
MIT PC-Squared £75	Fair Good	This multi-gauge cable produced a very open and buoyant midband but sounded slightly 'peculiar' at frequency extremes.	OFC, multi-gauge	R	59
MIT Spectral MI330 £193	Poor Fair	MI330 displays a marvellously open and enticing midband quality, bass is warm and rich but this character has a tendency to dominate.	Multi-gauge balanced bandwidth		59
Monitor PC 0100381 £17	Good Fair	There is more than a hint of instrumental muddling and bass is slightly soft, however, the slightly 'shut-in' sound is par for the course at the price.	OFC, coaxial	R	59
Monster Interlink 400 £30	Good Good	Bass is solid and punchy, counterpointed by a slightly overblown midband which tends to make vocalists sound larger-than-life.	Multi-gauge	R	59
Monster Interlink CD £44	Fair Fair	Low frequency is commendably weighty, but the top-end sounds vague and lacking in image focus. Suited to some systems better than others.	Multi-gauge		59
Monster Interlink Reference £88	Good Fair	Protracted listening indicated a lack of dynamic speed – a subjective sluggishness. It may prove well suited to up-front systems.	Multi-gauge Balanced bandwidth Gold plated plugs		59
Myst Tm £15.60	Fair Good	Fairly neutral with a pleasantly open and transparent midband. Some deep bass detail is lost but treble is sharply focused.	Solid-silver PTFE dielectric	BB	59
Origin Live Soli-Core Super £60	Good Fair	Improves over previous Soli-core samples in stereo depth and bass weight, but a 'loud' treble presentation remains.	Solid-core gold-plated AT plugs		59
QED Incon P1-Gold £14.95	Good Good	A lively open presentation that just borders on the lean side of neutral, the quick and lucid delivery affording considerable musical insight.	OFHC, gold plated Deltron plugs	BB	59
QED Incon Graphite GP1 Gold £18.95	Fair Fair	A shielded version of Incon P1, it sounded thicker at the frequency extremes, the top end being coarser and more out of focus. Good for long runs though.	OFHC Graphite shielding	R	59
Sony RK-C310ES £40	Excellent Good	Possessing deep firm bass and a sparkling top end it offers a balanced perspective with negligible coloration.	Coaxial LC-OFCC	R	59
Sterling £250	Fair Good	Possessing a neutral if faintly rich overall balance it supplies a pleasantly open and transparent perspective. (Reviewed in pre-production form.)	2 silver strands per conductor		59
Thorens SAC 100 £50	Good Fair	Performance is undermined by a slightly coarse and splashy treble, not necessarily bright, simply rather confused – and fine detail lacks resolution.	Silver-plated OFC, coaxial		59
Van den Hul MC-D300II £59	Poor Good	It tended to highlight some upper mid detail, but a generally open and spacious acoustic proved its saving grace. Slightly soft at LF.	Silver plated single strand VdH plugs	R	59
Van den Hul MC-1021II £69	Good Good	Possessing the same endearing qualities as the D300 it presented open and transparent soundstages and improved timbral resolution.	Twin axial silver plated copper	R	59
Van den Hul MC-D502 £77	Fair Fair	The tonal balance was 'tilted' by a strong and authoritative bass line, which had the knock-on effect of muting treble detail. A bit dear.	Twin axial silver plated copper, teflon dielectric		59
Van den Hul Thunderline £147	Good Fair	Thunderline essentially parallels the sonic performance of the cheaper D102. HF is occasionally tainted by a 'tizzy' 'coarseness', bass is tight and dry.	Silver plated 'matched copper'		59
Van den Hul MC-Gold £247	Fair Good	It possesses a rich and beguiling treble balance that matches a weighty, slightly warm bass character. Seductive balance may prove worthwhile in some circumstances.	Silver & gold plated copper		59
Van den Hul MC-Silver £747	Good Good	Although remarkably transparent for an asymmetric design this costly cable was not considered to be of 'state-of-the-art' standard, and is bettered by cheaper models.	19 silver plated copper strands		59
Vecteur 8045 £49	Very Good Good	Sounding solid and forthright it might seem slightly cold in some systems but the treble 'edge' is mercifully clean. Very low frequencies were a little lacking in 'slam'.	LC-OFCC signal & screen	R	59

LOUDSPEAKER CABLES

MODEL PRICE	LAB SOUND	COMMENTS	FEATURES	VALUE	BACK ISSUE FULL REVIEW
Absolute Wire Force 4 £4.50 per metre	Good Fair +	By current standards there was a loss of fine, sharp detail at the frequency extremes, but it has a big and friendly sound.	744 OFC strands, PVC dielectric		64
Audionote DR-200 £16 per metre	Fair + Fair +	Open and detailed throughout the midband but a grainy coloration tended to corrupt subtle timbral information at very high frequencies.	200 LC strands, polyurethane and cotton dielectric		64
Audionote AN-SP £100 per metre	Average – Good	A clean and open sounding cable that offered a deep and pleasantly detailed perspective. Bass was slightly restricted, but seemed tight and coherent nonetheless.	15 silver strands, polyethylene dielectric		64
Audioquest BC-4 £2 per metre	Average + Good +	There was a slowing of fast transient edges to contend with but in general BC-4 offered a delightful clarity and sparkle throughout the highest octaves.	4 OFHC strands, PVC dielectric	BB	64
Audioquest Livewire Black £15 per metre	Good Good	It proved clear and punchy but with some grain across the treble. Nevertheless Black remains an interesting concept and proved better than Livewire Green.	OFHC, surface only – foam core construction	R	64
Audioquest Livewire Green £30 per metre	Good Fair +	Green proved more overtly dynamic and forward than BC-4 with simple music, but complex passages tended towards a mushy and ill-defined perspective. FCL – functionally crystal less.	FCL, surface only – foam core construction		64
Audio Technica AT6120 £95 – 10m	Fair + Fair	Compared to earlier LC-OFCC cables this PC-OCC derivative sounded smoother and less aggressive.	PC-OCC, PVC dielectric		64
Bellwire 12p per metre	Poor Average –	Broadly speaking it delivered a bright and tizzy sounding treble with a fairly open and detailed mid with little or no bass resolution.	0.5mm single strand, PVC dielectric		64
Deltec 8S £144 – 5m pair	Good Good +	The unerring transparency and detail resolution of 8S throughout the midband makes it a far cleaner and more spacious sounding cable than others at the price.	4 silver plated OF copper strands, PTFE	R	64
Deltec Black Sixteen £456 – 4.5m pair	Very Good Excellent	Bass was deep and rhythmically secure, the mid tonally pure and free of additional sibilance while the treble was both relaxed, sweet and highly detailed.	16 silver plated OF copper strands, PTFE dielectric	R	64
DNM Solid core £2.30 per metre	Average Fair	DNM cable seems too unbalanced for general consumption but excellent results have been obtained in sympathetic systems.	0.54mm single strand, webbed PVC dielectric	R	64
Exposure £2 per metre	Good Good	It could sound a trifle matter of fact but this emotive flattening was also somewhat dependent on the music program. It is also highly suited to long runs.	56 OFC strands, webbed PVC dielectric	R	64
Kimber Kable 4PR £49.45 – 5m pair	Fair Fair +	This directionally marked cable benefitted from an open and airy treble quality but seemed notably leaner than 4TC. Bass was well round and satisfyingly taut.	4 x 7 copper strands per conductor, PVC dielectric		64
Kimber Kable 4TC £16 per metre	Good Good +	4TC made a great impression in the listening tests with an open midband, a smooth and unfatiguing treble with slightly rich but suitably weighty bass.	OF copper, PTFE dielectric	R	64
Linn K20 £2.20 per metre	Good Fair	Subjectively it erred on the forward and bright side of neutral but enjoyed an essentially clear and punchy delivery.	56 OFC strands, webbed PVC dielectric		64
Marantz ML-55S £24.90 – 10m	Fair Fair	Subjectively this cable offered a loose and splashy treble which, though not overtly bright, did compromise both tonal and timbral accuracy.	30 OFC strands, 3 conductors PVC dielectric		64
Mission Cyrus £2.50 per metre	Average + Good	Because of its impedance characteristic this cable will deliver a smooth and unfatiguing treble balance with loudspeakers offering an easy load.	0.8mm single strand, PVC dielectric	BB	64
Monitor PC Silverline PC4 £5.75 per metre	Good Average	Sonically it laboured under a heavy and claustrophobic balance, lacking the see through transparency and lucidity of the better solid core cables.	2072 x 0.07mm silver plated copper strands		64

THE WORLD'S NO 1 GUIDE TO BUYING HI-FI

THE DIRECTORY

LOUDSPEAKER CABLES

MODEL PRICE	LAB SOUND	COMMENTS	FEATURES	VALUE	BACK ISSUE FULL REVIEW
Monster Superflex £2.50 per metre	Fair + Fair +	Treble detail was both reserved and confused though there was little in the way of harshness and grain. Deep bass notes were also found to be lacking	OFC, multistrand, Duraflex dielectric		64
Monster Original £4 per metre	Good Fair +	Original sounded relatively congested and murky at higher frequencies but possessed weight and conviction in the bass	Multistrand		64
Monster Powerline 2 £12 per metre	Good Good -	Powerline stamped its own hallmark on the sound with a strong taut bass and an essentially clear midband giving tactile stereo images	Multistrand, helical construction		64
Musical Fidelity Lifeline £11.50 per metre	Fair Good -	Lifeline did demonstrate a strong directional inclination, affording a laid back but fairly neutral balance when correctly oriented	4 x 0.8mm PC-OCC strands	R	64
Naim NAC-A4 £2.25 per metre	Good Fair +	Tinged with brightness while the deep bass response seemed both over heavy and poorly integrated compared to the immediate competition	Multistrand, webbed PVC dielectric		64
NVA £6 per metre	Average + Good	A light and breezy sounding cable best suited to short lengths, NVA benefitted from a clear and transparent outlook	7 x 0.25mm silver alloy strands, PTFE	R	64
Origin Live Soli-Core Ordinary £1.80 per metre	Good Fair +	Subjectively it bettered the performance of the costlier Super version, affording a pleasantly detailed and spacious soundstage with firm bass but slightly coarse treble	1.8mm and 0.5mm single strands	R	64
QED 79-Strand 90p per metre	Good Fair	For much of the last decade QED 79-Strand has been the first port of call for enthusiasts on the upgrading ladder, a tradition that should still hold true today	79 strand, PVC dielectric	R	64
QED Incon Graphite £1.75 per metre	Fair + Fair +	This graphite version of Incon sounded cruder and generally more heavy handed than the cheaper unshielded type. Overall presentation was mildly restricted and cloaked in a faint aural haze	OFHC, polymeric screen		64
QED Flat 200 £1.95 per metre	Good Good	I detected a degree of confusion at low frequencies but this did not stifle the acoustic atmosphere which remained open and positive	200 strands, flat webbed PVC dielectric	R	64
Rotel Supra 4 £2.49 per metre	Good + Good	Ideal for both long and short runs, it furnishes a big sound that benefits further from a smooth, unfatiguing treble	1,036 OFC strands, webbed PVC dielectric	R	64
Rotel Supra 10 £6.49 per metre	Good + Good	Supra 10 provided a very free and open sound that was unhindered by any excess at low frequencies. Worth its weight in scrap copper!	2,562 OFC strands, webbed PVC dielectric	R	64
Sony RK-S5ES £59.95 - 5m	Fair + Fair +	The sound of this cable was also somewhat controlled and over damped. The treble was relatively free and airy but lower octaves, including the midband, were constrained	350 x 0.08mm OFC strands, heat shrink dielectric		64
Solid core mains cable 36p per metre	Fair + Good	It enjoys much of the smooth treble and articulate midrange usually associated with the better solid core derivatives. Lean but taut and rhythmically coherent	1.5mm square, 3 cores, PVC dielectric	BB	64
Sterling £499 - 5m pair	Fair Fair	This pre-production sample possessed a strangely muddled and reserved sound quality. It suffered from a progressive instrument modulation that totally confused more complex orchestral passages	Pure Silver, PTFE dielectric		64
Townshend Isolda £400 - 5m pair	Fair + Good	Isolda possessed a truly dark background out of which rose a very solid and extended bass together with an excellent sense of transparency through the upper octaves	8 coax cables per conductor - very thick	R	64
van den Hul CS-122 £5.50 per metre	Fair + Good -	Characterised by a driving and powerful bass, CS-122 proved to be a heavy sounding cable. Mid treble detail was refreshingly clear but there was a slightly muted air about the extreme treble	19 x 0.45mm silver plated strands, webbed rubberised dielectric	R	64
van den Hul CS-352 £12.95 per metre	Good Fair +	Subjectively it sounded like CS-122 only more so, the deep rumbling bass tending to overwhelm subtle musical details. It also appeared a trifle peaky in the treble	7 x 0.76mm + 168 x 0.125mm silver plated strands, rubberised dielectric		64
van den Hul SCS-12 £29.95 per linear metre	Good + Good +	SCS-12 set a high standard with a tight and well focused soundstage populated with tactile stereo images. Bass wasn't as extended or resolved as some other cables	19 silver plated strands of 12 different guages, PTFE dielectric	R	64
van den Hul SCS-2 £99.95 per linear metre	Good + Good +	Overall it was commendably neutral and transparent but nothing less would be acceptable bearing in mind the tremendous cost of a stereo pair	665 silver plated matched crystal copper strands, PTFE dielectric	R	64
Vecteur R-CV30 £4.99 per metre	Fair Good	Subjectively the better of Vecteur's three-strong cable line-up offering a neutral overall perspective but with a slight loss of detail resolution at both frequency extremes	4 x 0.8mm LC-OFC PTFE insulated strands	BB	64
Vecteur S-CV90 £1.99 - 5m pair	Fair + Fair +	It seemed both less transparent and integrated throughout the midband than R-CV30, though both frequency extremes were spruced up with a tighter sharper delivery	6 x 0.7mm LC-OFC strands		64

To Advertise in
this space ring Miriam Young
on 01-631 1433

THE DIRECTORY

IN-CAR ENTERTAINMENT

In-car entertainment is an area not usually associated with the esoteric world of domestic hi-fi. However, it represents a source of musical entertainment that many of us are exposed to every day. The majority of new cars are fitted with some form of radio before they leave the showroom and in many cases this usually very basic player is taken for granted and accepted as representative of in-car audio standards.

For the price of a budget amplifier or more, there is a wide variety of in-car machines to choose from,

including cassette, CD and even DAT players. The majority of sub £300 players are integrated units featuring a cassette player, AM/FM tuner and amplifier, all in one remarkably compact standard sized box. At this price level the cassette players tend to be fairly basic affairs, although autoreverse and noise reduction systems are both fairly common. Tuners are usually of the digital variety with varying degrees of sophistication in signal tuning and presetting, with some machines featuring as many as 18 FM presets. The emphasis is on the frequency

modulated band and AM often suffers as a consequence, but fortunately for radio enthusiasts there are some exceptions.

The amplifier is usually designed to drive two pairs of speakers mounted fore and aft of the vehicle, and a fader is fitted to adjust the balance between the two. The dearer machines feature separate bass and treble controls which can be quite handy given the unusual acoustic of the car environment and the variety in balance and presentation to be had from car speakers.

MODEL PRICE	LAB SOUND	COMMENTS	FEATURES	VALUE	BACK ISSUE FULL REVIEW
Alpine 7202L £250	Good Very Good	A very attractive and seductive sounding player. The matt surfaced transparent preset keys are especially sexy	Bass/treble controls, 12 FM 6 AM presets, chrome eq., clock, 8W	R	61
Alpine 7905M/3539 £650/£350	Excellent Excellent	An easy to use and attractive CD/tuner, partnered with a powerful and flexible amplifier to give an effortless source of in-car entertainment	Bass/treble controls, 12 FM, 12 AM presets, slide-out, 150W	R	68
Aiwa CT-23500YL £199	Fair Fair	A nicely designed machine with a flip up lid for disguise purposes. Sound quality from cassette is a bit poor but the radio is exemplary especially on AM	Bass/Treble controls, 6 FM, 12 AM presets, Dolby, chrome eq., 8.4W	R	62
Blaupunkt Paris SQM 48 £253	Average Average	A powerful and sensibly designed player but let down by a very dull sounding cassette. The radio is a bit better	Bass/treble controls, 5 FM, 10 AM presets, uni-directional, 11.5W		62
Blaupunkt Windsor SQR 38 £275	Good Average	Not very enthralling sonically, the Windsor is rather low powered but does have a reasonably stable tape transport	5 FM, 10 AM presets, 3.1W		62
Clarion 916HP £160	Good Average	With its rubbery buttons and touches of white this is a modest looking player let down by a weak cassette	Bass/treble controls, 5 FM, 5 AM presets, 9W		61
Clarion 946HP £250	Very Good Very Good	A good FM side let down slightly by AM performance. This Clarion is particularly nice to use with its nifty SAM tuning system	Bass/treble controls, 12 FM/6 AM presets. Slot-in, 15.1W	R	61
Clarion CDC7000/10028HA £650/£250	Very Good Excellent	Despite a slightly off-beat cartridge system the Clarion combo put in a performance that had the sonic edge over other CD/tuners in its test group	Bass/treble controls, 12 FM, 12 AM presets, security code, 80W	R	68
Goodmans GCE229 £150	Fair Average	If knobs, switches and legends are your bag then the GCE229 is the one for you – a lot of gizmos for the price and it even sounds OK	Bass/treble controls, 6 FM/6 AM presets. Chrome eq., clock, MSS, 10.1W	BB	61
Hitachi CSK-402E £250	Good Good	An attractively designed little player that for once doesn't disappoint when it comes to playing music, and it even has a security system	Bass/treble controls, 6 FM, 12 AM presets, Dolby, chrome eq., music search, 7.4W	R	62
JVC RX-318 £200	Average Average	This JVC sounded quite enjoyable and turned in an impressive performance on FM. It even looks quite nice	Bass/treble controls, 5 FM, 10 AM presets, slot-in, 8.8W	R	62
JVC RX-418 £250	Average Fair	An attractively designed machine with a fair selection of features – even an aux socket for a portable CD player	Bass/treble controls, 10 FM, 10 AM presets, Dolby, chrome eq., slot-in, aux socket, 7.7W		62
JVC XL-C30E/KS-A102 £499/£130	Very Good Very Good	Not sonically as impressive as the other CD cartridge players in its group, the C30/A102 combo is, however, a versatile and fast sounding player	Bass/treble controls, 10 FM, 10 AM presets, direct track access, 30W		68
JVC KS-D1 £1000	n/a Excellent	The only in-car DAT player we've tested proved musically quite impressive and if software ever becomes prolific it will be able to offer CD a run for its money	Bass/treble controls, no tuner, direct track access	R	68
Nakamichi TD-400E/PA-300 II £450/£275	Very Good Excellent	If you want your in-car entertainment to compete on sound quality grounds with your domestic system, this combo offers a very strong challenge	Bass/treble controls, 5 FM, 10 AM presets, uni-directional, chrome eq., Dolby B, C, 75W	R	62
Nakamichi TD-700E/PA-300II £795/£299	Very Good Excellent	For those who appreciate the wonders of analogue there are few in-car players to really compete with this superb cassette/radio. You can even adjust azimuth	Bass/treble controls, 6 FM, 6 AM presets, music search, Dolby, 75W	R	68
Panasonic CQ-497 £117	Fair Poor	The CQ-497 has a traditional style analogue tuning system making it easy to use. AM reception was good but the other sources are less encouraging	Bass/treble controls, chrome, NR, 7W		62
Philips 553 £120	Average Average	Not the most ergonomic player on test but sound quality was quite refined for the price. Presets are a bit gauche	4 FM, 4 AM presets uni-directional cassette 3.1W		61
Philips DC680 £180	Average Good	A colourful and musically competent player that despite a gammy volume knob is well worth checking out	8 FM, 4 AM presets 3.5W	R	61
Pioneer KE-3030 £150	Poor Fair	A tasty looking, if sonically bass heavy, little box well suited to blasting out rock or dub	18 FM, 6 AM presets 4.2W		61
Pioneer KEH-5080B £230	Fair Good	A chunky and neatly styled player with healthy power output and an easy relaxed sound. Just the thing for pumping up the volume	Bass/treble controls, 18 FM, 6 AM presets, anti-theft device, slot-in, 9W	R	61
Pioneer DEX-M300/CDX-M100/ GM-3000 £300/£450/£280	n/a Very Good	Separate control unit and boot mounted multi play autochanger make this a bit of a hefty installation but it uses the same magazines as their domestic players and sounds fine	Bass/treble controls, 18 FM, 6 AM presets, 80W, removable fascia		68
Proton 214CD/D275 £300/£175	Very Good Very Good	This Proton cassette/tuner offers good power and a level of fidelity appropriate to its price. Musically it has a Decca-like charm that is very appealing, plus a sensitive radio	Bass/treble controls, 8 FM, 8 AM presets, Dolby B/C NR, chrome eq., 85W	R	68
Sansui RX-3100L £180	Poor Fair	Quite flash looking with a reasonable feature count but FM sound and cassette replay quality could be a bit stronger at the price	Bass/treble controls, 12 FM, 12 AM presets, chrome eq., 8W		61
Sansui RX-5100L £250	Good Very Good	One of the cleaner machines around the 5100 has an excellent AM section and a reasonable cassette player	Bass/treble controls, 12 FM, 6 AM presets, chrome eq., slot-in, 12.5W	R	61
Sharp RG-F816E £200	Poor Average	Nothing if not novel the 816, with its unusual anti-theft system is custom built for the furry dice brigade, but is sonically a bit lacklustre	Four band graphic, 8 FM, 16 AM presets, ASP, Dolby, MSS, 10.9W		62
Sharp RG-F882E £220	Average Average	Again a glitzy full feature machine with a flip out control panel and plenty of lights. However, sound quality is a bit disappointing	Seven band graphic, 5 FM, 10 AM presets, ASP, chrome eq., Dolby, 8.5W		62

THE WORLD'S NO 1 GUIDE
TO BUYING HI-FI

THE DIRECTORY

RECEIVERS

Purists will look down their noses at the very idea of combining two functions into one box, and indeed they always have done. But unless we're talking about the exotic elite, the creme de la creme of amplifier and tunerdom, intrinsic technical shortcomings simply aren't an issue.

One obvious reason why you should buy a receiver if you were otherwise considering an amplifier and a tuner is that there are savings, ie of

size. Generally you end up with one box in place of two similarly sized boxes, which has got to be a good idea. Receivers are also simpler to operate, in principle anyway. At the very least you save on one power switch, and typically you are presented with an integrated control system that is bound to oil the wheels of ergonomics.

But there is one important point to watch. Because receivers don't sell in vast quantities in

this country, and because this is one of the very few countries to use Long Wave for public service broadcasting, many - no, most - receivers on sale in this country cover FM and MW only. Remember that LW is the home of Radio 4, where it can be heard on the all too frequent occasions it is not on FM.

MODEL NAME PRICE	LAB SOUND	COMMENTS	FEATURES	VALUE	BACK ISSUE FULL REVIEW
Harman Kardon HK330Vi £259	Average Average-	No LW, and FM section best suited to strong, local transmissions. The amplifier is quite powerful but favours the treble. Bass is tuneful but lacks weight	5 inputs (inc 2 tape), FM/MW tuner		70
Harman Kardon HK440Vxi £329	Good Good	Clear, dynamic, slightly bright sounding design, a little grainy in extremis. Mono switching and LW missing from tuner, which otherwise performs well	5 inputs (including 2 tape) with FM/MW tuner	R	70
JVC RX-777VL £500	Good Good	Sharp, lively but euphonious sound quality from line and phono source is matched to a high grade tuner. However, many half-baked facilities blunt value for money	A/V capable with 6 inputs, equaliser, digital ambience, FM, MW/LW		70
JVC RX-1001V £770	Average Poor	Power output is well below spec, and sound quality is cluttered and messy on all inputs	Digital ambience processing, Dolby Surround, 2/4 speaker, 40 FM/MW presets		70
Revox B285 £1782	Average Average-	Sophisticated and capable tuner is married to a muddled, compressed sounding amplifier, which also has low sensitivity preventing the amplifier being driven fully in many situations	70 watts/ch, 4 inputs (inc 2 tape), 29 FM/MW/LW presets		70
Rotel RX-850AL £230	Good Good	Well built and sensibly equipped receiver with outstanding sound quality for the price via the tuner, phono and line sources alike. It majors on subtlety however, and may not impress the heavy metal brigade	4 inputs (inc 1 tape), FM/MW/LW tuner BB		70
SAE R102 £599	Average- Average	This is an uneven but mostly good performer. It sounds constrained but musical, but the tuner is weak on both wavebands.	4 inputs (inc 2 tape), FM/MW tuner		70

VIDEO RECORDERS

For some time there's been a move to improve both the video and the audio quality of video recorders and TV sets alike as a necessary prelude to a proper integration between the two. Hi-fi video is obviously an important element in the story, and so is Dolby Stereo, the ambient 'surround sound'

system. The weak link of course is on the broadcast side. Although TV sound is well up to normal hi-fi standards, it has always been in mono and unjustly or otherwise has rarely attracted much audiophile interest. But TV sound is - or shortly will be - freed of the shackles of mono by the introduction of NICAM

stereo. NICAM - an acronym for Near Instantaneous Companding and Modulating - is the missing link that will help facilitate the much feted integration of video with audio. And then we have S-VHS, a system which does for picture quality what the other developments promise to do for the sound...

NAME PRICE	LAB SOUND & PICTURE	COMMENTS	FEATURES	VALUE	BACK ISSUE FULL REVIEW
Akai VS-75EK £550	Average Good	Excellent performance and a slick set of controls make this recorder a pleasure to use. Good price is a bonus	Hi-fi, NICAM, programmable remote	BB	71
Akai VS-77EK £700	Average Good	Another fine and carefully designed model from the impressive Akai video stable. The Dolby installation, whilst flawed, is certain to increase interest in the system	Hi-fi, NICAM, Dolby Surround decoder & stereo amp	R	71
Ferguson FV33H £500	Very Good Below Average	Beer budget NICAM has excellent tape search facilities and an intelligent remote control. Neither picture nor sound quality however are state of the art, and ergonomics are poor	Hi-fi, NICAM, transmitter LCD remote control		71
JVC HR-D750EK £500	Good Average+	Well sorted and relatively affordable NICAM recorder with LP sound only. It is pleasing to use and helpfully equipped, especially when trying to find individual recordings buried in long tapes. Performance is good in relation to price	Hi-fi, NICAM, transmitter LCD remote control	BB	71
JVC HR-S5000EK £1000	Good Very Good	This is the first domestic S-VHS recorder on the market, and it's an unusually well designed one with a wide range of well sorted features and controls. Sound and picture quality are close to state of the art, and miles ahead of any non-S-VHS recorder	S-VHS, Hi-fi, NICAM, LCD remote	R	71
Mitsubishi HS-B70 £1000	Very Good Very Good+	Superb model, and true state of the art picture quality, though you'll need a high grade S-VHS compatible monitor to reap full advantage. The facilities are also wide ranging and generally helpful	S-VHS, Hi-fi, NICAM, LP & SP, programmable remote	R	71
Nordmende V4405K £799	Good Good	Fine basic sound and picture quality, but the RF converter introduced significant losses. An excellent model, but configured for German home market. VPS compatibility is of no practical use here, and the recorder lacks NICAM	Hi-fi, transmitter handset, digital FX		71
Panasonic NV-FS1 £1000	Poor Good	The control system is poorly organised, with cramped legends and some strange machine logic. Bar code programming is hardly a great achievement either. Picture and sound quality are good, but not state of the art	S-VHS, Hi-fi, NICAM, bar code programming		71
Sanyo VHR-D4710E £900	Very Good Good	Fine colour and moderate detail make for a basically good video section to match a fine sound section. Some of the facilities are a little disappointing however and the deck looks expensive	Hi-fi, NICAM, infra-red headphone remote, digital FX		71

To Advertise in
this space ring Miriam Young
on 01-631 1433

VIDEO RECORDERS RECEIVERS

HI-FI CHOICE



PERSONAL MESSAGES

After last month's comprehensive loudspeakers tests Paul Messenger now examines speaker classifications.

Now that the household is recovering from its recent deluge by loudspeakers, it's time to draw breath and take a further look at some of the issues involved. One school of hi-fi holds that the loudspeaker is the least important item in the chain, by virtue of its position at the end thereof. There's some truth in this, to be sure. But loudspeakers are also both tricky and personal things which offer much greater opportunity for and a much wider range of real choice than any other component.

Obligated to compile *Directory* entries which require one word value judgements for measured performance and sound quality, I find myself baulking at the oversimplification involved. What is fair enough when comparing and classifying thirty CD players which are all more or less the same size, doing more or less the same thing with varying degrees of success, becomes an obvious case of *reductio ad absurdum* when applied to loudspeakers. There are simply far too many variables to consider.

'Measured performance' attempts to bring together such elements as frequency responses, sensitivity and low frequency extension while keeping a weather eye on the impedance characteristic. Points are awarded both for the overall balance, and also the evenness thereof.

'Sound quality' too has to attempt to sum up a variety of often conflicting aspects of performance. Tiny, and consequently often quite cheap loudspeakers with small diameter bass/mid drivers tend to give rather better mid-to-treble integration than physically larger designs, while their small box area helps minimise cabinet coloration too. But then these little loudspeakers don't have the bass extension, power handling and dynamic range of larger designs. One provides subtlety, the other scale. And whereas the reviewer should identify how these compromises have been drawn in a specific design, it should, of course, be down to the customer to weigh up the various factors according to his/her

particular situation.

Obviously price is a major criterion for most people, and this in turn will probably put a maximum ceiling on the size. The room (size, character etc) and the speakers' placement therein are also usually predetermined by domestic considerations. These considerations will all narrow down the field, but taste in music, ancillary equipment and even the proximity to or tolerance of neighbours or children's bedrooms are all factors worth bearing in mind, even before tackling the nebulous area of personal taste.

Speaking personally I rate bass extension and dynamics far higher than stereo precision and minimal coloration. So the Linn *Isobariks* I've been using for more than a decade continue to suit me very well, and I've grown quite accustomed to their foibles and limitations. At the opposite extreme in many ways, I can also see the attraction of the Celestion *SL700*, which is just as much a reference yardstick in its own way.

But any attempt to compare these two designs is doomed to failure, since there is virtually no common ground to form the basis of serious comparison, and to some extent each must be judged by its own lights. Even were it possible to match them for balance, the entirely different sound radiation pattern would result in an entirely different listening experience.

Fundamentally, loudspeakers have much more to do with contrast than comparison.

I choose those two examples on the basis of long term personal experience and respect, but could just as easily draw similar contrasts amongst the 30 tested last month. The five models costing £600-800 – two Spicas, an Alphason, an NVA and the SD *OBS* – are each valid enough from a design point of view and can be contrasted to illustrate the same points equally well.

Budget price loudspeakers are invariably constrained by costs, so the designer himself is forced to work within a fairly limited range of options. But at this higher price level there is room for more creativity, and each

design makes its own compromise between cabinet size and build (besides a few other things). The results are directly reflected in the sound each creates.

My money would go to the *OBS*, though it takes up more space than the others in the listening room, needs a big room and isn't the tidiest sounding. I've just received some bits and pieces, known formally as half a network modification. This is intended to tame the treble 'sting' I complained of in the review, and I will report back as soon as the rest of the bits arrive.

Both Alphason and NVA are very tempting too, and just as uncompromisingly incomparable. I could probably live with either at a pinch, but each has minor annoyances of its own. I spent last weekend trying the 'grown up' NVA *Cubix* (£1,200, double the volume and an internal extra bass driver), which I hoped might turn out to be the 'mini *Isobarik*' that Linn has never attempted with the *Sara*, but have thus far been foiled by a faulty driver, inherited from a previous reviewer, so further comment will again have to wait.

However, rummaging around amongst some of my older references has proved to be a sobering experience. The Spondor *BC1* has now been around for at least 20 years, and my samples must date back some 12 or more – Tygan grille cloth and teak veneer looks almost antique, or at least 'period'. Yet this near geriatric of the speaker world can still show the youngsters a few tricks, particularly in the vital voice band, while sans pareil stereo imagery can rival the aforementioned *SL700*.

The old *BC1*s still have their slightly coloured and heavy bass, low sensitivity and slightly recessed midband. But the basic rectitude of a genuine classic shines through strongly. They remain fundamentally very musical and can boogie with the best of them, with perhaps surprisingly good speed and timing, if slightly muted midband dynamics.

With hindsight, both the *BC1*

and the (now sadly deceased) original Quad *Electrostatic* shared the two characteristics of low sensitivity and a mildly unruly low frequency control which ill suited them to the growing importance of high level rock music from vinyl sources that became popular during the 'seventies. The steady improvement in vinyl replay (less low frequency 'grunge' from much higher quality turntables) – and the arrival of CD for that matter – make these LF limitations much less significant. Either model could make a fine secondhand purchase for the impecunious, while the *BC1*'s current £700 pricetag still looks very realistic.

There are a great many differences in the ways all the abovementioned designs vary one from another. But perhaps the most important is also the one which seems most difficult to define. It has to do with the way the sound is directed out into the room, and comes back to the old dichotomy between directional and omni-directional designs. One reason I tolerate the somewhat bloated and vague imaging of the *Isobarik* is because the design also offers unusually stable and consistent (if slightly bloated etc) image wherever I happen to be. Which just happens to suit my (pardon me) lifestyle (sorry).

However, it's naive to regard directional and omnidirectional designs as a straightforward either/or choice. There's been some polarisation in the past as each has been touted as an ideal in itself, but perhaps the time is coming when designs will succeed in combining some of the better traits of each. I was particularly impressed by the directional characteristics of the new KEF *Uni-Q* driver used in the *C75*, and also liked the 'character' of the slant baffle approach introduced by Spica (and since employed by Naim). It may be that some worthwhile answers will lie in the synthesis of some of these design techniques.

Indeed, there are so many other possibilities I shall reserve the right to return to this topic in a future column.

QUART

*The wraps are off
the Quart sound revolution*

Times and sounds are
changing

And Quart Loud Speakers
are right behind the sound
revolution — as one of the
biggest names in Germany.

Now, here in the UK, Quart is
set to challenge every opinion
you have ever had about
quality sound reproduction.

Hear the sound, appreciate
the finish, enjoy the value —
starting at only £299.90.

Quart — take the wraps off
soon at your dealer.



Soundtec Marketing Limited,
Unit 9, Belfont Trading Estate,
Mucklow Hill, Halesowen,
West Midlands, B62 8DR
Telephone: 021-550-7387

MAKING GOOD
SOUND BETTER
TALK TO YOUR
DEALER NOW

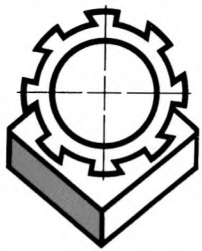

ROKSAN

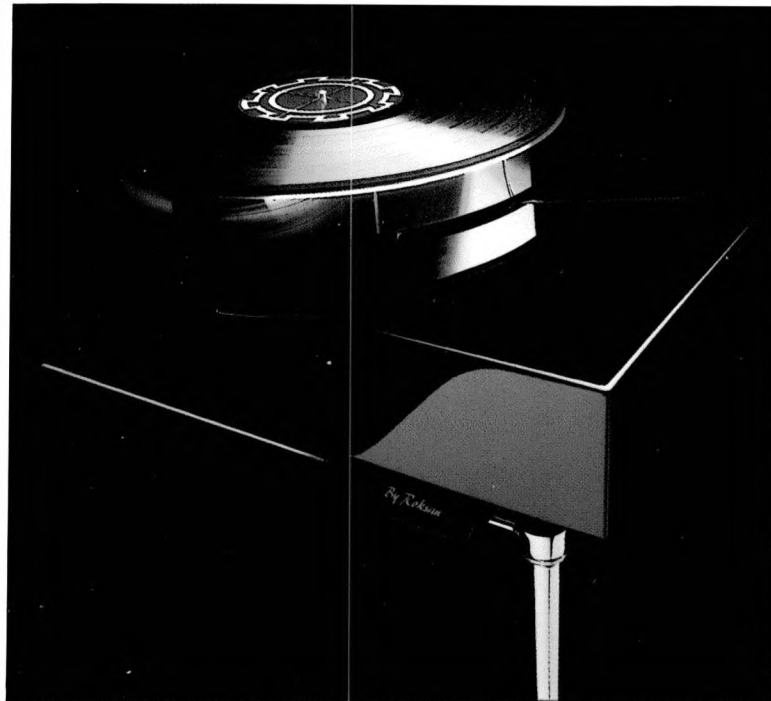

XERXES

ARTEMIZ

SHIRAZ

DARIUS

HOTCAKES

TABLES

ROKSAN ENGINEERING LTD, 21 DDOLE RD. POWYS, UNITED KINGDOM, (0597) 4911 Fax (0597) 3617.

USA & CANADA: BRYSTON (802) 223 6159 & (416) 746 1800.

JAPAN: TECHNICA TRADING CO. (03) 255 6996. WEST GERMANY: TUBAPHON (0234) 430800.