

13

A Permanent and Up-to-date Reference Work

1^s/₃^d

HARMSWORTH'S WIRELESS ENCYCLOPEDIA

For Amateur & Experimenter

HIG—IVO

CONSULTATIVE EDITOR

SIR OLIVER LODGE, F.R.S.

THIS PART CONTAINS

146 New Photos & Diagrams with 110
'How-to-Make' & Other Articles

HIGH-FREQUENCY TRANSFORMERS
HIGH-SPEED TRANSMISSION
HOWLING
INDUCTANCE COILS
INTERFERENCE ELIMINATORS

Special Articles by Sir Oliver Lodge
THEORY OF INDUCTANCE & INDUCTION

SPECIAL PHOTOGRAVURE PLATE
HIGH-FREQUENCY AMPLIFIER

J. LAURENCE PRITCHARD, F.R.Ae.S., Technical
Editor, with expert editorials and contributing staff

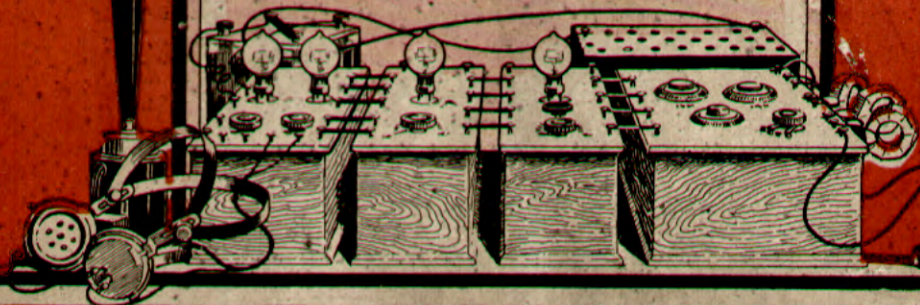
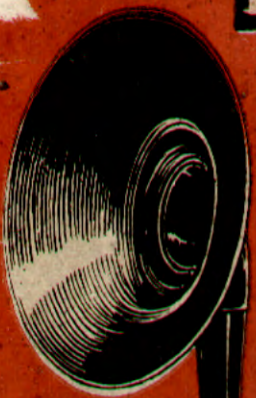

The Only ABC Guide to a Fascinating Science-Hobby

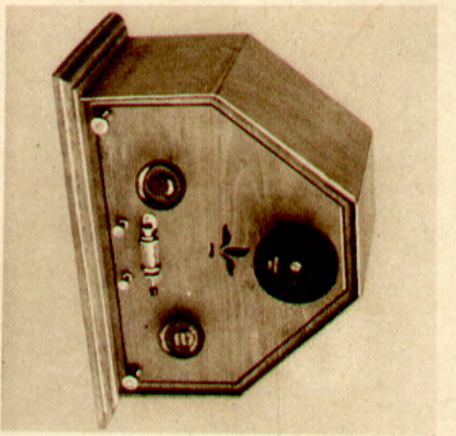

Fig. 9. The complete H.F. amplifier and crystal detector set

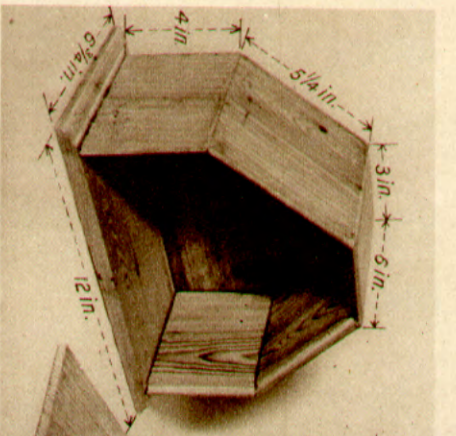

Fig. 10. Dimensions of the cabinet, which has a pleasing appearance when finished



Fig. 11. Sand-papering the cabinet before staining and polishing



Fig. 12. No. 24 gauge wire is wound on ebonite for the inductance



Fig. 13. Screws and crossbar attach the inductance to the panel

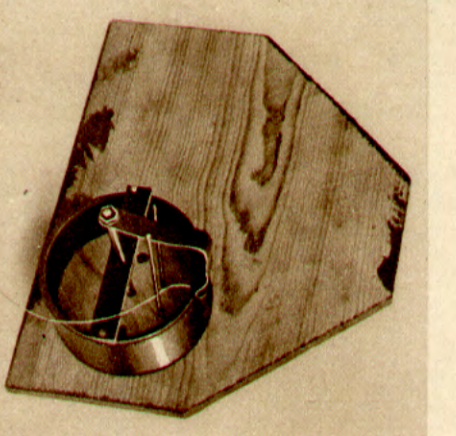

Fig. 14. Notches are made on the tuning slider

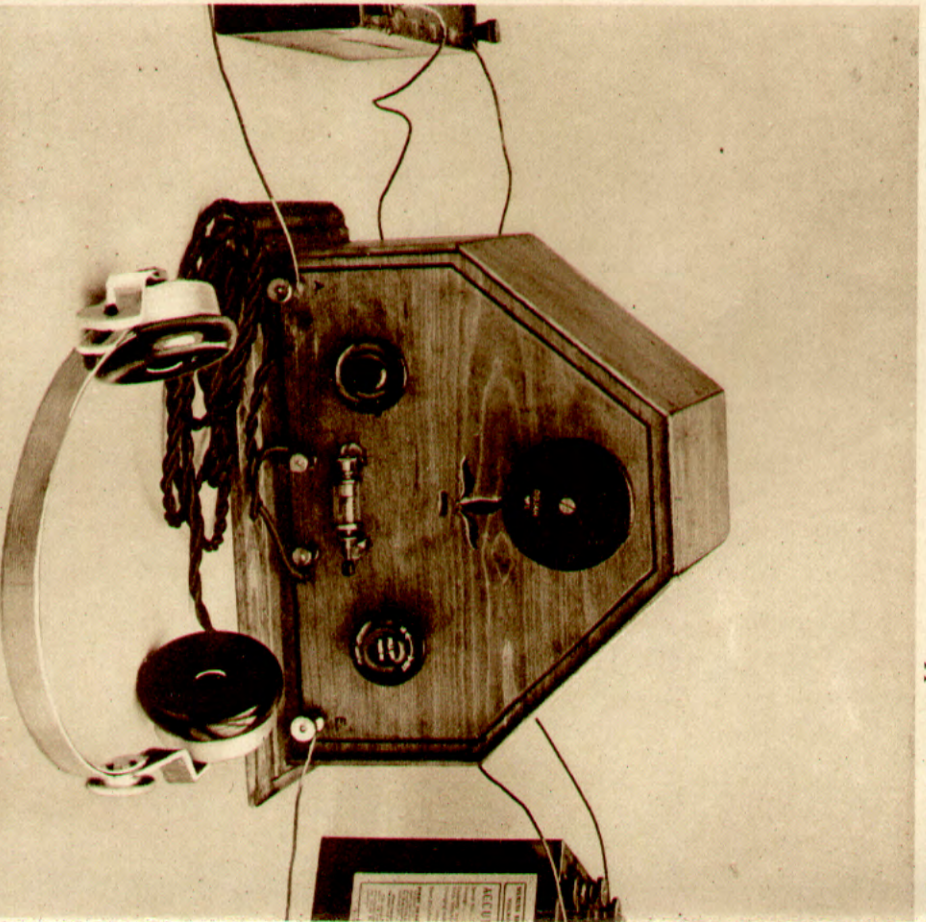

Fig. 15. Excellent results at a range of 30 miles are obtained with the single-valve H.F. amplifier and crystal detector shown connected up ready for use

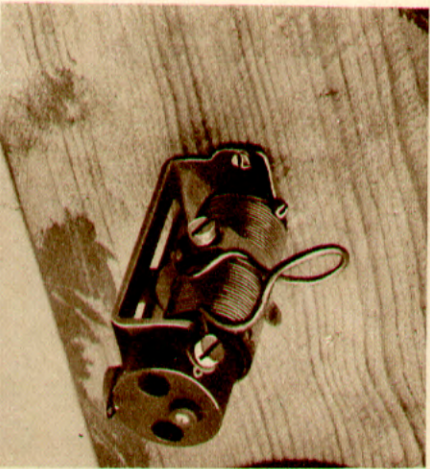

Fig. 16. How the continuously variable rheostat is attached to the panel

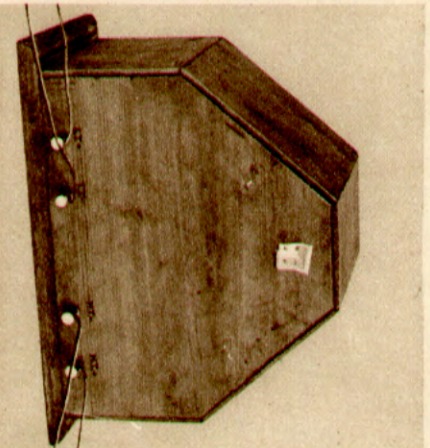

Fig. 17. Battery terminals and leather tab for removing back panel

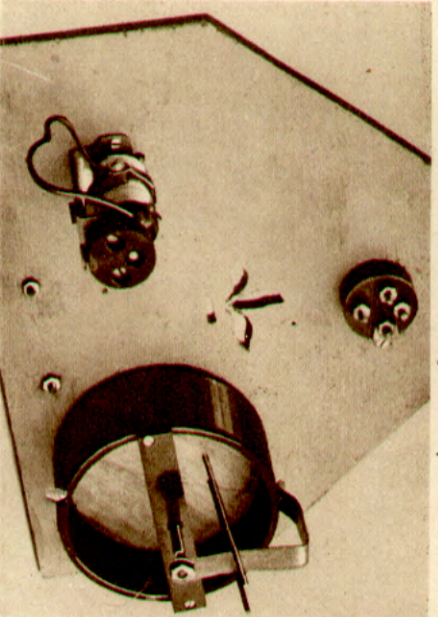

Fig. 18. At the top is a valve-holder used to connect the plug-in high-frequency transformer

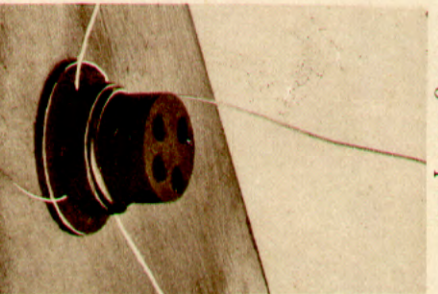

Fig. 19. How the valve-holder is mounted

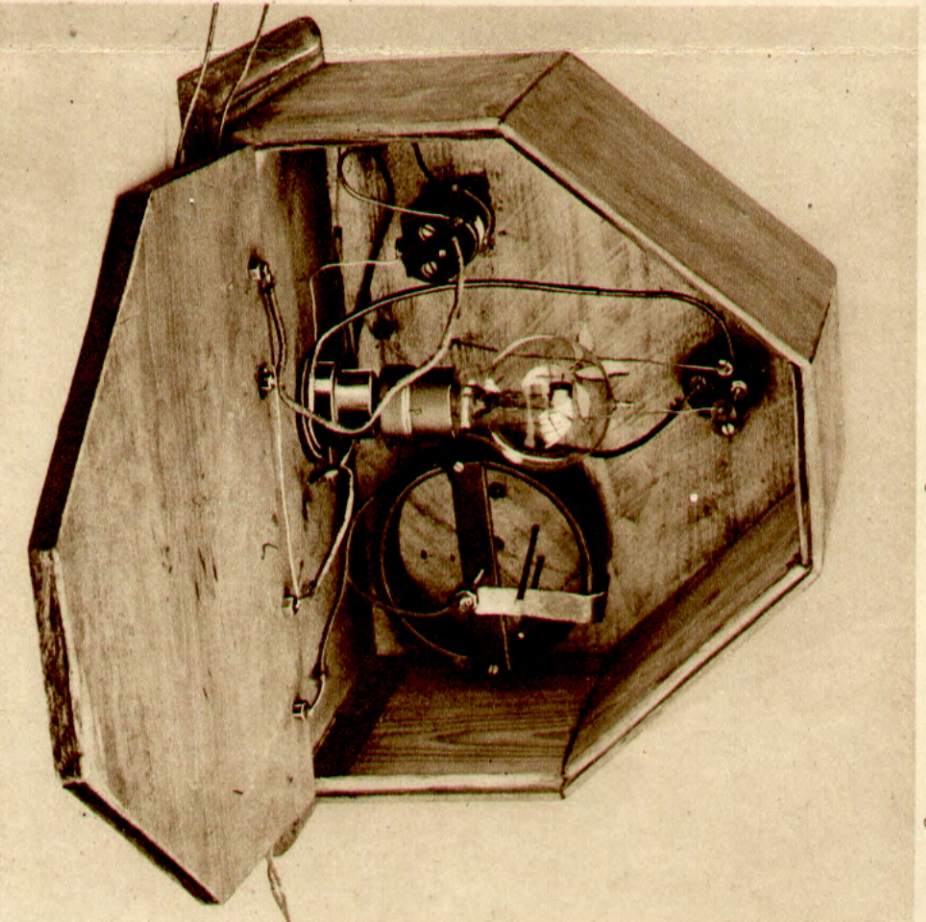

Fig. 20. Interior of the cabinet showing the position of the components. The back panel is lowered without disconnecting the wiring of the battery terminals

HIGH-FREQUENCY AMPLIFIER: HOW TO MAKE A SIMPLE UNIT EMPLOYING ONE VALVE IN CONJUNCTION WITH A TRANSFORMER-COUPLED CRYSTAL RECTIFIER

in position on the bobbin side, and the rod left of sufficient length to allow a nut and washer on the outside of the panel, when the bobbin may be fitted in place.

The wires may now be soldered in position, and if these are fastened to the tip of the terminals and studs with just a touch of solder, it will not be difficult. With the bobbin and panel placed upon the bench with the pair of terminals, without flat connecting pieces, towards the experimenter, take the commencing wire from the top slot and solder to left-hand terminal. The finish of the winding and the commencement of the winding go to contact stud No. 1 on the left side. The finish of this winding and the commencement of No. 5 winding go to No. 2 stud, and so on, the end of No. 7 winding going to stud No. 4. This will be made clearer by a study of Figs. 7 and 8.

Exactly the same process is followed with the secondary slots, viz. 2, 4, 6, and 8.

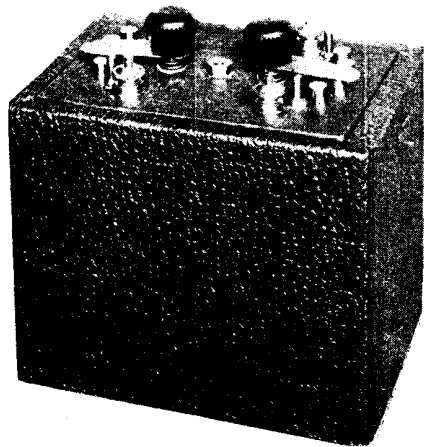

H.F. TRANSFORMER COMPLETE

Fig. 9. Enclosed in the case with the panel on top is the complete high-frequency transformer. The case is covered with Rexine.

We are thus able to put in circuit progressively one, two, three, or four slots, in either the primary or secondary side, as required, which will be found to give a very useful choice, whether the transformer is used in an ordinary valve circuit or in a valve and crystal combination, which in many cases works better with a step down to the crystal upon the secondary side.

The containing box, Fig. 9, measures $4\frac{1}{2}$ in. by 5 in. and 4 in. deep, being made of

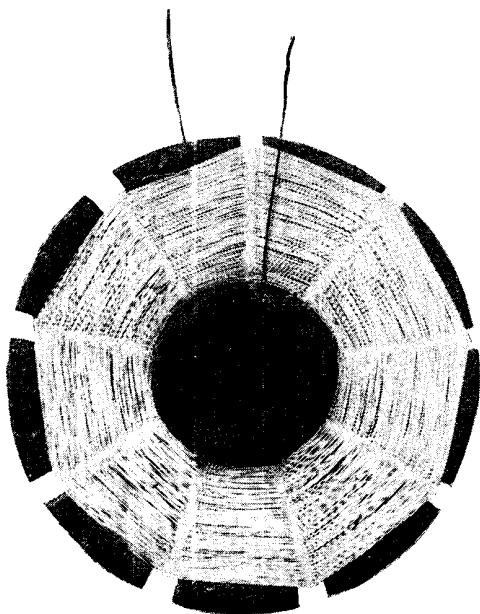

BASKET COIL H.F. TRANSFORMER

Fig. 10. Basket coils wound with 42 D.S.C. copper wire are used in making this high-frequency transformer. This is useful for wave-lengths between 600 and 3,000 metres

$\frac{1}{4}$ in. wood, two fillets being fitted inside for recessing the panel.

The transformer described above will appeal to those who desire to cover a fairly wide band of wave-lengths with one instrument, whilst the basket pattern, shown in Fig. 10, will be found efficient in working over a wave-length range of about 600 metres to 3 000 metres, without tapings or further trouble, thus eliminating at least one control in tuning-in a station.

Cut out two cardboard disks, 4 in. in diameter, and provide them with nine slots $\frac{1}{4}$ in. wide to within $\frac{3}{4}$ in. from the centre. The formers should be well rubbed down with glass paper, given a good coat of shellac varnish, which, when dry, may be further rubbed down and again coated with shellac varnish. If the formers are made perfectly smooth before starting to wind on the wire, the latter process will be greatly facilitated, the wire falling into the slots without further trouble. The formers are filled with 42 gauge double silk covered copper wire, care being taken to solder on a short connecting piece of thicker wire at start and finish.

The case is made of cardboard by first cutting out a circle $4\frac{1}{2}$ in. in diameter, and

damping a strip of similar material $\frac{3}{4}$ in. wide, which is wrapped round, glued, and temporarily held in position with string. A further strip of cardboard, slightly less in width, is now glued in position inside the case in order that a recess may be formed for the cardboard lid to press in with a

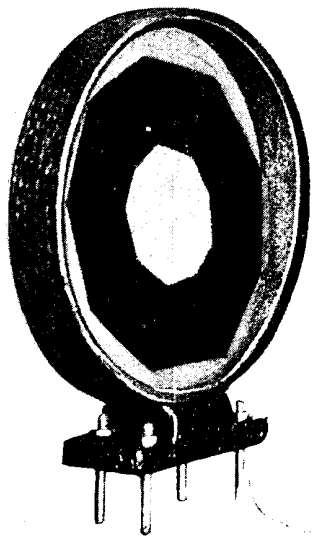
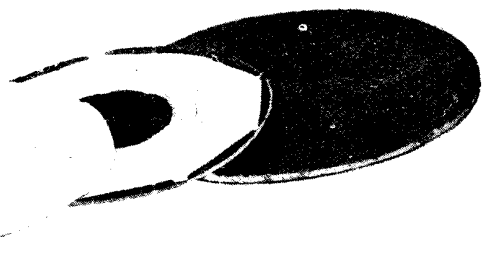

Fig. 11, or disposed in any other convenient manner. The respective ends of the two basket windings being pushed through holes in the case, they may be soldered to the valve pins, the basket coils being placed in position within the case with a piece of waxed paper between them; the continuity of windings may be tested in the usual way with a small battery and a pair of telephones. Those who are not accustomed to testing the component parts of a circuit should refer to the directions given under the heading *Faults* in this Encyclopedia.

In many cases it will be preferable, perhaps, to wind separate plug-in high-frequency transformers to cover only a narrow band of wave-lengths, this type



CONTENTS OF HIGH-FREQUENCY BASKET TRANSFORMER

Fig. 11. This basket coil plug-in transformer is quickly made by the amateur, and will cover wave-lengths commonly used by ship stations and the Eiffel Tower time signals. The coils and waxed paper disk are shown in their order when assembled.

tight fit. When all is dry, the whole may be given a liberal coat of shellac varnish inside, the outside being smoothed with glass-paper and ultimately covered as desired.

A small foot may now be prepared, preferably of ebonite, in order that four valve pins may be accommodated, and may be set out to fit a standard valve socket,

being particularly suitable for use with more than one stage of high-frequency amplification.

The plug-in transformers illustrated in Fig. 12 are made up with two circular pieces of very thin three-ply wood, two separating pieces of cardboard, and in the centre of the whole a piece of mica, thus forming two slots for the primary and secondary winding. The outside diameter is $2\frac{1}{2}$ in., the circles of cardboard being $1\frac{1}{2}$ in. in diameter.

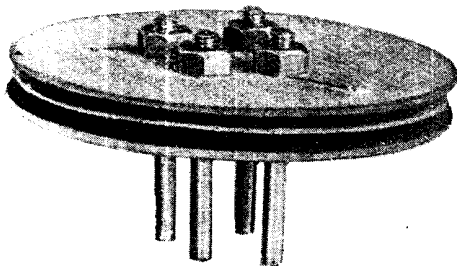
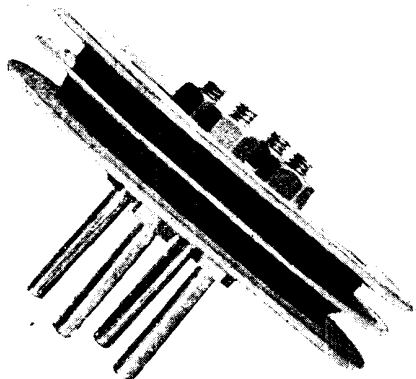

HIGH-FREQUENCY PLUG-IN TRANSFORMER

Fig. 12. Amateur-made plug-in high-frequency transformers are not difficult to construct. The circular pieces upon which the wire is wound are made from three-ply wood, and the plugging device comprises four valve legs attached on either side of the disk by nuts.

The whole is fastened together with thick shellac varnish, four valve pins being fitted in order that they may plug in to the usual valve holder. The bobbins may be wound by holding the valve pins in the left hand and the bobbin of wire in the right hand, which may be revolved round the stationary high-frequency transformer bobbin.

A set of seven bobbins may be wound with from 38 to 42 double silk-covered copper wire, an equal number of turns being put on each half of the transformer. The set may start with 50 turns in each slot for No. 1 transformer, the second having 75 turns, proceeding with 100, 150, 200, 400, and 600 turns for a set of seven transformers, and such larger ones as may be necessary. It will be desirable in making formers for the larger sizes to increase the thickness of the cardboard separators, making the slots at least $\frac{3}{16}$ in. wide.

In connexion with the use of high-frequency transformers for dual-amplification sets which use crystal rectification, it may be noted that the ordinary one to one ratio does not give nearly such good results as a step-down to the crystal. Consequently it is recommended, for broadcast wave-lengths, at least, that variable high-frequency transformers should be tried in such sets prior to winding special transformers of the plug-in type after the best ratio has been found experimentally. See Dual Amplification; Reflex Circuits; Transformer.

HIGH RESISTANCE. In wireless, the property of that part of a circuit whereby very considerable opposition is occasioned to the path of an electric current flowing through the circuit. High resistances play a very important part in wireless, one common application being the high-resistance grid leak placed in the valve-detector circuit. The resistance in this case may be of the order of two megohms or more. Its function is to allow a charge of current on the grid condenser to dissipate itself away from the grid of the valve.

Another application of high-frequency resistances is for the purpose of amplification at radio-frequency. This method calls for the use of suitable values of non-inductive resistances in the circuits between two or more valves.

A circuit may have a very low resistance to the path of a unidirectional current, but yet have an extremely high resistance to a current at radio-frequency. In the

latter case this resistance is called impedance, but is measured in the same unit, the ohm. An application of this is found in the tuned-anode method of high-frequency amplification, where the impedance is greatest when a circuit is tuned to the frequency of the current traversing it.

Many other instances of high resistances are found in wireless, of which the use of high-resistance telephones is one application. These are used in the anode circuit of a valve without a step-down transformer. A common resistance for such telephones or loud speaker would be 2,000 to 4,000 ohms. See Eureka Wire; Resistance; Skin Effect.

HIGH - RESISTANCE TELEPHONES.

Expression applied to telephones having a resistance of 2,000 ohms or more. High-resistance telephones, when employed in a crystal set, may have as high a resistance as 4,000 to 6,000 ohms. In ordinary valve receiving sets, telephones of 2,000 to 4,000



HIGH-RESISTANCE GECOPHONES

Gecophones are the standard high-resistance telephones made by the General Electric Co., Ltd. The headband is a flat metal spring strip covered with leather for comfort in wearing

ohms are used, and should be protected by a suitable value fixed condenser shunted across the high-tension leads. High-resistance telephones are not used when a telephone transformer forms part of the circuit. The expression is applied to all

makes of telephones, irrespective of their particular details of construction. The photograph shows a standard pair of high-resistance telephones. See Handphone; Headphone, and under the names of particular brands, *e.g.* Ericsson.

HIGH-SPEED RECEPTION & TRANSMISSION

How Radio-Telegrams are Daily Sent and Received Across the World

The great organization which has been built up by the Marconi Company in sending and receiving wireless telegraphic trans-continental and transatlantic messages at high rates of speed is graphically described in this article, with special photographs of the apparatus used. See also Morse Code; Omnigraph; Relaying; Remote Control; Transmission.

The term "high speed" as applied to wireless telegraphy refers to any speed above that at which a first-class operator can send or receive. In actual practice, the latter figure is in the region of 30 to 35 words per minute.

The speed of normal mechanically operated transmission is largely dependent upon the degree of accuracy required. Business telegrams, particularly in code, demand the greatest accuracy, and are very seldom transmitted above 140 words per minute. Press reports, the letter accuracy of which is relatively unimportant, are frequently transmitted at a far greater speed.

Speed is, again, very much dependent upon atmospheric conditions, for reception must necessarily be made upon automatic mechanical devices, which are not able to differentiate between Morse or other code and atmospheric interruptions. This trouble is particularly noticed in trans-oceanic work on high wave-lengths, but is not of much consequence on the short-wave Continental work.

The most important private undertaking in Great Britain dealing with high-speed telegraphic work is Marconi's Wireless Telegraph Co., Ltd., and a resumé of the system of this company is given here. The two chief transmitting stations in this system are situated at Ongar, in Essex, and Carnarvon, in Wales, and the principal receiving station is at Brentwood, Essex. Carnarvon station is principally confined to the transatlantic traffic, and Ongar to the Continental. Brentwood receives from any foreign station.

From a wireless standpoint the most remarkable feature of this system lies in the fact that these stations are controlled entirely by operators at one point. This is at Radio House, London. From this building land-lines are connected to the

transmitting and receiving stations mentioned, and it is by a system of remote control that the respective stations are operated. An operator at Radio House actually transmits the message from Carnarvon or Ongar, as the case may be, without any intermediate human relaying.

The operating room at Radio House is divided into a number of sections, each section containing a bench upon which the apparatus is located. Above each bench is a sign-board indicating the station with which the operator is working. These stations are as follows. Barcelona, Berne, Glace Bay (Nova Scotia), Madrid, New York, and Paris.

Operators work in pairs, one receiving and the other transmitting. The receiving operators are equipped with Morse writing machines, typewriters, and telephones. The transmitting operators have a Wheatstone, Gell, or other perforator, and a high-speed transmitting machine, operated by the tape prepared by the perforator.

A typical perforator, in this case a Creed machine, is illustrated in Fig. 1. It will be seen that it is a keyboard-operated machine, similar to a typewriter. The action of depressing the keys causes a series of holes, corresponding to the Morse signs, to be punched in a paper strip. The latter is driven by the small electric motor shown on the left of the photograph. A portion of the strip may be plainly seen. The holes on one side represent dashes, and on the other side dots. The paper strip is transferred from this machine to the transmitter, an illustration of which is given in Fig. 2. This machine converts the perforations in the strip into a series of electrical impulses, which are the usual Morse symbols. This is accomplished by means of contacts which are arranged on either side of the paper strip.

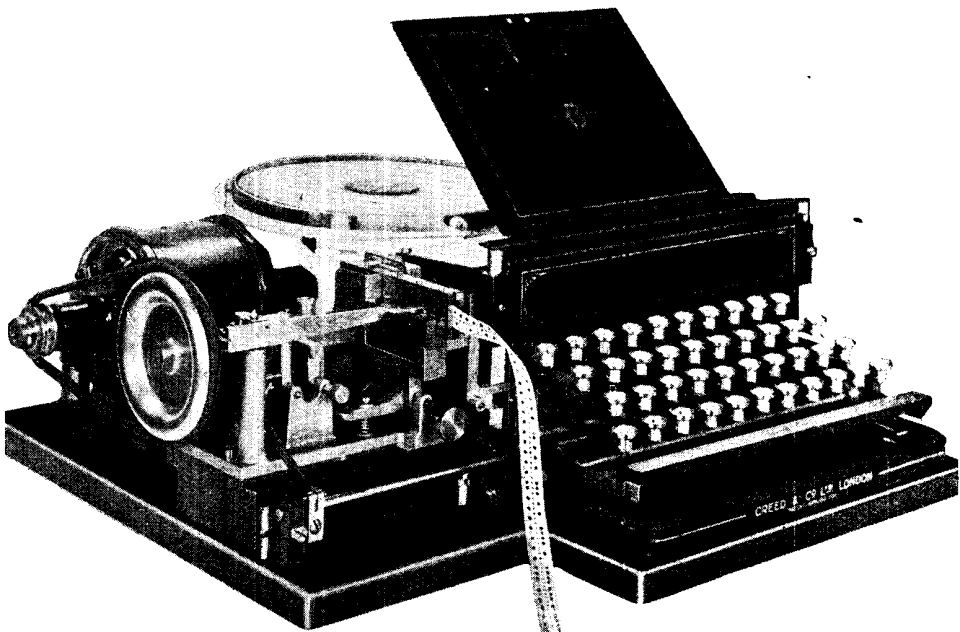

Fig. 1. By means of this machine, which is a Creed

keyboard perforator, a series of holes corresponding to Morse signs are punched in a strip of paper. This strip is used on the transmitter, and is run through it at a high speed

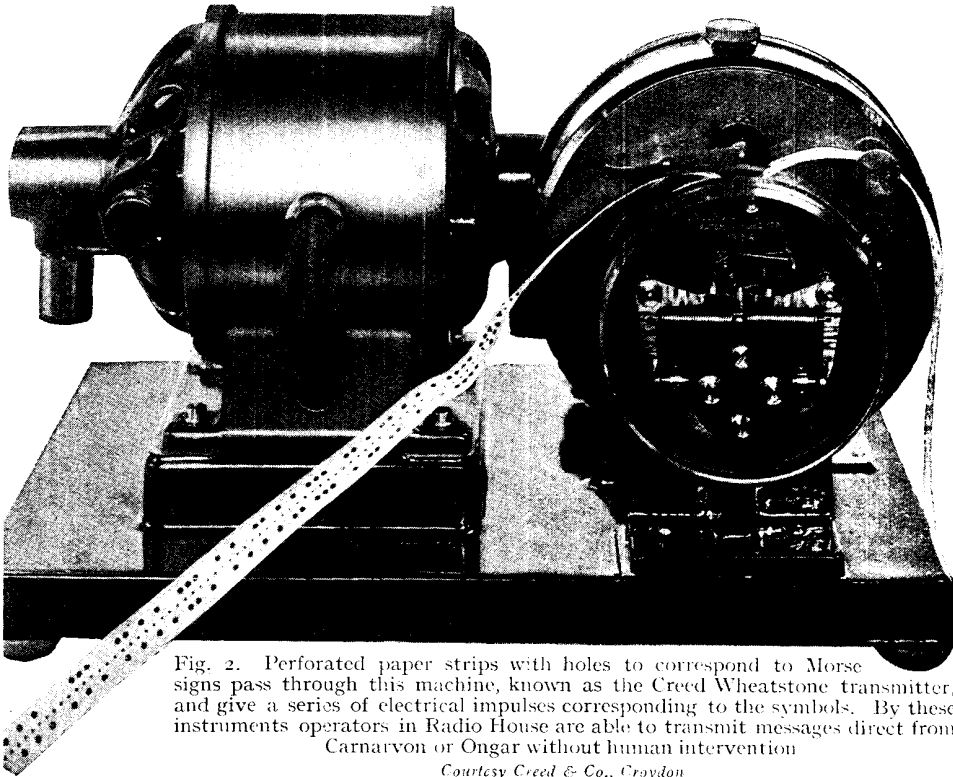
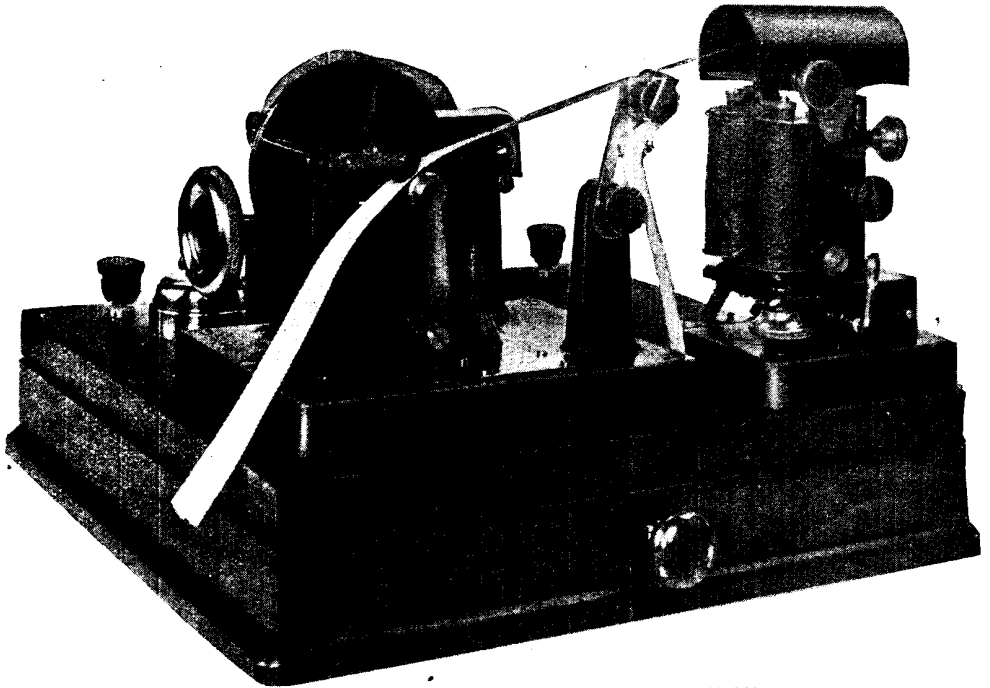

Fig. 2. Perforated paper strips with holes to correspond to Morse signs pass through this machine, known as the Creed Wheatstone transmitter, and give a series of electrical impulses corresponding to the symbols. By these instruments operators in Radio House are able to transmit messages direct from Carnarvon or Ongar without human intervention

Courtesy Creed & Co., Croydon

CREED HIGH-SPEED TAPE RECORDING AND TRANSMITTING INSTRUMENTS



CREED UNDULATOR FOR HIGH-SPEED RECEPTION

Fig. 3. Wireless messages are received on this instrument at high speed. The strip of paper is marked with a series of undulating lines, which correspond to the dots and dashes which appear on the strips in the transmitting apparatus

Courtesy Creed & Co., Croydon

Two types of receiving instrument are used, one of which is illustrated in Fig. 3. This is known as an "Undulator," because of the type of symbol which it reproduces on the strip. Reference to Fig. 4 shows the appearance of these symbols. They are in the form of an inverted "U," the dots and dashes being clearly indicated by the length of the "U." The pen which accomplishes this action is shown in Fig. 3. It may be seen projecting from

the semicircular-shaped cover, and consists of a very thin tube through which spirit ink is syphoned. The message conveyed on this strip is read by the operator, who types it out upon the telegraph form. Copies of the latter are made by the surface contact method.

The second method of receiving is shown in Fig. 5. The received signals are here made to operate a perforator, which punches holes in a strip in the same manner as the

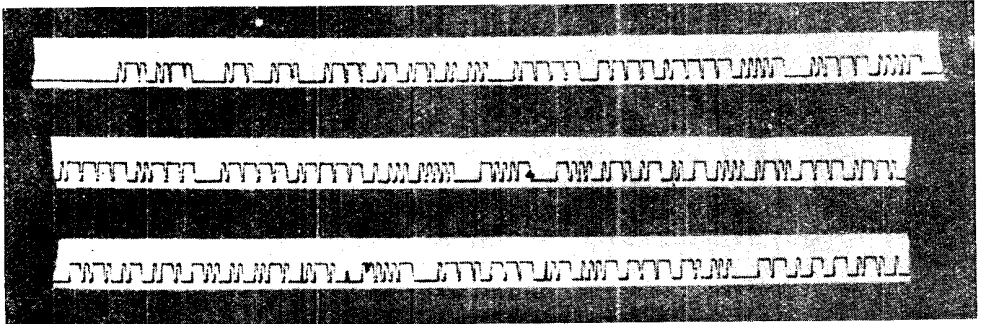

HIGH-SPEED MORSE SIGNALS AS RECEIVED

Fig. 4. Tape from a high-speed Creed receiving apparatus is illustrated above. This is the method employed by the instrument in Fig. 3. The undulating lines clearly indicate the dot and dash symbols of the Morse code by their varying lengths

transmitter previously described. The strip produced is passed on to another machine, which automatically types the message on another strip. The latter is cut into convenient lengths and pasted upon the telegraph form. The appearance of this is no doubt familiar to most people.

Valve amplifiers are used on both the transmitting and receiving sides. In the former case they fulfil the function of making the current sufficiently powerful to overcome the resistance of the land lines, and in the latter case they are necessary to operate the perforator or undulator, as required.

The above is a brief exposition of the mechanical and electrical methods employed in high-speed working. An outline of the

pigeon-holes, then, is for one station, and each individual hole in the group represents the order of priority for that station. The pigeon-holes are open at both ends, and the other side to the sorting clerk faces the terminus of the conveyor system. Another clerk places the telegrams on the conveyor required.

The conveyors are of the continuously moving type, and are automatic in the sense that they pick up the telegraph form when the latter is placed in the correct

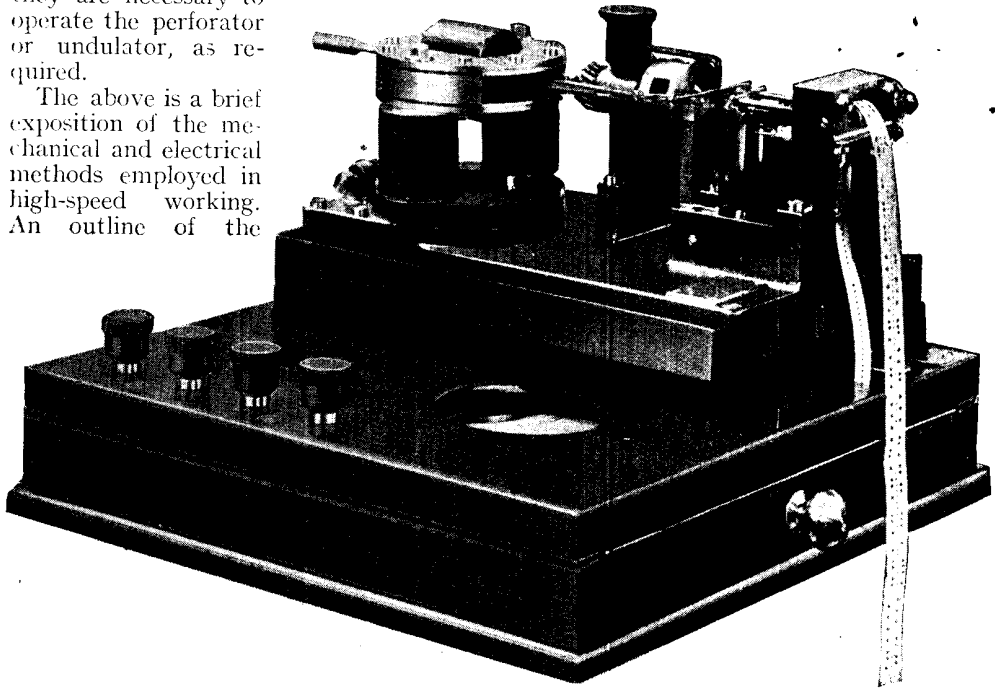

CREED HIGH-SPEED PERFORATED-TAPE RECEIVER

Fig. 5. Messages are received on this instrument in Morse code, and instead of an undulating line making the record, the tape is punctured to correspond to the tape in the transmitting instrument seen in Fig. 2

system used to deal with telegraphic traffic will now be given.

Telegrams given in at Radio House or a branch office are conveyed first of all to the sorting department. Here clerks sit before a desk fitted with a number of pigeon-holes, from which run automatic conveyors. Each pigeon-hole is for a particular purpose, and is one of a number of groups. Telegrams are sorted either for destination or priority. For instance, by the payment of a higher fee, it is possible to obtain priority of sending over the ordinary telegrams. Each group of

position. Again, each conveyor probably passes two or three stations, and matters are arranged so that the form always drops from the conveyor only at that station for which it is intended. By this means all running about on the part of messenger boys within the operating room is avoided, and, further, a great deal of valuable time is saved.

Stations on the conveyors are arranged on the side of the telegraph operators. On the arrival there of the telegraph form they unfold it, place it on their desks, and proceed with the transmission.

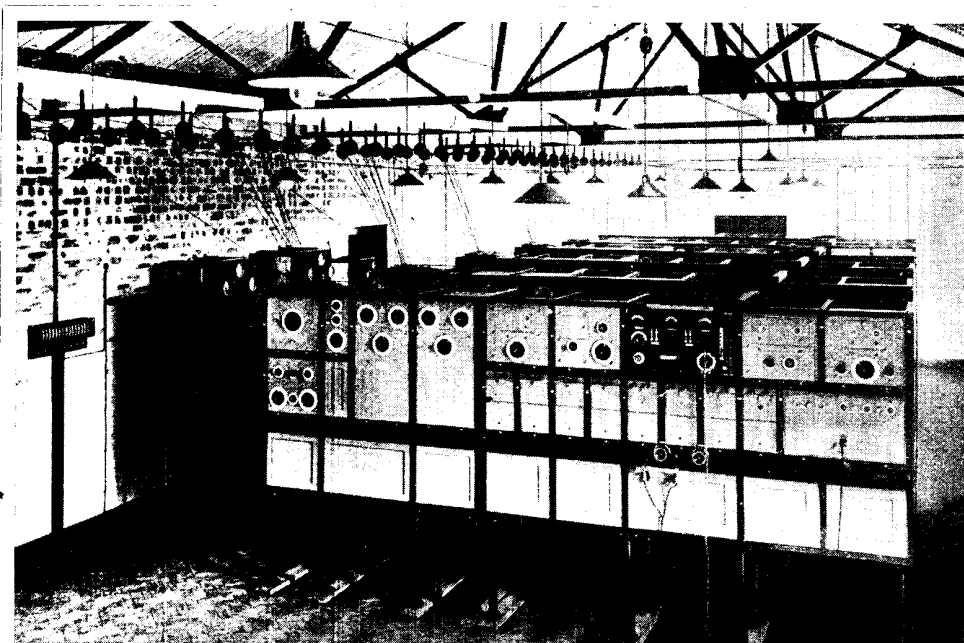

Fig. 6. Five rejector circuits are used in the receiving apparatus, of which this view shows the panels. The object is to eliminate jamming and atmospherics of one foreign station

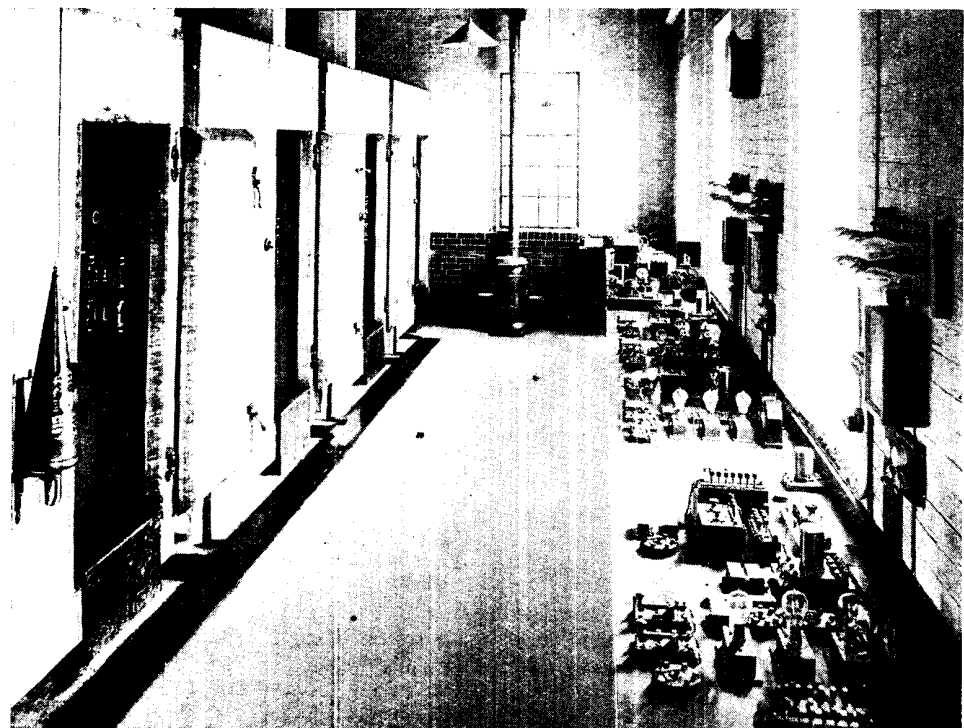

Fig. 7. Rooms on the left are for operators of receiving apparatus. Each room is employed for reception from one station, such as Paris, New York, Madrid. On the right the bench contains relays and amplifiers for direct relaying to Radio House

Courtesy Marconi's Wireless Telegraph Co., Ltd.

HIGH-SPEED APPARATUS AT BRENTWOOD WIRELESS TELEGRAPH STATION

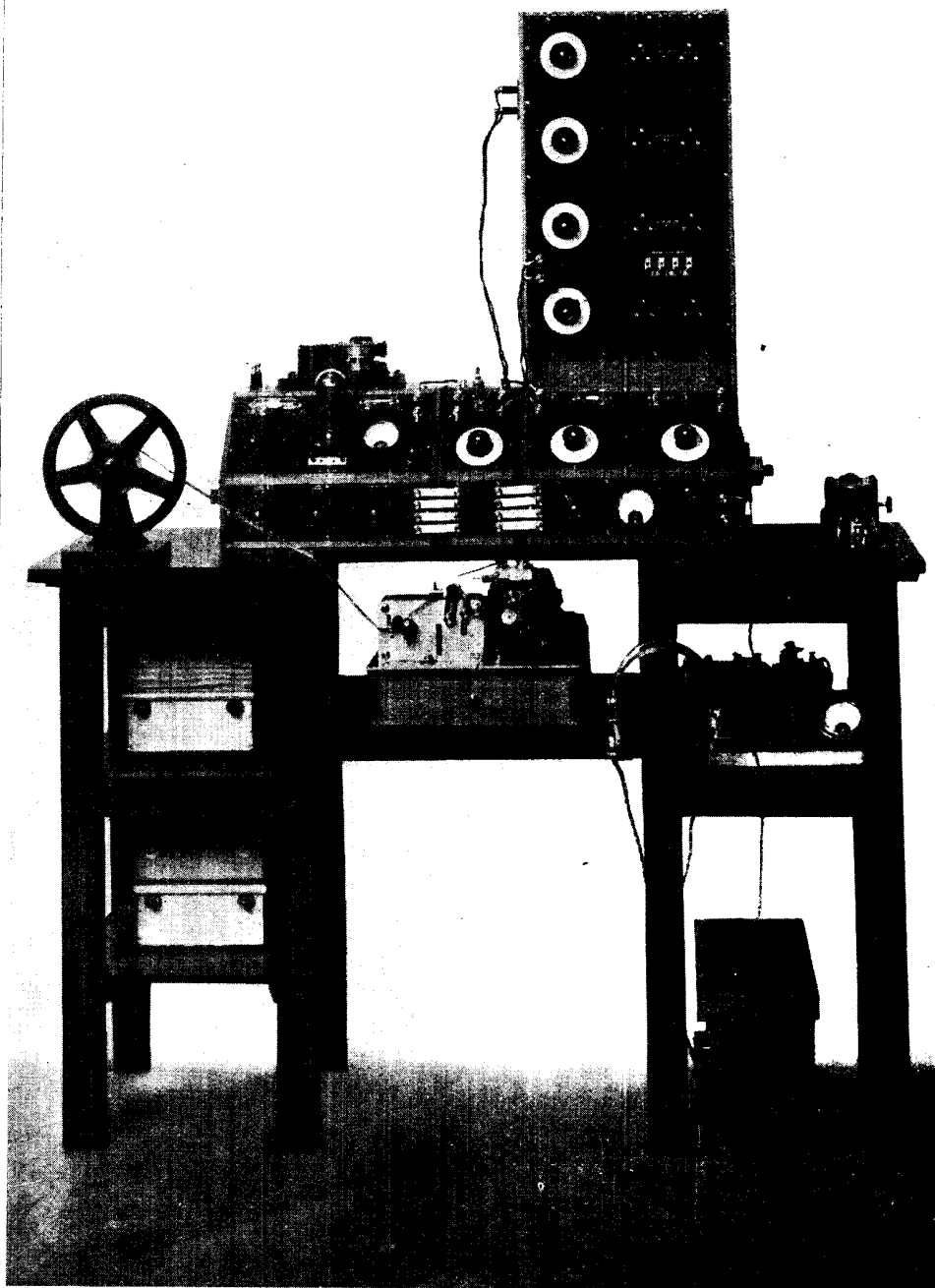

Fig. 8. On the top of the bench appears the receiver, together with four rejctor circuits. Beneath is the automatic Morse undulator, which records the message. The recorder is for testing purposes only, the actual message being passed on. By such an instrument commercial messages are conveyed with the precision and accuracy of cable traffic despite all kinds of atmospherics and other interference, and a high speed is maintained automatically

Courtesy Marconi's Wireless Telegraph Co., Ltd.

MARCONI HIGH-SPEED RELAY FOR TRANSMISSION AND RECEPTION

Certain firms, particularly financial houses, have special facilities for sending telegrams direct to the station by telephone over private wires. In this case the telephone operators place the message on a special conveyor, to which priority over all others is given. Received messages are all conveyed to one room, where they are sorted. If they are for the country, they are telegraphed to the required district by the ordinary telegraph system. London messages, however, are dealt with in a different manner. Should a telegraphic address be given, the latter is looked up in a very comprehensive card-index system. When the name and address of the recipient has been found, the message is placed in a special envelope, with the full name and address printed upon it.

Very urgent messages, which are telephoned from Radio House to their destination, are also delivered by messenger, in order that a record may be available which may be filed by the recipient.

Some idea of the enormity of the undertaking may be appreciated when it is realized that there are over eighteen thousand telegraphic addresses registered with the Marconi Company, each of which is provided with printed envelopes waiting always ready for a message to be received and delivered. This is quite apart from the casual traffic, the number of messages of which runs into thousands daily. Further, the omission or inaccuracy of one letter or word may mean the loss of thousands of pounds to the sender or recipient. Every effort is therefore made to see that errors are avoided.

Two illustrations of the Brentwood station of the company are given in Figs. 6 and 7. Fig. 6 shows the receiver panels, each of which contains the apparatus from one foreign station. Great precautions are taken to ensure absence of jamming, and for this purpose five rejector circuits are used. It is thus practically impossible for an atmospheric or other interruption to interfere with the accuracy of the signal. Fig. 7 illustrates the relays and other apparatus which are used in the transference of the radio signals to the land lines. These are shown on the bench in the right of the picture. On the left are the rooms containing part of the receiving apparatus. Each room contains one receiver, and each receiver is permanently tuned to one transmitting

station. Operators are always on the watch here to see that everything is in order. The rooms are sound-proof so that the operator shall not be disturbed by external noises.

A typical Marconi high-speed relay is shown in Fig. 8. The receiver is mounted on the top of the bench together with four rejector circuits. Beneath this is an automatic Morse undulator, which records the message. This recorder is purely for testing purposes. Such an installation as this would be used at a station such as Brentwood, where the radio signals are not actually terminated, but passed on by land line to a central clearing house.

Despite the fact that all kinds of unforeseen atmospheric conditions are always likely to interfere with radio work, commercial messages are now sent and received with the same precision and accuracy as by cable. Furthermore, efficiency in methods of traffic handling have made them probably even faster than the older method.—*R. B. Hurton.*

HIGH-TENSION BATTERY. Expression applied to a battery of dry cells, or a storage battery, employed for the purpose of supplying high-tension current to the anode circuit of a valve set. It is also known as the B battery.

The electro-motive force of a high-tension battery varies according to the needs of the circuit or valves in the set. In the example illustrated the voltage is 54, and there are tapplings at each 6 volts, thus allowing of the use of wander plugs, which can be placed into the appropriate

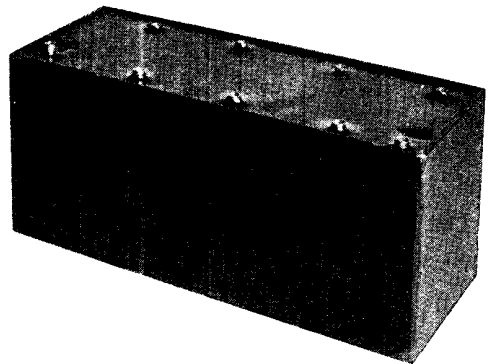

HIGH-TENSION DRY BATTERY

Voltages vary according to the make and requirements of high-tension batteries. This is a 54 volt battery with tapplings at every 6 volts. Wander plugs are used to allow the required voltage to be tapped

Courtesy Economic Electric Co., Ltd.

tapping point to give a choice of voltage and make the battery more extensively serviceable. It is an advantage to be able to select the best voltage by trial, as a slight variation in the anode current value will often effect an improvement in signal strength in a receiving set. See Accumulator; Battery; B Battery; Cell; etc.

HIGH - TENSION BATTERY BOX.

Term used to describe the container for a high-tension battery. It is usually provided with a series of contacts connected by suitable conductors to tappings taken from the battery, so that various voltages may be employed to meet the requirements of a circuit. See Battery Box.

HIGH-TENSION CIRCUIT.

Named given to that part of a transmission circuit comprising the secondary and transformer leads of a primary oscillating circuit, as well as the oscillatory circuit comprising a primary condenser, primary inductance, and spark gap. In high-tension circuits of this type the transformer and condenser should be protected against excessive strains on the insulation by means of safety gaps, in the form of spark gaps which will operate automatically when

the terminal voltage of the secondary rises above its normal working limit. In receiving sets the expression is sometimes applied to the anode circuit (*q.v.*).

HISSING ARC. A phenomenon occurring in the electric arc when the positive end of the arc stream travels over the surface of the electrode at a high speed. It is accompanied by a loud noise suggestive of a hiss. A sudden increase of current is one cause of the trouble.

HOGAN, JOHN V. L. American wireless expert. Born at Philadelphia, United States, he was educated at Sheffield Scientific School, Yale University, where he made a special study of physics and mathematics. In 1906 he became assistant to Dr. Lee de Forest, and in 1909 he joined the National Electric Signalling Co. In 1914 he was appointed chief research engineer to the International Radiotelegraphic Company.

Hogan has written many articles on wireless, and is a past president of the Institute of Radio Engineers, member of the American Institute of Electrical Engineers, of the American Association for the Advancement of Science, of the Radio Club of America, and other societies.

HOMCHARGER. Electrical apparatus for the conversion of alternating current to direct current for the purpose of charging accumulators or other purpose where a unidirectional current is required. A feature of this rectifier is that its operation is fully automatic, and does not require any special knowledge or tuition in order

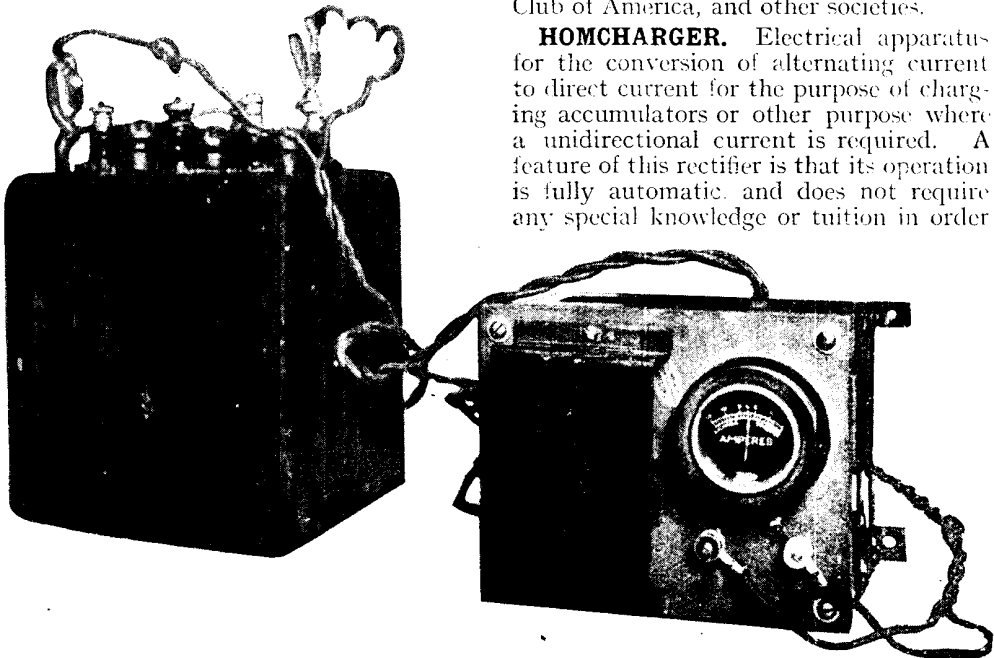

HOMCHARGER AND ACCUMULATOR ON CHARGE

Accumulators may be charged at home from alternating current mains by using the Homcharger, which includes an automatic rectifier. In this photograph the apparatus is seen connected to an accumulator to be charged; the two remaining wires at the top of the instrument are inserted into a standard lamp holder by means of a plug

Courtesy Carfax Co., Ltd.

range or the power from the set. The use of constructional parts of this character makes the home constructor appreciate the details of the set and acquire a more practical knowledge of the functions and purpose of the separate parts. In addition, there is the charm of having actually made the set. The practical side is looked after by the makers, as when a complete set is obtained in this way the values of the components are sure to be correct and well balanced. See Amplifier; Burndept; Crystal Detector Unit; Detector Unit; Geophone.

HONEYCOMB COIL. Coil so called because of its similarity in appearance to the honeycomb. The construction of a typical plug-in commercial honeycomb coil may be seen by reference to Fig. 1. It will be seen that the windings interlace and cross one another, forming diamond-shaped spaces between each wire. Furthermore, the method of winding is such that succeeding layers of wire do not come into contact with, or lie in the same plane, as those which precede them.

The object of this method of winding is to reduce self-capacity to a minimum and,



STANDARD HONEYCOMB PLUG-IN COIL

Fig. 1. Winding in this form reduces the self-capacity of the coil to a minimum, and keeps the inductive value at a maximum

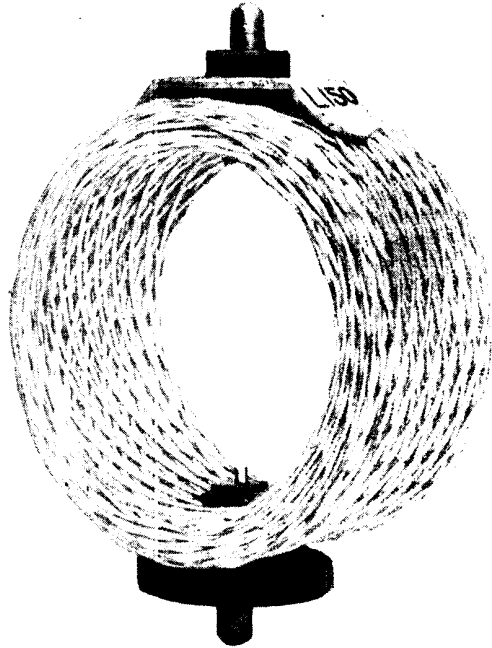

IGRANIC GIMBAL HONEYCOMB COIL

Fig. 2. Pins at the top and bottom of the coil illustrated fit into a gimbal coil holder, which allows a movement on its own axis as well as the usual swinging motion

at the same time, to keep the inductive value at a maximum and ensure a low high-frequency resistance. The first object has been achieved by spacing the adjacent turns of wire in such a manner that, with the exception of the comparatively small points where the wires cross, they are completely surrounded by air. Air has the lowest specific inductive capacity of any dielectric, and is therefore the most efficient medium to use. The correct spacing of the adjacent turns has ensured a high inductive value.

The coil illustrated in Fig. 2 is an Igranic gimbal-mounted coil. The ends of the coil are connected to the pins which project from the coil mounts. These pins fit into a special type of gimbal coil holder, which allows the coils to be moved on their own axis besides having the usual swinging motion. An exceedingly fine adjustment of relationship may be made by this means. The relationship varies in two planes, so that the interaction can be made with a much greater degree of refinement than with the ordinary plug-in moving coil.

It is a comparatively simple matter to wind honeycomb pattern coils by hand.

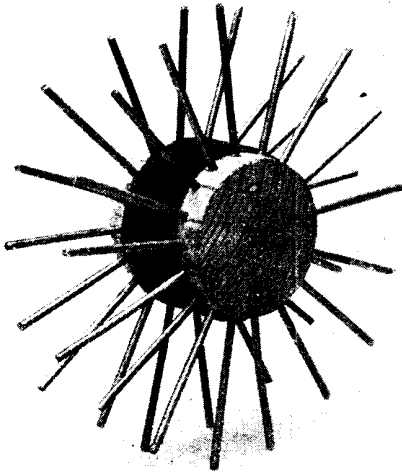

BOBBIN AND PINS FOR HONEYCOMB COIL

Fig. 3. Preliminary stages in making a honeycomb coil include constructing a former as above, upon which the coil is wound

and it does not become at all monotonous, as is the case with single-layer coils, providing only that reasonable wave-lengths are desired to be covered. Procure a piece of wooden rod about $1\frac{1}{2}$ in. in diameter and $1\frac{1}{2}$ in. long as a bobbin, and at $\frac{1}{4}$ in. from each end mark off and draw a line around the circumference parallel with the edge.

The circumference is now divided into seventeen equal parts. This is best done

by wrapping the rod round with a piece of stiff paper so that it just meets, removing, and dividing with a millimetre rule, afterwards marking the correct positions upon the wood. Another and more exact way is to strike a circle upon paper of the same diameter as the rod and divide with a protractor, using a pair of compasses to space off upon the pencil lines already drawn upon the bobbin.

Having now marked out the bobbin satisfactorily on two parallel sides with small sets of points in line with each other, holes should be drilled in the wood, taking care that they all radiate towards the central point of each flat side, though they need not be more than $\frac{1}{4}$ in. deep. It is now necessary to obtain sufficient spokes about 2 in. long. These can conveniently be ordinary 2 in. oval brads; but the pins shown in the illustrations are made from galvanized iron wire cut to length and pointed with a file, a rather laborious process.

If oval brads are used the heads are not large enough to matter, but should round nails be chosen it is necessary to cut off the heads.

One row of pins may now be inserted, and a cardboard ring prepared of sufficient width to fit between the two rows of pins, being careful not to make it fit the bobbin too tightly or it will be difficult to remove

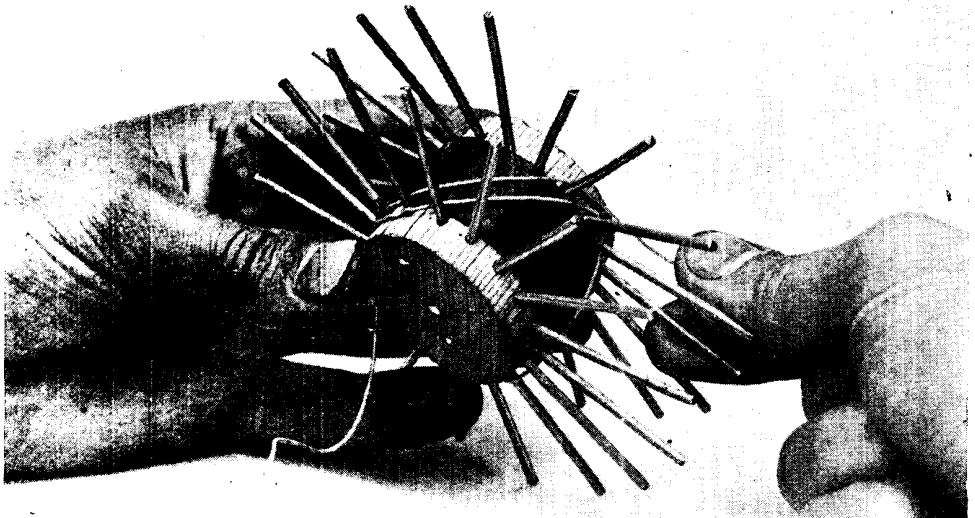

HOW TO WIND A HONEYCOMB COIL BY HAND

Fig. 4. Having made the former shown in Fig. 3, which consists of a bobbin and pins, the wire is wound, commencing as illustrated in this photograph. The second turn of the wire is laid on, and it will be noticed that the direction of winding is from side to side of the bobbin

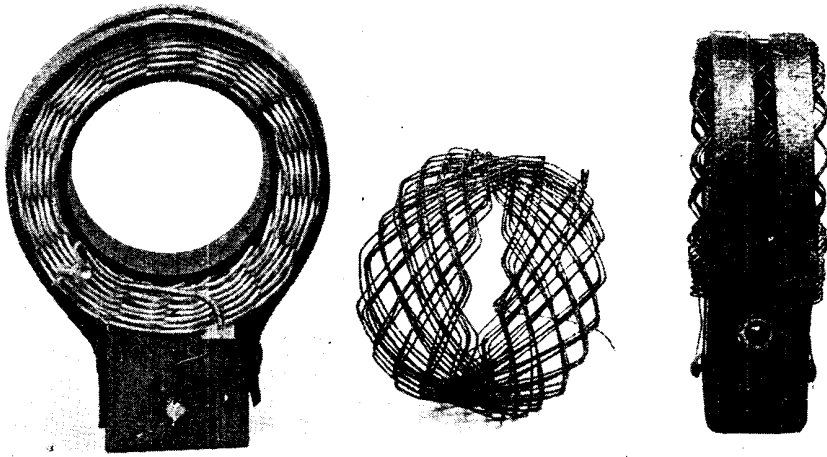

COMPLETED HOME-MADE HONEYCOMB COILS

Fig. 5. When the coil which is shown being wound in Fig. 4 is completed, and the pins and bobbin are removed, it appears as shown in the centre of this photograph. This has not yet been mounted. On either side is a similar coil, mounted, and the method of making fast the connecting wire is seen on the left. An edge-wise view is given on the right.

with the coil. This ring should be noted in the photographs, and is of practical importance, as it allows the finished coil to come away easily after the removal of the pins and thus preserve the character of the winding. Each pin should be numbered in order to make the winding easier.

The cardboard ring being placed in position, the second set of pins is inserted (Fig. 3), and they may all be driven in slightly with a hammer, using a piece of wood as a support in the centre of the bobbin when so doing. The coil is now commenced by starting at a pin marked No. 1, crossing over to the first row of pins No. 9, over again to No. 13 and back to No. 17, as in Fig. 4.

The wire is now one pin behind where it started in the front row, and thenceforth the wire will be parallel. When one complete layer is put on and the pins are all occupied, the constructor will start upon a fresh layer, which will be above, though separated from, the first. The photograph, showing a layer actually being wound, clearly indicates the method of winding, and a few experiments with a piece of string preparatory to starting with wire, and a study of the illustrations, will make the winding of the coils a very simple matter. A coil having been wound, the commencement and the end should be

bound and tied with thread, and a piece of cardboard just wide enough to pass between the pins and long enough to wrap round the coil should be prepared, and may be split or decorated with diamond-shaped openings, as fancy may dictate.

A wooden or ebonite block of the same width, and 1 in. high by 1 in. wide, should be prepared with a slightly curved top side to fit the circumference of the coil. This can be pushed tightly against the outer edge of the winding; the cardboard strip, well moistened with shellac varnish, is fastened to the block on one side, wrapped round the coil, and fastened upon the opposite side. When the shellac has dried, the cardboard will be found to hold the coil quite firmly. The pins may now be removed.

In the illustration (Fig. 5) it will be noticed that round-headed brass screws are used for connexions, the screws simply being driven in sufficiently tight for a slotted plate to make a good fit behind the screw heads, the coil ends being then soldered into the screw slots. With suitable slotted plates, a good coil holder may be constructed, as described on pages 466 to 469, or the ready-made coil mounts may be purchased quite cheaply, together with a two- or three-coil tuning stand upon which the coils may be plugged in. Alternatively, valve sockets and pins

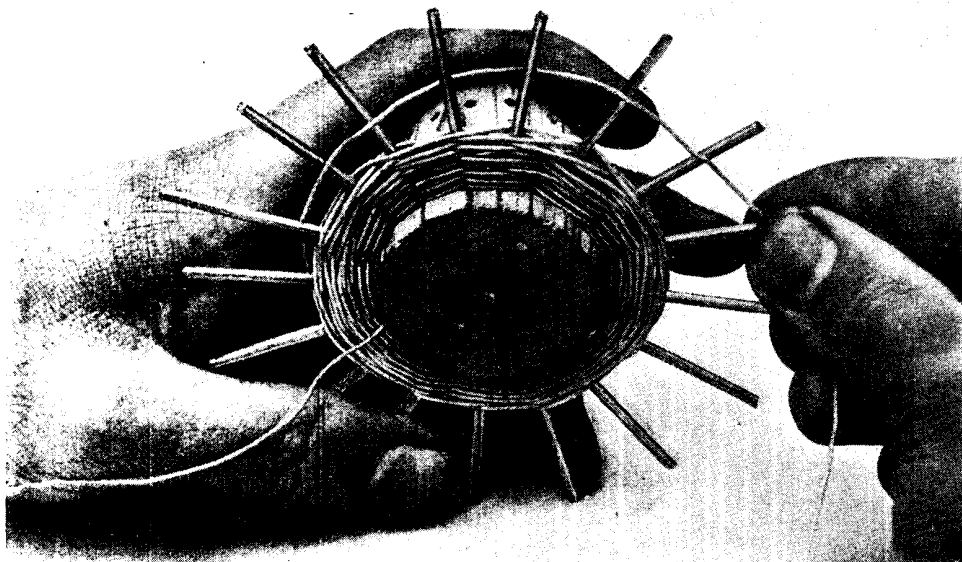

HONEYCOMB COIL FORMER USED FOR BASKET COIL

Fig. 6. Basket coils may be wound on the same former as honeycomb coils, except that one row of pins must be taken off. In the photograph above the bobbin and one row of pins are seen in use, with a basket coil being wound.

may be used, the sockets upon the tuning stand and a pair of valve pins upon the coil base, this method, whether for honeycomb, basket, or slab coils, being very satisfactory in practice.

It is interesting to note that very substantial basket or spider coils may be wound upon the former described above, using only one row of pins, especially if two pins are passed each time, as shown in the illustration (Fig. 6). This makes a coil of a much better and more substantial shape for mounting than is usually the case with a basket coil wound in and out of each following pin, as is the usual form of basket coil. See Bank-wound Coil; Basket Coil; Coil; Duolateral Coil; Inductance Coil; Plug-in Coil.

HOOK UP. This is a well-known American term for the circuit diagram showing the wiring of any wireless receiving or transmitting set.

HOOPER, STANFORD C. American naval wireless expert. Born on August 16th, 1884, at Colton, California, and educated at San Bernardino, California, he joined the Southern Pacific Company as a telegraph operator. In 1901 he entered the Naval Academy at Annapolis, and entering the navy, became Commander in

1918. From 1910-11 he was instructor in electrical engineering, physics, and chemistry at the U.S. Naval Academy, and in 1912-13 Fleet Radio Officer of the United States Atlantic Fleet. During the great war he was responsible for the supply of wireless instruments, etc., for the American navy, and he was also responsible for the construction of many of the larger American wireless stations, including those at Annapolis, San Diego, and Pearl Harbour. Hooper was one of the chief men concerned with the radio-compass system now used in the American navy.

HORIZONTAL AERIAL. General term given to any aerial in which the wire or wires are approximately horizontal. See Aerial.

HORSE-POWER. Unit for the rate of doing work. In British units a horse-power is defined as the power required to raise 33,000 lb. one foot in one minute. In the C.G.S. system the unit of power is one erg per second. This unit is too small in practice, and the watt, equal to 10^7 ergs per second, is taken. A still larger unit, the kilowatt, is frequently used. One horse-power equals 746 watts, or about three-quarters of a kilowatt. See Units.

HORSESHOE MAGNET. Name applied to a U-shaped permanent magnet. This type of magnet is extensively used in magnetic machines, and is found in a modified form in many telephone receivers

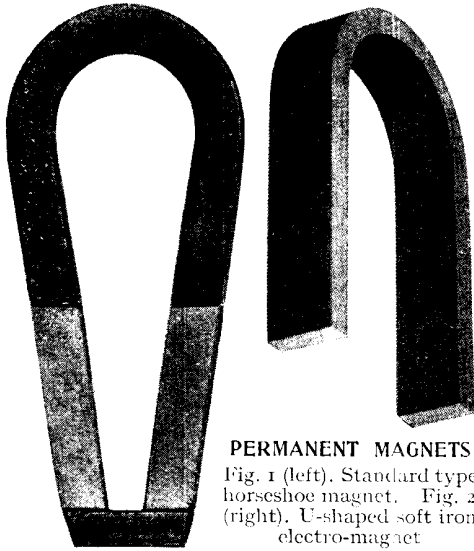

and other wireless and electrical apparatus. Two examples are illustrated. With all horseshoe magnets the end of one leg is known as the north pole and the other as the south pole. See Electro-magnet; Magnet; Magnetism.

HOT-WIRE AMMETER. The hot-wire ammeter is a current-measuring instrument which depends for its action on the heating effect of the electric current.

The advantages of this type of instrument for radio work are that it possesses practically no inductance and very little capacity. On this account it may therefore be inserted into any circuit where a reasonable current is passing without seriously interfering with the characteristics of that circuit. Against this, it has the disadvantage that, owing to the fact that current does not instantaneously heat a wire, it is somewhat sluggish in action.

It is chiefly applied in radio work to the output circuits of a transmitter, where it registers the current radiated from the aerial. Hot-wire instruments, suitably calibrated, may be used for either alternating current or direct current. Their greatest advantage for the former work is that they are entirely independent of frequency, wave form, or external magnetic fields. Furthermore, their construction, which is very simple, allows them to be sold at a very reasonable price.

In theory the action of the hot-wire ammeter is extremely simple. Practical experiment will show that heat always accompanies the flow of current through a conductor, and, further, that the heat produced is directly proportional to the square of the current, providing that the conductor is maintained in a constant physical state. Again, wire, of which conductors are invariably composed, expands with its temperature. It will therefore be seen that a measure of current is obtainable if convenient means are available to ascertain the amount of expansion

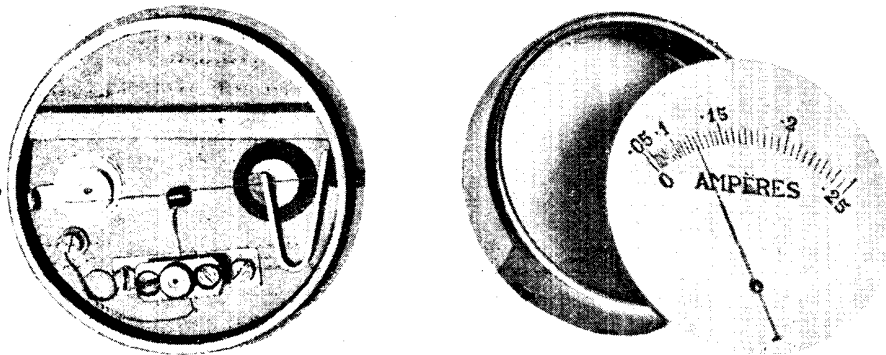

INTERIOR OF HOT-WIRE AMMETER

Fig. 1. From this view of the interior of a hot-wire ammeter may be seen the construction. The actuating wire is in the left-hand illustration, together with its central connexion. On the right is seen the indication disk and pointer and part of the case

with a given current. The only problems which present themselves, therefore, are the mechanical one of attaching a pointer or other system of reading to the hot conductor in such a manner that it will give a true indication of the amount of expansion, and also of rendering the instrument reasonably free from changes in atmospheric temperature.

The method generally adopted to effect the movement of a pointer to indicate the expansion of the wire is illustrated in Fig. 1. Here it will be seen that the hot wire, which is usually a platinum-iridium alloy, is stretched horizontally between two fixed points. At a point near the centre of this wire is attached at right angles a phosphor-bronze wire. The opposite end of this wire is also fixed to a set pillar. A

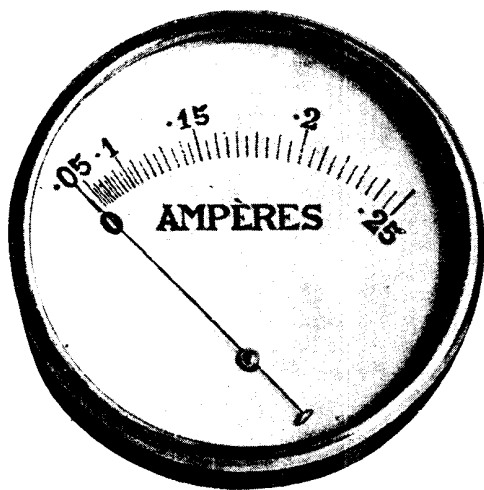

HOT-WIRE AMMETER

Fig. 2. This external view of the hot-wire ammeter shows the pointer, which is made to move due to the heating effect of a electric current through a wire. The instrument reads up to a quarter of an ampere

fine silk fibre is attached, again, at right angles to this second wire. This has its other end coiled tightly round a small pulley situated on a staff or shaft turning in agate bearings.

A pointer, which moves over a scale, is fixed on the staff and moves with it. A second pulley is fixed immediately behind the first, which has a second silk fibre fixed to it. This projects on the opposite side to the first fibre, and is attached at its free end to a flat spring, which is adjusted to keep all the other parts of the moving system in a state of tension.

The principle underlying the above system is that a very small elongation of a wire will produce a comparatively large amount of sag in a lateral direction. This principle is, in fact, made use of in two places: first between the hot wire and the phosphor-bronze, and secondly between the phosphor-bronze and the silk. From this it will be evident that a comparatively great movement is given to the silk thread compared with the small linear expansion of the hot wire.

An idea of the relative amounts of sag between the hot and the phosphor-bronze wires may be gathered from the fact that in one particular instrument which was tested a sag of .2 mm in the hot wire produced one of 6 mm. in the phosphor-bronze one. This latter sag was sufficient to move the pointer through an angle of 90°. The amount of current which was necessary to produce this effect was only .15 ampere.

The second problem of making the instrument free from changes in the atmospheric temperature is effected by making the base of the instrument of composite materials. The illustration shows how this is done. The main base is composed of cast iron. One pillar only of the hot wire is attached to this. The other one is fixed to an extension of the cast-iron base composed of nickel-steel. The effect of this is to make the coefficient of expansion of the base the same as that of the wire.

This ensures that both will expand a similar amount for the same rise in temperature, and therefore no alteration in the tension of the hot wire will result. Should, however, any change ever occur in the tension of the wire, it would throw the zero reading of the instrument out. This contingency is provided for by an adjusting screw situated in such a manner that it alters the relative disposition of one of the pillars to which the hot wire is attached. The method of effecting this adjustment will be apparent from the illustration.

The cheaper classes of hot-wire instrument have no damping device, neither is such a device usually necessary with this type of instrument. Occasionally, however, some sudden change in current or temperature may cause violent fluctuations of the needle which would render reading difficult until the fluctuations had subsided. To this end a damping magnet and an aluminium vane which moves

through the field of the magnet are fitted. The action which results through the vane moving in the field of the magnet is such that it checks the movement to a certain extent.—*R. B. Hurton.*

See Ammeter; Relay.

HOWE, GEORGE WILLIAM OSBORNE. British scientist. Born at Charlton, Kent, 1875, he was educated at the Roan School, Greenwich, Woolwich Polytechnic, and Durham University. He obtained much of his early electrical training with Siemens Bros., at Woolwich, and Siemens and Halske in Charlottenburg. He afterwards became lecturer at the Hull Technical School, and assistant professor of electrical engineering at the City and Guilds Engineering College, Imperial College of Science and Technology, at South Kensington. In 1921 Professor Howe was appointed head of the department of electric standards and electric measurements at the National Physical Laboratory. In the same year he became the James Watt professor of electrical engineering at Glasgow University.

Professor Howe has carried out many researches in wireless telegraphy, and has written many papers on the subject. For his paper on "Some Recent Developments in Wireless Telegraphy," read before the Royal Society of Arts, he was awarded their silver medal. Professor Howe is vice-president of the Physical Society, a member of the Radio Research Board, and chairman of the wireless section of the Institution of Electrical Engineers. *See* Aerial; Capacity.

HOWLING. Term used to describe the noise produced in, and sometimes by, a wireless receiving set, usually as the result of reaction (*q.v.*) applied in such a way as to set a valve or valves oscillating.

When signals are received in the ordinary course by a simple valve set not employing reaction, there is complete interaction between the aerial, grid, and plate circuits, with the result that the sounds heard in the telephone reproduce faithfully, even if weakly, the signals, whether Morse or telephony, sent out by the transmitting station.

The aerial circuit acts as an inlet pipe through which, at a regulated pressure—represented by the process of aerial tuning—the incoming oscillations are led in from the source of supply and impressed upon the grid of the valve. The valve represents a rather complicated tap, in

which a plate current derived from another source—the high-tension battery—assists the current in the aerial and grid circuits, and helps it to emerge from the "tap" in greater volume, as well as in a single unidirectional flow. The amplification of the incoming signals in a valve circuit not employing reaction is appreciable, but only moderate compared with that obtainable by means of reaction.

In a circuit employing reaction the current is, as it were, fed back to the plate



PROF. G. W. O. HOWE, D.Sc.

As chairman of the wireless section of the Institution of electrical engineers, and vice-president of the Physical Society, as well as a noted professor of several important schools and colleges, Dr. Howe is regarded as a leading wireless scientist

Photo: Elliott & Fry

circuit, the assistance lent by the plate current to the oscillations in the aerial and grid circuits being thereby greatly augmented. The process, in its simplest form, consists of coupling inductively to the aerial coil—which thus becomes a primary winding—a secondary winding, known as the reaction coil, one end of which is led to the telephones, the other to the plate of the valve. Its immediate effect is to increase both the amplitude of the incoming waves and the length of the wave-trains.

In the case of a receiving set not employing reaction, there is a procession of wave-trains, or of waves, in orderly sequence, whether Morse signals transmitted by spark or telephony by means of continuous wave are being received. This also happens as long as reaction is kept within bounds by a loose coupling of the reaction coil to the aerial coil.

But as the coupling is tightened, since not only the amplitude of the waves, but also the length of the wave-trains is increased, the latter tend to overlap, and a mixture of blurred and harsh signals culminating in horrible noises is produced. Nor is this the only effect. By reinforcing unduly the oscillatory current in the aerial circuit a stream of continuous oscillations is set up, and the oscillating valve thus becomes a miniature transmitter of wireless waves from what ought to be solely a receiving aerial. This form of irregular radiation produces in the receivers of sets distant sometimes a good many miles very marked "howling," and such interference is a serious limitation to the success of broadcasting, notwithstanding the restrictions—frequently altogether ignored—which have been placed upon the use of reaction by the Post Office.

Cardinal Duty of the Wireless Worker

The avoidance of any approach to being a nuisance to his neighbours should be a cardinal duty of the wireless worker. He is accordingly urged to free himself of the imputation of being a possible "howler," by, in the first instance, keeping his valves as far as possible from oscillating, and, in the second, conforming strictly to such Post Office regulations as may from time to time be in force as regards the method of employing the principle of reaction.

The first is a simple matter, and attention to it is in the worker's own interests. For when reaction is permitted, the most favourable condition for reception is commonly just below the oscillation point, *i.e.* before the wave-trains have begun to overlap. It may be ascertained whether a valve is oscillating by wetting the point of a finger and applying it to the aerial terminal. If a "plop" is heard, the valve is oscillating owing to unduly tight coupling of the reception coil to the aerial or anode coil (see below) from which it is deriving current by induction.

The Post Office allows certain forms of reaction, and although some of these may,

if unskillfully used, cause "howling," there is no question that in a two or three or multi-valve circuit the employment of tuned anode with reaction on to the anode instead of on to the aerial coil greatly diminishes the risk of radiation.

On the other hand, in some of the super-regenerative and other special circuits now becoming popular there is an additional tendency to "howling," partly owing to the effort made to force the amplification to the utmost possible limit.

In certain cases, more particularly when two or more stages of high-frequency amplification are employed, oscillation and a consequent tendency to howl may be present in tuned anode circuits even if no reaction is employed. It is attributable to the capacity, minute though it is, between grid and plate which exists within the valve. This is apt to render fine tuning of both of two tuned anode circuits almost impossible unless special means are employed to prevent oscillation.

One method is to have a combination of high-frequency transformer and tuned plate when listening to transmissions from very distant stations, the transformer being of a semi-a-periodic type which does not require to be tuned by a variable condenser. The instability may also be overcome either by a separate potentiometer to the second anode coil, or by inserting a graphite resistance of about 80,000 ohms in the high-tension positive feed of the second anode coil.

How to Trace Faults which cause Howling

If howling occurs which is clearly not due to tight coupling of the reaction to the aerial or anode coil, it may arise from internal oscillation caused by interaction between some parts of the set, such as parallel connecting wires run at too close an interval, or other metallic parts acting inductively or electrostatically upon one another. The remedy lies in separation or better insulation, especially in the case of the connexions to the grids of the valves.

Howling is sometimes traceable to transformers, both high- and low-frequency. In the former case, an improvement can sometimes be effected by using a potentiometer. In the latter, the trouble may be due to proximity to another low-frequency transformer. If such proximity is unavoidable, shielded or "iron-clad" transformers should be used. Where internal oscillation is caused by a flow, in

the low-frequency transformer or in the telephone circuits, of high-frequency currents which have got past the detector, the primaries of the transformer or the telephones or both may be shunted by fixed condensers—in the case of a transformer one of, say, .001 mfd., and in that of telephones .002--005 mfd., according to the strength of the signals.

A. Douglas points out that dual amplification or reflex circuits are often specially liable to howling, because when simultaneous high- and low-frequency amplification are performed by one valve the currents readily interact and produce reaction effects, most commonly at low frequencies. He recommends (1) raising the value of the grid leak and high-tension battery, (2) decreasing the filament pressure by connecting a graphite resistance of about 80,000 ohms across the grid and low-tension positive leads of the first valve.

If a valve has become too soft, or has been gassed by excessive plate voltage, it may give trouble unless both the filament is "turned down" and the high-tension voltage is decreased.—*O. Wheeler.*

See Oscillation; Reaction; Regeneration; Valve.

HOYT-TAYLOR BALANCE. Name given to a system for the elimination of atmospherics by the use of an underground wire. *See* Atmospherics; Direction Finder.

HUNTING. Word used to describe a state of momentary fluctuation of pressure

in a synchronous generator or motor which results in a phase swing or change of step, often produced by uneven running of the machine. *See* Generator.

HYDRARGYRUM. This is the Latin name for mercury, from which its chemical symbol Hg is derived. *See* Mercury.

HYDROGEN. One of the gaseous chemical elements. Its chemical symbol is H, and its atomic weight 1.008 when oxygen is taken at 16.

Hydrogen is one of the most widely distributed elements, appearing as a constituent of water, the acids, and in most animal and vegetable tissues. It is tasteless and odourless, and its specific gravity is 0.06947 compared with air.

In wireless, hydrogen or one of the hydrogen compounds is widely used in arc oscillation generators. It was in 1902 that Poulsen discovered that if an arc is burnt in an atmosphere of hydrogen or of a hydrogen compound, as coal gas, that it is capable of generating more powerful oscillations than when it is burnt in air. Since his discovery it has now become general to use some form of hydrogen or hydrocarbon atmosphere round the arcs. *See* Arc Transmitter; Electron; Poulsen Arc.

HYDROMETER. An instrument for measuring the specific gravity of a liquid. It is used very largely for ascertaining the specific gravity of the acid in accumulators, which indicates to a large extent the



BALL-TYPE HYDROMETER FOR TESTING ELECTROLYTE

Syringe or ball-type hydrometers, such as the one illustrated, are used for testing the specific gravity of the acid in accumulators, and so testing the extent of the charge

charged condition of the cell. When the conditions of the acid are known, the use of the hydrometer affords the best test for the state of charge of the cell. But, unfortunately, other factors enter into the reading which tend to make it misleading.

When distilled water has been added to a cell to raise the level of the electrolyte it does not combine with the existing acid for some time, and the hydrometer would thus show a lower reading than was actually the case. It will be seen from the specific gravities which follow of a cell in its charged and discharged states that the reading taken under the above conditions would show the cell to be more nearly discharged than it really was. When fully charged the electrolyte should read from 1.275 to 1.300, and when fully discharged 1.160.

It is important, when making a test with the syringe-type hydrometer, to replace the acid from the cell from which it was taken, as failure to do this will destroy the uniformity of the electrolyte, as the cell that is robbed of some of its acid will probably be filled up with water, thus lowering the specific gravity.

A type of hydrometer in which a rubber bulb or piston is used in order to suck the liquid into the instrument is shown in the figure. Such a hydrometer is of the greatest value for ascertaining the specific gravity of accumulator electrolyte.

A syringe hydrometer consists of a glass tube having one end drawn in the form of a nozzle. Inside the tube is a float, having a hair line described horizontally around it. The outer tube is graduated, one graduation being marked red. The latter marking is the correct reading for the acid.

The method of using the hydrometer is to dip the nozzle into the top of the acid, at the same time compressing the bulb with the fingers. On releasing the bulb some acid will be drawn into the instrument. The float will then rise and indicate the specific gravity of the acid by a line on the bulb coming opposite to a line on the tube. It is important that when a reading is taken the hydrometer be taken out of the accumulator and held on a level with the eye. If this is not done, an incorrect reading will be made. Readings must always be taken when the acid is at normal atmospheric temperature.

HYGROSCOPIC EFFECTS. The hygroscopic properties of certain materials are most undesirable in many applications

in wireless work, as, for instance, the use of a cardboard tube as a former for an inductance coil. In such a case the straw and other materials used in the construction of the tube are hygroscopic—that is, they possess the power of absorbing moisture from the atmosphere. This results in a change of form, and also has a detrimental effect on the insulating properties of the tube.

Another material that is hygroscopic is fibre, and this also changes form when moistened by atmospheric action, a sheet often buckling and bulging. High-tension or high-frequency currents of electricity are more liable to leak across a surface when it is damp than when it is dry. This is an important matter to consider when constructing a panel or other part of a wireless set. Wood is also liable to the same trouble. When dry, it is a good insulator; but unless treated by immersion in molten paraffin wax or by other effective means, it will give endless trouble to the experimenter, especially with high-frequency currents, should the weather turn wet.

All wireless apparatus should be kept quite dry and carefully stored in an equable temperature.

HYSTERESIS. In dealing with magnetic measurements it is found that some qualities of iron and steel are more responsive to magnetizing forces than others. In other words, the effects of applying a magnetizing force show a certain sluggishness in the results which has sometimes been called magnetic friction, and for which the correct term is hysteresis. The popular definition of hysteresis is the lagging of the magnetic flux produced behind the magnetizing force producing it.

To investigate this attribute it is necessary to carry a sample of iron through a complete cycle of magnetization, that is to say, starting in a virgin condition with an induction value, B , of zero, a gradually increasing magnetizing force is first applied in a certain direction, resulting in the well-known curve of magnetization, A , indicated by the BH values in Fig. 1.

At saturation points the magnetizing force H is gradually decreased, and, naturally, the iron loses some of its magnetic condition, but not to the same degree as the rate at which the magnetizing force H diminishes. For instance, when H has been reduced from maximum positive value to zero, the curve of

induction falls to a point such as C on the diagram, which is still a long way above the zero value, and the harder the sample of iron the higher will this point be on the hysteresis curve. The degree by which the induction remains above zero with a cessation of the magnetizing force is a measure of the "remenance" of the iron.

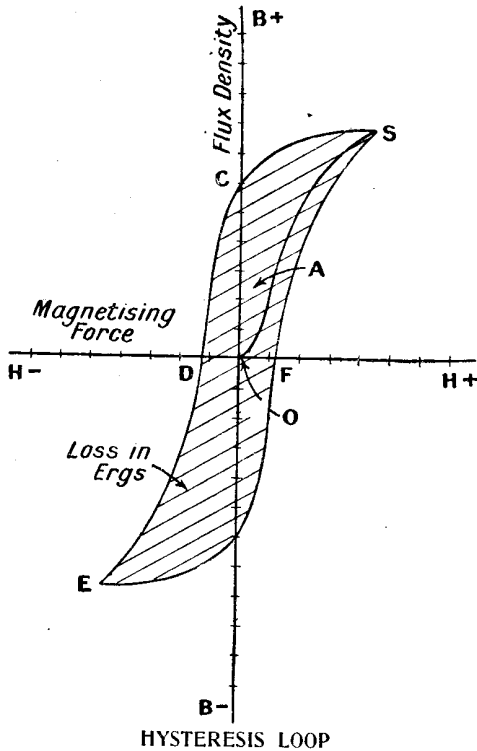

Fig. 1. Investigation of a sample of iron gives the above result when the complete cycle of magnetization is gone through

To bring the iron down to its zero value of induction again it is therefore necessary to apply another magnetizing force in the reverse direction, when the point D is reached on the curve. On increasing still further the negative value of H, the curve repeats itself as to general shape and reaches a saturation point at E, corresponding to the same position it previously took up in a positive direction. On then removing the negative magnetizing force the iron still retains a number of lines of force, and only drags back to point F, and has to be brought back to zero condition by a further application of reversed force H. It will be noticed that this point does not correspond with the origin O of the curve, as the iron, once

having been magnetized, never again entirely loses its residual magnetism; but from this point the curve joins up with the first saturation point A, and thereafter the rise and fall of induction will repeat itself exactly along the previous lines in successive magnetizing cycles.

The height O C on the diagram is a measure of the remanence or retentivity of the iron, while the amount of reversed magnetic force necessary to bring the curve down to zero again is known as the coercive force.

A study of such magnetization cycles or hysteresis loops throws much light upon the suitability of various samples of iron for commercial purposes, since the area included by this loop is a measure of the energy wasted in overcoming the lagging tendencies of the iron. Especially in alternating current work is this of importance, since the reversals of magnetization occur at very rapid rates, usually between 25 and 100 times per second, and the waste of power attendant is evidenced as useless heat generated in the iron.

In the case of air spaces a magnetization curve connecting magnetization and magnetizing force would be a perfectly straight line, since any increase or reduction in the magnetizing force would be accompanied by an absolutely proportional increase or reduction in the magnetic lines produced in the air space. On reducing the magnetizing force there would be returned to the electrical circuit an amount of energy precisely equal to that which had been expended in setting up magnetization.

But if the air space is now filled with iron the power demanded in magnetization is greatly in excess of the energy returned to the circuit on demagnetization. If the magnetism were to die down exactly along the same curve as that of the rising cycle, when the magnetizing power were reduced or removed the work stored up in magnetization of the iron would all be returned to the circuit. But it is not returned, and in consequence the reversed magnetizing force necessary to reduce the iron to zero condition again represents so much energy which has to be imparted to it, and which is irrecoverable.

If the curve represented by any hysteresis loop is drawn to scale such that the C.G.S. unit of magneto-motive force H is represented horizontally by a length of one centimetre, and the C.G.S. unit of flux density (which is one line per square

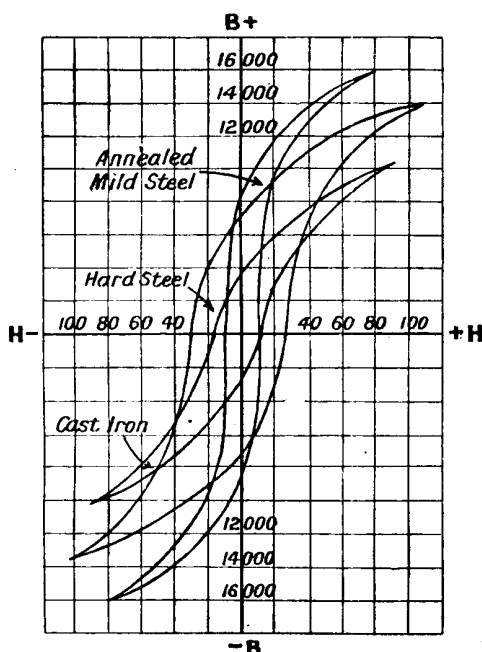

EXAMPLES OF HYSTERESIS LOOPS

Fig. 2. Hysteresis loops for various samples of magnetic material are plotted in the diagram above

centimetre) is also represented by one centimetre in the vertical scale, then the area of the loop in square centimetres will represent accurately the actual energy absorbed per cubic centimetre of iron by hysteresis measured in the C.G.S. unit, that is, ergs, for that particular sample of iron.

The behaviour of various samples of magnetic material taken through the complete cycle of operations is well illustrated by the curves which will be found in Fig. 2. See B.H. Curve; Magnetism.

I

I. This is the chemical symbol for iodine. It is also the symbol suggested by the International Electrotechnical Commission for current.

I.C. Abbreviation often used for intermediate circuit and intermediate condenser. See Intermediate Circuit.

I.C.W. This is the usual abbreviation for interrupted continuous waves, the term applied to that method of signalling in which the waves are modulated at a constant low frequency. See Interrupted Continuous Waves.

I.E.C. These are the initials of the International Electrotechnical Commis-

sion, the commission which suggested the international abbreviations and symbols used in electricity and magnetism. See Abbreviations and Symbols.

IGRANIC. The Igranic Electric Co., Ltd., of Bedford, are known for their electrical controlling devices and switch-gear, and as licencees of the De Forest honeycomb duo-lateral coil-winding process.

A low-frequency inter-valve transformer by this company is illustrated. This pattern is made in a variety of winding ratios to suit individual requirements. Its outstanding feature lies in the fact that it is completely surrounded by an iron shroud which, it is claimed, screens it from external magnetic fields. Spring-clip terminals are fitted, which render its connexion a very simple and quick process, whilst ensuring a good contact. Their other manufactures include coil holders, filament resistances, potentiometers, variometers, telephone transformers, etc.

The best-known products of the company are their Igranic coils. These are made in sixteen different sizes, each size having a definite wave-length range, and in conjunction with suitable condensers a wave-length range with these coils of 150 to 23,000 metres is possible. Some of these coils and their holders are illustrated on pages 444, 463 and 464 of this Encyclopedia under the headings Coil and Coil Holder.

The following table shows the inductance, distributed capacity, natural wave-length, and the wave-length obtainable when using different values of condensers, and will be found extremely useful to experimenters who are trying out new circuits.

INDUCTANCE VALUES & WAVE-LENGTHS

Coil No.	Inductance Microhys.	Distributed capacity Mfds.	Wave-lengths in metres obtained when shunted by the capacity indicated			
			Natural (o mfd.)	'0001	'0005	'001
25	30.2	26	53	116	327	330
35	60.3	34	85	170	338	471
50	134	47	148	265	510	706
75	297	38	200	381	752	1,046
100	517	43	281	512	1,000	1,383
150	1,151	31	355	732	1,473	2,053
200	2,150	28	402	987	2,010	2,800
250	3,480	22	522	1,230	2,540	3,560
300	4,980	27	602	1,495	3,040	4,268
400	8,980	26	910	2,005	4,085	5,720
500	14,510	25	1,135	2,538	5,210	7,273
600	20,110	25	1,337	2,970	6,122	8,545
750	32,300	22	1,588	3,775	7,720	10,825
1,000	59,740	22	2,160	5,080	10,450	14,725
1,250	91,830	21	2,680	6,310	13,100	18,240
1,500	136,400	21	3,190	7,635	15,900	22,210

In selecting a coil, it is better to take half the maximum capacity of the variable condenser as a guide, so that the full range of the condenser may be used. Thus suppose the variable condenser has a maximum capacity of .001 mfd., and it is required to choose a coil for a wave-length

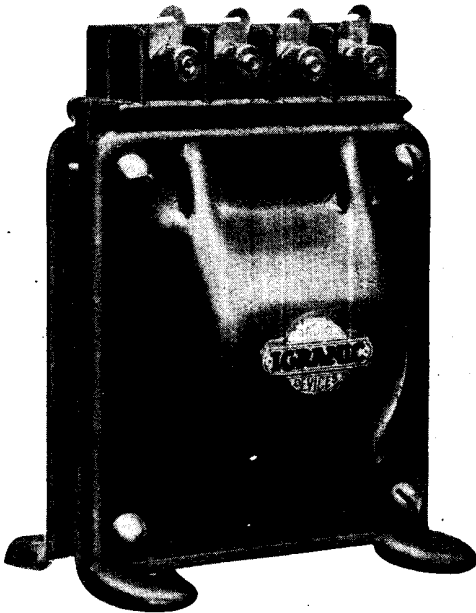

IGRANIC TRANSFORMER

Illustrated above is an Igranic low-frequency intervalve transformer. It is completely surrounded by an iron casing, which screens it from external magnetic fields

of 600 metres. If we take half the value of the condenser, *i.e.* .0005 mfd., it will be seen that a No. 50 coil will give a range between 150 and 700 metres approximately. When used in the aerial circuit, however, it must be borne in mind that the fundamental wave-length of the aerial should be taken into account.

The size of the reaction coil is not important, and it is best found by experiment. It is advisable to begin with a coil about two sizes larger than the secondary, and trial will show, whether increasing or decreasing the coil will render the tone of reception more pure. It will generally be found, however, that the reaction coil need not be smaller than No. 75, nor greater than No. 200.

I.H.P. Abbreviation for indicated horse-power, *i.e.* the total power a machine exerts, including that necessary to run the machine against its own friction, etc. It is

the actual power exerted by the expanding steam in the cylinder of a steam engine, or the power of the explosion and expansion of the gases in the cylinder of a gas or oil engine. It is always greater than the brake horse-power, which shows the horse-power delivered from the main driving shaft of the machine.

IMPACT EXCITATION. Method of producing free oscillations in a circuit by an exciting current whose duration is short in comparison with the duration of the excitation produced. *See* Quenched Spark.

IMPEDANCE. When a steady electro-motive force is applied to a circuit the current does not at once reach its final steady value, owing to a property of every electrical circuit known as impedance. The final steady value will depend on the magnitude of the electro-motive force and the impedance of the circuit. In a direct current circuit of low resistance the impedance of the circuit is generally small, and is only effective during a short period when the current is switched on or off, or varied in intensity.

If an alternating electro-motive force replaces the direct electro-motive force, then the presence of inductance has a marked effect on the current and is effective during the whole time the current is flowing. When an inductance is included in an alternating current circuit an electro-motive force known as the electro-motive force of self-induction is set up which acts in opposition to the impressed electro-motive force. If the inductance is very large and the resistance negligible, then the electro-motive force of self-induction, or "back electro-motive force," will be equal and opposite to the applied electro-motive force. This is shown in Fig. 1, where A is the applied electro-motive force, B the back electro-motive force, and C the current. It will be seen from the diagram that the current is 90° out of phase with the applied electro-motive force, and 90° out of phase with the back electro-motive force.

If, however, the resistance is not negligible the resistance and inductance act together, and the applied electro-motive force required to produce a given current in the circuit must be sufficient to overcome the back electro-motive force of self-induction and the volts lost across the resistance—known as the effective electro-motive force. When both resistance and inductance act in a circuit the total effect

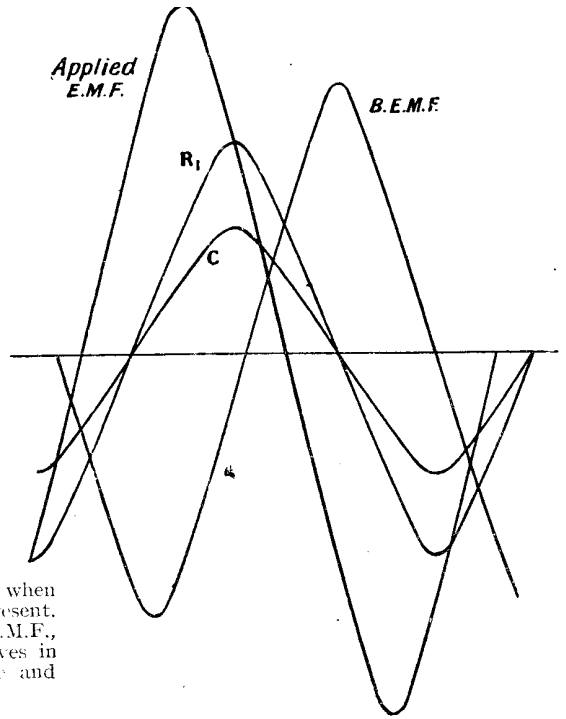
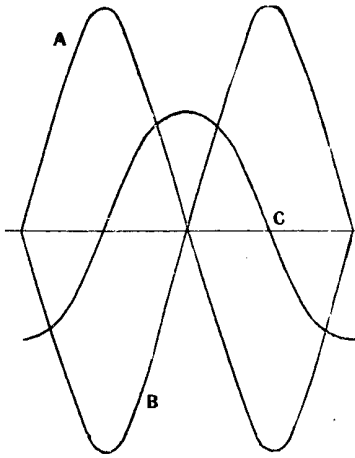

CURVES SHOWING IMPEDANCE

Fig. 1 (left). Phase relations are shown when inductance is large and no resistance is present. A shows the applied E.M.F., B the back E.M.F., and C the current. Fig. 2 (right). Curves in this case show relations when resistance and inductance are present

acting against the applied voltage is known as the impedance. If the resistance can be neglected the effect of the inductance acting against the applied voltage is known as the reactance.

In a circuit consisting of resistance and inductance, the current flowing will be in phase with the voltage across the resistance, and is represented by curve C in Fig. 2, while curve R_1 represents the voltage across it. The back electro-motive force of self-induction is represented by the curve B.E.M.F., 90° out of phase with the current. The applied electro-motive force is obtained by vectorially adding the

ordinates of the R_1 curve and the B.E.M.F. curve.

The relationship between the applied electro-motive force, the back electro-motive force, and the electro-motive force across the resistance can be shown by a vector diagram, as in Fig. 3, in which AB represents R_1 , the voltage across the resistance, AC represents the back electro-motive force, and angle ABC is the angle of lag, so that BC will represent the applied voltage. From the diagram it will at once be seen that

$$E \text{ applied} = \sqrt{(R_1^2 + ES_1^2)}$$

The tangent of the angle of lag $= \frac{ES_1}{R_1}$

$= \frac{\text{Back E.M.F.}}{\text{Effective E.M.F.}}$ and the cosine of

the angle of lag, or the power factor $=$

$$\frac{R_1}{\sqrt{(R_1^2 + ES_1^2)}} = \frac{R_1}{E}$$

The electro-motive force of self-induction depends on the rate of increase and decrease of the current, and is measured by the rate of change of the magnetic flux in the circuit. The coefficient of self-induction, or the inductance of the circuit, is the ratio of the total number of lines of force in the circuit to the current producing them.

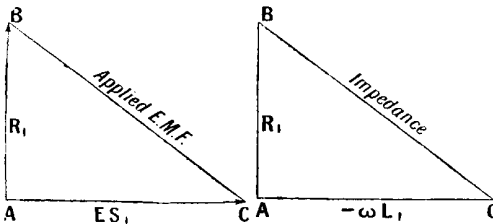

VECTOR DIAGRAMS SHOWING IMPEDANCE

Fig. 3 (left). Relation between the applied E.M.F. and back E.M.F. is shown, with the E.M.F. across the resistance in a circuit. Fig. 4 (right). In this case relation is shown between applied E.M.F., effective E.M.F., and back E.M.F.

The unit of inductance, L , is the henry, and the inductance of a circuit is τ henry when a back electro-motive force of τ volt is induced by a current changing at the rate of τ ampere in τ second.

The rate of change of a current in an inductive circuit is a function of the inductance, and since $I_v = I_{max} \sin \theta$, if

$$\begin{aligned} \omega &= 2\pi n \\ \text{then } E_{max} &= \omega L I_{max} \cos \theta \\ &= \omega L I_{max} \sin (\theta - 90^\circ) \\ &= \omega L I_{max} 90^\circ \text{ out of phase} \end{aligned}$$

This relationship is shown by the vector diagram Fig. 3, where AC represents the applied electro-motive force, AB the effective electro-motive force, and BC the back electro-motive force = $-LI 90^\circ$ out of phase with R_1 .

Then it will be seen that

$$\begin{aligned} E &= \sqrt{\{(-\omega LI)^2 + (RI)^2\}} \\ &= I \sqrt{\{R^2 + (\omega L)^2\}} \end{aligned}$$

The term (ωL) is known as the reactance of the circuit.

The impedance of the circuit is

$$\sqrt{\{R^2 + (\omega L)^2\}}.$$

In circuits where R is small compared with L , R can be neglected. This usually applies to the case of impedance coils inserted in a low-frequency circuit, where the resistance of the coil is a fraction of an ohm and the inductance is comparatively large.

In high-frequency circuits the resistance of the circuit is generally higher than the direct current resistance, and if the inductance is small—which is often the case— R cannot be neglected, and the whole formula $\sqrt{\{R^2 + (\omega L)^2\}}$ must be used.

Measurement of Impedance. The inductance of a coil should be measured with the full current the coil is intended to carry and at the working frequency. Provided the coil is not wound with very thin wire, in which case the direct current resistance will be different from the high-frequency resistance, the resistance can be measured by a bridge method, or the voltage drop noted when a direct current is passed through the coil.

The coil is then connected to an alternating current supply, and the current in the circuit and the voltage across the coil measured. Then the impedance is calculated from the formula

$$I = \frac{E}{\sqrt{\{R^2 + (2\pi nL)^2\}}}$$

This method is particularly suitable for measuring the impedance of choke coils, etc.

For the measurement of large impedances, such as that of telephone receivers, the above method is not suitable, owing to the high resistance, and, consequently, the very small current to be measured. For such measurements it is usual to employ a Drysdale alternating current potentiometer. This instrument is in effect an ordinary direct current potentiometer, but instead of being supplied with direct current for the resistance coils, a special form of transformer is used, which is connected to the same generator supplying power to the inductance to be measured. The usual direct current galvanometer is replaced by a vibrating galvanometer, or a pair of telephones.

To obtain a balance the volt drop across the coil being measured must be equal to that across the potentiometer coils, and these two voltages must be in phase. The first condition is obtained by the usual direct current potentiometer method. The second condition is obtained by the use of a special transformer, consisting of fixed primary coils and a rotating secondary coil. Two coils wound at right angles to each other form the primary coils, and these are supplied with two-phase current. A rotating field is therefore set up in the centre, and the position of the secondary can be adjusted to give any desired difference of phase between the supply and the current in the potentiometer.—*R. H. White.*

See Inductance.

IMPEDANCE COIL. An added inductance coil used in connexion with spark transmitters. Such a coil is placed in the circuit for three reasons. First, it enables the maximum possible voltage to be built up across the transmitting condenser for a given voltage applied by the alternator. Second, it puts the charging circuit in resonance with the frequency of the alternator while the condenser is charging. Third, it prevents a sudden rush of current through the transformer while the condenser is discharging.

Impedance coils generally consist of nearly complete magnetic circuits of laminated iron stampings, having in them air gaps across which the magnetic lines of force have to flow. The coils of wire are wound round these iron cores, and are, of course, thick enough to carry the maximum current of the circuit.

By the provision of the air gap the inductance of the coil remains constant for various frequencies, which would not be

the case if the magnetic circuit were completely of iron. The reason for this is as follows:—The inductance of a coil varies inversely with the reluctance of the magnetic circuit, and the latter depends upon the frequency of the flux traversing it. The reluctance of the iron, however, is small compared with that of the air gap, which becomes, therefore, the controlling factor. The reluctance of the air gap is constant, so the reluctance of the impedance coil is practically constant, and, therefore, its inductance. See Spark Transmitter.

IMPERIAL WIRE GAUGE. Name used for the British Imperial Standard Gauge for wires, as officially recognized, in Great Britain, and often abbreviated to I.W.G. It is sometimes known as Standard Wire Gauge, and abbreviated to S.W.G. Practically all the wires used in wireless work are measured by this gauge.

It comprises, as far as the experimenter is concerned, a table of numbers with corresponding diameters of wires. The numerals commence at 0,000,000, which represents a wire ½ in. in diameter, and the highest number is No. 50, having a diameter of 10000 in. The numbers most commonly used by the amateur are set out in the following table, with the corresponding diameters in 10000 in. or decimals of an inch. When purchasing wires, the diameter is reckoned as that of the metal, and not of the diameter of the applied insulation, if any. The wire gauge is also extensively used for measuring thin sheet metals.

Gauge No.	Diameter, Decimal of inch.	Gauge No.	Diameter, Decimal of inch.
16	0.064	30	0.0124
18	0.048	32	0.0108
20	0.036	34	0.0092
22	0.028	36	0.0076
24	0.022	38	0.0060
26	0.018	40	0.0048
28	0.0148	42	0.0040

IMPURE WAVE. A pure sine wave is of the well-known form shown in Fig. 1, and may be plotted from the formula $V = V_{max.} \sin WT$, where V = the voltage at any instant, $W = 2\pi$ the frequency, T = the time of one alternation.

A sine wave is taken as the standard for a pure wave, and any other shape of wave may be regarded as an impure wave when considering alternating currents. If the primary circuit and the aerial circuit of a

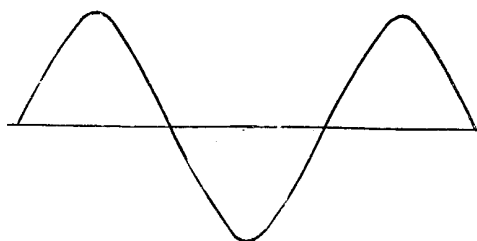

PURE SINE WAVE

Fig. 1. As compared with an impure wave, illustrated below, this is a pure sine wave

wireless transmitter are not quite in tune with one another—that is to say, they are tuned to two slightly different wavelengths—when the two circuits are coupled they will oscillate as one, but the wave given out will not be a pure one, it will tend to have two humps, one for the primary tune and one for the secondary (see Fig. 2). Whilst as a rule the difference between the two tunes will not be enough to produce the actual humps as shown in

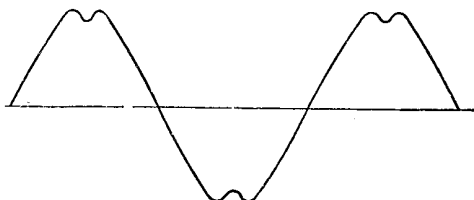

WAVE IN TRANSMITTER INCOMPLETELY TUNED

Fig. 2. If the primary and aerial circuits of a transmitter are not quite in tune the wave given out will take this form or the flat-topped shape shown in Fig. 3

Fig. 2, it may easily be sufficient to produce a wave having a flat top, as Fig. 3.

Such a wave is fairly common, and although easy to receive, it has a disadvantage, for if several waves of this character are in use it is difficult to cut out those not required on account of flat tuning. A pure continuous wave is, as a rule, of such a frequency or wave-length

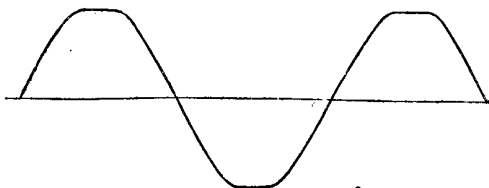

EXAMPLE OF IMPURE WAVE

Fig. 3. An impure wave may take the above form, due to the aerial and primary circuits of a transmitter being not quite in tune

that it is quite inaudible in the telephones of the receiver, but should there be any rapid variation in the source of supply to the valve oscillator or other continuous wave generator, then the wave emitted will not be pure, but will carry with it an audible ripple.

This form of impurity is fairly common, and may sometimes be noticed in the waves emitted from continuous wave stations which use valve-rectified alternating current for their supply, due to the fact that insufficient precautions are taken to ensure the smoothing out of the low-frequency alternating current ripple.

A similar impurity often exists in stations which use direct current generators to supply their transmitting valves; in this case the audible ripple is due to bad commutation or tooth effect in the armature or field. This defect may be overcome by suitably designing the direct current generator. It should have a commutator with very many sections, so that the difference of potential between adjacent commutator bars is low. The armature slots should not run parallel with the centre line of the armature shaft, but the armature stampings should be assembled in such a manner on the shaft that the slots run in a slightly spiral manner, as shown in Fig. 4.

Alternatively, or in addition to this, the pole tips of the field magnets may be

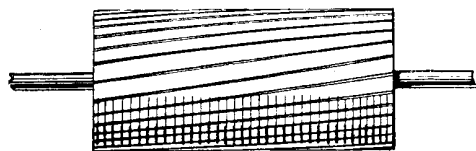

PREVENTING IMPURE WAVES

Fig. 4 (above). Slots in a C.W. generator armature should be out of parallel with the shaft. Fig. 5 (right). Smoothing circuit for generator. The condensers are of $\frac{1}{2}$ to 1 mfd., and L_1 of 50-100 henries

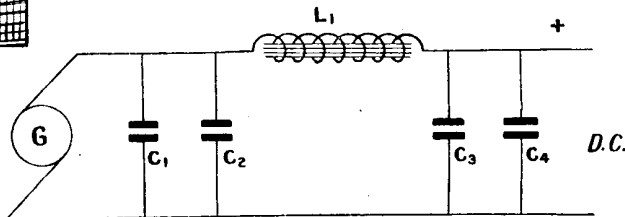

sloped off in the opposite direction, special precautions being also taken over the design and exact shape of these pole tips. Even after all these precautions have been taken it is general to add a smoothing circuit between the generator and the valve transmitter if perfectly pure continuous waves are essential.

Such a smoothing circuit is shown in Fig. 5.

Another impurity which exists in nearly every wave, to some extent, is the wave of another frequency superimposed on the main wave. Such waves have a definite relation to the primary wave, and are known as harmonics. For instance, any given aerial can be made to oscillate in several ways, the most natural being the quarter-wave condition, in which the aerial potential increases all the way up the aerial from the ground, and reaches a maximum at the top. But the same aerial can be made to oscillate at three times the frequency, *i.e.* to the first harmonic, the second, third, fourth, etc., harmonics will be five, seven, and nine times the frequency of the fundamental.

Thus any wave may have these higher harmonics superimposed upon it in the form of ripples. In practical wireless stations harmonics intrude themselves upon very slight provocation. The very act of keying or modulating introduces them. They are probably least noticeable in stations using valves as oscillation generators, whilst arc stations are, as a rule, very bad in this respect.

A last form of wave which may in one sense be termed impure is a wave of variable frequency, that is, of variable wave-length. This defect is due to moderately slow change in capacity or inductance of aeriels and other circuits. An aerial may be suspended in such a manner that it moves or swings in the wind. As it moves nearer or farther from adjacent objects, including the ground, it changes its capacity, and the wave-length will go up and down slowly.

Any single wave on analysis might seem to be a pure wave, but the waves taken from different parts of the wave-train would be found to be different; it therefore follows that in the transition from one wave-length to the other, each succeeding wave becomes longer or shorter than the one preceding it. These waves cannot therefore be regarded as pure waves. See Harmonics: Oscillation.

INCOMMENSURABLES. Most ratios which occur in physics are incommensurable: that is, the relation between two units cannot in general be expressed numerically, except by an infinite series of decimals. The relations of a yard to a metre, or a pound to a kilogram, are of this nature. But, of course, in any artificial system of units the ratios are made commensurable. There is a definite number of yards in a mile, a definite number of pennies in a pound. But the ratio of a franc to a pound, or a mark to a pound, varies in a capricious manner, in accordance with human—or possibly unhuman—arrangements. The ratio of a volt to an ampere is called an ohm, and has to be determined experimentally, with as much accuracy as possible—never with complete accuracy. But it has the merit of not varying. A centimetre per second is a definite velocity and so is the velocity of light; but the ratio between the two speeds is an incommensurable number, which has to be determined by experiment, with as much accuracy as possible.

A kilometre per hour, however, is a definite number of centimetres per second. It is defined by a definition of the units; and there is nothing empirical or experimental about it. These things, thus defined, are mere conventions, adopted for convenience. It is a convention that there are 3,600 seconds in a hour. But the number of seconds or hours in a year have to be determined by observation, and can only be expressed approximately. The number of hours in a day is called 24. But that involves a definition of a day. It approximates more or less closely to a real day. The number of days in a year is incommensurable.

The number of volts of a given battery is also incommensurable; but it can be determined with as much accuracy as you please. The same may be said of the number of microfarads in a condenser, or the number of ohms in a given piece of wire or coil. When a measurement is made in a laboratory, the accuracy of the result is never complete, but is expressed by saying that the determination is made to so many significant figures. If it is right to three significant figures, the error is less than 1 per cent. The determination to four significant figures is a very accurate measurement. In some parts of astronomy, accuracy of measurement has, by generations of skilled workers, been

brought to such a pitch that six significant figures can be given. But this is exceptional; and in ordinary amateur work accuracy to two significant figures is not to be despised.—*Oliver Lodge, F.R.S.*

INDEX. An index, or small figure affixed to a number, which signifies how many times it is to be multiplied by itself. This very simple operation is sometimes called "involution"; and the index is called the "power" of the number. For instance, two-to-the-fifth power equals 32. It is commonly called two-to-the-fifth. Two-to-the-tenth (2^{10}) equals 1024. And 2^{100} is an enormous number greater than the number of atoms in the solar system.

The basis of arithmetic is addition. When the same number is added to itself so many times, the process is called multiplication. When the same number is multiplied by itself several times, the process is called involution, or raising to a power.

10^6 will be found to be 1 followed by six 0's, *i.e.* a million. Small indices like 2 and 3 are commonly called square and cube, from their obvious geometrical analogy. Thus three-square is 9, the number of square feet in a square yard. And three-cube is 27, the number of cubic feet in a cubic yard. Three-to-the-fourth has no geometrical analogy, unless one is prepared to deal with space of four dimensions, which, for wireless purposes is unnecessary. But indices are by no means unnecessary. 10^3 watts equals 1 kilowatt. 10^6 ohms equals 1 megohm.

Fractional indices occur too; such as $9^{\frac{1}{2}}$, which signifies the square root of 9, namely, 3. $27^{\frac{1}{3}}$ means a cube root, and is also 3. The statement that $8^{\frac{2}{3}} = 2$ is only another way of saying that $2^3 = 8$.

The opposite of addition is subtraction.

The opposite of multiplication is division, that is, finding how many times one number will go into another.

The opposite of involution is evolution, which is also called extracting a root. The square root of 100 is 10. The cube root of 1,000 is 10. The sixth root of 1,000,000 is 10. The cube root of 1,000,000 is 100. The square root of 1,000,000 is 1,000. The fifth root of 32 is 2. The early powers of 2 should be remembered. They are 2, 4, 8, 16, 32, 64, 128, 256, 512, 1024. The last number is 2^{10} .

We might go on to say that the opposite of differentiation is integration. The operation of finding an index to which a given base must be raised to equal a specified

number is called "finding a logarithm." Thus, 3 is the logarithm of 8 to the base 2; 3 is also the logarithm of 1,000 to the base 10, because it is the number of times that 10 must be multiplied by itself in order to make 1,000.

Negative Indices. Instead of raising a number to a positive power, one may lower it, so to speak, to a negative power. In that case you get the reciprocal. Thus $2^3 = 8$. But $2^{-3} = \frac{1}{8}$. And $10^{-3} = \frac{1}{1,000}$. $10^{-6} = \frac{1}{1,000,000}$. 10^{-6} farad = 1 microfarad. 10^{-3} ampere = 1 milliamper. $2^2 = 4$. $2^{-2} = \frac{1}{4}$. $2^1 = 2$. But $2^{-1} = \frac{1}{2}$.

By the use of indices, multiplication can be turned into addition, and division into subtraction; addition and subtraction being performed among the indices, not among the numbers themselves.

Thus 2^5 is 32, and 2^3 is 8. But 2^{5-3} is 4. 2^{5-3} might also be written $\frac{2^5}{2^3} = \frac{32}{8} = 4$. So in general $2^{m-n} = \frac{2^m}{2^n}$.

Hence now we can find what 2^0 means. For it is 2^{m-m} , that is $\frac{2^m}{2^m}$, which equals 1.

Any number raised to the power 0 equals 1. The number which is going to be raised to any power is sometimes called "the base." The index of the power to which it is to be raised is called a "power" when thinking of the base, but is called a "logarithm" when you are thinking of the resulting number.

Some numbers have only square roots. Some have only cube roots. Some have both. And many have neither. Some have no roots at all of any kind; 2, 3, 5, and 7 are all in this predicament. Their roots can only be approximately represented; though it is true they can be obtained with any required amount of accuracy, but never completely. Such numbers as these, which cannot be expressed by any finite number of digits, are called "incommensurables." They are extremely common. $\sqrt{2}$ is one of them, and π is another; for there is no numerical relation between the circumference of a circle and its diameter, nor is there any numerical relation between the diagonal of a square and its side.

These ratios—and, indeed, most others—can only be expressed approximately. Whenever a ratio can be expressed precisely as a number, it becomes a matter of great importance.—*Oliver Lodge, F.R.S.*

See Logarithm; Quantum.

INDIARUBBER. In its commercial state indiarubber is a manufactured material compounding a number of ingredients. The raw material is obtained from various trees, bushes and vines in the tropical regions. Indiarubber has many uses in wireless work, chiefly as an electrical insulation. To render it fit for service, the raw material undergoes various manufacturing processes according to the purpose for which it is to be used, but is chiefly compounded with various mineral substances, such as hydrocarbons and sulphur. As much as 65 per cent of mineral substances can be compounded with the rubber gum before the characteristics of the rubber cease to predominate. Commercial insulating indiarubber may contain, for example, about 30 per cent of rubber, the remainder being made up of litharge, zinc oxide, whiting, sulphur, or other substances in smaller quantities.

Rubber may be used in a more plastic state, moulded in that condition, subsequently treated with heat, and converted into hard substances known under various trade names, the composition of which may vary considerably, and known variously as ebonite, vulcanite, etc.

The hardness is largely obtained by a vulcanizing process, that is, the soft rubber has to be treated with sulphur, which turns it into a harder material, the hardness depending upon the completeness of the chemical combination between the rubber and the sulphur and other ingredients. Hard rubber is a very good electrical insulator, and may withstand voltages up to 10,000 for good quality sheets of hard rubber $\frac{1}{32}$ in. thick; $\frac{1}{8}$ in. thickness of hard rubber will generally withstand 25,000 volts on test; thus its dielectric strength is high.

The specific gravity varies considerably according to the composition, and may range from 1.1 to 1.4, the tensile strength also varying, and may range from 7,000 lb. per square inch downwards. Hard rubber resists the action of most chemicals, softens when heated, and can be bent readily at the temperature of boiling water (212° F.). To cut soft rubber, such as tube or sleeving, sometimes used as insulation on connecting wire, it is best to use a very keen, thin-bladed knife, and dip it repeatedly in cold water.

Soft rubber can be turned in the lathe, but the process is difficult. It can be done with a small, round, ordinary wood turner's

gouge if it be ground hollow and kept very sharp. The lathe tools should be razor-like in keenness. Hard rubber can be machined more readily with tools made of brass than those made with steel, and even ordinary soft mild steel tools usually give better results than the usual pattern of lathe tool. The tools, however, must have an absolutely keen cutting edge, and will last longer if the cutting edge is coated with fine emery powder. Polishing is effected by the use of rotten-stone and oil.

In marking out panels and the like, the work is carried out by coating the face of the work with Chinese white diluted with water. When this is dry, marks can readily be made upon it. Rubber can be made to attach firmly to any alloy which contains antimony, all that is necessary being to vulcanize the rubber while in contact with the metal. Sheet rubber is sometimes used in wireless sets for mounting valve holders and the like, to guard them against the effects of vibration and thereby minimize microphonic noises. Similar material may also be used on the exterior of receiving sets and elsewhere.

Rubber belts are extensively used for machine-driving purposes, particularly in places where they are exposed to the weather or the action of steam, or when in damp situations, as they are comparatively impervious to damp. The electrical insulation of rubber varies a good deal, according to its composition, and particularly when the material is heated. See Ebonite.

INDIARUBBER SOLUTION. Name given to a semi-fluid substance consisting largely of pure rubber and a solvent. It is usually obtainable in small collapsible tubes, or in metal containers. It is highly inflammable, and should, therefore, not be used in the vicinity of a naked flame. It is used for cementing articles made of indiarubber, but only those which are flexible—generally, soft rubbers.

The solution is practically useless as a cement for hard rubbers. It is generally applied by first cleaning the surfaces to be united, coating them with the solution, allowing the solution to dry partially, and then pressing the joint firmly together. Rubber solution hardens when exposed to the air, and therefore should be kept in an airtight container.

INDICATED HORSE-POWER. This is the total horse-power a machine exerts; the actual horse-power, for example,

exerted by the explosion of a mixture of petrol vapour and air in the cylinder of an internal combustion engine. The term is usually abbreviated I.H.P. (*q.v.*).

INDOOR AERIAL. Term used to describe aerials erected within a building. Generally, frame aerials are excluded from the category, as they are virtually self-contained units, possessing distinctive features, and are dealt with in this Encyclopedia under the heading of Frame Aerial (*q.v.*). Indoor aerials are essentially a convenience for the amateur and experimenter, but even under the best conditions are not so efficient as the regular outdoor aerial. Their convenience, however, and the general ease with which they may be erected justify their adoption, especially in locations in the vicinity of a broadcasting station or in any circumstances where it is not desirable to erect an outside aerial.

The methods to be adopted will be governed almost entirely by the nature of the building in which they are to be placed. It is practically useless to attempt to make a successful indoor aerial if the roof is of corrugated iron, sheet lead, or other metal. In the ordinary run of domestic dwellings a good plan is to erect a multi-wire aerial as near to the apex of the roof as circumstances will permit, somewhat as shown in Fig. 1. Points to note are to make a secure fastening to some dry and strong timbers or horizontal members known as collars.

The wire is best arranged in one continuous length, as long as possible, within the limits prescribed by the Postmaster-General, and preferably pointing in the direction of the broadcasting station it is most desired to hear. The wire must be very carefully insulated by the use of the ordinary pattern of insulation, or may be fixed to strong insulated screw hooks, the aerial being insulated by means of rings of porcelain formed with an eye in the hook.

The lead-in should be a well-insulated wire, preferably stranded. The aerial wire should be the usual stranded copper, phosphor-bronze, or silicon-bronze.

Another plan when the roof space is not accessible is to use separate insulators, and attach them by screw-hook insulators or screws driven into convenient parts of the building, such as the timbers of a timbered ceiling, into the picture rail, or in other points where a firm support can

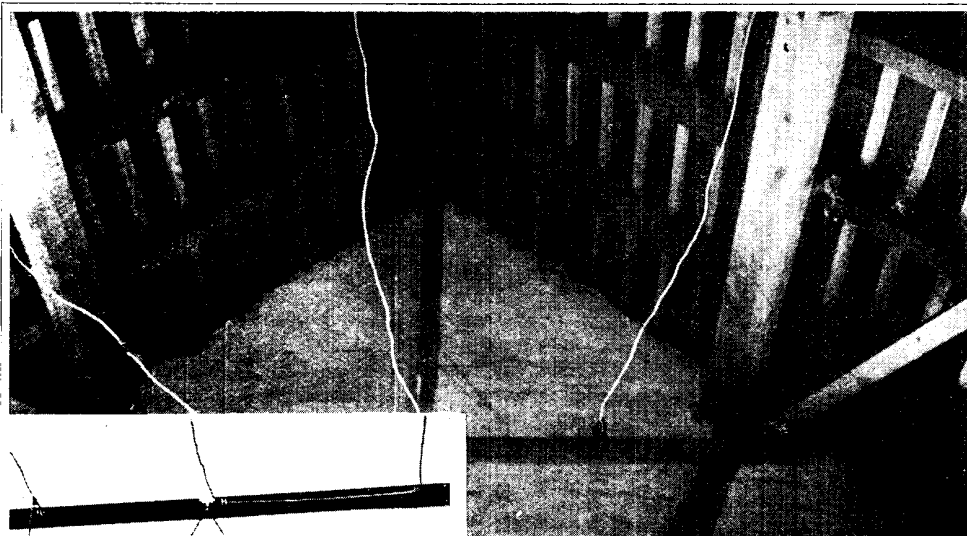

Fig. 1. In the apex of a roof a multi-wire aerial is erected as high as possible. It is then out of the way

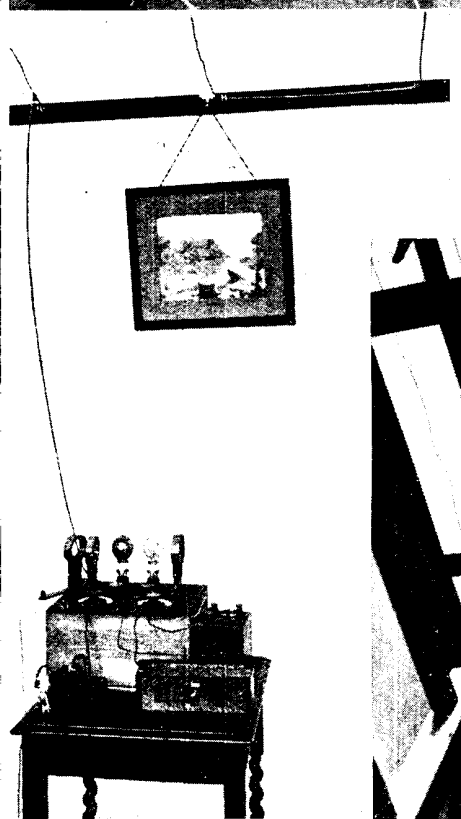

Fig. 2 (right). Over the well of a staircase this aerial is erected. Five wires, about 18 in. apart, are connected to a common lead-in. Fig. 3 (left). Screw eyes are fixed to the top edge of the picture rail to support this aerial, which consists of three or more strands stretched across the room



THREE SIMPLE METHODS OF ARRANGING INDOOR AERIALS

be obtained. Fig. 3 illustrates such an arrangement that has proved entirely satisfactory in use.

In some cases it is desirable to dispose a considerable amount of wire in the form of a square and to arrange this just under the ceiling of a staircase well or opening,

as in Fig. 2, the lead-in wire being taken down the centre of the staircase well as far as possible before attaching the insulated lead-in wire. This arrangement has the advantage of giving considerable height. In such an arrangement a number of insulators can be attached to

one screw, which itself may be secured to a strong hook firmly fixed in the angle of the walls, the aerial being threaded through the insulators nearest the wall first, then through the next set of insulators, and so on towards the centre. The wires should be placed not less than 9 in. apart.

An alternative method adaptable to reception rooms is to fix small screw eyes in the top edge of the picture rail moulding, and by means of short lengths of cord to fasten the insulators to them, arranging these insulators to come 3 or 4 in. from the surface of the wall. The wire may then be stretched from one side of the room to the other, passed through the insulators, carried along parallel to the wall for a foot or so, through another insulator, and then again across the room, and backwards and forwards until as much wire as possible has been used. A short, insulated lead-in wire should connect the aerial wire to the instrument, as in Fig. 3. In all cases a thoroughly efficient aerial is desirable.

When arranging the wires between the walls, the directional application should be remembered, and the wires arranged, if necessary, to pass angularly across the room so that the greatest length of wire is pointing as nearly as possible in the direction of the nearest station.

Numerous other methods are adopted, as, for example, placing the aerial on the inside of a cupboard door. This gives a certain measure of directional effect, as the angle of the door can be adjusted to a considerable extent by opening or closing as required. Other systems, somewhat in the nature of freak reception, include the use of metal laths of the bedstead, wire netting laid underneath the carpet, and attachment to leaded light and other metal frames. Reception in such cases is largely a matter of the receiving strength of the set. An excellent indoor aerial is provided by the electric lighting system, the wires of which may be used as the aerial. To do this, a condenser is required in series with the aerial wire, and this is most conveniently obtained by the use of a special appliance, purchasable from any wireless dealer, and known as the Ducon attachment (*q.v.*). See Aerial.

INDUCED CURRENT. The conditions of current induction, as distinguished from current conduction, lie in the fact that the effects are produced in the first case without any actual electrical

connexion between the inducing and the conducting circuit, whereas conduction of current calls for an actual material connexion between all parts of the circuit in which current is flowing continuously. In both cases, however, current is unable to flow unless a previous difference of potential between the ends of the circuit has been established.

It is therefore essential to study the subject initially from the point of view of induced electro-motive force, and reference should be made to this heading. A current can be "induced" in a neighbouring wire, provided it is a closed circuit, by two different means. One is by suddenly plunging the electrical circuit into a magnetic field, or, conversely, by suddenly removing it (or the field), in which case the current will reverse its direction as compared with the previous conditions.

Another way of inducing currents is to place a closed circuit in the neighbourhood of a similar conductor, and to pass a current through the latter. On starting up a current in the latter, the former will show the presence of a momentary induced current through a galvanometer connected with it, provided the wires are sufficiently close together and carrying a sufficiently heavy current. On interrupting the current which caused the first deflection, it will be found that the galvanometer shows another deflection, but in the opposite direction this time.

The similarity between the two cases is evident, and, in fact, the inductive effects are really due to exactly the same causes, namely, reaction between the magnetic and the electric circuit by inter-linking. But whereas the magnetic field is assumed to be already in existence in the first case, it is artificially created in the second by the fact that all current-carrying conductors set up magnetic stresses in the ether, and it is the sudden growth, followed by the sudden collapse, of this magnetic field which is the origin of the inductive effects experienced by the conductor in the second case.

The induction of current is therefore somewhat of a misnomer, since it is potential difference that is really set up, and the resulting current is conditional upon the presence of a closed circuit and dependent in magnitude upon its resistance or inductance.

The mere presence of a conductor in a magnetic field is by itself insufficient to

give rise to an induced electro-motive force or current; there must be relative motion between the two. Also this motion must be in a certain sense or it will be unproductive of results. Stated briefly, the essential condition for electro-magnetic induction, whether of electro-motive force or current (the latter being the result of the former) is the actual cutting of the magnetic field by the conductor, that is relative movement between the two, irrespective of which is the stationary unit. They may both be moving, in fact, but they must move in such a way as to effect a change in the rate of cutting the flux in order to bring about inductive effects. See Electro-motive Force; Inductance; Self-inductance.

INDUCED ELECTRO-MOTIVE FORCE.

The meaning of the term induction is in reality action at a distance, as distinguished from the production of electro-motive force by means which depend upon the actual conduction of current in the material sense. For instance, electro-motive forces may be set up by moving a magnetic field in the proximity of a conducting wire, and the same result may also be produced by altering the value of a current in a neighbouring wire, changing its direction, stopping or starting the flow, or even by varying the distance between the two wires. In all these cases it is seen that there is no actual electrical connexion between the two, and it is necessary to look for the origin of such induced electro-motive forces in some other direction.

When an electric current is flowing along a wire, the surrounding ether is subjected to a magnetic strain, which is equivalent to saying that the wire is surrounded by a magnetic field, or concentric lines of force having the centre of the wire as a centre. The effect of changing the value of the current in this wire upon any neighbouring wire would be to relieve or increase the magnetic strain, causing a transference of electrons along it, raising the potential momentarily at one end to a higher value than the other.

Any such conductor interlinked with a magnetic field will therefore experience a potential difference between its ends if the intensity of the field varies or changes its direction, and this fact is taken advantage of in one well-known piece of apparatus, namely, the dynamo, for the purpose of generating electric power. It

is necessary to remember, however, that the production of electro-motive force must always precede the flow of current and that the value of the electro-motive force will depend upon the rate of change in the flux.

Whether the flux in this magnetic field is due to the presence of a magnet or a current-carrying wire is immaterial, and the so-called "induction of currents by currents" is really the induction primarily of an electro-motive force in a closed conducting circuit by varying the interlinkage between the magnetic and the electric circuits. Current flows round the closed circuit by virtue of the potential difference between its two ends, and the presence of the magnetic flux is due to the magnetic region or ether stress inseparable from any current-carrying conductor.

The various methods by which induced electro-motive force can be originated may be classified as follows:—

- (a) A stationary flux and a moving conductor.
- (b) A moving flux and a stationary conductor.
- (c) A variable flux and a stationary conductor.
- (d) A variable flux and a moving conductor.

As examples of induced electro-motive force due to the above-named causes, may be quoted: (a) The ordinary direct current generator, wherein a system of conductors on a moving armature rotates in a fixed magnetic field. (b) The alternating current generator, in which the conductors are disposed on a stationary element called the "stator," while a magnetic field sweeps across them, originated by a rotating element called the rotor. (c) A static transformer, consisting of stationary windings on a stationary iron core, the magnetic flux being made to vary and change its direction by changes in the magnitude and direction of the exciting current in one of the windings. (d) Alternating generators with a rotating system of conductors, having their fields excited by alternating current, as, for example, the various types of frequency adders.

To generate an electro-motive force by induction introduces several factors, all of which co-ordinate to affect the intensity of the results. Thus the speed or rate of cutting, whether it is the flux or the conductor that moves, is one thing to be

taken into account. Another is the strength of the field, that is, the number of lines being cut by the conductor in a given time. And still another factor is the angle which a conductor moving at uniform rate makes with any magnetic field having a fixed direction in space. If a conductor is moving at right angles to the direction of the magnetic lines it will obviously cut more in a given time than if it were cutting them at some other angle.

It is obvious that as the angle decreases, the induced electro-motive force will fall off, until when it is moving parallel with the field there is no cutting action at all, but the conductor is simply sliding along the lines. The rate of change then becomes nil, and likewise the induced electro-motive force. Finally, the length of the conductor must be taken into consideration, since the longer the conductor the more lines will it cut, provided it operates in a magnetic region of constant intensity and unlimited extent.

The relationship between the electro-motive force induced in a circuit and the other factors may be expressed as follows:—

Electro-motive force in volts = change of flux divided by 10^8 times the time in seconds.

If the number of lines included by the circuit at one instant is n' , and at another instant n'' , the intervening time being t seconds, the average electro-motive force induced will be

$$E \text{ (volts)} = \frac{n' - n''}{10^8 \times t}$$

See Induced Current.

INDUCED MAGNETISM. Magnetism can be communicated to a piece of iron or steel without actual contact with another magnet, and without any of the usual modes of excitation employing the aid of current-carrying coils of wire.

If a piece of soft iron *A* (see the figure), is brought near a permanent magnet, *B*, it will exhibit polarity all the while it remains within the influence of the permanent magnet, but will lose its poles to all intents and purposes when removed to a sufficient distance. Its magnetic condition is therefore a transient one due to the influence or proximity of another magnet; or it might be said to have taken up a definite polarity while lying in the magnetic field due to the first magnet.

That end of the iron bar lying nearest to the inducing magnet will acquire a

polarity of opposite sign to the permanent magnet pole, and, of course, a pole of similar sign at its far end, indicated in the figure by the letters *N* and *S*. It is impossible to produce a magnet having only one pole, whether by induction or otherwise. All magnetic poles possess this power of inducing in any magnetic material a condition such that the end nearest the magnet is of dissimilar polarity to the inducing pole, and a pole of similar polarity at the distant end. At the same time, the body that has poles induced in it will be attracted as a whole towards the inducing magnet, owing to the law that unlike poles attract, since the repelling effect of the similar but more distant poles is exerted under more unfavourable conditions than the attractive effect of the dissimilar and nearer poles.

The latter forms a rough test as to a body being temporarily magnetized by

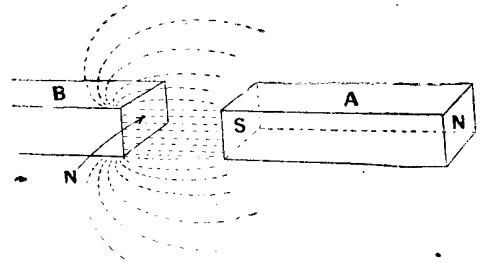

PARTIAL REPRESENTATION OF MAGNETIC FIELD

Induction of magnetic poles in a soft iron bar by an adjacent permanent magnet is shown in this diagram

influence from another magnet, or permanently magnetized from within; for if one is allowed to approach the other and repulsion effects are obtained, it is clear that both are permanent magnets, since an unmagnetized body would always experience a force of attraction by virtue of the induction of a dissimilar pole to the permanent magnet on its nearest end. The only case in which this law might not hold would be where an exceedingly powerful magnet were brought up to a much weaker and fixed permanent magnet, whose natural polarity would be then overpowered by the more intense inductive effect it experienced, and its poles temporarily reversed.

Any magnetizable body generally shows slight traces of magnetic polarity, as few samples are sufficiently soft not to retain a certain magnetic bias after having once

been subjected to a magnetizing force. The polarity of the earth is in itself quite sufficient to account for this, and all iron railings or vertical steel masts in the northern and southern hemispheres will be found to exhibit more or less pronounced polarity, while for the same reason horizontal steel or iron structures near the

equator will show the same condition. The explanation is that the direction of the magnetic meridian, that is the earth's field, runs more or less parallel to these structures, hence they acquire by magnetic influence a definite polarity although unexcited from any but natural causes. See Magnet; Magnetism.

INDUCTANCE IN MAGNETIC CIRCUITS & ITS MEASUREMENT

By Sir Oliver Lodge, F.R.S., D.Sc.

Here our distinguished Consultative Editor, who has also written the associated article on Inductance, describes the fundamental conditions of inductance in magnetic circuits, its measurement and its application to inductance coils where maximum inductance with minimum capacity and resistance are required. See also Inductance; Magnetism; Mutual Induction; Self-induction

Inductance is a name given by the mathematician, Mr. Oliver Heaviside, to the coefficient of induction, especially of self-induction (*q.v.*) in magnetic circuits. The inductance of a coil is measured by the total number of magnetic lines of force which thread every turn of the circuit when unit current circulates through the coil—multiplied by the total number of turns, or number of times the unit current circulates round the self-generated lines of force. The mutual inductance of two coils is the number of lines of force which effectively thread the second coil when unit current circulates in the first, multiplied by the number of turns in that second coil. (See, however, Mutual Induction, as well as Self-induction.)

The term Induction is more general, and signifies not a particular coefficient, but the phenomenon of action across empty space in general; and it applies to static electricity as well as to current electricity and magnetism. (See Induction.)

The inductance of a coil can be calculated if its dimensions and number of turns are known, and also the thickness of its wire, both covered and uncovered. It can also be determined experimentally; but these determinations are better given under the respective heads of Mutual Induction and Self-induction.

What is wanted in a coil is inductance only, and neither resistance nor capacity. Yet some amount of both resistance and capacity is inevitable. The best thing is to keep them low, reducing them to a minimum for a given amount of inductance. This means winding the coil of such shape as to give maximum inductance for a given length of wire; for both the resistance and the capacity are proportional to the length of wire used.

The capacity of a coil is due to the inductive effect of each turn upon the others near it. It is not useful capacity, like that of a condenser: it is distributed capacity, which is deleterious. The actual best shape of a coil can be departed from, within certain limits, without much damage, but the theoretical best shape is a coil wound in a square channel or cross-section, with the same number of layers as there are turns in each layer, and of such dimensions that the outside diameter is seven-fourths of the internal diameter. Or, to put it another way: if the channel in which the wire is to be wound is 3 millimetres square, the inside diameter of the coil should be 8 millimetres, and the outside diameter 14 (Fig. 1). The actual size does not matter, as far as this condition is concerned; maximum self-induction is given by the shape alone; "millimetres" in the above statement can be replaced by centimetres or tenths of an inch or any other unit. The shape here given will be called "the best shape," though there may be good reasons for departing from it.

The inductance of a coil is proportional to the square of the number of turns of wire. Hence to get a considerable inductance in small compass, thin wire should be used. But the wire should always be of the highest conductivity: unnecessary resistance tends to damp out the oscillations. The turns of wire need not be very close together. That is why the wire may be thickly covered; or it may be wound basket-wise, so as to leave some air-space between the turns. What may be called "the effective thickness" of the covered wire is its actual diameter plus the average distance apart of neighbouring turns. It is not really necessary to use basket winding; for though it reduces capacity, it

reduces inductance as well. Hence there must be some compromise. A fairly thick covering to the wire is sufficient.

If a coil is wound in the best shape, as given above, its inductance has this simple value: three times the total number of turns multiplied by the length of the wire, $L = 3nl$. Thus suppose 10 metres of wire are wound into a coil of the best shape, with 10 turns in each layer and 10 layers, the inductance will be 300 times 10 metres, *i.e.* 300,000 cm., or 300 microhenries.

How to Calculate Inductance of a Coil

The inductance of a coil can be calculated only when you know the number of turns. If a coil is not wound in the best shape, it is usually either a single-layer cylindrical coil or a disk coil. The number of turns in such coils is easily counted, as the turns will be exposed. And the following expression can be given for reckoning the inductance of coils such as these:—

For a short fat circular cylinder of radius a and short length b , wound with n turns,

$$L = 29an^2 \left(\log_{10} \frac{a}{b} + .7 \right)$$

For a long narrow cylinder or solenoid, of length b , radius a , and n turns of wire,

$$L = 40n^2 a^2 / b = \text{square of total length of wire divided by the length of the solenoid.}$$

For a disk spiral or flat coil of n turns, with external diameter D and internal d ,

$$L = \pi n^2 (D + d) \left(\log \frac{D + d}{D - d} + .88 \right)$$

The best units to employ for calculated inductance are length units; and the result so expressed can easily be interpreted. Every centimetre of inductance length is exactly equivalent to a millimicrohenry, or what is sometimes called a billihenry. One henry is 10,000 kilometres; a microhenry is 10 metres; a millimicrohenry is 1 centimetre.

Example.—What is the inductance of the small coil of dimensions suggested above, if wound with a covered wire half a millimetre thick. The cross-section of the winding is 3 mm. square, the internal diameter is 8, and the external 14 mm.; so the mean diameter is 11 and the mean circumference 11π , or, say, 34 mm. The number of turns will be $6 \times 6 = 36$. Hence the total length of wire will be $36 \times 34 = 1,224$ mm., and $3nl =$

$$3 \times 36 \times 1,224 = 132,200 \text{ mm. or } 13.22 \text{ microhenries.}$$

If the coil is magnified by 10 so that the dimensions are centimetres instead of millimetres, the coil would be a large one; and if the same wire were wound on it, which would probably be injudicious, its inductance would be increased by the factor 10^3 ; *i.e.* it would be 1322 henries.

In considering the inductance required to make an oscillating circuit which with a given capacity shall respond to a given wave-length, the following formula can be used:—

$$L = \frac{\lambda^2}{4\pi^2 C}$$

remembering that $\pi^2 = 10$ very nearly; and that 1 microfarad = 9 kilometres. For instance, to receive a wave-length of 200 metres with an aerial whose capacity is 1 metre, or the ninth of a milli-microfarad, which would be a likely value for a small amateur aerial, the coil to be put in series with it should have an inductance comparable to

$$L = \frac{40,000}{40} = 1,000 \text{ metres;}$$

that is, 1 km., or 10^5 cm., or a tenth of a millihenry.

Practical Applications of Inductance Formulæ

To get a wave-length of 1,000 metres with an aerial of 2 metres capacity would need an inductance

$$L = \frac{10^6}{80} = 12,500 \text{ metres,}$$

that is, $12\frac{1}{2}$ km. or $1\frac{1}{4}$ millihenry. Twice this value would be needed if the capacity of the aerial were halved; whereas if the wave-length to be emitted or received were doubled, using the same capacity, the inductance must be quadrupled.

To determine the external diameter of a best-shape coil which shall have a given inductance, L , for a given thickness of covered wire, the following expression serves:—

$$D^3 = 66.6 \times LT^4$$

and once having determined D , the size of the coil is known in every detail, also the number of turns of the given kind of wire and the length of wire necessary.

The use of this formula will be best illustrated by an example. Suppose the inductance required is a millihenry, that is to say, 10 km. or 10^6 cm.; and let the thickness of the covered wire (*i.e.* the covered wire plus the air space, if any)

be 2 mm. or $\frac{1}{5}$ cm.; then D^5 comes out from the above formula as

$$\frac{66.6}{625} \times 10^6$$

or a trifle more than 10^5 ; and, therefore, the external diameter of the coil should be

$$D = 10 \text{ cm. practically.}$$

The internal diameter, d , will then be

$$\frac{8}{14} D = 5.7 \text{ cm.}$$

The breadth of the coil, or side of the square channel in which the wire is wound,

$$b = \frac{3}{14} D = 2.142 \text{ cm.}$$

The number of turns of covered wire of this size, five turns to the cm., will be

$$n = \left(\frac{b}{\bar{T}}\right)^2 = 115$$

The mean radius of a turn is

$$r = \frac{1}{4}(D + d) = \text{nearly } 4 \text{ cm.}$$

And hence the total length of wire is

$$l = 2\pi nr = 27.6 \text{ metres.}$$

If, to verify these approximate figures, we now reckon $3nl$, we shall find that the inductance comes out 9,522 metres, which is fairly near the 10 km. or 1 millihenry aimed at: sufficiently so for most practical purposes. All fine adjustments must be made experimentally by trial. Simple calculation in such cases can only give approximate values, but it is very useful to know these beforehand.

As regards the size of bobbins wound with the best shape, for a given thickness of wire, we can make this statement: that doubling the linear dimensions of the coil, for a given wire, magnifies its inductance 32 times.

Or, again, if the size of the channel is given in which the wire is to be wound, then the thinner the wire the greater the inductance. Halving the thickness will multiply the inductance sixteen-fold. This is because inductance depends on the square of the number of turns. In all cases, in speaking of thickness, the average distance from the middle of one winding to the middle of the next is meant, whether the winding be close or open. This distance only comes under a logarithm, and need not be known with precision.

For a long cylindrical coil, the principal term in the inductance is the square of the total length of wire wound, divided by the length of the coil. If the cylinder is not a very long one in proportion to its diameter, then we must apply a correction, which may be written thus. Let the

ratio of its radius to its length, r/l , be called x .

Then $L = \frac{\text{square of total length of wire}}{\text{length of coil}}$

multiplied by $\left(1 - \frac{8x}{3\pi} + \frac{1}{2}x^2 - \frac{1}{4}x^4\right)$

the last two terms in the brackets being

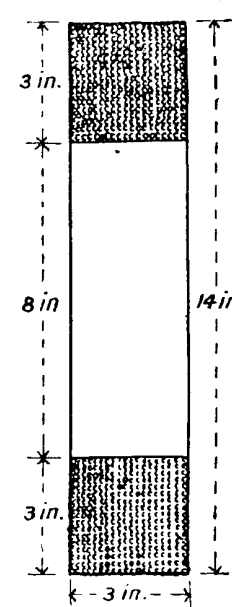

usually unimportant unless the coil is too stout in proportion to its length.

All such expressions for L inevitably involve the square of the number of turns and the linear dimensions of the coil, so that the answer comes out as a length. All the rest of the formula consists of ratios of similar quantities, that is to say, of mere numbers. All such formulae, provided there is no error, will give the right order of magnitude for the self-induction, on the assumption, of course, that the core is air, and not iron.

"BEST SHAPE" INDUCTANCE COIL

Fig. 1. This diagram shows the theoretical best shape and proportions of a coil for maximum inductance. Dimensions may be read as inches or millimetres or other unit

But there will usually be some corrections to apply. More accurate formulae are given in Eccles' "Handbook to Wireless," but usually the accurate value is best obtained by experiment.

For a disk coil of large aperture, with external diameter D and internal diameter d , an expression has already been given

$$L = \pi n^2 (D + d) \left\{ \log_e \frac{D+d}{D-d} + .9 \right\}$$

Let us apply this to a disk spiral of 10 turns of wire, with external diameter 6 in. and internal diameter 2 in.

$L = 2,500 \times 1.6 = 4,000$ in., or about 111 yards, which equals 10,150 cm. or about 10 microhenries. A long cylindrical coil or solenoid may be convenient for sliding contact purposes, but it is very far from giving maximum self-induction. A disk coil, on the other hand, is not usually so far away; and, indeed, a best-shaped coil can readily be built up of disk coils. The

close addition of one disk coil to another similar one will practically quadruple the self-induction, and therefore double the wave-length to be dealt with. A third coil will approximately treble the wave-length, the aerial or condenser capacity remaining the same.

When two similar coils are put together, as two disk coils or two cylinder coils easily might be, the combined inductance is equal to the sum of their separate inductances plus twice their mutual inductance, or

$$L = L_1 + L_2 + 2M$$

This is the principle of sliding inductances and variometers. One coil might, for instance, be rotated inside the other. When their turns agree in direction, their mutual inductance is positive; when they are in opposite direction, it is negative. So, by putting two oppositely wound coils very close together, it is possible to reduce the resultant inductance to somewhere near zero. For its value will be $L_1 + L_2 - 2M$. And if they are very close together and similar, $L_1 = L_2 = M$ approximately. Hence, the result is approximately 0. But if one coil is turned round through 180° , so that their directions agree, then the result is $L_1 + L_2 + 2M$, which is approximately $4L$. So that the inductance has been quadrupled, in accordance with the invariable rule that it depends on the square of the number of turns; for the number of turns in this case has been doubled by the addition of the second coil.

Clerk-Maxwell's Inductance Formula

The fundamental formula of Clerk-Maxwell for the inductance of a coil whose diameter is much greater than the cross-section of its winding is approximately as follows:

Let r be the mean radius of the coil.

Let b and c be the breadth and depth of the cross-section, which may be very different, making a very oblong section. Then

$$L = 4\pi n^2 r \left(\log_e \frac{8r}{\sqrt{(b+c)^2}} - 2 \right)$$

or, what is almost exactly the same thing, l being the total length of wire, and D and d the external and internal diameters of the winding,

$$L = 2nl \log_e \left(\frac{D+d}{b+c} \right)$$

For maximum inductance the quantity in brackets in the first expression, or the logarithm number in the second, will be

$\frac{3}{2}$; and that is why the inductance of a best-wound coil is

$$\max L = 3nl$$

Strictly speaking, a correction ought to be applied for the thinness of the uncovered wire, for that slightly increases the inductance. If T is the covered and t the uncovered wire thickness, a more correct expression is

$$L = l(3n + 2 \log_e T/t)$$

But for a coil of many turns the correction is unimportant.

Experimental Methods of Measuring Inductance. The inductance of a coil means the number of lines of force induced in it by a unit current circulating round the coil, multiplied by the number of turns of the coil; that is, by the number of times the circuit encloses those lines of force. Experimental methods of determining this quantity are nearly all based on a modification or adaptation of the Wheatstone bridge (*q.v.*).

The resistances have first to be balanced, in the ordinary way, under conditions which enable the current to have a steady value. And then the current is made to vary, so as to exhibit the disturbance of the balance due to the inertia or inductance of the coil; that is to say, its choking effect on a varying current. The simplest mode of varying the current is a make-and-break arrangement, in which case a galvanometer can be used, preferably a ballistic galvanometer (*q.v.*), to measure or indicate the momentary impulse or disturbance. An absolute measure can be got with a ballistic galvanometer, but the more usual method is to make compensating adjustment, so as to reduce the momentary disturbances to zero. Another plan, used in comparison and null methods, is to vary the current sinusously, as by a vibrating reed or rotating armature, with a rapidity sufficient to give a musical note; and then a telephone is used as the detecting instrument in the cross-arm of the bridge instead of a galvanometer.

The fundamental method of this kind, the foundation of all the more modern devices, was first planned by Clerk-Maxwell; and this is still the best method for obtaining a very accurate result when all suitable precautions are taken. But in practice Maxwell's method is not the most convenient. It has been ingeniously modified by Anderson and others. These methods are handier in practice, though they all depend on Maxwell's principle.

When measuring the resistance of the wire wound on an electro-magnet, it is instructive to put a keeper on or pull it off while the current is steadily flowing, the magnet being in one arm of the balanced bridge. In either case a wave of induced current is sent round the circuit, and the galvanometer shows a sudden kick or deflection, in one direction when the keeper is put on, and in the opposite direction when it is taken off: because the putting-on or taking-off of the keeper varies the induction (*q.v.*) or number of lines of force through the coil. The keeper closes the magnetic circuit, and thereby increases the number of lines of force (Fig. 2).

The way to get a steady current in a Wheatstone bridge for measuring resistance is to close the battery circuit before the galvanometer circuit; and that is the object of the two keys supplied in many patterns of Wheatstone bridge. When the resistance to be measured has any inductance, if the galvanometer circuit is

denser it is possible to neutralize or destroy these momentary impulses, and so to make the determination by what is called "a null method": that is, to adjust conditions so that the galvanometer is not affected either by a steady or by a transient current. To achieve this, a double adjustment is inevitable. The resistance and the inductance must be balanced separately. A sinuous variation of current, and detection by telephone, is now convenient (Figs. 2 and 3).

The reason a shunted condenser can neutralize an inductance is because it acts just oppositely—not as a choking opposition to change of current, but as an attractive and easy path, which, so to speak, pulls the current forward instead of opposing it. Hence in balancing an inductance against a condenser, they must be put in opposite arms of the bridge. Inductance usually gives a spark at break. Capacity gives it rather at make. They act oppositely in many respects. The two in series generate oscillations.

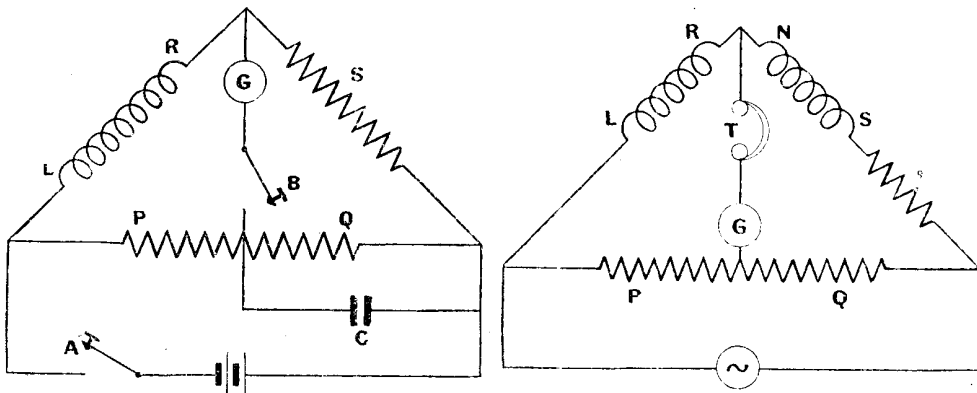

METHODS OF DETERMINING INDUCTANCE VALUES

Fig. 2 (left). With the aid of a condenser of adjustable and known capacity the Maxwell Wheatstone bridge is used as represented in this diagram for measuring inductance. P, Q, and S are non-inductive resistances. If the key A is put down before B a steady current balance can be obtained. If C be adjusted until galvanometer needle does not kick when A is closed after B, then constants of opposite arms will be equal, or $L/R = CQ$. Fig. 3 (right). Maxwell's Wheatstone bridge arrangement for comparing the inductances of two coils. When the balance is complete the telephone, T, or the galvanometer, G, will not be affected by the alternating current. $L/N = R/S = P/Q$ because the time constants of the two currents must then be the same.

closed before the battery circuit, then the galvanometer is bound to be affected by the make-and-break of the battery in a momentary manner, which, however, makes the balancing of resistance alone impossible. This momentary kick of the galvanometer constitutes a measure of the unbalanced inductance in the circuit. That is the principle on which these methods act. But by the use of a con-

It is possible also to neutralize the effect of alternating currents of known frequency by a suitable adjustment of resistance without the introduction of capacity. The possibility of employing and combining these three things, resistance, inductance, and what is sometimes called "capacitance," has given scope for considerable ingenuity, and some of the methods of combining them are highly

ingenious. But they are best described under the heads Mutual Induction and Self-induction. Nevertheless, a brief account can be given here, to illustrate what has been said about the general principle of these measurements.

When two coils are balanced against each other in a Wheatstone bridge, with the other arms non-inductive, the time constants of the two coils must be the same. The time constant of a coil means its inductance divided by its resistance L/R , for this regulates the rate of rise or fall of the current. The rise of current at make is controlled by the equation

$$L \frac{dI}{dt} + RI = E$$

where E is the battery electro-motive force applied.

At any time t after make, the strength of the current is

$$I = \frac{E}{R} \left(1 - e^{-\frac{Rt}{L}} \right)$$

So in a time L/R it rises to within $\frac{1}{e}$ of its final value, which, of course, is E/R . Here e is the natural base of logarithms (*q.v.*). In a time two or three times L/R it has attained nearly full strength.

So to compare the inductance of two coils, one of which may be a standard, you connect them in the arms of a Wheatstone bridge, with suitable non-inductive resistances for the other arms. You first balance for steady currents, and then for make-and-break or varying currents. Calling the resistances in the four arms P, Q, R, S , and the inductances L and N , as in the figure preceding, where S means not only that coil but an additional resistance, s , as well, the first adjustment gives

$$\frac{R}{S} = \frac{P}{Q}$$

The second adjustment gives

$$\frac{L}{R} = \frac{N}{S}$$

Hence when both adjustments are perfect

$$\frac{L}{N} = \frac{R}{S} = \frac{P}{Q}$$

But the double adjustment can only be performed by varying S , by addition or subtraction of a non-inductive resistance, s , which is to be included in S as part of the reckoning. The double adjustment is troublesome, and the employment of variable capacity in one of the arms is a help (Fig. 2).

The galvanometer used for these determinations should be a sensitive one, but while the rough adjustments are in progress it may advantageously be shunted, in order to protect it.

The time-constant of a shunted condenser is the shunt resistance multiplied by the capacity, say QC in Fig. 2. Hence we can arrange a plan for comparing an inductance with a condenser, instead of with another inductance.

If capacity is expressed in microfarads and resistance in ohms, the product will come out in millionths of a second, and can be equated to L/R , where L is in microhenries and R in ohms. Thus a coil of induction 15 millihenries and resistance 5 ohms can be balanced against a capacity of 3 mfd. shunted by 1,000 ohms, because

$$\frac{15,000}{5} = 3 \times 1,000$$

the time-constant in each case being .003 second. The general relation for balance or equality between the time-constants is

$$\frac{L}{R} = CQ$$

where Q is the resistance shunting the capacity C .

In applying the equation

$$L = RQC$$

resistance being in ohms and capacity in microfarads, the induction will come out in microhenries. Thus, if $R = 5$ ohms, $Q = 1,000$ ohms, and $C = 3$ mfd., the inductance will be

$L = 15,000$ microhenries or 15 millihenries.

INDUCTANCE COIL. Any coil which is designed to produce an inductive effect. Coils of this nature are used in great variety in wireless work, and are known by various names, depending upon the use to which they are put and the particular qualities which they possess. Certain forms of inductance coil, however, are known simply as inductances, and of these the most familiar take the form of those illustrated in Figs. 1, 2, and 3.

Fig. 1 shows a typical variable inductance coil, using sliding contacts as a means of varying the number of turns desired to be used. Such coils are always of the single-layer variety, and are wound with enamelled wire upon ebonite or impregnated strawboard formers.

The coil illustrated in Figs. 2 and 3 has tapings instead of a sliding contact. In this case it is more convenient to use silk or cotton-covered wire. This particular coil has 110 turns, and is divided into

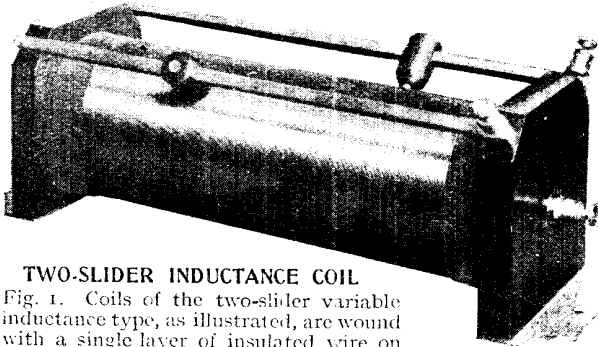

TWO-SLIDER INDUCTANCE COIL

Fig. 1. Coils of the two-slider variable inductance type, as illustrated, are wound with a single layer of insulated wire on cardboard or ebonite formers

Courtesy Economic Electric Co., Ltd.

11 main sections. Ten of these sections have one tapping taken of each, while the remaining one is tapped at every turn. Thus any desired number of turns may be used from 1 to 110 in steps of one by means of suitable switches.

How to Make a Tapped Inductance Coil.

A tapped inductance coil suitable for general broadcast reception and put up in the form of a unit is illustrated in Fig. 4. Arranged in this way, it is adaptable to a variety of purposes, and can be coupled up with practically any form of receiving set. The case can be of any convenient size, and that shown in the illustrations measures $4\frac{1}{2}$ in. square and 4 in. deep. It can be constructed along the lines described under the heading Cabinet.

The top is covered with an ebonite panel $\frac{1}{4}$ in. thick and 5 in. square, with neatly rounded edges and both sides matted, it being secured to the case by four screws, one at each corner. The inductance is wound on an impregnated cardboard former, or, if preferred, an isolite or ebonite tube may be substituted. The former measures 4 in. in length and $3\frac{3}{8}$ in. in diameter, and is wound with No. 24 D.C.C. wire and has a value suffi-

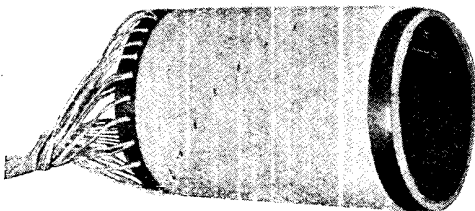

TAPPED INDUCTANCE COIL

Fig. 2. Silk or cotton covered wire is generally used in this form of inductance coil

Courtesy Economic Electric Co., Ltd.

cient for the whole range of broadcast wave-lengths in use with the average P.M.G. aerial.

The taps are made in the following way, and taken in regular intervals, eleven in all. The winding is commenced by fastening the wire to the former by passing it through two small holes made near the edge of the former. Seven turns of wire are then taken round the former, and a strip of ebonite 4 in. in length, $\frac{3}{8}$ in. wide, and $\frac{3}{16}$ in. thick is placed over the windings, and the eighth turn taken round so that it passes over the ebonite strip.

Seven more turns are taken around the cardboard tube, the ebonite slip pushed

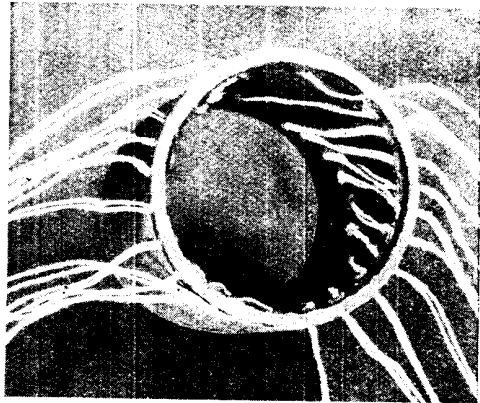

INDUCTANCE COIL TAPPINGS

Fig. 3. Tappings are taken internally in this case at every 10 turns up to 110 turns, and the tapped wires are passed through holes in the former and carried internally to one end

Courtesy Economic Electric Co., Ltd.

along and one turn taken over it, and so on, as shown in Fig. 5. The winding continues in this way until the former is complete. This ebonite strip remains in position throughout to keep the winding taut.

The next step is to scrape the insulation off the single turns of the wire on the top of the ebonite strip, and to solder a good length of insulated wire to each tap. These wires should be about 9 in. in length, and the insulation should be removed from the end to permit of the soldering. The soldering should be carried out very carefully and with the point of the iron, as shown in Fig. 6, and every

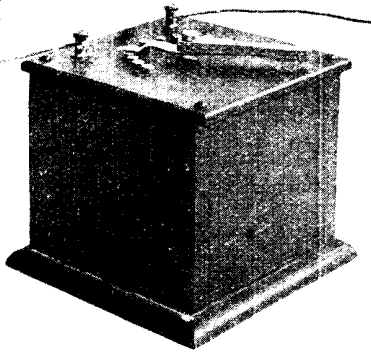

Fig. 4. Enclosed in a case with a panel and switch is a tapped home-made coil for inductance

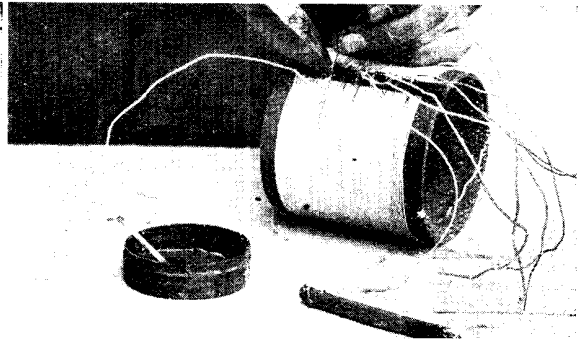

Fig. 6. Leads from the tapping points are soldered on the inductance coil by removing the insulation from the wire, which is separated from the coil at the tapping point by an ebonite slip



Fig. 5. Winding the tapped inductance coil is here seen in progress. Note the method of taking taps. The ebonite slip is not removed when the taps have been made

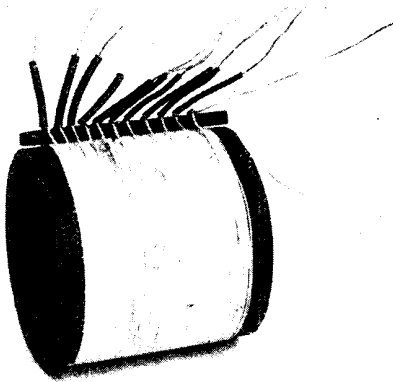
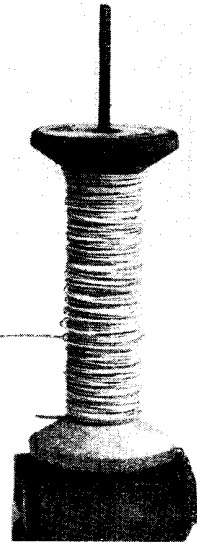

Fig. 7. Sleeving is attached to the leads from the tappings

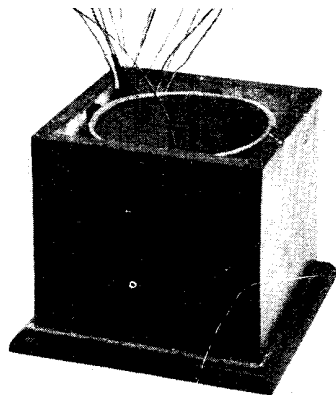
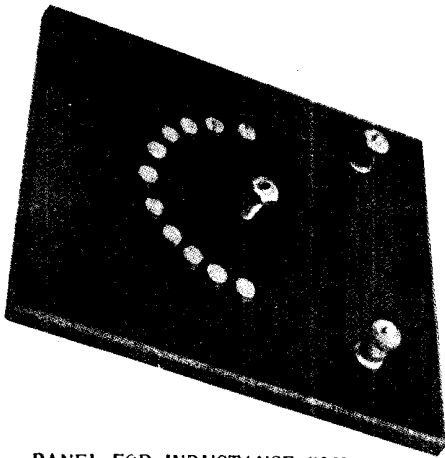

Fig. 8. Ebonite strips are used to fix the coil in position in the case

HOW TO MAKE A TAPPED INDUCTANCE COIL AS A SEPARATE UNIT



PANEL FOR INDUCTANCE COIL UNIT

Fig. 9. Terminals, switch, and centre spindle are shown mounted on the top panel of the case for the tapped inductance coil

trace of soldering acid carefully removed after each operation.

The next step is to cover the wires with a short length of systoflex or insulating sleeving, as shown in Fig. 7. It will be noted that the last turn of the wire forms a tap. The first turn is connected to the aerial terminal in the usual way.

The inductance is now ready for placing within the case, and is simply pushed into position and held there firmly by means of a small strip or strips of ebonite to prevent it moving about, as shown in Fig. 8. The taps are brought out to the top, and should be straightened out as shown, to give as little trouble as possible when connecting them in their proper order to the contact studs. The top panel has now to be fitted with the studs, one in the centre to act as a pivot bearing for the contact arm and handle, while a further eleven studs have to be fitted at equal distances apart and arranged in the form of a half-circle, as is shown in Fig. 9.

Two terminals are also fitted to the opposite part of the panel to the studs, and one of them is connected beneath the panel to the centre stud, and the other to the first turn of the inductance winding. The wires leading from the taps have now to be connected in correct order to the contact studs, the first tap being taken to the first stud nearest to the aerial terminal, the second to the next, and so on. They may be secured by soldering, or, if preferred, with lock nuts, whichever is the most convenient. A good soldered joint is better than a nutted joint.

It is very important that the insulation of the connecting wires is only bared sufficiently to make contact under the nut, as there should be no fear of any of the wires touching each other underneath the panel, or the inductance will not function properly. The panel is then securely screwed to the top of the case, and a test made for continuity by attaching one lead of the terminal of a dry battery to the aerial terminal, and the other lead of the dry battery to the earth terminal on the panel. A pair of telephones is then placed on the head and the tags attached, one to the centre stud and the other to one of the contact studs, when at the moment of making and breaking the connexion a sharp click should be heard

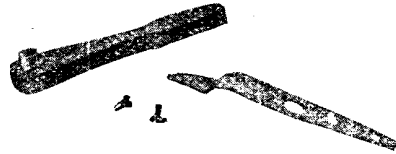

INDUCTANCE COIL SWITCH ARM

Fig. 10. Details of the construction of the handle and contact. The arm is bent to make a springy contact

in the telephones. Each stud should be separately tested, and should give similar signals, those nearest the aerial terminal giving a slightly louder click than the others, as the resistance is reduced.

It now only remains to prepare an ebonite handle by cutting a piece of $\frac{1}{4}$ in. ebonite sheet to shape and drilling a hole through it at one end, so that it may turn freely, but without shake, on the centre stud. A brass contact blade is then prepared and screwed to the underside of the ebonite handle, and may be a strip of brass about $\frac{3}{8}$ in. wide, tapered off somewhat at the contact end, and bent downwards so that it presses sufficiently on the studs to give good contact (Fig. 10).

A hole is drilled through it to clear the centre stud, and it is secured to the ebonite with two small countersunk brass screws. Alternatively, a laminated flexible brass bush can be prepared and similarly fitted. A flat washer is then slipped over the centre stud, then a spring washer, another flat washer, then the handle, still another washer, and, finally, a nut on the top of the stud, which is tightened down so that the handle can move smoothly and the blade bring pressure to bear on the contact faces (Fig. 11).

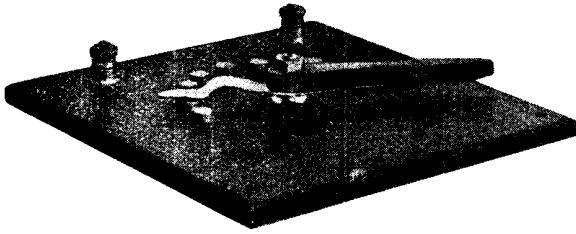

TAPPED INDUCTANCE PANEL COMPLETE

Fig. 11. In this photograph the panel is shown complete, with the handle and contact arm mounted

A test should then be made in a similar manner as before, but in this case the positive terminal of the dry battery should be connected to the aerial terminal on the panel, and a buzzer or bell connected between the earth terminal and the negative terminal of the battery. On moving the contact handle from the first to the last stud the buzzer should continue to function. If it does not, it indicates that the taps have been connected in incorrect order. The remedy is obvious.

The construction of other forms of inductance coil, as well as other methods of making taps, are dealt with under the headings Basket Coil; Coil; Honeycomb Coil (*q.v.*). See also Aerial Tuning Inductance; Loose Coupler, etc.

INDUCTANCE FORMER. Name given to a foundation whereon to wind an inductance coil. With the ordinary form of single-slider contact inductance the former is often made of cardboard tube (*q.v.*), iso, ebonite, bakelite, or other good insulating material, and when the

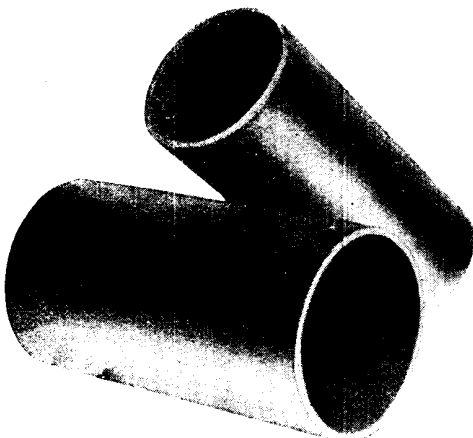

FORMERS OF INDUCTANCE COILS

Cardboard, ebonite or fibre formers are usually employed for winding inductance coils. An ebonite and a fibre tube are shown

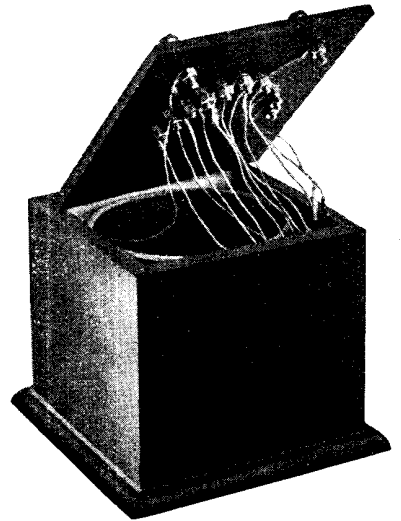

INDUCTANCE COIL UNIT TAPPINGS

Fig. 12. With the panel of the complete unit raised, the tappings are seen connected to the underside of the contact studs. Leads are made of sufficient length to allow the panel to be lifted

coil is completed the former is left in place to support the winding.

In the case of some forms of plug-in inductance coil, as well as some forms of honeycomb coil, the former consists of a ring of insulating material on which the wire is wound. In other patterns the former is only used as a temporary support, and is withdrawn when the coil is completed. In the case of basket coils, for example, the former consists of a reel or spool and a series of pegs or plugs, which are removed when the coil is finished.

Other forms of inductance are either built up on a former which subsequently acts as part of the structure, or they are removed when the winding is completed. The figure shows two inductance formers, one made of ebonite and the other of fibre. See Basket Coil; Coil.

INDUCTANCE SWITCH. An inductance switch is one intended to be used for the purpose of cutting in or out of circuit a certain number of turns in the winding of an inductance coil. A pattern is illustrated in Fig. 1, and comprises an ebonite base, with mounted upon it a number of contact studs. A substantial brass contact arm, carrying a separately bushed laminated contact brush, is pivotally mounted on an ebonite base, and can move across the tops of all the contact studs. The terminal and stop pins

complete the switch, except for the connexions, and these are simply made with the various tappings on the inductance coil, and connected in order to the contact studs. A connexion is made from the pivot of the contact arm to one of the terminals, the other terminal being connected to the commencing end of the inductance coil winding.

The pattern illustrated is intended for mounting on a baseboard, and is suitable for experimental use, having four small insulated feet fixed to the underside of the panel to provide studs for the connecting wires. Many other patterns are available, the disposition of the parts, the number of contact studs and other details varying according to the requirements of the set.

A very useful inductance switch suitable for amateur construction is illustrated in Fig. 2, and is a self-contained unit adaptable for experimental purposes. The sizes may be modified, but those given in the illustration comprise a baseplate 3 in. wide, $2\frac{1}{2}$ in. deep, and a vertical member 3 in. square. Mounted in the centre of this panel is a movable contact arm and knob, which makes contact with any of the eight separate contact studs, thus providing eight tapping points.

The construction should be commenced by preparing the base and panel from ebonite $\frac{1}{2}$ in. thick, cutting it to shape, and matting all the surfaces. The next step is to prepare two small brass angle plates $\frac{3}{4}$ in. high and $\frac{1}{2}$ in. wide, making these from brass strip $\frac{3}{8}$ in. wide and $\frac{1}{16}$ in. thick. The two short legs are then screwed to the ebonite base so that their faces are at a distance of about 1 in. from the edge of the ebonite, as shown in Fig. 3.

The next step is to prepare the panel, marking it out accurately, drilling a central hole to clear the bush for the contact arm spindle, and also holes for the eight contact studs, and those for the fixing screws, as shown in Fig. 4. The studs should be equally spaced, and be sufficiently close together to permit of the brush bearing on the second stud before it has entirely left the first, so that a smooth action may follow. The studs must all be carefully adjusted for height for the same reason, otherwise the action will be jerky and the contact be faulty.

The next step is to turn up a bush for the contact spindle. This should have a large flange $\frac{1}{4}$ in. in diameter, and is best prepared by drilling a hole through a casting or a piece of brass rod about $\frac{1}{2}$ in. in thickness, mounting it in the mandrel of the lathe, as shown in Fig. 7, and turning the bush out of the solid, and all the operations can then be performed at one setting, as it is important that the flange be in a plane at right angles to the centre line of the spindle.

Three fixing holes are drilled through the flange, and it may then be screwed into its position on the panel. The contact spindle is simply a length of screwed brass rod with a double-ended contact arm made of four or five laminae of strip

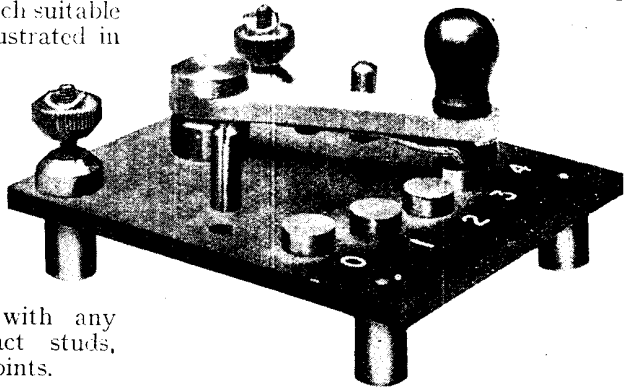

SWITCH FOR INDUCTANCE COIL

Fig. 1. Five studs are mounted on this panel. The switch arm making contact with studs 1 to 4 includes inductance at various values in a circuit. When the arm makes contact with the stud O the inductance is cut out

copper or phosphor-bronze attached to it by means of a circular nut having a small slot across its upper face so that the contact blades may rest in the notch. A hole is drilled through the blades to permit the spindle to pass through, and the ebonite knob is then screwed firmly on, thus holding them securely together, as shown in Fig. 6.

The ends of the contact arms will have to be carefully filed until the longer arm bears evenly on the tops of the contact studs, while the short arm, with a longer projection, bears firmly on the flange of the spindle bush. Contact is effected by placing a couple of spring washers over the projecting end of the spindle and adjusting the pressure by means of two brass lock nuts, locking them together securely to prevent them moving.

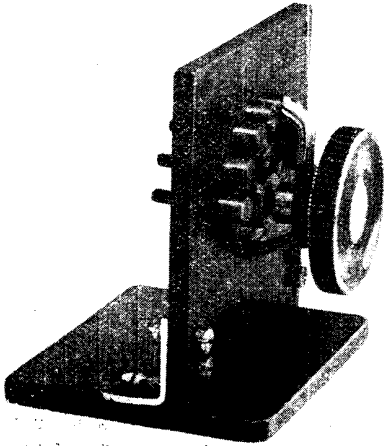

Fig. 2. Experimenters can easily make an inductance switch, which is shown complete as a unit

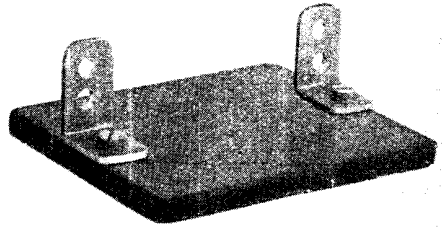

Fig. 3. Brass angle pieces are attached to an ebonite base to support the panel in a vertical position

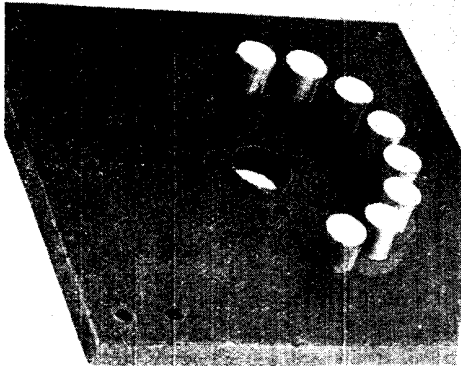

Fig. 4. Contact studs are mounted on the panel, and must be evenly spaced

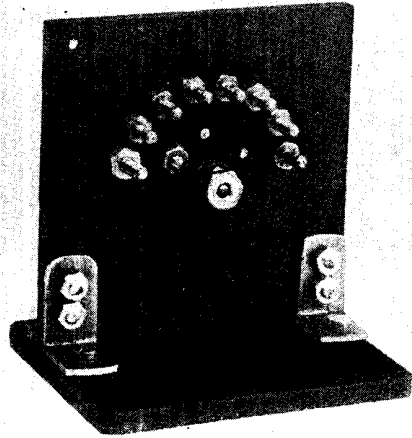

Fig. 5. This is a back view of the complete instrument, showing the stud legs

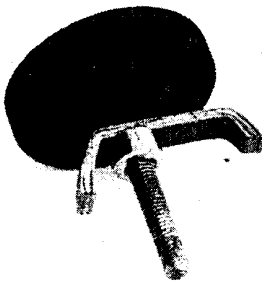

Fig. 6. Details of the knob, contact brush, and spindle

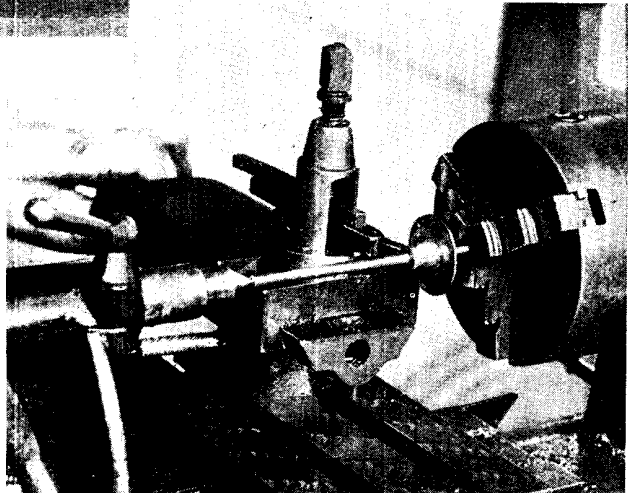

Fig. 7. On the mandrel of the lathe is the bush being turned for the spindle of the switch. The bush has a large flange

CONSTRUCTION OF AN EXPERIMENTAL INDUCTANCE SWITCH

The switch is wired by connecting the studs to the taps on the coil in the usual way. The connexion from the spindle bush is effected by placing two lock nuts on the projecting portion and securely locking them together, as shown in Fig. 5, fixing the wire to them. If desired, terminals may be fitted on the top corners of the panel and used for connexions. For experimental work this is unnecessary, as the aerial can be connected direct to the inductance coil and the wire from the contact bush taken to earth. See Change-over Switch; Knife Switch.

INDUCTANCE TUNING.

The general method of tuning, whereby inductances are used to vary the wave-length of a transmitter or receiver. For transmitting it is usual to allow only a small variation in the amount of inductance used, for the wave-length of the transmitters (except those of a purely experimental type) is not generally changed when once installed. In the case of receivers it is essential that their natural wave-length be identical with that of the signals desired to be received. When a receiver is in that condition it is said to be "in tune." As inductance and wave-length are interdependent, and as their relationship is connected by a mathematical law, it follows that a change in inductive value will effect a change of wave-length. Capacity must also be considered in conjunction with inductance, for it is always present and cannot be entirely eliminated. Furthermore, capacity affects wave-length in a manner similar to inductance. (greatest efficiency is always obtained, however, by reducing capacity to a minimum, and, conversely, using the maximum amount of inductance, the wave-length depending upon the product of the capacity and the inductance. A single-circuit tuner represents the simplest possible method of inductance tuning. This consists simply of a continuous coil of wire, which may be made variable in effective length by means of a sliding contact or tapping, or on the variometer principle, connected directly across aerial and earth. Such a circuit is not very selective; its only advantage being that of simplicity.

The two-circuit tuner represents a distinct advance over the single-circuit type as regards selectivity, while it is not too difficult to manipulate. Here, one inductance is connected directly across

A further method of inductance tuning consists in altering the angle of relationship between the windings in two coils. It is to this class that the variometer and variocoupler belong. The former instrument usually takes the form of two spherical windings wound in the same direction. One of the spheres is a rotor, and is smaller than and rotates within the stator. It is usual to connect the two windings in series with one another. When the rotor is placed in such a position that both windings are in the same direction, the inductive effect is at a maximum. It is at a minimum when these positions are reversed. Any position between these two represents a corresponding difference in inductive value, so that a continuously variable inductance results from the use of this device.

The variocoupler is a development of the variometer, and differs from that instrument only in that the stator is tapped, thus providing a further latitude in available inductance range. See Coil; Loose Coupler; Tuning; Vario-coupler; Variometer.

INDUCTION: WHAT IT IS & HOW TO CALCULATE IT

By Sir Oliver Lodge, F.R.S., D.Sc.

Here in this second of two associated articles our distinguished contributor and Consultative Editor describes the various forms which induction may take, the manner in which it acts in each case, and the methods of calculating it. See Electricity ; Inductance ; Magnetism ; Self-induction

Induction is a name first employed by Faraday for any magnetic or electrical action across empty space. When a charged body is brought near a conductor, it is said to act inductively on that conductor. If the conductor is insulated, its potential is thereby raised by an amount proportional to the charge, and inversely as the distance of that charge. *Not* the square of the distance.

Electrostatic Induction. An insulated conductor thus acted upon inductively has not only its potential raised, so that it can give off a spark similar in sign to that of the inducing body, but it has its own electricity redistributed ; the opposite sign being attracted towards the neighbourhood of the inducing charge and a charge of similar sign being repelled, so that it has opposite charges at its two ends, and is said to be polarized. If it be earthed, the repelled electricity escapes and an extra supply of the attracted sign is supplied, sufficient to neutralize its potential and reduce it to zero in spite of the continued neighbourhood of the inducing charge.

For instance, if a positively charged sphere is brought into a room, the floor, walls, and ceiling of that room, and especially the table and all neighbouring objects, are charged inductively ; and negative electricity can be removed from any of them by means of a proof-plane. If the hand of an operator is brought near to the inducing charge, that hand at once acquires an opposite charge ; in other words, electrons crowd into it from the earth and face the inducing positive charge, until, if the hand be brought near enough, the opposite charges rush together disruptively, breaking down the insulation of the air and causing the momentary evolution of heat and light called a spark.

If instead of a flat surface a pointed body be brought near the charge, the electrons crowding on to that point are able to break down the air at a considerable distance ; giving, however, not a spark but either a luminous glow or a brush. In other words, they electrify the air in the

immediate neighbourhood ; which then, no doubt, moves towards the charged body and rapidly discharges it. In this way what is called "an electric wind" can be produced ; which wind can drive a small paper-mill, or by its action on the point can propel that backwards, if it is free to move.

When an elongated insulated conductor is subjected to induction and then broken in half or separated (by previous arrangement) into two portions, one half will be charged negatively, the other positively. And the two charges can be separated to any distance by what might be called "convection" ; though the term convection is more usually applied to the automatic carrying of charges by the atoms of matter, instead of to their artificial conveyance by hand, or other means of locomotion.

Magnetic Induction. When one end of a long magnet, that is to say, a magnetic pole, is brought near a piece of iron, it, too, is acted on inductively and is said to be polarized. If, for instance, the inducing pole is a north pole, the piece of iron will have a south pole at the near end and a north pole at the far end. But if it be now broken in half, these poles cannot be separated. New poles appear at the break, and each half is a complete magnet. And the same will occur into however many pieces it is broken.

This is an important distinction between magnetism and electricity. It may be said that whereas electric lines of force terminate on conductors, one end being positive, the other end negative, magnetic lines of force never terminate, but are always closed curves. Only, when they quit the air and enter iron or steel, the change in what is called "magnetic permeability," or, more simply, the change of material, causes poles to appear at the boundary. And these poles appear wherever there is a boundary.

Moreover, there is no ordinary induction for magnetism, as there is for electricity ; and a magnet cannot be discharged by touching it. Steel magnets are magnetized by induction ; and if the

steel is hard they retain the magnetism imparted: that is to say, the material does not allow the lines of force produced in it to subside again. A portion may subside, but a portion is retained; the retained portion being called "permanent magnetism." It can, however, be got rid of in several ways. It partly subsides if the steel is treated violently, as by the blows of a hammer. It subsides to some extent by lapse of time. It diminishes also if the steel is heated: at a certain temperature it disappears altogether. At a red heat iron becomes insusceptible to magnetism. Nickel loses its susceptibility at a much lower temperature. Cobalt retains it to a white heat.

Concerning the nature and cause of these differences, and the reason for the susceptibility of iron and other magnetic substances, some progress has been made; but there is much still to be discovered. At present, in an elementary treatment, we must ascertain and accept the facts.

Hard steel is not easily magnetized; but when it is magnetized it retains the magnetism, especially if the bar is long and thin. A short stout bar is quite unsuitable for a permanent magnet. If such a bar magnet is wanted it must be made of thin bars separately magnetized and then riveted or clamped together (*see* Compound Magnet).

Magnetism Transmitted Only by Induction

Electricity may be conveyed from one body to another by conduction; but magnetism can only be transmitted by induction: and the two opposite poles can never be separated. The poles of every magnet are equal in strength, though, if they are of different size, one may be more concentrated than the other. Lines of force from every portion of the north pole curve round to a corresponding portion of the south pole, and then continue through the steel or iron, completing the magnetic circuit. Such a circuit is sometimes called "open"—meaning that it has an air-gap; in the case of a bar magnet a wide and diffuse air-gap. It may be technically closed, or short-circuited, by a piece of iron or "keeper," so that the stray field in the air can be reduced to insignificance. But all magnetic circuits are really closed in one material or another.

The same statement may be made for "current" electricity, for when a current

flows it must flow in a complete circuit. But if a dielectric or insulator is interposed in that circuit, then the circuit is completed, not by conduction, but by electric displacement; that is, it is completed in an elastic manner: like the stretching of a membrane across a pipe, which would be displaced by the flow of water, until either it bursts or else stops the flow, and causes an elastic recoil or discharge.

That is just what happens in a condenser, though the displacement is not of a mechanical and obvious kind. The electric flow is checked and driven back again when the propelling force is removed and the external metallic circuit completed. Some dielectrics are much more easily burst than others. Glass and ebonite, and even liquid insulators, such as oil, can stand a considerable strain. Air is burst more easily. Induction always precedes a spark; and it is induction which chiefly operates in condensers.

Current Induction. But Faraday found that another kind of induction could go on from an electric current when there was a conductor in its neighbourhood. This kind of induction is very important, and not quite so simple as static induction. When a current is steady it has no inductive effect. To produce electro-motive force by induction, currents must vary in strength. When they rise in strength they induce an opposite current in neighbouring conductors. When they fall in strength they produce a current of similar sign to themselves. And they do this even in their own conductor, a phenomenon which was called by Faraday "Extra Current," but is now known as self-induction (*q.v.*), a name given by Clerk-Maxwell.

The electro-motive force set up in a conductor depends on the rate of change in the number of lines of force which thread it, and in fact is equal to that rate of change, dN/dt . As long as the lines of force are steady there is no visible effect, but Faraday called that "the electronic state," because when the lines of force subside, or are removed, or otherwise destroyed, a wave or pulse of current circulates in the conductor, its strength depending on the electro-motive dN/dt , divided by the resistance of the conductor, in accordance with Ohm's law (*q.v.*).

If the inducing coil has an iron core, that iron is acted on by the current and magnetized inductively; and the lines of

force due to the iron add their effect to those of the coil, and exert stronger induction at a distance. The conductor in which induced currents are set up is called a secondary circuit; the original current being called the primary. If the secondary circuit is wound on the primary, or wound on some part of its iron core, nearly all its lines of force can be got through it, and the inductance is then a maximum. This is what is called an induction coil (*q.v.*).

The object of an induction coil is to generate a sudden and violent electromotive force in the secondary circuit; and for that purpose the strength of the primary current is varied very rapidly. It may be made and broken in rapid succession. The break can be made more rapidly than the make, because a complete break in the circuit can stop it almost dead—not quite dead, because you cannot introduce the insulator with infinite speed.

If you break it in air there is sure to be a spark, which prolongs the current for an instant. If you break it under a liquid, the stoppage is more sudden. Even in air, however, the stoppage made be made rather sudden by supplying a condenser to the terminals of the break; for then the first rush of the self-induced or extra current expends itself in charging the condenser, so as to give time for the terminals to separate, and so to either avoid the spark altogether or reduce it to a minimum.

Induction in the Dynamo

Moreover, the stored charge in the condenser immediately recoils back, producing a current in the opposite direction; so that the primary current is not only stopped, but reversed, thus giving a double effect on the secondary. And if the secondary has a large number of turns, so as to surround the magnetic lines of force a great many times, the induced electro-motive force may reach a very high value, giving a spark in favourable cases a foot or more in length.

A dynamo also acts by induction. But in that case the current is induced in the armature not by making and breaking the primary current, which can remain steady, but by rapidly moving it; or, what is more convenient, by rapidly rotating the armature coils, so that the steady lines of force of the inducing magnetic field shall thread the secondary circuit or armature,

first in one direction and then in the other. And the more rapid the rotation, the more vigorous is the induced electromotive force.

The total induction in a magnetic circuit, say a horseshoe electro-magnet with an air-gap (in which experiments can be made), is the total number of lines of force generated. If A is the sectional area of the circuit and l the width of the air-gap, if μ is the magnetic permeability of the iron core, n the number of turns of wire wound on it, and I the strength of current circulating through it, then a first approximation to the total induction is "the magneto-motive force" $4\pi nI$ divided by the "reluctance," $l/\mu A$; in close analogy with Ohm's law for an electric circuit. Consequently, the total induction is

$$N = \frac{4\pi\mu nAI}{l}$$

If a wire is moved across the gap it cuts all these lines, and the electro-motive force induced in it is proportional to the speed with which it moves, being dN/dt . If an armature is revolved in the gap it can cut all these lines twice at every revolution. That is the beginning of dynamo theory.

What the Act of Induction Is

Since magnetic lines of force always form a closed circuit, they cannot be made to thread a coil as you thread a needle, by pushing their ends through it, because they have no ends. They have to be moved sideways into its aperture; and when they are removed, they must shift sideways out. Hence, in entering and leaving they must cut all the wires of the coil. That is one way of expressing the act of induction—a coil is arranged to cut the lines of force as quickly as possible.

But it is not really the cutting that does the business. For if you move a coil across a uniform field, with the lines always perpendicular to the coil, the total number of lines through the coil continues constant, and then no effect is produced. (It may be said, however, that one half the coil is cutting the lines one way, the other half the other way; so discrimination is not easy.) If, however, the coil is turned through a right angle in a steady uniform field, all its lines are taken out; and if turned through another right angle, all the lines are put in again in the inverse direction. And this goes on at every revolution. But such induced currents

are always and naturally in opposite directions. Hence, to get a one-direction current from such a coil you are bound to have a commutator (*q.v.*). And a commutator always means a sliding contact of some kind.

It is possible to have an expanding or a contracting circuit, and in that way the number of lines of force can be changed and a current induced. But you cannot go on contracting or expanding for ever without a sliding contact, such as might be given by a revolving copper disk with one spring touching its axle and the other spring resting on its rim. If such a disk is rotating in a magnetic field, a steady current is produced in any circuit joining the two springs. And this was Faraday's first dynamo, the origin and precursor of all the dynamos of the present day. He also made alternating dynamos in their most elementary form. But those do not need a commutator, though, even in them, there must be a sliding contact.

The Universal Magnetic Field

When a primary and secondary circuit are brought close together, so that lines from one easily thread the other, they are said to be close-coupled. When they are far apart, they are said to be loose-coupled. It is possible to put two coils quite close together, and yet to adjust their position so that no lines from one thread the other. Their mutual induction is then zero; but it is rather a delicate adjustment to get such zero, except when they are far apart.

Practically every moving conductor is moving in a magnetic field, viz., the field of the earth. Hence induced currents of insignificant strength are exceedingly common. The rings of a horse's harness, as he trots, must have currents induced in them. If we stir up the coins in our pockets, currents are induced in them. Current induction goes on wherever conductors are moving near magnets of any kind, or when they are in the neighbourhood of varying magnets. The magnets might be permanent steel magnets; they might be electro-magnets with iron cores; or they might be mere coils of wire attached to a battery.

If the variation of a magnetic field is considered a kind of motion, we may generalize and say that current induction is the result of magnetism and motion. Even if there are no conductors in the

neighbourhood of a varying or moving magnet, electro-motive force is still produced; but that only results in electric displacement, not in a conduction current. And such electric displacement would be permanent as long as the magnetism kept on varying and would only subside with a condenser-like recoil when the magnetic field became constant.

The interlocking of magnetism and electricity is most important. It may be likened to the interlocking of two curtain-rings threaded together, like the two links of a chain. A current started in one induces magnetism in the other. And, conversely, magnetism generated in one induces a current in the other. The fact of this reciprocal interlocking, and the fact that it goes on, though less obviously, in insulators, and even in empty space—where the current must be of the displacement and not of the conduction kind, furnishing, therefore, an elastic recoil—is responsible for the generation and transmission of electro-magnetic waves. The electric force and the magnetic force in space are at right angles to each other; and their advancing wave-motion is at right angles to them both.

The electric and magnetic forces are in the plane of the wave; and the line at right angles to them both is the direction of advance of the wave: The advancing energy depends on the product of the electric and magnetic forces; and the speed with which they can advance through so-called empty space, that is, through the ether, is the velocity of light.

That is what light is; and there is no other kind of light. That is what wireless waves are; and hence induction dominates the whole field of electrostatics, current electricity, magnetism, and optics. Induction is a sign that all material objects are intimately connected and thoroughly impregnated with the ether of space. Without that, there could be no action at a distance. And it now appears that gravitation is another manifestation of the properties of the ether, of a not wholly dissimilar kind, and that in some recondite way the velocity of light regulates the transmission of gravitation also.

INDUCTION COIL. A device for obtaining a very small current at high pressure through conversion by induction of a current of low voltage into one of high voltage with a corresponding decrease of amperage. The most familiar type is the

so-called Rühmkorff coil, named after a Paris instrument maker who, in 1851, produced a model showing certain important advances upon the work of predecessors. Since Rühmkorff's first instrument fresh improvements have been introduced, but in his later patterns he embodied the most essential of these, namely, the hammer break and the condenser, the former attributed variously to C. E. Neef, J. P. Wagner, and J. W. M. Gauley, of Dublin, the latter to Bizeau.

Fig. 1 gives a clear idea of the working of an induction coil.

The current from the battery flowing through the primary windings, P, causes a magnetic field to grow up around the secondary conductors, S. The spring, G, carries a piece of soft iron, and also a platinum contact, A, which normally touches another contact, B, the two contacts together forming part of the primary circuit.

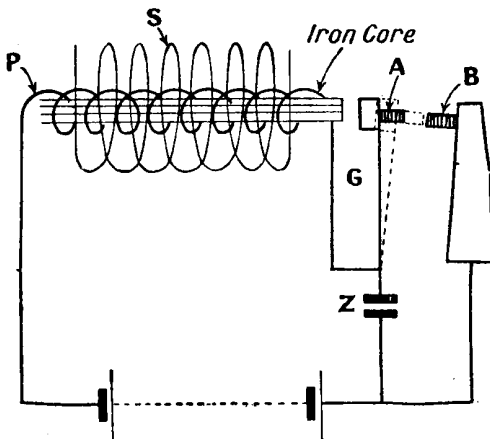

INDUCTION COIL AND HAMMER BREAK

Fig. 1. Represented in this diagram is the action of an induction coil. How the coil is used in the well-known hammer-break or interrupter, as with an electric bell, is shown

When the magnetic field of the primary has grown to a sufficiently high value the piece of soft iron mounted on the brass spring G is drawn over to the iron core of the primary, thus separating the contacts A and B, and breaking the primary circuit. But, because the primary circuit has been broken, the magnetizing current from the battery ceases and the magnetic field dies away. There is, therefore, nothing to attract the contact A to the iron core, and consequently, through the action of the brass spring G, it flies back into touch with

B. This again "makes" the primary circuit, and so the process goes on automatically, a momentary electro-motive force being induced in the secondary circuit for each make-break. For, as noted in the article on induction, in dealing with mutual induction, any stoppage or variation of current in a circuit produces an induced electro-motive force in a neighbouring circuit owing to the cutting of the second circuit by the lines of force produced in the first.

The voltage induced in the secondary will be very much higher than that of the primary if a sufficiently large number of turns are included in the former. In the modern induction coil the primary consists of a bundle of soft iron wires enclosed in an ebonite tube, the primary circuit being wound round the latter, usually in several layers. No. 14 S.W.G. wire, silk-insulated, is very suitable for this purpose. The secondary circuit generally consists of a large number of flat sections wound separately, the adjacent ends of the sections being soldered together and insulated so that there are no inaccessible joints. The use of very fine wire such as No. 32 or 36 S.C. for the secondary, coupled with the sectional method of winding, enables a very large number of turns to be included.

The condenser, Z, shown in the diagram, is inserted partly to prevent destructive sparking at A and B, and partly because a much higher electro-motive force is induced in the secondary owing to the more rapid decay of the magnetic field brought about by the passage of extra current into the condenser, and the consequent sharp cutting off of the current in the primary circuit.

Owing to occasional irregularities in the action of hammer-breaks, various other forms of break or interrupter have been devised, of which the best known are the mercury turbine and electrolytic interrupters.

The former were frequently used in connexion with the large spark coils formerly employed for transmission in wireless telegraphy, but are now rapidly being pushed into the background by C.W. and valve methods. The electrolytic interrupters are of value in X-ray work, but have no special application to wireless.

An induction coil for the transformation of alternating currents is called a transformer, an instrument of which various

types are employed in wireless. But in this case, as the alternations of current produce sufficient variations in the magnetic field to induce a current into the secondary winding, no automatic make-break is needed. Nor is a core employed in high-frequency transformers.

It must be fully understood that the induction coil increases voltage only at the expense of current. For instance, a coil which is designed to work off a ten-volt battery and which consumes, say, one ampere, might conceivably be made to deliver a voltage of 10,000 across its secondary. Thus a wattage of 10 is applied to its primary. The output would still be of the order of 10 watts, less the losses in heat and the current consumed in providing the power for working the interrupter. In this case, then, the output current would be something less than one-thousandth of an ampere.

Induction coils are always rated by the length of spark which they will normally deliver from their secondary, providing pointed discharge rods are used. Ball or disk dischargers, such as are generally used for wireless work, whilst more efficient than pointed ones for this purpose, cut down the length of spark according to

their shape, and therefore may not be used for rating purposes.

A typical small induction coil for amateur use is illustrated in Fig. 2. Its construction is of the simplest possible character, and it is designed to give a $\frac{1}{2}$ in. spark. Such a coil will be found useful for working small Geissler tubes, or similar static experimental apparatus. This coil will work quite well off a 4 volt accumulator and will consume approximately 4 amperes.

The coil itself is mounted upon a hollow base in which the condenser is assembled. The latter consists of sheets of tinfoil separated by paraffin-waxed paper. The core of the coil is shown projecting from the end-pieces, and the iron wire of which it is composed may be plainly seen. The coil is wound upon a bobbin having a very thin paper centre. At either end of the bobbin are the cheeks, which are of hardwood, polished and stained black. The primary is wound in very close proximity to the core, the connexions from it being taken to the two terminals shown on the near end of the base. It is, of course, to these terminals that the battery is connected.

A layer of thin insulating material separates the secondary winding from the primary. The secondary consists of very thin wire, well insulated, and wound layer upon layer with a paper insulation between each. The final layer is protected from mechanical injury by having layers of thin

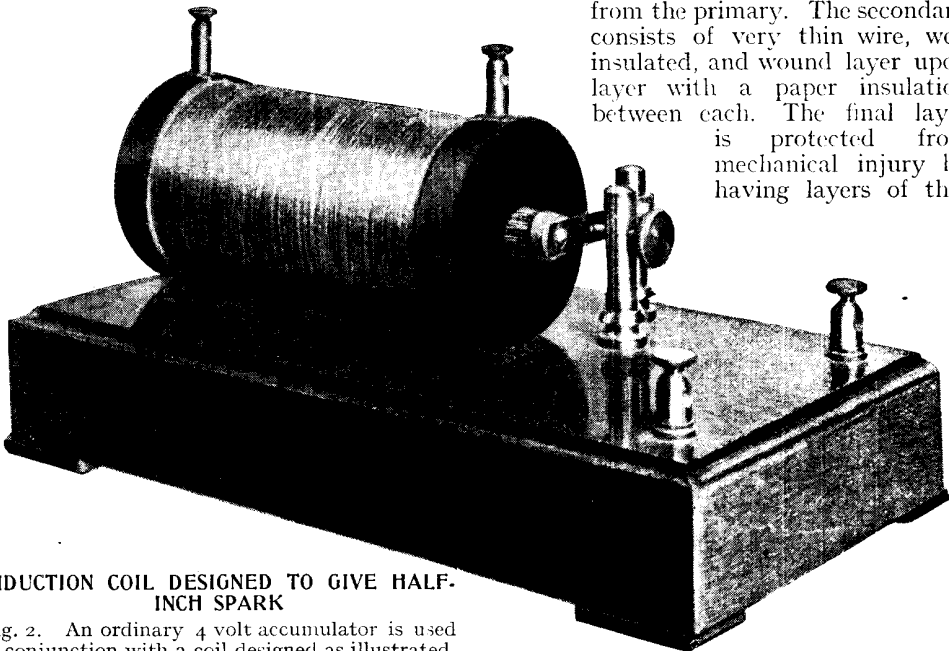

INDUCTION COIL DESIGNED TO GIVE HALF-INCH SPARK

Fig. 2. An ordinary 4 volt accumulator is used in conjunction with a coil designed as illustrated.

This induction coil gives a spark across a gap the electrodes of which are spaced half an inch. Small Geissler tubes may be worked with a coil of this kind

Courtesy Economic Electric Co., Ltd.

twine wound over it. The secondary terminals are fitted on the tops of the end cheeks, one being on each. These terminals form convenient clamps for fitting discharge rods.

The interrupter is of the simplest possible character and is clearly shown. It consists merely of a pillar on which the armature spring-strip is fixed. A further pillar, located by the side of the armature, carries a platinum contact, which engages with a contact on the strip itself.

A very much larger coil, capable of delivering a 6 in. spark, is illustrated in Fig. 3. While the appearance of this coil would suggest the same methods of construction as for the smaller one, it is really very different as regards the winding of the secondary. The winding of a secondary of such a coil as this is a matter requiring great care, owing to the enormous

such a size that they will slip easily over the primary winding and any intervening insulation.

The sections, which would probably be about one hundred in number, are threaded over the primary and connected in series. The wire used should be double silk-covered, and there should be one or two paper disks, thoroughly impregnated, between each disk. It will be seen that such a construction renders the location of faults in insulation a matter of comparative ease, and, furthermore, should a fault

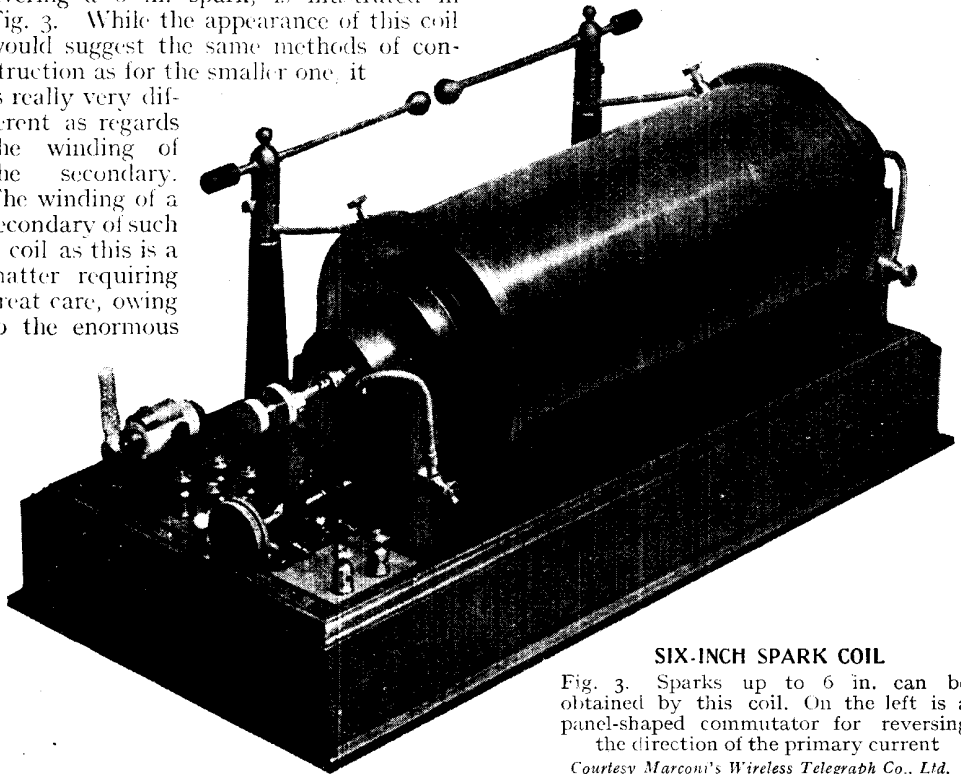

SIX-INCH SPARK COIL

Fig. 3. Sparks up to 6 in. can be obtained by this coil. On the left is a panel-shaped commutator for reversing the direction of the primary current

Courtesy Marconi's Wireless Telegraph Co., Ltd.

voltage generated. The insulation of secondary windings of large induction coils is a thing which is always likely to break down. This being so, it is obviously necessary that any fault occurring should be easily located and rectified. The secondaries of such coils, therefore, are invariably wound in small sections. These usually take the form of thin flat disks of wire, very similar in appearance to the well-known pancake inductance. For a 6 in. coil it is usual to make them about $\frac{1}{8}$ in. thick. The centres of these sections are made hollow, the holes being of

arise, the bad section may be removed and a new one substituted. Should the latter not be available, and the coil be required for immediate use, sections on either side of the faulty one may be connected together and the coil used with only a very slight lowering of efficiency and slight reduction in the length of spark obtainable.

On such a coil as this it is essential that all external insulation be of ebonite. A thin sheet of this material is wound round the secondary winding to protect the latter from the effects of dust and damp, and also from mechanical injury.

A hammer break is fitted to this coil. This is of very heavy construction, and is fitted with contacts sufficiently large to carry a current of six amperes at a pressure of ten volts. To the left of the break is a barrel-shaped commutator for reversing the direction of the primary current. Such a device is useful for some experimental work in static electricity.

It is possible to use an induction coil as an ordinary high voltage step-up transformer if a suitable alternating current supply is available. For this purpose the alternating current supply voltage must be cut down to the same as that if direct current were used, and the frequency should not exceed fifty cycles. It is necessary in this case to disconnect the interrupter, as this is not required, the alternating current of itself possessing the necessary fluctuating character to perform the inductive effect.—*O. Wheeler and R. B. Hurton.*

See Hammer Break; Induction; Interrupter; Mercury Break.

INDUCTIVE CAPACITY. Ease with which a dielectric permits static induction to act through it. Different dielectrics in a condenser, for example, act differently as regards the inductive action between the plates. Mica, one of the most commonly used dielectrics, will suffer a greater electric strain than air, for example, which is another way of saying that a more powerful inductive action can take place across it. Other things being equal, a mica condenser, therefore, has a greater capacity than an air condenser.

The ratio of the inductive capacity of any particular dielectric to that of air is called its specific inductive capacity, or dielectric constant, and this ratio is usually denoted by the letter *K*. This constant is an important one in wireless construction, and the experimenter will find that it occurs on every occasion he has to calculate the capacity of home-made condensers. See Dielectric for a list of dielectric constants.

INDUCTIVE COUPLING. The arrangement of a coil of wire so placed in respect to a similar coil, that oscillations or alternations of current flowing through

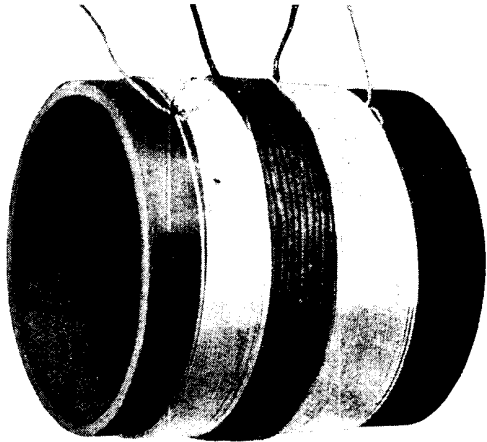

AERIAL TUNING COUPLED INDUCTANCE

Fig. 1. Wound on the secondary of this inductively coupled aperiodic aerial tuning inductance is a primary coil composed of a few turns of stout-gauge wire

the one coil induce similar oscillations in the other coil.

The principle of inductive coupling depends on the varying lines of magnetic force cutting a conductor and creating a current within that conductor. It follows that the closer the conductor or secondary coil is to the coil emanating lines of force, due to the varying current in it, the greater will be the induced current. Another

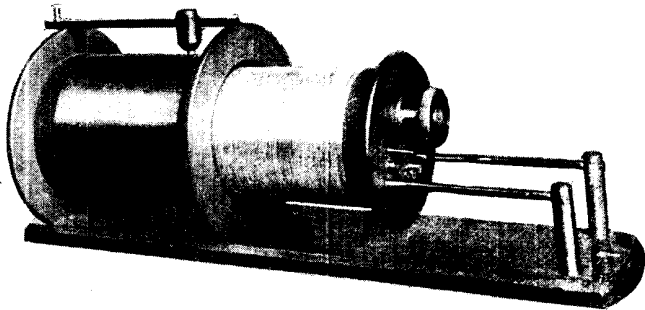

INDUCTIVE LOOSE COUPLER

Fig. 2. Selectivity is the principal advantage of this type of loose-coupler tuning inductance

Courtesy Economic Electric Co., Ltd.

factor regulating the amount of induced current is the number of conductors in the secondary coil. The greater the number of these conducting lines the greater will be the current induced.

The methods of inductive coupling may be divided into two main classes which embrace fixed and variable coupling. High and low-frequency transformers figure largely in the former class, while the

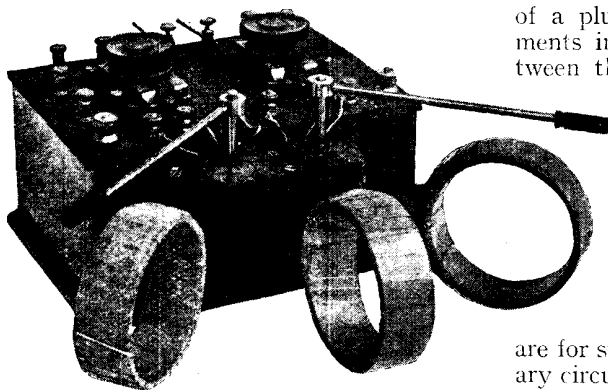

INDUCTIVE COUPLING

Fig. 3. Inductive coupling between aerial primary and secondary coils and between secondary and reaction coil is arranged in this set. The two outside coils are variable in position, and the centre coil is fixed

latter mainly covers methods of aerial tuning for both transmitting and receiving stations.

An exception to this is shown in Fig. 1, which shows a fixed inductive coupling applied to an aerial tuning system. It consists of a secondary coil over the centre of which is wound the primary coil of a few turns of wire. The primary is connected to aerial and earth, the oscillations from which are induced at higher amplitude, but at the same frequency in the secondary coil. This is shunted by a small variable condenser and connected in the grid or detector circuit of the receiving set. This inductive coupling is known as aperiodic, which indicates that it is not tunable to any wave-length. It has good selectivity over a limited wave-length.

Of the variable inductive couplings, Figs. 2 and 3 show two common forms. A loose coupler is illustrated in Fig. 2, where the primary and secondary coils are wound on ebonite tubes, variable coupling being arranged by sliding the secondary coil inside the primary. Both coils are tunable, the primary by means of a slider rod, and the secondary by a seven-stud switch giving tapings of this coil. Intermediate wave-lengths are found with the use of a small variable condenser shunted across the secondary coil. The method of connecting this instrument for aerial tuning is the same as described for the aperiodic coupling shown in Fig. 1.

A very convenient method of inductive coupling is shown in Fig. 3. In this case the inductance coils are mounted by means

of a plug and socket to similar attachments in a coil holder, the coupling between the coils being varied by the extension arms. The illustration shows a double variable coupling, the first being between the primary and secondary coils shown to the right and centre respectively, and the second coupling between the secondary and reaction coil, the latter being shown to the left. The

switches on the top of the panel are for switching a condenser in the primary circuit from series to parallel, and also for cutting the primary circuit right out for tuning-in on the secondary circuit. The coils shown in the illustration may be substituted by duo-lateral or honey-comb coils. Other methods of inductive coupling employ basket coils.

The effect of inductive coupling in an aerial tuning system is to produce a greater selectivity and freedom from interference than is obtained with a direct circuit. This advantage is obtained at the expense of ease of tuning, as it is more difficult to tune two circuits to a desired wave-length than one. For this reason a stand-by switch is often used which cuts out the primary circuit until the secondary circuit has been tuned to the wave-length required. See Anode; Basket Coil; Coil; Magnetism; Reaction; Tuning.

INDUCTIVITY. This is a word occasionally used for the specific inductive capacity or dielectric constant of insulating materials. See Dielectric.

INDUCTOMETER. The inductometer is an instrument for the measurement of self and mutual inductance. Many forms of the instrument have been designed, but the general principle is the employment of two coils—a primary and a secondary—one of which can be moved relatively to the other, its position being read off a scale usually calibrated to give the inductance directly.

Lord Rayleigh used a mutual inductometer formed of two coils, the secondary being of larger diameter than the primary. The two coils are so mounted that the secondary coil is fixed, while the primary can be rotated round a common diameter. When the two coils are at right angles to each other, then the mutual inductance is zero, and when parallel to each other, the mutual inductance is a

maximum. There are, therefore, two positions of maximum inductance and two of zero inductance.

The Campbell form of inductometer consists of two primary coils A, B, mounted with their axes in the same line, as shown in Fig. 2. They are connected in series so that their fields are in the same direction.

The secondary consists of two coils, E, F, connected in series. The coil F is pivoted at a point O, so that it can be moved eccentrically with respect to the axis of A and B, the rotation being measured by a pointer moving over a scale. The coils are wound with stranded and separately insulated wire, so that the mutual inductance between each strand of the primary coil, and each of the strands of the secondary coil will be equal, and these inductances can be added or subtracted by connecting the strands in series, according to the direction of the winding. The range of the instrument can, therefore, be considerably increased by bringing a suitable subdivision of the turns of both primary and secondary turns to terminals.

In the bridge form of inductometer the variable mutual inductance and two non-inductive resistance coils are connected to form three arms of a bridge, the fourth arm including the inductance to be measured. To measure a mutual inductance when the value is less than that of the variable standard, the connexions shown in Fig. 1 are used, where A is the primary of the standard, B is the secondary of the standard, C the primary of the unknown, and D is the secondary of the unknown. The coils B and D are con-

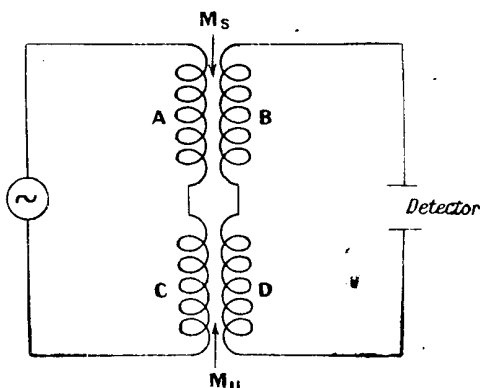

MEASURING MUTUAL INDUCTANCE

Fig. 1. When mutual inductance is less than the standard against which it is being measured the bridge method in this diagram is employed

nected so that their fields oppose each other. A balance is obtained by adjusting the mutual inductance of the standard, and when obtained, the scale reading indicates the value of the unknown mutual inductance.

If the mutual inductance is greater than that of the standard, the connexions shown in Fig. 3 are used, adding a small variable inductance C, or a non-inductive resistance to one of the inductance arms of the bridge.

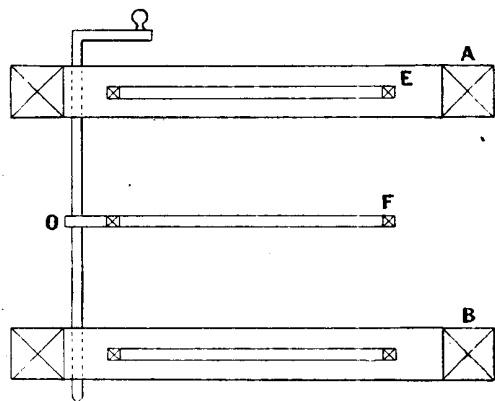

CAMPBELL FORM OF INDUCTOMETER

Fig. 2. Self and mutual induction can be measured by the Campbell form of inductometer represented above

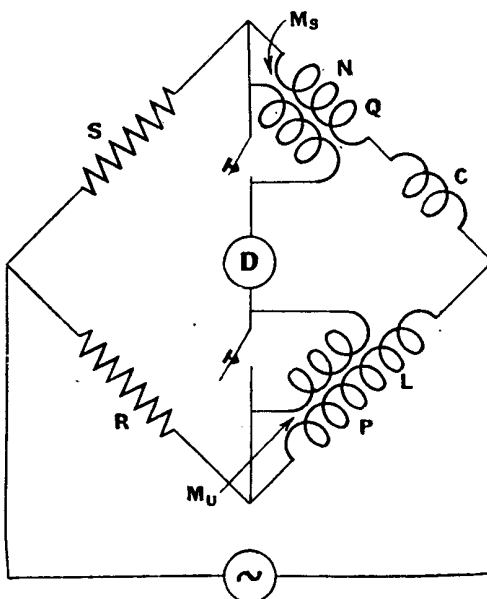

MUTUAL INDUCTANCE MEASURING BRIDGE

Fig. 3. Inductance being greater than the standard against which it is being measured a bridge of this kind can be used

The condition of balance is then

$$PS = RQ$$

$$NS = LR$$

where P, S, Q, N, L and R are the resistances. The secondaries are then connected in series (in opposition) with the telephones, and the variable mutual inductance is adjusted to obtain a balance. Then

$$RM_s = SM_u,$$

M_u being the mutual inductance of the unknown.

The alternating current supply for inductance measurements should, as nearly as possible, conform to a sine curve. One of the test instruments for this purpose is the microphone hummer, which emits a very constant note and a fairly pure wave form. When an audio-frequency note is utilized, the detector can be an ordinary telephone receiver, a balance being indicated when no sound is heard in the telephones.

If audio-frequency buzzers do not give sufficient power, then some form of alternator must be used, and then a vibrating galvanometer must replace the telephones for detecting the balance.

INDUCTOR ALTERNATOR. An alternator in which the armature winding and the field magnet winding are wound on projections inside the stator, while the rotor consists of a drum carrying projections of some magnetic material.

Higher speeds are possible with this type of alternator by using solid steel rotors, instead of the ordinary laminated type. The 100,000 cycle alternator first described by Alexanderson in 1908 was an inductor alternator. The rotor consisted of a steel disk with a thin rim and a thick hub. The edge of the disk was provided with slots milled through the rim, so as to leave spokes of steel between the slots. The slots were filled with a non-magnetic material, as phosphor-bronze, and riveted in place to withstand the high strain when the alternator was running at full speed. The field excitation is provided by coils located concentric with the disk. See Alternator; Dynamo; Frequency Changers; Generator.

INERTIA. That property of a body which tends to keep it in a state of rest, or to resist a change of motion. In electricity there is a very similar property of an electrical circuit, its self-induction or inductance. In a circuit containing an electro-magnet, for example, the inertia

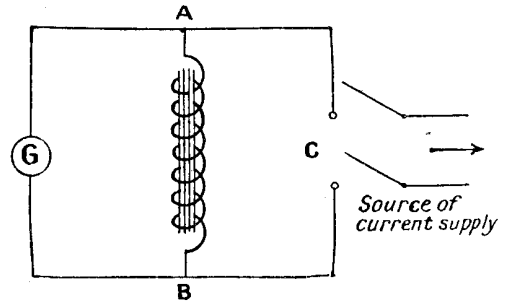

ELECTRICAL INERTIA

An electro-magnet in a circuit demonstrates electrical inertia. Although the switch is out, the current still flows, falling comparatively gradually to zero.

of the electric current is measurable. That is to say, when the current is switched on through such a circuit, it does not immediately reach its maximum, but rises gradually, and when the current is switched off, it does not immediately cease to flow in the circuit, but falls off from its maximum to zero. This is easily shown by the insertion of a galvanometer in the circuit.

The figure shows how the slowing up of the current may be demonstrated. A B is an electro-magnet, C a switch, G a galvanometer. The switch cuts the current off from the source of supply, and at the same time it will be found that the galvanometer continues to be deflected, showing that a current is still flowing. Of course this effect lasts but a very short while, but is similar to the process of slowing up a motor car, for example, when the throttle has been closed. It is the overcoming of the electrical inertia as it were, in the same way as the slowing up of the motor car demonstrates mechanical inertia. See Inductance; Induction; Lag; Lead; Lenz Law; Phase Angle.

INFLUENCE MACHINE. Influence, or electrostatic induction, is a word intended to convey action at a distance, as distinguished by conduction, which implies the conveyance of an effect by actual material conductors.

The presence of an electrically charged body exerts an inductive influence upon any other body in its neighbourhood, although the latter is unconnected in any way by an electrical conductor of current. The familiar experiment of rubbing a stick of sealing-wax with flannel and holding it in the proximity of a scrap of tissue paper or other light material which is not an electrical conductor, is a case in point.

As is well known, the paper will first stand up on end when approached by the sealing-wax, and ultimately will leave the ground and fly to the sealing-wax, where it adheres for some considerable time until the charge has leaked away, when it will fall to the ground, the force of gravity overcoming the force of electrostatic attraction.

It is a condition of success in the foregoing experiment that the body to be attracted must be insulated from earth. otherwise the charge induced upon it will be neutralized by an equal and opposite charge passing to it from earth. The simple laws of magnetism resemble closely those of electrostatic influence in that (1) like charges repel one another, and (2) unlike charges attract. Also (3) induction or influence must precede attraction.

A body is said to be statically charged when its potential is maintained at a higher or lower level than that of its natural surroundings, which can only be done if the body is efficiently insulated so that the excess or shortage of potential is prevented from being neutralized by drawing upon that of the earth. It is customary to represent a positive charge upon a body by a dotted line exterior to its natural outline, and a negative charge by a dotted line internally, as in Fig. 1.

The distribution of a charge can then be conveniently shown by the contours of the dotted line, indicating whether positively or negatively charged, as for instance, the body shown at the right-hand side of Fig. 1. When there is an equal amount of both negative and positive charges on the body their presence is not evident by the fact of being opposed, but on the approach of another charged body this balance becomes upset, and a distribution of the charges is brought into evidence.

This is illustrated by Fig. 2, where the charged body A is supposed to have an excess or positive potential, and to approach a normal uncharged body, B. The

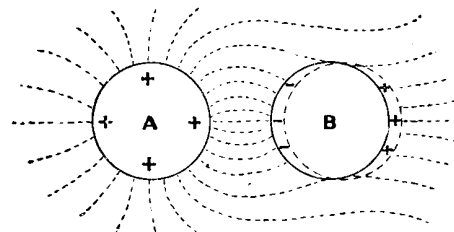

ELECTRIC FIELD DUE TO INFLUENCE

Fig. 2. How a positively charged body affects one which is neutral, redistributing the positive and negative charges on the latter

previously equally balanced charges upon B now redistribute themselves as shown by the dotted lines, and the positive charge is repelled from A, while the negative charge is attracted by A. The electrical stresses set up in the intervening medium may be roughly indicated by the surrounding lines denoting the electric field, somewhat in the manner of the magnetic field surrounding a system of magnets.

If while under the influence of the charge on A a conducting path is established between B and the earth, the repelled or positive portion of the charge will escape to the earth, while the attracted or negative portion of the charge will be held by the presence of the opposite charge on A. The negative charge on B would in such a case be termed "bound" electrification, while the positive charge would be termed "free."

The attractive or repelling forces exerted between two such charges will vary as the strength of the charge and as the square of the distance separating them. If two oppositely charged bodies are approached, the closer they get the more will the space between them become stressed, until a point is reached where the mechanical resistance of the air can no longer withstand the stress and becomes pierced by a spark, accompanied by the familiar crackling noise and flash of light.

The distribution of charge upon an electrified body is not even unless it is perfectly spherical in shape. The more angular the outline the more does the charge "heap up" at the corners, and in the case of points, the density of the charge is so great as to actually dissipate itself by electrifying the air in contact to a sufficient extent to cause a brush discharge, accompanied by a faint blue light and a hissing sound. From this it follows

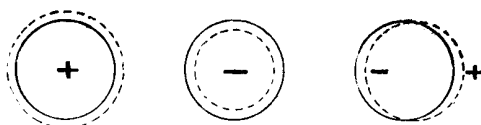

CONVENTIONAL POLAR REPRESENTATION

Fig. 1. Conventional representation of positive and negative charges upon a body is shown in this diagram

that all bodies required to retain a charge of high potential must not only be highly insulated, but must be kept free from all roughness or sharp points (*see* Fig. 3).

One of the earliest examples of influence machines was the Electrophorus (*q.v.*). Although entirely obsolete as a useful piece of apparatus, it retains a considerable historical interest, since the principle of its operation is identical

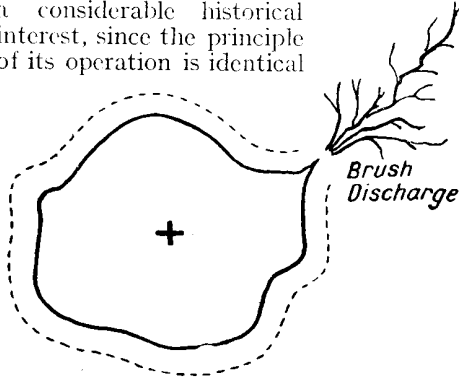

EFFECT OF POINTS IN CHARGED BODIES

Fig. 3. Sharp points in an electrified body tend to dissipate static charges, as illustrated above

with that of the modern influence machine. *See* Inductance; Induction, etc.

INFRA-RED WAVES. Those heat waves which are below the ordinary heat waves of red heat. They are those ether waves which come in between light waves and wireless waves. *See* Ether; Wave.

INKER. An inker is a special type of automatic Morse telegraphic writing machine, which records the received signals upon a paper strip in the form of dots and dashes. This instrument must not be confused with an undulator, which carries out the same operation, but in a different manner, and which has now largely taken the place of the inker on account of its greater speed and reliability.

A typical commercial form of inker is shown in the figure. The large rectangular case, mounted upon the wooden base, contains a clockwork motor, the winding key of which projects from it. This motor drives, through suitable gearing, a drum, over which the paper strip is made to pass. A second drum, which is weighted, presses on top of the paper with the object of eliminating all tendency to slip. After passing over the drum, the paper is made to slide under a smooth brass plate, which takes the thrust of the

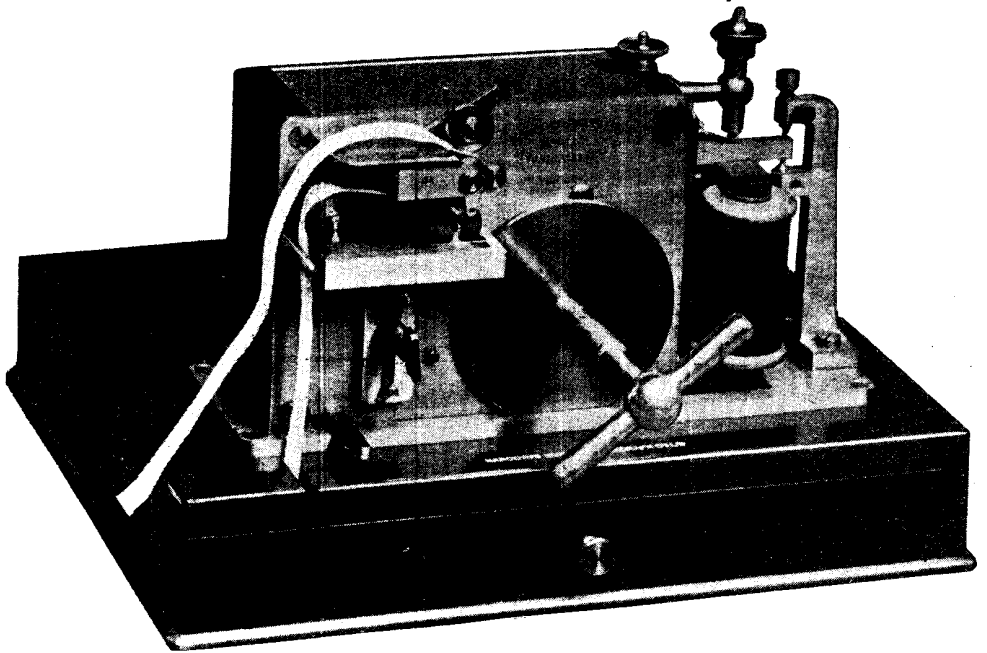

INKER OR AUTOMATIC RECORDING DEVICE

Wireless messages are taken down or recorded automatically by this instrument, which is known as an inker. The record is made in Morse code on a strip of paper driven by a clockwork motor

Courtesy Marconi's Wireless Telegraph Co., Ltd.

inking appliance. The latter is attached by a lever to a kind of Morse tapper situated at the right-hand end of the instrument. The magnets of the tapper are energized by means of the output current of the wireless receiver. Current passing through these magnets causes an armature to be depressed for long or short intervals, according to whether the signal is a dash or a dot. The armature is fixed on the end of the lever, and it is this lever which actuates the inked marker.

It is clear that if the paper is moved at a constant speed past the marker, and if the latter is pressed against the paper in accordance with the received signals, the latter will be recorded accurately upon the strip.

INSULATED EYES. Expression used to describe various patterns of screw eye and screw hook, where the screwed portion and hook or eye are of metal, and the interior lined with a ring of porcelain, ebonite, or other insulating material. A typical example is illustrated, and shows

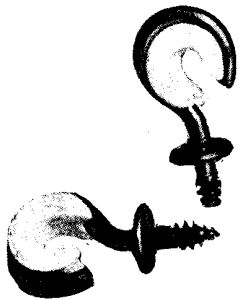

PORCELAIN EYES

Porcelain is used to insulate the interior of these eyes. Ebonite is sometimes used

that a small slot is formed in the eye, and also in the insulated ring, thus enabling the ends connecting the aerial wire or some similar part of the apparatus to be slipped through the notches, and the insulating ring turned partially around so that the conductor bears upon the insulation. The insulating value of such devices is

not high, and they should be sparingly used in wireless work. They are, however, admirable when there is a short cord connecting the insulator on the end of the aerial wire to an insulated eye, as this provides double insulation. In use a hole should be bored with a gimlet or drill, so that the screw eye can enter without hammering or undue pressure or leverage, as the porcelain ring is a fragile article.

INSULATED KNOBS. These are moulded pieces of ebonite or some similar insulating material used for the control knobs of such parts of a wireless set as the condenser, filament rheostat, etc.

The illustration shows views of two types of insulated knob. The upright knob on the left is a small knurled cylinder of ebonite, which may be used at the end of a long brass rod for the control handle of a moving coil holder, or as part of the control handle for a crystal detector.

The circular moulded disk is the standard insulated control knob used for filament resistances. The corrugations on this type of knob allow an absolutely firm

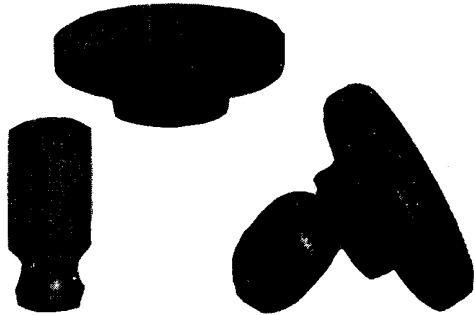

INSULATED KNOBS

Two kinds of knobs are shown: the round flat knobs are used for filament resistances or other rotating devices, the other kind illustrated may be used for control handles

Courtesy Economic Electric Co., Ltd.

grip to be obtained, so that the most delicate movement of the control may be made to find the best position when listening-in. See Condenser ; Crystal Detector ; Filament Resistance, etc.

INSULATED SCREWS. Term often applied to a screw which is insulated in some manner. For example, a screw may be entirely covered with insulating varnish. A better plan, however, is to employ small ebonite bushes. These may either be sunk into the base and the screw screwed into the bush, or in cases where the insulation is required above the surface of the baseboard the insulation may take the form of a bush of ebonite, having

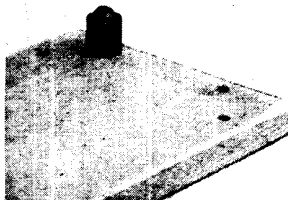

EBONITE-COVERED SCREWS

Screws may be insulated with ebonite, as in the case illustrated. Short lengths of tube, or ebonite bushes, are used for this purpose

a central hole for the passage of the shank of the screw and a larger hole counter-bored to receive the head of the screw, the hole being subsequently filled with special compound or wax, the purpose in either case being to isolate the screw and make it impracticable for it to function as a conductor of electricity.

INSULATED STAPLE. Name applied to a fastening device used for attaching an electrical conductor. It consists of a U-shaped piece of metal, the two



STAPLES WITH FIBRE INSULATION

Electrical conductors, such as flex or bell-wire, may be fastened to their supports by insulated staples. The examples shown are insulated with fibre

ends of which are sharpened to a point. Disposed in the U-shaped portion is a small piece of insulating material, such as fibre or ebonite. In use the conductor, generally an insulated wire, is placed in position and the staple placed over it, with the legs spanning the conductor, and then driven home so as to hold the conductor firmly in position, the insulation preventing any chance of a leakage to earth.

Such fittings are extensively used in electric bell and some lighting circuits, and will be found very handy by the wireless experimenter for fixing conductors to baseboards, to prevent their moving out of place.

INSULATING MATERIALS. Those materials through which electricity will only pass under great electrical pressure. Such materials are sometimes defined as non-conductors of electricity, but this definition is only true within certain limits. It is probably always possible to break down the insulation of any substance by the application of a high enough voltage. But in general it may be stated that an insulating material is one through which the normal currents for which it is designed will not pass. The insulators on telegraph poles, for example, prevent any leakage to the ground, but may easily be broken down if struck directly by lightning.

Insulating materials are really those substances in which the electrons are held tightly in the atoms. Thus, electric conduction currents cannot flow readily in an insulating material because the electrons are unable to move easily from atom to atom. When an electro-motive force is applied to an insulating material the electrons try to get away from the atom, with the result that a strain is set up in the material. If the electro-motive force

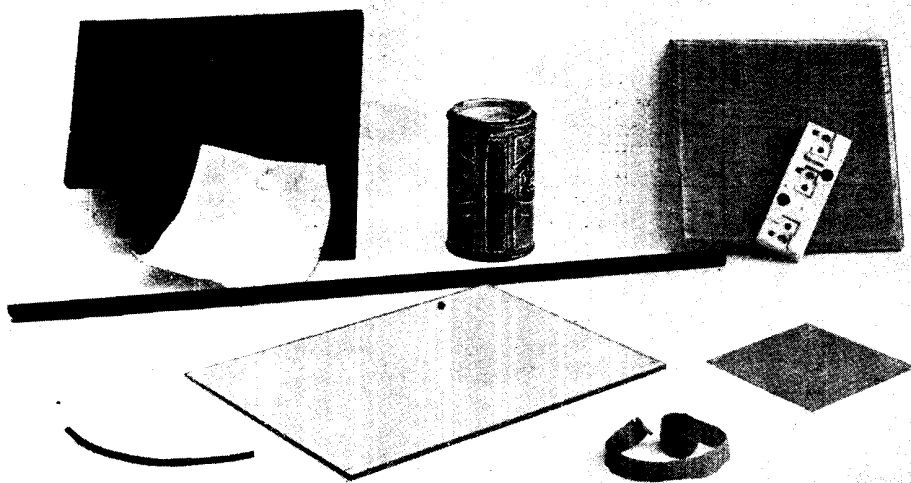

MATERIALS USED FOR INSULATION IN WIRELESS APPARATUS

Common insulating materials are shown in this photograph. Ebonite, mica, glass, wood, porcelain, waxed paper, and insulating tape, are included, and in the construction of wireless sets these materials are constantly brought into use for confining electrical paths to the channels designed for them

is great enough a few electrons may keep on breaking away, as it were, and there is a leakage across the insulator, or, in other words, it is a bad insulator. The perfect insulator would allow no electrons to escape, no matter how high the applied electro-motive force, but such an insulator does not exist.

Among the best insulators are, in the order of their insulating powers, the best insulator coming first: dry air, glass, paraffin wax, amber, jet, mica, ebonite, shellac, indiarubber, guttapercha, resin, sulphur, sealing wax, silk, wool, dry leather, porcelain, oils.

Wood is a partial insulator, but it should be perfectly dry, and it is better to impregnate it with paraffin wax or oil. Paraffin wax is one of the most useful insulating materials for the wireless experimenter, in fact. With it many indifferent insulating materials which are comparatively cheap to buy may be converted into very good insulators at a much less cost than is required to buy good insulating materials. Instead of the expensive ebonite formers for winding inductances, for example, an ordinary cardboard tube, when thoroughly impregnated with paraffin wax, makes a perfect substitute.

Ebonite is another, and perhaps the most useful of all insulating materials for the wireless experimenter. The surface, however, should be well matted, as the highly polished surfaces of some pieces of ebonite which are sold for the sake of their appearance prove very inefficient insulators, and are the cause of much trouble which is often difficult to trace by the amateur.

Porcelain for insulators and insulating bases, ebonite for panels and the insulation of various parts of a set, and for such things as control handles and knobs, silk and cotton for covering wires, rubber for the same purpose as the silk and cotton, rubber insulating tape for binding round the joints of wires, mica for dielectrics in condensers, glass for the same purpose, and paraffin-waxed paper for condensers comprise the most commonly used insulators in wireless, and many of these insulating materials are illustrated in the photograph.

For the further application of many of these insulating materials the reader should consult such articles as Ebonite; Insulated Knobs; Mica; Paraffin Wax;

as well as under the names of such parts that require insulation, as Control Knob; Handle; Panel, etc.

INSULATION. The prevention of the leakage of electric currents. The insulation of all parts of apparatus used in wireless transmission and reception is one of great importance, and one which requires careful attention. In this Encyclopedia the importance of insulation is dealt with in



INSULATING A WOODEN BASEBOARD

How a wooden base board is insulated by inserting it in molten paraffin wax to impregnate it is illustrated in this photograph

many of the constructional articles, and the methods of insulation are described under such headings as Insulator, the various types of insulator and insulating materials, as Ebonite, Mica, Paraffin Wax, etc. Here the subject is dealt with on general lines.

In the case of aerials and aerial masts, these should be thoroughly well insulated. It is a sound principle to over-insulate rather than to under-insulate. Insulators only cost a few pence each, and the addition of one or two insulators in their right positions may make all the difference between good and indifferent reception.

Guy-ropes supporting an aerial mast, for example, should be interrupted by insulators, a point often overlooked by the wireless experimenter. Porcelain, rubber, or electrose moulded insulators

with eyebolts moulded in them will be found the best. It must not be forgotten that insulators in this position have to withstand a big mechanical strain, and such insulators should be chosen with this in mind. All insulators used in wireless for aerial and similar purposes should be examined before being used to see that their surfaces are free from cracks, and types should be chosen for outdoor work which will easily throw off the rain. Any insulator which has a tendency to keep the water on it should be scrapped, as in wet weather the insulation will break down and spoil reception.

Special care is required, both in receiving and transmitting apparatus, where the lead-in wires pass through the walls of the house. There are many types of good lead-in insulator tubes now on the market, and one of these should be employed. Any makeshift method of insulation at this point is found to give trouble in the long run. Alternatively, a heavily insulated wire may be used as a lead-in, but care should be taken to fasten it securely where it enters and leaves the house, as the swaying of the wire will cause it to fray in time. In the case of some aerial masts it may be found advantageous to insulate the mast itself from the ground.

The Importance of Aerial Insulation

The aerial should be well insulated from the mast or the supporting ropes or wires. Two insulators joined together, as shown on page 32 (Fig. 12), should be used in preference to one. It is better to use a corrugated insulator than one with a perfectly level surface. The path along which the electric currents might creep is very largely increased by the corrugations, and, in fact, the length of the surface path is often doubled or trebled by this means. A long insulator will do quite as well, of course, the important point to be aimed at being to provide as long a resistance path as possible.

The insulation of the aerial and the lead-in should be constantly looked after. In spells of bad weather the insulators may easily become dirty, and an accumulation of dirt on the surface of the insulators will lead to faulty transmission or reception. Wherever an insulator is more or less vertical it will be found an excellent plan to protect it against the weather by means of a conical shield which throws off

the rain from the insulator and so prevents leakage. For horizontal insulators, where such a scheme is not practicable, it will be found a good plan to paint the insulators with a bitumastic varnish. By this means the moisture will not form a film over the surface, but will detach itself in separate drops.

Only the Best Insulation is Worth While

Although it has been advised to over-insulate rather than to under-insulate, it must not be forgotten that every indifferent insulator used forms another leakage path for the high-frequency currents, and if the experimenter is sure of his insulators he can use a few in place of many. For example, in the insulation of the aerial wires it might be done in several ways. An insulator might be inserted in each arm of the bridle of the spreader, or each wire may be separately insulated from the spreader, or one or two insulators might be inserted at the end of the halyard. Actually, if a long insulator is used, this last position will be found the best, and only one, or at the most two, insulators need be used instead of the greater number in any other position.

Insulation is as important on the receiving set as it is in the aerial. If the experimenter uses wood for the base of his set he should see that the wood is perfectly dry, and it will be advisable not only to give it a good soaking in paraffin wax, but to set it on four feet of some insulating material. Such feet may be made from good thick rubber, or old pieces of ebonite may be used. The ordinary type of bobbin insulator will be found excellent for the purpose as well, or glass supports. In any case the shiny ebonite should be avoided, as this is a prolific cause of surface leakage, and is worse than no insulation at all.

It will pay the amateur over and over again to insulate all wires he uses on his set. Ready insulated wires may be used, or bare wires covered with some insulated sleeving, as systoflex. This latter method not only looks neater, but it is better from a soldering point of view when making the necessary connexions. Leads to the batteries should always be insulated. If they are not the experimenter will not be very long in getting a short circuit through accidentally crossing two exposed leads. An excellent method of insulation for connecting wires is to run them in grooves



WIRELESS INSULATORS

Fig. 1 (top, centre). Fluted moulded insulator with large shell on its right. Fig. 2 (left, top). Egg insulator, below which is a small shell, with umbrella on its right. Fig. 3 (beneath). Two barrel insulators

Fig. 1, Courtesy Economic Electric Co., Ltd.

cut on the underside of the ebonite panel and then filled in with paraffin wax. This makes an exceedingly effective and neat job, and though a little laborious in the beginning, does away with many unsightly wires.

For the working of highly sensitive sets, as the Flewelling or the Armstrong, it will be found necessary to have long insulated control handles for the condensers, reaction coils, etc. Neglect of this point will cause a great deal of unnecessary howling while the set is being adjusted for reception.—*J. L. Pritchard.*

See Ebonite; Mica, etc.

INSULATOR. Device for confining electric currents to certain specified paths. Insulators are of the utmost importance in electrical machinery and electrical circuits generally, and in wireless circuits, both transmitting and receiving, particularly. A bad or an indifferent insulator will spoil reception entirely, either weakening the signals received or setting up parasitic noises which prevent the voice or music being heard clearly.

There are many types of insulators used in wireless, some of which are described under their particular headings in this

Encyclopedia, and others are illustrated here. Figs. 1 and 2 show some types of insulators which are particularly useful in mast erection and aerial construction.

In Fig. 1 is illustrated the fluted type of moulded insulator with eyes at each end. This kind of insulator is made of various materials and in various shapes. Materials used are porcelain, fibre, ebonite, and ebonite. These insulators are useful for connecting a spreader on to a halyard or to the supporting rope on a mast.

The insulator shown on the right of Fig. 1 is a large-sized porcelain shell insulator, a smaller size being shown below Fig. 2. The large-size insulators are excellent for aerial insulation, and two of them joined together make as good an insulation as the amateur will ever need. Their breakdown voltage is of the order of 30,000, and similar types of insulator are used at high-power stations. The smaller sizes will be found very convenient for use with indoor aeriels, or the well-known egg insulator shown in Fig. 2 may be used. How an egg insulator is wired up for the

bight of a single-wire aerial and lead-in is shown on page 36, and how two single-wire aerials may be joined together and insulated from one another with egg and shell insulators is shown on page 32.

Below Fig. 1 is shown a special form of porcelain insulator with an umbrella-shaped disk which serves to keep the lower part of the insulator dry in wet weather, and also offers a longer resistance path to the high-frequency currents. A similar principle is made use of in the Bradfield insulator (*q.v.*).

In Fig. 3 are shown two types of barrel insulator. These insulators will stand a considerable mechanical strain. They are made of highly glazed porcelain, and a full description of their various sizes and the way they should be used, as well as the fibre barrel insulator, appears under the heading Barrel Insulator on page 199 of this Encyclopedia. See Aerial; Bobbin Insulator; Insulation; Lead-in.

INTEGRATING WATTMETER. An instrument which measures the total amount of energy consumed, and has a recorder fitted which makes a record of its readings in B.O.T. (kilowatt-hour) units. These instruments are fitted in houses and other places where electricity

is consumed for the purpose of registering the energy consumed over any desired period. They are familiarly known as electricity meters.

The photographs, Figs. 1 and 2, are illustrations of a standard meter, as made by Ferranti, Ltd. It consists essentially of a small motor, which drives a recording apparatus giving readings in kilowatt-hours (Board of Trade units).

Its construction will be understood by reference to Fig. 2. This shows the instrument with the cover and recorder removed. Inside the top of the case, which is of cast iron, is placed a coil shunted across the mains. This forms part of the stator of a small alternating current motor. Its design is such that it is very inductive and causes the current in it to lag 90 degrees behind the electromotive force. Underneath this coil, and separated from it by an air-gap, is another coil. The winding in this is very heavy, and it is placed in series with the mains. This coil is designed to have very little inductance, so that the current in this case is very nearly in phase with the line voltage. The combined effect of this arrangement is to produce a rotating flux.

A thin aluminium disk, which is mounted on a spindle, is situated between these two

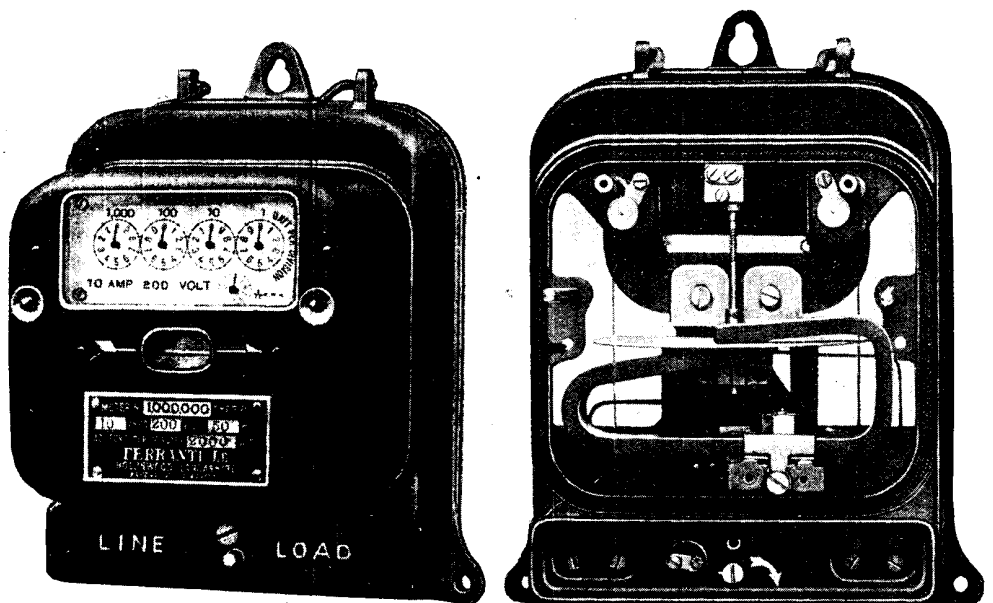

EXTERNAL AND INTERNAL VIEWS OF INTEGRATING WATTMETER

Fig. 1 (left). Energy consumed over any given period can be measured by this instrument, which is familiarly known as an electricity meter. Fig. 2 (right). With the cover of the wattmeter removed, the rotating disk and retarding horseshoe magnet may be seen

Courtesy Ferranti, Ltd.

coils. The magnetic field set up by the latter produces eddy currents within this disk. As a result of the rotating magnetic field and the eddy currents in the disk, the latter is made to rotate.

Means of retarding the rotation of this disk are necessary, however, otherwise it would rotate at too high a speed. This is effected by placing the disk also within the field of a convenient-shaped horseshoe permanent magnet. This magnet is clearly shown in Fig. 2. It will be seen that the poles are flattened at their tips, and that the disk is situated so that the poles come near to its edge.

The disk, therefore, in its motion, cuts the lines of force of the permanent magnet, and thus has a further series of eddy currents induced in it, which results in a retarding torque being exerted.

As the driving torque exerted upon the disk by the shunt and series coils is directly proportional to the energy passing through them, and as the retarding torque resulting from the flux of the permanent magnet is directly proportional to the speed of the disk, it follows that when the speed is constant the two torques must be equal. Therefore, the speed of the disk, providing no allowance is made for frictional losses, must be proportional to the current consumed.

The recorder in the particular instrument illustrated consists of five spindles, upon which pointers are mounted, connected by gearing to the rotor spindle. The arrangement of the gears is such that each successive spindle is geared ten times slower than the first one. Therefore, if the first spindle registers one revolution for one tenth of a kilowatt, the next will register one kilowatt, the next 10 kilowatts, etc. Reference to Fig. 1 will indicate how the spindles appear from the exterior of the case. Behind each pointer is a circular scale having ten divisions. The small scale at the bottom indicates one-tenth of a kilowatt, the first one of the larger scales on the right indicates in single kilowatts. Each successive scale registers a number of kilowatts ten times greater than that of the previous one, the final one being for 1,000 kilowatts.

INTENSIFIER CIRCUIT. Whilst the high-frequency amplifier may be compared to a telescope in its ability to bring distant signals or objects nearer, so may the intensifier, or low-frequency magnifier be compared to a microscope, which will con-

siderably magnify signals or objects which are presented close to it.

Low-frequency magnification should only be resorted to after the signal has already been brought to a good readable strength by means of high-frequency amplification. To attempt to produce loud signals from almost inaudible signals by means of low-frequency magnification is not to be recommended, as the note magnifier will also magnify all other signals, atmospherics and, to some extent, mechanical variations coming to the receiver. In addition it is very difficult to employ many stages of note amplification without bringing in distortion.

Probably the best quality of speech and music is obtainable when using a resistance intensifier.

The resistance intensifier is the easiest form of magnifier to construct, whilst it is very reliable in action. The transformer type of intensifier is, however, more generally in use, and this will therefore be described in its simple and more complex forms before giving a full description of the resistance type.

Fig. 1 represents the simplest form of single note intensifier with transformer coupling, for use with any type of existing receiver.

The terminals A B are the old telephone terminals of the existing receiver. The transformer T_1 should have a primary of moderate impedance, some 2,000 ohms or so, connected to A B, whilst the secondary should be some four or five times this value, depending on the valve which is to be used. V_1 is the valve, having its anode connected to the high-tension battery and its grid to the transformer. The high-tension battery may be from 20 to 50 volts, again

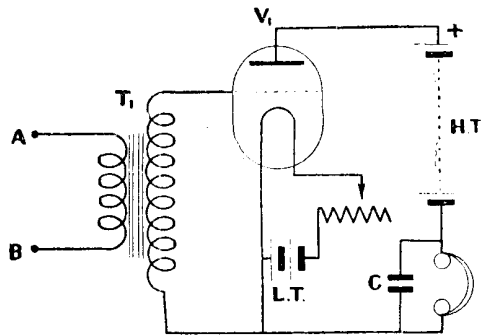

SINGLE NOTE L.F. INTENSIFIER

Fig. 1. A transformer-coupled circuit of a simple form of single note intensifier for use with any type of existing receiver is shown here

depending on the valve. High-resistance telephones should be used, and it is better to shunt these with a small condenser C, say .002 mfd.

Having constructed the single-stage intensifier, it is quite easy to make a two- or three-stage one on the same principle. Fig. 2 illustrates a three-stage intensifier, which is of ample power to work a large

frequency intensifier. One form of circuit used is shown in Fig. 4. It will be noticed that this circuit requires a valve having four electrodes.

The action of the circuit is as follows:—

The incoming signal causes a variation in the potential of the first grid, G_1 , which causes a variable current to flow from the battery B_2 in the circuit B_2, T_2, G_2, F . This

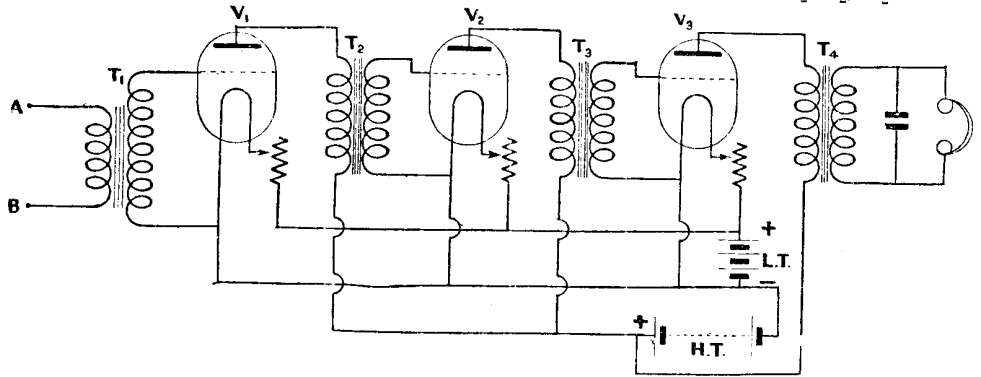

THREE-STAGE TRANSFORMER-COUPLED INTENSIFIER CIRCUIT

Fig. 2. A and B are the terminals, to which are connected the leads from the detector unit, or any existing receiving circuit. The three valves are for intensifying the signals. T_1 may couple a low-resistance loud speaker instead of the headphones in this circuit

loud speaker, even from a crystal set. For ordinary purposes one of these stages may be omitted, or may be so arranged that it can be switched in or out at will.

The transformers T_2 and T_3 should have iron cores, and have a ratio of 1 to 1½, both windings of high resistance, whilst the transformer T_4 should have a ratio of 100 to 1 if low-resistance telephones are to be used, or may be omitted altogether if high-resistance telephones are preferred.

The resistance type of intensifier may be constructed with many more stages of magnification than is used with the transformer type. Fig. 3 illustrates a three-valve one, but it may be extended to seven or eight valves without trouble. The condensers C_1, C_2 are .005 mfd., whilst all resistances, R_1, R_2 , are 1 megohm each. Resistances RG_1 and RG_2 are 2 megohms.

These resistances are more reliable if made of wire, but for two or three stages the paper cartridge type of high resistance will be found satisfactory.

There is still another type of intensifier, which is not only a low-frequency intensifier, for although only one valve is employed this valve and circuit act as a high-frequency amplifier, rectifier, and low-

varying current flowing through the primary winding of T_2 causes a corresponding variation in the potential of A, whilst the current flowing in the circuit F, T_1, T_2, G_2 has to pass through the primary winding of T_1 , in doing which it induces variable potentials in the original grid G_1 , thus causing an intensified current to flow from the battery B_2 through the transformer T_3, T_2, G_2, F . This current induces a current in the secondary of the transformer, which passes through the telephones. See Amplifier; Audio-frequency Amplifier; Dual Amplification; Low-frequency Amplifier.

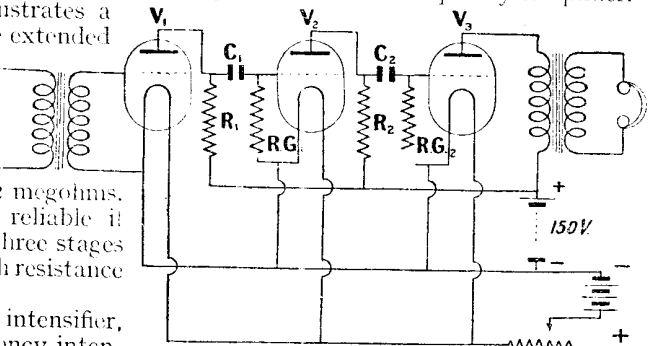

RESISTANCE TYPE OF INTENSIFIER

Fig. 3. Like the circuit in Fig. 2, this is a three-stage intensifier, but instead of transformer coupling between the valves, resistances are used

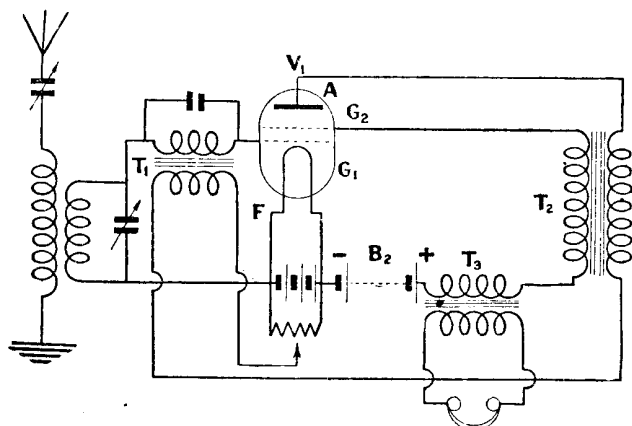

FOUR-ELECTRODE INTENSIFIER CIRCUIT

Fig. 4. Using the same valve as a high-frequency and low-frequency amplifier, as well as a rectifier, this circuit employs a four-electrode valve, such as the Marconi FE1

INTENSIFIER HANDLE. Name occasionally given to the ebonite or other insulated handle on multiple tuners, which regulates the coupling of the intermediate circuit with the aerial and detector circuits.

INTERFERENCE. The reception of wireless signals is liable to interference from two distinct sources: (1) from a transmitting station other than the station required; (2) from atmospheric disturbances.

Interference from either of these sources can be reduced if the ratio of the signal strength to the interference strength can be increased. The methods adopted to increase this ratio do not, however, apply equally to reduce interference from both the above-mentioned sources. In other words, the measures taken to prevent interference from another station, or "jamming," would not necessarily reduce the interference due to X's, and, conversely, the measures adopted to reduce X's would not necessarily reduce jamming.

An oscillatory circuit has a natural period of oscillation and will be resonant to this frequency. At the same time it will oscillate to frequencies nearly the same if the energy supplied to the circuit is sufficiently great. Hence a single-circuit receiver tuned to a definite wave will also respond to a different wave-length if the interfering signals are sufficiently strong.

The use of a coupled circuit receiver enables more selective tuning to be obtained, thereby reducing jamming. Instead of confining the receiver to a coupled circuit, several stages of high-frequency tuning

can be employed, but there are practical limitations to the number of stages, since tuning would become difficult.

Again, it is possible to use several stages of low frequency or note filters after the signal has been rectified. A note filter is a circuit which only oscillates to a very narrow predetermined band of frequencies, and any signal of a frequency outside the filter wave band would not cause the filter circuit to respond. Thus, if a note filter is designed to respond to a frequency of 1,000, then any frequency of about 1 per cent above or below

this would only very slightly affect the filter circuit, and a frequency differing by a greater percentage would not affect the filter.

Great advantage can also be made of directional selection for reducing both jamming and atmospheric disturbances. With this method of reception use is made of two loop aerials and a vertical aerial in conjunction with a radiogoniometer. If the loop aerials alone are used, then a figure of eight is obtained and the search coil of the radiogoniometer has two minimum positions and two maximum positions. If the effect of the vertical aerial is superimposed on the effect of the loop aerials, then a heart-shape reception is obtained. The search coil will now have one maximum position and one minimum position. The search coil is placed to give maximum signals from any particular station, and any station transmitting within the angle defining the minimum of the heart shape, *i.e.* the blind space, will be unheard.

The design of the transmitter and its circuits is also an important feature in the elimination of jamming. If the wave from the transmitter is not a sine curve, then harmonics are transmitted which will cause interference. Again, the frequency of the transmitter must be constant, as any variation will cause receivers tuned to other wave-lengths to be interfered with.

It is now a fairly well-established fact that atmospheric disturbances are largely directional, and therefore the heart-shape method of reception is also useful for reducing this type of interference.

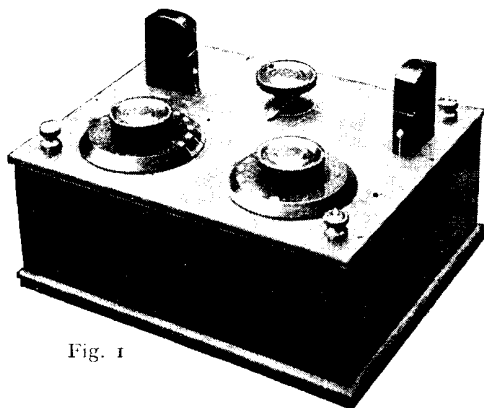

Fig. 1

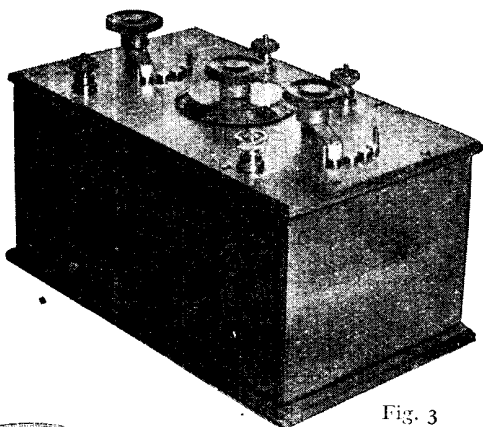

Fig. 3

TWO TYPES OF INTERFERENCE ELIMINATORS

Fig. 1 (left). External view of Peto-Scott apparatus for eliminating undesired waves. Fig. 2 (beneath). Internal view of eliminator in Fig. 1. Fig. 3 (right). Tapped inductances are used in this eliminator made by Radio Instruments, Ltd.

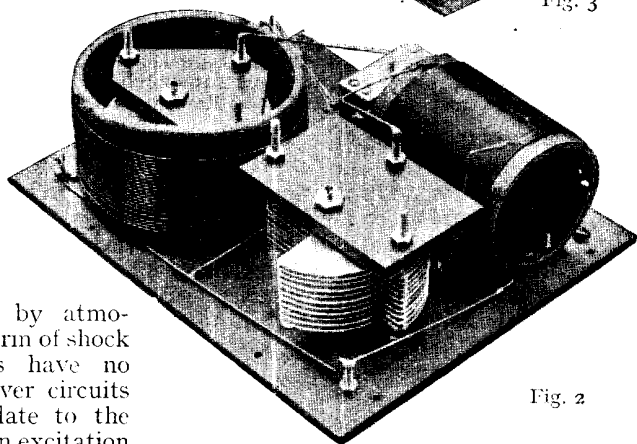

Fig. 2

The interference produced by atmospheric disturbances is in the form of shock excitation, as seemingly X's have no definite frequency. The receiver circuits are therefore caused to oscillate to the shock excitation of the aerial, an excitation which will occur irrespective of the wave-length to which the aerial and its associated circuits are tuned. Nevertheless, the use of high- and low-frequency filter circuits and heart-shape reception will effectively reduce the effect of the atmospheric disturbance. At the same

time the use of several stages of high- and low-frequency filters also reduces the strength of the signals; but this can be increased by high- and low-frequency amplification, thus increasing the ratio of interference to signal strength. See Interference Preventer.

INTERFERENCE ELIMINATORS & HOW TO MAKE THEM

How to Overcome One of the Most Serious Troubles in Wireless Reception

Here is described the best apparatus available for dealing with jamming and interference in broadcast reception, with full instructions for constructing a home-made eliminator illustrated with a photogravure plate. Information from the transmitting point of view is also included. See also *Atmospherics; Directional Wireless; Frame Aerial; Rejector Circuit; Wave-trap*

An interference eliminator is an instrument designed as an addition to any existing receiving set in order to give greater selectivity and freedom from interference caused by stations jamming on near-by wave-lengths. While individual makes of interference eliminator vary slightly in construction and electrical design, they nearly all use the principle of the rejector circuit (*q.v.*) This system

makes use of an additional inductance across aerial and earth, which is separately tuned, usually by means of a variable condenser, to the wave-length of the interfering signal. By this means the jamming signals on the wave-length to which it is tuned are by-passed to earth, and the desired signals should be heard quite free from jamming, but slightly weaker in strength.

Most forms of eliminator employ two circuits, one tunable to signals above the wave-length of the one desired, and the other for signals below it. A typical instrument embodying this principle is that made by Peto-Scott Co., Ltd., illustrated in Figs. 1 and 2. Fig. 1 is an external view of the instrument. In this illustration the two condenser dials, switch knob, and coil plugs, together with their short-circuiting plugs, are shown.

Reference to Fig. 2 will indicate how the by-pass inductances and condensers are arranged. These self-contained inductances are wound for any wave-length up to 500 metres. Above that wave-length it is necessary to plug in honeycomb or other similar coils in order to make the desired change. To effect this, the ebonite-shrouded short-circuiting plugs shown in Fig. 1 must be removed and the coils inserted in their place.

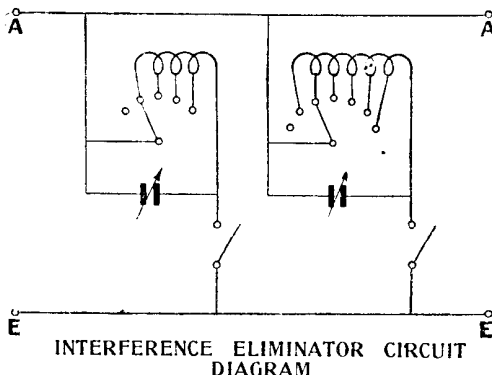

Fig. 4. Two circuits, each made up of aerial, earth, an inductance, and a variable condenser, are wired in the above manner to form the interference eliminator described on page 1195

In order to use the eliminator, the aerial and earth wires are disconnected from the tuner on the receiver and connected to corresponding terminals on the additional instrument. Connexions from the output

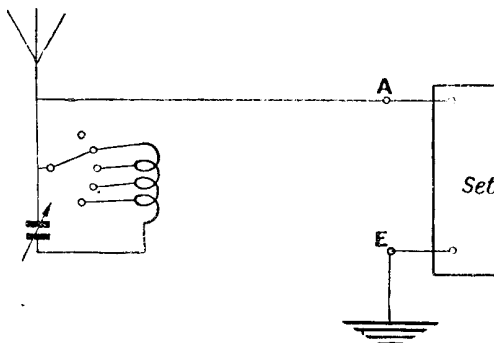

Fig. 5. Instead of the two elements of the amateur-made eliminator shown in Fig. 4, in this case one element only is used as a wave-trap

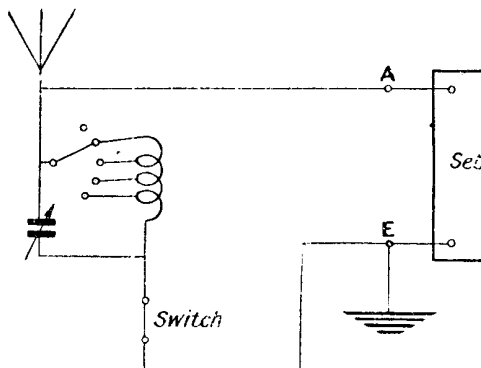

Fig. 6. By the method illustrated in this diagram one element only is used shunted across the receiving set

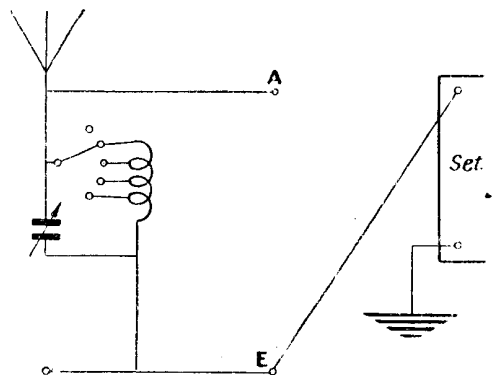

Fig. 7. In this case one element is employed, being in series with the set and wired from the earth terminal of the eliminator to the original aerial terminal of the set

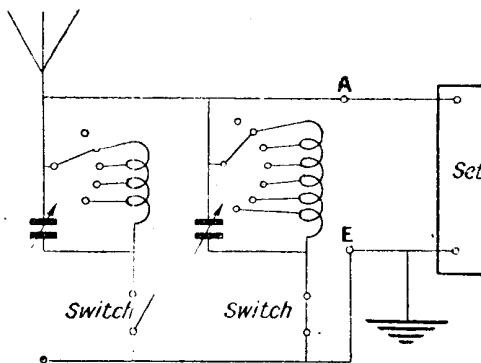
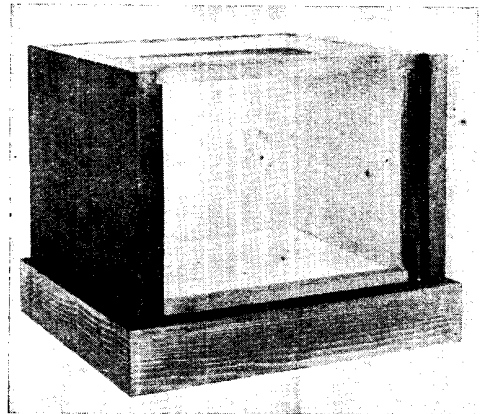
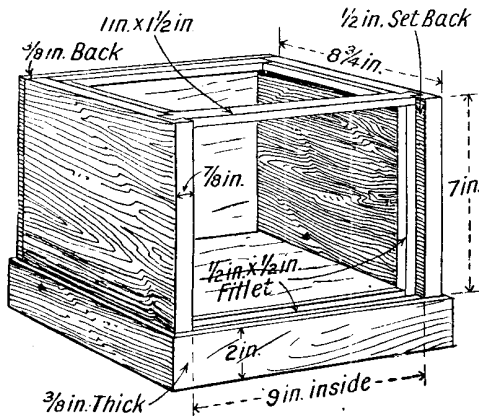

Fig. 8. Two elements are brought into circuit in this arrangement, one element being in shunt and the other in series

ALTERNATIVE METHODS OF WIRING A HOME-MADE INTERFERENCE ELIMINATOR



CASE, SHOWING FILLETS

Fig. 10. At this stage in the building up of the case for the interference eliminator the fillets which hold the panel can be seen

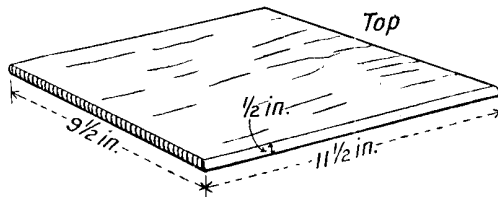

HOW TO MAKE THE CASE FOR THE INTERFERENCE ELIMINATOR

Fig. 9. Dimensions are given to show the amateur making his own interference eliminator how to make the cabinet to house it

terminals on the eliminator to the aerial and earth terminals of the tuner are then made.

Tuning out the jamming signals is quite a simple matter. The switch on the eliminator is set to whatever position is indicated by the nature of the interruptions—*i.e.* whether of higher or lower wave-length than the desired signals—and the interruptions are then tuned to their maximum. Thus two series of wave-lengths are tuned simultaneously: (a) the jamming signals on the eliminator or by-pass circuit, and (b) the desired signals on the tuner. The result of this is to by-pass the jamming signals to earth and allow the other signals to come through free from interruptions but slightly lower in strength.

A somewhat similar instrument by Radio Instruments, Ltd., is illustrated in Fig. 3, on page 1192. Here two tapped inductances are used, theappings being brought out to stud switches on the top of the panel. A different circuit arrangement allows of one tuning condenser only being required, the knob and dial with which it is controlled being shown projecting from the centre of the panel. The method of connecting this instrument to the aerial and earth terminals of the receiver is identical with that for the first eliminator described.

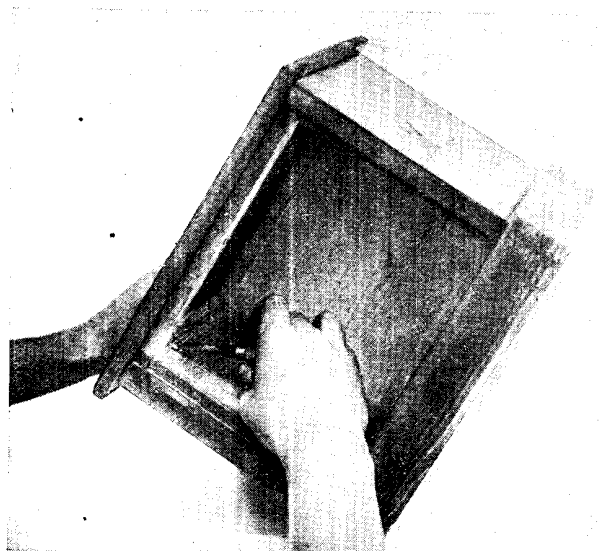

ATTACHING THE CASE TOP

Fig. 11. In this photograph the operator is seen fixing the top to the case with screws from inside through the fillets

It must be understood that no eliminator will relieve jamming on the same wave-length as the signals which are wanted to be heard. In that event the stronger signal will always override the weaker one. Occasionally some relief may be given by careful tuning of reaction and filament and adjustment of high-tension voltage.

How to Make an Interference Eliminator.

The construction of an experimental type of interference eliminator does not present any great difficulties, but in designing it the primary point to bear in mind is the nature of the prevailing interference, as upon this will depend the value of the inductances and condensers which are incorporated in the apparatus. The present design was prepared to deal with spark and Morse interference in an inland district some 30 miles from a broadcasting station, the chief source of interference being in this case in the lower wave-lengths in the region of 200 metres, and also some amount of interference on wave-lengths from 400 to 600 metres.

The set was designed with a view to getting the greatest possible number of

changes of circuit without the necessity of rewiring, this being accomplished by means of two control switches and by suitably connecting the eliminator to the receiving set. The circuit diagram illustrated in Fig. 4 shows the general lay-out, and that the apparatus comprises two separate inductances of different values, a small one with four taps for the lower wave-lengths and a large one with six taps for the higher wave-lengths.

Each of these inductances is tuned by a condenser shunted across it. It should be noted that the first stud of each of the inductances is blank, so that when the contact arm is on this stud, the inductance is cut out of the circuit. The two separate control switches are for the purpose of connecting the shunted inductance and condenser to earth. Some of the possible combinations without alteration to the set or its wiring are shown in Figs. 5, 6, 7, and 8, from which it will be seen that either one or two separate eliminators can be used in series with the aerial, can be shunted across the receiving set, or put in series with the

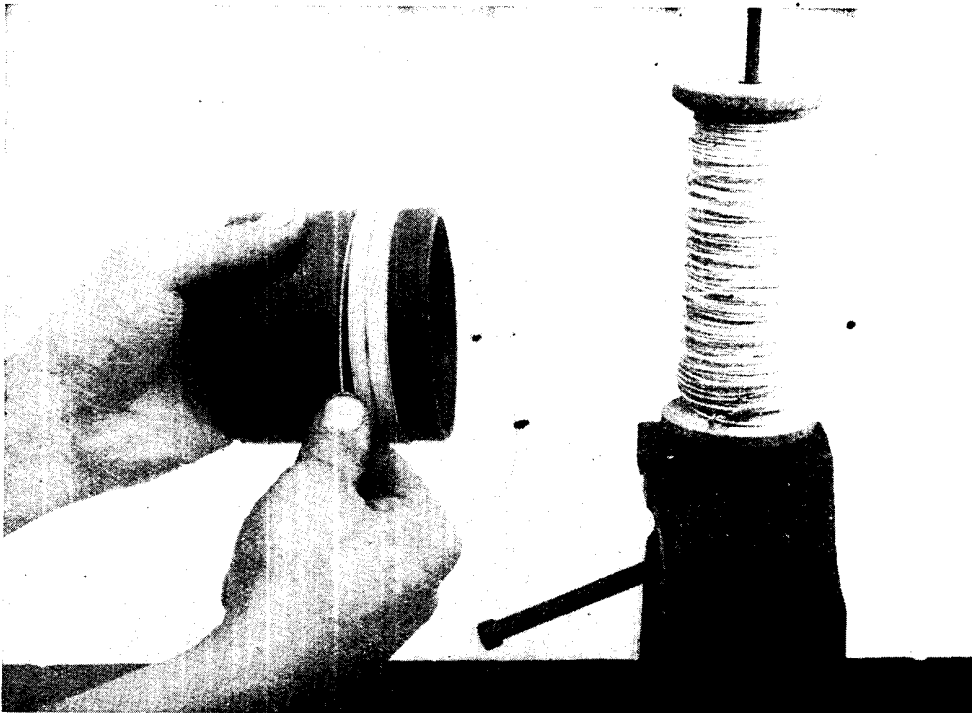

WINDING SMALL INDUCTANCE FOR INTERFERENCE ELIMINATOR

Fig. 22. Lower wave-lengths are received on a smaller inductance coil in the interference eliminator. The operator has fastened a wire spindle in a vice to hold the spool of wire, and is seen winding the coil by hand on an ebonite former. Two separate inductance coils are used in the apparatus

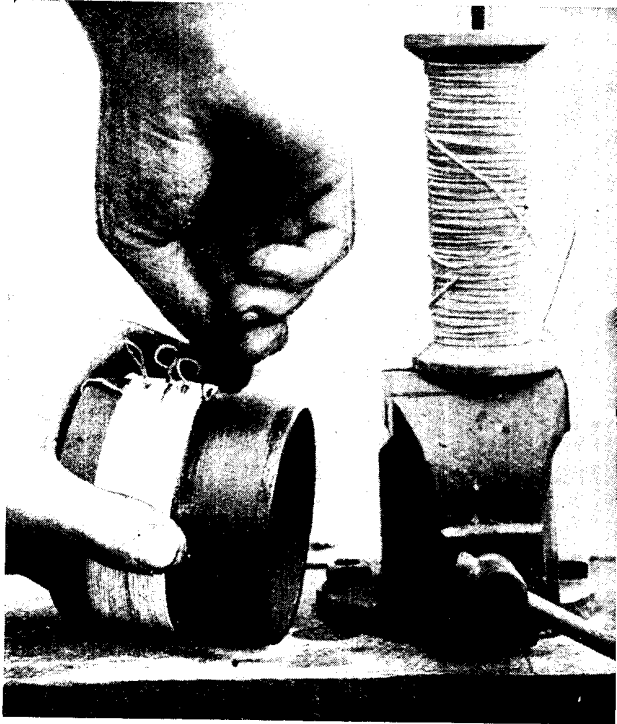

WINDING COIL FOR INTERFERENCE ELIMINATOR

Fig. 23. When the inductance coil for the interference eliminator is wound the wire is twisted into a loop at each specified number of turns to provide a means of contact for the tap wires, which are soldered to the studs of the switch. This photograph shows the coil being wound and a loop being made

aerial lead-in of the aerial side of the receiving set, by connecting the aerial terminal A on the eliminator and taking a connexion from the earth terminal of the eliminator to the aerial terminal of the set and earthing the receiving set in the ordinary way.

This allows a variety of combinations, and from amongst them it is generally possible to tune out any persistent interference by tuning the set or the eliminator to the interfering stations and then retuning the set to the desired station. Some loss in signal strength appears to be accompanied by any combination, but the resulting clarity and quietness of reception is well worth the slight loss in strength.

The dimensions of the case, which may be of ordinary deal, are given in Fig. 9, while Fig. 21 on the special plate shows the eliminator connected to a set. The case is illustrated in Fig. 10, and Fig. 11 shows how the cover is screwed to it by passing the screws through fillets on the top of the case. The

panel, illustrated in Fig. 13 on the plate, is prepared from ebonite to the dimensions given. After the holes have been drilled, the calibration scales for the condensers should be marked out with dividers, as shown in Fig. 24.

The condensers can be ordinary components, preferably of the centre-fixing type, and are attached by means of a lock nut, as shown in Fig. 25. The long ebonite knobs with specially made pointers are then prepared, the moving plates of the condenser set to zero, and the knob secured to the spindle with a set-screw, adjusting it as shown in Fig. 14. The separate control switches are made from strip brass with ebonite handles, and make contact with shouldered studs, as is clearly visible in Fig. 15.

The contact arms for the inductance switches are double-ended, and work over an ebonite quadrant attached to the panel, as in Fig. 18. The inductances should be wound on cardboard or ebonite formers in the manner shown in Fig. 22.

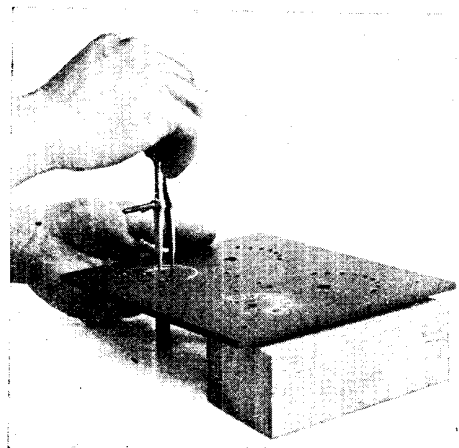

INTERFERENCE ELIMINATOR CONDENSER SCALES

Fig. 24. Special scales are used for the condenser pointers of the interference eliminator, and in this photograph is shown how the panel is marked out for engraving the scales

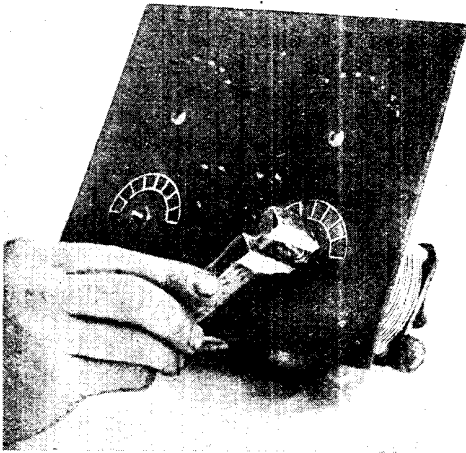

ATTACHING CONDENSERS TO THE PANEL

Fig. 25. The two tuning condensers in the home-made interference eliminator are fixed to the panel by screwed bushes and lock nuts

and tappings taken by twisting loops in the wire, as in Fig. 23. When they are wound, the inductances are mounted on pillars made from screwed rod and secured with lock-nuts, as shown in Fig. 19.

The wiring should be carried out in square tinned copper bus-bar, and is clearly shown in Figs. 16 and 17. The whole of the apparatus is mounted on the back of the panel, and when everything is complete and has been tested it is inserted in the case, as shown in Fig. 20, and secured with four brass screws, the apparatus when completed being shown in Fig. 12.

The eliminator should be located at a distance from the receiving set, or at a considerable angle to it, otherwise there may be some interaction between it and the receiver.

Various values of inductance coils should be tested, as well as different circuit arrangements. This, with careful tuning, will go far to remove troublesome interference.

The constructive details for all this work are described under the respective headings in this Encyclopedia, to which reference should be made. See *Frame Aerial*; *Wave-trap*.

INTERFERENCE PREVENTER. In the general and commercial applications of telegraphy and telephony there is no greater trouble than interference. Yet, in spite of this, the elimination of interference

has been carried to such an extent that it is seldom indeed that it is sufficient to prevent the regular working of commercial and other transmitting wireless stations.

Interference may be either atmospheric, or actual interference of one signal wave with another.

Interference of one signal wave with another will not take place provided that, (1) the two waves are of different wavelength and are separated one from another, or (2) that the receiver employed is capable of sufficiently accurate and selective tuning as to pick up only the desired signal wave.

There are many places in the circuit of the receiver where the unwanted wave may be rejected. It is often possible to prevent the signal from coming much farther than the aerial. For instance, if it is desired to receive from X, one of two distant stations, and not from the other, Y, the receiving station would be equipped with a long horizontal aerial, bent directly away from the station X, which it was desired to receive. This would give an aerial which favoured reception of signals from the

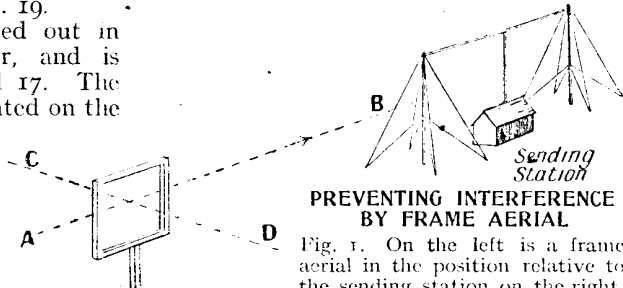

PREVENTING INTERFERENCE BY FRAME AERIAL

Fig. 1. On the left is a frame aerial in the position relative to the sending station on the right, which it occupies to cut out interference

station X and reduced the strength of signals from all other directions.

If Y is nearer to the receiving station than X, then it would be necessary to install a second aerial pointing away from Y. When Y was working it would produce signal currents in both aeriels, and the current so produced in the aerial which has been erected for reception from X would be the unwanted one. It is, however, possible to cancel these unwanted signals by tuning into the same circuit with them the same signals from the balancing aerial and adjusting, so that these signals are of the same strength, but 180° out of phase with them. This can be done, and is often a very good way of preventing interference from a fixed station.

A more convenient method, however, is to employ directional frame aerials for reception. Such aerials in their simple form are constructed as large closed loops, either square, triangular, or circular in shape. They will receive with maximum intensity from a station situated on a line joining the sides of the frame and the distant station (see Fig. 1), whilst they will receive a minimum if the frame is at right angles to the direction from which the signals are coming (see Fig. 2).

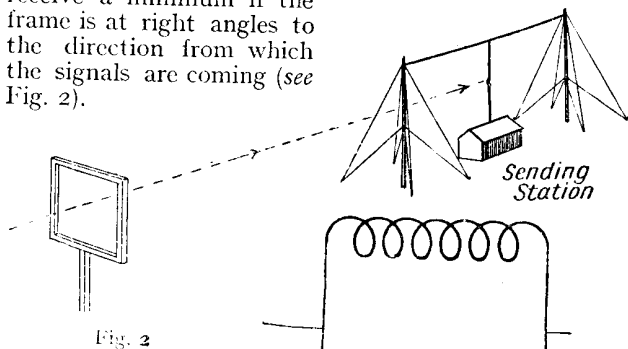

Fig. 2

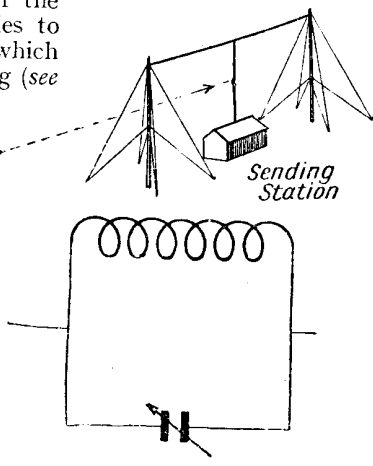

Fig. 3

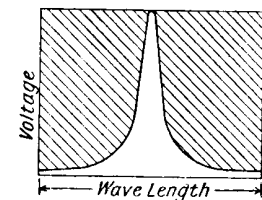

Fig. 4

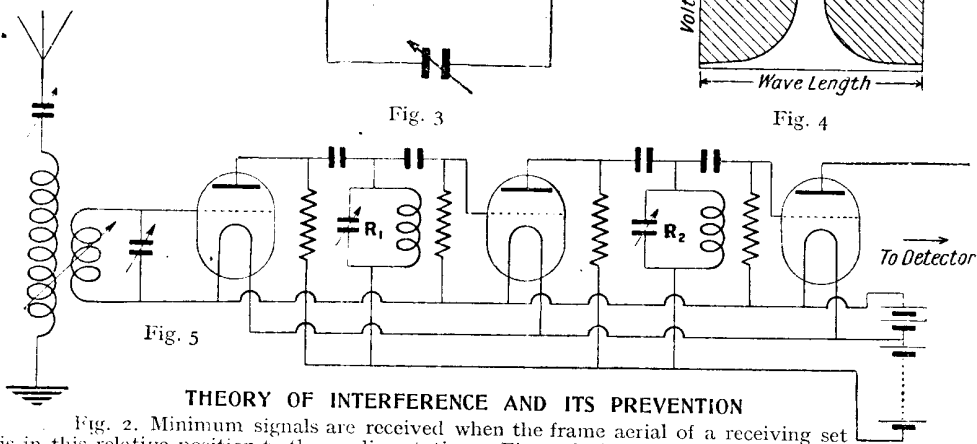

Fig. 5

THEORY OF INTERFERENCE AND ITS PREVENTION

Fig. 2. Minimum signals are received when the frame aerial of a receiving set is in this relative position to the sending station. Fig. 3. This is a simple rejector circuit consisting of an inductance and condenser. Fig. 4. The shaded area shows waves which will be rejected, the white portion shows the wave to be received. Fig. 5. R_1 and R_2 are rejector circuits in a three-valve amplifier circuit

The directional frame aerial described up to the present will respond to signals coming from two directions, that is, from A towards B (Fig. 1), or from B towards A (Fig. 1), whilst it will not respond to any appreciable extent to signals from a direction at right angles to this line.

A further addition is now made to direction-finding stations which is a simple vertical aerial. This, when used in conjunction with the double frame, gives the whole combination "sense," so that instead of responding to signals from two directions, it will now only respond to signals from one direction. By employing efficient directional reception inter-

A still better form of frame for reception consists of two frames at right angles to one another. Both the ends of wire from each frame are taken to two coils mounted at right angles to one another. Within these two coils is a third coil, on a spindle, so that it can readily be turned. This coil is connected to the receiver. This aerial system together with the coil system is known as a direction finder, or radiogoniometer, whilst one aerial of this type is known as the Bellini-Tosi aerial. For further information see under these headings.

ference may be to a very large extent eliminated, but at the same time two stations, X and Y, both situated on the same direct line from the receiving station, may both be sending at the same time.

If this is the case it will generally happen that one station is slightly stronger than the other. If this is so, either one receiver having a split circuit may be employed, or, alternatively, two separate receivers may be employed, the final signals from both receivers being taken to a three-winding transformer which has the coupling of each winding adjustable. The telephones are

connected to the centre winding, and one receiver to each of the other windings. The signals are then opposed, so that they tend to cancel one another. As, however, they are not of the same strength some of the stronger signals will still be left after the weaker ones have been eliminated. This remainder of the signals may then be passed through an intensifier to bring it up to good readable strength.

There is still another very useful way of preventing interference, which is by employing a rejector circuit. A rejector consists of (Fig. 3) an inductance and a condenser. If the inductance is made so that it has a very low resistance, and of such a value that only a very small condenser has to be used to bring the circuit into tune with the wave which it is desired to receive, then the tuning of the circuit (Fig. 3) will be sharp, and it will respond readily to waves of that wavelength, but will offer a high impedance to waves of any other wave-length.

It will therefore be seen that the inclusion of one or more rejector circuits between the aerial and the rectifier will do much to prevent interference from unwanted stations.

If this circuit is included in a resistance amplifier, it may cut down successively by stages almost all unwanted signals.

Such a circuit is shown in Fig. 5, where R_1 and R_2 are the rejector circuits.--*R. H. White.*

INTERMEDIATE CIRCUIT. This is the name given to the circuit of a multiple tuner consisting of two statically coupled closed oscillatory circuits, by means of which selectivity of the detector circuit is increased and the coupling with the aerial circuit is more easily varied. The figure shows the intermediate circuit of a multiple tuner, and it will be noticed that it consists of two in-

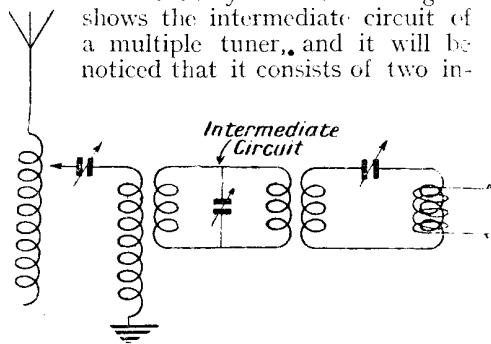

MULTIPLE TUNER INTERMEDIATE CIRCUIT

Interference may be eliminated by an intermediate circuit of a multiple tuner, as shown in the above diagram

ductance coils shunted by a variable condenser. This intermediate closed circuit acts as an interference eliminator. One coil acts secondary to the primary of the aerial circuit, and the other as primary to the secondary coil of the detector circuit. See Multiple Tuner.

INTERMITTENT CURRENT. Name given to any current which is being constantly interrupted, *i.e.* which flows intermittently. The current generated by a D.C. dynamo is a form of intermittent current. See Current; Dynamo.

INTERNATIONAL CODE. Also known as the Continental code, this is a dot and dash code which is now universally used in wireless in place of the ordinary Morse code. The International code was adopted on July 1, 1913. The chief distinction between the Morse code and the International code is the elimination of spaced letters in the latter code. In the International code there is a maximum of four elements to any one letter, and only one length of dash is used. The time occupied by a dash should be equal to that occupied by three dots. The time occupied by the interval between two elements of one letter or other symbol should be equal to the time occupied by one dot. The interval between two letters in a word should be equal to the time taken to send three dots, and the interval between two words should be equal to the time occupied in sending five dots. These time intervals are, of course, independent of the speed of transmission. The following is the International code.

SYMBOLS	CODE	SYMBOL	CODE
A ..	.-	T ..	-
B ..	-...-	U--
C ..	-.-.-	V-
D ..	-.-.	W ..	-.--
E	X ..	-.--
F-.-	Y--
G--	Z ..	--..
H	1 ..	.-.-.-
I	2-.-.-
J ..	.-.-.-	3-.-
K ..	.-.-	4-
L ..	.-.-.	5
M ..	--	6 ..	.-.-.-
N ..	-.	7 ..	.-.-.-
O ..	---	8 ..	.-.-.-
P ..	.-.-	9 ..	.-.-.-
Q ..	.-.-	0 ..	.-.-.-
R ..	.-.-	.	.-.-.-
S-	?	.-.-.-

Under the heading Abbreviations and Symbols will be found a number of the dot and dash signs used for quick transmission in this code. See Morse Code; Omnigraph.

INTERNATIONAL UNITS. These are the practical electrical units which were agreed upon internationally at an electrical congress held in London in 1908. At this congress the ohm, ampere, volt, etc., were defined as follows:—

The international ohm is the resistance offered to an unvarying current of electricity by a column of mercury at the temperature of melting ice, having a mass of 14.4521 grammes and a constant cross-section and a length of 106.3 centimetres.

The international ampere is the unvarying current which, when passed through a neutral solution of silver nitrate, deposits silver at the rate of 0.001118 of a gramme per second.

The international volt is that electro-motive force which, when steadily applied to a conductor having a resistance of one international ohm, creates in it a current of one international ampere.

The international coulomb is the quantity of current transferred in one second by a current equal to the international ampere.

The international farad is the capacity of a conductor which is charged to a potential of one international volt by imparting to it a quantity of one international coulomb.

The international henry is the inductance of a circuit in which an induced electro-motive force of one international volt is created when the current in it varies at the rate of one international ampere per second.

The international joule is the work done between two points in a circuit in which there is a current of one international ampere, and between the ends of which there is a difference of potential of one international volt. See under names of various units; C.G.S.; Units.

INTERPOLES. Small auxiliary poles which are placed midway between the main poles of a dynamo. They are wound in series with the armature, and have the same polarity as the main poles next ahead of them in the direction of rotation. In a motor they are wound in the same way, but are of the same polarity as the main poles next behind them.

In the figure N and S are the main poles, n , s the interpoles. The interpole flux opposes that of the armature current. The interpoles s , n induce polarity n_1 , s_1 , in the armature and neutralize the induced

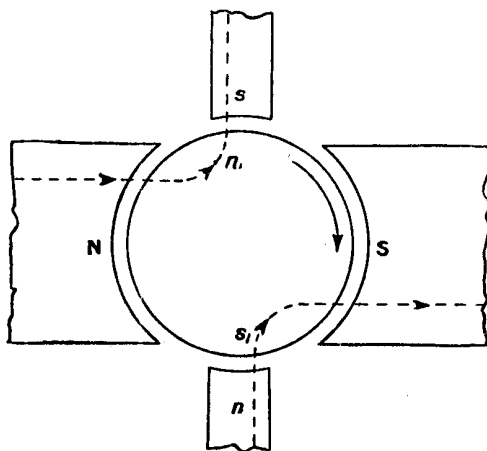

INTERPOLES OF A DYNAMO

Between the two main poles of a dynamo are placed interpoles, or auxiliary poles, which are wound in series with the armature

polarity that the armature current tends to set up. The arrows in the figure show the direction of rotation and the added flux.

Interpoles are also used to correct the sparking defect. The armature coils, during their short-circuited period under the brushes, are influenced by the interpoles, and have induced in them the necessary amount of electro-motive force in the reverse direction to stamp out the current and electro-motive force of self-induction before the coils leave the brushes.

INTERRUPTED CONTINUOUS WAVES. The term interrupted continuous waves has been applied to that method of signalling in which the waves are modulated at a constant low frequency. Strictly speaking, an interrupted continuous wave is used when the aerial system of the transmitter is energized for short and long periods corresponding to the Morse code and a wave of unvarying amplitude is transmitted. This, of course, is ordinary continuous wave signalling and necessitates the use of a heterodyne receiver.

The term has, however, come into general use to denote the superimposing of a low-frequency note on the continuous wave oscillations to act as a "carrier" wave, the amplitude of the continuous oscillations being periodically varied at the low frequency.

Under these conditions the continuous wave oscillations are suitable for receiving without the aid of a heterodyne receiver.

There are several methods by which the continuous wave oscillations can be modulated by a low-frequency note (1) a high-tension direct current usually supplied to the plate of the valve by the alternating E.M.F. supplied by the transformer. When the plate of the valve is at a positive potential with respect to the filament, high-frequency oscillations are set up in the aerial. During the next half-cycle the plate potential becomes negative with respect to the filament and the aerial oscillations decrease. The oscillations therefore cause to a series of oscillations the amplitude of which increases and decreases at the alternator frequency, producing a succession of tonic trains. Fig. 2 shows the alternating voltage applied to

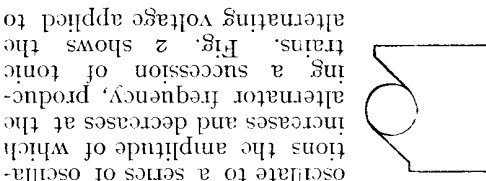

Fig. 2

INTERMITTED CONTINUOUS WAVES

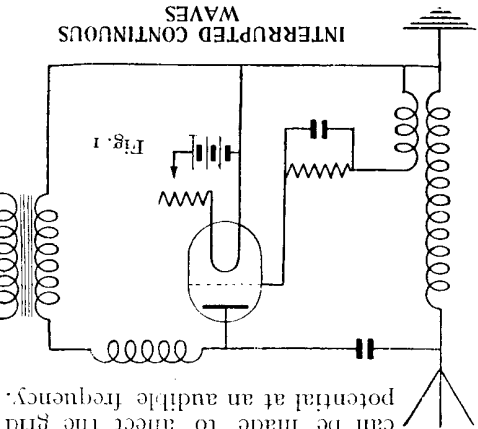
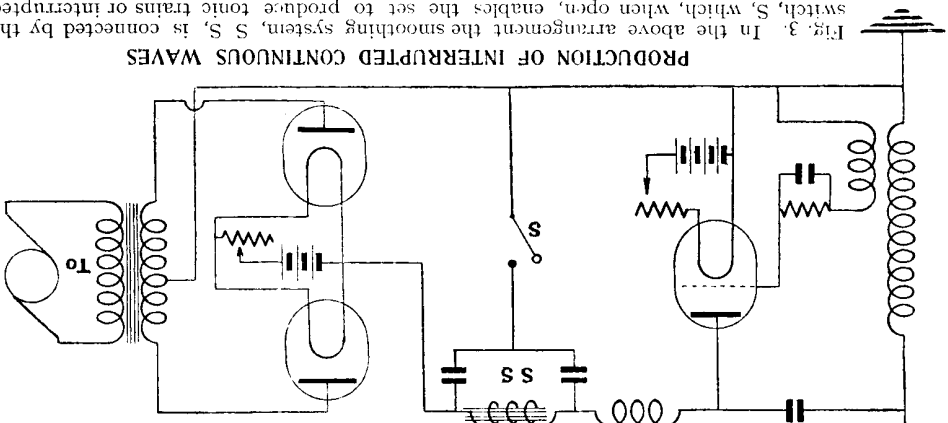

Fig. 1 (above). Direct current usually supplied through the transformer. Fig. 2 (right). Relation of alternating voltage to anode and H.F. oscillations in aerial shown by curves

(1) When a steady voltage is applied to the plate of an oscillating valve high-frequency oscillations of constant amplitude are set up in the aerial. If an alternating voltage is applied to the plate circuit the amplitude of high-frequency oscillations will vary at a frequency equal to that of the alternating E.M.F.

Fig. 1 is a simplified diagram of connections showing how a

(2) The method of producing interrupted continuous waves by disconnecting the smoothing system is shown in Fig. 3. The voltage applied to the plate of the valve, instead of being steady, as is the case when the smoothing system is connected in circuit, would vary in accordance with the voltage curve impressed on the



PRODUCTION OF INTERRUPTED CONTINUOUS WAVES

Fig. 3. In the above arrangement the smoothing system, S S, is connected by the switch, S, which, when open, enables the set to produce tonic trains or interrupted C.W. With the switch closed continuous waves are generated

transformer by the alternator. It should be noted, however, that if two rectifiers are used the frequency of the pulsations applied to the plate is double the alternator frequency, and therefore the tonic train note is twice the alternator frequency. Fig. 4 shows the pulsating E.M.F. applied to the plate and the oscillations set up in the aerial circuit.

(3) The method of generating interrupted continuous waves by means of a buzzer connected in the grid circuit of a valve is particularly useful for small sets up to about half a kilowatt. The usual way is to connect a small buzzer across a transformer, the second winding of which is connected in the grid circuit. The buzzer

transmitter generally used for continuous wave signalling can be employed.

For continuous wave signalling the transmitting key generally breaks the high-tension feed circuit or the grid circuit, or in larger sets both of these circuits. Therefore the same transmitting key can be used for interrupted wave signalling.

If two rectifiers are used, the frequency of the train is twice the alternator frequency, and if this frequency be 500, a very usual one, the train frequency of 1,000 produced in the telephone receivers is a distinctive one, and is capable of being read through a certain amount of interference.

The method of interrupting the grid

circuit by a buzzer is useful in those cases where only one rectifier is used and the frequency of the alternator is low. It is not advantageous to use a note of below 500 for receiving, hence if the alternator frequency is below this value it is better to use a buzzer giving a note higher than this. The frequency of the note produced by the buzzer should be of as high an order as possible, as a

high-pitched note is more readily singled out from any interference than one of a low pitch. The design of the buzzer is therefore a matter of considerable importance, and it should be as light as possible consistent with mechanical strength and continuity of action.

A variation is to employ in the grid circuit a buzzer wheel or motor buzzer, which by means of separate contacts and a brush gear controls the aerial oscillations. The tonic train thus has a frequency dependent on the speed of revolution of the buzzer wheel. See Continuous Wave.

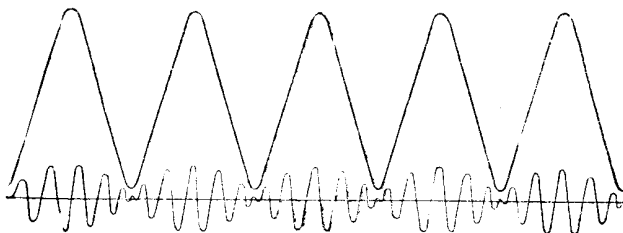

TONIC TRAINS PRODUCED WITHOUT SMOOTHING SYSTEM

Fig. 4. When the smoothing system employed in the circuit in Fig. 3 is disconnected, tonic trains as represented above are produced, which shows in larger curves the pulsating E.M.F. in anode circuit and oscillations in aerial

is connected through a transmitting key to an accumulator.

A simplified diagram of connexions is shown in Fig. 5.

The action of the buzzer is rapidly to make and break at a constant frequency the voltage across the primary of the transformer. This causes an alternating E.M.F. at the secondary terminals, thus causing the grid to be alternately at a positive and negative potential with respect to the filament. The valve is, therefore, conductive during the positive half-cycles and sets up oscillations in the aerial. During the negative half-cycles these oscillations are damped out, thereby causing a sequence of wave trains of a frequency equal to the note of the buzzer.

The method of producing interrupted waves by the use of the alternator frequency when two rectifying valves are in use is probably the most common. This method has the advantage that the

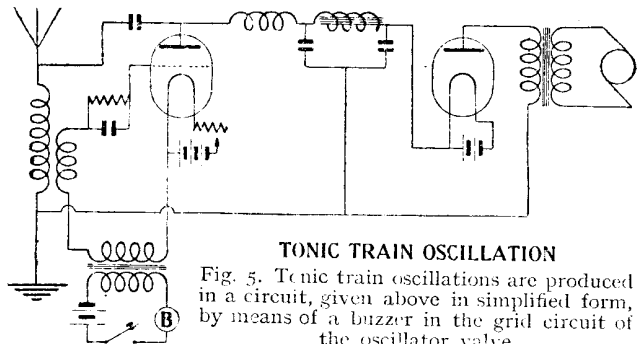

TONIC TRAIN OSCILLATION
Fig. 5. Tonic train oscillations are produced in a circuit, given above in simplified form, by means of a buzzer in the grid circuit of the oscillator valve

INTERRUPTERS: MAKE & BREAK MECHANISMS

Theory and Practice of an Important Accessory in the Transmitter

The interrupter is of considerable importance in wireless work ; as a periodic switch it is used to energize oscillating circuits in spark telegraphy and similar forms of radio-communication. Such headings as Hammer Break ; Quenched Spark ; and Rotary Spark Gap should also be consulted. See also Buzzer

The usual function of an interrupter may be said to be that of an automatic periodic switch which opens and closes a circuit in regular succession. Thus the buzzer, whether of the attracted-armature or motor-driven type, the chopper, or the coil interrupter in one or other of its various forms, all come under the same designation.

The buzzer (*q.v.*) is used to raise a condenser to its discharging voltage in the manner shown by Fig. 1. Here the "in-

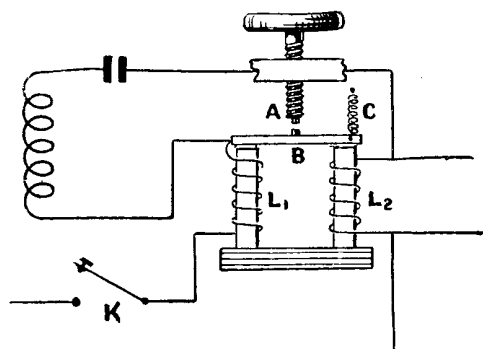

BUZZER-TYPE INTERRUPTER

Fig. 1. Mechanism of an interrupter is shown in this diagram. The condenser is raised to its discharging voltage by the buzzer

errupter" part of the mechanism consists of a fixed platinum-tipped contact A, and the vibrating contact B with a similar platinum contact point, B forming the armature to the pair of electro-magnet coils below, L_1 and L_2 . When at rest B is held in contact with A by a small spring C. The circuit through the magnets is made by means of key K, but directly they are energized the armature is attracted downwards, and therefore interrupts the current. The magnets at once become de-energized, and the spring C returns armature B into contact with A. This re-establishes the circuit once more, and the same cycle of operations is repeated until the key K is opened. The remaining part of the circuit is arranged to energize a transmitting oscillator, and is referred to elsewhere, as the interrupter action alone is here considered.

A more effective way of energizing an oscillating circuit than the attracted-armature-type buzzer just referred to is to employ the motor-driven type illustrated in Fig. 2. This also goes by the name of a chopper, and "chopped D.C." current may be used to energize the primary of a spark coil or static transformer in much the same way that interrupted direct current or alternating current would be used.

The motor in Fig. 2 has its speed controlled by a variable rheostat, and the rate of interruptions or "chops" is under complete control. The two brushes are made adjustable as regards their angular spacing apart, so that the duration of each contact can to a certain extent be modified as well, irrespective of the speed of the disk. The disk consists of metal, with inserted sectors of insulating material ; when both brushes come upon a metal sector contact is established, and when one or both are upon the insulating material sectors, contact is, of course, interrupted.

Another kind of interrupter, such as would be used with a spark coil, is given in Fig. 3. This is known as the "hammer-head" interrupter or break, and at one time was almost universally employed on all induction coils. Varieties of this type are still in exclusive use for the small ignition coils employed with internal combustion engines. The principle on which this interrupter acts can be gathered from reference to the diagram, Fig. 3. The primary

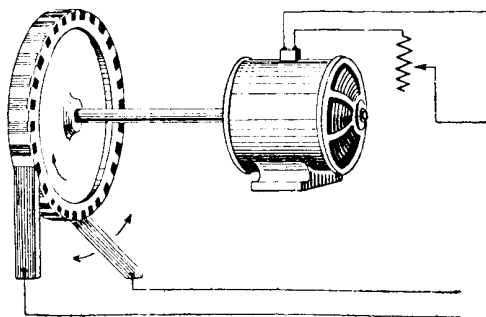

CHOPPER-TYPE INTERRUPTER

Fig. 2. Direct current may be used in the motor-driven chopper-type interrupter illustrated above

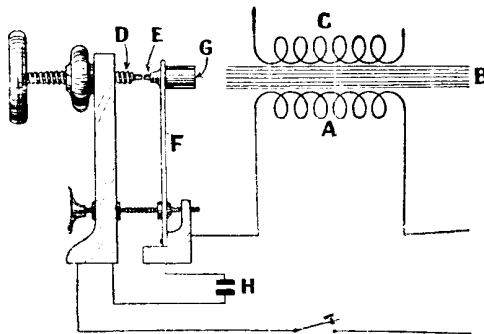

HAMMER INTERRUPTER

Fig. 3. Reference to the above diagram shows the action of this type of interrupter

winding of the coil is represented at A, the iron core at B, and the secondary winding at C. In series with the primary are the two contact points, which are usually made of platinum or iridio-platinum, this being the only material which will stand the great heat without oxidation, and that will also resist the hammering action of the interrupter when at work. To economize cost steel rivets are generally employed, with iridio-platinum faces electrically welded on.

Normally the two contact points D and E are held together by the tension of the flat spring F, but as soon as the primary current is switched on the core B is magnetized and draws towards it the iron hammer head G. This automatically interrupts the primary current, demagnetizes the iron core, and releases G, which flies back to its original position. In doing so it re-establishes connexion with the primary, and repeats the sequence of oscillations, the rapidity of the interruptions being governed by the natural period of oscillation of the weighted spring F. The condenser H is placed in parallel with the interrupter points D and E. It helps to reduce the inductive spark which appears on interrupting the primary circuit, and also helps to demagnetize the iron core quickly.

The function of an interrupter is not only to close and open the primary circuit in regular and rapid succession, but it should keep the primary circuit closed just long enough to allow the iron core to reach its maximum saturation point; the break must then be as rapid as possible, since any delay after this instant merely leads to extra primary current being consumed without any compensating gain in the

energy of the secondary discharge. Also the break period must continue for a sufficient interval to allow the iron core to become completely demagnetized before closing circuit again. The more or less perfect manner in which these conditions are fulfilled influences the intensity of the secondary discharges which can be reached with various types of interrupters.

Hammer-type interrupters have been superseded to a great extent on account of their relatively low efficiency, but they still hold a place in certain equipment where extreme simplicity of operation is desirable. The perfect interrupter must fulfil certain requirements; not only must the contact period be adjusted to suit the time-constant of the circuit, but the primary circuit must be broken cleanly and quickly, so that the flux surrounding both primary and secondary windings may collapse with the utmost rapidity in order to get the greatest inductive effect. The time-constant of the secondary must also be sufficiently low. Considering the importance of these effects, it is useful to attempt an analysis of the actions which occur during the period of "make" and "break" in an interrupter.

Imagine the supply of continuous current to be first closed in the primary circuit of any spark coil, that is the condition of a constant electro-motive force impressed on an inductive circuit; the resultant current does not rise to the value predicted by the circuit resistance alone until an appreciable interval of time after first contact is established. That is to say, that although the inductance of the primary circuit does not affect the final value of current which flows, it does affect the interval of time necessary to establish the full flow. This interval of time depends upon the ratio of the inductance to the resistance of the circuit, and the value of the current is expressed at any time after closing the circuit by the equation

$$i = \frac{E}{R} \left(1 - e^{-\frac{Rt}{L}} \right)$$

in which i = the current in amperes at time t after closing the circuit, E is the electro-motive force of the battery, R the total resistance of the circuit, including that of the battery, in ohms, L the coefficient of self-induction of the circuit in henries, and e is the base of natural logarithms, namely, 2.718. If a circuit has a very large value of inductance the rise of current may be so slow that it can be even observed

by means of an ammeter. When the time which elapsed after first closing the switch is equal to the value $L \div R$, the current will have risen to $(1 - 1/e)$ of its final value, or to about 63 per cent of that value. The time taken by the current to reach this fraction of its final value is called the time-constant of the circuit.

This gradual rise of current in the primary of the spark coil may be represented by curve *a* in Fig. 4. The magnetic flux in the core will, ignoring hysteric lag, which is usually very small, follow along practically identical lines, indicated by curve *b*, Fig. 4. Since both primary and secondary windings surround the same iron core, an electro-motive force will be induced in both; in the case of the primary this is the counter electro-motive force of self-induction; in the case of the secondary it will be simply an induced electro-motive force, and is equal to

$$N_s \frac{d\phi}{dt}$$

where N_s is the number of secondary turns and ϕ the magnetic flux. The curve *c* in this figure indicates the secondary induced electro-motive force. At the instant of first contact in the primary circuit the changing flux in the iron core must be just sufficient to balance the impressed battery volts. At this instant, therefore

$$\frac{d\phi}{dt} = \frac{E \times 10^8}{N_p}$$

E being the impressed voltage and N_p being the number of turns in the primary winding. If there were no magnetic leakage between the primary and secondary windings the induced secondary voltage would be equal to

$$\frac{N_s}{10^8} \times \frac{d\phi}{dt} \text{ that is, to } E \frac{N_s}{N_p}$$

Hence, at the instant of "make" the induced secondary voltage is so low as to be practically negligible compared with the voltage obtained at the instant of "break."

When the primary circuit is broken at the interrupter contacts a high electro-motive force will be induced in each winding, the relative values in the two being determined by the ratio of turns in each. The counter electro-motive force due to self-induction will tend to maintain a primary current across the gap on separating the interrupter contacts, and if permitted to do this the heating effect of the

arc is not only very detrimental to their life, but checks the rapid collapse of flux which is so desirable. To prevent such effects from taking place, therefore, a capacity is shunted across the interrupter contacts. The counter electro-motive force of the primary now charges this condenser, and since its capacity is large it does not rise to a very high potential, limiting, therefore, the potential across the interrupter contacts and avoiding arcing.

As the condenser becomes charged and the energy of the magnetic field is discharged a point will be reached when the potential of the condenser is greater than that of the coil. The condenser will then discharge into the coil, but this current will oppose the original direction of current, and will therefore increase the rate at which the current decays in the circuit.

The effect of the condenser, so far as the interrupter action is concerned, is therefore to prevent arcing at the contact points and to increase the decay of flux on breaking the primary circuit, which reacts by greatly increasing the secondary electro-motive force. As will be seen on examining curve *c* in Fig. 4, the period of time during which the high voltage at the secondary terminals is available is exceedingly small, and unless the various time elements are accurately proportioned in the make-and-break action of an interrupter a very poor performance may result from any spark coil or similar device.

The mercury type of interrupter is generally recognized as being superior to

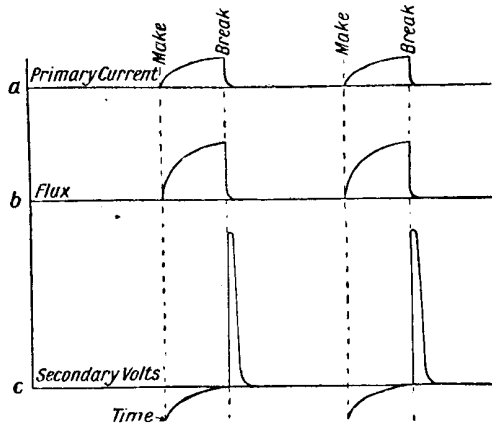

MAKE-AND-BREAK CURVES

Fig. 4. Rise of current in the primary of a spark coil is represented at *a*, magnetic flux at *b*, and periods of time when high voltage is available at the secondary are shown at *c*

the hammer-break type, and much ingenuity has been expended in bringing this to its present state of perfection. The older types consisted of blades or needles dipping rapidly into a jar of mercury, and were either hand or motor driven. Later patterns took the form of a rotating blade or segment at the end of an inclined shaft which was rotated by a motor, the blade dipping under the surface of the mercury at one point and rising clear from it at others. Oxidation of the mercury was minimized by keeping it covered with a layer of paraffin or alcohol.

Highly Efficient Mercury Interrupters

These types required a somewhat liberal allowance of mercury, and to minimize this expense the turbine type of mercury interrupter was brought out. One form consisted of a motor mounted with a vertical shaft terminating in a cone-shaped casting. Two small holes were drilled from the bottom of the cone upwards, inclined to the vertical and communicating with two outlets on the large diameter of the cone on an opposite diameter. A small quantity of mercury was placed in the bottom of the iron containing vessel into which the end of the cone dipped. On rotating it at a sufficiently high speed the mercury was forced up the inclined holes and flung outwards by centrifugal force in two continuous streams against a copper contact blade insulated from the rest of the apparatus, but forming one terminal of the primary circuit in the interrupter.

The stream of mercury formed a flexible connexion which, by impinging on the blade twice in every revolution, established contact, and also gave an extremely clean and certain "break." One of the features of this interrupter, known under the name of the "Gaiffe" interrupter, was the use of coal gas as an electrolyte instead of paraffin or alcohol. By keeping the interior of the vessel filled with coal gas through a small rubber supply pipe, oxygen was excluded, and the mercury and contacts kept in a clean bright condition for long periods. The objection to the use of paraffin or liquid electrolytes is the tendency of the mercury to emulsify with the liquid and form a pasty mess which results in uncertain contact.

In yet another type of mercury interrupter a vertical motor drive is adopted, the shaft containing a chamber with sloping sides, in which is a small quantity

of mercury and a fibre wheel with a copper bar across its face. The shaft of this wheel is electrically continuous with the copper strip, but insulated from the rest of the mercury chamber, and the wheel is free to revolve. On speeding up the motor the mercury is flung outwards inside the chamber into a ring form by centrifugal effect, and the edge of the ring, catching the edge of the fibre disk, causes the latter to rotate rapidly, bringing the copper strip in contact with the mercury, so making and breaking the primary circuit at a high speed.

For certain purposes where interrupters are used in conjunction with vacuum tubes for radiographic work it is necessary to cut out the reverse current at "make," shown by the lower part of the secondary electro-motive force at *c* in Fig. 4. To accomplish this a complete rectification of the secondary electro-motive force is secured by arranging a revolving arm or "windmill" opposite discharge points, in such a way that the small inverse electro-motive force is unable to jump the air gap these arms introduce, and yet offers little opposition to the full electro-motive force in the forward sense.

Extraordinary Characteristics of the Electrolytic Interrupter

There is also an interrupter based on an entirely different principle than any of the foregoing, known as the electrolytic interrupter. In this type a thin platinum wire forming one terminal is immersed to a greater or lesser degree through an aperture in a porcelain tube, the end of which is placed in a jar containing dilute sulphuric acid in the proportion of 1 oz. of acid to 5 oz. of water. The other electrode consists of a plate of stout lead sheet. A minimum electro-motive force of 50 volts has to be used with this type of interrupter to break down the electrolyte, and a current of not less than five amperes.

The platinum is made the anode, and the lead the cathode. On closing the circuit, the density of the current is so great as to cause the formation of steam, and in addition electrolysis causes hydrogen and oxygen to appear, these gases forming an insulating mantle round the anode which interrupts the current. If there is a sufficient amount of self-induction in the circuit a spark appears at the point of "break," that is the anode, igniting the gases. A small explosion ensues, which gives the acid access once more to the

platinum point, and closes the circuit again. This process goes on with extraordinary rapidity and regularity.

The intensity of the discharge and the frequency of the interruptions can be adjusted between wide limits by varying the electro-motive force of the primary circuit, the exposed surface of the platinum point, and the amount of self-induction in circuit. The character of the spark discharge from a coil actuated by an electrolytic break differs from that of a hammer or mercury break in an extraordinary manner, probably owing to its extreme rapidity of action, and the use of a condenser shunted across the terminals of the

break seems to be unnecessary. Great care is needed in experiments with these interrupters when substituting them for the mechanical or

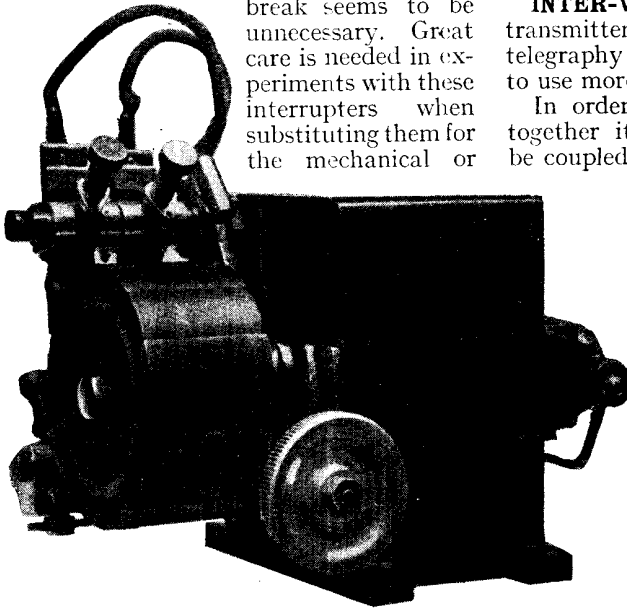

MOTOR-DRIVEN INTERRUPTER

Fig. 5. Motor-driven commutator-type interrupters, as above, are used to interrupt the primary current of an induction coil

mercury types, or an excellent spark coil may be ruined in a few seconds.

A motor-driven commutator type of interrupter is illustrated in Fig. 5. This particular device is used to interrupt the primary current of a special form of induction coil (*q.v.*) which is used in certain ship installations purely for emergency use.

The square, box-like casting is the motor body. The motor itself is driven from the same batteries which are used as the current supply for the primary of the coil. The brush gear of the motor is just visible on the right-hand side.

The commutator, which is fixed to the motor shaft, is clearly shown. A point to be particularly noted is the relatively large amount of insulation compared with the copper segments. Four flat brushes are fitted, these being arranged in pairs, and it is from these brushes that the interrupted current for the primary of the coil is taken. Adjustment is provided for altering the relative angle of phase of the brushes. The milled hand wheel which controls this adjustment is shown immediately in front of the commutator.—*A. H. Avery, A.M.I.E.E.*

See Buzzer ; Chopper ; Hammer Break.

INTER-VALVE COUPLING. In both transmitters and receivers for wireless telegraphy and telephony it is now usual to use more than one valve.

In order that these valves may work together it is necessary that they shall be coupled one to another. This coupling is necessary in order to keep the current in each valve circuit in constant phase relationship with the current in associated valve circuits.

Due to the great sensitivity of valve circuits, such couplings often exist without having been intentionally made. These accidental couplings have a marked effect on the working of the receiver or transmitter, and it often happens that results are obtained with wireless apparatus which are very difficult to repeat. This is because in the first instance some unintentional coupling, either by means of capacity or inductance, has been made

between two parts of the circuit ; and as this coupling has not been noted, it is not intentionally introduced when repeating the experiment, with the result that the second experiment does not reproduce the first.

Couplings between valves may take any or one of the following forms :—

1. Direct or physical.
2. By means of resistance.
3. By means of inductance coils.
4. By means of condensers.

A good example of the direct method is in the parallel running of valves for transmitters, in which case two, three,

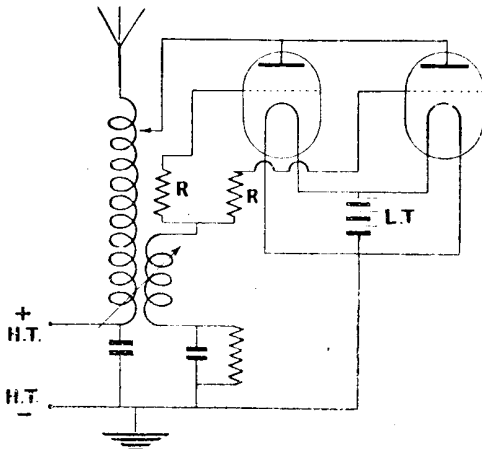

VALVES COUPLED IN PARALLEL

Fig. 1. Two valves of a transmitter are coupled in parallel by the direct method

or more valves may be connected in parallel in either a transmitter or receiver (Fig. 1). The effect is similar to increasing the size of the transmitter or other valve, and enables larger currents to be dealt with. In this case the anodes of the two valves are directly coupled together by a copper wire, whilst the filaments are treated in a similar manner.

The grids are usually provided either with separate resistances, R, R , in series with them, or with separate grid leaks, across which condensers are shunted; but in any case both grids depend on one reaction coil for the supply of their variable potential. A pure resistance coupling between

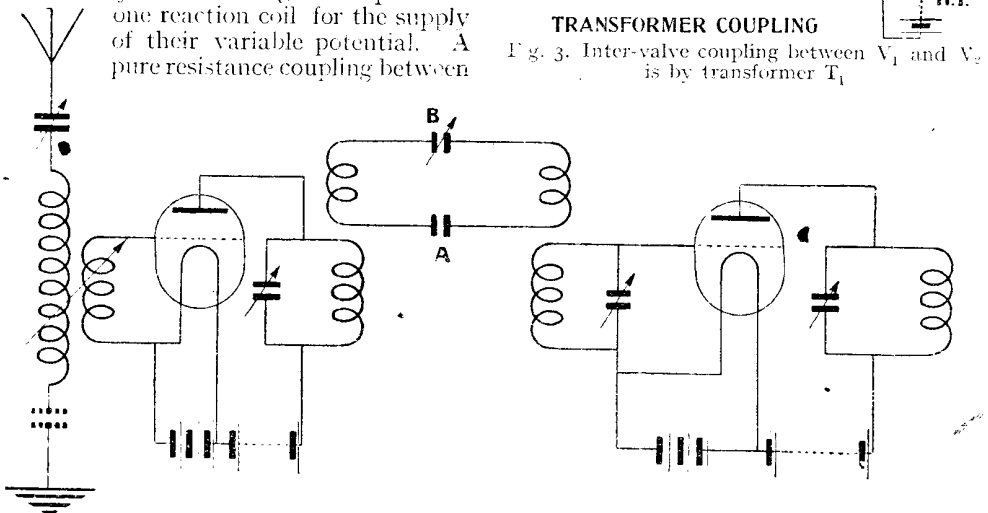

INTER-VALVE CAPACITY COUPLING IN A TWO-VALVE SET

Fig. 4. Between the two valve circuits in the set represented by the above diagram is a capacity coupling circuit comprising two coils, a condenser, A and a variable condenser, B

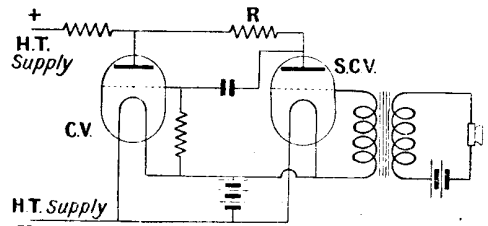

RESISTANCE-COUPLED VALVES

Fig. 2. Control and sub-control of a telephone, with resistance coupling, R , between the anodes, is provided in this circuit. The control valve is at C.V., and the sub-control valve at S.C.V.

valves is not usual, although in some cases resistance may play an important part in the composition of the circuit; for instance, in the modulation of a wireless telephone it may be desirable to employ two valves for the control circuit (Fig. 2), a main control valve, C.V., and a sub-control valve, S.C.V., the latter being a smaller valve than the former. If it is intended to use the same

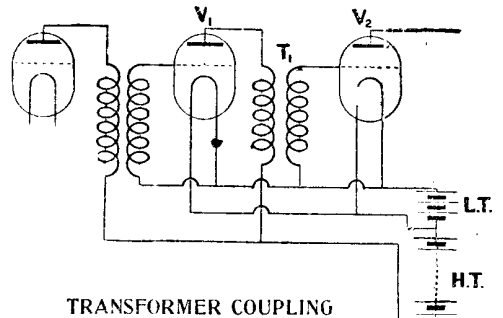

Fig. 3. Inter-valve coupling between V_1 and V_2 is by transformer T_1

high-tension supply for both these valves, it will be necessary to reduce the anode potential which is supplied to the sub-control valve; this may be effected by inserting a high resistance between the anodes of the two valves. When a feed current is passing to the valve S.C.V., there will be a potential drop over the resistance R, and the anode potential of S.C.V. will be lower than the voltage supplied to C.V.

The method of coupling inductively is well known, and is used in most circuits, such as amplifiers of both high- and low-frequency currents. It is illustrated in Fig. 3, where the valve V_1 , forming part of an amplifier or intensifier, is coupled to valve V_2 by the transformer T_1 , which in the case of a high-frequency amplifier would be a transformer having an air core, and with the windings wound closely one on the top of the other, or in alternate sections; whilst in the case of a note magnifier the transformer T_1 would be a transformer wound on a closed iron core, or a core which was closed with the exception of a small air gap.

The capacity coupling is often present without being intentionally placed in the circuit, but capacity coupling is used intentionally in many wireless circuits; it is, in fact, almost general to couple the aerial to a receiver through a condenser placed between the aerial and the aerial inductance, or between the inductance and earth, as shown dotted in Fig. 4, whilst valve circuits may be coupled through tuned intermediate circuits broken up by condensers at A and B, although as a rule only one condenser, as at B, is used. See Amplifier; High-frequency Amplification; Intensifier Circuit; Transformer.

INTER-VALVE TRANSFORMER. General term used to describe a transformer disposed in a circuit between two valves, as, for example, a high-frequency amplifying transformer used between the high-frequency valve and the detector valve, or between each of two or more high-frequency valves.

Such an example is illustrated in Fig. 1, and shows a standard form of four-pin plug-in transformer. This general type of transformer is characterized by an air core; that is to say, there are simply two windings of insulated wire, usually of very fine gauge and of an equal number of turns. The amateur is more concerned with the

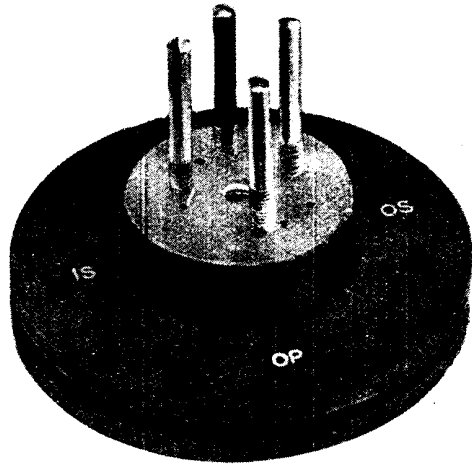

INTER-VALVE PLUG-IN TRANSFORMER

Fig. 1. Reversed to show the underside of a standard plug-in inter-valve high-frequency transformer. This form is easily interchangeable

low-frequency inter-valve transformers used in the low-frequency or note-magnifying side of the circuit, as, for example, the transformer located between the detector valve and the low-frequency amplifying valve. These are characterized by the presence of a soft iron core, customarily taking the form of a rectangle, which

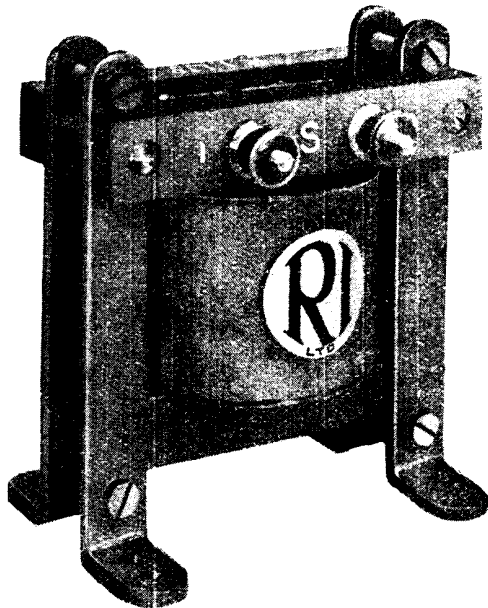

LOW-FREQUENCY INTER-VALVE TRANSFORMER

Fig. 2. Laminations of soft iron form the core of this inter-valve low-frequency transformer
 Courtesy Radio Instruments, Ltd.

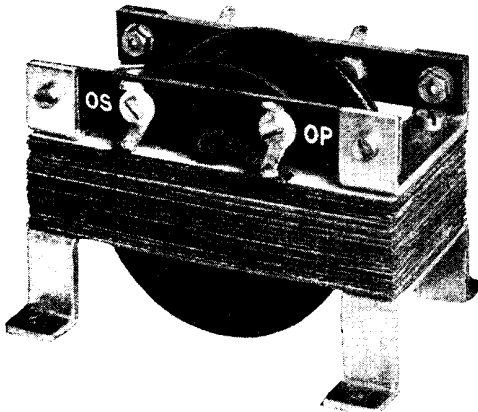

STERLING L.F. TRANSFORMER

Fig. 3. Inter-valve transformers of this type are designed for convenience of space. The construction is somewhat similar to that of the transformer shown in Fig. 2

Courtesy Sterling Telegraph Co. Ltd.

surrounds the windings and having a bridging piece spanning two sides of the rectangle, thus forming what is known as a closed core. Usually such cores are composed of a large number of thin soft iron or special alloy laminations. A typical example is illustrated in Fig. 2, and shows the instrument complete with the windings disposed about the central core.

The windings in this case give a step-up effect, the primary consisting of a relatively small number of turns, usually of comparatively thick wire, the secondary

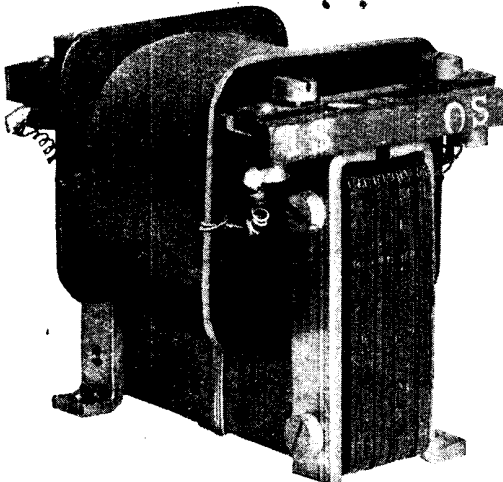

INTER-VALVE CLOSED-CORE TRANSFORMER

Fig. 4. In this inter-valve closed-core transformer the windings are wound on one of the sides of the rectangular laminated core

being composed of a greater number of turns of thinner wire. The sets of windings are thoroughly insulated from each other, and the ends of the windings connected to terminals disposed on the insulated bar or bars.

Another type, illustrated in Fig. 3, is similar in its essentials, but all parts are so disposed that they occupy little space, the core in this example being placed horizontally and the windings vertically.

Another arrangement of closed-core inter-valve transformer, illustrated in Fig. 4, consists of a rectangular laminated core with the windings disposed on one of the sides.

Inter-valve transformers may also consist of two windings wound above the other on a suitable former, as, for example, an ebonite tube. In this case the windings should be equal in value and number of

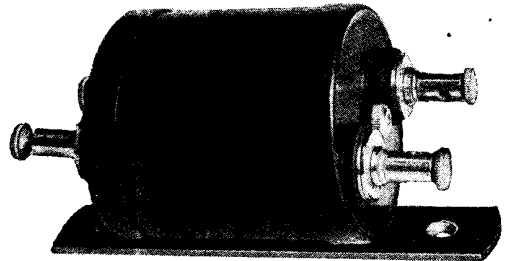

DRUM-SHAPED INTER-VALVE TRANSFORMER

Fig. 5. Here the windings are wound above one another on a circular former and enclosed in a metal or ebonite case

turns, and the whole may be enclosed in a metal or ebonite case with end caps, as shown in Fig. 5, and terminals mounted thereon to which the primary and secondary windings respectively are connected.

The choice of a suitable inter-valve transformer for any given service is largely determined by the nature of the circuit and the duty it has to perform. See Audio-frequency Transformer; Transformers.

INVERTED L-TYPE AERIAL. Name given to the most general form of receiving aerial. It consists of one or more horizontal wires with one or more lead-in wires taken off one end, giving the general appearance of an inverted L. See Aerial.

INVERTED ROTARY CONVERTER. This is the name given to a rotary converter when its usual functions are reversed, *i.e.* when it is used to convert

direct current into alternating current. See Rotary Converter.

ION. A term originally used by Faraday to describe the elements given off in electrolysis, the element given off at the anode being the anion, and that at the cathode the cation. More recently the term has come to denote an atom from which one or more electrons have been removed, or to which one or more electrons have been added. In the former case it is called a positive, and in the latter a negative ion.

In electrolysis the presence of ions carrying charges of positive and negative electricity respectively produces the necessary conductivity on the solution. Monad-ion is one carrying unit charge, dyad-ion one carrying two, and triad-ion one carrying three unit charges. During the process of electrolysis the charged ions of the electrolyte move with various velocities towards the two electrodes, the fastest being the hydrogen ions. See Electron; Ionization.

IONIC VALVE. This is a term sometimes used for the ordinary thermionic valve. See Valve.

IONIZATION. The liberation of ions, either in electrolysis or in the case of gases and air, the result in all three instances being to confer conductivity. The principle is made use of in the case of valve detectors, in which, during the incandescence of the filament, the space between it and the plate is rendered conductive in one direction only, owing to the fact that it is filled with a gas permeated with negative ions. When the process of applying the plate potential has been carried to excess, undue ionization may take place, causing the valve to "blueglow" (*q.v.*).

In less pronounced cases the difference between a hard and a soft valve may be said to depend upon the extent to which ionization has taken place, a hard valve being one in which the vacuum is high, while in a soft one the space surrounding the filament, grid and plate contains a much larger proportion of negative ions.

The ionization of air and the effect of the process upon reception in the form of atmospherics and other phenomena is closely discussed in Professor Fleming's "Introduction to Wireless Telegraphy and Telephony." He points out the probability of the existence at a high level in the earth's atmosphere of free electrons and positive ions sufficient to give the rarefied air a considerable electric conductivity. Hence

the theory of the Heaviside layer, which is supported by the independently ascertained fact that the electric conductivity of the air, small at the earth's surface, increases as we ascend to a great height. The source from which the electrons and positive ions that give the upper air its conductivity arise is explained by another established fact, namely, that ultra-violet rays can ionize molecules of oxygen, nitrogen, and other gases, and liberate electrons from them.

In this way sunlight may ionize the upper air, but when sunlight is withdrawn, the ions more or less combine. The sun may exert an additional influence in the way of ionization by reason of the continual violent agitation of its incandescent atmosphere, which tends to the creation of immense masses of electrified dust. As Fleming points out, if the earth, moving in its orbit, should happen to be struck by this electrified dust, the upper layers of our atmosphere, which chiefly consist of hydrogen and helium gases, will be ionized.

The earth as a whole, however, possesses a charge of negative electricity. The exact source of this is not yet known. Nevertheless, the negative charge of the earth exerts an electric force which will tend to separate these positive ions and electrons and draw the former to a lower level.

Atmospherics, being largely caused by flashes of lightning, are thus originally traceable to ionization, a theory regarding which serves to explain the fact that (1) wireless signals from a given apparatus can as a general rule be received over much greater distances by night than by day; (2) that atmospherics are usually more prevalent by night than by day, and (3) that atmospherics are specially troublesome during thunderstorms. During the day the earth's atmosphere on the side presented to the sun becomes ionized by ultra-violet rays in its upper layers, and owing to the earth's electric force the positive and negative ions become somewhat separated.

It may be shown mathematically that an electric wave travels rather faster in a space impregnated with heavy ions than in an ion-free air. Hence, if a wave is sent out from a radio station the upper or higher portions may travel more quickly, and the ray or wave direction is curved down so as to bring it to the earth at a less distance than would be the case if there

were no ions. This process of ionic refraction, as it is called, shortens the range.

Both by day and night the electric waves are guided round the earth—according to the latest theories—chiefly by reflection from the permanently ionized layer of the atmosphere. But in the daytime the ionization by sunlight at lower levels bends down the electric waves and so tends to make the range of efficient reception shorter.

Similarly atmospheric effects are felt more by night than by day because the more or less distant lightning flashes to which they are due travel farther. At sunrise and sunset the applied or withdrawn ions, by recombining, are apt to produce special disturbances. To other electric discharges and recombination of ions in the Heaviside layer the more permanent disturbances heard in daytime may be due.—*O. Wheeler.*

See Distortion; Electricity; Heaviside Layer; Refraction.

I.R.E. This is the standard abbreviation for and the initials of the Institute of Radio Engineers.

IRON. Iron plays a very important part in wireless and in all forms of engineering practice. With steel, which is an alloy of iron, it is the most important metal capable of assuming magnetic properties. It is in this connexion that iron is of such value in the construction of wireless and electrical apparatus. Iron is used as the core of transformers, as it affords a path of low resistance to lines of magnetic force. In this way the lines of force may be directed to a large extent within limits where their effects will secure maximum efficiency. An application of this is seen in the closed core of a low-frequency transformer.

Iron has the property of reluctance, by which is meant its disinclination to change from its magnetic condition. This is often a serious disadvantage, and two methods are commonly adopted where reluctance would tend to decrease the efficiency of a particular piece of apparatus. The first method is to select an iron of the softest variety, as a soft iron has a lower reluctance than a harder one. Stalloy iron belongs to this class, and is largely used in telephone diaphragms. The second method of securing low reluctance is by the use of laminations of soft iron, as a small mass of iron will accept or yield up a magnetic influence more readily than a larger mass.

Another reason for laminating an iron core is to break up the eddy currents which develop in the core. These currents are generated in a dynamo or motor armature in the same way as the legitimate currents, and unless steps were taken to eradicate them they would cause a considerable loss in efficiency. *See Electricity; Dynamo; Magnet; Magnetism; Transformer.*

IRONCLAD EXIDE CELL. A type of Exide cell in which the positive plate consists of an antimony-lead alloy grid arranged with a number of vertical parallel rods united at top and bottom with a strong framework. Each of the vertical rods is surrounded with a cylindrical pencil of peroxide of lead, which forms the active material of the plate. To prevent disintegration of the material each pencil is surrounded with a hard rubber tube having a number of horizontal slots through which the electrolyte reaches the active material. Two stiffening ribs are provided on opposite sides of the tubes which also act as insulating spacers. The elasticity of the rubber tubes permits of any change of volume likely to occur in the active material.

The negative plate is of the standard Exide type, the plates being separated by means of wooden separators. *See Exide.*

IRON CORE INDUCTANCE. It is explained under the heading Induction that self-induction is most pronounced in cases where an iron core is introduced, and this fact is taken advantage of in the construction of choke coils, the function of which is to check by reaction, in the form of impedance, the amount of current flowing in the circuit. The iron core of a choke coil usually consists of a bundle of wires insulated from one another to prevent "eddy currents." A low-frequency iron core inductance is an iron-cored choke coil used to resonate the low-frequency circuit to applied alternating current frequency. *See Choke Coil.*

IRON FILINGS. The use of iron filings in wireless is more or less limited to purely experimental work. In this connexion iron filings are of considerable use in determining the nature and direction of magnetic lines of force emanating from a magnet or electrical circuit in which a current is flowing. The method of accomplishing this is to surround the magnetic field with a smooth sheet of white paper where it is desired to find the lines.

magnetic flux. A quantity of specially prepared filings is heaped on another piece of paper and shaken from some height over the paper where the lines of force radiate. It will be seen that the filings take up a definite position where the lines of force are greatest. If the filings show any tendency to stick together and not shake well, they should be washed and then thoroughly dried. Illustrations of this use of iron filings are given under the heading Magnetism.

IRON LOSSES. The losses which occur in the magnetic portion of an electrical apparatus containing iron are usually spoken of collectively as the iron losses, whether they arise from hysteresis or magnetic lag, or whether from eddy currents or any other similar cause. These losses represent energy imparted to the core of a dynamo, motor, or transformer which cannot be recovered as useful work, and are normally dissipated in the form of heat.

The two chief losses occurring in iron which is subjected to an alternating magnetic field are (1) the hysteresis loss, and (2) the eddy current loss. In considering the first of these, a distinction has to be drawn between a true alternating field having a fixed axis in space, and a rotating magnetic field in which the

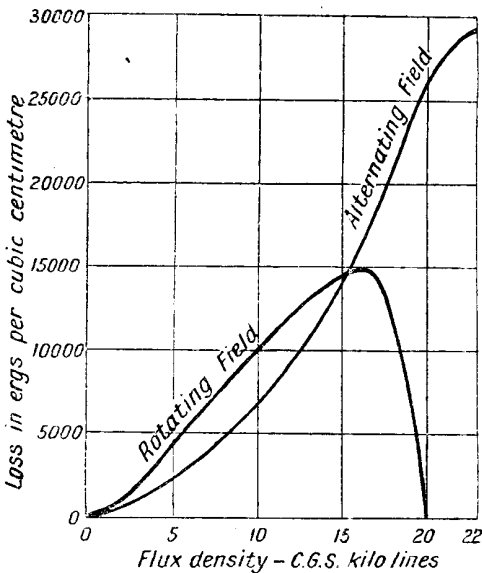

DIFFERENCES IN HYSTERESIS LOSS

Fig. 1. Energy losses in soft iron under the influence of rotating and alternating fields are shown in Prof. F. G. Baily's curve

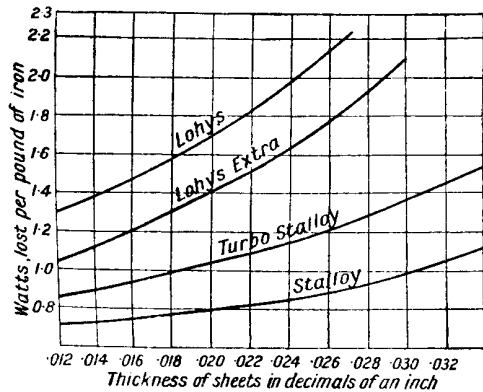

COMPARATIVE LOSSES OF DIFFERENT IRONS

Fig. 2. Iron losses are shown in various grades of iron at a flux density of 10,000 lines per square centimetre at a frequency of 50 cycles

Courtesy J. Sankey & Sons, Ltd.

orientation of the magnetic induction is in continuous rotation. The difference in the hysteresis loss brought about by these two causes, according to Prof. F. G. Baily, is represented in Fig. 1, and the curves there shown indicate that at low flux densities up to about 15,000 lines per square centimetre the rotating field gives a rather greater loss than the alternating field. The upward slope of the two curves is seen to be much the same, but after reaching a value of $B = 16,000$, the losses produced by the rotating field decrease, and at $B = 20,000$ they come down to almost zero. On the other hand the losses due to an alternating field increase continuously up to $B = 24,000$, after which they remain almost constant.

In practical design, calculations for separating out the relative strengths of the alternating and rotating field losses are too complex and too lengthy to admit of going into great detail, and it is usual to compile curves based upon the actual-measured losses in the various kinds of apparatus under test, from which can be read off the number of watts lost per pound of iron under varying conditions of flux density and frequency.

It will be readily understood that different samples of material will exhibit slightly different behaviour, and certain grades of iron give consistently better results than others. By courtesy of J. Sankey & Sons, Ltd., of Bilston, Staffordshire, Fig. 2 may be taken as a representative example. Four grades of sheet, such as would be used in ordinary

commercial work, are taken through a series of tests which consist of magnetizing them at a constant frequency of 50 cycles per second. The increase in the losses which results from increasing the thickness of the sheets is well shown, also the advantages possessed by certain kinds of material over others as regards low energy loss, both in hysteresis and eddy current. Any such losses that can be saved in the iron core, whether it belongs to a transformer, dynamo, motor, or alternator, or, in fact, any kind of electro-magnetic apparatus, reduce the heating and increase the output capacity, hence the efficiency. Therefore the careful choice of material has a distinct commercial aspect.

That the losses in an iron core bear a definite relation to the induction value, or flux density, at which the material is being worked is made clear by reference to Fig. 3. This shows the typical performance curves for both "Lohys" and "Stalloy" grades of sheet, all of the same thickness and worked at the same flux densities.

Stalloy, in particular, gives an extremely good performance, and is almost uni-

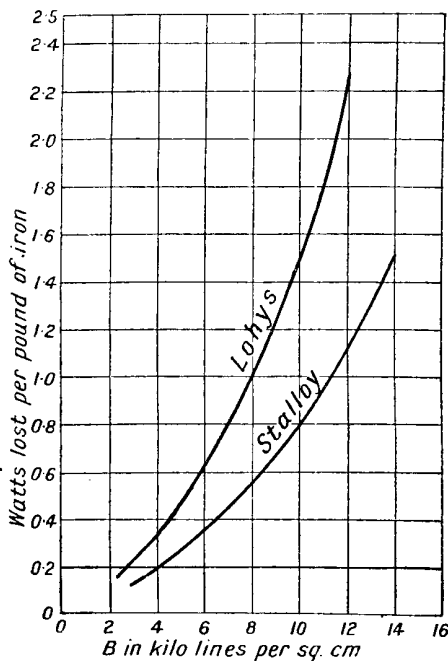

Fig. 3. These curves show variations in iron losses at different induction values, with constant thickness of .018 in. and constant frequency of 50 cycles

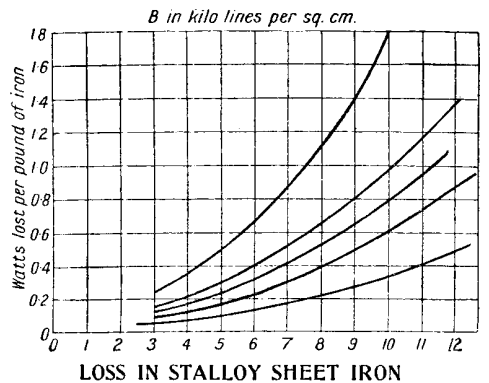

Fig. 4. Energy loss in stalloy sheet of .018 in. thickness is represented by this curve, at various frequencies and flux densities

versally used for transformer cores, when worked at audio-frequencies, and on ordinary frequencies associated with commercial supply systems. Its composition is stated to be as follows: carbon .03; silicon 3.40; sulphur .04; phosphorus .01; manganese .32; and iron 96.2. A more detailed performance curve of stalloy is given in Fig. 4.

Contrary to the general impression that high-resistance steel is only necessary, or, rather, advantageous, in the case of transformer cores and other structures subjected to a purely alternating flux, core losses are found to be considerably reduced by its use in armatures intended for direct current machinery, and since the reduction in heat is proportional to the square of the eddy currents, the saving effected on this count alone is very pronounced.

For an alternating magnetic flux, and a flux density not exceeding about 17,000 lines per square centimetre, the hysteresis component of the iron losses will be given approximately by the formula

Watts per cubic centimetre = $\eta \cdot B^{1.6}$
 where η = the hysteric constant, varying between .002 and .00076, according to the grade of material employed.

Eddy current losses follow the law expressed in the formula below, provided the direction of the flux is strictly parallel to the plane of the laminations, and also that the individual stampings are perfectly insulated from one another.

Watts per cubic centimetre =

$$\frac{\pi^2}{6} \times \frac{I}{\rho} \times l^2 \times n^2 \times B_{MAX}^2 \times 10^{16}$$

where ρ is the specific resistance of the

iron, t is the thickness of the sheet in centimetres, n is the frequency, and B_{MAX} is the maximum flux density in lines per square centimetre.

The actual measured iron loss in a completed motor, generator, or transformer is nearly always in excess of the sum of the calculated hysteresis and eddy current losses, which are due principally to the hardening experienced during the various stamping, piercing, and assembly processes, also to short-circuiting between burrs on the edges of individual stampings, bolting-up pins, and to shaft contact.

Filing slots and grinding surfaces of the laminated iron cores will always have a detrimental effect as regards iron losses, and it is the practice of many manufacturers to re-anneal all iron stampings after they have been finally machined to shape, and to leave them untouched after assembly. It is also good practice, and one in general use where large outputs are concerned, to coat one side of all iron sheets with a thin hard paper, pasted on before stamping or notching, and to omit the re-annealing, which sometimes leads to distortion troubles. The slight extra cost of production is well justified by the saving effected in iron losses, and increased output capacity as a consequence, or the advantage of a reduced temperature rise. A good commercial brand of iron will have an average hysteretic constant of .0027 after the average stamping processes have been carried out upon it, and calculations may be safely based upon this figure.

The high electrical resistance of stalloy is sufficient to prevent the eddy current component of the iron losses from rising to an excessive figure, if the thickness of the sheets is kept down to about .018 in., that is No. 26 standard wire gauge.--
A. H. Avery, A.M.I.E.E.

IRON PYRITES. A natural mineral crystal sometimes used as a crystal rectifier. In appearance the crystal has a very smooth surface with a high polish and in

colour is a very pale gold. Iron pyrites is a non-battery crystal, and works best with a fine cat's-whisker of gold. A steel point is also used in connexion with this crystal. In its natural state the crystal is not always stable, but methods have been found for treating the crystal which make it equally sensitive over its entire surface.

IRON WIRE. The word wire is applied to various diameters, from the finest up to about $\frac{5}{16}$ in. or so in diameter, the larger sizes being generally known as rods or bars. The wireless experimenter will find that soft iron wire, especially annealed, can be serviceably used for the cores of various forms of transformers and also in spark coils, and for other purposes when a magnetic core is required.

Iron is a poor conductor of electricity, and for this reason iron wire is often used for resistance purposes, but is not so efficient as the regular alloys made specially for resistances. Iron wire is often galvanized and stranded, and is then used in that condition for the guys for aerial masts and numerous other purposes, the object of the galvanizing being to render the material resistant to the attack of dampness and to prevent oxidation.

I.R.V.B. This is an abbreviation used to denote the form of insulation on a wire. It means that the wire is covered with an indiarubber, vulcanized and braided protection.

ISOBARS. Line upon a meteorological map passing through places at which values of barometer readings, duly corrected to sea level, are the same. They are the lines in which the isobaric surfaces would cut the earth at its surface if the latter were entirely at sea level.

General isobaric charts provide the means of reviewing at a glance the distribution of atmospheric pressure over given areas, and are based on the average values calculated from past records. An annual map for the globe will show roughly the existence of five belts of pressure. A zone of low pressure exists near the equator, on either side of which are belts of high pressure; beyond the latter the value diminishes towards the polar regions. A consideration of the variation of these curves during the year involves the use of monthly charts, particularly those for January and July, as being typical of winter and summer.



SPECIMENS OF IRON PYRITES

Crystals of iron pyrites, used for detectors, have a smooth polished surface and in colour are a very pale gold

The most important application of isobars to-day lies in the construction of daily weather charts for forecasting purposes. By comparing the variation of isobars based on readings taken at regular and frequent intervals, and so anticipating their future arrangements, the weather for a short time ahead may be deduced.

ISOCLINAL. Line of equal inclination of the dip needle, called an isoclinic line.

ISOCLINIC LINES. Name given in terrestrial magnetism to lines passing through places on the globe where the dip needle has the same angle of inclination from the horizontal at the same time.

In general, such lines circle the surface of the earth in a similar fashion to parallels of latitude, but are in no way parallel to them, the unequal distribution of the earth's magnetism precluding any possibility of regularity of form. Their curvature is continually changing, owing to the variation with time of magnetic dip at any given spot.

The line along which the angle of dip has zero value is termed "aclinic," and runs roughly along the equator.

ISODYNAMIC LINES. Lines connecting places on the globe at which the total magnetic force of the earth has the same value for a prescribed period. In common with the curves for declination and dip, their shape is subject to change from time to time. They will show that the intensity of this force has a maximum value near the magnetic poles, and decreases in strength towards the magnetic equator.

ISOGONAL. Line of equal declination of the compass needle. An alternative denomination for isogonic line.

ISOGONIC LINES. Name given in terrestrial magnetism to lines passing through places where the declination of the compass needle or angle between the magnetic and geographical meridians is the same at any prescribed time. In conjunction with isoclinic and isodynamic lines they provide a means for reviewing the magnetic condition of the earth as revealed at its surface.

Owing to the uneven distribution of the earth's magnetism, isogonic lines assume a somewhat complex form, but their general trend is from the north magnetic polar regions to those of the south. They intersect at both magnetic and geographical poles. The declination of the compass needle being subject to secular, monthly, diurnal and even hourly changes,

isogonic lines must alter their form accordingly. In general, these changes are not erratic, so that they may be predicted ahead and charts constructed for navigation purposes. The isogonic line to which zero value is allotted is termed agonic.

ISOLIT. An insulating material similar to adit (*q.v.*). It consists of papier mâché impregnated and covered with insulating compounds. Its composition is a trade secret.

ISOMAGNETIC. Term used in terrestrial magnetism to designate curves which pass through places on the globe where the intensity of the earth's magnetic field is the same at the same time. Due to the fluctuating value of this force at any given spot, the curvature of these lines is subject to change.

Charts are constructed to convey information regarding both the horizontal and vertical components of this force, and will indicate that the vertical force is greatest at the poles where the horizontal component is zero.

ISOTHERMS. Lines upon meteorological maps connecting places at which the temperature has the same value. For general purposes the actual values of thermometer readings as observed are first reduced to an estimated equivalent at sea level, and it is from these records that the isothermal curves are drawn.

An annual chart of isotherms for the globe will show the general distribution of temperature, the lines indicating the existence of a belt of high value over the equator, decreasing towards the poles. Such maps are based on the average value of numerous readings observed over lengthy periods, and therefore do not actually show the existing temperatures and cannot be taken as giving a correct impression of climatic conditions at a given place. For this purpose, monthly charts must be consulted, those for January and July usually being accepted as typical of winter and summer.

IVORINE. Manufactured article imitating ivory, usually white, but sometimes coloured. Its use in wireless work is largely restricted to name tablets, scales, dials, and occasionally for the control knobs of the various parts of the apparatus. The illustration shows a number of applications of ivory in the form of scales, dials, disks, name plates, and indicating tabs suitably lettered and calibrated according to their purpose.