

3

To be Completed in about 20 Fortnightly Parts

1^s/₃^d

HARMSWORTH'S WIRELESS ENCYCLOPEDIA

For Amateur & Experimenter

AUD—BOL

CONSULTATIVE EDITOR

SIR OLIVER LODGE, F.R.S.

LEADING CONTRIBUTORS

PROF. J. A. FLEMING, F.R.S.
INVENTOR OF THE FLEMING VALVE

PROF. W. H. ECCLES, F.R.S.
PRESIDENT. RADIO SOC. OF GT. BRITAIN

E. V. APPLETON, M.A., D.Sc.
OF THE CAVENDISH LABORATORY, CAMBRIDGE

N. W. McLACHLAN, D.Sc.
RESEARCH ENGINEER, MARCONI CO.

E. E. FOURNIER D'ALBE, D.Sc.
AUTHORITY ON PHOTOGRAPHY BY WIRELESS

WILLIAM LE QUEUX, M.Inst.R.E.
PIONEER IN AMATEUR TRANSMISSION

J. H. T. ROBERTS, D.Sc., F.Inst.P.
OF THE CAVENDISH LABORATORY, CAMBRIDGE

*J. LAURENCE PRITCHARD, F.R.Ae.S., Technical
Editor, with expert editorial and contributing staff*

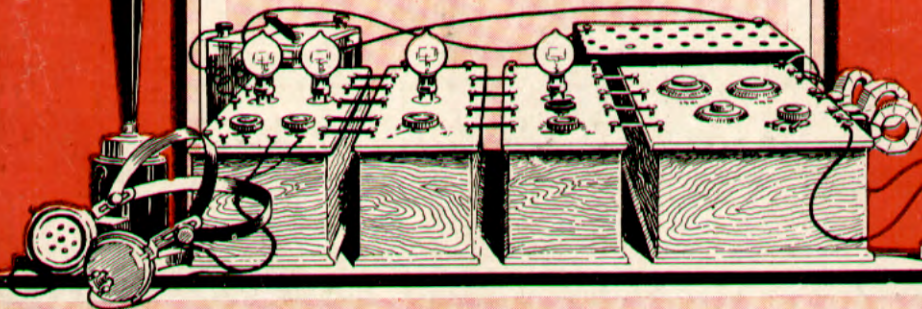

The Only ABC Guide to a Fascinating Science-Hobby

strength of current, as that set up by radiation from a transmitting station. This presupposes that the transformer does not introduce any detrimental effects into the circuit.

In practice a poorly designed or constructed transformer may set up a number of objectionable features, distorting the signals and causing a number of disturbing noises in the telephones. These may be due to the arrangement of the transformer in the circuit or to inherent faults. The former are remedied by rewiring the circuit; the latter may not be amenable to treatment short of reconstructing the instrument as a whole.

The size of the transformer and the disposition of its parts have an important bearing on the efficiency. Both may have to be subordinated to other limitations imposed by considerations of space or some specially desirable feature. Other items that affect the design of an efficient transformer are those imposed by manufacturing conditions and the commercial cost. A good and a bad audio-frequency transformer will often look alike, but the good one will have perfect insulation between winding and winding, and between winding and core. The material will be appropriate, and the iron used in the core will be either a very soft, thin sheet-iron, properly annealed, or preferably one of the special transformer brands of iron, such as stalloy.

Why Transformer Cores are Laminated

One effect of the passage of a current around the iron core is to induce a magnetic state in the core. When the core is solid metal, minor currents are set up in it, and these are known as eddy currents. They have the effect of upsetting the stability of the transformer, and make their presence heard in the form of a hissing or grating noise in the telephone, and the greater the amplification the louder are these noises. These effects are reduced by making the core with laminations, cut from sheet metal and insulated from each other by thin sheets of insulating material, or by insulating varnish. Another way to minimize such noises is to connect the iron core to the common earth side of the circuit. In some cases, instead of connecting to the negative side they are connected to the positive.

The wire for the windings should be of very good quality copper, perfectly insulated with enamel or silk. In some good examples the windings are separated by an interleaving of insulating material. The insulation should be capable of withstanding at least four times the normal high-tension voltage, as under certain conditions, for example, when the set is violently oscillating, the electrical pressure may rise very high and break down the insulation or burn out the transformer. For this reason the insulation must be complete both between the windings and the core. Efficiency is aided by setting the plane of the core parallel to the lines of force.

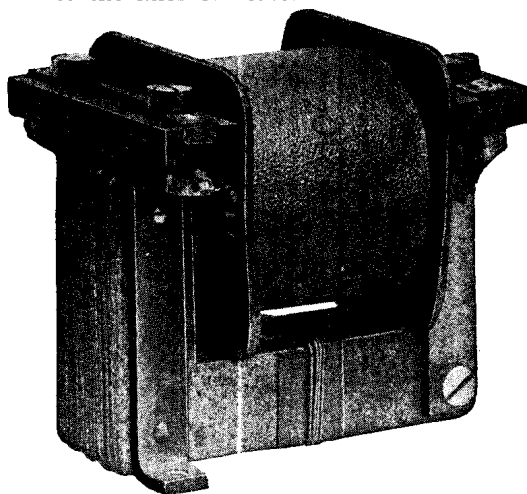

COMPACT TRANSFORMER

Fig. 1. An audio-frequency transformer of the pattern illustrated needs but small space among surrounding components. This is an advantage in the case of receiving sets with shallow containers

No transformer is 100 per cent efficient. There are unavoidable losses in the resistance of the windings, and in the eddy currents in the core. Hysteresis in the core is another loss, most of it due to the physical properties of the iron. The hysteresis coefficient may vary as the instrument ages.

The voltage ratio and many of the losses can be measured on an existing transformer by the aid of a voltmeter and ammeter or a wattmeter, according to the design and type of instrument. The voltage ratio is the difference between the primary and the secondary windings, and is chiefly determined by the relative number of turns of wire on the two coils. A typical example is wound with 3,000 turns of No. 44 gauge wire, and the secondary

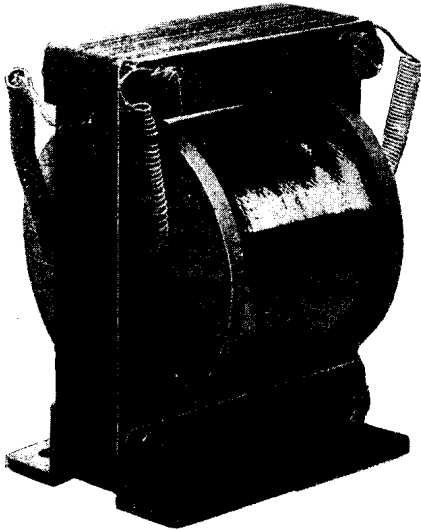

UPRIGHT TRANSFORMER

Fig. 2. Amateur experimenters will find this design of audio-frequency transformer suitable for all-round purposes

with 15,000 turns of the same gauge wire. The ratio is then 5 to 1.

When two or more transformers are used in the same set there is no need for them both to have the same ratio; the first, or that one next to the detector, should preferably have a low step-up ratio of, say, $1\frac{1}{2}$ to 1, and the others a ratio of 4 or 5 to 1.

The effect of using too high a voltage ratio on the first transformer is to distort the signals, and although the volume of sound may be reduced, the resulting purity and lack of distortion is very marked. The higher ratios of the second and third transformers are then able to amplify the sounds which they receive in a comparatively pure state. Another feature is that too powerful a transformer on the first stage brings in the mush of high-frequency current that is heard as a sort of jumble of sounds and scratches and buzzings. This is reducible by the use of a fixed condenser across the primary terminals of the first transformer. The condenser value can be found by experiment, but will have a value of the order of .0003 mfd.

Another plan is to use a fixed resistance across the terminals of the secondary windings with a value of the order of 100,000 ohms. The resistance may be made from a piece of paper attached to the terminals and a line drawn upon it with a lead pencil, increasing the thickness

of the line until the best results are found. In some circuits a biasing battery may be added to the circuit of the second valve to stabilize the instrument.

In use, avoid oscillation, whenever possible, as this sets up enormous electrical pressure in the windings, is the cause of howling and whistling, and is an annoyance to others. When reaction is used in a circuit, do not let it be excessive or too tightly coupled, as this results in harsh reception and blaring, distorted speech and music. Always work on the lowest voltages possible; it saves current and increases purity of reproduction, as well as increasing the life of the components.

For proper functioning, the resistance of the transformer windings should be appropriate to the circuit, and should be approximate to that of the anode circuit, with a value of the order of 10,000 to 20,000 ohms, the secondary being likewise proportioned. The connexions to an audio-frequency transformer are generally to terminals on the exterior, and the primary winding is often marked P1, P2. The outer primary winding goes to the anode and the inner to the H.T. plus in the case of a valve-detector set, or to the telephone terminals of a crystal set.

The secondary is generally marked S1, S2, and the outer winding goes to the L.T. negative, the inner to the grid circuit. Terminal nuts should be well tightened up to avoid crackling noises due to bad joints.

Audio-frequency transformers are best if allowed to stand on a firm base, as any

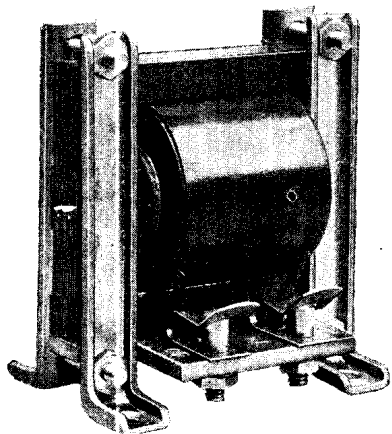

"IGRANIC" TRANSFORMER

Fig. 3. Non-resonating secondary winding and corrected primary winding constitute the chief points of note in this type of audio-frequency transformer

vibration will be communicated to the valve and set up a ringing noise in the telephones. The use of transformers in too close proximity is undesirable, as it tends to set up interaction, and it is best to keep them as far apart as possible.

There are on the market a number of attractive and efficient transformers, and the pattern shown in Fig. 1 is an example of a low pattern that builds into a table set and does not call for a very deep case. The example in Fig. 2 is taller, and is suitable for all-round use by the experimenter. The Igranic, shown in Fig. 3, is a very efficient model with non-resonating secondary windings and corrected primary winding. It is ideal for the experimenter, the use of patent spring-clip terminals enabling connexions to be made and removed with the greatest ease.

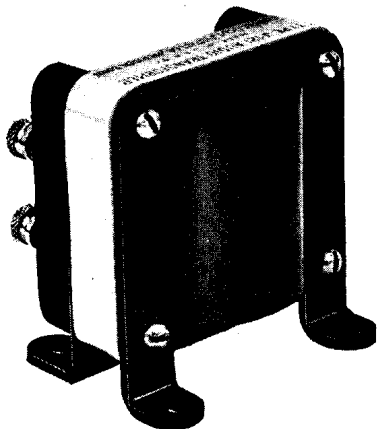

CONNECTICUT TRANSFORMER

Fig. 5. In this model of audio-frequency transformer the windings are insulated by interleaved material.

A fully enclosed audio transformer is shown in Fig. 4, the Elwell, and is provided with a valve holder on the top of the metal case. Thus it can be used as the essential element of a low-frequency amplifier without much trouble beyond that of making the connexions.

Another type of shrouded transformer is that shown in Fig. 5, the Connecticut; the windings are well insulated with interleaved insulation, and the coils and core shrouded with removable metal coverings.

Although almost all the audio-frequency transformers are of the closed core type, as already illustrated, there are still several of the open core type in use, and

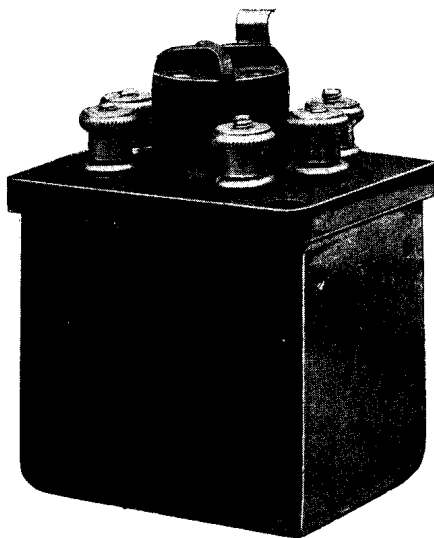

ELWELL ENCLOSED TRANSFORMER

Fig. 4. A fully enclosed type, this audio-frequency transformer is provided with a metal case and valve holder

an example is illustrated in Fig. 6. The core is in this case a bundle of soft iron wires, well insulated, and surrounded with windings of comparatively coarse wire wound in opposite directions.

Similar types of transformer are used in some transmitting circuits to modulate the plate circuit energy of the oscillation valve, efficient modulation on this system being obtained from the use of a voltage amplifying transformer coupled in the grid circuit of the modulating valve and the microphone. The characteristic of such a transformer is that, in conjunction with a suitable battery and a microphone, a secondary voltage is obtained to provide control of radiated energy.

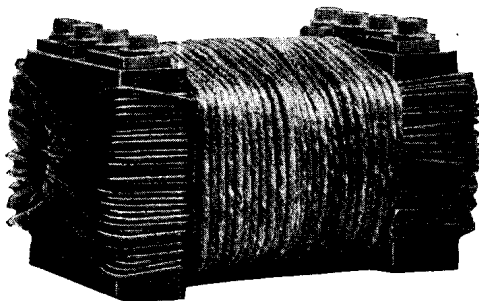

OPEN CORE TRANSFORMER

Fig. 6. Soft iron wire, well insulated, is used in the construction of the open core type of audio-frequency transformer illustrated

How to make an Audio-frequency Transformer. The construction of an audio-frequency transformer is interesting, and calls for good and careful workmanship and the use of nothing but the best and most appropriate material. Good quality, soft annealed sheet iron should be used for the core, and completely insulated wire of very fine gauge for the winding, and the utmost care has to be taken to preserve the continuity of the wire and completeness of insulation.

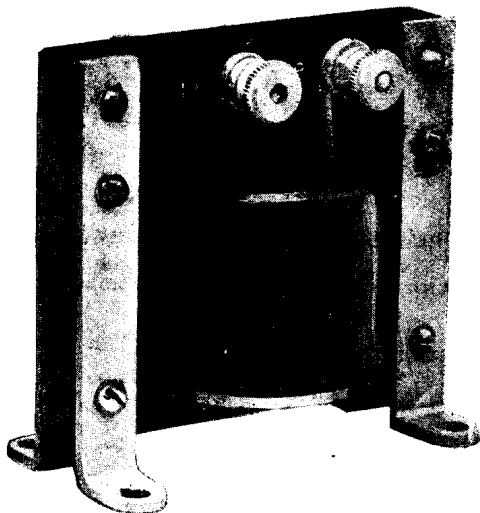

HOME-MADE TRANSFORMER

Fig. 7. Completed instrument, showing the neatness of construction and finish. An idea of its size is given by comparing the appearance of the No. 7 B.A. screws and the terminals.

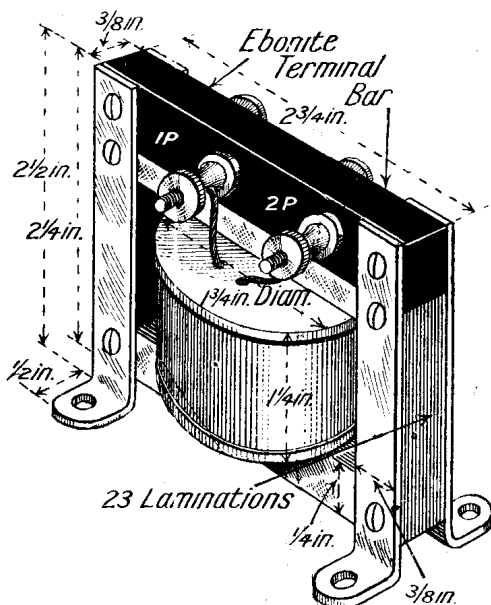

DIMENSIONS OF THE TRANSFORMER

Fig. 9. Exact dimensions are given in this diagram, which will serve as a guide when building up the audio-frequency transformer, as well as at the time of making the various parts. Note the disposition of the primary and secondary terminals.

The appearance of the finished transformer is shown in Fig. 7, while the chief components are shown separately in Fig. 8, and the dimensions of the various parts are given in Fig. 9. This has a 4 to 1 ratio, that is to say, the primary winding occupies one-fifth of the total winding on the bobbin.

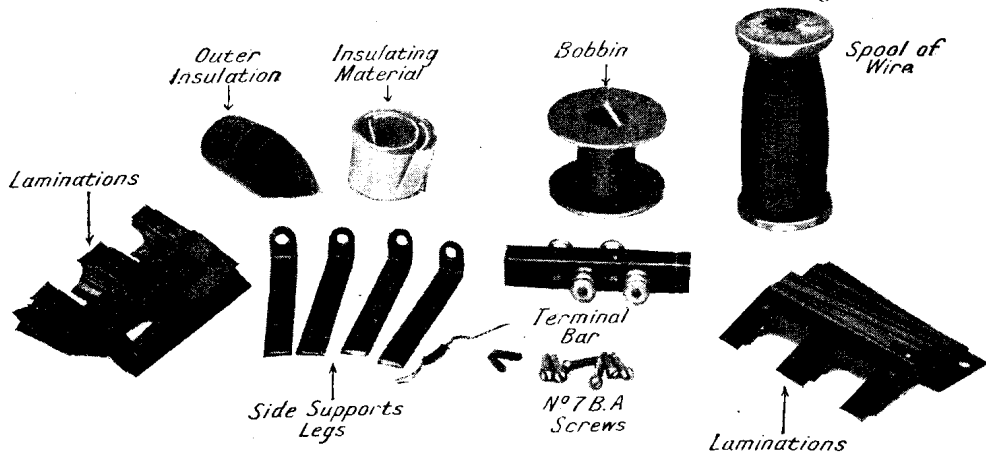

PARTS OF AN AUDIO-FREQUENCY TRANSFORMER BEFORE BUILDING UP

Fig. 8. Complete set of the component parts of an audio-frequency transformer before it is built up. When the various components have been made they are collected together and carefully counted out. There should be more of each part rather than the exact number necessary present, in order to ensure progression of the work should any be lost or damaged.



CUTTING SERRATIONS

Fig. 10. A cold chisel and small anvil are being used in the operation of cutting serrations from a plate in the course of making the laminations

The first step is to make the iron core. This is done by marking out a sufficient number of sheets of soft iron and cutting them to shape by means of tinman's snips as shown in Fig. 11. After which, holes are drilled or punched through the corners for the binding screws which hold them together to the side supports. The serrated portion is then cut out by means of a cold chisel by supporting the plate upon a small bench anvil or some similar rigid support and using the cold chisel with a hammer as shown in the illustration, Fig. 10. When all these pieces

have been cut out in this way, the whole set of plates is temporarily fixed together with a couple of soft iron or copper rivets, grasped in the vice, and neatly filed to shape in the manner illustrated in Fig. 12. It will be noticed that one set of plates is slightly longer than the other. This is to allow them to overlap and interlock into each other to make a perfect metallic connexion. When shaped they must be wholly coated with good insulating varnish.

The next step is to make the bobbin. This can be done with an ebonite tube for the centre and two ebonite or stout cardboard disks for the sides. Small holes are drilled through one side of the bobbin flanges and one end of the wire inserted through the one nearest the centre. The bobbin is then mounted in the lathe or on the end of a little polishing head, and a reel of fine-gauge, enamelled copper wire, about No. 44 gauge, is supported by a rod held between the two hands and its rotation checked by pressure of the second and third fingers of the right hand.

If now the polishing head be treadled so that it revolves backwards, the wire is speedily wound on to the bobbin. Care

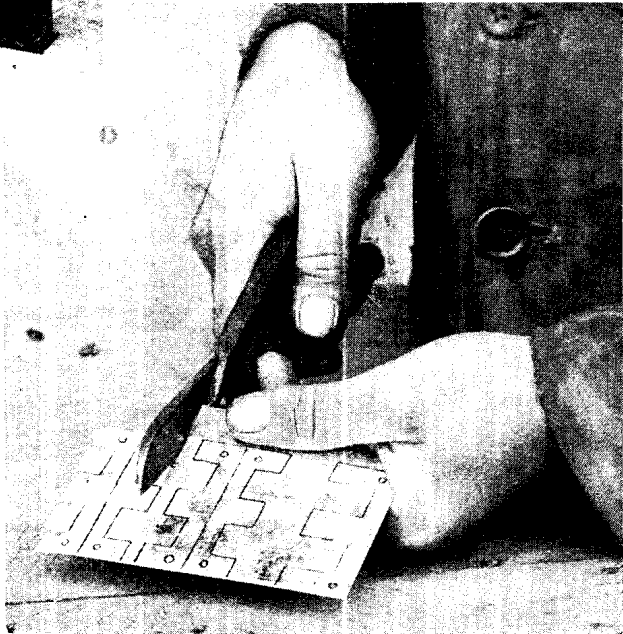

SHAPING LAMINATIONS

Fig. 11. Cutting out the laminations to be used in the transformer may be accomplished with the aid of ordinary tinman's snips, used as shown in the photograph

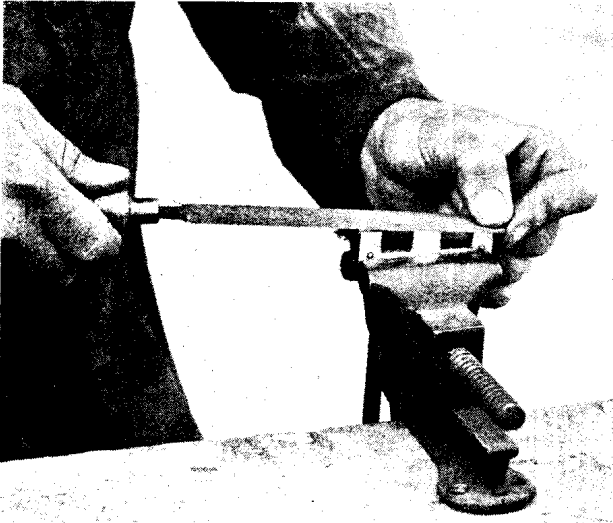

FILING THE LAMINATIONS

Fig. 12. Shows the manner in which the laminations of an audio-frequency transformer are filed to size and shape. They are temporarily held together with soft iron or copper rivets

must be taken, however, to check the speed of the spool with the fingers, so that it does not unroll too quickly, and so that a slight regular tension is maintained on the wire. This is best accomplished by

resting the hands on the edge of the bench or on the top of the machine in the manner illustrated in Fig. 13. can be wound as before described. The winding is continued as regularly and evenly as possible until the bobbin is completely full. The exterior is then covered with similar insulating material,

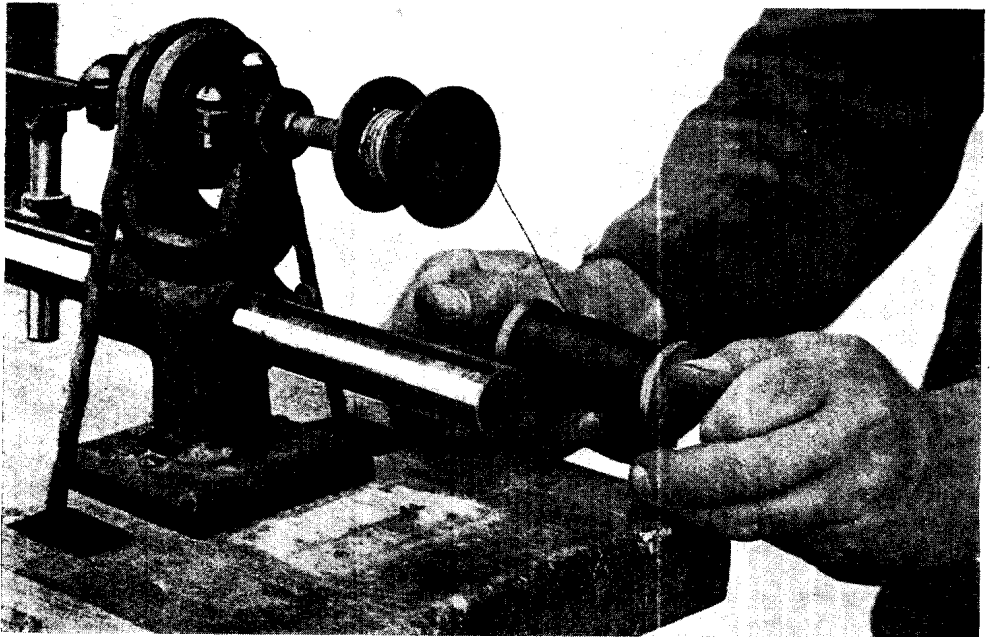

WINDING THE BOBBIN OF THE AUDIO-FREQUENCY TRANSFORMER

Fig. 13. For the purpose of winding the bobbin a small polishing head is employed. In order to regulate the tension of the wire, and to hold the reel steady, the operator is supporting his hands on the bench while holding the spindle of the reel, his thumbs being used as a brake

resting the hands on the edge of the bench or on the top of the machine in the manner illustrated in Fig. 13.

When sufficient of the wire has been wound for the primary, it is passed through the second hole on the side of the bobbin for a distance of about 3 in. and strengthened by soldering to it a few strands of slightly thicker wire, as in Fig. 14. This primary winding has to be covered with a strip of insulating material, such as impregnated paper, empire cloth, or the like. On the top of this a secondary winding is wound.

This is commenced by passing the wire through the flange of the bobbin and rotating it gently by hand for two or three turns until the wire has tightened up nicely, when it

can be wound as before described. The winding is continued as regularly and evenly as possible until the bobbin is completely full. The exterior is then covered with similar insulating material,

after the end of the wire has been brought through the hole in the flange of the bobbin and reinforced as before.

Now prepare four uprights or side supports, making these from brass strip $\frac{3}{8}$ in. long, $\frac{3}{8}$ in. wide and $\frac{1}{16}$ in. thick. Holes are drilled in one end for the holding down screws and on the other for the binding screws, which are No. 7 B.A. brass screws with round heads. One pair of plates have clearance holes and the other tapped holes. The screws are passed through the clearance holes and screwed into those on the opposite side.

To assemble the transformer, lay the iron core and the plates, one on top of the other (Fig. 15), alternating a full width with a narrow one, until half of them have been used up. Prepare the second bank in the same way, insert the bobbin over the centre core, and bring the other set of plates into position, interleaving them so that they make proper contact and assume the correct position. Screw the side supports into place and attach the terminal bar to the top.

This is made from ebonite, $\frac{3}{8}$ in. thick, $\frac{1}{2}$ in. deep and $2\frac{3}{4}$ in. long. It is held in place by the two upper binding screws, and

is provided with four terminals, two of them on one side and the other two on the opposite side. The ends of the primary winding are attached to one side by clamping them beneath the clamp nuts, and the secondary to the other side. The terminals are distinguished by the letters P₁, P₂ for the primary, and S₁, S₂ for the secondary, marking the commencement of both windings, the figure 1 distinguishing them subsequently. To reduce

eddy current effects, the binding screws should be coated with insulating varnish.

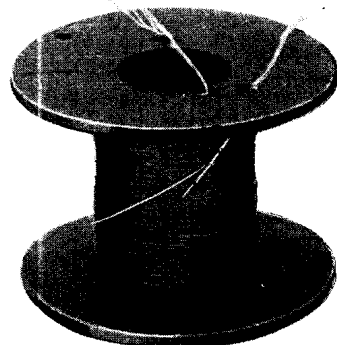

PRIMARY WINDING

Fig. 14. The primary winding is shown in place on the bobbin. After the ends of the wire have been passed through the holes in the bobbin, a few strands of thicker gauge wire are soldered on to hold the winding in position

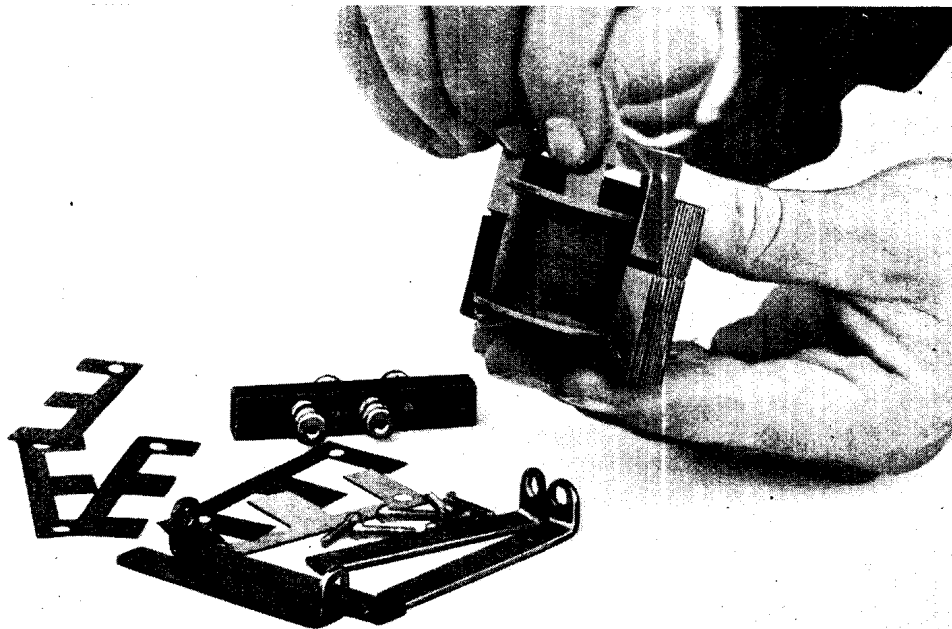

ASSEMBLING THE PARTS OF THE HOME-MADE AUDIO-FREQUENCY TRANSFORMER

Fig. 15. In the operator's right hand will be seen one of the laminations being placed in position. At this stage the making of the transformer is nearly complete, for the assembling of the parts is a simple process. The whole task of building up should be accomplished in one operation, and all the components should be made and ready for putting together before commencing the final process

AUDION. This is the name given by Dr. Lee de Forest to the three-electrode valve which he invented. De Forest began experimenting with the properties of Bunsen flame relays in 1900, and this led to the invention of his two-electrode



AUDION VALVE

The Audion or three-electrode valve, invented by Dr. Lee de Forest, is shown in an Ediswan type

grid circuit were inductively coupled with the plate circuit of the valve, the Audion became a generator of continuous undamped oscillations.

The photograph shows the three-electrode valve as manufactured by the Ediswan Electric Co., Ltd. The grid, plate, and filament are all first mounted on the glass stem through which the wires are led to the valve legs. The bulb is sealed at one end to this stem and at the other to a small glass tube, through which the valve is exhausted. In another form of Audion valve there is a long hairpin filament which functions with a current of one ampere on 2.2 volts. The grid is of fine wire open mesh and the plate of crinkled nickel sheet. See Valve.

valve. He was led to the invention of the now all-important three-electrode valve by considering how he could separate the aerial circuit, with its high-frequency currents, from the telephone circuit, with its low-frequency or radio-frequency currents. In his first attempts to produce the three-electrode valve de Forest placed the grid outside the valve, but a very little later he realized the importance of placing it within the valve between the plate and the filament. His first grid consisted of a perforated cylinder or plate, but the modern three-electrode valve usually uses a spiral of wire. In 1912 the discovery was made by de

Forest that if the

AUSTRAL POLE. This is a French term which is occasionally used to denote the south pole of a magnet. See Magnet.

AUTO-CAPACITY COUPLING. This term is used for the coupling between two oscillatory systems due to a condenser common to both. See Condenser.

AUTO-CUT-OUT. An automatic cut-out, in electrical engineering, is any device which will break the flow of current in a circuit should its value or direction change. A cut-out may be made to operate by a change in a mechanical force, by a temperature difference, or electrically by an alteration in the pull of an electro-magnet.

A cut-out may be arranged to work on an overload or a reversal of the direction of the current. No-load switches are devices which operate when the load is temporarily interrupted.

The simplest form of cut-out is the fuse. Any given wire will carry only a certain current strength (amperage) without overheating to an extent which will fuse that wire. Special wires of metals or alloys, such as tin and lead and their combinations, which fuse at comparatively low temperatures, are used. Their sizes are stated in terms of the amperage at which they will fuse and break the circuit. A "5-amp." fuse will melt and cut out the circuit when a strength of 5 amperes has been reached. If several strands of this wire are employed, the fusing point will be increased in direct proportion to the number of strands; two, for example, will raise the cut-out to 10 amperes.

Fuses have a time element. A momentary overload would not affect them, the analogy being the rapid insertion and withdrawal of a poker in a white hot fire. The poker would require to be in the fire a certain length of time to make it red or white hot.

With heavy currents fuses are fitted inside an asbestos covering. This prevents the molten metal splashing about when they "blow." Mechanical cut-outs are not used to any extent. It would, however, be quite feasible, should occasion require, to arrange a cut-out operated by a fly-ball governor on a rotating machine which would at a predetermined speed actuate an electrical switch. When such a device is employed the switch should have a spring-trigger action. A contact which cuts cut gradually is likely to arc (*i.e.* create an electric flame) badly and

burn the contacts. A cut-out of this kind could be made to operate by air or fluid pressure, for instance, as in the case of a compressing plant driven by an electric motor where the latter is required to be stopped when the maximum pressure required is attained. The rapid trigger action of the cut-out switch is again necessary to prevent arcing.

The type of automatic cut-out in general use is that employed to protect the secondary battery and dynamo of a charging set. When running, the dynamo is impressing a voltage higher in value and opposite in direction (polarity) on the accumulator. Should the motive power fail and the speed of the generator fall, the battery would push a current back through the dynamo and tend to work it as a motor. Virtually, what is the back electro-motive force of the system would become the forward electro-motive force.

The dynamo, because it is coupled to the engine which has failed, may not be able to rotate, and the cell voltage would have no resisting voltage or "back E.M.F." A large current would therefore flow and serious and permanent damage accrue to both cells and dynamo. An automatic cut-out would, however, immediately act and prevent such an occurrence.

The photograph shows a typical instrument. The action is magnetic, the energy being obtained by passing the main circuit through the coils of an electro-magnet.

Between the poles of the electro-magnet is arranged a short "permanent" bar magnet held in a brass arm and pivoted by a spring as shown. At the other end of the arm is fitted a contact strip. This, when depressed, makes a cross connexion between the mercury-filled contact cups.

If the dynamo voltage fails the current tends to pass back from the accumulator to the machine and makes the right-hand pole piece of the electro-magnet opposite to that of the adjacent end of the swinging permanent magnet. It is consequently drawn down and the contact raised out of the mercury cups, breaking the contacts and stopping all flow of current. When, as in normal working, the dynamo voltage exceeds that of the accumulator, the direction of the current is the reverse. The left-hand cut-out pole pieces, being of N polarity, draw the S end of the permanent magnet down, the contacts then dipping into the mercury and closing the charging circuit.

A reversal of the current would change the left-hand pole to S and repel the magnet, while a no-load would render the pole pieces inert. The spring would then lift the contacts out of the cups.

Ordinarily, mercury switches are objectionable, but in this instance the instrument may be adjusted to work on quite a small variation of voltage. The current passing through the contacts is therefore small, and the arcing at the moment of breaking the circuit is not dangerously large.

The adjustment of the point of cut-out is effected by the spring. This is attached to a long adjusting spindle, and its value may be altered by altering the length of the spindle, screwing it up or down as required.

Other forms of cut-outs or circuit breakers are employed for special purposes, but usually they are one of two generic types, *i.e.* overload or reverse current auto-switches. In some the magnet is of the solenoid type. The moving armature in the solenoid coil may be arranged to give a smart blow to a release trigger. This trigger trips a spring-loaded switch and effects a quick-acting break in the

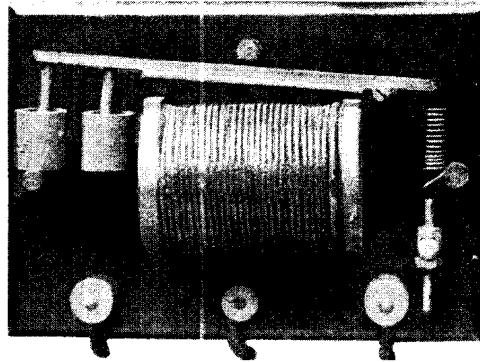

AUTOMATIC CUT-OUT

The photograph shows a typical auto-cut-out with mercury-filled contact cups seen on the left

circuit. Where a reverse current has to be contended with the instrument must be polarized, *i.e.* one of its components must be a permanent magnet of fixed polarity or its equivalent. Such switches will then work on the principle that unlike poles attract and like poles repel. The auto-switch illustrated is a polarized one, as it embodies the two functions, *i.e.* it is

sensitive to both an overload and a reversal of current.

Where the cut-out is in series in the main circuit, the wire must be sufficiently thick to take the full current. Very often such a winding is simply a coil of heavy bare copper rod, like a spiral spring.

AUTODYNE or Auto-Heterodyne A receiving device in which one valve generates the local oscillations required for beat reception in addition to performing some other function, such as amplification or detection.

The general principle of heterodyne working is that of producing beats or interference between two sets of oscillations or waves of slightly different frequencies. Signals from a distant transmitter are the origin of one set of oscillations, while the other set of oscillations is generated locally at the receiving end. It is necessary to arrange that the frequency of the two sets of oscillations shall both lie outside the range of audibility under ordinary conditions, in order that only the "beat" frequency may be heard.

For heterodyne reception it is usual to let the generator of local oscillations take the form of the ordinary three-electrode valve, as the oscillation frequency is easily under control and within fairly wide limits. Instead, however, of employing two separate valves, one as a detector and the other as a generator of local oscillations, it is quite possible to combine the two functions in one valve, which arrangement is known as autodyne, self-heterodyne, or auto-heterodyne reception.

A circuit of this nature is shown in Fig. 1, where C_1 and L_1 are tuned to a different frequency from the circuit C_2L_2 : the beat frequency is then determined by the difference between them. A small condenser connected between grid and plate electrodes may be advantageous. A great number of variations upon this circuit are possible, but all have the same object in view, namely, to combine the function of local generator and amplifier as well as that of detector in one valve. It is hardly possible

to say which is the best combination, this being a matter to be judged from locality and peculiarities of reception at the individual station concerned. The best condition for a combined heterodyning and detecting circuit is when the self-oscillation is not unduly powerful compared with the incoming signal, and this condition can usually be obtained by reducing the anode voltage until the changes in anode current are only just sufficient to maintain self-oscillation. The drawback of the autodyne circuit is that it must be thrown out of tune with the incoming signals, which are consequently weakened. The effect is very marked with long waves, and renders the use of separate heterodyning desirable for their reception. Another autodyne circuit is illustrated in Fig. 2.

Autodyne Reception. A practical lay-out for this method of reception is illustrated in Figs. 3 and 4, which show one of the simplest forms of circuit. Commencing with the high-tension battery to the right of the illustration, one wire from the positive terminal goes to one of the telephone terminals, and thence the circuit runs from the positive telephone terminal to one side of the reactance coil, and from this coil by another wire to the plate or anode terminal of the valve holder. The negative side of the high-tension battery is connected to the terminal wires. Branch leads are taken to one side of the fixed condenser to the positive side of the A battery and to the positive terminal for the filament connexions. These are passed

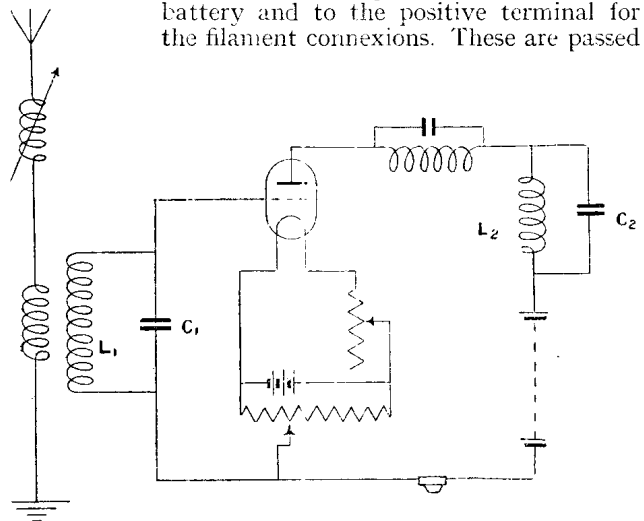

AUTO-HETERODYNE RECEPTION

Fig. 1. Connexions are shown in this diagram for wiring a circuit designed for reception on the auto-heterodyne principle, in which one valve performs two offices in "beat" reception

through the filament to the moving contact arm to the filament resistance wire and to the negative side of the A battery.

Another lead is taken from this wire to one side of the aerial tuning coil, otherwise it branches to earth and to one side of the variable tuning condenser. The fixed condenser circuit is

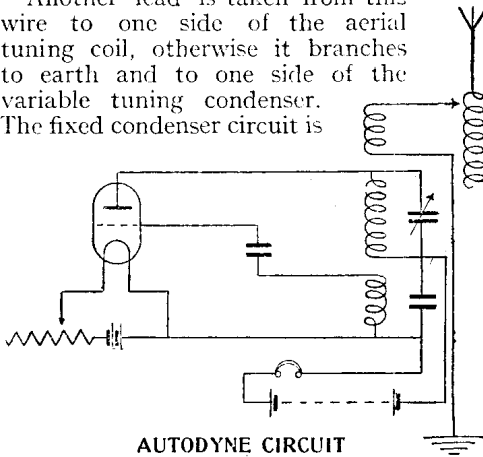

AUTODYNE CIRCUIT

Fig. 2. Many variations of design of circuit are possible in autodyne reception. Above is an example

completed by wiring from the other side of the condenser to the wire connecting the telephone terminal to the reactance coil. The grid circuit runs from the grid to the valve, to one side of the grid leak and condenser, and thence to one side of the aerial tuning coil. A branch lead is taken to the variable tuning condenser, and from the same terminal to the aerial lead.

AUTO-INDUCTIVE COUPLING. This term is used for a coupling between two oscillatory systems due to an inductance common to both. See Coupling; Loose Coupler.

AUTO-JIGGER. An oscillation transformer consists of a few turns of wire in the oscillatory circuit external to the condenser, and usually has a separate set of coils,

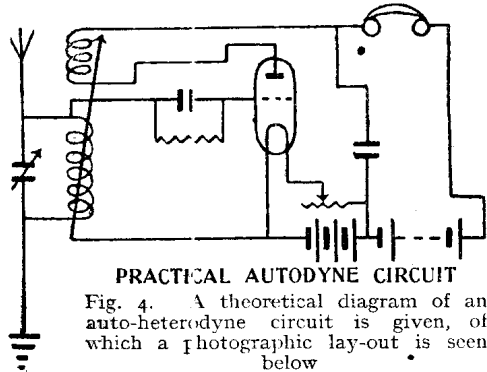

PRACTICAL AUTODYNE CIRCUIT

Fig. 4. A theoretical diagram of an auto-heterodyne circuit is given, of which a photographic lay-out is seen below

either wound directly over it or placed in some way that will allow of the second winding being brought nearer or farther from the first set of coils. Such coils are inductively coupled, and if the distance between the two is small they are said to be tightly coupled, whereas if large they are loosely coupled. Current is circulated through the primary of one of these coils

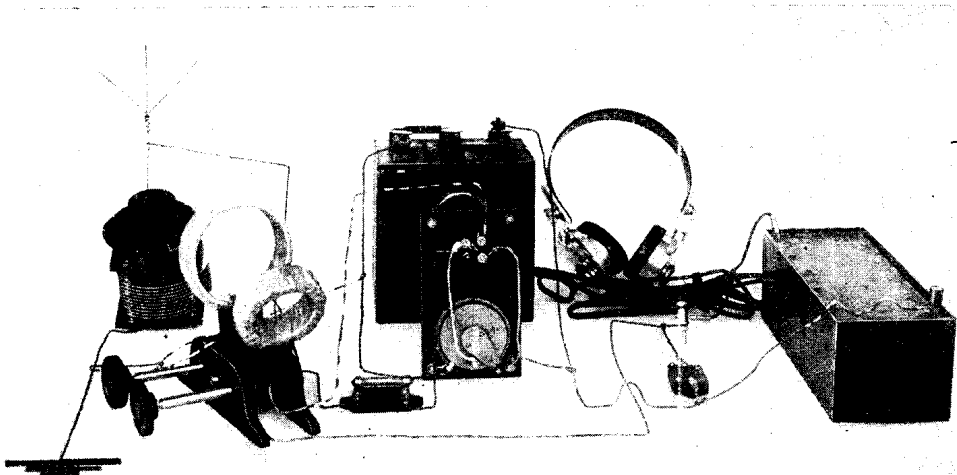

PHOTOGRAPHIC LAY-OUT OF AN EXPERIMENTAL AUTODYNE RECEIVER

Fig. 3. A bench lay-out for the experimenter is given in the photograph, and a careful examination will show the whole system of wiring. On the left, near the bottom, is a grid leak and condenser. Aerial and earth are represented in wire to give a clear idea of the position of the components in the circuit. This simple arrangement is given diagrammatically in Fig. 4, above

by the oscillatory discharge from the condenser, and acts inductively on the secondary coil. In certain cases, however, only one coil is used between the two circuits, one portion of it acting as a primary and the other portion as the secondary. When one part is common to both circuits like this, the circuits are said to be directly coupled, and the arrangement is called an auto-transformer or auto-jigger. See Direct Coupling.

AUTOMATIC INTERRUPTER. This is an electro-mechanical device to make or break an electric circuit by means of the energy passing through it. A typical application is the interrupter on a spark coil, one example of which is illustrated in Fig. 1, and shows the general disposition

This is accomplished by means of the moving or vibrating contact which, under the mechanical influence of a spring, is forced into contact with the contact post.

When, however, the current flows around the primary coil, it energizes the core, and this, by its magnetic property, attracts an iron strip or armature with sufficient force to cause it to overcome the tension of the spring and pull the contact points apart. This naturally interrupts the current flow, the magnetism ceases, and the spring is again able to press the contact points together, and the current again flows, with the same sequence of happenings. The speed at which this takes place depends on the design of the coil and also on the

relative strengths of the spring and the magnetic flux. The mechanical action of the spring is much more sluggish than the magnetic action of attraction, and it is thus possible to refer to a definite polarity in the secondary current.

There are numerous devices to effect this automatic make and break of the primary current. Some are detached and driven by a small motor or other source of power. The type illustrated is built on to the end of the coil winding case, which is made of hardwood, with an ebonite end plate, whereon are mounted the

components of the interrupter. The core, which is composed of a bundle of soft annealed iron wires, projects beyond the surface, and immediately

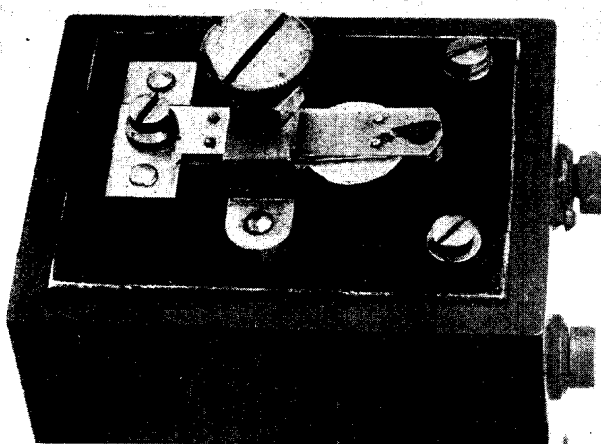

AUTOMATIC INTERRUPTER

Fig. 1. An example of a small but efficient type of interrupter, showing disposition of the parts, including soft iron armature

of the parts of which it is composed. The principal components are shown in Fig. 2, detached from the coil.

In a spark coil the usual arrangement is that of two coils of wire wound over a core of soft iron wires. The primary windings are insulated from the secondary, and a battery is connected with a condenser in the primary circuit. The secondary circuit leads to and from a spark gap. For the spark coil to function properly it has to be fed with an interrupted direct current, and it is the function of the interrupter to make and break the current automatically.

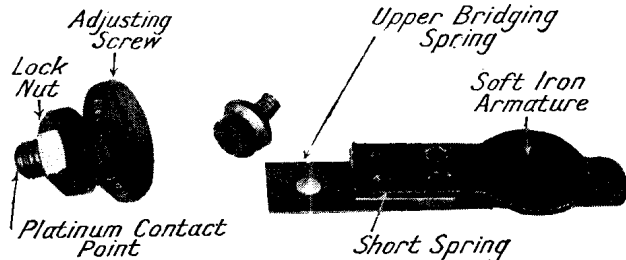

COMPONENTS OF AUTOMATIC INTERRUPTER

Fig. 2. Some of the parts of an automatic interrupter. These are the components of the make and break device

above it is located a soft iron plate attached to a short spring, which is in turn attached to a block of brass mounted somewhere about the centre of the upper spring. This rests on the top of an adjusting screw at one end, and at the other is screwed to a metal block which is connected to the primary circuit from the battery. On the upper side of this blade is a platinum contact point.

Mounted in a bridge-piece is an adjustable contact screw with a platinum contact point. To adjust the make and break, the contact screw has to be so positioned that when the current is not flowing, as when the switch is off, the contact points are in firm contact, but when the current flows the points can separate under the magnetic attraction of the core. The exact adjustment is rather critical to get the very best results; too wide a contact results in speedy pitting of the contact points, as sparking is likely to occur. If the adjustment is too close, the secondary current is diminished in strength. The points should be kept clean and in perfect

condition with the aid of a small magneto file or a trace of old and very smooth emery paper, as used by scientific instrument makers.

AUTO-RECEIVER. The problem of high-speed automatic transmission is intimately associated with the question of automatic reception, since aural reception at anything over about one hundred words per minute would be an impossibility. Automatically recorded signals or speech have the advantage of accuracy, and avoid mistakes in reception; the lasting and permanent record they afford is also another advantage.

Three methods are chiefly used: one is the use of the resonance intensifier with a Morse inker; another method employs a phonographic recorder; while the third records the signals by photographic means.

The photographic method is the most sensitive and rapid form of automatic reception, a beam of light being projected from a very powerful source of illumination, such as an electric arc, on to a mirror which is made responsive to the signals

in much the same way as the action of the well-known mirror galvanometer. This reflected beam of light falls upon a sensitized photographic strip or film moving along at a continuous rate, and the general arrangement of the apparatus is shown in the diagram, Fig. 1.

A fine gold thread is suspended loosely between the poles of a permanent magnet, and carries at its middle portion a tiny mirror, the reflecting face of which is

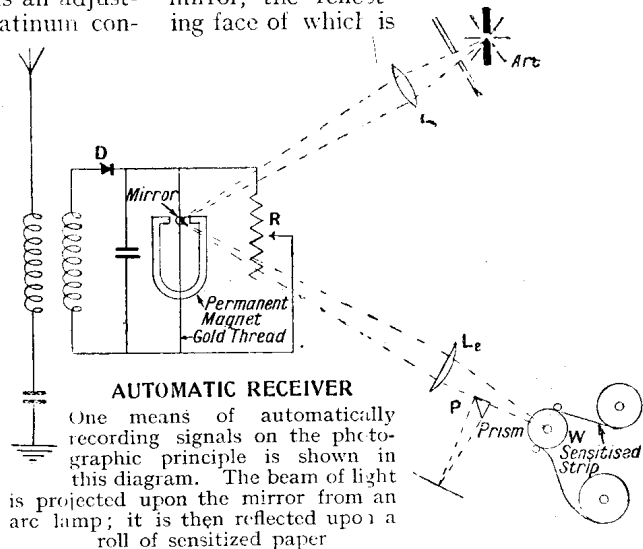

ground to a definite focus. The suspension thread is in series with the secondary coil of the receiving circuit and detector D.

When current, due to a signal, flows through this thread, a weak magnetic torque is experienced from the fact of the field due to the current-carrying thread and that due to the permanent magnet reacting upon one another. The mirror therefore undergoes a deflection, more or less pronounced according to the strength of the incoming signal. A beam of light from the arc is focussed upon the mirror by means of a lens, L_1 . This ray of light is, after reflection, again focussed by another lens, L_2 , on to the sensitized photographic strip wound upon the drum W, so making a record.

This strip is afterwards developed, in some cases automatically, in others by hand, and affords a permanent record of the movements of the mirror, due to the signals received. The prism P is placed so as to intercept and divert a small part of the reflected light on to a darkened screen,

the purpose being to keep a control upon the amplitude of the movements by means of the resistance R.

If the movements of the spot of light were too great, they would go right off the sensitized strip. To avoid disturbances of the galvanometer mirror from outside causes, such as vibration of air currents, it is usually mounted on a pneumatic cushion and enclosed in a draught-proof cover. The motor driving the drum which carries the sensitized strip is also controlled as to speed by means of another resistance, in order that the signals can be sufficiently separated without unduly wasting the film. Thirty yards of strip will suffice for about 200 words to be recorded.

The sensitive strips are made in sufficient lengths to last for about twenty minutes of continuous working, and in this regard the instrument has an advantage over the phonographic recorder.

In the latter method, a receiving telephone is acoustically coupled with a phonographic receiving trumpet. The phonograph is extremely sensitive, and the drum upon which the message is written is rotated by a small motor controlled by a regulating series resistance graduated in words per minute. The record receives at high speed the impression of the dots and dashes, and these can be translated by subsequently slowing down the speed and receiving the sounds at an audible frequency in the telephone. Each recording drum will contain 320 words, and if desired the message can be erased by a cutter and the drum used again.

AUTO-STARTER. The auto-starter is applied to single-phase and polyphase induction motors, and also to alternating current commutator motors, for starting purposes, in much the same way that graduated resistance is used for direct-current motor starting.

When a motor starts up from rest, an appreciable interval of time elapses before the armature or rotor attains full speed and is able to generate a counter electromotive force sufficient to prevent a heavy rush of current. The larger the armature the greater its inertia and the longer will it take in getting up speed. Unless means are taken to limit the starting current, it may cause disturbances along the transmission line, besides risking the motor windings or blowing the fuses.

Where direct-current motors are concerned, the field coils are first of all fully excited, and the armature circuit then closed through a series resistance of sufficient ohms to limit the starting current to approximately 50 per cent of full load

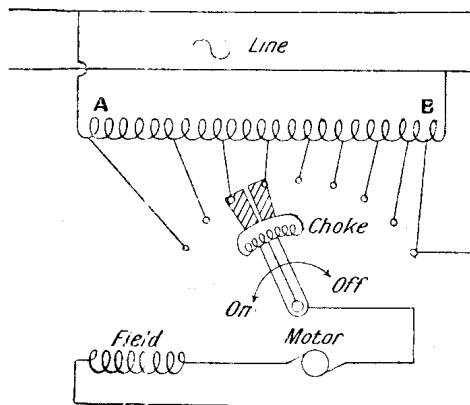

AUTO-STARTER FOR ALTERNATING MOTORS
 Fig. 1. Connexions are shown of a single-phase commutator with auto-starter

running current. As the motor speeds up, the series resistance is gradually cut out of the armature circuit, and when at full speed the resistance is all cut out.

A considerable loss of energy is unavoidable in starting by this means, which can largely be overcome in the case of alternating current motors, because the line voltage can be very easily changed to a lower value without appreciable loss of efficiency by means of a transformer. The losses in a series starting resistance are proportional to the square of the current multiplied by its ohms, whereas the losses in a transformer are negligible by comparison, consisting only of a few watts spent in heating up the copper windings and a small iron loss by hysteresis.

The auto-transformer or single-coil transformer is generally employed for starting purposes. Its application, in the case of a series-wound alternating commutator motor, is shown in Fig. 1. The terminals of the auto-transformer coil, A and B, are connected directly across the line, and the potential falls regularly from one end to the other. If, therefore, one terminal of the motor is connected to A and the other to a sliding contact which can include a progressive number of turns of the winding, the volts applied at the

motor terminals will rise progressively as the motor speeds up, and prevent the line current from assuming abnormal values.

A small choking coil is included, to avoid the short-circuit current between two contacts which might come under the switch arm at the same time assuming dangerous proportions. Auto-transformers, with multiple tapplings to the secondary, are somewhat expensive to produce, and the tapping points are, therefore, generally limited to one or two at the most.

Fig. 2 represents the connexions of a three-phase induction motor, with an auto-transformer starter in each phase. The change-over switch is placed on the bottom contacts on starting, and takes something less than full-line voltage, according to the ratio of the number of turns included in the tapping point to the full number of turns in the transformer winding. The exact tapping point is a matter to be decided by trial, and will vary with individual motors, according to the starting torque required. When full speed is attained the switch is thrown over to the top set of contacts, which is the running position, and the auto-transformer then carries only the very small magnetizing current taken by the primary windings, which are otherwise unloaded.

AUTO-TRANSFORMER. The voltages of circuits conveying pulsating, oscillatory, or, as generally termed, "alternating" currents can be easily and conveniently varied by appliances known under the class heading of transformers. When applied to direct current circuits they are termed rotary transformers. On alternating circuits they are static transformers. Both classes of instruments depend on the same general principles, that is to say, they depend for their action upon the mutual interaction between electric and magnetic circuits, although they may take entirely different forms.

The essential conditions for transformation are (1) a magnetic circuit, (2) an electric circuit, and (3) motion between the two. In the rotary transformer as used with direct current voltage transformation, the electric circuit moves within a fixed magnetic field. In the static transformer it is the magnetic circuit which moves across a stationary electric circuit. The absence of visibly moving parts gives the latter instrument its name of static transformer.

The electro-motive force generated in the coils of any transformer follows the same laws as those governing dynamo design. that is to say, the electro-motive force is proportional to the length of wire (or number of turns), to the strength of the field and to the velocity of movement. If the alternating or oscillating magnetic flux therefore has a definite strength and frequency, the electro-motive force in the transformer coils will vary directly as the number of turns in the two windings, primary and secondary, on the transformer core. Both the windings being on the same core, they both come under the influence of the same pulsating magnetic

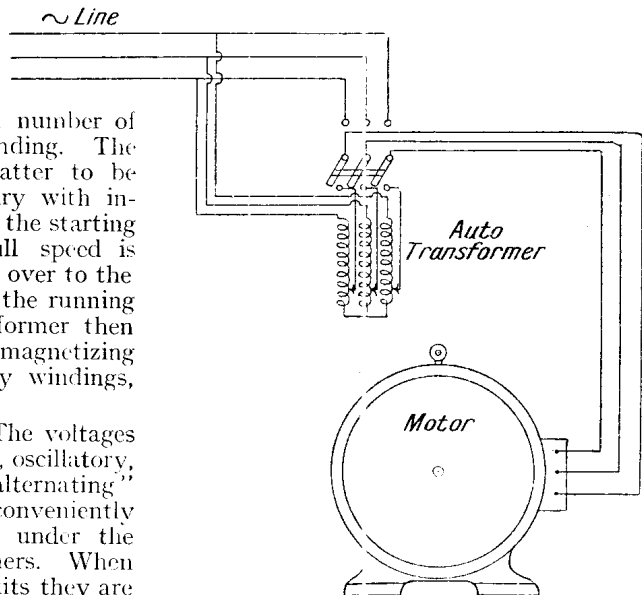

AUTO-STARTER AND MOTOR

Fig. 2. Connexions of an auto-starter to a 3-phase induction motor are shown with an auto-transformer starter for each phase

field, and consequently the electro-motive force generated in the two coils will be in direct ratio to their respective number of turns.

In Fig. 1, for instance, the laminated iron core A forms a closed magnetic circuit, the magnetic leakage of which may be counted negligible, and consequently the same number of magnetic lines may be assumed to pass through the coil B as through the coil C. If the magnetic oscillations are of such strength and frequency as to generate a machine voltage of 100 in coil B, containing, say,

100 turns, the volts generated in C, consisting, say, of 50 turns, will simply be proportional to the ratio of B to C—that is, 50 volts—and if a supply of current is required at any other pressure than that on the primary it can easily be stepped up or stepped down, according to whether the secondary coil for the transformer has a greater number or fewer turns than the primary.

The point in which the auto-transformer differs from the ordinary static transformer

proportions as the difference in the turns. The two cases are illustrated in Figs. 4 and 5.

Transformers with iron cases are for use with low-frequency currents only. The extremely high-frequency oscillations due to current from a condenser discharge would not permit the iron case to respond rapidly enough so far as magnetic effects are concerned, and much power would be wasted in hysteresis. Iron core transformers, therefore, are only serviceable for ordinary commercial and audio-frequencies,

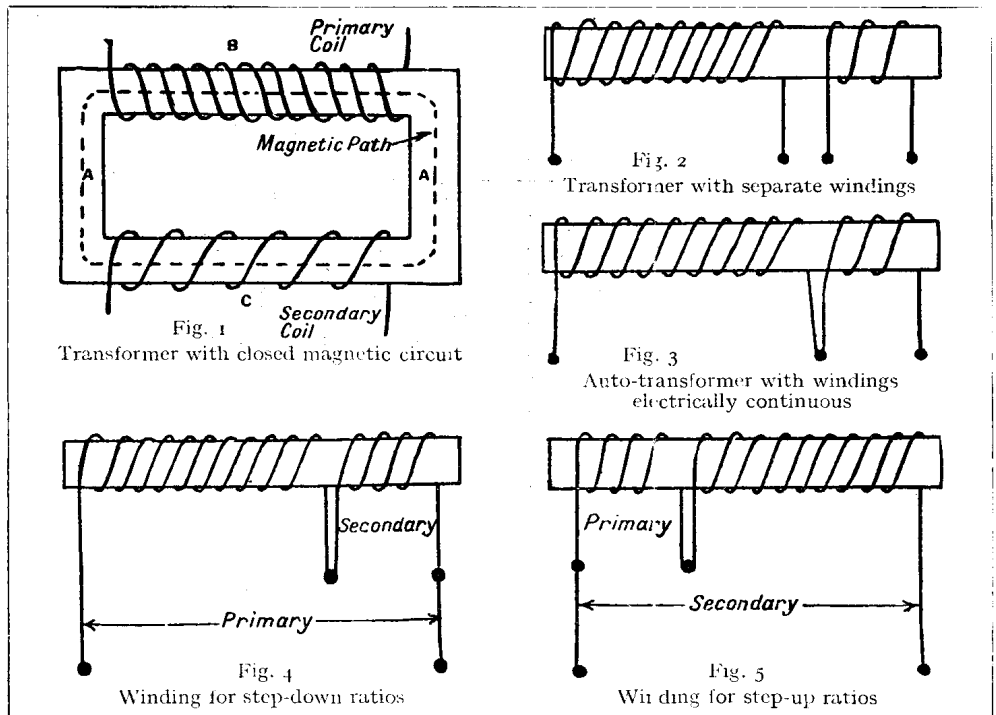

DIAGRAMMATIC REPRESENTATIONS OF THE PRINCIPLES OF AUTO-TRANSFORMER WINDINGS

lies in the electrical circuit. In the ordinary double-wound transformer the two windings, primary and secondary, are quite distinct and electrically separated from one another, as in Fig. 2.

In the auto-transformers the two windings are electrically continuous, as in Fig. 3. In the latter, the primary would include the whole of the winding for a step-down ratio, the secondary being taken from any two intermediate points whose included turns are equal to the fraction that is required of the primary voltage. For step-up ratios the primary would be connected across a portion only of the total turns, and the secondary potential will then be higher than the primary in the same

air-core transformers being employed for high-frequency or radio-frequency oscillations. See Transformer.

AUTO-TRANSFORMER COUPLING.

Method of coupling two synchronized electrical circuits. Fig. 1 shows the theoretical auto-transformer coupling circuit. The inductance coil is connected to the aerial on one side and the earth on the other, and to a closed circuit. Now, if the inductance and capacity of the open aerial-earth circuit are L and C, respectively, and those of the closed circuit L_1 and C_1 , the circuits are in tune with one another if

$$LC = L_1 C_1$$

When such a condition of affairs occurs the current displacement on the aerial

current is a maximum for the given energy used in the closed circuit, and the aerial oscillations persist for a longer period than if the two circuits were not tuned together.

The lay-out of a typical set of parts for such a circuit is illustrated in Fig. 2, and comprises a two-slider tuning inductance, one of the sliders being connected to the aerial circuit, the other to one side of the fixed condenser. One end of the inductance winding is connected to the aerial. From the opposite side of the fixed condenser a wire is taken to the spark gap, and thence by a branch lead to the high-voltage circuit. The other side of the spark gap is similarly connected to the high-voltage circuit, and also to the aerial.

The instruments shown in the photographic diagram, Fig. 2, are intended to illustrate the principle of auto-transformer coupling. In practice, apparatus of a different size and design would be used, but its function and purposes are identical.

AUTOMATIC TRANSMITTER. High-speed automatic transmitting apparatus for wireless is now quite a practicable proposition, and nearly every wireless company has its own particular form of high-speed transmitter. In the main the principles are the same with all types, differences being those of detail only.

Automatic transmitters have a wide field of application, and a speed of 100 words per minute or more is now quite possible between land stations. Various types of Wheatstone transmitters are generally used, working upon the weight-driven or motor-driven principle, and operating intermediate relays to interrupt transmission, while the corresponding reception is carried out by either a photographic or phonographic receiving apparatus, one

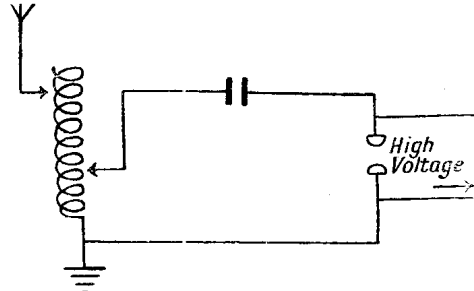

AUTO-TRANSFORMER COUPLING

Fig. 1. A simple theoretical diagram showing the auto-transformer coupling circuit

form of which is described below. This apparatus is in reality a special form of double current transmitter, in which the moving parts are rotary instead of reciprocating, as is more customary.

The motor, M, shown in the diagram supplies the driving power, and the rotary transmitter functions in very much the same manner as the ordinary Wheatstone apparatus, sending marking and spacing currents to the wireless relay under the control of a perforated strip. Instead of two reciprocating needles which enter the holes of the perforated strip, however, two contact springs, S_1 and S_2 , are arranged side by side and alternately drop into the holes in the strip, one contact spring being slightly in advance of the other.

In place of the ordinary reverser or compound contact there will be found a polarized relay, which is operated by the charging or the discharging current of a condenser under the control of the springs S_1 and S_2 in the

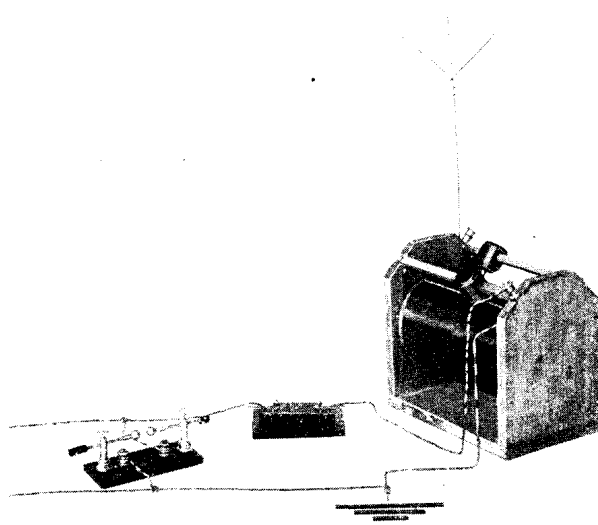

PRINCIPLE OF AUTO-TRANSFORMER COUPLING

Fig. 2. This photographic lay-out should be compared with the diagram in Fig. 1. The principle of auto-transformer coupling only is illustrated

holders *a* and *b* by means of a commutator fixed on the motor shaft seen to the right of the motor in the diagram. Directly the marking spring S_1 drops through one of the holes in the perforated strip the rectified current, as distributed by the commutator, brings up the armature of the relay to the spacing spring S_2 , and so charges the condenser.

At this stage the commutator connects the relay to the spacing spring contact, and immediately one of the spacing holes in the strip allows the spring to drop and make contact with the condenser, discharges itself, and throws the armature of the relay over to the spacing contact. Once in each revolution of the motor the strip travels forward by the distance separating the two guiding holes in the strip, and the charging and the discharging connexions are made automatically by the commutator at intervals of one-half a revolution for a period of one-quarter of a revolution. The speed of the motor, and the transmitting speed of the apparatus as a consequence, is variable and under the control of the two rheostats, R_1 and R_3 . Also, there is an automatic governor brake attached to the motor shaft itself.

For very high speeds a further rheostat, R_2 , is inserted between the two terminals, F, F. The working of the relay is found to be quite reliable and satisfactory even with fairly heavy currents, and it is not too susceptible to very fine adjustment. The terminals, A, M, and R are provided for ordinary key transmission should it be desired, and the apparatus is changed over from automatic to key or hand operation by means of a switch, in which case the motor requires to be short-circuited by means of the link shown.

Current from the polarized relay passes from the terminals, L, B, to the intermediate relay (1), working from the direct current supply, the pressure of which is reduced by the resistances R_1 and R_2 . A second relay (2) is

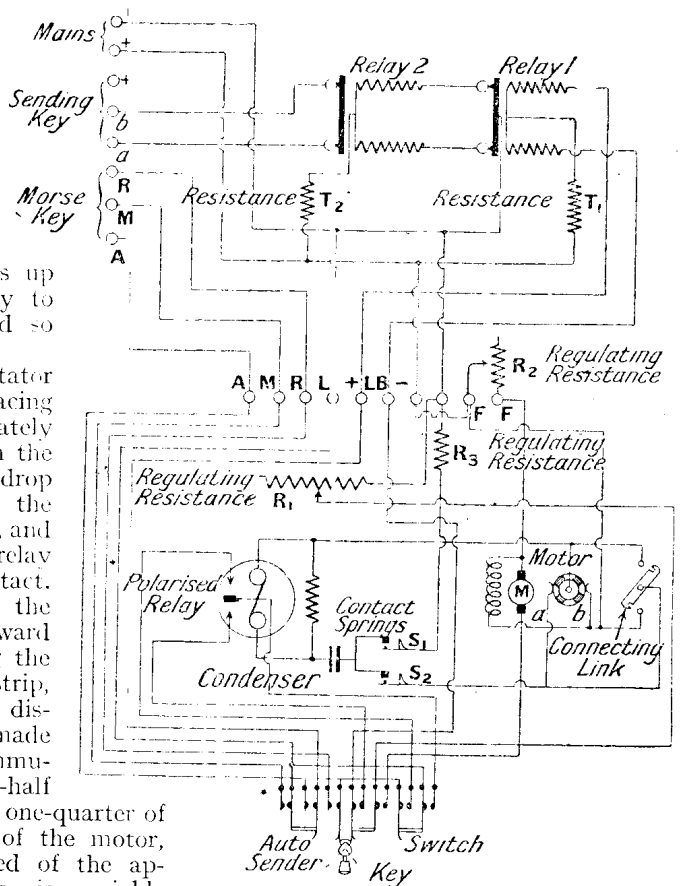

AUTOMATIC TRANSMITTER CIRCUIT

This type of transmitter works in a manner similar to the Wheatstone apparatus. It works upon a motor-driven principle, operating intermediate relays to interrupt transmission

then actuated, and from this the normal wireless relay of the wireless transmitter.

The success of the whole apparatus depends upon the design of the relays, which must not only be able to carry heavy currents and of a robust nature both electrically and mechanically, but they must also have very little inertia, in order to be able to follow with sufficient rapidity the high-speed transmission. In the Hovland typewriting apparatus, transmission of messages is accomplished by operating a keyboard similar to an ordinary typewriter.

Messages can be sent either in printed character, Morse, or code, and by means of a "cryptograph" attachment, included in the apparatus, two or more stations can be

set to a common combination, while all others will receive only a meaningless mixture of letters or signals. A rotating contact closes the transmitting relay circuit for periods determined by the dots and dashes of the depressed type key.

All receiving stations adjusted to the same combination as that of the sending station will then receive the decoded signal. The translation of the ordinary written message to code and back again is thus freed from error, and becomes perfectly automatic in action. An expert operator can transmit from 60 to 100 words per minute by means of this apparatus, while the range of operation depends merely upon the working range of the wireless equipment. It is a valuable device where secrecy is essential, and saves time in coding and decoding messages.

An example of auto transmitting is the great wireless station at Sainte Assise, some twenty-five miles from Paris. The station contains a high-frequency power plant consisting of four groups of motor-driven alternators. All the machines can be connected in parallel, so as to add to their power when long distances are to be covered. Wavelength is controlled by the speed of the generators.

Messages are sent out, by means of automatic control, from Paris. The wires coming into the Sainte Assise station are connected to high-speed relays, whose local circuit controls larger relays, and these serve to operate the switching apparatus for working between the wireless alternator circuits and the aerial.

The receiving plant is some miles from that for transmitting, and receiving is carried out by means of large wire coils or loops mounted upon movable frames.

operated in connexion with improved tuning apparatus in a metal cage. Messages are received by the photographic method with a spot light and sensitized paper strip. From Paris messages are sent out by high-speed transmitters, so that 36,000 words an hour may be reached.

B

B.A. SCREW THREADS. The B.A. screw thread comprises a range of sizes of small screw threads designed for instruments and the finer mechanical appliances. The sizes are in fractions of an inch, to the nearest one-thousandth of an inch, and are numbered from No. 0 to No. 25, the larger number representing the smallest diameter of screw in the series. In ordinary practice, the sizes from No. 0 to No. 10 are mostly used. Electricians use all.

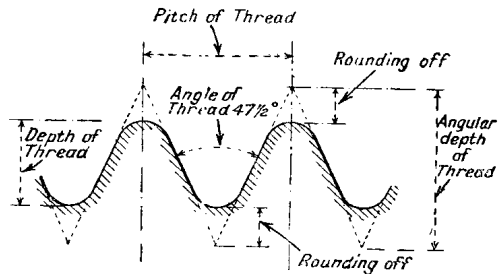

SCREW THREADS

Fig. 1. Characteristics of the B.A. screw thread with the angles at which the thread is cut, are shown also the pitch of the thread and depth

The form of the British Association thread is rounded at the root and tip, like the Whitworth, but rather more so in proportion to the pitch. The angle, instead of being 55 deg., is 47½ deg., as

B.A. SCREW THREADS AND TAPPING SIZES.									
B.A. NO.	DIAMETER OVER TOP OF THREAD.		DIAMETER AT BOTTOM OF THREAD.	SIZE OR MORSE NO. OF TAPPING DRILL.	CLEARANCE SIZE OF DRILL.	PITCH OF THREAD.	B.A. NO.	NEAREST FRACTIONAL INCH SIZE.	
	IN.	M/M.	INCHES.			M/M.			
0	.236	6.0	.1887	No. 12	6 m/m.	1.0	0	1/16"	bare.
1	.209	5.3	.1665	No. 19	No. 3	.9	1	3/32"	bare.
2	.185	4.7	.1467	No. 26	1/16 in.	.81	2	1/8"	full.
3	.161	4.10	.1266	No. 30	No. 10	.73	3	3/16"	full.
4	.142	3.6	.1108	No. 34	No. 27	.66	4	5/16"	bare.
5	.126	3.2	.0981	No. 40	No. 30	.59	5	3/8"	full.
6	.11	2.8	.0849	No. 44	No. 34	.53	6	7/16"	full.
7	.098	2.5	.0753	No. 48	No. 39	.48	7	1/2"	bare.
8	.087	2.2	.0657	No. 51	No. 43	.43	8	5/8"	full.
9	.075	1.9	.0565	No. 53	No. 48	.39	9	3/4"	bare.
10	.067	1.7	.0504	No. 55	No. 50	.35	10	7/8"	full.

shown in the diagram, Fig. 1. The table on page 179 gives all particulars of the sizes between No. 0 and No. 10, the useful sizes, in decimals of an inch and millimetres, and also includes the tapping size drills and those which should be used for clearing the tops of the threads.

While the B.A. screw threads are strongly recommended for all small work, it is not absolutely necessary, in the average case, to purchase dies and taps for anything but the even sizes from No. 2 to No. 10. For the $\frac{1}{4}$ in. diameter either Whitworth or the British standard fine (B.S.F.) threads may be used.

Only the best English and American grades of taps and dies should be purchased if accurate work is desired. Round, split dies are to be recommended, as with these a slight adjustment in the fit of screws can be obtained, as shown in Fig. 2. Screwing down the middle pointed screw into the split portion opens the die and increases the diameter of the cutting edges. The two side screws will close the die if the middle is withdrawn, and reduce the diameter of the thread cut.

With regard to the tapping sizes, the drills used are not the fractional inch or millimetre sizes, but those made under the Morse sizes and numbered. The larger the number, the smaller the size.

It is not possible to screw-cut B.A. threads on an English lathe with a lead screw of a fractional inch pitch without

applying a change wheel which will convert the pitch into a metrical one. The best thing to do if B.A. threads are to be cut is to have the lathe fitted with a metric lead screw, as the pitches of the B.A. threads are of regular metrical dimensions.

The clearing sizes given in the table of dimensions are arranged for the best work. Fits which allow much clearance between the hole and the screw may be adopted where greater freedom is desirable, or in cases where the work is not so important. See Nuts; Screws.

Ba. This is the chemical symbol for the metallic element barium (*q.v.*).

BACK COUPLING. Another term for a reactance coil. In a combined amplifier and heterodyne for continuous waves, for example, a back-coupling coil couples the plate circuit of the valve to the grid circuit. Any oscillations set up in the plate circuit cause high-frequency changes in the current through the back coupling, which will maintain self-oscillation in the grid circuit if the coupling is sufficiently tight. See Reactance Coil.

BACK E.M.F. Opposing electro-motive force. It is analogous to the resistance of a spiral spring which is being compressed by a force applied by the hand. It therefore may be considered as a resisting electro-motive force (E.M.F.) in an electrical machine to which is being applied an outside electro-motive force. The

latter term, it must also be understood, is synonymous with volts, voltage, and electrical pressure, and does not represent the quantity of electricity in a circuit. It is the force which pushes the current through against any resistance in the system.

The effects of back E.M.F. are observed in dynamos and motors. A dynamo generates a current when rotated, the pressure, E.M.F., or voltage of such current depending on the speed of the machine. If a current of similar value is applied to the same machine it will revolve at approximately the same speed as that at which it was driven to produce a current of the given voltage. The dynamo is then acting as an electro-motor. Under such

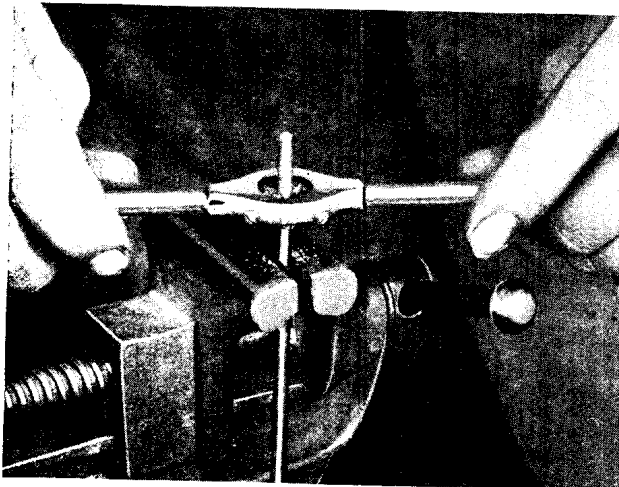

MAKING A THREAD

Fig. 2. An operation is shown in progress during the cutting of B.A. thread on a brass rod. Note the adjusting screws of the die, which allow an increase or decrease in the diameter of the thread cut

conditions, that is to say, with the machine working as a motor, it will be found that the current supplied will be reduced in strength as the speed rises. This may be explained by the fact that the voltage shown to have been produced at its terminals at a given speed, when acting as a dynamo, is being produced at that speed when it is being supplied by electricity from an outside source, say a battery or accumulator, and is resisting the inflow current. This opposing voltage is, therefore, called the back E.M.F.

It will also be noticed, if suitable instruments are introduced in the circuits, that while at rest the motor takes much more current than when it is allowed to revolve. The only resistance under stationary conditions is the normal resistance of the wires in the machine, which is relatively very low, and the amount of current the applied voltage will force through will be high. As the speed rises, the consumption of current will fall, showing that something is impeding it. This is the effect of the back E.M.F., created by the rotation and by the motor acting as a dynamo. At the full speed, running light, the motor will only take a very small amount of current. When loaded up at this speed, the additional current it will consume will be comparable with that load.

Back E.M.F. is a function observed in electrical machines and instruments other than dynamos and motors. It may be observed in any piece of electrical apparatus to which a current is applied, and in which, due to mechanical or chemical forces, effects of temperature or any energy convertible to electricity in the machine, a voltage is produced which acts against the applied potential. In charging an accumulator, the voltages of the cell and the dynamo are opposed. Each discharged accumulator cell has a voltage of about 1.8 volts. The dynamo may produce say 2.4 volts. The accumulator voltage may be termed the back E.M.F., and that of the dynamo the applied E.M.F. The virtual voltage pushing the current through the plates of the cell will be the difference between

the two pressures, *i.e.* $2.4 \text{ minus } 1.8 = .6$ volts. As the cell becomes charged, the back E.M.F. rises to the maximum of 2.4 volts. When fully charged, the dynamo cannot push any more current in, as the forward and back E.M.F. balance each other, and the charging will stop. In practice, however, the dynamo voltage can be adjusted, and as the back E.M.F. of the cells rises, the dynamo voltage is also raised.

It is essential in thinking of back E.M.F.

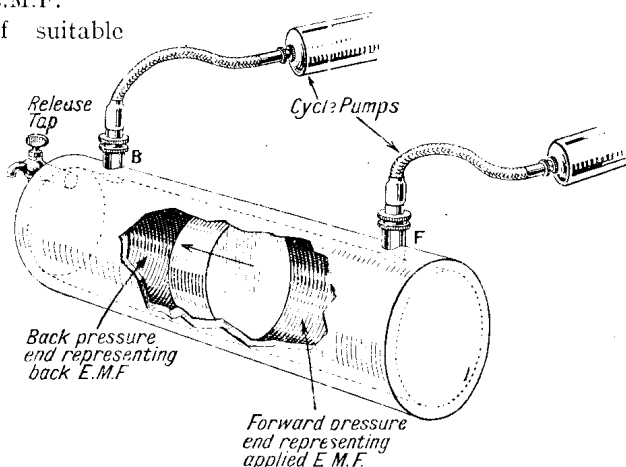

BACK ELECTRO-MOTIVE FORCE

A mechanical analogy to illustrate the theory of back E.M.F. Differences in the pressures of applied and resisting E.M.F.'s represent the effective pressure, or voltage. If the cylinder be imagined as of infinite length a forward movement or current flow will be continued as long as pressure at F overcomes that at B

that it should not be considered as anything but an electrical potential, or "power to act." While no mechanical analogies are completely true in explaining electrical phenomena, to demonstrate the effects of back E.M.F. a device such as that shown in the figure may be imagined.

It comprises a cylinder of any length entirely enclosed. Between the end covers a loose piston floats. Each end of the cylinder has a cycle or other air pump connected to it, with a release tap, as shown, fixed into one cover. The pump at B may be considered as that which creates the back pressure, F being used for the forward pressure. With the same amount of air pressure at each end, the piston will remain stationary in equilibrium, but an increase in forward pressure will obviously cause the piston to move in the direction of the arrow, with a force equal to the difference between

the backward and forward pressures. By allowing air to leak at the release valve, the back pressure may be reduced and the same effect obtained. Operating the pump at B would stop movement when a balance is obtained.

The cylinder may be considered as one of infinite length, and any movement due to difference in pressures would then be continuous so long as the pump at F was operated and the forward pressure maintained. In electrical instruments and machines the useful work or external effects are obtained in a similar way, and their magnitude depends upon the difference between the forward voltage and the resisting or opposing voltage, viz., the back E.M.F. See Accumulator; Electro-motive Force.

BACK OSCILLATION. In a spark transmitter circuit when the condenser discharges across the spark gap, it sometimes happens that some of the high-frequency oscillatory current flows back through the secondary of the transformer, instead of flowing across the spark gap. This flowing back is known as back oscillation, and if not controlled might lead to the breaking down of the transformer insulation. The back oscillations are prevented from setting up high voltages through the transformer by means of coils of wire of about 250 mics. inductance. The reactance of these coils becomes so large when the H.F. discharge tries to break through that they form insulators to the H.F. current. The coils are shunted with non-inductive carbon rod resistances, since their capacity and inductance might otherwise form an oscillatory circuit, with the same natural frequency as the primary oscillator. See Choke Coil.

BAKELITE. An insulating material. Bakelite is a manufactured article, and is made in several grades. In wireless work it is usually employed in the form of sheet and bar under various branded names, but is also used in a liquid form and as a plastic material. In other work it is used for making gear wheels and other working parts. In the liquid form it is used to impregnate other materials and as a binder for insulating materials.

The wireless experimenter can use bakelite for almost all work where ebonite would be otherwise employed. Bakelite is rather less brittle than ebonite, and is readily machined. As an example, take

the case of a plate for the top of a condenser of the variable or moving plate type, such as that illustrated. Suppose this to be 3 in. square. The first step is to mark out a sheet to the shape of the exterior and cut it to shape. This is done with a back-saw with fairly fine teeth, and the edges finished by filing with a fine-cut file.

Use the file across the material to remove any surplus quickly, but finish by filing along the edge as if draw filing.

The location of the holes is then marked out, and the drilling accomplished with a fluted drill with two flutes; the

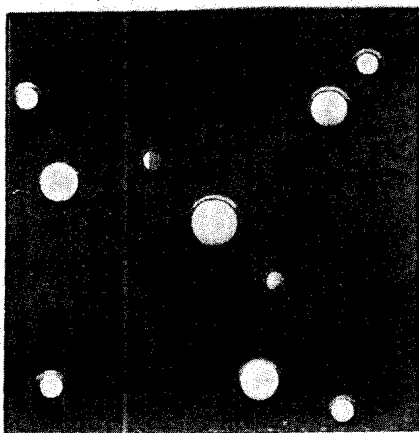

BAKELITE, AN INSULATING MATERIAL

A panel of this insulating material, drilled and bushed for the top of a variable condenser. Bakelite is rather less brittle than ebonite and can be used for all varieties of wireless work

type of drill known as a straight flute is the best. Run the drill at a high speed with moderate pressure. No lubricant is necessary, but as oil does not affect bakelite it can be used in moderation when drilling a deep hole. To prevent the drill running as it emerges from the back of the panel illustrated, place it on an odd piece of the same material and secure it with a clamp to the surface of the bench, thus keeping both in close contact. Turning is accomplished with the aid of very keen tools with considerable top rake. Milling is carried out with the same cutters as for mild steel, but run at twice the normal cutting speed. Support the work at any edge where the cutter will emerge, as unless this is done the edges may be frayed.

Holes can be tapped in bakelite as if tapping brass.

The electrical puncturing voltage of bakelite varies from 13,000 to 38,000 volts per millimetre of thickness, according to the grade of the material. A good brand of bakelite, sometimes known as micarta, is not affected by water, steam, oil, or by practically any of the chemicals used in wireless. It is generally a tan-coloured, hard material with a dull, smooth surface, and has a mechanical strength of 50 per cent above that of hard rubber or vulcanite. It is not brittle, and will not warp, expand, or shrink under normal conditions of service. Other applications are as bushes for electrical conductors, commutator bushings, coil separators, are shields in circuit breakers, and as formers for coil windings. See Ebonite; Micarta.

BALANCED CONDENSER. A condenser with moving vanes so arranged that the weight of one part counter-balances that of the other, with the result that there is no tendency for the moving parts to change their position, except under the action of the operator. The ordinary variable air condenser with moving vanes is particularly prone to shift its position unless a good deal of

friction is present in the bearings for the spindle, at least, if it is not exactly vertical. This can be overcome by the simple expedient of rearranging the normal disposition of the moving and fixed vanes. The common practice is to arrange all the fixed vanes on the same side of the centre line and all the moving in a similar manner. When the vanes are arranged so that half of them are on one

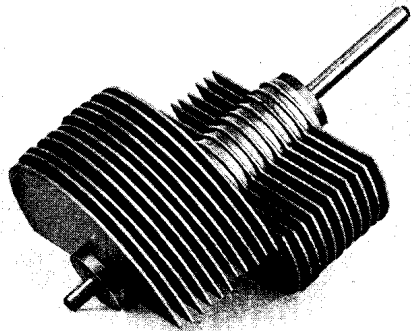

BALANCED CONDENSER VANES

Fig. 2. Showing how the moving plates are attached, one half being on one side of the spindle, and the remainder on the other

side and half on the other of the centre line, and the moving vanes are similarly disposed, there is no tendency for the vanes to shift their position owing to gravity.

This balancing arrangement is very beneficial when the condenser is arranged for panel mounting. The illustration shows the rearrangement of an ordinary commercial pattern of condenser. It can also be constructed throughout from standard parts with the addition of a few extra upright posts and nuts. The method adopted in the condenser illustrated consisted in removing the lower half of the fixed vanes and making up the gaps between the remainder and the base by interposing three long collars or tubes, fixing these between the base and the fixed plates. The moving plates were dealt with in the same way, by removing the upper half and replacing them on the spindle in the reverse direction, as shown in Fig. 2. The fixed vanes which had been removed were then mounted on three upright columns, and secured by nuts and washers in the customary manner, these simply standing up from the base.

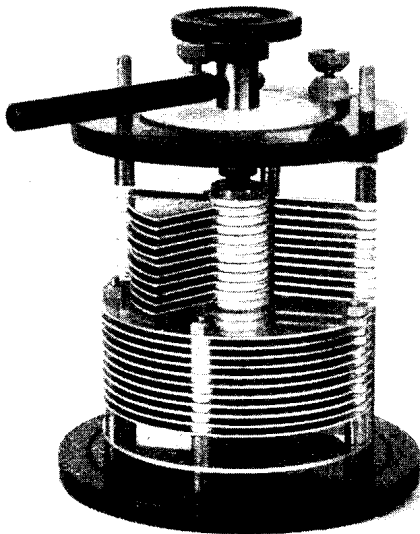

BALANCED CONDENSER

Fig. 1. An ordinary commercial condenser rearranged to secure complete mechanical balance. Notice how the fixed and movable vanes are equally disposed on each side of the centre line

It will be noted in Fig. 3 that the lower plate carrying the spindle bearing has been removed from its original position to the opposite side of the base. To ensure the condenser working smoothly and freely, it is necessary to mark out very carefully and accurately the positions for the extra posts, so that the spindle will be perfectly in line. This can readily be accomplished by leaving the spindle in position and rotating the bottom plate exactly 180 deg., and carefully scribing off the positions for the bolt holes by marking through those in the plate. In this sense it is used in the same way as a drilling jig.

Any final adjustment can be made with the aid of the eccentric bush in the usual way, and the result is a condenser which is very light and easy to adjust. It is more readily turned and is responsive to the slightest movement on the extension handle. Various patterns of commercial balanced condenser are available, and have much to recommend them on the score of smoothness in working and easy adjustment. See Air Condenser; Bridge Condenser; Condenser.

BALANCED CRYSTALS. A balanced crystal circuit is one in which two or more separate crystal detectors are used, and their purpose is to minimize the results of interference. A typical theoretical circuit diagram is shown in Fig. 1 and the actual wiring in Fig. 2, which will make the disposition of the parts apparent. In the circuit illustrated the telephone and detector circuit is completely closed, and coupled to the aerial circuit by an induc-

tive coupling illustrated by means of two Burndept coils and the usual form of coil holder. The aerial circuit may include a tuning condenser for fine tuning and variations in wave-length, and other modifications may obviously be made.

The essential principle is that the detectors are so disposed that signals of ordinary strength affect one detector more strongly than the other, the principle being that one detector is arranged in opposition to the other. If they were both

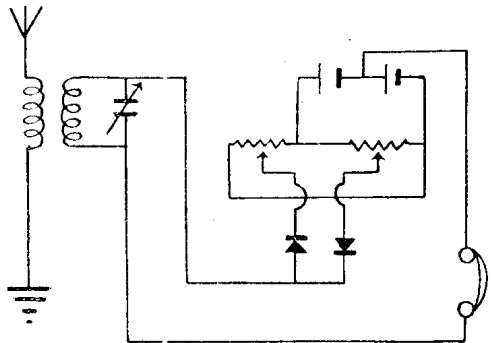

CIRCUIT FOR BALANCED CRYSTALS

Fig. 1. Two crystals, balanced, are employed in this circuit, the purpose of which is to minimize interference

equally receptive to signals, one would cancel the signals of the other, and nothing would be heard at all, but by tuning one detector so that ordinary signals affect it strongly and the other hardly at all, atmospherics are largely minimized and interferences reduced, because strong atmospherics will give rise

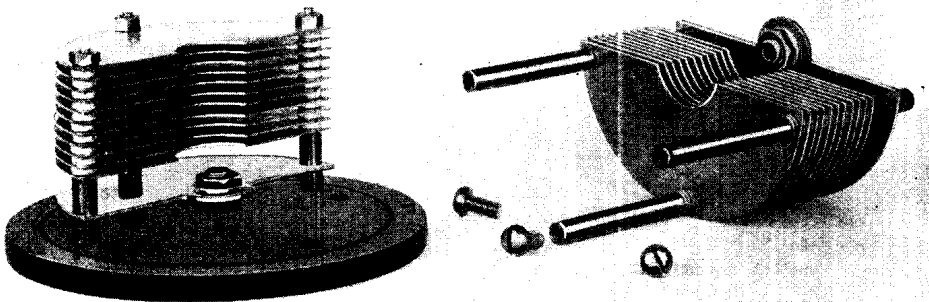

REARRANGEMENT OF PARTS TO MAKE A BALANCED CONDENSER

Fig. 3. The fixed plates may be seen with one section dismounted. The lower plate carrying the spindle bearing has been removed from the position it occupied when the condenser was of the ordinary type, with all the fixed plates on one side, and placed on the opposite side of the base



LAY-OUT OF A RECEIVING SET EMPLOYING BALANCED CRYSTALS

Fig. 2. Two crystals are used in this set, the circuit diagram of which is shown in Fig. 1. Such a method enables the receiver to be so tuned as to lessen considerably the effect of atmospherics. The principle may also be applied to valves, and is one of considerable interest for the experimenter

to nearly the same resistance in both detectors, but the effect in the telephones is minimized because the two detectors are in opposition.

To control the detectors, apart from the ordinary adjustments of the cat's-whisker or other device in the crystal holder, two resistances are provided, wired as shown in the diagram (Fig. 1). By varying them, the required variation in receptive power is obtained and the signals controlled accordingly. A similar arrangement can be used with a valve or any other form of detector.

The subject contains considerable possibilities for the experimenter, as it offers a means of dealing with one of the greatest problems of wireless reception, that is, the elimination of interference from unwanted stations and effects due to atmospherics. The general idea is that the signals pass through the first detector in one direction and through the other in the opposite direction, and if both had exactly the same characteristics, one would damp out or cancel the other and no reception would be possible in the telephones. But by varying them, some of the stronger signals are passed on by both detectors, but the weaker signals diminish. Results in practice depend

very largely upon the care with which the two circuits are tuned.

Another balanced crystal circuit used to increase the strength and purity of signals is illustrated in Fig. 3, which shows the theoretical circuit diagram, while Fig. 4 shows typical parts wired up for this circuit. In this case an ordinary loose

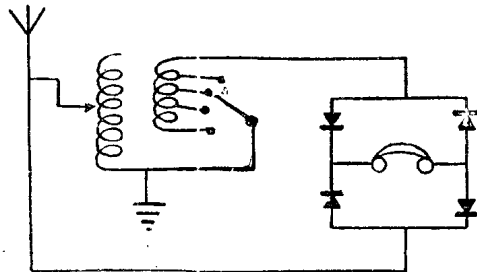

QUADRECTOR, OR FOUR-CRYSTAL, CIRCUIT

Fig. 3. This diagram represents another form of balanced crystals set, in which four crystals are employed without batteries. It is somewhat difficult to tune, since all the four crystals must be in perfect adjustment. This circuit is devised by the Economic Electric Co., Ltd.

coupler is used and both of the coils are connected to a common earth, thus making a close circuit and giving a certain amount of step-up effect between the coils. The balancing of the crystals

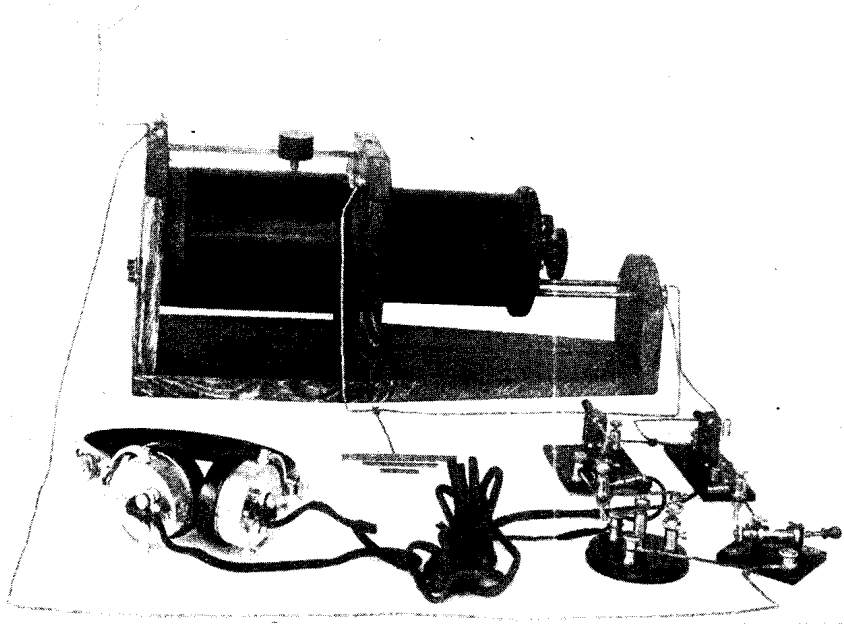

QUADRECTOR CIRCUIT ARRANGEMENT FOR REDUCING INTERFERENCE

Fig. 4. Four crystals of different types are used in opposition. By the principle employed interference due to atmospherics and other strays is considerably lessened. Experimenters may use a single four-crystal holder with the separate crystals mounted on one base for permanent use

reduces atmospherics, and when all four are in perfect adjustment greatly increases the quality of the reception. It is far more difficult to tune, as all four crystals have to be tuned into perfect unison for the best results to be obtained. The circuit is, however, very interesting, and offers great possibilities to those suffering from considerable interference. The four-crystal circuit is also known as the quadrector circuit. See *Crystal Receiver; Interference; Tuning.*

BALANCER. A balancer, or direct current compensator or equaliser, consists of two or more similar machines in the form of shunt or compound wound direct-current generators. They are used on three-wire distributing circuits for the purpose of supplying out-of-balance currents between either of the outer wires and the middle wire of the system. If the two sides of the circuit are equally loaded the equalizers or balancers run like unloaded motors, but if the voltage

on either side of the system drops the armature of the machine on that side of the system supplies the deficiency, taking power from the other pair of mains to drive it as a motor. The principle is shown in the figure, where the main

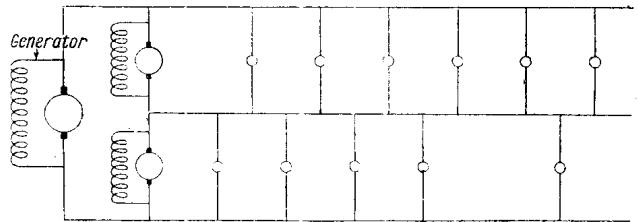

BALANCER ON THREE-WIRE SYSTEM

The diagram shows a direct-current compensator used on a three-wire distributing circuit for supplying out-of-balance currents between either of the three wires

generator is shown on the left and the balancers coupled together on the right.

BALANCING. Method of eliminating interference sounds in amplification circuits. In any method of amplification the difficulty which has to be faced is that as the signals which are being received are increased in sound, so, generally,

are those due to atmospheric and extraneous causes. When balancing methods are resorted to, to lessen the effect on amplification of these strays, an adjustment of the circuit is made by which a weak signal is rectified and made audible, while a signal slightly stronger is not rectified and therefore not made audible. See Atmospherics; Balanced Crystals; Interference.

BALANCING AERIAL. Term applied to any aerial system utilized to eliminate interference in a receiving aerial by a local transmitting aerial.

When a powerful transmitter is radiating energy it will induce in a nearby receiving aerial currents out of all proportion to the currents induced in it by the distant transmitting station, with the result that unless special precautions are taken the received signals are "wiped out" by the local transmitter.

In order, therefore, that a pair of stations shall be enabled to work duplex, the power of the transmitter must either be so small that, in combination with very selective receiving circuits and a sufficient distance between the transmitting and receiving aerials, the receiving aerial is unaffected by the local transmitter, or the effect of the transmitting aerial on the nearby receiving aerial must be balanced out.

There have been many attempts to effect duplex telegraphy and telephony by the use of only one aerial in conjunction with balancing-out circuits incorporated in the receiving apparatus. This arrangement, however, has up to the present only been of practical use with comparatively small power.

When stations of several hundred kilowatts became necessary for long-distance

working, the capital cost and maintenance charges were not proportionate to the comparatively small amount of traffic that could be handled by the simplex method of working. It therefore became essential to devise some method by which the amount of traffic handled could be greatly increased. Two ways of attaining this end consist of increasing the speed of transmission and reception and the

employment of duplex working. It was found the most efficient method was that by which the transmitter signals could be balanced out in the receiving aerial.

One of the first commercial services based on this method of working was instituted for trans-Atlantic working between Ireland and Glace Bay, Canada. In this system the transmitting and receiving stations in Ireland were separated by about 12 miles, while at Glace Bay the transmitting and receiving stations were separated by about 30 miles.

Landlines connected each transmitting station with its receiving station, the transmitting operator being located at the receiving station, and the transmitter was controlled through relays.

The wave-length in use for the Glace Bay transmitter was 8,000 metres, while that for the station in Ireland was 5,500 metres. The effect of the 8,000 metres wave on the associated receiving station

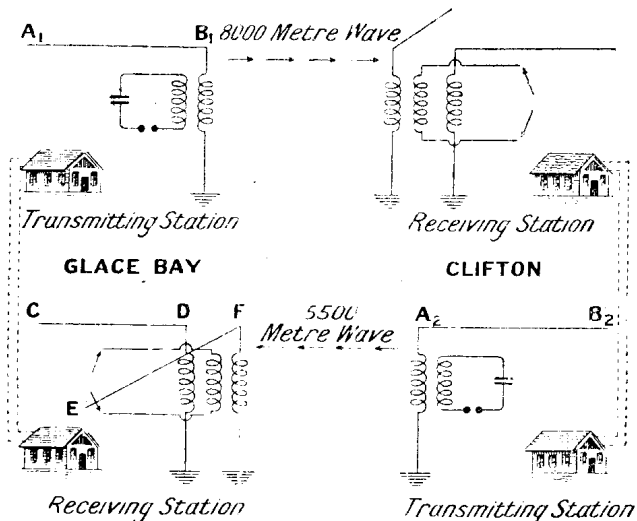

ELIMINATING INTERFERENCE BY BALANCED AERIALS

In the example given two well-known stations have been chosen, one being in Canada and the other in Ireland. The balanced aerials of the Clifton station were 12 miles apart and those of Glace Bay 30 miles apart

was eliminated by the employment of a second aerial at the receiving station erected in such a direction and connected in such a manner that the induced currents were balanced out in the receiver. A similar method of balancing out was installed at the receiving station in Ireland.

The figure illustrates the disposition of the transmitting and receiving stations at each end, and also shows the balancing

aerials. The balancing aerials are erected at right angles to the main receiving aerial in such a way as to receive the maximum induction from the nearby transmitter and the minimum induction from the distant transmitter.

The receiving aerial is tuned to the wave-length of the distant transmitter, while the balancing aerial is tuned to the wave-length of the nearby transmitter, i.e. to the interfering wave.

The receiving circuit is electro-magnetically coupled to each aerial, and is affected by the two sets of oscillations, but by the correct adjustment of the coupling and phase relation of the induced currents the effect of the interfering wave is balanced out, thereby enabling the receiving aerial to respond to the signals from the distant transmitter.

In the diagram the aerial CD represents the aerial for receiving the 5,500 metre wave from the aerial $A_2 B_2$. Aerial EF represents the balancing-out aerial for the receiving station, and oscillations are induced in it by the 8,000 metre wave from the aerial $A_1 B_1$. The effect of the 8,000 metre wave is then balanced out in the receiver circuit, leaving it free to respond to signals from aerial $A_2 B_2$.

A similar arrangement of aerials is made in the other receiving station. This system worked well in practice, but has since been superseded by a system in which the effects of loop or frame aerials are combined with the effect of a vertical aerial in such a manner that the receiving circuit shall only be influenced by signals from any particular direction.

BALANCING CAPACITY. Phrase with several meanings. A balancing condenser, or a balancing capacity, is any condenser used to balance out the effect of other condensers, or inductances, or of a combination of both.

Fig. 1 represents a circuit in which are included two condensers of X mfd. capacity each. The combined capacities of these two condensers is X/2 mfd. If the capacity of the third condenser--connected in parallel--is X/2 mfd., then the total capacity of the circuit is X mfd. Hence, the effect of the capacity X/2 is to balance out the effect of the two condensers of value X mfd. connected in series, making the capacity of the circuit X mfd.

The method of balancing one capacity against another is often used to measure the capacity of a condenser by comparison

with a standard capacity. The two condensers are connected each in one arm of a Wheatstone bridge. The other two arms are formed of two resistances, with a galvanometer connected across the corners. The condensers are alternately charged

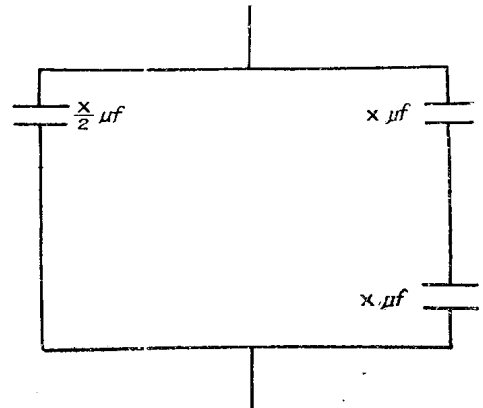

MEANS OF BALANCING CAPACITY

Fig. 1. By using condensers in the manner indicated the capacity of the two in series is balanced out by a third in parallel. The method is used to measure the capacity of a condenser by comparison with a standard

and then discharged through the resistances, these being adjusted until the galvanometer is unaffected by the discharge current.

In a circuit containing both an inductance and a condenser, as shown in Fig. 2, the value of the condenser's capacity can be made such that the effect of the in-

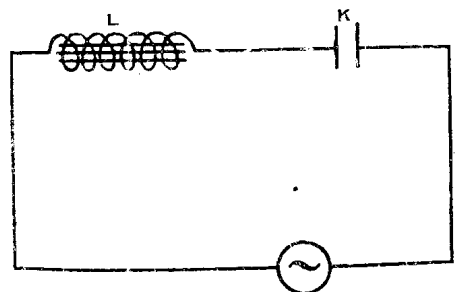

CONDENSER TO BALANCE INDUCTANCE

Fig. 2. By the use of the condenser K the effect of the inductance L is neutralized. For a definite frequency or wave-length this depends on \sqrt{LK}

ductance is neutralized. Let an oscillating voltage, E, of frequency n produce in the circuit a current of I ampere. If the value of the inductance is L henries, and

of the capacity C farads, then, neglecting the resistance of the circuit, we have

$$I \text{ amp.} = \frac{E}{\sqrt{(2\pi nL)^2 - \left(\frac{I}{2\pi nC}\right)^2}}$$

the voltage across the inductance L equals

$$I2\pi nL;$$

and the voltage across the condenser equals

$$\frac{I}{2\pi nC}.$$

If $2\pi nL$ is greater than $\frac{I}{2\pi nC}$ the effect of the inductance will predominate, causing the current to lag behind the impressed electro-motive force. When the effect of the capacity is greater than that of the inductance, then the current will lead the impressed electro-motive force. If the effects of the inductance and capacity equal, then

$$I2\pi nL = \frac{I}{2\pi nC}$$

$$\text{or } WL = \frac{I}{WC} \text{ where } W = 2\pi nL.$$

In these circumstances the circuit is resonant to a frequency N, and the inductance effect balances the capacity effect. If the frequency N is altered to N', an adjustment of either L or C will cause the circuit to be resonant to N'.

Balancing capacity or a counterpoise, as it is often called, was utilized in the Lodge-

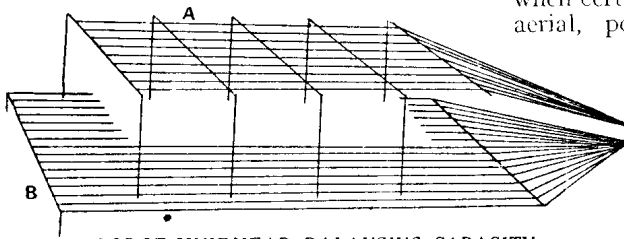

LODGE-MUIRHEAD BALANCING CAPACITY

Fig. 3. Counterpoise is here shown suspended below and beyond the aerial. One layer of wires is elevated and the other near the ground, both being equal and radiating from a centre

Muirhead system of wireless telegraphy some years ago, and is still in use, although in an altered form.

With transmitting aerials it is the general practice to connect them through the transmitting inductance to a series of plates buried some distance in the ground. In the majority of cases this method is efficient, but even in the most favourable

conditions, as regards a good earth connexion, the resistance losses, and hence the radiation efficiency, are such as to cause appreciable loss of efficiency.

Instead of employing a buried earth, the aerial can be connected to insulated plates or wires suspended in a horizontal plane above the earth and beneath the aerial. In the Lodge-Muirhead system two equal horizontal layers of wires radiating from a centre are used. One of these sets is arranged at a considerable height, and the other near the ground. The centres of the wires are connected to the transmitting inductance.

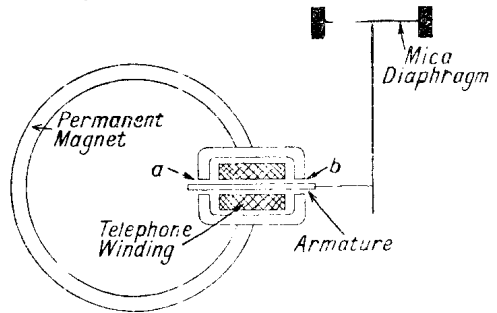

BALDWIN TELEGRAPHY RECEIVER

Fig. 3. Principles of the construction are seen in this diagram. This receiver is used in spark-gap telegraphy

Fig. 3 shows one method of suspending the counterpoise below and beyond the aerial. The correct design of a counterpoise capacity is a matter of investigation when certain quantities, such as height of aerial, power and wave-length of the transmitter, are known, and no hard-and-fast rules can be laid down for their design.

In practice, the use of a counterpoise has resulted in the resistance losses of the aerial system being considerably reduced, with a corresponding increase in radiation efficiency. See Capacity ; Counterpoise.

BALDWIN RECEIVER.

A type of receiver used in spark-gap telegraphy which possesses certain advantages in having a complete magnetic circuit of very low reluctance, leading to relatively large effects arising from weak signal currents. In Fig. 1 the principles of its construction are shown. When no signal is being received and the armature is balanced in its neutral position, the

magnetic flux between the air gaps *a* and *b* traverses the same direction and is equal in intensity on either side; no pull, therefore, is exerted on the diaphragm. Directly a signal or current impulse passes through the receiver winding, however, it produces a flux which is superimposed on that due to the existing field from the permanent magnet, and the combination results in a distortion of the original symmetrical field and introduces a stress on the movable armature. A movement is thus produced in the

bearings. These have an inner and an outer race, or circular rings with a groove in the face, in which the balls turn. The balls fill the space between the two races.

The wireless experimenter uses ball bearings for the support of a frame aerial fixing them into the base to support a vertical rod to which the frame of the aerial is attached. The ease with which such a bearing can be rotated is of assistance, as it facilitates accurate orientation of the frame aerial for tuning purposes. Another and particularly effective application of the ball bearing to wireless apparatus in common use is the ball-and-socket type used in many types of crystal detector to permit of universal movement of the cat's-whisker.

The component parts of the ball joint are illustrated in Fig. 1, and the same assembled complete in Fig. 2. In this case the parts are appropriate to any type of detector employing a cat's-whisker. The ball is turned from the solid out of a piece of brass rod, and it is formed with a projecting piece to act as a support for

the bar of the cat's-whisker. The socket is made by drilling a hole in the end of a flat piece of copper or brass sheet, which should be sufficiently springy to

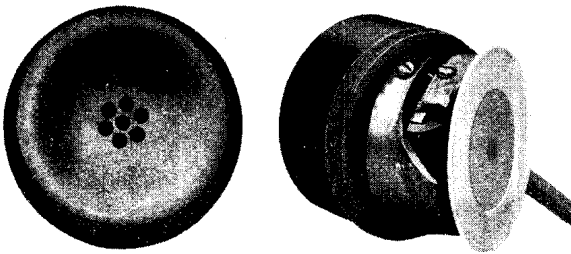

BALDWIN RECEIVER FOR LOUD SPEAKER

Fig. 2. A receiver for strongly amplifying sound through a magnetic field. It is also used in a form of loud speaker

latter and communicated to the diaphragm, which vibrates in sympathy.

The Baldwin receiver, used with a loud speaker, consists of a strong permanent magnet, a coil of which is connected in the plate circuit of the last stage of amplification. A soft iron armature moves in the field of the magnet in sympathy with the variations of the amplified telephone current which passes through the coil. To the armature is fastened a diaphragm or disk by means of a lever, so that the movement of the armature is magnified on the diaphragm. See Loud Speaker.

BALL BEARING.

In wireless work a ball bearing is any type wherein a ball or spherical member is held between two other members and free to move therein. Examples are found in the commercial patterns of ball bearing of the journal and thrust types used in the bearings for an armature shaft, or for other running

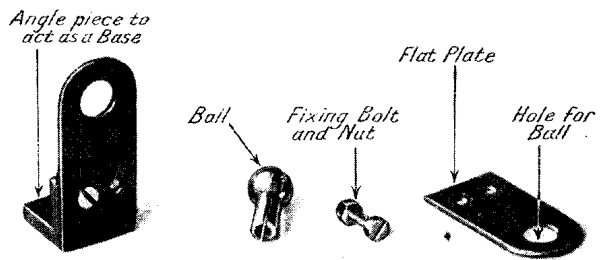

BALL-BEARING COMPONENTS

Fig. 1. These are components of a ball-and-socket type of ball bearing, as used in the making of a crystal detector, which gives universal movement to the cat's-whisker

grip the ball and prevent it moving too freely. Two plates are made in this way and the ball grasped between them. The same idea can be applied to other pieces of apparatus, such as a tuning-stand for a basket coil. Ball bearings of the type illustrated are electrically efficient, since

the bearing has a rubbing contact as the ball turns in two holes in the socket pieces and makes firm contact with both of them.

These pieces are generally attached by small bolts and nuts to an angle plate that acts as a base or support. The distance between the two plates should

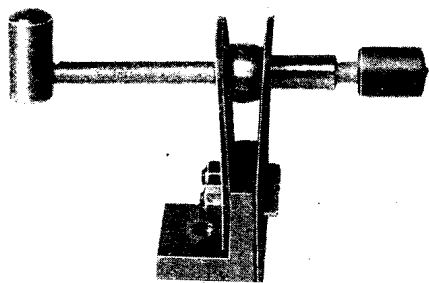

BALL BEARING FOR CRYSTAL DETECTOR

Fig. 2. An example of the use of a ball bearing in a crystal detector cat's-whisker arm

be such that the ball is grasped firmly between them, and the degree of friction is to some extent variable by tightening or slackening the bolts. When using this type of ball bearing the contact surfaces should be kept bright, and they should not be lacquered, as this partially insulates the contacts and reduces signal strength.

Running bearings as used in a generator must be well lubricated and kept clean.

Another application of the ball-bearing joint is found on many patterns of head-phone, such as the Ericsson. This is a good example of this class of joint, as the fullest advantage of the universal movement is found under the normal conditions of service. The ball joint allows the head-phones to follow the movements of the wearer's head, thus conducing to comfort. See Headphone.

BALLISTIC GALVANOMETER. Galvanometers intended to measure transient currents, lasting perhaps for a very short fraction of a second, must have certain properties which enable the impulse given them by the first rush of current to form a measure of the total quantity, even though the needle has not had time to move appreciably before the initial impulse has died away. Instruments designed for such purposes are named ballistic galvanometers, and should fulfil the following conditions. They act as

if the needle had received a blow and had subsequently swung the measured amount.

The periodic time of their own moving parts should be great as compared with the duration of the current, so that the whole quantity of current has passed through the instrument before the needle has had time to move appreciably from its zero position. Also the frictional or damping forces tending to bring the needle to rest after displacement should be small. In other words, the needle should make many oscillations before coming finally to rest, the amplitude of one swing not differing much from that of another. The difference between the amplitude of one swing of the needle and that of the next swing is termed the decrement.

Any galvanometer which fulfils these requirements may be used as a ballistic

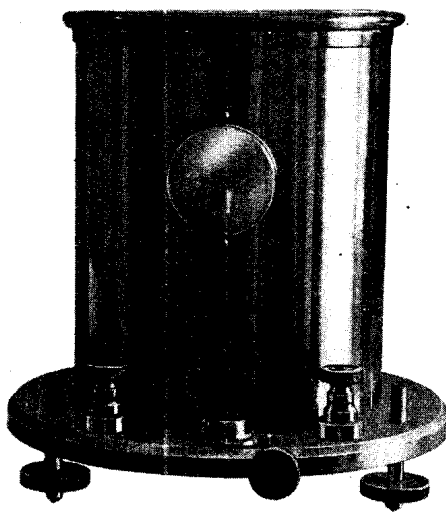

BALLISTIC GALVANOMETER

Fig. 1. A laboratory instrument for measuring small quantities of electricity, especially transient currents. It can also be used for measuring the capacity of condensers

Courtesy J. J. Griffin & Co., Makers, London

galvanometer, but ballistic galvanometers as a class would, as a rule, be particularly unsuited for ordinary measurements of permanent deflections, since they are exceedingly slow in coming to rest, and taking readings by their aid is a very tedious process. In fact, they exhibit the direct reverse of all the desirable attributes

of ordinary commercial instruments, which are required to give a quick indication of the value being measured and to respond quickly to variations; these are made as nearly "dead-beat" as possible.

In the customary type of instruments the working parts of the galvanometer consist of three bell-shaped permanent magnets fixed to a vertical wire, the upper and lower magnet poles being arranged in an opposite sense to those of the middle magnet, and satisfying the conditions for increasing the sensitivity of the instrument by lessening the earth's directive force, on the same principle as that applied in the astatic galvanometer. By placing one of these magnets inside the deflecting coil and the others outside, the forces exerted by the coil on the magnets are all resolved into one direction and have a threefold effect.

To multiply the actual movement of the magnets a mirror is attached to the wire stem supporting them and a spot of light is reflected from a lamp to a distant screen containing a graduated scale. The law of the ballistic galvanometer is that the quantity of current discharged through

it is proportional to the sine of the first half-swing produced, consequently no matter how short a period the discharge lasts, all that is necessary is to note the full swing the needle first makes, and find the sine of half this angle of deflection.

The capacity of a condenser is often measured by means of a ballistic galvanometer. If the angles moved through are small, the throw of the moving part is approximately proportional to the quantity of electricity passed. The capacities of two condensers are compared by charging each in turn from the same battery and discharging them through the galvanometer. Then

$$K_1 = K_2 D_1 / D_2$$

where K_1 , K_2 are the respective capacities of the two condensers and D_1 , D_2 the readings of the galvanometer. From this equation it is easy to find the capacity of an unknown condenser from that of a standard or known condenser.

The drawback of the ballistic galvanometer method of measuring the capacities of condensers is that due to absorption. This is present in all condensers except air condensers. In effect the charge or

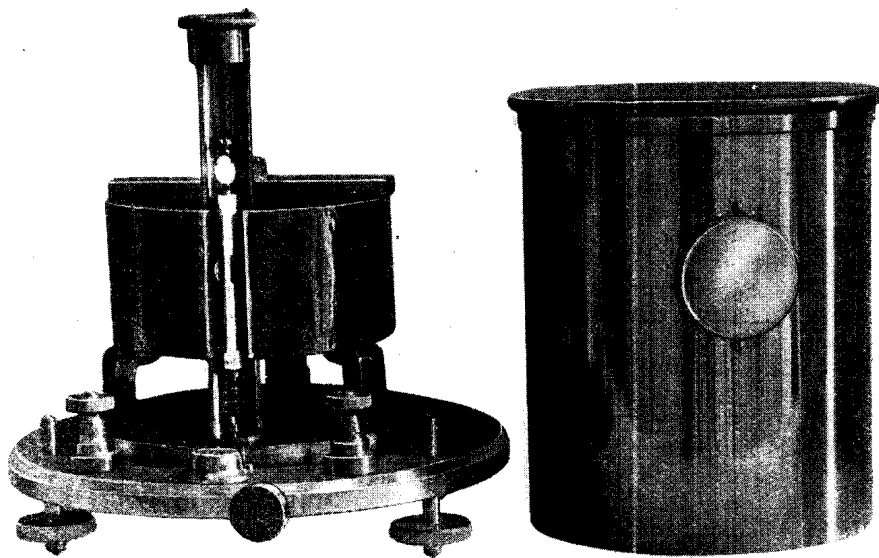

INTERIOR VIEW OF BALLISTIC GALVANOMETER

Fig. 2. With the outer portion removed the three permanent magnets can be seen and the mirror which works with them. The position of the mirror is changed as the magnets move, and a beam of light from a lamp is reflected by the mirror to a screen upon which is a graduated scale. The ballistic galvanometer is an instrument of fine sensitivity

Courtesy J. J. Griffin & Co., London

discharge of the condenser is not instantaneous, and in charging a small additional amount goes into the condenser after the first charging rush is over. On discharge there is the first rush, followed by the slow discharge of the absorbed overcharge, as it were. The value of the capacity measured, therefore, depends partly on time, and this must be taken into account when measurements are being taken. Figs. 1 and 2 show a commonly used type of ballistic galvanometer. Fig. 1 shows the complete instrument, and Fig. 2 the interior, with the permanent magnets and mirror. See Astatic Galvanometer; Galvanometer.

BALL REACTANCE. Electrical circuits subjected to high-frequency oscillations are often coupled together in order that the one shall transfer energy to the other. This applies equally to both transmitting and receiving circuits. The method of coupling the two circuits may be by direct connexion, in which case it is said to be auto-coupled; it may be by magnetic induction, in which case the coupling is electro-magnetic; it may be by condensers, in which case it is electrostatic; or it may be by a combination of the electro-magnetic and electrostatic effects.

The first method was originally used to excite the transmitting aerials by means of a spark discharge, and is still used in many receiving circuits. A diagram of the connexions of an auto-coupled aerial is shown in Fig. 1.

The second method is the one most used. And although with this method of coupling the electrostatic effect is present to a certain extent, the main transference of energy is due to electro-magnetic induction. Fig. 2 shows the two circuits coupled together by electro-magnetic induction.

Lines of magnetic force due to a current flowing in coil A, Fig. 3, thread coil B, and induce a voltage to act in coil B, causing a current to flow in the circuit. The current in coil B will be 180° out of phase with that flowing in A, since the magnetic field induced in B will be of opposite direction to the magnetic field of A. If coil A or B is rotated through 90°, then no lines of force due to one coil can thread the other. Hence, when the two coils are at right angles the circuits are not coupled.

Two circuits are said to be perfectly coupled when all the lines of force of one coil thread the other coil. This condition, however, cannot be attained in practice, owing to leakage of the lines. It is usual, therefore, to represent the degree of coupling between two circuits as a percentage, and this figure is known as the "coefficient" of coupling. If L and N

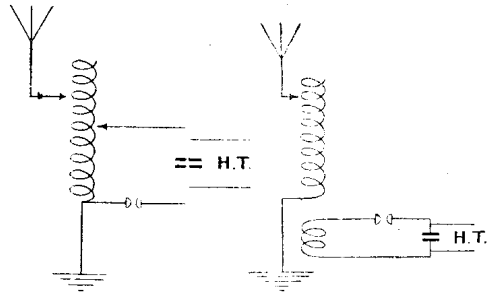

Fig. 1. An auto-coupled aerial

Fig. 2. A magnetically coupled aerial

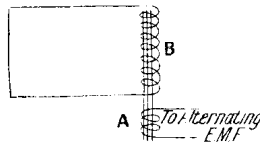

Fig. 3. Coupling due to magnetic lines of force in coil A completely threading coil B

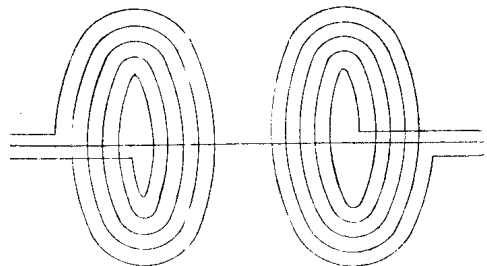

Fig. 4. Coupling obtained in flat coils arranged on the same axis

PRINCIPLES UNDERLYING WINDING OF BALL REACTANCE

represent the inductances of each circuit respectively, and M the mutual inductance between them, then the coefficient of coupling is equal to

$$\frac{M}{\sqrt{LN}}$$

If the percentage coupling exceeds 10 per cent the circuits are considered to be "tightly" coupled; but if it is less than ten per cent, the coupling is "loose."

Inductances used for coupling purposes may be wound as flat coils and arranged with their axes in the same straight line, as shown in Fig. 4; they may be wound on cylinders, as shown in Fig. 2; or they

may be wound on spherical formers, as shown in Fig. 6. Each method has its particular sphere of usefulness.

The spherical or ball type of coupling, seen in Fig. 6, is often used, as it can usually be mounted inside a tube and is more economical in space than any of the other methods.

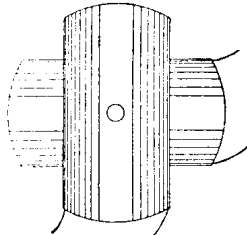

Fig. 5. Ball reactance wound on spherical formers

The spherical former is mounted in such a way that the diameter of the spherical winding is coincident with the diameter of the tube. Hence, when the axis of the

spherical winding and the winding on the tube coincide, the two circuits are in a condition of maximum coupling. If the spherical coil is rotated through 90° , the axis of the two windings will then be at right angles, and the lines of force of the one coil cannot thread the other coil. The two circuits are then in a condition of minimum coupling.

A point to remember in this connexion is that when two circuits are coupled together by a spherical coupling the rotation of the spherical coil through 90° alters the coupling from a maximum to a minimum, or vice versa. If, however, a spherical coil is used in series with the outer winding to act as a variometer to alter wave-lengths, the maximum and minimum effect are obtained with a spherical rotation of 180° . The reason for this is that in the one position of the

spherical coil the magnetic fields help each other, and therefore increase the inductance of the circuit. Whereas, in the second position the magnetic fields oppose each other to cause a minimum of inductance.

A spherical coil used for coupling the circuits of a valve transmitter or receiver in such a way that oscillations are set up in a circuit is governed by the same

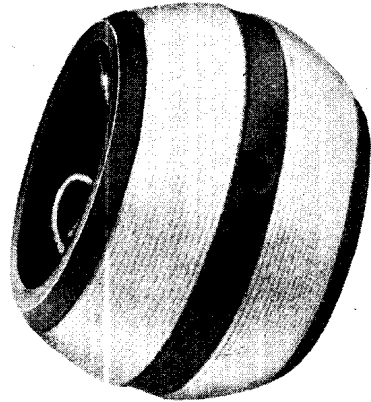

BALL REACTANCE COIL

Fig. 6. A common type of reactance ball coil is as the one illustrated. This is a spherical form of inductance coupling, which is more economical in space than many other types of coil effecting the same purpose

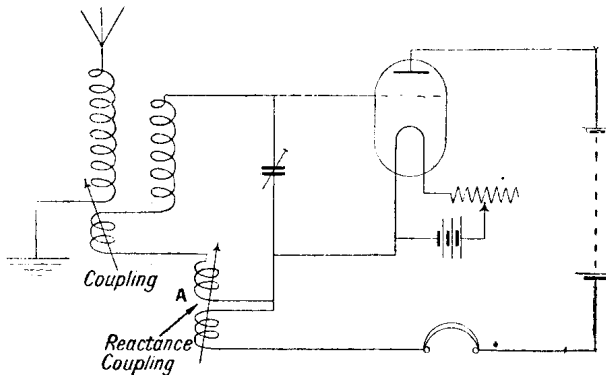

BALL REACTANCE SHOWN IN CIRCUIT

Fig. 7. Reactance coupling by ball-type coils is effected in this circuit diagram. The method of coupling the two windings will be seen, as well as the general wiring arrangements

general principles as apply when the coil is used as an ordinary coupling coil between two circuits. Fig. 7 shows a three-electrode valve connected to a tuning circuit. The coil A is a variable reaction coil between the anode circuit and the grid circuit of the valve. The valve, when connected as shown, can be made to detect wireless signals of the spark or damped-wave type; it can be made to amplify received oscillations; or it can be made to generate weak continuous oscillations for the detection of continuous wave signals.

In the first case, if the coupling between two coils is sufficiently weak, the oscillating current in the anode circuit will not affect that in the grid

circuit, and the valve acts as a simple detector. In the second case, when the coupling is made tighter, the oscillating current in the anode circuit will react on the current in the grid circuit, provided the phase relation between these two currents is correct. The correct phase relation can be obtained by altering the position of the reactance coil to one side or the other of the minimum position. When the anode current thus helps the grid current, the incoming signals are amplified.

In order to produce the self-oscillation state the reactance is still further increased until, at some position of the reactance coil, the anode circuit supplies just sufficient energy to the grid circuit to balance the electrical losses and cause an oscillating current to flow in the circuit.

When a transmitting valve is directly connected to the tuning inductance of an aerial circuit, the coupling of the circuits to produce self-oscillation is carried out by means of a reactance coil coupling the grid circuit to the aerial tuning circuit. If the oscillatory current induced in the grid circuit by the aerial circuit, through the agency of the reactance coil, is of the correct phase, the aerial circuit will be maintained in a state of continuous oscillation, the energy for which is supplied by the high-tension voltage applied to the plate of the valve. *See Beat Reception.*

BAMBOO. A tall, light, rigid, and hollow grass often growing to a height of 100 ft. or more. The wireless experimenter can use bamboo poles in many ways. The ordinary bamboo, as obtainable from the oil and colour shops, is generally about $1\frac{1}{2}$ in. to 2 in. in diameter at the thickest part, but thicker and longer pieces up to 10 ft. or 12 ft. may be obtained from furnishing houses as used for cornice poles. Such poles make effective aerial masts when the height is not above 25 ft. They are jointed by means of a lashing, as shown in Fig. 1, which provides the soundest joint if the lashing is properly applied with stout string or thin cord and then well treated with varnish. Other methods of jointing include internal pegs of wood that fit tightly into the hollow bore. The exterior should be bound with cord or reinforced with a metal tube at least four times the diameter of the pole in length.

Another use for bamboo poles is in the construction of spreaders for multi-wire aerials, as shown in Fig. 2. The pole in this case is for a spreader for a two-wire aerial.

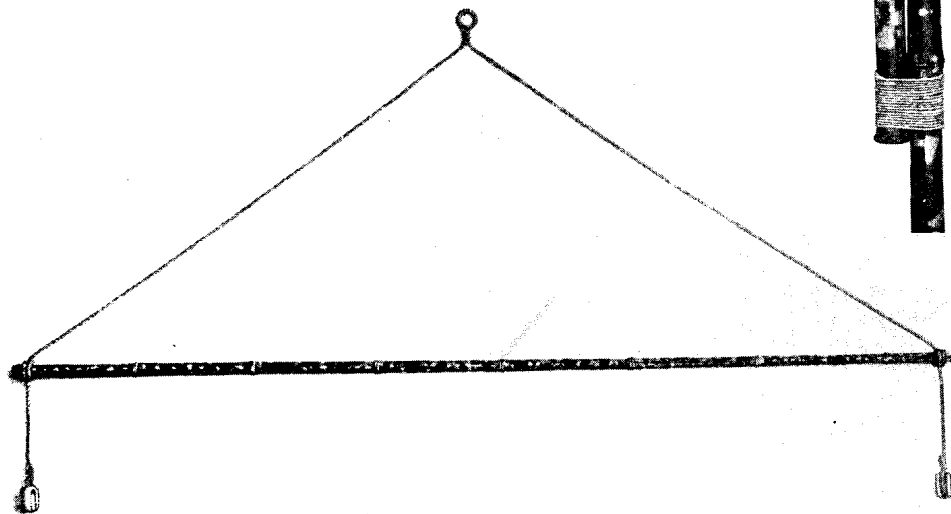

BAMBOO AND HOW TO USE IT

Fig. 1 (top). Shows how to make joints by a lashing of cord or copper wire. Bamboo poles make light but efficient aerial masts up to about 25 ft. in height. Fig. 2. For twin aerials bamboo may be used as spreaders. The photograph shows the attachment of the bridle by means of a half hitch. Holes should not be made in bamboo if they can possibly be avoided.

The bridle (*q.v.*) is attached to the pole with a knot known as a half-hitch, and is continuous from one insulator to the other. The bight (*q.v.*) of the rope is equipped with a thimble in the usual way. When using bamboo it is desirable to make attachments to it by binding them on with cord or copper wire, as it is detrimental to the strength to make holes in the bamboo. Bamboo may be used as a handy leading-in tube by running the aerial wire in through the hollow part of the bamboo and filling with pitch or paraffin wax.

BANK-WOUND COILS. A method of winding whereby one layer is superimposed upon another. The winding of bank-wound coils is a difficult operation, calling for accuracy in winding and for the proper disposition of the wires.

There are various ways of bank winding. In the first case, one set may simply be wound upon the other, completing the whole of the first layer and then going back to the starting point and laying the next winding over the first. This, however, has serious technical objections, although it is easiest from the construction point of view.

To avoid these theoretical objections it is desirable that the arrangement of the windings be such as to make the distance between adjacent coils as great as possible.

To make this clear, the series of photographs, Figs. 1 to 5, show the first four turns of the wire in position. The fifth turn of wire is turned across them and wound on top of, but in the little valley between them. This second set of windings results in three layers being superimposed upon the first. But the first turn of the second layer comes between the first and second turns of the first layer. Consequently, although the first turn of the second layer is on top of the first turn of the first layer, there is actually a length of wire separating them, composed of the length of the second, third, and fourth turns of the first winding or layer.

In the photograph, Fig. 1, the first layer consists of four turns, which is the manner in which to commence a four-layer bank winding.

To take a characteristic example, the windings are wound upon a former consisting of an ebonite or cardboard tube well impregnated with paraffin wax. The wire

is commenced by passing it through a small hole drilled in the tube for that purpose, and for a four-layer coil four turns of the wire are taken around the tube. The wire is then passed over the top of the wire to the starting-point, but is laid into the valley between the first and second turns of the first layer, as shown in Fig. 1. To keep the wire in place a number of fine pins can be driven into the tube as shown, and it is also a convenience to wind the coil first and cut off the surplus tubing later on, as the presence of the long length of tubing is a help when handling the tube.

From the stage shown in Fig. 1 the wire is turned three times over the first layer, thus forming the second layer, which is composed of only three turns, and it terminates at the finishing point of the first layer. This turn, when so completed, is passed over the others as shown in Fig. 2, and two turns are made. These turns lie in the valley between the turns of the second layer. When the two turns of the third layer are thus completed the wire is turned across the two turns as shown in Fig. 3, and is then only a single turn, which lies in the valley between the two turns of the third layer.

There are thus four layers in all superposed on each other and consisting of four turns on the first or bottom layer, three on the next, two on the third layer,

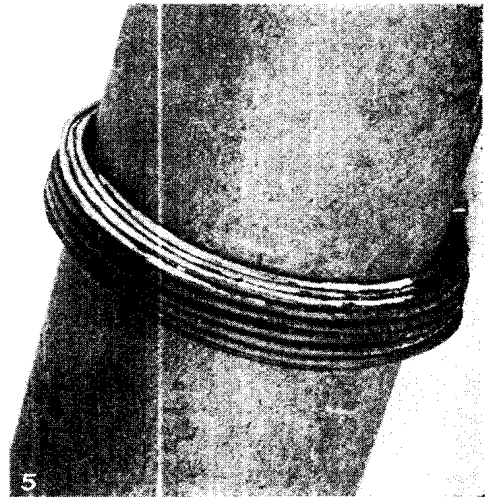

BANK-WOUND COILS

Fig. 5. The work in progress, showing six completed turns. The last four turns of wire have been whitened to make the process clearer

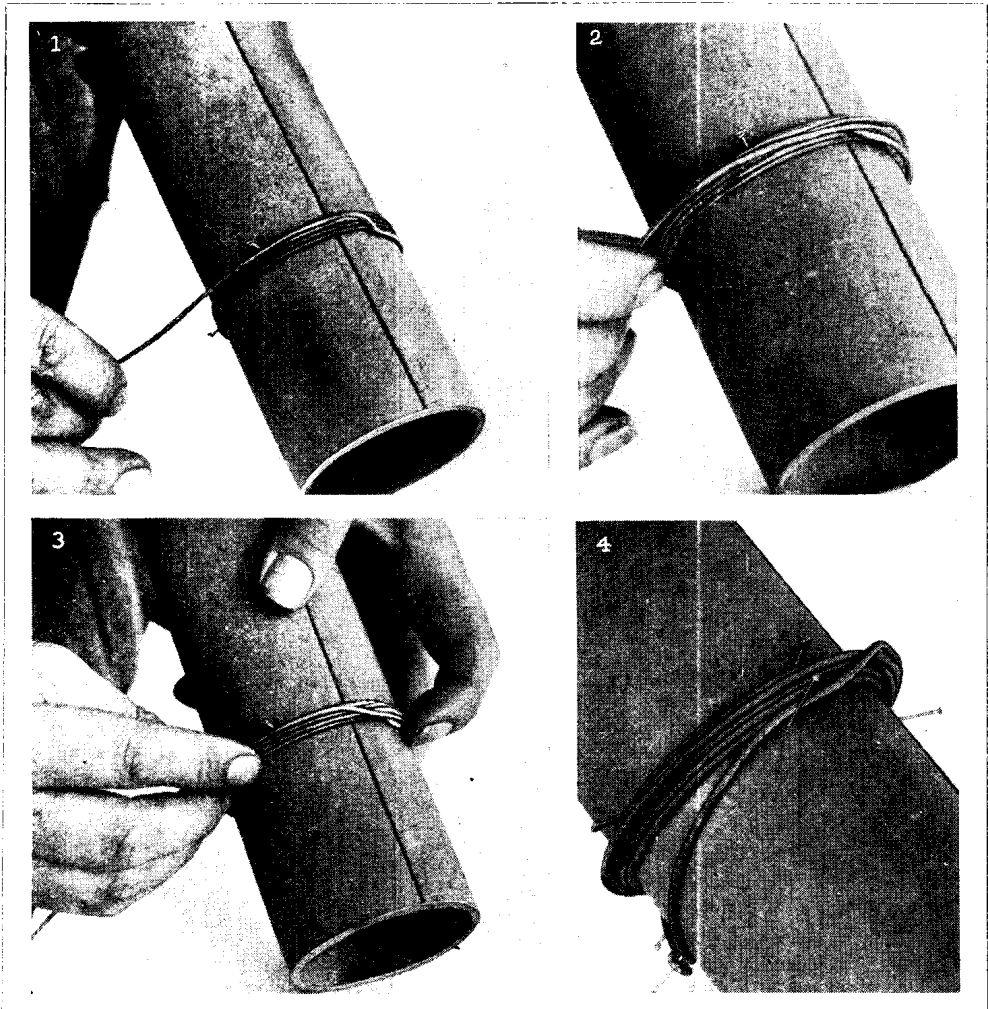

FOUR STAGES IN MAKING A BANK-WOUND COIL

Fig. 1. After the first four turns of wire are wound on the cardboard base the fifth turn is taken across to begin the banking. Fig. 2. The second series of turns is shown completed and the third is being wound over these to form the third bank. Fig. 3. After the third layer is complete the wire is turned on the top as before to commence the last layer. Fig. 4. The basis of the winding is now complete and the illustration shows the commencement of the regular windings. The top layer is being brought down to the former again, when the process shown in the first three stages is repeated.

and the fourth layer represented by a single turn of wire. The wire is then passed down to the surface of the tube (Fig. 4) and one turn made around it.

At this stage there will be a pyramidal arrangement of wires with one single turn in addition on the tube. The wire is then turned regularly until the whole is complete in the same manner, as follows: Make three turns on top of the one already on the tube, the wires working, as it were, uphill until they reach the top, when the wire is again passed down to

the level of the tube, and the same process repeated until the whole of the wire has been wound.

The state of the wiring after six such turns have been made is shown in Fig. 5, where the last four turns have been coloured white to identify them. To keep the coils from shifting it is a good plan to put a few panel pins or brads into the tube against the side of the lower turn of wire, removing the pins each time a fresh turn is made on the tubes—that is, at every completed four turns of the wire.

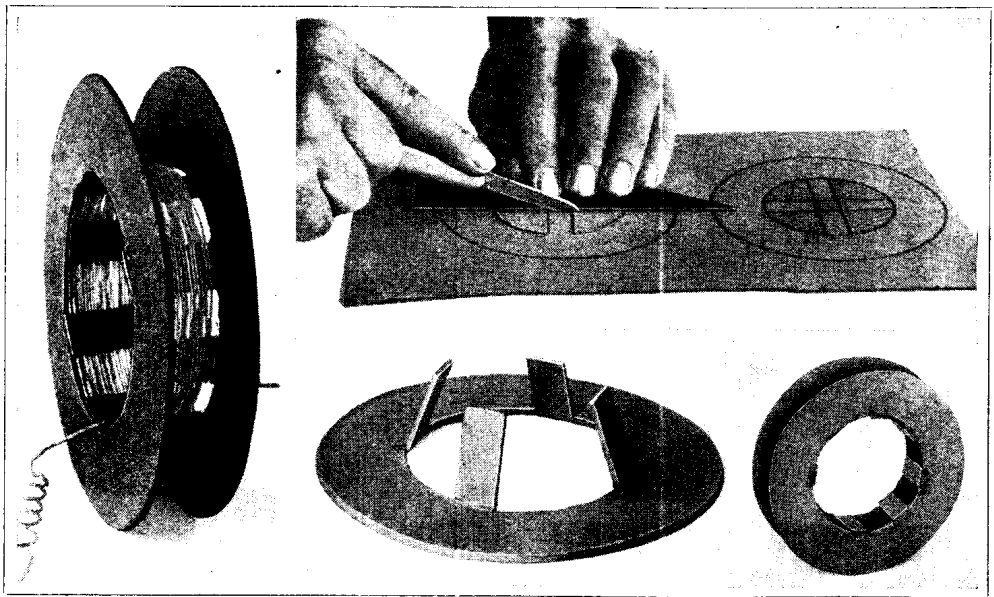

MAKING AN OPEN TYPE BANK-WOUND COIL

Fig. 6. A coil wound with multi-strand wire, as shown, gives a bank-winding effect. The former is of the open type. Fig. 7. In order to make an open-type former a piece of flat cardboard or fibre material is marked out and cut to shape in the manner illustrated. Fig. 8. One side of the former is now seen. The struts are bent outwards ready for gluing to the other side of the former. Fig. 9 shows the former completed. The windings being now applied provide the maximum air spaces and reduce capacity effects.

When the whole of the winding is complete the wire is finished off by passing it through a hole in the tube in the usual way. The winding does not present much difficulty after the first few completed layers have been wound. The wire should be as flexible as possible and free from kinks and twists of any kind, otherwise it will never lie in place nicely. The amount of tension put on the wire is a matter for experience and judgement, or the under layers will be displaced. If the tension is insufficient the wire will shift and present a very untidy appearance, apart from causing electrical losses.

The work, when finished, can be made more stable by the use of insulating paint, or by steeping the whole in molten paraffin wax. The great feature of this winding is that adjacent turns of the wire are separated by at least three turns of wire. Self-induction is thereby increased and self-capacity reduced. The method is of the greatest use when coils have to be wound to deal with considerable wavelengths, and the ordinary single-layer coils would become unduly cumbersome. The same principles are applied to the winding of two- or three-layer coils.

Another type of bank winding, when a multi-strand wire such as Litzendraecht is used, is shown in Fig. 6, wound on to an open-type former. The former is made in this way to reduce capacity effects and to provide the maximum air spaces. The preparation of the former takes longer than the actual winding of the wire. The first stage is shown in Fig. 7, which depicts the sheet of fibre or cardboard marked out and the shape being cut out with a pocket-knife guided by a set square. The four quadrants are cut out first, and then the outer edge is cut around with the knife in preference to scissors, as the latter have a tendency to cockle the edges.

When the former has been cut out the four legs on each are bent over at right angles, as shown in Fig. 8, and the two parts assembled so that the legs reach from side to side, thus making eight cross-members connecting the rims or flanges. The legs are attached to the side pieces by seccotine and held in close contact with pins until dry. The pins are then removed and the outside of the former cleaned up smooth with fine sandpaper, the resulting appearance being as shown in Fig. 9, when the former is ready for

winding. The wire is simply wound around the former in a single layer and the ends connected to the apparatus in the usual way. The size of wire to be used on any of the foregoing is determined by the purpose of the coil, and calculated as described in the articles on Capacity; Coil; Inductance (*q.v.*).

BARIUM. One of the metallic elements. Chemical symbol, Ba. Its atomic weight is 137.4, specific gravity 3.75, electrical conductivity 30.61 (silver 100). Barium is little used in its pure form, but the barium salts are important for hardening high-speed steel.

BAR MAGNET. A magnetized, straight bar of steel. Such magnets may easily be made by stroking a bar of hardened steel several times from end to end, always in the same direction, with one of the poles of another magnet. A bar magnet, suspended horizontally by a thread, will come to rest in the magnetic meridian, with one end pointing to the north magnetic pole and the other to the south magnetic pole. An ordinary compass needle is in effect a bar magnet. See Electro-magnet; Horseshoe Magnet; Magnetism.

BARREL INSULATOR. The name given to a particular type of insulator used in wireless work in connexion with the aerial. It is made in various grades and sizes; a regular pattern is illustrated in Fig. 1, and shows how the halyard and aerial are attached to it.

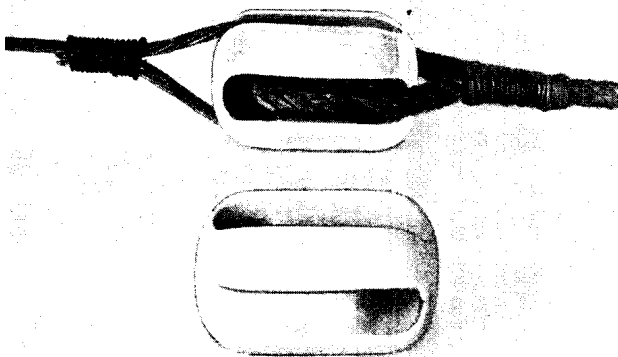

BARREL EARTHENWARE INSULATOR

Fig. 1. In these two examples is shown a commonly used type of insulator. The top insulator is engaged with the aerial wire on the left and the supporting rope on the right. The insulator provides the non-conducting medium, or link, between the two. These insulators should be examined occasionally, since cracks, which may develop, will greatly lessen their insulation value

This class of insulator is generally made of china or earthenware and finished with a glazed surface to resist the weather. A good example ought to be free from any cracks or chips, uniform in shape and colour, and perfectly smooth. One advantage of the barrel insulator is that there is a long block of the material to take the considerable strain of the aerial. When the aerial is of considerable length, say 75 ft. or so, it is as well to use two insulators, one attached to the lanyard and one to the aerial, connecting them with a short length of cord turned once or twice through the holes in the insulators, and to tighten the aerial by adjusting the cord to the length to be dealt with.

Another way to attach the aerial wire to the insulator is to use a leather thong and to attach it to the insulator by

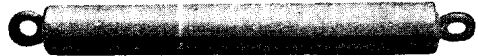

FIBRE BARREL INSULATOR

Fig. 2. Barrel insulators of this kind are made of fibre, ebonite or similar insulating material, fitted with eyes for the wires, and have a fairly high insulation value

passing it twice through the hole therein and through a thimble spliced into the eye at the end of the aerial wire. This reduces the risk of the insulator cracking when the aerial is in place, as any small surface cracks will cause a leakage of the incoming waves of energy, with reduction in the strength of the signals. It is just as well to examine the insulators from time to time to see that they are intact, as should they break the aerial will not fall, but the crack in the insulator will cause considerable loss of signal strength and is difficult of detection.

Another type is illustrated in Fig. 2 and shows a useful pattern made with two metal eyes one at each end of a strong insulating barrel made of fibre or some similar material. The great advantage of this type is the length of the insulation, as the great distance between the two points of attachment of the aerial and halyard reduces the chances of surface leakage of incoming currents of electrical energy. See Insulation; Insulator.

BARREL SWITCH. A form of switch which carries a series of contacts capable of giving a number of switching combinations. It consists of two ebonite plates carrying a number of contacts and held together by ebonite end pieces, which serve as bearings for a revolving drum. On the latter are a number of pegs which force contact between spring-brass contact strips. *See* Switch.

BARRETTTER. A thermal detector. There are several forms, one of which is shown in the photograph. It consists of a small tube filled with hydrogen and finished with end connecting lugs. Between the lugs is fixed a fine wire of an alloy whose resistance increases rapidly with

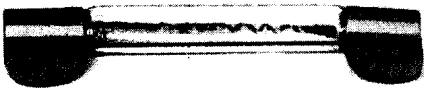

GLASS BULB BARRETTTER

Barretters of this kind are used for thermal detectors to limit current passing to a filament

the increase of current which passes through it. The barretter is used to limit the amount of current which can pass to the filament of a valve, and so reduces the risk of burning out.

In another form of barretter a small loop of Wollaston wire is enclosed in a glass bulb which has been exhausted of air. The tip of the loop is dipped in nitric acid, which dissolves the silver and leaves a short length of extremely fine platinum wire. The ends of the loop are connected across the ends of a small dry cell to the telephones. When oscillations of current pass through the barretter wire it is heated, and its resistance increased, so decreasing the amount of current passing. The change of resistance produces audible sounds in the telephones.

A simple form of barretter consists of a single fine wire forming one arm of a Wheatstone bridge, and in this form is used for measuring radio-frequency currents. By mounting fine iron or platinum wires in a vacuum tube, as described above, the sensitivity of the barretter is greatly increased, and currents down to a few micro-amperes, as those in an aerial, say, forty miles from a receiving station, may be measured. *See* Bolometer.

BASE. The lowest part of a structure, which acts as a support or foundation. In wireless work it is often made in ebonite or other insulating material, when the parts mounted upon it are subject to currents of electricity. The base of a box or cabinet is however, generally made of hardwood unless parts carrying electric currents are to be mounted within the box, in which case the base may be of insulating material or locally insulated with ebonite or other substance.

In the case of a switch base, china or earthenware is often employed on account of its physical properties. An example of this type is shown in Fig. 1, which shows a moulded base for a double-throw switch. When fixing the mounts to such a base it is important not to exert too much force in tightening the screws, or the material may be cracked and the insulating value destroyed. It should be remembered that a tiny crack will ruin a base of this type if the crack penetrates to the vicinity of any of the fixings. To minimize this trouble, a small amount of plastic material can be embedded beneath the mounts, as this tends to distribute the pressure.

Another type of base is that found in many types of wireless apparatus and used as a base for a crystal detector. In this example, illustrated in Fig. 2, the base is moulded in ebonite, or similar insulating material, and the space beneath is used to accommodate the contact strips.

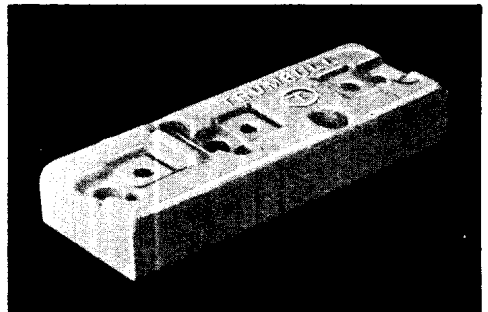

CHINA BASE

Fig. 1. The base for a double-throw switch, made of china is shown. Bases of this kind make excellent insulators

These are shown in position, and take the form of strips of thin copper clipped beneath the terminal nuts. Such an arrangement is neat and effective when the contacts are well above the surface upon which the base is fixed, otherwise

much of the insulation value may be lost, especially if the base be affixed to a wooden panel.

When fixing such a base with hidden contact strips, be sure that the fixing screws do not pass so close to the contacts that a leakage of high-frequency current can take place.

A base for a variable moving vane condenser is shown in Fig. 3, and is characteristic of this class. It is made in ebonite, and can be turned to shape in a lathe. The material is usually some $\frac{1}{4}$ in. thick for the ordinary condenser, with a value of, say, 1000 mfd. In marking out the holes in such a base it is very important that they be accurately spaced, so that the parts to be assembled will fit together properly. To ensure this it is a good plan to work from the centre and set out all the other holes from it. In some cases it is desirable to have some means of setting a base truly level, and a simple way to do this is to fix three small telephone terminals to the

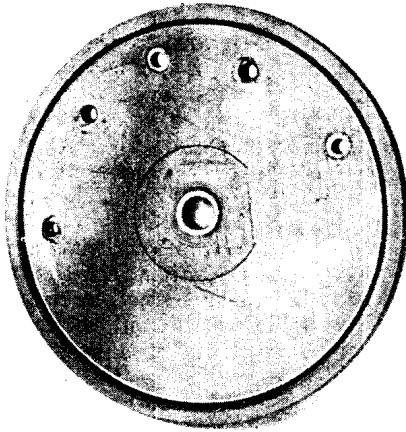

EBONITE BASE FOR CONDENSER

Fig. 3. The base of a variable air condenser is illustrated. It is easily made by employing a lathe and turning to shape

underside, as by adjusting the terminal screws the base is readily levelled. The screws should be secured with locking nuts to prevent their shifting.

Wooden bases for instruments and similar purposes, such as the mounting of various pieces of apparatus for experimental purposes, should be made of good sound material at least 1 in. thick, and clamped at the ends with cross battens to

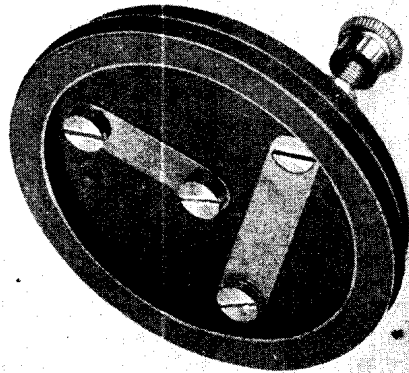

MOULDED BASE

Fig. 2. In this example of a moulded base a cavity is provided to accommodate the connecting strips of copper between the terminals. This type of base is often used for crystal detectors

prevent the wood warping or twisting. The wood is improved as regards its insulating properties by boiling it in paraffin wax until its pores are filled and the surface is greasy to the touch. The base for such a thing as the bottom of a frame aerial should be made of ornamental hardwood, as this is always to be seen and the finish and appearance are of importance. The use of french polish and stains on such bases adds to the effect and gives a workmanlike finish. *See Ebonite; Panel.*

BASE CONDENSER. A condenser which is used to eliminate the danger of arcing in a transmitting set. The condensers chiefly used are the forms of Leyden jar with inside and outside coatings of specially prepared tinfoil. The glass dielectric extends considerably above the coatings, to prevent any risk of brush discharge loss. This depends on the length of the metallic edge of the coating in each jar. This type of condenser has the advantage of taking up very little floor space for its capacity, and it is light. Such a condenser is used in the Telefunken system.

In the Marconi ship and land transmitting systems, zinc plates separated by glass are used. The plates are all fitted with lugs, so that the capacity of the condenser can be added to or subtracted from easily, and the whole is immersed in transformer oil to eliminate any direct arcing. *See Condenser.*

BASKET COILS: THEIR USE AND CONSTRUCTION

How to Make These Efficient Forms of Inductance

This extensively illustrated article, including a photogravure plate, deals with the construction and functions of a well-known form of inductance coil. Articles of a similar nature which should be consulted are Bank-wound Coils, Coil, Coil Windings, Loose Coupler, Variometer, etc. See also under their titles the many circuits in which basket coils may be used, e.g. Anode

A form of inductance coil in which the wire is coiled in such a way that the windings are superimposed and interlaced. They are flat or disk-like in appearance and comparatively thin, and are wound on special formers, with an unequal number of pegs. The characteristic form is shown in Fig. 1. These coils can be made without difficulty by the amateur, and have many applications, especially for the experimenter. A few of the circuits in which they can be incorporated include the tuning of the aerial, tuned anode, and reaction circuits. They can also be used as a loose coupler, or can perform the functions of a variometer.

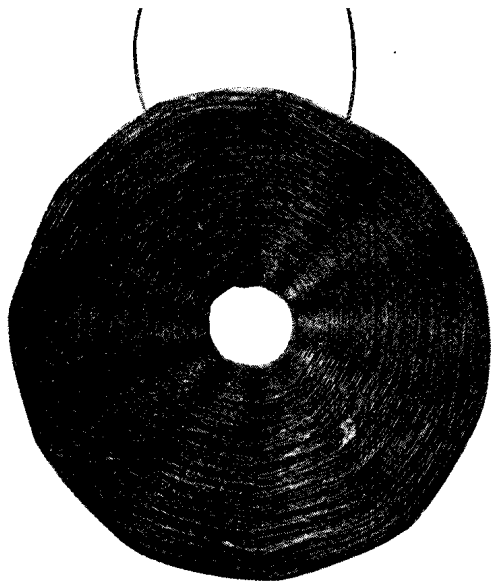

STANDARD TYPE OF BASKET COIL

Fig. 1. In this useful and efficient form of inductance the wire is wound over a number of pegs, which are afterwards removed. The coil is dipped in wax and has low self-capacity

The basket coil makes a very efficient inductance when properly made with wire of a suitable gauge and when the coils are correctly spaced. The type of coil shown in Fig. 1 is quite satisfactory, but if the inductance has to be very large it would necessitate a bulky coil that is difficult to wind and keep in shape.

To overcome this difficulty several smaller coils can be connected in series. The coils when arranged in this way should not be fixed too near each other, so that there is risk of their actually touching, but they must be arranged so that all the turns of wire in all the coils turn in the same direction, so that the total inductance is increased as much as possible.

With basket coils the inductance can be varied by using two or more coils and arranging them in such a way that they can be brought nearer to each other or moved apart. Another way is to use several and have one of them in opposition to the remainder. The wave-length of these coils depends on the length of the wire and its gauge and other factors.

Commercial basket coils can be purchased separately or in sets of five or more, the usual wave-length ranging from about 100 to 500 metres in the smallest size to some 10,000 in the largest. For aerial tuning circuits they are generally shunted with a variable condenser with a value of about 0.001 mfd., but with some of the smaller coils the condenser has to be put in series to receive on the lower wave-lengths.

Basket coils are very efficient on the shorter wave-lengths, their self-capacity is low, and the coils are small in size and readily adaptable to different conditions. The usual construction of a basket coil is such that the ends of the winding terminate at the outer and inner edges, and connect to any form of suitable terminal. The coils can be mounted on holders or superposed and mounted on an ebonite cage, with each winding end connected to a separate contact stud and controlled by a suitable switch.

Basket coils are usually thin and relatively large in diameter, but can be wound to form a narrow ring of comparatively large diameter. These make very efficient inductances, especially when wound on the duo-lateral principle. They are made as described later, but on a large diameter former. There are no losses due to dead-end effects, and the distributed capacity is lowered, as the wire in one

layer crosses the next layer several times at an angle in any one complete turn.

A few basket coils are made with separate tappings—that is, the wire is tapped at several points in the turns. For example, a coil 5 in. in diameter may have twenty tappings composed of ten unit tappings—that is, one tap per turn—and ten tappings of ten turns each. Such a coil will usually tune from less than 100 metres to some 1,800 metres. The range of the coil is increased, and would cover a range equal to four separate coils, but it is probable that for the best results it is better to have a good selection of separate coils and to use the one best adapted to the needs of the moment. This is especially so when the coils are mounted on plug-in holders, as it is then only a matter of seconds to substitute one coil for another.

How to Wind Basket Coils. The method of winding basket coils is to turn the wire in and out between the spokes on a special former in the manner to be described later.

A simple way that can be tried by the wireless experimenter is to take a piece of stout white cardboard and mark upon it three circles of sufficient diameter for the size of the coils to be made, in this particular case 5 in. Then draw another circle inside each of them, 2 in. in diameter. Divide the rim of each circle into nine equal parts. This may be done by setting the compasses to the radius of the circle, and stepping round the circumference of the circle. This will divide the rim into six equal parts. Mark every other one of these divisions, and divide the space between them into three, doing this by trial and error, setting the compasses and working from the marks until the circle is equally divided.

Draw radial lines from these nine points to the centre, stopping the lines at the 2 in. diameter circle, and proceed to cut the disks to shape with a pair of scissors, as illustrated in Fig. 2 on the special plate. The next step is to smooth off the edges of the circles with a piece of old sandpaper, and, placing them on top of each other, put them into a vice and make a saw cut with a tenon saw along each line, as shown in Fig. 3.

To prevent the cardboard buckling while it is being cut, it should be supported by means of an upright piece of wood held in the vice at the side remote from

the operator. This gives something to press against, and ensures a better result. To keep the cards concentric, place a small brad through the centre of them, and as one slot is sawn the cards can be turned and the next slot cut without risk of them altering position. When all the slots are cut, clean the edges with fine sandpaper to remove any roughness, and complete the work by punching two small holes, one through the centre part opposite a slot and the other at the top near the side of the same slot, as shown in Fig. 4. These are to take the ends of the wire during the winding process. The card can be impregnated by immersing it in boiling hot paraffin wax for a few moments and setting it aside to drain and cool off. Alternatively, it may be painted with insulating varnish. In place of the cardboard better results are obtained from the use of red fibre sheet or celluloid sheet, but when using the latter, remember it is very inflammable, and should never be brought anywhere in the vicinity of a naked light or it will be destroyed.

Winding the Cardboard Former

To wind a cardboard former such as that described above, commence by passing the free end of the wire through the small hole punched near the centre, and leave about 6 in. projecting. Pass the wire through the nearest slot, take it round behind the card, through the next slot, over to the front of the card, down through the next slot, and so on alternately in front of and behind the card, until the whole is wound. Always wind in the same direction and evenly. Wind up as many turns as are needed and finish by passing the end of the wire through the small hole punched in the card opposite the starting point. Leave about 6 in. of the wire free, and cut off. Two finished coils are shown in Fig. 5. The free ends can then be jointed in any desired form to terminals.

The appearance of the winding is clearly shown in Fig. 6, where thick wire is used to show the path it takes around and behind the spokes, and the manner in which the wires cross over at each slot. As an example of the approximate number of turns and gauge of wire for a pair of coils for use on a tuner up to 600 metres wave-length, the primary could have twenty turns of insulated wire,

between Nos. 18 and 24 gauge. The secondary could have twenty-five turns of the same size wire. Both coils would be tuned with variable condensers, one shunted across the secondary, the other in shunt or series with the aerial. This class of coil is sometimes known as a spider web coil.

The method of winding basket coils on peg formers is somewhat different, as the former is in this case a purely temporary affair, so far as the coil is concerned. It is only needed for the winding operation itself, and it is then removed. The former can be purchased or made as described in the article on basket coil formers (*q.v.*).

Having obtained the former, mount it on a peg held at an angle in the jaws of the vice, as illustrated in Fig. 7. Fix a spool of wire in a vertical position on the bench by driving a stout nail into the bench so that the spool can rotate upon it. Twist the wire around one of the spokes of the former, leaving about 6 in. of wire projecting, and press the wire down upon the hub of the former. Take the former in the right hand and hold the wire in the left, and constantly keep moving the former with the right hand, either towards the body or away from it, if a right-handed or left-handed coil is needed, otherwise proceed in exactly the same way for either type.

With the left hand guide the wire to the front of the spoke next to that which it is attached and press it down as near to the hub as possible. Guide the wire through between this spoke and the next following, let the wire turn around it on the opposite side to the previous spoke, press it down as near as possible to the hub, and guide the wire through between the third and fourth spokes, bringing it around to the front of the fourth spoke, and follow on by alternately turning it behind and in front of the spokes.

When one revolution has been made, press the wire down firmly against the hub and draw it tight. Continue in the same way until a sufficient number of turns have been wound on to the former. The commencement of this work and the method of procedure are illustrated respectively in Figs. 7 to 13 on the plate facing this page.

On looking at the work as it proceeds, it will be found that the wires alternate one over the other, making a lattice-like

structure, which has very much the appearance in general construction of a wicker basket, as in Fig. 8, and gives its name to the coil. It is important not to lose step while winding the wire. For the first few turns it will appear to be a very tedious job, but after one or two coils have been made, they can be wound very quickly, either with thin or thick wire, the gauge and type being selected according to the purpose of the coil.

When sufficient coils have been wound, cut off the wire so that about 6 in. of surplus remains, turn it over, and thread it through the gap alongside the spoke of the former to which the starting end of the wire has been fixed. Then, carefully holding the former in the left hand, draw out the spokes until they are clear of the hub, as in Fig. 9, but do not draw them right out of the wire winding.

Remove the hub, as illustrated in Fig. 10. The finishing end of the wire should then be passed through the eye on the starting end by passing the finishing end through the windings in the place of the spoke, as in Fig. 11, which can be entirely withdrawn for this purpose. The wire is then drawn tight.

Prepare a bath of molten paraffin wax by melting it over a gentle heat. The wax may be melted in a small saucepan of convenient size, such as that illustrated in Fig. 12. Take care that none of the wax is spilt or to the fire, or the work may be ruined. When the wax has melted, set the saucepan on the bench, remove all the spokes from the coil, and, with the two ends of the wire held at right angles to the windings, so using them as handles, immerse the coil in the wax and leave it there until the wax begins to cool. Carefully remove the coil and let it cool off in a current of air. Keep it horizontal while doing this, or the wax will largely drain down the windings. This process is illustrated in Fig. 12.

When the wax has set hard, the coil is ready for mounting, and appears as shown in Fig. 13. If preferred, the starting end of the wire can be brought to the outside of the coil, as in Fig. 1.

To wind a basket coil on the duo-lateral system, any former with an odd number of spokes may be used, but instead of turning the wire around every spoke as previously described, wind it in front of two spokes and behind two, as shown in

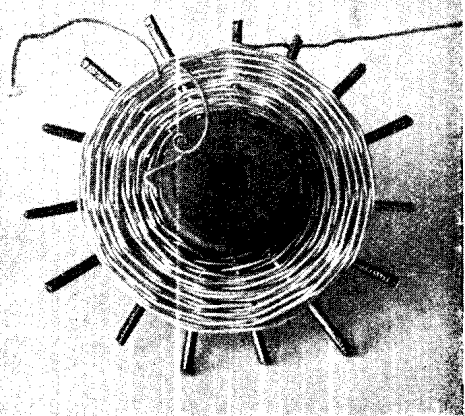
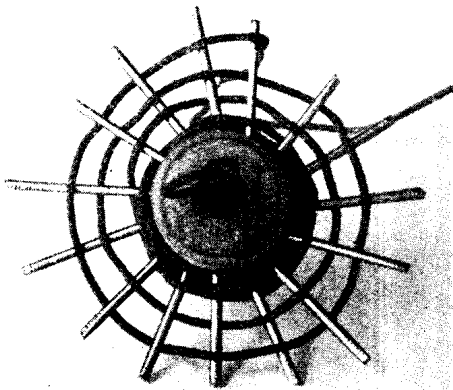

WINDING A COIL ON THE DUO-LATERAL SYSTEM

Fig. 14 (left). Shows the principle of winding, thick wire being used to make the arrangement clear. The wire passes in front of two spokes of the former and then behind two spokes alternately.

Fig. 15 (right) shows the coil wound, with the last two turns in place

Fig. 14, turning the wire in front of two spokes, through the space between it and the next spoke, behind the next two, through the space between that spoke and the next, and in front of the next two, and so on until the coil is wound, as shown in Fig. 15. This method is considered to reduce the self-capacity of the coil. It may be treated in wax as previously described, or the coils may be bound together with silk, as in Fig. 16, turning this between the wires in the spaces left by the former, taking two or three turns of thread to the one side of the coil and two or three turns to the opposite side, to avoid distorting it.

Other methods of finishing such coils are by painting them with an insulating varnish, shellac varnish, or similar material. This results in a stiff coil, but its self-capacity is greater than by the other method.—*E. W. Hobbs.*

BASKET COIL FORMER.

Formers for winding basket coils consist essentially of a hub or centre piece and a series of radial pegs or spokes. The size of both these elements may be varied to suit the size and type of coil to be wound. Commercial patterns, such as that illustrated in Fig. 1, are generally com-

posed of a hardwood, ebonite, or metal hub, and a series of brass spokes screwed into it. Such patterns are readily procurable. In use, the wire is wound around the spokes, and, when finished, they are unscrewed to permit the removal of the windings.

The amateur can easily construct formers from homely material. The first requirement is an empty cotton reel, such as those used for thread, of plain parallel type with small flanges. Cut off one of the flanges and smooth off the edge with

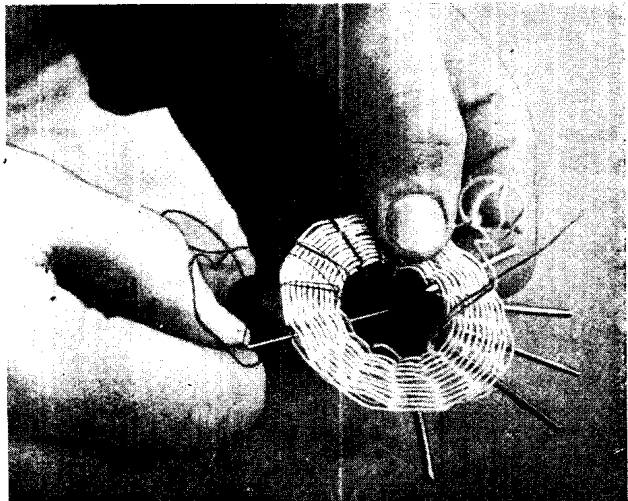

SEWING THE COIL AFTER WINDING

Fig. 16. How to sew the coil together with silk thread to give it additional rigidity. This is an alternative method to waxing

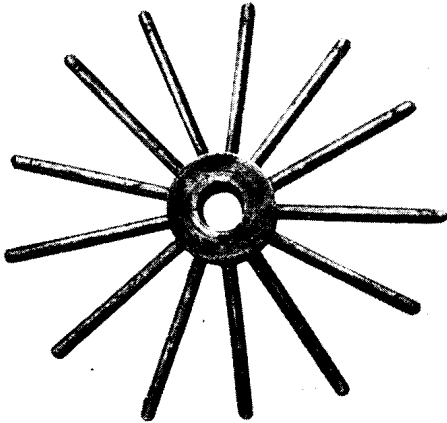

TYPICAL COMMERCIAL FORMER

Fig. 1. Hardwood, ebonite or metal are sometimes used in making this type of basket coil former. The hub and spokes are removed when the coil is wound

very easily accomplished by mounting the boss, otherwise the cotton reel, in the chuck and supporting it with the tail-stock.

Suppose a 60-division plate is available. Set the pointer into one of the holes and use every fourth hole. This will give 15 divisions. Make a small angle piece of

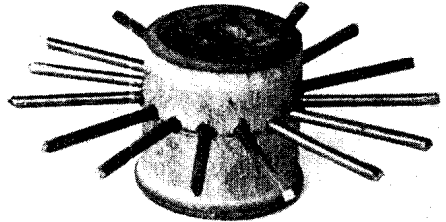

HOME-MADE FORMER

Fig. 3. In order to make this former for basket coils, all that is required is a cotton reel and a few wire nails with the heads cut off

sandpaper. The next step is to drill a series of holes around the middle part of the reel, spacing them equally and making them any odd number, say, for example, 15. If a small turning lathe with a divided head is available, the job is

metal, mount it in the tool post of the lathe, and exactly at the centre line drill a hole through one lug by the same drill which will be used for drilling the hub. This can be done with a small hand drill unless a overhead is available. The

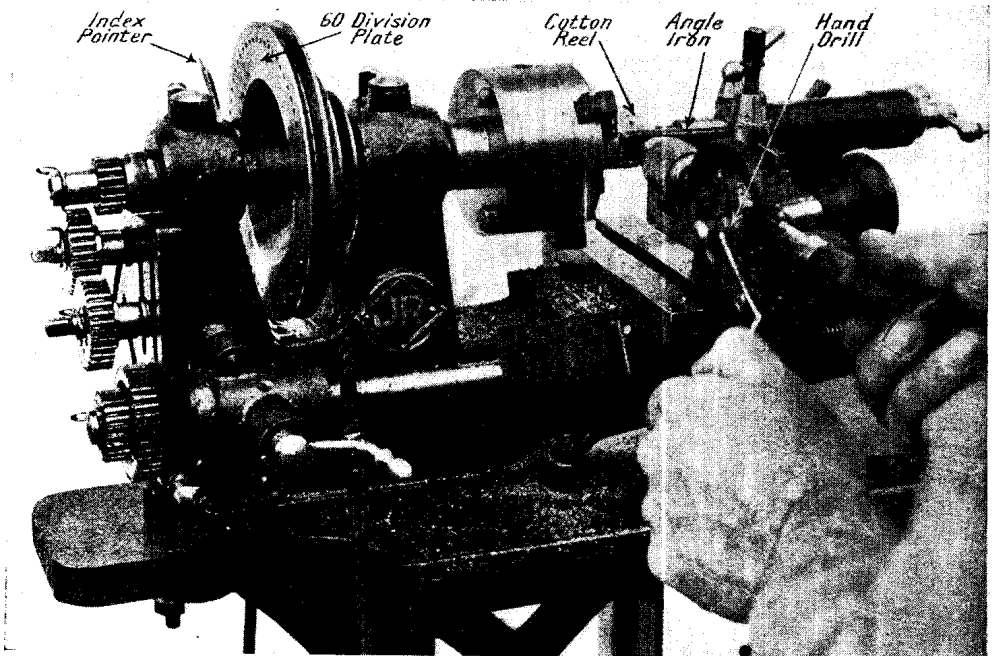

MAKING A BASKET COIL FORMER ON THE LATHE

Fig. 2. Making the former shown in Fig. 3 is not difficult when a lathe is employed. In this photograph the cotton reel is seen on the lathe, being divided and drilled. A hand drill is employed, and the hub is nearly ready for insert the spokes

hole drilled in the angle piece is then used as a jig or guide to the drill, to keep it in line.

The cotton reel is then mounted in the lathe, the pointer set in position on the division plate, and the hand drill operated as shown in the illustration, Fig. 2, drilling right through to the centre of the reel. Then turn round to the fourth hole on the division plate from the starting point, and drill another hole in the reel, and so on until all are completed. Now cut off a number of pieces of stout wire, or in emergency use French stails with the heads clipped off, and press one of them into each of the holes in the hub. This completes the former, as shown in Fig. 3. The wire spokes should be a good press fit in the holes; alternatively they may be screw-threaded and screwed into position. See Basket Coil; Coil Winding.

BASKET COIL HOLDER.

When basket coils have been made, or purchased ready for use, it is desirable to provide some means of supporting them so that they can take their place in the circuit. The simplest way is to hang them on a strip of round wood, passing it through the hole

in the centre of each coil and sliding them along the bar.

The latter should rest on blocks of wood, or otherwise be kept clear of the operating table. This is scarcely a method to be recommended, and something more practical is desirable. There are numerous ways in which the desired result can be attained, and some are here illustrated and described as a suggestion to the experimenter.

An efficient holder for three coils is illustrated in Fig. 1, and can readily be constructed by any amateur. The base consists of a piece of hardwood

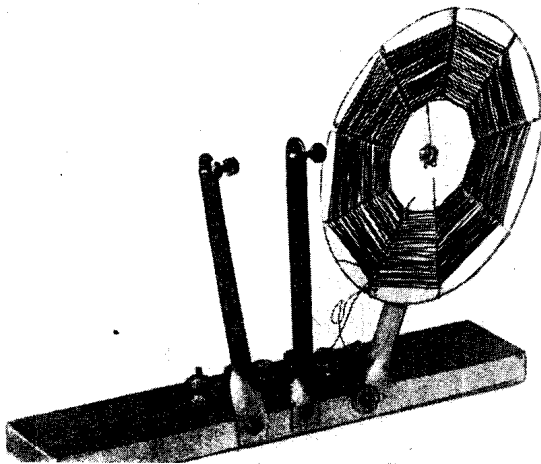
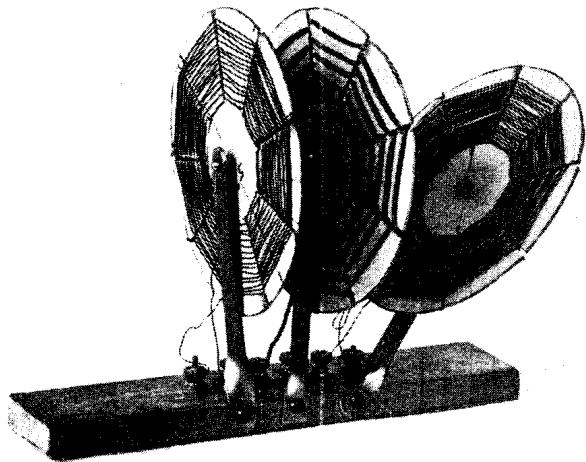

AMATEUR-MADE COIL HOLDER

Fig. 1. (Above, right.) When three basket coils are to be held the amateur will find the model illustrated very efficient and not difficult to construct. Fig. 2. Shows the manner in which the supports for the coils are made. Brass strips are twisted in a vice in order to produce the means of holding the coils at right angles to the movable base

about 6 in. in length, 2 in. in width, and $\frac{7}{8}$ in. in thickness, and in the middle of this is mounted a row of 6 terminals. These are screwed in from the top through holes drilled for the purpose, and secured by countersunk nuts on the underside. To make the supports for the coils, obtain a strip of brass, $\frac{1}{2}$ in. wide and $\frac{1}{16}$ in. in thickness, and cut off three pieces, each 5 in. in length. Round off both ends with a file and drill a hole to suit a No. 4 or No. 6 B.A. screw.

Place the strip of brass in the vice, grasping it about 1 in. from one end, and, with the aid of a spanner, twist the brass so that the part of it above the vice is at right angles to the other. Screw

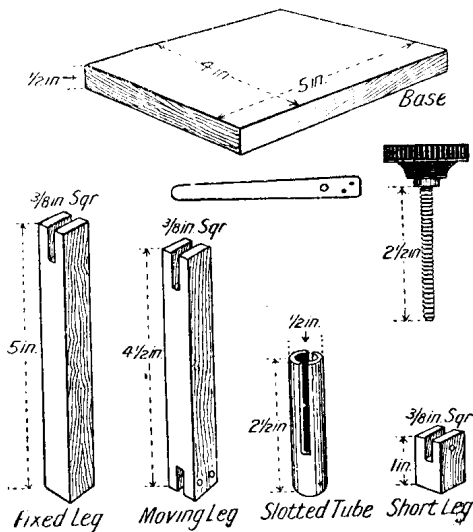

WOOD BASKET COIL HOLDER

Fig. 3. Dimensions of a coil holder are given which the amateur can make chiefly of hardwood

the lower part to the side of the base-board, as shown in Fig. 2, and having made three such strips, fix them so that the middle one is rigid and the other two free to move under the control of spring

washers, which may be inserted between the head of the screw and the metal.

The coils, if wound on card or fibre formers, may be mounted by simply bolting them in position with No. 4 or No. 6 B.A. screws. One nut is used to hold the screw firmly to the support and the second nut holds the screw in position, as can clearly be seen in the illustrations, Figs. 1 and 2.

For tuning purposes the outer coils are simply moved nearer to or farther away from the fixed centre coil.

Another type can be made largely of hardwood, to the size given in the diagram, Fig. 3. The base is rectangular, and upon it are rigidly mounted one tall upright and one shorter one. The tall one is slotted at the top to accommodate a basket coil and the lower one acts as a fulcrum for a lever, which may be made from brass strip $\frac{3}{8}$ in. wide and $\frac{1}{8}$ in. in thickness. These should be cut and drilled to the sizes given in the diagram, Fig. 3, and pivoted on a screw passed through a slot in the shorter upright. The short end of the lever is then fixed in a slot cut in the bottom of a third upright, A, Figs. 3, 4, the upper end of which also accommodates a basket coil.

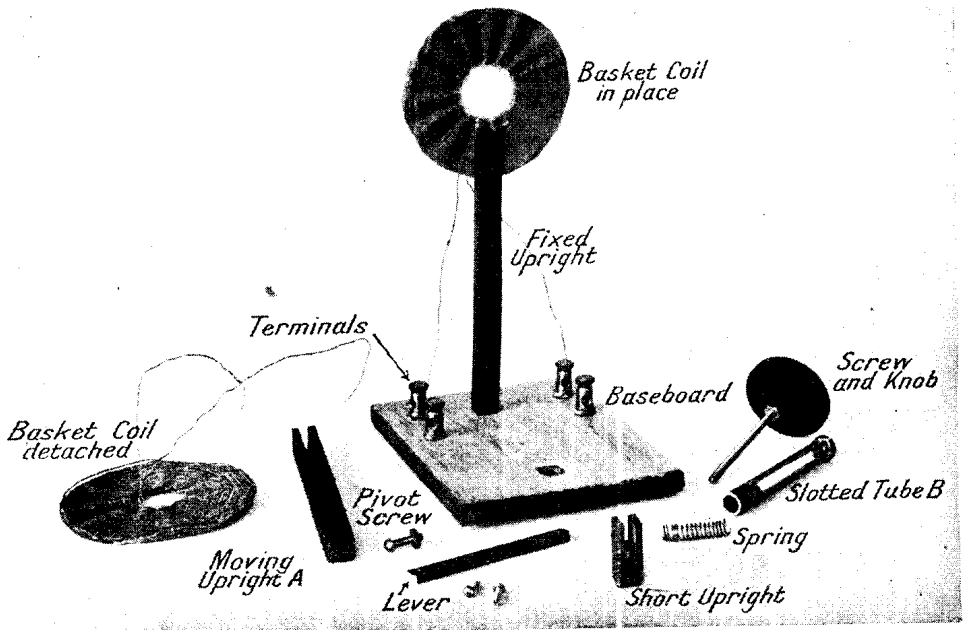

SIMPLE METHOD OF CONSTRUCTING A BASKET COIL HOLDER

Fig. 4. The components here laid out will be seen to consist of material common to the amateur's workbox. Construction is simple, and if neatly assembled the home-made basket coil holder is an efficient device and one capable of fine adjustment for tuning

The control is effected by means of a long screwed rod which works in a nut soldered to the upper part of the tube B, Figs. 3, 4, the lower end of which is fixed tightly into a hole drilled in the baseboard, to which it may be further secured by means of a small screw passed edgewise through the wood. A slot is then cut through the top of the tube, almost to the bottom, and filed out, so that the lever can move freely up and down therein, and a coiled spring fixed into the lower part. A long screw is then provided with an ebonite knob, and screwed into position to bear upon the top of the lever, so that by turning the screw the lever is forced down, or by reversing the rotation is allowed to work up. The second basket coil is thus moved towards or away from the other, providing a very fine adjustment (Fig. 5).

The connexions may be made to terminals attached to the baseboard and connected to the coils by means of flexible wires.

An efficient tuning stand for a pair of basket coils is shown in Fig 6, and comprises a base made from ebonite about $\frac{1}{4}$ in. thick; on this is mounted a movable part shaped like a lever with a projecting handle. This is pivoted on a screw at the outer end, and can therefore be turned outwards to reduce the coupling between the coils. There are terminals on the moving arm and also on the fixed base,

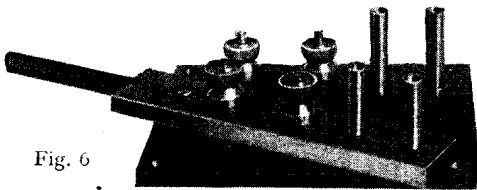

Fig. 6

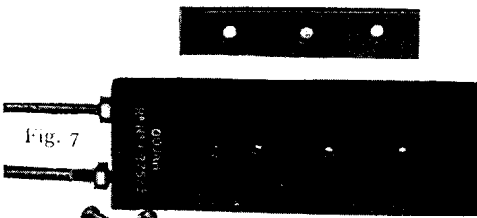
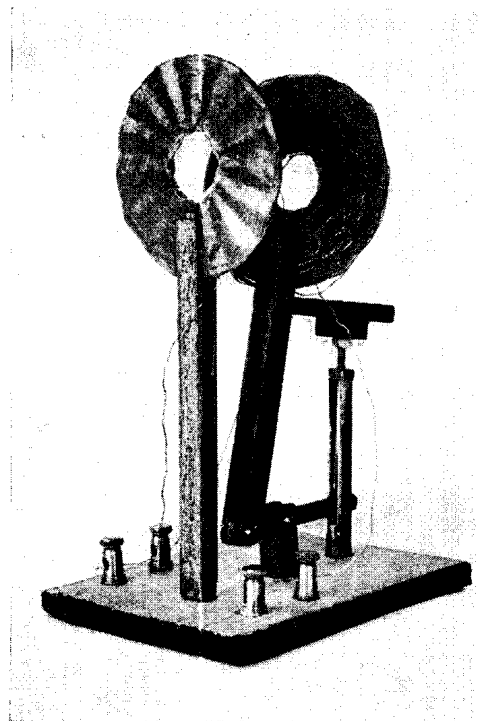

Fig. 7

EFFICIENT TUNING STAND

Fig. 6 (above). By moving the adjusting holder, which is pivoted on the ebonite base, the required amount of reduction of coupling can be obtained. Fig. 7 (below). An ebonite support is fitted with two terminal legs, to which the ends of the coil are attached. The coil is held in position by the attachment of a small strip of ebonite to the support. See Fig. 8



MEANS OF FINE ADJUSTMENT

Fig. 5. In order to adjust the two coils finely, a turning screw is used so that very small movements can be made in this way

connexions being made to them by means of copper conductors sunk into grooves formed in the underside.

The coils are attached to an ebonite support of the type illustrated in Fig. 7, which comprises the flat ebonite plate to which are attached the two terminal legs. Contact is made to them by attaching the ends of the wires from the coil to the nuts at the top of the legs. The coil is held in place by the narrow slip of ebonite which is screwed to the flat plate, thus grasping the coil between the two and holding it securely. The coils are simply plugged into the holder, as shown in Fig 8. The circuit wires are attached to the terminals, and therefore to change a coil for another it is only necessary to remove it from the holder and replace with another, if a supply of the separate mounts are available, otherwise the coil itself can be changed in a few moments.

In some cases it is necessary to fix the basket coils to some existing apparatus such as a detector panel, as, for example, when it is desired to introduce a tuned

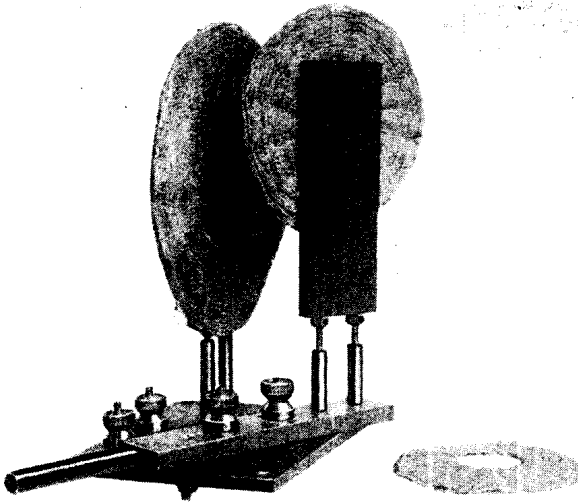

PLUG-IN BASKET COILS

Fig. 8. Having completed the means of supporting the coil, the whole detachable part is plugged into the holder in the same manner as ordinary plug-in coils

anode circuit. Such an arrangement may easily be extemporized in the manner shown in Fig. 9 by making two brass angle pieces cut to lengths of one about 1 in. and the other $\frac{1}{2}$ in. These are screwed to the side of the case. A piece of ebonite, about $\frac{1}{4}$ in. square and of a length to fit nicely between the two projecting angle plates, should then be mounted with a handle or knob at one end and a small screw or retaining nut on the other, the whole disposed so that it can turn freely in the angle plates but cannot shift its position. This is best carried out by means of a spring washer interposed between the handle and the side of the angle plate or by tightening it up sufficiently that it will retain its position through friction.

An upright piece of rod about $\frac{1}{8}$ in. diameter is then mounted vertically on the

centre bar, and upon this the coil is placed by merely pressing it on to the end of the rod and in one of the spaces left by a spoke on the former when the coil was wound.

The connexions are made by means of flexible wire to the coil and to two terminals on the top of the panel, leads being taken beneath the panel to the desired circuit. The other coil may be mounted on ebonite with a pair of valve legs acting as plug connectors, and contact made by means of valve sockets on the panel or by bushing the panel itself.

Experimenters who are in possession of standard coil holders, as used for Igranic, Burndopt (*q.v.*), and other coils of the duo-lateral type, can adapt them to basket

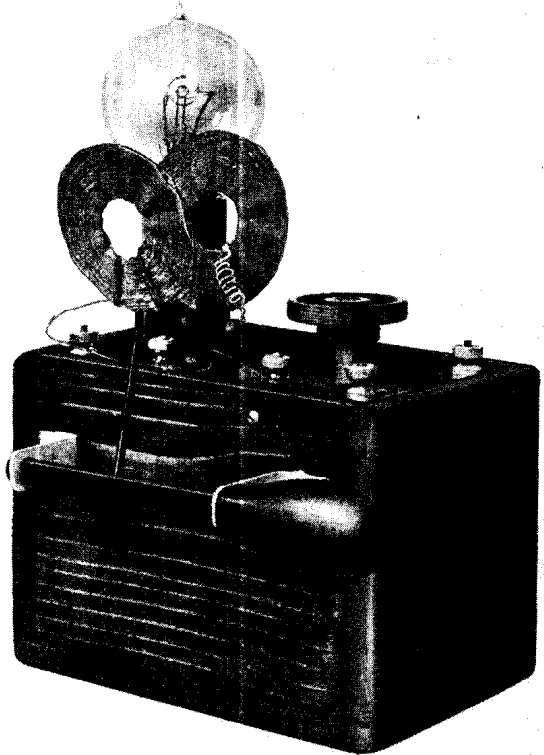

EXTEMPORIZED BASKET COIL HOLDER

Fig. 9. Existing apparatus to which an additional tuning device is to be attached may be fitted with basket coil holders on the outside, as here illustrated

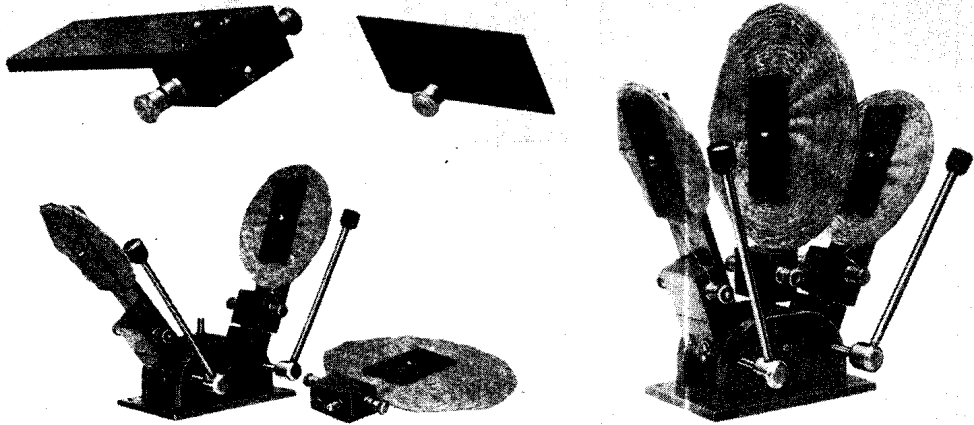

ADAPTED STANDARD COIL HOLDERS

Fig. 10. Mounts are made for adapting standard types of coil holders as used for Igranic, Burndept and other makes of plug-in coils, to take basket coils. In this photograph the mounts shown are made by Will Day & Co. Fig. 11. Another example of the same principle applied to a standard form of holder is here given. Fig. 12. Shows the method of attaching and detaching the coils to standard holders employing adaptors

coil holders by means of the mounts, shown in Fig. 10, as made by Will Day & Co. These have terminal connexions at the base, and can be plugged into any standard coil mounting or holder. The coil is held in place by the flat plate and the set screw, as shown in the illustration. The same principle applied to a standard form of holder is shown in Fig. 11, and the method of attaching and detaching the coils is shown in Fig. 12, which emphasizes the convenience of the appliance.

A useful plug-in coil mounting is illustrated in Figs. 13-15, and is made from a piece of ebonite $\frac{5}{16}$ in. in thickness, $1\frac{1}{8}$ in. long, and $\frac{3}{4}$ in. wide. This is cut to a T-shape with the aid of a hack-saw and two holes drilled through the arms of the T to accommodate two valve legs, which are held in position by means of a pair of lock nuts. A saw cut is then made longitudinally through the upright part of the T and of such a width that it will just accommodate the desired basket coil, as

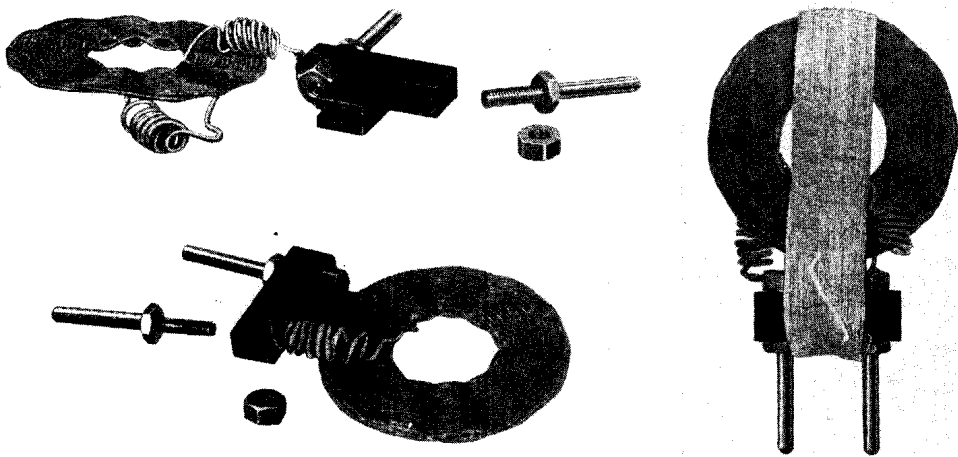

EBONITE T-SHAPE BASKET COIL HOLDER

Fig. 13. After the T-shape piece of ebonite has been cut as shown in this photograph, the arms of the T are drilled to provide for the fixture of two valve legs. A longitudinal saw cut to enable the coil to be inserted is then made, and this simple but efficient device is almost complete. Fig. 14. Gives a clear idea of how contact is made between the coil and the valve legs. Fig. 15. Shows the coil mounted

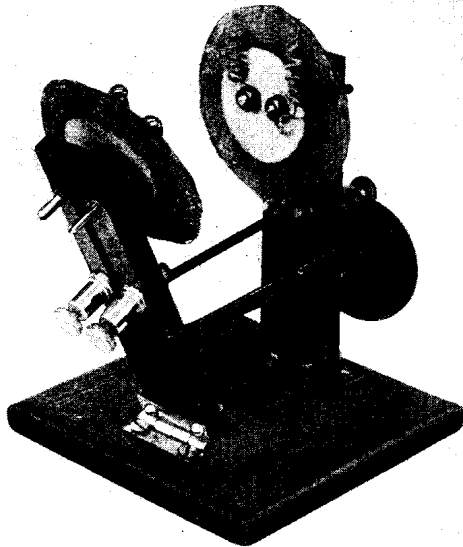

HOLDER FOR TWO BASKET COILS

Fig. 16. Hardwood or ebonite may be used for making this type of holder. The fixed upright is held by angle brass and a small butt hinge serves as a pivot for the movable arm

in Fig. 15, the terminal wires from which are turned around the free ends of the valve legs—and should make good contact therewith, as shown in Fig. 14—and secured by the upper lock nut.

If a number of these holders are to be made, a simple drilling jig should be provided, to ensure all the holes being exactly the same distance apart. Made in this way, the coils can be plugged into the filament terminals of an ordinary valve holder, or valve sockets may be fixed to the panel or baseboard, according to the style of winding. They are very quickly interchangeable, are light and neat in appearance and effective in use. The coil is attached to the holder by securing it in position with a band of tape or silk, as is clearly visible in Fig. 13. This obviates the risk of pulling the coil out of the holder whenever it is taken out of the plug-in sockets.

Another holder for two basket coils, shown in Fig. 16, is constructed from a baseboard of hardwood or ebonite about 3½ in. square, upon which are mounted two uprights, one hinged and the other permanently fixed with a piece of angle brass. These uprights are cut from two pieces of ebonite, 1 in. wide, 4 in. long, and about 7/16 in. thick. The hinge may be an ordinary small butt hinge, secured to the ebonite by drilling and tapping holes for No. 6 B.A. screws and screwing the hinge to the baseboard with ordinary counter-sunk brass wood screws.

Four telephone terminals are then obtained and fitted into holes drilled in the centre of the ebonite strips. Copper

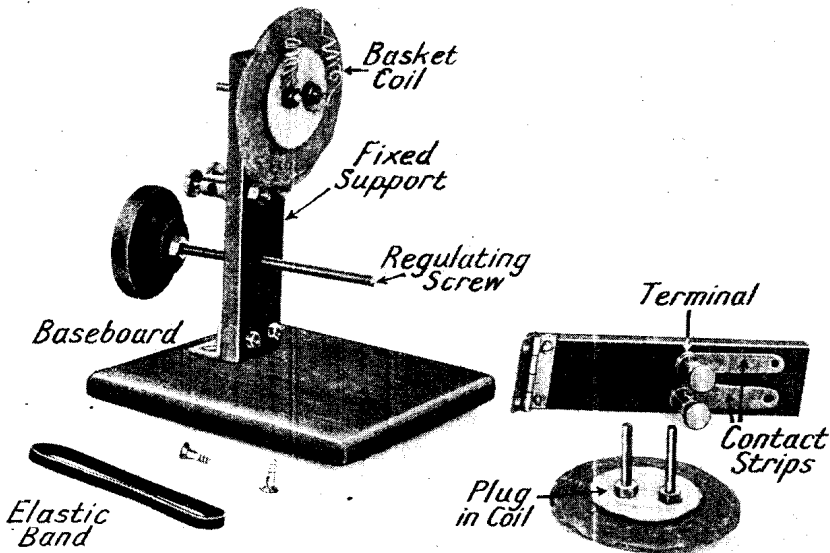

COMPONENTS OF HOME-MADE BASKET COIL HOLDER

Fig. 17. Most of the material used in the construction of this holder may be found among the ordinary spare parts of an amateur experimenter's equipment. In this photograph will be seen the parts necessary for constructing the holder. One coil is mounted to show the method of assembling

contacts are then made measuring $1\frac{1}{2}$ in. in length and $\frac{3}{16}$ in. in width. These are simply flat strips of copper with holes punched at each end. Those at one end are for the telephone terminals and those at the other for the valve legs, which are fitted to the coil holder. The fixed support is secured by means of a small piece of angle brass screwed to the base and to the upright. These parts are shown in Fig. 17.

A hole should be drilled through the ebonite at a distance of $1\frac{1}{4}$ in. up and tapped to suit a No. 2 B.A. screw rod, one end of which should bear against the opposite upright and the other end be provided with an ebonite knob and lock nut. The screwed rod should be about $3\frac{1}{2}$ in. in length, and an elastic band should be slipped over the two uprights so that it presses them together, the amount of separation being controlled by rotating the ebonite knob, which forces the movable support backwards or forwards.

The coils are mounted between two stout disks of card or thin fibre, as in Fig. 18, and are held together by means of ordinary

valve legs, the nuts of which are placed on opposite sides of the card and tightened up. They should be spaced $\frac{1}{2}$ in. apart and should register with the holes through the ebonite uprights, so that when the legs are pressed through these holes they make contact with the copper strips. A better job results from the use of small brass bushes made from little pieces of tube with a bore equal in diameter to the valve legs. These tubes should pass through the ebonite and be soldered to the copper contact strip. They can be fixed to the ebonite by lock nuts.

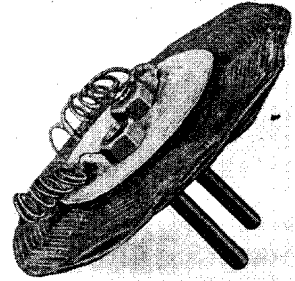

BASKET COIL MOUNT

Fig. 18. Fibre or card disks are spaced by valve legs to form the support for the coil

BATTERIES: TYPES, FUNCTIONS & CONSTRUCTION

Their Uses and Methods of Connexion for Wireless Work

In this article a description is given of the general construction of batteries and the connexions of the cells composing them. The article should be read in conjunction with other sections such as Accumulator; Dry Cell; High-tension Battery; and Storage Battery. See also under the names of primary cells, as Bunsen Cell; Clark Cell; Daniel Cell; Leclanché Cell; and A Battery; B Battery

Two or more cells for transforming chemical into electrical energy are called a battery. Batteries are of two general types, those known as primary batteries, which are self-generating in the sense that the electrical energy is derived from the chemical action set up within the individual cells of which the battery is composed. The second class are known as storage batteries, because the electrical energy is stored, and can be discharged from them after they have been charged by a long-continued current of electricity, and they have the property that they can be recharged or re-energized by reversing their discharge current.

Examples of the primary battery are such constructions as a Bunsen cell, a Daniell cell, and a Leclanché cell, all of which are described in detail in this Encyclopedia under their respective headings.

In any primary battery there are several cells, and they are connected

together in several ways, either to increase the voltage, when they are said to be connected in series; or to increase the amperage, and are described as in parallel.

Primary batteries, as a class, are composed of two elements and an electrolyte. The elements are generally carbon and zinc. The former carries a terminal known as the positive terminal, distinguished by the + (plus) sign, or coloured red. The zinc has a terminal known as the negative, coloured black or blue, and denoted by the - (minus) sign. The electrolyte is generally sulphuric acid or sal-ammoniac solution. When in the form of gelatine and not a liquid the cell or battery is known as a dry cell or battery.

The composition and functions of the different batteries are determined by the nature of their constituent cells. In a storage battery the elements are generally lead and the electrolyte dilute sulphuric acid.

As a battery is governed as to its mechanical and electrical properties by those of the constituent cells, it follows that the choice of a battery is really a choice of the individual cell. In wireless work experience has shown that, as far as amateur requirements are concerned, the batteries most used are those generally known as the A and the B batteries.

The former is of low voltage, sometimes known as the low-tension battery and is generally in the form of an accumulator. The B battery is a high-tension battery, generally composed of a number of small dry cells. The former is a good example of the storage battery, the latter of a primary battery. The reasons for the use of these types in wireless work are due to the different conditions of service that they have to fulfil.

The A battery is generally of the order of 4 to 6 volts capacity, but it has to yield up a considerable amount of current, often, of the order of $1\frac{1}{2}$ to 3 amperes with ordinary high-temperature valves. Consequently the accumulator or storage battery is desirable, as it can readily be re-charged as often as necessary.

Advantages of a Dry Battery

The high-tension or B battery, however, has the opposite duty to perform of delivering a very small quantity of current, generally to be measured in milliamperes, but at a high voltage, ranging from some 20 to 240 volts. Speaking generally, the storage battery is able to deliver larger quantities of current in an economical manner, whereas a high-tension battery of dry cells is more economical, as a dry cell is naturally able to yield only a small quantity of current. As a matter of fact, any storage battery may be made up of a large or small number of units, and each of them could be of any reasonable capacity, large or small, but customarily the foregoing are the most usual arrangements.

The dry battery has other advantages of a practical nature. It can be used in any position without risk of fumes or acid spilling and spoiling the apparatus, it can be retained for lengthy periods of time without deterioration, and does not need re-charging. The storage batteries are almost always made so that they have to be kept in a vertical position, or the contents will run out, and there is the need for regular re-charging. The details

of this class of battery are dealt with fully in this Encyclopedia under the titles of Accumulator and Storage Battery. The construction of dry cells is dealt with under the heading Dry Cell.

Although a battery is composed of a number of cells, there is no reason why it should not be assembled into a complete unit with a common retaining case. Internally it is composed of individual cells, and each is connected to the other in the appropriate manner.

How to Construct a H.T. Battery

An example of this type is the Siemens dry battery, shown in Fig. 1. This is built up of a number of separate dry cells, and these batteries are obtainable in various voltages from 15 upwards. The Exide, Fig. 2, is a typical example of the storage battery type, and is composed of a number of small accumulators made up into a wooden frame or case. The cells are connected in series and the voltage is in all cases double the number of cells in the unit. Thus, if there are 16 cells the effective voltage is reckoned as 32, as each cell of any storage or secondary battery is always taken as 2 volts.

The construction of a high-tension battery of any desired voltage is comparatively a simple matter, if a sufficient number of ordinary pocket flash-lamp batteries are purchased. These have a nominal voltage of $4\frac{1}{2}$, and consist of three separate cells, each with an electro-motive force of 1.5 volts approximately, this varying with some makes, and with the age of the cells. In the usual construction these batteries are made up of three cells, with flat strips of brass as terminals, one end being connected with the carbon element on the first cell, and the other to the zinc element of the last cell. The former is the positive and the latter the negative electrode.

The connexions between the cells are effected inside the battery itself. To make up a battery of any desired voltage, the flash-lamp batteries should be connected together with copper strips, or with wires soldered to the proper terminal strips. The copper strips are quite practical and have the merit that when the batteries are run down and have to be thrown away, these connexions can be removed, and used with the new batteries.

By connecting in series is meant that the positive terminal of the one battery is

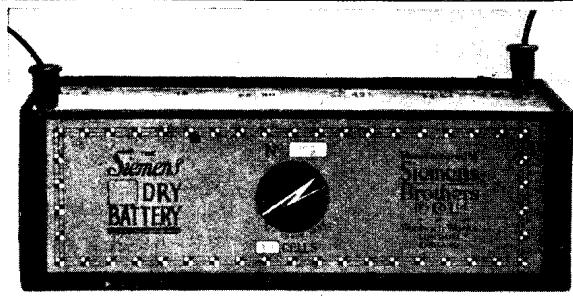

Fig. 1. Dry cells are arranged in batteries for wireless work by many makers. This Siemens battery contains 44 cells

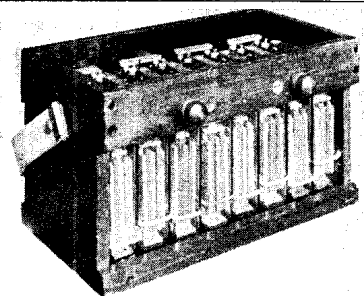

Fig. 2. High-tension accumulators are sometimes used as the example shown, which is an Exide battery



Fig. 3. Pocket lamp batteries are here seen connected in series with copper strip connexions. Note that the positive and negative terminals are joined together alternately

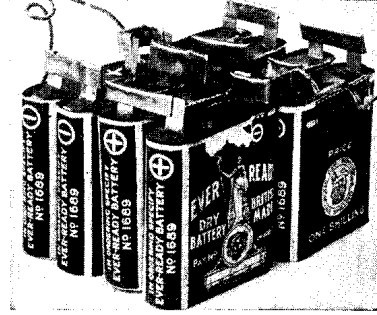

Fig. 5. Series-parallel connexions. Here the negative and positive cells are connected partly in series and partly in parallel. See Figs 3 and 4

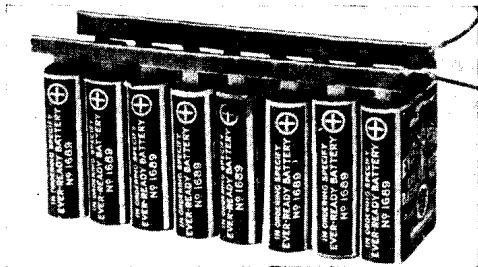

Fig. 4. Parallel connexions may be made with the same kind of batteries as used in Fig. 3, but in this case it will be noted all the positive terminals are connected together and all the negative together

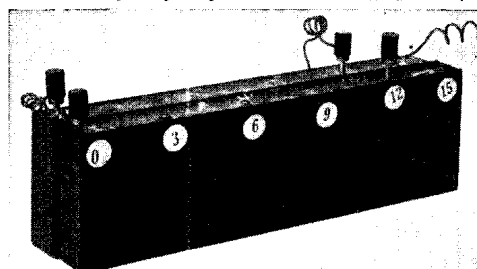

Fig. 6. Two 15-volt H.T. batteries connected in series to give voltage higher than may be obtained from either separately

BATTERIES EMPLOYED IN WIRELESS APPARATUS AND THEIR ARRANGEMENT

connected to the negative of the next, and so on, with the requisite number of batteries. This is illustrated in Fig. 3, which shows a group of cells connected together in series, that is the positive of one is connected by the copper strip to the negative of the next, and so on. The ultimate result is that two terminal ends remain unconnected. These are, respectively, the negative and positive. The difference of potential between them, that is to say, the amount of the voltage in the battery, will then be the sum of the voltages of each pocket flash-lamp battery. In this case,

36 volts, as there are eight batteries, each of $4\frac{1}{2}$ volts capacity, but the amperage will only be that of any one individual cell.

In connecting them in parallel, either copper strips can be used, or the terminals may be connected by soldering wires to them, but in this case, all the positive and all the negative poles must be connected together, as illustrated in Fig. 4. The voltage of such a battery will then be that of one individual pocket flash-lamp battery, in this case $4\frac{1}{2}$, but the amperage will be the sum of the amperage of the eight batteries. Consequently, with such an

arrangement, if the amperage is to be high and the voltage low, the batteries are connected in parallel. If the voltage is to be high and the amperage low, they will be connected together in series. If both the amperage and the voltage is to be the maximum, both systems may be combined. In this case alternative batteries must be connected together in series, and these groups connected together in parallel, as illustrated in Fig. 5.

Commercial high-tension dry batteries are obtainable in various voltages, already connected up, and are generally provided with tapping points. That is to say, the internal connexions are attached to brass tubes or plug sockets, so that convenient detachable plug connexions can be made on any of these points. Such tappings are generally taken in steps of 3 or 6 volts, and are convenient when, for example, 6 volts are required on one part of the circuit, and say, 24 volts on some other part of the circuit. In this case the negative wire is

may be connected in series, by plugging in two wander plugs connected up by a short wire to the negative terminal and to the positive, and then taking tappings from any of the plug contacts that give the required voltage. This is illustrated in Fig. 6, which shows two 15-volt batteries connected in this way with tappings of 24 volts.

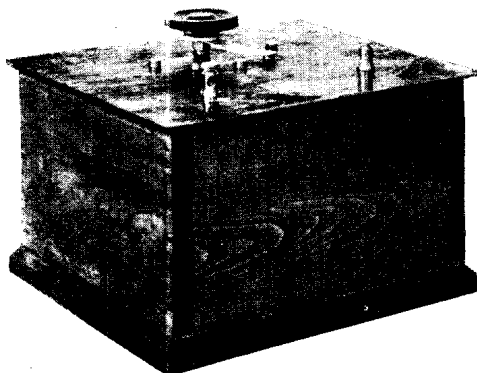

CONTAINER FOR BATTERY

Fig. 1. Multi-contact studs are in this case mounted on the battery box and are engaged by a blade arm operated by a turning knob. The line wires are attached to the terminals, which are also mounted on the top of the box

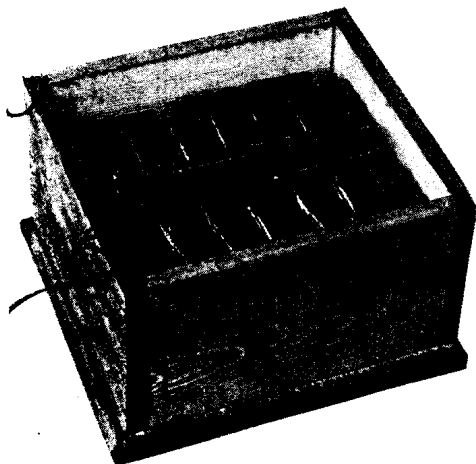

INTERIOR OF BATTERY BOX

Fig. 2. Flash-lamp batteries are shown in position. The dimensions of the interior of the battery box should not be too closely calculated, as the size of batteries varies; superfluous space is filled by packing

plugged into the minus side of the battery, and one of the positive leads plugged into the 6 plug, and the other in the 24 plug. The voltage on these wires will be 6 and 24 respectively.

When the high-tension battery is not of sufficient voltage, as, for example, when only two separate batteries of 15 volts each are available, and the required voltage is 24 to 30, these two batteries

Batteries of dry cells should be stored in a cool, dry place, and the terminals protected with some insulating material so that there is no fear of a short circuit as the result of a metallic object coming into contact with the terminals. Should a battery fail to give satisfactory results, the individual cells should be tested with a voltmeter to see they are not exhausted.

If one of the cells should be run down, and the others still be usable, the affected cells can be cut out of the circuit by severing the connexions between them and reconnecting the terminals of the adjacent cells. It is desirable to use only the best types of battery for the plate or anode circuits, as the use of a poorly-made battery, or one of inadequate capacity, will often set up objectionable noises in the telephones that might be attributed to atmospherics. Another practical point is to see that the insulating wax from the top of the battery has not worked into the plug-in sockets, as, should it have done so, it may cause noises due to the resulting poor connexions, and in a bad case may interrupt the circuit altogether. Also see that the plug makes perfect contact, and that the surfaces are quite clean.

BATTERY BOX. A container specially intended to receive the cells composing a high-tension battery. There are many excellent types of battery box on the market adapted to the reception of varieties of batteries, and some are equipped with control switches and other devices to facilitate the use of the battery. The experimenter can, however, make an effective battery box by simple means and equip it with a multi-contact switch.

The appearance of such a box is shown in Fig. 1, from which it will be seen that a contact arm and knob is used to effect the connexions through the contact studs. The terminals for the line wires to the wireless set are seen at the front. The size for the box will have to be determined by the size of the battery, but in the case illustrated this was composed of 12 pocket flash-lamp batteries, each with a nominal voltage of $4\frac{1}{2}$ volts, consequently the maximum voltage is 54.

The batteries are connected together in series by means of copper connectors, made by cutting strips of copper, $\frac{3}{4}$ in. wide, and bending them over in the centre of their length, thus forming a clip-on contact connector. The tapping wires are attached by soldering. The batteries are separated by means of strips of cardboard, and space is left at the ends for a little packing, as the actual size of the batteries sometimes varies, and the packing allows for this, as shown in Fig. 2.

The construction of the box can be on quite simple lines, as shown in the illustrations, or may be as elaborate as the constructive ability of the experimenter allows. The simplest way is to obtain some prepared timber from the timber-yard as sold for door stopping and similar purposes. This is obtainable about $3\frac{3}{4}$ in. wide and is some $\frac{3}{8}$ in. thick.

It is, however, very necessary that the cuts be made at right angles to the edge, and that the end of the pieces, when cut off, are also square with the flat face. This is accomplished by accurate cutting and by the use of a shooting board to enable the ends to be planed up true.

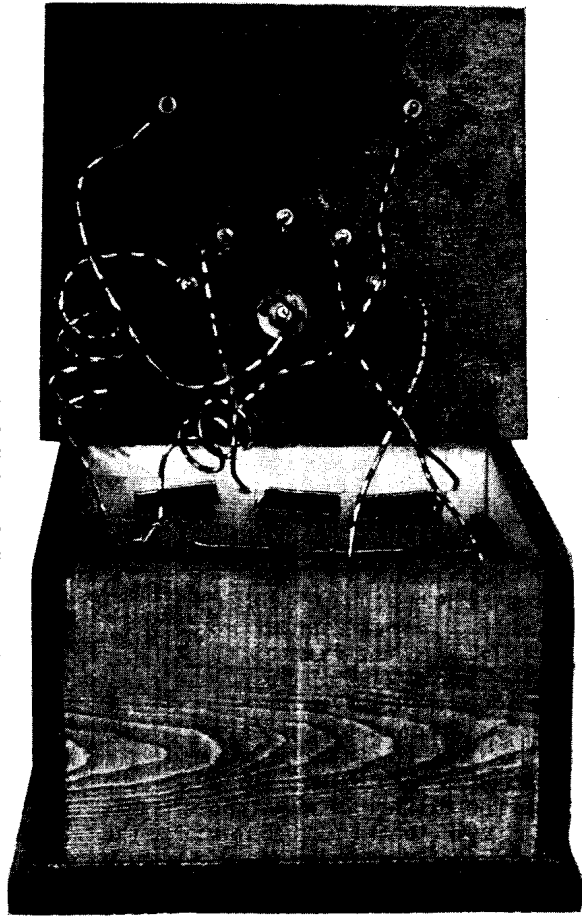

HOW THE BATTERY BOX IS WIRED

Fig. 3. Battery boxes employing multi-contact switches are wired as seen in this photograph. The two terminals are at the top. That on the left is the positive terminal, from which connexion is made to the contact arm, and that on the right is the terminal connected with the negative side of the battery. Tappings are taken at various voltages and the wires joined to the underside of the contact studs.

The four pieces for the sides and ends are then nailed together with fine oval brads, about 1 in. in length, and spaced about $\frac{3}{4}$ in. apart. The bottom is cut from a piece of prepared board, $\frac{3}{4}$ in. thick, and should project slightly, the edge being finished by planing to a bevel. The bottom is attached with fine wood screws passed through the base and well countersunk. The panel or top is best made from ebonite, but thin three-ply wood will do if well impregnated with paraffin wax and finished with insulating paint.

The panel should be cut to shape and the holes drilled for the contact arm

spindle and for the studs and terminals before it is impregnated, as the wax can then get into the end grain around the holes. The studs are the regulation pattern as supplied for tapped inductances and other wireless parts. The connexions are made with insulated wire of about No. 16 gauge.

One wire is taken, as shown in Fig. 3, from the negative terminal to the right-hand terminal on the panel. The other line terminal is connected to the bushing of the contact arm spindle. The studs are wired progressively to the desired tapping points on the batteries by soldering them to the copper contact strips. When any of the batteries are exhausted they can easily be removed and new ones substituted. The copper strips have only to be pulled off the brass contacts on the batteries and replaced on the corresponding terminals on the new batteries. See A Battery; Accumulator; B Battery; Cell; Dry Battery; High-tension Battery.

BATTERY CHARGING PANEL. An expression applied to any type of portable charging board used to re-charge the accumulators of a wireless set. Frequently it takes the form of a separate unit that can be wired up and operated in con-



BATTERY CONNECTOR WITH SPADE TERMINALS

Fig. 1. One of the most useful types of connectors with screw-down terminals employs spade terminals. A connector of this type is shown above. A short insulated wire is furnished with two spades; one is seen engaged by the battery terminal, the other is exposed from the insulation to show the connexion

junction with the receiving set. The supply of current is taken from the house lighting circuit by means of a plug-in connexion and a flexible wire. The subject is dealt with in this Encyclopedia under the heading Charging Board.

BATTERY CONNECTORS. Electrical conductors connecting the terminals of a battery. Such connectors may consist simply of flat strips of brass or copper of suitable length drilled at each end. These are slipped over the terminals and secured by tightening the terminal nuts. Other examples of battery connectors are those

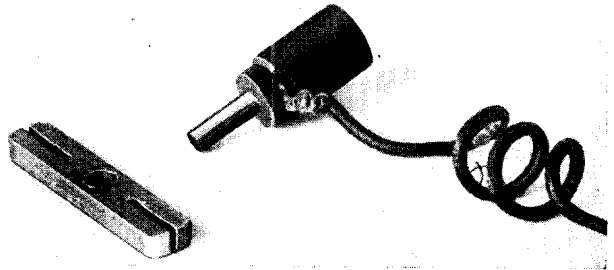

PLUG-IN CONNECTOR FOR BATTERY

Fig. 2. Wander plugs may be used in conjunction with pocket-lamp batteries by the use of the flat brass strip shown in this photograph. Hack-saw cuts are made in the strap to fit the brass strip terminals of the batteries, and a hole drilled to take the plug

made of lead, burnt on to the terminal lugs of an accumulator. Usually, however, the connector is a detachable conductor and may take the form of a heavily insulated wire, about No. 10 to 16 gauge, for an ordinary battery such as is used for wireless receiving sets. These are most convenient if provided with a spade terminal (*g.v.*), or some similar tag or end piece to facilitate attachment to the terminals of the battery.

Such an example is illustrated in Fig. 1, which shows a heavily insulated and graded conductor provided with spade terminals and attached to one pole of a dry battery. In the illustration the insulation has been drawn back from the conductor to show its relative dimensions, but in practice the end of the conductor is preferably wrapped with insulating tape, a few turns taken around

the end of the spade terminal reducing the risk of damaging the conductor where it is attached to the terminal.

Another type of connector, Fig. 2, of considerable utility to the wireless experimenter is intended for use with the

ordinary type of pocket flash-lamp battery. These batteries are usually fitted with flat brass strips which act as terminals to the battery. The connector may consist of a piece of strip brass about $\frac{3}{8}$ in. in width and $\frac{1}{8}$ in. in thickness, and approximately $1\frac{1}{2}$ in. in length, the exact length being determined according to the make of the battery.

A hole is drilled in the centre to suit an ordinary standard wander plug, which should be a nice close fit in the hole. Each end of the conductor is slotted by making a saw cut in it with a hack-saw. In use, the connector is fitted to the terminal strips of the battery, and when it is desired to make a tap, the wander plug, with the conductor attached to it, is simply plugged in the hole. If the connector does not fit quite tightly to the contact strips, due to the saw cut being rather too wide, connexion is easily made by closing the slot, either by squeezing the end of the connector between the jaws of a vice, or by gently hammering them together. Another plan is to fit a small set-screw through the side of the connector and to tighten this when it is in place, so bringing the pole close against the side of the slot in the connector. This plan is, in any case, desirable for the first and last terminals of the battery, as these have only one terminal strip on which to fit.

Numerous other kinds of battery connectors are available, but in essence they are of the wire or of the metal-strip type. In some cases, pressure is relied upon to make contact by attaching the fixed brass or copper strips to the top or sides of the battery box. The flat brass strips on pocket flash-lamp batteries are then disposed so that they will press against these strips, and thereby make contact, but this method is not so efficient as the use of separate connectors. If the strip-terminals of the battery are not perfectly clean and properly adjusted, an inefficient connexion will result and a good deal of battery power will be lost. See Busbar; Carbon Clamps; Conductors; Connectors.

BATTERY SWITCH. A switch used to control the voltage of a battery. Various kinds of commercially made switch are available, and may comprise a simple two-way switch, or an elaborate affair with many contacts. With all of them the same essential principle is adopted—that of a movable contact arm making contact with any desired contact stud. The arm

is connected by means of a bush, or brush, and wire to one pole of the battery. Tappings are taken from any desired points in the battery to the various contact studs. Usually one stud is left blank, and is the off position. Set, next to this is the stud of usually the lowest voltage tapping point. The others progressively increase the voltage as the contact arm is turned in a clockwise direction.

In some cases the contact arm is double-ended, one arm projecting and making contact with separate studs, the other arm bearing constantly on the segmental contact surfaces these surfaces being electrically connected to some part of the circuit. Tapping points are taken from the battery to the different contact studs, and the battery wire from the battery negative terminal to the circuit direct. Consequently, when the switch knob is turned, the contact arm connects with one

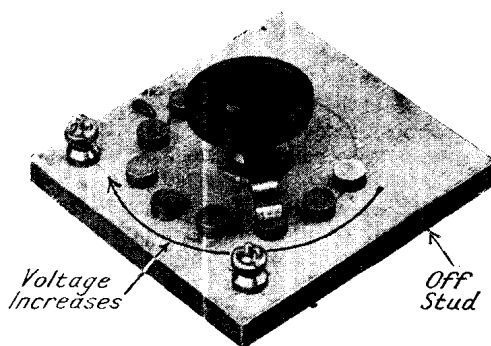

CONTROL SWITCH FOR BATTERY

Amateurs making up this switch should note the stud seen on the right. This is not wired, and forms a rest for the contact arm when the battery is not in use.

of the studs on the segmental plate, thus completing the desired circuit.

The experimenter can readily construct a battery switch suitable for the control of a high- or low-tension battery. The base may be a piece of ebonite, or, for some apparatus, hardwood impregnated with paraffin wax will answer sufficiently well. The exact sizes will be determined by the number of contacts to be provided, but may be from 4 in. to 5 in. square, as shown in the illustration. A standard ebonite knob with a laminated copper contact arm and spindle, such as can be obtained from the wireless dealers for use with inductance switches, is mounted in a brass bush in the centre of the base, and a copper wire about No. 16 gage soldered to the flange

on this brass bush, and connected to one terminal in the corner of the base.

The contact arms are usually about $1\frac{1}{4}$ in. in length, and with a radius corresponding to this arm, scribe a circle from the centre of the spindle and mark it upon the base, and on this line set off, at equal distances, a number of spaces equivalent to the number of studs to be accommodated. These may be ordinary contact studs with a nut and washer, and are simply fixed by passing a shank through the hole, and securing with a nut and washer.

If it is desired to break contact between each of the studs, they must be spaced so that the width between them is greater than the width of the contact arm. But it is preferable for the studs to be placed sufficiently close together that the contact arm touches the second stud before leaving the first, but to connect only alternate studs. This conduces to steadiness in action and automatically breaks the current. It also ensures that the movement of the contact switch does not short circuit through the battery.

The second terminal should be fitted on the opposite corner of the baseboard for the wire connecting the negative terminal to the battery. Such a switch can be mounted on a panel, if clearance holes are cut through to accommodate the wires and ends of the contact studs. If the switch is to be mounted on a base, an efficient method is to attach a piece of moulding on the inside of the edges, sufficiently deep to leave the base clear and leave room enough for the wires. These may be led through one or two holes drilled in the moulding and bushed with ebonite bushes. See Accumulator; Control; Switch.

B.A. UNIT. The unit of electrical resistance adopted by the British Association in 1863. Its value is 9867 ohm. The unit was supposed to be equal to the ohm within about one part in a thousand, and was the result of a series of measurements by Maxwell, Jenkin, and Balfour. In the following year, however, Matthiessen and Hockin constructed a number of coils to represent the B.A. unit. It was found that the resistance of these coils did not remain constant, and the B.A. unit was taken as the mean value of six of them. See Ohm; Units.

B BATTERY. This is a high-tension battery used to supply high-tension current to the plate circuit or for other purposes, such as, for example,

supplying power to a loud speaker. It may consist of quite a small group of dry cells or may be a powerful battery of accumulators. This depends upon the load likely to be put upon it, and also facilities for charging or otherwise. Where these facilities are available a high-tension accumulator is generally preferable to dry batteries, provided the accumulator be of excellent quality.

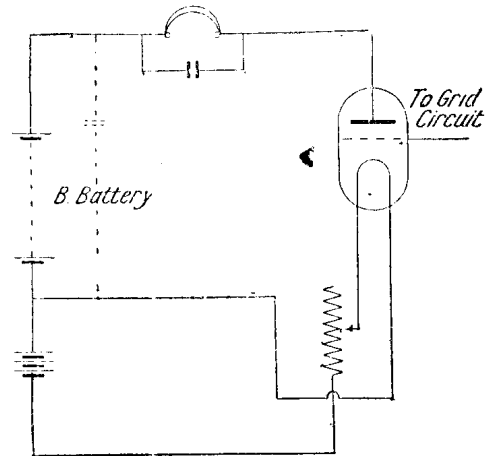

HIGH-TENSION OR B BATTERY CIRCUIT

Fig. 1. High-tension current is supplied to the plate circuit by means of a battery arranged as shown in the above diagram, or arranged similarly in any circuit of a like nature

A typical B battery circuit is shown in the form of a theoretical diagram in Fig. 1, and parts wired up are shown in the photographic illustration, Fig. 2. The B battery circuit comprises all the connexions from the positive to the negative poles of the battery.

These circuits are purely explanatory of the application of the B battery in a circuit, as any particular circuit to which a B battery is applied varies considerably, according to the number and purpose of the other components. In the illustrations the positive terminal of the B battery is connected to the headphones and shunted by a fixed condenser. From the phones the wiring is continued to the plate or anode terminal of the valve and valve holder. The negative terminal of the B battery is connected to the positive terminal of the A battery (*q.v.*), the latter is connected to the filament in the usual way. In other cases the negative of the B battery is connected to the negative of the A battery. Generally a fixed condenser is shunted

across the terminals of a B battery to protect the telephones from any sudden pulse of current from the batteries which might burn out the magnet windings. The condenser is shown dotted in Fig. 1.

The voltage of the B battery varies considerably, according to the apparatus to be energized by it. In ordinary receiving sets the voltage will be of the order of 15 to 45 volts, while for power purposes with a loud speaker the voltage may be as high as 240 volts. In some cases the voltages may be variable in a circuit as a whole, as, for instance, the case of a multi-stage amplifier, where the first valve may have a B battery voltage of, say, 30 and a voltage of 100 or more on the plate of the last valve. This is done to supply a sufficiently strong current to such appliances as a loud speaker. In transmission work of certain types, the B or high-tension battery has an important duty to fulfil. See A Battery; Accumulator; High-Tension Battery; Transmitter.

B BATTERY SWITCH. A switch used in conjunction with a high-tension battery to enable various voltages to be switched on to the valve. This type of switch generally has five or six contacts, the studs being so spaced that the contact arm cannot make contact with more than one at a time, this being effected by spacing them sufficiently widely apart to break contact between each of the studs. By this means there is no fear of the battery being short-circuited when moving from one contact point to the other.

It is often convenient to fit such a switch on to a battery box, but the illustrations show an alternative plan of making the switch in the form of a neat complete unit, as in Fig. 1, particularly

adaptable for experimental purposes. The base measures $3\frac{3}{4}$ in. square, and may be a piece of ebonite; or, for ordinary purposes, hardwood, such as mahogany, will answer very well, especially if it be coated with shellac or impregnated paraffin wax. The framework is made from simple



SWITCH USED WITH B BATTERY

Fig. 1. Instead of employing wander plugs a B battery is sometimes tapped and wired to a switch as shown above

moulding, such as the standard $\frac{1}{2}$ in., obtainable from any timber yard. This is mitred at the corners in the manner illustrated in Fig. 2, and its dimensions are such that the panel will just rest on the flat part of the moulding and is secured in position with four small screws through

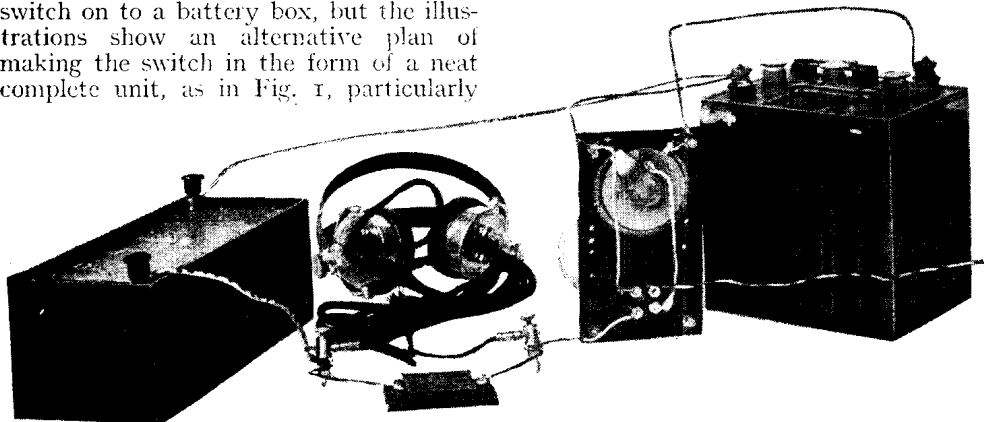

HOW THE B BATTERY IS WIRED IN CIRCUIT

Fig. 2. On the left of the photograph is the high-tension battery employing wander plugs. One of the wires is taken, as shown diagrammatically in Fig. 1, to the positive tapping of the B battery. From the other end of the battery the negative wire is seen connected to the A battery positive terminal

the corners. The advantage of using the moulding in this way is that it lifts the baseboard of the switch above the level of the table, and provides a cavity for the reception for the nuts on the ends of the

receiving set, and as the knob is turned to the right or in a clockwise direction the voltage is increased step by step as the arm makes contact with the various studs. If desired, stop pegs may be placed to limit the travel of the contact arm, and an additional stud to act as the off position.

Other modifications, such as the addition of further contact studs, can obviously be provided to meet any particular requirements. The contact arm is made from a piece of springy brass. The outer end is rounded with a pair of round-nosed pliers, so that as the arm brushes over the studs there is no fear of it jamming on the corners of the studs. The latter should be slightly rounded for the same reason. The arm is attached to a screwed

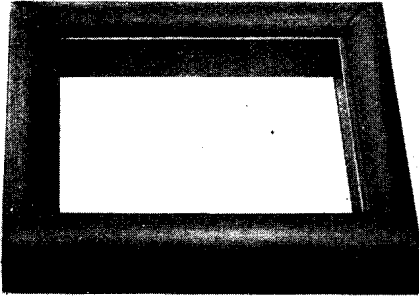

FRAME FOR B BATTERY SWITCH

Fig. 2. Framework made of simple moulding serves conveniently in the construction of a B battery switch, and is mitred at the corners

contact studs and also provides room for the end of the contact arm spindle.

The panel should be marked out in the manner shown in the diagram, Fig. 3, and the holes drilled with a straight-fluted drill. The studs are then fixed in position by passing them through the holes and securing them with nuts and washers. Contact may be made to each of them by means of separate insulated conductors, secured by soldering, or by means of a second nut. The former is the preferable plan. A groove is cut through one side of the moulding framework, or a hole may be drilled through it, and wires taken through the hole, as in Fig. 4, to the contact point on the battery. One wire is then

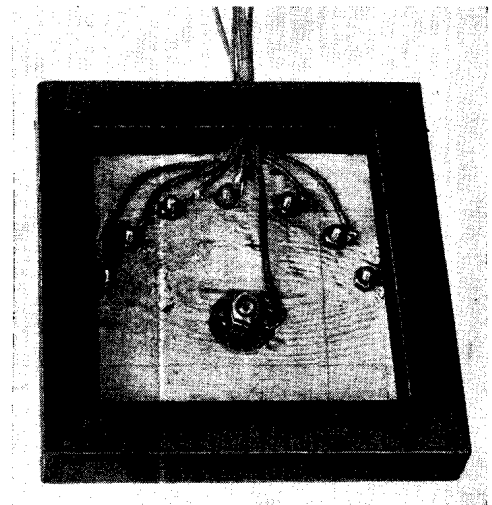

UNDERSIDE OF SWITCH

Fig. 4. Tappings are taken from the B battery, and pass through a hole in the side of the moulding. The negative connexion is wired to the bottom of the contact arm

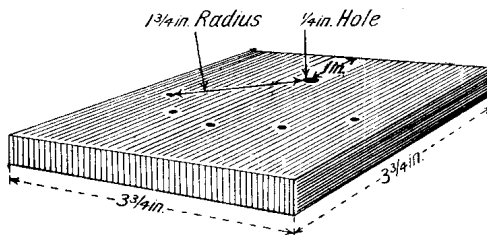

DIMENSIONS OF SWITCH PANEL

Fig. 3. In this panel for a B battery the holes for contact studs should be equally spaced out whatever the number used

taken from the bush of the contact arm to the receiving set. The connexion switch is such that when the contact arm is on the end contact, the lowest voltage passes through the contact arm to the

spindle by means of locking nuts, as is usual with this class of wireless apparatus. A knurled ebonite knob is attached by screwing and a lock nut. To ensure a good contact the inner end of the spindle has a spring washer and lock nuts, these being adjusted to the desired tension to ensure a good contact between the arm and the studs. See Brush; Contact Stud; Switch.

B.B.C. Abbreviation for the British Broadcasting Company. Under the contract made by the Postmaster-General in 1922—revised by agreement in 1923—with the British Broadcasting

Company, the Postmaster undertook to issue licences for receiving sets to persons who purchased wireless sets from the members of the British Broadcasting Company. All sets manufactured by



Apparatus made by firms associated with the British Broadcasting Company bears this seal

members must be submitted to the Post Office for approval, and each approved set bears the registered seal with the letters "B.B.C." Such a seal is shown in the illustration.

BEARING.

In wireless work a bearing is a small metal part used as a support for a movable shaft. Such fittings are generally used on panels and fixed parts of apparatus. An example is in a multi-contact switch, the arm of which would be mounted on a spindle, and this, in turn, supported in a bearing attached to the panel itself. Another type of bearing is that forming part of a machine, such as a dynamo or motor. But so far as the wireless experimenter is concerned,

the expression "bearing" is limited to the type first mentioned.

Despite their small size they are worthy of considerable care and attention both when fitting them and in the general lay-out of the panel. For one thing, the bearing is very often required to provide a path for an electric current flowing, for example, from the contact arm through the spindle, and then through the bearing to the conductor.

Consequently, it is necessary that the bearing shall function perfectly as a mechanical support for the spindle, and at the same time shall provide a good and efficient electrical contact.



BEARINGS FOR WIRELESS SETS

Fig. 1. On the left is a bearing suitable for screwing to a panel. An eccentric bearing is seen in the centre, and on the right is a plain bearing

In some types of variable condenser a bearing is used in this way, and should this be a poor fit the resistance to the passage of the current of electricity varies and the reception by the instrument as a whole suffers.

Commonly used examples of this class of bearing are illustrated in Fig. 1, which shows three simple types machined from solid brass rod. Flanges are generally provided to enable the bearing to be attached by screws or bolts to the panel or other mounting. The central or bearing hole is preferably reamed to make it perfectly smooth, and the spindle which fits it should be a close fit, tight enough to keep the spindle steady, but at the same time free enough to permit movement without any tendency to jam.

A type of adjustable bearing applicable to a variable air condenser or other part can be made from a simple flat strip of brass about 1/2 in. or so in width, 1 1/2 in. in length, and about 1/4 in. in thickness. Holes are drilled through the ends to accommodate screws for attaching the bearing plate to the apparatus. Another hole is then drilled through the centre of the metal for the spindle, which should fit closely into the hole. Then, to provide

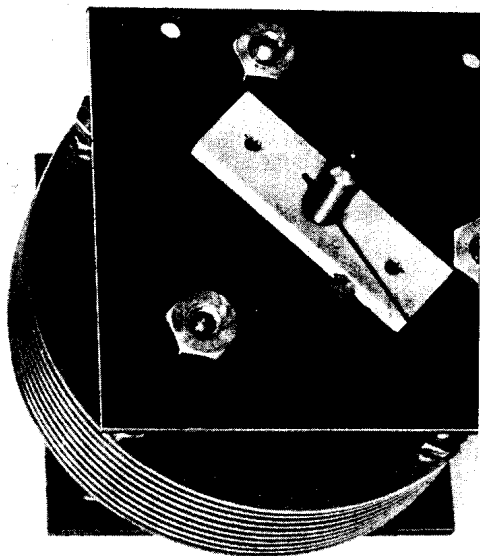

ADJUSTABLE BEARING

Fig. 2. This photograph shows a bearing adjusted to accommodate the spindle of a condenser. By means of a diagonal cut tightening or loosening is effected with a set-screw

for adjustment, a cut is made with a hacksaw diagonally across the plate, as shown in Fig. 2, the saw-cut terminating in the bearing hole.

A small screw, about No. 8 B.A. is then provided and fitted into a hole drilled and tapped into the edge of the bearing plate and passing through the saw-cut. The outer part of the plate is drilled with a clearance hole, and the inner or fixed part is tapped. Tightening this screw closes up the slot, and slightly contracts the bearing hole, thereby making it adjustable. This hole for the set-screw should be drilled and tapped before making the saw-cut, as, unless this is done, there is considerable risk of breaking the drill and tap when performing these operations.

Another type of adjustable bearing takes quite a different form, and is used in a different manner. One example is that found in some types of variable condenser. In this case an angular adjustment is provided by means of which the alinement of the spindle is varied. A typical example comprises a brass bearing with a flange piece shaped like a hexagon, or simply left circular in form, as shown in Fig. 1. The outside of the barrel is screw-threaded and provided with a small

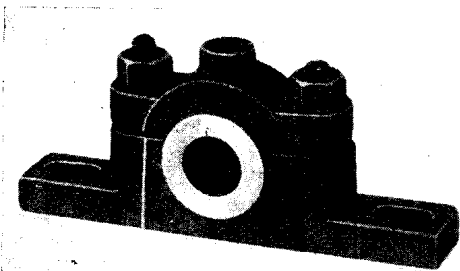

PLUMMER BLOCK BEARING

Fig. 3. Gunmetal or bronze is used for the bush of a plummer block bearing. The body is of cast iron, and constructed in two parts. Bolts and nuts hold the cap in position as here shown

hexagonal nut and washer. The bearing is inserted into a hole drilled in the panel, and held by a lock nut.

To provide for alinement, the bearing may be rotated bodily in the panel by first slackening the lock nut, and then turning it into any desired position. As the bearing hole for the spindle is slightly eccentric, it follows that the spindle is constrained to move in a small circle, the diameter of which will be double the eccentricity of the bearing. Thus, if the

bearing of the spindle hole is drilled out $\frac{1}{16}$ in. from the centre, it provides for a total adjustment of $\frac{1}{8}$ in. for the spindle.

This type of bearing is useful on a multi-plate variable condenser, as by careful adjustment the plates can be set so that the moving plates are exactly parallel to the fixed plates. Such a bearing is generally considered to be more efficient than one of a similar type, but fixed by clamping it with a lock nut to the panel and drilling a larger hole in the panel, so that the bearing as a whole can be moved about in it. When this method is adopted, there is the greatest risk that the bearing will shift during service and cause trouble. But when the eccentric bearing is used there is very little risk of its moving its position when it is properly adjusted and tightened up.

Another type of bearing that is of service to the experimenter is that illustrated in Fig. 3, and known as a plummer block. This consists of a cast-iron body, and a gunmetal or bronze bush. The bush is made in two parts divided horizontally and held to the body of the bearing by a cast-iron cap. The cap is held in place by two bolts and nuts. The latter should be tightened down firmly on to the cap, and any fitting needed is carried out on the bushing. A commonly used method is to insert very thin slips of brass between the joints of the brasses to separate them sufficiently to allow the shaft to revolve freely in the hole.

Two ears or flanges formed on the base provide a means of fixing the bearing to any part of the apparatus. With a bearing of this type the adjustment for wear is provided by filing off some of the metal from the joint faces of the brasses. This type is useful to those experimenters who use power-driven appliances of any kind, as, for example, a shaft for transmitting power from an engine to a dynamo used for charging the batteries for a large receiving set. The plummer blocks should be securely bolted to a strong foundation of some kind, such as stout bearers of wood, or to the standard brackets and other fittings sold by mill-wrights for use with shafting of all kinds. Lubrication is an important matter, and is generally carried out by fixing an oil bottle into the hole in the top of the cap.

BEAT. The rise and fall of resultant amplitude due to the combination of oscillations of two different frequencies.

One set of oscillations is due to the signals received from the transmitting station and the other to local oscillations set up at the receiving station. The frequency of the latter oscillations are so arranged that they differ but slightly from the frequency of the incoming oscillations. The beat frequency is the difference between the two frequencies, and is kept small so as to be within the acoustic limits.

Beats may be explained simply by considering two interacting valve motions. When the two waves are in step, the beat is at a maximum, and when out of step at a minimum. Superimposing one frequency upon another so as to produce a third frequency is called heterodyning. See Audio-frequency; Autodyne; Heterodyne; Radio-frequency; Wave.

BEAT RECEPTION. Reception by means of the combination of a locally generated alternating current with the alternating current resulting from incoming signals, the two being of different frequencies.

Telegraph signals propagated by a damped wave or spark transmitter, owing to the audio-frequency of the wave train can be detected by a simple rectifier of the crystal or valve type.

Telegraph signals propagated by a continuous wave transmitter, either of the alternator, the arc, or the valve type, owing to the absence of an audio-frequency wave train, can only be detected when some

to deflect the diaphragm at the commencement and end of the signal; a steady current would flow in the telephones for the duration of the signals. Hence the necessity for using some method by which the continuous wave can be converted into a wave train of audible frequency.

A method adopted for this purpose is based on the principle of interference produced between two sets of vibrations, differing in frequency, acting on each other. If two strings are each tuned to the same note and each is made to vibrate, the vibrations of each string will add their effects to produce a greater sound than one string alone. If one string is tuned to a slightly

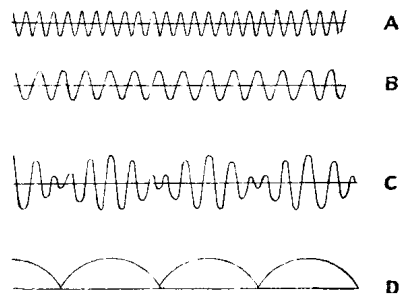

RENDERING CONTINUOUS WAVES AUDIBLE

Fig. 2. A and B represent two sets of vibrations singly, and C one superimposed upon the other. When this analogy is applied to radio-frequencies the beat-wave, C, being rectified, produces a mean telephone current, D

higher or lower note, then the frequency of the notes produced will differ. When the strings now vibrate at the same time, the sound of one string will at definite time intervals reinforce the sound of the second string to produce a beat note. The beat note will be heard to increase and decrease gradually in intensity. Obviously the beat note frequency depends on the frequencies of the two strings, and is, in fact, equal to their difference. Fig. 2, A, represents vibrations of frequency n , and B, represents vibrations of frequency n^1 . These two frequencies when superimposed produce the beat frequency $n - n^1$, represented by the curve C.

Although in the analogy we have taken sound frequencies, the curves A, B, and C can actually represent radio-frequencies, the beat-wave C being rectified to produce the mean telephone current shown in D.

When this principle is applied to the detection of continuous waves, the interfering note has to be set up at the receiver end, and there are several methods

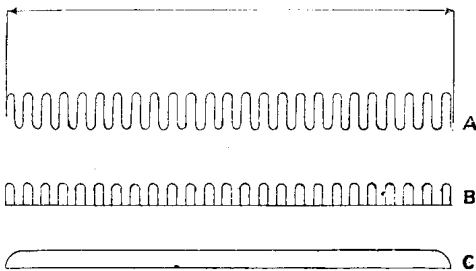

RECEPTION OF INAUDIBLE WAVES

Fig. 1. Continuous waves are represented by A, rectified continuous waves by B, and the current in the telephones by C.

means are adopted to convert the continuous wave into an audio-frequency wave train.

Fig. 1, A, represents continuous wave oscillations produced in a receiving aerial. If these oscillations are rectified, either by a valve or crystal, the result can be represented by the half oscillations, B. The resulting action in the telephone is merely

by which this can be carried out, but it is advisable to discuss first the actual requirements of the receiver.

Continuous wave transmission and reception is carried out on wave-lengths usually between the limits of 300 metres and 30,000 metres. These wave-lengths correspond to frequencies of 1,000,000 per second and 10,000 per second respectively.

Audio-frequencies lie between the approximate limits of 50-10,000, and a frequency of about 2,000 is usually adopted for reception work.

The following table shows the frequencies of an interfering wave acting on a wave of 100,000 frequency (wave-length 3,000 m.), in order to produce a beat note of different frequencies:

Incoming Frequency.	Interfering Frequency.	Beat Frequency.
100,000.	102,500	2,500
(corresponding to a wave-length of 3,000 m.)	102,000	2,000
	101,500	1,500
	101,000	1,000
	100,000	0
	99,000	1,000
	98,500	1,500
	98,000	2,000
	97,500	2,500

Taking 2,000 as the required beat frequency, in order to receive continuous waves of 3,000 metres (100,000 ~), the means provided to supply the interfering frequency must be capable of producing a frequency of $100,000 \pm 2,000 = 102,000$, or 98,000. Similarly for a 30,000 metre wave (10,000 ~), the interfering frequency must be $10,000 \pm 2,000 = 12,000$ or 8,000.

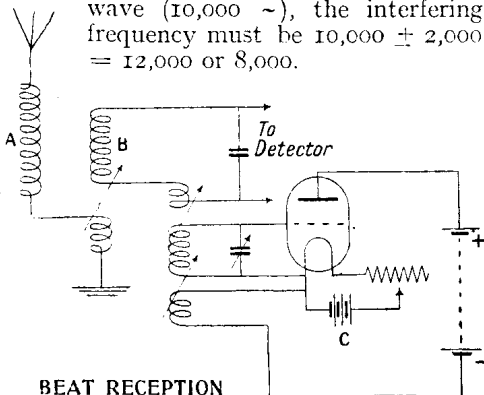

Fig. 3. Connexions of the valve are shown in this diagram, which represents the separate heterodyne method of beat reception

To supply the local oscillations of the required frequency, the three-electrode valve is generally used. The valve can

either be used simply to generate oscillations, which by suitable means act on the receiving circuits, or the valve used for detection can be utilized also to set up the required oscillations.

In the first method, known as the separate heterodyne method, a valve is connected up as shown in Fig. 3. By the correct proportioning of the various electrical constants of the circuits, the valve will set up continuous oscillations of any desired frequency. These oscillations are then superimposed by means of a coupling coil on some circuit of the receiving circuit, to produce the "beat note" of required frequency.

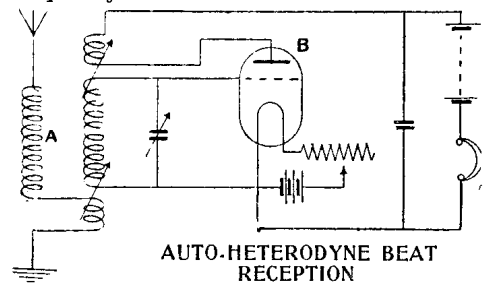

Fig. 4. Detection and generation of local oscillations are carried out in the auto-heterodyne method as shown in the above diagram

In the second, or auto-heterodyne method, a three-electrode valve is utilized both for the detection and the generation of the local oscillations. The diagram of connexions shown in Fig. 4 illustrates this method. When the valve is used, both for rectification and as the oscillation generator, the high-frequency tuning circuits are mis-tuned by an amount corresponding to the frequency of the required beat note.

With either method of reception it will be seen that when the frequencies of the received wave and the local oscillations are the same no beat note is produced. This point is known as the silent point, and is in fact used as a heterodyne wavemeter to measure the wave-length of continuous wave signals. On either side of this point the beat frequency increases and eventually comes within the limit of audibility. If the difference between the two frequencies is made still greater, the beat note frequency becomes above the upper limit of audibility.

The first or separate heterodyne method of continuous wave reception is more efficient than the second method, since the aerial and receiver circuits are tuned

to the received wave-lengths. Besides increasing the sensitivity of the receiver, the effects of an interfering transmitter can be reduced and often entirely eliminated, since the frequency of the beat note can be made entirely different from that of the interfering station, or the frequency of the interfering station can be made to come within the silent space and thus be eliminated. See Autodyne; Heterodyne.

BELL, ALEXANDER GRAHAM (1847-1922). Scottish scientist. Born in Edinburgh, March 3, 1847, he was educated at the High School and University and graduated as a doctor of medicine. In 1870 he went to Canada, and in 1872 became professor of vocal physiology in the University of Boston. In 1876 he exhibited his apparatus for the trans-

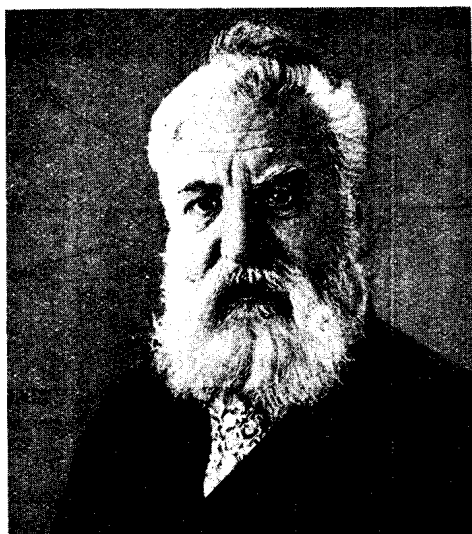

ALEXANDER GRAHAM BELL

Inventor of the telephone, which made wireless communication possible, of other apparatus, and author of many scientific papers

mission of sound, afterwards developed into the telephone.

Bell was experimenting with an electric invention by means of which he hoped to make speech visible to the deaf. A delicate metal reed was caused to vibrate by spoken speech and to transmit an electric current to the opposite end of a wire, where the vibrations of the first reed were reproduced in a second reed by a magnet. He found that it was possible to transmit not merely the vibrations of the original reed, but to reproduce the sound itself in the vibrations of the second reed.

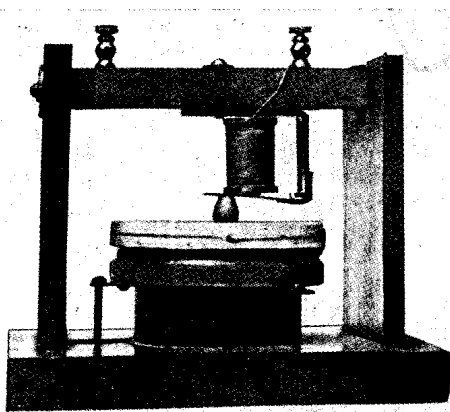

BELL'S FIRST TELEPHONE RECEIVER

Developed in 1876 from an invention designed to aid the deaf, this telephone is in principle similar to the modern telephone except that speech at the transmitting end generated its own current by movement of the armature

In 1878 he invented the photophone, to enable sound to be transmitted by variations in a beam of light, and later a phonograph. Bell was the author of many scientific papers, was awarded the Albert Medal of the Royal Society of Arts in 1902, and the Hughes Medal of the Royal Society in 1918. He died Aug. 2, 1922.

BELLINI, DR. ETORE. Italian wireless expert. Born at Foligno, Italy, April 19, 1876, he was educated at Naples University. He joined the Italian Navy, and became electrical engineer to it in 1901, and chief of the naval electrical laboratory, 1906. Bellini became responsible for carrying out the research work for the use of wireless on naval ships and submarines. He is famous for his invention, with Captain Tosi, of the Bellini-Tosi directional aerial.

BELLINI-TOSI AERIAL. An aerial system devised by E. Bellini and A. Tosi, which, when used in conjunction with special receiving apparatus, can be used to find the direction of a transmitter with respect to the position of the receiver.

If a vertical aerial is used for reception work, the amplitude of the oscillations induced in the aerial by a transmitter is unaffected by the direction from which the signals proceed. In other words, the signal strength would remain constant if the transmitting station were moved in a circle round the receiving aerial. If a curve termed a "polar diagram" is plotted between the signal strength or amplitude of induced oscillations and the direction

in degrees of the transmitting station, then a circle, as shown in Fig. 1, is obtained where θ is the direction of the transmitter with respect to the receiver and R the signal strength.

Bellini and Tosi, in order to determine the direction of a transmitting station, used a loop aerial consisting of two

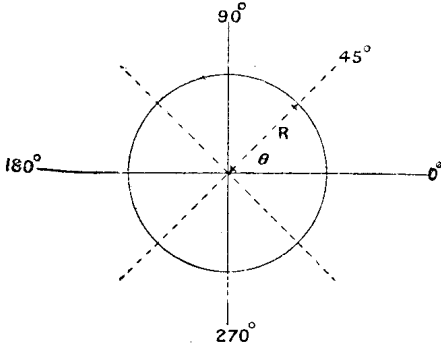

DETERMINATION OF DIRECTION

Fig. 1. Bellini and Tosi observed the theory here represented when devising their aerial system. A "polar diagram" being plotted between amplitude of induced oscillations and the direction in degrees of the transmitting station a circle is obtained where θ is the angle giving the direction of the transmitter with respect to the receiver and R the signal strength

triangular loops fixed at right angles to each other. The two loops were insulated from each other and connected to an instrument termed the radiogoniometer. Before, however, describing this unit it is as well to study what occurs in the two loops when they are in the field of an electro-magnetic wave.

The two loops are erected as shown in Fig. 2 ("a"). In the original design the

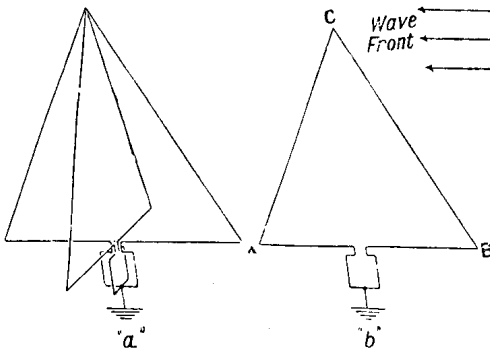

BELLINI-TOSI AERIAL

Fig. 2. Two loop aerials ("a") at right angles to each other were used by Bellini and Tosi in order to determine the direction of a transmitting station. One loop ("b") is shown alone

loops were open at the four ends, these being insulated from one another, but this has since been superseded by using two closed loops.

Let ABC Fig. 2 ("b") represent one loop. An electro-magnetic wave from a transmitting station situated in line with the loop will induce in the limb BC an oscillatory current. The wave will also induce an oscillatory current in the limb AC, but later than, and in the opposite direction to, that induced in the limb BC. Since at any instant the voltage induced in BC is greater than that induced in AC, a current due to the difference in voltages will flow round the circuit.

An electro-magnetic wave from a transmitting station situated at right angles to the plane of the loop will induce in the limbs AC, AB, equal and opposite currents, with the result that no current will flow in the circuit. If a polar curve

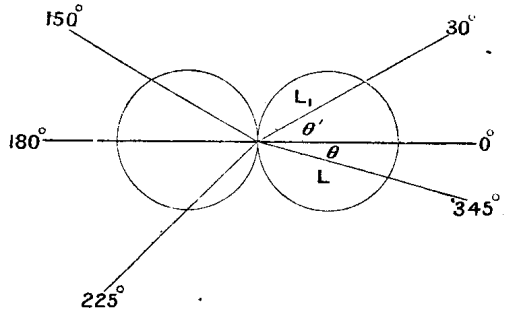

PLOTTING CURVE FOR BELLINI-TOSI AERIAL

Fig. 3. In this diagram the angles θ , θ' represent the direction of the transmitter, and L, L_1 the strength of the induced current

of a loop aerial is plotted a double circle is obtained, as shown in Fig. 3, where θ , θ' , etc., represent the directions of the transmitter, and L, L_1 , etc., the strength of the induced current. It must be noted that when the wave advances firstly on CB the direction of the induced current is opposite in direction to, that induced when the wave advances from the opposite direction—that is, advances firstly on AC.

To indicate this the two circles are usually indicated by the positive and negative sign. It is seen, therefore, that an advancing wave from any direction except at right angles to the loop will induce a current in the loop, and the strength of the current is proportional to the cosine of the angle of direction. The polar curve, Fig. 3, is, in fact, a cosine curve.

A single loop aerial connected to a suitable amplifier and detector can be

used for direction finding, since the plane of the loop could be turned to produce maximum signals, or, conversely, the plane of the loop can be turned to produce minimum signals. In the first case the plane of the loop would indicate the direction of the station, whereas in the second case the plane of the loop would be at right angles to the direction of the transmitter.

A great advance, however, is made when two loops at right angles to each other are used. It is then possible by the addition of the radiogoniometer to eliminate the necessity of actually rotating the aerials.

It will easily be seen from the previous reasoning that, when two loops are used and the transmitting station is in line with one loop, the other loop (at right angles) is unaffected by the wave, and no current will be induced in that circuit. Similarly, if the transmitter is in line with the plane of the second loop, no current will be induced in the first loop.

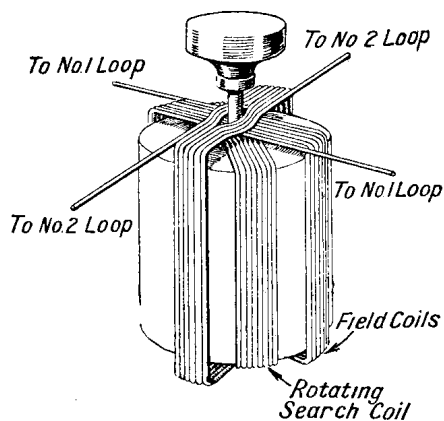

RADIOGONIOMETER CONNEXION

Fig. 4. Both loops in the Bellini-Tosi aerial are insulated from each other, but connected to a radiogoniometer, as shown

By means of the radiogoniometer the effects of each loop are combined together to affect simultaneously the receiving apparatus.

The radiogoniometer consists of a hollow cylinder with two coils of wire wound at right angles to each other round the cylinder as shown in Fig. 4. These coils are fixed, and form what are termed the field coils. Inside the field coils is mounted a cylinder or a spherical former, but wound with one coil only, and arranged so that it can be rotated about a vertical

axis. A pointer moves over a scale marked in degrees showing the position of the inside coils with respect to the fixed coils. The rotating coil is usually termed the search coil.

The ends of one field coil are connected to points equidistant from the bottom corners of a loop aerial, the other coil being similarly connected in the second loop. The search coil is connected to the receiving circuit.

The diagram of connexions shown in Fig. 5 indicates in a simple manner the method of connecting the aerials, the field coil, and the search coil.

Let the transmitting station be in a line with the plane of one loop. The induced current will be a maximum in that loop, and no current will flow in the other loop. The current flowing in No. 1 loop will cause an oscillating magnetic field to be set up round the field coils associated with that loop, while no magnetic field will be set up by the field coils associated with No. 2 loop. Hence, if the search coil is rotated a position will be found where the search coil is acted upon with maximum induction due to the magnetic force of No. 1 field coils.

An oscillating current will flow in the search coil which can, if necessary, be amplified, and must be rectified in order to obtain audio signals. The position of maximum inductance is evidenced by maximum signal strength. There are, in fact, two positions of maximum inductance, the second one being obtained when the coil is rotated through 180° from the first position of maximum effect.

Similar effects are obtained if the transmitting station is in line with the plane of No. 2 loop. If now the direction of the transmitting station is between the two loops, say, at 45° , then oscillating currents of equal amplitude are set up in each loop

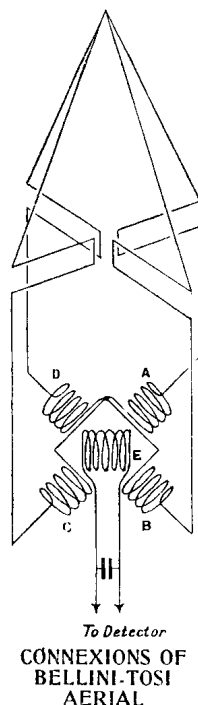

CONNEXIONS OF BELLINI-TOSI AERIAL

Fig. 5. Connexions of the aerials, field coil, and search coil are shown in this diagram

and field coils, and the position of the search coil to give maximum signals will be found to be a position between the two sets of field coils-i.e., at 45° to one of them. There will, of course, be two positions of maximum effect, differing in position by 180°, similar to that obtained with the single loop. Hence the effect of an advancing wave on the loop aerial has been reproduced in the field coils, and instead of rotating the loops the position of the search coil indicates the direction of the transmitting station.

In the original design of direction finder, each loop aerial included in the circuit, besides the field coils, a variable condenser for tuning each aerial to the transmitted wavelength. The method had great disadvantages, the chief of which was the difficulty of tuning

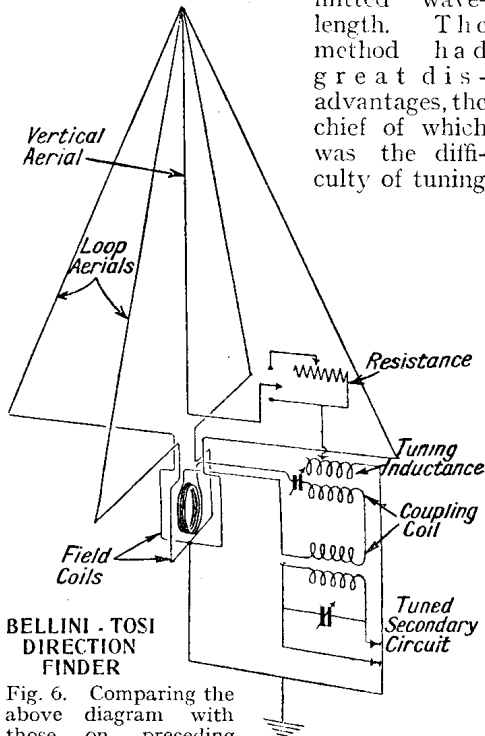

BELLINI-TOSI DIRECTION FINDER
 Fig. 6. Comparing the above diagram with those on preceding pages, it will be seen that a vertical aerial has been introduced into the system. By means of this addition the actual bearing is found, the effect of the vertical aerial being superimposed on the secondary circuit

each aerial so accurately as to ensure that the advancing wave affected each loop by the correct amount.

Obviously, if one aerial is slightly mis-tuned, the amplitude of the induced current will be smaller than it should be with a consequent decrease in the strength of the magnetic force of the field coil,

which results in the position obtained with the search coil being inaccurate. Also the number of tuning circuits greatly reduces the speed of taking bearings, an important point when the direction of a moving station is required.

Considerable advance was made, therefore when the field and search coils were so closely coupled as to render the aerial circuit aperiodic. Tuning the search coil

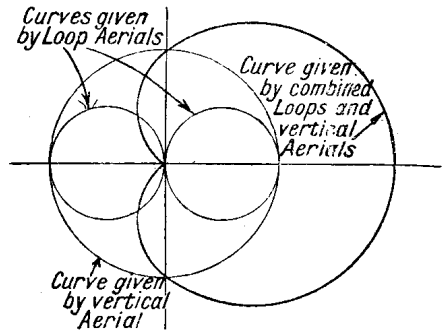

LOOPS AND VERTICAL AERIAL CURVE

Fig. 7. Combining the effects of the two loops and the vertical aerial in the Bellini-Tosi system, a curve is obtained as shown above. This polar diagram is known as heart shape

unit is then sufficient to tune the aerial circuit also.

If, however, a vertical aerial, in addition to the loop aeri-als, is coupled to a receiver in such a way that the receiver is affected by oscillations in the vertical and the loop aeri-als, then it is possible not only to obtain the direction of the transmitter, but its actual bearing with regard to the position of the receiving station.

A simplified diagram of connexions for obtaining the bearing is shown in Fig. 6. In this arrangement the search-coil circuit contains a tuning condenser and two coupling coils. One of these coils is inductively coupled to a tuned secondary circuit and the amplifier, while the second coil is inductively coupled to a variable inductance in the vertical aerial circuit.

The direction of the station is obtained by the use of the two loops (using the figure of eight polar curve), and the actual bearing is found by superimposing on the secondary circuit the effect of the vertical aerial. When these two effects are added together in the secondary circuit, then a new polar diagram, Fig. 7, is obtained, known as the heart shape. The minimum of the heart shape is 90° out of phase with the minimum of the figure of eight, hence

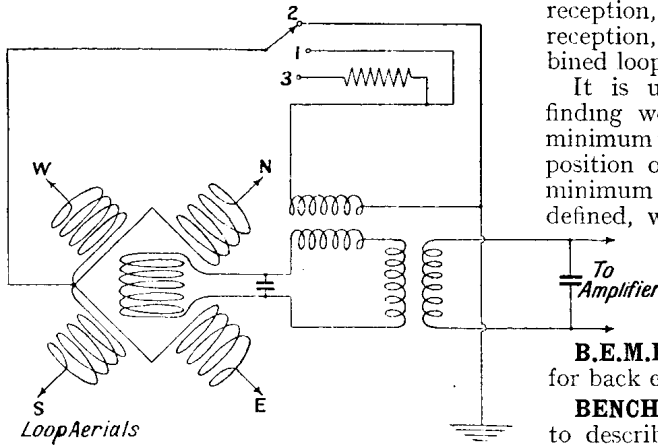

BELLINI-TOSI AERIAL

Fig. 8. When the loops of a Bellini-Tosi aerial are also used as the vertical aerial the connexions are made as shown in this diagram

the sense pointer in the radiogoniometer is at right angles to the direction pointer.

Fig. 8 shows the connexions used when the loops are also used as the vertical aerial. The common point of the field coils is then connected either (1) direct to earth, (2) through one winding of a closely coupled transformer, or (3) through a resistance in series with the transformer winding. The first stud is for all-round

reception, the second stud for loop-aerial reception, and the third stud for combined loop and vertical reception.

It is usual in practical direction-finding work to take bearings on the minimum position and not the maximum position of signal strength, since the minimum position is much more sharply defined, with the result that bearings

correct to within $\frac{1}{2}^\circ$ are easily obtained. See Radiogoniometer; Direction Finding.—R. H. White.

B.E.M.F. This is the abbreviation for back electro-motive force (*q.v.*).

BENCH. An expression which is used to describe a particular form of strong table. It is used when any heavy work is to be undertaken, and is generally equipped with a vice and with other appliances such as a bench stop, for retaining the wood in position while it is being planed. The size of the bench will be governed entirely by individual requirements and the amount of space available for the location of the bench, itself. If a small workshop is available, the bench may either be built against one of the walls and supported by strong legs, well braced together, or may take the form of the regulation carpenter's bench such as that illustrated in Fig. 1. This type of bench is a good, all-round

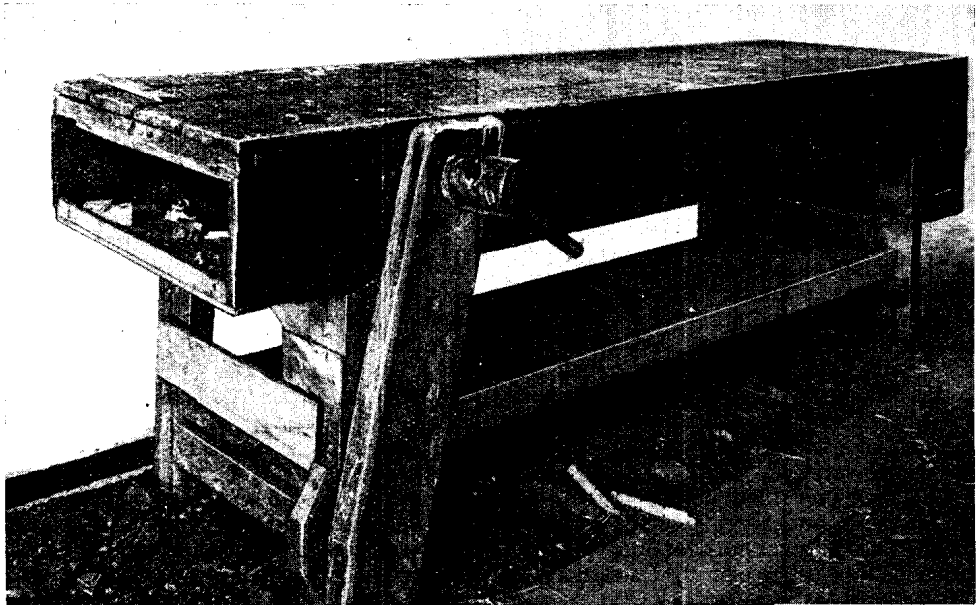

WIRELESS AMATEUR'S WORK BENCH

Fig. 1. Regulation carpenters' benches are very suitable for wireless amateurs and experimenters. The bench here shown is provided with a vice and planing stop. A metal vice in addition is useful

pattern, and where space permits the dimensions may be 6 ft. long, 24 in. wide, and 33 in. high.

One end should be fitted with a carpenter's wooden vice of the regulation pattern, such as that illustrated, or it may be of iron or of the regulation engineers' pattern. In any case, a vice for wood work should be capable of holding objects 1 to 15 in. in width, and should also be fitted securely.

For metal work, and holding smaller parts made of ebonite and other material, the ordinary pattern of engineers' bench vice is very useful. This may be bolted

square wood, which can be held in place with a wedge or set-screw, the whole more or less disposed in the manner shown in Fig. 2. This bench top is made detachable, and is held in place on the table top by battens screwed to the underside of the plank, and held in position by turn buttons. When not in use the top can be removed from the table and stored away in any convenient cupboard.

Another plan which is very satisfactory for ordinary wireless work is to make up a small bench about 3 ft. 6 in. in length, 2 ft. 6 in. in width, and 1 ft. 9 in. deep. This can be framed up from 2 in. by 2 in. framing and panelled by matchboard. The front is closed with simple match doors, with hinges and catch, or a lock and key as desired. The top should be composed of planks 2 in. in thickness. The whole of the bench should be stained and dull polished, and presents quite a good appearance. Such a bench is illustrated on page xxiv at the beginning of this Encyclopaedia.

In use, the tools and wireless parts should be stored on shelves fixed in the interior of the cupboard. A small portable bench vice with a screw clamp is screwed to one end of the bench, and should be about 2 in. to 3 in. in width between the jaws, and should be capable of holding objects from 3 in. to 4 in. in thickness. When not in use, the top can be covered with a fancy cloth and ornamented with a bowl

of flowers, vases, and the like. Consequently, such a bench can be used in any of the reception-rooms, and provides a home for the tools and work while in progress, and ensures the room being always tidy when the work is over.

The experimenter will find that when the bench is in constant use it almost invariably gets littered up with tools and odd pieces, in spite of the saying "A place for everything and everything in its place." It is seldom in practice that this can be adhered to, and, consequently, it is a practical plan to provide a number of little racks to support tools and others for the reception of valves and various

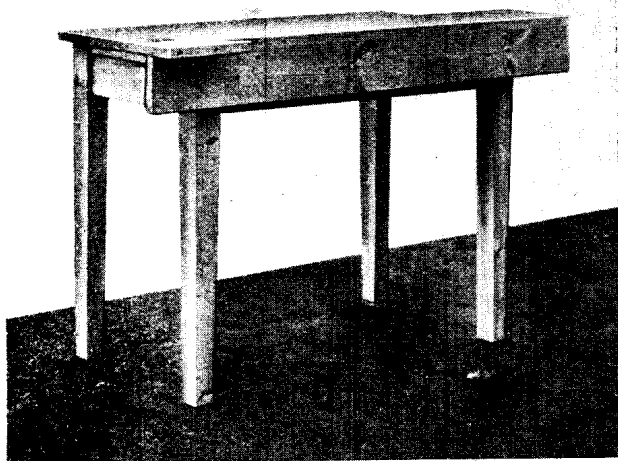

HOME-MADE BENCH

Fig. 2. Experimenters making their own bench will find the type here shown easily constructed from a plain but strong kitchen table. The holes seen in the side piece are made to accommodate pegs used to support long pieces of material

to the bench in any convenient position. Where space is limited, and work has to be carried out in the home, a bench can be made from a kitchen table, if the legs are sufficiently strong. The bench top in this case would consist of a strong plank 11 in. wide and $1\frac{3}{4}$ to 2 in. in thickness, to one end of which a 9 in. by 1 in. board is glued and screwed.

This may be drilled with holes at regular intervals, and a peg inserted in one of them to act as a support for long pieces of material, the other end of which may be conveniently held in a V-shaped wooden block screwed to the front of the bench. A stop is made from a piece of 2 in.

small parts—such as condenser spindles, and the numerous accessories which are required from time to time. A suggestion along these lines is given in Fig. 4, which shows an ordinary bench equipped with various home-made devices of this character which have proved very convenient in everyday use.

For example, the various coils of wire can be supported on nails with the heads cut off. This facilitates unwinding when a few feet only is needed. Another handy arrangement is to take two or three boxes, such as cigar boxes, and make compartments in them with thin strips of wood, generally obtainable from the lid of the box itself. These boxes may be screwed to the top of the bench, and are admirable for the reception of small screws, terminals, nuts, and odds and ends which are otherwise apt to get lost.

In any case, whatever kind of bench be used, the essential requirements are that it should be absolutely stiff and rigid. This is more a question of strong joints and correct bracing than anything else,

as often a bench with thin legs can be made quite rigid by nailing stout battens diagonally in the frame in the form of the letter "X" between the legs at the back and sides. When there is any choice in the matter, the bench is most useful to the amateur if placed against a window with a north light. It is advantageous that the light should fall rather slantwise across the bench, and should be particularly good where the vice is located, as it is generally here that most of the small fitting work is done.—*E. W. Hobbs.*

BEVELLING. The art or act of producing a bevel on the edge of a piece of material. A bevel is a face that is inclined at an angle to the normal surface and extends from one surface to the other. The processes involved are similar to those needed in forming a chamfer on the edge of material, and the whole of them are dealt with in detail under the heading Chamfer.

A bevelled edge is used on all sorts of wireless apparatus and for various reasons. One is to improve the appearance by

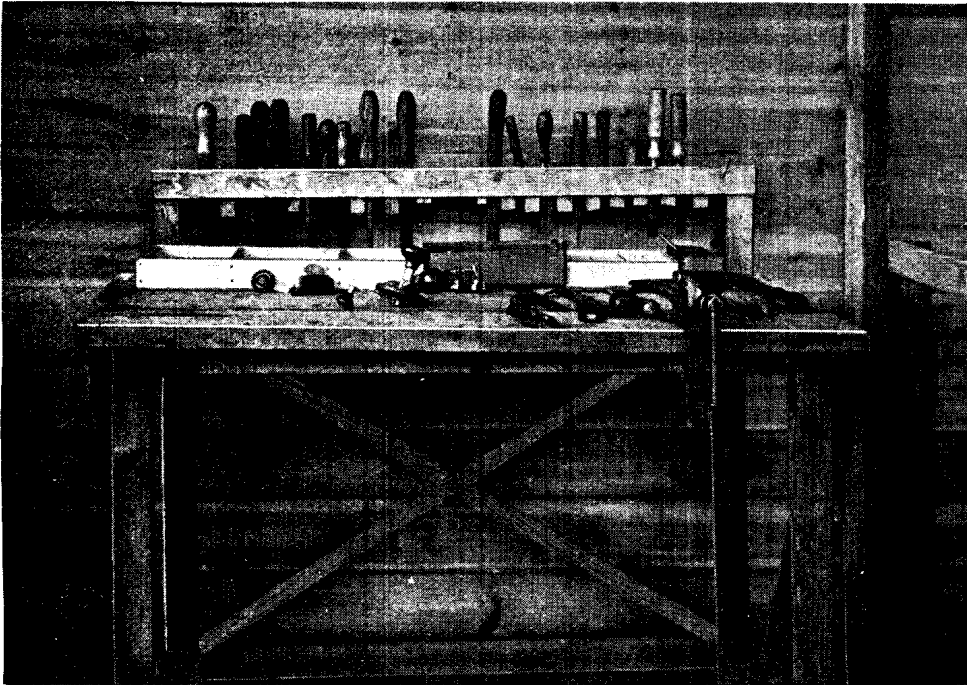

SUITABLE BENCH FOR WIRELESS WORK

Fig. 3. Although quickly made, the bench shown above is suitable for all types of amateur wireless work. As in the case of the bench shown in Fig. 2, this is made by converting a common kitchen table, strengthening it by cross-bracing legs. A tool rack and ordinary pattern engineer's bench vice are also added, and compartments or a range of small boxes for the reception of small components make the bench complete

reducing the apparent thickness of the material, another is because it provides a convenient face whereon to engrave any desired calibrations, as, for example, those on a condenser dial. When the meeting faces of two pieces of material are uniformly bevelled the edges are said to be mitred, and the junction of the two is described as a mitred joint. This aspect of bevelling is dealt with under the heading Joints and Cabinet Making (*q.v.*).

B. H. CURVE. Name given to a method of expressing the magnetic permeability of a material. The permeability of various grades of iron and steel is one of the principal factors in the design of transformers, motors and generators. In the equations which follow H represents the magnetizing force and B represents the magnetic induction density.

The two are related to one another as shown by the following equation :

$$\frac{B}{H} = \mu$$

or $B = \mu H$ where μ is the magnetic permeability of the material.

The magnetizing force H, can be calculated from the formula :

$$H = \frac{4\pi}{10} \times \frac{AN}{L}$$

Where A = the amperes flowing in the coil,

N = the number of turns of wire of the coil,

L = the length of the coil.

The magnetic permeability, μ , varies considerably with the material; μ is large for a soft wrought iron, whilst for

ordinary cast iron and steel it is much lower. Special open-hearth annealed steel castings are now, however, produced in which the value of magnetic permeability is as high as in ordinary wrought iron.

The magnetic induction density, B, is usually expressed in commercial electrical engineering in the number of lines of force per square centimetre.

The usual method employed for the measurement of permeability is to have a sample ring turned from the material which it is desired to test.

The ring may conveniently have a mean diameter of some ten centimetres and a cross-sectional area of about three square centimetres.

The whole ring should then be uniformly wound with a single layer of No. 18 S.W.G. double cotton or silk covered wire. This coil will be used as the exciting coil.

When the coil is finished a small secondary winding is wound directly upon a part of it which has previously had a single layer of thin Empire tape wound over it. This winding may consist of some ten turns of a fine wire, say No. 36. This second winding is known as the exploring coil, and the two ends of it are connected to a ballistic galvanometer (*see Fig. 2*).

To make a test, the circuit should be connected up as in Fig. 2, with the exception that one wire should be left off the galvanometer.

The resistance is now adjusted to give a large current, and the switch is thrown backwards and forwards several times, without taking any readings.

Now connect up the galvanometer. Note the current A, and then throw over the reversing switch. Note the deflection of the galvanometer pointer θ . Now adjust the current to a lower value with the resistance. Take the current reading and again throw over the switch, taking a second reading of the galvanometer deflection.

Continue in this manner until a full set of readings has been obtained.

Then H can be obtained from :

$$H = \frac{4\pi}{10} \times \frac{AN}{L}$$

and B is obtained from :

$$B = \frac{10^6 RK\theta}{2an}$$

where R = Resistance of the exploring coil and circuits,

K = The galvanometer constant,

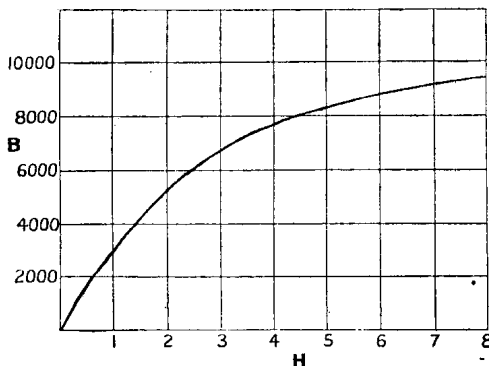

MAGNETIC PERMEABILITY

Fig. 1. B.H. curves are used to express the magnetic permeability of material. In the above curve magnetising force is represented by H, and magnetic induction density by B

- θ = The throw of the galvanometer.
- n = The number of turns in the exploring coil.
- a = The cross section of the ring in square centimetres.

If the constant, K , of the galvanometer is not already known, it may be obtained by passing a known quantity of electricity from a charged condenser through it.

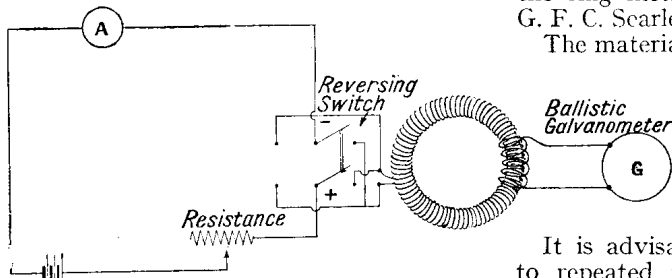

TAKING READINGS FOR A B.H. CURVE

Fig. 2. When permeability is to be measured the method represented by this diagram may be employed. In this case a sample ring made of the material to be tested is wound with insulated wire and inserted in the circuit. Current readings are taken and galvanometer deflection noted

Take a good condenser of capacity C in microfarads ; charge it to a voltage V , and discharge it through the galvanometer, noting the deflection.

Then K , the constant of the galvanometer, will be :

$$K = \frac{CV}{1,000,000 \theta}$$

In addition to the method described above, there are now several permeability meters which will measure the permeability of a sample without the necessity of having the sample turned up in the form of a ring. These methods have been devised for the more rapid testing of samples. At the same time the standard ring method is very reliable, although not quite as convenient as the following split-ring method.

The ring may be cut into two halves, and the surfaces of these halves accurately ground, so that the ring fits together so tightly that no air is included between the adjacent surfaces. This method enables the windings to be removed from one sample and replaced on another.

Bar Method. In place of the ring, a standard bar of the material may be used, the bar being turned up so that it will

slide tightly into a solenoid which has already been wound. The rod should have a length of at least one hundred times its diameter. The solenoid should be a long one, consisting of a single layer of wire, with the small exploring coil wound over it in the centre.

When using this method a correction factor has to be introduced to make allowance for the leakage lines.

Another method somewhat resembling the ring method has been suggested by G. F. C. Searle.

The material is built up in the form of a square, using strips of the material. The strips must be carefully built up, with the edges overlapping. The square must be large compared with the width of the strips.

It is advisable to subject the material to repeated reversals of current before making any test on it, and this may conveniently be done by passing an alternating current through the main coil.

B.H.P. This is the abbreviation for break-horse power—that is, the measured power of any engine delivered from the fly wheel shaft or main driving shaft of the machine. See Horse Power.

Bi. This is the chemical symbol for the metallic element bismuth (*q.v.*).

BICHRIMATE BATTERY. A collection of two or more bichromate cells. A bichromate battery can be made up from homely material at comparatively small expense, and the accompanying illustrations show a three-cell battery as made up by an amateur experimenter.

The chief requirements for a battery as illustrated are three 1 lb. glass jam jars, measuring $4\frac{3}{8}$ in. high and 4 in. in diameter ; 6 carbons, 5 in. long, 1 in. wide, and $\frac{3}{16}$ in. in thickness, or thereabouts ; three zinc plates about 2 in. long, 1 in. wide and $\frac{1}{8}$ in. thick ; 5 telephone terminals ; a few lengths of wire ; half a dozen small brass nuts ; a few screws and nails, and some prepared deal, nominally known as 4 in. by $\frac{3}{8}$ in. prepared, actually measuring about $3\frac{3}{4}$ in. wide and $\frac{1}{16}$ in. thick. A piece 3 ft. long will be sufficient. Two 12 in. lengths of 2 in. by $\frac{3}{8}$ in. prepared door stopping are required for the side rails, and another piece $10\frac{1}{2}$ in. long, $\frac{3}{4}$ in. in thickness and 1 in. wide, for the battery bar, and two pieces $2\frac{1}{2}$ in. long and $\frac{1}{2}$ in. square for the

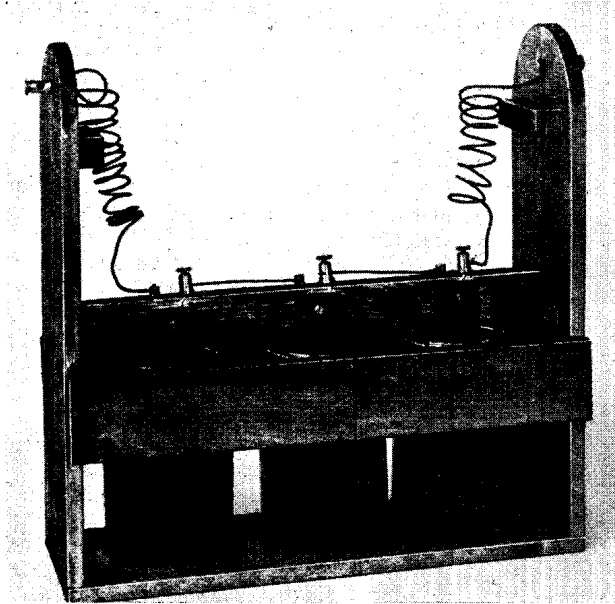

BICHROMATE BATTERY FROM JAM JARS

Fig. 1. Three cells have been made with jam jars in this home-made bichromate battery. Such a battery has a voltage of $5\frac{1}{2}$ to 6.

top supports. The necessary acid completes the list of materials.

The electrolyte is composed of a saturated solution of bichromate of potash and sulphuric acid. This is mixed in the proportions of eight of the bichromate to one of the sulphuric, and gauged by bulk, not weight. The acid should be added to the bichromate solution. Never add a solution to the sulphuric acid. Alternatively use the specially prepared crystals sold by the electricians, that only need dissolving in water.

The general arrangement of the battery is such that when in use the bar on which the carbons and zincs are attached can be lowered into the glass jars, which are filled with the acid electrolyte. In this position, and when connected in series as shown in Fig. 1, the voltage across the terminals on the top of the case should be about $5\frac{1}{2}$ to 6 volts, each

cell having an E.M.F. of about 1.8 to 2.0 volts.

As this type of battery continues its chemical action when the elements are in the electrolyte, regardless of the consumption, it is imperative that when not in use the elements should be raised out of the electrolyte. The simplest way to do this is the method illustrated in Fig. 2, which shows the battery bar and elements attached to it raised from the jars, and resting upon the two upper blocks or supports, in which position any liquid on the bottom of the carbons will simply drip back into the jars. In this position no chemical action takes place, and, naturally, there is no flow of current.

In the construction of such a battery the dimensions will have to be governed by those of the glass jars, as these may

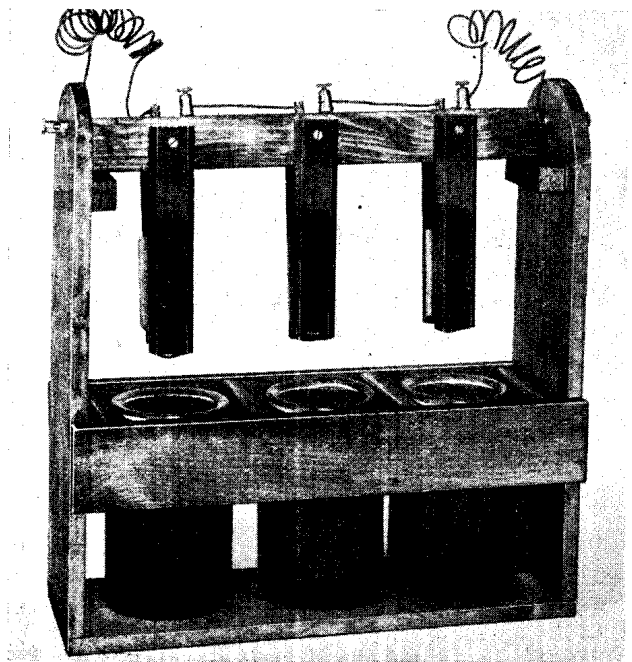

BICHROMATE BATTERY ELEMENTS WITHDRAWN

Fig. 2. When it is desired to raise the elements from the bichromate cells to prevent the electrolyte wasting, the cross bar is rested on the upper supports

vary slightly from the size already given; but most of the ordinary commercial jam jars are practically 4 in. in diameter. The outside length of a case for a three-cell battery should be $10\frac{1}{2}$ in. and the width $3\frac{3}{4}$ in.

The first step is to make the case or wooden framework. This is done by cutting two pieces of the 4 in. prepared deal to a length of $11\frac{1}{2}$ in., rounding off the upper ends, but cutting the bottom perfectly square. The bottom is $11\frac{3}{4}$ in. in length, of the same material, and is simply nailed or screwed to the end pieces. These are further strengthened by two pieces of 2 in. door stopping, $11\frac{3}{4}$ in. in length, and nailed on to the side pieces at a height of 5 in. from the bottom of the base. Before assembling these parts, the two upper supports should be nailed in position at a height of 2 in. from the top of the uprights.

The final stage in the construction of the framework is shown in Fig. 3, which clearly shows the method and details of the construction, and the positions of the respective parts. Two of the telephone terminals should then be fitted to the

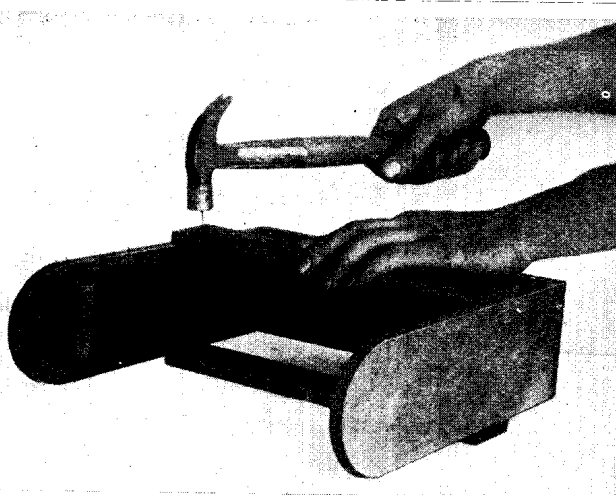

FRAMEWORK OF BICHROMATE BATTERY

Fig. 3. Details of construction of the framework may be seen from this photograph. The final stage of construction is here shown

upper part of the side pieces at distances of 1 in. from the top. These are secured by passing the screwed shank through a hole drilled in the wood, and making it secure by means of a small brass nut and washer. The connecting wires from the terminals of the battery are subsequently held in position by these nuts, which should be well tightened.

To keep the glass jars in position they should be put in their place and four small pieces of wood, about 1 in. deep and $\frac{3}{8}$ in. wide, nailed between the two side rails of the framework to hold the necks of the jars, as is clearly shown in Fig. 4. These pieces are simply nailed in position, and their purpose is to hold the jars securely, so that there is no fear of them sliding about when the battery is moved.

The battery bar and the elements have now to be assembled, and their relative positions and dispositions are shown in Fig. 5. The carbon plates are simply screwed in place on the battery bar, spacing them so that they are central with the three jars. The zincs are generally supplied either with a brass rod attached to them, or already drilled and tapped for a thin brass rod. These should measure in this case 3 in. in length. Each end should be screwed. The lower end screws into a tapped hole on the top of the zinc and the other hole is provided with two brass lock nuts. Holes are drilled through the battery bar to

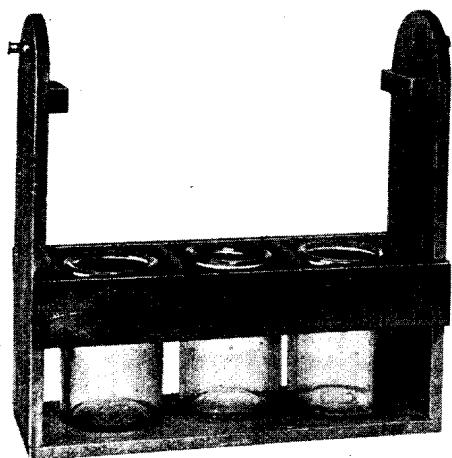

FRAME AND JARS OF BATTERY

Fig. 4. Transverse bars are part of the framework to prevent the bichromate cells from shifting their position. Note the position of the two terminals

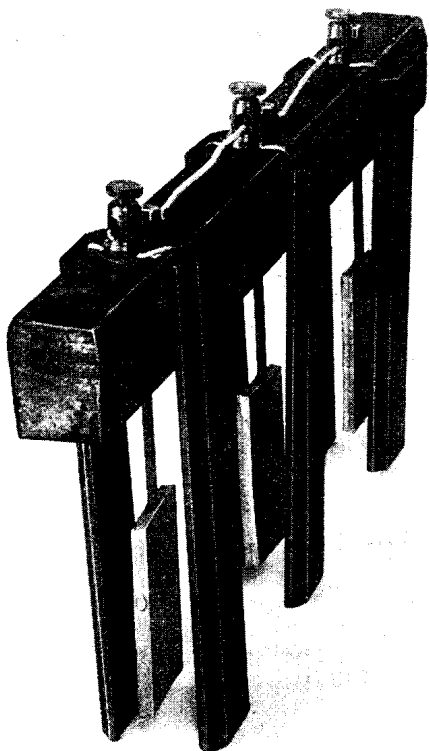

BICHROMATE BATTERY ELEMENTS

Fig. 5. Carbon and zinc elements are connected to a crossbar, as will be seen above. The wiring of the details should be noted

accommodate these rods on the zinc plates, and a close fit in the wood should be made. The rods are then pushed through the holes and the first of the nuts screwed down.

The carbons may then be screwed to the sides of the battery bar, and a length of bare copper wire, about No. 18 gauge, twisted around the screw, taken over the top of the battery bar and wound one turn around the shank of the telephone terminal, taken down over the other side of the battery, around and on to the second carbon screw. These screws may then be tightened up sufficiently to hold the carbons and the wires in firm contact, but too much pressure must not be exerted or the carbon will be split. The telephone terminals are simply fitted to the battery bar by drilling small holes therein and screwing the terminals in place, taking care to pass them right through the eye formed on the wire connecting the two carbon plates.

At this stage three groups of carbons are separately connected together. It is now required to connect the first telephone terminal, and the wire from the carbons is attached to the second zinc terminal—that is, the middle one on the bar, accomplishing this by means of a piece of bare copper wire about No. 16 gauge. One end is formed into an eye and held in place by a second lock nut on the end of the zinc rod, and the other end clamped by the telephone terminal.

The telephone terminal on the middle of the bar is then connected in a similar way to the next zinc. There now remains one telephone terminal connected to the carbon plates at one end of the battery, and the nuts on the end of the zinc rod as a terminal at the other end of the battery. A length of flexible insulated wire is connected from these terminals to those on the top of the uprights, allowing sufficient lengths to permit of the battery board being raised or lowered bodily, as illustrated in Figs. 1 and 2.

It now only remains to make up the electrolyte and put it into the glass jars.

BICHROMATE CELL. A primary cell with many applications for the wireless experimenter. The cell consists essentially of an outer container or pot and two elements which are immersed in an electrolyte. The elements are composed of a plate of carbon and one of zinc. The former is the positive and the latter the negative. The electrolyte is a solution of bichromate of potash and sulphuric acid. The normal electro-motive force per cell is of the order of 2 volts, but may vary from 1.8 to 2.1, according to the purity of the materials and the general design of the cell. In the ordinary type of bottle bichromate cell the container is in the form of a glass bulb with a long neck and a solid base or foot. The electrolyte is introduced into the bottle and fills the bulb, and the elements are attached to the top of the bottle.

The appearance of this type of cell is shown in Fig. 1 and the chief components in Fig. 2. This shows the wooden cap that forms the top of the cell with one of the carbon plates attached to it. The other is detached, and shows the metal plate to which it is normally secured with a set-screw and washer. The zinc plate is shown detached and the ebonite guide plate and the lifting rod removed to reveal the construction. It is important for the experimenter to appreciate the positions

of these parts of the cell, as they have to be replaced from time to time as the zinc and carbons deteriorate, or may need to be removed for cleaning and repairs.

The wooden cap is made of hardwood with a beaded overhanging edge. Two round-headed screws are fixed at opposite sides, and these fix into a bayonet catch in the brass rim attached to the neck of the bottle. The cap has to be securely held in place as the cell is portable, and when fixed in this way there is no fear of the cap pulling off. The construction also permits the zinc rod to be drawn up and the zinc withdrawn from the electrolyte when the cell is not in use. The carbon plates are attached to the cap by the channel-shaped piece of brass screwed to the cap, and are connected to one of the terminals on the outer side thereof. The zinc is screwed to the metal rod and terminates in a knob.

The rod is electrically connected to the other terminal by the brass plate on the top of the cap. This has an upright brass guide tube attached to it, and serves as a guide for the rod and to effect a good

electrical connexion between the rod and the terminal. To prevent the zinc plate touching the carbon and thereby short-circuiting the cell, a plate of ebonite is attached to the top of the zinc plate, and this slides between the two carbons. When the cell is not delivering current the plate should be raised out of the electrolyte, as shown in Fig. 3, which also clearly illustrates the parts referred to. When the battery is in use the zinc plate is lowered into the electrolyte, and the parts then appear as in Fig. 4.

The current delivered by the cell is to some extent controlled by the amount of the zinc which is immersed in the fluid. The electrolyte is composed of a saturated solution of bichromate of potash, or one made by dissolving 6 oz. of powdered bichromate of potash in one pint of clean water. To this is added 5 oz. of sulphuric acid. The acid should be added slowly. Never add the solution to the acid, or it will boil up. An alternative solution is composed of 3 oz. of chromic acid in one pint of water, to which is carefully added 1 oz. of sulphuric acid.

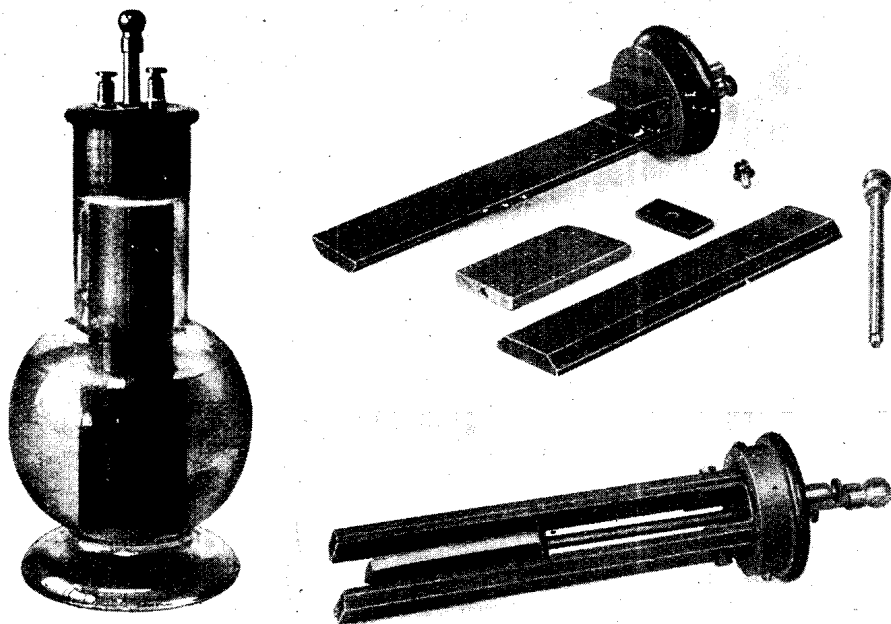

HOW A BICHROMATE CELL IS MADE UP

Fig. 1. On the left is a complete bichromate cell, showing construction and disposition of zinc and carbon plates, control rod, and terminals. Fig. 2. (Top, right.) Carbon plates removed. One of the plates is attached to the cell top, the other is removed, as also are the zinc element and adjusting rod. Fig. 3. (Bottom, right.) The zinc and carbon elements are assembled, with the adjusting rod pushed in, holding the zinc near the bottom end of the carbons

The zincs should always be well amalgamated, as this adds greatly to their durability. Cells of this type are very handy for many electrical experiments, and when a higher voltage is needed several such cells can be connected in series by coupling the carbon terminal of one to the zinc of the other, and so on; the voltage across the last terminal and the first is then the sum of the number of cells multiplied by two. See Accumulator; Bichromate Battery; Cell; Sulphuric Acid.

BIGHT. A bend or kink in a rope. The expression is often used in connexion with the fitting up of an aerial mast, or in any work calling for the use of ropes and cordage. As illustrated, the bight is nothing more or less than a loop or bend formed in a rope. When it is desired to

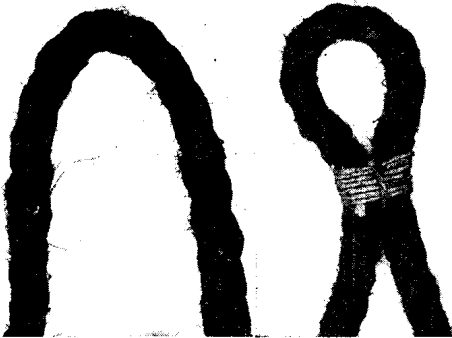

PLAIN AND SEIZED BIGHTS

On the left is a plain bight or bend in a rope, and on the right the manner in which the bight should be seized is shown. A thimble or eye is sometimes fitted in the bight to reduce chafing

attach one rope to another, as, for example, a halyard to a bridle for an aerial, it is good practice to fit an eye or thimble into a bight of the bridle by whipping the rope with twine or copper wire, so that the bight is contracted and drawn tightly around the groove formed in the thimble. Thus the pull and chafe of the second rope is distributed over a large area and the chafing taken by the metal eye or thimble. Alternatively the eye is formed with a seizing, as is clearly shown in the photograph.

BIFILAR WINDING. Term used for non-inductive windings. Non-inductive coils are made by first doubling the wire

and then winding it double, the loop being at one end of the winding, and the two ends of the wire at the other end of the coil. Such a coil is, in effect, two coils wound in opposite directions, so that the self-induction of each coil neutralizes that of the other. A bifilar micrometer is an instrument fitted with two fine filaments or spider threads for measuring small angles. Bifilar suspension, as of a magnetic needle, is suspension by two parallel threads.

BILLI. This is another term for millimicro. It means a billionth, or 10^{-9} .

BILLI CONDENSER. Variable tubular condenser capable of very fine adjustment and so called because of its small capacity being easily expressible in billifarads. The billi condenser consists of two metal tubes which are separated from one another by a dielectric, one tube being made to slide in and out of the other.

In one such form of billi condenser the metal tubes are made of brass and the dielectric is ebonite. Connexions to the tubes are made by means of brass plugs, and the two tubes slide over one another by means of a simple rack and pinion arrangement. The instrument has a calibrated scale on it, so enabling the capacity to be determined for any particular overlapping of the two tubes. It is clear that the capacity depends on the area of the overlapping metallic surfaces, the greater the overlap the greater the capacity. Billi condensers are made which have a minimum capacity of '00002 mfd. and a maximum of about '00045 mfd. Such condensers are useful in carborundum crystal circuits, or any crystal circuit employing a battery on

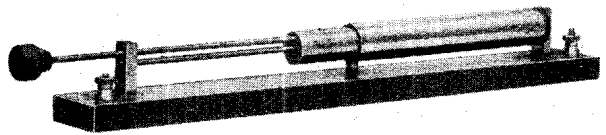

BILLI CONDENSER WITH PUSH ROD CONTROL

Fig. 1. Various types of this fine adjustment condenser are made. The one shown is operated by the long rod, which controls the sliding movement of the inner metal tube in or out of the external tube

the crystal, in order to keep as high as possible the high-frequency potential affecting the crystal.

The photograph (Fig. 1) shows a standard type of billi condenser controlled by

means of a long metallic push rod with an insulating ebonite knob. In some of these condensers the outer tube only is of solid metal and the inner tube consists of ebonite or some other dielectric which has a metallic lining on its inner surface.

The capacity of a billi condenser may be calculated from the formula given below, provided that the thickness of the dielectric is small compared with the radii of the two tubes. If r_1 , r_2 are the radii of the inner and outer tubes respectively, K is the dielectric constant and C the capacity per unit length, then

$$C = K / (2 \log r_2 - 2 \log r_1)$$

This type of condenser is well adapted to the requirements of the experimenter, and it is simple to make. The general appearance is clearly shown in Fig. 2,

wide, and $\frac{3}{4}$ in. thick. They should be rounded off at the top, and at the bottom are shaped to fit the guide rails. The fixed end, A, Fig. 2, is cut away at the sides so that the remainder is in the shape of a dovetail. The sliding end is formed with a tenon on the bottom, as shown in the detail, Fig. 4. This part fits into a slot cut in the sliding base, which measures 7 in. long and $1\frac{1}{2}$ in. wide before it is bevelled. The head should be glued and pinned to the sliding base after it has been fitted to the guide rails.

The latter measure $15\frac{1}{2}$ in. long, $\frac{3}{4}$ in. wide, and $\frac{1}{2}$ in. thick. They are bevelled on one side, and one of them is then screwed to the baseboard with the widest part of the guide at the top. The sliding base is then bevelled to the same angle

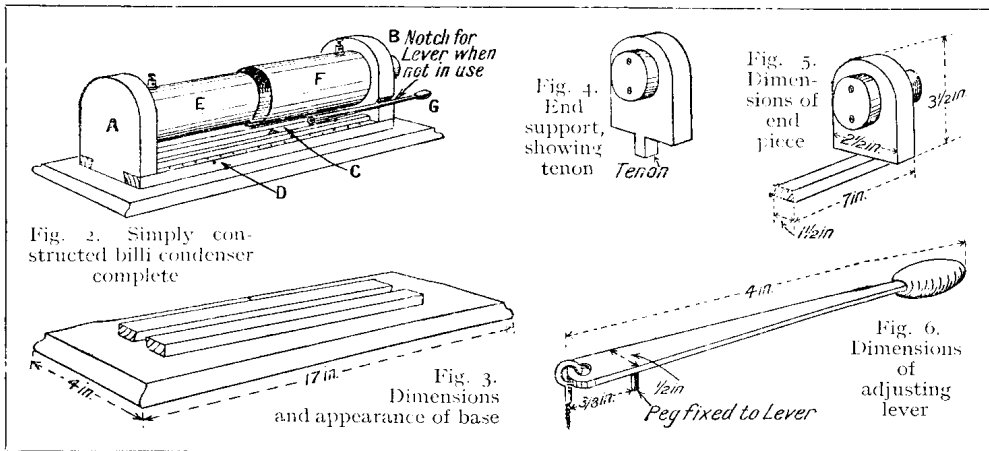

CONSTRUCTIONAL DETAILS FOR THE MAKING OF A BILLI CONDENSER

which shows the fixed and insulated tube at E attached to an upright, A, fixed to the baseboard. The movable tube, F, is attached to a sliding head, B, which works in guide pieces, as at D, attached to the baseboard. Provision for fine adjustment is made by the lever G.

The baseboard is illustrated in Fig. 3, and this can be made from good sound deal 4 in. wide, 17 in. long, and about $\frac{1}{2}$ in. thick, although it would be preferable to use a hardwood, such as mahogany, for the whole of the woodwork in the condenser. The baseboard must be clamped on the underside by screwing to it cross-pieces of hardwood $3\frac{1}{2}$ in. long, $1\frac{1}{2}$ in. wide, and $\frac{1}{2}$ in. thick, to prevent warping. The tube supports are shaped from timber $3\frac{1}{2}$ in. high, $2\frac{1}{2}$ in.

and laid against the fixed rail and the other rail laid against it. Set the sliding base in the centre of the rails and fix the second one with a fine screw in the centre. Test the alinement by sliding the base from end to end, and see that it can slide freely, and without any noticeable shake. If necessary, adjust the fit by planing the edges of the base until a perfect fit results. Fix the guide rails with a few fine screws. Fix the head to the sliding base, and when the glue has set test it to see that the whole can slide freely. Then cut two disks of wood, each 1 in. in thickness and one about 2 in. in diameter, the other slightly larger. They have to fit tightly into the bore of the fixed and the moving tubes respectively.

These tubes can be obtained from most metal warehouses, and ordinary thin brazed or treble tube 7 in. long will serve. The fixed tube should be 2 in. outside diameter, the moving tube about $\frac{1}{16}$ in. larger in the bore than the outside diameter of the fixed tube. The exact size is not critical, and the nearest commercial tube will answer all requirements. Cut the edges of the two wooden disks to fit tightly into the tubes, and glue and screw the disks to the ends.

To ensure them being in line, fix one of the disks first and then cut a cardboard template to fit over the edges of the guide rails. Press it against the end of the fixed disk and run a pencil round it. Cut out to the line, and test to see that the template is true, and transfer the position of the disk to the opposite end by marking through the hole on to the inside end of the head. Fix the second disk by this mark with a screw passed through from the outside, or with a small knob with a screwed shank, somewhat as shown in Fig. 2. Clean up and polish the tubes and fix them to the disks with a telephone terminal on the upper part and with two small screws (brass) towards each side at the bottom, Fig. 2.

Test the alinement by sliding the moving tube over the fixed, and if all is in order proceed to fix the insulation to the fixed tube. This may be composed of good quality stout white paper, which may be attached by coating it with shellac varnish. The paper should be damped prior to applying the shellac, using a nearly dry sponge for the purpose.

Several layers of the paper may have to be used, but in such a case it is better to use a continuous strip rather than separate pieces of paper, as it then lies more smoothly on the tube. Fine adjustment is provided on this condenser by the lever shown at G in Fig. 2, and detailed in the illustration Fig. 6. It is made from strip brass $\frac{1}{2}$ in. wide and $\frac{1}{4}$ in. thick, shaped as shown. One end is rounded and drilled with a hole $\frac{1}{4}$ in. in diameter. The outer end has a knob of ebonite or hardwood attached to it by sharpening the end of the brass bar and driving the wooden knob on to it. An ebonite knob is fixed by riveting to the lever. A peg is fixed by riveting to the lever at a distance of $\frac{5}{8}$ in. from the inner end. A $\frac{5}{8}$ in. screw eye is then opened out and slipped into the hole in the lever, and the eye closed

again. The eye is then screwed into the sliding base at about the middle of its length and near to one edge.

A series of $\frac{1}{8}$ in. diameter holes is then drilled into the guide rail and spaced at $\frac{3}{4}$ in. centres. If the holes have been correctly spaced, the peg on the lever can now be inserted into the nearest hole, and on moving the handle of the lever it will be found that the sliding tube will be moved along a small amount, giving a fine adjustment to the tube. To hold the lever out of action when making quick adjustments, a notch is cut in the side of the moving head and the lever rested in it. The lever is placed into the nearest available hole, after the approximate position for the moving tube has been found by trial, the final fine tuning being imparted by the lever, which thus serves as a simple form of vernier adjustment. A workman-like finish is given by neatly lacquering the metal and french polishing the woodwork. See Capacity; Condenser.

BINDING POST. A kind of terminal, comprising a screwed rod to which is attached one or more terminal nuts. The expression is often used to define terminals

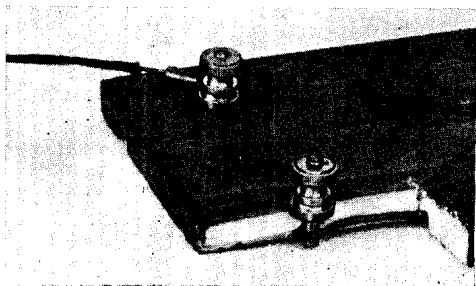

TWO BINDING POSTS

Temporary connexions are frequently made to binding posts, of which the above are examples. The wood has been cut away round the right-hand post to show the method of fixing

which are used chiefly to make temporary connexions. A typical example showing two binding posts is illustrated; one binding post is in position, and the other shows one way of fixing it to a wooden base, the wood having been cut away to provide a sectional view of it. It comprises a central screw held in position by means of a small nut tightened up from beneath the base. The plain-edged nut is rigidly attached to the central screw by screwing it into position and making it fast during the process of manufacture, or by soldering or otherwise fixing it. This provides a

shoulder or bearing surface, so that when the nut is tightened the binding post is held firmly in position on the base. Any surplus is cut off the end of the screwed part, so that it does not project below the surface of the base.

To provide a snug housing for the wire or conductor a small groove is cut on the inside of the base, connecting the binding screw to any other part of the apparatus to which the conductor is to be taken. In such a case the conductor may be a plain piece of copper wire about No. 16 gauge, the ends formed into eyes, slipped over the screw on the binding post, and secured by means of a nut. Connexions are made on the top of the post by means of a milled edge terminal nut. Utilized in this way, the expression binding post is somewhat loosely applied to various types of connexions. See Terminal.

BINDING SCREW. An expression often used synonymously for binding post. In wireless work it can be considered as an ordinary flat-headed screw, used for effecting temporary or other connexions. An example is illustrated, and shows such a screw attached directly into a base plate. The wire to be secured is held between two washers, which are pinched together and both drawn tightly against the base plate. The wire is thereby

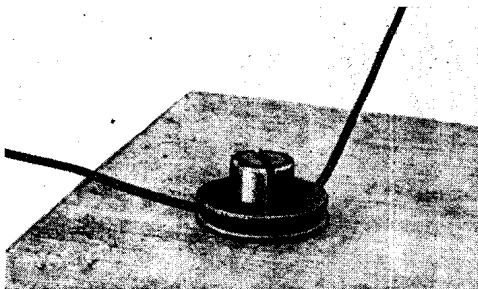

GRIPPING WIRE BY BINDING SCREWS

When a wire is to be temporarily held in position a binding screw and washers are used

held in position and makes an efficient connexion.

Customarily, two circuits can be con-

nected together by bringing the wire from one of them to the binding screw and another wire from the other circuit to the same screw. Such a course is often adopted when it is desired to test a piece of apparatus, and when it is desired to make a good



BINDING WIRE TO PREVENT FRAYING

Rope ends are sometimes bound with binding wire in this manner to prevent fraying. The wire may be fine gauge copper, but for heavier work soft iron wire is often used

electrical but temporary connexion. All that need be done is to drill and tap a hole or holes in the panel and provide screws and washers to suit. See Terminal.

BINDING WIRE. In wireless work this expression is used to describe a fine copper wire used for fastening various connexions by binding one part to another. In the example illustrated, fine binding wire is shown in use in binding, or whipping, the end of a rope to prevent it from fraying. The wire is first laid longitudinally on the rope and a turn wound around it; other turns are taken around the rope, drawing the binding wire tight at each turn and finishing by tucking the free end of the wire under the last two or three turns of binding and drawing it up tight.

In the workshop, the experimenter will find that soft iron binding wire is very useful for fastening together parts intended to be brazed, as by so doing the pieces can be held in their proper positions and will not shift while the brazing is in progress, the wire being subsequently removed when the job is completed. Another use is for attaching one piece of apparatus

temporarily to another ; but when this is done, care must be taken to prevent a short circuit or setting up electro-magnetic effects between the parts.

Desirable qualities in binding wire are that it should be sufficiently fine to conform readily to the contour of the objects to be joined together ; it must also be strong enough to withstand all strains likely to be brought upon it. With some structures, such as a bamboo-pole mast for an aerial, joints are often effected by lashing or binding the different sections together. In this case the binding wire would be a heavier gauge, about No. 20 or 18 B.W.G.

Wire for binding is most conveniently kept in stock in coils on wooden spools or bobbins, as these may be suspended by a cord from the ceiling or mounted on pegs on a wall or bench. If some such plan is not adopted, a loose coil of wire will speedily tangle or kink, and take a long time to straighten out, and even when this has been done the wire will be bent and kinked, and never give such satisfactory results as if it were taken care of at the start. For very small work, floral binding wire is useful, and is obtained in small quantities coiled on reels. It is tinned, clean to use, and is easily soldered

BIPOLAR. Having two poles. The term usually refers to a dynamo or motor whose armature rotates between a field magnet having only two poles. As a rule generators furnishing alternating current less than one or two kilowatts are bipolar. Other machines are multipolar on account of the high speed required to obtain high voltages. *See Magnet.*

BIRMINGHAM BROADCASTING STATION. The Birmingham station (5 IT) is situated in New Street. The transmitting plant is situated at Summer Lane power works, and the 100 ft. aerial is 210 ft. in height, slung between two chimney stacks. As will be seen in the illustration on page xvi, the aerial is a T-cage aerial with a cage lead-in, and is one of the largest broadcasting aerials in Great Britain.

The transmitting apparatus is divided between two rooms, the generator room and the transmission room. In the former are situated high and low voltage direct-current generators, coupled to a driving motor. The generators are in duplicate and are shown in Fig. 1. The main supply is at 400 volts D.C., and the high-voltage generator supplies the plate current to the transmitting valves at 1,250 amperes at 1,600 volts. The low-voltage

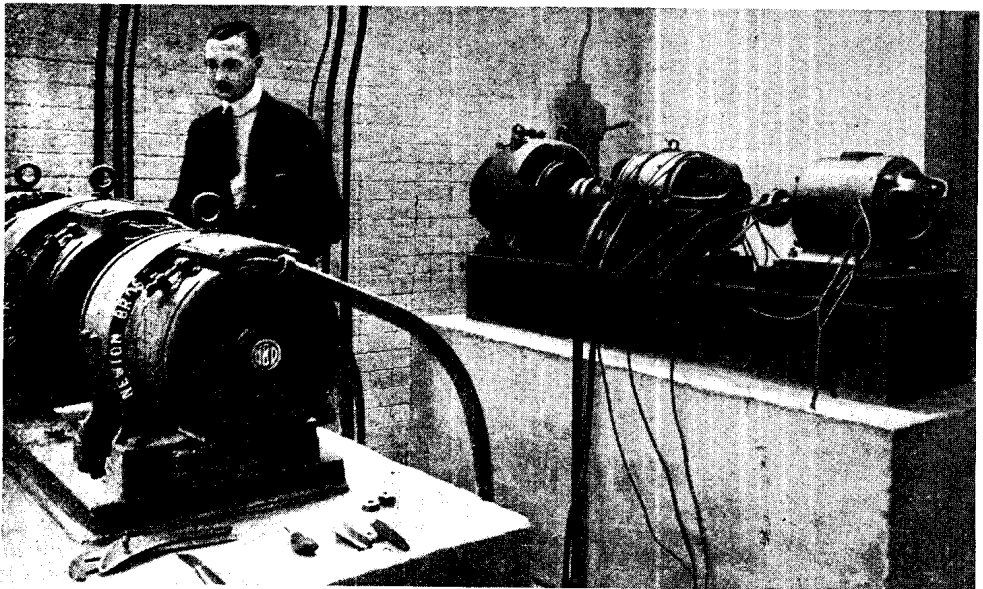

DUPLICATE GENERATORS OF THE BIRMINGHAM BROADCASTING STATION

Fig. 1. Nearly a mile away from the studio of 5 IT, the Birmingham broadcasting station, is a control department where the duplicate generators shown in this photograph are installed. These high and low voltage direct-current generators are coupled to a driving motor, and serve the transmitting apparatus in the next room

Photo. George Dawson

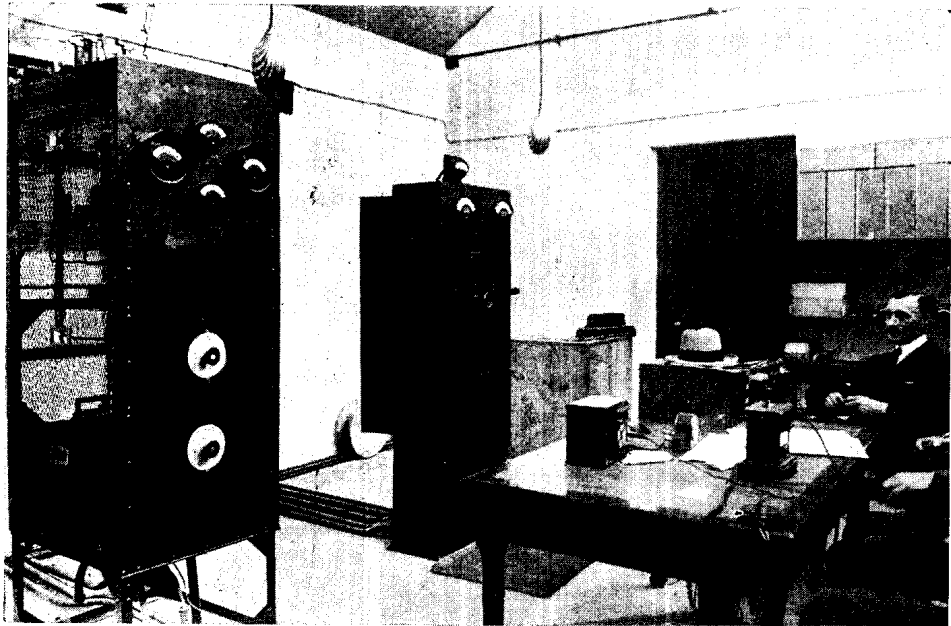

Fig. 2. Transmitting valves are used for broadcasting from the Birmingham station, 5 I T, with a plate current voltage of 1,600 and a filament current supplied at 14.5 volts. The control panels are shown in this photograph

Photo, George Dawson

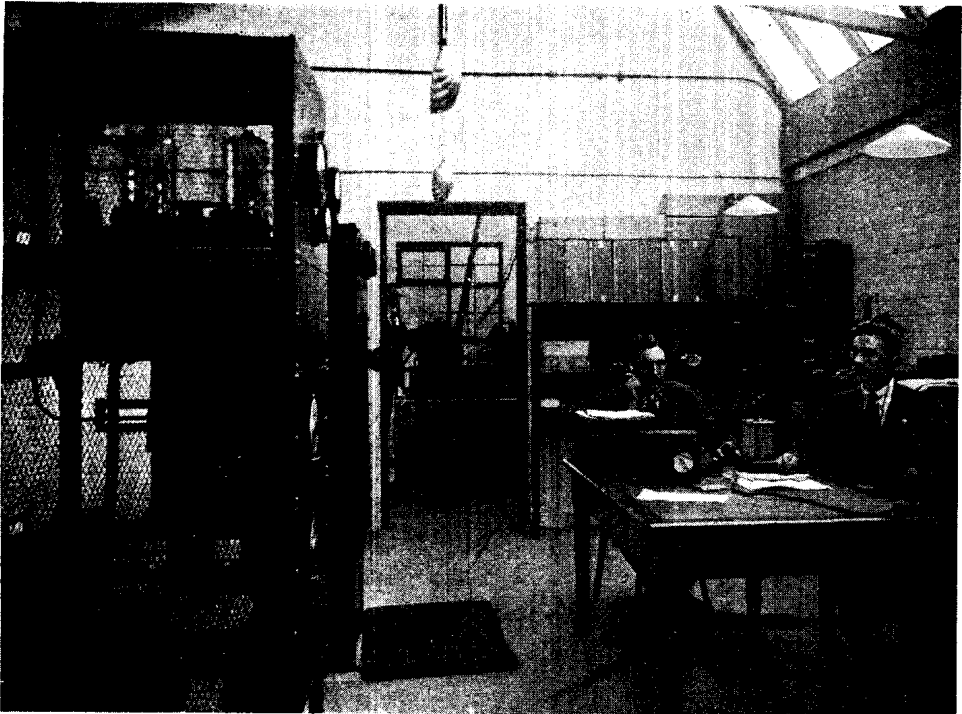

Fig. 3. At the far end of the transmitting room is a door leading to the generating room. The dynamos can be seen in the background. A near view of the control panel is here given, and the transmitting valves may be seen through the wire guard of the apparatus

Photo, G. A. R. Palmer

GENERATING AND TRANSMITTING ROOMS OF BIRMINGHAM BROADCASTING STATION



MODULATION ROOM OF 5 I T

Fig. 4. Modulation is an important part of the operative side of broadcasting. In the Birmingham Broadcasting Station modulation room the apparatus shown above is employed

generator for the filament supplies current at 28 amperes at 1.45 volts.

In the transmitting room are four 250-watt valves, two oscillators and two modulators, and a 50-watt amplifying valve. The oscillator valves are connected to a closed circuit with variable inductance and capacity and to the aerial by inductive coupling.

In New Street are the studio and the modulator room. The latter is in touch with the former by means of a small window which enables the engineer in charge of the modulator panel to see what is happening in the studio. In addition there is a signalling device in the wall of the modulating room to signal his requirements (see page xix.).

In the modulator room is situated a control panel, a three-valve receiving set, a crystal set and a loud speaker, clearly shown in Fig. 4.

BISMUTH. One of the metallic elements. Its chemical symbol is Bi, atomic weight 208.5, specific gravity 9.8, its thermal conductivity the lowest of all metals, and its electric conductivity 1.2 to 1.4 (silver 100). A brittle metal, reddish-white in colour, it is one of the

important alloy metals. Its most useful property is that of expanding when changing from the molten to the solid state, so completely filling any mould in which one of its alloys may be cast.

Bismuth is important in the measurement of magnetic fields. The effect of a magnetic field on the electrical conductivity of metals, known as the Hall effect, is extremely marked in the case of a plate or wire made of bismuth. The wire for the purpose of measurement is made in a thin, flat bifilar spiral.

BIT. A small cutting tool used for making holes, generally in wood, and mostly used in conjunction with a tool known as a brace. All experimenters who make any part of their apparatus from wood will find a knowledge of the various types of bits and the way to use them is of great value. The varieties and correct ways of using these tools are fully dealt with under the heading *Brace and Bit (q.v.)*, for the reason that a bit by itself is of no utility.

BLACKLEAD. Popular name for plum-bago and graphite. One of the forms of carbon, blacklead is important in many ways in wireless and experimental work.

Blacklead has a high resistance, and it is very convenient in the making of certain simple forms of resistances. An ordinary pencil line can be used in making a grid leak. A grid leak and fixed condenser, using blacklead for the grid leak, may be made as follows.

Cut two pieces of ebonite, one $\frac{1}{4}$ in. thick and the other $\frac{1}{8}$ in. thick, and each piece $1\frac{3}{8}$ in. by $2\frac{7}{8}$ in. The thicker piece of

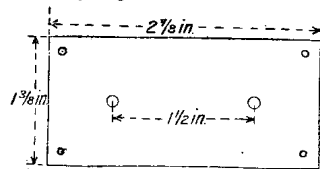

CONDENSER BASE

Fig. 1. Ebonite for blacklead grid leak and fixed condenser

ebonite serves for the base of the fixed condenser, the thinner for the top and the grid leak. The ebonite should have four holes tapped in the corners to take ordinary brass wood screws, and two centrally placed holes, $1\frac{1}{8}$ in. apart, to take terminals, as shown in Fig. 1. Cut a number of pieces of mica, $1\frac{3}{4}$ in. by $\frac{1}{2}$ in., and a number of copper foil strips, $1\frac{3}{8}$ in. by $\frac{3}{8}$ in. The copper foil strips and the mica should be pierced close to both ends in the case of the mica, and at one end only in the case of

the copper foil, and arranged as shown in Fig. 2. It will be noticed that the copper strips are attached alternately to each terminal, so that no strip touches both terminals.

Screw the two plates together with the terminals in position, and before fixing on the upper nuts of the terminals fix a slip of soft paper over the terminals, rub some blacklead round the paper near

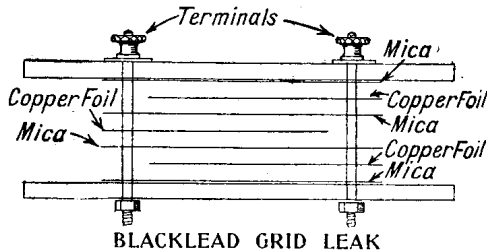

BLACKLEAD GRID LEAK

Fig. 2. Copper foil and mica strip spacings are arranged in the making of a condenser for a blacklead grid leak, as shown in this diagram

the terminals, sufficient to be just covered by the two small brass washers, one of which is placed over each terminal before the nuts are screwed down tight. The ebonite base should have the terminal holes countersunk so that the terminal nuts may clear the baseboard. Two grooves should be cut in the ebonite to take the connecting wires. Finally, when the terminal nuts are screwed up

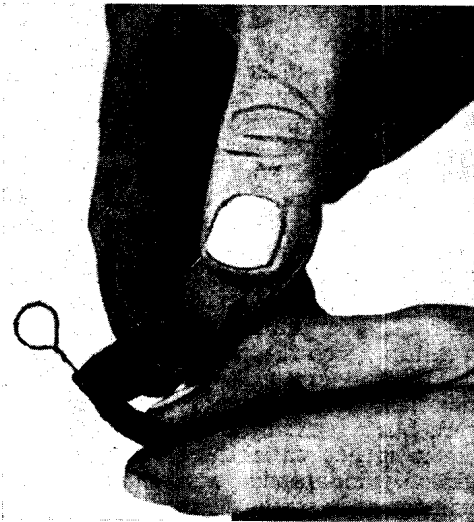

INSULATION BY BLACK TAPE

When a wire or two or more wires joined have been stripped of their insulating material, re-insulation may be effected by covering with black tape. The illustration shows a wire, stripped to make an eye, being protected

tight, draw with a soft lead pencil a line on the paper between the terminals. This line must connect up with the blacklead beneath the terminals, and the grid leak condenser is complete.

The advantage of a blacklead grid leak is that it is easily renewable and easily variable by varying the thickness of the line or using different leads. It is advisable to try several pencil lines joining the terminals, as the resistance of blacklead, though fairly constant for one particular pencil, varies within wide limits for different pencils. A 4 B pencil is best to use, taken all round. The ordinary H.B. is too uncertain in its value to use, and usually has a comparatively low resistance.

The resistance of blacklead is taken advantage of in the Filtron variable grid leak. In this leak a groove is cut in the

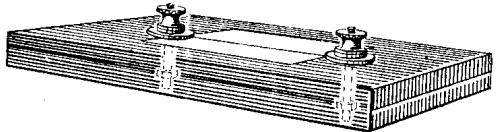

FIXED CONDENSER AND GRID LEAK

Fig. 3. After constructing the condenser the grid leak is made by drawing a line with a soft blacklead pencil on a strip of paper between the terminals

form of an Archimedean spiral in a disk of insulating material, and the groove rubbed round with graphite. A piece of blacklead carried on a revolving switch arm may be moved along the groove, and serves for contact. A pointer is attached to the arm, and the resistance of the grid leak is increased by the rotation of the pointer.

Inasmuch as blacklead is a conductor, it is inadvisable when setting out panels to use a lead pencil to mark the positions of terminals, screws, and the like, otherwise, with a pencil giving a low resistance, trouble may be experienced when the set is assembled. It is better to use a template of paper, which is held on the ebonite by a little shellac, and can be cleaned off when the panel is ready.

BLACK TAPE. The name often applied to a form of impregnated material, such as linen, woven in a long length and treated with an insulating mixture. It is used to bind over a conductor or other part of a piece of apparatus to complete its insulation. One application is illustrated, and shows the end of a conductor from which the braiding and insulation has been removed to permit the wire to be formed

into an eye for convenient attachment to a terminal. No matter how carefully this is done the end of the covering will be loosened and the insulation value diminished. This is rectified by binding it with the black tape as shown. The tape is simply wound tightly around the outside of the braiding or covering of the wire.

The binding should start some distance from the end, and be continued to the turn of the eye. The binding overlaps each turn, and where the wire is not insulated the black tape should be wound around several times to build up a sufficient amount of insulation. The tape is adhesive, and as the binding proceeds the turns ought to be well compressed between the fingers to consolidate the material as much as possible.

The wireless experimenter will find that a supply of black tape is always handy, as it can be used in the manner described to finish the ends of all insulated conductors. In some cases the terminal nuts can be entirely covered, especially on outside points, such as the lead-in and earth terminal nuts. This not only improves the insulation value, but holds the nuts securely and prevents them loosening from the effects of vibration.

Another use is as a temporary support for a cable or conductor when wiring up a set of parts for some experimental purpose. The tape can be cut into short pieces and simply pressed over the conductor on to the base, and will hold sufficiently firmly to keep the conductor in place and obviate risk of accidental short circuits and entanglement of the wire. Temporary control handles can be made with it by binding it around the end of, say, a brass rod attached to such a thing as a cat's-whisker or to the end of a long handle used on a condenser or coil holder.

BLACK TELLURIUM or Leaf Tellurium.

Alternative name for nagyagite, a crystal rectifier. Black tellurium is one of the more important minerals containing gold, and consists of gold, lead, tin, tellurium, and sulphur. It is of little use as a rectifier. *See* Tellurium.

BLACK WAX. An insulating compound that can be used in the plastic state. The chief ingredients are resins, asphaltum, and wax. It is generally used for filling cavities in a base where terminals and conductors are fitted into recesses, and for filling the tops of some types of dry cells and accumulators. One way to use it is

to warm it with gentle heat and work it into place with a smooth wooden stick, or with a piece of metal that has been warmed. Another method is to heat the mixture sufficiently to render it fluid enough to be poured into place. *See* Pitch; Wax.

BLISTERING. An expression describing an objectionable or detrimental excrescence on the surface of an object—such as the cabinet of a wireless receiving set. On woodwork blistering is generally the result of excessive local heat, causing the polish or other finishing preparation to soften. The imprisoned air, by expanding, raises a blister on the surface. Similar effects may be due to chemical action, as, for instance, when acid is spilled on the surface. Remedies are to puncture the blister, warm the surface in the vicinity, and press the blister back with a warm, flat piece of metal. When the surface is smooth a weight is applied to help to assist in sticking the film of polish to the wood. When the blister is a large one, or this method fails, it is preferable to scrape away all the affected parts and fill the cavity with a hard stopping and repolish it to conform with the original condition.

The term blistering is also applied to an accumulator plate, and is an indication of a fault. It is caused by impurities in the material of the plate or the electrolyte. The effective remedy is to remove the impurity by emptying out the electrolyte, washing out the cell, and refilling with fresh solution, under due precautions, as dealt with in the article on Accumulators. The expression is also applied to an excessive bulging or swelling of the plates, often associated with softening or due to the too violent gassing of the plates due to an excessive charging rate. *See* Buckling.

BLOCK. In wireless work the word block is used in various connexions. It is the trade description of a well-known type of cell in which the plates are compressed or built up in the form of a block of material. When allied to condensers the word block generally means that the condenser is not variable in value, and is generally in a solid form, more or less rectangular in shape.

As applied to the erection of an aerial system or for many constructive processes a block is a form of pulley, and comprises a block of wood or metal, somewhat egg-shaped and pierced with a

slot. In the interior of the slot is located a sheave or wheel with a grooved edge. This is mounted on a pivot pin that passes through the centre of the block. Around the outer surface of the block is formed a groove for the reception of the strop or rope that is used for attachment of the block to some other appliance. A standard example is illustrated, and shows how a

tackle is to be put. The lanyard, B, is simply a strong rope that is reeved through the blocks and one end made fast to the thimble on the single block. In practice, with the ropes arranged as shown in Fig. 2, the effective pull on the rope A, as exerted through the tackle, is three times that which would be possible by exerting the same pull directly on the rope A, and the lanyard, B, has to travel three times the distance travelled by the rope A.

When the experimenter has to deal with heavy weights, the use of some such tackle will greatly lighten the labour. Blocks are measured by their length, and should be three times the size of the rope that is rove through them. The outside part, known as the shell, ought to be of elm or hardwood or of metal. The groove cut in the sides and bottom of the block is technically named the score. A block with one sheave or wheel is known as a single

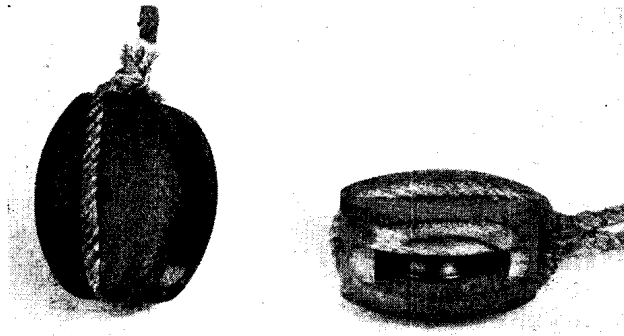

BLOCKS USED FOR WIRELESS

Fig. 1. How a small block is attached to a single rope is shown on left, and a block seized in the bight of a rope is seen on the right. Such blocks are of great use in hoisting aerial masts

small block can be attached to a single rope; and on the right the method of seizing a block into the bight of a rope.

The use of two blocks to form a simple lifting or hauling tackle lightens the labour of such work, as the raising of the aerial mast or exerting a considerable pull on a heavy object. There are very many types of block, some with a single sheave, as illustrated, others have two or more sheaves in one block; they are generally arranged in this way to secure a greater mechanical advantage.

The principle of a block and tackle is shown in diagrammatic form in Fig. 2, which indicates how a single and a double block are used to make up a simple purchase tackle. The double block is spliced into an eye on the end of the rope A, which is taken to any desired point, such as the aerial mast to be lifted. The strop of the single is worked around a thimble at one end and a ring at the other. A strong hook is secured to the ring, and forms a convenient means of connecting the tackle to some strong support, such as a post or the side of a house.

Alternatively the block could have another rope in place of the hook, such being determined by the use to which the

block, those with two sheaves as a double block. A single block is generally used at the top of an aerial mast to accommodate the halyard employed in raising the aerial wire or spreader; but this fitting is more often known

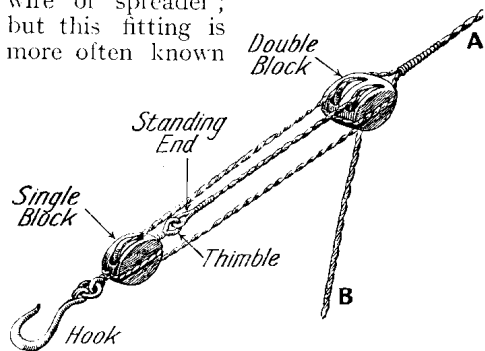

TACKLE WITH TWO BLOCKS

Fig. 2. Pulley blocks and tackle are used to gain a mechanical advantage. In the case illustrated one single and one double block are employed

as a pulley, as it is generally fitted for direct attachment to the mast. See Aerial; Guy; Pulley; Ropes; Wire.

BLOCK CONDENSER. Small fixed condenser, so called from its general resemblance to a small block of wood or other

material. The photograph shows the ordinary type of block condenser for panel mounting. A block condenser must not be confused with a blocking condenser.

BLOCKING CONDENSER. A small fixed condenser. A blocking condenser is so called from its function of affecting the path of certain electrical currents according to its position in the circuit. A small fixed condenser shunted across the telephones in a receiving circuit is often known



BLOCK CONDENSER

Block condensers and blocking condensers are different. This is a block condenser, so called because of its shape

as a blocking condenser. A condenser acts to some extent like an elastic partition or membrane stretched across a pipe. If water is pushed through the pipe it stretches the membrane and its flow is stopped, unless it bursts the diaphragm.

But if an oscillating current of water is generated by pumping to and fro, the membrane yields easily backward and forward, and offers no obstruction. It rather helps the recoil and overcomes the inertia of the water.

So it is with a condenser. It permits the passage of an alternating current, especially a high-frequency current of small amplitude, with perfect ease; but it blocks a battery current, or any other current in one direction, by setting up an opposition voltage when charged, and thereby tending to drive the current back again. It acts as an obstruction or block. A condenser in the path of a rapidly alternating current rather helps the oscillations than otherwise.

The high-frequency oscillations of grid potential in a receiving valve produce corresponding oscillations in the anode current. In a valve receiving circuit embodying a telephone transformer, to have the high-frequency oscillations reproduced in the anode circuit current a path of low impedance is provided in the shape of the

small condenser shunted across the high-impedance portion of the circuit. The main pulses of anode current go through the battery and primary of the telephone transformer as usual, while the high-frequency pulses pass through the blocking condenser, as generally shunted across the battery and transformer. Fig. 1 shows the usual kind of blocking condenser of .003 mfd.

The construction of a small fixed condenser applicable to most circuits where a condenser is needed for blocking purposes is simple.

The appearance of the finished article is shown in Fig. 2, from which it will be apparent that the condenser proper is in the form of a detachable block. This has the advantage that the baseboard, with the contact terminals, can remain intact and the value of the condenser be changed by the simple removal of one block and the substitution of another. Contact between the condenser and the base is effected by the copper strips attached to the side of the block and communicated to the terminals by the spring-clip contacts.

The base can be made from hardwood, or preferably of ebonite, about $\frac{3}{8}$ in. thick. The dimensions can be adjusted to suit individual ideas, but somewhere of the order of 4 in. in length and $1\frac{1}{2}$ in. in width



BLOCKING CONDENSER

Fig. 1. The function of this condenser is to stop direct currents and to transmit rapidly alternating currents or radio-frequency currents

will be serviceable. The contacts are cut from sheet brass about No. 16 to No. 18 gauge, the shape when cut being like a letter T, the length of the upright being $1\frac{1}{4}$ in. and the width of the cross bar 1 in.

The latter is then bent up at either side to form the spring contact. This is accomplished with the aid of a small pair

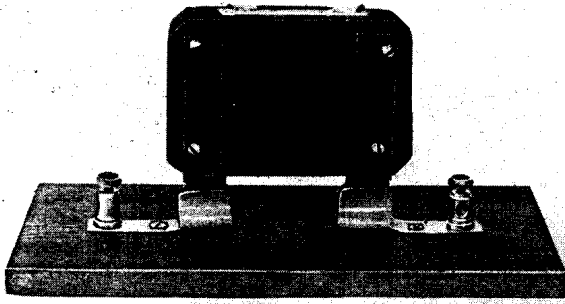

Fig. 2. Complete blocking condenser on wooden base



Fig. 4. Only the contact strips are allowed to protrude when the case is screwed down

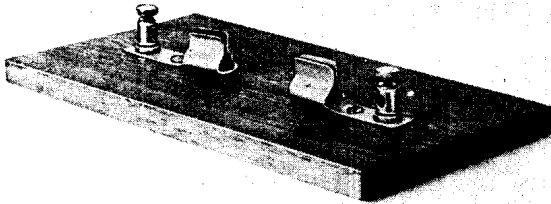

Fig. 3. Details of the baseboard and spring contacts are here shown. The spring contacts are made of T-shaped strips of metal

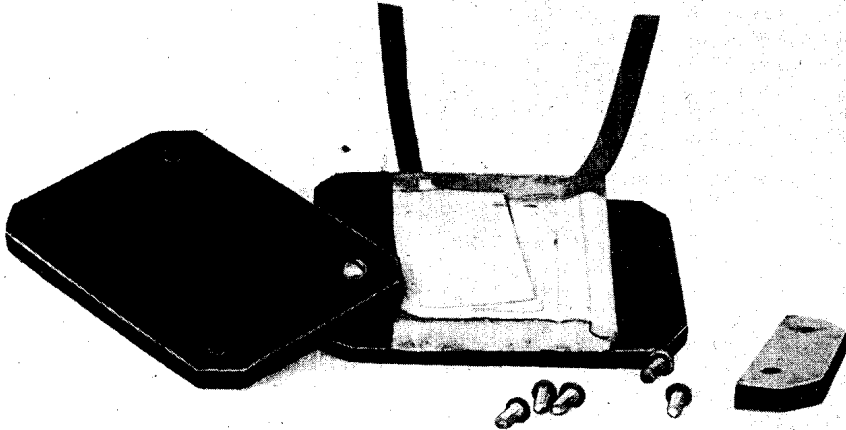

Fig. 5. Tinfoil and waxed paper layers may be seen in this photograph. A blocking condenser has been dissembled to show the various parts and general construction. Note the contact strips

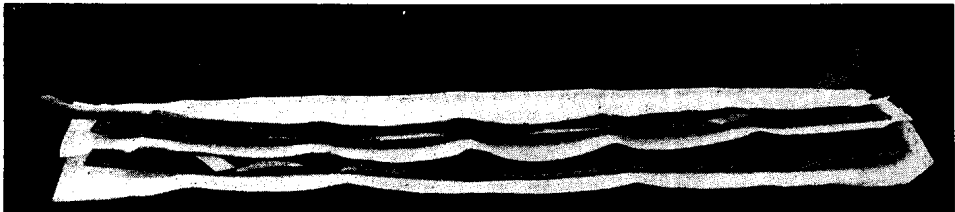

Fig. 6. Paraffin-waxed paper is here seen insulating the strips of tinfoil in the order in which they are placed in the blocking condenser. The contact strips may also be seen in position

HOW TO MAKE A BLOCKING CONDENSER

of round-nosed pliers. Holes are then punched or drilled for the passage of the telephone terminal and the round-headed screw that is used to hold the contact to the base. The disposition of these parts is clearly shown in the illustration, Fig. 3, which gives a good idea of the permanent base. Should it be desired to cut out the condenser from the circuit for any reason, all that need be done is to short-circuit the contacts by placing a strip of copper across them.

The condenser proper is made from strips of tinfoil and waxed paper interleaved and folded over each other, the whole enclosed in an ebonite casing. This is made from thin ebonite sheet, two pieces being cut to shape for the sides and united by end slips, and the whole fixed together by screws passed through the ends of the ebonite and well away from the tinfoil, which is embedded in wax in the interior of the case. The sizes can be varied according to the capacity or value of the condenser, but as a start they can be made from ebonite $\frac{1}{8}$ in. thick, 2 in. long, and $1\frac{1}{2}$ in. wide. The end slips are $\frac{3}{8}$ in. wide and $\frac{1}{8}$ in. thick. The corners are cut off at an angle of 45° , as shown in Fig. 5, which clearly illustrates the location of the condenser and the component parts of the case.

How the Condenser is Assembled

Round-headed brass screws, No. 8 B.A., are used to hold the parts together, and clearance holes are drilled through one side piece and through the end slips, but tapped holes are provided in the other side piece for the screws to bite into. To make the condenser, take two long strips of tinfoil and two strips of paraffin-waxed paper, or the regular condenser paper as sold by electricians can be used instead. The size and number of sheets of the tinfoil will be determined by the desired capacity of the condenser, but those illustrated are 1 in. wide and 6 in. long. The paper should be about $\frac{1}{2}$ in. wider all round than the tinfoil.

Commence assembling by laying one of the strips of paper on the table and placing a strip of tinfoil on it, then place a strip of copper foil, about $\frac{1}{4}$ in. wide and 2 in. long, upon the tinfoil in a diagonal manner, as shown in Fig. 5. This is necessary for connecting purposes. Then place the second strip of paper on the foil, then the second strip of tinfoil,

then another copper strip, and, finally, the third layer of paper. The appearance of these parts will then be as shown in the illustration, Fig. 5. The next step is to fold over the whole set of paper and foil strips. This requires care so that the paper does not shift nor the foil become detached or displaced, otherwise all that has to be done is to turn over the end of the strips bodily at a distance of about an inch from one end.

Fitting the Contact Strips

Crease the folds to make them lie closely together, and turn over another inch, and so on, until the whole is in the form of a flattened bundle. Then place the whole in the cavity in the case, screw it together, and seal it with melted paraffin wax. The appearance is now as shown in Fig. 4, and it is necessary to bend the two projecting strips of copper over the outside of the case near to its edge. Brass or copper contact plates have then to be prepared from strip metal $\frac{3}{8}$ in. wide, about No. 18 gauge, and approximately 3 in. long.

Fold this strip over in the middle, and hammer the corner flat; bend the two parts open, and insert the case between them. Press back the strips so that they lie flat against the sides of the case, and mark off the position of the screw holes in the case, and drill through the strips at these points. Remove the screws from the case at one end and press the copper foil contact strips under the brass contact pieces and secure with the screws as before, but holding the contact plate secure with a nut on the outer end of the screw. Treat the other end in the same manner, and test the condenser in the contacts on the case or holder, adjust them if necessary, and the condenser is complete. See By-pass Condenser; Condenser; Impedance.

BLONDEL, ANDRÉ E. French electrical expert. Born at Chaumont, France, in 1863, he graduated at Paris University, and studied electric waves, on which subject he early contributed a number of papers to various scientific journals. In 1893 he invented the oscillograph (*q.v.*), an instrument somewhat similar to a mirror galvanometer, for showing curves of oscillating or alternating currents. This invention opened up a fresh field in the study of alternating currents. In the same year Blondel explained for the first time mathematically the effect of inertia in the

shunting of alternators. He is responsible for a system of acoustically syntonized wireless telegraphy, and for directed waves produced by a double aerial. In 1902 he patented a method for producing electric oscillations for wireless telephony, and has written many papers on microphonic control for transmitters, wireless telephony, the singing arc, etc.

BLONDEL COHERER. Type of coherer devised by M. M. A. Blondel. The coherer consists of a sealed glass tube in which are a number of metal filings. The tube has a side pocket or extension in which is placed a reserve of filings. A varying quantity of these may be shaken into the gap between the electrodes to increase the sensibility of the coherer. *See* Coherer.

BLONDLOT, PROFESSOR PROSPER RENE. French wireless expert. Born at Nancy, France, in 1849, he studied at Paris, and became professor at the faculty of sciences, Nancy, and afterwards Honorary Professor and Correspondent of the Institute of France. Professor Blondlot is famous for his studies of electro-magnetic waves, particularly with regard to their speed, and the laws of propagation of wireless waves in various media.

BLOWING MOTOR. The blowing motor forms part of the equipment in the special apparatus used for high-speed transmission and reception of wireless signals. As in line telegraphy, the operator first punches the message on a tape, which is fed into a Wheatstone transmitter. The current passing through this works a relay, and also closes the circuit of a second relay controlling the supply of compressed air operating a special air engine. The latter, by operating the arms of a high-tension transmitting switch, controls the spark discharge, consisting of four fixed contacts supported by hollow ebonite pillars corrugated on the outside to reduce leakage.

The moving contacts are supported at the ends of two strong steel springs mounted on ebonite pillars, also corrugated, and arranged to work in ball bearings with an air gap of about $\frac{1}{4}$ in. between the fixed and moving elements of the gap. An air blast is conveyed through the hollow ebonite pillars, holding the fixed contacts in such a way that the arc formed on breaking the high-tension sparking current is forcibly blown out. The air blast is derived from a

centrifugal type of blower driven by an electric motor, and the whole is referred to as the "motor-blower," or blowing motor.

BLUE GLOW. A blue light sometimes visible within the bulb of an ionic valve, resulting from gas ionization.

The blue glow appears in soft valves—that is to say, valves in which the vacuum is not very high. Some valves depend upon the presence of gas to obtain the best results—*e.g.* the soft Round valve, which becomes sensitive as the valve becomes harder. When a current is passed through a soft valve in the ordinary way there is a certain amount of ionization, due to the flow of the electrons from the filament to the plate. When there is too much gas in the valve a strong blue glow appears and the valve becomes insensitive.

This is because there is excessive positive ionization, neutralizing the space charge, with the consequence that the relaying action of small potentials on the grid is lost. When the blue glow is noticed the filament current should usually be reduced. Often, accompanying the blue glow phenomenon, there may be heard a hissing sound, and the current should be reduced until this sound becomes inaudible. The glow considerably shortens the life of a valve, though the glow is not detrimental in ordinary soft valves so long as it does not extend beyond the inside of the plate. *See* Electron; Ion; Space Charge; Valve.

BOARD OF TRADE UNIT. This is the name given to 1,000 watt-hours. It is usually abbreviated to B.O.T. Unit. Such units are measured by an instrument known as the watt-hour meter, an energy meter in which the record is produced by the action of both the pressure and the current. The fundamental principles of the motor type watt-hour meters are those of the electric motor, and the application of the motor principle to energy meters is chiefly due to Thomson, from whom the instruments are known as Thomson meters. *See* Unit.

BOBBIN. A reel or spool wherewith to wind a coil of wire. Bobbins are used as the foundation of many forms of transformer winding, as, for example, the high frequency type illustrated. Bobbins are always made of

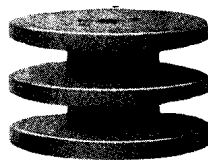

Bobbin as used in H.F. transformers

insulating material, and generally circular in section. They may have flanges at each end formed by turning away the material from the solid, as when they are made of wood.

Other examples are made from ebonite or some moulded composition of a like character. When this is used the bobbin can be moulded with the requisite grooves for the wire. In some cases a bobbin can be made up by the experimenter from a piece of small diameter cardboard tube with ends cut from thick card and glued on. Others can be made in the same way from fibre, or some such material as celluloid. In any case the chief requirements are that the bobbin be well made and stiff enough to retain the wire. Various methods of making the bobbins include turning them from hard wood in a lathe or building them up from sheet materials such as fibre and cardboard. Small bobbins can also be turned up from rod ebonite.

Whatever the method adopted, the insulation should be perfect, a result generally accomplished by the use of suitable materials, and in the case of those like cardboard by coating them with an insulating paint or varnish such as shellac or by impregnating with paraffin wax.

BOBBIN INSULATOR. A circular insulator made of porcelain or similar material. It is used in any place where its shape is appropriate to support an overhead wire or conductor. For example, it could be attached to a shackle, or to a bar of wood by means of a bolt and nut. It is also useful for placing under a base to insulate it from the wall or other surface to which it is attached.

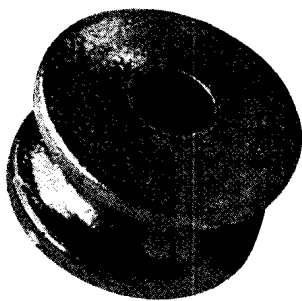

PORCELAIN BOBBIN

Insulators of this kind are in common use for wireless work

The central hole permits of the passage of a bolt or screw. As this type of insulator has flat sides it can be used in other ways, as by placing several on top of each other. This is especially useful when it is desired to elevate a baseboard or panel above the normal surface of the surroundings. When

several of these insulators are employed to support a long wire the latter can be turned around the bobbin, but a preferable plan is to attach the wire by means of a separate binding or retaining wire, thus avoiding the need of kinking the conductor. A further example of the use of a bobbin insulator is to work it into an eye in the end of, say, an aerial wire, the latter being spliced or seized to the bobbin. When purchasing see that the material is perfect and free from cracks on the surface or otherwise, as cracks of any kind are detrimental. *See* Insulation.

BODY CAPACITY. Term used to indicate the electrical capacity of the human body.

Many experimenters are puzzled by the discordant howls and shrieks which may start suddenly in a receiving set, which are not due to atmospherics, bad connexions, or extraneous causes. If these noises increase when a terminal or contact is touched, and die away when the hand is withdrawn, the cause is body capacity, and this factor has to be taken into account in delicate adjustments.

The human body has conduction and capacity. It is capable of transmitting energy or storing it, and offers a certain resistance to the passage of an electrical current. Many people are very sensitive to the approach of a thunderstorm, or to other natural electrical phenomena, and these persons have usually the worst effect upon a finely adjusted receiving instrument. An accidentally touched terminal means an extraneous small charge of electricity entering the circuit, and so temporarily detuning it. Proper insulation control knobs and handles should be used to lessen the effects of body capacity and the insulation of all parts should be carefully watched.

BOILING. A term used in connexion with accumulators to denote a state when the plates are gassing very freely and the electrolyte is in a state of ebullition. The matter is dealt with in this Encyclopedia under the heading Accumulator.

BOLITHO CIRCUIT. Super-regenerative circuit patented by Captain J. B. Bolitho, Oct. 6, 1919. The circuit as given in the patent was applied to operate a relay device, but Bolitho pointed out the applicability of the circuit as an amplifier for wireless telegraphy and telephony; and it has been claimed that he has a priority over the Armstrong circuit.

The diagram shows the main parts of the Bolitho circuit. V_1 is a triggered valve, that is, one adjusted to the threshold of oscillation. This valve is intermittently quenched by means of a second valve, V_2 . This valve is excited by a generator G forming part of the plate circuit. The plate circuit of the other valve V_1 is back-

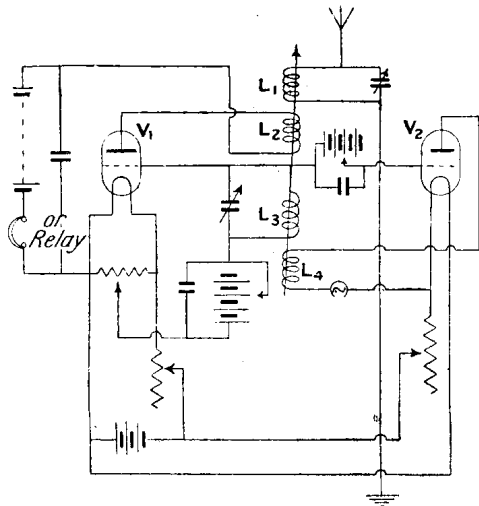

BOLITHO CIRCUIT

Bolitho applied this circuit as an amplifier. One valve being excited by a generator and adjusted to the threshold of oscillation is quenched by a second valve intermittently. When self-oscillation is stopped the system becomes responsive to incoming signals in the aerial coil

coupled to the tuned grid circuit through coils L_2 and L_3 . The coupling is arranged so that the valve is on the threshold of oscillation.

The plate circuit of V_2 has in it a reaction coil L_4 , coupled to the coil L_3 , opposing the magnetic linkage between L_2 and L_3 . V_2 is excited by the generator at a frequency considerably lower than that due to the received signals, and it may consist of a third oscillating valve coupled to a coil in the plate circuit of V_2 .

As shown in the figure, the grids of V_1 and V_2 are connected together. The valve V_2 keeps the whole circuit in a responsive condition when V_1 is tuned to the threshold point. The plate of V_2 is charged alternately positive and negative by the generator, and this causes a cycle as follows:

When the plate is negative no current can flow in the coupling coil L_1 which, therefore, does not affect the coils L_2 and L_3 , leaving V_1 to build up into self-

oscillation. When the plate is positive current flows through L_4 , neutralizes the coupling between L_2 and L_3 since it is coupled to them in the reverse direction, and stops any transfer of energy between the grid and plate circuits of V_1 . This gives the quenching, stops self-oscillation, and the system becomes responsive to the signal energy flowing in the aerial coil L_1 . The cycle continues at a rate which is settled by the frequency of the generator.

It will be observed that the circuit in many respects fulfils the same functions as the Armstrong super-regenerative circuit. In that circuit, as in the Bolitho circuit, back coupling is used to keep the valve on the threshold of oscillation; and a quenching action is used either by varying the magnetic leakage across the back-coupling coils or by periodical variation of the damping factor of one of the oscillating circuits. See Armstrong Regenerative Circuits; Back Coupling; Feed-back Circuits; Oscillation.

BOLOMETER. Type of Wheatstone bridge used in measuring resistances and high-frequency currents of the order of milliamperes. It is well known that the resistance of a conductor varies with the temperature, and in the original bolometer, as invented by S. P. Langley, the instrument was used to detect small temperatures due to radiation. It consisted of two strips of platinum arranged to form two arms of a Wheatstone bridge, one strip being exposed to a source of heat radiation and the other being shielded.

For the detection of radio-frequency currents Rubens and Ritten constructed the circuit shown in Fig. 1. A and B are two diamond-shaped fine platinum or iron wires connected with two resistances, R_1 ,

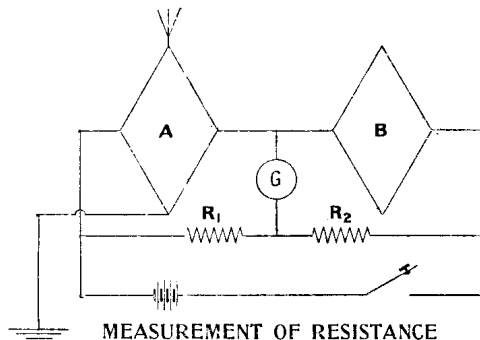

MEASUREMENT OF RESISTANCE

Fig 1. Resistances and high-frequency currents are measured by instruments of which the bolometer is one. A circuit diagram is given showing the arrangement theoretically

R_2 , to form a bridge with a galvanometer G and a battery. To A is connected the aerial lead-in and the earth connexion as shown. When the high-frequency oscillations come via the aerial, oscillations are set up in A , raising the temperature, and so the resistance of A is increased and the balance of the bolometer bridge destroyed, the galvanometer being deflected. When the wires A and B are mounted in a

choking coils L_1, L_2 are used in place of the resistance wire A and B , and fine resistance wire or resistance lamps, of 2 to 4 volts, as shown, may form the bridge. R_1, R_2 are fixed resistances of a few ohms, screened in actual practice from temperature changes. The resistances R_1, R_2 should approximately equal those of the lamps. A potentiometer R_3 enables a fine adjustment of the bridge to be made to bring the galvanometer to zero when there is no high-frequency current. A variable resistance is shown in series with the battery, and allows an adjustment to be made so that the current through the lamps only just makes the filament red. A is a milliammeter, and is useful to maintain the bridge adjustment constant. See Foster Bridge; Resistance; Wheatstone Bridge.

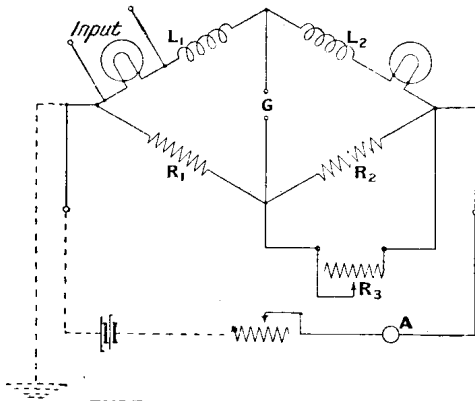

EXPERIMENTAL BOLOMETER

Fig. 2. Experiments are sometimes carried out with a form of bolometer represented in the above diagram

vacuum the sensitivity of the circuit is greatly increased, and currents down to a few microamperes can be measured.

Fig. 2 shows another form of the bolometer bridge which is useful for experimental work in wireless. Low resistance

BOLTS AND NUTS. Fastening devices generally made of metal and circular in section. The bolt is a bar of metal with a screw thread formed or cut on the exterior and for only a portion of the length from one end. The other end has a head, shaped in different characteristic ways. The shape is as a rule the distinguishing feature of bolts of different types. The nut is a block of metal with a hole through the centre, this hole being threaded in a corresponding way to the bolt. When the bolt and nut are the same size and type of screw thread, the nut will just screw on to the bolt without difficulty and without any shake.

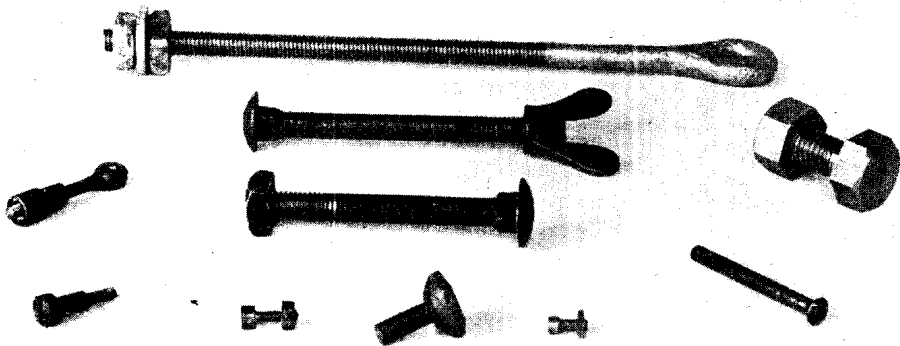

SELECTION OF BOLTS AND NUTS FOR WIRELESS PURPOSES

Fastening devices used in aerial construction and other branches of wireless work call for a selection of many sizes and shapes of nuts and bolts. Standard types are mostly used unless special work demands otherwise. Above will be seen an eye-bolt and nut (top), coach bolt and flynut (second from top), coach bolt used in woodwork (third from top), set-screw bolts (bottom line), small eye-bolt (left), and engineer's bolt and nut with hexagonal heads (right)

Editorial Note

IN offering this entirely new work to the very large and rapidly increasing public that is interested in the popularization of the science of Wireless, the publishers may be permitted to point out that not only is HARMSWORTH'S WIRELESS ENCYCLOPEDIA unique in being the very first effort to provide a complete and exhaustive work of reference in a highly specialized field of study, but that the thousands of photographs and drawings which its pages will contain have, with few exceptions, been expressly made for this work.

THE WIRELESS ENCYCLOPEDIA is one of a series of educational works issued by the same publishers, in which the instructional value of the photograph has been demonstrated to the full. Every item of Wireless equipment photographed for the pages of this work has been prepared and tested by experts. Where details of mechanism are illustrated, and the varying stages of their assembling shown, the mechanism has in every case been actually tried, as to its working accuracy, before the taking of the photograph, so that it might be claimed for the illustrations in the WIRELESS ENCYCLOPEDIA that they are not merely theoretical, but are photographic reproductions of "practical" pieces of mechanism.

IN this way, the Wireless experimenter who makes use of the literary and pictorial matter here provided for his guidance can be assured that at every turn such advice as he is given and such hints as he may derive from the information provided are soundly based upon actual practice and not merely upon theory. Every care has been taken to acknowledge proprietary circuits

READERS will notice that the arrangement of the contents in the WIRELESS ENCYCLOPEDIA is strictly alphabetical, thus facilitating reference to the particular detail in which the reader may be for the moment most interested. Every subject, circuit, instrument, accessory, constructional or theoretical detail connected with wireless work will be found instantly under its own heading, while, at the same time, the most important subjects, e.g. Coils, Condensers, are complete articles in themselves.

THE WIRELESS ENCYCLOPEDIA contains at least double the number of entries yet published in any glossary or list of wireless terms.

**Order Part 4 to-day, and ask Your
Newsagent to reserve a copy of
every succeeding fortnightly part,
and so avoid disappointment**

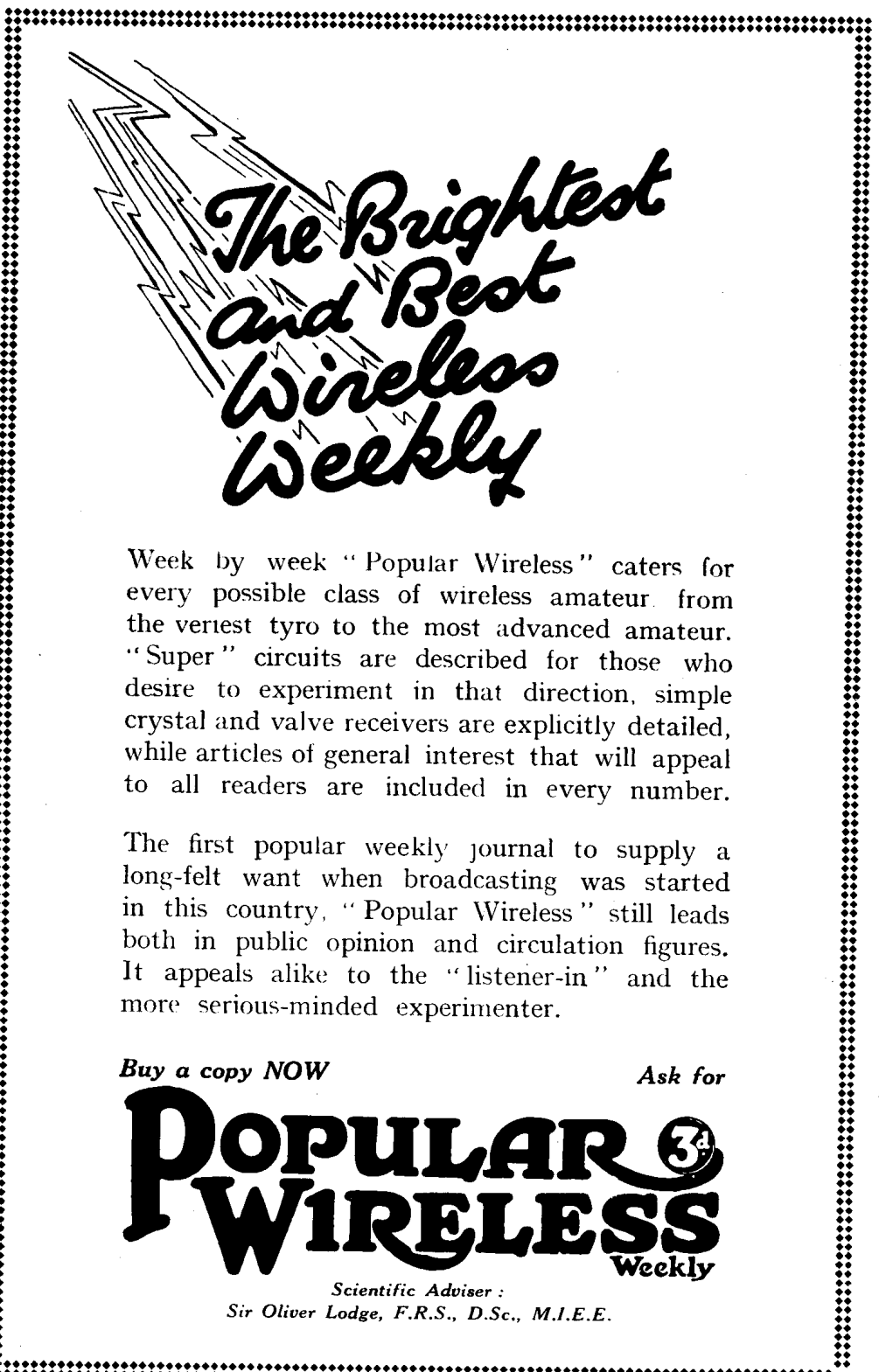

The Brightest and Best Wireless Weekly

Week by week "Popular Wireless" caters for every possible class of wireless amateur, from the veriest tyro to the most advanced amateur. "Super" circuits are described for those who desire to experiment in that direction, simple crystal and valve receivers are explicitly detailed, while articles of general interest that will appeal to all readers are included in every number.

The first popular weekly journal to supply a long-felt want when broadcasting was started in this country, "Popular Wireless" still leads both in public opinion and circulation figures. It appeals alike to the "listener-in" and the more serious-minded experimenter.

Buy a copy NOW

Ask for

POPULAR ^{3d} WIRELESS Weekly

Scientific Adviser :

Sir Oliver Lodge, F.R.S., D.Sc., M.I.E.E.

Printed and Published every alternate Tuesday by the Proprietors, The Amalgamated Press (1922), Ltd., The Fleetway House, Farringdon Street, London, E.C.4. Sole Agents for South Africa: Central News Agency, Ltd.; for Australasia: Messrs. Gordon & Gotch, Ltd.; and for Canada: The Imperial News Co. (Canada), Ltd. Subscription Rates: Inland and Abroad, 1s. 5d. per copy. December 4th, 1923.