

RADIO

TODAY



GET CONNECTED!
1st UK review
of the latest
packet deal

Get converted-
A Class B's guide to HF operating
Exclusive reviews-
FT2311 23cm mobile & FT736 VHF/UHF rig
ICS Weather FAX unit on test

FREE! INSIDE THIS ISSUE
32-page SATELLITE TV SUPPLEMENT



For Tomorrow's Radio Technology

TODAY

BASE STATIONS

Good News for FT767 owners. Work more effectively with the IMPROVED YAESU FT767 RWC/MK2 HF-UHF BASE STATION

FT767GX RWC MK2

NEW

We are pleased to announce that we have now improved the synthesizer (software revised) to better dynamic range by up to 20dB which now puts this transceiver in a class of its own! The modification is only available from RWC and a fixed price to all New units sold by us, or we will modify any existing unit for £50.50 inc. return postage. Available at some Yeasu dealer.

FT767 RWC MK2 COMPLETE TOP CLASS BASE STATION (EX VHF-LHF) £1499.00
 FT767 RWC MK2 COMPLETE TOP CLASS BASE STATION (EX VHF-LHF) WITH 2M FITTED £1599.00
 FT767 MK2 NEW IMPROVED HF TRANSCEIVER £895.00
 FT767 RWC MK2 COMPLETE TOP CLASS BASE STATION WITH 2MTRS. (SPECIAL PRICE) £300.00 off £999.00
 ICOM IC735 SUPER MINI HF ALL BAND TRANSCEIVER £392.50
 ICOM IC735E WITH 2M BAND BASE STATION, CW, AGC, PS £439.00
 NEW ICOM IC735 8M 10W BASE STATION, 26.5MHZ RECEIVER TX10 AND 6M £394.00

Many more Makes and Models in Stock. Please enquire.

ICOM IC735

HANDHELDS

NEW

Extended RX coverage available, call for details

YAESU FT207R 2.5W (0.5W) DUAL BANDER CW/CHRG £396.00
 YAESU FT207R-NE10 2.5W (0.5W) 2MTRS CW/CHRG £243.00
 YAESU FT207R-NE10 2.5W (0.5W) 2MTRS CHRG £259.00
 ICOM IC20E QUALITY 2.5W (0.5W) BP CW/CHRG £225.00
 ICOM MICRO 2E MINI 2.5W 2MTR CW/CHRG £220.00
 GTE I800 (VY 5M) 100W 2.2 SW 2MTR CW/CHRG £198.00
 KENWOOD TK400EE 2.5W 70CM CW/CHRG £193.00
 KENWOOD TK235EE 2.5W (0.5W) 2MTR LCD CW/CHRG £193.00
 KENWOOD TP121E 2W 2MTRS. (WHITE STOCKS LAST) £139.00

PORTABLES

FT690R/MK2 2.5W MULTIMODE JCON IN THE FLUKI £399.00
 FT690R/MK2 AS ABOVE CW/NCDS AND CHARGER £420.00
 FT209R/MK2 2.5W MULTIMODE IMPROVED RECEIVER £396.00
 FT209R/MK2 AS ABOVE CW/NCDS AND CHARGER £420.00
 FT290R/MK1 2MTR MULTIMODE SPECIAL PRICE £329.00

MOBILES

YAESU FT121E 1.5W 4MTR NEW SUPER MOBILE FREE £299.00
 SW 50239 MOBILE ANTENNA CW 50239 GMOUK £199.00
 ICOM IC2BE 25W SUPER MOBILE FREE SUN £359.00
 SW 50239 GUTTERMUND ASSY+EXT LOUDSPEAKER £425.00

NEW LICENCES CALL FOR SPECIAL DEALS

INSURED PSP £10

SCANNERS

YAESU FRG9600/RWC

(Please allow 2-3 weeks delivery on modified units)

FRG 9600

We supply the Yaesu FRG 9600 modified receiver to Government departments and professional users. We offer more options and facilities than any other company. We transform the basic unit by improving sensitivity and adding extra bands. No other scanner has the many options and modes available. Call now for full brochure information. Overseas dealer required for outside UK.

Modified Yaesu receivers, NOBODY can beat the price we can offer!

YAESU FRG9600 RWC/MK2 50 CHANNELZ IMPROVED RECEIVER £945.00
 YAESU FRG9600 RWC/MK2 60 CHANNELZ IN CO-INTEGRATED £985.00
 YAESU FRG9600 RWC/MK2 100RZ-2500HZ MULTIFUNCTION £1095.00
NEW YAESU FRG9600 RWC/MK2 100RZ-2500HZ ACTIVE FIELD £625.00 **NEW**
 YAESU FRG9600 Mk2P/1000GSR/50MHz AGC PSU COMPLETE £999.00
 100RZ-2500HZ ALL MODE SUPER RECEIVER £687.00
 ICOM CR7000/25.2GHZ ALL MODE SUPER RECEIVER £687.00
 ICOM CR7000/4000 ABOVE WITH 4MTR IN DISCOUNT £945.00
 UNDEN BEARCAT UBC100XL SUPER NHELO CW NCDS PSU £119.00
 UNDEN BEARCAT UBC17KXSL SUPER DESKTOP CW PSU £179.00
 UNDEN BEARCAT UBC55XL NEW MINI SCANNER VHF/UHF £39.00

NEW UNDEN BEARCAT UBC55XL NEW MINI SCANNER VHF/UHF £39.00
 FOK AIR BAND HANDHELD TRIMWELL MINI CW MODS PSU £139.00
 FOK AS ABOVE COVERAGE 144.120MHz FM BANDS £139.00
 NEW WAVE MAKES AND MODELS IN STOCK, PLEASE CALL FOR DETAILS
 INSURED PSP £10 ON SCANNERS

SHORT WAVE RECEIVERS

YAESU FRG8800 SHORT WAVE ALL MODE 10MHz 30MHz £572.50
 YAESU FRG8800FR8800 AS ABOVE WITH VHF CONVERTER £659.00
 DUAL BAND 100kHz-30MHz TOP CLASS FT-207 £299.00

NEW PRODUCTS

IDEAL INTRODUCTION TO VHF LISTENING

INTERNATIONAL MODEL 877R AIR-BAND RECEIVERS

This new tuneable receiver covers 52.174 MHz as well as all 110 MHz bands and is a cost effective alternative to handheld scanners. The receiver is fitted with a helical antenna and has good performance for a radio with this coverage. It is ideal for monitoring Air Band, the two metre and 70cm bands as well as Band 2 and 70cm. A built in cast a squelch control is also provided. Two versions are currently available.

Model 877R for use with Dry cells £39.50
 Model 877R, CW Nicads and charger £49.50

DEALERS CALL FOR TRADE PRICES

Sorry, not now available mail order. Please visit our new Show Rooms for a free demonstration.

RWC NOW APPOINTED SONY DEALERS. CALL FOR LATEST STOCK AVAILABILITY ON RECEIVERS AND ACCESSORIES

ANTENNAS & ACCESSORIES

ICOM AH7000 SUPER DISCONE 25-130MHz INC POST £79.00
 NEW RAYCOM AIR BAND DISCONE 118-170 MHz 6 ELEMENTS £27.50
 RAYCOM DISCONE 60-600 MHz 8 ELEMENTS S0239 SOCKET £27.50
 SUN MOBILE SW 50239 CW 50239 MOLDED LEAD/MOUNT £22.50
 GSKW 1/2 SIZE HF MULTI BAND HF ANTENNA (INC POST) £15.00
 GSKW FULL SIZE MULTIBAND HF ANTENNA (INC POST) £17.50
 GSKW/WDZ22 1.5MHZ TRAP DIPOLE AS ABOVE S0239/COAW/FED £17.50
 GSKW/WDZ27 1.5MHZ 2X BAND AS ABOVE, BALANCED FED £22.50
 GSKW/WDZ27 1.5MHZ 2X TRAPS, FOR SELF ASSY ANT £9.95

Hundreds of other types of base and mobile antennas in stock
JAYBEAM, TONNA, MET, SUN, HOXIN - POPULAR MODELS IN STOCK.
NEW RWC are now appointed dealers for the West Midlands for Butterut, Cushtarr and MfJ products. Please ask for details of the range currently available.

SPECIAL OFFERS

PYE W15 F.M. mount, 3 channel, 15 watt, suitable for conversion to 2mtrs, with instructions. Supplied as seen untested (less mic and loudspeaker) £37.50 incl. P&P

ROTATORS

40kg loading, 3 call lightweight rotators
 £38.50 + £3.50 P&P
 Optional alignment support bearing £12.50 + P&P

ANTENNAS

Sun % tilt over 2 metre aerial, complete with SU239 gutter mount and lead. (High quality) £17.50 + £2.50 P&P

MOD KITS

RWC MOD KITS, ANNOUNCEMENT

We recognize to customers waiting for various mod kits of crystals and components are in continuing demand for us. Values, no more occasionally a delay before we can send you your kit of parts, please be patient. Home was NOT been a DAY KIT still available.

SAVING L77137 2MHz/500KHz CB-10MTRS. £10.00
 LCLCUT CB (10MTRS) FT767GX MK1 FAST TUNING MOD STATION COMBIS TRAP/BTR KIT. £10.00
 KIT, PYE A200 2 BAND 50MHz KIT. call for technical details, prices and delivery

WANTED DEAD OR ALIVE

You used equipment. We also offer a very comprehensive range of quality used equipment, e.g. Amateur band transceivers, SW receivers, scanning receivers, FMER, and accessories. As far as we are aware we are the only company in the UK to offer a weekly computerized used equipment list and special offers list.

Send a large SAE for copies: ALL USED EQUIPMENT CARRIES 3 MONTH WARRANTY

RAYCOM

Communications Systems Ltd.

Manufacturers, Importers and Suppliers of World Famous Communications Products
INTERNATIONAL HOUSE, 963, WOLVERHAMPTON ROAD, OLDBURY, WARLEY, WEST MIDLANDS, B69 4RJ. TEL: 021 544 6767 (PBX). VODAFONE: 0836 282228. TELEX: 336483 G. FAX: 021 544 7124. PRESTEL MBX: 0214218216

Amateur Radio, Business Radio, Radio Telephones, Sales, Service Accessories and Antenna Systems.

Ordering Information: For fast delivery please order by Telephone, Telex or Fax, or send cash/cheques/drafts by post. All Credit/Charge cards accepted. £1000.00 limit Credit available subject to status. We also offer our RWC Chargecard. Please call for further details and information. We do NOT advertise products that are not normal stock items. All prices correct at time of going to press. However, prices subject to change without prior notice. E&OE.

Most other products advertised in this magazine are available at RWC/RAYCOM.

STOP PRESS... PLEASE NOTE NEW ADDRESS

★ WE WILL MATCH OR IMPROVE ANY GENUINE ADVERTISED PRICE ★



HAM RADIO CONTENTS

TODAY

VOLUME 6 NO 3 MARCH 1988

Editor
 Dave Bobbett, G4IRQ
Technical Illustrator
 Jerry Fowler
Advertisement Manager
 Christopher Harris
Classified Sales Executive
 Evelyn Coombes

Published by:
 Argus Specialist
 Publications Ltd

Distributed by
 SM Distribution Ltd

Printed by:
 Adlard & Son Ltd, The Garden
 City Press, Letchworth, Herts
 SG6 1JS

Design by
 ASP Design Studio

**Editorial and Advertising
 address:**

Ham Radio Today
 ASP Ltd
 1 Golden Square
 London W1R 3AB
 Tel: 01 437 0626

*(please mark your letter for the
 appropriate department)*

Subscriptions and back issues:
 Ham Radio Today Subscription
 Dept, Infonet Ltd, 5 River Park
 Estate, Berkhamsted, Herts
 HP4 1HL

Tel: (04427) 76661/4

Subscription rates:
 UK £15.60, Europe £20.10,
 Middle East £20.30, USA \$30,
 Far East £22.00, Rest of world
 £20.60. Airmail rates on request
 ISSN No. 0269-8269

Member of the
ARGUS PRESS GROUP Audit Bureau
 of Circulation

ABC

Ham Radio Today is normally published on the first Friday in the month preceding cover date. The contents of this publication including all articles, designs, plans, drawings and programs and all copyright and other intellectual property rights therein belong to Argus Specialist Publications Limited. All rights conferred by the Law of Copyright and other intellectual property rights and by virtue of international copyright conventions are specifically reserved to Argus Specialist Publications Limited and any reproduction requires the prior written consent of the Company © 1988 Argus Specialist Publications Ltd.

All reasonable care is taken in the preparation of the magazine contents, but the publishers cannot be held legally responsible for errors. Where mistakes do occur, a correction will normally be published as soon as possible afterwards. All prices and data contained in advertisements are accepted by us in good faith as correct at the time of going to press. Neither the advertisers nor the publishers can be held responsible, however, for any variations affecting price or availability which may occur after the publication has closed for press.

FEATURES

- DON'T PANIC** 4
 Think selling-off our spectrum is a hair-brained idea?
 That's the latest government plan — now is the time to act
- MATCHING OPERATORS** 18
 Bored with the same old waffle, maybe it's time
 to introduce 'special interest' codes
- CLASS B'S GUIDE TO HF OPERATING** 26
 All you ever wanted to know but were afraid to ask.
 How to get started and what to expect
- BOOK REVIEWS** 49
 A quick canter through the latest
 assortment of bookshelf fillers.

REVIEWS

- KANTRONICS KPC-2 PACKET TNC REVIEW** 14
 Two for the price of one, a peek at
 the Kantronics stable of data decoders
- YAESU FT-2311R REVIEW** 20
 Road testing the latest 23cms mobile talkbox
- YAESU FT-736 REVIEW** 36
 Never reviewed before! We put the
 latest box of tricks through its paces

REGULAR COLUMNS

- LISTENING ON** 42
 Read this for the latest bumper crop of eavesdropping tips
- RADIO TOMORROW** 46
 The diary page which lets you know
 what's happening, where and when
-
- HAM RADIO TODAY JOB AD** 12
- HRT UK SUBSCRIPTION RATES** 25
- HRT OVERSEAS SUBSCRIPTION RATES** 51
- FREE READERS' ADVERTISEMENTS** 52
- CLASSIFIED ADVERTISEMENTS** 56

DON'T PANIC?

British Telecom, British Gas, British Petroleum, The Trustee Savings Bank and several other companies have all been privatised. People are now asking what will be next. One answer is that it could be the radio spectrum! Unlikely as it may seem, the Government is actually looking into ways of doing it, hoping that it may bring some 'benefits'. As the first step along the road they commissioned consultants CSP International to investigate the idea and produce a report. The consultants have now completed this with the Department of Trade and Industry (DTI) overseeing what was done.

Time to protect your licence. Now they want to sell frequency space. Ian Poole, G3YWX explains.

Now the DTI are looking at the document with a view to possibly implementing some, if not all, of its recommendations. If this happens then amateur radio as we know it today will be at best greatly changed and at worst very severely restricted. All of the hard earned privileges and frequency bands would be at risk giving even more overcrowding than we have today.

What the Report Says

The report is quite a large and comprehensive document. It covers the whole radio spectrum and looks at all its users including amateur operations as well as CBs. The amount of spectrum devoted to amateur use, as well as the way in which it is used, is mentioned. In essence the report says that 2.9MHz is allocated to amateurs as primary users in the HF spectrum. In addition to this, 2.5MHz was available at the time of the report in the VHF spectrum. This has obviously increased now with the release of the extra portion of six metres. Finally there is a total allocation of 50MHz in the SHF part of the spectrum. This, of course, is in addition to any secondary allocation there may be.

In terms of usage the report states that the HF bands together with 2 metres suffer the highest levels of occupancy. However, it is noted that amateurs tend to self-regulate the amount of congestion by being able to move to another frequency or band when the levels of interference become too high. It is also stated that amateurs have learned to live with interference on the secondary bands.

A mention is also made of the fact that an amateur licence costs £12 per year whereas the average amateur spends about £2000 on equipment. The way this was worded may indicate that a sizeable increase in

the licence fee could be justified.

Finally, CSP list the benefits of amateur radio to the country as a whole. They say it is useful for personal education, and an initial training for future radio engineers. The hobby is also useful for experimentation, amateur research and propagation tests, as well as being useful in the event of an emergency when amateurs can use their equipment and skill to help the emergency services. However, they say that it is difficult to quantify all of these benefits.

The Recommendations

When it comes to the report's recommendations the alarm bells of every radio amateur should start ringing very loudly indeed. It starts off by comparing the radio spectrum to land ownership. Some land is sold at competitive prices whereas some areas are set aside for recreational use as parks. These parks are effectively the equivalent of the amateur radio bands in the spectrum, and the analogy is quite fair.

Unfortunately the report goes on to say that 'the amount of spectrum given over to amateur radio is larger than economic considerations would dictate.' As if this was not enough it goes on to recommend that 'the UK Government should apply pressure in international discussions to avoid further increases in allocations and reduce existing ones'. For the moment the report proposes that any applicants for a spectrum manage-



No — I don't mind having only one band left but I've had to make a few cutbacks to get the licence fee together...

ment licence (the licence issued to those who would rent out the spectrum) should keep any amateur allocation within their bands for five years. They also state any further allocations would have to be kept if they were ratified by a World or Regional Administrative Radio Conference (WARC or RARC).

Even so it does not bode at all well for the future if the policy of our government is to reduce the allocations of amateur radio. It should also be remembered that it would not only affect amateurs in the UK, but all over the world as they would be bringing pressure to bear at international conferences. If this were done it would surely be the biggest crisis to hit amateur radio since its foundation.

Course for Action

The report asked for responses to the document to be sent to the Department of Trade and Industry by the 30th June 1987. Normally one would expect that the RSGB, who knew about the report and its contents, would have sent in a submission. This did not happen and therefore we are left as individuals to fight for the future of amateur radio. If enough people put pen to paper then it can influence the powers that be. It has worked in the past and there is no reason why it cannot work now.

The first step is to write to the RSGB and ask them to respond to the report. They do have close links with the DTI and a response from them is quite likely to carry some weight. After all, we have only recently been given an extra allocation at 50MHz and class B licences have been allowed onto 4 and 6 metres.

Secondly a letter to the DTI will not go amiss. It can

state all the advantages of amateur radio, not only for this country but world wide. On top of this it is also worth mentioning that the following of amateur radio is well in excess of the number of licences which are issued. This is because there is a very large number of short wave listeners who gain a lot of pleasure from the amateur bands without actually transmitting.

Finally, a letter to your MP can help. This will be of particular use if this idea ever comes to Parliament. They your MP will know that there is significant support for amateur radio and he will be acquainted with its advantages. It is also worth asking him to take the matter up with the appropriate Minister and inform you of his reply. In this way he will be forced to take notice of your letter. It also has the advantage that he will have to write you a reply and it does look rather impressive when a letter from the House of Commons drops onto the mat!

Conclusion

It is worth acting and it is worth acting now. Some may say that it will never be implemented. If it does and we lose out then we only have ourselves to blame. Isn't your licence and all its privileges worth a couple of stamps and a little time?

Useful Addresses

Radio Communications Division, Department of Trade and Industry, Room 305, Waterloo Bridge House, Waterloo Road, London SE1 8UA.

Your MP, House of Commons, London SW1A 0AA.

Since this article was written, the RSGB has confirmed that they have responded to the report.

ATTENTION ALL WRITERS . . .

*...or just readers who sometimes think
"I could write that!"*

We're looking for authors to help us keep 'Ham Radio Today' at the forefront of the radio scene. So if you've designed some novel or cost-effective gear, you've done something that is of interest to other amateurs, or you've got a controversial axe to grind, we'd like you to contact us!

If you're interested in writing for us, send us an outline of any ideas you might have and tell us a little about yourself. Write to: The Editor (submissions), Ham Radio Today, ASP Ltd, 1 Golden Square, London W1R 3AB.

Please note that we cannot be held responsible for the loss of unsolicited manuscripts. We advise all authors to keep a copy of any articles they send us.



ICOM

LOOK TO THE FUTURE WITH



Features:

- AC power supply
- Automatic antenna tuner
- Multi function CRT display
- Twin passband tuning
- Dual-watch
- 99 memories

Advanced engineering from ICOM has produced the most sophisticated Amateur HF transceiver on the market today, whether DX'ing, contesting or simply enjoying top performance the IC-781 is a top of the line performer. A unique multi-functional CRT displays frequencies, modes, memory contents, operating rates, RIT, two menu and seventeen optional screens. The soft orange display also serves as a display for DATA modes such as RTTY, AMTOR and PACKET.

The PAN display continuously indicates all signal activities and pile-ups with your operating frequency in the centre. Selectable frequency spans of 50kHz, 100kHz and 200kHz. Vertical range indicates relative signal strength. Twin passband tuning with separate controls for second and third IF stages increases selectivity and narrows bandwidth, independently varies low and high frequency response or functions as a IF shift.

Icom (UK) Ltd.

Dept HRT, Sea Street, Herne Bay, Kent CT6 8LD. Tel: 0227 363859. 24 Hour.

Count on us!

HF TRANSCEIVER IC-781



The IC-781 has a dual-watch function which allows simultaneous receive of two frequencies in the same band. Balance controls adjust VFO A/B receive strength levels. This feature is especially useful on Dx-expeditions or contests to check band activity or to tune in your next contact. The newly developed ICOM DDS (Direct Signal Synthesizer) system is incorporated to provide a fast transceiver lock-up time. This is essential for data communication systems.

The IC-781 communication system includes a built-in 100% AC supply, high speed automatic antenna tuner, iambic keyer, semi-automatic, or full QSK CW break in to 60 wpm, audio peaking filter, RF speech processor, multi-scanning plus much more. Look into the future of Amateur communications, ICOM products will be setting the pace others try to follow. For more information on the IC-781 contact your local authorised ICOM dealer or phone ICOM (UK) Ltd direct.

- SSB, CW, FM, AM, RTTY
- 160-10m/general coverage receiver
- Direct keyboard entry
- 150 watt output
- QSK up to 60 wpm
- CI-V communications interface

Helpline: Telephone us free-of-charge on 0800 521145. Mon-Fri 09 00-13.00 and 14 00-17 30. This service is strictly for obtaining information about or ordering Icom equipment! We regret this cannot be used by dealers or for repair enquiries and parts orders, thank you

Datapost: Despatch on same day whenever possible.

Access & Barclaycard: Telephone orders taken by our mail order dept, instant credit & interest-free H.P.





South Midlands Co

SCHOOL CLOSE, CHANDLERS FORD IND. EST., EASTLEIGH

THE FT747GX LOW COST HF TRANSCEIVER



- ★ 160-10M HF TRANSCEIVER
- ★ GENERAL COVERAGE RECEIVER
- ★ ALL MODE (FM OPTIONAL)
- ★ 0-100W OUTPUT (25W AM CARR.)
- ★ CW NARROW (500Hz) STANDARD
- ★ COMPUTER CONTROL CAPABILITY
- ★ LARGE CLEAR LCD DISPLAY
- ★ SIMPLE OPERATION

MD-188 BASE MIC £79.00
 MM58B MOBILE MOUNT £22.00
 FP700 STANDARD P.S.U. £195.50
 FAS14R REMOTE ANT. SW £80.00

MH-188 HAND MIC £21.00
 FIF232C INTERFACE £75.00
 FC757AT AUTOMATIC ATU £349.00
 SP757 EXT SPKR £69.95

FRB757 RELAY BOX £10.50
 FP757HD HEAVY DUTY P.S.U. £239.00
 FL7000 500W P.E.P. LINEAR £1600

FT747GX HF TRANSCEIVER RRP £659.00 inc. VAT

BEST VALUE ON 2M, 70CMS & 23CMS

NEW
 FT2311R
 £475.00 inc.

- ★ 45(35)*(10)\$/5(4)*(1 or 5)\$ WRF OUTPUT
- ★ Easy 'one touch' push button operation
- ★ Reversible sloped front panel
- ★ Large green easy to read LCD
- ★ Ten memories (independent Tx & Rx)
- ★ Switchable 12.5/25kHz steps
- ★ Priority channel monitoring
- ★ CCC/w Hand mic and mobile mounting bracket

THE FT211RH
 THE FT711RH
 and the NEW FT2311R

FT211RH
 £300.00 inc.
 FT711RH
 £349.00 inc.

OPTIONAL ACCESSORIES

SP55 External Speaker £19.55
 YH1 Headset (C/W Mic) £19.99
 SB10 PTT Switch Unit £22.00
 MH 10F8 Speaker/Mic £25.00
 MH 14A8 Speaker/Mic (C/W Tone Burst) £23.00
 MF 1A3B Boom Mic (Via SB10) £25.00



*FT711RH \$FT2311R

★ UNREPEATABLE SPECIAL OFFER ★

FT726R(2)
£699 inc. VAT



430/726 70cms UNIT Special Offer* £199
 50/726 6m UNIT £249
 MD-188 BASE MIC £79

SAT/726 SAT UNIT Special Offer* £59
 21/24/28 HF UNIT £269
 MH-188 HAND MIC £21

COMPARE THE COMPETITION

The FT726R 2m base station, at only £699, is £240 cheaper than its nearest rival. Add 70cms at £199, you now have 2m & 70cms capability for less than the oppositions 2m bases.

WITH 12 MONTH WARRANTY AND FREE FINANCE AVAILABLE

★ SPECIAL OFFERS ONLY AVAILABLE WHEN PURCHASED WITH FT726R(2) ★

LEEDS
 SMC (Westhead)
 Nowell Lane
 Industrial Estate
 Leeds LS1 6JE
 Leeds (0532) 350608
 9-5.30 Mon-Sat.

CHESTERFIELD
 SMC (Midlands)
 102 High Street
 New Whittington
 Chesterfield
 Chest: (0248) 453340
 9.30-5.30 Tues.-Sat.

BUCKLEY
 SMC (TMB)
 Unit 27, Pinfold Lane
 Buckley, Chwyd
 Buckley (0244) 549553
 10-5 Tues. Weds. Fri.
 10-4 Sat

JERSEY
 SMC (Jersey)
 1 Belmont Gardens
 St. Helier, Jersey
 Jersey (0534) 77057
 9-5 pm Mon.-Sat.
 Closed Wed.

N. IRELAND
 SMC N. Ireland
 10 Ward Avenue
 Bangor
 County Down
 (0247) 271875

BIRMINGHAM
 SMC (Birmingham)
 504 Alum Rock Road
 Alum Rock
 Birmingham B8 3HX
 (021-327) 1487/5313
 9-5 Tues.-Fri.
 9-4 Sat.

AXMINSTER
 Rex. Ward & Co. Ltd.
 1 Western Parade
 West Saxons
 Axminster
 Devon EX13 5NY
 Axminster (0297) 34918
 9-5.30 Tues.-Sat.



Southampton Showroom open 9.00-5.00 Monday to Friday, 9.00-1.00 Saturday, Service Dept. open Mon.-Fri. 9.00-5.00.

AGENTS: JOHN DOYLE, TRANSWORLD COMMS, NEATH (0639) 52374 DAY (0639) 2942 EVE

DAVID STENNING, G4JA, LOUTH 0507 604967

INTRODUCING THE FT736R FROM YAESU



The FT-736R is a solid-state, frequency-synthesized VHF and UHF amateur transceiver incorporating up to four band modules covering the 50, 144, 430 and 1200 MHz amateur bands. The standard model provides 25 Watts RF power output on the 144 and 430 MHz amateur bands in SSB, CW and FM modes, with any two of the remaining three bands installable as options (10 Watts output on the 50 and 1200 MHz bands).

An 8-bit CMOS main microprocessor and 4-bit V/O coprocessor provide exceptional digital integration and control, including selectable tuning rates or mode dependent channelized tuning selectable steps for each mode.

Operational conveniences usually found only HF transceivers, such as front panel adjustable IF shift and IF notch, a noise blanker, all-mode VOX and three-speed selectable AGC are included. GaAs FET receiver RF amplifiers are provided in the 430 and 1200 MHz bands.

The innovative memory system includes one hundred general purpose memories plus ten full duplex cross-band memories, all of which store mode and receive and transmit frequencies independently. In addition, fourteen vfos are provided: two general purpose plus one PMS (Programmable Memory limit Scanning) on each band, two special-purpose full duplex vfos, and up to four clarifier (receiver offset) memories, one per band.

Operational conveniences usually found only HF transceivers, such as front panel adjustable IF shift and IF notch, a noise blanker, all-mode VOX and three-speed selectable AGC are included. GaAs FET receiver RF amplifiers are provided in the 430 and 1200 MHz bands.

The innovative memory system includes one hundred general purpose memories plus ten full duplex cross-band memories, all of which store mode and receive and transmit frequencies independently. In addition, fourteen vfos are provided: two general purpose plus one PMS (Programmable Memory limit Scanning) on each band, two special-purpose full duplex vfos, and up to four clarifier (receiver offset) memories, one per band.

Operational conveniences usually found only HF transceivers, such as front panel adjustable IF shift and IF notch, a noise blanker, all-mode VOX and three-speed selectable AGC are included. GaAs FET receiver RF amplifiers are provided in the 430 and 1200 MHz bands.

The innovative memory system includes one hundred general purpose memories plus ten full duplex cross-band memories, all of which store mode and receive and transmit frequencies independently. In addition, fourteen vfos are provided: two general purpose plus one PMS (Programmable Memory limit Scanning) on each band, two special-purpose full duplex vfos, and up to four clarifier (receiver offset) memories, one per band.

Each of the two full duplex vfos can be selected so that its receive and transmit frequencies and modes can be displayed and turned independently, or linked to tune synchronously in opposite directions for satellite operation. You can retain twelve satellite uplink/downlink modes in the special vfos and ten full duplex memories at all times. Of course, metering of either transmitter or receiver parameters is selectable during full duplex communications. For CW operators, the FT-736R offers quick-changover semi break-in and includes provisions for an optional internal electronic keyer and narrow (600 Hz) CW crystal filter.

Naturally, with FM the predominant mode on the VHF and UHF bands, the FT-736R includes all manner of convenient features for both FM simplex and repeater operation, special narrow FM mode to cut adjacent channel interference in crowded areas, Automatic Repeater Shift when turned to 2-meter repeater subbands and a 1.700 Hz Burst Tone Generator is installed as standard.

An enhanced CAT (Computer Aided Transceiver) System allows addition and customization of features and user-designed controls from an external computer. The FT-736R also includes a V/F-switched DC supply line for matched preamplifiers, activated from the front panel, and digital signal connection directly to the modulator for high performance packet radio net interfacing.

Optional add-on accessories include the TV-736 Amateur Television Modulator/Demodulator for ATV operation, FIF-series CAT Interface Units, SP-767 External Loudspeaker, FMP-1 AQS Message Processor, and FVS-1 Voice Synthesizer and FTS-8 CTCSS Tone Squelch Unit (both mount internally).

OPTIONAL ACCESSORIES

FEK736/SO	50MHz module	£239.00	XF45EMC	600Hz CW Filter	£60.00
FEK736/1.2	1.2GHz module	£425.00	SP767	External Spkr c/w Audio Filters	£69.95
FMP-1	AQS Message Processor c/w display	£189.00	MD-188	Desktop Microphone	£79.00
FTS-8	CTCSS Tone Squelch Unit	£145.00	MM-118B	Band Scanning Handphone	£21.00
FVS-1	Voice Synthesizer Unit	£33.00	FIF232Cvan	CAT/TNC Interface for Packet & CAT	£18.00
Keyer Unit B	Internal Lambic Keyer Unit	£15.95	FIF232C	CAT Interface for RS232 C/P	£76.00
TV-736	Fast Scan TV (ATV) Mod/Demod Unit	£169.00	FIF65A	CAT Interface for Apple II series	£60.00

FT736R RRP £1450 c/w 2m & 70cms

HY-GAIN - LOW PRICES

5% off YBEAM



Due to the strong pound and our special purchase we can now offer for a limited period, up to 15% discount on their range of antennas and 10% on their larger rotor Ham V. Buy now whilst stocks last (from January 1st they increased their prices and if the dollar recovers prices could go up by 30% to 40%).

		Offer	P&P
12AVQ	Vert. 10-15-20-40M	£78.95	£71.00
14AVQ	Vert. 10-15-20-40M	£106.00	£96.00
18AVT	Vert. 10-15-20-40-80M	£172.00	£146.00
18V	Vert. 10-80M tapered coil	£48.50	£43.66
TH3Jr	3 Ele. Yagi 10-15-20M	£299.00	£284.00
TH2MK3	2 Ele. Yagi 10-15-20M	£279.00	£249.00
EX14	5 Ele. 10-15-20M Explorer	£499.00	£449.00
DK710	EX14 to cover 40M	£139.00	£115.00
TH5MK2	5 Ele. 10-18-20M T bird	£649.00	£676.00
THY0XX	7 Ele. 10-15-20M T bird	£755.00	£669.00
103BA	3 Ele. Yagi 10M	£99.00	£93.95
106BA	5 Ele. Yagi 10M	£220.00	£187.00
153BA	3 Ele. Yagi 15M	£135.00	£121.00
155BA	5 Ele. Yagi 15M	£299.00	£288.00
203BA	3 Ele. Yagi 20M	£259.00	£233.00
204BA	4 Ele. Yagi 20M	£420.00	£357.00
205BA	5 Ele. Yagi 20M	£499.00	£442.00
DB10-15A	3 Ele. Yagi 10-15M	£209.00	£199.00
AR40	Famous Bell Type		£125.00
CD45	Medium Bell Type		£213.00
Ham IV	Heavy Duty Bell	£359.00	£329.00
T2X	Very Heavy Duty Bell	£449.00	£399.00

By purchasing large stocks during December, S.M.C. is now able to offer 5% discount for a limited period.

		Normal	Offer
		Price	Price
HQ/2M	Halo head only	9.78	9.29
HM/2M	Halo with 2ft mast	11.50	10.93
UGP/2M	Ground plain flooded radiator	16.96	16.11
CS/2M MK2	Vertical Colinear 4 80db	90.85	86.31
LV1/2M	Vertical Colinear 4 30db	37.95	36.05
LR2/2M	Vertical omnidirectional	29.61	28.13
LWS/2M	5 Element Yag 7 80db	18.69	17.76
LW8/2M	8 Element Yag 9 50db	23.98	22.78
LW10/2M	10 Element Yag 10 50db	29.04	27.89
08/2M	16 Element Yag 12 40db	42.55	40.42
PBM10/2M	10 Element Parabeam 11.70db	57.50	54.63
PBM14/2M	14 Element Parabeam 13.70db	70.15	66.84
04/2M	4 Element Quad 9 40db	37.09	36.24
08/2M	8 Element Quad 10 30db	48.89	46.16
DS/2M	5 over 5 slot fed Yagi 10 0dbd	33.93	32.23
DS/2M	8 over 8 slot fed Yagi 11 1dbd	45.98	44.25
5XV/2M	5 Element crossed Yag 7 80db	36.23	34.42
8E/2M	8 Element crossed Yag 9 50db	46.00	43.70
10XY/2M	10 Element crossed Yag 10 50db	57.50	54.63
PMH2/C	2 Way harness circ: polarisation	13.51	12.83
PMH2/M	2 Way harness for 2 Meters	14.89	14.14
PMH/2M	4 Way harness for 2 Meters	36.80	34.96
JAYBEAM 4M/6M			
DB4	4M/5M Dual Band 4 Ele	117.88	111.99
4Y6M	6M 4 Ele 70dbd	49.45	46.98
4Y4M	4M 4 Ele 70dbd	40.54	38.51
PMH2/4M	4M 2 Way Phasing	20.87	19.83

Prices subject to fluctuation.

FREE FINANCE

On many regular price items S.M.C. offers free finance (on invoice balances over £120) 20% down and the balance over 6 months or 50% down and the balance over a year.

You pay no more than the cash price!

Details of eligible items available on request.

FREE S.M.C. SERVICE

INTERLINK DELIVERY . . .

Free interlink delivery on major equipment. Small items, Plugs, Sockets, etc. by post £1.75. Antennas, Cables, Wire & larger items. Roadline up to £5.00. Interlink delivery available, upon request, for items other than radios, from £7.50 depending on weight. Same day despatch whenever possible.

GUARANTEE

Importer warranty on Yaesu Musen products. Ability staffed and equipped Service Department. Daily contact with the Yaesu Musen factory. Twenty-five years of professional experience. ● 2 years warranty on regular prices Yaesu products.

NEVADA

THE UK'S SCANNER SPECIALISTS

NEW MODELS AND
LOWEST PRICES FROM
UNIDEN



MODEL BC 50 XL
Handheld scanning receiver
with 10 memories.
Covers: 66-88MHz,
136-174MHz, 405-512MHz

£99.99

NEW

MODEL 100 XL HAND HELD

Scanner with 16 channels
memory scan covering
66-88MHz, 118-174 Mhz,
405-512 Mhz.
Super sensitive receiver.

£199.99



MODEL 70 XLT
New pocket size scanner
with 10 memories. Covers
66-88 Mhz, 118-174 Mhz,
405-512 Mhz

£229



BLACK JAGUAR POCKET SCANNER

Switchable AM/FM. Covers CB
plus the following frequencies:
26-30MHz, 60-90MHz, 210-260MHz,
410-520MHz.

ONLY
£225



MODEL 175 XL BASE

Scanning receiver with 16 channel
memory scan covering: 66-88MHz,
118-174 Mhz, 405-512 Mhz.

NEW LOW PRICE
£189.99

SCANNING ANTENNAS CTE DISCONE WIDEBAND ANTENNA

Receive 70 - 700 Mhz
Transmit 70 - 500 Mhz
Power: 500W
8 Element High Quality

£26

SSE DISCONE

RX ANTENNA
70 - 500 Mhz With 3 Elements

£24.95

NEVADA TEL: (0705) 662145

189 LONDON ROAD PORTSMOUTH PO2 9AE.

USE YOUR CREDIT CARD FOR IMMEDIATE DESPATCH

TX-3 RTTY/CW/ASCII TRANSCIVE

The high performance, low cost system
Split-screen, type-ahead operation, receive screen
unwrap, 24 large memories, clock, review store,
callsign capture, RTTY auto CR/LF, CW software
filtering and much more. Needs interface or
T.U. **BBC-B/Master** and **CBM64** tape £20, disc £22.
Spectrum tape £35 inc. adaptor board (needs inter-
face/TU also).
For **VIC20** we have our RTTY/CW transceive
program. Tape £20.

RX-4 RTTY/CW/SSTV/AMTOR RECEIVE

This is still a best-selling program and it's easy to see
why. Superb performance on 4 modes, switch
modes at a keypress to catch all the action. Text and
picture store with dump to screen, printer or
tape/disc. An essential piece of software for trawling
the bands. Needs interface. **BBC-B/Master**, **CBM64**
tape £25, disc £27. **VIC20** tape £25. **SPECTRUM** tape
£40 inc. adaptor board (needs interface also). The
SPECTRUM software-only version (input to EAR
socket) is still available £25.

TIF1 INTERFACE Perfect for TX3 and RX4, it has 2-
stage RTTY and CW filters and computer noise
reduction for excellent reception. Transmit outputs
for MIC, PTT and KEY. Kit £15 (assembled PCB +
Cables, Connectors) or ready-made £25, boxed with
all connections. Extra MIC leads for extra rigs £3
each. State rig(s).

WORLD AND UK/EUROPE MAP LOCATOR Maps,
great circles, distances, bearings, contest scores.
Lat/Long, locators, NGR, hundreds of placenames.
BBC-B/Master, **ELECTRON ONLY**. Tape £10.

LOCATOR Distances, bearings, contest scores.
Lat/Long, locators. **SPECTRUM**, **CBM64**, **VIC20**
tape £7.

And for the **BBC-B/Master**, **SPECTRUM**,
ELECTRON, **CBM64**, **VIC20**.

MORSE TUTOR 1 - 40 wpm. Learn by ear, practise
using random letters, figures, punctuation, words.
40 plain language texts supplied or type your own.
With learning guide, tape £6.

LOGBOOK Date, band, mode, call and remarks.
Instant callsearch. log printout. Tape £8.

RAE MATHS Unlimited practice and testing for the
exam calculations. Tape £9.

All **BBC** and **CBM64** programs are available on **DISC**
at £2 extra.

Prices include VAT and P&P, 1st Class inland,
airmail overseas, normally by return. Eire, C.I, BFPO
deduct 13%.

technical software (HRT)

Fron, Upper Llandwrog, Caernarfon LL54 7RF.
Tel: 0286 881886



SPECTRUM COMMUNICATIONS

MANUFACTURERS OF RADIO EQUIPMENT AND KITS

**FM BOARD FOR YAESU'S
AND KENWOOD'S (TRIO'S)**

£81.00

SEND FOR DETAILS NOW!

RECEIVE PREAMPS

2, 4, 5, or 10 metres RF switched and DC sensing, 100W transmit handling power, gain 0-20dB adjustable by panel control, NF 1dB on 2M, 2dB on 4 & 6M, 3.5dB on 10M, 13.5V negative ground operation. Excellent performance at a reasonable price. Well made attractive boxed unit 77x70x39mm, an asset to any Ham shack. Types RP2S, RP4S, RP6S, & RP10S. PCB KIT £12, PCB BUILT £16.75, BOXED KIT £20.25, BOXED BUILT & TESTED £27.



VAT & P&P INC PRICES Delivery within 14 days subject to availability. 24 hr answering.

UNIT B6, MARABOUT INDUSTRIAL ESTATE, DORCHESTER, DORSET. TEL: 0305 62250

4 and 6m EQUIPMENT

RECEIVE CONVERTERS 4 or 6m antenna input, 10 or 2m i.f., variable gain 0-26dB, n.f. less than 3.5dB. Buffered local oscillator output, types RC4-10, RC4-2, RC6-10 and RC6-2. PCB kit £17.25, PCB built and tested £24.50, boxed kit £29.25, boxed, built and tested £41.00.

TRANSMIT CONVERTERS 4 or 6m variable power 80mW to 2.5W, 2m or 10m drive 10mW to 100mW. Local oscillator input matches receive converters. Types TC4-10H, TC4-2H, TC6-10H, TC6-2H. PCB kit £27.50, PCB built and tested £37.75, boxed kit £39.50, boxed built and tested £53.00.

TRANSCIVE CONVERTERS Single board version of receive converter and 500mW transmit converter, 10m drive 25mW to 500mW. Types TRC4-10 and TRC6-10. PCB kit £39.00, PCB built and tested £54.00, boxed kit £54.00, boxed, built and tested £83.25.

TRANSCIVE CONVERTERS Separate receive converter and 2.5W transmit converter in a single boxed unit, 2m or 10m drive 10mW to 100mW only, requires r.f. sensing switch and attenuator for use with 2.5W 2m rigs. Types TRX4-10H, TRX4-2H, TRX6-10H and TRX6-2H. Boxed kit £60.00, boxed and built £99.50.

TRANSCIVE CONVERTERS As above but including an interface providing RF sensing attenuation and PTT switching. 5AW-5W 2M drive. Types TRX4-2I and TRX6-2I. Boxed kit £87.00, boxed and built £115.00.

CB to 10m

CB TO 10 FM CONVERSION BOARDS - THE FIRST COMMERCIALY AVAILABLE, suits all UK FM CB rigs to give 29.31 to 29.70MHz. Size only 63x40x13mm. Built and aligned board SC29 £15. Or send your rig and we'll fit it. £28 inc. return P&P for mobiles. £31 inc. for base rigs.

MULTIMODE CB CONVERSIONS, send your 120 channel rig and we'll convert it to give 28.01 to 29.70MHz in straight sequences without gaps. Coit 1200DX, Cobra 148, Hy Gain 5, Multimode 2, Major M360, Tristar 747 & 777, Super Star 360, Concorde, etc., £62 inc. return P&P. Jumbo or Coit Excalibur 1200, £65. 80 Channel rigs such as Slaker 9 or Major M588 are modified to give 28.31 to 29.70MHz in straight sequence without gaps, £55.00 inc. return P&P. 200 Channels in 4 banks of 50 are converted to give 28.00 to 30.00MHz or 28.00 to 29.70MHz as required. Super Hy Gain 5, Lafayette 1800, Super Star 2000. £45.50 inc. return P&P. Nato 2000 £52.50, Super Star 2000-5x40CH £70. Coit 1600, 4x40CH, £65.50.

ARGUS BOOKS

SCANNERS 2

Peter Rouse

The companion book to the best selling Scanners provides even more information on the use of VHF and UHF communication bands and gives details on how to construct accessories to improve the performance of scanning equipment. The book is international in its scope and contains frequency allocations for all three ITU regions, including country by country variations.

234x156mm
0 85242 924 X
PUBLICATION

ILLUSTRATED
£9.95
NOVEMBER 1987

272 PAGES

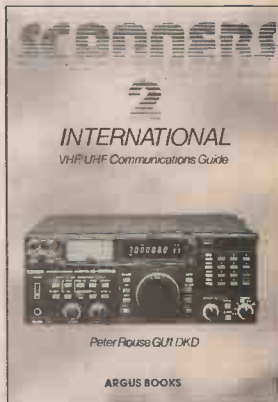

HOW TO ORDER BY POST

Indicate *titles* required

SCANNERS 2

(Please add 10% part postage and packing min 50p)

I enclose my remittance for £
* Please charge my Access Mastercard/Barclay/Visa
Delete as appropriate

Signature

Name

Address

Complete details and return form to

Argus Books Ltd Freepost
Hemel Hempstead, Herts, HP2 4BR

By Phone
Telephone (0442) 41221 Ext 222
Quote Access/Mastercard/Barclay/Visa No
Allow up to 21 days for delivery

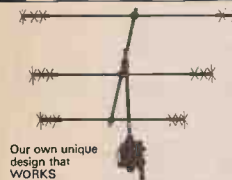

ALTRON

**COMPACT
Spacesaver
ANTENNAS**

AQ6 20, 2 Ele and 3 Ele
4 BAND, 6, 10, 15, 20 M
AQ6-20 4 Ele **NEW**

Our own unique design that WORKS

CLOSE COUPLED - HI 'Q' - CAPACITY HAT LOADED YAGI

Special features:

- Unique Altron fully sealed coils for max stability
- Resonant length elements for improved VSWR (1-1)
- Selectively detuned for optimum performance and gain (no gimmick quad needed)
- Easy trim spokes with lock nuts and spares
- Minimized wind load and weight
- Double insulated elements

As reviewed by
G4HCL in HRT
APR 87

Typical performance

Antenna model	AQ-20/2E	AQ6-20/3E	AQ6-20/4E
Forward Gain Dbd	3.8 to 4.8	5.5 to 7.5	7 to 8
Front to Back Db	13 to 15	16 to 18	18 to 20
Side Null Db	-28	-32	-35
VSWR (typical)	1.1:1	1.1:1	1.1:1
Weight	7.5lb	12lb	16lb
Wind load	2ft ² 0.18M ²	3ft ² 0.27M ²	4ft ² 0.37m ²
Turning radius	76"/1930mm	96"/2438mm	117"/2971mm

PRICE + p&p £114.50 (8.00) £169.00(11.50)£230.00 (11.50)
PRICES ARE INCLUSIVE OF VAT. TERMS: C.W.G. ACCESS, VISA, UK Mainland
WE DESIGN - WE MAKE - WE SELL DIRECT. You get best value

Callers welcome
Open Mon-Fri 9am-5
Sat 9am-12.15pm

ALLWELD ENGINEERING
Unit 6, 232 Selsdon Road
S Croydon CP2 6PL
Telephone: 01-680 2995 (24 hr) 01-681 6734

STOCK ITEMS NORMALLY DESPATCHED WITHIN 7 DAYS

WIN

A 600MHz FREQUENCY COUNTER!

**IN THE NEW STYLE
WINTER 1987/88**

Circuit CATALOGUE

- Oscilloscope Digital Storage Unit
- Temperature Controlled Irons
- 5 and 50W RF Power Heads
- £££s of Discount Vouchers
- Easy to Enter Competition
- Quantity Price Discounts
- PCB Prototyping System
- 2 new HF Receiver kits
- 24 hour order line
- Component Packs
- 12 new books
- Special Offers

**ONLY
£1.20**

PACKED WITH NEW LINES

Available from your local newsgagent or direct from Cirkit at the address shown below

Cirkit

Park Lane, Broxbourne, Herts EN10 7NQ
Telephone (0992) 444111 Telex: 22478

K W TEN-TEC LTD

TRANCEIVERS
CORSAIR II
ARGOSY II
CENTURY 22
*PARAGON

H F MOBILE WHIPS
Helium-filled

**AIRBAND
WALKIE-TALKIES**
CAA Approved

LINEAR AMP
TRITON

**DUMMY LOADS,
MICROPHONES,
FILTERS, REMOTE
VFO, etc**

**ANTENNA TUNER
MODEL 229A**

*We now have many delighted customers using the
NEW PARAGON

K W TRAPS. K W TRAP DIPOLES. BALUNS, ANTENNA
SWITCH, PRECISION MORSE KEYS.

LATEST NEWS FROM K W
FRITZEL BALUNS, H.F. BEAMS AND VERTICALS NOW IN
STOCK FROM CUSHCRAFT, BUTTERNUTT, HYGAIN, MfJ
PACKET RADIO UNITS AND ATUS, etc.
HYGAIN ROTATORS, VHF BEAMS AND VERTICALS

Prices on many products from U.S.A. have been reduced
due to favourable rate of exchange. (Including TEN TEC
equipment and ancillaries).

K W TEN-TEC LTD

(A subsidiary of K W Communications Ltd.)
Vanguard Works,

Jenkins Dale, Chatham, Kent ME4 5RT
Tel: (Medway) 0634-815173; Telex: 965834

HAM RADIO TODAY

**EDITORIAL ASSISTANT/
ASSISTANT EDITOR WANTED**

Ham Radio Today, now entering its fifth year of publication, was the only retail ham radio magazine to increase its circulation in 1987. Following internal promotion, we are now looking for an Editorial Assistant/Assistant Editor to work on all aspects of the magazine from authors copy right through to final production.

We are looking for a licenced, literate radio amateur who would be able to work in our central London office on a part-time basis.

If you think that you might fit the bill,
please send your CV to:

The Editor, Dave Bobbett, Ham Radio Today,
No.1 Golden Square, London W1R 3AB.

Closing date: 19th February, 1988.

AUDIO • COMPUTING • MUSIC • DOMESTIC

APRIL 1988 £1.40

ETI
ELECTRONICS
TODAY INTERNATIONAL

VIRTUOSO

CAPACITORS: the inside story & FIRST CLASS: progress in power supplies

NEW LOOK!

The New



**ELECTRONICS
TODAY INTERNATIONAL**

hits the newstands on
March 4th at just £1.40!

*Ingenious projects and instructive features
plus the latest news, reviews and comment
to keep you in touch with electronics today.*

AUDIO • COMPUTING • MUSIC • DOMESTIC

Books for radio amateurs

FDK

ELLIOTT ELECTRONICS

THE HAM SHACK!

AERIAL ACCESSORIES AND MASTS

JAYBEAM AMATEUR ANTENNAS

RIGS, ANTENNAS, SWR BRIDGES, POWER SUPPLIES, TEST GEAR, COMPONENTS, MORSE KEYS, COAXIAL CABLES, ROTATORS, MICS, PLUGS AND SOCKETS, SWITCHES

Call us on (0533) 553293
OR COME AND LOOK AROUND AT
26/28 Braunstone Gate, Leicester

APPOINTED DISTRIBUTOR

INSTANT HP AVAILABLE

HEY OLD MAN TO

R.A.S. (NOTTINGHAM)

Radio Amateur Supplies
Tel. 0602 280267

Visit your Local Emporium
Large selection of New/Used Equipment on Show

AGENTS FOR:	ACCESSORIES:	DRAE products
F.D.K.	Wels Range	RNOS Lincors and PSUs
AZDEN	Microwave Modules	
ICOM	Adon's Mics	
YAesu	Mutek Pre-Amps	
ALINCO	Borens Most Supports	
EMPRO	Agents for YODAPHONE & CELLNET	

AERIALS: Tonna, Halber, Jaybeam, New Diamond Range of Mobile Whips
Bring in your secondhand equipment for sale
JUST GIVE US A RING
Monday: CLOSED Tuesday-Saturday: 10am to 5pm
3 Farrdon Green, Wollaton Park, Nottingham NG8 1DU
Off Ring Rd, between A82 (Derby Road) & A69 (Ilkeston Road)

**ENTERPRISE
ERA
APPLICATIONS
LTD.**



**Introducing the
MICROREADER**

all prices include VAT & Post & Packing.
Discounts for clubs.

Low Cost
Standard
Microreader
£119.95
Tutor Version
£134.95

FEATURES

- 1 Low cost. We pay no importers, agents or salesmen & pass the saving on to you the customer.
- 2 High quality. The standard of construction & components used ensure a high degree of performance & reliability.
- 3 Easy to use. Simply connect to either the headphone or speaker socket of any radio apply 12V supply and you're ready.
- 4 Self contained. No computers, interfaces, program tapes or special leads required. Built in LCD display.
- 5 Performance (CW). Copies hand sent or bugkey cw 5-40 WPM. Both analogue and digital filtering together with built in noise blanking gives good noise immunity. Digital tuning indicator & signal strength lamps make tuning simple.
- 6 RTTY. Reads both commercial & ham shifts. Auto baud rate and polarity sensing. Synchronous sampling system gives excellent noise immunity & wide operating range. 2 fast processors to edit decode & display text.
- 7 Tutor version Sends groups of 5 characters with auto repeat. All the expected features plus the ability to see what is being sent to or from the unit. Rear panel switch returns to normal Microreader functions.

To order or for more information contact: Bill Green G8 H LZ,
E.R.A. Ltd., Unit 26, Clarendon Court, Winwick Quay,
Warrington WA2 8QP. Tel: (0925) 573118

KPC-2 Packet deal

REVIEW



Packet Radio, that's for the computer freaks isn't it? Not at all. Maybe it holds a special interest for them, but you don't even need a computer to operate Packet, a simple dumb terminal will do, so you can forget

O's also, and sent over the air in short 'packets' of a few words at a time. At the other end, an error-check is carried out, and if the message is received corrupted then an automatic retransmission occurs, up to

Mailboxes and Digipeaters

There are several GB callsign designated packet repeaters in the UK at the moment and their numbers are increasing all the time, the accompanying map shows the currently operational and planned units at the time of writing. These together with most individual packet operators presently operate on 144.650MHz FM, if you take a listen on that frequency you'll no doubt hear short bursts of packet data going backwards and forwards between stations. Many also have a 'Mailbox' facility, where one can log in, read and send messages to other amateurs, and in some cases these may be automatically forwarded along a path of other 'Digipeater' stations to reach the intended recipient or the packet radio mailbox nearest to them for storage and later retrieval. As well as these specially licenced unmanned stations, it is technically possible for any amateur with a packet station to act as an automatic digipeater, and with a suitable computer program even set up a mailbox and bulletin board system.

Is this type of individual repeater/mailbox operation legal? Well the tactful answer is that the present licence was written a long time before anyone invented packet mailboxes, and just as we were going to press it came to our attention that the DTI has clarified the position with regard to packet

Packet radio gives fault free communication over distances great and small. Chris Lorek, G4HCL, tests out two of the latest units and realises why this 'magic mode' has caught on.

trying to learn how to be a wizz-kidd de-bugging programs in the middle of the night!

What does Packet Offer?

Worldwide, error free communication, simple as that. When I say worldwide, I mean just that, even if you're using a 2m handheld with a rubber duck on the end you can communicate with stations in Australia, with 100% perfect error-free copy. No wonder packet radio usage is increasing at such a phenomenal rate. It's no secret that many commercial communication links are changing over to digital modes, because messages are then just a combination of 1's and 0's, ie. an on or off state, with nothing in between. As such, they can be regenerated over and over again, hopping from one digital repeated point to another right across the world with no degradation whatsoever in quality as often occurs with analogue speech links. With packet, your messages are converted into strings of 1's and

10 or 15 times, to ensure the 'packet' gets across before your transmitter sends the next short burst.

This transmission may of course be regenerated by several other amateur stations along the route acting as 'Digipeaters', automatic packet repeaters operating on a 'store and forward' basis transmitting and receiving on the same frequency using a timesharing system. Some orbiting amateur satellites have such a facility and you can send a message to them via intermediate stations linking to a gateway such as GB3UP at the University of Surrey. The satellite stores the message in its digital memory for re-transmission at some later time when it is in range of the receiving station, be they in New Zealand, California, or the Ukraine. All done automatically for you, just come back later and read the reply from your mate with his 2m portable and terminal in the Australian outback.

radio operations; the amateur radio licence (which is of course already under review) will incorporate these amendments in due course.

1 It will be considered to be legal to operate individual unattended packet digipeaters in the UK provided that they are limited to a maximum power level of 25W erp, ie. the same power level as is currently used by voice repeaters.

2 Stations offering facilities for the storage and later retrieval of messages ie. mailboxes are likely to be prohibited except for stations which are specifically licenced for that purpose.

3 These specifically licenced mailbox stations will be issued with callsigns in the series GB7???? (eg the RSGB HQ mailbox will have the call GB7HQM) and will have '-2' appended to the call for packet stream handling — ie. GB7HQM-2. A list of mailbox licence application as of 21st December 1987 is given elsewhere.

There have also been moves afoot for several years to achieve a network of packet repeaters covering the UK each connected to its neighbour by a 23cm or 13cm high-speed data link, to allow even faster data transfer between repeaters rather than all operations taking place on one frequency. Looks like we're not going to need written communication soon!

Getting Going

The first thing you'll need is a TNC — "What's that?" you may ask. Well it's a *Terminal Node Controller*, an interface box which you connect to your radio to handle all the digital goings-on. You'll also need some form of terminal to connect to it, maybe a home computer and TV set or a purpose designed affair, which will allow you to send your messages via a keyboard, and read messages from other stations or your monitor screen.

There are several TNCs on the market, the latest from Kantronics being the KPC-2, together with the all-mode KAM model offering CW, RTTY, AMTOR and ASCII data modes in addition to Packet. Worth a try? We thought so, and G4HCL went fully digital!

KPC-2 Offerings

The size of the TNC is a tiny 150mm(W) x 40mm(H) x 225mm(D), the unit operating from a 12V supply.

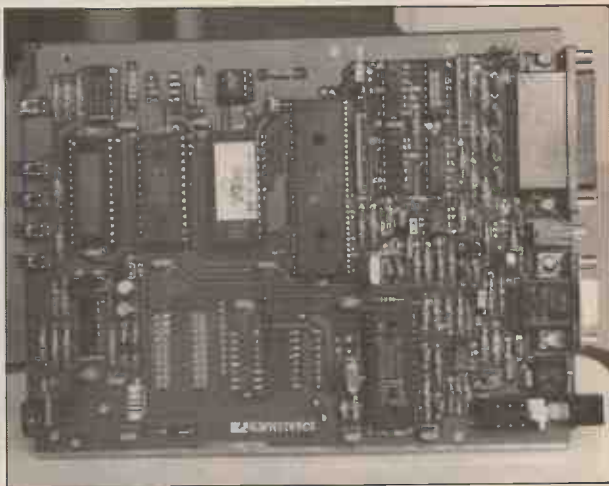

The KPC-2 circuit board

Front panel LEDs show PWR (Power On), TX (Transmit mode), CON (Packet Connect Mode) and STA (Unacknowledged packets). Round the back is the power on/off switch, a 25 way D-type connector for RS232 or TTL connection to your terminal unit or computer, a 9 way D-type connector providing PTT control, TX audio output, RX audio and squelch inputs, and a 3.5mm jacket socket for a monitor speaker if required. Pre-wired interfacing cables are provided with the unit, terminated at the KPC-2 connection end. The unit has its own operating system stored in 128K of EPROM (Erasable Programmable Read Only Memory), 16K of RAM (Random Access Memory, and 4K of EEPROM (Electrically Erasable EPROM). All this jargon means that the unit doesn't need a clever computer program to drive it, although the suppliers of the unit do offer a program to use with some commonly found computers such as the BBC. A recent plug-in EPROM chip upgrade is a WEFAX option (Weather FAX) which was not available at the time of writing but should be fitted as standard when this appears in print.

As well as normal two-way communication, a "Personal Packet Mailbox" feature is offered, whereby the packet situation may be used as a message store, independent of any intervention by

the operator; in fact the operator could even be having packet QSOs at the same time as messages are being stored and read by other stations. Up to 26 simultaneous connections are possible apart from the Mailbox connection, ie. you can have up to 26 QSOs all going on at the same time if you can stand the pace! As over a hundred operating commands are available it would be impossible to describe them all, the operating manual itself stretches to over 80 pages; suffice is to say that these cover everyday control commands right down to 'fine tuning' adjustments to the software.

In Use

When first powering up the unit, you see strings of garbled text on your monitor as the unit automatically sends messages at different baud rates, when you see "PRESS (*2) TO SET BAUD RATE" on your screen that's the one that matches your terminal system and hitting "*" within a couple of seconds then locks the KPC-2 at that rate, followed by a further message asking for you to type in your callsign. Do that and it's away we go!

Or is it ... there are so many features and commands it is almost impossible to remember them all, keeping the manual close at hand is certainly a wise move! A few examples of various operating

APPLICATIONS FOR MAILBOX LICENCES

List to date: 21 Dec 87

Applicant's callsign	Location	Software	Mailbox callsign
G0BSX	Plymouth	WA7MBL	GB7PLV-2
G0DQW	Shrewsbury	WA7MBL	GB7DQW-2
GM0FRI	Oban	WORLI	GB7FRI-2
G1APC	Swindon	WA7MBL	GB7APC-2
G1AWD	Reading	WA7MBL	GB7AWD-2
G1BYS	Bromley	K8KA	GB7BYS-2
G1DIL	Wolverhampton	WA7MBL	GB7BBS-2
G1KVD	Taunton	WA7MBL	GB7KVD-2
G1HZI	Hexham	WA7MBL	GB7TVM-2
G1NNB	Wtham	WA7MBL	GB7ESX-2
G1SJU	East London	K8KA	GB7ELO-2
G1UWS	South London	WA7MBL	GB7UWS-2
GM1VBE	Glasgow	K8KA	GB7JSC-2
G3LDI	Norwich	WORLI	GB7LDI-2
G3OUF	Potters Bar	WA7MBL	GB7HQM-2
GM3SAN	Glasgow	WA7MBL	GB7SAN-2
G3VMR	Maldenhead	WA7MBL	GB7VMR-2
G3VOM	Manchester	WA7MBL	GB7GMX-2
G3WGV	Wokingham	Homebrew	GB7WOK-2
G14AHP	Belfast	WA7MBL	GB7TED-2
GM4AUP	Airdrie	K8KA	GB7MAC-2
G4BVE	Crewe	WA7MBL	GB7DMC-2
G4CLI	Wakefield	WA7MBL	GB7WFD-2
G4DGK	West Drayton	WA7MBL	GB7DGK-2
G4IDX	Ashford	WA7MBL	GB7SEK-2
G4JBX	Tamworth	WA7MBL	GB7MAX-2
G4KCM	Southampton	WORLI	GB7KCM-2
G4KLX	Wirksworth	WORLI	GB7KLX-2
G4LBJ	Liverpool	Homebrew	GB7LIV-2
G4MTP	Daventry	WA7MBL	GB7MTP-2
G4PHL	Sheffield	WA7MBL	GB7PHL-2
G4SPV	Stevenage	WA7MBL	GB7SPV-2
G14WRI	Randalstown	WA7MBL	GB7WRI-2
GU4YMV	Guernsey	WA7MBL	GB7GUR-2
G4ZBA	Norwich	WORLI	GB7ZBA-2
GBAMD	Sutton Coldfield	WA7MBL	GB7SUT-2
GBEIA	Middlesbrough	WA7MBL	GB7NEM-2
GBIMB	Bristol	WA7MBL	GB7IMB-2
GM8SNE	Dalgaty Bay	WA7MBL	GB7SNE-2
GBUFO	Grimsby	WA7MBL	GB7GBY-2

Total applications: 40

stations who have been using packet for several weeks admit to occasionally getting into a muddle, so don't worry too much! An 'off-air' test is useful in getting used to the operating system, before unleashing your packets onto the airways.

The normal mode of operation is "Converse" and the unit is pre-set to enter this mode automatically upon establishment of communication. To 'call' a station you simply type in "CONNECT GOXYZ" after "Cmd:" (Command) appears on the screen, the TNC then automatically keys your transmitter and sends a connect request. Providing the station is on the air, and acknowledgement is normally sent back by their TNC and you're in QSO, the 'CON' LED lighting on your KPC-2. If no acknowledgement is received this will be due to 'collisions' occurring between your packets and other packet bursts, so the TNC repeats the message up to 10 times before displaying 'RETRY COUNT EXCEEDED' on your monitor. When connected, the message "***CONNECTED TO GOXYZ" appears, and you're in contact. QSOscan take the form of typed messages, or if you are using a computer with disc drives you may also send pre-prepared messages or files — over the review period I received one or two rather nice computer-prepared Christmas cards.

As some computer commands could conflict with the KPC-2 commands, a 'Transparent mode' is available where the computer software rather than the TNC takes control. An automatic digipeat mode may also be switched in to allow other amateurs to use your station as a 'stepping stone' for communicating over long paths; you may allocate an 'alias' callsign for this if you wish. The EPROM software upgrade allows a "KA-NODE" facility, where the TNC may be used as a 'node', providing acknowledgement for local packet repeating as opposed to simple (dump) digipeating, which allows a far higher throughput due to a lower number of retries being necessary along the link.

As many packet conversations are 'time-shifted', ie. performed as messages back and forth while you're busy in the shack, the KPC-2 allows you to enter a 'Connect Text'



On board links allow the KPC-2 to be used with virtually any transceiver modes are given to get you started, but to get the best out of the unit you really do need to study the manual carefully and if you know a little about the subject or know a packet-active amateur all the better. Even

into its memory, which may be any combination of up to 128 characters that act as a 'welcome' message when someone connects to you. You may also program the unit to emit a beep from your terminal when a 'connect' takes place. As well as that, you may allocate memory storage space and program in a 'PBBS' callsign for use with the personal mailbox facility which allows stations to leave messages for you or other stations, when you are not available. A hardware-programmed greetings message is sent to the connected station, with a short menu presented. If any messages are present for that station, the KPC-2 sends "YOU HAVE MAIL WAITING" to alert the user. Messages are stored in numerical order and after you have initially programmed the KPC-2 with the date and time the information will automatically accompany the stored list. Although limited to a maximum of 32K (16K fitted) of memory and hence limited to a small-user mailbox, the PBBS uses a standard Bye, Kill, List, Read and Send format to allow distant community store-and-forward mailboxes to download remotely sent messages to you. A comprehensive description of typical packet activity is beyond the scope of this article, but the accompanying printout shows a typical few minutes of operation when I logged into GH3HQ-2, the RSGB packet mailbox at Potters Bar using GB3PX as local relay.

In use, I quickly learned to use most of the command functions without the need to employ the use of a computer program to drive the unit. Many of the default codes programmed into the EEPROM may be changed to suit your own individual preferences, such as automatic return to command mode following disconnection (end of QSO), key commands to switch between different incoming 'streams' for multiple QSO's, as well as callsign identification of each one well as stream designation, time and date identification of each QSO to help logkeeping and so on. Once changed these may be stored in EEPROM by typing "PERM", this data being alterable over 1000 times as and when you decide on later changes!

I must confess to finding one or two anomalies with the BBC computer program supplied, which



KPC-2 rear connections

caused rather a lot of confusion at first, both to me and another amateur using an identical system — eventually I just ended up using a simple dumb terminal program instead. Many computer manuals list such a program, often consisting of just 10 to 20 times and the KPC-2 manual offers a selection for computers commonly found in the USA. In all, easy to operate once learned, but allow yourself plenty of learning time!

KAM Offerings

The KAM is identical in size to the KPC-2, but as well as having separate VHF and HF ports with the appropriate 1200 Baud (for VHF) and 300 Baud (HF) packet rates, there is a switchable VHF-HF 'Gateway' crossband link as well as in-band HF and/or VHF digipeating. The KAM also allows the use of RTTY, AMTOR, CW, ASCII and WEFAX via the HF port. Again, over 100 commands are available for operators to play with, the manual having 104 pages to read through.

The CW mode has a selectable speed range of 6-99 words per minute, with auto-tracking on receive of ± 20 wpm, the RTTY and ASCII modes have a variable baud rate of 45-300 in 1 baud increments with selectable shifts and tone frequencies, and AMTOR modes include ARQ, FEC, SELFEC and a listen-ARQ mode for the earwiggers. A 12-pole programmable switched capacitor filter is used to obtain a degree of audio filter 'selectivity' in the unit and this is extremely useful on today's crowded bands. The WEFAX software upgrade (although not tested) promises a 8-bit pixel by pixel output to your computer, complete with start and stop bits, to allow suitable computer processing, storage to disc or RAM and subsequent printing if desired.

Front Panel

Front panel LEDs show the same TX, RCV, CON and STA modes on VHF as the KPC-2, together with TX,

CON and STA indicators for HF use. These double up in AMTOR usage to indicate LOCK and VAL (valid data link) modes. A front panel power on/off switch is fitted together with an AM/FM demodulator switch which can be useful on noisy HF links to allow 'limiterless' reception, the receiver volume control then being used to set the input level. A 10-section LED bargraph display acts as a peak audio tuning aid for CW and as a Mark/Space tuning indicator for RTTY etc.

Yours truly got the hang of it all eventually, and took great delight in trying it out on the air. The sample RTTY reception printout shows the good receive quality of a weak RTTY signal on 20m in heavy QRM conditions, stronger signals giving 100% copy. Operating the unit in CW mode gave varying results, machine-sent "perfect" Morse came out very well, but each brasspounder had their own, often characteristic 'fist' with the result that the KAM sometimes gave oddly spaced text; under no-signal conditions band noise would give a string of 'E's as the unit tried the non-existent moves. I did find the audio selectivity in each case superb though, with the unit often dragging text out of signals right down on the noise level which is very impressive. On VHF packet, the unit operated in a virtually identical fashion to the KPC-2, apart from the facility of indicating HF as well as VHF modes of operation and allowing me to have a HF RTTY QSO whilst simultaneously seeing what the latest Oscar orbits were via the G4SPV-2 Stevenage mailbox on 2m!

Overall I was very pleased with both the KPC-2 and the KAM, so much so that the KAM has now become a permanent addition to my station. Must go now to see who my station has been working in the last few hours while I've been writing this article...

My thanks go to Lowe Electronics for the provision of the review samples.

Matching Operators



Bored with "you're 5 and 9 - name is Fred - 73's' QSO's? John Worthington, GW3COI, may have the answer - from Uncle Syd!

One often hears complaints about such and such a band where the operator says that nobody seems to want to work him, or on the other hand *he* doesn't want to work *them*. Indeed there must be a vast amount of CQ'ing done to no avail — not because listeners do not like a voice but because they don't fancy the old routine of reports, QTH'S, WX and jargon.

Testing Access

On my local repeater there is always a fairly high level of activity as regards merely 'testing' access it

but the number of folk actually having a QSO is very low. This morning I was listening to an old timer and he expressed pleasure at a QSO he had just made in which the other fellow and he 'were obviously matched.' Now, there will be those who say that this does happen occasionally and to cause it to happen more often would destroy the pleasure derived, but in the case I am quoting I feel there is not only a lack of QSOs but many of the QSOs that are made are ill-matched. The operators involved do not share the

same interests and therefore quickly bore each other.

Get Netted

There is a strong case for anything that will be of service in bringing 'matched' QSOs about. Of course, the idea is not new; you have only to remember the WAB nets Raynet, RAFARS etc — all of these sprang from the need to bring like-minded souls together and there have been attempts of all kinds over the years to try and get other nets going such as Bank Managers, Dentists, Doctors, Rotarians and so on. Many have succeeded in establishing regular meetings and as a keen listener I derive much enjoyment from many of these, not to say the odd tip which has led to fascinating mini-hobbies. If this article seems a little disjointed it is because I am simultaneously doing a job on my upper set!

Mind you, nets are not everyone's cup of tea — but whatever one can say against nets they *do* save band space, even if you get someone like GW3COI coming on badly netted.

An Idea is Born

From time to time, my uncle Syd, who spends periods of pipe smoking in my shack, comes up with suggestions that are mostly frivolous, sometimes wounding but seldom useful. Anyway, he is one of the large number we class as short wave listeners and although his technical expertise and know how is minimal and even tinier than mine his imagination is still in the grip of the wonders of electromagnetic radiation and is therefore just as much one of us as a heavily-lettered-after-the-name physics man.

ACME RIGS

© GW3GOR



"Keep your eye on him, Johnson, he may be a QRP fanatic..."

The idea in practice would be to call CQ in the usual way adding for example the letters A, J and R thus: 'CQ CQ CQ from G9BC whose group is AJR K please.'

Someone with one of the interests indicated would then call to establish whether in fact G9BC really did like all the items and before you know it the two are away like a house on fire.

Uncle Syd sits noiselessly puffing away, having Condor moments every ten minutes, pretending to read the small ads but listening and noting my every move. When he heard the Old Timer say that he had been 'matched' he stirred, coughed

and suggested that we should always include a three letter group in our CQ calls to indicate what our interests were. OK I said 'I'll tell them and dashed out of the shack to do something or other.

Matching Table

But the more I thought about our brief conversation the more the idea interested me and I show here with a draft list which could be used according to the CQ callers' interests (see table). No doubt this table could be improved but it would be interesting to hear the idea 'kicked' around to see if any improvement comes up.

© GW3GOR

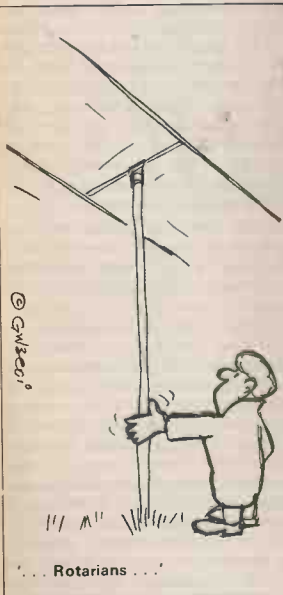

... Rotarians ...

Operator Matching Table

A	Antennas Art	N	Music making Modelling
B	Boats Books	O	TV watching
C	Cookery Cycling	P	Bridge Photography
D	Diving 'Sub aqua' DIY	Q	... (for any subject not covered)
E	English historic places Engineering	R	Reading Recording
F	Foreign travel Farming	S	Sports Space
G	Golf Geology	T	Theatre Treasure hunting
H	Horticulture Hi Fi	U	Open University
I	Inventions	V	Amateur Video
J	Jazz	W	Wildlife
K	Clay pigeon shooting Karate	X	Xylophone or other instrument
L	Chess Stamps	Y	You suggest something
M	Motoring Motorcycling	Z	Zoology

FT 2311R REVIEW



Ever thought about what goes on above 70cm? Maybe you believe it's the domain of the experienced radio 'experimenters' interested in testing out new constructional techniques with 2C39A valves and the like? That may still happen in many cases, but now many users of the band are finding that it offers a welcome break for local nattering

such, the only way you can easily tell them apart is from the front label! The same operating method as employed on the FT23/FT73 portables is used, readers of previous reviews of these equipments will therefore be familiar with the set's easy operation. At just under the £500 mark, it is not a cheap set, but taking a look at the

12.5kHz steps, this covers the entire FM voice allocation and rather a bit more besides. The set offers 10 Watt RF output with a 1 Watt low power facility, drawing around five and a half Amps maximum from a 13.8V supply in high power mode. As much of the activity on FM in the UK is through repeaters, each acting as a 'focus' for activity, a programmable transmit repeater shift is provided and a 1750Hz access toneburst may be enabled either from the fist microphone or from a facia-mounted button.

23cm just ain't what it used to be. Now you can get QRV without a degree in mechanical engineering! G4HCL tries out Yaesu's latest.

and even data communication, away from the more congested 2m and 70cm bands.

The latest mobile offering for the band from Yaesu just came into the country a few weeks ago and HRT was offered the first opportunity to test the new set for UK amateurs. So out came the magmount Alford Slot aerial and off we went microwave mobile!

A 23cm FT2117

The set is a virtual 'lookalike' to Yaesu's FT211 2m mobile and FT711 70cm mobile, in both physical and operating features. As

price of other equipment available for the band it is certainly competitive. The activity on the band at the moment is increasing all the time, a bit like 2m and 70cm was in the beginning, and I'm confident that in the future 23cm will be the band to be on. It's certainly like that at the moment in Japan, where 23cm appears to be more popular than 2m if their JARL magazine 'CQ Ham Radio' is any indication.

Features

The set offers FM operation over the 1260MHz to 1300MHz frequency range using either 25kHz or

As well as controlling the operating frequency from the main tuning knob, mic-mounted up/down buttons are also fitted to step in the pre-set 12.5kHz or 25kHz channel increments, facia mounted up/down buttons give 1MHz steps when you want to get from one part of the band to the other quickly (it is a large band!). Ten memory channels are fitted, each storing the operating frequency and programmed Tx offset, seven of the memories may also be used for odd-split Tx/Rx offsets. Following a push of the facia-mounted D/MR button, memory channel selection is performed by using any of the up/down buttons or the main rotary knob. A large green-backlit LCD

displays the operating frequency, memory channel, offset, and gives a bargraph-type S-meter and an indication of transmit mode (not the relative power output, although it's meant to look like it). An adjacent dual-colour LED lights green when the receiver squelch raises, and red when in transmit mode.

Scanning

Scanning of the entire band for activity is possible in VFO mode by keeping one of the mic-mounted up/down buttons pressed for half a second or more, the scan halting on an occupied channel for five seconds and then resuming. In memory mode, this operation scans the programmed memory channels, and you may inhibit any of the memory channels from scan mode if you wish, yet still allowing their manual selection by using the knob or up/down buttons. By altering the position of an internal switch, the scan mode may be changed to stay locked onto an occupied channel until two seconds after the squelch closes. A 'Priority' scan mode is also available, this briefly checks any selected memory channel for activity whilst you are operating in VFO mode, halting on this channel if occupied, again either for five seconds or until a couple of seconds after the signal disappears.

The microphone socket is capable of providing all the connections required for Packet Radio use, that is the receive audio and squelch state as well as transmit audio and PTT keying. To achieve this, a small internal re-wire linking modification is required which then disables the microphone-mounted toneburst button, however the toneburst may still be enabled by the fascia-mounted button.

Sizing it up

The set is supplied with four small rubber feet for base station use as well as a mobile mounting bracket, and measures 160mm(W) x 50mm(H) x 175mm(D). The front panel is tilted for normal upward viewing and this may be reversed by partially dismantling the case so as to tilt downwards for when the set is mounted above eye-level. An internal speaker is fitted to the bottom lid, and a rear panel mounted 3.5mm jack socket allows a larger external speaker to be

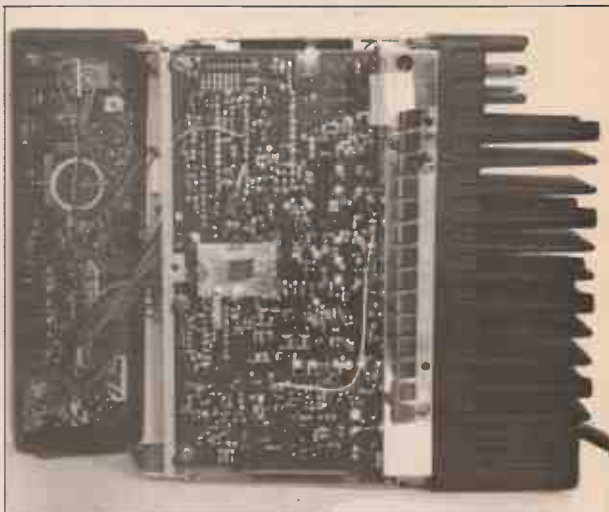

Top view of the 2311.

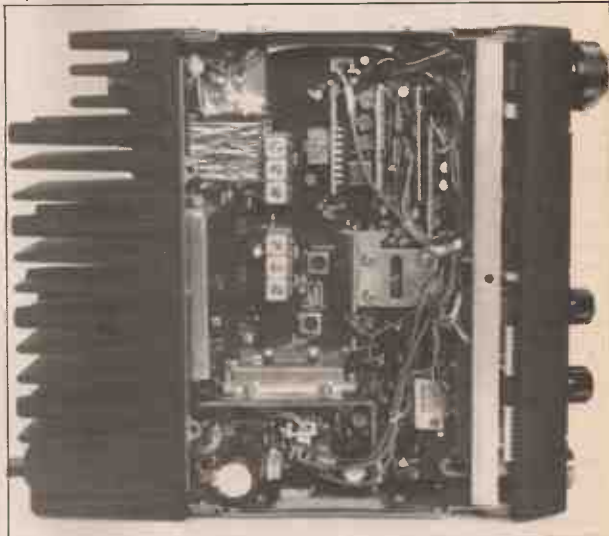

Underside view.

fitted. Also on the back panel are flying leads for 13.8V DC connection, and a panel-mounted N-type aerial socket. Optional extras include the SP-55 external speaker, an FTS-12 sub-audible tone squelch unit (very useful — see later), and mobile boom mic and headset units for those who dislike

fist mics whilst driving. The set is supplied with a user instruction manual and a quick-reference operating chart, block and circuit diagrams are supplied but no fault-finding details.

I have already become accustomed to using the Yaesu 2m and 70cm mobiles, so I must confess

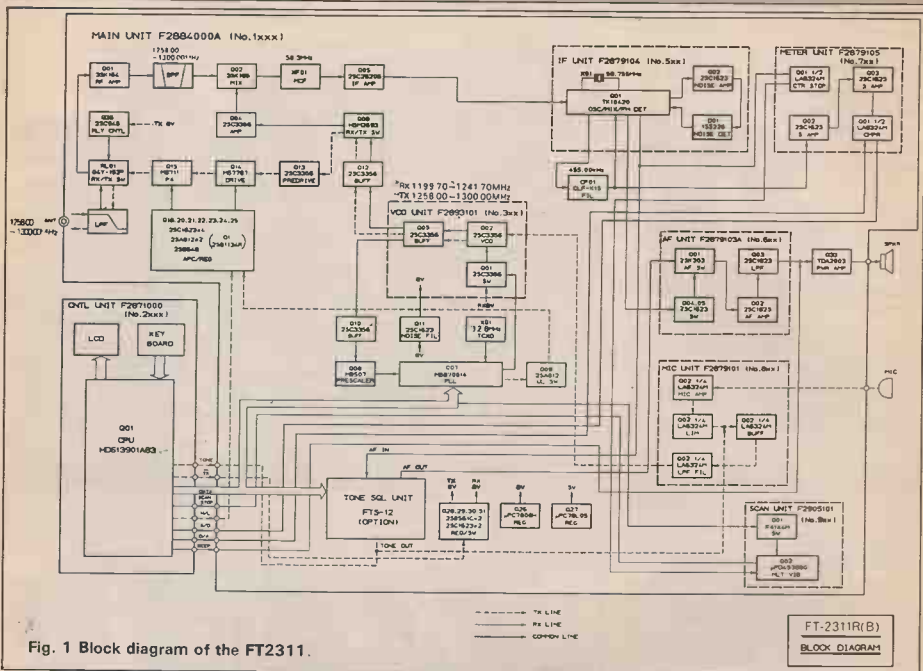

Fig. 1 Block diagram of the FT2311.

that I had no difficulty at all in operating the set without even opening the instruction book. As such, all I can say is that I found the other mobile 'look-alikes' extremely easy to use, and the FT2311 is no exception. By sensible use of dual-function backlit controls of a decent size, rather than small unraised, unlit affairs that you accidentally operate while driving along, the set lent itself to easy use when mobile as well as simple base-station operation.

I first used the set in my shack to see how it compared with my normal 23cm equipment, using aerials ranging from a JVL loop-yagi, to a homebrew 4 x 18 element modified TV aerial array. I have two 'local' 23cm repeaters, even though one is over 50km away it was still fully quieting on an indoor aerial using the set, showing that 23cm isn't just limited to a few miles of line-of-sight operation as some amateurs think! I was pleased with the ability of the scanning facility to half for only a few seconds on a carrier and then resume, as all 23cm repeaters are licenced as

'beacon/repeaters' meaning they radiate a carrier at all times. If your set is constantly locked onto one signal in scan mode for instance, you could miss out on someone calling you on another frequency.

I use low-loss LDF-450 heliax coax to my main 23cm yagi — using this and switching in my masthead preamp made only a slight degree of improvement to readability of weak beacon signals, but this test showed the front end of the FT2311 was perfectly adequate for weak signal work. Using the preamp with my older FM black-box or my transverter gave a greater improvement, to such an extent that I was pleasantly surprised with the Yaesu set.

Out and about

With this in mind, out came the MRZ mag-mounted mobile Alford Slot, and G4HCL/M went out to see what the coverage of the 23cm repeater GB3PS was like in East Anglia when using the FT2311. Apart from confusing some Cambridge city-centre cyclists with the strange-looking bright blue

aerial, the installation was a pleasure to use. Signals on 23cm often seem to penetrate some built-up areas far better than 2m, and I found I could happily communicate well using the FT2311 in some places where I had difficulty in using the co-sited 2m repeater with a 10W 2m mobile setup. Out in the Fenlands on my way home I found I could communicate up to around



40km away from the repeater using the car roof mounted aerial, but what a pity 23cm operation is all horizontally polarized at the moment, if vertical polarisation becomes the norm in the future for mobile/portable operation, possibly using circular polarisation at repeater sites to keep everyone happy, it should be possible to obtain higher gain, less conspicuous aerials and hence improve the popularity of 23cm mobile even further.

PA Cooling

The set always kept cool both in mobile and fixed station use, even during long waffle-type overs, no doubt due to the substantial rear heatsink provided. Normally the higher the operating frequency, the more difficult it is to achieve high efficiency in the transmitter stages with extra resultant heat generated. Due to the majority of operation being performed on one or two channels, I found little need to use the many scanning functions of the set, but I did find all the indicators and controls were easily visible, especially when used mobile during dark winter evenings. I programmed the seven repeater channels used in the UK together with SM20, SM21 and SM22 as simplex channels



Afford slot aerial used in tests.

to make up the ten memory channels available.

For the near future this should of course cover most needs but bear in mind that the current bandplan allows for up to twenty repeater channels, so ten

channels could possibly be limited in years to come, but maybe I'm thinking too far ahead ...

I was pleased to see that a sub-tone unit was available, which the importers can supply as an optional extra to fit inside the set. Although these units are normally used to relieve the operator from monitoring congested channels of

unwanted activity (most amateurs wouldn't want to miss any 23cm station!) it could be very useful when receiving a weak repeater in the shack, or a fluttery signal when mobile, as 23cm repeaters often have the facility of radiating a 100Hz sub-audible tone when in talkthrough mode, ie. when someone calls through the box, alerting the operator of activity. This is certainly the case with my local box, allowing users at extremes of range to listen and monitor for activity without suffering a constant weak signal noise emanating from their speaker.

Insides

The set is constructed using a pressed metal frame and lids bolted onto the rear cast alloy heatsink which houses the transmitter PA. Modular driver and final amplifiers are used and these, together with much of the remainder of the internal circuitry, is well screened. The accompanying block diagram shows the general circuitry arrangement, this consisting of a dual-conversion receiver with a first IF of 58.3MHz, and a final-frequency VCO (unusual on this band) driving a discrete amplifier followed by two block modules. A genuine electromechanical relay is used for Tx/Rx switching and this would normally give better performance than PIN diode switches albeit at the expense of a slight delay in switching speed. The majority of the analogue circuitry is fitted to the main 'motherboard', with chip components liberally used on its reverse; further vertically-mounted 'daughter' sub-boards containing circuit elements such as the IF stages connect directly onto this. A temperature compensated crystal oscillator is used to ensure a low frequency drift for the frequency synthesiser reference oscillator. A HD613901 CPU controls the sets functions, memory backup being achieved via a small backup battery fitted to the front control board. This must be another of those batteries that will never need replacing, as Yaesu give no hint of its existence, or how to replace it, in the supplied instruction manual.

Laboratory Tests

Measuring the receiver sensitivity certainly showed the set to be very sensitive indeed, in fact

more so than some 2m and 70cm transceivers which I have come across recently. Surprisingly, the intermodulation rejection was quite good when taking into account the frequency band in use and the excellent receive sensitivity. The blocking performance was limited close-in by synthesiser reciprocal mixing effects, but improved to give a very good performance further out. The receiver selectivity was remarkably narrow, which would lend itself well to rejecting strong off-channel signals. This was the case even 12.5kHz away, but unfortunately some other 23cm sets might not be as stable as the FT2311 and distorted reception could then occur when in simplex QSO (most repeaters have AFC fitted).

The transmitter was very clean in terms of spurious outputs and I could not detect anything down to 80dB below the carrier level. The power output at 1296MHz was around the 15W level, which is where the set would normally be operated in the UK. At the other end of the band the power output went

down slightly and the efficiency grew worse, showing the transmitter to be operating at its best just where we would use it the most.

Conclusions

The FT2311 uses the same operating parameters and physical features as its 2m and 70cm counterparts, and as such it is extremely easy to use both mobile and as a base station. As the operational frequency of equipment goes up, so normally does the price, and a 23cm 'Black Box' such as this would normally only be bought by the keen enthusiast. For those within the coverage area of an existing or planned 23cm repeater, the FT2311 at £475 would let the user get in on the activity without the worry of specialised RF techniques as would be necessary if constructing homebrew gear. Once hooked on the 'elite' 23cm repeaters (just like 70cm was a few years back) you'll no doubt find it a welcome change, with unhurried QSOs often lasting all night!

My thanks go to South Midlands Communications Ltd. for the loan of the review transceiver.

Laboratory Results Receiver

Sensitivity: Input level required to give 12dB SINAD

Frequency	Level
1260MHz	0.163 μ V pd
1296MHz	0.177 μ V pd

Adjacent Channel Selectivity: Measured as increase in level of interfering signal, modulated with 400Hz at 1.5kHz deviation, above 12dB SINAD ref. level to cause 6dB degradation in 12dB on-channel signal

Spacing	Level
+12.5kHz	46.5dB
-12.5kHz	39.5dB
+25kHz	56.0dB
-25kHz	53.5dB

Blocking: Increase over 12dB SINAD level of interfering signal modulated with 400Hz at 1.5kHz deviation to cause 6dB degradation in 12dB SINAD on-channel signal

Spacing	Level
+100kHz	72.5dB
+1MHz	91.5dB
+10MHz	109.0dB

Intermodulation Rejection: Increase over 12dB SINAD level of two interfering signals giving identical 12dB SINAD on-channel 3rd order intermodulation product

Spacing	Level
25/50kHz	63.0dB
100kHz	63.0dB

Maximum Audio Output: Measured at 1kHz on the onset of clipping

Load	Output (RMS)
3 ohm	3.25W
8 ohm	1.85W
15 ohm	1.10W

S-Meter Dynamic Range 10.3dB

Harmonics/Spurii	All less than -80dBc
Peak Deviation	6.6kHz
Toneburst Deviation	4.4kHz

Transmitter

Tx Power and Current Consumption

Freq (MHz)	Power	Supply		
		10.8V	13.8V	15.6V
1260	High	9.6W/4.4A	13.4W/4.9A	15.1W/5.1A
	Low	1.96W/2.4A	1.95W/2.4A	1.95W/2.4A
1296	High	12.3W/4.0A	15.8W/3.7A	16.0W/3.6A
	Low	1.55W/1.8A	1.55W/1.8A	1.55W/1.8A

SUBSCRIPTIONS SENSATIONS! AT COVER PRICE ONLY!

Any of the magazines from the list below can be delivered to your door
with : **NO handling charge** **NO postage costs**

A&B Computing	£18.00
Aeromodeller	£22.20
Citizens Band	£16.20
Clocks	£27.00
Commodore Disk User	£15.00
Disk User	£17.70
Electronics Digest	£11.00
Electronics Today International	£16.80
Ham Radio Today	£15.60
Military Modelling	£15.60
Model Boats	£15.60
Model Engineer	£26.40
Photography	£15.00
Photoplay	£12.00
Popular Crafts	£16.20
Radio Control Model Cars	£16.20
Radio Control Boat Modeller	£7.50
RCM&E	£14.40
Radio Control Scale Aircraft Quarterly	£9.00
Radio Modeller	£14.40
Sea Classic International	£11.70
Scale Models International	£15.00
Video Today	£15.00
Which Video?	£15.00
Woodworker	£15.60
Your Commodore	£14.40
Model Railways	£13.20
Practical Wargamer	£7.80

The Above Prices Refer to U.K. Subscriptions Only

This offer is also open to existing U.K. subscribers who
may wish to extend their current subscriptions.

Please commence my subscription(s) to with the Issue
I enclose my cheque/money order for £..... made payable to Argus Specialist Publications Ltd.
or debit £..... from my Access/Barclaycard No.

valid from to Signature

Name

Address



Send this form with your remittance to:
**INFONET LTD. (N.R.S. 88) 5 River Park Estate,
Berkhamsted, Herts. HP4 1HL.**



A class Bs Guide to HF

Bird Island S79LJ Seychelles



If you read the correspondence columns of the amateur radio press, you may be forgiven if you were to gain the impression that many people believe that operating standards, especially on the HF bands, are in a constant state of

decline. I am by no means 'an old timer' (yet) — being 32 years of age — but having been interested in amateur radio for over half my life time, I find that regrettably I must agree with these statements. Many hypotheses have been put forward for this supposed state of affairs; the ease of availability of black-boxes, the multiple-choice RAE, CB, and so on. But I would suggest that whilst

in the *good old days* of amateur radio (whatever they were) virtually all newcomers to the hobby spent a year or two apprenticeship as short wave listeners before getting their licences. Today many new operators have *never* listened on HF

have only operated on 2m FM before their local G3, regaling them with tales of daily skeds with relatives in Melbourne or Toronto, has persuaded them to get their morse up to the magic 12 wpm. This may be unfortunate, but it is not at all surprising, and the impecunious G1 is not to be blamed, since a general coverage communications receiver costs very nearly as much as a new transceiver and it is getting very difficult to find good, cheap ex-government receivers which were so plentiful when I started out as an SWL.

So, with their brand-new G0 callsign, they lash out £300 on an old FT101 or — if they are very lucky or very rich — £2000 on a shiny new TS940S, plug it into a 20 metre dipole in their loft, and after two or three weeks of 'name, QTH, 73 trx for QSO' type contacts with UA and I stations, wonder why they ever

"What are the 'DC' Bands Really Like?"

by Steve Telenius-Lowe, G4JVG or "All you ever wanted to know about HF operating, but were afraid to ask."

before getting their Class A licences, so they are totally unprepared for the 'culture-shock'. It is like a man, never having left his home town before, suddenly deciding to take his holiday in Calcutta or Shanghai. He feels somewhat lost!

Early Days

Many recently-licensed G0's

bothered with all those hours of CW practice. After all, on 2 metres there is occasionally a lift on, and even with their 10 watts of FM into a Slim-Jim in the same loft as the 20 m dipole, it is quite easy to work ON, PA0 and even DL stations, and that is much better DX on 2m than UA's on 20m!

Well, there are an awful lot of HF operators who never venture above 30MHz, so there must be *something* in what the VHF-types somewhat facetiously refer to as 'the DC bands'. The purpose of this article, then, is to give some sort of idea what that 'something' is, for those recently-licensed G0's who may be thinking of taking their first hesitant steps on to the 'DC' bands. It may also dispell one or two myths that seem to have arisen recently.

The Language Barrier

One such myth is that there is nobody who is prepared to have a natter on HF: there are only ever 'rubber-stamp' QSOs. The difficulty here is the language barrier—if you speak any foreign language fluently, or even haltingly, you will find dozens of stations queuing up to have a natter with you in their mother-tongue. Every day a certain Liverpoolian station can be heard having lengthy natters with stations in Swedish, which he has learnt over the years entirely through amateur radio. Another Englishman in Harrow, who is fluent in Greek, can be heard most evenings working the Greek stations on 20 metres. If you only speak English it is perhaps unfair to expect every European station you work to be able to have detailed discussions about subjects of which they may only have a very limited vocabulary. Often many European operators may *sound* as if they speak good English; their pronunciation may be excellent, and yet if you ask them something unexpected and away from the typical amateur radio subjects of name, QTH, wx, rig etc., they may have great difficulties in understanding you. Their difficulties are compounded if you happen to have a strong regional accent, whether it be Scots, Welsh, Geordie or whatever. However, having said this, there are many operators who do speak excellent English (within Europe the Germans, Scandinavians and



5Z4RL KENYA

Dutch seem to be the best linguists) and there is no difficulty finding stations who wish to have a natter from these countries. There are also many British and American expatriates living in Europe and elsewhere, and just about everybody in Malta and Cyprus (to name but two places within easy reach of the UK on HF) speaks English as a second language. Then there are all the W's, VE's, VK's etc. . . . myth number one dispelled, I hope!

Antennas . . .

So why can it seem to be difficult to have an interesting QSO on the HF bands? One problem is that the newly-licensed station often calls CQ and awaits replies from other stations, which on 20 metres, tend to be from East European or Russian stations, few of which speak good English, and so we are back to the language barrier problem again. It tends to be far

more productive to listen to QSOs in progress, find one that sounds interesting to you and call one of the participants after the QSO finishes. Another difficulty often encountered by the newcomer to the HF bands is that QSO partners are often unwilling to engage in lengthy QSOs because of difficulties in fully copying you, even when the other end is coming in 59+. And here we encounter DC band myth number two: that you need a 2kW amplifier to get anywhere.

It is far more efficient to run 100 watts into a decent beam antenna than running 400 watts plus into the proverbial dipole in the loft, though there are of course circumstances where it is not possible to put up a rotary beam for the HF bands. However, if you do only have 100 watts and an inefficient antenna, it is perhaps not surprising that the EA8 station running a kilowatt to his six-element mono-

W. R. STEVENS
P.O. Box 18, Jamestown

ST. HELENA ISLAND
South Atlantic Ocean

OHØMD/OJO

MARKET REEF

NOKIA  MOBIRA

band yagi has difficulties in hearing you and so keeps the QSO short.

Many newcomers to the HF bands tend to gravitate towards 20 metres first, the theory being that this is the band where there is both most activity and most DX around, and where therefore it should be easiest to get interesting QSOs. But in practice the opposite is often true: the moment a rarish DX station shows up on 20 metres, the newcomer is usually swamped by the big guns with their huge beams and — it has to be said — high power. Far better for the newcomer to specialise in one or more of the other bands. Already, despite being at the bottom of the sunspot cycle, the 10 metre band has been showing signs of activity, and within a year or so this band could be in very good shape again. When 10 metres is open, it is *wide* open, and it is very easy to work DX stations in Africa and other parts of the world with relatively modest stations. A 2 element quad for 10 metres is a very small antenna, can be built easily from bamboos and wire, can be turned with a small VHF-type rotator and will give you almost as much gain as the big guns with their monster beams. One

design was given in *March 1987 HRT* and other designs can easily be found in the handbooks.

Verticals

A quarter-wave vertical, with four or more radials, while rather a poor compromise on 10, 15 or 20 metres, can be a very effective DX antenna on 40 metres, often outperforming even quite high dipoles

in the clear, and requires next to no space to put up. The radials can even be bent to fit into the available space, though a purist would squirm at the idea, but one has to be practical — use what space you have. The reason that quarter-wave verticals *appear* to work better on the lower-frequency bands than they do on the higher bands (or especially when compared with



VHF) is simply that as you get lower in frequency it gets more and more difficult to put up antennas with any real gain, so that with a quarter-wave vertical on 40 metres your signal is comparable with many more stations than it is on, say, 10 metres where it is relatively easy to generate 7 or 8dBd gain.

So, with a 2 element quad on 10 metres, and/or a quarter-wave vertical on 40 metres (two simple antennas) the newcomer to HF will have a decent signal even with only 100 watts, and should be able to make any number of interesting QSOs with both European and DX stations, given reasonable conditions.

DXCC

It may be true that some operators on the HF bands are only interested in having natters, or testing out their own home-brew equipment, but for the majority of HF operators, especially on 10, 15 and 20 metres, chasing DX takes up most of their air time. Some people chase just about everything going: Swiss Captions, Swedish Laen, Russian Oblasts, US States and counties, WAB squares, CQ Zones and so on. There is a certificate available for almost every endeavour, but the big one, the one that most HF operators have at least a passing interest in, is DXCC. This is the *DX Century Club* awarded by the USA national society — the ARRL, and in its basic form is awarded for confirmed (ie. QSL'd) contacts with 100 countries. Countries should be in inverted commas, because the ARRL definition as to what is, and what is not, a country has evolved over the decades and is the subject of constant argument by ardent HF DXers. Suffice to say that the United Nations building in New York is a 'country', whilst North Korea is not, and that there are 317 at present. The basic DXCC is quite easily achieved: working 100 countries on the HF bands is no great problem even with a modest station, as there are about 45 countries very active within Europe that can be picked off in a day or so. The other 55 may take a little longer, and it may take some time to receive the QSLs from all 100, but nevertheless after a while the newcomer DXer will have

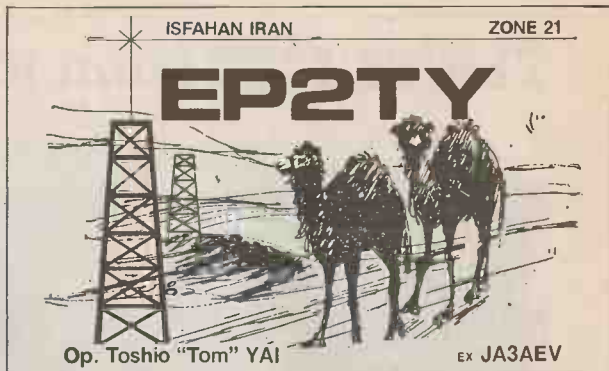

enough cards together for the DXCC application.

By the time he/she has worked 100 countries, though, either the DX bug will have bitten, or it won't. If it *has*, he/she will not be content with working 100 countries, and will have set a target of 150, or 200, or 300, or even the ultimate, all 317 DXCC countries. If the basic DXCC is easy, the ultimate 317 can be a lifetime's endeavour. At present, it is in fact impossible to achieve for anyone starting out in the last year or two. This is because several of the countries on the list have not permitted any form of amateur radio activity for several years. Albania is one such country — geographically adjacent to Yugoslavia and Greece, both of which are very easy to work, yet ZA is 'one of the rarest countries in the world. However, prospective HF DXers should not let this put them off: by the time they have worked all the possible countries, some of the impossible ones *may* be active again. Who would have thought just a few years ago that China, QRT since the 1940s, would have so many active club stations by now, with more coming on the air all the time?

'DC' differences

And here is one of the major differences between VHF and the DC bands. On VHF, DX (apart from e-m-e) is proportional to distance. The greater the distance worked, the better the DX. On HF, this isn't so. It may be very thrilling to work your first ZL or VK stations, but assuming average propagation it

should be possible to work VK's or ZL's almost every day of the year on 7 or 14MHz. No, on HF, DX is proportional to the number of stations active from any particular country, rather than how far away they are, so that to take our extreme example, an Albanian station is far better DX than a ZL simply because they are so few and far between. Apart from the countries that are *always* DX, because of their extreme lack of activity, the general definition of DX is any station outside your own continent. So, if you hear a JX station on Jan Mayen island, or an SV9 on Crete, calling "CQ DX" you should not strictly speaking answer him, even if you 'need' those countries for your own DXCC application. Wait until they are working Europeans before you call.

If, having worked your first 100 countries, the DX bug has bitten, you will soon want to increase your countries worked score. This is when it becomes necessary to improve your station. Antennae such as a 10 metre quad will help an awful lot, as will a 400 watt amplifier, but you will still find it hard going, especially on 20 metres, to work real DX without a really effective DX antenna.

Nets and 'Lists'

One way around this is to listen out for the growing number of 'nets' or lists that seem to materialise almost always when a choice piece of DX appears. There is an enormous amount of controversy surrounding the use of nets and lists to work DX, the majority of

The TS 140S from Kenwood



Every once in a while, something comes along which marks a true turning point in amateur radio equipment. Such was the case when Trio-Kenwood introduced the TS-120 series; the first of the small solid state transceivers to appear.

Following the trends of the last few years towards more "sophisticated" equipment (really meaning more and more complicated), we have seen Kenwood engineering directed more towards better performance, particularly in HF transceivers; performance which has become a standard of excellent for others to try to match.

Study of recent reviews of equipment which has been introduced to try to match Kenwood's TS-940S reveals just how far behind some manufacturers have fallen: I am reminded of some lines from Kipling which run (more or less):-

"They stole everything I had, but they couldn't steal my mind. So I left them sweating and stealing, A year and a half behind."

Well, the chaps at Kenwood have not been asleep, and they have come up with a new transceiver which I believe will mark another turning point in HF equipment. This is the TS-140S, and I can tell you that from a short "hands-on" session which I was given in Germany recently, I am certain that the TS-140S will satisfy many many users.

The new TS-140S is about the same size as the TS-430 or TS-440, and on the face of it is similar (yawn) to other transceivers of the genre in that it gives you 100 Watts of RF on all the amateur bands, in all modes including FM; has a general coverage receiver covering 500 kHz to 30 MHz; and has loads of facilities that you might expect - BUT - Kenwood have studied what the radio amateur has been saying and have refined and simplified the operation of the TS-140S to

make it a real dream to use.

Not only that, they have given the user a receiver section with real performance which matches today's expectations, and remember that Kenwood have consistently set the standards for the last few years.

It is almost impossible for any manufacturer to give every potential customer everything that the customer wants, but there is little doubt that many people have been asking for "simplicity". However, it is also possible to carry the "simplicity" concept too far, resulting in a transceiver which is certainly low priced but lacks facilities which many users see as essential. I happen to believe that Kenwood have achieved the right balance in the TS-140S. It will be interesting to see what you, the users think.

Obviously it is impossible to describe all the features and facilities of the TS-140S in a few paragraphs, so why not drop us a line and ask for complete information. What's that? Oh, the price. Not yet finally determined, but quite a bit less than £950 but not quite as low as the £750 we have been asking for the TS-830S and TS-430S in recent weeks.

In my opinion, the TS-140S in combining performance with simplicity at an attractive cost will give real satisfaction to the radio amateur who wants to enjoy his hobby of communicating, rather than counting the buttons on the front panel. And who am I to make this pronouncement? Well, I'm John Wilson and I am one of the original gang of three which became Lowe Electronics Ltd. I haven't written for the magazines for many years, but the TS-140S really attracted me so I thought I should tell you about it rather than bore you with a specification. Hope you like it too.

73.
G3PCY/5N2AAC

FREE

Send only £1 to cover postage and packing and we will send you, by return, a FREE copy of the new full colour KENWOOD catalogue which lists the features and specification of every model and accessory currently available. We will also include, FREE OF CHARGE, a copy of our general catalogue which, along with items to enhance your operating contains much useful information. Finally, we will add the latest edition of our price list.

LOWE ELECTRONICS LTD.

LOWE SHOPS

Our Head Office is at Matlock, but we have conveniently placed branches around the country. Each branch is run by a manager who is an active radio amateur and also keen to help you. He normally stocks everything in our extensive range and can demonstrate all major items of radio equipment to you. Note though that all mail orders must be sent to Head Office at Matlock.

Call in to your nearest branch soon.

In Glasgow, at 4/5 Queen Margaret Road, (off Queen Margaret Drive). Tel: 041 945 2626

In Darlington, at 56 North Road. Tel: 0325 486121

In Cambridge, at 162 High Street, Chesterton. Tel: 0223 311230

In Cardiff, at South Wales Carpets, Clifton Street. Tel: 0222 464154

In London, at 223 Field End Road, Eastcote, Middlesex. Tel: 01 429 3256

In Bournemouth, at 27 Gillam Road, Northbourne. Tel: 0202 577760

Branches are normally open from Tuesday to Saturday inclusive, with lunch breaks to suit local conditions. If in doubt, just telephone your nearest branch.

HF125 HF all mode receiver



Why did we design and produce the HF125 receiver? Simply to provide the keen short wave listener with a receiver which offered not only all the facilities he or she needed in an HF receiver, but to give at the same time a level of performance which would cope easily with HF conditions likely to be encountered in Europe. You all know the problems, high power broadcast stations pounding in at night, blotting out the weak signals you wanted to hear - and many of the unwanted signals were generated in your receiver itself. That we succeeded in designing a receiver which could solve the listening difficulties is obvious from comments from reviewers, but we also did it at an attractive price. The HF125 performance ranks equal to or better than imported receivers at twice its price, and its success stretches around the world. So what did the reviewers say, I'll give you a few comments, but for the full story why not send a stamped addressed envelope marked "HF125" and we will return a fully descriptive brochure with all the review comments included.

Notes:

"What is particularly important is the fact that so much attention has been paid to RF and IF performance; areas so lacking in many Japanese sets. Short Wave Listeners will be particularly pleased about the many choices of selectivity on AM." Angus McKenzie

"I tuned straight to the 40 metre amateur band to see how it stood up to the battering from high powered propaganda broadcasters when attempting to resolve relatively weak amateur signals trying to get contacts. The simple answer was, no problem." Chris Lork

"After an hour, drift was less than 50Hz in each instance. This is comparable with receivers in much higher price classes." World Radio and TV Handbook

"I have no doubt that the Lowe HF125 represents extremely good value for money, and the performance far exceeds so much of its competition, including some receivers costing rather more." Angus McKenzie

"It's refreshing to find a receiver that does exactly what it claims." World Radio and TV Handbook

The HF125 costs £378 including VAT. Need I say more? (Carr. £8.00)

packet radio from Kantronics



When I first heard of packet radio, I said "What?", and that is the reaction of many radio amateurs. However, I never expected it to be so much fun, and judging by the demand and the queue to get at our demonstration station here at Matlock, a lot of other people are also finding it truly fascinating.

There are several companies offering ready made packet systems, and the descriptions are usually full of terms you don't understand (including some of our own ads in the past). What for example is "enhanced generic command structure"? Sounds very much like something taught at Sandhurst or West Point.

From the equipment available, we chose to represent Kantronics, because their units are a sheer delight to see, to use, and to enjoy. For full information on this most interesting aspect of our hobby, just send a couple of first class stamps and ask for "Kantronics".

Prices range from £159 to £298, and I know I haven't told you what packet radio will do - send for the info ...

HOKUSHIN aerials.

BASE STATION AERIALS

HSVK8...80 to 10 metres vertical, includes radials £218.00 inc. vat, carriage £8.00

GPV5...Two metre base station colinear, 6.8 dB gain, 3.1 metres high £54.92 inc. VAT, carriage £3.00

GPV23...as above but 3 section colinear, 7.8 dB gain, 4.45 metres high £51.97 inc. VAT, carriage £3.00

GPV7...Seventy centimetre triple 5/8 base station colinear, 6.8 dB gain inc. VAT, carriage £2.00

GPV720...Dual band (144/430 MHz) base station aerial £45.68 inc. VAT, carriage £3.00

MOBILE AERIAL

2E...Two metres 5/8 whip, 3.4 dB gain, foldover base £14.55 inc. VAT, carriage £2.00

2NE...Two metres 7/8 whip, 4.5 dB gain, foldover base £24.23 inc. VAT, carriage £2.00

OSCAR430...Seventy centimetre triple 5/8 whip, 6.3 dB gain £27.72 inc. VAT, carriage £2.00

OSCAR720...Dual band (144/430 MHz) whip £24.59 inc. VAT, carriage £2.00

HS710...144/430 MHz diplexer for use with OSCAR720 £18.02 inc. VAT, carriage £1.50

GSS...Gutter mount (requires RG4M cable assembly) £6.26 inc. VAT, carriage £1.25

RG4M...Cable assembly for GSS base, complete with SO239 and PL259 plug £6.26 inc. VAT, carriage £1.00

12B...Car wing mount with SO239 top and bottom £5.73 inc. VAT, carriage £1.00

HTMB...Car boot mount including cable and PL259 £15.42 inc. VAT, carriage £1.50

MA2005...High quality mag mount with cable and strong protective cover to prevent paintwork damage £22.90 inc. VAT, carriage £2.00

LOWE ELECTRONICS LTD.

Chesterfield Road, Matlock, Derbyshire DE4 5LE

Telephone 0629 580800 (4 lines)



K L 7 Y

second-hand rig, such as a Trio TS520, make sure you can get a remote VFO or you will miss out in working most of the DXpeditions. Second-hand 'separates', such as the Drake T4XC transmitter and R4C receiver (with which you can work transceive on either the transmitter VFO or the receiver VFO, or work on separate frequencies) can still outperform many a more modern transceiver and are well worth considering if you are getting into the DXing game seriously. It is much easier to break a pile-up if the DX station is working split than if he is only listening on his own frequency. This is because you should be able to hear him better (e is not being swamped by the stations calling him) and if he is listening over a 10kHz segment of band, and the stations calling him are spread out over this bandwidth, he is more likely to hear you if you are calling on the frequency on which he is listening.

To stand as good a chance as possible, listen to see if you can hear the stations he is working. Is he coming back to stations all calling on the same frequency, or is he tuning from one up (or down) to

the next? Try to anticipate where the DX station is listening, and call only when and where you think he is going to hear you. If you hear a well-known DXer with a known 'big signal' there in the pile-up, get on the same frequency as him and call the DXpedition station immediately after the guy with the big signal has made his QSO: in this way you know that the DX station will be — or will have just been — listening on exactly that frequency.

QSLing

Once you have worked the DXpedition station — or any DX station for that matter — you will, no doubt, want your efforts to be rewarded by a QSL card. QSLs are required for most operating awards, including DXCC, but even if you are not particularly interested in applying for awards, many DX QSLs are very attractive and are worth possessing in their own right. The question is, to QSL via the bureau,

NORFOLK ISLAND



VK9NS

ZONE 32

J. B. SMITH
P.O. BOX 90
NORFOLK ISLAND
AUSTRALIA. 2899.

HEARD ISLAND CORMORANT

HEARD ISLAND DX ASSOCIATION

Incorporated Tasmania

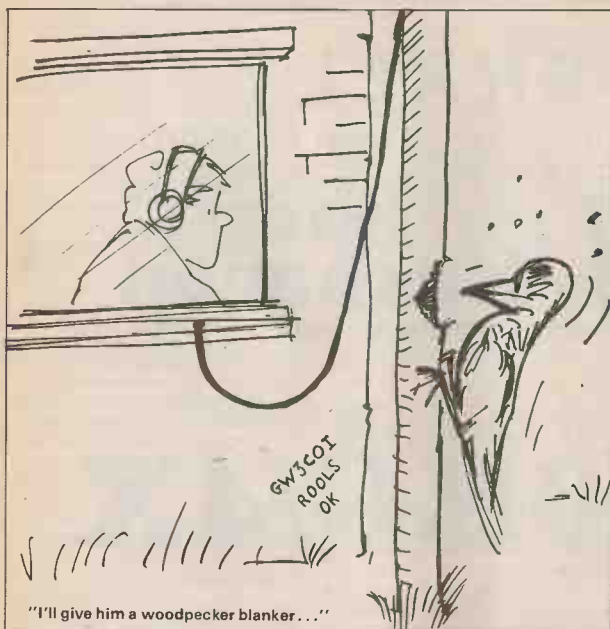

work, it is illegal for people to receive foreign currency through the mail).

If you do not send any return postage with your QSL, the chances are that the DX station or his QSL manager will either send your card back by the bureau (which is OK if there is an operating QSL bureau in his country) or not at all.

You must appreciate the reasons for this. A DX station almost never really wants your QSL card: he will almost certainly already have several hundred G QSLs, and another one will only give him more problems of where to store them. Secondly, a well-organised DXpedition can easily work 20,000 QSOs or more in a week or two, and — especially if they decide to print a glossy colour photo QSL — the cost of getting so many cards printed can be phenomenal. Added to the cost of mounting the DXpedition in the first place, the DX operator often counts on receiving quite a lot of income in the form of IRCs or dollar bills just in order to pay for his printing bills. If he has to pay the equivalent of 30p or 35p just to get your QSL back to you, you can understand it if he files it in the waste bin instead!

So *always* send sufficient funds if you QSL direct, and if you think it has been a particularly well-organised and successful DXpedition the DX operator would always appreciate a few kind words to that effect. You may also wish to put in a sort of 'tip' — an extra IRC, or a dollar bill and an IRC in order to show your appreciation, but this is by no means necessary, and you should always expect a QSL from any station to whom you send one. A few DX stations have been accused of collecting dollars and IRCs and not coming up with the goods, but these are very rare occurrences and I believe are more usually explained by failings in the international postal system rather than any deliberate desire to defraud.

So, if you have recently obtained your shiny new GØ licence, don't be content with having a few rubber-stamp type QSOs around Europe: put up a decent antenna, have some interesting QSOs around the world, and join the ever-growing bands of DXers on the DC bands.

or direct, or even to QSL at all! There are some rules to be observed here. It is probably not worth QSLing run-of-the-mill European QSOs. You will, of course, receive QSLs via the bureau, from European contacts, and you should naturally reply the same way to these. The same applies to other 'DX' QSOs with countries which have large amateur populations, such as the USA, Canada, Australia and so on. QSOs with somewhat rarer countries, such as Gibraltar or the Åland Islands in Europe, or Indonesia or Kuwait, are probably not worth initiating QSLs 'via the bureau' for. This is because the chances are that these stations will already have so many G QSLs that they probably will not bother to send a card to you unless and until they have received one from you.

Some DX stations announce that they have QSL managers, but the same rules of thumb apply: it is probably not worth QSLing direct to a QSL manager for an expedition station to one of the Italian islands. You should, however, QSL *direct* (assuming you want a card from the station concerned) to any

DXpedition station, other than those to the more common European countries — Andorra, Liechtenstein etc., or to any permanent resident DX station in really rare spots. Stations wanting their QSL direct only will always announce either their QSL manager, or a PO Box number. Beware of using the callbook unless you know that the address is still accurate.

'Green Stamp'

If you QSL direct to a DX station you must enclose two things with your QSL: one is a self-addressed envelope and the other is some form of return postage. IRCs (International Reply Coupons — available at most Post Offices) have become a sort of international amateur radio currency and you should send at least one for a European destination and preferably three or more for managers or addresses outside Europe. It is cheaper to buy a single US dollar bill than three IRCs, and these have become another acceptable means of sending return postage (beware though: in some countries, especially in the third

DX-peditions

I mentioned the thrill a true-blue DXer has when he has generated a huge pile-up and is working it quickly and efficiently. It is not so easy to generate a large pile-up from England (unless you have an extremely good station and beam into the States when conditions are good) because there are just too many 'G' stations active for one to attract much attention. It is a different story for those lucky enough to have a GD, GJ or GU callsign, of course. But for many DXers living in relatively common countries one way of getting the huge pile-ups (and have an exotic if not exactly relaxing holiday at the same time) is to go on a DXpedition. These DXers spend much of their free time, instead of operating from home, pouring over an atlas, looking at the DXCC countries list and the 'most-wanted countries' lists and packing their bags, rigs and antennae off to some rare spot with the idea of simply working as many stations as possible during the short time they are there.

Working 'Split'

For the newcomer DXer, trying to increase his countries worked score, these DXpeditions are one of the best ways of working new countries. This is because DXpeditions are usually made to fairly rare (or occasionally extremely rare) places, the operator or operators are there solely to provide as many QSOs as possible, and they are on the air almost all the time, often sleeping only three or four hours a day. So, if you are on the air at the same time, the chances are you will be able to work the DXpedition station. If it is to a very rare location you will either have to be very lucky to work the station as soon as they come on, and before the majority of other DXers know about the activity, or to wait towards the end of the expedition, when most DXers have already worked them. Once the operation becomes generally known, activity can be frenetic and it can be difficult to work the DX station simply due to the number of stations calling.

However, help is at hand. Most experienced DXpeditioners, when they get a large pile-up, will

ZONE 29

VK9YC

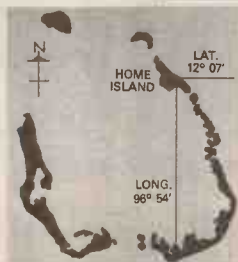

OCEANIA HOUSE
HOME ISLAND
COCOS (KEELING) ISLANDS
INDIAN OCEAN



announce that they are listening on a frequency other than the one they are transmitting on. This procedure is known as 'operating split'. There are certain specific frequencies often used by DXpeditioners, although there are no rules to say where they must be, and there are exceptions. On 20 metres the usual DX frequency on SSB is 14195kHz, with the DX station, if he is working split, listening either on 14200, or between 14200 and another nominated frequency, say 14210. The DX operator, transmitting on 14195, will announce "QRZ 200 205" (meaning he is listening between 14200 and 14205) or "QRZ listening on 200 and above" or simply "QRZ, listening up". On

15 metres it is usually 21295 (listening above 21300) and on 10 metres 28595 (listening above 28600). On CW the DX station usually transmits 5kHz up from the bottom band edge, and listens two or three kHz higher; again, he should announce where he is listening.

DX Dodges

To work a DXpedition station when he is operating split, you will of course need either a separate transmitter and receiver, or a transceiver with a remote VFO, or a dual-VFO transceiver. Most modern transceivers coming on to the market do now have two VFOs built in, but if you are looking for an older

STATE OF QATAR

A7XM

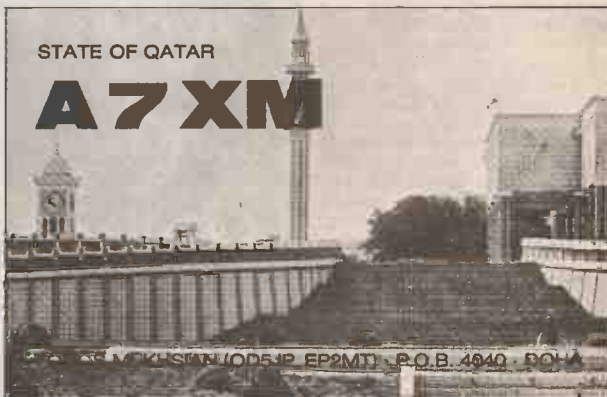

WORLD FIRST FT 736 REVIEW

If, like myself, you're a keen VHF/UHF enthusiast who likes the 'ultimate' in base station equipment, then Yaesu's latest offering may just start you drooling! With 2m and 70cm as standard, 6m and

with a built-in switched mode power supply, and is also capable of operating from a 13.8V DC supply with an 8A maximum capability by using an optional power lead. The set has interconnection facilities for

Accessories supplied include an AC power lead and spare AC fuse, two internal preamp switching jumper plugs, 2 extra feet for tilting the set upwards, six foot pads and an instruction manual giving operating, interconnection and internal linking details, CAT commands, and complete block and circuit diagrams. The FT736 measures 368mm(W) x 129mm(H) x 286mm(D) and weighs in at 9kg.

Want to know what the latest VHF/UHF base station offering is like under the covers? Then read Chris Lorek's latest exposé

23cm as plug-in options, multiple full-duplex VFOs and over a hundred memories, synchronous tuning of VFOs in opposite directions with full duplex operation for satellite working, what more could any one want with the odd £1450 to spare?

General Features

The set looks virtually identical to Yaesu's HF counterpart, the FT767GX, in both cases a glance at the front panel controls sends one wondering where the on/off switch is located. Fourteen knobs and 49 buttons, many of which have multiple functions need a bit of getting used to! All this of course gives a good indication of the large number of facilities and operating modes which the set offers.

The '736 comes equipped for operation on 144-146MHz and 430-440MHz as standard with 25W maximum transmit power output on USB, LSB, CW and FM, in each case a Tx drive control allows you to vary the power output down to zero. Optional plug-in band options are available covering 50-54MHz (£239) and 1240-1300MHz (£425), both of these extend the sets operating facilities to the optional bands with 10W maximum output. A 1296MHz fast-scan TV option is also available, this however gives AM video rather than FM as used throughout Europe.

Power and Interfaces

The set operates from an AC mains supply of 85-132 or 170-264V covering most eventualities

a number of external facilities such as independent linear amplifier Tx control switching, front panel controlled masthead preamp switching (internally linkable for each band), CAT (Computer Aided Tuning) serial in/out data, packet radio TNC (Terminal Node Controller) interconnections and so on. Yaesu's AQS (Amateur Quinmatic System) is fitted as standard in the set, and an optional AQS message processor may also be plugged in if required.

Internal view from below showing 6m module and space provided for 23cm module fitment

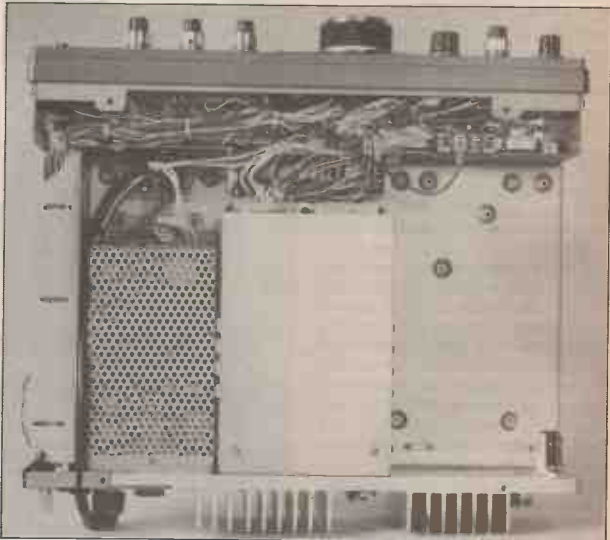



may be used to give 1MHz steps, and a 'channel step' facility allows you to control FM and SSB frequencies in independently pre-set steps for each mode and band, using a further click-step rotary knob or up/down buttons. Split VFO operation may be used for inter-band split frequency/mode working or for cross-band full duplex operation (more of this later).

One hundred memory channels are provided, each storing mode and independent receive and transmit frequencies. As well as these, a 'call' channel button recalls a pre-set channel for each band, and a further 'global' memory channel gives one-button access to a pre-programmable channel irrespective of the band in use. A large display gives an indication of the operating frequency to the nearest 100Hz. Internal view from above showing main boards

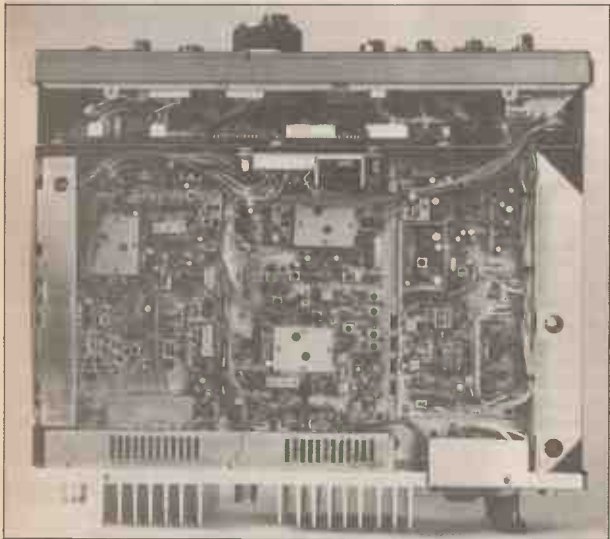

together with the selected VFO or memory channel and mode, plus scan, clarifier, offset, subtone and AQS states. An optional voice synthesiser (£33) may be fitted to give a verbal rendition of the operating frequency if required. The large front panel meter may be switched to indicate relative power output or Tx ALC (Automatic Level control) on transmit, and show the relative signal strength or act as an FM centre-zero discriminator meter on receive. A dimmer switch is provided to save your eyes from strain during all-night DX chasing.

Scanning

In conjunction with the all-mode squelch provided, many and varied scanning modes are possible

to let you seek out people to talk to. Memory scan may be initiated to scan *all* memory channels, solely channels in the currently selected band, or only memories with a selected operation mode. Any number of channels may be independently locked out of scan selection if required to prevent the set stopping on each beacon or busy repeater frequency, whilst still allowing their manual channel selection. Scanning between two pre-set VFO frequency limits in pre-programmed steps is also possible, and a 'priority' scan mode briefly samples a pre-set memory channel every few seconds whilst operating in VFO mode. The scan halts when the squelch raises, and dependant upon the setting of a front panel 'pause' button continues either two seconds after the squelch closes, or five seconds after the scap has halted, regardless of squelch state.

SSB/CW

For the DX hunters, an SSB RF processor is fitted to increase your average transmitter power, and to help QRM rejection on SSB/CW receive an IF shift control allows the crystal filter bandwidth to be 'slid' from side to side to reduce to effect of a strong adjacent signal. In-band carriers may be tuned out by the use of a variable IF notch filter, and other forms of QRM such as next door's lawn mower or the portable contest generator may be reduced by a switchable IF noise blanker. The AGC delay may be switched to either fast, medium or slow, a manually variable RF gain control also being fitted.

A fixed 2.2kHz wide filter is normally used for both modes, however an independently selectable 600Hz crystal filter may also be fitted as an optional extra (at £60) for the CW enthusiasts. For those who like a little electronic help with their key-bashing an optional CW iambic keyer (at £15.95) may be internally fitted to allow the use of paddles as well as a straight key, a front panel knob varying the optional keyer speed. A further 'monitor' knob gives control of the 600Hz audio CW sidetone volume, and semi break-in or hard Tx/Rx switching may be employed. CW semi break-in uses the all-mode VOX facility, with front panel controls for VOX gain, delay, and anti-vox.



Front panel view head-on

Beaming Upwards

Satellite operation is well catered for with full duplex 2m/70cm operation fitted as standard. Two separate digital full-duplex cross-band VFOs are used for this purpose, these may be independently tuned or linked to tune synchronously either in the same or in opposite directions to cater for satellite transponder frequency shifts. Together with the VFOs there are also ten further designated full-duplex memory channels giving single-frequency operation. A separate meter function position allows you to monitor your transmitter power output and ALC whilst operating, otherwise receive signal strength is normally indicated. As well as satellite capability, the duplex facility may of course be used for more mundane terrestrial contacts when you fancy a cross-band 'telephone-style' ragchew with your mate down the road.

FM

Two FM bandwidths are provided, wide (FMW) and narrow (FMN). The former provides 'normal' operation using 5kHz deviation and a 12kHz wide IF filter, suitable for use with 25kHz channel spacing. However as many of us in congested areas on 2m know, 25kHz channels are getting very busy and amateurs are using 12.5kHz steps more and more. Selecting the FMN position on the 736 brings in a narrower 8kHz wide IF filter and reduces and transmit deviation accordingly to 2.5kHz eminently suitable for 12.5kHz spacing.

As well as continuous frequency tuning with the main VFO, this being more suited to narrow band modes of communication such as SSB, an 'FM CH' facility allows you to use a separate knob or

up/down buttons to tune in selectable 5, 10, 12.5, 15, 20, 35, 30 or 50kHz increments, with independently selectable steps for each band and VFO. Independently programmable repeater offsets may be selected for each band and VFO, these may be switched to give a positive or negative shift as required; also when operating in FM CH mode on 2m, an automatic 600kHz shift is selected when operating between 145.60 and 145.80MHz. Both manual and automatic 1750Hz tonebursts are fitted and are independently selectable, giving either a half second toneburst at the beginning of each transmission with a programmed Tx offset, or manually for as long as the 'T CALL' button is pressed.

To permit 'quiet' monitoring of channels, an optional subtone unit (£49.95) may be internally fitted to perform subaudible encoding and/or decoding for club or net use. There are already several areas in the UK where this is used, together with one or two 2m repeaters with sub-tone regeneration facilities fitted, many 23cm repeaters also radiate a 100Hz sub-tone when in talkthrough mode to alert monitoring amateurs.

Amateur Quinmatic System

Although AQS has been around for some time, (see *HRT June 86*), this is the first radio to appear in the UK with the facility fitted. AQS is a digital selective calling system compatible with that used in some Icom and Standard sets, but not Kenwood equipment which use the same tone frequencies but a different protocol. It allows silent monitoring of an FM channel until called by a similarly equipped AQS station with either your callsign or a five digit group call code that you have pro-

grammed in your radio for club or group net use. When suitably called, the 736's receiver bursts into life and a 'Ready' indication blinks on the display. If you have already programmed in the calling station's callsign in the 10 AQS callsign memories provided in the 736, the memory number is also displayed to let you know who called you. An auto-QSY facility, CAC (Channel Access Call) is also available, upon request the calling set will search for a clear frequency between two pre-programmed limits and send the relevant data to the called set, both sets then automatically QSYing. When replying to an AQS call, the 'ready' extinguishes as soon as you press your PTT, AQS operation may be re-established at the end of the QSO by pressing the 'reset' button once, if auto-QSY has been used then a further press of the 'reset' takes you back to your original frequency.

The optional AQS message processor (£189) takes the form of a 16 digit dot-matrix display with a 14-button keypad, the unit being placed alongside or on top of the 736, and having the capability of displaying the callsigns of AQS signals received and messages of up to 14 characters in length. Up to ten callsigns, three incoming messages and three outgoing messages are stored in battery-backed CMOS memory, and facilities are provided for connection of an external computer in case you want to expand your capabilities a little further.

On The Air

The set was supplied with the 50MHz option fitted, the 1296MHz module not having arrived in the country at the time of the review. I must confess that it took me a good two or three hours to read the comprehensive instruction manual and get the hang of operating the set 'off air,' and I had to suppress my natural desire to immediately try the set out in QSO a few minutes after unpacking it due to the many operating modes and commands involved. However once learned, I found operating on the bands very nice indeed. I normally use a high performance HF transceiver with transverters for the VHF/UHF bands, limiting me to one band at a

time without furious knob-twiddling, and it was pleasing to be able to use the 736 to quickly check and automatically search for activity on different bands. I have certainly missed more than one opening in the past on 6m because I was monitoring 144.3 or whatever at the time!

I tested the set on all bands into a variety of aerials over a period of several weeks. Living within a few hundred metres of other amateurs operational on 6m, 2m, and 70cm gave a good test of the set's strong signal handling capabilities, as well as running 2m SSB at the same time as my packet station was doing its stuff on 144.650MHz into an adjacent aerial. I found the receiver sensitivity perfectly adequate on all bands, 6m sensitivity was limited by external noise, this hovering around the S2 mark most of the time, 2m was OK if not exceptionally sensitive, but I was pleasantly surprised with 70cm. Distant repeaters were more readable than I was normally used to on my detached FM set, and comparing distant beacon signals against my usual SSB setup showed the 736 to be nicely sensitive, in fact switching in my usual 70cm in-line GAsFET preamp made little difference. Tuning towards

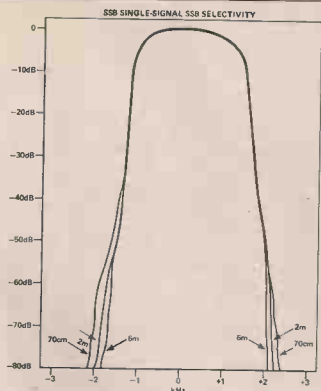

Fig. 1 Single-signal SSB selectivity on 70cm, 2m and 6m.

strong signals showed no evidence of an increase in synthesiser noise, carriers came and went cleanly without a gradual increase and decrease in 'burbly' noise that sometimes occurs, for instance on early unmodified FT767's used in a similar fashion on VHF/UHF, showing that Yaesu have improved on this somewhat.

Channel Steps

I found the SSB channel step

facility very useful when QSYing, a quick press of the 'SSB CH' button gave me 5kHz steps on the rotary channel knob enabling me to make a quick check of clear channels followed by an equally rapid QSY, a further button push then taking me back into VFO mode for fine tuning. 2.5kHz channel steps are also available on SSB, these possibly being useful for a quick check of a band segment for activity. I set the FM channel steps to 12.5kHz on 2m and 25kHz on 70cm, the current FM bandplan on 6m calls for 20kHz steps but I found a slight limitation here. As the FM calling channel is 51.51MHz ie. offset by 10kHz, as soon as I tuned up from this the set reverted to 51.52MHz and went up in 20kHz steps from there. On other bands this facility could certainly be an advantage so I shouldn't complain too much, but it would mean that 6m FM operators (are there any?) would need to program in 10kHz steps or indeed just use memory channels. Another minor grumble is that although it is possible to transfer VFO information into a memory channel, it is not possible as far as I can see to QSY from a recalled memory channel, this would have been very useful in my opinion.

Fig. 2 IMD plots on transmit: (a) 70cm half-power; (b) 70cm full power; (c) 2m half power; (d) 2m full power; (e) 6m half power; (f) 6m full power.

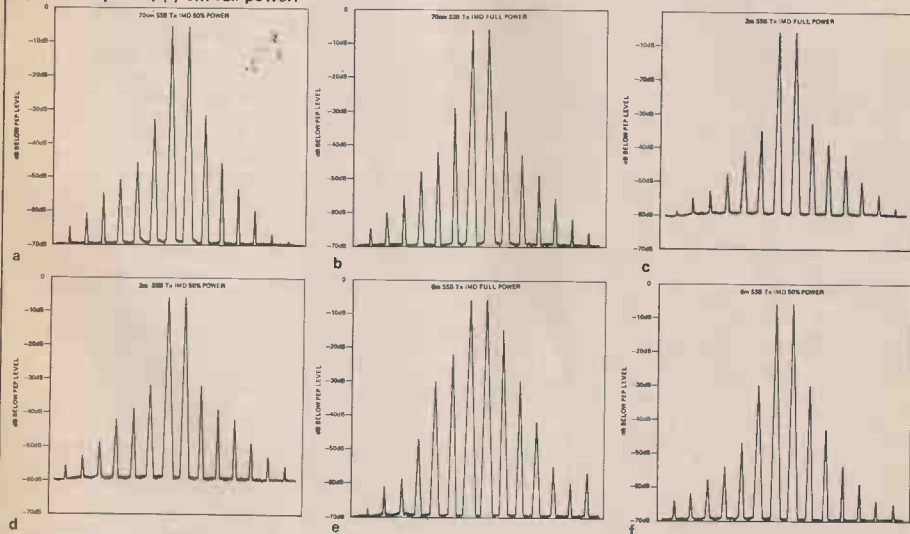



Rear Panel view showing facility connections

Switching into 'narrow' FM mode when operating 12.5kHz away from a strong station certainly gave a good deal better rejection although sometimes at the expense of distorted reception, but it normally didn't help the station I was in QSO with due to the narrower transmit deviation, of course, if they had been equipped with a narrower filter also I'm sure everyone would have benefitted.

Transmit Features

Transmit audio reports were

very pleasing, especially so on SSB with no reports of excessive spreading even when running the RF processor flat out. Likewise on SSB receive I found the AGC to operate well, the 'mid' delay setting often providing a good compromise when tuning around for signals. I must say though that linear amplifier interconnection suffers from the odd drawback. Firstly there is no provision for an external ALC input that I can see, I needed to manually adjust the drive control when

operating on 2m to avoid over-driving my 4CX350A linear. Secondly, although not stated in the manual, the maximum output current available for linear Tx switching is 20mA, this will normally suffice for users of external sequencers and the like but would not be suitable for direct connection to changeover relay coils, an external transistor switch *must* be used so be warned! Although I did not use it myself, users of mast-head preamps may find the facia-mounted preamp on-off switch handy, and this would allow them to dispense with a separate in-line power supply with its inherent connector loss and so on.

Inner Workings

The set is constructed on a metal plate chassis with a cast heat-sink fitted onto the rear panel. Several printed circuit boards with plugged interconnection are used, the odd small sub-board also being fitted vertically onto these. The general arrangement, as may be seen in the accompanying photograph, lends itself to easy access for servicing and alignment. A complete technical description is beyond the scope of this article so I will only attempt a brief overview, even the simplified block diagram takes an hour or so to digest!

A dual conversion superhet receiver is used on 6m and 2m with IFs of 13.69MHz and 455kHz, on the 70cm and 23cm bands, a GAsFET RF amp is employed together with a triple conversion approach, this having first IFs of 47.43MHz and 133.91MHz respectively. All RF processing and first local oscillator generation is performed in the individual band modules, signals to and from the main transceiver taking place at the fixed 13.69MHz IF. Individual multi-loop synthesisers are hence used in each module, allowing the performance to be tailored in each case, with a digital control link to the set's main microprocessor being used for frequency addressing. The synthesiser reference frequency in each case is taken from the set's main TCXO (Temperature Compensated Xtal Oscillator) to give consistent accuracy. On transmit the modulated IF signal is mixed with the locally generated VCO signal up to final RF frequency and amplified

Close-up of front panel controls



with the usual PA module 'brick' in the final stage.

Laboratory Tests

The receiver gave a generally good all-round performance, the synthesiser reciprocal noise mixing effects being exceptionally low. The SSB single-signal selectivity plots show very little 'widening' in the skirt selectivity down at the -70dB and 80dB levels due to this. What I did find though was weak synthesiser-generated sideband signals separated by 15-20kHz from the wanted signal hovering around 90dB down on 6m, 86dB on 2m, and 71dB on 70cm, giving spurious receiver responses at this level. Apart from these, the selectivity slopes on all modes were very sharp giving good adjacent frequency rejection. The strong-signal blocking rejection was very good, especially when measured close-in to the carrier, the intermodulation performance was reasonable although not spectacular, however

it should be totally adequate for most users. The S-meter gave a good dynamic range on SSB, but was rather limited on FM although better than most FM-only sets.

On transmit, the second harmonic on each band was the only one of significance, the 6m one being notably better than many at B2dB down on the carrier level, although I would still recommend further in-line filtering if you live in close proximity to Broadcast Band II listeners. The two-tone SSB intermodulation was reasonable on 2m and 70cm, but a little poor on 6m, if you intend driving a linear amplifier on 6m I would suggest using the minimum drive power possible from the FT736. The full power plots in each case were taken at the onset of TX ALC, driving the audio hard into ALC as well as switching in the RF processor made little difference to the signal width. The frequency accuracy was very good, the set always being within 100Hz of the displayed nominal frequency, and

throughout the lab tests drifted by less than 50Hz which is excellent.

Conclusions

Yaesu's new VHF/UHF base station offers an extremely versatile array of features, coupled with a reasonable RF performance. The synthesiser reciprocal noise level is excellent, very much an improvement over many sets found today, however a few close-in 'birdies' are present. I'm sure the set will be just as popular, if not more so, than its predecessor the FT726, especially for satellite enthusiasts. The set is still in operation here in my shack, and I'll be very reluctant to send it back!

My thanks go to South Midlands Communications Ltd for the loan of the review transceiver.

Just as we went to press, the 1296MHz module arrived in the UK and Yaesu announced modifications designed to improve the spurious responses mentioned in the review. So look out next month for the FT736 update!

LABORATORY RESULTS

Receiver

Sensitivity: input level in μ pd required to give 12dB SINAD			
Mode	51MHz	145MHz	433MHz
SSB/CW	0.105	0.123	0.111
FM(N)	0.147	0.178	0.134
FM(W)	0.187	0.207	0.163

FM Adjacent Channel Selectivity Measured as increase in level of interfering signal, modulated with 400Hz at 1.5kHz deviation, above 12dB SINAD ref. level to cause 6dB degradation in 12dB SINAD on-channel signal

Mode	Band		
	51MHz	145MHz	433MHz
FM(N)			
+12.5kHz	75dB	66dB	64dB
-12.5kHz	72dB	59dB	69dB
+25kHz	86dB	76dB	74dB
-25kHz	82dB	72dB	70dB
FM(W)			
+12.5kHz	57dB	58dB	53dB
-12.5kHz	54dB	50dB	46dB
+25kHz	85dB	80dB	73dB
-25kHz	82dB	78dB	71dB

Blocking Increase over 12dB SINAD level of interfering signal, unmodulated carrier (SSB/CW), and modulated with 400Hz at 1.5kHz deviation (FM), causing 6dB degradation in 12dB SINAD on-channel signal

Spacing	Band		
	51MHz	145MHz	433MHz
*100kHz			
SSB/CW	92dB	101dB	95dB
FM	96dB	92dB	91dB
*1MHz			
SSB/CW	109dB	102dB	101dB
FM	101dB	98dB	98dB
*10MHz			
SSB/CW	113dB	104dB	
FM	106dB	104dB	103dB

Intermodulation Rejection Increase over 12dB SINAD level of two interfering signals giving identical 12dB SINAD on-channel 3rd order intermodulation product, measured with 25/50 and 50/100kHz spacing

Mode	Band		
	51MHz	145MHz	433MHz
SSB/CW	72dB	76dB	69dB
FM	72dB	76dB	69dB

Image Rejection Increase in level of signal at first IF image frequency giving over level of on-channel signal to give identical 12dB SINAD signals

Frequency	51MHz	145MHz	433MHz
Level	87dB	101dB	97dB

S-Meter S9 Sensitivity

Mode	51MHz	145MHz	433MHz
SSB/CW	5.00 μ V pd	6.31 μ V pd	5.53 μ V pd
FM(W)	1.68 μ V pd	1.70 μ V pd	0.94 μ V pd
FM(N)	1.88 μ V pd	1.92 μ V pd	1.05 μ V pd

S-Meter Linearity (Measured at 145MHz)

Indication	Sig. Level (SSB)	Sig. Level (FM)
S1	0.387V (-24.2dB)	0.155 μ V (-21.4dB)
S2	0.500 μ V (-22.0dB)	0.467 μ V (-11.9dB)
S3	0.643 μ V (-19.8dB)	0.707 μ V (-8.3dB)
S4	0.838 μ V (-17.5dB)	0.890 μ V (-6.3dB)
S5	1.11 μ V (-15.1dB)	1.07 μ V (-4.7dB)
S6	1.55 μ V (-12.2dB)	1.24 μ V (-3.4dB)
S7	2.31 μ V (-8.7dB)	1.42 μ V (-2.2dB)
S8	3.58 μ V (-4.9dB)	1.61 μ V (-1.1dB)
S9	6.30 μ V (0dB ref)	1.83 μ V (0dB ref)
S9+20	46.7 μ V (+17.4dB)	2.56 μ V (+2.9dB)
S9+40	0.291mV (+33.3dB)	4.55 μ V (+7.9dB)
S9+60	1.46mV (+47.3dB)	9.61 μ V (+14.3dB)

Transmitter

Band	Power		
	6m	2m	70cm
Max Tx Power	14.45W	26.3W	27.2W
Harmonics/Spurri			
2nd Harmonic	-82dBc	-84dBc	-69dBc
3rd Harmonic	<-90dBc	<-90dBc	<-90dBc
All higher-order harmonics up to 1.8GHz	<-90dBc	<-90dBc	<-90dBc
Spurri (see text)	<-90dBc	-62dBc	-66dBc
FM Peak Deviation			
FM(W)	4.46kHz	4.50kHz	4.51kHz
FM(N)	2.60kHz	2.65kHz	2.68kHz

Listening On...



when you want to keep the programme at the same time of day throughout the year and when many of your listeners are using insensitive transistor portable receivers rather than the communications receivers and efficient antennas that radio amateurs tend to use. For the non-technical listener, too, it can be very confusing if his favourite radio programme, which for months or years has been broadcast at the same spot on his radio (say, around 21MHz) suddenly moves to 15MHz. So, although broadcast stations do change their frequencies four or six times annually, most transmitter planning engineers try to keep their programmes for a particular target audience in more-or-less the same place in the spectrum for as long as possible. One way to achieve this is to use relay stations closer to the target audience.



Tien-an-Min square, in Peking (Beijing) — from a Radio Beijing QSL card

Our bi-monthly guide to the international broadcast scene solves a Chinese riddle and says that Helsinki's transmitters aren't Finished yet!

In the November 1986 *Listening On* I made the prediction that more and more broadcast stations would make relay agreements with foreign governments and (theoretically, at least) competing stations, in order that their voices be better heard in the target areas. Well, perhaps the planning people of these organisations read *Ham Radio Today*, because in the last few months there has been a spate of agreements and new relay stations coming on the air!

Relays revisited

Even with 250 or 500kW of power to play with, and antennas giving around 20dBd gain, it can be very difficult to ensure good reception of a programme on the other side of the world, especially

An aerial view (pun intended!) of the Noblejas transmitter site near Madrid which should soon be used for relays of Radio Beijing programmes.



Radio Canada International

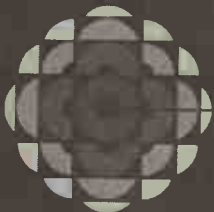

station in South America. The agreement fell through for political reasons, but now, a year later, there are many reports in the short wave radio media that Radio Beijing has signed a similar agreement, this time with the Spaniards. This is to be a reciprocal agreement, ie. Radio Beijing's programmes would be relayed for North America via Radio Exterior de España's transmitters near Madrid, while REE's programmes for the Far East, which at present are apparently only poorly received, would be relayed from Chinese transmitters.

Meanwhile, the Chinese have already reached agreement with the Swiss, and some Radio Beijing programmes are now being relayed on 6165 and 3985kHz for listeners in Western Europe from Swiss Radio International's site. If this were not enough, from early November last year Radio Beijing's programmes were being heard by short wave listeners in Europe and North America on two frequencies quite clearly not coming from China, but not admitted to by the Swiss either. There was much speculation on various DX programmes such as *Media Network* on Radio Netherlands, *Sweden Calling DXers* and Radio Canada International's *SWL Digest* as to where these transmissions were coming from. The most likely contenders seemed to be the Radio Trans Europe site in Portugal, which leases transmitter time out to more-or-less anyone who is willing to pay; 'Africa No 1' in Gabon or one of the Spanish transmitter sites.

However, at the end of November, all was revealed. On *Media Network*, Jonathan Marks, the producer-presenter of the programme, said that he had heard that these strange transmissions were coming from Mali in West Africa, so he phoned the official broadcasting station in Mali and asked them directly if this was so. A transmitter engineer there confirmed the story — there was no secret apparently, it was just that no-one had asked them before and they did not seem to think that anyone would be interested to know where the transmissions came from! The Mali station had a couple of ancient transmitters which had been off the air for many years, as there had not been sufficient money to keep them properly maintained and anyway, the Malinese did not need an external broadcasting station. The Chinese got to know about this, volunteered to repair the transmitters, added a satellite-receiving station and voilà, an instant relay.

Also on *Media Network* was news that the *Christian Science Monitor World Service* radio station, which presently transmits from a single 500kW station near Boston, was planning to put a second 100kW transmitter into operation at radio KYOI on Saipan in the Mariana Islands, south east of Japan. WSCN, the *Christian Science Monitor*, already owns KYOI, and as we have also reported before in *Listening On* is still planning to use this as a relay station. They are also planning to

build a second station in the USA itself, this one to be down in the deep south at Savannah, Georgia and to be used for transmission to Canada and South America.

The BBC has not been idle in the relay station stakes either. Its Hong Kong relay is now on the air, and giving broadcast DXers another country to chase. It broadcasts in Chinese, and also carries BBC World Service on 11775kHz at 0400-0900 GMT, 15280kHz at 0400-0815 GMT and on 11820 and 15435kHz at 2330-0030 GMT. Meanwhile, the BBC relay being built on the Seychelles is well on the way to completion.

Finally, Radio Canada International has announced that its programmes will very shortly be relayed by new facilities in Japan. NHK, the Japanese Broadcasting Corporation, has been renewing equipment at its transmitting site at Yamata, about 150kms from Tokyo, some of which dated from before the second world war, and RCI has made an agreement to use this in exchange for broadcasting *Radio Japan's* programmes from the RC1 site at Sackville, New Brunswick. Starting on 4th April, RCI will broadcast for three hours a day to Asia and Siberia in English, French, Japanese, Russian, and Ukrainian.

The Winter Olympics

Having mentioned Radio Canada International, I cannot fail to also mention the 15th Olympic Winter Games, which take place in Calgary, Alberta from 13th-28th February. RCI is mounting a massive outside broadcast operation for this event, the first time the winter Olympics have been held in Canada. They will broadcast live from the Games in English, French, Russian, German, Czech and Slovak, and listeners to other language services will hear recordings and up-to-the-minute reports on what has been happening at Calgary. At the time of writing, it is not clear if RCI's live English broadcasts from the Olympics will deviate from their regular transmission schedule or not. Assuming they stick to their planned times and frequencies, Radio Canada International can be heard in English in Europe at the times and on the frequencies shown in the table.

GMT	Frequencies (kHz)	Notes
0615-0630	6050 6140 7155 9740 9760 11840 15235	Monday-Friday
0645-0700	ditto	
1545-1600	9555 11915 11935 15315 15325 17820	daily
1800-1830	15260 17820	daily
1830-1900	15260 17820	Sat. & Sunday
1900-1930	15260 17820	Monday-Friday
1930-2000	5995 7235 11945 15325 17875	Monday-Friday
2100-2130	5995 7130 11945 15325	daily
2130-2200	11880 15150 17820	daily
2200-2300	9760 11945	Monday-Friday
2130-2200	5995 7130 11945 15325	Sat. & Sunday
	(this is a different programme to the one at the same time on 11880, 15150 and 17820 kHz.)	

Radio Canada's English Broadcasts.

Don't worry if some of the times and frequencies look propagationally unlikely: RCI uses relay stations in Daventry and Portugal! All the above frequencies are valid until 26th March; after that date some of them change, though the majority remain the same. This information came from RCI's own programme schedule, which they will send free of charge to any listener upon request, as do most stations broadcasting to an international audience. Their address is: Radio Canada International, PO Box 6000, Montreal, Canada, H3C 3A8.

Transmitter trouble

It can't be all plain sailing getting a very high power broadcast station on the air. This has been shown by Radio Finland, who have been having some awful problems with their new transmitter at Pori, in south western Finland. This station should have been in full operation many months ago, but for weeks on end last year there were frequent announcements saying that due to maintenance work at Pori they would only be using one out of the scheduled three frequencies for certain transmissions, or sometimes they would be off the air altogether for several hours. They seem to have got it right on medium wave though, for their new 600kW transmitter on 963kHz is very much stronger than their old, lower power one. It even forced Radio Monique, the Dutch-language pirate station on the same ship as Radio Caroline, from 963 to 891kHz before a bad storm forced them off the air altogether. Two weeks later, at the time of writing, they are still off the air, though I guess they will be back. Going back to Radio Finland, their



English programme (when it is being broadcast normally) is at 0930-1000 on 6120, 11755 and 15265kHz. Programmes in Finnish, Swedish and English can also be heard during the late evening on 963kHz.

The Voice of South Africa

From the snows of Canada and Finland to the sunshine and deserts of apartheid South Africa. Radio RSA started broadcasts in May 1966 and nowadays broadcasts for 208 hours a week in eleven languages: English, French, German, Portuguese, Spanish, Dutch, Afrikaans, Swahili, Chichewa, Lozi and Tsonga. Radio RSA's official purpose is to *foster understanding of South Africa among other nations and to counter propaganda against South Africa*. naturally, this means that their commentaries and some other programmes express the official South African government point of view of world affairs, and the apartheid question in particular. However, their news is quite objective and the non-political programmes are presented in an often light-hearted and friendly way. One of Radio RSA's most popular programmes is *PO Box 4559* their mailbag show, which answers questions from listeners about any topic. It is broadcast on Sundays in the 1100 GMT transmission, on Saturdays in the 1300 and 2100; and on Fridays in the 1500 trans-

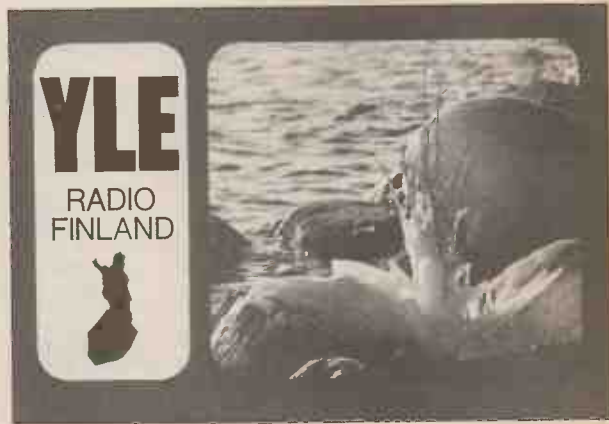



The presenters of Radio RSA's Current Affairs programme, 'Africa Today', l. to r.: Colin Houston, Wallace Baird, Clive Ravenscroft, Virginia Haas, Dave Holt-Biddle, June Palmer and Mike Shepstone.

missions.

Another popular programme, especially among short wave listeners, is the *DX Corner* broadcast on Sundays in the 0630 and 2100 broadcasts. Radio RSA says it wants to strengthen existing bonds of friendship and win new friends for South Africa. One way it sets out to do this is to set great store by listeners' participation in

programmes, which means listeners' questions about South Africa, even on controversial topics, are often answered in programmes. After the news at 1500GMT, a listener's question is answered as clearly as possible every day, Monday to Friday. One of my favourite programmes on this station is called *Our Wild Heritage*, which takes a look at the wild life,

game parks and conservation measures in South Africa, and is broadcast in the 1400 GMT programme on Fridays. During the last sunspot maximum, Radio RSA was one of the few stations to use the 11 metre band for inter-continental broadcasting with, thanks to trans-equatorial propagation, 25790kHz putting in a reliable signal almost daily. A few years ago they finally gave up the struggle against the lack of sunspots, and reverted to the 13 metre-band and this is proving very reliable. At present, Radio RSA can be heard in Britain at 0630-0730 on 17790 or 17825kHz, at 1100, 1300, 1400 and 1500 GMT on 21590kHz continuously from 1100-1600 GMT in English, except for 1200-1300 when programmes are in French, and finally at 2100-2200 GMT on 9580 and 11900kHz. For an up-to-date frequency schedule or programme schedule, you can write to: Radio RSA, English Service, PO Box 4559, Johannesburg, 2000, South Africa. This is also the address to send reception reports to, which are appreciated by the station and confirmed upon request with colour photograph QSL cards showing views of South Africa, its flora and fauna, etc.

Table Mountain, near Cape Town — one of Radio RSA's QSL cards.



RADIO Tomorrow

- 1 Feb** Todmorden DARS: AGM.
Hambleton ARS: RAE Course. Details — Ken Shearman, G1XLZ (0609) 775478.
- 2 Feb** Rugby ATS: Night on the air.
Wakefield DRS: Night on the air.
Workshop ARS: Video night — 'Electromagnetic Wave'; 'The Electron's Tale'; Thin Film Microcircuits'
Fylde ARS: Visit to Blackpool Police HQ. 7.30pm.
Ealing DARS: Morse Training with Bill G3SGT, 7.30pm The Community Centre, 71a Northcroft Road, Ealing.
East Lancashire RC: Film show.
Stevenage DARS: HF Operating forum, Sitec Ltd, Ridgemoor Park, Telford Ave, Stevenage.
- 3 Feb** Cheshunt DARC: Natter evening Church Room, Church Lane, Wormley, Nr. Cheshunt, Herts. 8pm.
S Bristol ARC: Talk 'Ambulance equipment' by Clive G4OPO. Whichurch Folk House, East Dundry Rd, Whichurch, Bristol.
- 4 Feb** Yeovil ARC: Talk 'A Simple Shortwave Receiver' by G3MYM.
Bredhurst RTS: Talk 'How to Use a "scope"' by Bernie Bowden G0ENN.
Salop ARS: Talk 'Model Steam Engines' by G0EBD.
Horsham ARC: Talk — 'How linear is your linear?' by G3WZT.
Vale of Evesham RAC: Skittles, The Round of Gras, Badsey, 7.30pm. Info — Mike G4UXC on Evesham 831508 or Peter G6JNS on MBX 219999979.
East Kent RS: KANGA products introduce their amateur radio kits, Dick Pascoe, G0BPS and Ian Keyser, G3ROO, 7.30pm Parkside Lodge, Kings Road, Herne Bay. Info from Brian Didmon, G4RIS. Whitstable 26042.
North Wakefield RC: Natter night. Details — Steve Thompson, G4RCH. Leeds 536633.
Barry College of Further Education RS: Video 'Aerial construction & principles' by G6CJ.
- 5 Feb** Coventry ARS: DF Finding contest (Cup qualifier). 8.00pm. Baden Powell House, 121 St. Nicholas St, Radford, Coventry.
Dunstable Downs RC: AGM.
- 8 Feb** Atherstone ARC: RSGB film.
Hambleton ARS: RTTY by Barry Wilkinson. Details — Ken Shearman, G1XLZ (0609) 775478.
- 9 Feb** Rugby ATS: Constructors corner.
Keighley ARS: Natter night.
Wakefield DRS: Club project — introduction.
Willenhall DARS: Junk Sale.
Workshop ARS: Natter nite.
Ealing DARS: Open evening, 7.30pm. The Community Centre, 71a Northcroft Road, Ealing.
- 10 Feb** Farnborough DRS: Talk/Demo: 'Packet Radio' by G3RRA. 7.30 for 8.00pm. Railway Enthusiasts Club, Harley Lane, Farnborough. Further details from Tim Fitzgerald (G4UQE) on Camberley 29231.
Willenhall DARS: Junk Sale. 8.15pm Cross Keys Inn, Ashmore Lake Rd, Willenhall, W. Midlands. Info — Dave Jackson, G0EGG (0902) 734475.
Cheshunt DARC: Aerial planning. Church Room, Church Lane, Wormley, Nr. Cheshunt, Herts. 8pm.
S Bristol ARC: 10m activity evening with Peter GODRX. Whichurch Folk House, East Dundry Rd, Whichurch, Bristol.
- 11 Feb** Bredhurst RTS: Construction and natter night.
Salop ARS: Natter night.
Edgware DRS: Talk 'Computer databases and their application' by G4IUZ.
North Wakefield RC: On the air — G4NOK. Details — Steve Thompson, G4RCH. Leeds 536633.
Southgate ARC: Talk on Energy by CEGB. 7.45pm Holy Trinity Church Hall (Upper), Green Lane, Winchmore Hill, London N21.
Yeovil ARC: Talk 'Moon bounce' by G3MYM. 7.30pm. Recreation Centre, Chilton Grove, Yeovil. Details from David Bailey G1MNM on (0935) 79804.
- 12 Feb** Wimbledon DARS: Surplus Equipment sale. Herbert Rd, Wimbledon, London SW19 Info from David Love (0737) 51559.
Itchen Valley RC: Talk 'Manual Telegraphy or CW' by Mort G3JZV.
Loughton DARS: Informal evening. Loughton Hall, Rectory Lane, Loughton, Essex.
Coventry ARS: Night on the air and Morse tuition. 8.00pm. Baden Powell House, 12 St Nicholas St, Radford, Coventry.
- 14 Feb** Porthmadog DARS: Talk 'Microprocessors Part 2' by GW3UTI.
- 15 Feb** Todmorden DARS: Morse activity evening.
Halifax DARS: Junk sale.
Hambleton ARS: RAE Course. Details — Ken Shearman, G1XLZ (0609) 775478.
- 16 Feb** Workshop ARS: Talk 'The history of amateur radio' by Bill Parry (Founder member).
Fylde ARS: Informal natter night.
Ealing DARS: Talk — 'TVI Dfing' by L Robotham G8KLN. 7.30pm The Community Centre, 71a Northcroft Road, Ealing.
Stevenage DARS: Talk on planning permission. Sitec Ltd, Ridgemoor Park, Telford Ave, Stevenage.
- 17 Feb** Cheshunt DARC: Natter evening. Church Room, Church Lane, Wormley, Nr Cheshunt, Herts. 8pm.
S Bristol ARC: Talk 'Ambulance equipment' by Clive G4OPO. Whichurch Folk House, East Dundry Rd, Whichurch, Bristol.
- 18 Feb** Salop ARS: Talk 'Leadmines' by G4ZZP
East Kent RS: Natter Night. 7.30pm. Parkside Lodge, Kings Road, Herne Bay. Info from Brian Didmon,

Didmon, G4RIS. Whitstable 26042.
 North Wakefield RC: Talk 'Machine monitoring of health in the mining industry' by GOCOA. Details Steve Thompson, G4RCH. Leeds 536633.
 Barry College of Further Education RS: Amateur radio quiz.
 Yeovil ARC: RSGB Video 'The world of a amateur radio' 7.30pm Recreation Centre, Chilton Grove, Yeovil. Details from David Bailey G1MNM on (0935) 79804.

19 Feb Sutton & Cheam RS: Talk 'Commercial antennas and feeders' by John Tranter.
 Coventry ARS: Talk 'Computers (The Big Ones!)' by G0AJB. 8.00pm. Baden Powell House, 121 St. Nicholas St, Radford, Coventry.

20 Feb Cheshunt DARC: Talk — 'Marine Radio Communication' by G4SEV. Church Room, Church Lane, Wormley, Nr. Cheshunt, Herts. 8pm.
 Dunstable Downs RC: Ten-pin bowling at Chicksands.

21 Feb Sheffield ARC: Special event station GB4GOS, celebrating Guides' thinking day. Venue: Guides' HQ, Tripett Lane, Sheffield.

22 Feb Atherstone ARC: Night on the air.
 Hambleton ARS: Talk 'Satellite Operations' by Wilf Walker and Brian Anderson. Details — Ken Shearman. (0609) 775478.

23 Feb Keighley ARS: Talk 'Ten metres' by G4YDI.
 Worksop ARS: Natter nite.
 Verulam ARC: Talk 'EMC Matters' by Angus McKenzie G3OSS. RAF Assoc HQ, New Kent Rd, St. Albans. Further info from Hilary G4JKS on St. Albans 59318.
 Ealing DARS: Computers — Radio. 7.30pm. The Community Centre, 71a Northcroft Road, Ealing.

24 Feb Farnborough DRS: Talk 'Instrumentation' by G3HEJ 7.30 for 8.00pm Railway Enthusiasts Club, Harley Lane, Farnborough. Further details from Tim Fitzgerald (G4UQE) on Camberley 29231.
 S Bristol ARC: Bristol rally — planning evening. Whitechurch Folk House, East Dundry Rd, Whitechurch, Bristol.

25 Feb Bredhurst RTS: Radio Rally Briefing.
 Salop ARS: Talk 'Early television' by G3BZQ.
 Edgware DRS: Talk 'patents for everyone' by G3SJE.
 North Wakefield RC: Monthly meeting. Details — Steve Thompson, G4RCH. Leeds 536633.
 Southgate ARC: Informal evening. 7.45pm Holy Trinity Church Hall (Upper), Green Lane, Winchmore Hill, London N21.
 Yeovil ARC: Natter night. 7.30pm. Recreation Centre, Chilton Grove, Yeovil. Details from David Bailey G1MNM on (0935) 79804.

26 Feb Wimbledon DARS: Meet the committee evening. Herbert Rd, Wimbledon, London SW19. Info from David Love (0737) 51559.
 Itchen Valley RC: Talk 'Voyager Satellite' by Dick, G6GLQ.
 Loughton DARS: Junk Sale. Loughton Hall, Rectory Lane, Loughton, Essex Loughton Hall, Essex.
 Coventry ARS: Night on the air and Morse tuition. 8.00pm. Baden Powell House, 121 St. Nicholas St, Radford, Coventry.

27 Feb Third Rainham Radio Rally. 10am Special event station GB4RRR. Parkwood Community Centre, Deanwood Drive, Rainham, Kent, Gillingham. Trades, bring and buy, refreshments, raffle.



- Admission 50p. Talk in on S22, SU22, 28.5MHz. Details — Bob Mullett, G1LKE (0634) 362154 or MBX Prestel 819991488.
 Cheshunt DARC: Natter evening. Church Room, Church Lane, Wormley, Nr. Cheshunt, Herts. 8pm.
- 28 Feb Taw & Torridge Rally BAAC, The Pill, Bideford, N. Devon. Details from GOAYM. QTHR GOAYM. QTHR 02375-488.
- 29 Feb Hambleton ARS: AGM. Details — Ken Shearman, G1XLZ (0609) 775478.
- 1 Mar Rugby ATS: Craft Fair planning night.
 Wakefield DRS: Night on the air.
 Worksop ARS: Magazine sale.
 Ealing DARS: Committee meeting. 7.30pm. The Community Centre, 71a Northcroft Road, Ealing, East Lancashire RC: Surplus equipment sale.
 Stevenage DARS: Construction evening. Sitec Ltd, Ridgmond Park, Telford Ave., Stevenage.
- 2 Mar Cheshunt DARC: 'Data transmission' by G4LJE. Church Room, Church Lane, Wormley, Nr. Cheshunt, Herts. 8pm.
 S Bristol ARC: Microwave workshop — Glen Ross with G8MWR/G0FGZ Whitechurch Folk House, East Dundry Rd, Whitechurch, Bristol.
- 3 Mar Bredhurst RTS: Talk 'The new collectors' by Tony Cockle G3IEE.
 Salop ARS: Video night — circuit design.
 Horsham ARC: Spring junk sale.
 Vale of Evesham RAC: Talk by Microwave Modules. The Round of Gras, Badsey. 7.30pm. Info — Mike G4UXC on Evesham 831508 or Peter G6JNS on MBX 2199999979.
 East Kent RS: Annual Junk sale. 7.30pm. Parkside Lodge, Kings Road, Herne Bay. Info from Brian

- Didmon, G4RIS. Whitstable 26042.
North Wakefield RC: Visit to Birkenshaw Fire Station. Details — Steve Thompson, G4RCH. Leeds 536633
Yeovil ARC: Talk 'Aerial Matching' by G3GC. 7.30pm. Recreation Centre, Chilton Grove, Yeovil. Details from David Bailey G1MNM on (0935) 79804.
- 4 Mar Coventry ARS: Surplus Equipment sale. 8.00pm. Baden Powell House, 121 St. Nicholas St, Radford, Coventry.
- 5 Mar Blue Star Rally, Newcastle. Venue — High Gosforth Park Racecourse (5mls N of Newcastle upon Tyne). Trade stands, morse tests, bring and buy, refreshments. Talk In on 2m wth GBOBSR. Details from Terry G8VEG on 091 2866 908.
- 6 Mar 8th Annual Welsh Amateur Radio Rally. Barry Leisure Centre. Opens 11am (10.30am for the disabled). Trade stands, bring and buy, RSGB book stall and morse testing facilities. Leisure centre facilities (swimming pool, bar, cafeteria) also available. Enquiries — Mike Adcock GW8CMU: (0446) 711426.
- 7 Mar Sheffield ARC: Talk 'Principles of Aerials' by Barry Chambers G8AGN.
- 8 Mar Keighley ARS: Natter night.
Wakefield DRS: Talk 'Morse adaptors for FM and other TXs by G1PNV.
Workshop ARS: Natter nite.
Ealing DARS: Morse Training with Bill G3SGT. 7.30pm. The Community Centre, 71a Northcroft Road, Ealing.
- 9 Mar Cheshunt DARC: Natter evening. Church Room, Church Lane, Wormley, Nr Cheshunt, Herts. 8pm. S Bristol ARC: QRP activity evening with John G4YQH. Whitchurch Folk House, East Dundry Rd, Whitchurch, Bristol.
- 10 Mar Bredhurst RTS: Construction and natter night.
Salop ARS: Natter night.
Edgware DRS: Informal with training for 'Great Egg Race'.
North Wakefield RC: G4NOK on air. Details — Steve Thompson, G4RCH. Leeds 536633.
- 11 Mar Wimbledon ARC: Talk 'The Metropolitan Railway' by G1ADW. Herbert Rd, Wimbledon, London SW19
Info from David Love (0737) 51559.
Itchen Valley RC: AGM.
Loughton DARS: Informal evening. Loughton Hall, Rectory Lane, Loughton, Essex.
Coventry ARS: Night on the air and morse tuition. 8.00pm. Baden Powell House, 121 St. Nicholas St, Radford, Coventry.
- 13 Mar Bury Radio Society Annual Rally at the Castle Leisure Centre, Bolton Street, Bury, Lancs. Opens at 10am. Many stalls, bring and buy, displays and trade stands. Ample parking and refreshments available. Talk in on S22. Further details from G1VQE QTHR.
Wythall RC: 3rd Annual Wythall RC Rally. Opens 12 noon. Admission 50p (OAPs & Accompanied children free). Trade stands, RSGB morse tests, junk, flea market, bar and snacks. Free parking. Wythall Park, Silver Street, S of Birmingham on A435, 2 miles from Junction 3 on M42. Talk in on S22. Stand bookings and info from Chris G0EYO on (021) 430 7267.
- 15 Mar Wakefield DRS: Club project — surgery.
Halifax DARS: Microwave Modules demo.
Workshop ARS: Official Club Meeting.
Ealing DARS: Preparation for BARTG Spring Rally RTTY Contest with GBMPGP-G1ZTN. 7.30pm. The Community Centre, 71a Northcroft Road, Ealing.
Stevenage DARS: AGM. Sitec Ltd, Ridgemoor Park, Telford Ave, Stevenage.
- 16 Mar Cheshunt DARC: Talk '50MHz One year on' by G3WFM. Church Room, Church Lane, Wormley, Nr Cheshunt, Herts. 8pm.
S Bristol ARC: Inter-club contest — 'Bullseye', Whitchurch Folk House, East Dundry Rd, Whitchurch, Bristol.
- 17 Mar Bredhurst RTS: AGM.
Salop ARS: DF hunt.
Vale of Evesham RAC: Natter night. The Round of Gras, Badsey. 7.30pm. Info — Mike G4UJC on Evesham 831508 or Peter G6JNS on MBX 21999979.
North Wakefield RC: Club project night. Details — Steve Thompson, G4RCH. Leeds 536633.
Barry College of Further Education RS: Video 'Amateur TV as used in our hobby'.
Porthmadog DARS: Home brew kits and projects.
- 18 Mar Sutton & Chems RS: Construction contest.
Coventry ARS: Illustrated talk on astronomy. 8.00pm. Baden Powell House, 121 St. Nicholas St, Radford, Coventry.
- 20 Mar Tiverton SWRC Mid-Devon Rally. At the Pannier Market, Tiverton from 10am. Eight mins from Junction 27 of M5; free parking, two halls of trade stands, bring and buy, refreshments. Talk in on S22. Further info from: Mid-Devon Rally, PO Box 3, Tiverton, Devon.
Cambridgeshire Repeater Group: Junk Sale Rally Extravaganza. All day event from 10.30am. Phillips RCS (Pye Telacom) Canteen, St. Andrews Road, Chesterton, Cambs. Free parking, bring and buy, trade stalls and refreshments. Talk-in on S22 and RB14 (GB3PY) by G5PI. Proceeds to finance 6 local repeaters. Details: G8XMS, QTHR. Tel: 022-023-3362.
Pontefract DARS: 8th Annual Components Fair, Carleton Community Centre, Carleton, Pontefract. 11am-4.30pm. Trade stands, bar, bring and buy, prize draw and space for car boot sales. Free admission. Talk in on S22. Info from Colin Miles G0AAO on (0977) 43101.
- 22 Mar Fylde ARS: Informal natter night.
Workshop ARS: Natter nite.
Ealing DARS: Talk 'Innovations in Japanese Equipment' by Martin G4HKS. 7.30pm. The Community Centre, 71a Northcroft Road, Ealing.
- 23 Mar Willanhall DARS: AGM — Cross Keys Inn, Ashmore Laka Rd, Willenhall, W Midlands. Info — Dave Jackson, G0EGG (0902) 734475.
Cheshunt DARC: Natter evening. Church Room, Church Lane, Wormley, Nr Cheshunt, Herts. 8pm. S Bristol ARC: Contest planning event. Whitchurch Folk House, East Dundry Rd, Whitchurch, Bristol.
- 24 Mar Bredhurst RTS: Construction and natter night.
Salop ARS: Talk 'All at sea' with GW4XXF.
North Wakefield RC: Talk 'Power generation and Dinorwic' by Trevor Parkinson, CEBG. Details — Steve Thompson, G4RCH. Leeds 536633.

BOOK PAGE

Short Wave Radio Listeners Handbook

Good books on short wave listening and amateur radio are few and far between and Arthur Miller's Short Wave Radio Listeners Handbook falls into the 'good' category. The introductory chapter deals with what exactly short wave is and what it has to offer and included here are explanations of simple terminology which would be useful to a beginner, such as 'wavelength' and 'frequency'. Also outlined are the types of stations available on the different bands, broadcast, amateur, utility etc. and an explanation of the various transmission modes and how the short wave listener can resolve these.

Propagation, and its effects on reception is clarified by references to the ionosphere and sunspots, with accompanying graphs. The graphs themselves are fairly extensive in explaining the effects as they cover a ten year period. Interference is also explained, with reference being made to the Q code names for the different types, and this leads on to fuller details about the abbreviations used in short wave listening.

The following section focusses on receivers and antennae, guiding the prospective buyer through the intricacies of what to look for. This is written in a clear, methodical and easy to follow style with a lengthy list of brief questions which should be asked by someone about to buy a receiver. This is then expanded into careful detail about some of the features, such as BFO's, attenuators, filters, S-meters and frequency pre-sets. Examples of various recent receivers are shown with photos, and a general section on each which details what sort of facilities they have. The antenna section which compliments this offers advice on both interior and external aerial systems with helpful and simple diagrams and designs.

Although both broadcast and amateur radio stations are topics covered by the hand-book, a little more attention does tend to be given to the latter, principally because of

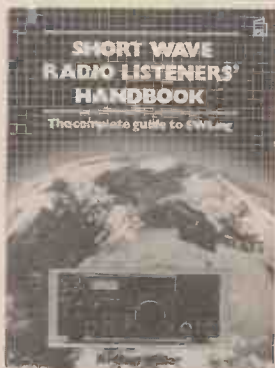

the more 'alien' nature of ham radio, with a good example of this being a typical conversation between two stations. To the unacquainted ear or eye it would appear as gobblegooked as a tax form, and appropriately this leads into easy to understand explanations of the phonetic alphabet, how to write reception reports using the RST code and further details are given about the international Q code. A similar approach is taken with CW, there is an extensive section on call signs and the rules and regulations regarding amateur radio operating are clearly laid out for the uninitiated. The broadcast section deals with the types of programmes readily available from station to station, who is where on the bands and a fairly large part is devoted to the past and present activities of Swiss Radio International by way of an insight into a typical SW broadcast station.

Other sections deal with the HF, VHF and UHF amateur bands with descriptions of what is where and which receivers have the facilities to receive them. A small but comprehensive review of receivers specifically designed for this use is included, and again, an antenna section complements this, with details of manufacturers. Building on the propagation theory covered earlier in the book, the mechanism of Sporadic-E is explained. A more extensive explanation of QSL cards

and SWL cards is given under the 'verifications' chapter which incorporates some tips on how to verify stations when listening to them, and in turn, how to keep a log book. 'Measuring Achievements' is an interesting section which attempts to clarify what actually constitutes a country, since some of the more obscure 'homelands' created by South Africa are, rightfully so, not accorded separate status by the ARRL, even though the ITU has allocated block call signs to them. Different zoning systems are also discussed, and this leads on to what contests are run, by whom, what they are like and how long they run for. As in other parts of the book, graphs illustrate the section, and pertain to the countries heard over a given period during contests.

One of the concluding chapters deals with how to become involved in amateur radio if the bug has bitten after much SWling. It details the actual composition of the papers and goes some way to listing the regulations which govern the operation of ham radio stations. CB radio also receives attention, a brief history and background are given, the difference between CB and ham radio is explained and the regulations for CB are outlined.

A wide range of appendices are incorporated in this useful handbook — ITU block call sign allocations, short wave radio countries and prefixes, ham radio prefixes, morse code, Q-code and other abbreviations; short wave broadcast station addresses, DX bulletins in English from broadcast stations, and a general list of frequencies used by broadcast stations.

In conclusion, this is a very comprehensive and readable handbook which explains its subject lucidly in its 200 pages. It is an excellent starting point for a beginner and can act as a permanent reference source at the side of the receiver. Arthur Miller's 'Short Wave Radio Listeners Handbook' is published by Patrick Stephens Ltd, cost £6.99 and can be thoroughly recommended to any budding short wave enthusiast.

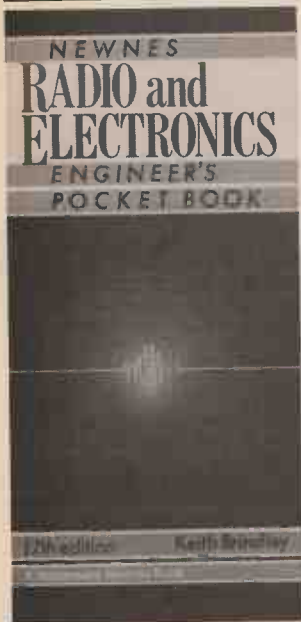

Radio & Electronics Engineers Pocket Book

Although there are a good number of reference guides available for the radio amateur most of them suffer from the problem of either needing a shopping trolley to carry them about or are such brief works that there isn't really all that much information in them in the first place. Keith Brindley's 'Pocket Book' is now in its 17th edition and that fact alone must say something for its usefulness. Although only measuring 9x19.5cms (3.75x7.75 inches) the book manages to pack just about every conversion factor, electrical constant, component symbol, formula and plug connection known into its 200 pages.

An extensive section covering TTI and CMOS ICs gives pin-out details and operating parameters and the transistor section gives equivalents and data for commonly occurring devices. The more directly radio orientated part of the book offers UK TV and AM/FM radio allocations, including details of the various types of TV systems used in other parts of the world and list of international callsign allocations

are also provided. At a price of £6.95 for this handy 200 page reference book the 'Radio & Electronics Engineers Pocket Book' written by Keith Brindley and published by Heinemann, is certainly worth recommending.

The CB EPROM Data Book

Before the anti-CB lobby throw their hands up in horror perhaps we should say that this 54 page offering from Martin Pickering is specifically intended to help radio amateurs get their not-awfully-legal CB sets onto the 10m ham band. Although the precise legal situation with regard to duty due on such sets is rather obscure, it has got to be said that a converted CB rig used by a radio amateur on 10m is preferable to an unconverted set in other hands.

Although the book is described as dealing with 'advanced frequency techniques, true enough for the average CBER, it is more of a simple introduction for anyone holding a ham licence or perhaps a refresher for somebody who didn't really get into synthesis techniques. In brief, the book explains what EPROMs are, how they are used in CB rigs for frequency generation and how to modify their contents and surroundings hardware in order to get into 10m. It is presented in a very light-hearted style and contains details of replacement EPROM boards and modifications but not specific re-alignment instructions for the rigs and synthesis chips mentioned in the text. Martin Pickering's 'The CB EPROM Data Book' costs £5.50 and is avail-

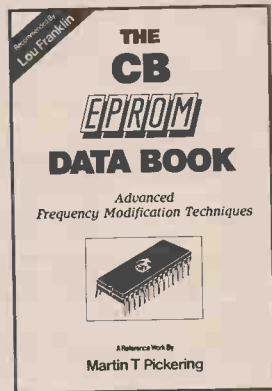

able from the UK distributor: S. Tonks, 53-55 Darlaston Road, Pleck, Walsall, West Midlands WS2 9QT.

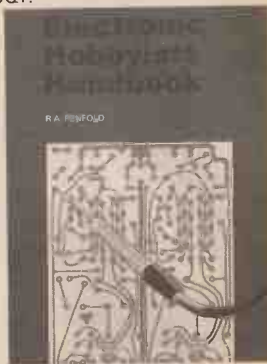

Electronic Hobbyists Handbook

R A Penfold's latest book from the Babani publishing house is exactly what the title suggests, a handbook containing useful data on component colour codings, IC pin-outs and transistor parameters. Unlike the 'Engineers Pocketbook' mentioned earlier, this 90 page soft-back publication is aimed at what could be described as the beginner/intermediate category of reader. Perhaps someone who is in the early stages of getting involved with the electronics hobby and needs both an elementary text and reference book rolled into one.

In addition to introducing the newcomer to transistor theory the book covers the functioning of op-amp integrated circuits, not encountered in ham radio as often as in other areas of hobby electronics but useful nevertheless. Other devices are also covered such as traics, FETs, SCRs, diacs regulators and SMDs. Circuit details are included for such devices as timers, oscillators, audio amplifiers, filters and PSUs. Finally the book also offers circuit symbol data, brief CB and ham band frequency allocation, and a table of amateur abbreviations. Q codes and signal rating systems — this last section being a little out of place in a book which hardly touches on the radio aspect of electronics. 'Electronic Hobbyist Handbook' by R A Penfold is published by Bernard Banani Ltd and costs £4.95.

2 issues FREE

When you take out a subscription to any of these magazines

	EUROPE	MIDDLE EAST	FAR EAST	REST OF THE WORLD
A&B Computing	£27.30	£27.60	£31.10	£28.30
Aeromodeller	£27.00	£27.20	£29.00	£27.50
Citizens Band	£20.10	£20.30	£21.80	£20.50
Clocks	£32.40	£32.60	£34.70	£33.00
Commodore Disk User	£18.00	£18.20	£19.30	£18.40
Disk User	£21.60	£21.70	£23.20	£22.00
Electronics Digest	£12.90	£13.00	£13.70	£13.10
Electronics Today International	£21.00	£21.20	£22.80	£21.50
Ham Radio Today	£20.10	£20.30	£22.00	£20.60
Military Modelling	£22.40	£22.60	£25.20	£23.10
Model Boats	£20.00	£20.10	£21.80	£20.40
Model Engineer	£35.40	£35.70	£39.00	£36.30
Photography	£22.00	£22.30	£25.00	£22.80
Photoplay	£16.70	£16.90	£18.70	£17.20
Popular Crafts	£21.40	£21.60	£23.60	£22.00
Radio Control Model Cars	£21.10	£21.30	£23.10	£21.60
Radio Control Boat Modeller	£10.00	£10.20	£11.10	£10.30
RCM&E	£20.40	£20.60	£22.90	£21.00
Radio Control Scale Aircraft Quarterly	£11.10	£11.20	£12.00	£11.30
Radio Modeller	£20.00	£20.20	£22.40	£20.60
Sea Classic International	£10.70	£10.80	£12.00	£11.00
Scale Models International	£19.60	£19.80	£21.50	£20.10
Video Today	£20.20	£20.40	£22.30	£20.70
Which Video?	£19.40	£19.50	£21.20	£19.80
Woodworker	£22.80	£23.00	£25.70	£23.50
Your Commodore	£22.00	£22.30	£25.20	£22.80
Model Railways	£19.10	£19.30	£21.50	£19.70
Practical Wargamer	£7.10	£7.20	£8.00	£7.40

The Above Offer Applies to Overseas Subscriptions Only

This offer is also open to existing subscribers who may wish to extend their current subscriptions.

Please commence my subscription(s) To with the Issue
 I enclose my cheque/money order for £ made payable to Argus Specialist Publications Ltd.
 or debit £ from my Access/Barclaycard No.

valid from to Signature
 Name
 Address

Send this form with your remittance to:

INFONET LTD. (S.O. 88) 5 River Park Estate,
 Berkhamsted, Herts. HP4 1HL.



Free Readers Ads!

FOR SALE

FT101E HF Tcup with mod for 10M and spare valves £325.00 rotator soft small 2M beam £20.00 2M 5 eud beam £5.00 2M 6 eud beam £20.00 G4UCX Paul Johnson 61 Moss Lane, Alderley Edge, Cheshire SK9 7HP.

B41 low FCY 5ch receiver 50 kHz to 500 kHz new condition! Due to FCY coverage only £35. Buyer collects. "Heavy" Gramplan. SO2ILS. Valve amplifier and three 12" loud speakers 50 watt output £50. G8BSK, 290 Priory Road, St. Denys, Southampton.

KENPRO KR-5400 AZ/EL rotator and controller plus original packing. Never used £190 or P/Ex KR400RC. Met 144MHz two way power splitter. Never used £20. Part built circuit 50MHz transverter £25. Mark Cooper, 33 Park View, Royston, Barnsley, South Yorkshire S71 4AA.

DATONG ASP RF speech processor. Boxed as new £50 ono. Realistic PRO2009 8 channel scanning receiver, covers 70cm, 2mtrs and 4 meters FM plus lots more. C/W outdoor antenna. Both brand new. £120 ono. Maidstone 63918.

FOR SALE 2 element Tri-band beam DX 3L £65 ono aluminium lattice tower 19' high with parts to extend to 32' £80 ono. Danish Marine Tx "Sailor" 76D offers or exchange for general coverage receiver Rx. Tel. 0905 354942 G3WPP QTHR.

ICOM IC210 2 meter 1-10 watts FM base station removable PSU for mobile and base % over 1/2 Collinear £175 lcom ICB1050 10meter FM with xtal filter £30 Stalker 9. AM/FM SSB, 80 channel. Excellent sideband audio ideal for 10 meters conversion. £70. G1NZS Telford 607542.

DATONG PC-1 general coverage converter 0-30MHz perfect condition £100. Grimsby 0472 352359.

FOR SALE. Belcom LS-102L mobile transceiver, 26-30 MES continuous LSB USB FM AM. VGC. Original mic

and boxed. £185. Phone John 0734 411501.

LINDEN Bearcat 100XL VAF/UHF scanner for sale. Mint cond. Only 3 months old. Mains/battery. Hand held £130. Realistic PRO-2009. UHF/VHF scanner for sale. Mint cond. Mains/battery. £95. Receivers in maker's packaging. Phone G4EJH, Bristol (0272) daytime 623284 eve 843897.

HY-GAIN 2795 200 channels, FM, SSB, VGC. Will easily convert to 10m band £70 ono. Ring Leeds (0532) 622975 after 5pm. Buyer collects or pays postage.

TRIO 9130 2 metre multimode excellent condition with all accessories/original box £335. ICS/AEA PI CW/Ritty unit complete with BBC 'B' driver Eprom If required £115. SSB LSM24 24cms (2 metre. IF) Transverter £150. Phone Paul G4XHF (0293) 515201.

KW2000B with AC PSU good condition £185. Tel. (0249) 653740 (not Sundays please) buyer to collect.

YAESU 726R 2m 77cms Sat speaker SPT102 MD1 desk/mike £730.00 OVNO. ZX Spectrum 128 tape recorder power pack leads £70.00 FT980 speaker filters £40.00 four element 2m Jay beam £10.00 all plus postage G0CAM. 0761 415746.

FT290R case, nicads, charger, Weltz 1.8-144MHz SWR meter, Drae wave meter, gutter mount, Mag-mount, 1/2, 1/8 and Slim Jim antenna £335. Phone Huntingdon 55694 evenings.

SWAP. Roband Vorex Twin voltage power supplies 0-30V 0-10 amp. Metered parallel/series fully controlled solid state good condition for oscilloscope not home brew round or square screen 3" or larger G3JDA. Sussex, Rotherfield 2144.

PSU ex-laboratory AC mains input AC/DC output 0-20V variable. 0-40A twin meters 16" x 24" x 12" very heavy £60. Buyer must collect. Peter, 0642 456327 daytime (Cleveland).

FOR SALE new MC50 MIC £35 wood and Douglas Pip-

tone PT3 and circuit £5 SWR FSI-2X £5. All excellent condition. Tel. Chesterfield 0246 36496.

FOR SALE. Regency digital flightscan. Airband scanner 108-136 16 channels, programmable. First class condition. £120 with handbook.

DATONG PC1 2m to HF receiver converter hardly used cost £137 will accept £90 ono. Various Amstrad computer programs/games offers? Phone Mark (0278) 760303.

BEARCAT hand held scanner. 100XL £130 ono. Will swap cash adjustment for Sony 2001D or similar. Ring 051 336 1556 after 6pm.

CONVERTED Ex-CB FM/AM/SSB covers 28.05MHz to 29.7MHz in five bands including Tx/Rx fine tuning with mike and box £110 inc. post. Daiwa electronic keyer DK210 runs on 13.8V or INT 9v PP3 (supplied) £50 inc. post. Telephone 0904 792208 weekends and evenings.

FRG-7 for sale good condition. General coverage up to 30MHz. Sell for £120 or may exchange for 2m transceiver. Buyer pays postage. Contact David, Airdrie, Scotland. Tel. (0236) 51774 after 5pm. No callers on Sunday please.

BARGAINS HF linear amplifier 2-30 MHz 400W pep with preamp £49. Welz SP-122 SWR/power meter 1.6-60MHz £49. Commodore 64/128 Miracle Technology Multimodem for Prestel, RSGB databox etc. Plug-in switch-on £65. Polarpshar II 2m £29. Tel. 01 845 4008.

YAESU FT757GX, FP757HD PSU FC757AT auto ATU boxed as new. GTEED until Feb 1988 5 hrs use £950. Standard C58 Multimode 2m portable, nicads, case, strap, scanning MIC, Helical, mobile quick mount, £230. Part exchange gen coverage receiver. Garry (0625) 530200.

FRG7700, as new, £220. RS375 airband monitor, as new, £45. NR56VF1 2m monitor, VFO and four

crystals, £29. Grundig concert box, £12. Sony Air 7, three months old, £200. Tel. Peter 01-643 5063 (Surrey). **YAESU** FT-23R 2m handie, soft case, 12VDC adaptor, £180. Realistic PRO-31 hand held FM scanner, 10 memories, £120 ERA micro-reader, RTTY/CW decoder with built in display, £80. BNOS 144MHz low pass filter, unused, £15. DDM55 dipole £5. G4ILO, Colchester 210878.

BEARCAT base scanner £80, SEM HF converter £30. TH2IE mini handheld, with case, spare nicad pack and speaker mike £165. FT73R mini 70CMS handheld, with speaker mike, DC charger, case, £200, two metre mini, receiver hand held £60. 248 4252 461 5398, J. Barton.

MATMOS (Triumph Adler) computer CP/M22, Micro-soft basic, ROM word processor, dual 5 1/4" disc drives, disc basic-80, parallel and serial interfaces, cp/m plus and terminal emulation ROM available. Pristine. £175 plus carriage or swap for FT290, ICF7600D, WHY? Jon 01 399 1606.

FOR SALE 10 element YA6I for two metre operation, as new £15. Buyer collects or postage extra. GM1XHZ QTHR. Tel. 0674 76503.

WKS 1001 trans. 280 channels plus. 26-28MKZ. Receiving, but only transmitting on LSB. Approx £180 one year ago. USB, LSB, AM, FM. Offers or swap good 2m mobile antenna assembly or BP5/A battery pack for IC-2E. Phone Mark, 0256 781197.

REALISTIC PRO2004 25-520 760-1300MHz. 300 memories AM/W/FM/W/FM. New August. Boxed as new condition. Top line scanner. £275 which includes carriage by compensation post. Or call at No. 2 Park Road, Granborough, Bucks, MK18 3NS Nr. Aylesbury, Bucks.

LINEAR MML144 30LS microwave modules 1 or 3 watts in 30 watts out. £45. Buyer collects. Contact G6JFS. Tel. 0706 213515. **TR9000** 10XY (new),

Colinear (new), LSE16 signal generator, wavemeter, SWR meter, pre-amp £400. Kenpro KR400 rotator £75. Spectrum 48K plus books and software £75. CBM64 software. Send SAE. Ron G6BMY 061 437 0916.

Two Yaesu FRV 7700 VHF converters A and B type both are new and unused still in box £15 each ono. Ring 0672 52571.

FOR SALE Adonis AM503 compressor amplifier microphone FM/SSB tone up/down switches etc. Unused in original box. £25 ono. Hounslow evenings NPTON 0604 24486; 46 Garrick Road, Abington, Northampton NN1 5ND.

YAESU FT767GX with synthesiser modification excellent condition with original packing £1199 ono. Balun 1:1 50VC rated 1kw £10. Kenpro rotator stay bracket. £15 both unused. Paul G4DXG QTHR. Tel. 0892 35830 (Kent).

FOR SALE radio service manuals as follows Yaesu 7700 price £12.00. Grundig 1400 price £4.50. Panasonic RF4900 price £4.50. Panasonic RF1150 price £4.00 all post paid, ring 051 920 6226. **FT290R** C/W nicads, slide-mount, Helical, carrying case, and strap £275. KR-400RC rotator £80. Jaybeam 10XY offers. Tel. Crawley 24620.

MORSE keys RA Kent solid brass key on oak base £20. lambic paddle, well engineered copy of Bencher key £25. G3T50 028 575 532 (Cirencester).

LINEAR MML 144 30LS microwave modules 1 or 3 watts in 30 watt out. £45. Buyer collects, contact G6 JFS. Tel. 0706 213515.

FOR SALE Welz AC38M ATU. £50. Trio DM801 GDO £50 both items mint condition. Carr included. Tel. John G4YDM. Tyne Wear 091-4162606.

SUPERSTAR 360 as new easy to convert to 10MHZ £120 OVNO ATU £15 frequency counter 5 digits £35. 0283 21870.

GARRARD 301 3-speed transcription motor. Black strobe turntable. Good condition in original packing. £50 ono. Phone Southampton (0703) 466506.

YAESU FT 290 Mk1 with

muter nicads and speaker mike. £250 ono or exchange for FT 73R 01 878 2126.

YAESU FT301D Tx/Rx. 160 to 10M CW, SSB, FSK, AM solid state, VOX MOX, RIT on RX, TX. Speech processor, dual Calib, three position AGC. Notch, all filters fitted with FP301D, FV301, YO-301, FC301. Will split, £750. Yaesu FVT107R transverter 2m module £85. Tel. St. Albans 39333.

DAIWA search 9 2 metre monitor VFO + crystals (3) £28. Tamiya Rough Rider with 2 channel controller & Nicad power pack. £85. Pentax Spotmatic (F18 Takumar) Camera +200mm telephoto + converter £80. 0458 47019.

DATONG AD270 indoor active antenna system £15. Scopex 4SG oscilloscope 6MHz £45. Thandar TM353 digital multimeter £25 all in full working order with handbooks. G1ZMF. 2 Swanbourne Close, Biggleswade, 0767 315868.

ARA Dressler 30 Active Ant. Excellent cond. £90.00. Post paid ARA Dressler 500 VGC. £90.00 ono post paid all with co-ax and inter-face and original packing include phone No. and I will contact you. S. P. Martin, 24 Collingwood Close, Worle, W-S-Mare, Avon. BS 22 9PQ.

MICROWAVE Modules 144/100 LS 2 meter linear amplifier with pre amp 1 or 3 watts in 100 out as new £100. Yaesu-FP 757 HD heavy duty power supply 25 amp with fan and speaker as new. Bargain £140. Telephone 0294 217611.

YAESU FT757GX +withers modification £600 or exchange Drake TR7, FT1012D "Mint" condition £475 or exchange FT707. Low SRX30 £75 FR50B £65 HY6AIN DB1015A 3 ele 10 & 15m beam £60 AV08 MkIII £40. Dick G0BPS QTHR 0303 76171.

HAM Major SSB/FM and AM converted to ten metres in five bands with mike and box £110 inc pp. Daiwa electronic Veyer £50. KW-103 SWR/PWR meter £16. Tel. 0904 792208 after 8pm.

YAESU FT290, charger, nicads, rubber duck, 30 watt linear, Slim Jim with co-ax £275 ono. TS530S CW filter

fitted. ATU230, SP230 speaker, 240 remote VFO. Mike, dummy load, little used, near mint condition, £650 ono. Jeff 0484 645923.

SELLING Cuscraft AV3, three band vertical, with approx 20 yards UR67 £25. Oldfield, 49 Stansfield Street, Todmorden, Lancs. OL14 5EB. Tel. Todmorden 6165.

Drake TR7 transceiver with broadcast band fan and microphone and RB75 remote VFO £850 will separate also Capco antenna tuner as new £125 Phone evenings 0277 823434 or write. 11 Steeple Way, Dodingtonhurst, Brentwood, Essex.

SONY Air 7 £150 Yaseu FT203R two metre transceiver + extras, £160. Sony 7600D £120 or with Air 7 £250 + PSU nicads, no offers, all items VGC. Write 20 Monmouth Street, Chaddesden, Derby c/o G8UFC.

FT73R 7CCM with CSC23 PA6 FBA70 FMB-10 MK12H2B NC28C £300. Sinec 3 103 model £165. Thamoar SC116A scope + £174. Thamoar TG102 Fun/Gen + £150. Marconi attenuator. Cost £913. Sell £200. Tandy digital 25 range fold up multimeter £30. Ring any time. Pete 0473 85203.

FT207R two metre hand-head TCVR, complete with NC-2 NC-9C, YM-24, flexible aerial, case, plus spare nicad FNB-2 and handbook. Excellent condition. £185.00 ono. Phone Mike G2FZ QTHR 082-98-410.

YAESU FRG9600 scanner 60-905MHz as new in original box with PA4C AC adaptor £350 ono. Ilfracombe 63455.

YAESU FT-23R 2m handie, soft case, 12VDC adaptor, £180, realistic PRO-31 hand held FM scanner, 10 memories, £120, ERA micro-reader, RTTY/CW decoder with built in display, £80. BNOS 144MHz low pass filter, unused, £15. DDM50 dipole £5. G4ILO, Colchester 210878.

YAESU FT757GX as new boxed hand mike VGC £750.00 ovno for sale again due to time wasters. Sun 2m 7/8 car aerial £10.00. All plus p&p OTHR GOCAM. Tel. 0761 415746.

AR2002 scanner 25MHz-

550MHz 800MHz-1300MHz. AM/FMWBFBM brand new still in box cost £487 sell for £375. Maplin 300 BAUD Modem for any computer with leads for BBC micro £50. Tel. Paul on 0366 388615.

PROFESSIONAL satellite 600 Rx must sell mint condition. Sensible offers please not less than £200. Flat 10, Riverside House, Penkridge, Stafford. Phone 078 571 4606.

FT207R 2MTRS handle speaker Mic de luxer charge all boxed £155 ono. Mike GW1LHV Wrexham 751328.

REALISTIC DX200 communication receiver boxed. Good condition £80. Tel. Eric, Macclesfield 29180.

TRIO TS711E 2M Multi mode base station £595. Mutek SBLA144E 2m mast head pre-amp £40. 9 Ele 2M Tonna new type £18. 19 Ele 70cm Tonna old type (unused) £16. 3 Ele 6m Met £20. Tel: 0926 498388.

EDDYSTONE 770R 19 to 165 MC5 and 770U 145 to 520 MC5 both in lovely condition good for civil and military air band and the public services manuals and CCT; for both selling because space is needed £75.00. Each ring after 6.30 on 070 621 8290.

MURPHY B40 ex admiralty receiver 0-30 MHz, USB, LSB, RT etc. recently re-valved. Works fine. No rear case though one could be made. Still experienced or novice SWL. Offers. Robert, Rhyl 0745 38197. Buyer collects.

YAESU FT225RD. Two metre base station transceiver. Good ring, muff front end, £400. Buyer collect. I want digital readout, DG5 for trio TS520S. Geoff, 41 Penn Grove, Norwich, NR3 35Z. Phone Norwich 406331.

TRIO 9000 multimode boxed bracket for mobile bargain. £320. Tel. 0302 859451.

VALVES 4CX250B believed unused with VHF holder, no chimney, £10. Pair of used 4X150A. £250 each. Used QVQV06-40A £3.00. Phone Chris GOFJY, Worthing 0903 40072 evenings.

JUNK. Mostly new components, never used, all gathering dust. Books, switches, relays, valves, resistors, must sell. All sold

as seen, sensible rumagers. Phone 01 857 2157. Ask for Glenn.

RELUCTANT sale. The ultimate HF rig, Yaesu, FT1, all options fitted, excellent condition £1,100.00 ono. Kenwood TH205E with extras, full years guarantee £165.00. PK232/6 plus CBM-64 software pack 11 months guarantee including leads £300.00. ATV transceiver, monitor £75.00. Rotherham 0709 554665.

TRIO TS820S fitted 500Hz filter also 6146'B. £495. Matching R820 Rx transceivers or separate with TS820S fitted extra 250 500Hz. Filters notch filter passband VBT. All boxed mint buyer collects. Wanted Drake "C" line. Phone Trowbridge 3166 any time. G4LW QTHR.

HAM International Concorde 2, boxed, vgc, 26.5 to 28.3MHz. Ideal for full 10M conversion. Also CP100 linear amplifier. 100W output, built in pre-amp. Offers for both or will consider swap for 2m Tx/Rx. Tel. 0782 774842.

10m multimode 29.3MHz to 29.7MHz AM/FM SSB 12 watt output sell or exchange. Burndept BE600 UHF 6 channel hand held with diagram sell or exchange. Wanted 3 ELE triband beam. Tel. 0742 465145.

TRIO R600 receiver 150KHz to 30 meg in excellent condition with instruction manual £210. Phone Guildford 0483 66317.

SHACK clearance going HF FT209R3, NC15, AR409-ELE Tonna, 4-ELE quad, Yaesu YHT1, SBZ for FT290, PA3, countless volumes of mags, Radcom, PW, CD1400 scope (tatty), aerial brackets, etc. offers? All plus carriage — can't stand overcrowding any more. Nick 0252 876277.

KENWOOD low pass filter LF30A. £17.50. Mini-max 6 digit automatic frequency counter. 100MHz, 50MHz £25. ICS practical radio servicing course. 28 books, ideal RAE candidates £25, WPD Communications speech processor, MiC socket, electret MiC insert. £14. Post extra. 021 777 6086.

HF Communications receiver Century-21 same as Drake SSR-1 500KHz to 30MHz in

30 bands product detector for SSB switched sidebands USB LSB AM outstanding performance all round as new with manual AC mains or 12 volts DC £185.00. 01 785 9325 SW London.

HAM International Jumbo suitable for conversion to amateur band AM FM LSB USB open to offers or WHY. amateur radio wise. Telephone Mervyn 0474 B74480.

SONY Trinitron television with remote control. 20" model KV2022. Can be seen working perfectly. £120 evenings Maldon 0621 54547 (Essex).

YAESU FT708 portable 70cms with SPHR mike. Charter car adaptor switch box vgc. £180. Tel. Grantham 0476 70877 evening. G1PML.

TRIO TR751E 2 metre multi mode, with box, mic, manual bracket — £450 ono — ring Rich 0454 318770 or leave message at 0272 561301.

FDK multi 750XX 2 metre multimode transceiver, 1/20 watts, 2 VFOs, scanning, plus expander 430 matching 70cms transverter, 1/10 watts, allows 2 metre, 70cm or semi duplex cross band operation. As new condition, boxed, £300 or exchange FT790 nicads etc. Same condition 01 647 3056.

SONY ICF2001 D receiver and Sony AN-1 active aerial, bought November 1987, as new, £320 the lot, phone Colchester 298402. (Boxed) (bills) (guarantee).

SMC SWR meter — T3-170L. New condx. HF/VHF. £10 (incl post) include SAE. R. Bunney, 33 Cherville St., Romsey, Hants, SO51 8FB.

BC221 F/Meter £30. Heath kit distortion meter £25. Vidor radio CN418 bandspread 6-shorts £20. AVD OSC £15. Bush tuner good inter £5. Plinths with 1/table 10. Ferguson b/w TV-1500 tube weak £10. Wanted scope tube LD924E. AR77 manual £5. R1155 £5 SA520. Cossor 2000-2100. £15. 01-883 3474.

MICROWAVE modules MML144/100S 10W input 100w output 2m linear amplifier. Ex cond. orig. packing £90. Dressler ARA30 active receiving antenna mint cond. Used internally only. £65. Tel. Dinnington 0909

565443.

YAESU FT902DM. Transceiver, Datong FL3 Filter Shure 444, Carco 300, ATU 1KW Welz, SWR RPM PEP Bridle 1Kw. Frequency counter HF VHF with probes Scarisbrick 880345.

COMPLETE SWL receiving station comprising of a trio R1000 communication receiver a Sony AN1 active antenna and a Global AT1000 ATU all in excellent condition. £250 complete. Phone Southend 0702 77601 or phone London 01 837 2736 and ask for Tony.

HAM International Multimode 3 (5 bands), modified 10 metres 28.010 to 30.000MHz (Spectrum), fitted transverter Lo-Level RF socket. Original condition £160. Transcom 4000 CB, modified 26.515 to 28.151 MHz, can be supplied as 28.000 to 29.8000. Mint condition. £100. (Banbury) 0295 69367.

FT290R, nicads, mobile mount, case Flexi ¼ wave, headset MiC, mobile MiC with scaw buttons. Listen on input intelligent toneburst. £250 ono. Icom IC2E hand-held modded, listen on input, 10MHz coverage £130 ono. Julian G6LOH 0327 857766, 29 High St, Whittlebury, Towcester NN12 8XH.

SALE ex-lab PSU 0-20V 0-40A. Fully metered 240V AC Input AC-DC output. Large heavy unit. Buyer to collect. Peter 0642 456327 Cleveland (daytime only) £60.

FOR SALE Datong FL3 multi mode audio filter, good condition £80. Ring 0772 704009 after 6pm.

MM4001 RTTY/Data self contained unit complete with keyboard message stores etc. No computer needed! £125. Chris Lorek, G4HCL Tel. 0354 56392 any time.

FOR SALE Sony ICF700D receiver FM76-108MHz 153-29.9995MHz £108. Yaesu FT290R 2mtr all mode. Transceiver Inc Ni-Cads £220. Tel. 824972.

WANTED

WANTED Yaesu FT7^B or Concord 3 must be in perfect condition 0283 221870.

WANTED Field Mast ex-British arm green approx 30' with whip and insulator. All

supplied with guys, hammer and base, canvas BA5. Previously sold by John's Radio in Birkenshaw, Bradford. Also want WS No. 11, WS 65 and WS 66, 5ZERT RG37, AD67, SGYQ. Will collect 02820. Tel. 0110 452 801875.

DATONG MK Morse Keyboard, Yaesu CPU2500R 2M FM Trans VFO120, SP120, VIC20 computer wanted. All must be vgc. Tel. (0305) 813202.

WANTED used FT707 or TS130S also 2M linear amp from 20 — 40W 12 volts. Guildford 0483 235544 any time.

WANTED TS940S or TS930S also TL922 linear cash waiting. G3VOF QTH R (Essex) 04023 73366.

WANTED Circuit manual of "HAM" International broadband linear LA120 copy or buy, Reg G8QS.

TRANSFORMERS wanted. 1250V 500mA. 240V 12V 50mA; 6.3v 2A also PL T4356 (350-0-350 100mA 6.4, 2A; 6.4, 5A; 6.4, 2.3A 60V). A. Gibson G1EUU, 68 Aire Road, Grantham, Lincs. NG31 7QP.

WANTED AOR2002 must be mint. Exchange FT790 70cms multimode with nicads, charger, soft case, FL7010 matching linear amp. Mobile mount boom headset, PTT box. All as new with original packing etc. Tel. Reading 0734 668532.

WANTED Zenith D7000 radio or Sony CFR5090 radio or Panasonic RF6300. Others considered. Have — Philips D2395 digital world radio costs £180 — sell for £80.00. Tel. 0462 420515.

WANTED can anyone help with info on modifications for Belcom LS102L 28MHz rig especially want Mod for 100KHz repeater shift on FM plus anything else you may know about. All costs gladly refunded. Ian G0BGH QTHR. Tel. 01 668 4990.

WANTED CBM64 programme "Geneology." Will swap prog send disk or £2 for my file. Have Practical lenses flash pistol grip. £55 or swapt 200 singles wooden box 100W amp with spare module £175 or offers. Call Martyn 0924 495916 anytime.

Free Readers Ads!

Buy, sell or exchange your gear through our free service to readers.

1. These advertisements are offered as a free service to readers who are not engaged in buying or selling the same equipment or services on a commercial basis. Readers who are should contact our advertising department who will be pleased to help.
2. Advertisements will be inserted as and when space becomes available.
3. The insertion of advertisements will be on a first come, first served basis, subject to condition 2. As a result, it will not be possible to guarantee the insertion of a particular advertisement into any particular magazine.
4. Readers should either write out their advertisement in BLOCK CAPITALS or type it. The first word will appear in bold.
5. The magazine cannot accept any responsibility for printers' errors in the advertisements. However, we will do our best to ensure that legibly written advertisements are reproduced correctly. In the event of a gross error, at the Editor's discretion, a corrected version of the advertisement will be printed (at the advertiser's request) in the earliest issue in which space is available.
6. The magazine or its publishers will not accept responsibility for the contents of the advertisements, and by acceptance of these

conditions, the advertiser undertakes to indemnify the publisher against any legal action arising out of the contents of the advertisement.

7. The magazine reserves the right to refuse to accept or to delete sections of advertisements where this is judged necessary. Illegal CB equipment is not acceptable unless specified as suitable for conversion to amateur or legal CB frequencies.

8. Advertisements are accepted in good faith; however, the publisher cannot be held responsible for any untruths or misrepresentations in the advertisement, nor for the activities of advertisers or respondents.

9. Advertisers must fill in their names, addresses and (if available) telephone number in the space provided, and sign the form to indicate acceptance of these conditions (forms returned without a signature will not be used).

10. All that is to be reproduced in the advertisement should be entered into the space provided on the form printed in the magazine. A photocopy is only accepted if accompanied by the corner of this page. All advertisements must give either a telephone number or address for respondents to contact or both — these must be included in the advertisement.

11. Advertisements must be 40 words or less in length including the address or phone number information. Telephone numbers normally count as two words, exchange or exchange code plus number.

Name

Address

I accept the conditions above.

Signature

Send this form to: Free Readers Ads, Ham Radio Today,
1 Golden Square, London, W1R 3AB

ENTER YOUR ADVERTISEMENT HERE:

RETAIL NETWORK

BEDFORDSHIRE

ELECTRO COMM NEW CB SHOP

2A Tennyson Road, Luton
Tel: 0582 458310

CB RADIOS ALL ACCESSORIES.
RELIABLE SPEEDY REPAIR SERVICE.
USED CB'S BOUGHT AND SOLD
(Open 9-6 Mon.-Sat.) ½ mile town centre

LANCASHIRE

AMATEUR ELECTRONICS/HOLDINGS G3LLL

YAESU, JAYBEAM, DRAE, DATING, BLACK STAR COUNTERS
ETC. FT 101 EXPERTS
G3JSC 120V 120V/A Original type approved
valves & our own Double Balanced Mixer and
new band WARC Kits for original FT 101 MK1 E
& A.E. List. Full Yaesu range. 15 mins. Junction
31 MB. Free parking. Call and consult G3LLL
without obligation. Holiday? Phone check
we are open before calling.
45 CHINWORTH STREET, BLACKBURN BB2 1EF.
0254 9958. CLOSED THURSDAY.



SUSSEX

G.W.M. RADIO LTD.

40/42 Portland Road, Worthing,
Sussex Tel: 0903 34897
Constantly changing stock of interesting items for
callers. Receivers, test equipment, components
etc. P.ye pockophone PFI TX units with battery and
circuits £12 inc. p.p. Racal RA17's and Eddystone
730/4's NOW IN STOCK.

BIRMINGHAM

R. WITHERS COMMUNICATIONS

584 Hagley Road West
Oldbury, Warley B68 0BS

(Quinton B'Ham) Tel: 021-421 8201/2/3
Opening hours 9-5.30pm Late nights Thurs-Fri.
(Send just £1.00 (refundable against purchase)
for latest catalogue + our exclusive products & used list.

MERSEYSIDE

ARE COMMUNICATIONS LTD

For Yaesu Icom & Kenwood
Phone us for the best deals on all
amateur radio equipment.
38 Bridge St, Earlestown,
Newton-le-Willows, Merseyside.
Phone Peter G4KKN on 09252-29881
Opening hours Tuesday-Saturday 10am-5pm

WEST SUSSEX

BREDHURST ELECTRONICS LTD

HIGH ST., HANDCROSS,
WEST SUSSEX.
TEL: (0444) 400785
Sited at the Southern end of M23. Easy
access to M25 and South London. Open Mon-
Fri 9am-5pm except Wed 9am-12.30pm.
Sat 10am-4pm
MAIL ORDER RETAIL

BIRMINGHAM

HEWARD'S HOME STORES LTD.

(Est. 1983)
822/4 Kingstanding Rd., Birmingham B44 9RT.
Tel: 021-354 2083

G4RJM with 38 years in The Radio Trade
Ham Equipment urgently wanted!
Open: Mon-Sat 9-6

MERSEYSIDE

MGR SERVICES

Wirral based communications
ICOM - YAESU - M. MODULES - HOWES -
CIRKIT - WOOD & DOUGLAS - PART-EX -
AERIALS - PMR - MARINE - MET ANTENNAS -
ALINGO - HEATHERLITE - SPECTRUM COMMS
48 Shrewsbury Road, Oxton, Birkenhead L43 2HZ.
Telephone: 051 853 3437
(Callers by appointment 9am-5pm, Mon.-Sat.)

TYNE & WEAR

FLYNTRONICS

For all amateur communications equipment and
accessories authorised dealers for
 and
129 Chillingham Road, Heaton, Newcastle Upon
Tyne, NE6 5XL. Tel: 091 276 1002.
Open 10am-6pm Tues-Fri. 10am-5pm Sat
Access & Visa accepted

CHESHIRE

FAST AND FRIENDLY SERVICE

PARMA HOUSE,
443 Wilmslow Rd,
Manchester
M20 9AF
061-445 8918
061-434 5701

WHOLESALE CB



NORFOLK

D.P. HOBBS (Norwich) Ltd
13 St. Benedicte Street, Norwich
Tel: 615785

Open Mon-Sat 9-5.30
Thurs 9-1pm.
Stockists of:

YAESU, FDK, ICOM, JAYBEAM
& Electronic Component Specialists

YORKSHIRE

ALAN HOOKER ELECTRONICS

42 Netherhall Road,
Doncaster
Tel - 0302 25690
Large stocks of electronic
components.

DEVON

AGRIMOTORS

Merton CB & Radio Centre
Merton Garage & Post Office, Merton.
Nr. Oakhampton EX20 3DZ.
Open 6 days 9-6
(Sundays by appointment)
Specialists in 934MHz
Suppliers of all 27MHz and 934MHz equipment

N. WALES

NORTH WALES AMATEUR RADIO MART

AMATEUR RADIO — CB RADIO — MARINE
RADIO — P.M.R.
25 ABBEY STREET
RHYL

Open Monday-Saturday: 11am-5.30pm
All repairs and accessories available ex
stock. Mail order welcome.
Tel: 0745-51579

SCOTLAND

JAYCEE ELECTRONICS LTD

JOHN GM30PW
20 Woodside Way, Glenrothes,
Fife KY7 5DP
TEL: 0582 756962
Open: Tues-Sat 9-5
Quality secondhand equipment in stock. Full
range of TRIO goodies. Jaybeam - Microwave
Modules - LAR

KENT

ICOM (UK) LTD

ELECTRONICS
2 Stanley Road, Herne Bay, Kent
Tel: (0227) 369464

Open Mon-Sat 9-5.30pm
except Thursday 9-1pm

SURREY

GUILD福德 COMMUNICATIONS

34 Aldershot Rd., Guildford
Open Mon-Fri 8am-6.30pm
Sat 8am-5.30pm
Secondhand wanted
ASDEN
0483-574434

RING EVELYN COOMBS

ON 01 437 0626 FOR
DETAILS ON SERIES
DISCOUNTS IN HRT

HAM RADIO TODAY CLASSIFIED

Lineage: 50p per word VAT inclusive (minimum 15 words) Semi Display: (minimum 2cms) £7.75 per single column centimetre. Ring for information on series bookings/discounts. All advertisements in this section must be prepaid. Advertisements are accepted subject to the terms and conditions printed on the advertisement rate card (available on request).



01-437 0699 Ext 292. Send your requirements to: Ham Radio Today Class. Dept., ASP Ltd., 1 Golden Square, London W1R 3AB

ACCESSORIES

WHOLESALE CB

CB radios including new frequency CEPT transceivers, aerials, accessories - in stock now.

Parma House, 433 Wilmslow Road, Manchester M20 9AF



Open Every Day. Fax Number: 061-445 0978

NATIONWIDE DELIVERY CB DEALERS

contact us today
Fast, Friendly Service, Competitive Prices, Widest Range & Latest Products

Tel: 061-445-8918

061-434 5701

Telex: 666762 PAMACO G

PACKET RADIO SOFTWARE

GROSVEAUX SOFTWARE

G4BMK

AX25
DRAGON 32/64 and TANDY color A Breakthrough in Packet Radio-Ax25 stand alone software in ROM cartridge plus a built VHF/HF modem for just £88! New DRAGON 32 Computers available at £54.00. Full AX 25 implementation with up to 8 simultaneous connections, optional beacon and diplexer operation. Modem kits & PCB's available. Send SAE for full details of this & RTTY, CW, SSTV & AMTOR.
2 Beacon Close, Seaford, East Sussex BN25 2JZ. Tel: (0323) 893378

TERMS + CONDITIONS

CLASSIFIED ADVERTISING TERMS & CONDITIONS

Our terms for new advertisers (team-display and lineage) are strictly pro-forma payments until satisfactory reference can be taken up (excluding recognised advertising agencies). Cheques and P.O.'s should be crossed and made payable to ARGUS SPECIALIST PUBLICATIONS LTD and sent together with the advertisement to:

The Classified Dept.
No. 1 Golden Square,
London W1R 3AB.

There are no reimbursements for cancellations. Advertisements arriving too late for a particular issue will be inserted in the following issue unless accompanied by instructions to the contrary. It is the responsibility of the advertiser to ensure that the first insertion of every series is published correctly, and corrections must be notified in time for the second insertion, otherwise the publishers will not accept any liability or offer any reduction in charges.

All advertising sales are subject to Government Regulations concerning VAT. Advertisers are responsible for complying with the various legal requirements in force eg. The Trade Description Act, sex discrimination act & the business advertisements (disclosure) order 1977.

Full Terms & Conditions of Advertising available on request

Phone 01-437 0626
to find out why
you should
advertise
in H.R.T.

VALVES

Billington Valves

Valves Transistors I.C.'s.
Usually the lowest prices...
Rarities our speciality.

Wholesale + Export enquiries welcome.

20lb (9kg) of resistors, capacitors, potentiometers etc. etc. 1930's-1960's £10 + V.A.T. delivered.

We wish to purchase a small quantity of valve types PX4 + PX2S (or equivalents) also types KT66 KT88, we'll also buy valve collections, transistors + shop clearance.

For quotations contact: **Martin Billington**,
39 Highland Road, Horsham, W. Sussex RH13 5LH.
Phone 0403 864086.

Fax 0403 210108. Telex 87271

COMPUTER SUPPLIES

Disks & Ribbons

3" CF2	£1.90
3.5" DS unbranded	£0.90
5.25" Memorex branded	
SS/DD	£0.60
5.25" 96 ips DS, unbranded, labels etc.	£0.35
Vision 10 storage box 5.25" or 3.5"	£1.05
Imagewriter	£2.95
Citizen 120D	£3.50
Epson MX/RX/FX80	£2.75
Epson MX/RX/FX100	£3.10
Cannon FW 1080A	£2.68
Epson LX 80/86	£2.50
Kaga Taxan	£2.69

Please add 15% VAT carriage free.

T-systems Ltd.,
The Signal Cabin,
61 High Street, Orpington,
Kent BR6 0JF
Tel: 0689 22196

COPY DEADLINE
APRIL ISSUE
IS...
26th JANUARY
1988

ACCESSORIES

IAN FISHER Communications of Stanhope. Main distributors for 27 MHz & 904 MHz CB radios & accessories. Open Mon-Sat 10.30-6.00pm. Sun 2.30-4.30. CB Works. The Market Shop, Market Place, Stanhope Tel (0388) 528464.

SOFTWARE

Moray Micro Computing

Commodore Computers (14, C16, 64, 128), MICROCOM cw/tx/tx with superb mouse tutor.

"TURBOLOG" ultimate high speed station bus "MICROCOM INTERFACE" ready built. Complete range of Amstrad, Commodore + BBC/Atom hardware available. S.A.E. to: MORAY MICRO COMPUTING, Enzie, Stanhead, Baddis, Honey Ays 28R, Tel: 0642 7384.

FOR SALE

ELECTRONIC MORSE KEYS



Available with internal paddle (TA2) or for use with external paddle (TA6) 12v supply or 240v P.S.U. available.

* Wide range speed control
* Adjustable sidetone vol. & tone.
TA2 - with internal paddle £49.90
TA6 - requires external paddle
PUJ - A.C. mains P.S.U. £7.50
All prices fully inclusive.

NO EXTRAS
TARGA ELECTRONICS
9, Renshaw Road, Washin Moor, Chesterfield, Derbyshire S43 3DW

FOR SALE

ICOM ICR71E a receiver as new with FRI and speechboards fitted £550 or nearest offer. Dunstable 699573.

GENERAL

PSSS....
ALL THE SUPER BARGAINS ARE ON THE INSIDE-FRONT COVER OF THIS MAGAZINE!!



USED AMATEUR EQUIPMENT BOUGHT SOLD EXCHANGED.
SAE for latest list. Second hand price guide updated monthly useful guide for buying/selling £2.
ATU mods add top band to SEM KW etc £6.50

Call **Martin G4SUU**, Geofor Enterprises 112 Leeds Road, Miffield, West Yorks. Personal callers by arrangement. (0924) 495916

ACCESSORIES

WHOLESALE CB

CB radios including new frequency CEPT transceivers, aeriels, accessories - in stock now.

Perme House, 433 Wilmslow Road, Manchester M20 9AF



Open Every Day. Fax Number: 061-445 0978

NATIONWIDE DELIVERY

CB DEALERS contact us today
Fast, Friendly Service, Competitive
Prices, Widest Range & Latest
Products

Tel: 061-445-8918
061-434 6701

Telex: 666762 PAMACO G

VHF RECEIVERS

GAREX VHF PREAMPS AND RECEIVERS

Simple versatile designs for spot frequencies in the range 40-200MHz. Preamps measure only 34x8x15mm. Up to 28dB gain.

6m, 4m, 2m & Weather Sat £11.45 Receiver is basically single channel xtal controlled offering choice of IF bandwidths, excellent sensitivity, 2 watt audio o/p stage, fully assembled, tested boards (see to order).

Other variations and frequencies to order:
6m, 4m, 2m & W/Sat £49.95
Timesat Weather satellite systems: complete & ready to go. Microwave Meteoros & VHF (NOAA) systems. Ask for full details of these products. Prices inc p/p & VAT.

GAREX ELECTRONICS

Harrow House, Akeman St., Tring HP23 8AA 044 282 8580 & 0285 686884
Mail Order only Access/Visa

**TO ADVERTISE
RING 01 437 0626**

COURSES

RADIO AMATEUR LICENCE

Start training now for the following courses. Send for our brochure - without obligation or Telephone us on 06267 79398

HRT14

NAME _____

- Radio Amateur Licence
- City & Guilds Exam 271
- Micro-processor
- Introduction to Television

Radio & Telecommunications Correspondence School,
12, Moor View Drive, Teignmouth, Devon TW14 9UN.

WANTED

IDEAS, INVENTIONS wanted.
Call I.S.C. 01-434 1272 or write:
Dept (ASP) 99 Regent St.
London W1.

TO IMPROVE ENHANCEMENT IS HERE
ALL NEW APR 3500 ALL MODES MOBILE TRANSDUCER
- NOW AVAILABLE IN THE UK!
MANY FEATURES INCLUDE: DIGITAL FREQUENCY
READOUT - 28/30MHz - AM, FM, USB, LSB, CW -
SCANNING - SPLIT FREQUENCY OPERATION - AND
MANY MORE!
S.A.E. FOR FULL DETAILS TO:
PETE JENKINS 30, ECKHILL, 43 GREEN LANES,
WEST WELLS, EPDM, BURREY, KT19 9TW.

VALVES, Transistors, I.C. purchased, especially types PX4, PX2S, KT66 & KT88. Billington Valves. See Ad page.

CLASSIFIED COUPON

HAM RADIO TODAY, CLASSIFIED ADVERTISEMENT
DEPT, No 1 GOLDEN SQUARE, LONDON W1R 3AB

PLEASE DEBIT MY ACCESS(BARCLAYCARD NO. EXPIRY DATE -



FOR SALE

SOFTWARE

WANTED

Rates: Lineage 51p per word (VAT Inclusive) minimum £7.59
semi-display £7.75 per single column cm. No reimbursements for
cancellations. All ads must be pre-paid.

Name _____

Address _____

Daytime Tel. No: _____

Signature _____ Date _____

EQUIPMENT AERIALS OTHERWISE STATE



CAP CO ELECTRONICS LTD

63 Hallcroft, Birch Green
Skeimersdale, Lancs
WN9 6QB
Tel:0695 27946

Stay Tuned Forever with a CAP.Co ATU-
Once Bought - Never Replaced



ANTENNA TUNING UNITS

SPC-300D 1Kw p.p.p.	£225.00
SPC-3000D 3Kw p.p.p.	£325.00
NEW PRODUCT - W/F A.T.U.	
SPC-100 1Kw p.p.p.	£59.95 + £2 p&p

CAPACITORS

CAP-25S S GANG 250 pfd	£15.50
CAP-25T T GANG 250 pfd	£18.95
CAP-10S S GANG 500 pfd	£21.95
CAP-25D DIFF 500 pfd	£18.95
CAP-31S S GANG 250 pfd	£17.95
CAP-31T T GANG 250 pfd	£22.95
CAP-12S S GANG 1200 pfd	£25.95
12V 4.5mm plate spacing - 2.50 p & p	
ROLLER COASTER - 2.00 p&p	£22.95
28 micro henries	
BALUNS 4:1, 1:1 - 2.00 p&p	£16.50
Fully encapsulated	
AERIAL KIT - 1.00 p&p	£5.30
Clip-on Spreaders	
URNS COUNTER - 1.00 p&p	£22.50
Digital	

CAP CO. are proud to announce

THE GENUINE MAGNETIC LOOP ANTENNA
- A RARE TECHNOLOGICAL BREAKTHROUGH

The Magnetic Loop Aerial is totally different from any other aerial. It relies solely on the magnetic portion of the electromagnetic wave to operate. It filters out all unwanted noise via 180° phase shift between the magnetic and electrical wave, exactly what is required from 1 to 14MHz where the electrical noise is virtually unbearable.

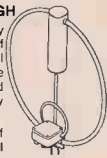

Transceiving Loop

Depending on the model used and within the bounds of the frequency designated for that model, the Control Box enables the user to operate the antenna from the lowest to the highest part of the frequency with no gaps.

There are various models of loops - typically 2 antennas and 1 Control Box is required to cover the whole HF frequency range from 1 to 30 mcs. A reduction of £100.00 is allowed for two aerials. Prices range from £79.95 for the receiving Loop to £456.00. Power ratings for these versions are from 100-200watts.

The Commercial versions, power rating 500 and 1000 watts come complete with Automatic Controller which selects frequency required.

PLEASE WRITE INCLUDING SAE FOR FURTHER DETAILED INFORMATION.

- It has a very high Q
- A radiation resistance of 0.003 of an ohm, never more than 800 milli ohms.
- Has a bandwidth from 3KHz to 50KHz
- It has an SWR of 1.4 to 1 at the very best, 1.1 to 1 on most bands
- Will operate at virtually ground level
- The loop has a vertically polarised radiation pattern containing both very high and very low angle radiation (ideal as a DX antenna)
- Does not require an Antenna Tuning Unit
- Depending on the model used, it only occupies from 80cm to 4mt of space
- It is ultra compact, light and waterproof
- Planning permission is not necessary

Receiving only Loop - ideal for S.W.L.



Manufactured in Great Britain

Our equipment is guaranteed, unique and as such protected by registered designs and copyright. Our policy is one of continual research and improvement therefore current specifications are subject to change without notice.

Multi-Mode Audio Filters

FL2 or FL3 improve even the best of communication receivers by allowing optimum removal of noise from the signal you want to copy, whether SSB, CW, or RTTY. Extremely versatile yet easy to use and install.

Price: FL2 £89.70 FL3 £129.37
inc. VAT (as FL2 plus auto notch).

To order simply dial

0532 744822

or write with cheque or postal order to



Dept HRT Datong Electronics Ltd., Clayton Wood Close, West Park, Leeds LS16 6QE



Access/Barclaycard welcome - Fast delivery service

Catalogue and data sheets on any product available free on request. Dial 0532 744822

Yaesu's FT-736R. Because you never know who's listening.

Why just dream of talking beyond earth?

With Yaesu's new FT-736R VHF/UHF base station, you can discover some of the best DX happening in ham radio. Via moonbounce. Tropo. Aurora. Meteor scatter. Or satellites.

You see, the FT-736R is the most complete, feature-packed rig ever designed for the serious VHF/UHF operator. But you'd expect this of the successor to our legendary FT-726R.

For starters, the FT-736R comes factory-equipped for SSB, CW and FM operation on 2 meters and 70 cm, with two additional slots for optional 50-MHz or 1.2-GHz modules (220-MHz North America only).

Crossband full duplex capability is built into every FT-736R for satellite work. And the satel-



lite tracking function (normal and reverse modes) keeps you on target through a transponder.

The FT-736R delivers 25 watts RF output on 2 meters, 220-MHz, and 70 cm. And 10 watts on 6 meters and 1.2-GHz. Store frequency, mode and repeater shift in each of the 100 memories.

For serious VHF/UHF work, use the RF speech processor. IF shift. IF notch filter. *CW Narrow Optional and FM wide/narrow IF filters. VOX. Noise blanker. Three-position AGC selection. Preamp switch for activating

your tower-mount preamplifier. Even an offset display for measuring observed Doppler shift on DX links.

And to custom design your FT-736R station, choose from these popular optional accessories: Iambic keyer module. FTS-8 CTCSS encode/decode unit. FVS-1 voice synthesizer. FMP-1 AQS digital message display unit. 1.2-GHz ATV module. MD-1B8 desk microphone. E-736 DC cable. And CAT (Computer Aided Transceiver) system software.

Discover the FT-736R at your Yaesu dealer today. But first make plenty of room for exotic QSL cards. Because you *never* know who's listening.

YAESU

*CW narrow optional



**UK Sole Distributor South Midlands Communications S.M. House, School Close,
Chandlers Ford Industrial Estate, Eastleigh, Hants SO5 3BY. Tel: (0703) 255111**

Prices and specifications subject to change without notice. FT-736R shown with 220-MHz option installed.