

57-58
128-49

WIRELESS ENGINEER

THE JOURNAL OF RADIO RESEARCH & PROGRESS

OCTOBER 1947

VOL. XXIV. TWO SHILLINGS AND SIXPENCE - - No. 289



CONDENSERS

*See
them in the*

BEST SETS

AND ON STAND No.5

Radiolympia



THE TELEGRAPH CONDENSER CO. LTD.

RADIO DIVISION

NORTH ACTON · LONDON · W.3. Telephone: ACORN 0061

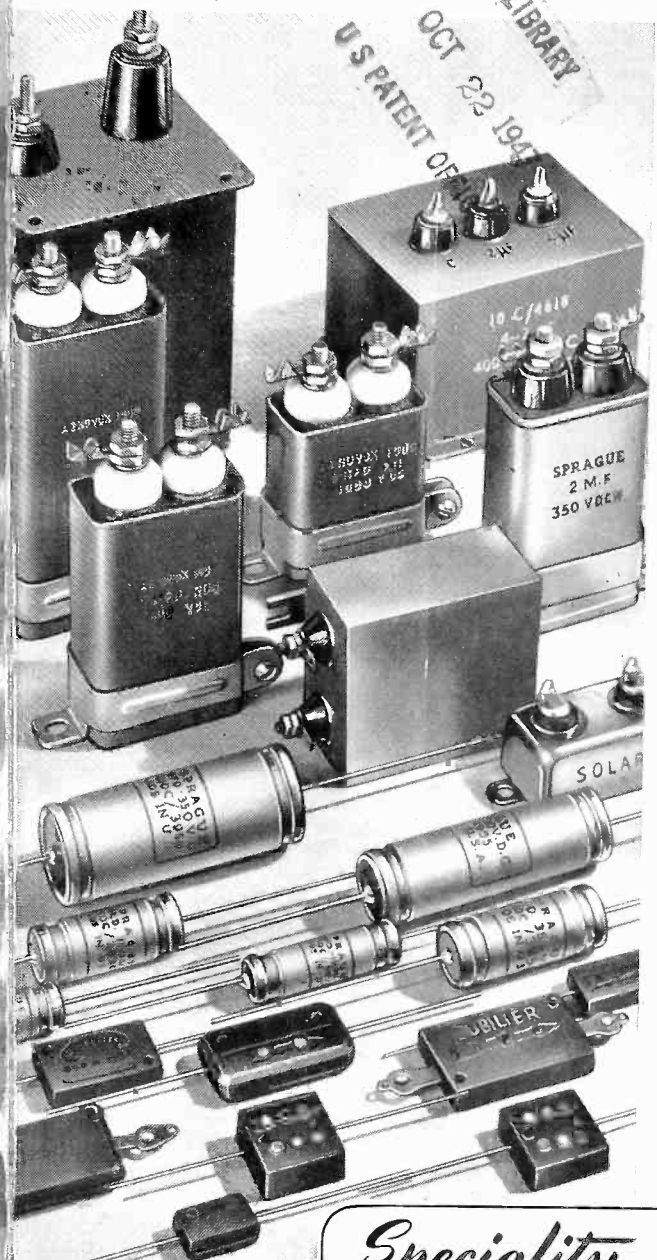

CONDENSERS *of all types—*

We can offer, FOR IMMEDIATE DELIVERY from very generous stocks, a wide range of ultra-high quality fixed paper Condensers, from .001 uF to 8 uF. Also STOCKS of small, genuine MICA Condensers from .00001 (10 pf) to .01 uF (10,000 pf). Prices are exceedingly moderate.

Enquiries are invited for bulk quantities, and for scheduled deliveries over a period, as required.

Condensers of close or very close tolerance can be supplied within about one week.

Speciality . . .

American Valves (Tubes) of all patterns, for radio receiving and transmitting: also special types, including phototube, cathode-ray, thyratron, ignitron, electron-multiplier, etc. Large STOCKS, at Board of Trade controlled prices.

Claude Lyons Ltd

ELECTRICAL AND RADIO LABORATORY APPARATUS ETC.
80, Tottenham Court Road, London, W.1 and 76, OLDHALL ST. LIVERPOOL, 3, LANCs.

TAYLOR made - to measure

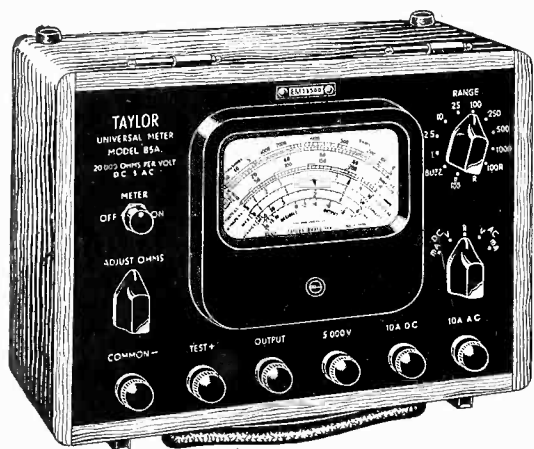

List Price

£19.19.0d

Immediate Delivery.

Illustrated leaflet on request from the manufacturers

The UNIVERSAL TAYLORMETER

Model 85A.
90 RANGES.

Unequalled Sensitivity

20,000 ohms per volt
on all D.C. and A.C. Ranges.

Instantaneous Meter

Overload protection

on all D.C. and
A.C. Ranges.

Specification.
D.C. Volts. 1 mV to 5,000 Volts.
D.C. Amps. 1 μ A to 10 Amps.
A.C. Volts. 0.1 Volt to 5,000 Volts.
A.C. Amps. 1 μ A to 10 Amps.
Resistance. 0.1 Ohm to 20 Megohms with internal battery, and up to 2,000 Megohms with external battery.
Continuity Test. By built-in Buzzer battery.
Capacity. .0002 to 100 mfd. with external adaptor.
Inductance. 0.2 to 1,000 Henrys with external adaptor.
Decibels. -34 to +69.
External Adaptors. For Low Resistance, High Voltage, A.C. Millivolts, etc.



TAYLOR ELECTRICAL INSTRUMENTS LIMITED

419/424, MONTROSE AVENUE, SLOUGH, BUCKINGHAMSHIRE

Telephone: SLOUGH 21381.

Grams and Cables: "Taylins" SL

R.F. ATTENUATOR TYPE D-239

BRIEF SPECIFICATION

ATTENUATION RANGE: TYPE D-239-A: 0—61.5 db variable in steps of 0.5 db. TYPE D-239-B: 0—80 db variable in steps of 1 db. CHARACTERISTIC IMPEDANCE: 75 ohms ("T"-network). PERFORMANCE: At frequencies up to 5 Mc/s and for any setting of the switches the error in attenuation will not exceed ± 0.2 db. Reasonable accuracy is maintained up to 10 Mc/s. TERMINATIONS: Coaxial connectors. INPUT: 3 volts maximum. DIMENSIONS: $6\frac{1}{2}$ in. \times $2\frac{3}{8}$ in. \times $5\frac{1}{4}$ in. WEIGHT: $2\frac{1}{2}$ lbs.

Manufactured to a design of the Radio Branch of the Post Office Engineering Department.

Full details are given in Bulletin B-562-A, a copy of which will be sent on request.



DELIVERY FROM STOCK

THIS small compact attenuator is characterized by a relatively high insertion loss and outstanding accuracy of attenuation at high frequencies. Wire wound resistance elements ensure accuracy, good stability and freedom from noise. It can be used as a bench instrument or for incorporation in other apparatus where its small size is a considerable asset. Two types, giving alternative values of attenuation, are available.

MUIRHEAD

Muirhead & Co. Ltd., Elmers End, Beckenham, Kent. Telephone: Beckenham 0041-2.

FOR OVER 60 YEARS DESIGNERS AND MAKERS OF PRECISION INSTRUMENTS.

CARPENTER

High Speed Polarised RELAY

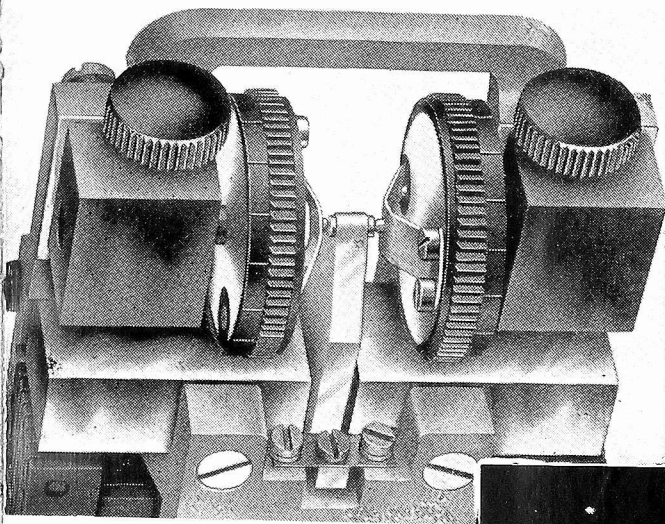

The Carpenter Relay in its standard adjustment reproduces, with a 5 AT input, square pulses from less than 2 milli-seconds upwards with a distortion of 0.1mS, i.e., 5% for 2mS pulses or 1% at 10mS.

This unequalled performance is due to inherent features of the design of the relay, ensuring short transit time, high sensitivity and low hysteresis.

- (Above) Contact mechanism of Relay showing damped compliant mountings of side contacts.
- (Right) Unretouched photograph (3 sec. exposure) of oscillogram showing contact performance of Relay in special adjustment for a measuring circuit; coil input 18 AT (25 mVA) at 50 c/s.

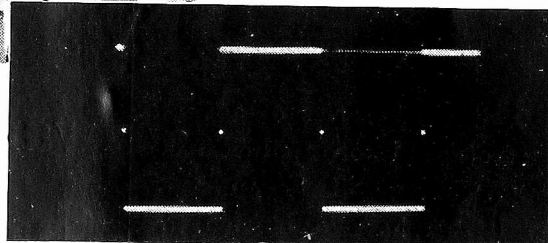

(Below) Graph showing contact pressures developed at 50 c/s against mVA and ampere turns input for type 3E Carpenter Relay.

There is complete absence of contact rebound at any input power and contact pressures are exceptionally high (see graph). Adjustment can be made with great ease. Moreover, since the armature is suspended at its centre of gravity, the relay has high immunity from effects of mechanical vibration and there is no positional error. Effective screening is provided against external fields. Because of these characteristics, the Carpenter Relay has many applications in the fields of measurement, speed regulation, telecontrol and the like, in addition to the obvious use in telegraph circuits; details of models suitable for such purposes will be supplied willingly on request.

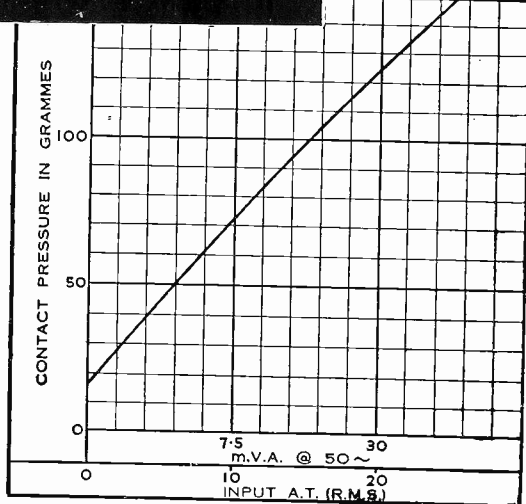

DIMENSIONS IN COVER: 2 3/8 x 1 1/8 x 4 1/2. WEIGHT with standard socket: 22 ozs.

Ask for Booklet 1017 W.E.

TELEPHONE MANUFACTURING CO. LTD.

BOLLINGSWORTH WORKS • DULWICH • LONDON • S.E.21

Telephone: GIPsy Hill 2211 (10 lines)

You've probably come across the Walter Type 40 dozens of times, for we have produced over 2,000 *different* assemblies. Like all Walter switches the Type 40 is 100% British in conception, design and construction and (unlike many other switches) it has built itself a world-wide reputation for reliable operation for long periods. The Type 40 in many of its 2,000 and more forms has found its place in a great deal of Radio and Electronic War Apparatus. It is fitted as standard by leading radio set makers.

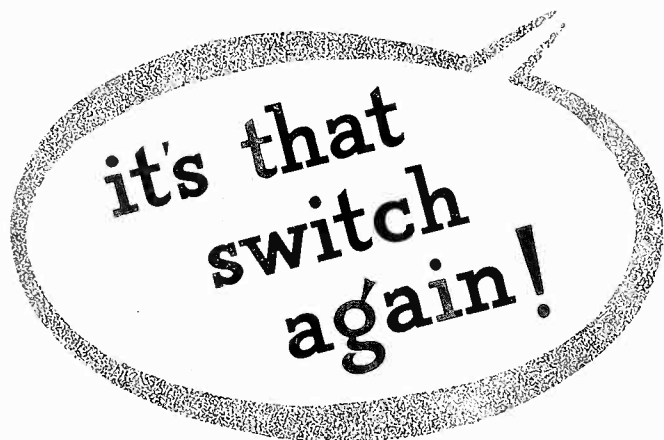

We are showing you in this series of advertisements a few of the 2,000 and more applications of the Walter Type 40. Meanwhile if you have any switch problem let us have a chance to provide the answer you want.

WALTER
Type 40

made for



THE SWITCH OF OVER 2,000 ASSEMBLIES

WALTER INSTRUMENTS LTD., GARTH ROAD
LOWER MORDEN, SURREY. Tel.: Derwent 4421-2-3
CRC 137

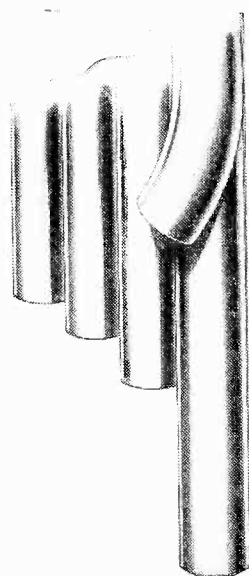

"SEND TO SERCK"

is the first step to
wards a solution of
the tube problem

Serck
NON-FERROUS
Tubes

AS USED BY SERCK

SERCK TUBES LTD., BIRMINGHAM

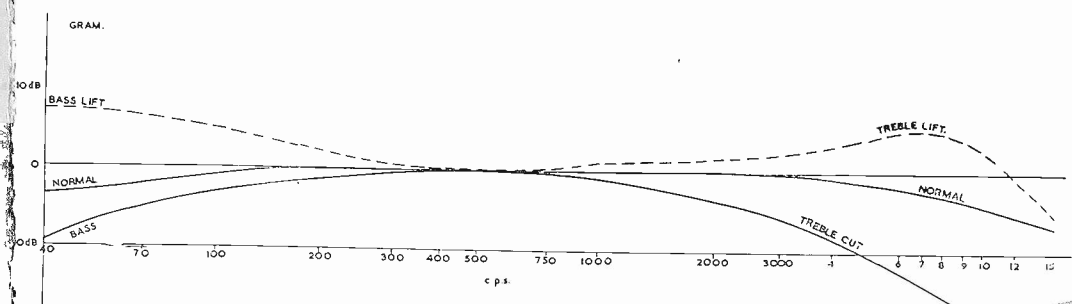

**HIGH QUALITY
LOCAL STATION
RECEIVER**
by
RM

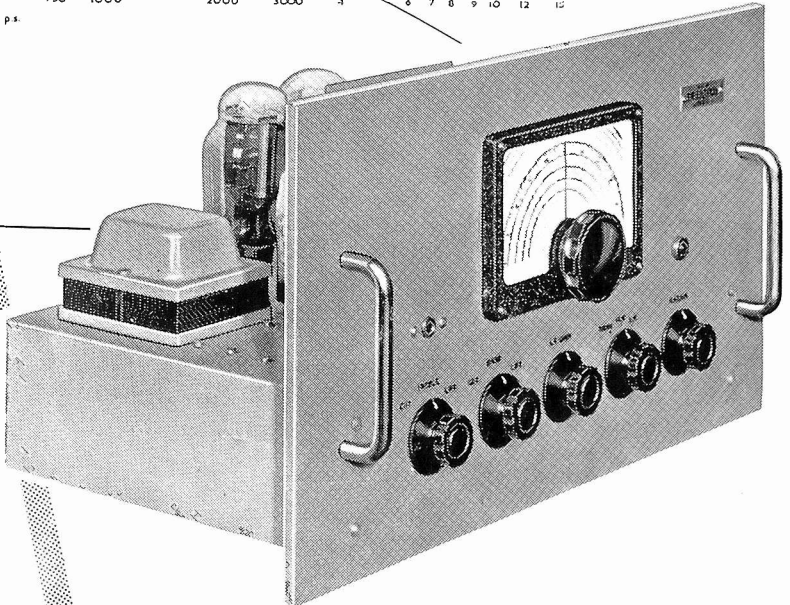

T.R.F. Circuit
For 19" Rack or Steel Cabinet
Push-Pull Triode Output
Bass and/or Treble Lift
Bass and/or Treble Cut

This receiver is specially built for the reception of local stations attaining the highest possible quality of reproduction. It incorporates a stage which restores the highest frequencies cut off in the tuned circuits. It also amplifies the bass to compensate for the lack of the lower register in recordings.

This receiver is also available as a feeder to drive large amplifiers.

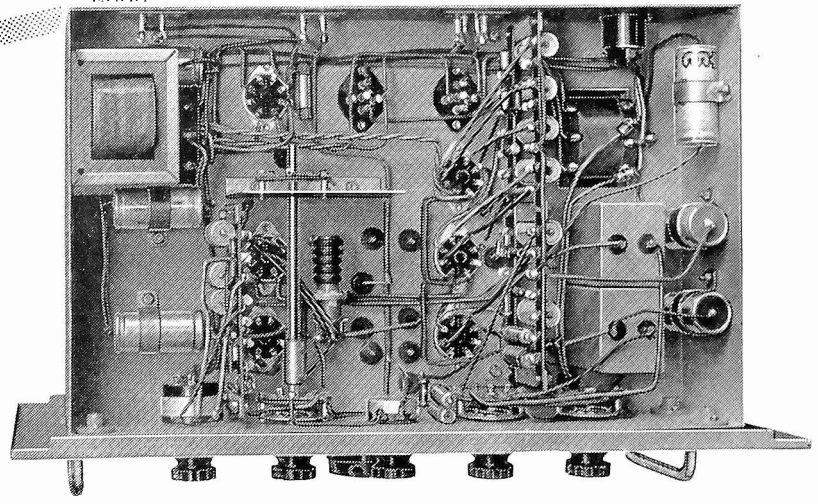

Send for detailed information

M. ELECTRIC LTD., TEAM VALLEY, GATESHEAD 11, ENGLAND

The Directors and Sales Staff of Aerialite Limited will be pleased to meet their many customers and friends at Stand No. 78, "Radiolympia" 1947, from October 1st to 11th. (Telephone: "Renown" 4129). A wide range of Radio and Television Aerial Equipment and "Ashton" Cables and Flexibles will be on display.



AERIALITE *Limited*

STAND No. 78, RADIOLYMPIA 1947. TELEPHONE · RENOWN · 5129

CASTLE WORKS · STALYBRIDGE · CHESHIRE. TELEPHONE · STALYBRIDGE · 2223/6

London Office.

Telephone: Welbeck 79

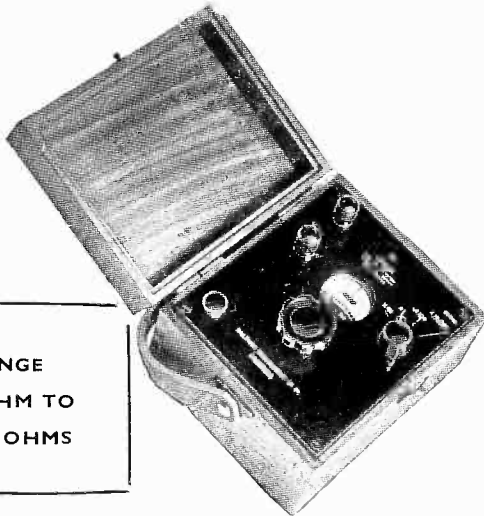

RANGE
0.05 OHM TO
5 MEGOHMS

THE NEW BALDWIN 'LOGOHM'

RESISTANCE BRIDGE

Direct reading . . . quicker measurement

This wide range instrument, completely self-contained, embodies the latest improvement in Resistance Bridge design. It gives direct reading and is most simple to operate. Compact and robust, the instrument is ideally suited for both laboratory and workshop.

Fully descriptive leaflet supplied on request.

BALDWIN INSTRUMENT CO., LTD.
BROOKLANDS WORKS, PRINCES ROAD,
DARTFORD, KENT. Tel: DARTFORD 2989

★
LIGHT
WEIGHT
— 36 lbs.

★
COMPACT
12½" x 13½" x 7¾"

★
NEGLIGIBLE
STRAY FIELD

★
PRECISION
SLOW MOTION
DIAL

★
DUAL POWER
SUPPLY
100-250v., 40-100~
10v., 40-2000~

★
WIDE RANGE
10-310 mcs.

★
MODULATION
10% sine wave 1,000~
and pulsed
50/50 square wave
at 1,000~

★
FREQUENCY
CALIBRATION
1%

★
ATTENUATION
Max. error at 300 mcs.
± 2dB.

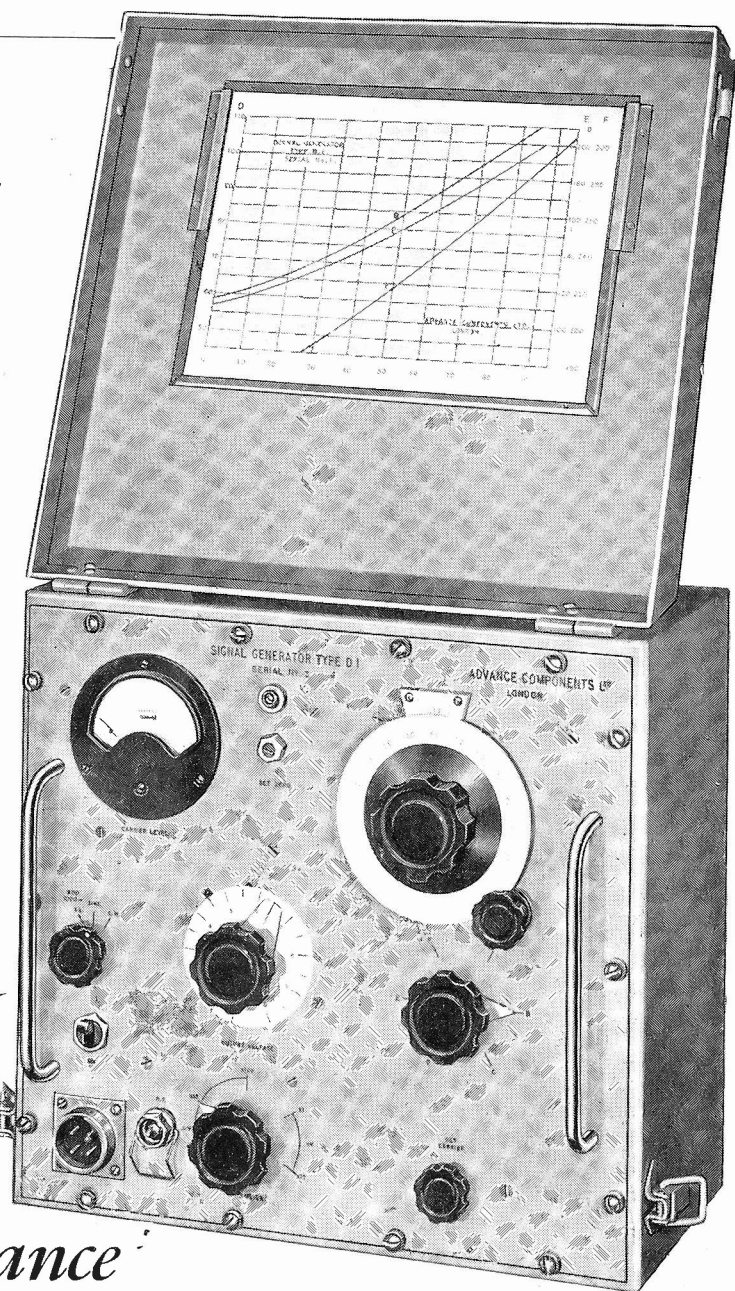

Price £80
Delivery—ex Stock

'Advance' Signal Generator type D.1.

"ADVANCE" Signal Generator is of entirely new design and embodies many novel constructional features. It is compact in size, light in weight, and can be operated either from A.C. Power Supply or low voltage high frequency supplies.

6X4 valve is employed as a colpitts oscillator, which can be Plate modulated by a 1,000 cycle sine wave generator, or grid modulated by a 50/50 square wave. Both types of modulation are internal and selected by a switch. The oscillator section is triple shielded and ex-

ternal stray magnetic and electrostatic fields are negligible. Six coils are used to cover the range and they are mounted in a coil turret of special design. The output from the R.F. oscillator is fed to an inductive slide wire, where it is monitored by an EA50 diode. The slide wire feeds a 75-ohm 5-step decade attenuator of new design. The output voltage is taken from the end of a 75-ohm matched transmission line.

The instrument is totally enclosed in a grey enamelled steel case with a detachable hinged lid for use during transport.

Write for descriptive leaflet.

ADVANCE COMPONENTS, LTD., BACK ROAD, SHERNHALL STREET, WALTHAMSTOW, LONDON, E.17
Larkswood 4366-7

A NEW OSCILLOSCOPE

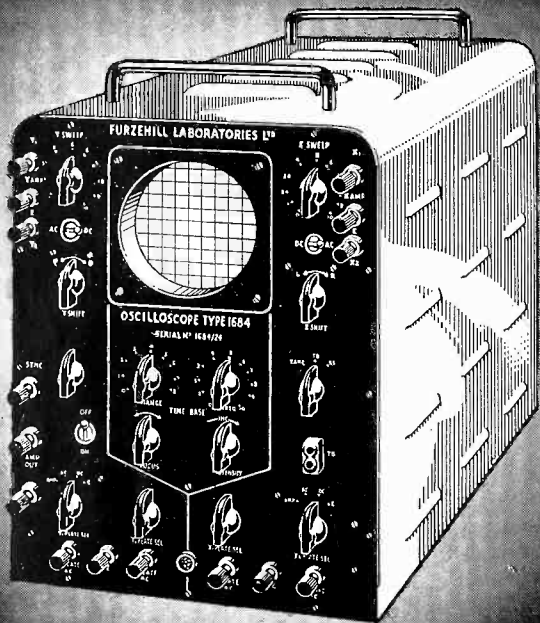

TYPE 1684B

PRINCIPAL FEATURES.

★ **TUBE.** 3½ in. diam. Blue or green screen.

★ **SHIFTS.** D.C. thus Instantaneous on both axes.

★ **AMPLIFIERS.** X and Y amplifiers are similar. D.C. to 3 Mc/s 24 mV. r.m.s. per c.m. or D.C. to 1 Mc/s 8 mV. r.m.s. per cm.

★ **TIME BASE.** 0.2 c/s to 150 Kc/s. Variable through X amplifier 0.2 to 5 screen diameters. Single sweep available.

The Oscilloscope Type 1684B has proved an invaluable instrument for applications ranging from Servo Development, where signal frequencies may be as low as 0.1 c/s, to Television Research. The Oscilloscope is equipped with high gain d.c. coupled amplifiers having a frequency response from d.c. to 3 Mc/s. These amplifiers will handle symmetrical and asymmetrical input. In general the instantaneous shifts, semi-automatic synch, steadiness of image and general ease of operation are features which appeal to all engineers.

FHL FURZE HILL LABORATORIES LTD

TELEPHONE
ELSTREE
1137

BOREHAM WOOD
HERTS

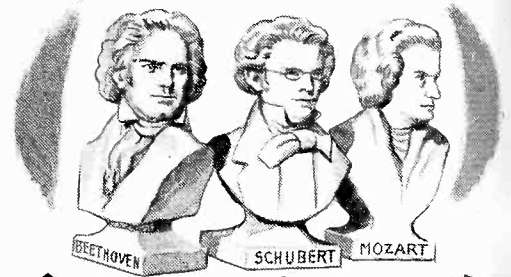

BRING THEM BACK
"ALIVE!"

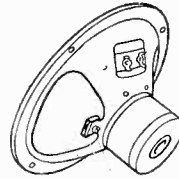

Monobolt Speakers

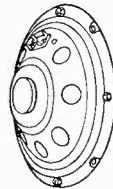

Water Speakers

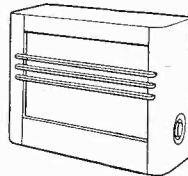

Cabinet Speakers

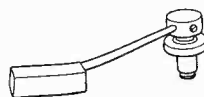

High Fidelity Pick-ups

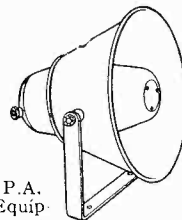

P.A.
Equip-
ment

We can't, of course. Not just like that. But we say that if you use Truvox Equipment with amplification of comparable quality you will get realism as dramatic as if the composer were indeed conducting again. New Truvox loudspeakers, new gramophone pick-ups, results of years of special endeavour, will be shown for the first time at Ray Olympia on Stand 81. We hope that you will see them there, but if you cannot a postcard will bring satisfying literature.

TRUVOX

ENGINEERING CO., LTD
Exhibition Grounds · Wembley · Middlesex

Radiolympia Stand Report

Belling-Lee Stand No 33

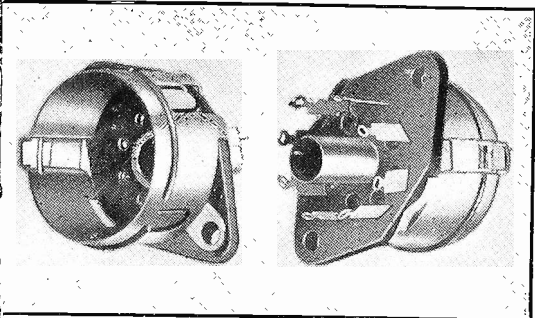

The new **B8A VALVEHOLDER**. List No. **L.620**.

A **B.8A VALVEHOLDER** has been added to the range of well-known types which include **HIGH VOLTAGE VALVEHOLDERS**.

THERMAL CUTOUTS for the protection of fractional motors are being shown and demonstrated, a motor run which may be stalled by a brake. The action of cutout being brightly illuminated is observed through a powerful lens. Cutouts are a rapidly increasing part of our production, and our engineers will be glad to discuss these engineers of firms who are interested.

A range of **FILTERS FOR THE SUPPRESSION OF H.F. INTERFERENCE** is shown. Most of these have been revised since last Radiolympia, to take care of the higher frequencies now more commonly in use.

COMPONENTS include a full range of **TERMINALS**; revised single, double and multi **PLUGS AND SOCKETS**; a comparatively new range of **COAXIAL PLUGS AND SOCKETS**; single, twin "T" section and couplings; **AND FUSEHOLDERS**, including a fairly new miniature fuseholder; also **GLASS SEAL TERMINALS**.

PARKING PLUG SUPPRESSORS and **DISTRIBUTOR PRESSORS** are available to prevent motor cars from interfering with television.

AMATEURS will find that they are interested in practically everything shown and will be made specially welcome. **AMATEUR AERIAL KIT** is already fairly well known.

The new Belling-Lee Skyrod will be 18 feet long, in three sections, of high tensile alloy, for chimney mounting. Instead of one set of transformers for the "Skyrod" and another for the "Eliminoise," there will be one set only, which will normally be used with the "Skyrod," but may also be used with a horizontal aerial, or attached to the cross bar of a television dipole (Belling-Lee U.K. patent No. 520628) to enable the reflector to be used as an anti-interference aerial. As we have been unable to improve the electrical design, this has been left as in the original "Eliminoise," the performance of which has never been equalled. We have, however, considerably improved the mechanical design of both the aerial and receiver transformers. They have been "streamlined" inside and out. All parts necessarily so, are easily accessible and much time will be saved in installation. A very real facility has been added to the receiver "Eliminoise" which is intended to be fixed to the skirting board, and is provided with a coaxial output, the new Belling-Lee Coaxial plug and socket being incorporated. The lead to the receiver consists of a 5ft. coaxial cable with its appropriate plug to the transformer, the set end terminating with two O.Z. 1/8in. dia. plugs soldered on, the junction being a polythene moulding. We would remind readers that the wave bands covered are 10-56, 200-560, 1,000-2,000 metres.

We are also showing a full range of **TELEVISION AERIALS** including the comparatively new **INDOOR TELEVISION AERIAL FOR ATTIC OR LOFT**. This is intended for districts where field strength is strong. It has very distinct minima, which can be used against interference. Can be used indoors, or is supplied with metal mast and lashings for chimney mounting. If you do not already know them, see also the "WINROD" **WINDOW AERIAL** and the "CAROD" **CAR AERIAL**.

We are proud of our production, but, although in general our deliveries are as good as most, we are anything but proud of them, nor are we complacent. We do our best and crave your patience although we are ourselves impatient.

BELLING & LEE LTD
CAMBRIDGE ARTERIAL ROAD, ENFIELD, MIDDX

SEE US AT

RADIOLYMPIA—STAND No. 87

SPEAKING OF

Quality...

The leading radiograms
are fitted with Goodmans
12" loudspeaker.

Type No. T2/1205/15

GOODMANS

Loudspeakers
A TRADITION OF EXCELLENCE

GOODMANS INDUSTRIES LTD.
LANCELOT ROAD, WEMBLEY, MIDDX.

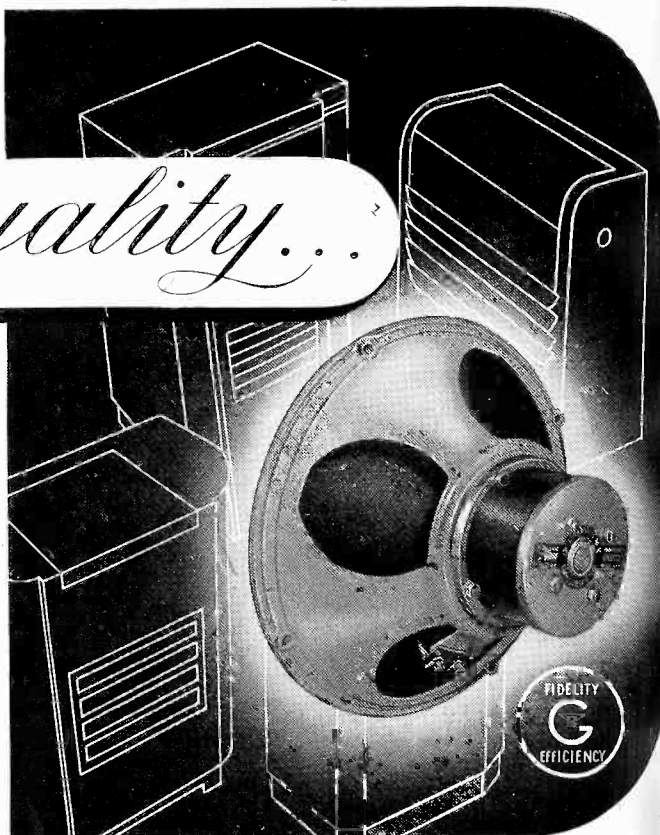

Made to Measure

INTER-ELECTRODE CAPACITY METER

An instrument for the precise measurement of Grid-Anode Capacity, input and output capacity of any type of valve. Range 0.0002 pf to 1.5 pf and 0 to 3 and 0 to 30 pf. This is one more sample of our wide range of instruments of pioneer design produced to meet the needs of communication engineers.

If you have any special problem do not hesitate to make use of our team of experts.

Another Instrument of
Pioneer Design
by—

BRITISH PHYSICAL LABORATORIES
HOUSEBOAT WORKS · RADLETT · HERTS · TELEPHONE: RADLETT 5674

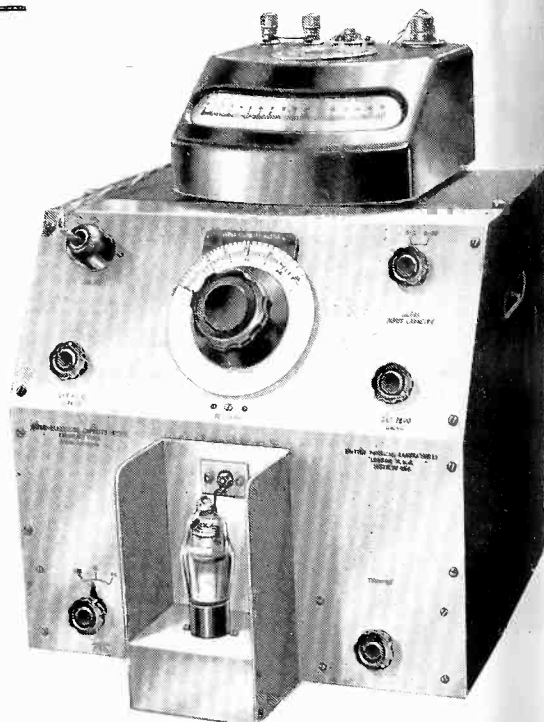

METALLISED CERAMICS

There's a size for every job
in the S.P. range of
metallised
ceramics

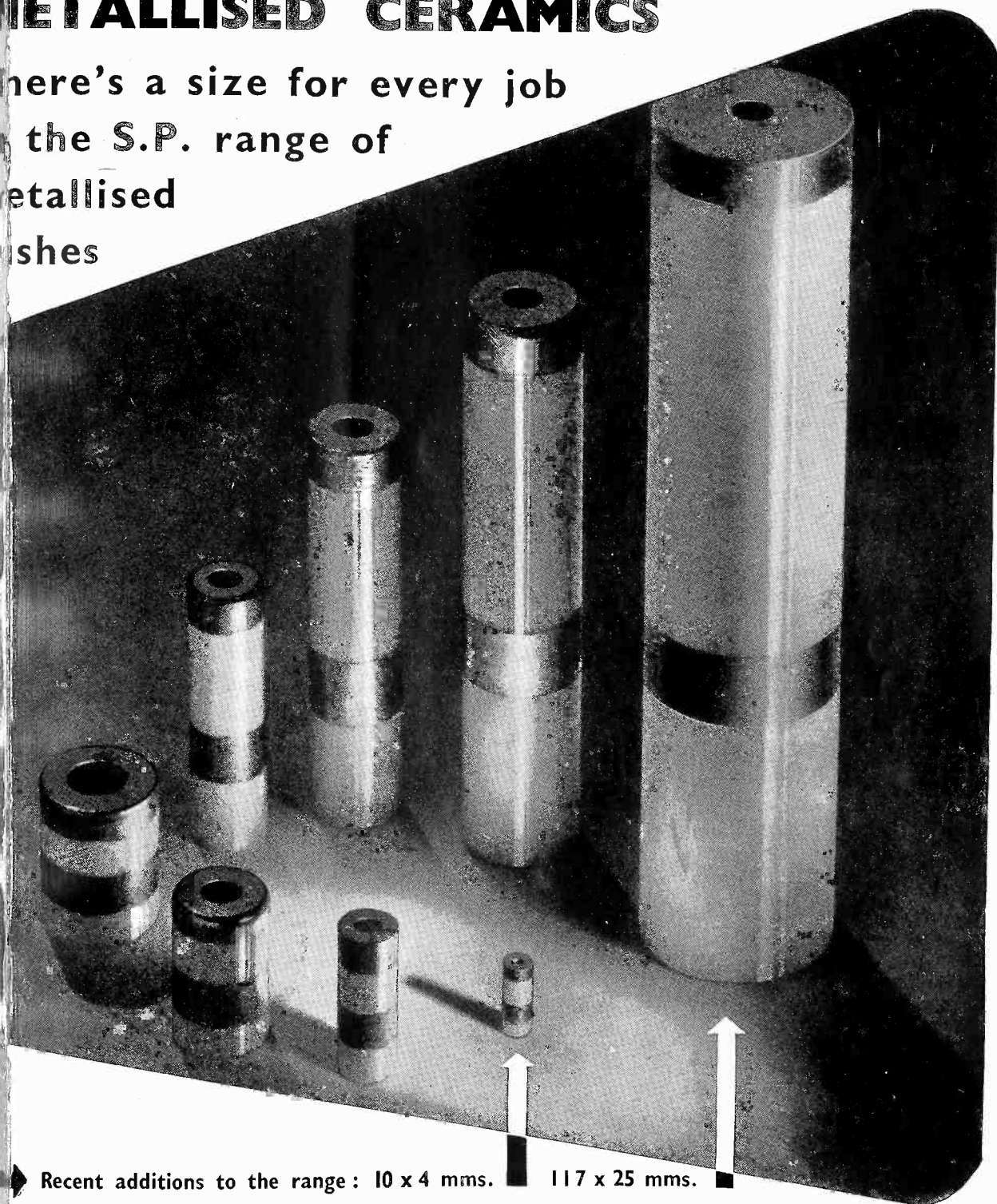

Recent additions to the range : 10 x 4 mms. 117 x 25 mms.

For all information and prices please write to :

STEATITE & PORCELAIN PRODUCTS LTD.

STOURPORT-ON-SEVERN, WORCS. Telephone: Stourport III. Telegrams: Steatoin, Stourport.





Hermetically Sealed

TRANSFORMERS

W.A.B. Hermetically Sealed Transformers were developed during the war to meet the requirements of the Services for a unit which would operate continuously under conditions of high relative humidity and high ambient temperature.

A patented method of internal construction ensures that the weight of the Transformer is taken directly on the fixing bushes and not on the case, thus preventing a risk of damage to the sealing of the case when the unit is subjected to mechanical shock.

All Transformers in this range are so constructed that they can be used for either chassis or baseboard mounting.



W. ANDREW BRYCE & CO. LTD., Shenley Road, Boreham Wood, Herts. Tel. ELStree 1870, 1875 & 1117

1000 different voltage ratios!

DECADE POTENTIOMETER Type 202A

A potential divider of high accuracy for use at audio and carrier frequencies providing voltage ratios between 0.001 and 1.000 in steps of 0.001.

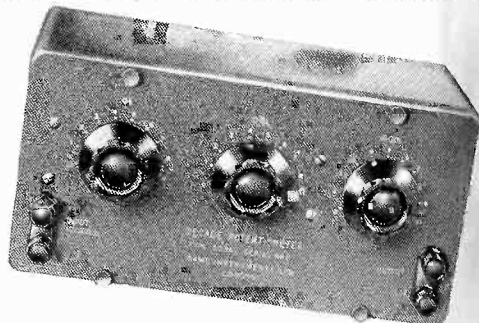

DAWE

Two useful instruments for fidelity determinations; calibration of valve voltmeters; amplifier-gain measurements; and connection to any high impedance circuit where the input voltage must be varied in accurately controlled steps.

A.F. MICROVOLTER Type 615A

A combination of a variable attenuator and meter which provides accurately known small voltages from an external oscillator.

1 microvolt to 1 volt!

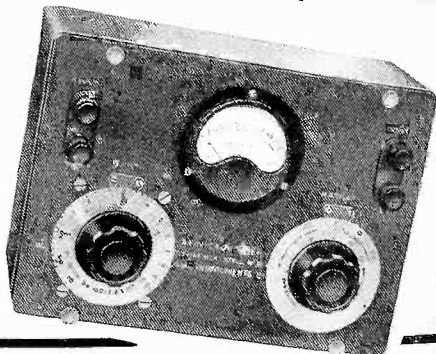

For complete technical data, write: DAWE INSTRUMENTS LIMITED, Harlequin Avenue, Great West Rd., Brentford, Middx.

Ealing 1850

HIGH
STABILITY RESISTORS

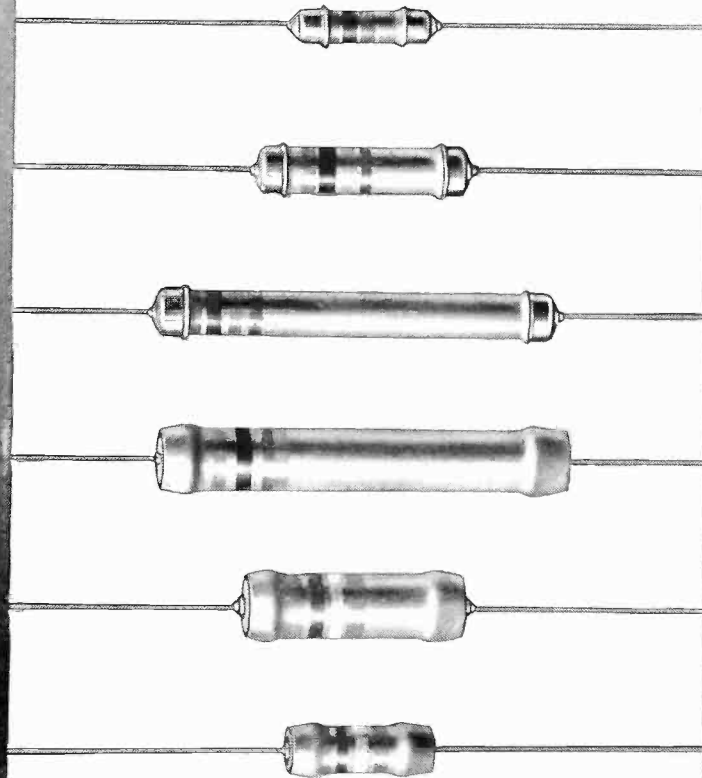

DUBILIER
 CONDENSER CO. (1925) LTD.

WHERE HIGH STABILITY IS ESSENTIAL

operation in certain special conditions, a high degree of stability is the chief characteristic required of fixed resistors. For example, in television, electronic and instrument applications where maintenance of maximum stability is desired over long periods of continuous use, high stability in resistors must be the primary qualification. A particular process of manufacture to which Dubilier High Stability Resistors are subjected ensures this stability of resistance value, coupled with a low temperature coefficient of resistance, a negligible temperature coefficient and a low "noise level".

In conditions where high stability is vital, a selection from this specially designed range of Dubilier High Stability Resistors type R should be made. Full technical details and prices will be sent upon receipt of your enquiry.

Electrical Standards for Research and Industry

WAVEMETERS

OSCILLATORS

CONDENSERS

INDUCTANCES

ALL TYPES

ALL ACCURACIES

AND ALL FREQUENCIES

Testing and Measuring Apparatus

FOR COMMUNICATION
ENGINEERING

RESISTANCES

BRIDGES — Capacitance
Inductance
Resistance

INEXPENSIVE

DIRECT READING

DECADE STABLE MICA CONDENSERS

50 $\mu\mu\text{F}$ to 1.0 μF
(continuously variable)

DIRECT READING ACCURACY 0.5%
PERMANENCE 0.1%
MAY BE CERTIFIED TO 0.1%

In addition to the well known Precision and Laboratory grades of Sullivan Decade Mica Condensers we have introduced a new **Inexpensive Series** especially designed for use in **Colleges** and for the more ordinary **Routine Testing** and **Industrial Research**.

Suitable for use at Low and High Frequencies.



H. W. SULLIVAN
— LIMITED —

LONDON, S.E.15

Telephone: New Cross 3225 (P.B.X.)

LOW TEMPERATURE CO-EFFICIENT
PROTECTION FROM THE EFFECTS
HUMIDITY
TROPICAL CLIMATE
SUITABLE FOR USE IN

WIRELESS ENGINEER

The Journal of Radio Research & Progress

Editor

Managing Editor

Technical Editor

W. T. COCKING, M.I.E.E. HUGH S. POCOCK, M.I.E.E. Prof. G. W. O. HOWE, D.Sc., I.L.D., M.I.E.E.

Editorial Advisory Board.— F. M. COLEBROOK, B.Sc., A.C.G.I. (National Physical Laboratory),
L. W. HAYES, O.B.E., M.I.E.E. (British Broadcasting Corporation), Professor E. B. MOULLIN, Sc.D.,
M.I.E.E., A. H. MUMFORD, O.B.E., B.Sc. (Eng.), M.I.E.E. (G.P.O. Engineering Department), R. L.
SMITH-ROSE, D.Sc., Ph.D., M.I.E.E. (National Physical Laboratory).

OCTOBER, 1947

Vol. XXIV.

No. 289

CONTENTS

EDITORIALS.

Radiolympia	283
Ohm and his Law	284
OSCILLOSCOPE TIME-BASE CIRCUIT. By H. den Hartog and F. A. Muller	287
ELECTRO-ENCEPHALOGRAPH AMPLIFIER (<i>Conclusion</i>). By Denis L. Johnston, B.Sc. (Eng.)	292
TEMPERATURE-DEPENDENT RESISTORS. By W. H. B. Cooper and R. A. Seymour	298
NEW BOOKS	300
CORRESPONDENCE	300
WIRELESS PATENTS	311
ABSTRACTS AND REFERENCES. Nos. 3001—3385	A 217—A 240

Published on the sixth of each month

SUBSCRIPTIONS

Home and Abroad: One Year 32/-. Six Months 16/-.

Editorial, Advertising and Publishing Offices:

DORSET HOUSE, STAMFORD STREET, LONDON, S.E.1

Telephone: WATerloo 3333 (50 lines).

Telegrams: Wirenger, Sedist, London.

Branch Offices:

COVENTRY
8-10, Corporation Street.
Telephone: Coventry 5210.
Telegrams:
"Autocar, Coventry."

BIRMINGHAM 2
King Edward House,
New Street.
Telephone: Midland 719 (7 lines).
Telegrams:
"Autopress Birmingham 2."

MANCHESTER 3
260, Deansgate.
Telephone:
Blackfriars 4412 (4 lines).
Telegrams:
"Hiffe, Manchester 3."

GLASGOW C2
26B, Renfield Street.
Telephone: Central 4857.
Telegrams:
"Hiffe, Glasgow C2."

LONG LIFE WITH **CONSTANT** PERFORMANCE

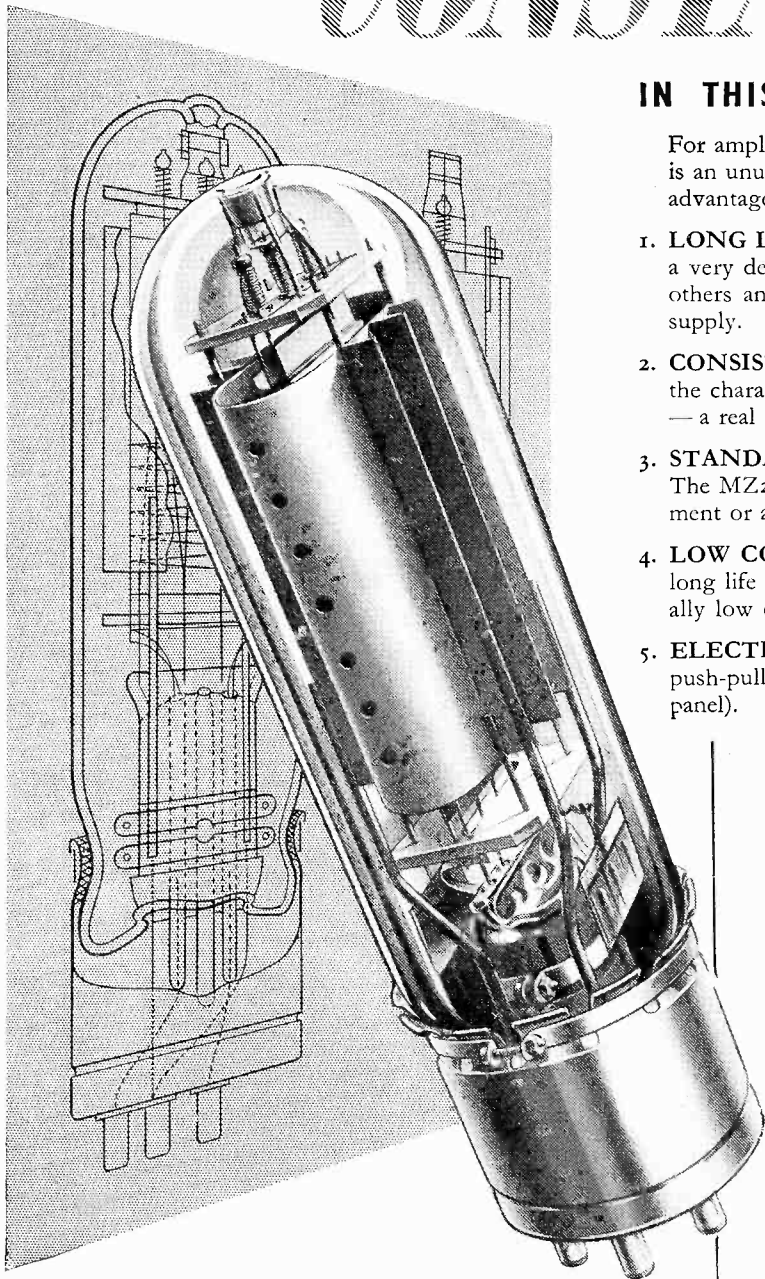

IN THIS REDESIGNED OUTPUT TRIODE

For amplifiers in the 500 - 1000 W. range, the new MZ2 - 200 is an unusually good valve. Here are some of its outstanding advantages :

- 1. LONG LIFE FILAMENT.** The filament is oxide coated — a very definite advance in a valve of this size. It will outlast others and is unaffected by normal fluctuations in the mains supply.
- 2. CONSISTENT CHARACTERISTICS.** Variation between the characteristics of one MZ2 - 200 and another is negligible — a real trouble saver in maintenance.
- 3. STANDARD DIMENSIONS AND CONNECTIONS.** The MZ2 - 200 can be used with equal benefit for new equipment or as a straight replacement of equivalent types.
- 4. LOW COST PER KILOWATT/HOUR.** Low initial cost, long life and modest filament consumption give an exceptionally low cost per kilowatt/hour.
- 5. ELECTRICAL PERFORMANCE.** With two valves in push-pull, 1100W output at less than 3% distortion (see data panel).

MZ2-200 OUTPUT TRIODE.

Filament Voltage	-	-	14.0 V.
Filament Current	-	-	2.2 A.
Anode Dissipation	-	-	275 W.
*Mutual Conductance	-	-	7.2 m A/V.
*Amplification Factor	-	-	15
*Internal Impedance	-	-	2085 ohms.
*Measured at $V_a=2000$ V; $I_a=180$ mA.			

TYPICAL OPERATION FOR TWO VALVES IN CLASS AB2 PUSH-PULL.

Anode Voltage	-	-	2400 V.
Anode Current (no signal)	-	-	2 x 60 mA.
Anode Current (max. signal)	-	-	2 x 350 mA.
Anode Load (anode-anode)	-	-	8000 ohms.
Output Power	-	-	1130 W.
Total Distortion	-	-	2.8%

OTHER VALVES IN THE MULLARD L.F. RANGE		
	V_a	w_a
MZ1-75	1250V.	75W.
MZ1-100	1250V.	100W.

Mullard

THE MASTER VALVE



THE MULLARD WIRELESS SERVICE CO. LTD., TRANSMITTING & INDUSTRIAL VALVE DEPT., CENTURY HOUSE, SHAFTESBURY AVENUE, LONDON, W.C.2

MYT18C

Virtually Distortionless

A.D/47 AMPLIFIER



This is a 10-valve amplifier for recording and play-back purposes for which we claim an overall distortion of only 0.01 per cent., as measured on a distortion factor meter at middle frequencies for a 10-watt output.

The internal noise and amplitude distortion are thus negligible and the response is flat plus or minus nothing from 50 to 20,000 c/s and a maximum of .5 db down at 20 c.s.

A triple-screened input transformer for $7\frac{1}{2}$ to 15 ohms is provided and the amplifier is push-pull throughout, terminating in cathode-follower triodes with additional feedback. The input needed for 15 watts output is only 0.7 millivolt on microphone and 7 millivolts on gramophone. The output transformer can be switched from 15 ohms to 2,000 ohms, for recording purposes, the measured damping factor being 40 times in each case.

Built-in switched record compensation networks are provided for each listening level on the front panel, together with overload indicator switch, scratch compensation control and fuse. All inputs and outputs are at the rear of the chassis.

Send for full details of Amplifier type AD/47.

257/261, THE BROADWAY,
WIMBLEDON, LONDON,
S.W.19.

Telephones: LIBerty 2814 and 6242/3.

Telegrams: "VORTEXION, WIMBLE, LONDON."

Vortexion
LIMITED

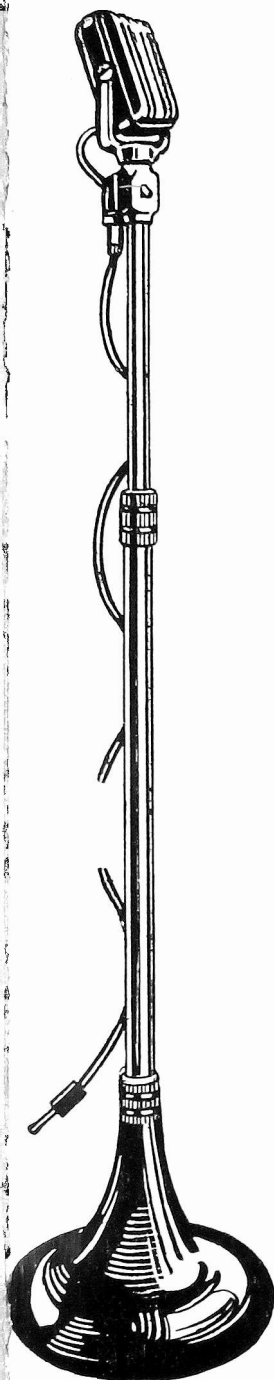

The service that never sleeps

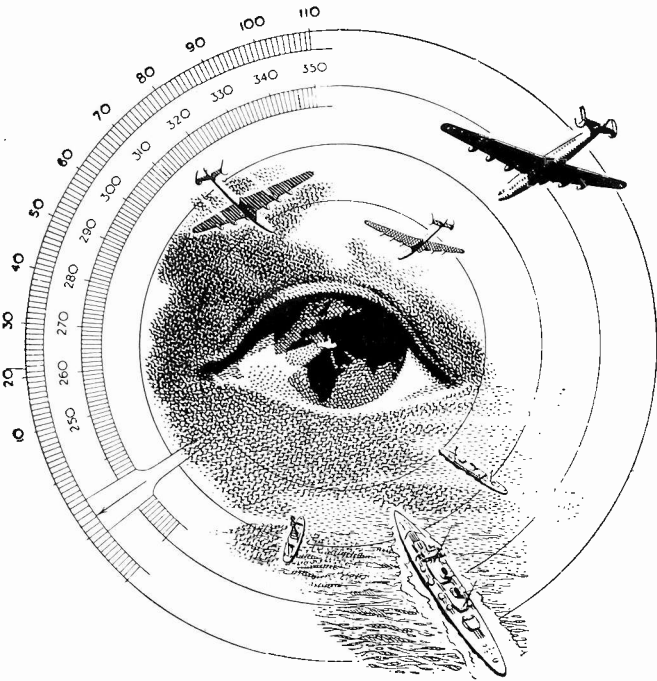

All over the world, all round the clock, Marconi apparatus guides the coming and going of ships at sea and planes in transit. It's always on duty. First in the field for 50 years—with the best team available for every new problem of wireless communications—Marconi's are looking ahead to still greater developments in post-war practice.

MARCONI



MARCONI'S WIRELESS TELEGRAPH COMPANY LTD

THE MARCONI INTERNATIONAL MARINE COMMUNICATION COMPANY LTD

MARCONI HOUSE, CHELMSFORD, ESSEX

immediate delivery!

TEXOLEX TUBES IN LAMINATED
FABRIC OR PAPER BASE

THE BUSHING CO. LTD.
HEBBURN-ON-TYNE

BROOKES CRYSTALS

EST. 1929 ————— LTD.

FOR
HIGH PERFORMANCE
OSCILLATORS
AND
RESONATORS
ACCURACY GUARANTEED

51/53, GREENWICH CHURCH STREET,
LONDON, S.E.10. 'Phone: GRE. 1828

When the aim is

ACCURACY

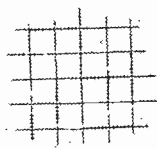

the Instrument is

COSSOR

● An important section of the Cossor Organisation is devoted to the production of electronic indicating and recording equipment of the highest calibre, designed to fulfil the most critical of current scientific demands. Enquiries relating to problems arising in recording indicating and monitoring where effects can be made available as a voltage, should be addressed to: A. C. COSSOR LTD., Instrument Dept., Highbury, London, N.5.

A. C. COSSOR LTD
INSTRUMENTS DEPT.

— ALL-POWER —

CONSTANT VOLTAGE POWER SUPPLIES

Announcing Series 1120!

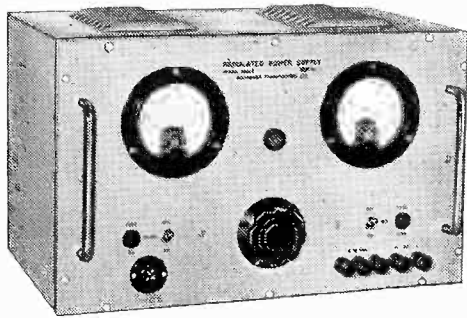

As a result of the increasing demand for our medium sized industrial Power Supply Units we are introducing a new semi-standard unit, Model 1120, which will enable us to satisfy a large proportion of our customers' requirements in the quickest, most efficient, and most economical manner.

Details On Application.

ALL-POWER TRANSFORMERS LTD.
8a, GLADSTONE ROAD, WIMBLEDON, S.W.19
TEL. : LIBerty 3303.

Miniature or Midget

ACTUAL SIZE

30%
10%
XY 14A

ACTUAL SIZE

24%
10%
XW 0-75A

NEW TYPES FOR
MIDGET RECEIVERS
HEARING AIDS
METEOROLOGICAL
INSTRUMENTS
ETC.

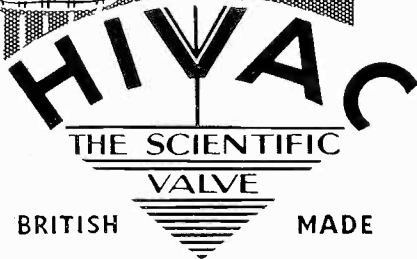

HIVAC LIMITED Greenhill Crescent, Phone HARROW
Harrow on the Hill, Middx. 0895

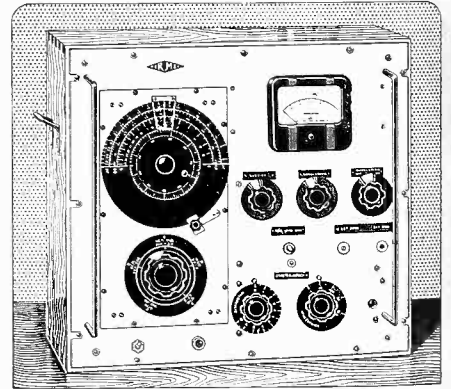

Standard Signal Generator

With its extreme accuracy and stability, the Airmec Signal Generator is an indispensable instrument wherever radio-frequency measurements are made. Whether in a laboratory, a service station, or on a production line, it will speed the work and guarantee accurate results.

Write for full descriptive literature
AIRMEC LIMITED
Wadsworth Road, Perivale, Greenford, Middlesex
Telephone: Perivale 3344



CVR-11

A Group Company of Radio
& Television Trust Ltd.

Announcing...

★ ORIGINAL DESIGNS

The following new U.I.C. Components for which patents have been applied, are shown for the first time at any exhibition in this country

Ceramic High Voltage Lead-through Capacitors—specially designed for lead-through and by-passing applications where appreciable amounts of H.F. power have to be handled.

Ceramic Wafer Capacitors— inexpensive flat plate capacitors suitable for receiver type applications.

Silvered Mica Twin Capacitors—intended for use as an end-plate or base on an I.F. Transformer.

★ SEE THEM ON STAND
No. 126 RADIOLYMPIA

... their first appearance

UNITED INSULATOR CO. LTD., OAKCROFT ROAD, TOLWORTH, SURBITON, SURREY

Telephone: Elmbridge 5241

Telegrams: Calanel, Surbiton

Unsurpassed In Ceramics



VARIAC

. . . . the infinitely variable
AUTO TRANSFORMER

These entirely British-made Transformers are available in ratings from 50 Watts to 7 Kilowatts. Most types can be furnished in parallel assemblies or in 3-gangs for 3-phase operation.

Usual winding is 230V. input (tap at 115V.), 50 cycles per sec., 1-phase: Output is usually from 0-230V. and/or 0-270V.

Well-illustrated Brochure 424-E and List VAR 747 gives uses, circuit applications and other useful data. Prices are reasonable.

Deliveries ex stocks, on most types.

Claude Lyons LTD
ELECTRICAL AND RADIO LABORATORY APPARATUS ETC.

Electrical and Radio Laboratory Apparatus, Etc.
180, Tottenham Court Rd., London, W.1
and
76, Oldhall Street, Liverpool 3, Lancs.

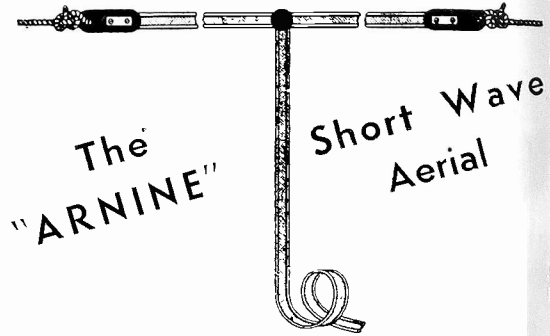

The
"ARNINE"

Short Wave
Aerial

The most suitable aerial for short wave band listening. Aerial spans and down lead consist of twin parallel feeder of 300 ohm impedance, polythene insulated. Pack includes all the necessary insulators, fittings, etc., for easy erection.

ANTIFERRENCE
LIMITED

Sales Division :

67, Bryanston St., Marble Arch, London, W.1

Telephone : PADdington 7253/4,5

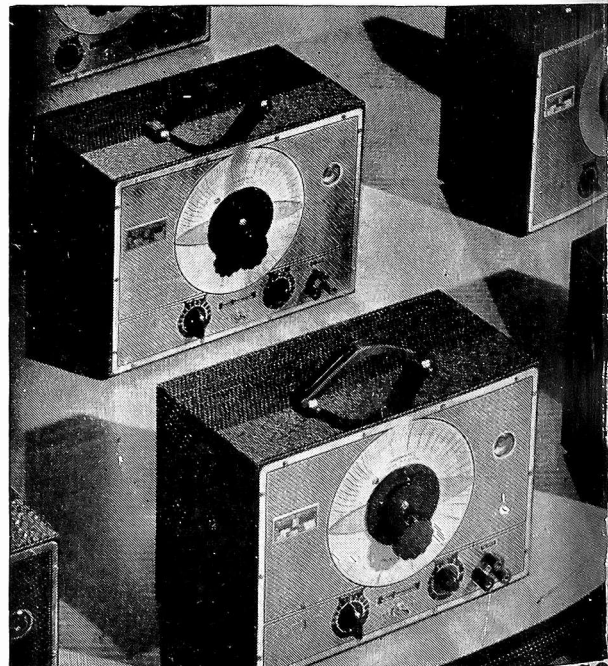

BEAT FREQUENCY OSCILLATOR

LELAND
INSTRUMENTS LTD.

—for priority requirements
at present. Write for particulars
stating frequency range required.

21, JOHN STREET, BEDFORD ROW, LONDON
TELEPHONE: CHANCERY

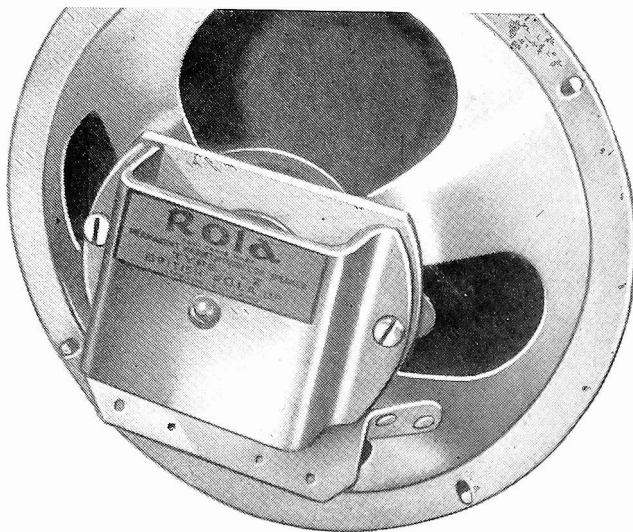

FIT **ROLA** AND RELAX



Once a receiver has left the works, the Works Manager has no wish to see it back again. But so far as the speaker is concerned, he has no worries. Now as always his motto is—fit Rola and relax !

ROLA SPEAKERS
THEIR QUALITY SPEAKS FOR ITSELF

BRITISH ROLA LTD • 8 UPPER GROSVENOR STREET • LONDON W.1

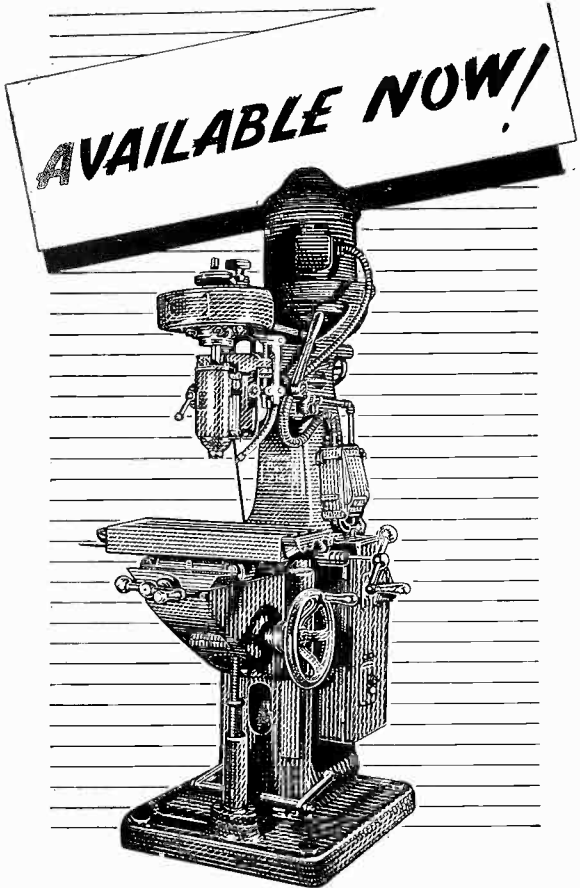

machine tools

OF NUMEROUS TYPES

Government Surplus machine tools available NOW at attractive prices. YOUR opportunity to get better equipment and increase production.

DISPOSAL CENTRES, where records of all machines available may be inspected, are open to the public for enquiries from 10 a.m. to 4 p.m. Monday to Friday inclusive:—

BIRMINGHAM C.M.L. Buildings, Great Charles Street.

BRISTOL 8/9 Elmdale Road, Bristol 8.

CARDIFF Imperial Buildings, Mount Stuart Square.

GLASGOW 21 Glassford Street.

LEEDS 10 Bank Street, off Boar Lane.

LONDON Room 0088, Ground Floor, Thames House, North, Millbank, S.W.1.

MANCHESTER Britannia House, Fountain Street.

ISSUED BY THE MINISTRY OF SUPPLY

K

STERLING FELT

for sound and resonance suppression

You gain all the advantages of long specialisation when you use Sterling Felt, which is accurately patterned for all radio purposes. Ask Sterling about Felt Strips and Washers for Cabinets and sound deadening Felts for resonance suppression. Also Cardboard Segments and Rings for Speakers and Cabinet backs.

Felt cut to suit any specification.

Any SHAPE—any SIZE—any QUANTITY

STERLING TEXTILE INDUSTRIES LTD

STERLING WORKS, ALEXANDRA ROAD, PONDER'S END
MIDDLESEX
*Phone: HOWARD 2214-5, 1755
*Grenz: STERTEX, ENFIELD

LEWIS'S SCIENTIFIC LENDING LIBRARY

ELECTRICAL & RADIO ENGINEERING
TEXTBOOKS & WORKS OF REFERENCE
New Works and New Editions can be had from the Library immediately on publication.

ANNUAL SUBSCRIPTION from ONE GUINEA
Prospectus on Application

H. K. LEWIS & Co. Ltd.

136 Gower Street, London, W.C.1

Telephone: EUSon 4:82 (5 lines)

SPECIALIST ATTENTION

The solution of individual problems has for many years formed a part of our normal day's work. If transformers are employed in the equipment you manufacture, we shall be glad to give you the advantage of our experience and to offer the same efficient

Telephone: Abbey 2244

PARTRIDGE TRANSFORMERS LTD

76-8, PETTY FRANCE, LONDON, S.W.1

service that has won the confidence of the Government Experimental Establishments and of the Leading Industrial Organisations.

SOUND SYSTEMS USED

THROUGHOUT THE WORLD

Meet us at
RADIOLYMPIA
OCT 1-11

BIRMINGHAM SOUND REPRODUCERS LTD

CLAREMONT WORKS, OLD HILL, STAFFS. TEL : CRADLEY HEATH 6212/3

LONDON OFFICE : 115 GOWER STREET, W.C.1. TEL : EUSTON 7515

M-W.88

PRECISION CONTROLS

for COMMUNICATIONS AND MEASURING EQUIPMENT

SLOW-MOTION DRIVE

A Unique Control giving complete 360° rotation

Double friction epicyclic mechanism — enclosed in dust-proof bakelite housing.

Torque — 12 inch-ounces before slipping

Ratio — 44 to 1 approximately

Supplied with dials up to 6 inches diameter — any engraving.

PRICES ON APPLICATION

DECADE SWITCH

A Precision Component embodying all the best design features

Very low contact resistance. Positive location. Sturdy action.

Twelve positions — providing two extra contacts — 30° angular spacing simplifies dial calibration. Two types available

— 416A (Shorting) and 416B (Non-Shorting).

Can also be supplied in ganged units of two or more switches

PRICES ON APPLICATION

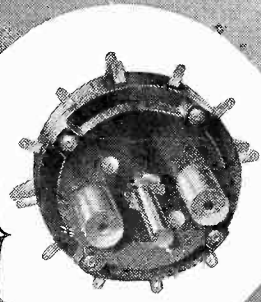

SALFORD ELECTRICAL INSTRUMENTS LTD.

PEEL WORKS, SALFORD 3

Telephones : BLAckfriars 6688 (6 lines).

Telegrams and Cables : " SPARKLESS, MANCHESTER "

Proprietors: **THE GENERAL ELECTRIC Co. Ltd., of England**



Trade Mark.

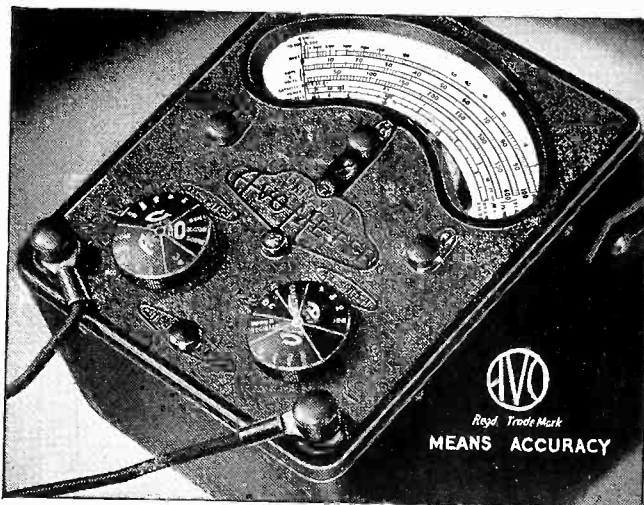

**PRECISION
TESTING INSTRUMENTS**

For manufacturers, service engineers, workshop and laboratory technicians are familiar with the precision and dependability of "AVO" Electrical Testing Instruments. Years of successful experience in the design and manufacture of first-grade instruments have produced a consistently high standard of accuracy which has become an industry standard as well as a standard by which other instruments are frequently judged.

**The MODEL 7 50-Range Universal
AVOMETER**
Electrical Measuring Instrument

A self-contained, precision moving-coil instrument, conforming to B.S. 1st Grade accuracy requirements. Has 50 ranges, providing for measuring A.C. & D.C. volts, A.C. & D.C. amperes, resistance, capacitance, audio-frequency power output and decibels. Direct readings. No external shunts or series resistances. Provided with automatic compensation for errors arising from variations in temperature, and is protected by an automatic cut-out against damage through overload.

Agents and Manufacturers:

AVOMATIC COIL WINDER & ELECTRICAL EQUIPMENT CO., LTD., Winder House, Douglas Street, London, S.W.1.

Phone: VICTORIA 3404-9

CABLE

to

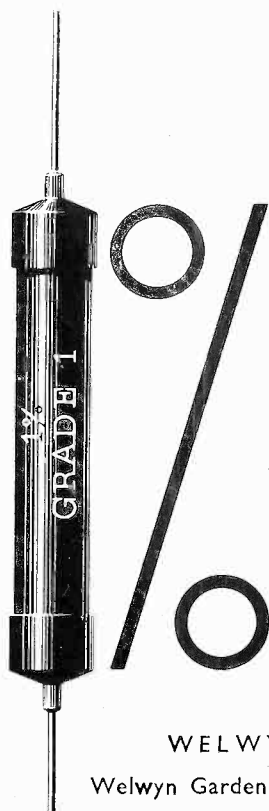

Resistors produced by the cracked carbon process remain stable to $\pm 1\%$ of initial value.

Tolerances $\pm 1\% \pm 2\% \pm 5\%$
Low temperature co-efficient.

Welwyn
carbon resistor

WELWYN ELECTRICAL LABORATORIES LTD.

Welwyn Garden City, Herts.

Telephone: Welwyn Garden 3816-8

THE MULLARD RADIO VALVE CO., LTD., have the following vacancies:—

(1) Engineer to carry out and supervise dynamic measurements and application experiments on transmitting valves between 10 watt and 20 KW anode dissipation and at frequencies up to 300 megacycle per second.

Qualifications required: A.M.I.E.E. or equivalent standard and experience in this field.

(2) Engineer to develop prototype broadcast receivers and amplifiers to demonstrate the application of new ranges of valves. Qualifications required: A.M.I.E.E. or equivalent standard and experience in this field.

(3) Junior Engineers for carrying out and supervising dynamic measurements on receiving or transmitting valves and for assisting in developing or develop and maintain test gear for these measurements. Qualifications required: B.Sc. 1st or 2nd class. Honours or equivalent.

Salaries will be in accordance with the Company's scales. Applications, which, in the first place, should be in writing only, should state full details of qualifications, past experience and present salary and should be addressed to the Works Personnel Officer, Mullards Radio Valve Company, New Road, Mitcham Junction, quoting the reference "HC."

PHYSICIST. Age 22-25. Honours Degree either in Physics with Electricity, or Mathematics with Applied Mathematics. To carry out calculations in electrical circuits and electro-magnetic radiation, supervise experiments and field work. Initiative and inventive ingenuity important. South-West London district. Write, stating age, experience and salary required, and when free to commence, to Group Staff Officer, (32), Philips Lamps Ltd., Century House, Shaftesbury Avenue, London, W.C.2.

MECHANICAL DESIGNERS. Age 30-40. Capable of completing mechanical design of fixed or mobile Transmitters to electrical information supplied, supervising detail drawings, preparation of stock lists and purchasing specifications. Location South-West London. Write, stating age, experience, salary required, and when free to commence, to Group Staff Officer, (31), Philips Lamps Ltd., Century House, Shaftesbury Avenue, London, W.C.2.

Murphy Radio Limited have a vacancy for a Senior Engineer having considerable experience in the development and design of communication receivers and allied equipment. Apply in the first place in writing, giving full particulars and stating salary required, to Personnel Department, Murphy Radio Limited, Welwyn Garden City, Herts.

"Applications are invited for the position of Senior Engineer to take charge of a laboratory principally engaged upon the design and development of electronic devices.

"Applicants should hold First Class Honours Degree in engineering or science and have had at least six years Development experience.

"Salary range £700-£900 per annum, according to qualifications and experience.

"Applications should be addressed to the Personnel Manager, Airmec Laboratories, Cressex, High Wycombe, Bucks."

THE MULLARD RADIO VALVE CO., LTD., require Senior Laboratory Assistants whose jobs will be to assist in the development for production of all types of receiving tubes or transmitting valves, or cathode ray tubes. Qualifications are (A) Honours degree or equivalent in Physics or Electrical Engineering and (B) considerable experience in the design of vacuum tubes. Salary will be in accordance with our scales—the maximum will be paid to men with the right background but we would emphasise that it is useless to apply without these qualifications.

Successful applicants will be working at the address stated below. Apply, in the first instance, in writing only to the Works Personnel Officer, New Road, Mitcham Junction, Surrey and quote the reference W.4.

Temporary Visiting Technical Authors in the Ministry of Supply for the compilation of Technical Air Publications for the Royal Navy and Royal Air Force relating to:—Aircraft, Aero Engines and Associated Equipment, including Armament, Instruments, Electrical Equipment, etc. Headquarters are in London and considerable travelling is involved.

Candidates must be British subjects and should be corporate Members of the Institution of Civil, Mechanical or Electrical Engineers or Associate Fellows of the Royal Aeronautical Society; failing this they should have passed examinations recognised by any of the above Institutions as granting exception from Section A and B of their examination for Associate Membership, provided Corporate Membership is attained within the period of probation. If candidates do not possess any of these qualifications they must be able to produce evidence of a high standard of attainment and in the field of Aeronautical, Mechanical or Electrical Engineering. All intending applicants must have had three years practical engineering experience.

The salary payable will be up to £650 (inclusive) according to age and qualifications.

Write quoting C. 523/47A to Ministry of Labour and National Service, Technical and Scientific Register, Room 171, York House, Kingsway, W.C.2 for application form. 28.8 A25 (20).

TELECOMMUNICATIONS ENGINEER required by Standard Telephones & Cables Ltd., North Woolwich, E.16, for the design and development of Radio Frequency Testing Equipment for Carrier Telephone and Television Cables. Applicants should possess an honours degree in Engineering or Physics and have had experience on comparable work. Salary up to £450 per annum according to qualifications and experience. Apply Personnel Manager.

DEVELOPMENT ENGINEER required for laboratory investigation and measurements in connection with development of Cables for Radio Frequencies. University degree or equivalent. Salary up to £400 per annum. Apply Personnel Manager, Standard Telephones & Cables, Ltd., North Woolwich, E.16.

LARGE ORGANISATION IN WEST MIDDLESEX requires FIELD SERVICE AND WORKSHOP ENGINEERS with good television and radio technical knowledge. Smart appearance, car an advantage, but not essential. Reply stating details, past experience, age and salary required to Box 2125.

The English Electric Valve Company, Chelmsford, require for their Research Laboratory, various grades of scientifically trained men ranging from graduates direct from the University to men with very considerable experience. A knowledge of Vacuum technique, Photo-emissive surfaces, Electron optics, Ultra short wave valves and allied subjects, would be advantageous. Remuneration according to qualifications. Please address applications to Central Personnel Services, English Electric Company, Ltd., Queen's House, Kingsway, W.C.2.

The Air Ministry has vacancies in the Meteorological Office organisation for a number of civilian Radio (Meteorological) Mechanics to maintain radio and radar equipment.

Applicants must possess a knowledge of the fundamental principles of radio and radar and have had practical experience in the use of tools, filing, drilling, hard and soft soldering, wiring and in the maintenance and use of electrical radio and radar instruments, including cathode ray oscilloscopes.

Preference will be given to former R.A.F. personnel and any other ex-servicemen possessing the requisite qualifications. Staff selected will be required to serve at any station at home or abroad and in the case of appointments at home units, will generally be expected to make their own arrangements for accommodation. Successful applicants will be engaged on a temporary non-pensionable basis only at commencing weekly wages (in the United Kingdom) of £6 5s. 0d. per week (inclusive) for appointees aged 21 and over.

Applications should be addressed to Air Ministry (S.5.h), Bush House, North West Wing, Aldwych, London, W.C.2.

ACOUSTICAL RESEARCH

THE TANNOY LABORATORY can provide a skilled and specialised service in the investigation of all problems connected with vibration and sound. This covers most aspects of acoustical research and is available to industry and Government Departments engaged on priority projects.

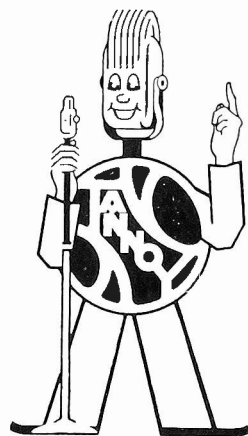

TANNOY
RESEARCH LABORATORY
GUY R. FOUNTAIN, LTD.
"THE SOUND PEOPLE"

"TANNOY"
is the registered Trade Mark of
Equipment manufactured by
GUY R. FOUNTAIN, LTD.
"THE SOUND PEOPLE"
WEST NORWOOD, S.E.27
and Branches.
'Phone - - Gipsy Hill 1131

Stand 17. Radiolympia, Oct. 1st - Oct. 11th.

sterling Furniture Ltd.

ARE

CABINET MAKERS

YOUR ENQUIRIES INVITED

Phone: TOTTENHAM 2041.

37-55, PHILIP LANE, N.15.

WHY

IRON POWDER ?

To improve the performance of inductances ; to permit a smaller coil to be used and thereby to decrease manufacturing costs ; to vary easily the inductance of coils by means of movable powder-iron cores ; to pre-set fixed inductances to accurate limits.



WHY

CARBONYL IRON POWDER ?

Because the carbonyl process produces a powder with the appropriate characteristics required by core-makers. Because each particle is spherical and the powder has therefore a high packing density, and is easily insulated. Because no heat treatment at high temperatures after pressing is required.

WHY

TWO GRADES ?

Because two grades cover the majority of requirements. *Grade ME* is very fine and hard, spherical and remarkably uniform; primarily suitable where electromagnetic losses are required to be very small, and especially for high-frequency applications. *Grade MC* is also fine and spherical but is softer and therefore more easily compressible. Useful in cases where higher permeabilities are required. Further information freely given on request.

The Mond Nickel Company, Ltd.

Grosvenor House, Park Lane, London, W. 1

13B/M/1

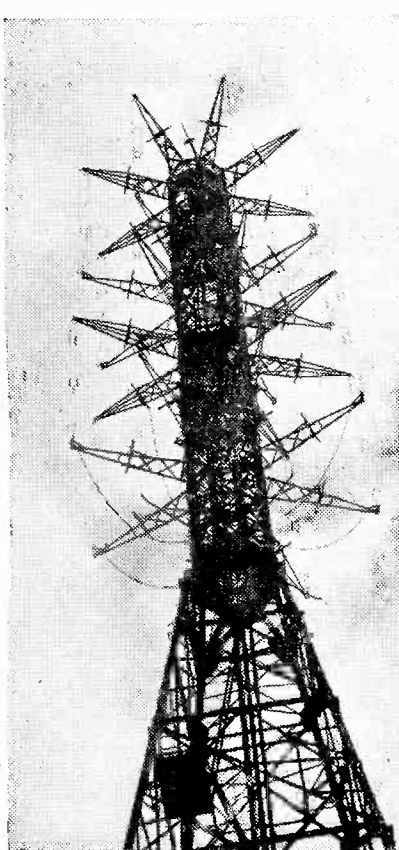

TELCON R.F. CABLES

for all Television and Radio requirements
CABLE CHARACTERISTICS

CODE	Z ₀	CAPACITY	ATTENUATION
K25	300 ohms	4.6 μμF per foot	At 1 Mc/s 0.15 db/100 Ft.
			" 10 " 0.4 " "
			" 50 " 1.0 " "

Dimensions 0.44" x 0.09"

TYPE : FLEXIBLE TELCOTHENE TRANSMISSION LINE

Further details of this and other R. F. Cables on application.

THE TELEGRAPH CONSTRUCTION & MAINTENANCE CO. LTD.
Founded 1864

Head Office : 22 OLD BROAD ST., LONDON, E.C.2. Tel : LONDON Wall 3141
Enquiries to TELCON WORKS, GREENWICH, S.E.10. Tel : GREENWICH 1040



Quality

ACKNOWLEDGED
THROUGHOUT
THE WORLD

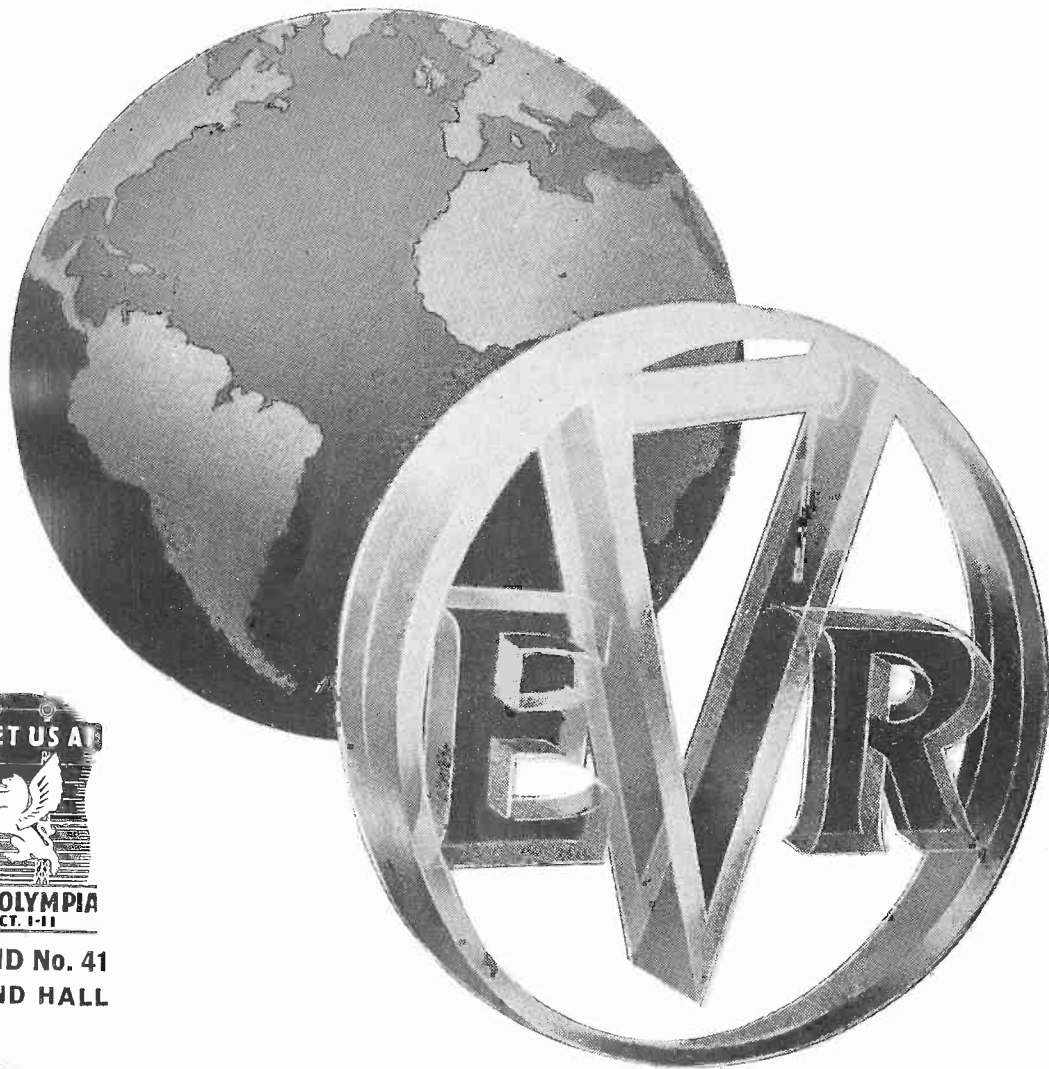

ND No. 41
ND HALL

ERIE

Radio & Electronic Components

ORS • CERAMICONS • Hi-K CERAMICONS • POTENTIOMETERS
SSORS • VITREOUS ENAMELLED WIRE-WOUND RESISTORS

Erie Resistor Ltd., The Hyde, London, N.W.9, England.
Telephone: COLindale 8011-4. Cables: RESISTOR, LONDON.
Factories: London & Gt. Yarmouth, England • Toronto, Canada • Erie, Pa., U.S.A.

The Finest **CORED** **SOLDER** in the World

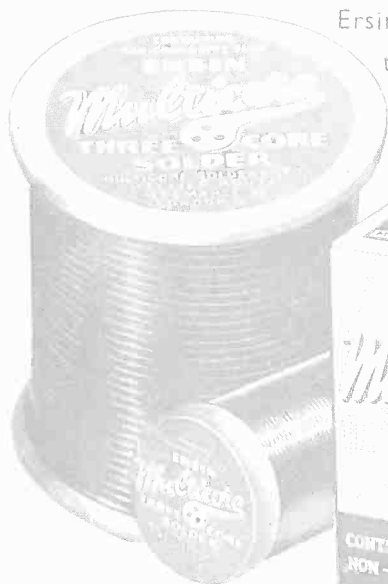
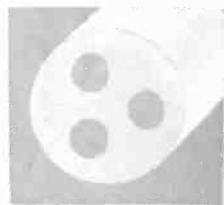

Ersin Multicore Solder is the only solder in the world containing three cores of extra-active non-corrosive Ersin Flux. Three cores of Ersin ensure speedy precision soldering and flux continuity, thus saving time and money and eliminating waste. No extra flux required.



Ersin Multicore Solder is widely used for all soldering purposes, in the manufacture and maintenance of Radio, Television and Electronic apparatus. Ersin Multicore is most efficient for all soldering purposes in the home.

FOR FACTORIES. Nominal 7 lb. and 1 lb. reels. Made as standard in 5 alloys and 9 gauges. Other specifications to special order. Bulk prices on application.

FOR SERVICE ENGINEERS and Maintenance Purposes. Size 1 Self-feeding Cartons are supplied in 4 specifications.

WRITE FOR YOUR COPY OF "MODERN SOLDERING" 28 PAGE BOOK CONTAINING COMPREHENSIVE TECHNICAL INFORMATION, TABLES OF MELTING POINTS ETC. AND SAMPLES.

NOMINAL 7 lb. AND 1 lb. REELS

Alloys specially recommended for Radio Production

ALLOY Tin/Lead	Equivalent B.S. Grade	MULTICORE Colour Code	Solidus C	Liquidus C	Recommended bit temperature	USES
60/40	K	Red	183	190	230 C	High quality work requiring low melting point alloy
45/55	M	Crimson Buff	183	227	267 C	Hand soldering, Radio, Telephone and Electrical Equipment - Batteries
40/60	C	Green	183	238	278 C	

STANDARD GAUGES

Ersin Multicore Solder can also be supplied in any intermediate size

Standard Wire Gauge	Diam. in Inches	Diam. in M. ms.	Approx. Number of feet per lb. ALLOY		
			60 40	45 55	40 60
10	0.128	3.251	25.2	23.5	23.0
12	0.104	2.642	38.1	35.2	34.9
13	0.092	2.337	48.7	45.3	44.5
14	0.080	2.032	64.4	59.2	58.6
16	0.064	1.626	100.5	94.3	92.1
18	0.048	1.219	178.5	167.8	163.5
19	0.040	1.016	257.5	240.4	235.5
20	0.036	0.914	318.0	302.5	291.0
22	0.028	0.711	526.0	492.0	481.0

If you are unable to visit Radiolympia, here are extracts from our advertisement from the Radiolympia Catalogue. If you are going to Radiolympia, be sure to visit our **Stand No. 23, Grand Hall**, where you will see an exhibition of special interest to Research Engineers. Our laboratories will be showing methods for determining spread and speed of fluxes, bit temperatures, insulation tests, etc.

MULTICORE SOLDERS LIMITED
MELLIER HOUSE, ALBEMARLE STREET, LONDON, W.1. Tel.: REGent 1411

LIBRARY
OCT 22 1947
U.S. PATENT OFFICE

WIRELESS ENGINEER

Vol. XXIV.

OCTOBER 1947

No. 289

EDITORIAL

Radiolympia

THE 15th National Radio Exhibition comes after a gap of eight years during which the energies of wireless engineers have been given chiefly to the development of apparatus for the purposes of war. It is natural, therefore, that the question of how wartime development has influenced the design of broadcast receivers should be prominent in one's mind, and that one should regard the exhibition as an opportunity for enquiry.

In the latter years of the war, when some of these developments had been partly revealed, it was fashionable in some circles to forecast enormous improvements in post-war receivers. Quite naturally this created the impression in the minds of the non-technical that these sets would be greatly superior in performance.

This view was never taken by those who understood the nature of wartime development, however, for although much of it has great peacetime application, comparatively little is of direct benefit to broadcasting as long as this is carried out on the present frequencies. The best-known developments of the war were in radar, pulse technique and centimetre-wave generators, radiators and feeders and are clearly unlikely to influence broadcasting much unless it moves to much higher frequencies than those now used.

The less publicized improvements of the war years, such as miniaturization and tropicalization, are of more benefit to the man-in-the-street. The former is most applicable to portable sets and hearing aids and the latter to equipment for overseas use. Neither is very spectacular, however. While a reduction of size and weight is obvious to the user, the benefits of tropicalization are apparent only in increased reliability in extremes of temperature and humidity.

At the time of writing only scanty details of the equipment shown are available, but they do indicate that these expectations are borne out. Most firms stress that their export models are designed for tropical use; there are quite a number of sets using some degree of miniaturization and all hearing aids are fully miniaturized. Television would seem to owe more to the war, for there are detailed improvements in circuits which can be traced back to the pulse technique of radar. In this radar is repaying the debt which it incurred to television in the early days, when much of its practice and many of the people concerned were drawn from television.

The "standard" broadcast receiver is still a four-valve three-band superheterodyne, however, with a triode-hexode frequency-changer, one i.f. stage, a duo-diode-triode providing detection, a.v.c. and a.f. amplifica-

tion, and a tetrode output valve. At first sight this would seem to owe little to the war years, but there are some indications of mechanical improvements. There are signs that the necessity for a robust, but light, construction to withstand the rigours of war

has in some degree been carried over to peace.

A better judgment on these matters will be possible when the exhibits have been examined, and in the next issue of *Wireless Engineer* the apparatus at Radiolympia will be reviewed.

Ohm and his Law

FROM time to time articles are published in the technical press dealing with the question, What is Ohm's law? Such an article was published in the *Electrical Review* of 31st January and, as usual, led to some correspondence. In the same journal of 1st August a very interesting article by Mr. Thomas Carter dealt with the same topic. We were glad to see that he had been delving into the original treatises in order to find out exactly what Ohm did and what he said. It is an interesting pursuit, as we found in 1931, when preparing a paper on "The Nomenclature of the Fundamental Concepts of Electrical Engineering."* As Mr. Carter says, it is difficult to translate some of Ohm's terms because of the difference of atmosphere between then and now. He was writing before Faraday had discovered electromagnetic induction, when an electromotor was a device for imparting motion to electricity (that is, a primary battery) and when a "calorimotor" was merely a battery designed to give a large current and thus heat the wires. Even in 1862 the British Association committee refer to a "battery or rheomotor of unit electromotive force."

To Ohm's first paper on the subject in 1825 Poggendorff, the editor of the *Annalen der Physik*, added a footnote expressing the hope that Ohm would repeat his experiments with the thermo-electric circuit because the action would be steadier than with the hydro-electric circuit, in other words, that he should use thermo-junctions instead of batteries as the source of his current, a suggestion that sounds somewhat amusing at the present day, but which Ohm acted upon with great success. These examples show how careful one has to be in translating Ohm's descriptions of his experiments into modern phraseology. It must also be remembered that the idea of an electric current was relatively new, the electricity of the past having been

almost entirely electrostatic and known to be a surface phenomenon. Ohm describes how he repeated an experiment made by Davy, who took a round wire and rolled it into a thin strip; when placed in a circuit the current was unchanged by substituting the strip for the round wire, although the surface was greatly increased, thus showing that the controlling factor was the cross-section and not the surface, and that the electric current flowed through the mass of the conductor as heat flows from a hot to a cold part of the material.

Georg Simon Ohm

Before discussing his experiments, however, let us look at the man himself. Georg Simon Ohm was born in Erlangen in Bavaria on 16th March, 1789, and not in 1781, as stated by Mr. Carter, nor in 1787, as stated in several encyclopædias, including the "Britannica." He died in Munich on 7th July, 1854. His father was a locksmith but took a keen interest in philosophy and mathematics, and helped and encouraged his sons in their mathematical studies. On leaving school he went to Erlangen University, but after three terms went to Switzerland as a teacher in a private school, where he remained for three and a half years, then going to Neuenburg in Prussia as a mathematics teacher. He continued his studies during this period, and in 1811, after six months in Erlangen, he was awarded the Ph.D. degree. He was recognised by the University as a coach in mathematics, but again after three terms he left the University and was appointed a teacher at a school in Bamberg, where he remained until 1817, when he went to Cologne as a senior teacher of mathematics and physics at the gymnasium or high school, formerly the Jesuit College.

It was here that he began his experimental researches and published his first papers on

* *J. Instn. elect. Engrs.*, Vol. 70, No. 420, Dec. 1931, p. 54.

the subject. There were no facilities for his experiments in the School and they were carried out in his lodgings in his spare time, of which he had so little that he applied for leave of absence for the school year 1826-1827 in order to concentrate on his research. This was granted at half salary, but at the end of the period he was so dissatisfied with the conditions under which he would have to work if he returned, that he resigned and went to Berlin, where he gave lectures on mathematics at the Military School. It was a financial sacrifice, but it gave him the leisure necessary to continue his experimental researches. He had a brother Martin Ohm, three years younger than himself, who became Professor of Mathematics at Berlin University and published many papers. He also lectured at the Military School and as he had been in Berlin since 1821, one can understand why Georg Ohm was attracted to Berlin.

After six years in Berlin, Ohm went to Nuremberg in 1833 as professor of physics in the Polytechnic of which from 1839 to 1849 he was the Director. Here again he found that his duties allowed too little time for research and in 1842 he asked for and obtained an assistant to help in the administration. What was almost certainly the greatest event in his life occurred in 1841 when the Royal Society awarded him the Copley medal in recognition of his outstanding achievements; this was followed in 1842 by his appointment as a foreign member of the Society. These distinctions must have been very gratifying to one who undoubtedly felt that his scientific work was not fully appreciated by German scientists and who had reached the age of 52 without achieving his ambition of being appointed to a University Chair. This he achieved in 1849 when he was appointed Professor of Physics in the University of Munich; he also acted as consultant to the Bavarian telegraph authorities and as Conservator of the Bavarian State Mathematical and Physical Collection, but his tenure of these offices was short for he died in 1854.

Even if his work did not receive the immediate general recognition that he expected, there were a number of German physicists who saw the importance of it; for example, Fechner said in 1929 that he must give Ohm the credit for having with the few letter symbols of a simple formula laid the foundations of a new epoch in the teaching of galvanic electricity.

As an indication of the conditions under which his experimental work was carried out he mentions in a communication to Schweigger's Journal in 1827 that he had discovered that some discrepancies in a previous communication were due to temperature changes in the attic-kitchen in which the experiments had to be carried out. This was in Berlin just after he had left Cologne.

He had only been dead seven years when at the British Association meeting in Manchester in 1861, Charles Bright and Latimer Clerk proposed that the unit of electromotive force should be called the ohmad—presumably to rhyme with farad—but in the report of the committee in 1864 the name "ohmad" is given to the B.A. unit of resistance.

It is not generally known in this country, or even in Germany, that the Ohm was a unit of liquid measure long before it had any electrical significance. It was used not only in Germany but in Scandinavia, Holland and Switzerland, mainly as a wine measure; it differed slightly in different countries, but was about 40 gallons.

First Statement of the Law

Turning now to Ohm's publications, the first, except for a purely geometrical paper, appeared in the *Annalen* in 1825; it was entitled "Preliminary Intimation of the Law according to which Metals Conduct Contact Electricity." He explained that it was very incomplete but that he had little leisure for prosecuting the experiments. As a matter of fact, his law was a logarithmic one and quite wrong, mainly because of the fluctuation of current due to polarization of the battery; hence Poggendorff's suggestion that he should use thermo-junctions instead of batteries.

A much more important paper followed in 1826; it was entitled "Determination of the Law according to which Metals Conduct Contact-electricity, together with an Outline of a Theory of the Voltaic Apparatus and the Schweigger Multiplier." He describes fully the thermo-junctions of bismuth and copper, one in boiling water and the other in ice, with which the current was generated, and the current measuring apparatus consisting of a magnetic needle suspended over a horizontal conductor by a thin strip of gold from a graduated head. He states that the current is given by the formula $a/(b+x)$ where a is proportional to the e.m.f. (erregen-

den Kraft), b is the internal resistance and x the resistance (Widerstandslänge) of the external conductor. He uses the term resistance-length because, having no unit of resistance he had to express it as the equivalent length of a certain wire.

In view of what has been said about Ohm's reluctance to use the term "resistance," it is interesting to note that in this very early paper, the word "Widerstand" occurs once, and "Widerstandslänge" six times on a single page; in some later papers he preferred "equivalent length." He confirmed the law that cylindrical conductors of the same kind but of different diameters have the same conductance if their lengths are proportional to their cross-sections. He says that Barlow and Becquerel had found the same result. Later in the same year (1826) he published a paper entitled "An Experimental Theory of the Electroscopic Phenomena Produced by Galvanic Forces." The electroscope was the instrument used to measure potential, and electroscopic phenomena were voltage phenomena. This is a very important paper. He gives two formulae; viz. (in modern symbols),

$$(a) I = \sigma a \frac{V}{l}, (b) V_x - V_o = \pm \frac{x}{l} V$$

in which σ is the conductivity, a the cross-section, l the length, V the potential difference (Spannung) between the ends, and V_x the potential at distance x along the conductor from the point at which it is V_o . He states then two laws that follow from formula (a);

I(a). The current is unchanged if, with the same V and σ , the length is made proportional to the cross-section.

I(b). The current is unchanged if, with the same V and a , the length is made proportional to the conductivity.

II. If σ and a are unchanged the current is proportional to V/l .

He also says that (a) may be written $I = V/l$ if by l one understands the equivalent and not the actual length.

He again disclaims any originality for law I(a); he says that it was discovered by Davy and confirmed later by Barlow, Becquerel and himself. The remainder of the paper is devoted to a study of the voltage drop around a circuit and the potential of any part of it.

It will thus be seen that Ohm's law, as generally understood, was published with experimental verification in 1826 that is,

the year before the publication in Berlin of his paper entitled "Die Galvanische Kette, Mathematisch Bearbeitet" (The galvanic circuit mathematically treated). This was a much larger publication and is the only one of his many papers that the "Encyclopaedia Britannica" regards as of the first order. It deals with the potential gradient and its relation to the other properties of the circuit, with conductors in series and in parallel and many other aspects of the galvanic circuit. What we call potential difference Ohm calls Elektrische Spannung or Differenz der Körper. Although it is more mathematical and discusses the problems at greater length, it adds nothing of fundamental importance to the statements of the preceding paper regarding Ohm's law.

In a paper communicated to *Schweigger's Journal* in 1829 Ohm says that the most general result of the experiments on the nature of the conduction of electricity is that the current in a galvanic circuit is (a) directly proportional to the sum of all the e.m.f.s. in the circuit, and (b) inversely proportional to the sum of all the resistances. In this paper he discusses the relative merits of the terms resistance and equivalent length and expresses his preference for the latter; he says that the word resistance gives a very imperfect picture of what is happening. Although during the following two or three years he contributed several lengthy papers on electrical matters, they do not contain anything that could affect one's views on Ohm's law. Most of his subsequent publications dealt with acoustics and the polarization of light, his last paper (1853) of nearly 200 pages being devoted to the latter subject and optical interference phenomena.

What is Ohm's Law?

We must now return to our opening question; What is Ohm's law? Is one justified in saying that certain conducting materials do not obey Ohm's law and can be referred to as non-ohmic materials? The first law that Ohm states definitely as a law and prints in italics, while disclaiming originality for it, is that cylindrical conductors of the same kind and different diameters have the same conductance if their lengths are proportional to their cross-sections. This would not apply to a non-ohmic material such as silicon carbide since on replacing one wire by another of smaller section the

current density would be different and therefore also its resistivity, and the length would have to be modified accordingly.

Instead of non-ohmic some people prefer non-linear, referring, of course, to its characteristic and not to the resistor itself, since a non-linear resistor may be a straight rod and a linear one a helically wound wire.

When formulating his law Ohm undoubtedly regarded the conductivity of the material as a constant and, apart from any secondary effect due to change of temperature, independent of the current flowing through it. When Ohm wrote the formula $I = \sigma aV/l$, he certainly expected I to be proportional to V in any given conductor; he knew of no such substances as silicon carbide. Of course, whatever tricks the material may play, one can always find a value of σ to satisfy the equation $\sigma = I/l/aV$, but is this a law or mere lawlessness? Is it not

inherent in Ohm's law that, apart from any secondary effects, the current is proportional to the voltage; that is, that σ is constant and not a variable like the permeability of iron? If so, then one is perfectly justified in referring to a material in which σ varies with the current as not conforming to Ohm's law. It seems very probable that materials of the silicon carbide type will come into more general use and it is necessary to have some simple designation so as to distinguish between them and ordinary resistances. Non-ohmic seems quite harmless, but as an alternative we may go back to the eighteen-sixties and say non-ohmadic, which would probably be shortened to nomadic,—a very descriptive designation for a resistance in which the value of the conductivity wanders about with every change in the current.

G. W. O. H.

OSCILLOSCOPE TIME-BASE CIRCUIT*

by *H. den Hartog and F. A. Muller*

(Laboratory of Physics, Amsterdam University).

SUMMARY.—This paper is an analysis of the mechanism of synchronization of conventional time-base generators, and a description of an improved circuit having an extended range of synchronization and automatic indication of the time-sweep frequency.

TIME-BASE circuits of the Puckle type have excellent linearity, high stability of operation, good flyback ratio, and a high upper frequency limit, but have certain drawbacks which detract from their utility when synchronization is important.

The analysis of saw-tooth generators, from the point of view of synchronization is best considered with the aid of the circuit diagram in Fig. 1. The capacitor C is charged by the constant current I_0 until the cathode of valve B reaches the threshold voltage at which it begins to conduct. Then, by trigger action, C is rapidly discharged through valve B; this completes the cycle and restores the original situation.

It is shown in Fig. 2 how the voltage V_x between the cathode of valve B and earth drops in a uniform fashion until the threshold voltage is reached. (For simplicity the flyback time has been neglected. The natural frequency $f_0 = 1/T_0$ of the saw-tooth oscil-

lation is determined by the charging current I_0 , the capacitance C , and the distance V_0 between the limiting voltages of the saw-tooth, by the equation

$$f_0 = \frac{I_0}{C V_0} \dots \dots \dots (1)$$

Thus the natural frequency f_0 of the saw-tooth oscillation can be adjusted to any desired value by suitably adjusting I_0 , to which it is directly proportional.

Now the threshold voltage is determined by the grid potential of valve B, and the usual method of synchronizing the time sweep with an external signal is based on superimposing the signal on this grid potential.

Again for simplicity we shall suppose that the synchronizing voltage is impressed between the anode of valve A and the grid of valve B, as shown in Fig. 1, and for the same reason we shall suppose this voltage to be sinusoidal and of peak value V_s .

The line representing the threshold voltage

* MS. accepted by the Editor, October 1946.

in Fig. 2 is no longer straight but undulating, as indicated in Fig. 3. The phenomenon of synchronization is explained by the fact that the distance between the voltages limiting the saw-tooth wave is no longer constant, but varies between $V_o + V_s$ and $V_o - V_s$, so that, depending on the frequency of V_s and the resulting phase relationship between it and the saw-tooth wave, the saw-tooth frequency may vary between $I_o/C (V_o + V_s)$ and $I_o/C (V_o - V_s)$.

By this action the frequency of the time

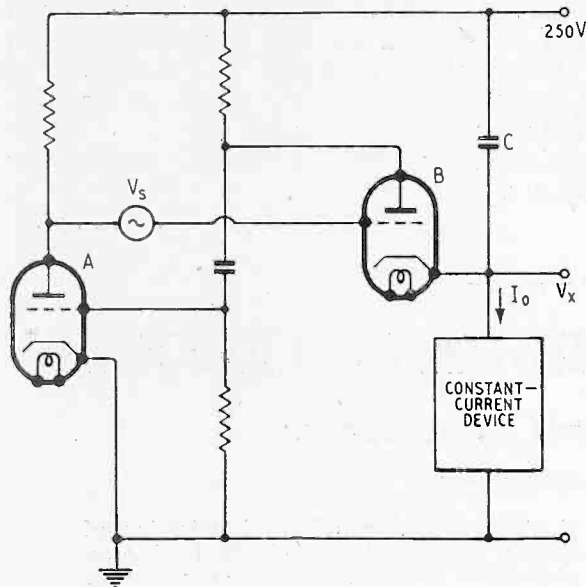

Fig. 1. Fundamental Puckle time-base circuit.

sweep may be lowered or raised (with I_o kept at a constant value), but at the same time the amplitude varies inversely as the frequency, the maximum relative variation being V_s/V_o in both amplitude and time, and approximately also in frequency:

$$\left(\frac{\Delta f}{f_o}\right)_{\max} \approx \frac{V_s}{V_o} \dots \dots \dots (2)$$

Now the frequency of the saw-tooth oscillation cannot be lowered indefinitely by increasing V_s , as might be inferred from Equ. (2), since the additional condition has to be fulfilled that the sloping part must have only one point of intersection with the sinusoidal threshold voltage.

In order to make this point clear, let us assume that starting from Fig. 3(b) an attempt is made to lower the synchronized saw-tooth frequency still further. It is clear that this cannot possibly be done without increasing V_s , as the largest amplitude

attainable is $V_o + V_s$, and in consequence the lowest frequency will be $I_o/C (V_o + V_s)$, which is the limiting case illustrated by Fig. 3(b).

The lower limit of the range of synchroniza-

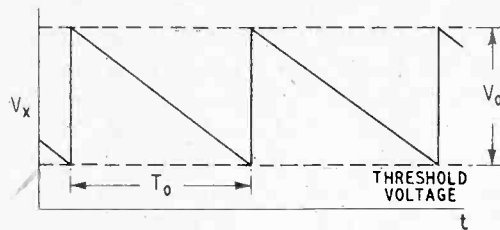

Fig. 2. Output voltage of the circuit of Fig. 1.

tion cannot be further reduced by increasing V_s , as might at first be expected, because the minima of the sinusoidal threshold can no longer be reached by the sloping part of the saw-tooth without a previous intersection. What actually happens on increasing V_s and lowering the frequency of the synchronizing signal is shown in Fig. 4. The result is distortion of the time sweep and a confused pattern on the oscilloscope screen as shown in Fig. 5.

For this reason the limit of smooth control of the saw-tooth frequency by synchronization is reached when, at the danger point indicated in Fig. 3(b) by an arrow, the sloping part of the saw-tooth is a tangent to the sine wave.

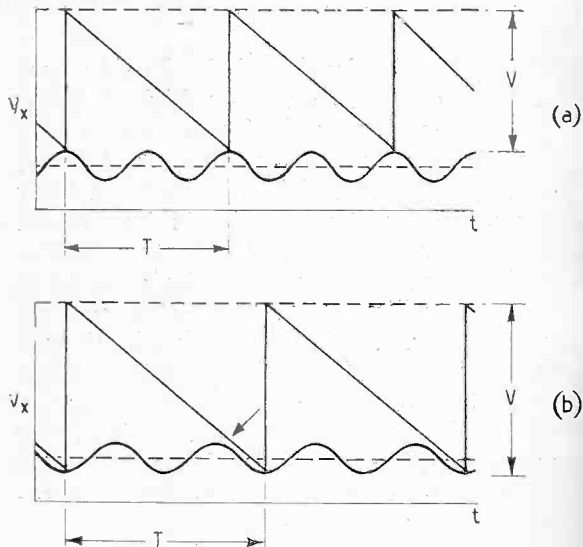

Fig. 3. Output voltages of the circuit of Fig. 1, with a sine-wave synchronizing voltage applied.

It may be shown from geometrical considerations that V_s must be kept below the limit given by

$$V_s < \frac{V_o}{4.55n - 1} \dots \dots \dots (3)$$

for synchronization with the frequency of the n th harmonic. From this result it follows that the maximum relative frequency decrease through synchronization with n sine-waves per saw-tooth cycle is

$$\left(\frac{\Delta f}{f_o}\right)_{\max \text{ sync}} = \frac{1}{4.55n} \dots \dots \dots (4)$$

or 22, 11, and 7 per cent for the 1st, 2nd, and 3rd harmonics respectively.

The higher-frequency limit of the range of synchronization, can in fact be raised by increasing V_s , but as soon as Equ. (3) is violated it will be effected only at the expense of the lower-frequency limit. The entire

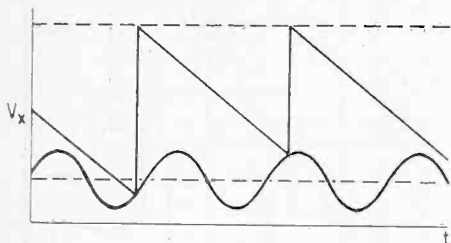

Fig. 4. Distorted saw-tooth oscillation resulting from too large a frequency shift in the synchronizing signal.

range is thus moved up the frequency scale even to the extent of excluding the natural frequency f_o of the time sweep. Besides the possibility of patterns like the one shown in Fig. 5, the general result is a marked reduction of the sweep amplitude.

As it is wise to keep well below the danger limit, it follows that only frequency deviations of the order of 10 per cent can be comfortably used.

In case of large frequency shifts in the signal under observation it becomes necessary to readjust the time-base oscillator by hand by increasing or decreasing I_o according to whether the shift is towards higher or lower frequencies.

To sum up; the inherent limitation of conventional synchronization systems lies in the fact that it is effected, with constant charging current, through varying the amplitude of the saw-tooth wave by plus or minus V_s , and that this variation must be kept comparatively small to prevent erratic behaviour.

Extension of Synchronization Range

It would obviously be much better if the charging current I and not the amplitude

V of the saw-tooth wave could be changed, for there are no such narrow limits for the admissible variations of I as for V . This leads one to investigate the following line of attack:—

A synchronizing voltage V_s , with a frequency lower than the natural frequency of the time base will increase the sweep amplitude V , as was shown in the preceding section and more especially in Fig. 3(b).

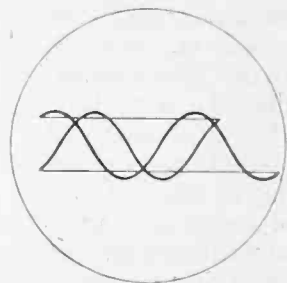

Fig. 5. Pattern appearing on the oscilloscope screen when the oscillation of Fig. 4 is used as a time base.

Now if this increase is itself made to cut down I , it will automatically reduce the natural frequency of the time base, much as one should do by hand when warned by the increase of the sweep amplitude by the point where the synchronizing signal will lose control is being approached. In this

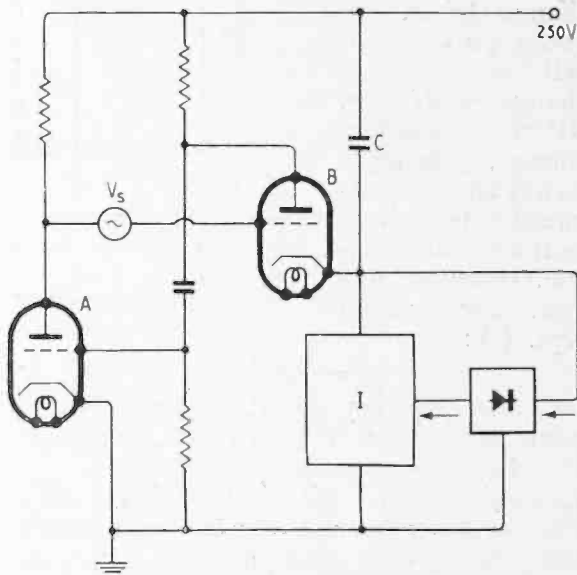

Fig. 6. Fundamental circuit for automatic charging-current control.

way, the natural frequency will come nearly to coincidence with the synchronizing frequency, and because of this reduced frequency shift the resulting change in amplitude will be quite small.

It will be noted that this mechanism may

be described as an inverse feedback applied to the amplitude, but the remarkable feature of this feedback is that it is only operative when a synchronizing voltage is present. Without a synchronizing voltage the charging current I has no influence on the amplitude V .

This system of extended synchronization will be indicated by the term *panchronization*, and the discussion will be based on Fig. 6. In this it is assumed that the amplitude of the saw-tooth oscillation appearing at the cathode of valve B is measured by means of a rectifying circuit, which in its turn feeds a control voltage to the constant-current device (indicated by I) which is thereby controlled in such a way that a change ΔV in the sweep amplitude V will result in a change $-\Delta I = g \cdot \Delta V$ in the charging current, g being a constant determined by both rectifier and constant-current device. Starting from Equ. (1):

$$f_o = I/C V_o$$

the new frequency $f = f_o - \Delta f$ will be the result of a change in both $I = I_o + \Delta I$ and $V = V_o + \Delta V$, so that

$$f_o - \Delta f = I/C V = (I_o + \Delta I)/C (V_o + \Delta V)$$

For the greatest frequency deviation attainable with panchronization

$$\Delta V = V_s$$

(as is the case with synchronization)

and accordingly

$$\Delta I = -g V_s$$

Eliminating from these four equations I_o , I , and V , we obtain

$$\left(\frac{\Delta f}{f_s}\right)_{\max} = 1 - \frac{V_o}{V_o + V_s} \left(1 - \frac{g}{I_o} V_s\right),$$

and when we consider that V_s is quite small, we obtain the approximate expression

$$\left(\frac{\Delta f}{f_o}\right)_{\max} \approx \frac{g}{I_o} V_s \dots \dots \dots (5)$$

as might be expected, gV_s/I_o being the relative change in charging current, and the direct effect of the amplitude variation on the

Fig. 7. Experimental time-base circuit.

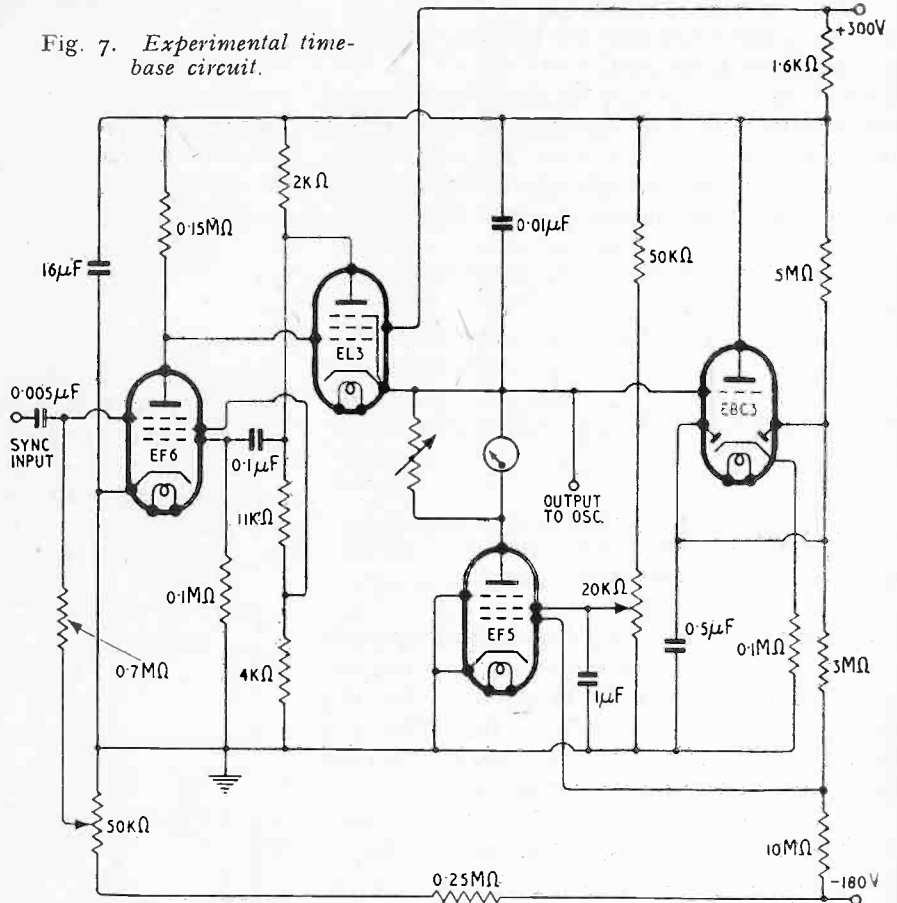

range of panchronization being negligible.

Comparing Eqs. (5) and (2) it is found that with the same very small signal V_s , panchronization is gV_o/I_o times more effective than synchronization.

For a pentode valve as the constant-current device, g/I_o will be about 0.5 per volt (assuming some loss in the connecting network), so that with $V = 200$ volts the superiority of panchronization is represented by a factor of 100.

The Practical Circuit

In order to try out this system, the experimental circuit shown in Fig. 7 was adopted. In addition to the panchronizing circuit, some deviations from usual practice were included

that are also useful with the ordinary synchronizing circuit. Among these are:—

(1) a lowering of the anode-voltage supply of valve EL3 with respect to the screen voltage, resulting in anode-current cut-off before the cathode current drops to zero, and an accordingly improved flyback ratio;

(2) a negative bias on the suppressor grid of valve EF6. (This bias, besides providing an amplitude control, is useful in preventing grid rectification of the synchronizing signal from causing a steady potential to be superimposed on the threshold voltage which would make synchronization possible only with frequencies above the natural frequency.)

The operation of the panchronizing circuit is as follows. In order to avoid distortion, the saw-tooth oscillation appearing at the cathode of valve EL3 is applied to the control grid of the EBC3 cathode-follower valve, so that it again appears at the cathode of this valve but at a much lower impedance level.

Now by means of the diodes in the EBC3 valve a rectified voltage is made to appear across the 0.5- μ F capacitor in such a way that an increase in the sweep amplitude results in a decrease of the steady voltage across it. By means of a potential-divider connection this voltage is fed to the EF5 constant-current pentode. In this fashion the anode current of this pentode is decreased by an increasing sweep amplitude, thus lowering the frequency of the time base in accordance with the lower frequency of the signal that is the primary cause of the rise in sweep amplitude.¹

With a signal of 1.5 volts r.m.s., the range of panchronization of this circuit is from 150 to 1,700 c/s, the amplitude, as measured on the oscilloscope screen, varying from 67 to 58 mm and the charging current varying from 0.36 to 3.5 mA. With only 0.45 volts r.m.s., the range is still remarkable: 250 to 650 c/s, with the amplitude varying from 67 to 65 mm and the charging current varying from 0.6 to 1.5 mA.

These figures refer to panchronization with the fundamental frequency; i.e., with one sine-wave per saw-tooth cycle.

When the frequency of the signal V_s is increased above the limit of panchronization

in the fundamental frequency, the circuit jumps over to panchronization in a higher harmonic without losing control, and the time-base frequency continues locked to that of V_s .

In a certain case, one sine-wave was obtained on the oscillogram from 120 to 1,900 c/s, two waves from 210 to 3,740 c/s, and three waves from 300 to 5,620 c/s, the r.m.s. panchronizing voltage being 1.5 volts. Even with as little as 0.5 volt there was ample overlapping of these ranges: one wave from 300 to 1,000 c/s, two waves from 640 to 1,900 c/s, and three waves from 970 to 2,700 c/s. (The number of waves for a certain signal frequency could be influenced by manipulating the suppressor-grid bias control if desired. Because of the amplitude-frequency feedback the main influence of this bias is on frequency rather than on amplitude as is the case with synchronization.)

Frequency Metering

As the amplitude of the time base is kept substantially constant, the charging current is almost proportional to the frequency. This is borne out by the graph of Fig. 8.

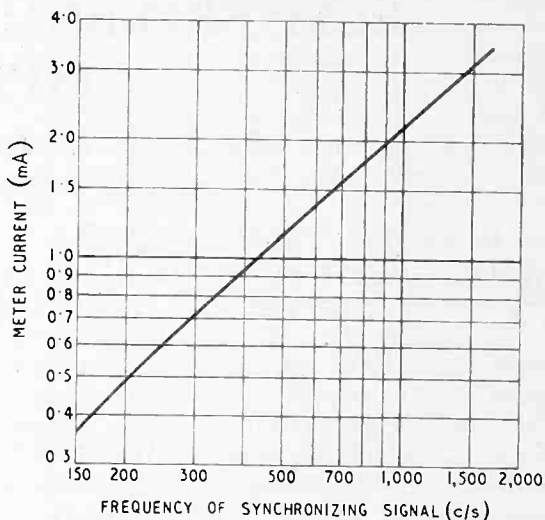

Fig. 8. Dependence of meter current on frequency.

This feature makes possible the incorporation of a frequency meter of fair accuracy in the time-base circuit. It is best to use a logarithmic milliammeter, calibrated in such a way that one has to multiply its reading by the frequency indicated on the time-base selector switch (selecting capacitor C) in order to find the frequency of the signal under observation.

The adjustment of the circuit is as follows:

¹ As the saw-tooth oscillation shows self-rectification (as is evident from Fig. 3) a separate rectifier is not an absolute necessity. The EBC3 cathode-follower may also be used as a phase-inverter to obtain push-pull output for oscilloscopes requiring symmetrical deflection.

The time-base selector switch is turned to the 50-c/s (power-line frequency) position, and a 50-c/s signal is impressed. Then the meter shunt resistance is adjusted until the meter points to the scale division marked 1. The signal is then removed and the screen-grid voltage of the EF5 charging pentode is adjusted until the meter points to 1 again. (To check the accuracy of adjustment, this procedure may be repeated.) In this way the natural frequency of the circuit is made to coincide with the frequency-meter midpoint, thus providing an easy means of reproducing one definite setting of the circuit at which the calibration has been carried out.² These adjustments need only be made occasionally, the two potential

² In doing this the natural amplitude should also be adjusted to a definite value by means of the EF6 suppressor-grid bias control, but in practice this has little effect on the calibration as the transconductance of the EF5 valve is nearly proportional to anode current within wide limits, and besides this only affects the small departure from proportionality of meter current to frequency shown in Fig. 8.

dividers being installed behind the panel and only accessible with a screwdriver.

The operating frequency is controlled by the EF6 suppressor-grid bias control, this and the panchronization attenuator (not shown in Fig. 5) being the only knobs that may (but hardly need) be manipulated.

The addition of panchronization and automatic-frequency indication makes the oscilloscope suitable for many new and unusual applications. However, it takes some time to get used to it, as it is at first strange to discern on the screen only changes in the shape of observed signals, and to have to depend on the frequency meter for changes in frequency.

Acknowledgments

The authors wish to accord their thanks to Prof. J. Clay for the interest taken in their experiments on c.r. oscilloscope construction, and to Sgt. Maurice Bierman of the Royal Dutch Meteorological Institute, De Bilt, for developmental work done on this time-base circuit.

ELECTRO-ENCEPHALOGRAPH AMPLIFIER

By Denis L. Johnston, B.Sc.(Eng.)

(Concluded from page 277, September issue)

3.3. Design of H.T. Stabilizing Circuit

AN acceptable level of ripple in the h.t. supply to the first stage of the signal amplifier is $15 \mu\text{V}$, for with an overall rejection factor of 50, an equivalent input signal level of $0.3\text{-}\mu\text{V}$ ripple will be realised. This $15\text{-}\mu\text{V}$ level is the performance required of the h.t. stabilizing circuits. It is a useful generalization that the stabilizing circuits must employ degeneratively a degree of amplification of about one order less than the degree of amplification of the signal-amplifier itself.

Consequently we can anticipate that the stabilizing circuits will contain roughly as many stages as the amplifier circuit. In a multi-channel amplifier it is possible to economize by using one power supply for several channels, and in a four-channel equipment it is convenient to use two two-channel amplifier units with two associated power units. The complete circuit, Fig. 31,

shows only one of two identical amplifier channels.

An electronically-stabilized supply used "floating" to earth must have no effective leakage or there will be trouble with ripple voltages in the high-impedance grid-input circuits of the signal amplifier. A high degree of insulation can be provided in mains-driven rectifier-stabilizer circuits, but it is an uneconomic way of attaining the required low level of leakage. It is easier to design with normal insulation and screening and then control the effect of leakage current by degenerative stabilization with respect to earth.

It can be shown that in a differential amplifier the overall stabilization of h.t. should be of a higher order than the stabilization of the h.t. to earth. Accordingly, it is better to stabilize the h.t. overall as in Fig. 29(a), and then control the potential to earth with an auxiliary stabilizer, than to use

one stabilizer between earth and positive and another between earth and negative as in Fig. 29(b).

The output impedances obtained in the present arrangement are tabulated in Fig. 28.

If all the amplification applied degeneratively over the two stages of the stabilizer is used in one stage the same degree of stabilization is obtained at an output impedance of

through an RC filter of about 10-seconds time constant to one grid of the amplifiers $V_{1,2}$ and $V_{6,7}$. The other grid of $V_{1,2}$ is connected to a potential divider across the 220-volt output of the stabilizer circuit. The difference voltage is amplified and applied to V_4 which controls the current in the 5-k Ω series load.

The second grid of amplifier $V_{6,7}$ is con-

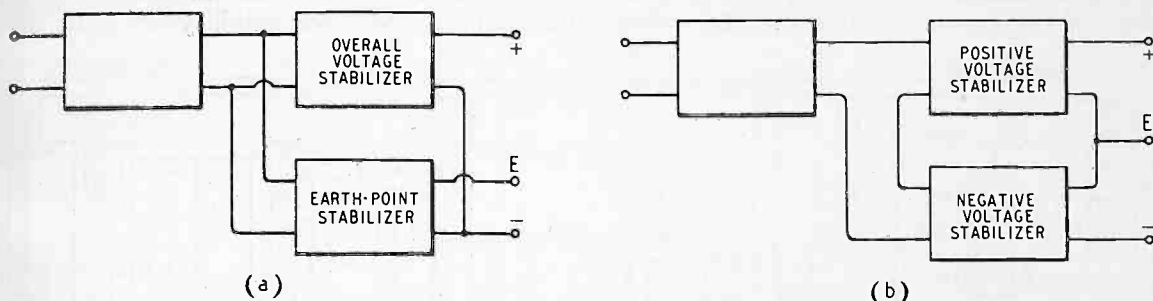

Fig. 29. Schematic arrangement of the stabilized earth point system (a) and combined positive and negative voltage-stabilizing circuits (b).

less than one ohm. But there is a tendency towards instability at a fairly high audio frequency, so it is not used in this case. The output impedances tabulated in Fig. 28 are adequate because the load current is constant and the amplifiers push-pull. The overall arrangement of the h.t. stabilizer and the control circuits is set out in the schematic circuit Fig. 30.

The detailed circuit of the h.t. stabilizer appears at the left hand side of Fig. 31. The division between the power unit and the amplifier chassis is made at the point in the circuit indicated by the dotted line.

A reference voltage of 30 V is derived from a potential divider connected across the voltage stabilizer valve V_3 , and is applied

connected to a potential divider across the “-70 to E” output point. The difference between this potential and the reference voltage is amplified and applied to V_5 which controls the current in the cathode-coupling load of V_4 and V_5 . The two sections of the stabilizer are effectively independent although the cathodes of V_4 and V_5 are coupled. This arrangement takes advantage of the fact that coupled-cathode stages of amplification can be directly connected in cascade without loss of amplification.

A potential divider across the 320-volt supply is tapped at a point proportional to 220 volts. This potential and that from the 220-volt supply are transmitted back to the grids of amplifier $V_{8,9}$ on the power unit

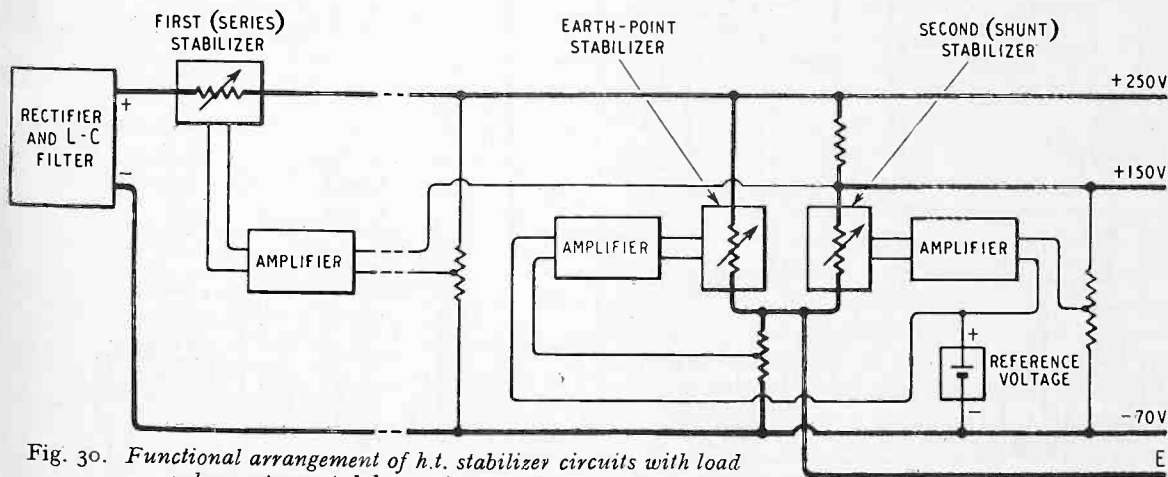

Fig. 30. Functional arrangement of h.t. stabilizer circuits with load valves represented by variable resistors.

chassis. The amplified difference voltage is applied to the grid of the series load valve V_{10} . The cold-cathode valve V_{11} relieves part of the load on V_{10} as the limit of anode dissipation is approached, thus extending the range of working voltage, which for this first stage of stabilization is represented by Fig. 32. The figures of overall performance have already been given.

The potential dividers are adjusted to exact values of resistance. Samples of the valves

used as V_3 vary widely from the nominal value of 70 volts, so the 20-k Ω variable resistor is provided for setting up the correct voltage. All resistors in the potential-divider circuits are wire wound for the sake of stability.

The purpose of the capacitors C_2 , C_3 , and C_5 , is to suppress spurious oscillation at supersonic frequencies. The values indicated are about ten times the minimum values necessary to achieve stability in order to

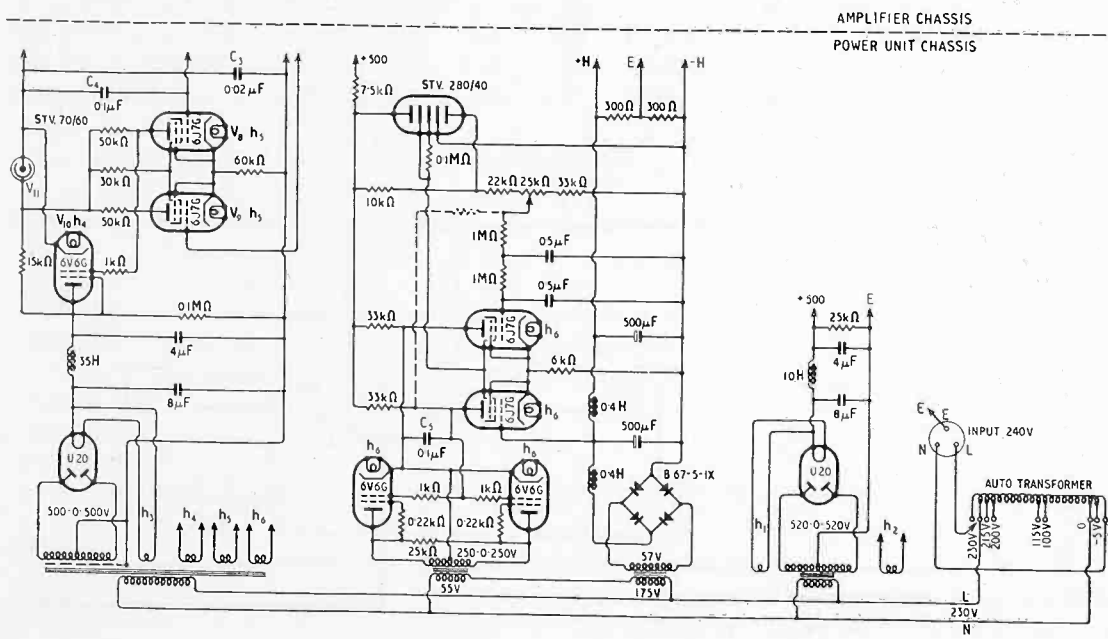
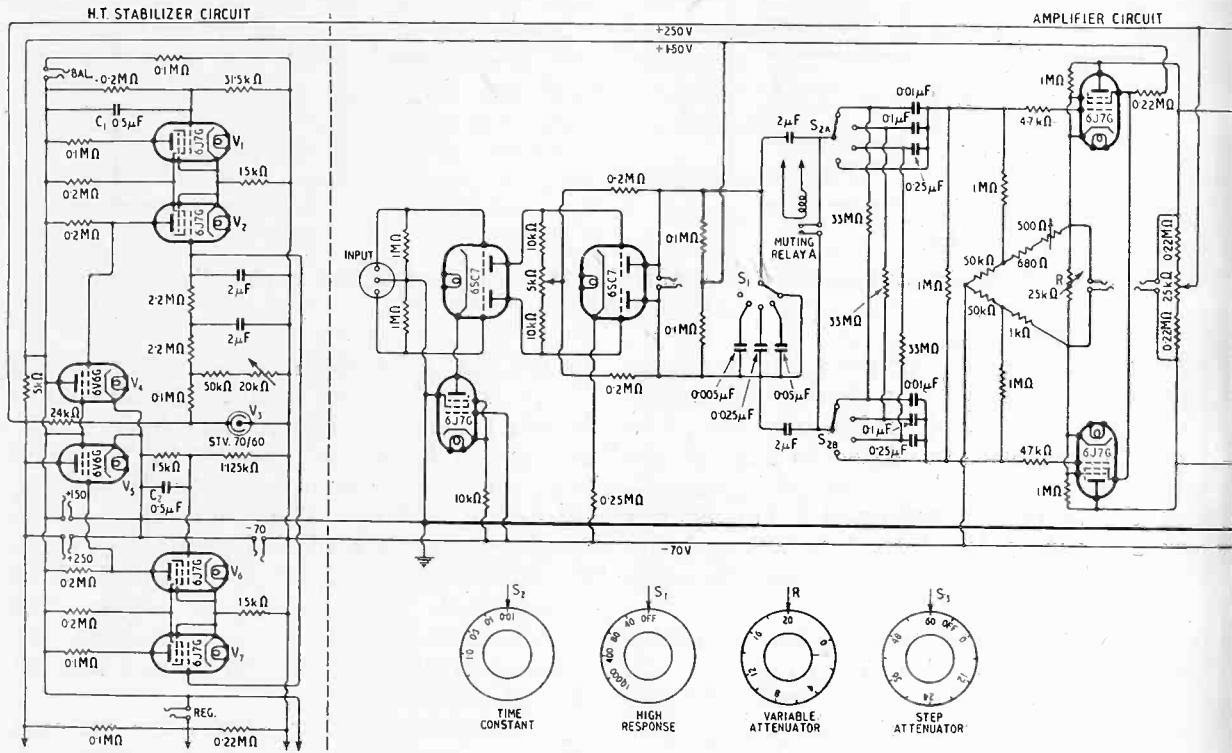

shown in Fig. 31 is more than adequate, only a single choke being used. In a practical case where two chokes were used in a smoothing filter the ripple was five times the calculated value due to induction between the chokes although they were fairly well spaced.

3.5. Stabilized Heater Supply

Adequately regulated direct current is

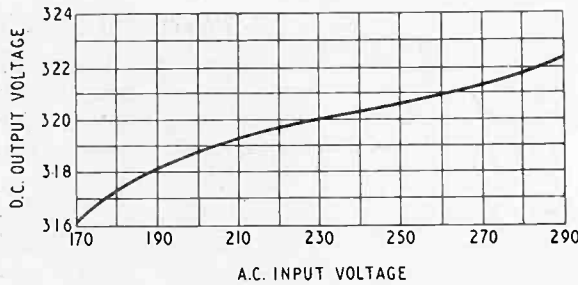

Fig. 32. Performance of the first stage of h.t. stabilization.

necessary for the heaters of the valves in the final stabilizing circuits and the first stages of signal amplification. For this purpose Miller³⁹ used 12.6-volt valves consuming 150 mA and connected them in series across a stabilized h.t. supply. As only 0.3-ampere valves were available this method could not be used in the present case. Barretters or bridge circuits of lamps or of semi-conductor elements were considered, but both per-

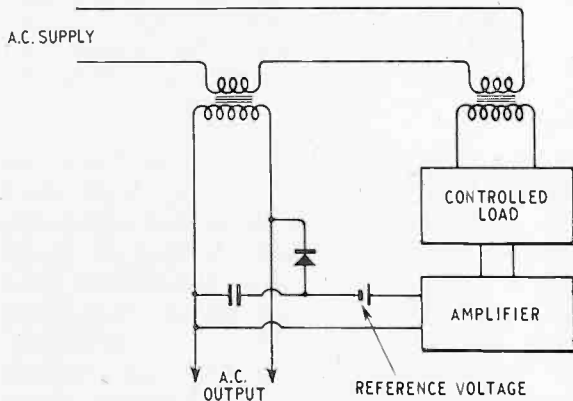

Fig. 33. Schematic arrangement of a.c. stabilizer of the series-transformer type.

formance and efficiency were poor. Stabilizing transformers were unattractive because of the considerable stray field.

Vance⁵⁰ and Hansen⁴⁹ have used series-transformer electronic stabilizers, and a circuit of this type was adopted. The basic

arrangement is shown in Fig. 33, and performance in Fig. 34. The stabilization ratio is 20 and the output impedance 6 ohms for a load of 38 volts, 0.9 ampere formed by valve heaters connected in series-parallel as shown in the complete circuit of Fig. 31. The advantage of this type of stabilizer is that the control circuit can operate at an impedance suitable to the load valves available, and the output may be at any desired higher or lower impedance.

The amplification of the stabilizing circuit can be increased by applying positive feedback as shown by the dotted connection, although the advantage is doubtful since the overall stability is reduced. The control voltage is taken from the centre of the smooth-filter and not from the output: this lessens

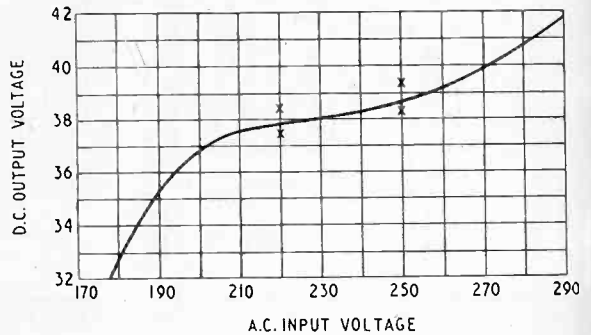
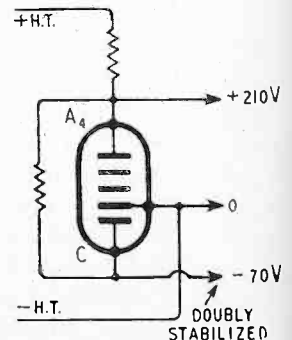

Fig. 34. Performance of the series-transformer stabilizer with rectifier load and d.c. output. The desired working range is indicated (210-250 V).

a tendency to instability owing to the very long time constant of the filter.

The four-gap stabilizing valve V_{27} is used in the duplex circuit of Fig. 35, which gives double stabilization of the 70-volt output used as a reference voltage. This is sufficiently stable to enable the h.t. supply shown (+ 500 V) to be taken from the unstabilized circuit which serves the output stages of the signal amplifier. Fluctuations in voltage of

Fig. 35. Duplex connection of 4-gap, 280-V stabilizing valve to obtain a 210-V stabilized output and a 70-V doubly-stabilized output.



the stabilizer tube are reduced to a slow rate by an RC filter of 1-second time constant.

Acknowledgment

This experimental design was developed with the assistance of a number of members of the staff of Marconi Instruments Limited and of the Research Laboratories, Marconi's Wireless Telegraph Co., Ltd. Thanks are due to W. Grey Walter, M.A., and Dr. G. D. Dawson for their help in interpreting the requirements of the electro-encephalographer.

REFERENCES

- ¹ G. Parr and W. Grey Walter, "Amplifying and Recording Technique in Electro-Biology." *J. Instn. Elect. Engrs*, Part III, September 1943, Vol. 90, pp. 129-144.
- ² W. E. Rahm, "Electro-Encephalography," *Electronics*, October 1939, Vol. 12, pp. 11-13.
- ³ H. Goldberg, "A High Gain D-C Amplifier for Bio-Electric Recording." *Electrical Engineering (Transactions)*, January 1940, Vol. 59, pp. 60-64.
- ⁴ H. Goldberg, "Bio-Electric Research Apparatus." *Proc. Inst. Radio Engrs*, June 1944, Vol. 32, pp. 330-336.
- ⁵ F. P. Herrinfeld and H. Sjaardema, "An Improved Amplifier or Electro-Encephalography." *J. of Experimental Psychology*, 1940, Vol. 27, p. 208.
- ⁶ M. Monnier, "Un électro-encéphalogramme à dérivation unique et enregistrement direct." *Comptes Rendus de la Société des Physiologistes Suisses*, Proceedings 20th meeting, Berne, 31st Jan., 1942, pp. 13-15.
- ⁷ F. F. Getman, "A Soviet Electrocardiograph—Electroencephalograph." *Byull. Eksper. Biol. Med.*, 1943, Vol. 15, pp. 76-77.
- ⁸ E. N. Rowland and W. Burns, "A High Gain Audio Frequency Amplifier for the Investigation of Weak Signals." *J. sci. Instrum.*, June 1942, Vol. 19, pp. 85-88.
- ⁹ P. Traugott, "Electro-Encephalograph Design." *Electronics*, August 1943, Vol. 16, pp. 132-144.
- ¹⁰ L. J. Black and H. J. Scott, "A Direct-Current and Audio Frequency Amplifier." *Proc. Inst. Radio Engrs*, June 1940, Vol. 18, pp. 269-271.
- ¹¹ F. Kerkhof, "Amplification of Direct Voltages with a High Frequency Push-Pull Circuit (for Measurement of Small Voltages)." *Z. techn. Phys.*, 1942, Vol. 23, pp. 267-9. (*Wireless Engineer* abstract 1387 of 1943.)
- ¹² C. Sheer and J. G. Lynn, "Electronics in the Study of Head Injuries." *Electronics*, January 1944, Vol. 17, pp. 112-117, 338-352.
- ¹³ C. A. Bevers and R. Furth, "On the Measurement of Small and Slow Potential Variations by Means of Frequency Modulation." *J. sci. Instrum.*, March 1945, Vol. 22, pp. 48-50.
- ¹⁴ R. S. Ogilvie, "Manual of Electro-Encephalography for Technicians." Cambridge, Mass.: Addison-Wesley Press Inc., 1945.
- ¹⁵ J. Debski, "Differential Input Circuits for Biological Amplifiers." *Electronic Engng*, May 1942, Vol. 14, p. 760, and discussion July 1942, Vol. 15, p. 80.
- ¹⁶ M. G. Saunders, "Differential Input Circuits for Biological Amplifiers." *Electronic Engng*, May 1942, Vol. 14, pp. 760, 762-3, and discussion August 1942, Vol. 15, p. 130.
- ¹⁷ D. H. Parnum, "Biological Amplifiers," *Wireless World*, November 1945, Vol. 51, pp. 337-340, December 1945, Vol. 51, p. 373-376.
- ¹⁸ G. D. Dawson, "A Note on Amplifiers for Electro-Encephalography." *Electronic Engng*, December 1944, Vol. 17, p. 293.
- ¹⁹ F. Offner, "Push-Pull Resistance Coupled Amplifiers," *Rev. i. Inst.*, January 1937, Vol. 8, pp. 20-21.
- ²⁰ F. Offner, "Balanced Amplifiers," (a letter). *Proc. Inst. Radio Engrs*, March 1945, Vol. 33, p. 202. *Electronic Engng*, May 1945, Vol. 17, p. 497.
- ²¹ O. H. Schmitt, "A Simple Differential Amplifier," *Rev. i. Inst.*, April 1937, Vol. 8, pp. 126-7.
- ²² O. H. Schmitt, "Cathode Phase Inversion." *J. sci. Instrum.*, March 1938, Vol. 15, p. 100.
- ²³ O. H. Schmitt, "Cathode Phase Inversion." *Electronic Engng*, February 1942, Vol. 14, p. 639.
- ²⁴ J. F. Toennies, "Differential Amplifier." *Rev. Sci. Inst.*, March 1938, Vol. 9, pp. 95-7.
- ²⁵ R. L. Kelly and N. H. Green, Summary of paper at I.R.E. Inter-Convention, January 1945, *Electronics*, April 1945, Vol. 18, p. 226.
- ²⁶ A. D. Blumlein, "Push-pull Amplifiers with Common Cathode Leads." British Patent 482 740, application date 4th July, 1936.
- ²⁷ W. Richter, "Cathode Follower Circuits." *Electronics*, November 1943, Vol. 16, pp. 112-7, 312.
- ²⁸ F. Butler, "New Valve Oscillator Circuit." *Wireless Engineer*, July 1944, Vol. 21, pp. 317-9.
- ²⁹ E. Williams, "The Cathode-Coupled Double-Triode Stage." *Electronic Engng*, May 1944, Vol. 16, pp. 509-11.
- ³⁰ O. S. Puckle, "Cathode-Coupled Push-Pull Amplifiers." *Electronic Engng*, July 1943, Vol. 16, pp. 55-7 (from book "Time Bases").
- ³¹ G. C. Sziklai and A. C. Schroeder, "Cathode-Coupled Wide-Band Amplifiers." *Proc. Inst. Radio Engrs*, October 1945, Vol. 33, pp. 701-9.
- ³² K. A. Pullen, "The Cathode-Coupled Amplifier." *Proc. Inst. Radio Engrs*, June 1946, Vol. 34, pp. 402-5.
- ³³ D. B. Penick, "Measurement and Reduction of Microphonic Noise in Vacuum Tubes," *Bell Syst. Tech. J.*, October 1934, Vol. 13, pp. 614-33.
- ³⁴ H. Burr, C. T. Lane and L. F. Nims, "A Vacuum Tube Microvoltmeter for the Measurement of Bioelectric phenomena." *Yale J. of Biology and Medicine*, October 1936, Vol. 9, p. 1.
- ³⁵ J. C. M. Brentano and P. Ingleby, "Measurement of Small Potential Differences by Means of a Double Triode Valve in a Bridge Circuit" (a special valve by Messrs. Ferranti), *J. sci. Instrum.*, March 1939, Vol. 16, pp. 81-84, refers to British Patent 526 869, application date 28th March, 1939.
- ³⁶ J. C. M. Brentano and E. R. Schleiger, "Compensation of Random Fluctuations in a D.C. Bridge Amplifier." *Phys. Rev.*, March 1943, Vol. 63, p. 218, abstract only.
- ³⁷ R. C. Spencer and L. Schulz, "Behaviour of a Balanced D.C. Amplifier." *Rev. Sci. Inst.*, January 1943, Vol. 14, p. 10-14.
- ³⁸ L. Jofeh, "Method of Varying Gain of a Push-Pull Amplifier." British Patent 529 044, application date 5th September, 1939.
- ³⁹ S. E. Miller, "Sensitive D.C. Amplifier with A.C. Operation." *Electronics*, November 1941, Vol. 14, pp. 27-31, 105-109. *Wireless World*, May 1942, Vol. 48, pp. 111-3.
- ⁴⁰ J. T. Pratt, "Signal-Noise Ratio in Feedback Amplifiers" (a letter). *Electronics*, June 1943, Vol. 16, pp. 336-9.
- ⁴¹ G. L. Pearson, "Fluctuation Noise in Vacuum Tubes." *Bell Syst. Tech. J.*, October 1943, Vol. 13, pp. 634-653.
- ⁴² B. J. Thompson, D. O. North and W. A. Harris, "Fluctuations in Space-Charge Limited Currents at Moderately High Frequencies." *R.C.A. Review*, April 1941, Vol. 5, pp. 505-24, July 1941, Vol. 6, pp. 114-124.
- ⁴³ W. B. Lewis, "Electrical Counting." Cambridge University Press, 1942, Chapter III "Limitations of Amplifiers."
- ⁴⁴ K. R. Sturley, "Low Frequency Amplification (Parts 1-7)." *Electronic Engng*, November 1944, Vol. 17, p. 236 to May 1945, Vol. 17, inclusive.
- ⁴⁵ G. D. Dawson and W. Grey Walter, "Physiological Amplifiers," (reply to a query by G. H. Bell). *Wireless World*, September 1945, Vol. 51, p. 282-3.
- ⁴⁶ L. C. Roess, "Vacuum Tube Amplifier for Measuring very Small Alternating Voltages." *Rev. Sci. Inst.*, July 1945, Vol. 16, pp. 172-183.
- ⁴⁷ O. E. Keall, "Compensating Circuit for Response at very low Frequencies." British Patent 458 450, application date 21st June, 1935.
- ⁴⁸ J. Moir, "Feedback Arrangements for Push-Pull Circuits." British Patent 555 334, application date 13th January, 1942.
- ⁴⁹ A. O. Hansen, "Voltage-Measuring and Control Equipment for Electrostatic Generators." *Rev. Sci. Inst.*, March 1944, Vol. 15, pp. 57-62.
- ⁵⁰ A. W. Vance, "Stable Power Supplies for Electron Microscopes." *R.C.A. Review*, January 1941, Vol. 5, pp. 293-300.
- ⁵¹ F. V. Hunt and R. W. Hickman, "On Electronic Voltage Stabilisers." *Rev. Sci. Inst.*, January 1939, Vol. 10, pp. 6-21.
- ⁵² Brown, "Voltage Stabiliser and Magnetic Current Stabiliser." *Rev. Sci. Inst.*, September 1941, Vol. 12, pp. 435-41.
- ⁵³ W. H. Huggins, "A Stabilised Neon Tube Direct Coupled Amplifier." *Electrical Engineering*, September 1941, Vol. 60, p. 437.
- ⁵⁴ G. R. Mezger, "A Stable Direct-Coupled Amplifier." *Electronics*, July 1944, Vol. 17, pp. 106-10, 352-3.
- ⁵⁵ L. D. Harris, "Electronic A.C. Voltage Regulator." *Electronics*, January 1946, Vol. 19, p. 150-1.
- ⁵⁶ A. B. Bereskin, "Voltage Regulating Power Supplies." *Proc. Inst. Radio Engrs*, February 1943, Vol. 31, pp. 47-52.
- ⁵⁷ J. L. Hogg, "Electronic Voltage Regulators." *Wireless World*, November 1943, Vol. 49, pp. 327-31, December 1943, Vol. 49, pp. 371-3.
- ⁵⁸ M. Levy, "Stabilising Electronic Circuits." *J. Brit. Instn. Radio Engrs*, March/May 1944, Vol. 4, pp. 48-74.
- ⁵⁹ (From E.M.I. Laboratories) "Positive and Negative Power Supplies." *Electronic Engng*, June 1945, Vol. 17, p. 559.
- ⁶⁰ (From E.M.I. Laboratories) "Balanced Output Amplifiers of Highly Stable and Accurate Balance." *Electronic Engng*, June 1946, Vol. 18, p. 189.
- ⁶¹ D. B. Penick, "Direct-Current Amplifier Circuits for Use with the Electrometer Tube." *Rev. Sci. Inst.*, April 1935, Vol. 6, pp. 115-20.

TEMPERATURE-DEPENDENT RESISTORS*

Use as Electric Circuit Elements

By *W. H. B. Cooper, A.M.I.E.E. and R. A. Seymour*

SUMMARY.—An approximate analysis is given of the behaviour of a temperature-dependent resistor in an electrical circuit; only relatively small changes of temperature are considered. The results are applied to the case of an oscillator which includes a temperature-dependent resistor as a control element.

1. Introduction

Resistors which exhibit non-linear electrical properties, by virtue of a change in temperature with applied power, are finding many applications in telecommunication work. They are particularly useful in circuits which are designed to exercise control over the amplitude of an alternating waveform without introducing non-linear distortion. Such devices, in practice, commonly take the form of "Glow lamps" and "Thermistors."

An approximate theory of operation of such devices is presented and this is followed by an analysis of an oscillator using a temperature-dependent resistor as an amplitude control element.

The following properties of the device are important:—

(a) Heat dissipation; due to radiation or conduction, or both.

(In the case of conduction the propagation time of heat transfer might be important, but can be ignored where energy is lost by radiation.)

(b) Change of resistance with temperature.

(The temperature coefficient may be either positive or negative.)

(c) Thermal capacity.

The manner in which these items vary with material, shape and size is not considered.

2. Static Characteristics

Under steady-state conditions the mechanism of heat dissipation is of no consequence, but an expression which fits the radiation case reasonably well is

$$P = AT^\alpha \quad \dots \quad (1)$$

where P is power radiated in watts and T is temperature in degrees absolute.

The change of resistance with temperature is expressed in the form

$$R = BT^\rho \quad \dots \quad (2)$$

Some representative values for α and ρ are given in Table I and whilst ρ and in particular α , vary somewhat with temperature, the expressions are adequate for the present purpose.

If a steady-state voltage V is applied, resulting in a current I amperes then

$$P = IV \text{ watts}$$

TABLE I

TEMP. : T Degrees Absolute	Res. at T Res. at 293°	ρ (Tungsten)	† α	Measured Values of α			
				A	B	C	D
293	1.0	—	—	—	—	—	—
300	1.03	1.23	—	—	—	—	—
350	1.25	1.23	11.4	7.6	7.6	6.9	7.1
400	1.47	1.23	9.5	5.7	4.4	5.6	6.2
500	1.92	1.23	7.6	3.7	3.3	5.0	6.2
600	2.41	1.23	7.1	3.2	3.3	4.5	5.6
700	2.93	1.23	6.7	3.0	3.3	4.5	5.2
800	3.46	1.23	6.3	—	—	—	—
900	4.0	1.22	5.9	—	—	—	—
1000	4.54	1.20	5.6	—	—	—	—

Sample A.—Switchboard Type of Lamp 6 V.

„ B.—Switchboard Type of Lamp 24 V 50 mA.

Sample C.—Osram "Pygmy" 240 V 15 W.

„ D.—Ordinary Vacuum Lamp 240 V 25 W.

* M.S. accepted by the Editor, Oct. 1946.

† Ref. No. 2.

and $R = \frac{V}{I}$ ohms

From (1) and (2)
 $V = KI^n \dots \dots \dots (3)$

where $n = \frac{\alpha + \rho}{\alpha - \rho}$

and $\frac{\partial V}{\partial I} = nKI^{n-1} \dots \dots (3a)$
 $= nR$

It is notable that a negative differential resistance can be obtained even if "ρ" is positive.

It is also interesting to note from equation (3) that when $n = -1$, $VI = \text{constant}$. This is clearly a limiting condition for negative values of n since when $n = -1$ a change of volts or current produces no change of power. It is brought about by making $|\rho| \gg \alpha$, the sign of ρ being unimportant.

The constants can be readily determined experimentally, first of all by using an oven or reasonably low temperatures, and determining ρ with the aid of equation (2) from the experimental results. Similarly T can be determined by means of equation (1) from the voltage/current characteristics.

Dynamic Characteristics

Only small changes of temperature are considered. Assume the temperature to change from some value T_0 to $T_0 (1 + y)$, where y is very small compared with unity, then equations (1) and (2) may be written

$P = AT_0^\alpha (1 + \alpha y) \dots \dots (4)$
 $= P_0 (1 + \alpha y)$

and $R = BT_0^\rho (1 + \rho y) \dots \dots (5)$
 $= R_0 (1 + \rho y)$

It is clear that if the power applied to the device is suddenly changed then the temperature will change only after a time lag since energy is absorbed or released by the thermal capacity H_0 . If W watts, the applied power, changing with time then the energy Wdt applied in time dt is used up partly in radiation Pdt and partly in changing the temperature by an amount dT .

Hence $Wdt = Pdt + H_0dT \dots \dots (6)$

the basic energy equation assuming energy lost by radiation and/or conduction, provided the propagation time can be ignored. Small fractional changes "y" are considered

$T = T_0 (1 + y)$

$\frac{dT}{dt} = T_0 \frac{dy}{dt}$

If this small change in temperature is brought about by a small change in applied power from W_0 to $W_0 (1 + \Delta)$ watts

then $\frac{H_0 T_0}{W_0} \cdot \frac{dy}{dt} = (1 + \Delta) - (1 + \alpha y) \dots \dots (6a)$

Since $W_0 = P_0$ (a steady-state condition)

$\therefore \frac{H_0 T_0}{W_0} \frac{dy}{dt} + \alpha y = \Delta \dots \dots (7)$

Hence $y = A \exp\left(-\frac{\alpha W_0}{H_0 T_0} t\right) + \frac{\Delta}{\alpha} \dots (7a)$

It is convenient to substitute

$\frac{H_0 T_0}{W_0} \equiv L_0 \dots \dots (8)$

so that $\frac{L_0}{\alpha}$ becomes the thermal time constant of the device.

4. Formulae for the Modulation Resistance

A voltage of the form $E_0 (1 + m \sin \omega t)$, where m is small compared with unity, is applied to a thermally-operated resistor whose resistance varies according to the law $R = R_0 (1 + \rho y)$ where y is a function of time to be determined. The power supplied will be

$W = \frac{E_0^2 (1 + m \sin \omega t)^2}{R_0 (1 + \rho y)}$
 $= W_0 \frac{\left(1 + \frac{m^2}{2} + 2m \sin \omega t - \frac{m^2}{2} \cos 2\omega t\right)}{(1 + \rho y)}$

where

$W_0 = \frac{E_0^2}{R_0}$

Since y is small compared with unity this becomes

$W = W_0 \left(1 + \frac{m^2}{2} + 2m \sin \omega t - \frac{m^2}{2} \cos 2\omega t\right) (1 - \rho y) \dots (9)$

From equations (6), (6a) and (9) it follows that

$\frac{T_0 dy}{dt} = \frac{W_0}{H_0} \left\{ \left(1 + \frac{m^2}{2} + 2m \sin \omega t - \frac{m^2}{2} \cos 2\omega t\right) (1 - \rho y) - (1 + \alpha y) \right\} \dots (10)$

which, if $\left(\frac{m^2}{2} + 2m \sin \omega t - \frac{m^2}{2} \cos 2\omega t\right)$ is small compared with unity becomes

$$L_0 \frac{dy}{dt} + (\rho + \alpha)y = \left(\frac{m^2}{2} + 2m \sin \omega t - \frac{m^2}{2} \cos 2\omega t \right) \dots \dots \dots \text{(II)}$$

This is a linear differential equation and its solution is

$$\rho y = \frac{\rho m^2}{2(\alpha - \rho)} + \frac{2m\rho \sin \omega t}{(\alpha - \rho) + j\omega L_0} \dots \text{(I4)}$$

5. Measurement of Modulation Resistance

The method of test employed a 300-c/s carrier supply instead of direct current, in

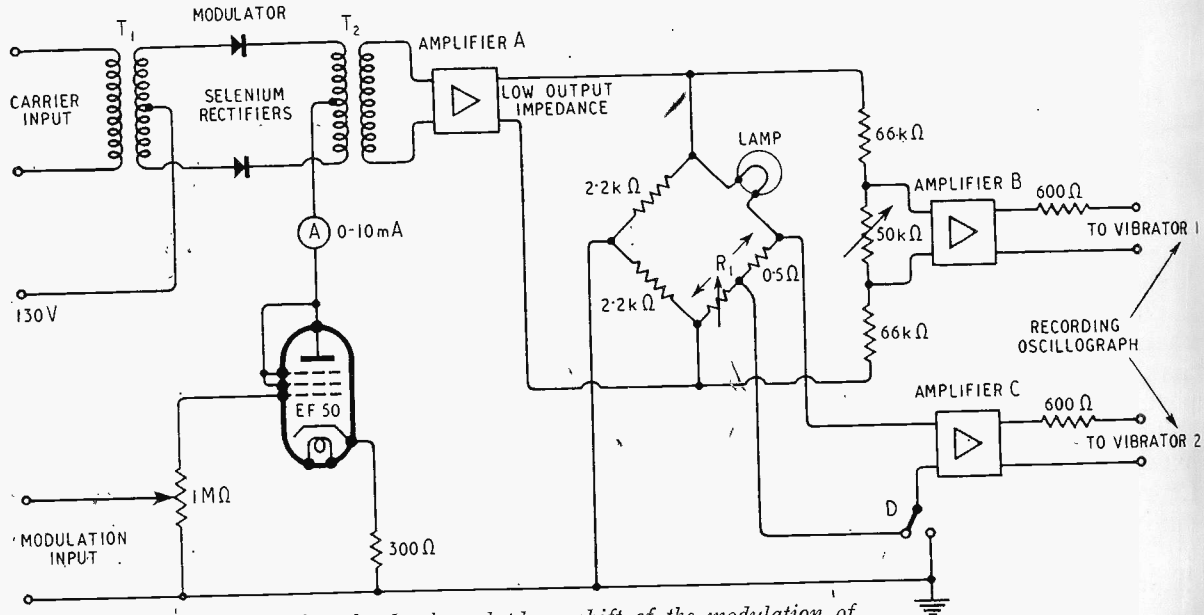

Fig. 1. Circuit for testing the depth and phase shift of the modulation of resistance of lamps.

$$y = A \exp\left(-\frac{\rho + \alpha}{L_0}t\right) + \frac{m^2}{2(\rho + \alpha)} + \frac{2m \sin \omega t}{(\rho + \alpha) + j\omega L_0}$$

if the harmonic terms are neglected.

Only the steady state solution is required and this is:—

$$y = \frac{m^2}{2(\rho + \alpha)} + \frac{2m \sin \omega t}{(\rho + \alpha) + j\omega L_0} \dots \text{(I2)}$$

The fractional change of resistance is ρy .

In the case where the device has a resistance added in series, of value equal to R_0 the solution for the modulation of resistance in the steady state for a voltage of the form $E_0 (1 + m \sin \omega t)$ applied to the combination is:—

$$\rho y = \frac{\rho m^2}{2\alpha} + \frac{2m\rho \sin \omega t}{(\alpha + j\omega L_0)} \dots \text{(I3)}$$

Where the device has in series with it a resistance considerably greater than the resistance R_0 , and a current of the form $I_0 (1 + m \sin \omega t)$ is passed through the combination, the fractional change of resistance will be

order to ease the amplification problems. The circuit layout is given in Fig. 1. The output impedance of amplifier A was low compared with the lamp circuit and the input impedances of amplifiers B and C not less than 100,000 ohms. The 300-c/s carrier could be modulated sinusoidally to a depth of 20% at frequencies from 0.1 c/s upward.

Amplifier B gave an output in phase with the input voltage to the bridge, and amplifier C an output proportional either to the voltage developed across the opposite diagonal of the bridge, or to the current passing through the lamp filament, according to the position of the link D. The bridge method was used when the phase shift was less than 6 degrees and hence difficult to measure by direct comparison. In this case, resistance R_1 was adjusted until a minimum output from the bridge was secured. The following calculation was employed to evaluate the modulation factor for the filament when using the bridge circuit:

For an input voltage of the form $E (1 + m \sin \omega t) \sin ct$ where c is so large that the filament does not respond, the filament

resistance has been shown to respond to the modulation ω in such a way that

$$R = R_0 \left(1 + \frac{\rho m^2}{2\alpha} + A \sin \omega t \right) \quad (15)$$

where A the modulation factor, is complex, $A = j\phi$, see equation (13), R_0 is the resistance with no modulation, and harmonics are neglected.

Now the current I through the filament and R_1 in series will be

$$I = \frac{E (1 + m \sin \omega t) \sin ct}{R_1 + R_0 \left(1 + \frac{\rho m^2}{2\alpha} + A \sin \omega t \right)} \quad (16)$$

When the bridge is adjusted for minimum

output $R_1 = R_0 \left(1 + \frac{\rho m^2}{2\alpha} \right)$

Hence $I = \frac{E}{2R_0} \cdot \frac{(1 + m \sin \omega t) \sin ct}{[1 + (A/2) \sin \omega t]}$

neglecting the $\frac{\rho m^2}{2\alpha}$ term, and the voltage across R_1 will equal

$$V = \frac{E}{2} \frac{(1 + m \sin \omega t) \sin ct}{[1 + (A/2) \sin \omega t]}$$

When $A/2$ is small compared with unity the expression can be simplified and to a first order becomes

$$V = \frac{E}{2} \left(1 + m \sin \omega t - \frac{A}{2} \sin \omega t \right) \sin ct$$

The voltage developed across one of the ratio arms will be

$$V_1 = \frac{E}{2} (1 + m \sin \omega t) \sin ct$$

The output from the bridge therefore will be $V - V_1$

$$\approx \frac{E}{4} A \sin \omega t \cdot \sin ct \quad \dots \quad (17)$$

TABLE II
COMPARISON OF MEASURED AND CALCULATED
VALUES OF $|A|$ AND ϕ FOR VARIOUS TYPES OF FILAMENT

Switchboard Type 6 V.

Mean Resistance 24 ohms. Mean Current 6.7 mA.

Frequency of Modulation c/s	m	Measured Values		Calculated Values	
		$ A $	ϕ	$ A = \frac{2mp}{\sqrt{x^2 + (\omega L_0)^2}}$	$\phi = \tan^{-1} \frac{\omega L_0}{x}$
0.1	0.176	0.093	17°	0.127	24°
0.2	0.16	0.061	45°	0.096	42°
0.5	0.16	0.034	72°	0.053	66°
1.0	0.16	0.02	79°	0.028	77°
1.5	0.16	0.011	82°	0.019	$81^\circ 24'$
2.0	0.16	0.0097	83°	0.014	$83^\circ 30'$

Osram "Pygmy" 15 W.

Mean Resistance 470 ohms. Mean Current 1.9 mA.

0.1	0.143	0.0057	—	0.0076	85°
0.2	0.143	0.003	86°	0.0038	$86^\circ 48'$
0.33	0.143	0.0022	86°	0.0023	88°
0.5	0.143	0.0023	90°	0.0015	$88^\circ 40'$

Switchboard Type 24 V 50 mA.

Mean Resistance 86 ohms. Mean Current 5 mA.

0.1	0.107	0.029	64°	0.048	49°
0.2	0.107	0.018	73°	0.03	67°
0.5	0.107	0.0072	82°	0.012	80°
1.0	0.08	0.0056	85°	0.0048	85°
2.0	0.08	0.0026	90°	0.0025	$87^\circ 30'$

By calibrating the recording circuit the value of $|A|$ may be determined, and by comparison with the reference trace the angle ϕ can be evaluated.

A comparison of measured and calculated values for $|A|$ and ϕ is given in Table II for the case where the filament has a resist-

to the bridge become $E(I+m)$ after opening the key. Let $R_1 = R_0$ the resistance of the lamp filament for a voltage E applied to the bridge and let the filament resistance vary as $R_0(I+\rho y)$ when the voltage is changed to $E(I+m)$, y being a function of time.

The current through the lamp filament will be—

$$\frac{E}{2R_0}(I+m)(I-\frac{1}{2}\rho y)$$

and the power W in the lamp filament will be

$$W = \frac{E^2}{4R_0^2}(I+2m)(I-\rho y)R_0(I+\rho y) = \frac{E^2}{4R_0}(I+2m) = W_0(I+2m)$$

Hence from equation (6) *et seq.*
 $W_0\{(I+2m) - (I+\alpha y)\} \cdot dt = H_0 dT$

$$\text{and } \frac{L_0 dy}{dt} + \alpha y = 2m$$

Fig. 2. Circuit for the measurement of the thermal time-constant of a filament.

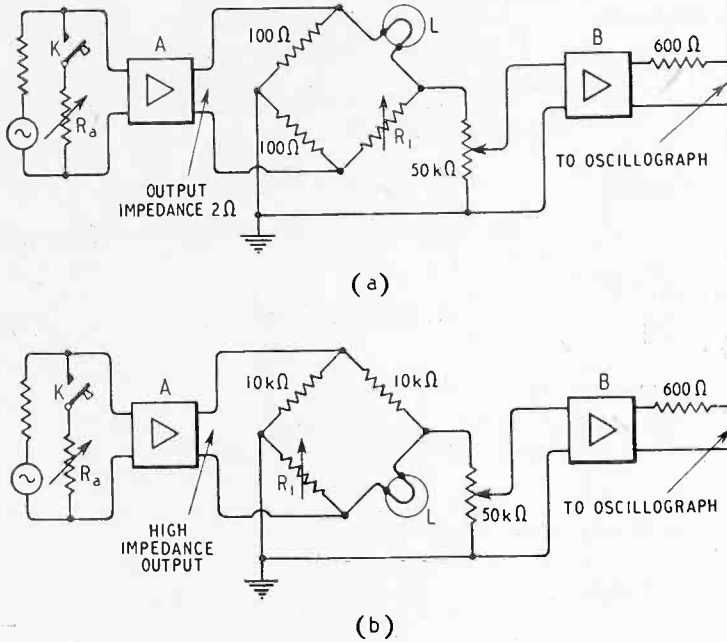

ance in series of a value equal to its mean resistance.

6. Measurement of Thermal Time Constant

The methods (a) and (b) shown in Fig. 2 differ only in that in method (a) the lamp filament is supplied from a generator whose resistance is equal to R_0 , the resistance of the filament, and in method (b) the lamp filament is fed from a high-impedance generator.

In both methods the operating procedure is as follows. The bridge is balanced by the adjustment of R_1 for a particular value of voltage in method (a), and of current in method (b). With key K first open and then closed, R_a is adjusted to give a certain percentage change in voltage or current. With the key closed the bridge is balanced; then the key is opened whereupon the output from amplifier B rises from zero to some steady value. The envelope of the trace as recorded on the oscilloscope* will be of exponential form. The value of this is obtained from the trace as follows:

Method (a)—Let the initial input voltage E

*A Cambridge Oscillograph was used.

and when the boundary conditions are such that when $t = 0$, $y = 0$ this becomes

$$y = \frac{2m}{\alpha} \left(1 - e^{-\alpha t/L_0} \right) \dots \dots (18)$$

The change of resistance by definition is $R_0 \rho y$

$$= R_0 \frac{2m\rho}{\alpha} \left(1 - e^{-\alpha t/L_0} \right) \dots \dots (19)$$

Now the output from amplifier B into the oscilloscope will be proportional to the above expression, and thus if the output reaches 0.632 of its final value in N seconds

$$\text{Then } L_0/\alpha = N \text{ sec} \dots \dots (20)$$

and since $L_0 = H_0 T_0 / W_0$

$$H_0 = \alpha W_0 N / T_0 \text{ watt sec}/^\circ\text{C} \dots (21)$$

Method (b)—The solution similarly obtained for the change of filament resistance is

$$R_0 \rho y = \frac{R_0 2m\rho}{\alpha - \rho} \left\{ 1 - \exp\left(-\frac{\alpha - \rho}{L_0} t\right) \right\} (22)$$

$$\text{and } H_0 = \frac{W_0 (\alpha - \rho) N}{T_0} \text{ watt sec}/^\circ\text{C} (23)$$

7. Control Element in RC Oscillator

7.1. Circuit arrangement

The essential portions of the oscillator circuit are shown in Fig. 3 (a). The transmission loss through the selective network

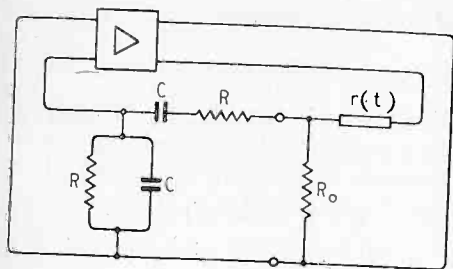

(a)

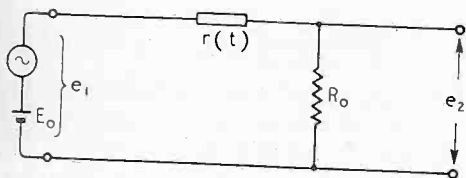

(b)

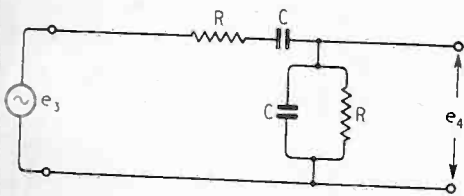

(c)

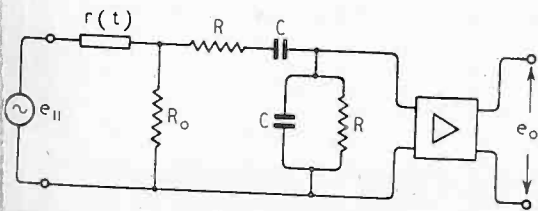

(d)

Fig. 3. Thermally controlled RC oscillator.

a minimum and with zero phase shift at that frequency $\frac{c_0}{2\pi}$ c/s at which $c_0 = \frac{1}{CR}$. The

drive amplifier is assumed to be perfect from the point of view of freedom from amplitude and attenuation distortion, whilst the amp circuit elements $r(t)$ and R_0 act as a vernor.

Circuit impedances are such that the lamp control circuit is fed from a constant-voltage source, the selective-network impedance at the oscillating frequency is high compared with R_0 and the amplifier input impedance again high compared with that of the selective network. The voltage loss in the

control circuit is approximately two to one when the circuit is oscillating at the design level and that in the selective network shown, three to one, so that the nominal gain of the amplifier is six times. Assume that steady-state oscillating conditions have been reached, then it has been observed that, if the circuit is given an impulse of any sort (e.g., the frequency-change switch operated), the oscillating voltage may be modulated by a low-frequency damped sine wave. An example of this is shown in Fig. 4. Whilst the oscillator circuit has a number of attractive features, particularly for audio-frequency work the duration of the disturbance may be so great as to render the circuit quite unsuitable as a variable frequency test oscillator. The duration of the disturbance is influenced by many factors one of which is the linearity of the drive amplifier. Other things being equal, the perfect amplifier allows the disturbance to last for the greatest length of time.

In the following sections an attempt is made to analyse the circuit using the theory for the temperature dependent resistor as developed in Sections 1 to 4.

7.2. Thermally operated circuit

In the circuit of Fig. 3 (b) the non-linear element is represented by $r(t)$. A modulated d.c. source represented by e_1 , where $e_1 = E_0(1 + m \sin \omega t)$, is applied to the circuit which has been previously adjusted so that in the absence of modulation (i.e., $m = 0$) the element $r(t) = R_0$

Under these conditions,

$r(t) = R_0(1 + \rho y)$ where y is the temperature modulation.

From Section 4, Equ. (13) it follows that, under steady state conditions

$$y = \frac{m^2}{2\alpha} + \frac{2m \cdot \sin \omega t}{\alpha + j\omega L_0}$$

where $L_0 = H_0 T_0 / W_0$
and $\alpha =$ radiation index.

The output voltage of Fig. 3 (b) will be

$$e_2(t) = \frac{E_0}{2} \frac{(1 + m \sin \omega t)}{\left[1 + \frac{\rho m^2}{4\alpha} + \frac{\rho m}{\alpha + j\omega L_0} \sin \omega t \right]}$$

$$\approx \frac{E_0}{2} \left[1 - \frac{\rho m^2}{4\alpha} + m \left\{ \frac{(\alpha - \rho) + j\omega L_0}{\alpha + j\omega L_0} \right\} \sin \omega t \right] \quad (24)$$

In the actual oscillator circuit E_0 will be the r.m.s. value of the oscillation frequency $\frac{c_0}{2\pi}$ c/s, a value so large that the thermal element will not respond cyclically.

7.3 Frequency-selective RC network.

A typical form of selective unit is shown in Fig. 3(c). This particular network produces a voltage loss (i.e., $\frac{e_3}{e_4}$) of 3 at the frequency of zero phase shift; it is referred to as the 10-db network.

$$c_0 = \frac{1}{CR} \text{ radians/sec.}$$

The steady-state frequency response is given by

$$e_4 = \frac{e_3}{3 \left[1 + j \frac{1}{3} \left(x - \frac{1}{x} \right) \right]}$$

where $x = \frac{\text{Frequency under consideration}}{\text{Frequency of zero phase shift.}}$

The effective Q_0 is only $\frac{1}{3}$.

The steady-state response to a signal of the form $e_3 = E (1 + g \cos \omega t) \cos c_0 t$ is given by:—

$$e_4 \approx \frac{E}{3} \left[\cos c_0 t + \frac{g \cos (c_0 + \omega)t}{2 \left(1 + j \frac{2\omega}{3c_0} \right)} + \frac{g \cos (c_0 - \omega)t}{2 \left(1 - j \frac{2\omega}{3c_0} \right)} \right]$$

provided $c_0 \gg \omega$

The modulation envelope is modified in amplitude and phase by the factor $\frac{1}{1 + j\omega L_c}$ in passing through the RC network. Corresponding values of L_c can be found for other types of selective network.

7.4. Combined response.

Considering now the circuit of Fig. 3 (d) where the amplifier is linear and has a voltage gain of 6 times, then when e_{11} is given by:—

$$e_{11} = E (1 + m \sin \omega t) \sin c_0 t$$

it follows from equations (24) and (25) that

$$e_0 = E \sin c_0 t \left[1 - \frac{\rho m^2}{4\alpha} + \frac{m \{ (\alpha - \rho) + j\omega L_0 \}}{(\alpha + j\omega L_0) (1 + j\omega L_c)} \sin \omega t \right]$$

For the purpose of the following analysis the oscillation frequency can be regarded as d.c. so that $E \sin c_0 t$ will be replaced by E_0 giving

$$e_0 = E_0 \left[1 - \frac{\rho m^2}{4\alpha} + \frac{m \{ (\alpha - \rho) + j\omega L_0 \}}{(\alpha + j\omega L_0) (1 + j\omega L_c)} \sin \omega t \right] \dots \dots (26)$$

If the output terminals are connected to the input as in Fig. 3(a), the system will behave like a feedback amplifier with a response

$$\mu = \frac{1}{1 - F(j\omega)} \dots \dots (27)$$

where

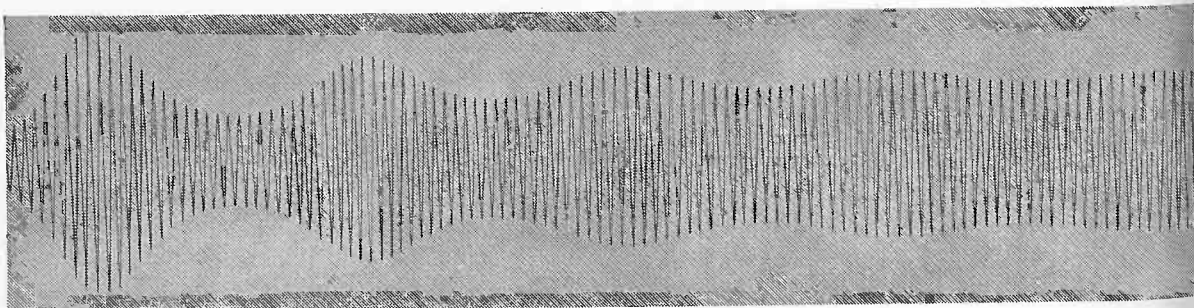

Fig. 4. Modulation of output of RC oscillator; carrier frequency 31 c/s, modulation frequency 1.26 c/s.

$$\therefore e_4 \approx \frac{E}{3} \left\{ 1 + g_1 \cos \omega t \right\} \cos c_0 t \quad (25)$$

where $g_1 = \frac{g}{1 + j\omega L_c}$

and $L_c = \frac{2}{3c_0}$

$$F(j\omega) = \frac{(\alpha - \rho) + j\omega L_0}{(\alpha + j\omega L_0) (1 + j\omega L_c)} \quad (28)$$

The system will be stable so long as $F(j\omega)$ does not enclose the point 1, 0 in the complex plane. Equation (27) contains all the information necessary to obtain the response of

the system to a suddenly applied pulse; it is complicated, but with typical values of constants encountered with these circuits some useful approximations can be made. It might be expected that the frequency $\frac{\omega_m}{2\pi}$ at which μ is a maximum would be given by equating the argument of $F(j\omega)$ to zero, when

$$\omega_m^2 = \frac{\rho}{L_c L_0} + \frac{\rho\alpha}{L_0^2} - \frac{\alpha^2}{L_0} \dots \dots (29)$$

$$\approx \frac{\rho}{L_0 L_c} \text{ for normal circuit values } (30)$$

Equation (30) agrees, to within a few per cent, with experimentally determined values.

From equation (27)

$$\mu = \frac{(\alpha - \omega^2 L_0 L_c) + j\omega (L_0 + \alpha L_c)}{(\rho - \omega^2 L_0 L_c) + j\omega \alpha L_c}$$

From equation (30) and neglecting αL_c compared with L_0

$$\mu \approx \frac{(\alpha - \rho x^2) + j\omega L_0}{\rho(1 - x^2) + j\alpha\omega L_c} \text{ where } x = \frac{\omega}{\omega_m}$$

It will be appreciated that the values of μ or values of x around unity are of prime importance so that if

$$(\alpha - \rho) \ll \omega L_0$$

$$\mu \approx \frac{j\omega L_0}{\rho(1 - x^2) + j\alpha\omega L_c} \approx \frac{L_0/\alpha L_c}{1 + j/\alpha \sqrt{\frac{L_0 \rho}{L_c}} (x - 1/x)} \dots (31)$$

Equation (31) is identical in form with that of an LCR circuit in which the Q_0 (Q at resonance) is given by

$$Q_0 = \frac{1}{\alpha} \sqrt{\frac{L_0 \rho}{L_c}} \dots \dots (32)$$

and it follows that the envelope of the response to a suddenly applied pulse will be given by

$$\text{Envelope of response} = (1 - e^{-t/\tau}) \quad (33)$$

where the time-constant

$$\tau = \frac{2Q_0}{\omega_m} \approx \frac{2L_0}{\alpha} = \frac{2H_0 T_0}{W_0 \alpha} \dots \dots (34)$$

This is independent of the oscillator frequency

$\frac{c_0}{2\pi}$; it is twice the thermal time-constant of the lamp. In view of the tuned circuit analogy this is not surprising.

The decrement is given by

$$\text{Decrement} = \text{antilog} [0.43\pi/Q_0] \dots (35)$$

A direct method of measuring the time constant is given in Section 6.

Some calculated and measured values of ω_m and decrement are given in the Table III for an oscillator incorporating a "10-db" RC network and a 6.0-V switchboard-type of lamp operating with an unmodulated current of 5.0 mA r.m.s.

$$\begin{aligned} \alpha &= 3.6 & \rho &= 1.2 \\ L_c &= 2/(3 c_0) & L_0 &= \frac{H_0 T_0}{W_0} \\ &= 0.0035 \text{ for } 30 \text{ c/s} & &= 6.2 \\ &= 0.0021 \text{ ,, } 50 \text{ c/s} & & \\ &= 0.0011 \text{ ,, } 100 \text{ c/s} & & \end{aligned}$$

TABLE III

$c_0/2\pi$	ω_m		Decrement	
	Measured	Calculated	Measured	Calculated
30 c/s	7.9	7.4	2.1	1.3
50	9.6	9.6	3.5	1.2
100	13.4	13.5	5.2	1.15

Whilst measured resonant frequencies are in good agreement with the theory, the measured time constants are very much shorter than those calculated. An attempt is made, in the next section, to explain this discrepancy.

7.5 Decrement as a Function of Modulation Depth "m"

In the expansion which gives equation (24)

the term $-\frac{\rho m^2}{4\alpha} \sin \omega t$ has been omitted and

if this included equation (28) becomes

$$F(j\omega, m) = \frac{(\alpha - \rho) + j\omega L_0}{(\alpha + j\omega L_0)(1 + j\omega L_c) - \frac{m^2 \rho}{4\alpha(1 + j\omega L_c)}} \dots \dots (36)$$

From this point onwards the analysis again follows on the same lines as that of Section 7.4 but since equation (36) represents a non-linear system the results obtained this way are open to question.

$$\mu \approx \left[\frac{\rho m^2}{4\alpha} + \frac{\alpha L_c}{L_0} \right] \left[1 + \frac{j\sqrt{L_0 L_c \rho} \left\{ x - \frac{1}{x} \left(1 + \frac{m^2}{4} \right) \right\}}{L_0 \frac{m^2 \rho}{\alpha} + \alpha L_c} \right] \dots \dots (37)$$

where $x = \omega/\omega_m$ } as before
and $\omega_m^2 = \rho/L_0L_c$ }

This expression of course reduces to (31) when $m = 0$. Considered as a function of x , equation (37) does not exhibit the symmetry of a normal resonance curve, but for values of x greater than unity, where the factor $(1 + \frac{m^2}{4})$ becomes less important, the response

will be similar to that of a normal resonant circuit with a Q_0 value given by

$$Q_{0m} = \frac{\sqrt{L_0L_c\rho}}{L_0 \frac{\rho m^2}{4\alpha} + \alpha L_c} \dots \dots (38)$$

In which case the time constant will be

$$\begin{aligned} \tau_m &= 2Q_{0m}/\omega_m \\ &= \frac{2L_0}{\alpha + \frac{L_0\rho m^2}{4L_c\alpha}} \dots \dots (39) \\ &= \frac{2L_0}{\alpha \left\{ 1 + \frac{m^2}{4} Q_0^2 \right\}} \dots \dots (40) \end{aligned}$$

and the decrement

$$= \text{antilog} \left[0.43\pi \left(\frac{1}{Q_0} + \frac{m^2 Q_0}{4} \right) \right] (41)$$

where $Q_0 = \frac{1}{\alpha} \sqrt{\frac{L_0\rho}{L_c}}$ [equation (32)]

Table IV gives calculated values of decrement, from equation (41) for different depths of modulation.

TABLE IV

$c_0/2\pi$	Q_0	Decrement (calculated)			
		$m = 0$	$m = 0.1$	$m = 0.2$	$m = 0.3$
30 c/s	12.8	1.3	1.4	1.9	3.2
50	16.5	1.2	1.4	2.1	3.9
100	23.5	1.15	1.4	2.5	6.2

The time constant τ_m of the disturbance may also be written

$$\tau_m = \frac{2L_0}{\alpha} \cdot \frac{1}{\left\{ 1 + \frac{m^2}{4} \left(\frac{L_0}{\alpha} \right)^2 \omega_m^2 \right\}} (42)$$

where $\omega_m^2 = \frac{\rho}{L_0L_c}$ [equation (30)]

ω_m being the modulation frequency.

Clearly the time constant $\frac{L_0}{\alpha}$ should be as

short as possible consistent with the condition that it should be long compared with the period of the oscillation frequency; in addition it is advantageous to make ω_m as large as possible. Whilst Table IV does not agree very accurately with experimental results the trend is in the right direction and the deductions from equation (42) are in accord with practice.

Acknowledgment

The authors are indebted to the Engineer-in-Chief of the British Post Office for permission to publish this article.

REFERENCES

- ¹ "On the Theory of Light Modulation of AC heated Glow-Lamps in the Audio Frequency Range," by Horst Kohler, *E.N.T.*, April 1938.
- ² "The Characteristics of Tungsten Filaments as Functions of Temperature," by Dr. H. Jones and I. Langmuir, *Gen. elect. Rev.*, Vol. 30, pp. 310, 354, 408.

NEW BOOKS

Electronics

Edited by BERNARD LOVELL. Pp. 660 + xvi with 404 illustrations. Pilot Press, Ltd., 45, Great Russell Street, London, W.C.1. Price 42s.

There are fourteen chapters by thirteen different authors in this book. The chapters are all on different subjects having in common only their dependence on electronics. The book is, therefore, essentially a collection of monographs on related subjects and there will be few individuals to whom the whole will be of equal interest.

The collection of such a diversity of material in a single volume is not without advantages, however, if only because it leads the specialist to read beyond his own narrow subject. It gives him an insight into many dissimilar problems and by doing so helps him to achieve a better perspective of his own.

Chapter I "Electron Physics" is by Dr. F. A. Vick of the University of Manchester. It comprises a review of 51 pages of the present state of knowledge of electron physics, "including the behaviour of electrons in metals and non-metallic solids." Thermionic, field, and photo-electric emission are dealt with as well as contact potentials, the luminescence of solids and photo-conductivity.

Chapter II is by Dr. H. G. Lubszynski of the E.M.I. Research Laboratories and is entitled "Photo-Cells for the Visible and Ultra-Violet." There are 43 pages covering photo-emissive, photo-conductive, and photo-voltaic cells, and gas-filled and electron-multiplier types are included. Several pages are devoted to noise and applications. In spite of the large amount of ground covered quite a lot of detailed information is included.

The discussion of photo-cells is continued for another 37 pages in Chapter III, "Recent Advances in Photo-Cells for the Infra-Red" by Dr. A. Elliott, formerly of the Admiralty Research Laboratory. This deals chiefly with thallium-sulphide, lead-sulphide, lead selenide and telluride photo-conductive cells.

Following this there is an extraordinarily good chapter (IV) on "Electronic Generation of Tele-

vision Signals" by Dr. J. D. McGee of the E.M.I. Research Laboratories. In the first nine of his 77 pages he briefly describes early methods of scanning, such as the Nipkow disc and Campbell-Swinton's early electronic suggestions, and reviews the Farnsworth image dissector and the intermediate-film method. There are then some five pages on the charge-storage principle. The rest of the chapter covers in considerable detail the operating principles and characteristics of the Emitron (iconoscope), Super-Emitron, Orthicon and Super-Orthicon. The author gives a very clear and well-balanced discussion of the characteristics of, and difficulties inherent in, each.

Chapter V is "Thermionic Valves for Very High Frequencies" by Dr. F. C. Thompson of Marconi Valve Laboratories; 25 pages are devoted to klystrons and magnetrons. The material is largely descriptive and gives a good general picture of the way in which such valves operate.

Chapter VI is of 81 pages; it is "Radar" by Dr. R. A. Smith of Telecommunications Research Establishment. The fundamentals of propagation and echoes are covered, as well as the frequency spectrum of pulses and the effect of bandwidth on pulse shape. Frequency- and pulse-modulation systems are compared and anomalous propagation (super-refraction) is dealt with. Display systems, responders and aerial scanners are covered. The chapter gives a very good technical picture of radar, but there is little detailed information on circuits.

Chapter VII by L. Atkinson of Ferranti, Ltd., is of 28 pages. "Control Applications of Cold Cathode Valves" covers ignitions, servotrons, stroboscopic lamps, pulse-trigger valves, and the megalite lamp. Circuits of control apparatus are given and include counters, magnetizing equipment, welders, stroboscopes, depth sounders and apparatus for high-speed photography.

"High-Frequency Heating" is dealt with in Chapter VIII by H. Wood of Ferranti, Ltd., in 33 pages. The theories of induction and dielectric heating are given briefly and there are circuits and details of the apparatus employed.

In Chapter IX the same author deals with "A Moisture Content Control Equipment." This is of only 7 pages but includes the principle of operation and the circuit of the apparatus.

"Electronics Applied to Servo-Mechanisms" is the title of Chapter X of 52 pages by F. H. Belsey of Metropolitan-Vickers Electrical Co. It is an extremely good account of the theory of servo-mechanisms and particular stress is laid upon the conditions which are necessary for obtaining stability. The analysis is mathematical.

Dr. L. G. Grimmett, formerly of the Radio-therapeutic Unit of the Medical Research Council contributes Chapter XI "Electronics in Medicine." It is of 38 pages and covers high-energy radiations, such as those produced by X-ray generators, electrostatic generators, cyclotrons, betatrons, synchrotrons, microtrons, linear resonance accelerations, and waveguide accelerators. Diathermy, electron optics, and electro-encephalography are also covered. The chapter is in the nature of a general survey of the subject.

"Electronics in Physiology" is the title of Chapter XII by Dr. R. J. Pumphrey of the Department of Zoology, Cambridge. In 19 pages he describes the use of electronics in the study of nerves and muscles.

Chapter XIII, "The Betatron" is by Dr. J. D. Craggs, of the Metropolitan-Vickers Electrical Co. Of 31 pages it includes the theory of the betatron and describes its construction; its applications to deep therapy, to nuclear physics and to radiography are also dealt with.

Chapter XIV of 107 pages is the longest in the book. By Dr. V. E. Casslett of the Electrical Laboratory, Oxford, it is entitled "Electron Microscopy and Electron Diffraction."

It includes a good deal of information about electron optics as applied to the electron microscope and the construction of the electron microscope is described. Stabilizing and supply circuits are covered.

Each chapter includes a bibliography and there is a good subject index. The book is well produced and covers an enormous range of material. Since each chapter is written by a specialist there are remarkably few errors. Its title is perhaps apt to be misleading, for the greatly overworked word "electronics," although used here quite correctly, is likely to convey something different to many.

W.T.C.

Klystron Tubes

By A. E. HARRISON. Pp. 271 + x. McGraw-Hill Publishing Co., Ltd., Aldwych House, London, W.C.2. Price 17s. 6d.

This book, as mentioned in the preface, grew out of the Klystron Technical Manual, which was widely distributed during the war by the Sperry Gyroscope Company to users of klystrons in the United States and also over here in Great Britain. It has been completely revised and much new material has been added, a good deal of which no doubt is based on the author's original contributions to our knowledge of the klystron tube.

No prior knowledge of the klystron tube is assumed and the author is to be congratulated on his extremely clear and readable introduction to a technique,—if not science,—which breaks away so radically from all radio techniques in use right up to the outbreak of war. Once the three or four essentially new principles, which form the basis of all electron tubes conceived in the last ten years, have been grasped,—and these principles are by no means more difficult to understand than those on which, say, triodes are based, most of the microwave-tube technique as applied in the war is intelligible to anybody who has only an elementary knowledge of radio and physics. These principles, in the order in which they emerged in the literature, are: the principle of an inductive coupling between an a.c. component in an electron beam and an external circuit; the principle of the formation of such an a.c. component, or of "bunching", by means of the drifting of electrons which have been given an a.c. component of velocity; and the principle of producing regions of very high r.f. field strengths in circuits by making them all-enclosed; i.e., cavities. These principles had been in the air for some time, and devices making use of one or two of them had been described. But it was not until the famous series of papers on the klystron by the Varian Brothers, W. W. Hansen and D. L. Webster was published, all in 1939, that it became obvious that a real and great step forward in radio technique had been made. It is no exaggeration to say that the whole of the centimetre techniques, which eventually culminated

in centimetre radar owe a good deal to the klystron in one way or another. Even the development of the magnetron, as invented by Boot and Randall in Birmingham, made a great and significant stride when Sayers applied a measuring technique to it which involved the use of a klystron.

At present, klystrons are virtually supreme in any laboratory which uses microwave techniques. They form the heart of great projects for microwave-transmission systems. They are absolutely essential in any navigation or blind-landing system at microwave frequencies. They form part of all kinds of radar systems. Therefore, a book as authoritative, comprehensive and at the same time as compact, as the one under review must be very welcome to many users and potential users, as well as to designers and investigators, of klystrons all over the world.

The headings of the chapters give a good idea of the ground covered in the treatise: 1. Klystron Construction. 2. Cavity resonators. 3. Electron-bunching theory. 4. Klystron amplifiers. 5. Klystron frequency multipliers. 6. Reflection bunching. 7. Reflex oscillators. 8. Two-resonator oscillators. 9. Multiple resonator tubes, with the sub-headings: oscillator-buffer tubes, cascade-amplifier klystrons, amplifier-multiplier tubes. 10. Modulation of Klystrons, with the sub-headings: frequency modulation, phase modulation, amplitude modulation, pulse modulation, klystron detectors. 11. Klystron tuners. 12. Klystron operation. 13. Klystron power supplies. 14. Microwave measurement techniques, with the sub-headings: Impedance measurement, power measurement, frequency and wavelength measurements, some typical microwave experiments.

There are also a number of valuable klystron design charts, particularly useful to designers of klystrons, and a fairly comprehensive bibliography. Very few references are made in the text, and a minor criticism can be made, namely, that work at places other than at Stanford University and the Sperry Gyroscope Company receives only scant mention.

Though much of the mathematical analysis of bunching, and the theory of the klystron as amplifier, oscillator and frequency multiplier is given in great detail, it is a little unfortunate that the problem of the coupling-out of r.f. power from the bunched-electron beam has not been treated more rigidly, and perhaps a little more convincingly. Also a quantitative treatment of beam loading and space-charge de-bunching would help in enabling a reader new to the subject to form at least an estimate of the order of magnitude of the effects. Designers of klystrons might expect information on the problem of the maximum obtainable beam current and the related electron-optical problems in a book of this kind, perhaps at the cost of the chapter on microwave measurement techniques, which, in my opinion, attempts too much in too short a space. On the other hand, a description of measurements of parameters peculiar to the klystron, such as of the shunt resistance of resonators or of the noise factor of the tube as an amplifier would be apt and welcome in a treatise on the klystron.

It is to be hoped that this book will go through many editions, and that in them the author will deal with the points referred to above.

R.K.

Kettenförmige Ultrakurzwellen-Bandfilter aus Quasistationären Schwingtöpfen

By FRIDOLIN STAUB. Pp. 89 with 43 Figs. Verlag AG. Gebr. Leemann & Co., Zurich. Price 10 francs (Swiss).

This is a doctorate thesis of the Zurich Technischen Hochschule. It deals with the use of cavity resonators in the construction of ultra-short wave band-pass filters. The first 50 pages deal with theory, the remainder with the design, construction and tests of various types of such filters. The filter theory is based on the work of Cauet. Very ingenious arrangements are described in which a number of coupled-cavity resonators are comprised in a single metal cylinder. The frequency employed is about 175 Mc/s and the dimensions of the cavity resonators are such that the conditions may be assumed to be quasi-stationary. The resonators are so enclosed that they do not radiate and they contain no dielectric; they are made of brass or gun-metal, but either coppered or silvered and highly polished on the current-carrying surface. In this way the losses can be kept down to a very low value with the result that very high-class filters can be constructed. The methods of measuring the Q values, bandwidths, etc., are described. This is certainly a valuable addition to the literature of the subject. G. W. O. H.

Radio-Technik, Theorie und Praxis

By Dr. J. DÜRRWANG. Pp. 216 with 168 Figs. B. Wepf & Co., Basel. Price 12 francs (Swiss).

This is the fifth edition; it has been improved and brought up to date by the addition of a chapter on ultra-short waves. It is a non-mathematical book intended for seriously minded amateurs and radio-technicians. It is well written and well illustrated. The eighteen chapters cover the whole field of radio from Ohm's law to Radar, including Television, every item being explained very clearly in an elementary way with the aid of models and diagrams. A pleasing feature is the meticulous care that has been taken with the nomenclature, and symbols, although in some of the diagrams mA becomes Ma. G. W. O. H.

Introducing Radio Receiver Servicing

By E. M. SQUIRE. 2nd Edition. Pp. 144 + vii. Sir Isaac Pitman & Sons, Ltd., Parker Street, Kingsway, London, W.C.2. Price 7s. 6d.

Welding of Plastics

By G. HAIM and H. P. ZADE. Pp. 206 + xv with 58 illustrations. Crosby Lockwood & Son, Ltd., 20, Tudor St., London, E.C.4. Price 21s.

Mainly devoted to the characteristics of plastics and general methods of welding them. Two of the seventeen chapters deal with high-frequency methods.

GRIFFIN & TATLOCK

A new 600-page catalogue, No. 52 AB, of scientific apparatus, has been produced by Griffin & Tatlock of Kemble Street, Kingsway, London, W.C.2. It is intended primarily for use in educational laboratories and it covers apparatus for metrology, mechanics, geophysics, heat, light, sound, magnetism, electricity including atomic physics, microchemistry, physical chemistry and biology.

CORRESPONDENCE

Letters of technical interest are always welcome. In publishing such communications the Editors do not necessarily endorse any technical or general statements which they may contain.

Stabilizing Direct-Voltage Supplies

To the Editor, "Wireless Engineer"

SIR,—Dr. Hughes' article in your August issue will be of little value in my opinion until the voltage of gas-filled regulating valves is both reproducible and permanent to within, say, 0.5 volt or less.

Considering regulating valves commercially available, voltage variations of ± 10 per cent exist between samples of any given type, and the voltage of any valve selected at random may vary between 1 per cent and 10 per cent over the permissible valve current range. The voltage will vary between -10 per cent and $+20$ per cent during 1,000 hours use. Further erratic jumps in voltage occur, and also drifts as valves heat and cool.

The S130 valve, used in Dr. Hughes' tests, is typical of other available valves; its voltage varies between 115 and 135 for new samples, and by between 0 and 10 volts over the normal current range. Thus two valves not specially selected, are not likely to operate from the 250-volt supply used in the tests. The close agreement between his calculated and observed values is because the "calculated" values are based on "observed" characteristics of the two valves used, so that the results only apply to these two valves, and will be in error if the valves are operated for some time.

The simplest solution to this problem is the most useful. The series-resistor value should be obtained from the following information:—(1) minimum supply voltage, (2) maximum valve voltage, (3) maximum load current, and (4) minimum valve current. Then the maximum valve current must be checked under the other extreme condition:—(1) maximum supply voltage, (2) minimum valve voltage, and (3) minimum load current. If the valve is not over-run, the output voltage and the variation of voltage with load are determined by the specified values for the valve.

The method of obtaining the necessary high striking voltage in the presence of load, as described in Section 4 of the article, is ineffective if, while the regulator is working, the load increases momentarily and extinguishes the glow, or if the supply voltage increases relatively slowly when switched on, as in the case of most valve rectifier supplies.

In July 1941 I approached the manufacturer to have a second anode introduced into the S130. The new valve, the CV45, has characteristics similar to those of the S130, though the connection of the auxiliary anode, through a resistor, to at least 190 volts above cathode, ionizes the gas and allows the main anode to strike at the actual running voltage. This eliminates the striking voltage problem as there is generally more than 190 volts across the reservoir capacitor in the power supply. Similar striking anodes have been fitted in valves since developed. Where two or more valves are connected in series, no higher voltage is required as they can be connected so that twice the running voltage is available in each valve, to cause the auxiliary anode to establish the ionizing glow.

In conclusion, it is to be hoped, now that the

causes of the variations in voltage with use, and between samples, are known¹ that British manufacturers will improve their technique and will produce gas filled valves which really are "voltage regulating valves."

WM. H. P. LESLIE.

N. Farnborough, Hants.

¹ Philips Research Reports, Vol. 1.

F. M. Penning and J. H. A. Moubis. "Contraction phenomenon in a neon glow discharge with molybdenum cathode." No. 2, p. 110.

T. Jurriaanse, F. M. Penning, and J. H. A. Moubis. "Normal cathode fall for molybdenum and zirconium in the rare gases." No. 3, p. 225.

T. Jurriaanse. "Influence of gas density and temperature on the normal cathode fall." No. 6, p. 407.

Partially-Screened Open Aerials

To the Editor, "Wireless Engineer"

SIR,—In reply to Señor Colino's letter in the August issue, I wish to state that his picture of the system is consistent with my analysis¹. Some more detailed discussion of the point raised was given in my paper on the screened-loop² where the "inner" and "outer" modes of propagation in a screened system were discussed.

Considering the partially-screened open aerial, we note that equations (1) give for the "inner" mode:

$$\frac{\partial}{\partial x}(v_1 - v_2) = -j\omega(L_{11} - L_{22})i_1$$

and

$$\frac{\partial i_1}{\partial x} = -j\omega C_{11}(v_1 - v_2)$$

showing that the potential difference ($v_1 - v_2$) between the conductors and the current i_1 flowing up the inner conductor and down the inner surface of the screen are exactly as in the coaxial transmission line which they form; this mode is independent of i_2 and of the medium outside the screen.

Similarly we have

$$\frac{\partial}{\partial x}(i_1 + i_2) = -j\omega(C_{22} - C_{11})v_2$$

and

$$\frac{\partial v_2}{\partial x} = -j\omega L_{22}(i_1 + i_2)$$

corresponding to the "outer" anode. The potential v_2 of the screen and the current ($i_1 + i_2$) flowing in the outer surface of the screen are propagated in a manner independently of the conditions within the screen.

Thus the screen supports a current ($-i_1$) flowing on its inner surface and ($i_1 + i_2$) flowing on its outer surface, the resultant i_2 being the quantity which is significant in reception or transmission. If the inner and outer radii of the screen are r_1 and r_0 the effective circulating current of i_1 in the screen neutralizes that portion of the magnetic field of the inner between r_1 and r_0 and so reduces L_{11} by $2 \log(r_0/r_1)$ e.m.u. per cm.

The fact that any break in the screen contributes

to the pick-up of a wave on the inner conductor has been emphasized in both papers^{1,2}.

National Physical Laboratory. R. E. BURGESS.
Teddington, Middx. Radio Division.

¹ R. E. Burgess: "Partially-Screened Open Aerials," *Wireless Engineer*, May 1947, Vol. 24, pp. 145-149.

² R. E. Burgess: "Screened Loop Aerials," *Wireless Engineer*, May 1944, Vol. 24, pp. 210-221.

Single-Phase and Polyphase Filtering Devices Using Modulation

To the Editor, "Wireless Engineer"

SIR,—In your May issue,* Mr. N. F. Barber describes a method of filtering by modulation, solving in a very elegant manner a problem which could hardly be solved in the conventional way. It may be of some interest to note that the proposed arrangement can be regarded, as a whole, as a set of polyphase modulating and filtering devices, while the simpler system referred to in the introduction of the paper as "the simplest process of filtering by modulation," appears as the corresponding single-phase arrangement. The correspondence would be complete if in the case of this simpler process the output of the filter were translated again into the region of the higher frequencies, by means of a second modulation.

It seems to be worth while discussing, from a general point of view, why the more complicated polyphase system is required for solving the proposed problem, and upon this question I cannot fully agree with Mr. Barber's statements. In his paper, the disadvantages arising from using the simpler system are quoted as follows:

- (a) the phase angle of the input voltages is lost;
- (b) voltages having the same frequency as the first modulating voltage can be lost.

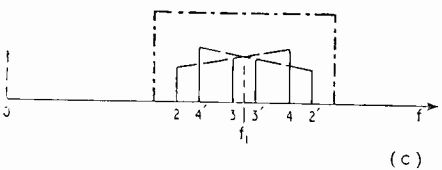
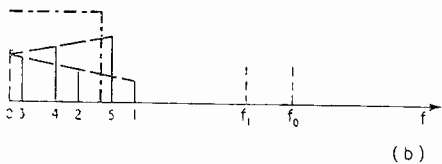
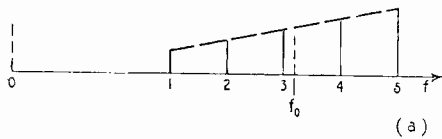

Fig. 1.

The disadvantage quoted under (a) is not connected with the number of phases of the system, but rather with the fact that, by the simpler method, the output voltage has not the same frequency as

* Narrow Band-Pass Filter Using Modulation, Vol. 24, p. 132.

the corresponding input voltage. Hence this limitation has no interest for the present question. One would conclude, therefore, that the only disadvantage arising from the use of a single-phase set would be the one quoted under (b).

I believe it is worth while emphasizing that a more fundamental disadvantage must be taken into account; namely, the fact that, by the single-phase arrangement, the spectrum of the output voltage would be *unavoidably* accompanied by another disturbing spectrum. This can be explained very simply if one regards a polyphase modulator as an algebraic frequency adder. The frequency of

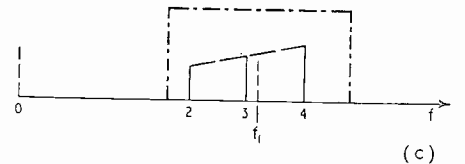
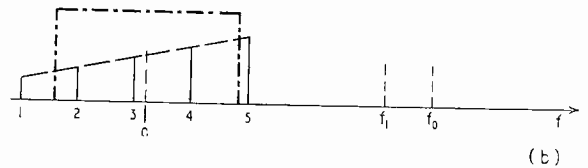
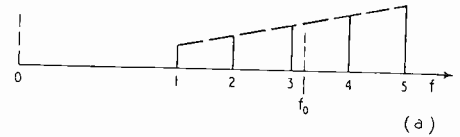

Fig. 2.

the polyphase voltages involved, either input or output, can be regarded as an algebraic quantity and is consequently defined both in value and sign (the sign being related to the sequence). However, the frequency of single-phase voltages can only be defined in value, not in sign.

From this standpoint, the problem involved in Mr. Barber's method can be discussed as follows: a frequency spectrum is translated from the neighbourhood of a frequency f_0 to the neighbourhood of zero frequency. It is here filtered, and then translated again to the neighbourhood of the frequency f_1 (which can eventually be equal to f_0). If this is accomplished by conventional single-phase modulators, then in addition to the disadvantages pointed out by Mr. Barber, the lines of the original spectrum [Fig. 1(a)], which lie on opposite sides of the first modulating frequency f_0 , are treated by the first modulation exactly in the same manner [Fig. 1(b)], and then, by the second modulation, added to and subtracted from the second modulating frequency f_1 [Fig. 1(c)]. The output spectrum is, therefore, accompanied by its mirror image with respect to f_1 .

Now suppose that one of the inputs of the first modulator is polyphase, and that the same holds for its output. In this case, the lines of the original spectrum lying on opposite sides of the first modulating frequency f_0 , [Fig. 2(a)] give, by the first modulation, polyphase voltages of opposite sequence, which can be regarded as voltages of opposite

frequency, and therefore represented by lines which lie on opposite sides of the zero frequency [Fig. 2(b)].

Suppose furthermore that both inputs of the second modulator are polyphase. Then the frequencies of the spectrum Fig. 2(b) are added to, or subtracted from, the second modulating frequency f_1 , according to their sign (i.e., to the sequence of the corresponding voltages) and so the lines of the final spectrum receive their proper allocation [Fig. 2(c)].

It can be concluded, therefore, that the necessity for employing the more elaborate polyphase system is by no means a casual one, but is strictly connected with the general features of polyphase and single-phase systems. Thus Mr. Barber's paper appears to be an excellent example of a comparison of the general performances to be expected from these two types of arrangements. It is obvious that the same results could be predicted, in any particular case, without introducing the conception of polyphase modulating systems, by merely analysing the assembly of single-phase modulators. The analytical treatment is, moreover, of invaluable help in studying the details of the set, the causes of errors and so on. I chose, however, the more synthetic treatment using the conception of polyphase systems, because of its power in predicting, in accordance with general rules, what can be done with a certain device, and what cannot.

G. B. MADELLA.

Instituto Elettrotecnico Nazionale Galileo
Ferraris Torino, Italy.

Degrees for Ex-Servicemen

To the Editor, "Wireless Engineer"

SIR,—With regard to my previous correspondence in connection with Degree Courses for ex-servicemen and those engaged in industry, the results of the enquiry have been sent to the Ministry of Education, who have handled the matter sympathetically. They are communicating with the local Councils concerned with a view to providing classes at times more convenient for those members of the staff of firms who cannot be released for day-time attendance, except on Saturday mornings. It must be realized, however, that the final responsibility for the organization of courses rests with the individual teaching establishments.

It is hoped that suitable arrangements can be made in time for the forthcoming winter sessions but it is regretted that it is only in certain parts of the country that the numbers of applications are sufficient to permit any action to be taken.

I would like to thank those who have helped by filling in my questionnaires and to apologise for being able to assist only a portion of them to obtain suitable courses.

O. S. PUCKLE,

Langley Park,
Nr. Slough, Bucks.

R.F. Equipment, Ltd.

WIRELESS PATENTS

A Summary of Recently Accepted Specifications

The following abstracts are prepared, with the permission of the Controller of H.M. Stationery Office, from Specifications obtainable at the Patent Office, 25, Southampton Buildings, London, W.C.2, price 1/- each.

ACOUSTICS AND AUDIO-FREQUENCY CIRCUITS AND APPARATUS

582 942.—L.F. selective relay in which the control signals are applied to two cold-cathode tubes, one of which responds to the beginning, and the other to the end of the signal-train.

Standard Telephones and Cables Ltd., F. H. Bray and L. R. Brown. Application date 11th February, 1944.

583 808.—Remote-control switching system for selecting one of several broadcast items distributed over a telephone network.

G. F. Wittgenstein. Application date 13th July, 1943.

584 354.—Thermo-plastic spider for centring the moving coils of a loudspeaker.

H. C. Willson. Application date 8th December, 1945.

AERIAL AND AERIAL SYSTEMS

583 496.—Aerial comprising resonant transmission-line elements the overall length of which is only one-fifth the operating wavelength, particularly for use on aircraft.

Standard Telephones and Cables Ltd. and E. O. Willoughby. Application date 21st April, 1944.

584 900.—Flexible streamlined aerial, comprising two wires or strips, for the roof of a motor-car.

E. St. J. Chesney. Application date 5th February, 1945.

DIRECTIONAL AND NAVIGATIONAL SYSTEMS

583 758.—Mechanical switching arrangement for reversing the aerial and indicator connections in an automatic direction-finder.

F. Tench (communicated by Automatic Electric Laboratories Inc.). Application date 30th November 1944.

583 787.—Blind-landing system in which an extended aerial system for defining the glide-path is combined with radiolocation equipment for indicating the point-to-point elevation of the aeroplane.

Marconi's W.T. Co. Ltd. and S. W. H. W. Falloon. Application date 5th October, 1939.

583 792.—Logarithmically-graded potentiometer for centring the echo-signal on the time-base of a radiolocation set, and so giving a direct indication of the range of the target under observation.

J. D. Cockcroft and J. W. Pletts. Application date 5th June, 1942.

583 996.—Stabilizing a multivibrator as used for gating or selecting a particular pulse-train from other trains, as in radiolocation equipment.

Standard Telephones and Cables Ltd. and C. W. Earp. Application date 15th September, 1944.

584 046.—Modulation circuit for navigational beacons of the kind in which one of the aerials is energized by sideband energy only.

Standard Telephones and Cables Ltd. (assignees of A. Alford and G. K. Paterson). Convention date (U.S.A.) 15th November, 1943.

RECEIVING CIRCUITS AND APPARATUS

584 082.—Cathode-follower circuit used as a phase-shifter, particularly for feeding signals of opposite polarity to the deflecting plates of a c.r. indicating tube.

Standard Telephones and Cables Ltd., (assignees of H. E. Beste). Convention date (U.S.A.) 6th December, 1943.

584 181.—Circuit design and operating conditions for increasing the overall gain of a transducer or power-amplifier using valves of the tetrode type.

B. M. Hadfield. Application date 15th December, 1944

584 191.—Phase-inverting bridge-circuit, particularly for coupling an unbalanced amplifier to a balanced push-pull stage.

Marconi's W. T. Co. Ltd., (assignees of H. W. Berry). Convention date (U.S.A.) 27th July, 1943.

584 218.—Automatic gain-control system in which regulation is effected by varying the heating current, and therefore the cathode-emission and effective impedance, of a valve.

Siemens Bros. & Co. Ltd., and J. H. Mole. Application date 15th December, 1944.

584 599.—Releasable stop-device for a slow-motion tuning-control to facilitate readjustment to a selected position, and to offset backlash.

H. S. Hall and Pye Ltd. Application date 9th January, 1945.

TRANSMITTING CIRCUITS AND APPARATUS

584 249.—Device for measuring the field-intensity inside a waveguide in terms of the angular displacement of a suspended disc.

E. C. Cork. Application date 25th September, 1941.

584 444.—H.F. impedance-matching transformer in which quarter-wave transmission-line elements are used to offset changes in the mean operating frequency.

J. Collard. Application date 3rd June, 1944.

584 465.—Frequency-modulating system in which the resonance of a crystal-oscillator is controlled by a variable-reactance valve.

Western Electric Co. Inc. Convention date (U.S.A.) 16th September, 1943.

584 642.—Radio-telegraphy transmitter in which the two valves of a multivibrator circuit are alternately blocked and unblocked to generate square-shaped signalling pulses.

Standard Telephones and Cables Ltd., M. M. Levy and E. A. Rattue. Application date 15th January, 1945.

584 942.—Arrangement of a discharge-tube for switching or attenuating the energy flowing in a waveguide.

G. E. F. Fertel and C. S. Wright. Application date 7th June, 1944.

SIGNALLING SYSTEMS OF DISTINCTIVE TYPE

584 427.—Pulsed carrier-wave system with synchronized control for producing stereophonic effects.

C. J. Carter and Pye Ltd. Application date 23rd February, 1943.

584 457.—Synchronizing system for multichannel communication on time-modulated pulsed signals.

Standard Telephones and Cables Ltd. (assignees of E. M. Deloraine and N. H. Young). Convention date (U.S.A.) 29th September, 1943.

584 513.—Two-way short-wave set on which a fraction of the transmitted wave is used to heterodyne the incoming signal through an adjustable aerial coupling.

"Patelhold" Patentverwertungs etc. A.G. Convention date (Switzerland) 26th July, 1943.

584 726.—Combined pulse transmitter and receiver, in which a radio-frequency circuit and a quench-frequency circuit are both operated by the same valve.

Marconi's W.T. Co. Ltd., N. M. Rust, G. E. Partington, D. L. Plaistowe and D. J. Fewings. Application date 4th February, 1941.

584 729.—Multichannel signalling system utilizing variable-width and fixed-amplitude pulses, with "stroboscopic" switching or synchronizing pulses.

W. A. S. Butement and A. J. H. Oxford. Application date 4th December, 1942.

584 733.—Variable-width pulsed signalling system, on which calling or supervisory signals are superposed by the deliberate suppression of selected pulses.

J. G. Macmillan and Z. Jelonek. Application date 7th September, 1943.

SUBSIDIARY APPARATUS AND MATERIALS

584 072.—Piezo-electric crystal resiliently mounted at the opposite ends of a nodal line of oscillation.

The British Thomson-Houston Co. Ltd. (communicated by the General Electric Co.). Application date 27th October, 1944.

584 088.—Piezo-electric crystal with a mounting which is adjustable, resilient and free from damping.

Standard Telephones and Cables Ltd. (assignees of S. A. Bokovoy and K. K. Garrison). Convention date (U.S.A.) 6th December, 1943.

584 315.—Glass-wool cover or flexible envelope for holding a thermionic valve in its socket.

D. R. Gamlen and J. Buckingham. Application date 2nd May, 1944.

584 329.—Multivibrator type of circuit in which a square-shaped wave triggers a cycle of operations through a step-by-step reduction of the anode voltage, suitable for counting operations or as a frequency-divider.

F. C. Williams. Application date 1st September, 1944.

ABSTRACTS AND REFERENCES

Compiled by the Radio Research Board and published by arrangement with the Department of Scientific and Industrial Research

The abstracts are classified in accordance with the Universal Decimal Classification. They are arranged within broad subject sections in the order of the U.D.C. numbers, except that notices of book reviews are placed at the ends of the sections. The abbreviations of the titles of journals are taken from the World List of Scientific Periodicals. Titles that do not appear in this List are abbreviated in a style conforming to the World List practice.

	PAGE
Acoustics and Audio Frequencies	217
Materials and Transmission Lines	218
Circuits and Circuit Elements	219
General Physics	222
Biophysical and Extraterrestrial Phenomena	223
Detection and Aids to Navigation	225
Materials and Subsidiary Techniques	226
Mathematics	227
Measurements and Test Gear	228
Practical Applications of Radio and Electronics	229
Propagation of Waves	232
Reception	233
Systems and Communication Systems	234
Subsidiary Apparatus	235
Television and Phototelegraphy	235
Transmission	237
Vacuum Tubes and Thermionics	237
Miscellaneous	239

Sound absorbers are described whose high efficiency depends upon the shape and the fact that the absorbers are not required also to act as building material.

534.851 3006
The Reduction of Background Noise in the Reproduction of Music from Records.—H. H. Scott. (*Proc. nat. Electronics Conference, Chicago*, Vol. 2, pp. 586-596.)

534.86 : 534.322.1 3007
Experiments in Listening.—N. D. Webster & F. C. McPeak. (*Electronics*, April 1947, Vol. 20, No. 4, pp. 90-95.) Audience reaction to reproduced music, from both live and transcribed sources, is tested with a high-quality audio system.

534.861.1 3008
Acoustical Design of Studios for A.M. and F.M.—C. R. Jacobs. (*Tele-Tech*, June 1947, Vol. 6, No. 6, pp. 46-50.) Details of the lay-out and construction of the New York WNEW studios, with particulars of the insulation of floors, walls, ceilings, windows and doors. To minimize background noise, the air-conditioning system is lined throughout with rigid rockwool material 1 inch thick. A feature of the inner lining of the studios is that no large area of any one type of absorbing material is used. Five different types are used in combination with serrated and curved plywood and plaster areas.

ACOUSTICS AND AUDIO FREQUENCIES

621.42 : 621.38 3001
A Method for Changing the Frequency of a Complex Wave.—Kent. (See 3048.)

621.62 : 621.396.001.42 3002
The Silent Room of the National Centre for the Study of Telecommunication.—P. Chavasse. (*C. R. Acad. Sci., Paris*, 12th May 1947, Vol. 224, No. 1, pp. 1341-1343.) A special arrangement of absorbing screens enables waves to be obtained which, in a test-space of 1.5 m³, are uniform to within ± 1 db for all frequencies from 200 to 2000 c/s.

621.756 3003
Acoustical Quanta and the Theory of Hearing.—A. Gabor. (*Nature, Lond.*, 3rd May 1947, Vol. 159, No. 3944, pp. 591-594.) A summary of the first parts of 1057 of April with emphasis on the physical and physiological aspects of the problem.

621.78 : [621.396.619.11/.13 3004
Narrow-Band F.M. for Voice Communication.—M. S. Atwood. (See 3275.)

621.845 3005
Functional Sound Absorbers.—H. F. Olson. (*ASA Rev.*, Dec. 1946, Vol. 7, No. 4, pp. 503-521.)

534.861.1 3009
Audio Problems in A.M. Broadcasting.—H. L. Blatterman. (*Communications*, April 1947, Vol. 27, No. 4, pp. 18-21.51.) The subjective effect of a given broadcast depends not only on the characteristics of the electrical circuits between studio and home, but also on the reverberation introduced. An equipment interposed between the studio microphone and the transmitter is described which gives a controllable amount of reverberation.

The variation in high frequency transmission with the diameter of the playing groove in a disk recording may be compensated electrically. An arrangement for achieving this is described.

534.862.1 3010
Recording Studio 3A.—G. M. Nixon. (*RCA Rev.*, Dec. 1946, Vol. 7, No. 4, pp. 634-640.) The acoustical design problems encountered in remodeling a studio for recording both broadcast transcriptions and records for home use are discussed and some methods of solution given.

621.395.625

Lateral Recording: Part 2.—W. H. Robinson. (*Communications*, April 1947, Vol. 27, No. 4, pp. 38-40, 58.) Discussion of cutter measurement technique, frequency run recordings, styli, cutting angles, disks, scratch filters and pre-emphasis. To be continued. For part 1 see 1993 of July.

3011

621.392.029.64 : 549.623.5

Mica Windows as Elements in Microwave Systems.—L. Malter, R. L. Jepsen & L. R. Bloom. (*RCA Rev.*, Dec. 1946, Vol. 7, No. 4, pp. 622-633.) "The design of a virtually reflectionless, vacuum-tight window made of mica for use in a waveguide system is described. The technique of manufacture and the experimental results with a number of models are given. Such mica windows have many applications but are particularly useful for the transmission of microwave power or electromagnetic radiation in particular portions of the spectrum."

3021

621.395.625.2

Embossing Type Sound Recorder.—(*Tele-Tech*, June 1947, Vol. 6, No. 6, p. 55.) Uses Vyniled disks of diameter $3\frac{3}{4}$ inches. These have a moulded guide groove, with 350 lines to the inch, on the underside and a sound groove is embossed on the smooth upper surface by a recording stylus which also serves for reproduction.

3012

621.392.21 : 621.315.1 + 621.396.664] : 621.396.712

The Design and Use of Radio-Frequency Open-Wire Transmission-Lines and Switchgear for Broadcasting Systems.—F. C. McLean & F. D. Bolt (*J. Instn elect. Engrs*, Part III, May 1947, Vol. 94, No. 29, pp. 216-217.) Discussion on 2139 of 1946.

3022

621.395.625.2 : 016 "1921/1947"

Bibliography of Disc Recording.—A. Jorysz. (*Tele-Tech*, June 1947, Vol. 6, No. 6, pp. 73-77, 104.) From 1921 to 1947, with brief summaries.

3013

621.395.625.3

Recent Developments in Magnetic Recording of Sound.—R. B. Vaile, Jr. (*Proc. nat. Electronics Conference, Chicago*, Vol. 2, pp. 597-602.)

3014

AERIALS AND TRANSMISSION LINES

621.315.211.9 : 621.315.616.1

Making Rubber Cables.—(*Elect. Rev., Lond.*, 22nd Aug. 1947, Vol. 141, No. 3639, pp. 278-283.) A description of the essential processes.

3015

621.315.212 : 621.317.73.029.63

Comparator for Coaxial Line Adjustments.—O. M. Woodward, Jr. (*Electronics*, April 1947, Vol. 20, No. 4, pp. 116-120.) The instrument, consisting of a T-junction and rotating loop coupling to the lines, can be used in place of a slotted line and probe to measure standing-wave ratios and load impedances at u.h.f.

3016

621.315.212 : 621.317.79

A Standing-Wave Meter for Coaxial Lines.—Pattison, Morris & Smith. (See 3196.)

3017

621.315.212.029.6 : [621.317.333 + 621.317.37

The Voltage Characteristics of Polythene Cables.—Davis, Austen & Jackson. (See 3179.)

3018

621.392 : 621.317.79

The Theory and Design of Several Types of Wave Selectors.—N. I. Korman. (*Proc. nat. Electronics Conference, Chicago*, Vol. 2, pp. 404-423.) Wave selectors are devices which, when attached to a transmission line or waveguide, set up in another system a response proportional to either the forward or the backward travelling wave in the line or guide. Lumped-constant and distributed-constant wave selectors for frequencies lower and higher than 1000 Mc/s respectively are described, with methods of adjustment.

3019

621.396.67 : 621.396.97

Theoretical and Practical Aspects of F.M. Broadcast Antenna Design.—P. H. Smith. (*Communications*, March 1947, Vol. 27, No. 3, pp. 14-15.) Summary of 1947 I.R.E. Convention paper.

3027

621.396.67 : 621.397.5

Load Characteristics of Television Antenna Systems: Part 3.—Hamilton & Olsen. (See 3303.)

3028

621.392.029.64

Wave Guides for Slow Waves.—L. Brillouin. (*Phys. Rev.*, 1st April 1947, Vol. 71, No. 7, p. 483.) Summary of Amer. Phys. Soc. paper. Pipes fitted with equidistant diaphragms, which behave as band-pass filters, show a very marked variation of phase velocity with respect to frequency.

3020

621.396.67 : 621.397.5

Television Antenna Installations giving Multiple Receiver Outlets.—R. J. Ehret. (*Tele-Tech*, June 1947, Vol. 6, No. 6, pp. 26-29, 100.) A distribution system, for hotel use, with a single aerial. Three or six receivers are fed through 300- Ω lines without interference.

3029

- 621.396.674 : 621.396.712 : 621.396.619.13
Loop Antennas for F.M. Broadcasting : Part 1.—
 Marchand. (*Communications*, April 1947,
 Vol. 27, No. 4, pp. 34-35..63.) Discussion of aerial
 requirements for f.m., with particular reference to
 loop type aerials. To be continued.
- 621.396.676
Aircraft Antenna Pattern Measuring System.—
 Schmitt. (*Proc. nat. Electronics Conference*,
 Chicago, Vol. 2, p. 132.) Summary only. A system
 drawing automatically the radiation patterns of
 aircraft aerials by use of scale models. See also
 621.396.677
- 621.396.677
Directional Patterns with a 54A Array.—H. R.
 Maley. (*Radio News*, April 1947, Vol. 37, No. 4,
 pp. 53, 143.) Directional aerial arrays are described,
 using as elements standard single aerials whose
 horizontal radiation pattern is circular.
- 621.396.677
Helical Beam Antenna.—J. D. Kraus. (*Electronics*,
 April 1947, Vol. 20, No. 4, pp. 109-111.)
 A special mode of operation gives circular polarization,
 and a readily controlled directivity and gain. Aerial
 dimensions are given for λ 10 cm.
- 621.396.677
Long Slot Antennas.—A. Alford. (*Proc. nat. Electronics Conference*,
 Chicago, Vol. 2, pp. 143-155.)
 An account of aerials with slot as long as possible
 to which metal wings are added to control the
 radiation pattern in the plane perpendicular to the
 slot, and of the use of arrays of such aerials to obtain
 directivity.
- 621.396.96 : 621.396.82
**Theory of Radar Reflection from Wires or Thin
 Metallic Strips.**—J. H. Van Vleck, F. Bloch &
 Hamermesh. (*J. appl. Phys.*, March 1947,
 Vol. 18, No. 3, pp. 274-294.) The radar reflecting
 properties of wires and thin metallic strips are
 analysed mathematically by two independent
 methods. The efficiency of a reflector is expressed
 in terms of the concept of 'radar cross-section', defined as
 the power per unit solid angle returned in the
 direction of the source divided by the incident
 wave density. This quantity, when expressed in
 terms of area equal to the square of the wavelength,
 depends only on the ratios of the length of the wire
 to the diameter and to the wavelength. For several
 values of diameter in random orientation an averaged 'radar
 cross-section' is calculated which is small when the
 wavelength is longer than the wire and passes
 through maxima when the wire is slightly less than
 an integral number of half wavelengths long. The
 ratio of maxima to minima decreases and their
 magnitude increases as the number of wavelengths
 in the wire increases. The values of the minima
 increase with the thickness of the wire. See also
 621.396.96 (Bloch, Hamermesh & Phillips).
- CIRCUITS AND CIRCUIT ELEMENTS**
- 621.396.694 : [621.385.029.63/.64
**the Helix Circuit used in Progressive-Wave
 Tubes.**—É. Roubine. (*Onde élect.*, May 1947,
 Vol. 7, No. 242, pp. 203-208.) A complete account
 of the work referred to in 2339 and 2340 of August.
- 621.314.2.029.5 : 621.396.69
Very-Wide Band Radio-Frequency Transformers.
 —D. Maurice & R. H. Minns. (*Wireless Engr*, June
 & July 1947, Vol. 24, Nos. 285 & 286, pp. 168-177 &
 209-216.) Toroidal transformers may be used for
 impedance matching, balanced-unbalanced coupling,
 d.c. isolation and the provision of accurate voltage
 or current ratios. The equivalent circuit of the
 2-winding transformer is used to deduce the i.f.
 loss; the winding data for 2-db loss are shown
 graphically for various commercial cores (dust and
 alloy-strip). The leakage inductance and shunt
 capacitance for various forms of winding are
 evaluated; their effect on the h.f. performance is
 minimized by a low-pass filter design technique.
 Multi-winding and auto-transformers are briefly
 discussed; balance and its measurement are
 described. The design procedure is illustrated by a
 numerical example.
- 621.314.23 : 621.396.69
Practical Transformer Design and Construction :
Part 1.—C. Roeschke. (*Radio News*, June 1947,
 Vol. 37, No. 6, pp. 60-61..165.) Simple method
 of calculating winding data from graphs and tables.
- 621.314.26 : 629.135
Electronic Frequency Changers for Aircraft.—
 O. E. Bowlus & P. T. Nims. (*Elect. Engng, N.Y.*,
 May 1947, Vol. 66, No. 5, pp. 463-466.) The
 frequency changer incorporates two distinct circuits :
 (a) power circuit for frequency conversion, and
 (b) control circuit to establish output frequency.
 Design and performance details of an experimental
 test unit are given. By using a similar unit with
 each alternator, several main aircraft engine-driven
 alternators can be operated in parallel.
- 621.314.671
**Circuit Cushioning of Gas-Filled Grid-Controlled
 Rectifiers.**—D. V. Edwards & E. K. Smith. (*Trans.*
Amer. Inst. elect. Engrs, December Supplement
 1946, Vol. 65, p. 1131.) Discussion on 361 of
 February.
- 621.315.2.011.3
The Inductance of Wires and Tubes.—A. H. M.
 Arnold. (*J. Instn elect. Engrs*, Part 1, Feb. 1947,
 Vol. 94, No. 74, pp. 116-118.) Summary of 1017
 of April.
- 621.316.313.025
A New Design for the A.C. Network Analyzer.—
 J. D. Ryder & W. B. Boast. (*Trans. Amer. Inst.*
elect. Engrs, December Supplement 1946, Vol. 65,
 pp. 1162-1165.) Discussion on 362 of February.
- 621.316.726.029.64.078.3
Microwave Frequency Stability.—Harrison. (See
 3321.)
- 621.316.86
Thermistors.—W. Rosenberg. (*Electronic Engng*,
 June 1947, Vol. 19, No. 232, pp. 185-187.) Discus-
 sion of characteristics and applications, including
 methods of use with ohmic resistors in amplifiers
 and oscillators.
- 621.318.323.2.042.15
Permeability of Dust Cores.—Friedlaender. (See
 3163.)

- 621.318.371.011.2/.4 **3046**
Q of Solenoid Coils.—M. V. Callendar. (*Wireless Engr.*, June 1947, Vol. 24, No. 285, p. 185.) Within the limits of Medhurst's data (1694 of June) $Q = 0.15\sqrt{f}/(1/R + 1/l)$ is accurate within a few per cent provided $l > R$.
- 621.318.572 : 621.396.615.015.33 **3047**
Electronic Switch for the Production of Pulses.—C. R. Smitley & R. E. Graber. (*Electronics*, April 1947, Vol. 20, No. 4, pp. 128-130.) A circuit providing variable pulse length and rate, variable delay of synchronizing pip and means for introducing a steady-state signal upon which pulses may be superimposed, in a laboratory generator.
- 621.38 : 534.42 **3048**
A Method for Changing the Frequency of a Complex Wave.—E. L. Kent. (*Proc. nat. Electronics Conference, Chicago*, Vol. 2, pp. 329-338.) A method retaining essentially the original waveform. Variants are obtained by different sampling procedures.
- 621.392.1 **3049**
On Methods for the Construction of Networks Dual to Non-Planar Networks.—A. Bloch. (*Proc. phys. Soc.*, 1st Nov. 1946, Vol. 58, No. 330, pp. 677-694.) A network having a non-planar circuit diagram (i.e. one with crossings between some of its branches) cannot be converted into its dual counterpart directly, but must first be converted to an equivalent planar network. The paper describes a number of methods for determining the equivalent planar network.
- 621.395.661 **3050**
Mica Capacitors for Carrier Telephone Systems.—A. J. Christopher & J. A. Kater. (*Trans. Amer. Inst. elect. Engrs.*, December Supplement 1946, Vol. 65, pp. 1116-1117.) Discussion on 374 of February.
- 621.396.611.4 + 621.385.1 **3051**
F.M./TV P-A Tube and Grounded-Grid Cavity Circuit.—Wells & Reed. (See 3337.)
- 621.396.615 **3052**
Non-Linear Regenerative Circuits.—D. G. Tucker. (*Wireless Engr.*, June 1947, Vol. 24, No. 285, pp. 178-184.) Analysis and curves for the frequency and amplitude discrimination of the synchronized oscillator with an unwanted signal mixed with the injected locking tone. Some discrimination occurs over the whole frequency range, and within limits a relatively pure tone can be obtained from a signal having other frequencies mixed with it that cannot be separated by ordinary frequency-selective circuits.
 The experimental results of Byard & Eccles (750 of 1941) are shown to be consistent with the theory given.
- 621.396.615 : 371.66 **3053**
A Demonstration Valve Oscillator.—E. Bradshaw. (*Electronic Engng.*, May 1947, Vol. 19, No. 231, pp. 162-163.) Meters in all parts of the circuit facilitate study of operating conditions of tuned-anode oscillator.
- 621.396.615.015.33 + 621.396.619.16 **3054**
Some Notes on Pulse Technique.—M. M. Levy. (*J. Brit. Instn Radio Engrs.*, May/June 1947, Vol. 7, No. 3, pp. 99-116.) The transmission of pulses through ideal filters and delay lines is discussed in detail and practical formulae are given for the design of delay networks. The use of pulsed valves is considered together with methods of obtaining high efficiency in practical circuits for power pulse generators. Pulse modulation and demodulation processes are studied, with particular reference to the choice of conveniently shaped pulses, in order to simplify the circuit design and eliminate harmonic distortion.
- 621.396.615.12 : 621.396.619.13 **3055**
Frequency Modulation of High-Frequency Power Oscillators.—W. R. Rambo. (*Proc. nat. Electronics Conference, Chicago*, Vol. 2, pp. 577-585.) An account with particular reference to common-grid reactance-valve circuits and to class-C operation of reactance valves.
- 621.396.615.14 **3056**
Study of a V.H.F. Oscillator.—L. Liot. (*Télévis. franç.*, April 1947, No. 24, Supplement *Électronique*, pp. 11-14.) A detailed description of a symmetrical arrangement using two 955 valves with $\lambda/4$ lines feeding the anodes and between the cathodes and earth. Short-circuiting bars across these lines give wavelength adjustment from 0.7 m to 2 m.
- 621.396.615.142 : 621.396.621.54 : 621.396.96 **3057**
Reflex Oscillators for Radar Systems.—J. O. McNally & W. G. Shepherd. (*Proc. nat. Electronics Conference, Chicago*, Vol. 2, p. 157.) Summary only. Design problems for oscillators for military radar receivers.
- 621.396.615.142.2 **3058**
Design of Wide-Range Coaxial-Cavity Oscillators using Reflex Klystron Tubes in the 1 000 to 11 000 Megacycle Frequency Region.—J. W. Kearney. (*Proc. nat. Electronics Conference, Chicago*, Vol. 2, pp. 624-636.) The design of an external-resonator type of reflex klystron oscillator, for use in standard signal generators and superheterodyne receivers. The tuning range is about 2:1 in frequency. Details of operation, and methods of adaptation of present day valves for use as coaxial resonators are given. Design characteristics are outlined for (a) optimum cavity dimensions, (b) suitable contacts to the valves, (c) non-contact, short circuiting tuning plungers, (d) output coupling devices. The factors involved in the choice of cavity and repeller modes, and precautions for the suppression of interference from undesirable modes, are discussed in some detail.
- 621.396.619 **3059**
Selective Demodulation.—D. B. Harris. (*Proc. Inst. Radio Engrs, W. & E.*, June 1947, Vol. 35, No. 6, pp. 565-572.) When an amplitude-modulated carrier f , together with other modulated carriers on frequencies harmonically related to f , is multiplied by the instantaneous value of a plain carrier whose frequency and phase are identical with f , only the modulation component of f appears in the output. The modulation components of two carriers in phase quadrature on the same frequency may be separated similarly. A suitable linear multiplicative pentagrid demodulator is described. The advantages and disadvantages of a system using these principles for multichannel carrier working are discussed, and a design for a hypothetical 8-channel system is outlined.

- 621.396.622
F.M. Detector Systems.—B. D. Loughlin. (*Communications*, March 1947, Vol. 27, No. 3, p. 18.) Summary of 1947 I.R.E. Convention paper.
- 621.396.622
A New Detector for Frequency Modulation.—Bradley. (See 3264.)
- 621.396/.397].645
Bandwidth and Speed of Build-Up as Performance Criteria for Pulse and Television Amplifiers.—D. G. Tucker. (*J. Instn elect. Engrs*, Part III, May 1947, Vol. 94, No. 29, pp. 218-226.) "A comparison is made of the two main methods of describing the performance of pulse and television amplifiers, namely bandwidth, and speed of build-up of a suddenly-applied signal. It is shown for a variety of circuit arrangements (including asymmetrical circuits) that equal speeds of build-up based on the slope of the build-up curve at half the steady-state amplitude correspond fairly closely to equal bandwidths measured between the points at which the response is 3 db below that at the applied frequency. It is therefore concluded that either of these criteria would be satisfactory in practice, since they are mutually consistent. Other methods of defining the speed of build-up are discussed, and the main inconsistency is shown to be that, for only one or two stages, but not for larger numbers, the use of the maximum slope of the build-up curve gives misleading results."
- 621.396.645
Stabilised Amplifiers.—J. J. Zaalberg van Zelst. (*Philips tech. Rev.*, Jan. 1947, Vol. 9, No. 1, pp. 25-32.) Two groups of circuits are discussed. The first adds a compensating quantity to the input or output signal of the main amplifier and uses either a negative feedback circuit or an auxiliary amplifier. The second group uses an auxiliary alternating voltage, generated either outside or inside the amplifier and passed through the same circuit as the main signal to keep the slope of the amplifying curve constant.
- 621.396.645
Input Admittance of Cathode-Follower Amplifiers.—H. J. Reich. (*Proc. Inst. Radio Engrs, W. & E.*, June 1947, Vol. 35, No. 6, pp. 573-576.) General expressions are derived, taking the valve inter-electrode capacitances into account, and curves of admittance and susceptance for typical valve constants are given. It is shown that capacitance across the cathode load resistance can produce a negative input conductance, and oscillations may result. Means of preventing such oscillations are discussed.
- 621.396.645 : 518.3
Exact Design and Analysis of Double- and Triple-tuned Band-Pass Amplifiers.—M. Dishal. (*Proc. Inst. Radio Engrs, W. & E.*, June 1947, Vol. 35, No. 6, pp. 606-626.) Nomograms for designing double- and triple-tuned coupled circuits to achieve desired bandwidth, gain, skirt-rejection, and phase-change characteristics are developed from conventional theory. Both inductive and capacitive coupling are considered. The work is extended to cover multiple-tuned band-pass amplifiers.
- 621.396.645 : 518.4
Graphical Analysis of the Cathode-Coupled Amplifier.—M. S. Rifkin. (*Communications*, Dec. 1946, Vol. 26, No. 12, pp. 16-43.)
- 3060
621.396.645.029.6 + 621.396.621.54.029.6
Gain and Sensitivity of Amplifier and Frequency-Changer Stages for Metre and Decimetre Waves.—M. J. O. Strutt. (*Onde élect.*, May 1947, Vol. 27, No. 242, pp. 184-193.) Methods are given for estimating the optimum gain for both narrow and wide frequency bands. For narrow bandwidths the optimum gain is equal to the square of the effective slope divided by the product of the effective input and output admittances. For wide bands the admittance product must be replaced by that of the input and output capacitances. The power gain of amplifiers with grid coupling is treated in detail. Three important properties of the noise factor are stated; these form a basis for applications which enable the noise factor to be reduced considerably, especially in the case of grid-coupling stages and multi-grid frequency changers.
- 3061
621.396/.397].645.029.62
Wide-Band I.F. Amplifier above 100 Mc/s.—M. T. Lebenbaum. (*Communications*, Dec. 1946, Vol. 26, No. 12, pp. 25, 50.) Summary of Rochester Fall Meeting paper. A brief outline of the general features and design considerations. The advantages of staggered tuning and the effect of grid-anode capacitance are discussed. For the full paper see *Electronics*, April 1947, Vol. 20, No. 4, pp. 138-141.
- 3066
621.396.645.029.62
A Compact Lightweight Amplifier for Radar.—P. L. Hammann. (*Bell Lab. Rec.*, April 1947, Vol. 25, No. 4, pp. 146-149.) Design and construction details of the 6AK5 amplifier used in AN/AP5-4 radar equipment and in the Bat radar-directed bomb.
- 3070
621.396.645.029.62.076.2
A Permeability-Tuned 100-Mc/s Amplifier of Specialized Coil Design.—Z. Benin. (*Proc. nat. Electronics Conference, Chicago*, Vol. 2, pp. 548-556.) Suitable spacing of coil turns and choice of core and coil lengths reduces frequency drift and makes trimmer capacitors unnecessary.
- 3071
621.396.645.371.029.4
The Parallel-T Bridge Amplifier.—A. B. Hillan. (*J. Instn elect. Engrs*, Part I, April 1947, Vol. 94, No. 76, pp. 188-189.) Summary of 2051 of July.
- 3072
621.396.662
The Design of Band-Spread Tuned Circuits for Broadcast Receivers.—D. H. Hughes. (*J. Instn elect. Engrs*, Part III, May 1947, Vol. 94, No. 29, p. 227.) Discussion on 1803 of 1946.
- 3073
621.396.662.2 : 621.397.62
Variable Inductance Tuning for TV Receivers.—M. F. Melvin. (*Communications*, April 1947, Vol. 27, No. 4, pp. 48-49, 63.) Description of a 3-gang tuning unit and its application in a television receiver covering the frequency range 44-216 Mc/s. Methods of adjusting the design to provide tracking and suitable bandwidths are described.
- 3074
621.396.662.3
The Design of Resonant Filters.—S. Y. White. (*Tele-Tech*, June 1947, Vol. 6, No. 6, pp. 56-57.) Discussion of pendulum analogy results in tuned filter with rapid rise, immunity from shock excitation and complete cut-off at 7% off resonance.

- 621.396.662.3 : 534.12 **3075**
Compact Electromechanical Filter.—R. Adler. (*Electronics*, April 1947, Vol. 20, No. 4, pp. 100-105.) The design and performance of a transmission-line type of filter consisting of a number of steel plates interconnected by steel wires. A model for a 455-kc/s i.f. channel is described.
- 621.396.662.34 : 621.396.645.37 **3076**
RC Bandpass Filter Design.—J. L. Powers. (*Electronics*, April 1947, Vol. 20, No. 4, pp. 131-133.) Design curves and applications to i.f. filters of a parallel-T RC network, used as the feedback loop in an amplifier to give narrow bandpass characteristics similar to those of an LC circuit.
- 621.396.69 + 621.317.7 + 621.38 **3077**
The Physical Society's Exhibition.—(*Electronic Engng*, June 1947, Vol. 19, No. 232, pp. 195-198.) See also 2494 of August.
- 621.396.69 + 621.317.7 **3078**
The R.C.M.F. [Radio Component Manufacturers' Federation] Exhibition.—(*Electronic Engng*, May 1947, Vol. 19, No. 231, pp. 164-165.) A further selection of exhibits. See also 2376 of August.
- 621.396.69 **3079**
Electronic Wiring Techniques.—C. Brunetti. (*Communications*, March 1947, Vol. 27, No. 3, p. 16.) Summary of 1947 I.R.E. Convention paper.
- 621.396.69 **3080**
Evolution of Printed Circuits for Miniature Tubes.—A. F. Murray. (*Tele-Tech*, June 1947, Vol. 6, No. 6, pp. 58-61. 112.)
- 621.396.69 **3081**
Materials and Techniques for Printed Electrical Circuits.—Rose. (See 3164.)
- 621.396.69 : 669.228 **3082**
New Types of Silver Coatings.—Hopf. (See 3166.)
- 621.396.96 : 531.76 **3083**
Timer for Radar Echoes.—L. A. Meacham. (*Bell Lab. Rec.*, June 1947, Vol. 25, No. 6, pp. 231-236.) A range measuring unit for radar systems which use irregularly spaced pulses. Each transmitted pulse initiates a sine wave reaching steady state immediately. This is passed through a continuously variable phase shifter and is formed into pulses, one of which is selected as a marker. By means of the phase shifter control, which is calibrated in distance, the marker can be continuously moved over the radar display.
- 531.18 : 531.15 **3084**
Absolute Rotation and a Rotating Magnet.—Chang-Pen Hsü. (*Wireless Engr*, June 1947, Vol. 24, No. 285, pp. 185-187.) Comment on 3564 of 1946 (G.W.O.H.); see also 2727 of September (Stedman) and back reference. Einstein's principle of equivalence, properly applied for any particular instant, gives a simple explanation of so-called 'absolute rotation'. The electromagnetic reaction upon a rotating magnet and the resultant electric field distribution in it can then be obtained from Maxwell's equations modified for the relativity effect.
- 537.291 : 621.385.833 **3085**
Oil-Drop Method for Electron Trajectories.—L. Jacob. (*Nature, Lond.*, 5th April 1947, Vol. 159, No. 4040, pp. 475-476.) Visual study of trajectories in air at atmospheric pressure of charged oil-drops falling under gravity through enlarged model of electrostatic electron lens.
- 537.311.33 **3086**
Surface States and Rectification at a Metal Semiconductor Contact.—J. Bardeen. (*Phys. Rev.*, 15th May 1947, Vol. 71, No. 10, pp. 717-727.)
- 537.312.62 **3087**
Super-Conductivity.—E. Schroter. (*Metal Ind., Lond.*, 13th June 1947, Vol. 70, No. 24, pp. 444-445.) A review of recent researches, abstracted from *Zentralblatt für die österr. Industrie und Technik*, discussing (a) the critical temperatures of pure metals, alloys and certain metallic compounds such as nitrides, carbides, etc., (b) the transition from normal conductivity to superconductivity and (c) the effects produced in superconducting materials by the application of a magnetic field. A result of practical importance has been the discovery of materials with critical temperatures in the region of the temperature of boiling hydrogen. Further research may reveal substances with critical temperatures easily attained.
- 537.312.62 **3088**
The Magnetic Quenching of Superconductivity.—J. W. Stout. (*Phys. Rev.*, 15th May 1947, Vol. 71, No. 10, p. 741.)
- 537.523.3 **3089**
The Mechanism of the Negative Point Corona at Atmospheric Pressure in Relation to the First Townsend Coefficient.—L. B. Loeb. (*Phys. Rev.*, 15th May 1947, Vol. 71, No. 10, pp. 712-714.)
- 537.525 : 621.3.015.5.027.7 **3090**
The Insulation of High Voltages in Vacuum.—J. G. Trump & R. J. Van de Graaff. (*J. appl. Phys.*, March 1947, Vol. 18, No. 3, pp. 327-332.) A description of research into the mechanism of electrical breakdown in vacuum for voltages from 50 kV to 700 kV. Results are given graphically supporting a theory of breakdown at these voltages due to secondary emission. See also 3575 of 1946.
- 538.3 **3091**
The Experimental Basis of Electro-Magnetism: The Direct-Current Circuit.—N. R. Campbell & L. Hartshorn. (*Proc. phys. Soc.*, 1st Nov. 1946, Vol. 58, No. 330, pp. 634-653.) The first part of an investigation of the extent to which the working principles of electromagnetism can be soundly based on real experimental facts as distinct from imaginary experiments such as those involving point charges and unit magnetic poles. The general principles of measurement are outlined. Current, resistance, conductance and voltage are then established independently of a knowledge of any other magnitudes. Ohm's Law and the conception of e.m.f. follow. An examination of the relations between these magnitudes and geometrical and mechanical magnitudes leads to the consideration of Ampère's two laws. See also 3092 below.

GENERAL PHYSICS

538.3
The Experimental Basis of Electromagnetism.—G. W. O. H. (*Wireless Engr.*, June 1947, Vol. 24, No. 285, pp. 161-162.) Editorial discussion of 3091 above.

538.52 : 537.123
On a New Electromagnetic Induction Effect due to Negative Ions.—T. V. Ionescu & V. P. Mihul. (*C. R. Acad. Sci., Paris*, 12th May 1947, Vol. 224, No. 19, pp. 1349-1351.) If a Geissler tube is placed within a coil forming part of an oscillatory circuit, the intensity of the current through the coil varies with the intensity of the tube current. A detailed study of this effect is described. In general an absorption of energy occurs in the discharge tube, but for certain frequencies the resonator current is much greater with the discharge than without it.

538.56 : [621.396.615.142 + 621.392.029.64
Generalized Boundary Conditions in Electromagnetic Theory.—S. A. Schelkunoff. (*Proc. nat. Electronics Conference, Chicago*, Vol. 2, pp. 317-322.) Generalization of the conception of an idealized perfectly conducting boundary, and its application to waveguides, magnetrons and velocity-modulation valves. The generalized condition is that E_t/H_t constant, E_t and H_t being the tangential components of the electric and magnetic vectors at a given surface. The condition may be extended to distinguish between isotropic and anisotropic boundaries, and the ratio E_t/H_t may be a given function of position on the boundary.

538.566.2 : 517.94
Two Notes on Phase-Integral Methods.—W. H. Murray. (*Phys. Rev.*, 15th March 1947, Vol. 71, No. 6, pp. 360-371.) In the first note, entitled 'New Derivation of the Connection Formulas', proof is based only on the fact that actual solutions of the differential equation must be single-valued. The results serve to establish the validity of WKB's phase-integral method for the treatment of problems of wave propagation. The second note, entitled 'Normalization of Approximate Wave Functions of the Anharmonic Oscillator', discusses the accuracy of the usual asymptotic formula for the normalization factor for the lowest quantum states of the oscillator.

538.569.4.029.64 : 546.171.1
Conversion Spectrum of Ammonia.—M. W. P. Anderson, R. Kyhl, T. Wentink, Jr. & R. E. Linger. (*Phys. Rev.*, 1st March 1947, Vol. 71, No. 5, p. 326.) Measurements of the frequencies of some of the lines have been made to an accuracy of ± 50 kc/s. A formula for these frequencies in terms of rotational angular momenta is discussed. See also 1399 of May (Townes) and back references, 3097 below.

538.569.4.029.64 : 546.171.1
Microwave Absorption Frequencies of $N^{14}H_3$ and H_3 .—W. E. Good & D. K. Coles. (*Phys. Rev.*, 1st March 1947, Vol. 71, No. 6, pp. 383-384.) Measurements of the frequencies of some of the lines to an accuracy of ± 20 kc/s. See also 3096 above.

3092 538.569.4.029.64 : 546.21
The Absorption of Microwaves by Oxygen.—J. H. Van Vleck. (*Phys. Rev.*, 1st April 1947, Vol. 71, No. 7, pp. 413-424.) A theoretical paper in which the features of the oxygen absorption spectrum at millimetre and centimetre wavelengths are derived and compared with existing experimental data. The absorption is caused by the interaction of the magnetic moment of O_2 with electromagnetic fields, and is most pronounced at a wavelength of about 5 mm where it exceeds 10 db/km. The theoretical dependence of absorption on pressure is considered.

538.569.4.029.64 : [546.212 + 546.212.02
Expected Microwave Absorption Coefficients of Water and Related Molecules.—G. W. King, R. M. Hainer & P. C. Cross. (*Phys. Rev.*, 1st April 1947, Vol. 71, No. 7, pp. 433-443.) A theoretical paper. The predicted positions and strengths of the absorption lines at centimetre and millimetre wavelengths are tabulated for H_2O , D_2O , HDO , H_2S , and H_2Se , and, where possible, compared with experimental data. It is pointed out that HDS and $HDSe$ will also have many absorption lines in this wavelength region. See also 3100 below.

538.569.4.029.64 : 546.212
The Absorption of Microwaves by Uncondensed Water Vapor.—J. H. Van Vleck. (*Phys. Rev.*, 1st April 1947, Vol. 71, No. 7, pp. 425-433.) A theoretical paper in which the characteristics of the absorption spectrum at centimetre and millimetre wavelengths are computed and compared with existing experimental data. Agreement is generally satisfactory and the comparison yields precise information concerning the wavelength and breadth of the absorption line at about 1.35 cm (attenuation 0.2 db/km per gm/m²). The predicted attenuation "due to the combined effect of all the other lines, whose wavelengths are too short for resonance" is about a quarter of the observed value; possible explanations of this discrepancy are discussed. See also 3099 above.

GEOPHYSICAL AND EXTRATERRESTRIAL PHENOMENA

523.53 : 621.396.11
3101
Meteor Detection by Amateur Radio.—O. G. Villard, Jr. (*QST*, July 1947, Vol. 31, No. 7, pp. 13-18.) A general explanation of the effect of meteors on radio propagation, and an account of experimental equipment used for their detection.

523.7 + 550.385] "1946.10/12"
3102
Solar and Magnetic Data, October to December, 1946, Mount Wilson Observatory.—S. B. Nicholson & E. S. Mulders. (*Terr. Magn. Atmos. Elect.*, March 1947, Vol. 52, No. 1, pp. 65-66.)

523.72 + 523.32] : 621.396.822.029.64
3103
Microwave Radiation from the Sun and Moon.—R. H. Dicke & R. Beringer. (*Astrophys. J.*, May 1946, Vol. 103, No. 3, pp. 375-376.) Measurement of thermal radiation at 1.25 cm; half-power beam width of 18-inch parabolic reflector was 2° and measured gain 6 000 times that of isotropic radiator. Size of sun's disk at 1.25 cm found to be nearly similar to that at optical wavelengths; effective black-body temperature of sun and moon found to be about 1.1×10^4 and 292°K respectively.

523.72 : 621.396.822

Origin of Solar 'Static'.—C. E. R. Bruce. (*Nature, Lond.*, 26th April 1947, Vol. 159, No. 4043, p. 580.) Comment on 2088 of July (Martyn). Suggestion that "discharges occur in the radial electric field set up by the emission of highly charged atoms from nuclear reactions in the sun's interior".

3104

523.74 : 551.593.9

Relations between Solar Activity and the Luminescence of the Earth's Upper Atmosphere.—J. Cabannes, J. Dufay & Tcheng Mao-Lin. (*C. R. Acad. Sci., Paris*, 19th May 1947, Vol. 224, No. 20, pp. 1393-1395.)

3105

523.746 " 1946.10/.12 "

Provisional Sunspot-Numbers for October to December, 1946.—M. Waldmeier. (*Terr. Magn. atmos. Elect.*, March 1947, Vol. 52, No. 1, p. 14.)

3106

523.746 " 1947.03/.04 "

Solar Notes.—H. W. N. (*Observatory*, April 1947, Vol. 67, No. 837, p. 74.) Two sunspots occurred in March and April 1947 without associated magnetic storms. The April spot was the largest ever recorded.

3107

523.78 " 1945.07.02 " : 621.396.822.020.64

Radio Noise from the Sun at 3.2 cm.—K. F. Sander. (*Nature, Lond.*, 12th April 1947, Vol. 159, No. 4041, pp. 506-507.) Comment on 716 of March (Martyn). Observations during the partial eclipse of July 2, 1945 indicate that the noise mainly emanates from the solar circumference and has a value of 4×10^{-18} W/cm² per Mc/s.

3108

523.78 " 1947.05.20 " : 551.510.535

To the Question of the Coefficient of the Ionosphere's Recombination and the Determination of Its Quantity at the Time of the Eclipse on the 20th of May 1947 in Brazil.—J. L. Alpert & A. A. Einberg. (*Bull. Acad. Sci. U.R.S.S., sér. géogr. géophys.*, 1947, Vol. 11, No. 2, pp. 137-140. In Russian with English summary.) Measurements at Tromsø during the eclipse of 9th June 1945 gave for the effective recombination coefficient of the E layer: $\alpha_E = 4.65 \times 10^{-9}$ and for the F₁ layer: $\alpha_{F_1} = 6.9 \times 10^{-9}$. The changes of ionization to be expected during the 1947 eclipse are calculated.

3109

537.591

Cosmic-Ray Research in B-29 Laboratory determines Nature of Secondary Particles.—G. Grosvenor. (*Terr. Magn. atmos. Elect.*, March 1947, Vol. 52, No. 1, pp. 84-87.) Proof that a large proportion of mesotrons is produced by electrically-charged particles.

3110

537.591

The Mass of the Mesotron as determined by Cosmic-Ray Measurements.—D. J. Hughes. (*Phys. Rev.*, 1st April 1947, Vol. 71, No. 7, pp. 387-392.) "The great majority of the results are statistically reconcilable with a single mass."

3111

538.12 : 521.15

The Magnetic Field of Massive Rotating Bodies.—P. M. S. Blackett. (*Nature, Lond.*, 17th May 1947, Vol. 159, No. 4040, pp. 658-666.) It is known that the magnetic moment and the angular momentum of the earth and sun are nearly proportional and that the constant of proportionality is nearly the square root of the gravitational constant divided by the velocity of light. The author points out that recent measurements of the magnetic

3112

moment of a star are in agreement with this relationship and that since its validity has been demonstrated over such a wide range of values of the parameters it should be given further consideration as a possible general law of nature. A review of previous theories of the magnetic field of the earth and sun is followed by a discussion of the application of the above relationship and of the possibilities of further measurements both for stars and in the laboratory.

550.38 " 1884/1889 "

Daily International Magnetic Character-Figures, C, for the Years 1884 to 1889.—J. Bartels. (*Terr. Magn. atmos. Elect.*, March 1947, Vol. 52, No. 1, pp. 33-38.)

3113

550.38 " 1945 "

Mean K-Indices from Thirty Magnetic Observatories and Preliminary International Character-Figures, C, for 1945.—W. E. Scott. (*Terr. Magn. atmos. Elect.*, March 1947, Vol. 52, No. 1, pp. 25-31.)

3114

550.38 " 1946.04/.06 "

Five International Quiet and Disturbed Days for April to June, 1946.—W. E. Scott. (*Terr. Magn. atmos. Elect.*, March 1947, Vol. 52, No. 1, p. 87.)

3115

550.38 " 1946.10/.12 "

American Magnetic Character-Figure, C_A, Three-Hour-Range Indices, K, and Mean K-Indices, K_A, for October to December, 1946, and Summary for Year 1946.—W. E. Scott. (*Terr. Magn. atmos. Elect.*, March 1947, Vol. 52, No. 1, pp. 15-24.) See also 1770 of June.

3116

550.385 : 523.755 " 1942.08/1944.07 "

The Correlation of Magnetic Disturbances with Intense Emission Regions of the Solar Corona.—A. H. Shapley & W. O. Roberts. (*Astrophys. J.*, May 1946, Vol. 103, No. 3, pp. 257-274.) Observations during 1942-1944 show that magnetic disturbance occurred when intense emission regions of the corona were situated in the eastern hemisphere of the solar disk.

3117

550.385 : 621.396.11

Effect of Magnetic Perturbations on the Velocity of Short Radio Waves.—Stoyko. (*See* 3251.)

3118

551.5 : 621.396.9

Recent Developments in Meteorological Equipment.—A. F. Spilhaus. (*Bull. Amer. met. Soc.*, Sept. 1946, Vol. 27, No. 7, pp. 399-409.) A review of wartime developments in electronic and other equipment for use both in aircraft and on the ground.

3119

551.510.535

The Ionosphere.—(*Observatory*, April 1947, Vol. 67, No. 837, pp. 51-53.) Sir Edward Appleton, introducing a geophysical discussion, pointed out that though the general structure of the ionosphere is well known, anomalies occur, especially in the F₂ layer with its winter ionization maximum and dependence on magnetic dip (see 2898 of 1946). A. H. Mumford described transatlantic experiments on the reciprocity of long distance transmission, and H. L. Kirke experiments on lateral deviation between London and New Delhi. J. W. Cox described work by the Interservice Ionosphere-Bureau on possible ways of using existing knowledge. J. S. Hey considered radiations associated with solar disturbances at wavelengths between

3120

and 15 m. 'Scatter bursts' were discussed; they occur at a height of about 95 km and are believed to originate from meteors. Finally, S. W. Massey considered the processes by which the ionospheric layers are formed.

510.535 **3121**
Ionospheric Studies in South Africa: Tele-
communications Research Laboratory Ionospheric
Recorder.—T. L. Wadley. (*Terr. Magn. atmos.*
ect., March 1947, Vol. 52, No. 1, pp. 67-69.)
description of the ionospheric recorder in use at
Johannesburg. The instrument covers the fre-
quency range of 2-15 Mc/s in 8 seconds. The
light/frequency graph is formed on a long-after-
glow c.r. tube and photographed on a single frame
16-mm film. The transmitter and receiver are
kept in tune by means of a common oscillator, and
D.F. tracking is obtained by cams which operate
the tuning capacitors.

510.535 **3122**
Echoes at D-Heights with Special Reference to
Pacific Islands.—C. D. Ellyett. (*Terr. Magn.*
atmos. Elect., March 1947, Vol. 52, No. 1, pp. 1-13.)
Radio echoes obtained from an equivalent height
150 km above Pitcairn Island during 1944 and
1945 by the usual vertical-incidence pulse technique
are attributed to D-layer reflections. Earlier data
collected and compared with these observations,
which are analysed with respect to frequency range,
diurnal and seasonal variations and echo strength.

510.535 **3123**
Temperature of the Upper Atmosphere.—S. I.
London. (*Phys. Rev.*, 15th April 1947, Vol. 71, No. 8,
pp. 57-67.) Calculations are made of the temperature
at various heights for three widely different lati-
tudes. At E-layer heights of about 100 km, high
temperatures are to be expected, while the F₁ and
F₂ layers at about 200 km and 350 km respectively
are to be at considerably lower temperatures, with
a diurnal variation from night to day.

510.535 : 621.396.11 **3124**
Equivalent Path and Absorption in an Ionospheric
Wave.—Jaeger. (See 3252.)

510.535 : 621.396.11.029.58 **3125**
Doppler Effect in Propagation.—Griffiths. (See
3124.)

593.5 **3126**
The Equilibrium of Atmospheric Sodium [Na-Na⁺
Na-NaO].—D. R. Bates. (*Terr. Magn. atmos.*
ect., March 1947, Vol. 52, No. 1, pp. 71-75.)

593.9 + [551.510.535 : 523.7 **3127**
Minutes of the Meeting of the Royal Astro-
nomy Society [14th March 1947].—(*Observatory*,
London, 1947, Vol. 67, No. 837, pp. 46-51.) Short
reports read and discussed included: The Origin
of the Night Sky Light, by D. R. Bates, and The
Connections between the Ionosphere, Sunspots and
the Corona, by K. O. Kiepenheuer (an account
by R. d'E. Atkinson).

LOCATION AND AIDS TO NAVIGATION

396.663 **3128**
Band Automatic Radio Direction Finder for
Transport Planes.—R. H. Bailey. (*Radio News*,
London, 1947, Vol. 37, No. 6, pp. 68-69. 130.) An

account of a new light-weight radio compass
covering all normal broadcast transmissions and
marine beacons. Improved bearings are obtained
because the compass loop is automatically turned
to face the incoming signal. High altitude and
atmosphere effects are reduced by hermetic sealing
of components and eliminating the receiver power
pack.

621.396.9 : 551.5 **3129**
Applications of Electronics to Meteorology.—
C. M. Reber. (*Bull. Amer. met. Soc.*, Sept. 1946,
Vol. 27, No. 7, pp. 365-372.) A brief account of the
application of radar to the detection of thunder-
storms, fronts and other precipitation areas, and
also to the following of free balloons for wind
determination. The use of the cathode-ray direc-
tion finder to obtain the position of sources of
atmospherics is also described.

621.396.9 : 551.5 **3130**
Recent Developments in Meteorological Equip-
ment.—Spilhaus. (See 3119.)

621.396.93 **3131**
Raydist—A Radio Navigation and Tracking
System.—C. E. Hastings. (*Tele-Tech*, June 1947,
Vol. 6, No. 6, pp. 30-33. 103.) A portable system
depending on the relative phase relationship
between c.w. transmitters operating on frequen-
cies of the order of 2-15 Mc/s. Block diagrams show the
arrangement of equipment at the master and relay
stations for (a) determining the position of a ship
or an aeroplane, (b) measuring the distance between
two stations, and (c) charting the flight path of a
guided missile.

621.396.93 : 551.594.6 **3132**
Location of Thunderstorm Centres from Direc-
tional Observations of Atmospherics during Sunrise
and Sunset.—S. R. Khastgir, M. K. Das Gupta &
D. K. Ganguli. (*Nature, Lond.*, 26th April 1947,
Vol. 159, No. 4043, pp. 572-573.) The time
variation of the intensity of atmospherics is in
agreement with the theory of Khastgir (1379 of
1943) and enables the difference of the longitudes
of the source and receiver to be estimated.

621.396.93 : 621.396.663 **3133**
The Design of Electromagnetic Radiogoniometers
for Use in Medium-Frequency Direction-Finding.—
J. H. Moon. (*J. Instn elect. Engrs*, Part I, April
1947, Vol. 94, No. 76, pp. 185-196.) Summary of
2127 of July.

621.396.932 **3134**
Radio Aids to Marine Navigation.—(*Nature*,
Lond., 10th May 1947, Vol. 159, No. 4045, p. 647.)
Brief description of the International Meeting,
London, May 1946, during which ship and shore
d.f., hyperbolic systems (Loran, Gee, Decca) and
radar were discussed. For the complete account
see 3135 below.

621.396.932 **3135**
Radio Aids to Marine Navigation. Vol. 1. Record
of the [international] Meeting held in London [in
May 1946] and of Demonstrations and Visits.
Vol. 2. Radio Navigation Radar and Position
Fixing Systems for Use in Marine Navigation.
[Book Notice]—H.M. Stationery Office. Vol. 1,
2s. 6d. Vol. 2, 5s. (*Govt. Publ., Lond.*, Nov. &
Dec. 1946, p. 16 & p. 16.)

621.396.932

Postwar Marine Radar in Great Britain.—M. G. Scroggie. (*Communications*, Dec. 1946, Vol. 26, No. 12, pp. 9-11, 41.) The design of the prototype set developed by the British Admiralty and demonstrated at the international meeting on Radio Aids (3135 above). Choice of frequency, pulse duration, horizontal and vertical beam widths, transmitter power and performance monitoring are discussed in some detail. New design features include facilities for superimposing the p.p.i. picture upon charts and a monitoring device which indicates voltages at 20 points as vertical lines on the display tube. A safety device automatically cuts out the p.p.i. should the performance of either transmitter or receiver fall below a certain level.

3136

15° cone. The mirror searches automatically or can be directed by the radar operator on to a chosen aircraft which it then follows, ignoring aircraft at different ranges. Indication is given to the pilot of range, azimuth and rate of overtaking.

MATERIALS AND SUBSIDIARY TECHNIQUES

621.396.933

Trends in Air Navigation.—H. Davis & L. Lader. (*Communications*, March 1947, Vol. 27, No. 3, pp. 15-16.) Summary of 1947 I.R.E. Convention paper.

3137

535.37 : 535.215.9

The Influence of Irradiation with Light on the Dielectric Properties of ZnS Phosphors.—W. de Groot. (*Philips tech. Rev.*, Dec. 1946, Vol. 8, No. 12, p. 370.) Brief summary of *Physica* paper. The change in dielectric behaviour is probably due to free electrons.

3148

621.396.933

Teleran.—D. H. Ewing & R. W. K. Smith. (*RCA Rev.*, Dec. 1946, Vol. 7, No. 4, pp. 601-621.) A system for air navigation and traffic control using television and radar. See also 3139 below.

3138

537.312.62 : 546.883

Magnetic Transition Curves in Superconducting Tantalum.—R. T. Webber. (*Phys. Rev.*, 1st April 1947, Vol. 71, No. 7, p. 471.) Summary of Amer. Phys. Soc. paper on the results of measurements made at the temperature of liquid helium with thin wires of pure tantalum in uniform longitudinal magnetic fields. Unannealed wires were used and the effects of annealing and outgassing were also determined. Experiments with pulse magnetic fields are mentioned.

3149

621.396.933

Teleran Air Navigation and Traffic Control by Means of Television and Radar.—D. H. Ewing & R. W. K. Smith. (*Proc. nat. Electronics Conference, Chicago*, Vol. 2, pp. 299-316.) See also 1546 of 1946 (Herbst et al.) and 3138 above.

3139

538.221

On the Isothermal Remanent Magnetization of Iron Sesquioxide.—J. Roquet. (*C. R. Acad. Sci., Paris*, 19th May 1947, Vol. 224, No. 20, pp. 1418-1420.) Measurements on stabilized $Fe_2O_3\alpha$ to field strengths of 32 300 gauss.

3150

621.396.933

Navaglobe Long-Range Radio Navigation System.—P. R. Adams & R. I. Colin. (*Proc. nat. Electronics Conference, Chicago*, Vol. 2, pp. 288-298.)

3140

538.221

Properties of a Fine-Grain Cubic Ferromagnetic Material.—L. Néel. (*C. R. Acad. Sci., Paris*, 28th May 1947, Vol. 224, No. 21, pp. 1488-1490.) See also 3152 below. Calculation for spherical grains shows that below a critical diameter of about 300 Å the magnetization is uniform. Powders have been obtained with a grain size of 200-300 Å and coercive field as high as 1 000 gauss; this field is too large to be satisfactorily explained by magnetocrystalline anisotropy and must probably be attributed to anisotropy of grain shape. Discussion of powders consisting of ellipsoids of different eccentricities confirms this view.

3151

621.396.933 : 629.135

Automatic Radio Flight Control.—F. L. Moseley & C. B. Watts. (*Proc. nat. Electronics Conference, Chicago*, Vol. 2, pp. 268-287.) An outline of various radio navigational facilities for automatic aircraft guidance.

3141

621.396.933.029.5/6

Ground-Air Communications Unit.—Meacham. (See 3325.)

3142

621.396.933.2

Improvements in 75-Megacycle Aircraft Marker Systems.—B. Montgomery. (*Proc. nat. Electronics Conference, Chicago*, Vol. 2, pp. 133-141.)

3143

538.221

The Coercive Field of a Cubic Ferromagnetic Powder with Anisotropic Grains.—L. Néel. (*C. R. Acad. Sci., Paris*, 2nd June 1947, Vol. 224, No. 22, pp. 1550-1551.) Abstracted with 3151 above.

3152

621.396.96+621.396.93

A Survey of the Development of Radar.—R. A. Smith. (*J. Instn elect. Engrs*, Part I, April, 1947, Vol. 94, No. 76, pp. 172-178.)

3144

538.221 : 621.317.41.029.62

Ferromagnetism at Very High Frequencies: Part 1—Magnetic Iron at 200 Mc/s.—Johnson, Rado & Maloof. (See 3182.)

3153

621.396.96 : 531.76

Timer for Radar Echoes.—Meacham. (See 3083.)

3145

538.221 : 621.317.41.029.62

Complex Permeability of Magnetic Iron at 200 Mc/s as a Function of Polarizing Field.—Rado, Johnson & Maloof. (See 3183.)

3154

621.396.96 : 621.396.82

Theory of Radar Reflection from Wires or Thin Metallic Strips.—Van Vleck, Bloch & Hamermesh. (See 3035.)

3146

621.396.96 : 629.135

Radar Eyes for the Black Widow.—J. B. Maggio. (*Bell Lab. Rec.*, June 1947, Vol. 25, No. 6, pp. 221-226.) Describes a night fighter radar system. A dipole rotating in a parabolic mirror scans a

3147

538.245 : 621.318.323.2

Non-Metallic Magnetic Material for High Frequencies.—J. L. Snoek. (*Philips tech. Rev.*, Dec. 1946, Vol. 8, No. 12, pp. 353-360.) 'Ferrites' of the type MFe_2O_4 , in which M is a bivalent metal, have specific resistance 10^7 - 10^{12} times that of iron, so that eddy currents are negligible; hysteresis can

3155

made small, while initial permeability is of the order of 1 000.

8.3 : 539.215.2

The Electrical Constants of a Material Loaded with Spherical Particles.—L. Lewin. (*J. Instn elect. Engrs*, Part I, April 1947, Vol. 94, No. 76, p. 186.) Summary of 2139 of July.

8.63 : 546.289

Hall Effect and Magneto-Resistance in Germanium. W. C. Dunlap, Jr. (*Phys. Rev.*, 1st April 1947, Vol. 71, No. 7, p. 471.) Summary of Amer. Phys. Soc. paper on the results of measurements made with polycrystalline and single-crystal specimens. "The magneto-resistance effect in germanium appears to be at least an order of magnitude larger than is predicted from the free electron theory for semiconductors."

431.284 : 621.385.1.032.216

A Study of the Barium Silicate Interface of Oxidized Cathodes.—A. Eisenstein. (*Phys. Rev.*, April 1947, Vol. 71, No. 7, p. 473.) Summary of Amer. Phys. Soc. paper. "The interface compound which is formed in the case of a BaO or (BaSr)O coating on a Si-Ni base is believed to be Ba_2SiO_4 rather than $BaSiO_3$. . ." The relation of the compound to an anomalous voltage at the interface (thickness from 5×10^{-4} to 10^{-3} cm) has been examined.

19 " 19/20 "

Corrosion Processes.—U. R. Evans. (*Metal Ind.*, 9th & 16th May 1947, Vol. 70, Nos. 19 & 20, pp. 35-37 & 355-357.) A survey, covering the last five years, of the British contribution to the understanding of metallic corrosion. A bibliography of items is included.

15.615.2

The Influence of the Concentration and Mobility Ions on Dielectric Loss of Insulating Oils.—K. Kang. (*Trans. Amer. Inst. elect. Engrs*, Number Supplement 1946, Vol. 65, p. 1132.) Discussion on 443 of February.

15.616.018.14

Note on the Effect of Combined Carbon Monoxide and Power Factor of Polythene.—W. Jackson & A. Forsyth. (*J. Instn elect. Engrs*, Part I, 1947, Vol. 94, No. 76, p. 187.) Summary of July.

8.322 : [621.314.2.029.4/.5

of Thin Permalloy Tape in H.F. Transformers.—(*Tech. mod.*, 1st/15th Feb. 1947, Vol. 39, No. 1/4, pp. 68-69. In French.) Summary of 2225 of (Ganz).

8.323.2.042.15

Permeability of Dust Cores.—E. R. Friedlaender. (*Engr. Engr.*, June 1947, Vol. 24, No. 285, pp. 18.) The observed increase of permeability is explained by the assumption of irregular particles and uneven distribution of air spaces. See also 1692 & 1693 of June.

5.69

Materials and Techniques for Printed Electrical Circuits.—K. Rose. (*Materials & Methods*, March 1947, Vol. 25, No. 3, pp. 73-76.) A war-time development having many post-war applications

whereby electrical components and circuit connections are produced as metallic and carbonaceous deposits on a ceramic plate thus enabling overall size of an instrument to be reduced while its mechanical stability is increased. See also 1913 of June (Sargrove) and 1887 of 1946 (Brunetti & Khouri).

669.14-41 : 538.221 : 621.314.1.1.2

Magnetic Sheet Steel.—D. Edmundson. (*J. Instn elect. Engrs*, Part I, April 1947, Vol. 94, No. 76, pp. 180-182.) An account of recent American improvements in both quality and production technique, special attention being given to heat treatment, cold rolling and subsequent re-annealing.

669.228 : 621.396.69

New Types of Silver Coatings.—P. P. Hopf. (*Electronic Engng.*, June 1947, Vol. 19, No. 232, pp. 193-194, 198.) A colloid containing up to 70% of metallic silver and containing no organic matter may be used in an offset printing press for depositing circuits such as spiral aeriels and can facilitate the manufacture of silvered polythene capacitors by h.f. eddy current heating methods.

678.1 : 537.226

Dielectric Properties of Rubber—particularly of Loaded Stock.—L. V. Holroyd, B. A. Mrowca & E. Guth. (*Phys. Rev.*, 1st April 1947, Vol. 71, No. 7, p. 488.) Summary of Amer. Phys. Soc. paper.

678.1 : 621.3.011.2

The Electrical Resistivity of Conducting Rubber.—P. E. Wack. (*Phys. Rev.*, 1st April 1947, Vol. 71, No. 7, p. 489.) Summary of Amer. Phys. Soc. paper.

679.5

Fugitive Fluorine works for Industry.—H. C. E. Johnson. (*Sci. Amer.*, Feb. 1947, Vol. 176, No. 2, pp. 60-62.) Short descriptions of commercial methods for the production of fluorine and some of its compounds. These include a new plastic called 'Teflon' which is a polymer of tetrafluorethylene, is stable and tough from -75° to 250°C , is not attacked by any chemical except molten alkali metals and has excellent electrical properties. See also 1121 of April.

679.5 : 537.226

Some Dielectric Properties of Butadiene-Containing Polymers and Copolymers.—R. F. Boyer, E. B. Baker & P. C. Woodland. (*Phys. Rev.*, 1st April 1947, Vol. 71, No. 7, p. 488.) Summary of Amer. Phys. Soc. paper.

MATHEMATICS

517.54 : 621.385.1

Conformal Transformations in Orthogonal Reference Systems.—C. S. Roys. (*Proc. nat. Electronics Conference, Chicago*, Vol. 2, pp. 323-328.) General equations are derived for transformations which correspond to the Cauchy-Riemann equations for Cartesian coordinates; these are applied to shielding and valve problems involving recurrent structures.

518.5

The Mechanical-Transients Analyzer.—G. D. McCann. (*Proc. nat. Electronics Conference, Chicago*, Vol. 2, pp. 372-392.) An electric analogue

3156

3157

3158

3159

3160

3161

3162

3163

3164

3165

3166

3167

3168

3169

3170

3171

3172

computer for the solution of complex algebraic and differential equations. It is designed primarily for the analysis of mechanical vibration problems and servomechanisms.

519.28 : 621.3

3173

A New Approach to Probability Problems in Electrical Engineering.—H. A. Adler & K. W. Miller. (*Trans. Amer. Inst. elect. Engrs.*, December Supplement 1946, Vol. 65, pp. 1118–1119.) Discussion on 465 of February.

517.512.4 (083.5)

3174

Tables of Spherical Bessel Functions, Vol. 1. [Book Review]—Mathematical Tables Project, National Bureau of Standards. Columbia University Press, New York, 1947, 378 pp., \$7.50. (*Gen. elect. Rev.*, May 1947, Vol. 50, No. 5, p. 60.) The Introduction summarizes their properties, expresses the Fresnel integrals in terms of them and describes methods of computation. The present tables, with their great scope and accuracy, now make possible the solution of a large number of important problems in a wide variety of fields.

MEASUREMENTS AND TEST GEAR

620.16 : 621.319.4.011.5

3175

Metallized Capacitor Tests.—P. Godley & J. C. Balsbaugh. (*Electronics*, April 1947, Vol. 20, No. 4, pp. 112–115.)

620.163 : 621.385

3176

Electrical Production Tests for High-Power Tubes.—Sheren. (See 3334.)

620.163 : 621.385

3177

Production Test Facilities for High-Power Tubes.—Lyndon. (See 3335.)

621.317.32 : 621.317.755

3178

Measurement of H.T. by Cathode-Ray Tube.—E.M.I. Laboratories. (*Electronic Engng.*, June 1947, Vol. 19, No. 232, p. 177.) A special tube is used with two anode systems. The unknown voltage is applied to the second of these and a calibrated lower voltage to the first. The value of this lower voltage for accurate focusing of the beam is a measure of the unknown voltage.

621.317.333 + 621.317.37 : 621.315.212.029.6

3179

The Voltage Characteristics of Polythene Cables.—R. Davis, A. E. W. Austen & W. Jackson. (*J. Instn elect. Engrs.*, Part III, May 1947, Vol. 94, No. 29, pp. 154–165. Discussion, pp. 165–170.) An experimental investigation of breakdown voltage, power factor, life with pulse voltages, discharge characteristics at power frequencies and performance with 600-Mc/s r.f. pulse operation. Tentative voltage ratings based on this work are proposed.

621.317.333.027.3

3180

High Voltage D.C. Testing of Rubber-Insulated Wire.—W. N. Eddy & W. D. Fenn. (*Trans. Amer. Inst. elect. Engrs.*, December Supplement 1946, Vol. 65, p. 1126.) Discussion on 3668 of 1946.

621.317.34

3181

Highly-Selective Transmission-Measuring Equipment for Communication Circuits.—D. G. Tucker. (*J. Instn elect. Engrs.*, Part III, May 1947, Vol. 94, No. 29, pp. 211–216.) The equipment can be

designed to be within a specified degree of accuracy; ± 0.25 db is readily obtainable. Basic principles are: (a) direct demodulation of the test signal by means of an identical frequency obtained from an oscillator synchronized to the test tone, (b) discrimination against unwanted line signals obtained by means of low-pass filters, (c) the elimination of the effect of the phase difference between the test and demodulating tones by Barber's two-path method (2697 of September), and (d) the use of an envelope-modulated test signal.

621.317.41.029.62 : 538.221

3182

Ferromagnetism at Very High Frequencies: Part 1—Magnetic Iron at 200 Mc/s.—M. H. Johnson, G. T. Rado & M. Maloof. (*Phys. Rev.*, 1st March 1947, Vol. 71, No. 5, pp. 322–323.) A method of determining the complex permeability by measuring the phase velocity and attenuation in a coaxial line whose centre conductor is the metal under investigation. The results at 200 Mc/s suggest that magnetization by displacement of domain boundary walls is greatly reduced and magnetization by rotation is the dominant effect.

621.317.41.029.62 : 538.221

3183

Complex Permeability of Magnetic Iron at 200 Mc/s as a Function of Polarizing Field.—G. T. Rado, M. H. Johnson & M. Maloof. (*Phys. Rev.*, 1st April 1947, Vol. 71, No. 7, p. 472.) Summary of Amer. Phys. Soc. paper. Results obtained by extension of method of 2852 of September.

621.317.44.025

3184

Alternating Current Probe for the Measurement of Magnetic Fields.—E. C. Gregg. (*Phys. Rev.*, 1st April 1947, Vol. 71, No. 7, p. 482.) Summary of Amer. Phys. Soc. paper. The probe consisted of a 150-turn primary winding and a 100-turn secondary wound on a 0.1-inch length of Permalloy wire 0.01 inch in diameter. The probe had the dimensions of a cylinder 0.1 inch long and 0.08 inch in diameter. An a.c. null detector method was used; an adjustable d.c. current in the primary serving as a measure of the unknown magnetic field. The accuracy of the probe measurements was about 0.2%.

621.317.7 + 621.38 + 621.396.69

3185

The Physical Society's Exhibition.—(*Electronic Engng.*, June 1947, Vol. 19, No. 232, pp. 195–198.) See also 2494 of August.

621.317.7 + 621.396.69

3186

The R.C.M.F. [Radio Component Manufacturers' Federation] Exhibition.—(See 3078.)

621.317.7.029.64 : 621.396.611.4

3187

Cavity Resonators for Measurements with Centimetre Electromagnetic Waves.—B. Bleaney, J. H. N. Loubser & R. P. Penrose. (*Proc. phys. Soc.*, 1st March 1947, Vol. 59, No. 332, pp. 185–199.) "A wave-meter for wavelengths of about a centimetre, with an accuracy of 1 to 2 parts in 10,000, is described." Measurements at wavelengths of 3.2 and 1.35 cm of the dielectric constant and power factor of six non-polar liquids are described and tabulated.

621.317.72.029.56/.58 : 621.392.43

3188

Additional Notes on the "Micromatch".—M. C. Jones & C. Sontheimer. (*QST*, July 1947, Vol. 31, No. 7, p. 45.) A complete account of the modifications to the original design (2853 of September) to

improve the performance at 30 Mc/s; details of revised circuit and components and the best method of assembly are given.

317.73.029.63 : 621.315.212

3189
Comparator for Coaxial Line Adjustments.—Edward. (See 3016.)

317.733

3190
Measuring Megohms to a Few Parts in a Million.—P. Wilhelm. (*Bell Lab. Rec.*, April 1947, Vol. No. 4, pp. 155-158.) Bridge method of measurement used in production to obtain resistances constant to <100 parts in 10^6 for a range of temperature from -40° to 60°C .

317.755

3191
Ends in Cathode-Ray Oscillograph Design.—L. Gaines. (*Proc. nat. Electronics Conference, Chicago*, Vol. 2, p. 454.) Summary only.

317.755 : 621.394.813

3192
Cathode-Ray Telegraph Distortion Measuring—W. T. Rea. (*Bell Lab. Rec.*, April 1947, No. 4, pp. 150-154.) A portable set with built-in supply unit. A simplified circuit diagram given.

317.761 : 621.165

3193
Electronic Frequency Meter and Speed Regulator.—E. Levin. (*Trans. Amer. Inst. elect. Engrs.*, Paper Supplement 1946, Vol. 65, pp. 1181-1182.) Discussion on 1148 of April.

317.761.029.64

3194
F. Heterodyne Frequency Meter.—C. D. S. (*Electronics*, April 1947, Vol. 20, No. 4, pp. 134-137.) Portable instrument for the range 1000 Mc/s with a maximum error less than 1%.

317.784 : 621.3.015.33

3195
Notch Wattmeter for Low-Level Power Measurement of Microwave Pulses.—D. F. Bowman. (*Proc. nat. Electronics Conference, Chicago*, Vol. 2, pp. 371-372.) The r.f. pulse of unknown amplitude is measured in amplitude with an interrupted c.w. signal. The interrupted portion or notch of the signal is adjusted to equal in length and to coincide in time with the unknown pulse. The notch width is then measured by a self-balancing Wheatstone bridge, an instrument which indicates the power and measures accurately the peak power of the unknown signal. Powers from 100 μW can be measured within 5%; accuracy independent of pulse shape, pulse length, repetition rate, and frequency modulation during the measurement.

317.79 : 621.315.212

3196
Standing-Wave Meter for Coaxial Lines.—H. Pattison, Jr., R. M. Morris & J. W. Smith. (*Radio News*, July 1947, Vol. 31, No. 7, pp. 41-43.) A description of the construction and performance, diagrams and details of circuit and components. The meter is essentially a resistance bridge with R_1 equal to the impedance of the line under test, in series with a 52Ω , so that substitution of R_1 is necessary for other cables. A calibration curve is given in the instrument shown, and the method of operation is described fully.

317.79 : 621.392

3197
Theory and Design of Several Types of Waveguide.—Korman. (See 3019.)

621.317.79 : 621.396.611

3198
The Design of a Universal Automatic Circuit Tester and Its Application to Mass-Production Testing.—R. C. G. Williams, J. E. Marshall, H. G. T. Bissmire & J. W. Crawley. (*J. Instn. elect. Engrs.*, Part I, April 1947, Vol. 94, No. 76, pp. 194-196.) Summary of 2181 of July.

621.317.79 : 621.396.615

3199
The Sweep-Frequency Signal Generator.—R. Endall. (*Radio News*, June 1947, Vol. 37, No. 6, pp. 47-50. 114.) A full general description of instruments used for testing i.f. and r.f. circuits and video amplifiers. The frequency response curve is observed visually on an oscilloscope screen.

621.317.79 : 621.396.615.14

3200
A New Frequency-Modulated Signal Generator.—D. M. Hill. (*Communications*, Dec. 1946, Vol. 26, No. 12, pp. 50-51.) Summary of a Rochester Fall Meeting paper. Covers the range 54-216 Mc/s and can be used for amplitude or frequency modulation either separately or simultaneously. A circuit diagram is given.

621.317.79.029.62

3201
Standing-Wave Ratio Meter for V.H.F.—G. G. Glinzki. (*Tele-Tech*, June 1947, Vol. 6, No. 6, pp. 34-35.) A simple directional coupler, consisting essentially of a section of auxiliary transmission line with matched terminations, coupled to the main transmission line. It can also be used as a power meter.

621.317.79.089.6 : [621.396.615.12].14

3202
A Method of Calibrating Standard-Signal Generators and Radio-Frequency Attenuators.—G. F. Gainsborough. (*J. Instn. elect. Engrs.*, Part III, May 1947, Vol. 94, No. 29, pp. 203-210.) The relative magnitudes of r.f. signals are measured by passing the signals through a linear heterodyne frequency-converter and comparing the magnitudes of the resultant i.f. signals with those of signals from a standard i.f. generator of known performance. Signal ratios up to 10 db can be measured to 0.02 db; greater ratios up to 90 db can be measured to within 0.2% of their decibel values. Signals 16 db below noise can be measured to 0.5 db. The method has been used for frequencies between 3 and 3000 Mc/s and this range can be extended.

621.396.11 + 538.566

3203
Velocity of Electromagnetic Waves.—Essen. (See 3249.)

OTHER APPLICATIONS OF RADIO AND ELECTRONICS

533.5 : 539.163.2.08 : 620.191.33

3204
The Mass Spectrometer as an Industrial Tool.—A. O. Nier. (*Proc. nat. Electronics Conference, Chicago*, Vol. 2, pp. 190-197.) Applications to continuous process gas analysis and to leak detection in high-vacuum systems.

535.33.072.029.63

3205
A Microwave Spectrograph.—R. H. Hughes & E. B. Wilson, Jr. (*Phys. Rev.*, 15th April 1947, Vol. 71, No. 8, pp. 562-563.) The basic principle is the use of a r.f. Stark effect field which modulates the absorption by the gas so that a radio receiver can be used for detection purposes.

- 538.74 : 621.385.832 **3206**
Cathode-Ray Compass.—R. T. Squier. (*Electronics*, April 1947, Vol. 20, No. 4, pp. 121-123.) Uses a vertical electron beam in a gimbal-mounted tube with four horizontal quadrantal targets. The action depends on the varying target currents due to the deflection of the beam by the earth's magnetic field.
- 539.16.08 **3207**
Velocity of Propagation of the Discharge in Geiger-Müller Counters.—E. Wantuch. (*Phys. Rev.*, 1st May 1947, Vol. 71, No. 9, p. 646.) Experimental results support the theory that the positive-ion sheath spreads by photon emission and ionization. Values of the propagation velocity are lower than those found by Huber, Alder & Baldinger (2867 of September).
- 539.17 : 620.93 **3208**
Some Fundamental Problems of Nuclear Power-Plant Engineering.—E. T. P. Neubauer. (*Proc. nat. Electronics Conference, Chicago*, Vol. 2, pp. 673-679.)
- 621.313.2-9 : 621.314.653 **3209**
Large Electronic Direct-Current Motor Drives.—M. M. Morack. (*Proc. nat. Electronics Conference, Chicago*, Vol. 2, pp. 212-225.) The use of sealed ignitrons extends electronic drives up to about 600 h.p. where reversing is not required.
- 621.313.2-9 : 621.316.721.076.7 **3210**
Constant-Current Systems for Electronic Control of D.C. Motors.—O. W. Livingston. (*Gen. elect. Rev.*, May 1947, Vol. 50, No. 5, pp. 38-44.) Adjustment of speed for a wide variety of applications is effectively accomplished through suitable modification of the basic constant-torque system.
- 621.313.2-9 : 621.316.721.076.7 **3211**
Electronic Constant-Current Motor Systems.—O. W. Livingston. (*Elect. Engng, N.Y.*, May 1947, Vol. 66, No. 5, pp. 432-437.) Constant torque characteristics simplify use for certain applications. As adjustable speed drive, similar characteristics to variable voltage systems, with minimum number of power valves.
- 621.316.7 : 621.313.2-9 **3212**
Basic Procedures in Motor Control : Part 1 — D.C. Series Motors.—G. W. Heumann. (*Gen. elect. Rev.*, May 1947, Vol. 50, No. 5, pp. 23-34.) Methods of calculating performance and of selecting types of control for matching motor characteristics to the operating requirements. To be continued.
- 621.316.718.5.076.7 : 621.313.3-9 **3213**
Electronic Speed Control of A.C. Motors.—W. H. Elliot. (*Proc. nat. Electronics Conference, Chicago*, Vol. 2, pp. 226-238.) A review of basic circuits, with practical applications.
- 621.317.39 : [531.71 + 531.787] **3214**
The Pressuregraph.—A. Crossley. (*Proc. nat. Electronics Conference, Chicago*, Vol. 2, pp. 352-360.) A compact pickup is used to modulate a h.f. source and transform pressure variation or mechanical motion into a pressure-time or displacement-time graph on a c.r.o.
- 621.317.39 : 531.717.1 **3215**
The Z-Callipers.—A. G. Long. (*Electronic Engng*, June 1947, Vol. 19, No. 232, p. 187.) Details of a simple instrument for measuring bulb wall thickness in terms of readings of an a.c. milliammeter
- 621.317.39 : 6 **3216**
Electric Gauges in Quality Control.—J. Manuele. (*Elect. Engng, N.Y.*, May 1947, Vol. 66, No. 5, pp. 441-444.)
- 621.317.39 : 620.178.3 **3217**
A Modern Vibration Measurement Laboratory : Part 3 — Types of Apparatus.—A. J. Cogman. (*Electronic Engng*, May 1947, Vol. 19, No. 231, pp. 152-156.) D.c. bridge methods of stress measurement using temperature compensation. An a.c. bridge circuit for measuring steady stress by means of a c.r.o. is illustrated. A mobile recording unit includes an amplifier of almost uniform response from 2 c/s to 10 kc/s. Some preliminary notes are also given on the measurement of h.f. vibrations. For part 4 see 3218 below.
- 621.317.39 : 620.178.3 **3218**
A Modern Vibration Measurement Laboratory : Part 4 — Fatigue Testing.—D. M. Corke. (*Electronic Engng*, June 1947, Vol. 19, No. 232, pp. 189-192.) The test apparatus is arranged as part of a regenerative electromechanical system; instability is reduced by limiting the amplitude and adjusting the phase of the electrical feedback. For part 3 see 3217 above.
- 621.317.755 : 535.33 **3219**
The Cathode-Ray Spectrograph.—R. Feldt & C. Berkley. (*Proc. nat. Electronics Conference, Chicago*, Vol. 2, pp. 198-211.) Produces complete spectral distribution curves on a c.r. screen. Applications to colour matching, etc., are suggested.
- 621.317.755 : 771.36 **3220**
Cathode-Ray Tube Shutter-Testing Instrument.—D. T. R. Dighton & H. McG. Ross. (*J. sci. Instrum.*, May 1947, Vol. 24, No. 5, pp. 128-133.) The apparatus gives, on an after-glow c.r. tube, the characteristic curve of a camera shutter, i.e., the variation with time of the light passing through the shutter. Full details are provided of the various circuits used in the instrument.
- 621.365.5 + 621.365.92] : 621.316.726.078.3 **3221**
The Problem of Constant Frequency in Industrial High Frequency Heating Generators.—E. Mittelmann. (*Proc. nat. Electronics Conference, Chicago*, Vol. 2, pp. 503-510.)
- 621.365.5 : 621.314.653 **3222**
Ignitron Converters for Induction Heating.—R. J. Ballard & J. I. Boyer. (*Proc. nat. Electronics Conference, Chicago*, Vol. 2, pp. 455-469.) A 'cyclo-inverter' circuit converting directly 3-phase 60-cycle power to single-phase power at a higher frequency.
- 621.365.52 **3223**
Coreless Induction Furnaces.—M. J. Marchbanks. (*J. Instn. Engrs*, Part I, Feb. 1947, Vol. 94, No. 74, pp. 119-120.) Summary of I.E.E. paper. Another account noted in 1937 of 1946.

- 365.92 : 679.5 **3224**
Heating by Dielectric Losses.—G. Gourod. (*Tech.*
Mag., 1st/15th Feb. & 1st/15th April 1947, Vol. 39,
 pp. 3/4 & 7/8, pp. 45-49 & 113-119. In French.)
 Formulae and graphical methods are given for finding
 the h.f. power required to raise a given quantity of a
 dielectric to a given temperature. Applications to
 various branches of industry are reviewed.
- 365.92 : 679.5 **3225**
Electric Preheating in the Plastics Industry.—
 Leland, D. E. Watts & T. N. Willcox. (*Proc.*
Electronics Conference, Chicago, Vol. 2, pp.
 502.)
- 365.92.029.64 **3226**
**Microwaves and Their Possible Use in High
 Frequency Heating.**—T. P. Kinn & J. Marcum.
Proc. nat. Electronics Conference, Chicago, Vol. 2,
 pp. 470-487.) Sources of c.w. power for r.f. heating
 frequencies from 1 500 to 30 000 Mc/s are dis-
 cussed and microwave coaxial transmission line
 waveguide technique, including matching
 methods, described. Possible methods of using
 waveguides, aerials and resonators to apply r.f.
 power to dielectric materials of various shapes are
 discussed.
- 365.92.029.64 **3227**
Electronic Method of Contouring Control.—
 G. E. Morgan. (*Proc. nat. Electronics Conference*,
Chicago, Vol. 2, pp. 239-249.) See also 207 of
 1947.
- 365.92.029.64 **3228**
**Electronic Register Control for Multicolor
 Printing.**—W. D. Cockrell. (*Trans. Amer. Inst.*
Elect. Engrs, December Supplement 1946, Vol. 65,
 pp. 1117-1118.) Discussion on 3697 of 1946.
- 365.92.029.64 **3229**
Electronic Reading Aid for the Blind.—V. K.
 Kin & L. E. Flory. (*Proc. Amer. phil. Soc.*,
 April 1947, Vol. 91, No. 2, pp. 139-142.) A
 description of the equipment and a critical account
 of its application. It is not considered that the
 aid is ready for general use, although after
 60 hours training two blind readers were able
 to identify letters at random with about 80%
 accuracy. See also 3700 of 1946.
- 365.92.029.64 **3230**
**A.C. Behaviour of the Barrier Layer Photo
 Cell.**—Sargrove. (See 3332.)
- 365.92.029.64 **3231**
Primary Application of Infrared Viewers.—G. E.
 Morgan. (*Proc. nat. Electronics Conference, Chicago*,
 Vol. 2, pp. 181-188.)
- 365.92.029.64 **3232**
**Minimum Disturbing Field for Synchrotron Beam
 Deflection.**—F. K. Goward & J. Dain. (*Nature*,
 10th May 1947, Vol. 159, No. 4045, pp.
 471-472.) Theoretical analysis of the reactive
 field required to build up the disturbing field and
 conditions that minimize this power.
- 365.92.029.64 **3233**
Near Research with the 100-MeV Betatron.—
 Charlton & G. C. Baldwin. (*Proc. nat. Elec-
 tronics Conference, Chicago*, Vol. 2, pp. 650-672.)
 Description of the General Electric betatron, with
 experimental results.
- 621.384.6 **3234**
**Initial Performance of the 184-Inch Cyclotron of
 the University of California.**—W. M. Brobeck, E. O.
 Lawrence, K. R. MacKenzie, E. M. McMillan, R.
 Serber, D. C. Sewell, K. M. Simpson & R. L.
 Thornton. (*Phys. Rev.*, 1st April 1947, Vol. 71,
 No. 7, pp. 449-450.) A brief description of equip-
 ment and experiments by which deuteron and alpha-
 particle beams, of approximately 200 and 400 MeV
 respectively, have been produced. The character-
 istics of the high power (18 kW input) frequency-
 modulated h.f. generator are mentioned.
- 621.384.6 **3235**
**An Accelerator Column for Two to Six Million
 Volts.**—R. R. Machlett. (*Proc. nat. Electronics
 Conference, Chicago*, Vol. 2, pp. 680-687.) Manu-
 facturing techniques for multi-section tubes.
- 621.385.833 **3236**
**Summarized Proceedings of Conference on the
 Electron Microscope Oxford 1946.**—(*J. sci. Instrum.*,
 May 1947, Vol. 24, No. 5, pp. 113-119.) Sessions
 were devoted to: (a) construction, including
 descriptions of various recent developments and
 discussion of design principles, (b) the technique of
 specimen preparation, and (c) special applications.
- 621.385.833 **3237**
**Proceedings of the Electron Microscope Society of
 America.**—(*J. appl. Phys.*, March 1947, Vol. 18,
 No. 3, pp. 269-273.) Titles and abstracts of
 36 papers presented at the 1946 annual meeting.
- 621.385.833 **3238**
**On the Limit of Resolution of the Electron Micro-
 scope: Round Lens.**—H. Bruck. (*C. R. Acad. Sci.*,
Paris, 2nd June 1947, Vol. 224, No. 22, pp. 1553-
 1555.) A discussion of the different values obtained
 for the limit of resolution in the Gauss plane by use
 of the superposition formula, that of Born & Glaser
 and Rayleigh's $\lambda/4$ rule, with graphs and a numerical
 table.
- 621.385.833 **3239**
**A Methyl Methacrylate-Silica Replica Technique
 for Electron Microscopy.**—A. F. Brown & W. M.
 Jones. (*Nature, Lond.*, 10th May 1947, Vol. 159,
 No. 4045, pp. 635-636.) A method requiring
 neither pressure nor high temperature and applicable
 to many types of material.
- 621.386.001.8 **3240**
**One-Millionth-Second Radiography and Its
 Applications.**—C. M. Slack & D. C. Dickson, Jr.
Proc. Inst. Radio Engrs, W. & E., June 1947, Vol.
 35, No. 6, pp. 600-606.) Outline of the development
 of the modern cold-cathode X-ray tube, in which
 1 000-A microsecond pulses are obtained, and of
 the associated 300-kV surge-generator. The equip-
 ment has had particular application to studying
 the effect of bullets passing through material opaque
 to light. Summary noted in 1613 of 1946.
- 621.391.64 **3241**
**Modulation of Infrared Sources for Signaling
 Purposes.**—W. S. Huxford. (*Proc. nat. Electronics
 Conference, Chicago*, Vol. 2, pp. 158-170.) An
 account of various modulation methods, including
 mechanical modulation used by the Japanese, and
 German mechanical and optical methods. Details
 are given of two new types of electrically modulated
 arc lamps, (a) the concentrated arc, and (b) the
 caesium vapour arc.

621.396.9.083.7 : 551.5
Telemetry from V-2 Rockets : Part 2.—V. L. Heeren, C. H. Hoepfner, J. R. Kauke, S. W. Lichtman & P. R. Shifflett. (*Electronics*, April 1947, Vol. 20, No. 4, pp. 124-127.) A time-modulated pulse system is used. The output of the ground station 1 000-Mc/s receiver contains trains of pulses spaced according to instrument readings in the rocket. Circuits for decoding these pulses into individual voltages for recording are given. For part 1 see 2536 of August.

3242

621.398 : 621.397.6
Television Equipment for Guided Missiles.—C. J. Marshall & I. Katz. (*Proc. nat. Electronics Conference, Chicago*, Vol. 2, pp. 115-129.)

3243

623.26 : 621.396.9
Detectors for Buried Metallic Bodies.—L. F. Curtis. (*Proc. nat. Electronics Conference, Chicago*, Vol. 2, pp. 339-351.) Various development problems are discussed and a description is given of the SCR-625 detector, which uses a 1-kc/s transmitter and receiver and a balanced coil system.

3244

623.978 + 550.838] : 538.71
Magnetic Prospecting.—W. J. Shackleton. (*Bell Lab. Rec.*, April 1947, Vol. 25, No. 4, pp. 142-145.) Short account of an airborne magnetic detector, and its application to submarine detection and geophysical prospecting.

3245

778.332
Electronic Timing provides Uniform X-Ray Exposures.—H. D. Moreland. (*Radiography*, May 1947, Vol. 13, No. 149, pp. 51-54.) X-ray radiation, after passing through an object, is converted to visible radiation measured by a photoelectric cell which opens a relay switch in the X-ray circuit.

3246

PROPAGATION OF WAVES

538.566.2 : 517.94
Two Notes on Phase-Integral Methods.—Furry. (*See* 3095.)

3247

538.569.4.029.64
Various Papers on Absorption of Microwaves.—(*See* 3096 to 3100.)

3248

621.396.11 + 538.566
Velocity of Electromagnetic Waves.—L. Essen. (*Nature, Lond.*, 3rd May 1947, Vol. 159, No. 4044, pp. 611-612.) An account of the results obtained from velocity determination by resonance of a short length of a waveguide closed at both ends, using centimetre waves. The accuracy is comparable with that of light velocity measurements, and the average result obtained is 17 km/s higher than that generally accepted for light waves, although this discrepancy is within the combined limits of error for the two measurements.

3249

621.396.11
The Elements of Wave Propagation using the Impedance Concept.—H. G. Booker. (*J. Instn elect. Engrs*, Part III, May 1947, Vol. 94, No. 29, pp. 171-198. Discussion, pp. 199-202.) The theory of transmission lines is normally approached from the point of view of circuits and developed in terms of the impedance concept, whereas the theory of more general forms of wave propagation

3250

tends to be developed from Maxwell's equations. By using the concept of field impedance, propagation and transmission line phenomena can be integrated into a single picture. Phenomena such as the Brewster angle, the critical angle, propagation in hollow metal pipes, reflection and transmission by wire netting, etc., all have their counterparts in transmission line theory. For example, it is easier to explain the part played by the less dense medium in total internal reflection by regarding total internal reflection as analogous to a reactive load on the end of a simple transmission system. The impedance concept can in fact be regarded as complementary to the optical approach to electromagnetic phenomena.

The impedance concept is here applied to: (a) a simple infinite plane wave, (b) reflection at a discontinuity between two dielectrics, (c) extension of (b) to conducting media and to oblique incidence, (d) extension of the use of circle diagrams, (e) the effect of obstacles such as an infinite plane sheet of wire netting on an incident plane wave, (f) propagation along a waveguide. Energy, metal losses, the use of matrices and radiation from aeriels are also discussed.

The correspondence between transmission-line and propagation phenomena is made clear by placing corresponding equations in parallel columns; for example, the obstacles mentioned in (e) above correspond to lumped shunt impedances.

621.396.11 : 550.385

3251
Effect of Magnetic Perturbations on the Velocity of Short Radio Waves.—N. Stoyko. (*C. R. Acad. Sci., Paris*, 5th May 1947, Vol. 224, No. 18, p. 1281.) From reception results for $\lambda 17-35$ m at Buenos Ayres, Paris, Tokyo and Washington and magnetic data provided by the University of Paris, it is found that for direct propagation the apparent velocity diminishes from 275 660 km/sec for magnetically calm conditions to 272 090 km/sec for very disturbed conditions, while for 'super-propagation' (along the longer arc of the great circle) the apparent velocity increases from 284 502 km/sec for calm days to 288 283 km/sec for very disturbed conditions. For earlier work see 3780 of 1945, 945 of 1942 and back references.

621.396.11 : 551.510.535

3252
Equivalent Path and Absorption in an Ionospheric Region.—J. C. Jaeger. (*Proc. phys. Soc.*, 1st Jan. 1947, Vol. 59, No. 331, pp. 87-96.) Formulae for the calculation of absorption and equivalent path for rays vertically incident on an ionized region, the ionization of which varies exponentially (a Chapman region), are deduced for the cases of transmission and of reflection from above and below. Tables of numerical values are appended.

The results are compared with those obtained on the basis of a parabolic variation of ionization.

621.396.11 : 551.510.535

3253
Predicting World Area Coverage by Reflected Waves.—N. A. Atwood. (*Tele-Tech*, June 1947, Vol. 6, No. 6, pp. 38-42. . 104.) Technical details of a new method for predicting the maximum usable frequency and the optimum working frequency for any radio link. Use is made of a slide-rule type of device consisting of a transparent world map, a transparent time-frequency chart

and a series of great-circle charts. These are similar to the maps and charts contained in the R.P.L. Basic Radio Propagation Predictions.

621.396.11.029.58 : 551.510.535 **3254**

Doppler Effect in Propagation.—H. V. Griffiths. *Wireless Engr.*, June 1947, Vol. 24, No. 285, pp. 2-166.) Changes of 2-7 parts in 10^8 have been observed in the received frequency of WWV standard transmissions on 15 Mc/s, which are accurate to ± 2 parts in 10^8 . Further measurements under different conditions have shown that the divergence is not wholly or largely due to the difference in frequency standards.

Trigonometrical formulae for the path length and the Doppler effect resulting from the changes in path length are deduced.

A rate of change of the virtual height of the reflecting layer of the order of 3-6 m/s could account for the observed frequency difference between received and transmitted signals.

621.396.11.029.6 **3255**

Radio Propagation at Frequencies above 30 Megacycles.—K. Bullington. (*Proc. nat. Electronics Conference, Chicago*, Vol. 2, p. 130.) Summary only. Discusses the effect on propagation frequency, range, aerial height, curvature of earth, atmospheric conditions, etc. Charts given from which an estimate of received power field intensity for a given transmission path can be obtained quickly.

621.396.11.029.6 : 621.397.81 **3256**

Analyzing TV Propagation at U.H.F.—R. P. Coleman. (*Tele-Tech.*, June 1947, Vol. 6, No. 6, pp. 62-65, p. 115.) From investigations by the U.S. Army, it appears that u.h.f. at present carrier levels appears to be useful only for line-of-sight service.

621.396.11.029.64 : 535.434 **3257**

Radar Echoes from the Sea Surface at Centimetre Wave-Lengths.—H. Davies & G. G. Macfarlane. (*Proc. phys. Soc.*, 1st Nov. 1946, Vol. 58, No. 330, pp. 717-729.) An account is given of quantitative measurements of the echoes obtained from the sea surface under various weather conditions with radars operating on wavelengths of 1.25, 3 and 10 cm. A necessary theoretical treatment is given; a 'scattering coefficient' of the surface is defined and its variation with sea conditions and angle of incidence is shown. See also 423 of February and 424 of July, for which the above U.D.C. would have been preferable.

621.396.81.029.63 : 621.397.81 **3258**

Results of Field Tests on U.H.F. (490 Mc/s) Television Transmissions in the New York Metropolitan Area.—W. B. Lodge. (*Proc. nat. Electronics Conference, Chicago*, Vol. 2, p. 156.) Summary only.

RECEPTION

621.396.621 - 621.396.662.2.029.62 **3259**

Front-End Design of F.M. Receivers.—C. R. Hoadley. (*Proc. nat. Electronics Conference, Chicago*, Vol. 2, pp. 564-569.) Details of a new type of line tuner for receivers for the 100-Mc/s band. See 2052 of July.

621.396.621 **3260**
High Fidelity Miniature Tube Receiver.—J. C. Hoadley. (*Radio News*, April 1947, Vol. 37, No. 4, pp. 47-49, p. 171.)

621.396.621 : 621.396.681 **3261**

28 Volts H.T. and L.T.P.—R. Terlecki & J. W. Whitehead. (*Electronic Engng.*, May 1947, Vol. 19, No. 231, pp. 157-159.) Discusses the design of receivers for operation direct from a 28-V supply, without either rotary converters or vibrators. Tests with a modified American communications receiver gave very satisfactory results. Suitable valves are listed.

621.396.621.54 : 621.396.615.142 : 621.396.96 **3262**

Reflex Oscillators for Radar Systems.—McNally & Shepherd. (*See* 3957.)

621.396.621.54.029.6 : 621.396.5 **3263**

An Experimental Receiver for Ultra-Short-Wave Radio-Telephony with Frequency Modulation.—A. van Weel. (*Philips tech. Rev.*, July 1946, Vol. 8, No. 7, pp. 193-198.) Description of a superheterodyne receiver for a mean carrier frequency of about 300 Mc/s. The push-pull mixing stage is made self-oscillating by introducing an 'asymmetric' input circuit tuned to the local oscillator frequency. As no separate oscillator is required there is a reduction in fluctuation noise, so that a h.f. amplifier can be omitted with only a small reduction in the signal-to-noise ratio. For a description of the transmitter used for the same Tilburg-Eindhoven link, see 2606 of August.

621.396.622 **3264**

A New Detector for Frequency Modulation.—W. E. Bradley. (*Proc. nat. Electronics Conference, Chicago*, Vol. 2, pp. 570-576.) A description of the circuit, design procedure, and alignment of a single stage f.m. detector. Tests show it to be comparatively unresponsive to a.m. and free from practical defects.

621.396.662 : 621.396.621.54.029.62 **3265**

V.H.F. Tuner Design.—G. Wallin & C. W. Dymond. (*Proc. nat. Electronics Conference, Chicago*, Vol. 2, pp. 557-593.) The design of a single-oscillator double-superheterodyne circuit for use on the 88-108 Mc/s f.m. band is described. Receiver performance characteristics are given.

621.396.82 : 621.396.619.13 **3266**

Frequency Modulation Distortion caused by Common- and Adjacent-Channel Interference.—M. S. Corrington. (*RCF Rev.*, Dec. 1946, Vol. 7, No. 4, pp. 522-560.) Formulae are developed for computing the amplitudes of harmonics and cross-modulation formed by the interference of two f.m. waves. From these the effects on f.m. reception of a de-emphasis network following the discriminator, of a low-pass audio filter and of nonlinear phase shift in the amplifiers are calculated.

621.396.82.029.5 **3267**

Interference between V.H.F. Radio Communication Circuits.—W. R. Young, Jr. (*Proc. nat. Electronics Conference, Chicago*, Vol. 2, p. 131.) Summary only. A discussion of common causes of such interference, with measurement results and computation formulae.

621.396.822 : 621.396.615.141.2

3268

Excess Noise in Cavity Magnetrons.—R. L. Sproull. (*J. appl. Phys.*, March 1947, Vol. 18, No. 3, pp. 314-320.) A fluctuating noise modulation in excess of shot noise in 4 000-Mc/s magnetron oscillations is described. The effects of gas pressure and cathode material on the ratio of noise to r.f. output were investigated and the gas near the cathode examined by spectrograph. The excess noise is attributed to the liberation of metal atoms from the oxide coated cathode by bombarding electrons. Details are given of a cathode in which the oblique path of bombardment is used to separate the emitting and bombarded surfaces.

between 80 and 100 Mc/s. The results of some field tests are given.

621.396.828 : 621.396.619.16

3269

Pulse Modulation Noise Suppression Characteristics.—S. Moskowitz & D. D. Grieg. (*Communications*, March 1947, Vol. 27, No. 3, pp. 42-43.) Summary of 1947 I.R.E. Convention paper.

621.396.619.16 : 621.396.13 : 621.396.97

3277

Pulse-Time Multiplex Broadcasting on the Ultra-High Frequencies.—D. D. Grieg & S. Moskowitz. (*Proc. nat. Electronics Conference, Chicago*, Vol. 2, pp. 531-547.) The advantages of a multiplex broadcast system over a simplex system are discussed. Details are given of time-division and frequency-division multiplex systems, apparatus employed, and results obtained. See also 3049 of 1946 (Grieg).

STATIONS AND COMMUNICATION SYSTEMS

621.394.44

3270

Carrier Telegraphy.—J. te Winkel. (*Philips tech. Rev.*, July 1946, Vol. 8, No. 7, pp. 206-213.) A method in which 18 telegraphic channels are contained in the frequency band of a single telephone connection.

621.395.44 : 621.315.952.63

3271

Rural Carrier Telephony.—(*Elect. Engng, N.Y.*, May 1947, Vol. 66, No. 5, pp. 425-431.) A carrier system for application on power lines. Summary of "A Carrier Telephone System for Rural Service", by J. M. Barstow and "Application of Rural Carrier Telephone System", by E. H. B. Bartelink, L. E. Cook, F. A. Cowan & G. R. Messmer.

621.395.44 : 621.315.052.63

3272

Field Tests on Power-Line Carrier-Current Equipment.—R. H. Miller & E. S. Prud'homme. (*Trans. Amer. Inst. elect. Engrs*, December Supplement 1946, Vol. 65, pp. 1177-1178.) Discussion on 1207 of April.

621.395.5 : 621.317.34

3273

Transmission Rating of Telephone Systems.—W. A. Codd. (*Trans. Amer. Inst. elect. Engrs*, December Supplement 1946, Vol. 65, p. 1123.) Discussion on 1208 of April.

621.396.1

3274

The Job Ahead.—C. R. Denny. (*Proc. Inst. Radio Engrs, W. & E.*, June 1947, Vol. 35, No. 6, pp. 598-599.) The chairman of the F.C.C. asks radio engineers for ways and means of winning the battle for ether space.

621.396.619.11/.13 : 534.78

3275

Narrow-Band F.M. for Voice Communication.—N. Bishop. (*QST*, May 1947, Vol. 31, No. 5, pp. 20-23.) Comparison of a.m. and narrow-band f.m. shows that the latter gives greater intelligibility with weak signals.

621.396.619.11/.13].029.62 : 621.396.931

3276

Amplitude-Modulated Communication in the V.H.F. Band.—D. H. Hughes. (*Electronic Engng*, May 1947, Vol. 19, No. 231, pp. 143-146, 151.) The relative merits of f. . and a.m. are discussed and miniature mobile radiotelephone equipment using a.m. is described. It occupies 1 ft³ for a weight of 40 lb and radiates 12 W at a frequency

621.396.619.16 : 621.396.41

3278

Multiplex employing Pulse Time and Pulsed F.M. Modulation.—H. Goldberg & C. C. Bath. (*Communications*, March 1947, Vol. 27, No. 3, pp. 41-42.) Summary of 1947 I.R.E. Convention paper.

621.396.65 + 621.397.26] : 629.135

3279

Stratovision System of Communication.—C. E. Nobles. (*Proc. nat. Electronics Conference, Chicago*, Vol. 2, pp. 54-72.) The proposed system uses high-altitude aircraft transmission. The same aircraft may carry television and f.m. transmitters, as well as radio-relaying transmitters. Experimental curves are given of field strengths at various distances from an aircraft transmitting on 107.5 Mc/s and 514 Mc/s at about 20 000 ft. For previous accounts see 3970 of 1945, 3090 and 3801 of 1946 and 2588 of August.

621.396.65 + 621.397.26] : 629.135

3280

The Stratovision System of Communication—Aircraft Requirements.—W. K. Ebel. (*Proc. nat. Electronics Conference, Chicago*, Vol. 2, pp. 73-81.) Design considerations for reliability and economy of operation.

621.396.65.029.63 : 621.396.619.16

3281

Pulse Time Division Radio Relay.—B. Trevor, O. E. Dow & W. D. Houghton. (*RCA Rev.*, Dec. 1946, Vol. 7, No. 4, pp. 561-575.) Description of a radio relay set developed for the U.S. Army. Two sets provide eight two-way telephone circuits over a line-of-sight path of between 50 and 100 miles. The frequency range is 1 350-1 500 Mc/s; a time division multiplex system and pulse position modulation are used. See also 3283 below.

621.396.65.029.64

3282

A Microwave Relay Communication System.—G. G. Gerlach. (*Proc. nat. Electronics Conference, Chicago*, Vol. 2, pp. 511-530.) A description of a multi channel f.m. 4 000-Mc/s relay system using a 1-Mc/s f.m. sub-carrier. The intermediate relay stations are unattended. See also 1578 of May (Thompson) and 3283 below.

621.396.65.029.64

3283

A Microwave Relay Communication System.—G. G. Gerlach. (*RCA Rev.*, Dec. 1946, Vol. 7, No. 4, pp. 576-600.) A review of experimental results obtained with a 4 000 Mc/s multichannel relay system using a f.m. sub-carrier for frequency-modulation of the final carrier. Demodulation to sub-carrier frequency is effected at the relay stations. The equipment developed from these experiments and to be used commercially for linking New York, Washington and Pittsburg, is described in detail. See also 3048 and 3748 of 1946 and 2935 of September and 3282 above.

396.712.2
NEW Program Dispatching System.—J. Peter-
son. (*Tele-Tech*, June 1947, Vol. 6, No. 6, pp.
51-53.) A master control console is designed
to deal with seven studios and three remote chan-
nels simultaneously.

3284

621.352.8

3295

**Characteristics of the Silver Chloride-Magnesium
Water Activated Battery.**—J. B. Mullen & P. L.
Howard. (*Electrochemical Society, Preprint* 90-33,
pp. 411-422.) The full account of a new type of
cell referred to in 2948 of September.

396.931
**Vehicle Radiotelephony becomes a Bell System
Service.**—A. C. Peterson, Jr. (*Bell Lab. Rec.*,
April 1947, Vol. 25, No. 4, pp. 137-141.) A brief
description of a mobile radiotelephone system,
operating on frequencies in the range 100-200 Mc/s
providing two-way communication between
subscriber's vehicle and the normal telephone
system.

3285

TELEVISION AND PHOTOTELEGRAPHY

537.291 + 538.691 : 621.385.832

3296

Electron Optics of Deflection Fields.—R. G. E.
Hutter. (*Proc. nat. Electronics Conference, Chicago*,
Vol. 2, pp. 424-453.)

396.931
**Selective-Calling Systems in Mobile Radio Com-
munication.**—L. Morris. (*Proc. nat. Electronics
Conference, Chicago*, Vol. 2, pp. 644-649.)

3286

621.397.3

3297

Simultaneous All-Electronic Color Television.—
RCA Laboratories Division. (*RCA Rev.*, Dec.
1946, Vol. 7, No. 4, pp. 459-468.) The first progress
report on the new system which enables the three
colour images to be transmitted simultaneously.
Each colour channel employs the same standards
as are in use for black and white transmission, so
that the green channel can transmit monochrome
pictures. Undesirable obsolescence is thus avoided,
as the system can be interchanged with ordinary
black-and-white television.

SUBSIDIARY APPARATUS

326
**Dimensionless Analysis of Servomechanisms by
Trigonometric Analogy.**—S. W. Herwald & G. D.
Ann. (*Trans. Amer. Inst. elect. Engrs*, December
Supplement 1946, Vol. 65, p. 1132.) Discussion
on 143 of February.

3287

Apparatus for scanning colour slides and colour
motion picture film is described in detail, and the
construction of the receivers used in the experi-
mental work is explained.

326
Parallel Circuits in Servomechanisms.—H. T.
Gy. (*Trans. Amer. Inst. elect. Engrs*, December
Supplement 1946, Vol. 65, p. 1128.) Discussion
on 63 of 1946.

3288

621.397.44

3298

Television Relaying.—P. H. Reedy. (*Com-
munications*, Dec. 1946, Vol. 26, No. 12, pp. 18-21.)
Summary of a Rochester Fall Meeting paper.
Colour television relaying by means of cable and
radio. Tests on short-range transmissions are
outlined and a description of a 530-Mc/s relay
transmitter is given. Long-distance cable tests
indicate the superiority of colour over black and
white, despite bandwidth limitations.

326
**Frequency Response of Automatic Control
Systems.**—H. Harris, Jr. (*Trans. Amer. Inst.
Engrs*, December Supplement 1946, Vol. 65,
pp. 1131-1132.) Discussion on 3764 of 1946.

3289

621.397.5

3299

A Report on the 1946 Rochester Fall Meeting.—
L. Winner. (*Communications*, Dec. 1946, Vol. 26,
No. 12, pp. 18-25.. 51.)

326
**High-Performance Demodulators for Servomech-
anisms.**—K. E. Schreiner. (*Proc. nat. Electronics
Conference, Chicago*, Vol. 2, pp. 393-403.)

3290

621.397.5

3300

Television as a Public Service.—R. F. Guy.
(*Communications*, Dec. 1946, Vol. 26, No. 12, pp.
21-22.) Summary of a Rochester Fall Meeting
paper.

3.2
"Electrotor".—J. V. Eurich. (*Electronic
Engineering*, May 1947, Vol. 19, No. 231, pp. 160-161.)
Another account of this equipment see 2943
of September.

3291

621.397.5

3301

Television.—(*RCA Rev.*, Dec. 1946, Vol. 7,
No. 4, pp. 641-655.) A list of some 275 papers
published by R.C.A. authors from 1929-1946 on
television and related subjects.

3.2
Tests in Cathode-Ray Oscillograph Design.—
L. (See 3191.)

3292

621.397.5 : 621.318.572

3302

Counter-Timer for Television.—C. E. Hallmark.
(*Communications*, March 1947, Vol. 27, No. 3,
p. 14.) Summary of 1947 I.R.E. Convention paper.

3.3
Magnets and Solenoids.—L. T. Rader.
Engng. N.Y., May 1947, Vol. 66, No. 5,
pp. 491-492.) The design and construction of single
a.c. magnets. Their advantages over d.c.
magnets are briefly discussed.

3293

621.397.5 : 621.396.67

3303

**Load Characteristics of Television Antenna
Systems: Part 3.**—G. E. Hamilton & R. K.
Olsen. (*Communications*, March 1947, Vol. 27,
No. 3, pp. 20-25.) Aerial impedance characteristics
are discussed and phasing and matching methods
for transmitting aeriels are given, with particular
reference to (a) the doughnut type of folded dipole
with elements of the same or unequal diameter,

3.5
**Telephone Relays — and Their Use in Electronic
Systems: Part 1.**—A. A. Chubb. (*Electronic Engng.*
1947, Vol. 19, No. 232, pp. 172-177.) The
operating conditions of common types of relay are
described and the load-line method of matching a
relay to a valve is discussed. To be continued.

3294

(b) a double-folded system in turnstile, and (c) three-element folded dipoles. Where many measurements are found necessary and the complex nature of the load must be plotted, transmission line charts may be used to simplify the calculation. Suitable charts are "Chart for Transmission Line Measurements and Computations", by P. S. Carter, (*RCA Review*, Jan. 1939); "Practical Analysis of Ultra-High-Frequency", by J. R. Meagher & H. J. Markley, (*RCA Service Co.*) and "Transmission Line Calculator", by P. H. Smith, (*Electronics*, Jan. 1939.) For parts 1 and 2 see 2262 of July.

621.397.5 : 621.396.67

3304

Television Antenna Installations giving Multiple Receiver Outlets.—Ehret. (See 3029.)

621.397.6

3305

Television Deflection Circuits : Part 1 — Molded Iron Dust Cores for Use in Horizontal [line] Deflection Circuits. Part 2 — Theory and Design of Combined Low-Loss Horizontal Deflecting and High Voltage Power Supply Systems.—A. W. Friend. (*RCA Rev.*, March 1947, Vol. 8, No. 1, pp. 98–138.) Part 1: A low-loss, inexpensive system using compressed sponge-iron cores for transformers and yokes enables line deflection to be obtained for a 27-kV kinescope from two Type 807 valves. Curves of the properties of the core material, photographs of typical yokes and transformers and circuit details are given. Part 2: A complete analysis with design equations and charts.

621.397.6

3306

The Use of Powdered Iron in Television Deflecting Circuits.—A. W. Friend. (*Proc. nat. Electronics Conference, Chicago*, Vol. 2, pp. 89–114.) A shortened version of 3305 above.

621.397.6

3307

Westinghouse Color Television Studio Equipment.—D. L. Balthis. (*Proc. nat. Electronics Conference, Chicago*, Vol. 2, pp. 27–39.) A descriptive account of the electrical and optical equipment required to convert a 35-mm colour slide, or a 16-mm colour film and its associated sound into signals suitable for an u.h.f. colour television transmitter (480–920 Mc/s). The colour operation is based on the use of three primary colours with sequential scanning by means of colour filters. Sound and picture signals are transmitted on the same frequency.

621.397.6 : 621.398

3308

Television Equipment for Guided Missiles.—C. J. Marshall & L. Katz. (*Proc. nat. Electronics Conference, Chicago*, Vol. 2, pp. 115–129.)

621.397.6 : 629.135

3309

Television Equipment for Aircraft.—M. A. Trainer & W. J. Poch. (*RCA Rev.*, Dec. 1946, Vol. 7, No. 4, pp. 469–502.) A light-weight airborne television equipment operating on a frequency of about 100 Mc/s is described, and the design considerations involved are listed and discussed. The transmitter and camera are enclosed in a single unit which, together with a monitor and power supply, comprises the transmitting station.

Flight tests of the equipment showed difficulties peculiar to the transmission of television signals from aircraft; methods used for minimizing these difficulties are discussed. In particular instability of synchronization was overcome by use of a keyed

automatic volume control and difficulties due to multi-path transmission from one plane to another by keeping the frequency modulation of the transmitter to a minimum.

621.397.61

3310

High Power Television Transmitters — Some Aspects of Their Design : Parts 1 & 2.—P. A. T. Bevan. (*Electronic Engng*, May & June 1947, Vol. 19, Nos. 231 & 232, pp. 138–142 & 181–184, 204.) Considers the problems associated with peak power outputs up to 50 kW, involving bandwidths up to ± 5 Mc/s, with special reference to the B.B.C. 405-line system. Wide bandwidth requires 'maximally flat' coupled circuits of low Q and this implies a low anode load resistance for the amplifier valve, thus limiting the power output and anode conversion efficiency. Recent short single-ended water cooled valves such as the CAT21 give the small grid-lead inductance required for neutralized push-pull grid-modulated amplifiers at 50 Mc/s. The estimated peak power of a CAT21 is shown graphically in terms of the bandwidth response. The requirements for capacitors, insulators and resistors are briefly described. After expressing the need for more accurate measurement of large currents in v.h.f. tank circuits, the idealized linear operating conditions of a grid-modulated push-pull r.f. amplifier are illustrated and the requirements for neutralization are given. Methods described for overcoming the effects of non-linearity include loading the grid circuit of the modulated amplifier with resistance and the use of a cathode-follower driver stage. The advantages and disadvantages of the grounded-grid r.f. amplifier, and the requirements for output transmission lines and cables are described.

621.397.61

3311

Television Transmitter for Black-and-White and Color Television.—N. H. Young. (*Proc. nat. Electronics Conference, Chicago*, Vol. 2, pp. 40–53.) A general description of a 490-Mc/s transmitter giving a peak power output of 1 kW. It is designed for operation from 3-phase 60-c/s mains at either 208 or 220 V. The total power consumption is 25 kVA.

621.397.611

3312

The Electrostatic [image] Dissector.—H. Salinger. (*Proc. nat. Electronics Conference, Chicago*, Vol. 2, pp. 82–88.) Magnetic focusing is used, but scanning is done by electrostatic deflection. The deflection is achieved by means of a number of wires (twelve in this case) disposed axially inside the tube. The two scanning saw-tooth voltages are applied in different proportions to each wire. Special networks to effect proper voltage distribution have been developed.

621.397.62

3313

A Simple and Practical Television Receiver.—M. Mars. (*Télévis. franç.*, April 1947, No. 24, pp. 15–17.) Circuit diagrams and constructional details of a receiver using only 18 valves, including the three rectifiers in the supply unit. Sensitivity can be improved by the addition of another h.f. stage.

621.397.62

3314

Color Television for Theatres.—H. G. Shea. (*Tele-Tech*, June 1947, Vol. 6, No. 6, pp. 44–45.) General principles of a R.C.A. system giving pictures $7\frac{1}{2}$ ft \times 10 ft. The colours are obtained by

pecial phosphors in the three c.r. tubes. See also 246 of April.

21.397.62 : 3315
Television Sound Channels.—R. B. Dome. (*Communications*, Dec. 1946, Vol. 26, No. 12, pp. 22-25.) Summary of a Rochester Fall Meeting paper. A television receiver using a single wide-band i.f. amplifier for both sound and vision signals. Final separation depends on the frequency difference between sound and vision channels.

21.397.62 : 621.396.662.2 : 3316
Variable Inductance Tuning for TV Receivers.—Melvin. (See 3073.)

21.397.743 : 3317
Television Network Facilities.—L. G. Abraham & I. Romnes. (*Elect. Engng*, N.Y., May 1947, Vol. 66, No. 5, pp. 477-482.) A discussion on the use of (a) balanced wire pairs, (b) coaxial cables, and (c) radio relays for the interconnection of television studios.

21.397.81 : 621.396.11.029.6 : 3318
Analyzing TV Propagation at U.H.F.—Wakeman. (See 3256.)

21.397.81 : 621.396.81.029.63 : 3319
Results of Field Tests on U.H.F. (490 Mc/s) Color Television Transmissions in the New York Metropolitan Area.—Lodge. (See 3258.)

21.397.5 : 3320
Television : Vols. 3 & 4. [Book Notice]—A. N. Szmith, A. Van Dyck, R. S. Burnap, E. T. Key & G. M. K. Baker (Eds.). Radio Corporation of America, Princeton, N.J. A collection of papers dealing with all aspects of television. Volumes 1 & 2 are now out of print, but summaries of the papers in them are included in Volume 3, which covers the period 1938-1941. Volume 4 covers the period 1942-1946.

TRANSMISSION

21.316.726.029.64.078.3 : 3321
Microwave Frequency Stability.—A. E. Harrison. (*Proc. nat. Electronics Conference, Chicago*, Vol. 2, pp. 615-622.) A discussion of the principles of operation of klystron frequency multipliers and other amplifiers for direct crystal control of the microwave power.

21.396.61 : 621.396.662.1 : 3322
Auto-Sequence Tuning.—J. N. Whitaker. (*Radio Engng*, June 1947, Vol. 37, No. 6, pp. 44-45..92.) A description of a single-dial tuning system for the transmitter and frequency multiplier stages of a multi-transmitter, using identical variable capacitor. Circuit details are given.

21.396.61 : 621.396.97 : 3323
Control 250-W A.M. Broadcast Transmitter.—Kees. (*Communications*, March 1947, Vol. 27, No. 11-13, 37.) A design with only one tunable circuit, simplified metering and controls, and visible components.

21.396.61.029.5 : 3324
Transmitter with Efficient Band Switching.—Turner. (*Radio News*, June 1947, Vol. 37, No. 6, pp. 53-55..150.) The coils for the range

10-80 m are mounted on a sliding carriage, with rack and pinion operation from the front panel, which carries all controls.

621.396.61.029.5/.62] : 621.396.933 : 3325
Ground-Air Communications Unit.—S. A. Meacham. (*Communications*, April 1947, Vol. 27, No. 4, pp. 22-23..54.) A medium-power transmitter covering the bands 125-525 kc/s, 2-20 Mc/s and 100-160 Mc/s.

621.396.611.21.029.56/.58 : 3326
A Table-Top Kilowatt.—G. Grammer, D. Mix & B. Goodman. (*QST*, May 1947, Vol. 31, No. 5, pp. 13-19..154.) Triode-tetrode crystal oscillator and frequency multiplier drive an 813 push-pull amplifier. With input of 1 kW, output of 600 W is obtained at all amateur frequencies from 3.5-30 Mc/s.

621.396.619.13/.14 : 3327
Low-Frequency N.F.M. [narrow-band frequency modulation].—B. Goodman. (*QST*, July 1947, Vol. 31, No. 7, pp. 21-27.) Comparison with narrow-band phase modulation and description of a simple phase modulator.

VALVES AND THERMIONICS

537.533.7+621.385.1 : 3328
Electron Optics and Space Charge in Strip-Cathode Emission Systems.—O. Klemperer. (*Proc. phys. Soc.*, 1st March 1947, Vol. 59, No. 332, pp. 302-323.) For small emission, electron-optical laws can be applied. Simple space charge theory does not hold for special systems of the type proposed by Pierce (4275 of 1940 and back references). In these systems, the potential distribution in the beam causes a lack of homocentricity, revealed by ray-tracing results.

621.383 : 3329
Spontaneous Fluctuations of Current in a Photo-Electric Cell.—D. K. C. MacDonald. (*Nature, Lond.*, 3rd May 1947, Vol. 159, No. 4044, pp. 608-609.) Graphical presentation of the results of shot-effect measurements, with brief discussion.

621.383 : 3330
Photodetectors for Ultraviolet, Visible and Infra-red Radiation.—R. J. Cashman. (*Proc. nat. Electronics Conference, Chicago*, Vol. 2, pp. 171-180.) Review of recent developments, including (a) photoemissive cells with activated and pure metal cathodes, (b) photovoltaic cells as used in exposure meters, and (c) photoconductive cells and their uses.

621.383 : 522.615 : 3331
Application of the Multiplier Phototube to Astronomical Photoelectric Photometry.—G. E. Kron. (*Astrophys. J.*, May 1946, Vol. 103, No. 3, pp. 326-331.) Characteristics of 1P21 multiplier phototube, which is many times superior to light-sensitive units previously used in the blue region of the spectrum.

621.383.5 : 621.318.57] + 621.383.5.001.8 : 3332
The A.C. Behaviour of the Barrier Layer Photo Cell.—J. A. Sargrove. (*J. Brit. Instn Radio Engrs*, May/June 1947, Vol. 7, No. 3, pp. 86-97.) When the cell is illuminated, it acts as a non-linear conductor to current in both directions,

whereas in darkness it behaves as a rectifier. This property enables the cell to be used directly for operating relays, with a sensitivity some 300 times greater than when used as a detector. A high degree of electrical stability is obtained by operating the cell from the same a.c. supply as the lamp which illuminates it. A number of industrial applications of the method are described.

621.385

3333

Similitude of Valves.—F. H. Raymond. (*Onde elect.*, May 1947, Vol. 27, No. 242, pp. 209-212.) A demonstration of the agreement between the general theory of similitude and the technical aspect of its application to valves described by Lehmann (3821 of 1946). The similitude of valves with a common cathode is considered in particular, the possibility of other types of similitude is discussed and the law of similitude for the magnetron derived simply.

621.385:620.163

3334

Electrical Production Tests for High-Power Tubes.—B. Sheren. (*Proc. nat. Electronics Conference, Chicago*, Vol. 2, pp. 250-255.)

621.385:620.163

3335

Production Test Facilities for High-Power Tubes.—W. L. Lyndon. (*Proc. nat. Electronics Conference, Chicago*, Vol. 2, pp. 256-267.) R.C.A. equipment for testing modern high-power valves. It consists of a 25-Mc/s oscillator unit, a 1.5-Mc/s oscillator unit, and associated dummy loads, power supplies, sub-station, control and water-cooling equipment.

621.385.029.63/.64]:538.3:621.396.694

3336

On the Helix Circuit used in Progressive-Wave Valves.—Roubine. (See 3036.)

621.385.1+621.396.611.4

3337

F.M./TV P-A Tube and Grounded-Grid Cavity Circuit.—H. D. Wells & R. I. Reed. (*Communications*, March 1947, Vol. 27, No. 3, p. 16.) Summary of 1947 I.R.E. Convention paper.

621.385.1:517.54

3338

Conformal Transformations in Orthogonal Reference Systems.—Roys. (See 3171.)

621.385.1:621.396.813

3339

Microphony of Radio Valves.—Chamagne & Guyot. (*Télévis. franç.*, April 1947, No. 24, Supplement *Électronique*, pp. 7-10.) Discusses definition and gives methods of measurement.

621.385.1:621.396.813

3340

Microphonism in a Subminiature Triode.—V. W. Cohen & A. Bloom. (*Communications*, March 1947, Vol. 27, No. 3, pp. 18-41.) Summary of 1947 I.R.E. Convention paper.

621.385.1.032.216:546.431.284

3341

A Study of the Barium Silicate Interface of Oxide Coated Cathodes.—Eisenstein. (See 3158.)

621.385.16+621.396.615.141.2

3342

The Donutron. An All-Metal Tunable Squirrel-Cage Magnetron.—F. H. Crawford & M. D. Hare. (*Proc. nat. Electronics Conference, Chicago*, Vol. 2, p. 623.) Summary only. For another account see 947 of March.

621.385.2

3343

Total Emission Noise in Diodes.—A. van der Ziel & A. Versnel. (*Nature, Lond.*, 10th May 1947, Vol. 159, No. 4045, pp. 640-641.) Measurements at $\lambda 7.25$ m on a diode with negative anode voltage show that the equivalent noise temperature of the conductance is approximately equal to the cathode temperature; this relationship is expected to hold over a wide frequency range.

621.385.2

3344

Total Emission Damping in Diodes.—A. van der Ziel. (*Nature, Lond.*, 17th May 1947, Vol. 159, No. 4046, pp. 675-676.) Results of measurements at $\lambda 5.8$ m of the additional admittance in a diode due to the space charge are given in curves which show the dependence of the admittance on the anode voltage and the saturation current. See also 3109 of 1946 (Smyth).

621.385.3:621.396.694.012.8

3345

The Equivalent Diode.—J. Eastabrook. (*Wireless Engr.*, June 1947, Vol. 24, No. 285, pp. 188-189.) It is concluded that experimental discrimination between the formulae of Walker (949 of March) and Tellegen (*Physica*, 1925, Vol. 5, p. 301) is not possible; between these two and Fremlin's (3166 of 1939) it is possible but unimportant. Walker's approach is preferred on account of its simplicity and because it is theoretically sounder and does not involve the three-halves law. See also 2622 and 2623 of August.

621.385.832:[537.291+538.601

3346

Electron Optics of Deflection Fields.—R. G. E. Hutter. (*Proc. nat. Electronics Conference, Chicago* Vol. 2, pp. 424-453.)

621.396.615.14

3347

The Generator of Centimeter Waves.—H. D. Hagstrum. (*Proc. Inst. Radio Engrs., W. & E.*, June 1947, Vol. 35, No. 6, pp. 548-564.) The physical principles and performance of three types of cavity-resonator magnetron oscillator are described and discussed in some detail. Disk-seal triodes (with built-in cavity-resonators) and velocity-variation oscillators are described briefly. References to basic papers are given.

621.396.615.14+621.385.1].029.63/.64

3348

The Generation of Ultra-High-Frequency Power at the Fifty-Kilowatt Level.—W. G. Dow & H. W. Welch, Jr. (*Proc. nat. Electronics Conference, Chicago*, Vol. 2, pp. 603-614.) A comprehensive description of the cavity and electrode structures of the resonator. The effects of transit time are considered with special reference to frequency stability. See also 1732 of 1946 (Salisbury).

621.396.615.141.2

3349

A Magnetron Oscillator with a Series Field Winding.—L. H. Ford. (*J. Inst. elect. Engrs.*, Part I, April 1947, Vol. 94, No. 76, pp. 187-188.) Summary of 2631 of August.

621.396.615.141.2:621.396.645.35

3350

A Magnetron for D.C. Voltage Amplification.—H. B. G. Casimir. (*Philips tech. Rev.*, Dec. 1946, Vol. 8, No. 12, pp. 361-367.) Use of diode in which magnetic field is excited by input circuit; input and output circuits thus separated; introduction of grid at cathode potential near anode increases magnetic sensitivity, which is comparable with the amplification factor of a triode.

3366.615.141.2 : 621.396.822
Excess Noise in Cavity Magnetrons.—Sproull.
p. 3268.)

3351

3366.615.142
Velocity Modulation: Parts 1 & 2.—J. H. Malm. (*Electronic Engng.*, May & June 1947, Nos. 231 & 232, pp. 147-151 & 199-201.) General discussion of the various types of tubes. Conditions for oscillation in the Heil tube are derived and it is shown how the power from the electron beam in a rhumbatron varies with the modulation amplitude. The methods for increasing operating efficiency using the reflex klystron oscillator are compared and the mechanism of focusing for different field distributions using a reflector at high negative potential is explained with the aid of mechanical analogies. By controlling the voltage and current conditions in the focusing gap it is shown how instantaneous frequency changes are effected in a klystron by variation of the high voltage or in a reflex oscillator by variation of the reflector potential.

3352

3366.615.142
Velocity-Modulation Valves.—F. M. Penning. *Brit. J. Appl. Phys.*, July 1946, Vol. 8, No. 7, pp. 224-224.) A theoretical discussion of the principles involved in their use as amplifiers and as oscillators.

3353

3366.615.142 + 621.392.029.64] : 538.56
Generalized Boundary Conditions in Electrostatic Theory.—Schelkunoff. (See 3094.)

3354

3366.615.142.2.029.64
Klystron as Amplifier at Centimetric Wavelengths.—R. Kompfner. (*J. Brit. Instn Radio Engrs.*, May/June 1947, Vol. 7, No. 3, pp. 117-123, Discussion, pp. 123-124.) It is shown that in theory a klystron is capable of giving r.f. amplification; a detailed examination shows that noise is the limiting factor. The reduction of shot noise by a special design is discussed briefly but it is concluded that the practical difficulties in the case of the klystron are much greater than for other devices.

3355

3366.694
Empirical Formula for [valve] Amplification.—E. W. Herold. (*Proc. Inst. Radio Engrs.*, May 1947, Vol. 35, No. 5, p. 493.) A formula based on Herne's table (2210 of *Proc. Inst. Radio Engrs.*, 1946) is given. See also 2406 of 1946 (Liebmann).

3356

3366.694
Mode Characteristics.—S. Rodda. (*Wireless Engng.*, May 1947, Vol. 24, No. 284, p. 157.) Method of calculating the equivalent grid voltage of a klystron. A first approximation gives a result in agreement with that of Tellegen; a second approximation includes the effect of space charge in the anode region.

3357

3366.694
Photoelectric Cells. [Book Review]—A. Sommer. (*Proc. Inst. Radio Engrs.*, May 1947, Vol. 39, Part 4, p. 180.) Describes the properties of photoemission, the properties of common photoelectric cathodes, the matching of photocathodes and photocathodes, the mechanism of photoamplification and multiplier cells, and applications.

3358

061.3 : 621.39

A Report on the 1947 I.R.E. National Convention.—(*Communications*, March 1947, Vol. 27, No. 3, pp. 14-16..43.) For titles of some of the papers read see individual sections.

3359

061.6(54) : 666

Central Glass and Ceramic Research Institute, India.—Y. P. Varshney. (*Nature, Lond.*, 1st March 1947, Vol. 159, No. 4035, pp. 290-292.) A description covering the functions of, and facilities to be provided by, the Institute which is in process of erection at Calcutta.

3360

5 + 6] : 016

Bibliography of Scientific and Industrial Reports.—A weekly publication by the U.S. Department of Commerce, giving abstracts of reports and patents dealing with electronics, plastics, electrical machinery, equipment and supplies, instruments, metals and metal products, physics, and other subjects.

3361

5 : 3

Science, Politics, and the National Welfare.—F. L. Hovde. (*Proc. nat. Electronics Conference, Chicago*, Vol. 2, pp. 15-19.)

3362

5 : 6

Physics of To-day becomes the Engineering of To-morrow.—C. G. Suits. (*Proc. nat. Electronics Conference, Chicago*, Vol. 2, pp. 20-26.) A discussion of developments resulting from physical research, illustrated by special reference to the magnetron. See also *Elect. Engng.*, N.Y., March 1947, Vol. 66, No. 3, pp. 241-243.

3363

538.3 : 001.5

The Electric-Magnetic Analogy.—G. W. O. H. : G. H. Livens. (*Wireless Engng.*, May 1947, Vol. 24, No. 284, pp. 131-132 & 156.) Comment on 970 of March. Various manipulations of the Lagrangian and Hamiltonian functions L and A for both electric and magnetic fields tend to show that in some cases E is analogous to B rather than to H, while D (= P + E/4 π , where P is the material polarization) is analogous to H rather than to B. The advantages and disadvantages of exchanging the roles of the vectors B and H are discussed.

3364

539 Rutherford

Rutherford : Life and Work after the Year 1919, with Personal Reminiscences of the Cambridge Period.—J. D. Cockcroft. (*Proc. phys. Soc.*, 1st Nov. 1946, Vol. 58, No. 330, pp. 625-633.) The second Rutherford Memorial Lecture.

3365

539 Rutherford

Rutherford and the Modern World.—M. L. Oliphant. (*Proc. phys. Soc.*, 1st Jan. 1947, Vol. 59, No. 331, pp. 144-155.) The third Rutherford Memorial Lecture.

3366

539.1 : 62

Atoms, Electrons and Engineers.—T. E. Allibone. (*J. Instn. elect. Engrs.*, Part I, April 1947, Vol. 94, No. 76, pp. 165-171.) The Faraday Lecture. Salient features of modern atomic theory. Common substances and processes used in engineering are examined in the light of this theory. Uranium fission and its applications are described.

3367

- 614.825 **3368**
Dangerous Electric Currents.—C. F. Dalziel. (*Trans. Amer. Inst. elect. Engrs*, December Supplement 1946, Vol. 65, pp. 1123-1124.) Discussion on 310 of January.
- 621.3.016.25 **3369**
The Sign of Reactive Power.—(*Elect. Engng, N.Y.*, May 1947, Vol. 66, No. 5, pp. 514-517.) Sixteen further comments on 971 of March. See also 1972 of June.
- 621.3 "1920/1946" **3370**
A Synoptic Review of Electrical Engineering Progress, particularly during the Last Quarter Century.—J. D. Ferguson. (*J. Instn elect. Engrs*, Part I, Feb. 1947, Vol. 94, No. 74, pp. 73-81.) Abstract of Chairman's address to Irish branch of I.E.E.
- 621.38/39 **3371**
Electronics and the Future.—E. U. Condon. (*Proc. nat. Electronics Conference, Chicago*, Vol. 2, pp. 1-14.) The opening address at the Conference.
- 621.38/39 **3372**
Some Aspects of Electronic Engineering.—T. P. Allen. (*J. Instn elect. Engrs*, Part I, Feb. 1947, Vol. 94, No. 74, pp. 113-115.) Abstract of Chairman's address to Northern Ireland Centre of I.E.E.
- 621.395 : 061.24 C.C.I.F. **3373**
The 14th Plenary Session of the Comité Consultatif International Téléphonique (C.C.I.F.) in Montreux, 21st-31st October 1946.—W. Schiess. (*Tech. Mitt. schweiz. Telegr.-TelephVerw.*, 1st April 1947, Vol. 25, No. 2, pp. 73-82. In German.) A general account of the proceedings.
- 621.396 **3374**
Scientific Problems of Contemporary Radio.—N. D. Papalexi. (*Vestnik Akad. Nauk, S.S.S.R.*, 1946, No. 7, pp. 9-15. In Russian.)
- 621.396 **3375**
[Radio Society of Great Britain] **Presidential Address.**—S. K. Lewer. (*Proc. R.S.G.B.*, Spring 1947, No. 1, pp. 1-6.) Discusses the revival of obsolete radio techniques to solve new problems.
- 621.396 : 06.053 URSI **3376**
Summary Report of the Seventh General Assembly of the International Scientific Radio Union (URSI) in Paris, September 27-October 25, 1946.—Newbern Smith. (*Terr. Magn. atmos. Elect.*, March 1947, Vol. 52, No. 1, pp. 80-83.) Statement of resolutions adopted. For a summary of selected papers read at the Conference, see 2758 of September.
- 621.396 "1939/1946" **3377**
Radio-Communication Developments.—(*Wireless World*, May 1947, Vol. 53, No. 5, pp. 158-160, 181.) Report of the I.E.E. Radio-Communication Convention of March 1947 which covered advances made since 1939.
- 621.396.1.029 **3378**
Proposed Frequency Band Designations.—(*Elect. Engng, N.Y.*, May 1947, Vol. 66, No. 5, p. 471.) Explanation, by the technical committee on standard frequency bands, of a 'decade frequency system' in which the designation of each band is the characteristic of the logarithm to base 10 of all the frequencies within the band. Band 5, for example, includes frequencies from 10^5 to 10^6 c/s. See also 3742 of 1945.
- 621.396.97 : 621.396.82 **3379**
The War of Broadcasting.—E. Wolf. (*Tech. Mitt. schweiz. Telegr.-TelephVerw.*, 1st April 1947, Vol. 25, No. 2, pp. 64-72. In German and French.) Discusses the part played by broadcasting during the war and describes the development of methods of attack and defence, from simple jamming of enemy transmissions to intrusion on the single sideband of the enemy carrier wave.
- 491.7-3 = 2 **3380**
Russian - English Technical and Chemical Dictionary. [Book Review]—L. I. Callahan. John Wiley & Sons, New York, 794 pp., \$10.00. (*Amer. J. Sci.*, July 1947, Vol. 245, No. 7, p. 463.) The book leans towards chemistry, but nearly every natural science, medicine, mathematics engineering, etc., receives some attention.
- 621.38/39 **3381**
Proceedings of the National Electronics Conference, Vol. 2. [Book Notice]—R. E. Beam (Ed.). Electrical Engineering Department, Northwestern University, Evanston, Illinois, 1947, 741 pp., \$3.50. A collection of papers presented at the Second National Electronics Conference held at Chicago, 3rd-5th Oct. 1946. For abstracts of selected individual papers, see other sections.
- 621.396 **3382**
Radio's Conquest of Space. [Book Review]—D. McNicol. Murray Hill Books Inc., 364 pp., \$4.00. (*Electronic Engng*, June 1947, Vol. 19, No. 232, p. 202.) The author traces "the evolution of radio as a disinterested observer... This is a good book and an authoritative book."
- 621.396 **338**
Reference Data for Radio Engineers. [Book Review]—W. L. McPherson. Standard Telephones and Cables, London, 175 pp., 5s. (*Overseas Engnr*, March 1947, Vol. 20, No. 234, p. 278.) "It consists of a series of tables which list mathematical theorems and short reminders of essential definitions. It is profusely illustrated with curves and diagrams relating to every important aspect of radio engineering."
- 621.396 **3384**
Second Year Radio Technology. [Book Review]—W. H. Date. Longmans, Green & Co., London, 222 pp., 7s. 6d. (*Elect. Rev., Lond.*, 22nd Aug. 1947, Vol. 141, No. 3639, p. 304.)
- 621.396 **3385**
The Radio Amateurs' Handbook. [Book Review]—Headquarters Staff of the American Radio Relay League. American Radio Relay League, West Hartford, Conn., 24th edn 1947, 470 pp., \$1.25 in U.S.A., \$2.00 elsewhere. (*Proc. Inst. Radio Engrs, W. & E.*, July 1947, Vol. 35, No. 7, p. 707.) For review of 1946 edition see 1303 of April. The section on equipment construction revised, and information on the mechanical construction of aerials has been added.