

THE WIRELESS ENGINEER

VOL. XVI.

MARCH, 1939

No. 186

Editorial

The Reception of Ultra-Short Waves by Metal Horns

IN the Editorials of June and September, 1936, we discussed the striking experimental results obtained by G. C. Southworth of the Bell Telephone Laboratories in transmitting ultra-short electromagnetic waves inside metal pipes in much the same way as sound waves are transmitted along a speaking tube. From time to time reports have been issued showing that work on the subject is being continued. If the pipe is left open, waves issue from the open end as sound waves do from an open pipe, and if the end is expanded into a horn the effects are similar to those occurring in acoustics. An acoustic horn can provide an efficient radiating load for a sound generator and in a similar manner an electromagnetic horn may provide a suitable radiating termination for the generator of ultra-short waves. G. C. Southworth and A. P. King have recently carried out a series of experiments with the open ends of pipes and with simple horns to determine their directivities*. The results have shown that it is possible to obtain with a simple horn a power gain of about a hundred times that of an ordinary half-wave antenna. They point out that this is about the gain obtained by the best transoceanic antenna arrays. Of the various types of waves which can be propagated along pipes, the only type employed in these experiments was that shown in Fig. 1, which is reproduced from Fig. 5, page 292, of the *Wireless Engineer*

* We are indebted to Dr. Southworth for an advance proof of a detailed paper on the subject which is being published in the Proceedings of the Institute of Radio Engineers.

of June, 1936. It is known in the Bell Laboratories as the H_1 type. The wavelength employed was between 10 and 15 centimetres and the distance between the transmitter and the receiver varied from 30 to 100 times the wavelength; both were situated about a metre above the floor when

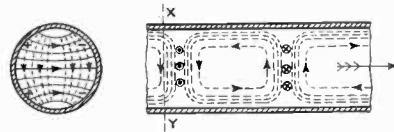

Fig. 1.—The crosses and dots in circles indicate the direction of the electric field. The dotted curves represent the magnetic field. (Left) Section through XY in the direction of arrow; dotted curves represent the magnetic field.

in a room, but in some of the experiments the waves were transmitted from an upstairs window to a receiver on the ground. The transmitter was not varied, but the horn under test was fitted to the receiver and turned at various angles to the line of propagation. The energy received was plotted against the direction, the polar curves thus obtained giving a measure of the directivity of the horn. Distribution in the horizontal is not the same as that in the vertical plane because of the polarisation of the waves. The receiver is shown diagrammatically in Fig. 2. The resonance of the cavity is adjusted by the metal piston *P*, which must make good contact with the walls. The side tube constitutes a concentric transmission line the length of which can be adjusted by a sliding piston making contact both with the walls and with the central

conductor. In this central conductor is a silicon-crystal rectifier actuating a microammeter or a potentiometer. By means of the two moving pistons the detector is matched to the horn, so that the receiver as a whole approximates to a perfect absorber of the energy entering the horn, and standing waves in the tube are reduced to a minimum.

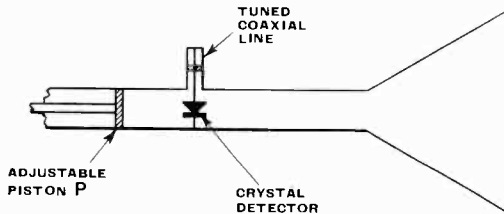

Fig. 2.

The rectifier consists of a piece of silicon about 1 mm. diameter and 1 mm. long, let into the end of a small screw, and a contact wire of tungsten or phosphor bronze about 10 mils diameter and 2 mm. long.

A great number of horns of various shapes but mostly conical were tested; they were made of 22 gauge galvanised iron riveted and soldered at the joint and attached to short lengths of 12.4 cm. brass pipe. Results showed that the sharpest directivity was obtained with horns having an opening of about 50 degrees; with smaller angles the directivity was not so sharp, and with larger angles side lobes and other irregularities became pronounced, as one would expect. When the angle was kept constant and the length of the horn varied, the directivity increased with the length of the horn. Increase of directivity means an increase of received power in the optimum direction. The authors express their results in terms of the power ratio, taking as their standard of reference a perfectly non-directional receiver, *i.e.*, a hypothetical receiver giving the same result for radiation arriving in any direction in space. Compared with this standard, a short doublet has a gain of 1.76 decibels, and a half-wave antenna in free space a gain of 2.15 decibels. If the polar curve of the power radiated from the open end of a pipe were a sphere, this would correspond to a gain of 7.78 decibels. In the experiments referred to above in which the angle of the conical horn was kept constant and its length increased, keeping the wavelength constant,

or the wavelength decreased, keeping the length constant, it was found that the power ratio was directly proportional to the ratio of the area of aperture to the square of the wavelength up to values of this ratio of about 10, *i.e.*, up to diameters of about 3.5λ ; further increase of the ratio gives very little increase of power. The maximum gain appears to be about 22 decibels. Antenna arrays used for transoceanic communication give a somewhat similar proportionality between area and received power.

Although, so far as we are aware, no practical application has yet been made of these hyper-frequency wave guides, it is noteworthy that ten papers on the subject have been published since 1936. The emission of electromagnetic waves from the end of a pipe and their collection by a conical funnel is certainly an achievement of great scientific interest. One cannot help wondering what happens to the peculiar type of wave shown in Fig. 1 when it reaches



Horn and receiver for 10 cm. waves.

the open end of the tube and goes out into space, being perhaps spared too sudden a transition by means of an expanding horn fitted to the end of the tube. A similar question arises in connection with the portion of the wave that enters the receiving funnel and is gradually reduced in cross-section until it enters the tube containing the rectifier.

G. W. O. H.

Ultra-Short Wave Propagation*

Comparison Between Theory and Experimental Data

By *R. L. Smith-Rose, D.Sc., Ph.D., M.I.E.E., and
(Miss) A. C. Stickland, M.Sc.*

(Radio Department, National Physical Laboratory)

ABSTRACT.—The object of the present paper is to make a comparison between the theoretical and experimental data so far available on the propagation of ultra-short waves to moderate distances. The study is limited to the propagation of waves below 10 metres in wavelength (frequency above 30 Mc/s) and at such distances and heights above the earth's surface that the influence of the ionosphere may be assumed to be negligible. It is convenient, although not necessary, to divide the range of distances concerned into two portions; the first covers the distance from the transmitter over which the earth's surface may be considered plane, while the second includes the longer distances over which the curvature of the earth and the consequent diffraction of the waves must be taken into account.

The experimental data utilised cover wavelengths from 0.73 to 8.8 metres (410 to 34 Mc/s) and distances of transmission of a few metres up to 200 km. In the majority of cases the radiation was vertically polarised, but in a few instances horizontal polarisation appears to have been employed. It is shown that there is general agreement between the experimental data and the current theoretical formulae for the above two cases. It is considered that the divergencies which occur, particularly at the longer distances and with the shorter wavelengths, may well correspond with the inaccuracies of the experimental measurements. There is clearly a need for the further development of the technique of field strength measurements, particularly at wavelengths below 5 metres, and for the carrying out of systematic experiments to compare the propagation of waves with the theoretical formulae now available.

1. Attenuation of Waves over a Plane Earth

(a) *Theoretical.*

THE problem of the propagation of waves over a plane earth was first investigated by A. Sommerfeld in 1909¹, and in a later paper published in 1926² he summarised and simplified the previous work, incidentally correcting an error in sign in the earlier paper. The expression obtained in the latter paper for the attenuation of the field with distance, is identical with that derived by B. van der Pol and K. F. Niessen³ in 1930 by a different method. At an intermediate period (1919), H. Weyl⁴ also studied the problem and obtained an expression giving values which agree with those obtained by K. A. Norton⁵ using the formula of van der Pol and Niessen. Thus there would appear to be substantial agreement between the theoretical formulae, and in a recent summary of the position, with a bibliography, C. R. Burrows⁶ has simplified Wise's⁷ expression of the attenua-

tion formula, and produced a form which is convenient for numerical calculation.† Until recently, these formulae have been calculated only for the case of medium or long waves propagated along the earth's surface under such conditions that the heights of both the transmitting and receiving aerials are small compared with the wavelength.

In ultra-short wave practice this condition frequently does not apply, and it is therefore necessary to take into account the effect of the height of transmitter and receiver on the field-strength at any distance. In many such cases the problem can be reduced to the calculation of the vectorial sum of two waves arriving at the receiver, one direct from the transmitter, and the other after reflection from the earth's surface. This matter has been explored to some extent by C. R. Burrows, A. Decino and L. E. Hunt⁸, who showed that when the angle of incidence of the waves on the earth's surface is sufficiently large, the reflection coefficient may be taken as unity, and the field strength at

* MS. accepted by the Editor, July, 1938.

† See Appendix.

the receiver then becomes inversely proportional to the square of the distance. The problem has been elaborated in a more recent contribution by B. Trevor and P. S. Carter⁹.

(b) *Experimental.*

It is not until comparatively recently that it has become practicable to measure

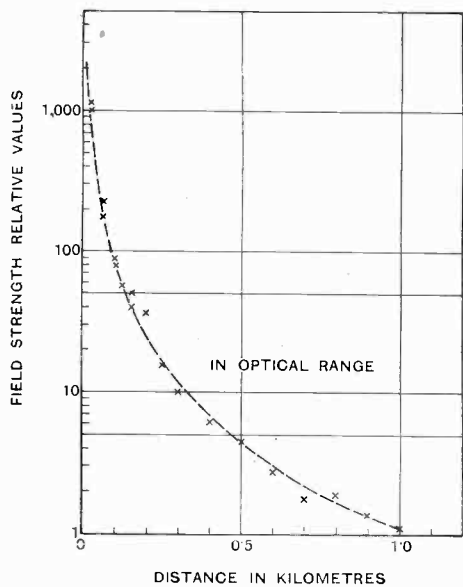

--- Theoretical curve for plane earth.

Fig. 1.—Burrows, 1937. Fresh water.
 $\lambda = 2 \text{ m}$; $f = 150 \text{ Mc/s}$.
 Polarisation—vertical.

field intensities at ultra-short wavelengths to an accuracy sufficient for comparison with the above theoretical formulae, and for this reason the quantity of reliable experimental data is not large. In a paper to which reference has already been made, Burrows has given the results of experiments made over fresh water on a wavelength of 2 metres (frequency 150 Mc/s) over distances up to 1,000 metres, and Fig. 1 shows that the agreement between the results and the theoretical formula (of Sommerfeld, van der Pol and Niessen, and Weyl) is very good and certainly within the limits of experimental accuracy.

In Fig. 2 this formula is compared with experimental results obtained by R. C. Colwell and A. W. Friend¹⁰ for propagation over fresh water on a wavelength of 5.1

metres (frequency 59 Mc/s). While the agreement in this case is not so good as that obtained by Burrows over the same distance (100 metres) it is possible that the discrepancies are due to experimental errors.

Trevor and Carter⁹ have made an extensive study of the propagation of ultra-short waves over sea-water under various conditions, and Figs. 3 and 4 show a comparison of their results with the theoretical curves calculated from the same formulae. Fig. 3 refers to a wavelength of 8.6 metres (34.8 Mc/s), and distances up to 50 km. For the heights of transmitter and receiver employed, the optical range was about 17 km, but it is seen that at greater distances experimental values tend to decrease somewhat more rapidly than the theoretical indications. Fig. 4 shows the results of several experiments on a wavelength of 5 metres (59.7 Mc/s). In successive experiments different radiated powers were employed but these have been corrected to a uniform value of

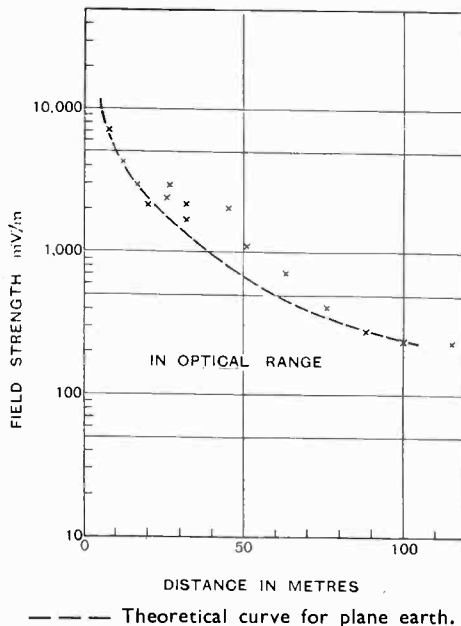

--- Theoretical curve for plane earth.

Fig. 2.—Colwell and Friend, 1937. Fresh water.
 $\lambda = 5.1 \text{ m}$; $f = 59 \text{ Mc/s}$.
 Radiation—120 W.
 Polarisation—no data.

10 watts. In one case the general agreement with the theoretical curve is reasonably good, but in the other two cases the measured field appears to be too high, and there is a

serious discrepancy between the two series of the measurements.

When the height of either transmitter or receiver is large compared with the wavelength, and the distance of transmission is within the optical range, the inverse square-law relationship referred to above may be employed to calculate the received field

the known radiation of the transmitter in a horizontal direction. For the distances shown the angle of incidence of the ray reflected from the ground varied from 81° to over 88° , and under these conditions the reflection coefficient of the ground has been taken as unity, with a phase change of 180° .

In concluding this section, it may be stated that a review of the somewhat scanty experimental data for short-distance propagation for wavelengths below 10 metres indicates that there is general agreement between these data and the theoretical values to within the experimental accuracy, which is naturally not very high. There appears to be a need for further experimental investigation of this problem under carefully

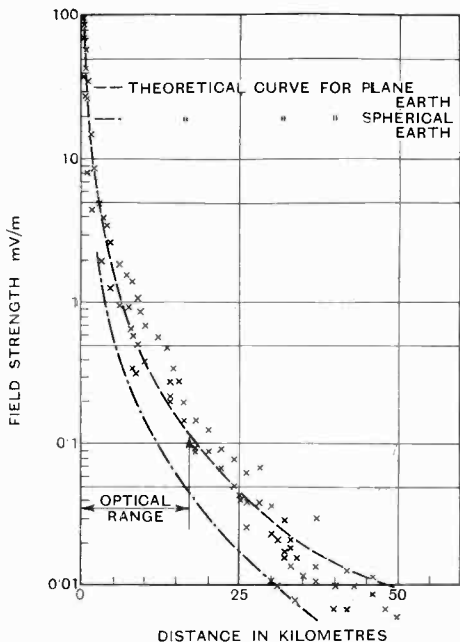

Fig. 3.—Trevor and Carter, 1933. Sea.
 $\lambda = 8.6 \text{ m}$; $f = 34.8 \text{ Mc/s}$.
 Radiation—22 W.
 Polarisation—vertical.

intensity. The closeness with which such a law will fit certain experimental results is illustrated in Fig. 5,* which shows the results of measurements made on the London Television Station (Alexandra Palace) and published by the British Broadcasting Corporation. The values plotted are the average of a series of measurements made in all directions round the station at distances up to 40 km. The theoretical curve has been calculated from the average height at which all the measurements were taken and

* Fig. 5 also shows the corresponding diffraction curve obtained from Eckersley's formula referred to in the next section. The agreement between this curve and the experimental results is also very good considering that the conditions are such that reception is always within the optical range.

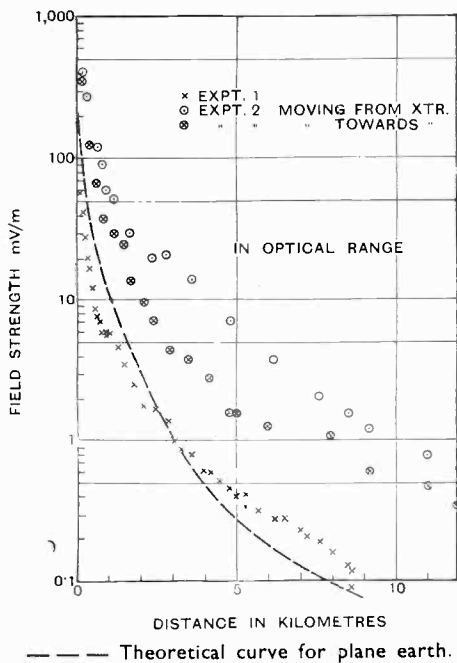

Fig. 4.—Trevor and Carter, 1933. Sea.
 $\lambda = 5 \text{ m}$; $f = 59.7 \text{ Mc/s}$.
 Radiation—10 W.
 Polarisation—vertical.

controlled conditions. The case of propagation over flat ground of different types appears to have received no attention so far, possibly due to the spurious effects which may be introduced by reflection and scattering from obstacles such as trees and buildings. It would, however, be interesting and useful to have some experimental

checks of the theory for such distances overland, for which the electrical constants of the ground are uniform and also known.

2. Attenuation of Waves Round a Spherical Earth

(a) Theoretical.

It is now well known that ultra-short waves can be transmitted to distances beyond the optical horizon from the source even under conditions for which there is evidence that the ionosphere does not play a definite part in the propagation. The reception of radio signals under such conditions is now recognised as being due to the diffraction of waves round the curved surface of the earth, or to refraction in the lower atmosphere, or to a combination of these effects. The calculation of the effects of diffraction has been made by T. L. Eckersley¹¹ who has based his work on the previous theoretical work of G. N. Watson¹² taking into account the electrical constants of the earth. P. von Handel and W. Pfister¹³ have also derived formulae based on the theoretical work of Watson, and of P. S. Epstein¹⁴, but they appear to have neglected the effect of the finite conductivity of the earth.

The results of Eckersley's calculation have been conveniently presented¹⁵ in a series of graphs, from which the field intensity may be obtained for a variety of conditions. An independent consideration of the problem of wave diffraction has also been undertaken by B. van der Pol and H. Bremmer and a paper on the subject has recently been published¹⁶. A further investigation of the problem has been carried out by B. Wwedensky¹⁷. The three sets of theoretical formulae thus made available have been compared for propagation over land and sea on a wavelength of 7 metres to a distance of 100 km. For small heights (i.e. in comparison with the wavelength) of sending and receiving antennae very close agreement is obtained between the formulae of Eckersley and van der Pol, but Wwedensky's formula, while giving good agreement in the oversea case, differs from the others by some — 40 per cent. for overland conditions. When the calculation is made for a height of sending antenna of 100 metres, the Eckersley and van der Pol formulae give a constant disagreement of some 30 per cent., while the

Wwedensky formula gives a different rate of attenuation with distance, and at the mid-distance (50 km.) in the range considered gives values of the field some 300 per cent. greater than those obtained from the other formulae. From this brief survey of the position of the theoretical analysis, it appears that there is some justification for assuming that the Eckersley and van der Pol formulae, derived by entirely different methods, represent, with fair agreement, the field resulting from diffraction effects. On account of the detailed manner in which the data have been presented by Eckersley, it was found con-

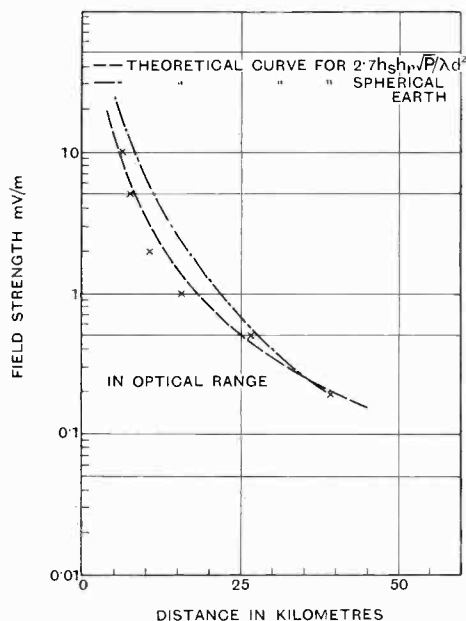

Fig. 5.—B.B.C., 1936. Land.

$\lambda = 7.25 \text{ m}$; $f = 41.5 \text{ Mc/s}$.

$h_s = 120 \text{ m}$; $h_r = 2.5 \text{ m}$.

Radiation—8.7 kW.*

Polarisation—vertical.

* This is the effective radiation allowing for the measured gain produced by the reflector array. The actual power supplied to the antenna system is 3 kW.

venient to use his theoretical values in the following comparison with experimental results.

(b) Experimental.

In the Document No. 16 presented by Great Britain to the Bucharest meeting of the C.C.I.R., some experimental results were included for comparison with the

corresponding theoretical curves calculated from the diffraction formulae.* These results included measurements made by L. F.

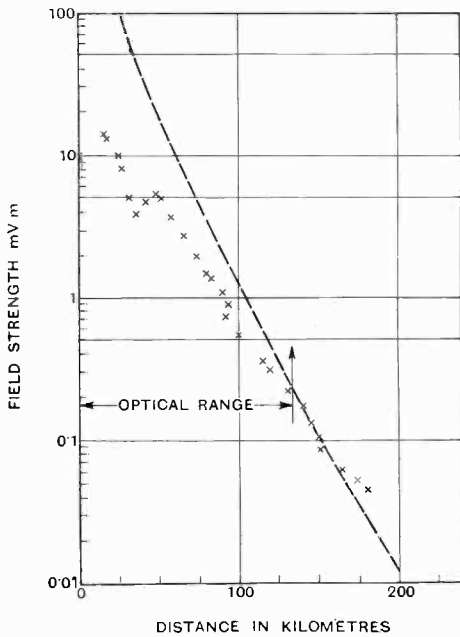

— — — Theoretical curve for spherical earth.
 Fig. 6.—Trevor and Carter, 1933. Along coast.
 $\lambda = 6.8 \text{ m}$; $f = 44 \text{ Mc/s}$.
 $h_s = 396 \text{ m}$; $h_r = 300 \text{ m}$.
 Radiation—2 kW.
 Polarisation—vertical.

Jones¹⁸ on a wavelength of 6.8 metres (44 Mc/s) and by Trevor and Carter⁹ on wavelengths of 6.8 and 8.8 metres (44 and 34 Mc/s). These comparisons were, however, made with a view to ascertaining the mode of the variation with distance and height rather than as a direct check on the absolute values of field intensity. In the experimental results discussed below, only the available material providing absolute measurements has been utilised. Such material is very scanty and is mainly concerned with the variation of field intensity with height at a fixed distance, although in one or two cases the variation of field intensity with distance has been measured.

In Fig. 3, already referred to in the consideration of propagation over a plane earth for low heights of transmitter and receiver, the appropriate diffraction curve has been added to illustrate the transition from the

* See also T. L. Eckersley, Ret. 15.

formula for plane earth to that for a spherical earth. It will be seen that the experimental results agree better with the plane earth curve inside the optical range, but gradually drop towards the spherical earth curve at some little distance beyond the horizon. Fig. 6 shows a comparison of some results obtained by Trevor and Carter on a wavelength of 6.8 metres (44 Mc/s) at distances up to and beyond the optical range for both transmitter and receiver raised well above the earth's surface. It is seen that while there is fair agreement with the theoretical curve, this gives excessive values at distances short of the horizon. Corresponding results obtained by Trevor and George¹⁹ for a wavelength of 73 cm (410 Mc/s) and shown in Fig. 7, do not give such good agreement beyond the optical range. Figs. 8 and 9 show the results of Trevor and Carter's

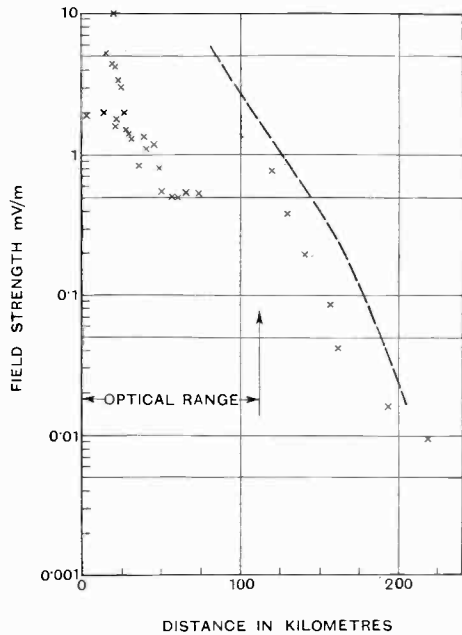

— — — Theoretical curve for spherical earth.
 Fig. 7.—Trevor and George, 1935. Land.
 $\lambda = 73 \text{ cm}$; $f = 410 \text{ Mc/s}$.
 $h_s = 37 \text{ m}$; $h_r = 1,035 \text{ m}$.
 Radiation—1 kW approx.
 Polarisation—horizontal.

measurements of the variation of field strength with height at fixed distances and on wavelengths of 6.8 and 8.8. metres (44 and 34 Mc/s) respectively. The shorter wavelength results given in Fig. 8 show good

agreement with the theoretical curve at distances well outside the optical range. All the results given in Fig. 9 refer to conditions outside the optical range, but the

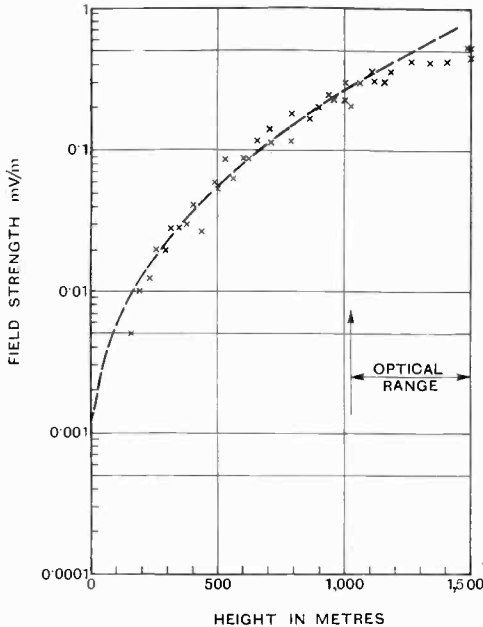

— — — Theoretical curve for spherical earth.

Fig. 8.—Trevor and Carter, 1933. Land.
 $\lambda = 6.8 \text{ m}$; $f = 44 \text{ Mc/s}$.
 $h_s = 396 \text{ m}$; distance = 185 km.
 Radiation—2 kW.
 Polarisation—vertical.

agreement is seen to be not so good. Fig. 10 contains the results of measurements made by Trevor and George of the variation of field strength with height for two distances of transmission on a wavelength of 73 cm (410 Mc/s). In view of the difficulties accompanying the carrying out of measurements at such short wavelengths, the agreement is remarkably good.

3. Refraction Effects and Fading

The problem of the refraction of ultra-short waves in the lower regions of the atmosphere was also discussed to some extent in Document No. 16 presented at Bucharest. The manifestation of this phenomenon is frequently obtained in communication to moderate distances outside the optical range when fading of the signals occurs. Up to the present time, however, no distinction has

really been possible between refraction of waves in the lower atmosphere and the return of waves from the upper atmosphere (or ionosphere) in the manner normally experienced on longer wavelengths. The variation of signal strength which can be obtained under such conditions is illustrated in Figs. 11 and 12, which show the results of measurements of the received field on experimental ultra-short wave radio telephone links operated by the British Post Office between England and Guernsey, in the Channel Islands. The vertical lines on these diagrams indicate the range of variation of field strength experienced under typical conditions, and the average value is indicated by an asterisk. The broken curves show the theoretical relationships between field strength and height of receiver as obtained from Eckersley's diffraction formula. The dotted and chain line curves show the corresponding field strengths which would be expected assuming refraction in a dry and moist atmosphere respectively (see section 5 of Appendix). It is seen that while in all cases the mean value of the

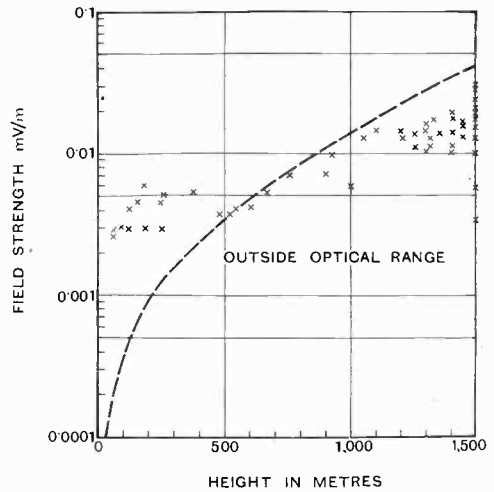

— — — Theoretical curve for spherical earth.

Fig. 9.—Trevor and Carter, 1933. Land.
 $\lambda = 8.8 \text{ m}$; $f = 34 \text{ Mc/s}$.
 $h_s = 39 \text{ m}$; distance = 182 km.
 Radiation—1 kW.
 Polarisation—vertical.

received field is from 40 to 300 per cent. greater than the diffracted field, the instantaneous values of the received field vary over a range exceeding ± 200 per cent.

When, however, the effect of refraction is included, it would appear that both the mean value and the range of variation may be accounted for, at least in a general way.

4. General Conclusions

The above paper constitutes a review of the present position of our knowledge concerning the propagation of ultra-short waves to short and moderate distances as obtained

of the agreement between theoretical and experimental results of wavelengths between 2 and 10 metres (150 to 30 Mc/s).

When the distance of transmission is so great that the curvature of the earth has to be taken into account, the variation of field intensity with distance follows approximately the diffraction formula of T. L. Eckersley, which has also been shown to be in substantial agreement with the corresponding relationship obtained by B. van der Pol. For wavelengths between 73 cm and 8 metres (410 and 37.5 Mc/s) the variation of received field strength with height above the ground follows also the same theoretical formulae to an accuracy which may correspond to that of the experimental measurements. Furthermore, when the dis-

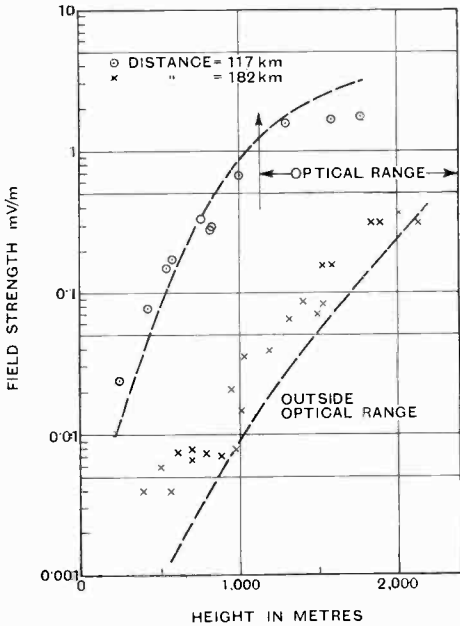

— — — Theoretical curve for spherical earth.

Fig. 10.—Trevor and George, 1935. Land.
 $\lambda = 73 \text{ cm}$; $f = 410 \text{ Mc/s}$.
 $h_s = 37 \text{ m}$.
 Radiation—1 kW approx.
 Polarisation—horizontal.

from a comparison between existing theoretical formulae and experimental results. The available data suitable for such a comparison on wavelengths below 10 metres are, on the whole, of rather a scanty nature, but are sufficient to enable tentative conclusions to be drawn. When the heights of both transmitter and receiver above the earth's surface are small compared with the wavelength, and the distance of transmission is up to about 10 km., it appears that the variation of the received field intensity with distance follows sensibly the theoretical relationship derived from the work of Sommerfeld and others. There is no obvious change in the accuracy

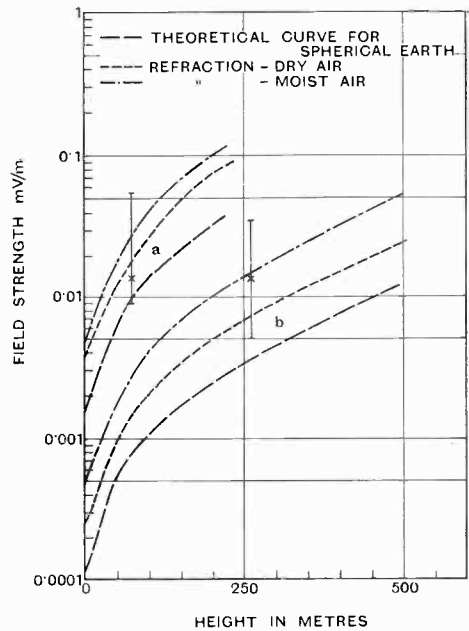

Fig. 11.—Post Office, 1934. Sea.
 $\lambda = 5 \text{ m}$; $f = 60 \text{ Mc/s}$.
 $h_s = 90 \text{ m}$.
 Distance (a) = 122 km, (b) = 171 km.
 Radiation—1 kW.*
 Polarisation—horizontal.

* The experimentally measured values of the field have been adjusted to an effective radiation of 1 kW after making allowance for the gain of the reflector system.

tance of transmission exceeds about 100 km considerable variations in the received field intensity with time are experienced and

these may be due to refraction effects in the lower atmosphere. In such circumstances the average received field appears to be somewhat greater than that to be expected from the diffraction effect alone.

The difference in the theoretical and experimental values for some of the cases considered above amounts to 100 per cent. or more, but it is doubtful if any definite accuracy can be ascribed to the experimental measurements, particularly at the shorter wavelengths, below about 5 metres. There is quite clearly a need for the further development of the technique of field strength

height of sending and receiving antennae, the magnitude and direction of the radiation are all measured as accurately as possible. Investigation should be made of the variation of the received field with height and with the electrical constants and contour of the ground. At the longer distances at which the curvature of the earth has to be taken into account, a study should be made of the variation of the field with time, in order to separate the component effects which may be due to diffraction and refraction respectively. Only by the study of the results of measurements carefully made in this manner, can our existing knowledge of the propagation of ultra-short waves be applied to practical radio communication.

5. Acknowledgment

The work described in this paper was carried out as part of the programme of the Radio Research Board, and is published by permission of the Department of Scientific and Industrial Research.

APPENDIX

1.—Field due to direct Radiation.

It is first necessary to establish the formula giving the field strength due to direct radiation from an aerial quite apart from any disturbing effects such as absorption of energy by the ground or diffraction.

For a linear antenna in free space the radiation in the equatorial plane is given in practical units by the formula :

$$E_0 = 60 \pi \frac{HI}{\lambda d} \dots \dots \dots (1)$$

where E_0 is the field strength in volts per metre

H is the length of the aerial in metres

λ is the wavelength in metres

d is the distance in metres

I is the current in amperes, assumed uniform.

If the current is not uniform throughout the aerial an effective value of H must be used to relate the current distribution to its maximum value I .

If the same antenna is placed above and perpendicular to a perfectly conducting plane, and the current in the aerial is maintained, then

$$E_0 = 120 \pi \frac{HI}{\lambda d} \text{ volts/m.} \dots \dots (2)$$

This formula is often applied in medium wave broadcast transmission to the radiation from vertical aerials up to $\lambda/4$ in height, when the field is

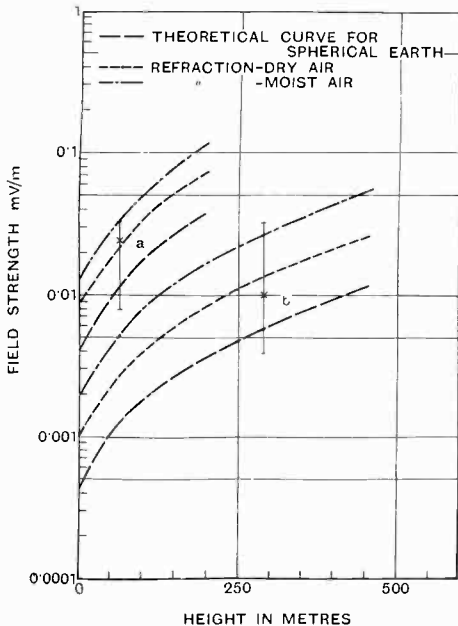

Fig. 12.—Post Office, 1934. Sea.

$\lambda = 8 \text{ m} ; f = 37.5 \text{ Mc/s.}$
 $h_s = 90 \text{ m.}$
 Distance (a) = 122 km, (b) = 171 km.
 Radiation—1 kW.*
 Polarisation—horizontal.

* The experimentally measured values of the field have been adjusted to an effective radiation of 1 kW after making allowance for the gain of the reflector system.

measurements at ultra-short wavelengths, and for the carrying out of systematic experiments to compare the propagation of waves with the theoretical formulae already available. The measurements should be conducted under carefully controlled conditions in which the wavelength, distance,

expressed conveniently in the form :

$$E_0 = 0.3 \frac{\sqrt{P_{KW}}}{d_{km}} \text{ volts/m.} \quad \dots \quad (2.1)$$

where P is the power in kilowatts applied to the aerial and d is the distance in kilometres.

In the case of ultra-short wave transmission, it is customary to use one or more half-wave dipoles, erected at such a height above the earth's surface that the radiation is sensibly that of a dipole in free space to which formula (1) applies. Since in this case, the radiation resistance is about 80 ohms, the power supplied to the aerial is

$$P = 0.08 I^2 \text{ kilowatts}$$

$$\therefore E_0 = \frac{60\pi}{\lambda d} \cdot \frac{\lambda}{\pi} \cdot \frac{\sqrt{P}}{\sqrt{0.08}} = \frac{0.212 \sqrt{P_{KW}}}{d_{km}} \text{ volts/m.} \quad \dots \quad (3)$$

The above simple relationships, representing the conditions for radiation through free space or over a perfectly conducting earth, are sometimes referred to as expressions of the "inverse-distance law." For transmission over sea-water with wavelengths of the order of 100 metres this law was first verified experimentally by Duddell and Taylor in 1905²⁰.

2.—Radiation over a plane Earth of finite Conductivity.

For the case of radiation transmitted over a plane earth, the heights of both transmitter and receiver being negligibly small, the expression for the potential of the field derived by Sommerfeld² and by van der Pol and Niessen³ is

$$\Pi = \frac{e^{jK_1 d}}{d} \cdot [1 - 2\sqrt{\rho} e^{-\rho} \int_0^{\sqrt{\rho}} e^{v^2} dv + j\sqrt{\pi\rho} e^{-\rho}] \dots (4)$$

where ρ is Sommerfeld's "numerical distance" defined by

$$\rho = \frac{K_1^4}{K_2^4} \cdot \frac{K_1^2 - K_2^2}{K_1^2} \cdot \frac{K_1 d}{2j}$$

with d = distance from transmitter to receiver

$$K^2 = \frac{\epsilon\omega^2 + j\omega\sigma}{c^2}$$

- ϵ = dielectric constant
- σ = conductivity
- ω = angular frequency
- c = velocity of light

(Suffix 1 refers to air and suffix 2 to earth).

For the case of ultra-short wave propagation in which we are interested the earth's constants are such that $\epsilon_2\omega$ is of the same order of magnitude as σ_2 , so that K_2 is complex, and the expression for ρ cannot easily be simplified. The expression for Π is therefore very complicated for numerical calculation, and the expansion as a power series

formulated by Wise⁷ and interpreted by Burrows⁸ has been used. This is presented as follows :

$$E = E_0 \left[A - \frac{B}{2} \right] \doteq E_0 C \quad \dots \quad (5)$$

where

E_0 is the field obtained from equations (1) to (3) for ideal conditions.

$$A = 1 + \sum_{n=1}^{\infty} \frac{x^n e^{2jn(d+\pi/4)}}{1.3.5 \dots (2n-1)}$$

$$B = \sqrt{2\pi x} e^{-(x/2) \sin 2\delta + j[(x/2) \cos 2\delta + (\delta + \pi/4)]}$$

$$C = - \sum_{n=1}^{\infty} \frac{1.3.5 \dots (2n-1)}{x^n e^{2jn(\delta-\pi/4)}}$$

$$x e^{2j\delta} = \frac{2\pi d \times 10^3 / \lambda}{\epsilon - 2j\sigma / f}; \quad 0 \leq \delta \leq \frac{\pi}{4}$$

- e = dielectric constant of earth in e.s.u.
- σ = conductivity of earth in e.s.u.
- λ = wavelength in metres
- f = frequency in cycles per second
- d = distance in kilometres

In applying this formula it is to be noticed that in order to obtain a convergent series, the form

$E = E_0 \left[A - \frac{B}{2} \right]$ must be used for x small and the form $E = E_0 \cdot C$ for x large, the transition point appearing in the course of the work.

3.—Field resulting from optical Reflection at the Earth's Surface.

In the use of ultra-short waves, it is frequently the case that the heights of both transmitter and receiver above the earth are one or more wavelengths. In this case the field at the receiver may be derived from the vectorial sum of the field due to the direct wave and that arriving after reflection at the earth's surface.

Let h_1 be the height of the transmitter above the earth and h_2 the height of the receiver. Then, assuming that the distance d between transmitter and receiver is such that

$$d > 4\pi \frac{h_1 h_2}{\lambda}$$

d, λ, h_1, h_2 being measured in the same units, the field at the receiver is given by the equation

$$E = E_0 \cdot A \cdot \frac{4\pi h_1 h_2}{\lambda d} \quad \dots \quad (6)$$

where A represents the reflection coefficient of the ground for the prevailing conditions.

When, as is frequently the case in ultra-short wave practice, the angle of incidence of the waves on the ground is sufficiently large ($> 80^\circ$ or 85°) the reflection coefficient of the ground may be taken as sensibly unity. The above formula therefore reduces to

$$E = E_0 \cdot \frac{4\pi h_1 h_2}{\lambda d} \quad \dots \quad (6a)$$

which is sufficiently accurate for most practical cases satisfying the above conditions.

By a combination of equations (3) and (6a), we obtain the expression

$$E = 2.7 \times 10^{-3} \cdot \frac{h_1 h_2}{\lambda d^2} \sqrt{P_{KW}} \text{ volts/m.} \quad \dots (7)$$

in which, for convenience, λ , h_1 , and h_2 are measured in metres, while d is retained in kilometres.

4.—Field due to Diffraction round a spherical Earth.

As mentioned on page 5, T. L. Eckersley¹⁵ has presented in graphical form the results of his theoretical calculation of the field obtained at any distance by diffraction round a smooth, spherical earth. These graphs are sufficiently comprehensive to enable the field to be derived for wavelengths of 10 metres and below, for distances up to 400 km and for heights up to 4,000 metres.

5.—Effect of Refraction in the lower Atmosphere.

It is now well known that ultra-short waves travelling through the lower atmosphere may follow a curved path concave towards the earth, due to the negative density gradient of the air. To a first approximation this curved path may be taken to be an arc of a circle. For the standard atmospheric conditions used in certain meteorological work the radius of this circle is about six times that of the earth²¹, while in air saturated with water this radius may be 3.5 times that of the earth^{22, 23}.

In the paper already referred to, T. L. Eckersley has shown how this refraction may be taken into account as a modification of the theoretical curves for a spherical earth. The relation between field strength and distance in the diffraction case is of the form

$$E = A \exp\left(\frac{-Bd}{R_0^{2/3} \lambda^{1/3}}\right) \quad \dots \quad (8)$$

where R_0 is the radius of the earth, and B is a constant.

The effect of a change of density in the atmosphere, with or without water vapour content, is to produce a change of refractive index resulting in curvature of the path of propagation. The radius of curvature, ρ , is given by

$$\rho = -\frac{\mu}{d\mu}$$

where μ = refractive index

h = height above earth.

Let $\rho = mR_0$, then the optical range from a height h , is

$$\sqrt{2R_0 h_1} \cdot \frac{m}{m-1}$$

as compared with the range $\sqrt{2R_0 h_1}$ for rectilinear propagation. Thus the effect of refraction is equivalent to increasing the radius R_0 to the value

$$R_1 = R_0 \cdot \frac{m}{m-1}$$

and hence the change in received field may be obtained by substituting R_1 for R_0 in equation (8). There is, in addition, a slight alteration to the amplitude factor A , but this is small for all usual values of m .

The theoretical curves plotted in Figs. 11 and 12 refer to values of m appropriate to dry air and to air with 80 per cent. water vapour saturation.

REFERENCES

1. A. Sommerfeld: "Über die Ausbreitung der Wellen in der drahtlosen Telegraphie." *Ann. der Physik*, ser. 4, 1909, Vol. 28, pp. 665-736.
2. A. Sommerfeld: "Über die Ausbreitung der Wellen in der drahtlosen Telegraphie." *Ann. der Physik*, ser. 4, 1926, Vol. 81, pp. 1135-1153.
3. Balth. van der Pol and K. F. Niessen: "Über die Ausbreitung elektromagnetischer Wellen über eine ebene Erde." *Ann. der Physik*, ser. 5, 1930, Vol. 6, pp. 273-294.
4. H. Weyl: "Ausbreitung elektromagnetischer Wellen über einem ebenen Leiter." *Ann. der Physik*, ser. 4, 1919, Vol. 60, pp. 481-500.
5. K. A. Norton: "The Propagation of Radio Waves over the Surface of the Earth and in the Upper Atmosphere." I. *Proc. Inst. Rad. Eng.*, 1936, Vol. 24, pp. 1367-1387.
6. C. R. Burrows: "The Surface Wave in Radio Propagation over Plane Earth." *Proc. Inst. Rad. Eng.*, 1937, Vol. 25, pp. 219-229.
7. W. H. Wise: "The Grounded Condenser Antenna Radiation Formula." *Proc. Inst. Rad. Eng.*, 1931, Vol. 19, pp. 1684-1689.
8. C. R. Burrows, A. Decino, and L. E. Hunt: "Ultra-Short-Wave Propagation over Land." *Proc. Inst. Rad. Eng.*, 1935, Vol. 23, pp. 1507-1535.
9. B. Trevor and P. S. Carter: "Notes on Propagation of Waves below 10 metres in Length." *Proc. Inst. Rad. Eng.*, 1933, Vol. 21, pp. 387-426.
10. R. C. Colwell and A. W. Friend: "Ultra-High-Frequency Wave Propagation over Plane Earth and Fresh Water." *Proc. Inst. Rad. Eng.*, 1937, Vol. 25, pp. 32-37.
11. T. L. Eckersley: "Radio Transmission Problems Treated by Phase Integral Methods." *Proc. Roy. Soc., A*, 1932, Vol. 136, pp. 499-527.
12. G. N. Watson: "The Diffraction of Electric Waves by the Earth." *Proc. Roy. Soc., A*, 1918, Vol. 95, pp. 83-99.
13. P. von Handel and W. Pfister: "Die Ausbreitung der ultrakurzen Wellen langs der gekrümmten Erdoberfläche." *Hochf. u. Elektr. u. 1936*, Vol. 47, pp. 182-190.
14. P. S. Epstein: "On the Bending of Electromagnetic Micro-Waves below the Horizon." *Proc. Nat. Acad. Sci.*, 1935, Vol. 21, pp. 62-68.
15. T. L. Eckersley: "Ultra-Short-Wave Refraction and Diffraction." *Journ. I.E.E.*, 1937, Vol. 80, pp. 286-304.
16. Balth. van der Pol and H. Bremmer: "The Diffraction of Electromagnetic Waves from an Electrical Point Source round a Finitely Conducting Sphere." *Phil. Mag.*, 1937, Vol. 24, pp. 141-176 and pp. 825-864.
17. B. Wwedensky: "The Diffractive Propagation of Radio Waves." *Tech. Phys. of USSR*, 1935, Vol. 2, pp. 624-639 and 1936, Vol. 3, pp. 915-925.
18. L. F. Jones: "A Study of the Propagation of Wavelengths between 3 and 8 metres." *Proc. Inst. Rad. Eng.*, 1933, Vol. 21, pp. 349-386.
19. B. Trevor and R. W. George: "Notes on Propagation at a Wavelength of 73 centimetres." *Proc. Inst. Rad. Eng.*, 1935, Vol. 23, pp. 461-469.
20. W. Duddell and J. E. Taylor: "Wireless Telegraphy Measurements." *Journ. I.E.E.*, 1905, Vol. 35, pp. 321-352.
21. R. L. Smith-Rose and J. S. McPetrie: "Ultra-Short Radio Waves; Refraction in the Lower Atmosphere." *Wireless Engineer*, 1934, Vol. 11, pp. 3-11.
22. C. R. Englund, A. B. Crawford and W. W. Mumford: "Further Results of a Study of Ultra-Short Wave Transmission Phenomena." *Bell S. Tech. Journ.*, 1935, Vol. 14, 369-387.
23. J. C. Schelleng, C. R. Burrows and E. B. Ferrell: "Ultra-Short-Wave Propagation." *Proc. Inst. Rad. Eng.*, 1933, Vol. 21, pp. 427-463.

Automatic Radiogoniometers*

Method of Measuring the Time Constants of Oscillating Circuits

By *Jean Marique*

(*Institute of Telecommunications, University of Brussels*)

MANY "automatic" radiogoniometers function with a frame aerial turning continuously at a certain speed, generally 5 to 10 revolutions per second; sometimes this frame is associated with a vertical aerial to give a heart-shaped diagram. When these rotating-frame arrangements are combined with highly selective amplifiers a phenomenon is noticed which, so far as the author is aware, has not yet been reported, and which forms the subject of this note.

Equipments with Frame Only

The amplitude of the e.m.f. induced in the frame varies as the sine of the angle which the direction of the transmitting station makes with the electric axis of the frame. If N is the number of turns per second made by the frame, and f the frequency of the incident wave, the e.m.f. induced in the frame has the form

$$e = E \cdot \sin 2\pi ft \cdot \sin 2\pi Nt \dots \dots (1)$$

This expression is that of an oscillation of the "carrier-suppressed" type; it can, in fact, be transformed so as to show two components of frequency $(f - N)$ and $(f + N)$, thus:

$$e = \frac{1}{2}E \cos 2\pi(f - N)t - \frac{1}{2}E \cos 2\pi(f + N)t.$$

The oscillation of frequency f is suppressed by the rotation of the frame.

The two components are applied to the input of the amplifier, in which they are, as a general rule, unequally amplified and unequally displaced in phase. Let ϕ represent the phase-displacement of the output voltage, of frequency f , with respect to the input voltage, in the absence of rotation of the frame: and for simplicity's sake let it be assumed that the two components pro-

duced by the rotation are symmetrically displaced in phase by an angle α with respect to ϕ . When the frame rotates, the output voltage has the form

$$v = A \cos [2\pi(f - N)t + \phi - \alpha] - B \cos [2\pi(f + N)t + \phi + \alpha] \dots (2)$$

where A and B are the amplitudes assumed by the two components.

Eqn. 2 can be written in the form

$$v = \sqrt{A^2 + B^2 - 2AB \cos 2(2\pi Nt + \alpha)} \cdot \sin (2\pi ft + \phi + \psi) \dots (3)$$

$$\text{and } \tan \psi = \frac{A - B}{A + B} \cos (2\pi Nt + \alpha) \dots (4)$$

Consequently, as a result of the phase displacement between the components and of the unequal amplification, the output voltage no longer has the same form as the input e.m.f. Not only do these phenomena introduce a supplementary phase displacement ψ of high frequency (a displacement which varies synchronously with the rotation—eqn. 4) but they also have the result—and this is the most important phenomenon—that the amplitude of the output voltage does *not* become zero when $2\pi Nt = 0$, as does the input e.m.f., but merely becomes minimum when $2\pi Nt + \alpha = 0$.

If the components are equally amplified ($A = B$), the expressions 3 and 4 become

$$v = 2A \sin (2\pi Nt + \alpha) \cdot \sin (2\pi ft + \phi) \dots (5)$$

$$\text{and } \tan \psi = 0 \dots \dots (6)$$

Thus when the components are equally amplified, the synchronous displacement ψ disappears, the minima become perfect zeros, but still occur when

$$2\pi Nt + \alpha = 0 \dots \dots (7)$$

Consequently, the indicator of a radiogoniometer, supplied with this output voltage

* MS. accepted by the Editor, October, 1938.

whose minima (or zeros) of amplitude are displaced by α with respect to those of the input e.m.f., should give bearings which are also displaced by α ; and this should happen no matter what type of indicator is used—phasemeter, cathode-ray oscillograph, neon lamp, etc.

A comparison of the equations 3 and 5 shows that it is not the inequality of amplification which causes the displacement of the minima; nevertheless, the sharpness of these minima decreases greatly when A and B are very different. This is made clear by taking the extreme cases $A \gg B$ and $B \gg A$, when it is found that the amplitude of the output voltage is practically constant and equal to A or B .

Equipments with Frame and Aerial

The above phenomena are reproduced exactly in automatic radiogoniometers working with a heart-shaped diagram. For the perfect cardioid, the input e.m.f. has the form

$$(1 + \sin 2\pi Nt) \cdot \sin 2\pi ft \dots \dots (8)$$

which may be written

$$\frac{1}{2} \cos 2\pi(f - N)t - \frac{1}{2} \cos 2\pi(f + N)t + \sin 2\pi ft.$$

Neglecting, this time, for simplicity's sake, the inequality of amplification, the output voltage is found to be of the form

$$\begin{aligned} &\frac{1}{2} \cos [2\pi(f - N)t + \phi - \alpha] \\ &\quad - \frac{1}{2} \cos [2\pi(f + N)t + \phi + \alpha] \\ &\quad + \sin (2\pi ft + \phi), \end{aligned}$$

which may be written

$$[1 + \sin (2\pi Nt + \alpha)] \cdot \sin (2\pi ft + \phi) \dots (9)$$

Comparing eqns. 8 and 9 it is seen that the minimum is displaced by the angle α as in the preceding case.

Method of Measuring α

The existence of the phenomena described above is due to the fact that the e.m.f. induced in the frame, and consequently the voltage applied to the input of the amplifier, has the form of eqn. 7. For the purpose of making the measurements, it is easy to obtain a difference of potential having this form, by rotating continuously the rotor coil of two "sinusoidal" windings, *i.e.* two coils whose mutual inductance varies in

proportion to the cosine of the angle between their electric axes. Such coils can readily be constructed on the basis, for example, of the well-known theory of Mesny ("Usage des Cadres et Radiogoniométrie"—Paris, 1925, p. 121).

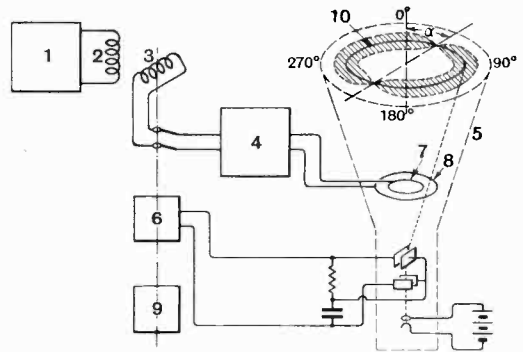

Fig. 1.

A measuring equipment might well be composed of the components shown in Fig. 1. An oscillator 1 is connected to the ends of the fixed coil 2, and the potential difference taken from the ends of the moving coil 3 is applied to the input of the amplifier under investigation, 4. The moving coil, which is rotated continuously at N revs. per sec. by the motor 9, is associated with an indicator having one component revolving in synchronism and in phase with the coil. In Fig. 1 this indicator is represented by a polar cathode-ray oscillograph 5 whose spot traverses on the screen a circular graduated base 10, thanks to an alternator 6 which moves with the rotor coil. The output voltage of the amplifier is applied to the concentric electrodes 7 and 8 between which the ray passes, and which cause radial displacements of the spot on one side or the other of the circle 10.

If the output voltage is of high frequency according to eqn. 5, a stationary image is obtained on the screen analogous to that shown in Fig. 1, and the angle α is equal to the angle between the origin of the graduations and the graduation at which the minimum occurs. A second minimum is found at 180° from the first.

Significance of the Angle α

Let ϕ_1 be the phase displacement of the output voltage of frequency f_1 with respect

to the input voltage of the same frequency, when the rotor coil is at rest; and let ϕ_2 be the corresponding phase displacement for a frequency f_2 .

We can obtain the oscillations of frequency f_1 and f_2 by the procedure already described, starting with an oscillation of frequency $f = \frac{1}{2} \cdot (f_1 + f_2)$ and choosing a rate of rotation for the moving coil such that $N = \frac{1}{2} \cdot (f_2 - f_1)$. Considering the phase displacement ϕ of the oscillation of mean frequency f , we have $\phi_1 = \phi - \alpha$, $\phi_2 = \phi + \alpha$, so that $\alpha = \frac{1}{2} \cdot (\phi_2 - \phi_1)$.

If f_1 and f_2 differ only slightly, that is, if N is very small compared with f , we may write $\alpha/N = \Delta\phi/\Delta f = d\phi/df$, or finally

$$\alpha = N \cdot d\phi/df \quad \dots \quad (10)$$

Consequently, if we observe the angles α obtained, during the rotation of the moving coil at N revs. per sec., when the frequency f of the oscillator is varied, then the curve

$$\alpha = F'(f) \quad \dots \quad (11)$$

is proportional to the first derivative of the curve

$$\phi = F(f) \quad \dots \quad (12)$$

representing the phase displacements between input and output. From this we deduce that α should be a maximum when ϕ varies most rapidly as a function of f ; that is to say, at the points of inflection of the curve 12.

Phase Displacements Observed in an Oscillatory Circuit L . R . C

For a simple oscillatory circuit it is obvious that the curve 12 can be deduced from the formula $\tan \phi = (L\omega - 1/C\omega)/R$, where $\omega = 2\pi f$; this gives the value of the displacement of the current with respect to the e.m.f.

If, in such a circuit, an e.m.f. of the form of eqn. 1 is induced, the two components of frequency $(f - N)$ and $(f + N)$ will be subjected to phase displacements ϕ_1 and ϕ_2 , and we shall have $2\alpha = \phi_2 - \phi_1$. For a frequency very close to the resonance frequency f_0 (where $\omega_0 = 2\pi f_0 = 1/\sqrt{LC}$) we may write

$$\tan \phi = (2L/R) \cdot (\omega - \omega_0) = (2L/R) \cdot 2\pi(f - f_0).$$

When the oscillator frequency is equal to the resonance frequency f_0 , the frequencies of the components produced by the rotation of the moving coil are $(f_0 - N)$ and $(f_0 + N)$, so that $\tan \phi_2 = -\tan \phi_1 = 2L/R \cdot 2\pi N$, and $\phi_2 = -\phi_1$.

Remembering that $2L/R$ is the time constant θ of the circuit, and that in the present case $\phi_2 - \phi_1 = 2\phi_2 = 2\alpha$, we may write

$$\tan \alpha = 2\pi \cdot \theta \cdot N.$$

Instead of considering, as above, a circuit of series-resonance, we may consider one of parallel-resonance; the same equation is reached if the circuit resistance is low.

It is known that the selectivity σ is connected with the time constant by the equation $\sigma = \sqrt{1 + \theta^2 \cdot (\Delta\omega)^2}$, where $\Delta\omega$ is the displacement between the resonance angular velocity ω_0 and that for which the selectivity is calculated. The following table gives an idea of the relation which exists between the three quantities θ , σ , and α ; we have calculated the selectivity at ± 2 kc/s, and have chosen a rotational velocity of $N = 10$ revs. per sec.

θ	σ (± 2 kc/s)	α ($N = 10$)
0.05 sec.	56 db.	72°
0.01	42	32°
0.005	36	17°
0.001	22	3° 30'
0.0005	16	1° 45'

We have actually observed, with quartz filters, values of α attaining as much as about 70°.

Phase Displacements Observed in Coupled Circuits

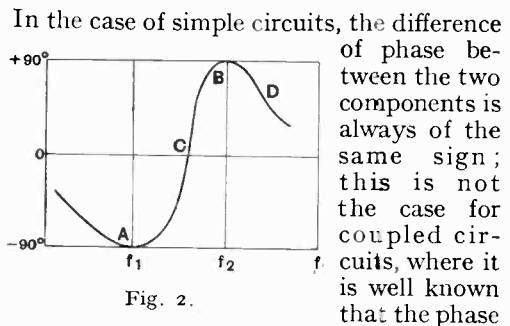

Fig. 2.

In the case of simple circuits, the difference of phase between the two components is always of the same sign; this is not the case for coupled circuits, where it is well known that the phase between the current in the secondary and the e.m.f. induced in the primary varies

according to the curve shown in Fig. 2. The voltage at the terminals of the con-

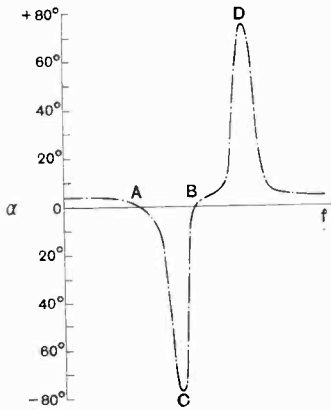

Fig. 3.

denser of the secondary circuit is displaced in phase by $1/2\pi$ with respect to the current.

The first derivative of this curve, and hence the angle α , should reach zero at the resonance frequencies f_1 and f_2 for which ϕ passes through a maximum (points A and B); on the other hand, it should be maximum at the points of inflection C and D, but these maxima should be of opposite sign. Fig. 3 corresponds to a case of this kind; it represents the values observed experimentally with a quartz filter whose compensation circuit was adjusted so as to have a "crevasse" in the resonance curve.

Conclusion

The importance of the first derivative of the curve of phase displacements as a function of frequency in automatic radiogoniometers with rotating loops has been shown. It has also been shown that this derivative is proportional to the time constant of the dephasing circuit when this is measured at resonance. A method of measuring this derivative as a function of the frequency is described.

Book Reviews

A Textbook of Electricity

By H. G. MITCHELL. Pp. 525 (19 x 13 cm.) and 357 Figs. Methuen and Co., Ltd., 36, Essex Street, London, W.C.2. Price 10s.

In the preface we read that "This book is intended to provide a complete course in Electricity for Higher School Certificate, Intermediate science, and University Scholarship candidates. . . ." As we should expect from this statement, the book is written from the point of view of the "pure" physicist; the practical electrician may think that the allocation of space between different subjects is out of proportion to their importance. For example, the thermionic valve receives three pages, twice as much space is given to the Tangent Galvanometer and its variants the Helmholtz and Sine galvanometers. Half of the thirty pages of the chapter on "Electrical Measurements" is devoted to different types of Wheatstone Bridge, including derivatives such as the Metre-wire and Carey Foster bridges, determination of end-corrections, Mance's method for battery resistance, etc. Electrostatic and ballistic methods, Kelvin's, Gott's, and de Sauty's methods of comparing capacities with direct current receive several pages, but the only A.C. bridge mentioned is not, as one might expect, one for the comparison of reactances, but the crude original method of Kohlrausch for conductivity of an electrolyte, in which no provision is made for the insertion of reactive components into the bridge-arms to balance the capacity of the electrolytic cell. Since the double balance conditions for resistive and reactive (or in-phase and quadrature) components are the very essence of the A.C. bridge, this is definitely misleading; it

may be doubted whether "A.C. bridges" is a suitable subject for an examination in elementary electricity, but it were surely better to omit it altogether than to mention a type of bridge which is misleading as well as antiquated.

While it is very desirable that writers and teachers should study the works of the pioneers such as Faraday and Clerk-Maxwell in order to understand the *principles* they laid down, it is surely unnecessary to teach students to use the *apparatus* of those times; it is as if the young engineer were taught to light the fire in a boiler by means of flint and steel, because Stephenson did so. The fault does not lie with the author, who is bound to keep within reasonable range of an examination syllabus however distasteful this may be; nor is it entirely the fault of examiners, for he who would try to set, say, a School Certificate paper in Electricity omitting obsolete methods and apparatus would find that there was not very much of the syllabus left from which to choose his questions. It is not a matter of expensive apparatus, but of using modern methods of measurement which are intrinsically of greater simplicity and accuracy than the old; for example to compare the capacities of two condensers by an A.C. method with buzzer and telephones demands less expensive apparatus than a ballistic galvanometer, and with quite crude apparatus is more accurate than the ballistic method unless the galvanometer is particularly good (and therefore costly), and the observer particularly skilled; and more important still, the student learns the principles of the method that would be adopted in modern practice for making such a comparison. To get an examination syllabus modernised is proverbially difficult, but now that we have "pure" physicists who work with

generators and switchgear of many kilowatts on a large engineering scale, instead of with a couple of Leclanché cells and some bell-wire, there is yet hope that revision may come in time. In any case, by 1940 the "mercury ohm" and the "silver voltameter" will be but evil memories; is it too much to hope that the opportunity will be seized to eliminate other antiquated methods and to institute drastic and much-needed reform? That such reform would not be unwelcome to the author may be surmised from his statement that the Tangent Galvanometer "would not be used by any practical electrician," a remark which ought, but is hardly likely, to earn him a seat on any board for syllabus revision.

In the latter third of the book we get away from academic electricity. The explanations in these chapters are very clear and simple, particularly the chapter on "Practical Electromagnetism." It is curious that in the next chapter, "Varying currents," the damped oscillatory discharge of a condenser through an inductive circuit is treated before the simple sine wave, although the ideas involved would seem to be more complex.

Chapter XX, "Discharge through gases," includes brief but interesting descriptions of the mode of action and applications of cathode-ray oscillographs, vapour lamps, and X-rays. A description of the Pointolite lamp is included, and it is stated that "unfortunately it will only work on a comparatively high voltage D.C. supply"; "comparatively high" compared with what? It will certainly work on 100 volts, and could probably be run on 50; the real drawback is the large momentary current for the heater at starting, but there has been an A.C. pointolite on the market for many years, in which a transformer can be used to provide the heavy initial current (at about 12 volts), so that it can be run off a lighting circuit.

An ingenious method of pictorial representation of electrons, protons, neutrons, etc., is adopted in the chapter on Atomic Physics, and some of the phenomena of nuclear disintegration are thereby explained in a very simple and intelligible manner. (Confusion may be caused by a misprint in the figure at the top of p. 501, where the last neutron symbol should be a proton.)

Bearing in mind the limits within which the author is confined by examinations, the book is of a more practical nature than would be expected in a theoretical textbook, the explanations of the action of practical devices such as bells, telephones, dynamos and alternators are particularly good, and the illustrations are excellent. Last, but by no means least, there is a really good index.

C. R. C.

Testing Television Sets

By J. H. REYNER, B.Sc. Pp. 128. Published by Chapman and Hall, Ltd., 11, Henrietta Street, London, W.C.2. Price 9s. 6d.

The author has succeeded in an endeavour to indicate rational methods of deduction applied to the tracing of faults in television receivers.

As he mentions in the preface, the author has been forced to discuss a number of technicalities in the text, but this has been carried out in a clear and concise manner, and greatly assists in the understanding of the methods described.

It is noticeable that far more attention is paid to receivers of the type employing electrostatically operated cathode-ray tubes than to those employing magnetically operated tubes. It is also stated on Page 40 that magnetic deflection is still in its infancy, a statement which is, in the opinion of the reviewer, erroneous, and one that would tend to reflect on several receivers on the market which employ magnetic deflection. When dealing with time bases, constant reference to gas relays is made, and the fact that hard valves are used in time bases seems to be ignored.

Throughout the book many very useful hints and tips are given, which would only be obtainable by one who was in a position to experiment with actual receivers, and from this point of view the book will be of considerable value to students of television and those who contemplate undertaking television servicing. Although there is little in the book which would not be known to the television service man or engineer, yet the manner in which the matter is set down and tabulated makes it a book well worth purchasing.

In conclusion, the sections on interference and laboratory technique are of considerable interest, although in a later chapter mention could have been made of a still picture transmitter of the block type, such as described in American and English journals during the last six months, and which should certainly form part of every television manufacturer's test room equipment before long.

N. W. M.

The Amplification and Distribution of Sound

By A. E. GREENLEES, A.M.I.E.E. Pp. 254 + xiii. Published by Chapman and Hall, Ltd., 11, Henrietta Street, London, W.C.2. Price 10s. 6d.

A large part of this book is devoted to brief descriptions of the apparatus employed in sound reproduction. Although brief the descriptions are accurate and admirably fulfil the purpose for which they are intended, which is obviously to give the reader an insight into the limitations of, and difficulties met with in the design of, the individual components of the equipment.

No more than elementary mathematics is encountered and the use of the decibel is well and correctly explained. A commendable feature is the stress which is laid upon the fact that the decibel fundamentally expresses a power ratio, and the reader is warned that in extending it to deal with voltage or current ratios the circuit impedances must be taken into account. At a time when the gain of an amplifier is all too commonly expressed as $20 \log V_{out}/V_{in}$ without any regard for the input and output resistances, the emphasis on the necessity for taking these resistances into account is especially to be welcomed.

Following upon the descriptions of the characteristics of the component parts of complete amplifiers and receivers, there are chapters on installation, maintenance, and specifications of apparatus and upon the characteristics of distribution lines. Acoustics are not overlooked and the book contains much useful information on the placing of loud speakers for public address purposes and on the amount of A.F. power needed to suit varying conditions.

W. T. C.

A Multi-Channel Oscillograph Amplifier*

By *F. C. Williams, M.Sc., D.Phil., and*
R. K. Beattie, M.Sc.

SUMMARY.—The paper describes a system whereby any reasonable number of separate traces can be observed simultaneously on one cathode ray tube. A brief critical review is given of earlier methods, often limited to two traces, which generally incorporate motor-driven commutators or Thyratrons as commutating devices. The operating principle of the fundamental unit of the present system—the intermittent amplifier—is then explained. The commutating voltage is usually derived from the mains, but a 1,500 c/s oscillator is used in cases where frequencies below 200 c/s are to be exhibited. *n* traces can be shown by incorporating *n* intermittent amplifiers in the final apparatus. Direct potentials applied to the apparatus are also recorded. Finally, the design of a 4-channel equipment is given in some detail; its applications are discussed, and some examples of its work shown.

(1) Introduction

SEVERAL instruments have already been described which permit the simultaneous observation of two wave forms with a single cathode ray tube and time base. The spot is made to trace out the waves alternately at such a frequency that persistence of vision causes two apparently steady waves to be seen. In some cases⁽¹⁾ mechanical switching has been adopted, in others^{(2) (3) (4) (5)} thyratrons have been used. Both these methods have the disadvantage that they may react on the circuit under test. An arrangement embodying a thermionic amplifier is preferable since the switching operation can then be isolated from the test circuit. Further, on account of the low sensitivity of cathode-ray tubes, some amplification is usually necessary. Instruments have already been described in which two amplifiers are used to amplify the two test voltages; the amplifiers are caused to function alternately by applying a suitable switching voltage at some point in the circuit. Davidson⁽³⁾ has described an apparatus using triode amplifiers in which a switching voltage of square wave form was applied to the cathode, biasing it alternately normally and beyond cut-off. This device operated satisfactorily up to 600 c/s. Hughes⁽⁵⁾ replaced the triodes by pentodes. The test voltage was applied to the suppressor grid. In each case a special thyatron oscillator was needed to generate the switching voltage. Garceau⁽⁶⁾ has used a comparatively high frequency (approx.

50,000 c/s) sinusoidal switching voltage applied to the screens of two pentodes. The test voltages, applied to the control grids, were then exhibited, in effect, as the upper and lower envelopes of the H.F. output voltage.

The present paper describes an apparatus which permits the simultaneous observation of any number of wave forms, and which employs only hard valves. It is designed primarily to operate on frequencies between 200 c/s and 500 kc/s; it then requires no switching oscillator, the 50 cycle mains voltage being utilised for that purpose. The principle can be extended to provide operation below 200 c/s but a switching oscillator of frequency about 1,500 c/s is then required. The apparatus has the further advantage that steady components of the input voltages are recorded along with the alternating component. It is thus possible, for instance, to observe simultaneously the two anode voltages of a full wave rectifier together with the current wave and the rectified output voltage, the latter being shown displaced from the zero line by an amount equal to the mean rectified voltage (see Fig. 10b).

Before giving a detailed description of the apparatus itself, the general principles and requirements of such a system will be discussed.

(2) General Principles

There are two methods of producing two distinct oscillograph traces on the screen at the same time. The first consists in causing the spot to delineate each of the

* MS. accepted by the Editor, September, 1938.

curves in turn, either once or several times, persistence of vision leading to an apparently simultaneous tracing of the curves. It has been usual to synchronise the change-over or switching frequency with the time base, but this does not appear necessary. In the second method the spot traces alternate

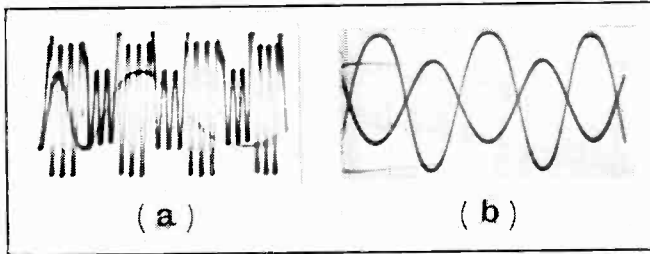

Fig. 1.

small segments of the two curves: the oscillogram then appears rather like a modulated oscillation, the two traces being the upper and lower envelopes of the switching oscillation.† In this second method the importance of persistence of vision is only that ascribed to it in normal oscillograph practice. The first method is preferable with high time-base frequencies, for complete traces of each curve are obtained: the second is used only when the time-base frequency is so low that persistence of vision cannot obscure the flicker. In general, the time-base frequency will be synchronised at $1/3$ to $1/5$ of the signal frequency, and it has been found experimentally that the first method operates satisfactorily with signals of frequency greater than 200 c/s, whereas the second is preferable for lower frequencies. Suitable switching frequencies in the two cases appear to be 50 c/s and 1,500 c/s respectively. In either case it is best to arrange that there shall be no exact integral relationship between the switching frequency and the signal frequency, for with such provision the valueless trace corresponding with the transition of the spot from one curve to the other is obscured by motion across the screen due to its not being synchronised with the time base. Further, with

† This method is similar to the system employed by Garceau except that now a square-topped instead of a sinusoidal switching voltage is employed.

the second method the segments of each curve traced by the spot in consecutive excursions of the time base do not superpose, and the full line is drawn out, whereas with synchronised switching a broken line only is obtained.

As an illustration of the mechanism of operation of the above methods, consider the wave form of the voltage applied to the Y-plates of the oscillograph when the two voltages to be examined are sine waves of different amplitudes but equal frequencies. Fig. 1a shows the wave form of this voltage when the first method is used, the sinusoids being switched in and out of circuit alternately at a frequency less than that of the sinusoids. Fig. 1b shows the result of synchronising the sinusoids and time base only, the time base being speeded up. Figs. 2a and 2b illustrate similar oscillograms relevant to the second method; in 2a, time-base signal and switching frequencies are synchronised; in 2b the switching frequency is unsynchronised. Neither method is basically limited to two oscillograms only.

An ideal multi-recording oscillograph would have provision for high and low switching frequencies of adjustable frequency to pro-

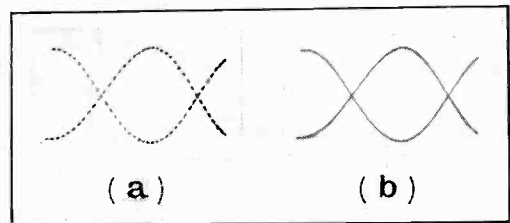

Fig. 2.

vide the required absence of synchronism in either method of operation. In practice it is found convenient to use the 50 c/s mains for switching purposes, absence of synchronism being achieved by a slight change of signal frequency if necessary. If the higher switching frequency is required this can be generated externally.

If "n" separate oscillograms are to be superposed some device is necessary whereby each oscillation in turn can be impressed

on the Y-plates for a time equal to $1/n$ of a complete switching cycle. It was noted in the introduction that it is preferable to have a buffer amplifier between the switch and the test apparatus, as switching reactions on the test circuits are thereby avoided. Such provision at once suggests the use of some form of electronic switch incorporated

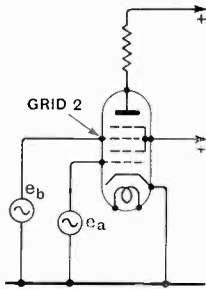

Fig. 3.

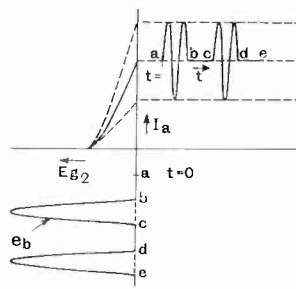

Fig. 4.

in each amplifying channel, the switch being such that each amplifier functions intermittently for a controllable portion of a switching period. Each amplifier in turn can then supply a record of its impressed oscillation to a final amplifier yielding a sufficient output to give full deflection on the oscillograph. A suitable intermittent amplifier is described in the next section.

(3) The Intermittent Amplifier

The basic circuit of one of the intermittent amplifiers is shown in Fig. 3. The voltage to be recorded, e_a , is applied to the inner grid of a hexode valve of the type commonly used as a frequency changer. The wave form of e_a is impressed on the current crossing the plane of the inner grid. The fraction of this current which arrives at the anode is governed by the potential of the outer grid. If it is held sufficiently negative with respect to the cathode no current flows to the anode. On the other hand, when the outer grid voltage is zero, considerably more than half the current passing the plane of the inner grid arrives at the anode. The amplifier is therefore effectively switched in and out of circuit by a voltage applied to the outer grid which is alternately zero and very negative. For an n channel amplifier n intermittent amplifiers supplying a common load resistance are

required, each amplifier operating in turn for $1/n$ of a complete switching period.

The operation of the amplifier is illustrated in Fig. 4. This shows the $I_a - E_{g2}$ characteristic of a hexode. The full line corresponds with zero signal on the inner grid; the dotted lines represent the limits of the excursion of this characteristic with a given sinusoidal e.m.f. applied to the inner grid. Below the figure the wave form of a suitable switching potential e_b is drawn to a time scale. The resulting time variation of anode current is drawn on the right of the characteristic. It will be seen at once that the wave form of the switching voltage between b and c is unimportant provided only that the transition to and from a highly negative but not necessarily constant value is very rapid: it is conveniently made a segment of a sine curve. Cut-off at b and c is then found to be sufficiently rapid with a switching amplitude of about 50 volts. The generation of such switching voltages is discussed in the next section.

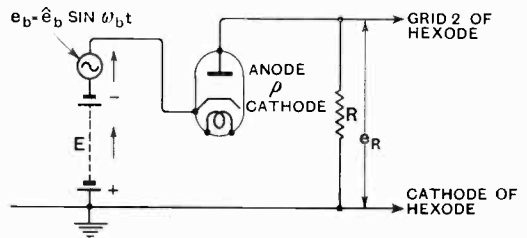

Fig. 5.

It may be noted that a pentode with the suppressor grid led out can replace the hexode, but then capacitance between the suppressor and anode may lead to the presence of undesirable higher frequency components of the switching voltage in the output.

(4) The Switching Voltage

A switching voltage of suitable form for a two element amplifier can be derived from a multivibrator, but the method does not appear easily extensible to multiple-element amplifiers. For these it has been found simpler to derive the required wave form from a sinusoid by means of the circuit of Fig. 5.

The operation of this circuit is best described with reference to Fig. 6.

The full sinusoidal curve represents the switching oscillation e_b displaced below the cathode potential of the Hexode by the bias E . Conduction in the diode will be continuous so long as $E + e_b$ is negative

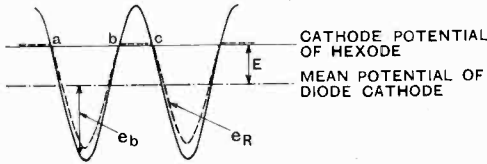

Fig. 6.

with respect to earth, for the diode cathode is then negative with respect to the anode. This is the epoch $a-b$, Fig. 4, and the potential across R is then given by

$$e_R = \frac{R}{R + \rho} (E + e_b).$$

However, when e_b opposes and exceeds E the diode cathode becomes positive relative to the anode and conduction ceases; e_R is then zero. This is the epoch $b-c$, in Fig. 6. It follows that the wave form of e_R is typified by the dotted line in Fig. 6, and is of the required form. It follows also from the figure that the ratio $\frac{bc}{ac}$ can be adjusted to any required value by variation of the ratio E/e_b . When e_R is used to control an

are to be accommodated in the final amplifier then it is required that $\frac{bc}{ac} = \frac{1}{n}$, and n such switching waves will be required displaced by an angle $2\pi/n$ from each other. Sinusoids having the required phase relations can easily be derived from a single source by phase-splitting circuits. A switching voltage generator suitable for a 4 channel amplifier is shown in Fig. 7: a, b, c and d go to the outer grids of the four hexodes.

Although the values of resistance and reactance in the bridge circuit necessary to produce a true 4 phase supply can easily be calculated, some experiment may be necessary in the final apparatus on account of the unknown shunting effects of the discontinuously operating diodes.

(5) Four Channel Mains Driven Amplifier

As an example of the application of the methods outlined in the preceding sections, a four channel mains driven amplifier has been constructed. The complete circuit diagram is shown in Fig. 8. It comprises four separate sections:—(A) four intermittent amplifiers, (B) a four phase switching voltage generator, (C) a single channel balanced amplifier, (D) a mains supply unit. The diagram is correspondingly sectionalised by dotted lines.

The mains unit is conventional and re-

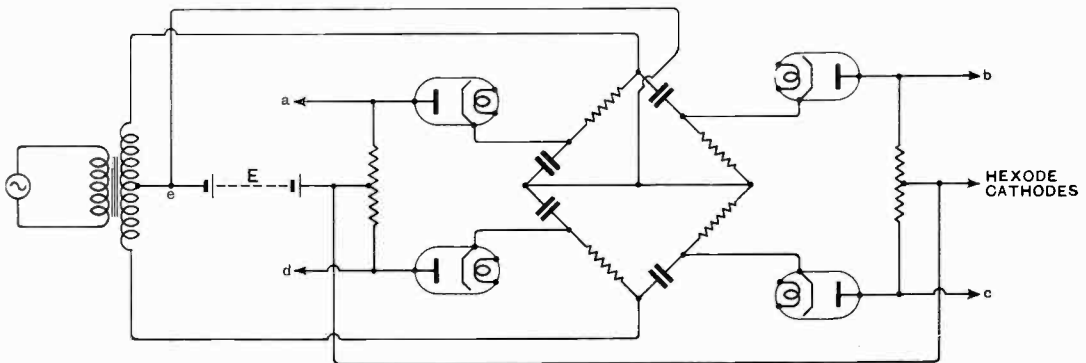

Fig. 7.

intermittent amplifier, the amplifier is operative over the interval bc and is inoperative for the greater part of the period ab ; the transition can be made as rapid as desired by sufficient increase of e_b . If n channels

quires no description; it yields a substantially smooth D.C. output at 500v.

In the circuit shown the switching voltage is derived from the high voltage secondary of the mains transformer. The phase split-

ting circuit used is an obvious modification of Fig. 7 adapted to the production of a 4 phase supply of comparatively low voltage from a high voltage source.

Provision is made for 1,500 c/s switching

generator is derived from the variable resistance R_1 ; in practice R_1 is set by experiment to that value which yields the smallest discontinuity in the switching operation. Too high a value of R_1 leads to

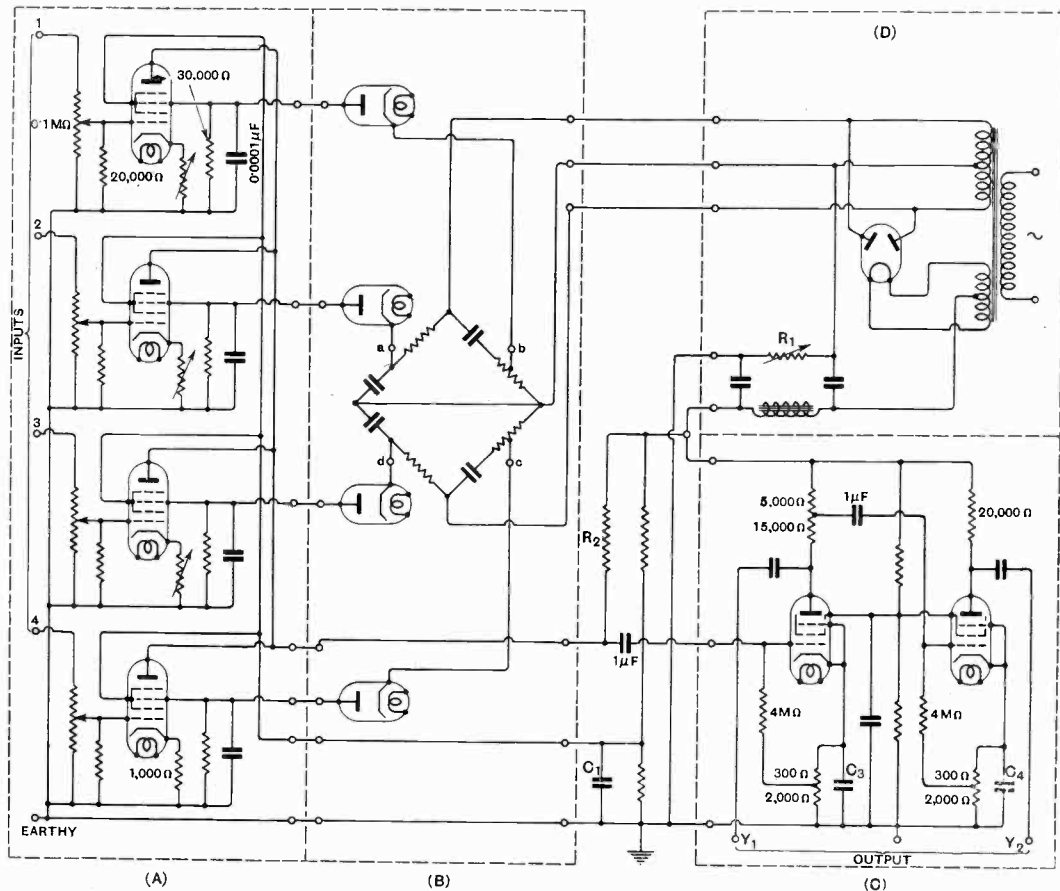

Fig. 8.

using an external generator, a second phase splitting circuit similar to Fig. 7† being provided (it is omitted from Fig. 8 to avoid complication). The change-over is performed by means of links, which may be connected as shown or to the points *a*, *b*, *c*, *d*, Figs. 7 and 8. In the latter event the point *e* of Fig. 7 is connected to the centre tap of the mains transformer secondary. The bias *E* supplied to the switching voltage

intervals during which none of the amplifiers passes current, too low a value leads to two amplifiers drawing current at once. In either event an unnecessarily large pulse of potential is applied to the balanced amplifier and overloading ensues.

The four intermittent amplifiers are identical. The anodes supply current to a common load resistance R_2 ; the screens are also connected together and shunted to earth by a condenser C_1 large enough to hold the screen voltage sensibly constant during a switching cycle. Bias for the inner grid is derived from

† The 4 diodes and their load resistances are not now required since they are already present in the apparatus.

a variable resistance connected in each cathode circuit; these are adjusted so that all the anode currents are equal with no signal input. The signal is fed to the con-

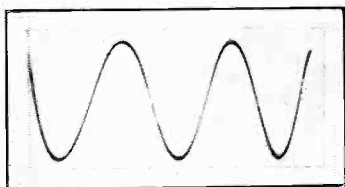

Fig. 9.

trol grid through a high resistance potentiometer; the grid itself is directly connected to earth through a 20,000 Ω resistance to limit the possible shunting effect of valve input capacitance. It will be noticed that condensers are not included in the grid circuit; the steady components of input potential thus appear at the grid and displace the intermittent anode currents from their preset equal values. In this way steady components of input voltage are retained despite the later introduction of coupling condensers. It is important that such "purely resistive" input and biasing arrangements be adopted, for otherwise time constants may be introduced which are comparable with the switching frequency; the amplifiers will not then attain a steady state during their short periods of operation and very blurred oscillograms will result. The small con-

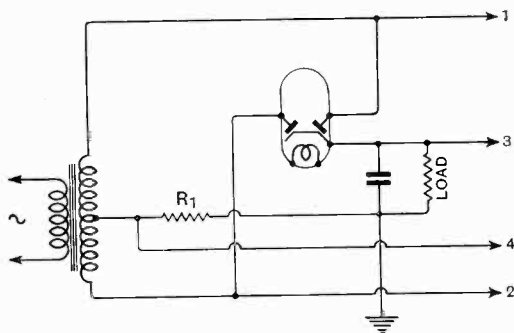

Fig. 10 a.

densers C_2 are introduced to inhibit a form of self oscillation fully described elsewhere⁽⁶⁾ by one of the authors' colleagues.

The balanced amplifier is of rather unusual design, high resistances being incorporated in the cathode circuits. This arrangement was adopted because a high output voltage, of the order of 180 volts peak, was required between anodes. High anode resistances were therefore necessary, and it was found that if the resulting high amplification was used mains ripple was very noticeable. The cathode resistances serve the dual purpose of reducing the amplification and of permitting some degree of frequency correction by means of shunting condensers C_3 and C_4 . Linearity is also much improved by such "negative feed-back." The actual voltage gain is about 8.

The resistance R_2 which supplies the amplifier is chosen so that with full deflection the intermittent amplifiers are approaching

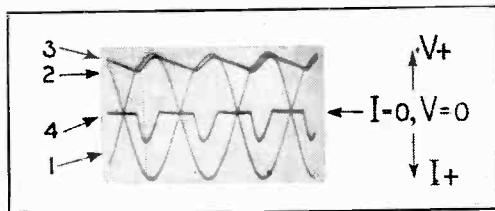

Fig. 10 b.—1,500 c/s switching and 50 c/s signals.

the limit of their linear regime: the relative importance of the inevitable oscillation associated with switching one amplifier out and another in is thereby greatly reduced. In the present model adjustment of C_3 and C_4 yielded an overall frequency response curve substantially flat up to a frequency of 500 kc/s. The low frequency response of the amplifier is also important. With 50 c/s switching and operation according to the first method, 50 c/s is the lowest frequency supplied to the amplifier: with 1,500 c/s switching and operation according to the second method the lowest frequency is more difficult to specify, for it depends on the modulation product of the signal frequency and 1,500 c/s; however, a 50 c/s lower limit appears more than adequate. Coupling circuit time constants of 2 seconds have therefore been adopted and have proved satisfactory. Further information regarding component values will be found in Fig. 8.

(6) Applications

The applications of such an instrument in accurately determining voltage, current, and phase relationships, and of instantly observing the effects of circuit changes, are as numerous as they are valuable, both for qualitative and quantitative work, and are perhaps best demonstrated by two simple examples of its application; these serve also to illustrate its extremely high educational value.

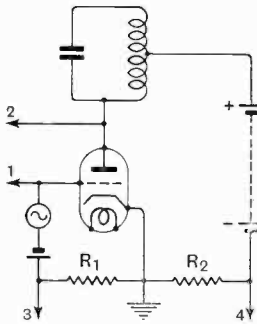

Fig. 11 a.

It may be noted that before taking records the gain of the four channels should be set to equality by adjusting the potentiometers with a common input voltage.

The degree of superposition obtainable in this test is illustrated by Fig. 9, which is a photograph not of a single sinusoid but of four superposed sinusoids.

Full Wave Mains Rectifier

A simple full wave rectifier, connected as shown in Fig. 10a, was used to obtain the oscillogram of Fig. 10b. The small resistance R_1 is included in order to provide a p.d. proportional to the pulses of current through the valve; this is shown by curve (4). Curves (1) and (2) show the A.C. voltages applied to the anodes, i.e., between (1) and (4) and between (2) and (4), whilst

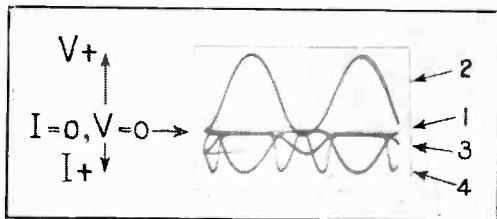

Fig. 11 b.—50 c/s switching and 5,000 c/s signals.

curve (3) is the unidirectional output potential, i.e., the p.d. between (3) and (4) shown properly disposed in relation to (1) and (2). The full advantage of the apparatus is only

apparent by visual observation with adjustable load currents.

Resonant Amplifier.

A flick-impulsed over-driven resonant amplifier (Fig. 11a) was used in obtaining the oscillogram of Fig. 11b. Small resistances R_1, R_2 , enabled curves of grid (3) and anode current (4) to be taken, whilst (1) and (2) show grid and anode voltages.

The swinging of the anode potential below cathode potential, and the "robbing" of anode current by the grid, are clearly shown.

A useful method of measuring voltages, currents and phase angles arises from the fact that the instrument acts as an amplifier of direct potentials. If a known variable direct voltage is applied to one input, the horizontal line corresponding with that amplifier can be made to assume any position on the screen, and the value of any dis-

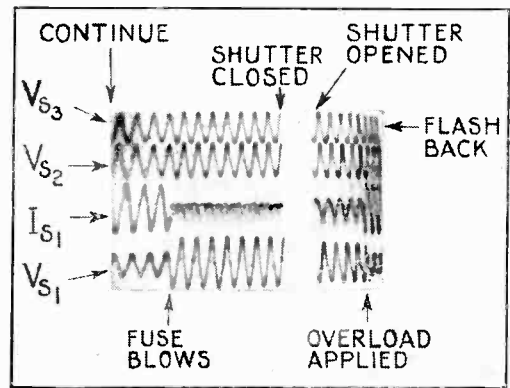

Fig. 12.

placement along the y axis found by measuring the change in steady potential required to shift that line the required distance.

Though originally intended for use with repeating linear time bases, the apparatus can be used for single stroke recording of transients provided they are sufficiently slow: 1,500 c/s switching being used. Each trace then appears as a dotted line.

Fig. 12 is an example of such use. It illustrates a fuse blowing on the secondary side of a transformer connected to the 50 c/s mains. The time base was repeating at a frequency of about 1.5 c/s and an incomplete trace (in two parts) is shown, for the exposure was of 0.5 sec. duration only. The

bottom trace shows the secondary voltage ; this falls when the overload is applied : at the same instant the current, shown by the neighbouring trace, increases. When the fuse blows the voltage recovers and the current falls to zero. The two upper traces show the voltages of two other secondaries and were included merely to use the remaining two channels. All curves are in broken lines, but the focusing is not sharp enough to show it. Similar records could be taken better on travelling film with the time base disconnected.

Acknowledgments

The research described in this paper was carried out in the Electrotechnics Department of Manchester University. The authors

are indebted to Professor R. Beattie for the facilities placed at their disposal.

The device is covered by a Provisional Patent.

REFERENCES

- (1) L. F. Woodruff : " Multi-element Operation of the Cathode Ray Oscillograph." *Elec. Engineering*, Oct., 1935, Vol. 54, p. 1045.
- (2) R. Sewig : " Simultanaufzeichnung mehrerer Vorgänge mit dem Kathodenstrahl-oszillographen." *Zeitschr. f. tech. Phys.*, 1933, Vol. 14, No. 4, p. 152.
- (3) I. B. Davidson : " A Double Wave Device for use with a Cathode Ray Oscillograph." *Journ. Scient. Instr.*, Nov. 1934, Vol. 11, No. 11, p. 359.
- (4) George, Heim, Mayer, Roys : " A Cathode Ray Oscillograph for observing Two Waves." *Elec. Engineering*, Oct. 1935, Vol. 54, p. 1095.
- (5) H. K. Hughes : " Thyatron Selector for Double Trace Cathode-Ray Oscillograph." *Review Scient. Instr.*, Feb. 1936, Vol. 7, p. 89.
- (6) L. Garceau : " Duplex Cathode Ray Oscillograph." *Review Scient. Instr.*, June, 1935, Vol. 6, p. 171.
- (7) H. O. Walker : " Investigation of the Behaviour of a Hexode." *Wireless Engineer*, Aug. 1937, Vol. 14, No. 167, p. 430.

Correspondence

Letters of technical interest are always welcome. In publishing such communications the Editors do not necessarily endorse any technical or general statements which they may contain

On the Measurement of Secondary Emission in Valves

To the Editor, The Wireless Engineer.

SIR,—I have read with the greatest interest Mr. Treloar's article on " The Measurement of Secondary Emission in Valves " published in the October 1938 issue of *The Wireless Engineer*.

I notice that a variety of methods for determining the value of secondary emission coefficients of thermionic valves is listed therein.

A further method¹, not quoted in the above list—in my opinion, a simpler and a more accurate one—has been developed and employed by the present writer.

All the results obtained by Lussanet de la Sablonière as well as those relating to the quoted researches agree in the conclusion that the curves $\gamma_{gs} = f(E_a|E_{gs})$ and $\gamma_a = f(E_{gs}|E_a)$, where $\gamma_{gs} = I_{gs2}/I_{gs1}$ and $\gamma_a = I_{a2}/I_{a1}$ (the indices 1 and 2 are respectively employed for primary and secondary currents), have a similar trend to that reproduced in Fig. 1. This enables us to state that γ_{gs} is equal to zero until E_a grows a little higher than E_{gs} , and that γ_a is equal to zero until E_{gs} approaches the value of E_a .

The above phenomenon has in the neighbourhood of the point $E_a = E_{gs}$ the qualitative trend represented by Fig. 2 (a); points P and Q being very close or even coincident.

Let us now consider the case in which E_a varies between zero and two or three times E_{gs} . We would expect, on the basis of simple physical reasons that, as E_a varies from a value equal to

E_{gs} to zero, the relation $I_{a2}/I_{a1} = \gamma_a$, after reaching a maximum, decreases.

If the voltage E_a grows less and less, γ_a will approach zero linearly; the velocity of the principal electrons, when $E_{gs} = \text{const.}$, increases in proportion to the voltage E_a applied to the anode, and in order that the secondary emission may appear, the principal electrons reaching the anode

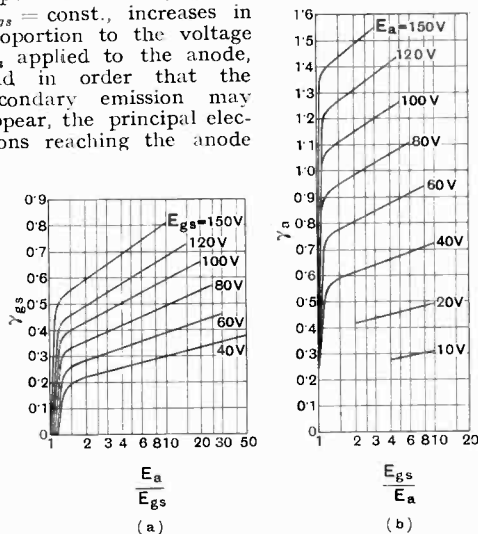

Fig. 1.

must be endowed with a certain velocity. On the other hand, it is possible to foresee that, as E_a varies from a value equal to E_{gs} to a value of two

¹ A. Pinciroli : " Correnti elettroniche secondarie nei tubi a più di due elettrodi." *Alta Frequenza*. Vol. IV, N. 3, June 1935.

or three times E_{gs} , the relation $I_{gs2}/I_{gs1} = \gamma_{gs}$ increases first rapidly and then slowly. Indeed the secondary emission of the screen grid is controlled to a large extent by the voltage applied to it; and the velocity also of principal electrons reaching the

value of the ordinate corresponding to the intersection of the two curves will be equal to $I_e/2$ (in fact $I_e = I_a + I_{gs} = I_{a1} + I_{gs1}$); we have therefore at our disposal sufficient elements to draw the characteristics $I_{a1} = f(E_a)$ and $I_{gs1} = f(E_a)$.

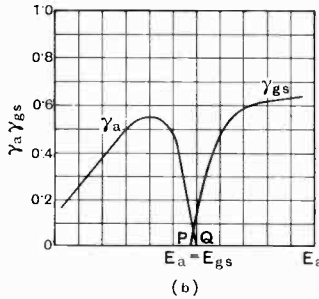
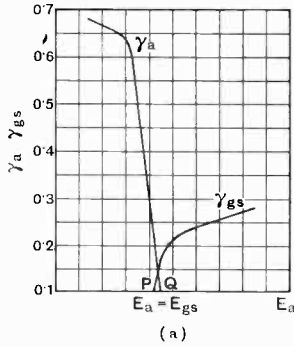

Fig. 2.

screen depends on the same. Also, when the plate voltage reaches a value only a little higher than the screen grid voltage all secondary electrons will be attracted by the anode. The further increase of anode voltage causes a moderate increase in the acceleration of the electrons reaching the screen grid, because of the screening of the latter, and consequently a little increase of the secondary emission.

The above considerations entitle us to assume that the functions $\gamma_a = f(E_a)$ and $\gamma_{gs} = f(E_a)$ have a trend like that of Fig. 2(b).

From the above statements it follows that, if we turn our attention to the region $E_a \leq E_{gs}$ (and also a little exceeding it), γ_{gs} can be presumed equal to zero. In the equations:

$$I_a = I_{a1} + I_{gs2} - I_{a2}$$

$$I_{gs} = I_{gs1} + I_{a2} - I_{gs2}$$

four unknown quantities are now left, and we have:

$$\left. \begin{aligned} I_a &= I_{a1} - I_{a2} \\ I_{gs} &= I_{gs1} + I_{a2} \end{aligned} \right\} \dots \dots [1]$$

J. Herweg and G. Ulbricht² have shown that, wherever the characteristics $I_a = f(E_a)$ and $E_{gs} = f(E_a)$ with negative slope present a straight trend, those of the corresponding primary current $I_{a1} = f(E_a)$ and $I_{gs1} = f(E_a)$ also, have a straight trend. Besides, H. Lange³ has found that the meeting point of primary characteristics $I_{a1} = f(E_a)$, $I_{gs1} = f(E_a)$ with the real ones (see Fig. 3) has a value of E_a being a little higher than E_{gs} ; consequently, the meeting point of $I_{a1} = f(E_a)$ and $I_{gs1} = f(E_a)$ takes place for a value of E_a a little less than E_{gs} . If, for simplicity's sake, we suppose that the primary characteristics meet at a point in which $E_{gs} = E_a$ and that, besides, at the same point the value of I_{a1} equals I_{gs1} , the

The points H and K where the characteristics sharply bend in consequence of the appearance of secondary electronics current and which thus belongs to the characteristics $I_{a1} = f(E_a)$ and $I_{gs1} = f(E_a)$ are indeed known; as well as the point of intersection of the characteristics themselves, and also their straight trend.

The characteristics $I_{a1} = f(E_a)$ and $I_{gs1} = f(E_a)$ being thus defined, one of the relations [1] enables us to find the value of I_{a2} , and thence to deduce the value of γ_{gs} . For the region $E_a > E_{gs}$, the value of γ_{gs} may be found, by a similar process, point by point.

In order to compare the results obtained by applying the method suggested above with those obtained by following the method suggested by Lussanet de la Sablonière, the present writer has studied the distribution of primary and secondary currents within a valve of the Arcturus, 136 A type.

After having traced very accurately the characteristics $I_a = f(E_a)$, $I_{gs} = f(E_a)$ and $I_e = f(E_a)$ according to the different values of E_{gs} , and having drawn, in accordance with the suggested hypothesis, the characteristics $I_{gs1} = f(E_a)$, $I_{a1} = f(E_a)$, the present writer has limited his research, in a preliminary stage, to the study of the trend of the function $\gamma_a = f(E_a)$, for a value of $E_{gs} = 60$ volt.

Fig. 4 shows the obtained results. We may remark that the trends of γ_a and of γ_{gs} are very similar to those deduced on the above hypothesis (Fig. 2(b)).

The value of γ_a , when $E_{gs} = 60$ volt, has been also determined by the method of Lussanet de la Sablonière, and the values thus obtained have been dot pointed on the same graph in Fig. 4. It appears from it that the difference between the values obtained by applying the two different methods is very small.

The above results have further suggested the

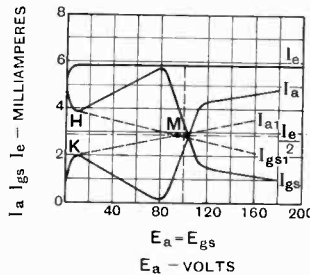

Fig. 3.

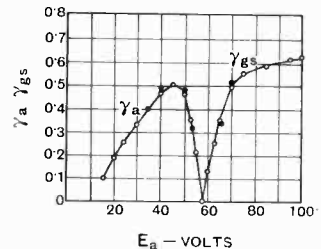

Fig. 4.

drawing of the curves $\gamma_a = f(E_a)$ and $\gamma_{gs} = f(E_a)$ for different values of E_{gs} ; Fig. 5 shows the results thus obtained. The examination of these curves allows us to state that the emission of secondary

² J. Herweg and G. Ulbricht: *Hochsch. tech. u. Elek. Akus.*, 1933, XL1, p. 189.

³ H. Lange: *Zeitschr. f. Hochf. Tech.*, 1928, XXXI, p. 105.

electrons by the plate is but little influenced, for $E_a < 0.8 E_{gs}$, by the value of the voltage applied to the screen grid; we may indeed remark that for $E_a = 40$ volt, the value of I_{a2}/I_{a1} , when passing from $E_{gs} = 60$ volt to $E_g = 100$ volt, reaches respectively the values 0.466 and 0.52.

We are also enabled to come to some interesting conclusions about the distribution of the velocity of electrons within an electronic tube (see Ref. 1).

ANDREA PINCIROLI.

Istituto Elettrotecnico Nazionale,
Turin.

"The 'Variable Q' Amplifier"

To the Editor, *The Wireless Engineer*.

SIR,—I have been much interested in the paper under this heading, published in the February issue of *The Wireless Engineer*, but should like to call the authors' attention to a slip in connection with the history of the device. They give the credit for the basic circuit to Boucherot, but surely this circuit, and the special characteristics which it displays, are only examples of the tuned quarter wavelength transmission line, the properties of which were stated clearly by Steinmetz at least forty years ago. It will also interest the authors to know that Steinmetz gives particulars of the converse property associated with their Figure 2. This does not in the least detract from the value of their paper, but I think that honour should be given where honour is due.

The University,
Birmingham.

WILLIAM CRAMP.

Noise of Frequency Changer Valves

To the Editor, *The Wireless Engineer*.

SIR,—In reply to our letter, published in the November issue of *The Wireless Engineer*, Mr. D. A. Bell—whose letter appeared in the January issue—offered an explanation for our results, with which we are unable to agree.

We should like to make the following remarks:

1. We do not think that the acoustic analogy proposed by Mr. Bell is justified. The beat frequency component, heard by the human observer when two pure tones are generated, is caused by the heterodyning action taking place in the human ear. It is evident, therefore, that a beat frequency component can arise only if both tones in question really reach our ear. If a bell or any other acoustic resonator is excited by lead shots, only the frequency of the resonator is transmitted to the heterodyning element, i.e., the human ear. In agreement with Mr. Bell's expectation we cannot imagine hearing beats with frequencies that are only contained in the rate of arrival of lead shots, but are missing in the form of sound waves.

2. On the other hand in the case of a frequency changer valve, we cannot agree with the statement

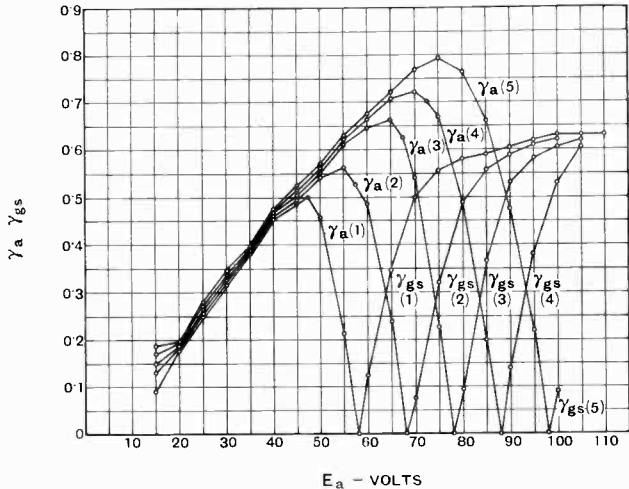

Fig. 5.

that "the signal-frequency spectrum does not exist at any point where it can be heterodyned by the local oscillator." According to our point of view the signal-frequency spectrum, i.e., the spectrum of shot noise, really does exist in the plate current and in the stream of electrons too, which are controlled by the oscillator grid. As the heterodyning action of the local oscillator consists of the modulation of an electron stream, which contains shot effect fluctuations, these current fluctuations are similarly modulated and heterodyned as proved in our "third test" for current fluctuations arising from Johnson noise of a grid resistance. Thus heterodyning already takes place at a point, where the signal-frequency spectrum is existent, before the selective action of the resonant system is introduced.

To obtain a correct analogy in the acoustic example, we should have to imagine a jet of lead shots influenced in such a manner as to vary the number of shots per second. The modulation of the strength of the jet carried out in this way, imitating the injected local oscillation would cause a complex effect in the excitation of the bell analogous to the performance of our F.C. valve.

3. We consider the plate current to contain frequencies of a broad interval up to a limiting frequency of from 10^9 – 10^{10} c/s given by the transit time of electrons. This statement may be proved by a suitable oscillographic arrangement, but the simplest proof is the fact that the noise output measurement on a resonant plate circuit of given bandwidth is independent of its resonance frequency. We find it more convenient in this case to think rather in terms of "Fourier components of current" existing steadily, the roll of the resonant circuit being to transform a narrow band of frequencies into voltage signals, than in terms of "exciting a voltage fluctuation by a number of short impulses of random character." Though the second picture may be equally correct it is not suitable for the

following up of the origin of a determined frequency component in the case in question.

4. The result of our considerations was, that according to experiment the noise output of F.C. valves may be averaged from noise output measurements without local oscillation. According to our explanation that does not mean the lack of heterodyning action, but results from the fact, that the amount of noise due to additional "R.F. noise bands" is equal to the decrease of noise components of the I.F. band. We should expect accordingly that if the assumption concerning the random character of shot noise were not fulfilled, the effect of heterodyning would be imminent. Assuming for example a cathode having "flicker effect" in one of the R.F. bands only, its effect would be detectable in noise output-measurement as soon as the oscillator voltage is injected.

E. LUKÁCS
F. PREISACH
Z. SZEPESI

Ujpest, Tungstram Research Laboratory,
near Budapest.

The Industry

STANDARD TELEPHONES AND CABLES has received an order from the Siamese Broadcasting Administration for a 100-kW. station to be installed at Bangkok. The order, which will amount to about £60,000, includes elaborate studio equipment and a "Standard-Blaw-Knox" anti-fading aerial with extensible topmast.

Halford Radio, of 31, George Street, Hanover Square, London, W.1, has taken over the manufacture, sale and service of Epoch loud speakers.

Erie Resistor, Ltd., wish to emphasise that they distribute their products themselves direct to wholesalers, trade service specialists and retailers.

Change of address: London office of Claude Lyons, Ltd., to Queen's House, 180/182a, Tottenham Court Road, London, W.1. Telephone: Museum 3025.

A series of leaflets giving full data on Reliance potentiometers and rheostats has been issued by the Reliance Manufacturing Company, Ltd., of Sutherland Road, Higham Hill, Walthamstow, London, E.17.

The aerial system of the B.B.C. station nearing completion at Start Point, Devon, is the first of its type to be used in England. It has two 470-ft. masts, one of which (the radiator) is cut two-thirds of the height from the ground, and in the gap is inserted an inductance coil. This is expected to provide a better radiator than the capacity-top aeriels in use at some other B.B.C. stations. The second mast will act as a reflector to reduce radiation over the English Channel.



Television Advisory Committee

THE Chairmanship of the Television Advisory Committee, which had become vacant through the death of Lord Selsdon, has been accepted by Lord Cadman. He was created a Baron in 1937 and is Chairman of the Anglo-Iranian Oil Company. Lord Cadman, who is Emeritus Professor, Birmingham University, is a member of the Advisory Council of the Department of Scientific and Industrial Research and served on the Television Committee, appointed by the Postmaster-General in 1934, under the Chairmanship of Lord Selsdon whom he is now succeeding.

The "Variable Q" Amplifier

REFERENCE 3 in the article with the above heading, which was published in the February issue of *The Wireless Engineer*, stated that a valve generator incorporating the "Variable Q" principle had been described in *The Post Office Electrical Engineers' Journal* of January, 1939. This description was unfortunately not accommodated in that issue, but we understand will be published later.

Abstracts and References

Compiled by the Radio Research Board and reproduced by arrangement with the Department of Scientific and Industrial Research

For the information of new readers it is pointed out that the length of an abstract is generally no indication of the importance of the work concerned. An important paper in English, in a journal likely to be readily accessible, may be dealt with by a square bracketed addition to the title, while a paper of similar importance in German or Russian may be given a long abstract. In addition to these factors of difficulty of language and accessibility, the nature of the work has, of course, a great influence on the useful length of its abstract.

	PAGE		PAGE
Propagation of Waves	137	Directional Wireless	147
Atmospherics and Atmospheric Electricity	140	Acoustics and Audio-Frequencies ...	147
Properties of Circuits	141	Phototelegraphy and Television ...	149
Transmission	142	Measurements and Standards ...	152
Reception	143	Subsidiary Apparatus and Materials	154
Aerials and Aerial Systems ...	145	Stations, Design and Operation ...	161
Valves and Thermionics	145	General Physical Articles	162
		Miscellaneous	162

PROPAGATION OF WAVES

872. COMPLEMENTARY STUDY ON THE COEFFICIENTS OF ATTENUATION IN CYLINDRICAL DIELECTRIC CABLES AND COAXIAL CABLES.—A. G. Clavier & V. Altovsky. (*Bull. de la Soc. franç. des Élec.*, Sept. 1938, Vol. 8, No. 93, pp. 793-804.)

Following on the work dealt with in 2174 of 1938. "The methods of analysis employed are the same as in the previous work, and derive from the papers published by the engineers of the Bell Laboratories of New York. But this new presentation brings to notice the expressions for the energy transmitted in the normal cross section and for the losses in copper and in dielectric, as functions of the amplitudes of the vectors at the surface of the conducting envelope. It gives, moreover, a graph of the coefficients of attenuation for the optimum working frequencies, in a particularly simple form which allows a rapid judgment to be made as to the most advantageous frequency to use, for a given diameter of cable and for a given type of wave, and as to the coefficient of attenuation corresponding to that frequency, according to theory."

873. PROPAGATION OF WAVES ALONG DIELECTRIC CABLES [Analysis for Tubes of Elliptic Section: Results show that $E_0 H_0$ Waves are "Stable" (Little Affected by Change of Tube Section), $E_1 H_1$ are "Unstable": Methods of Correction and Compensation: Possible Transformation of H_0 into E_1 at Bends of the Tube: Use of Mathieu Functions: Analogies in Acoustics, etc.].—L. Brillouin. (*Bull. de la Soc. franç. des Élec.*, Oct. 1938, Vol. 8, No. 94, pp. 899-932.)

874. ULTRA-HIGH-FREQUENCY TRANSMISSION ALONG CYLINDRICAL CONDUCTORS AND NON-CONDUCTORS.—H. W. Droste. (*T.F.T.*, Aug. & Sept. 1938, Vol. 27, Nos. 8 & 9, pp. 310-316 & 337-341.) For the previous parts see 4209 of 1938.

875. THE WAVES OF REFLECTION ON QUASI-HOMOGENEOUS LINES.—Aguillon. (*See* 1083.)

876. ELECTRICAL CONSTANTS OF IONISED AIR FOR MICRO-WAVES [Application of McPetrie's Lecher-Wire Method to Measurement of K and σ for Air (in Tube) ionised by H.F. Discharge: K decreases from 0.992 to 0.958, σ increases from 1.13×10^8 to 1.22×10^8 , as Wavelength increases from 23 cm to 45 cm].—A. K. Banerjee. (*Sci. & Culture*, Calcutta, Dec. 1938, Vol. 4, No. 6, pp. 359-360.) For McPetrie's method see 515 of 1935; for the work of Mitra & S. S. Banerjee, 14 of 1936.

877. WEAKENING OF ELECTROMAGNETIC FIELDS OF ULTRA-SHORT WAVES ON CROSSING RIVERS.—Y. Rocard. (*Comptes Rendus*, 12th Dec. 1938, Vol. 207, No. 24, pp. 1191-1192.)

878. FADING ON AN ULTRA-SHORT-WAVE RELAY CIRCUIT [New York/Philadelphia: Three Fadings in a Year: Suggested Cause].—Smith, Kroger, & George. (*See* 1285.)

879. AURORA BOREALIS AND 10 m RECEPTION, 21st/28th JAN. 1938 [10 m (and also 5 m)-Wave Observations over Short Distances suggest Intensification of E-Layer Ionisation by Violent Ultra-Violet Emission from Sun, arriving about 2 Days before the Corpuscular Radiation evidenced by Aurora and by Fade-Outs].—E. Fendler. (*Funktech. Monatshefte*, Sept. 1938, No. 9, p. 286.)

880. THE ATMOSPHERIC HEIGHT DISTRIBUTION OF BAND-ABSORBED SOLAR RADIATION.—S. Chapman. (*Proc. Phys. Soc.*, 2nd Jan. 1939, Vol. 51, Part 1, No. 283, pp. 93-109.)

For previous work on the absorption of monochromatic radiation see 1932 Abstracts, p. 27. Here, "the band absorption of radiation incident on the atmosphere at any zenith angle is considered, when the relation between the absorption coefficient and the wavelength has the form of an error function . . . and the intensity of the incident radiation is either constant across the absorption band or varies linearly across it. The height-distribution of absorbed-energy density, the height of maximum volume absorption, the spectral

composition of the energy absorbed at any level, and the proportionate daily variation of absorption density, are first discussed without any special assumption as to the height distribution of the absorbing constituent in the atmosphere. The height distribution of absorbed energy per unit mass of air is shown to depend only on a single function of a single parameter, which itself depends on the level, the angle of incidence, and the total absorption coefficient of the atmosphere in the centre of the absorption band. The general results are afterwards discussed in relation to the special case of an exponential height distribution of the absorbing constituent." The height of maximum absorption, the maximum volume density of absorbed energy, the height distribution of absorption, and the thickness of the band-absorption layer in this case are found and compared with the results for monochromatic absorption.

881. THEORETICAL IONISATION CURVES FOR THE E REGION [based on Chapman's Theory and calculated mechanically with Bush Differential Analyser: Experimental Results require Higher Rate of Recombination during Day than during Night].—M. V. Wilkes. (*Proc. Phys. Soc.*, 2nd Jan. 1939, Vol. 51, Part 1, No. 283, pp. 138-146.) The curves are calculated for the experimental results referred to in 3288 of 1936 (Kirby & others) and 1747 of 1938 (Best & others).

882. THE ORIGIN OF RADIO-WAVE REFLECTIONS IN THE TROPOSPHERE [Critical Examination of Evidence of Lower-Atmospheric Reflection: Probable Cause not Ionised Regions but Discontinuities in Water Content: All B-Region Echoes probably occur within Troposphere].—J. H. Piddington. (*Proc. Phys. Soc.*, 2nd Jan. 1939, Vol. 51, Part 1, No. 283, pp. 129-135: Discussion pp. 136-137.)

883. IONIC RECOMBINATION IN AIR [Variation of Recombination Coefficient with Pressure and Ionisation Intensity: Nature of Recombination Process: Calculations of Equilibrium Ion Density and Electrical Conductivity at Various Levels in Lower Atmosphere].—J. Sayers. (*Proc. Roy. Soc., Series A*, 6th Dec. 1938, Vol. 169, No. 936, pp. 83-101.)

884. IONISATION MEASUREMENTS IN THE TROPOSPHERE [Intensity and Minimum Ionisation Curves: Cosmic Radiation and Radioactive Matter as Causes: Connection with Ionic Clouds and Meteorites].—J. Juifs. (*Naturwiss.*, 2nd Dec. 1938, Vol. 26, No. 48, pp. 789-790.)

885. NOTE ON AN ANOMALY IN THE PROPAGATION OF DECAMETRE WAVES [15-60 m] AT SHORT DISTANCES [40-600 km: Adequate Field Strengths but Completely Deformed and Unintelligible Signals: Noiseau Centre Investigations using Spaced-Dot Transmissions: Time of Day has No Influence: No Hypothesis put forward].—L. B. de Clejoux. (*Ann. des Postes, T. et T.*, Nov. 1938, Vol. 27, No. 11, pp. 947-953.)

886. THE CRITICAL-FREQUENCY METHOD OF MEASURING UPPER-ATMOSPHERIC IONISATION.—E. V. Appleton, R. Naismith, & L. J. Ingram. (*Proc. Phys. Soc.*, 2nd Jan. 1939, Vol. 51, Part 1, No. 283, pp. 81-92.)

Author's summary:—The formulae normally employed in the application of the critical-frequency method of measuring upper-atmospheric ionisation are examined and are shown to be appropriate in the case of ionospheric regions which are thick when measured in terms of a wavelength. The complications arising from the occurrence of ionised clouds or strata embedded in the normal regions are described and interpreted.

887. ON THE REFLECTION COEFFICIENTS OF THE HEAVISIDE LAYER IN THE WAVE BAND FROM 200 TO 2000 m FOR VARIOUS DEPARTURE ANGLES.—F. Vilbig. (*T.F.T.*, Aug. 1938, Vol. 27, No. 8, pp. 291-294.)

"According to the equation [Appleton's], the reflection coefficient p has its lowest value for vertical radiation ($\delta' = 90^\circ$, $\cos \delta' = 1$) and then increases as the angle increases. Since B is not known, the absolute values cannot be calculated, but Fig. 3 shows the calculated course of the curve for $\lambda = 200$ m, as a function of the angle δ' . In the following work the reflection factor p is determined from measurements [taken from the CCIR curves Figs. 4 & 5, for $\sigma = 10^{-13}$: the writer subtracts the day values from the night values to obtain the sky-wave field strengths as a function of the distance: then, by dividing by the field-strength values calculated for complete reflection, he obtains p . His results are shown in Figs. 6 & 7], and the question examined whether the reflection factor does actually increase as the departure angle is decreased. Further, the problem will be tackled whether these measurements will allow the constant B (or similar constants in other equations for the reflection factor, such as those given by Försterling & Lassen) to be calculated." The writer sums up his results as follows: "It may therefore be said that the reflection factor of the Heaviside layer obtained by measurements is not the true reflection factor. The rays reflected from the Heaviside layer have superposed on them a radiation arising from an energy 'filling-up' of the energy absorbed in the earth. Special further researches are therefore necessary in order to separate these two values. Until this has been accomplished the constant B in Appleton's formula, for example, cannot be determined accurately by simple reflection measurements."

888. THE LIMITING POLARISATION OF MEDIUM WAVES REFLECTED FROM THE IONOSPHERE.—T. L. Eckersley & G. Millington. (*Proc. Phys. Soc.*, 2nd Jan. 1939, Vol. 51, Part 1, No. 283, pp. 110-128.)

The ratio of the axes of the projection of the polarisation ellipse on a horizontal plane is measured by two crossed loops adjusted in quadrature. "Results obtained on medium-wave broadcasting stations are compared with ellipses calculated on the magneto-ionic theory for an assumed angle of emergence and direction of the earth's magnetic field. The comparison shows that, within the present accuracy of the apparatus, the absorption due to electronic collisions does not appreciably

affect the limiting polarisation of the emergent wave, and sets an upper limit of 10^6 per sec. to the collisional frequency in the region where the polarisation assumes its limiting value. The experiments also suggest that the ratio of the number of ions to the number of electrons in this region is not greater than 10^4 , and further work with increased accuracy should give valuable information relevant to the inclusion of the Lorentz term in the magneto-ionic theory for the E layer."

889. THE LORENTZ "POLARISATION" CORRECTION AND THE BEHAVIOUR OF RADIO ECHOES FROM THE IONOSPHERE AT FREQUENCIES NEAR THE GYRO-FREQUENCY [Discussion of Criticisms: Further Experimental Evidence for Zero Value of Lorentz Polarisation Term in Ionosphere].—D. F. Martyn & G. H. Munro. (*Nature*, 31st Dec. 1938, Vol. 142, pp. 1159-1160.) For previous work see 1282 of 1938, and for criticisms of this, 1746 & 2185 [cf. also 3123] of 1938.

890. AUSTRALIAN RADIO RESEARCH BOARD, 10TH ANNUAL REPORT: 2. WORK ON CONDITIONS IN THE IONOSPHERE [New Ionosphere Height Recording Apparatus sensitive to Changes of 5 m: F_2 Ionisation greater above Anticyclone than above Cyclone (especially Cyclone of Tropical Origin): Effect of a "Front" on F_2 Ionisation: Every Solar Eruption accompanied by Decrease in F_2 Ionisation (Spectro-Helioscope Observations might be replaced by Radio Observations during Bad Visibility): Anomalous Echoes just below Gyro-Frequency, and the Lorentz-Sellmeyer Controversy: etc.]—(*Journ. of Council for Sci. & Indust. Res.*, Australia, Nov. 1938, Vol. 11, No. 4, pp. 328-330 and 331-332.)

891. THE IONOSPHERE [Outline of Short-Wave Propagation: the Wave Retardation (and Consequent False Equivalent Heights) near Critical Frequency: Conversion from Vertical to Oblique Incidence: the Three Main Layers and Their Production: Seasonal and Sunspot-Cycle Changes: Scattering ("Short" and "Distant" Scatter): etc.]—K. W. Tremellen. (*Marconi Review*, Jan./March 1939, No. 72, pp. 1-14.)

"Some years ago the short-wave direction finder gave us a clue to the origin of this distant, more or less horizontal, scatter, and it is difficult to convince some observers that it is not received from other layers of the ionosphere at great heights."

892. RESONANCE PHENOMENA IN IONISED GASES, AND THE PROPAGATION CHARACTERISTICS OF ELECTROMAGNETIC WAVES.—Y. Asami & M. Saito. (*Rep. of Rad. Res. in Japan*, Oct. 1938, Vol. 8, No. 2, Abstracts p. 7.)

Summary of a paper, in Japanese, published a few months after the short communication dealt with in 3122 of 1938. At resonance frequency, γ becomes a maximum and ϵ becomes 1 in its neighbourhood, becoming larger than 1 for the lower frequencies and smaller than 1 for the higher. The variations of the attenuation constant and refractive index have the same tendency as γ and ϵ respectively. As the frequency increases, the

coefficient of reflection, R , which at first gradually decreases, later increases after reaching its minimum value, rises to a maximum and then decreases again rapidly; so that "the variation in R has its max. or min. point over a wide range, if the frequency is varied. It is shown that by utilising these constants of the ionised gases it is possible to explain some of the propagation phenomena of electromagnetic waves in a totally different manner from that usually done at present."

893. ANNUAL VARIATIONS IN UPPER-ATMOSPHERIC IONISATION, and SOLAR RADIATION—ESPECIALLY THE INFLUENCE OF FACULAE ON UPPER-ATMOSPHERIC IONISATION.—Maeda, Takeda, & Kamoshida: Maeda. (*Electrotech. Journ.*, Tokyo, Oct. 1938, Vol. 2, No. 10, pp. 240-241: p. 241.) The full papers, in English, were dealt with in 2194 & 3118 of 1938.

894. ON THE LONG-PERIOD VARIATIONS IN THE F_2 REGION OF THE IONOSPHERE [Causes of the Seasonal and Annual Variations].—Tani, Ito, & Sinkawa. (*Proc. Inst. Rad. Eng.*, Nov. 1938, Vol. 26, No. 11, pp. 1340-1346.) See 2193 of 1938.

895. SELECTIVE FADING AND NON-LINEAR DISTORTIONS [Investigations on 80 m Wave over 50 km Distance].—A. Mayer. (*T.F.T.*, Nov. 1938, Vol. 27, No. 11, pp. 405-413.)

For 50% modulation, even with strictly linear rectification there was a "klirr" factor of 50% as soon as the space-wave field strength amounted to a third of that of the ground wave; for higher modulation percentages the "klirr" factor was still larger. "It seems therefore that these non-linear distortions (which must occur also in common-wave transmissions, by the interference between waves of neighbouring stations) play a greater part in setting the limits of undistorted reception than do the linear distortions caused by the selective amplitude fading." The equipment (with c-r oscillograph) was capable of indicating variations of a few metres in the equivalent height of the layer.

896. SOME RECENT OBSERVATIONS OF SUNSPOT SPECTRA.—H. D. Babcock. (*Proc. Nat. Acad. Sci.*, 15th Dec. 1938, Vol. 24, No. 12, pp. 525-527.) A summary was referred to in 432 of February.

897. ANOTHER LARGE SUNSPOT [Nov. 23rd-Dec. 5th: Data].—(*Nature*, 3rd Dec. 1938, Vol. 142, p. 991.)

898. MAXIMUM USABLE FREQUENCIES FOR RADIO SKY-WAVE TRANSMISSION, 1933-1937.—Gilliland, Kirby, Smith, & Reymer. (*Proc. Inst. Rad. Eng.*, Nov. 1938, Vol. 26, No. 11, pp. 1347-1359.) See 3107 of 1938.

899. DAILY VARIATION OF THE MEAN TEMPERATURE OF ATMOSPHERIC OZONE [Data: Use in Study of Movements of Masses of Stratospheric Air].—A. & E. Vassy. (*Comptes Rendus*, 12th Dec. 1938, Vol. 207, No. 24, pp. 1232-1234.)

900. THE PRESENCE OF ATOMIC NITROGEN IN THE UPPER ATMOSPHERE [Ascription of Wavelengths in Auroral and Night-Sky Spectrum to Forbidden Transitions of NI is not proved].—M. Nicolet. (*Naturwiss.*, 23rd Dec. 1938, Vol. 26, No. 51, p. 839.) See for example 3469 & 3470 of 1938 and 30 & 34 of January.
901. BLUE SUNLIT AURORA RAYS AND THEIR SPECTRUM.—C. Störmer. (*Nature*, 10th Dec. 1938, Vol. 142, p. 1034.)
902. HIGH-FREQUENCY ATTENUATION ON OPEN-WIRE LINES [and the Influence of Sleet and Frost].—H. E. Curtis. (*Bell Lab. Record*, Dec. 1938, Vol. 17, No. 4, pp. 121-124.)
903. ON THE ANOMALOUS PROPAGATION OF PHASE IN THE FOCUS [of Spherical Wave: Diffracting Aperture of Arbitrary Shape].—A. Rubinowicz. (*Phys. Review*, 1st Dec. 1938, Series 2, Vol. 54, No. 11, pp. 931-936.)
904. CORRECTION TO PRINTER'S ERRORS IN PAPER "ON THE MEASUREMENT OF THE OPTICAL CONSTANTS OF VERY THIN METAL FILMS."—K. Försterling. (*Ann. der Physik*, Series 5, No. 2, Vol. 33, 1938, p. 132.) See 1316 of 1938.
905. THE DIFFRACTION OF WAVES BY RIBBONS AND BY SLITS [Exact Solution in Elliptic Cylinder Co-ordinates from New Tables of Mathieu Functions: Possible Acoustic Applications].—P. M. Morse & P. J. Rubenstein. (*Phys. Review*, 1st Dec. 1938, Series 2, Vol. 54, No. 11, pp. 895-898.)
906. ON ASYMPTOTIC SERIES FOR FUNCTIONS IN THE THEORY OF DIFFRACTION OF LIGHT.—W. Pauli. (*Phys. Review*, 1st Dec. 1938, Series 2, Vol. 54, No. 11, pp. 924-931.)
907. "ÉTUDE SUR LA THÉORIE DES ONDES" [particularly the Study of the Discontinuities presented by the Solutions of the Equations of the Theory of Waves: Book Review].—J. van Mieghem. (See 1337.)
- ATMOSPHERICS AND ATMOSPHERIC ELECTRICITY**
908. THE NATURE OF ATMOSPHERICS: VI [Destruction of Cloud Moments by Sequence of Discharges: Oscillatory Wave Trains of Predominant Low Frequency with High Frequency Embroidery].—F. E. Lutkin. (*Proc. Roy. Soc.*, Series A, 22nd Dec. 1938, Vol. 169, No. 937, pp. S 157-S 158: abstract only.)
909. AUSTRALIAN RADIO RESEARCH BOARD, 10TH ANNUAL REPORT: 3. WORK ON ATMOSPHERICS [Wave-Form Records indicate that All Atmospherics are Reflected at Ionosphere: Reflection Height 59-88 km (*i.e.* Reflection Conditions for "Equivalent Wavelengths" 17 000-40 000 m are 10-30 km below E-Layer Boundary): No Evidence of D Layer: etc.].—(*Journ. of Council for Sci. & Indust. Res.*, Australia, Nov. 1938, Vol. 11, No. 4, pp. 330-331 and 332.)
910. OCCURRENCE OF "TWEEDS" ON A TELEPHONE LINE [Investigation of Faint Chirps (on 1500 ft. Telephone Line with Ground Return) Similar to Barkhausen's "Whistling Tones from the Earth": Mathematical Analysis on Basis of Barkhausen's Hypothesis of Multiple Reflection (of Single Static Discharge) between Earth and Ionosphere: Conclusions regarding Ionosphere].—R. F. Chase. (*Proc. Inst. Rad. Eng.*, Nov. 1938, Vol. 26, No. 11, pp. 1380-1384.) For Barkhausen's paper see 1930 Abstracts, pp. 622-623: for his second (alternative) hypothesis see 1931 Abstracts, p. 376.
911. OBSERVATIONS OF THE EARTH CURRENT IN A SUBMARINE CABLE [broken at 500 km from Land at Depth of 4400 m: Telluric Current is Sinusoidal, of Same Frequency as Tide, and reversing with This: Parasitic Disturbances, probably due to Phenomena of Solar Origin, interfere at Certain Moments with the Principal Current].—M. Bernard. (*L'Onde Élec.*, Oct. 1938, Vol. 17, No. 202, pp. 465-468.)
912. POSITIONS OF LIGHTNING STROKES IN THE DEPARTMENT OF THE UPPER GARONNE [indicate Connection with Radioactive Content of Soil].—C. Dauzère. (*Comptes Rendus*, 27th Dec. 1938, Vol. 207, No. 26, pp. 1433-1435.)
913. THE TRACING OF LIGHTNING "NESTS" BY THE DIVINING-ROD EXPERT.—Fritsch. (See 1317.)
914. THE DEVELOPMENT OF THE SPARK DISCHARGE: II [Discharge in Air at Atmospheric and Sub-atmospheric Pressures: Effect of Resistance on Velocity of Propagation of Leader Strokes as Factor in Discharge Development].—T. E. Allibone & J. M. Meek. (*Proc. Roy. Soc.*, Series A, 22nd Dec. 1938, Vol. 169, No. 937, pp. 246-268.) Extension of work dealt with in 3134 of 1938.
915. THE LIGHT IMPULSE OF THE SPARK AND THE LOWERING OF THE SPARK VOLTAGE THEREBY.—M. Toepler. (*Physik. Zeitschr.*, 1st July 1938, Vol. 39, No. 13, pp. 523-530.)
916. CONSIDERATIONS ON THE RECORDING OF TRANSIENT PHENOMENA BY THE CATHODE-RAY OSCILLOGRAPH [with Table of Data for Various Phenomena, collected from the Literature].—Th. Vogel. (*Bull. de la Soc. franç. des Élec.*, Nov. 1938, Vol. 8, No. 95, pp. 961-980.)
917. SCATTERING TIME AND PROBABILITY IN IMPULSIVE BREAKDOWNS: A CONTRIBUTION TO THE THEORY OF THE SCATTERING OF THE DISCHARGE DELAY IN ELECTRICAL BREAKDOWNS BETWEEN ELECTRODES IN AIR AT ATMOSPHERIC PRESSURE.—J. Müller-Strobel. (*Arch. f. Elektrot.*, 15th Nov. 1938, Vol. 32, No. 11, pp. 721-752.)
918. IONIC RECOMBINATION IN AIR, and IONISATION MEASUREMENTS IN THE TROPOSPHERE.—Sayers: Juilfs. (See 883 & 884.)

919. NUCLEUS FORMATION UNDER THE INFLUENCE OF ELECTRIC CHARGES [Theory of Wilson Chamber and of Electrochemical Over-Voltage: Comparison with Experiment].—G. Tohmfor & M. Volmer. (*Ann. der Physik*, Series 5, No. 2, Vol. 33, 1938, pp. 109-131.)
920. BALLOON TRANSMITTERS.—I. M. Hunter. (*Wireless World*, 29th Dec. 1938, Vol. 43, pp. 585-587.)
921. "PRÉVISION DU TEMPS [Weather Forecasting] PAR L'ANALYSE DES CARTES MÉTÉOROLOGIQUES" [Book Review].—J. van Mieghem. (*See* 1337.)
922. STUDY ON [Protective] EARTH CONNECTIONS.—R. Demogue. (*Ann. des Postes, T. et T.*, Oct. 1938, Vol. 27, No. 10, pp. 829-867.)

PROPERTIES OF CIRCUITS

923. RESISTANCE-CAPACITY TUNING [and Some Recent Practical Developments].—P. W. Willans. (*Wireless World*, 5th Jan. 1939, Vol. 44, pp. 5-8.)
924. CHOKON, A NEW RADIO PART: PARTS I & II ["Choking Condenser" (High-Frequency Attenuating Filter) made from (*e.g.*) Paper-Dielectric Condenser by utilising Distributed Resistance of Foil Strips as Series Impedance, and Distributed Capacity as Shunt Impedance: for Frequencies above a Few Megacycles/Second: Input Impedance No Higher than That of Usual Decoupling Filters with High-Capacity Mica Condensers].—H. Iinuma. (*Nippon Elec. Comm. Eng.*, Dec. 1938, No. 14, pp. 499-503; *Rep. of Rad. Res. in Japan*, Oct. 1938, Vol. 8, No. 2, Abstracts p. 9: p. 9.)
925. THE USE OF NEGATIVE FEEDBACK IN BROADCAST RECEIVERS.—Aschenbrenner. (*See* 976.)
926. USE OF FEEDBACK TO COMPENSATE FOR VACUUM-TUBE INPUT-CAPACITANCE VARIATIONS WITH GRID BIAS.—Freeman. (*See* 975.)
927. BALANCED FEEDBACK AMPLIFIERS.—Ginzton. (*See* 1080.)
928. AN ECONOMIC FEEDBACK CIRCUIT [for Transmitters].—Sandy & Twatt. (*See* 952.)
929. A NON-LINEAR DIFFERENTIAL-FEEDBACK OSCILLATOR.—Hakata & Abe. (*See* 955.)
930. INVERSION CIRCUITS.—Drabkina. (*See* 973.)
931. THE LOGARITHMIC AMPLIFIER.—Pevtsov. (*See* 1107.)
932. THE ANODE CHOKE IN THE PUSH-PULL CLASS A AMPLIFIER.—R. Feldtkeller. (*T.F.T.*, July 1938, Vol. 27, No. 7, pp. 251-256.)

H. F. Mayer has proposed to reinforce the distortion-reducing action of over-matching in a push-pull class A amplifier by leading the direct current to the anode through an anode choke of very high inductance (Fig. 2); this is instead of shunting the current source, as is usual, by a large capacity so that no noticeable a.c. voltage may occur between the mid-point of the push-pull transformer and the

cathodes (Fig. 1). This orthodox circuit has definite open-circuit distortion if the two valves differ at all in their electrical properties; as some degree of asymmetry is always present in a push-pull arrangement, the linearising effect of over-matching is nullified. Mayer's suggestion (Austrian Patent 151 767) prevents alternating current from flowing between the cathodes and the mid-point tapping, so that the two valves and the external resistance are in series without any branching-off of current: such an arrangement has no open-circuit distortion however much the valves may differ, provided that their amplification factors are *constant* (they may be *different*) in the working field of the characteristics.

The present writer's analysis, however, shows that Mayer's circuit, when the external resistance is small, gives greater distortion than the usual circuit. For external resistances greater than the internal circuit resistance, his arrangement has great advantages as regards the second harmonic. For the third harmonic it is of no service unless the over-matching exceeds 10; in practice it rarely exceeds 8, so that Mayer's circuit must be considered devoid of advantage as regards the third harmonic. With heavy modulation of the output valves the choke does nothing to diminish the non-linear distortion, as is shown by the shape of the characteristic fields (Figs. 4 & 5).

933. THE INFLUENCE OF REGENERATIVE COUPLING ON THE FREQUENCY OF RELAXATION OSCILLATIONS IN AN INTERRUPTED GENERATOR, AND THE APPEARANCE OF COMPLEX RELAXATION OSCILLATIONS.—A. I. Shostakov. (*Tech. Phys. of USSR*, No. 7, Vol. 5, 1938, p. 566: summary only, in English.)

934. EXPERIMENTS WITH NEUTRALISING CIRCUITS [and the Advantages of the A.C. Bridge Anode Neutrodyne Circuit].—K. Momotuka & K. Sazi. (*Rep. of Rad. Res. in Japan*, Oct. 1938, Vol. 8, Abstracts pp. 8-9.)

935. NEW POSSIBILITIES OF REALISING ELECTRICAL "SIEVES" ["Weiche"—Separating Filters].—H. Lehmann. (*E.N.T.*, Nov. 1938, Vol. 15, No. 11, pp. 342-351.)

For previous work on the formation of electrical "sieves" by series or parallel connection of filters and an additional negative reactance see Piloty, 2477 & 3623 of 1937, where it is pointed out that the filters must be altered if they are to be connected up into practicable "sieves". "It is here shown that this alteration corresponds to the omission of the so-called 'stray reactances' in a definite type of realisation. This general construction principle leads, in the case of known 'sieves' with constant input impedance, to realisation by means of iterative circuits, and further, when extended to filters in general, to practicable 'sieves' where the input impedance is no longer constant."

The filters here derived are open resistance circuits which produce "sieves" when the primary sides are connected in series. The formulae are worked out to match unit resistance. §1 gives the theory of reactance quadrupoles in partial-fraction and iterative circuits, derives the working magnitudes of filters terminated ohmically, and discusses "sieve" quadrupoles. The actual design

of electrical "sieves" is dealt with in § II. The generating functions of "sieves" of constant input impedance are illustrated by specific examples (circuits Figs. 8, 10-13); approximate "sieves" are similarly discussed (§ IIB). Measurements (Figs. 18-21) and numerical data of "sieves" designed on this theory are given in § IIC.

936. THE ELECTRICAL CONDITIONS FOR WIRE-BROADCASTING SEPARATING FILTERS.—W. Waldow. (*See* 1287.)
937. CORRECTIONS TO "ON SINGLE AND COUPLED CIRCUITS HAVING CONSTANT RESPONSE-BAND CHARACTERISTICS."—H. S. Loh. (*Proc. Inst. Rad. Eng.*, Nov. 1938, Vol. 26, No. 11, p. 1310.) *See* 2695 of 1938.
938. CHANNEL CRYSTAL FILTERS FOR BROAD-BAND CARRIER SYSTEMS: ELECTRICAL FEATURES: PHYSICAL FEATURES.—E. S. Willis; A. W. Ziegler. (*Bell Lab. Record* Oct. 1938, Vol. 17, No. 2, pp. 62-65; pp. 66-70.)
939. WORKING ATTENUATION AND ECHO ATTENUATION OF LOSS-FREE FILTER CIRCUITS.—R. Feldtkeller. (*T.F.T.*, Sept. 1938, Vol. 27, No. 9, pp. 342-343.)
940. TRANSMISSION FUNCTIONS OF QUADRIPOLES OF PURE REACTANCE INSERTED BETWEEN TWO RESISTANCES [including Application to Low-Pass Filters, etc.].—G. Cocci. (*Alta Frequenza*, Dec. 1938, Vol. 7, No. 12, pp. 804-843.)
941. "DEFICIENCY" ATTENUATION ["Fehlerdämpfung"] IN QUADRIPOLE TECHNIQUE.—H. Schulz. (*T.F.T.*, Oct. 1938, Vol. 27, No. 10, pp. 386-393.)
942. POTENTIAL DISTRIBUTION ALONG TRANSFORMER-WINDINGS [Two Elements in Waves—Travelling (Quasi-Conduction) Wave with Attenuation, and Pure Non-Attenuating (Quasi-Induction) Wave: Effect of Frequency Increase: etc.].—Ogawa. (*Electrotech. Journ.*, Tokyo, Nov. 1938, Vol. 2, No. 11, pp. 263-265.)
943. NON-UNIFORM LINES WITH DISTRIBUTED CONSTANTS.—Neiman. (*See* 987.)
- TRANSMISSION**
944. GENERATION OF HIGH POWER AT ULTRA-HIGH FREQUENCIES BY MEANS OF BACK-COUPPLING [using Water-Cooled Triodes Types TW-530-B and LD-22-E: 50 kW Output at 6 m, Efficiency 42%; 31.5 kW at 4 m, Eff. 30%; 17 kW at 3 m, Eff. 58%: All with Two Valves in Push-Pull].—M. Kobayashi & H. Nishio. (*Nippon Elec. Comm. Eng.*, Dec. 1938, No. 14, pp. 493-498; *Rep. of Rad. Res. in Japan*, Oct. 1938, Vol. 8, No. 2, Abstracts pp. 9-10.) The first type is the 60 kw short-wave valve referred to in 139 of 1938: the second was specially designed for ultra-short waves.
945. ULTRA-HIGH-FREQUENCY [Electron] OSCILLATIONS OBTAINED BY SENTRON TUBES [Micro-Waves down to 5 cm: Type A (λ Inversely Proportional to Magnetic Field), Type B (λ Directly Proportional), and a Third Less Important (Longer Wave) Type].—S. Uda, M. Ishida, & S. Sioji. (*Electrotech. Journ.*, Tokyo, Nov. 1938, Vol. 2, No. 11, pp. 266-267.)
946. THE GENERATION OF MICRO-WAVES WITH THE "SECTIONALISED MAGNETRON."—Owaki & Suzuki: Okabe. (*See* 989.)
947. UNBALANCING OF A SPLIT-ANODE MAGNETRON BY AN ANODE CURRENT [even when Anode Segments are Symmetrically Arranged].—S. Nakamura. (*Rep. of Rad. Res. in Japan*, Oct. 1938, Vol. 8, No. 2, Abstracts p. 11; *Nippon Elec. Comm. Eng.*, Dec. 1938, No. 14, p. 517: summary only.)
948. 22A TRANSMITTER [for Ultra-Short-Wave Police System].—W. K. Caughy. (*Bell Lab. Record*, Nov. 1938, Vol. 17, pp. 80-84.)
949. METHOD OF MODULATION ON THE 25 cm MICRO-WAVE SERVICE BETWEEN EINDHOVEN AND NIMEGUEN.—von Lindern & de Vries. (*See* 1286.)
950. THE RESTORATION OF THE SIDEBAND SUPPRESSED IN SINGLE-SIDEBAND MODULATION [to transform to Double-Sideband Modulation or to allow Single-Sideband Working with Either Sideband at Will].—F. Vilbig. (*T.F.T.*, Sept. 1938, Vol. 27, No. 9, pp. 321-324.)
Theoretical and experimental treatment. It is found that by the addition of an auxiliary oscillation of twice the carrier frequency, and subsequent rectification, an image of the original sideband, true in frequency and phase, is obtained with practically no distortion. The use of a "ring modulator" in place of an ordinary rectifier enables the first sideband to be suppressed at will.
951. THE STAR-CIRCUIT MODULATOR AS A DOUBLE-PUSH-PULL MODULATOR [free from Limitations of the Much-Employed "Ring Modulator": including Application to Heterodyne Note Generator].—V. Aschoff. (*T.F.T.*, Oct. 1938, Vol. 27, No. 10, pp. 379-383.)
952. AN ECONOMIC FEEDBACK CIRCUIT [correcting for Distortion introduced by Main Modulator Transformer: Feedback Voltage from Low Ohmic Resistance connected in Series with Secondary of This Transformer and shunted by Low-Resistance Choke to improve Low-Frequency Response].—Sandy & Twatt. (*Marconi Review*, Jan./March 1939, No. 72, pp. 34-35.)
953. THE ENERGY CONSIDERATIONS IN DETERMINING THE NUMBER OF STEPS IN THE FREQUENCY RANGE OF A RADIO TRANSMITTER.—F. E. Evteev & P. G. Panov. (*Izvestiya Elektroprom. Slab. Toka*, No. 11, 1938, pp. 26-34.)
The operations of the output stage of a medium- or long-wave radio transmitter, which is usually coupled to the aerial through an intermediate tuned

circuit, are considered; it is pointed out that if the total frequency range of the transmitter is divided into a number of steps and the intermediate circuit is tuned within each step by a continuous variation of either capacity or inductance, the efficiency of the stage will also vary. A formula (10) is derived showing the relationship between the frequency coefficient γ of a step (*i.e.* the ratio of the limiting frequencies of the step) and the maximum and minimum efficiencies of the stage within this step. From this a table of values of γ is calculated and a number of curves are plotted. The tuning of the intermediate circuit by a simultaneous variation of the capacity and inductance is then discussed, and it is suggested that in this way the necessity of dividing the frequency range of a transmitter can be obviated. The discussion is illustrated by numerical examples, and in conclusion methods are indicated for designing the shape of the moving plates of a condenser which is to be ganged with a variometer.

954. THE TEMPERATURE COEFFICIENT OF INDUCTANCES FOR USE IN A VALVE GENERATOR [Mathematical Treatment leading to Practical Conclusions: Importance of Ratio Internal-Inductance/Total-Inductance: Discussion of Three Methods of using a Ceramic Former: etc.].—E. B. Moullin. (*Proc. Inst. Rad. Eng.*, Nov. 1938, Vol. 26, No. 11, pp. 1385-1398.) For Douma's work covering part of the same field see 3712 of 1938.
955. A NON-LINEAR DIFFERENTIAL-FEEDBACK OSCILLATOR [with Resistance Lamp, Metal Rectifier, or Other Non-Linear Element in Differential-Feedback Circuit: Frequency Stability independent of Power Source: Multi-Frequency Oscillations are Reliable, Amplitude and Frequency controlled Independently: Other Advantages].—G. Hakata & M. Abe. (*Rep. of Rad. Res. in Japan*, Oct. 1938, Vol. 8, No. 2, Abstracts pp. 7-8.)
956. VARIABLE-FREQUENCY QUARTZ-CRYSTAL OSCILLATOR.—Uda, Honda, & Watanabe. (*See* 1097.)
957. A 50-KILOWATT BROADCAST TRANSMITTER, and IMPROVED DESIGN FOR 5-KILOWATT BROADCAST TRANSMITTER [both having Doherty High-Efficiency Circuits].—A. W. Kishpaugh; R. E. Coram. (*Bell Lab. Record*, Sept. 1938, Vol. 17, No. 1, pp. 2-6: pp. 7-11.)
958. CLASSIFICATION, ACCORDING TO EFFICIENCY, OF THE VARIOUS TRANSMITTING SYSTEMS FOR MODULATED WAVES.—J. Loeb. (*Bull. de la Soc. franç. des Élec.*, Sept. 1938, Vol. 8, No. 93, pp. 805-837.)
959. THE SYNCHRONY CONTROL IN THE IMPULSE SYSTEM [of Telegraphy].—E. Hudec. (*T.F.T.*, Aug. 1938, Vol. 27, No. 8, pp. 294-302.)

Author's summary:—The impulse system [for previous papers see 3793 of 1938 and back references] can be carried out in two fundamentally different ways: (1) we may transmit the beginning and the end of every telegraph signal, each by one pulse over the radio path, and combine the two

impulses at the receiver into a signal; (2) we may limit ourselves to sending out only the beginning or only the ending impulse, and then supply the absent ending or beginning impulse by an impulse of the correct spacing at the receiver. The first process demands only the same requirements of synchrony between transmitting and receiving apparatus as are required for ordinary telegraphy where the complete signal is transmitted. The second system, which makes much better use of the radio channel, places much more rigorous demands on the synchrony. In the present paper a synchrony control for this second system is described and discussed by taking a multiple telegraph system as an example. Tests with this arrangement, which have already been carried out over a short-range wireless link, will be reported later.

RECEPTION

960. MODERN RECEIVERS FOR METRE [Ultra-Short] WAVES.—G. Baron. (*L'Onde Élec.*, Nov. 1938, Vol. 17, No. 203, pp. 498-503.)

The first receiver outlined is a super-regenerative type preceded by one stage of r.f. amplification. It uses acorn valves. Sensitivity is such that to obtain an output level of 50 milliwatts, a r.f. input voltage of 4 microvolts modulated 50% is required: "the receiver is capable of following, in telephony, a 10-15 watts transmitter in an aeroplane flying in a radius of 200 km." The second apparatus described is a superheterodyne receiver of great sensitivity, also using acorn valves. Particular care is taken with regard to symmetry and screening. For the same 50 milliwatt output level a r.f. input voltage below, or at most equal to, one microvolt is required: this is for a wave-range 4.5 m to 9.0 m. The selectivity is deliberately kept fairly low (pass band of + 25 kc/s for 10 db attenuation) to allow easy reception of telephony stations.

961. NOISE LIMITERS [Use of Double-Diode Limiter for Elimination of Interference (particularly from Car-Ignition Systems) on Short and Ultra-Short Bands].—D. P. Taylor. (*Wireless World*, 5th Jan. 1939, Vol. 44, p. 15.)
962. CONTRIBUTION TO THE STUDY OF THE SCREENING OF THE IGNITION CIRCUITS OF AERO ENGINES [and particularly the Adverse Effects of the Screening on the Ignition Processes].—M. Marchisio. (*Alta Frequenza*, Dec. 1938, Vol. 7, No. 12, pp. 844-859.)

963. THE SUPPRESSION OF INTERFERENCE FROM INDUSTRIAL APPARATUS BY BLOCKING CONDENSERS.—L. A. Fomenko. (*Izvestiya Elektrom. Slab. Toha*, No. 12, 1938, pp. 17-28.)

The theory is discussed of the operation of a condenser connected in parallel with a source of interference to protect the supply mains from this interference. The conception is introduced of the average impedance of a condenser for a given frequency range, and a formula (7) is derived for calculating this. Formulae (8 and 12) are also derived determining respectively the optimum natural frequency of a condenser when, for a given frequency range, (a) C varies and L remains constant, and (b) C remains constant and L varies. Suitable condenser circuits are then discussed as

determined by the type of interference: *i.e.* whether it is propagated along both conductors or the earthed conductor only, the type of the source of interference, and of the network to which it is connected, and safety considerations. In conclusion a number of practical examples are worked out.

964. THE APPARENT IMPEDANCE OF POWER NETWORKS AT BROADCAST FREQUENCIES [in Connection with Interference].—Lev. (See 1104.)

965. RESISTANCE-CAPACITY TUNING [and Some Recent Practical Developments].—P. W. Willans. (*Wireless World*, 5th Jan. 1939, Vol. 44, pp. 5-8.)

966. MAGNETIC TUNING AND SINGLE-SPAN.—L. de Kramolin. (*Wireless World*, 19th Jan. 1939, Vol. 44, pp. 61-64.)

967. REMOTE TUNING OF COMMUNICATION RECEIVERS [and the Use of the "Syndec" (Synchronous Detector) Device].—H. O. Storm. (*Electronics*, Dec. 1938, Vol. 11, No. 12, pp. 14-15 and 32.) From Globe Wireless, Ltd.

968. OPERATING A "COMMUNICATION" RECEIVER [and the Differences between It and a Broadcast Receiver].—R. W. Hallows. (*World-Radio*, 13th Jan. 1939, Vol. 28, pp. 14-15.)

969. THE MONITOR [giving Automatic Indication of Frequency Drift during Checking of Large Number of Mass-Produced Receivers].—(*Wireless World*, 12th Jan. 1939, Vol. 44, pp. 35-37.)

970. FREQUENCY-DRIFT CORRECTION [Special Trimming Condenser with Bimetallic-Strip Compensation].—(*World-Radio*, 13th Jan. 1939, Vol. 28, p. 15: short note only.)

971. STUDY OF THE STANDARDISATION OF COILS, VARIABLE CONDENSERS, AND SCALES [forming the Aerial Circuit of a Receiver: Theoretical and Experimental Investigation, with Some Results with the New SPIR 1939 Standards].—J. Rothstein. (*L'Onde Élec.*, Nov. 1938, Vol. 17, No. 203, pp. 521-544.)

972. STANDARDISATION OF TESTS ON RECEIVERS: CHAPTER III—TESTS OF SELECTIVITY.—Société des Radioélectriciens. (*L'Onde Élec.*, Nov. 1938, Vol. 17, No. 203, pp. 504-509.) For previous chapters see 2300 of 1938.

973. INVERSION CIRCUITS.—F. A. Drabkina. (*Izvestiya Elektroprom. Slab. Toka*, No. 12, 1938, pp. 40-43.)

In recent years a tendency has developed to replace the input transformer of a l.f. push-pull amplification stage by a resistance-coupled phase-inversion circuit. The advantages of this system are discussed, and the operation of the following circuits is examined: (a) two-valve circuits which can employ either a dual triode (Fig. 1) or two separate valves (Fig. 4), and (b) single-valve circuits (Fig. 7). In each case the over-all frequency characteristics of the stage are plotted, and also curves showing the relationship between the input voltage to the inversion circuit and the power

output and "klirr" factor of the stage. A table is included giving the optimum operating conditions and component values of the systems under consideration. It appears that the single-valve system is the simplest, but on the other hand it requires special matching with the preceding stage.

974. ON THE MAXIMUM PERMISSIBLE DETUNING OF RADIO BROADCAST RECEIVERS.—V. P. Pevtsov. (*Izvestiya Elektroprom. Slab. Toka*, No. 11, 1938, pp. 35-42.)

In view of the appearance on the market of receivers with automatic tuning, it is important to know the accuracy with which a receiver should be tuned to the true resonance condition. The effect of detuning a receiver on its frequency characteristic, "klirr" factor, and output volume is discussed; receivers provided with a single tuning control, automatic volume control, and tone control are considered separately. On the basis of this discussion an experimental investigation was carried out in which the frequency characteristics and "klirr" factors of receivers were measured for various degrees of detuning, and the quality of reception was observed by a large number of persons listening to various broadcast items. A number of curves so obtained are shown, and permissible limits of detuning and of the beating-oscillator frequency-variation are determined for receivers whose audio-frequencies extend to 6000-8000 c/s and 10 000-12 000 c/s. It is finally stated that for optimum results the receiver should be tuned to a frequency lying within ± 1500 c/s or ± 2500 c/s, respectively, of the true resonance frequency.

975. USE OF FEEDBACK TO COMPENSATE FOR VACUUM-TUBE INPUT-CAPACITANCE VARIATIONS WITH GRID BIAS.—R. L. Freeman. (*Proc. Inst. Rad. Eng.*, Nov. 1938, Vol. 26, No. 11, pp. 1360-1366.)

A summary was dealt with in 3552 of 1938. A footnote refers to the similar use of an un-bypassed cathode-lead resistor by Strutt & van der Ziel (120 of 1937).

976. THE USE OF NEGATIVE FEEDBACK IN BROADCAST RECEIVERS [and a Circuit Arrangement giving Negative Feedback with Corrections of Various Distortions, yielding Good Overall Characteristic].—R. Aschenbrenner. (*L'Onde Élec.*, Nov. 1938, Vol. 17, No. 203, pp. 510-520.)

977. THE EVOLUTION OF "PROFESSIONAL" [Commercial] RECEIVERS, FOR FIXED, MARINE, AND AVIATION PURPOSES.—A. Berton. (*L'Onde Élec.*, Nov. 1938, Vol. 17, No. 203, pp. 476-497.)

978. RADIO PROGRAMME PRESELECTOR [incorporated in Some of the General Electric Receivers].—D. R. De Tar. (*Electronics*, Nov. 1938, Vol. 11, No. 11, pp. 16-17.) See also 136 of January.

979. NOTABLE NEW POINTS IN THE AEG BROADCAST RECEIVERS 1938/1939.—(*AEG-Mitteilungen*, Dec. 1938, No. 12, pp. 578-580.)

980. NEW LOCAL/DISTANCE CIRCUIT [combining in One Receiver the Advantages of a Superheterodyne and a Tuned R.F. Circuit using Infinite - Input - Impedance Detector].—J. White. (*Wireless World*, 19th Jan. 1939, Vol. 44, pp. 54-56.)
981. SINGLE-KNOB TUNING IN THE SUPERHETERODYNE RECEIVER [Comparison of the Various Methods].—M. Santoro. (*Alta Frequenza*, Nov. 1938, Vol. 7, No. 11, pp. 740-761.)
982. SURVEY OF THE BROADCAST RECEIVERS AT THE 1938 BERLIN EXHIBITION.—G. Flanze. (*T.F.T.*, Nov. 1938, Supp. Number, Vol. 27, pp. 452-468.)
983. THE "PEOPLE'S RECEIVER," VE 301, AND THE "GERMAN SMALL RECEIVER" DKE.—R. Moebes. (*T.F.T.*, Nov. 1938, Supp. Number, Vol. 27, pp. 468-473.)
984. DESIGNING A FILAMENT TRANSFORMER [4-Volt Input, 6.3-Volt Output].—H. B. Dent. (*Wireless World*, 19th Jan. 1939, Vol. 44, pp. 59-60.)

AERIALS AND AERIAL SYSTEMS

985. AN ANTI-PARASITIC AERIAL WITH A WIDE FREQUENCY RANGE FOR RECEPTION OF BROADCASTING.—V. A. Govyadinov. (*Izvestiya Elektroprom. Slab. Toka*, No. 12, 1938, pp. 47-52.)

The theory of the anti-parasitic aerial is discussed and a detailed description is given of an aerial developed in the U.S.S.R. for use on wavelengths up to 2000 m. The aerial is of the *L* type and uses an aerial transformer, a double-wire twisted downlead, and a receiver input transformer (Fig. 2).

986. MEASUREMENTS AT HIGH FREQUENCIES ON BROADCASTING AERIALS [Use of the H.F. Bridge illustrated by Measurements on the WEEL Two-Aerial System with Reduced East/West Radiation].—D. B. Sinclair. (*Ann. des Postes, T. et T.*, Sept. 1938, Vol. 27, No. 9, pp. 810-820.) Translated from an article in *General Radio Experimenter*.

987. NON-UNIFORM LINES WITH DISTRIBUTED CONSTANTS.—M. S. Neiman. (*Izvestiya Elektroprom. Slab. Toka*, No. 11, 1938, pp. 14-25.)

In designing a line with a continuously variable characteristic impedance it is usual to replace it either by a uniform line or by a number of sections each having a different but constant characteristic impedance. In the present paper a more accurate design is proposed of a line whose characteristic impedance varies in accordance with the exponential law. Equations are derived for determining the voltage distribution (eqn. 11) and the current distribution (eqn. 14) in such a line, and methods are indicated for solving these equations. The results obtained are discussed and conditions are established under which no reflection will occur at the ends of the line. In the light of the theory developed, the branching-off of a feeder without the use of a matching transformer is considered (Fig. 2), and a number of practical suggestions are made. A brief discussion is also given of a line

consisting of uniform sections of equal length and with a constant impedance ratio between any two adjacent sections.

988. SIMPLE TRANSMISSION THEORY RELATING TO THE MATCHING OF RADIO FEEDER LINES [Summary of Formulae and Their Derivations].—F. A. Lynes. (*P.O. Elec. Eng. Journ.*, Oct. 1938, Vol. 31, Part 3, pp. 210-212.)

VALVES AND THERMIONICS

989. SECTIONALISED MAGNETRON [Split-Anode Magnetron with "Sectionalising" Disc-Electrodes along Filament Direction: Empirical Formula: No Back-Heating (except at Critical Value of Magnetic Field): Small Air-Cooled Valve gives about 200 W Output at 90 cm, with Efficiency 70%].—K. Owaki & T. Suzuki: Okabe. (*Electrotech. Journ.*, Tokyo, Nov. 1938, Vol. 2, No. 11, pp. 257-260.) "First described by Prof. Okabe [521 of 1938], since when it has been considerably improved by the writers."

990. SENTRON—A NEW TUBE FOR ULTRA-SHORT WAVES [with Electrons supplied from the Side into Split-Anode Cylinder, giving 80 W (or 50 W with 88% Efficiency) at 17 cm: over 10 W at 10 cm: etc.].—S. Uda. (*Rep. of Rad. Res. in Japan*, Oct. 1938, Vol. 8, No. 2, pp. 47-56.)

For previous papers see 3166 of 1938 and back reference. "The author further believes that it is not impossible to obtain 100 watts with a 15 cm wavelength with a small air-cooled tube. And now there is also considerable hope that wavelengths below 10 cm . . . will be obtained by B-type oscillations."

991. MICRO-WAVES DOWN TO 5 cm FROM THE SENTRON VALVE.—Uda, Ishida, & Sioji. (*See* 945.)

992. TRIODES TYPE TW-530-B AND LD-22-E, AND THEIR USE FOR HIGH-POWER ULTRA-SHORT-WAVE GENERATION.—Kobayashi & Nishio. (*See* 944.)

993. GRID-CONTROLLED SECONDARY ELECTRON MULTIPLIER [Path of Photocurrent in Zworykin-Type Electromagnetic Multiplier changed by Change in First-Anode Voltage: Mutual Conductance 25 μ A/V, $\mu = 10$: Fairly Good Frequency Characteristic: Applicable as Frequency Multiplier or as Oscillator].—S. Chiba & Y. Makino. (*Electrotech. Journ.*, Tokyo, Oct. 1938, Vol. 2, No. 10, p. 244.)

994. ELECTRON MULTIPLIER FOR MEASURING IONISATION CURRENTS [Currents of Order of 10^{-12} A amplified to $10^{-6} - 10^{-5}$ A: of Order of 10^{-14} A detected: for Smaller Currents, Main Difficulty is to reduce Thermionic Emission from Multiplying Grids: Experiments to replace Bay's Method (Cooling to $120^\circ - 150^\circ$ K), by Use of Surfaces of High Work Function].—W. H. Rann. (*Nature*, 5th March 1938, Vol. 141, pp. 410-411.) Prompted by Bay's letter, 1891 of 1938.

995. ON THE DEVELOPMENT OF VOLTAGE AMPLIFIERS OPERATING ON THE PRINCIPLE OF ELECTRON-MULTIPLICATION [Survey].—V. N. Lepeshinskaya. (*Izvestiya Elektroprom. Slab. Toha*, No. 12, 1938, pp. 2-17.) With 78 literature references, of which more than a third are Russian.
996. THE INFLUENCE OF GASES ON THE SECONDARY EMISSION OF CERTAIN METALS.—Khlebnikov. (See 1070.)
997. GRID CONSTRUCTION IN THERMIONIC VALVES [Decreasing the Control-Grid Emission by reducing Temperature of Grid (e.g. from 400° C to 300° C) by winding with Wire with Good Radiating Coating (e.g. Carbon) on Outer Semi-Circumference only].—Siemens & Halske Company. (*Marconi Review*, Jan./March 1939, No. 72, pp. 36-37.)
998. THE CAUSES FOR THE FORMATION OF EMISSION CENTRES ON THE SURFACE OF OXIDE CATHODES.—W. Heinze & S. Wagener. (*Zeitschr. f. tech. Phys.*, No. 1, Vol. 20, 1939, pp. 16-26.)
 Authors' summary:—First of all the various possible causes are discussed which may lead to the appearance of emission centres in commercially prepared oxide-coated cathodes: distinction is here made between "accidental" causes and causes dependent on the essential nature of the oxide layer. For the investigation of the "accidental" causes—anchoring of residual gas or extraneous matter at the points lying between the centres—an electron-microscope was used which had a glass bulb and was sealed off from the pump: the vacuum conditions were as good, and the emission values (unvarying with time) as great, as those obtaining in commercially manufactured receiving valves. This microscope showed the presence of centres similar to those observed in less good conditions of vacuum with the earlier type of electron-microscope with metal envelope. The size and distribution of these centres were found to be practically independent of the activating condition (Fig. 2), of the time of life (Fig. 3), and of deliberate poisoning of the cathode (Figs. 4 & 5). It was therefore concluded that the "accidental" causes could not be used for the explanation of the building of the emission centres.
 Among the causes dependent on the nature of the layer a distinction must be made between the *primary* causes, conditioned by the building-up of the layer, and the *secondary* causes following on these and finding expression in the emission equation. These secondary causes, namely inhomogeneities of temperature, of internal and external work functions, and of electrical field strength, at various parts of the cathode, are traced to variations in the thickness of the layer, in the mixing proportions of the oxides, in the orientation of the emitting crystal surfaces with respect to the oxide-crystal concerned, and finally to the roughness of the surface, all as primary causes. By the electro-microscopic examination of various suitably prepared oxide layers it is shown that of all these primary causes only the varying orientation of the crystal surfaces, and the roughness, have any practical action in the formation of emission centres.
999. DISCUSSION ON ELECTRON-DIFFRACTION AND SURFACE STRUCTURE [including Results on Oxide-Coated Cathodes].—(*Proc. Phys. Soc.*, 1st Nov. 1938, Vol. 50, Part 6, No. 282, pp. 961-967.)
1000. FILAMENT DESIGN FOR HIGH-POWER TRANSMITTING VALVES [Comparison of Rukop's and Marconi Company's Data on Relation of Diameter to Life: Calculations of Operating Expense: Proposal to obtain Doubled (or Greater) Life and Decreased Operating Expense, by Small Increase of Diameter].—J. J. Vormer. (*Proc. Inst. Rad. Eng.*, Nov. 1938, Vol. 26, No. 11, pp. 1399-1407.)
1001. COMMENTS CONCERNING ANDERSON'S PAPER ON CONTACT DIFFERENCE IN POTENTIAL BETWEEN BARIUM AND MAGNESIUM [Facts supporting His Results].—R. J. Cashman: Anderson. (*Phys. Review*, 1st Dec. 1938, Series 2, Vol. 54, No. 11, p. 971.) See 664 of February.
1002. VARIATION OF AMPLIFICATION FACTOR IN THE "PLATE" VALVE [Wien Valve with Filament between Anode and Control Electrode].—H. Bode. (*Arch. f. Electrot.*, 15th Nov. 1938, Vol. 32, No. 11, pp. 753-766.)
 Author's summary:—"The introduction refers to the causes of non-linear distortion in amplifying valves and the possibility of their internal compensation. For this an amplification factor [reciprocal of the 'durchgriff'] increasing with anode voltage, for constant anode current, is required. The so-called 'plate valve' [Plattenröhre: Fig. 1] has this in a certain range [cf. Feldtkeller & Jacobi, 1933 Abstracts, p. 619]; the 'durchgriff' increases in ordinary amplifying valves. The reasons for this different behaviour of the 'durchgriff' in the plate valve are investigated. The effect of 'island' formation is calculated; this first causes the 'durchgriff' to increase with anode voltage for constant anode current. Subsequent decrease in the 'durchgriff' is due to variations in space charge. Measures for influencing this 'durchgriff' variation are discussed. The possibility of internal compensation of the non-linear distortions is shown by 'klirr' factor measurements on a 'screen-grid' plate valve." For Inceler's work on the "Platlon" valve (derived from a de Forest type) see 2350 of 1938.
1003. SUPPRESSOR-GRID MODULATION [and the Western Electric 312A and 322A Valves, designed to give about Max. Output with Zero Potential on Suppressor Grid].—C. B. Green. (*Bell Lab. Record*, Oct. 1938, Vol. 17, No. 2, pp. 41-44.)
1004. TUBES, INC. [First in a Series of Critical Surveys of Relations between Manufacturers and Customers].—(*Electronics*, Nov. 1938, Vol. 11, No. 11, pp. 13-15 and 83-86.) "100 million tubes a year—95% of them satisfactory, the rest replaced without argument—that is the commendable record of the tube manufacturers. But undue customer pressure has forced the industry into inefficient practices which are paid for by all of us."

1005. TRANSMITTING TUBE CHART [for Class C Telegraphy or Plate-Modulated Telephony, with Conversion to Other Modes].—B. Dudley. (*Electronics*, Nov. 1938, Vol. 11, No. 11, pp. 37, 38.)
1006. NEW VALVE TECHNIQUE: THE STEEL VALVES.—A. Gehrts. (*T.F.T.*, Nov. 1938, Supp. Number, Vol. 27, pp. 473-478.)
1007. THE NEW RECEIVING VALVES AT THE EXPOSITION-DEMONSTRATION OF DETACHED PIECES, ACCESSORIES, AND VALVES, PARIS, FEBRUARY 1938 [including Valves with "See-Saw Characteristic" (Sliding Screen-Grid Voltage)].—M. Adam. (*Ann. des Postes, T. et T.*, Oct. 1938, Vol. 27, No. 10, pp. 868-879.) Cf. Schiffler, 533 of February.
- DIRECTIONAL WIRELESS**
1008. A LOOP DIRECTION FINDER FOR ULTRA-SHORT WAVES: WAVE-RANGE 6-11 METRES [Rotating-Loop Type with Superheterodyne Receiver: Certain Operating Precautions].—H. G. Hopkins. (*Wireless Engineer*, Dec. 1938, Vol. 15, No. 183, pp. 651-657.) Based on the work dealt with in 3969 of 1938.
1009. DIRECTION FINDING OF VERY SHORT RADIO WAVES OF 20 TO 50 MEGACYCLES PER SECOND [Adcock Aerial System with Receiving Apparatus raised 3.5 m: Special Care in Design of Feeder: Some Results].—K. Maeda & K. Nishikori. (*Rep. of Rad. Res. in Japan*, Oct. 1938, Vol. 8, No. 2, pp. 77-90.)
1010. MULTIPLE COURSES OF THE [Kagosima] AERONAUTICAL RADIO-RANGE BEACON, AND THE CAUSES OF THE PHENOMENON [Result of Reflecting and Scattering Effects of Mountain Surfaces: Multiple Courses diminish with Increased Flying Height: Extent of Formation is influenced by Particular Field Patterns from which the Course is set].—S. Yonezawa & K. Hiraoka. (*Rep. of Rad. Res. in Japan*, Oct. 1938, Vol. 8, No. 2, pp. 61-75.)
1011. DIRECTIONAL OBSERVATIONS OF GNO II 605 kc/s FROM GREAT BRITAIN RECEIVED DURING THE DAY-TIME, IN WINTER IN JAPAN [Direction of Arrival usually deviates from 10 to 15 Degrees, Clockwise, from Great-Circle Path].—Ohno, Nakagami, & Miya. (*Rep. of Rad. Res. in Japan*, Oct. 1938, Vol. 8, No. 2, pp. 91-96.)
1012. VISUAL-READING DIRECTION FINDER FOR ROTATING SPACED-FRAME OR OTHER AERIAL SYSTEM [using Cathode-Ray Tube with Deflector System revolving with Frame System, giving Max. Deflection for Zero Signals].—Falloon. (*Marconi Review*, Jan./March 1939, No. 72, pp. 45-46.) One of the collection of Marconi Company patents given each month as a regular feature.
1013. AUTOMATIC NAVIGATOR [Arrangement of Two Linked D.F.s to give Position of Aircraft by Intersection of Pair of Pointers pivoted on Chart].—J. A. McGillivray. (*Wireless World*, 26th Jan. 1939, Vol. 44, pp. 76-78.) See also 562 of February.
1014. A DIRECT-READING RADIOGONIOMETER [also applicable as Altimeter for Landing].—L. Lévy. (*L'Onde Elec.*, Oct. 1938, Vol. 17, No. 202, pp. 469-472.)
The publication of Damyanovitch's article on an "Automatic Radio-Compass for Aircraft" (1824 of 1937) has led Lévy to ask that his own communication to the International Congress for Safety in Aviation, in 1930, should be published for comparison: it is accordingly reproduced here.
1015. THE ACOUSTIC ALTIMETER FOR AIRCRAFT [Survey].—C. S. Draper. (*Akust. Zeitschr.*, Nov. 1938, Vol. 3, No. 6, p. 393: summary only.)
- ACOUSTICS AND AUDIO-FREQUENCIES**
1016. SELECTING LOUDSPEAKERS FOR SPECIAL OPERATING CONDITIONS [and a Comparison between the Point-by-Point Method and the Continuous-Spectrum-Input Method: Effect of varying Selectivity of Analyser in Latter Method (leading to a Quick Production System of measuring Over-All Efficiencies): etc.].—L. B. Hallman, Jr. (*Electronics*, Nov. 1938, Vol. 11, No. 11, pp. 22-24.)
1017. TWO NEW LOUDSPEAKERS [Sunk ("Ground") and Flat Types].—G.W.O.H: Benecke. (*Wireless Engineer*, Dec. 1938, Vol. 15, No. 183, pp. 649-650.) Editorial on Benecke's paper dealt with in 183 of January.
1018. ACOUSTICAL PROPERTIES OF THE NTH SOKOLS SLET STADION IN PRAGUE [using Buried Loudspeakers].—J. B. Slavík. (*Otisk z Casopisu Slaboproudny Obzor*, No. 8, Vol. 3, 1938, 22 pp: in Czech, with English summary.)
1019. THE HEAT CAPACITY OF ROCHELLE SALT BETWEEN -30° and $+30^{\circ}$ C.—A. J. C. Wilson. (*Phys. Review*, 15th Dec. 1938, Series 2, Vol. 54, No. 12, pp. 1103-1109.)
1020. SYMMETRICAL FIGURES ON CIRCULAR PLATES AND MEMBRANES [Theory].—R. C. Colwell, J. K. Stewart, & A. W. Friend. (*Phil. Mag.*, Jan. 1939, Series 7, Vol. 27, No. 180, pp. 123-128.)
1021. OUTPUT TRANSFORMERS [Usual Output-Valve/Loudspeaker Matching Formula only Approximate: Serious Error if Transformer Resistance is Neglected].—N. Partridge. (*Wireless World*, 12th Jan. 1939, Vol. 44, pp. 30-31.)
1022. ON IMPROVING THE ARTICULATION QUALITY OF A TRANSMISSION CHANNEL BY THE USE OF SPECIAL FREQUENCY CHARACTERISTICS.—Tetelbaum & Vollner. (*See* 1293.)
1023. DEVICES FOR WIDENING THE DYNAMIC RANGE [Experimental Investigation of Some Compandor Systems].—Govyadinov & Sobolev. (*See* 1291.)
1024. VOICE-FREQUENCY VOLUME CONTROL.—Jefferson & Colchester. (*See* 1292.)

1025. ON THE NON-LINEAR DISTORTION, IN THE REPRODUCTION OF GRAMOPHONE RECORDS, RESULTING FROM PICK-UP TRACKING ERRORS.—E. Löfgren. (*Akust. Zeitschr.*, Nov. 1938, Vol. 3, No. 6, pp. 350-362.)
 From the author's summary:—"It is found that the distortion is quite different in nature from that of ordinary non-linear distortion, for instance in a valve amplifier. The combination tones are here highly dependent on the frequency relations, and may assume comparatively high values. As a result, a given 'klirr' factor corresponds to a much greater distorting effect than in the case of the amplifier. The optimum design, as regards distortion, of the tracking arrangements is determined; it is slightly different from that for least angle-error tolerance . . ."
1026. SOUND-ON-DISC RECORDING [Commercial, Professional, and Amateur Technique].—V. M. Brooker. (*Wireless World*, 29th Dec. 1938, Vol. 43, pp. 588-590.) From a Sydney World Radio Convention paper.
1027. ADVANCED DISC RECORDING.—C. J. LeBel. (*Electronics*, Nov. 1938, Vol. 11, No. 11, pp. 34-36 and 82.)
1028. FUNDAMENTALS OF THE MAGNETOPHON SYSTEM [using Powder-Coated Film: with Various Curves].—H. Lübeck. (*AEG-Mitteilungen*, Sept. 1938, No. 9, pp. 453-459.) For previous work see 1019 of 1938.
1029. STEEL-WIRE RECORDING OF SOUND AS A GENERAL COMMERCIAL POSSIBILITY: THE "TEXTOPHONE" [for Telephone Messages and Dictation].—Shipton & Company. (*Electrician*, 30th Dec. 1938, Vol. 121, p. 795.)
1030. THEORETICAL AND EXPERIMENTAL INVESTIGATION OF THE NON-LINEAR DISTORTION OF CARBON MICROPHONES [New Theory].—K. Braun. (*T.F.T.*, Nov. 1938, Vol. 27, No. 11, pp. 395-404.)
1031. THE TELEPHONE TRANSMITTER: A SUGGESTED THEORY OF OPERATION [Previous Theories of Carbon-Granule Microphone cannot explain All Performance Characteristics: Tests leading to New Theory].—D. McMillan. (*P.O. Elec. Eng. Journ.*, Oct. 1938, Vol. 31, Part 3, pp. 167-182.)
1032. CALIBRATION OF A [Condenser] MICROPHONE WITH THE RAYLEIGH DISC.—P. K. Kelkar. (*Electrotechnics*, Bangalore, April 1938, No. 11, pp. 77-83.)
1033. IMPROVED HEARING AID [Two-Valve Device with Differential Carbon Microphone].—T. S. Littler. (*Wireless World*, 19th Jan. 1939, Vol. 44, pp. 51-53.)
1034. THE DISTRIBUTION SYSTEM FOR LOUDESPEAKER TRANSMISSIONS AT THE BERLIN TRUNK EXCHANGE [for Line Transmission to Public Assemblies].—R. Kurtz. (*T.F.T.*, Aug. 1938, Vol. 27, No. 8, pp. 303-306.)
1035. THE MEASUREMENT OF THE PENETRATION CAPACITY ["Durchgriffskapazität"] BETWEEN SCREENED SPEECH CIRCUITS [including Coaxial Cables].—K. Kühnemann. (*T.F.T.*, Aug. 1938, Vol. 27, No. 8, pp. 306-310.)
1036. THE ELEMENTS OF THE ELECTRICAL RESISTANCE OF THE CONDUCTORS IN TELEPHONE CABLES, AND THEIR VARIATIONS.—J. M. Rouault. (*Ann. des Postes, T. et T.*, Dec. 1938, Vol. 27, No. 12, pp. 1020-1050.)
1037. AN AUTOMATIC REMOTE AMPLIFIER [situated at Pick-Up point (e.g. One of several Churches) but operated from Studio].—G. H. Brewer. (*Electronics*, Nov. 1938, Vol. 11, No. 11, p. 21.)
1038. THE NEW 94-TYPE BRIDGING AMPLIFIER [for bridging across Low-Level High-Quality Programme Circuits to give Distribution to Monitoring and Other Loudspeakers].—J. B. Harley. (*Bell Lab. Record*, Nov. 1938, Vol. 17, No. 3, pp. 89-92.)
1039. IMPROVED PROGRAMME AND LINE AMPLIFIERS FOR THE BROADCAST STUDIO.—H. M. Owendoff. (*Bell Lab. Record*, Dec. 1938, Vol. 17, No. 4, pp. 125-130.)
1040. THE ANODE CHOKE IN THE PUSH-PULL CLASS A AMPLIFIER.—Feldtkeller. (*See* 932.)
1041. SOUND INSULATION [Results of Measurements of Sound-Insulating Powers of Various Walls and Floors of Buildings].—J. E. R. Constable. (*Nature*, 3rd Dec. 1938, Vol. 142, p. 1003: note from communication to Physical Society.)
1042. TRANSMISSION OF SOUND BETWEEN NEIGHBOURING ROOMS IN A BRICK BUILDING [Importance of Indirect Transmission by Flanking Walls and Floors: Method of Prediction: No Advantage in Partitions of Special Construction with Sound-Reduction Factors greater than 60 db].—J. E. R. Constable. (*Proc. Phys. Soc.*, 2nd Jan. 1939, Vol. 51, Part 1, No. 283, pp. 53-61.)
1043. REVERBERATION THEORY AND FORMULAE [Survey].—K. Sreenivasan. (*Electrotechnics*, Bangalore, April 1938, No. 11, pp. 92-103.)
1044. CONSIDERATIONS UNDERLYING THE DESIGN OF STUDIOS FOR BROADCASTING.—K. Sreenivasan. (*Electrotechnics*, Bangalore, April 1938, No. 11, pp. 111-137.)
1045. THE ACOUSTICAL DESIGN OF BROADCASTING STUDIOS: IV.—J. McLaren. (*World-Radio*, 6th Jan. 1939, Vol. 28, pp. 16-17.)
1046. THE DIFFRACTION OF WAVES BY RIBBONS AND BY SLITS.—Morse & Rubenstein. (*See* 905.)
1047. FREQUENCY AND SOUND-STRENGTH MEASUREMENTS ON AEOLIAN TONES.—W. Holle. (*Akust. Zeitschr.*, Nov. 1938, Vol. 3, No. 6, pp. 321-331.)

1048. CONTRIBUTION TO THE INVESTIGATION OF THE MODE OF ACTION OF SIRENS.—H. Schiesser. (*Akust. Zeitschr.*, Nov. 1938, Vol. 3, No. 6, pp. 363-379.)
1049. NON-DESTRUCTIVE TESTING [including Acoustic Methods, Objective Noise Meters, etc.].—(*Nature*, 3rd Dec. 1938, Vol. 142, pp. 1005-1006: notes on discussion under I.E.E. auspices.)
1050. INVESTIGATIONS ON A NEW METHOD FOR THE DIRECT MEASUREMENT OF SOUND VELOCITIES IN LIQUIDS ["Schlieren" Method with Revolving Mirror, and a Stroboscopic Method].—L. Bergmann & H. Oertel. (*Akust. Zeitschr.*, Nov. 1938, Vol. 3, No. 6, pp. 332-349.)
1051. ABSORPTION MEASUREMENTS OF SUPERSONIC WAVES IN AQUEOUS SOLUTIONS [including Mechanical-Electrical Method of measuring Acoustic Radiation Pressure].—W. Buss. (*Ann. der Physik*, Series 5, No. 2, Vol. 33, 1938, pp. 143-159.)
1052. EXPERIMENTAL ARRANGEMENT FOR MEASUREMENT OF THE VELOCITY OF SOUND IN LIQUIDS, BY A RESONANCE METHOD: MEASUREMENT OF THE VELOCITY OF SOUND IN MERCURY.—C. Salceanu. (*Comptes Rendus*, 12th Dec. 1938, Vol. 207, No. 24, pp. 1184-1186.)
1053. VELOCITY OF SOUND AND DISPERSION AT AUDIO FREQUENCIES IN CHLORINE.—R. Schulze. (*Ann. der Physik*, Series 5, No. 1, Vol. 34, 1939, pp. 41-59.)
1054. SUPERSONIC SATELLITES [Supersonic Wavelength Measurements in Vapours give Curves with Irregularities resembling Wireless-Signal Fading Curves].—S. K. K. Jatkar. (*Electrotechnics*, Bangalore, April 1938, No. 11, pp. 84-86.)
1055. THE [Crystallising] EFFECT OF ULTRA-SOUNDS ON SUPERCOOLED WATER.—I. Sokolov. (*Tech. Phys. of USSR*, No. 8, Vol. 5, 1938, pp. 619-621.) English version of the second paper referred to in 625 of February.
1056. RADIAL VIBRATION OF MAGNETOSTRICTIVE RING PLATE [Theory and Experimental Confirmation].—T. Suita & K. Aoyagi. (*Electrotech. Journ.*, Tokyo, Nov. 1938, Vol. 2, No. 11, pp. 260-263.)
1057. ON THERMAL DEPENDENCE OF ELASTICITY IN SOLIDS [Theoretical Distinction between Elasticity Coefficients for Very High Frequencies (of Elastic Waves representing Thermal Agitation) and for Low Frequencies].—L. Brillouin. (*Phys. Review*, 1st Dec. 1938, Series 2, Vol. 54, No. 11, pp. 916-917.)
1058. THE PHOTOGRAPHY OF AIR SCREW SOUND WAVES.—W. F. Hilton. (*Proc. Roy. Soc.*, Series A, 22nd Dec. 1938, Vol. 169, No. 937, pp. 174-190.)
1059. RADIO ACOUSTIC RANGING CIRCUITS, and THE SONO RADIO BUOY.—Dorsey: Senior. (*Hydrographic Review*, Nov. 1938, Vol. 15, No. 2, pp. 140-141: pp. 141-142.)
1060. ECHO SOUNDING: XVIII [Survey of Recent Equipments].—(*Hydrographic Review*, Nov. 1938, Vol. 15, No. 2, pp. 26-65.)
1061. DIRECT-READING DEPTH-METER FOR PILOTING SHIPS IN RIVERS [Results with Instrument dealt with in 1116 of 1935].—S. Matsuo. (*Electrotech. Journ.*, Tokyo, Oct. 1938, Vol. 2, No. 10, pp. 235-236.) See also 3272 of 1938.
1062. THE ACOUSTIC ALTIMETER FOR AIRCRAFT [Survey].—C. S. Draper. (*Akust. Zeitschr.*, Nov. 1938, Vol. 3, No. 6, p. 393: summary only.)

PHOTOTELEGRAPHY AND TELEVISION

1063. METHODS AND ARRANGEMENTS FOR THE APPLICATION OF THE "STORAGE" PRINCIPLE TO TELEVISION RECEPTION.—M. von Ardenne. (*T.F.T.*, Nov. 1938, Supp. Number, Vol. 27, pp. 518-524.)

Based on experimental work begun before 1936 and now brought to a successful conclusion. The necessary high potentials on the insulated mosaic elements, by which the mosaic screen can be made to function as "a two-dimensional relay" controlling a beam of suitable power from a constant light source, may be generated by secondary emission by either of two methods: the first is to move the electron spot from a surface of small secondary-emission coefficient (by this method, using a change from aluminium to a copper-beryllium alloy and a ray with electron velocity corresponding to over 3 kv, a potential change of almost 2 kv was obtained). This system was used successfully in exploratory experiments on the charging-up times of mosaic elements (section 1), but for actual television the second method, described in section II, leads to simpler technical solutions. In this method the element potentials are generated by the action of electrons of differing velocities on one and the same material. The simplest scheme for obtaining a storage action by this method is seen in Fig. 5, where the charges (strongly negative with respect to the anode potential) are built up on the insulated elements by the left-hand high-velocity ray system, the absolute amount of the charges varying with the magnitude of the ray current, which is modulated by the image signals on the Wehnelt cylinder. The discharge process is carried out by the low-velocity ray system on the right of the diagram, which irradiates the screen with a permanent and uniform flow of electrons whose amount is so proportioned that a fully charged element is just completely discharged by the end of a frame period. The phases of the whole process must be such that an element appears black when in the discharged condition; this rule holds good, though less stringently, in the other arrangements described. The incomplete storage action (leading to intermittent images) of this simple scheme is seen in the curve to the right of Fig. 5.

Good storage action, on the other hand, is obtained by the dual-ray arrangement of Fig. 6,

where the discharge process begins only just before the new charge occurs, being accomplished by the right-hand ray which, by less sharp focusing, is given a larger spot size than that of the image-forming left-hand ray, so as to avoid the difficulty of adjusting two sharply defined rasters to coincidence. Although such a dual-ray arrangement presents no serious difficulties, the single-ray scheme of Fig. 8 is of considerable interest. Here the discharging is carried out by the same ray that forms the image-pattern of charges, by the artifice of making its fly-back occur at reduced electron velocity with larger spot size, and at such a displacement with respect to the new line just formed that it wipes out some of the lines of the preceding frame.

Section III deals with various methods of making the image-pattern of charges act as a relay to the constant projecting beam. Fig. 11 shows the "electrometer platelet" scheme, which is only mentioned in passing (the little reflecting plates forming the mosaic are supposed to be "tilted" by the electrostatic field). The really promising scheme is that based on the use of a crystal mosaic possessing electro-optical properties in the direction of the electrostatic field. Zinc blende has been found by Schramm (1876 of 1936) to have the greatest effect of all crystals so far examined, and it has the added advantage of a comparatively low dielectric constant. Fig. 12 shows such an arrangement, while in Fig. 13 a doubled action of the electro-optical effect of the crystal layer is obtained by backing the crystal layer with a reflecting surface so that the light ray passes twice through the crystal. With this scheme a stored potential of 4500 volts is enough to give an 85% control of the polarised beam. In all these diagrams a very fine network of extremely thin wire is seen just in front of the mosaic screen. The purpose of this, its design and arrangement, are dealt with at the beginning of section II: its main object is to reduce to a negligible amount the retroactive action of the mosaic charges onto the part of the ray in their neighbourhood—action which has results similar to that of flaws in an optical lens.

1064. ON THE PROBLEM OF RECEPTION "STORAGE" IN TELEVISION [Proposal to eliminate Optical Defects of Interlaced Scanning (Loss of Detail resulting from Viewing Distance being Excessive in order to avoid Line Flicker: Line-Wandering: "Treppen"—Staircase—Effect, etc.) by an Electronic "Push-Pull Storage System" Tube (similar Storage Principle to Iconoscope) working in conjunction with a Dual-Ray C-R Tube].—F. Schröter. (*T.F.T.*, Nov. 1938, Supp. Number, Vol. 27, pp. 525-527.)
1065. ON THE BUILDING-UP OF POTENTIAL AND THE EFFICIENCY OF SEMICONDUCTOR PICK-UP TUBES.—G. Krawinkel & H. Salow. (*T.F.T.*, Aug. 1938, Vol. 27, No. 8, pp. 285-290.)

An experimental investigation (Salow) and mathematical analysis (Krawinkel) of the devices dealt with in an earlier paper (1946 of 1938). As regards efficiency, Krawinkel says in section 1b: "Since the stored photoelectrons do not produce the image-signal directly, but only control the

magnitude of the range of the secondary emission at the scanning process, a relation between the two must be established." He therefore defines precisely the efficiency of a storage-type of pick-up, and arrives at a maximum value (averaged over several pick-ups, on the assumption of a sensitivity of $10 \mu\text{A/lumen}$) of 48%. "If we assume that the value of 5% given by Zworykin, Morton, & Flory (3790 of 1937) for the iconoscope [standard tubes, not of the image-multiplying type] is based on the same definition, the resulting ratio of about 10:1 for the efficiencies of the semiconductor pick-up and the iconoscope is in good agreement with the ratio of the light intensities which are required at the signal plates of the two devices in order to give good image transmission."

1066. NOTE ON THE EXTERNAL PHOTOELECTRIC EFFECT OF SEMICONDUCTORS [Analysis of Effect of Contact Potentials on Photoelectric Measurements with Semiconductors].—E. U. Condon. (*Phys. Review*, 15th Dec. 1938, Series 2, Vol. 54, No. 12, pp. 1089-1091.)
1067. ELECTRONIC CONDUCTION IN INSULATING CRYSTALS UNDER VERY HIGH FIELD STRENGTH.—A. von Hippel. (*Phys. Review*, 15th Dec. 1938, Series 2, Vol. 54, No. 12, pp. 1096-1102.) An abstract was dealt with in 656 of February.
1068. ON THE DEVELOPMENT OF VOLTAGE AMPLIFIERS OPERATING ON THE PRINCIPLE OF ELECTRON-MULTIPLICATION [Survey].—V. N. Lepeshinskaya. (*Izvestiya Elektroprom. Slab. Tola*, No. 12, 1938, pp. 2-17.) With 78 literature references, of which more than a third are Russian.
1069. ELECTRON MULTIPLIER FOR MEASURING IONISATION CURRENTS.—Rann. (*See* 994.)
1070. THE INFLUENCE OF GASES ON THE SECONDARY EMISSION OF CERTAIN METALS [Be, Mg, Ta].—N. Khlebnikov. (*Tech. Phys. of USSR*, No. 8, Vol. 5, 1938, pp. 593-618.) The original Russian version was dealt with in 4481 of 1938.
1071. NEW WAYS OF LARGE-PICTURE [3.60 m x 3.00 m] PRODUCTION IN TELEVISION: LARGE-PICTURE PROJECTORS AND LENS-MOSAIC SCREEN OF FERNSEH A.G. AT THE 1938 BERLIN EXHIBITION.—R. Möller. (*T.F.T.*, Nov. 1938, Supp. Number, Vol. 27, pp. 516-517.)
1072. THE TELEFUNKEN PROJECTION TUBE, 1938.—K. Diels. (*T.F.T.*, Nov. 1938, Supp. Number, Vol. 27, pp. 512-515.)
1073. PRESENT-DAY QUESTIONS OF TELEVISION TECHNIQUE.—A. Gehrts. (*T.F.T.*, Nov. 1938, Supp. Number, Vol. 27, pp. 481-484.)
1074. THE FERNSEH A.G. AT THE 1938 BERLIN RADIO EXHIBITION; also THE "OPTA" (LOEWE) TELEVISION APPARATUS; TELEVISION DEVELOPMENT OF THE C. LORENZ A.G.; and SOME TELEFUNKEN DEVELOPMENTS.—(*T.F.T.*, Nov. 1938, Supp. Number, Vol. 27, pp. 484-505.)

1075. THE TEKADE TELEVISION RECEIVERS; also THE FERNSEH SMALL RECEIVER DE7; and THE TELEFUNKEN TABLE MODEL TF1.—(T.F.T., Nov. 1938, Supp. Number, Vol. 27, pp. 505-512.)
1076. A LABORATORY TELEVISION RECEIVER: V & VI [including Adjustment of Circuits for Selective Sideband Transmissions].—D. G. Fink. (*Electronics*, Nov. & Dec. 1938, Vol. 11, Nos. 11 & 12, pp. 26-29 & 16-19.) Taking into consideration the fact that "at the Rochester Fall Meeting the RMA Television Committee tentatively adopted selective-sideband transmissions as a recommended standard."
1077. TELEVISION FOR INDIA.—J. K. Catterson-Smith. (*Electrotechnics*, Bangalore, April 1938, No. 11, pp. 87-88.)
1078. DIGEST OF TECHNICAL PAPERS AT THE ROCHESTER FALL MEETING, IRE-RMA.—(*Electronics*, Dec. 1938, Vol. 11, No. 12, pp. 8-13 and 33.)
1079. ALTERATIONS AT ALEXANDRA PALACE.—T. C. Macnamara. (*World-Radio*, 30th Dec. 1938, Vol. 27, pp. 12-13.)
1080. BALANCED FEEDBACK AMPLIFIERS [with Advantages of Negative Feedback without Its Disadvantage—Reduction of Over-All Amplification: Theory and Experimental Verification: Applications include Television: Linear Output Range of an Amplifier extended from 1000-600 000 c/s to 30 c/s—2.5 Mc/s: with Smaller Valves, Linear Response at High Gain expected up to 5 Mc/s].—E. L. Ginzton. (*Proc. Inst. Rad. Eng.*, Nov. 1938, Vol. 26, No. 11, pp. 1367-1379.)
1081. NOTE ON A PROGRAMME OF QUALITY TESTS INTENDED TO DEFINE OBJECTIVELY THE MERIT OF A TELEVISION INSTALLATION (EQUIPMENT FOR DIRECT PICK-UP OR TELE-CINEMA).—R. Villeneuve. (*Ann. des Postes, T. et T.*, Nov. 1938, Vol. 27, No. 11, pp. 909-946.)
1082. OPERATING TECHNIQUE IN TELEVISION.—D. C. Birkinshaw. (*World-Radio*, 13th Jan. 1939, Vol. 28, pp. 16-17.)
1083. THE WAVES OF REFLECTION ON QUASI-HOMOGENEOUS LINES: THE CASE OF TELEVISION TRANSMISSIONS BY COAXIAL CABLE: PART I.—L. Aguilon. (*Ann. des Postes, T. et T.*, Dec. 1938, Vol. 27, No. 12, pp. 997-1019: to be contd.) The application to coaxial cables and television will be dealt with in the second part.
1084. THE PROBLEM OF SYNCHRONISATION IN CATHODE-RAY TELEVISION [Demands of Interlaced Scanning: Causes of "Pairing": "Serrated" versus "Narrow" Vertical Systems: etc.].—F. J. Bingley. (*Proc. Inst. Rad. Eng.*, Nov. 1938, Vol. 26, No. 11, pp. 1327-1339.) From the Philco laboratories. The "narrow" vertical system is recommended for adoption as the U.S.A. standard.
1085. TELEVISION SYNCHRONISATION.—E. W. Engstrom & R. S. Holmes. (*Electronics*, Nov. 1938, Vol. 11, No. 11, pp. 18-20.)
1086. THE RESPONSE OF TELEVISION AMPLIFIERS TO PERIODIC SIGNALS OF SHORT DURATION AND TO TRANSIENT PHENOMENA.—P. Mandel. (*L'Onde Elec.*, Oct. 1938, Vol. 17, No. 202, pp. 425-445.)
Author's summary:—The classical method of studying transient régimes, by resolving them into Fourier series, lends itself badly to the interpretation of the distortions in television apparatus. Whatever number of terms may be considered, the amplitude is badly represented, and the effect of an irregularity of phase or of amplitude is a long job to calculate. It is therefore better to use a direct treatment of the application of the perturbation to the resistance-coupled amplifying stage; this shows, for example, the gain compatible with a certain permitted distortion, and the improvement obtained by introducing a self-inductance into the plate circuit.
1087. "PEAK" DETECTORS: APPLICATIONS TO TELEVISION.—R. Barthélémy. (*L'Onde Elec.*, Oct. 1938, Vol. 17, No. 202, pp. 446-457.)
"A problem often encountered is to separate two types of periodic signal whose ratio of maximum amplitudes alone is fixed, the amplitudes themselves being variable. In the case of fixed amplitude, the solution is direct: one of the signals is eliminated by a diode or valve, suitably biased. If the amplitudes vary, it is necessary to regulate the bias as a function of these variations. The object of the present note is to show how this regulation can be effected automatically."
1088. THE ACCURACY OF RECTIFIER-PHOTOELECTRIC CELLS [Effect of Resistance in Series with Cell on Linearity of Response and Temperature Coefficient of Sensitivity: Possible Explanation by Presence of Series Resistance inside Cell: Practical Conclusions].—J. R. Atkinson, N. R. Campbell, E. H. Palmer, & G. T. Winch. (*Proc. Phys. Soc.*, 1st Nov. 1938, Vol. 50, Part 6, No. 282, pp. 934-946.)
1089. TWO DIFFERENT EXAMPLES OF NON-ADDITIVITY OF THE PHOTOELECTRIC EFFECTS OF SIMULTANEOUS LUMINOUS FLUXES [Behaviour of Selenium and Thallofide Cells].—G. Liandrat. (*Comptes Rendus*, 27th Dec. 1938, Vol. 207, No. 26, pp. 1396-1397.)
1090. CORRECTION TO PRINTER'S ERRORS IN PAPER "ON THE MEASUREMENT OF THE OPTICAL CONSTANTS OF VERY THIN METAL FILMS."—K. Försterling. (*Ann. der Physik*, Series 5, No. 2, Vol. 33, 1938, p. 132.) See 1316 of 1938.
1091. COMMENTS CONCERNING ANDERSON'S PAPER ON CONTACT DIFFERENCE IN POTENTIAL BETWEEN BARIUM AND MAGNESIUM [Facts supporting His Results].—R. J. Cashman: Anderson. (*Phys. Review*, 1st Dec. 1938, Series 2, Vol. 54, No. 11, p. 971.) See 664 of February.

1092. TEMPERATURE VARIATION OF THE ELECTRIC AND MAGNETIC DOUBLE REFRACTION OF LIQUIDS [Measurements on Organic Liquids].—K. H. Grodde. (*Physik. Zeitschr.*, 15th Nov. 1938, Vol. 39, No. 22, pp. 772-783.)
1093. A SIMPLE XENON LAMP FOR THE SHORT-WAVE ULTRA-VIOLET [primarily designed for Photometric Output Measurements in This Region: also for Fluorescence Investigations, etc.].—M. von Ardenne. (*Zeitschr. f. tech. Phys.*, No. 1, Vol. 20, 1939, pp. 30-31.)
1094. "THE PERCEPTION OF LIGHT" [Book Review].—W. D. Wright. (*Electrician*, 30th Dec. 1938, Vol. 121, p. 786.)
- MEASUREMENTS AND STANDARDS**
1095. PRECISION WAVEMETER FOR ULTRA-SHORT WAVES [Defects of Absorption-Type Wave-meter avoided by Use of Heterodyne Principle and of Crystal Oscillator of Accurately Known Frequency as Continuous Means of Calibration: Successful Measurement of 30 cm Waves from "Sentron" Valve Oscillator].—S. Uda. (*Electrotech. Journ.*, Tokyo, Nov. 1938, Vol. 2, No. 11, p. 266.)
1096. IMPROVEMENTS IN THE EXECUTION OF MEASUREMENTS OF FREQUENCY [Special Receiver with Double Frequency Change, to decrease the Usual Error (around 1 c/s) to about 0.01 c/s and to eliminate Modulation Sidebands and Sign Ambiguities].—E. Fubini-Ghiron & P. Pontecorvo. (*Alta Frequenza*, Nov. 1938, Vol. 7, No. 11, pp. 731-739.) The second change is to a frequency of the order of 50 kc/s, from which the hundredth harmonic is obtained and measured with the ordinary accuracy to within 1 c/s.
1097. VARIABLE-FREQUENCY QUARTZ-CRYSTAL OSCILLATOR [making Use of the "Partial Vibration" of a Crystal with Large Area compared with Its Thickness, by means of a Small Movable Electrode: Variable-Frequency Range about 3%].—S. Uda, S. Honda, & H. Watanabe. (*Electrotech. Journ.*, Tokyo, Oct. 1938, Vol. 2, No. 10, pp. 243-244.) For these "partial" or "sectional" vibrations see 2268 of 1938.
1098. THE HEAT CAPACITY OF ROCHELLE SALT BETWEEN -30° and $+30^{\circ}\text{C}$.—A. J. C. Wilson. (*Phys. Review*, 15th Dec. 1938, Series 2, Vol. 54, No. 12, pp. 1103-1109.)
1099. INTERCOMPARISON OF THE ABSOLUTE VALUES OF FREQUENCY STANDARDS: NINTH REPORT OF THE SUB-COMMITTEE FOR FREQUENCY STANDARDS [Relative Deviations of Standards at Four Japanese Laboratories over One Month: Three agree within 3×10^{-7}].—Mitsuda, Tani, & Kusunose. (*Rep. of Rad. Res. in Japan*, Oct. 1938, Vol. 8, No. 2, pp. 57-60.) For a previous set of tests see 263 of 1938.
1100. RADIAL VIBRATION OF MAGNETOSTRICTIVE RING PLATE [Theory and Experimental Confirmation].—T. Suita & K. Aoyagi. (*Electrotech. Journ.*, Tokyo, Nov. 1938, Vol. 2, No. 11, pp. 260-263.)
1101. THE TEMPERATURE COEFFICIENT OF INDUCTIONS FOR USE IN A VALVE GENERATOR.—Moullin. (See 954.)
1102. A SIMPLE NOTE-MODULATED OSCILLATOR [e.g. for Receiver Alignment: Mains Driven, without Rectifier].—G. Dilda. (*Alta Frequenza*, Nov. 1938, Vol. 7, No. 11, pp. 792-796.)
1103. ELECTRICAL INSTRUMENT USING LOGARITHMIC CHARACTERISTICS [for Direct Reading of Apparent Power or Impedance].—K. Awaya, T. Kobayasi, & H. Kawai. (*Electrotech. Journ.*, Tokyo, Oct. 1938, Vol. 2, No. 10, pp. 242-243.)
1104. A METER FOR MEASURING THE APPARENT IMPEDANCE OF POWER NETWORKS AT RADIO BROADCASTING FREQUENCIES.—Kh. I. Lev. (*Izvestiya Elektroprom. Slab. Toka*, No. 12, 1938, pp. 44-47.)
- In designing filters for preventing the propagation of interference from industrial apparatus along the supply mains it is essential to know the impedance presented to the interference by the mains. In this paper a description is given of a meter developed in the U.S.S.R. for measuring impedances from 10 to 2000 ohms at radio broadcasting frequencies. The meter utilises the principle proposed by Reppisch & Schulz (2619 of 1935): that is, a r.f. voltage is applied to the terminals of the supply network and the current is measured. From this the apparent impedance Z of the network can be calculated. A further measurement with a series condenser, whose reactance is made equal to Z , enables the reactive and active components of Z to be determined with the aid of a vector diagram. The meter described uses a valve oscillator followed by a push-pull amplifier. The r.f. current and voltage are measured by a thermo-milliammeter and a valve voltmeter respectively. A circuit diagram and photographs of the meter are shown. A number of measurements were made with the meter, and these show that not only the value but also the sign of Z changes with frequency.
1105. A DIRECT-READING APPARATUS FOR THE MEASUREMENT OF INDUCTANCE AT RADIO-FREQUENCIES [with Elimination of the Influence of the Coupling Coil].—G. Rutelli. (*La Ricerca Scient.*, 15th/30th Nov. 1938, Series 2, Year 9, Vol. 2, No. 9/10, pp. 551-563.)
- "In a previous work [449 of February] certain equations were obtained which permit a wavemeter to be converted into a direct-reading inductometer or capacity meter operable by three different methods [the first using a variable frequency, the other two a constant frequency]. Successive analytical developments have rendered it possible to make the measurements independent of errors due to the natural resonance of the coupling-coil to the source of energy. The experimental results here described have confirmed all that the theory predicted." An experimental model is illustrated.

A commercial model "should cover a vast field of measurements, including as it would a wavemeter in one and the same instrument."

The arrangement (Fig. 2) consists of an interchangeable standard coupling coil L , of low self-capacity (powdered-iron core) and inductance either 1 mH, 100 μ H, or 10 μ H; a variable condenser C with exponential variation of capacity, and a valve detector circuit with indicating instrument. The semicircular scale of the condenser rotates inside a special ring-shaped scale which can itself be rotated and which is specially calibrated according to the curves in the previous paper. This second scale is not employed in the first of the three methods (where the measurement is made by observing the change of wavelength on introducing the unknown inductance) but is used in the other two methods: thus the procedure in Method B is to tune the instrument to a fixed input frequency, to set the zero of the outer scale against the index of the condenser graduations, to introduce the unknown inductance in series with L (top terminals in Fig. 2), and while keeping the outer scale fixed, to rotate the condenser till resonance is re-established. The unknown inductance may then be read off the scale. Method C is similar, except that the unknown inductance is connected in parallel to L (left-hand terminals of Fig. 2) and a different half of the scale is used.

1106. LOGARITHMIC GALVANOMETER.—Y. Le Grand. (*Electrician*, 30th Dec. 1938, Vol. 121, p. 787.) For a *Comptes Rendus* Note see 4058 of 1938.

1107. THE LOGARITHMIC AMPLIFIER.—V. P. Pevtsov. (*Izvestiya Elektroprom. Slab. Toka*, No. 12, 1938, pp. 36-40.)

A description is given of an amplifier-voltmeter developed in the U.S.S.R. for measuring the frequency characteristics of radio receivers. The voltmeter (Fig. 3) consists of three stages of amplification using valves with exponential characteristics, followed by two linear stages and a push-pull detector providing current for the meter and for the automatic grid-bias regulation of the first three stages. The frequency characteristic of the voltmeter between 30 and 10 000 c/s does not vary by more than ± 0.3 db. The amplitude characteristic is strictly logarithmic between the limits of 3 mv and 3 v and may be extended to 1 mv and 4 v respectively, in which case deviations not exceeding ± 0.5 db will appear. The operation of the voltmeter is discussed and a number of photographs are shown.

1108. ELECTRICAL METHODS OF MEASURING THE MOISTURE OF DISPERSE BODIES [e.g. Soil].—Alexandrov & Mikhailov. (See 1324.)

1109. ELECTRON-MULTIPLIER FOR MEASURING IONISATION CURRENTS.—Rann. (See 994.)

1110. DIELECTRIC LOSS MEASUREMENTS AT RADIO-FREQUENCIES [from 10 kc/s to 60 Mc/s: Temperatures 20° to 100° C: Probable Error Not Above ± 0.0001 : "Change of Reactance" Method and Its Advantages over "Change of Resistance" or "Change of Frequency" Methods].—A. Dunford & S. E. Goodall. (*Wireless Engineer*, Dec. 1938, Vol. 15, No. 183, pp. 662-668.) From the Metropolitan-Vickers laboratories.

1111. MEASUREMENT OF RELATIVE AND TRUE POWER FACTORS OF AIR CAPACITORS [High- or Low-Voltage Bridge for Measurements of Differences to $\pm 5 \times 10^{-7}$ in Commercial and Audio Frequencies: Theory for Perfect and Imperfect Balance: Variable Low-Loss Air Capacitors for use in the Bridge: Power Factor of Guard-Ring Air Capacitor may exceed 1×10^{-6} : etc.].—A. V. Astin. (*Journ. of Res. of Nat. Bur. of Stds.*, Oct. 1938, Vol. 21, No. 4, pp. 425-456.)

1112. THE PRECISION MEASUREMENT OF CAPACITANCE [in Terms of Mutual Inductance and Resistance: Development of Carey-Foster Bridge: Determination of Power Factor: Careful Screening].—N. F. Astbury & L. H. Ford. (*Proc. Phys. Soc.*, 2nd Jan. 1939, Vol. 51, Part 1, No. 283, pp. 37-52.)

1113. MEASUREMENT OF THE SPECIFIC INDUCTIVE CAPACITY OF DIAMONDS BY THE METHOD OF MIXTURES.—S. Whitehead & W. Hackett. (*Proc. Phys. Soc.*, 2nd Jan. 1939, Vol. 51, Part 1, No. 283, pp. 173-186: Discussion pp. 187-190.)

1114. PROPERTIES OF THIN BISMUTH FILMS [Sensitivity of Resistance Variation with Magnetic Field, as affected by Heat Treatments].—Yamaguti [Yamaguchi]. (*Electrotech. Journ.*, Tokyo, Oct. 1938, Vol. 2, No. 10, p. 242.)

1115. THE MEASUREMENT OF STEADY MAGNETIC FIELDS BY MAGNETRON VALVES.—F. W. Gundlach. (*E.T.Z.*, 29th Dec. 1938, Vol. 59, No. 52, p. 1417: summary only.)

1116. A POSSIBLE METHOD FOR DETERMINING THE TOPOGRAPHY OF WEAK HETEROGENEOUS MAGNETIC FIELDS [using Variation of Double Refraction of Colloidal Solution].—W. Heller & J. Rabinovitch. (*Comptes Rendus*, 5th Dec. 1938, Vol. 207, No. 23, pp. 1088-1090.)

1117. A LOW READING MEAN VOLTMETER [measuring True Mean Value of Distorted 50 c/s Voltage Wave within 1%: Negative Feedback: for Magnetic Tests].—J. Greig & H. N. Wroe. (*Wireless Engineer*, Dec. 1938, Vol. 15, No. 183, pp. 658-661.)

1118. MEASURING IRON-CORED INDUCTANCES [Chokes and Transformers: Use of the Resistance-Capacity Bridge].—M. G. Scroggie. (*Wireless World*, 12th Jan. 1939, Vol. 44, pp. 27-29.)

1119. SIMULTANEOUS DETERMINATION OF RESISTANCES, CURRENTS, AND E.M.F.s IN ABSOLUTE E.M. UNITS, OHM, AMPERE, VOLT.—A. Guillet. (*Comptes Rendus*, 28th Nov. 1938, Vol. 207, No. 22, pp. 1032-1034.)

1120. N.P.L. TESTS: NEW PUBLICATIONS RELATING TO FACILITIES FOR THE TESTING OF APPARATUS AND MATERIALS.—(*Electrician*, 30th Dec. 1938, Vol. 121, p. 797.)

1121. "ALTERNATING CURRENT BRIDGE METHODS: FOURTH EDITION" [Book Review].—B. Hague. (*Electrician*, 30th Dec. 1938, Vol. 121, p. 786.)

SUBSIDIARY APPARATUS AND MATERIALS

1122. CONSIDERATIONS ON THE RECORDING OF TRANSIENT PHENOMENA BY THE CATHODE-RAY OSCILLOGRAPH [with Table of Data for Various Phenomena, collected from the Literature].—Vogel. (*Bull. de la Soc. franç. des Élec.*, Nov. 1938, Vol. 8, No. 95, pp. 961-980.)
1123. THE ELECTRON MICROSCOPE [General Account: Possibilities and Problems].—Martin. (*Nature*, 17th Dec. 1938, Vol. 142, pp. 1062-1065.)
1124. ELECTRON MICROSCOPES [Short Survey].—(Electronics, Nov. 1938, Vol. 11, No. 11, pp. 30-33.)
1125. AN ANALYTICAL STUDY OF ELECTROSTATIC ELECTRON LENSES.—Sugata. (*Electrotech. Journ.*, Tokyo, Oct. 1938, Vol. 2, No. 10, pp. 237-239.) A summary was dealt with in 454I of 1938.
1126. RESEARCHES ON ELECTRON OPTICS [Theoretical Treatment].—Cotte. (*Ann. de Physique*, Oct. 1938, Series 11, Vol. 10, pp. 333-405.)
1127. ON THE EQUATION TO THE AXIAL POTENTIAL DISTRIBUTION IN ELECTRON-OPTICAL SYSTEMS [determined by using Legendre Polynomials for obtaining Approximation to Complicated Function].—Jacob. (*Phil. Mag.*, Oct. 1938, Series 7, Vol. 26, No. 176, pp. 601-609.)
1128. TRANSVERSE CONTROL OF A CATHODE-RAY BEAM IN MULTIPLE-PHASE FIELDS.—Hollmann. (*E.N.T.*, Nov. 1938, Vol. 15, No. 11, pp. 336-341.)

The drop in sensitivity of a cathode-ray tube due to the finite transit time of the electrons is known to be retarded by splitting up the deviating field into several partial fields connected in anti-phase (1932 Abstracts, pp. 652-653). This effect is here investigated theoretically by means of the writer's inversion theory, which is applied to multiple-phase fields (Fig. 1). Fig. 2 shows the inversion factors of one-, two-, three-, and four-phase systems as a function of the transit-time angle. An external-control tube with exchangeable deviating systems is used as an inversion spectrograph (274 of January) to obtain inversion spectra of the systems (Fig. 4). Systems whose middle zone is missing (Figs. 5, 7) are also investigated theoretically (inversion function and factors Figs. 6, 8).

1129. THE FOCUSING PROPERTIES OF THE ELECTROSTATIC FIELD BETWEEN TWO CYLINDERS.—Nicoll. (*Proc. Phys. Soc.*, 1st Nov. 1938, Vol. 50, Part 6, No. 282, pp. 888-898.)

Author's summary:—A general survey of the focusing properties of an electron mirror formed by two cylinders has been made. Photographs of the images formed are shown, and the relations between object and image distances for different voltage ratios on the cylinders are obtained. A special case of multiple reflections is described. Some qualitative results relating to the behaviour of the two-cylinder lens at very high voltage ratios are given, and the formation of intermediate images

in both lenses and mirrors is discussed. Finally, a qualitative description of the focusing properties of two cylinders for voltage ratios from plus to minus infinity is given.

1130. THE MOVEMENT OF AN ELECTRIFIED PARTICLE IN AN ELECTRIC FIELD WITH A SUPERPOSED MAGNETIC FIELD [Integral of Equation of Motion for Fields with Axial Symmetry].—Boggio. (*Comptes Rendus*, 12th Dec. 1938, Vol. 207, No. 24, pp. 1189-1190.)
1131. THE RELATIVISTIC ELECTRON IN CROSSED [Electric and Magnetic] FIELDS [Calculation of Relativistic Correction to Paths of Rapidly Moving Electrons].—Ott. (*Ann. der Physik*, Series 5, No. 7, Vol. 33, 1938, pp. 584-590.)
1132. MEASUREMENTS OF THE VARIATION IN MASS OF VERY RAPIDLY MOVING ELECTRONS [by Simultaneous Electric and Magnetic Deflection of Beta-Rays: Confirmation of Lorentz Formula].—Lahaye. (*Ann. der Physik*, Series 5, No. 1, Vol. 34, 1939, pp. 60-76.)
1133. ELECTRON-OPTICAL EXPERIMENTS ON THE PASSAGE OF SLOW ELECTRONS (0-200 V) THROUGH METAL FOILS, and PASSAGE OF SLOW ELECTRONS (0-200 V) THROUGH METAL FOILS.—Katz. (*Ann. der Physik*, Series 5, No. 2, Vol. 33, 1938, pp. 160-168: 169-184.)
1134. GENERAL THEORY OF DOUBLE-FOCUSING MASS SPECTROGRAPH.—Herzog & Hauk. (*Ann. der Physik*, Series 5, No. 2, Vol. 33, 1938, pp. 89-106.)
1135. THE OPTICS OF POSITIVE RAYS AND ITS APPLICATION TO MASS SPECTROGRAPHY.—Cartan. (*Ann. de Physique*, Nov. 1938, Series 11, Vol. 10, pp. 426-502.)
1136. ON THE PATHS OF IONS IN THE CYCLOTRON [Theory].—Schiff. (*Phys. Review*, 15th Dec. 1938, Series 2, Vol. 54, No. 12, pp. 1114-1115.)
1137. ON THE UPPER LIMIT OF ION ENERGY OBTAINABLE BY MEANS OF THE CYCLOTRON [Bethe & Rose's Results about Half the Correct Value].—Khurgin. (*Comptes Rendus (Doklady) de l'Acad. des Sci. de l'URSS*, No. 4, Vol. 19, 1938, pp. 237-238: in English.)
1138. MAGNITUDE OF ACCELERATED CURRENT IN THE CYCLOTRON [Measurements with Water-Cooled Probe].—Wilson. (*Phys. Review*, 1st Aug. 1938, Series 2, Vol. 54, No. 3, p. 240: abstract only.)
1139. INTERNAL TARGETS IN THE CYCLOTRON.—Wilson & Kamen. (*Phys. Review*, 15th Dec. 1938, Series 2, Vol. 54, No. 12, pp. 1031-1036.)
1140. SELF-EXCITING ELECTROSTATIC GENERATOR WITH CHARGING BANDS RUNNING IN COMPRESSED GAS.—Neubert. (*Zeitschr. f. Physik*, No. 5/6, Vol. 110, 1938, pp. 334-351.)

1141. AXIAL FIELD IN THE SUPPORTING TUBE OF THE COLLECTOR OF A HIGH-VOLTAGE GENERATOR, UTILISING AN ELECTRIFIED AEROSOL FOR THE TRANSPORT OF CHARGES [Calculations].—Virgitti. (*Comptes Rendus*, 5th Dec. 1938, Vol. 207, No. 23, pp. 1085-1088.)
1142. CONDITIONS OF PRODUCTION OF RAPID CARRIERS BY H.F. MULTIPLE ACCELERATION [Linear Method for Production of 200 kV Hg⁺-Beam].—Schlosser. (*Ann. der Physik*, Series 5, No. 6, Vol. 32, pp. 507-519.)
1143. A SIMPLE MODEL OF THE KNUDSEN MANOMETER [Radiometer Principle: Range 10³ μb to 10⁻⁵ μb: Very Useful for Vacuum Control in High-Vacuum Working].—Werner. (*Zeitschr. f. tech. Phys.*, No. 1, Vol. 20, 1939, pp. 13-16.)
1144. A SIMPLE DEVICE FOR THE PROTECTION OF HIGH-VACUUM PUMPS [against Failure of Cooling-Water Supply: the Use of a Tilting Mercury Relay].—Seiler. (*Zeitschr. f. tech. Phys.*, No. 9, Vol. 19, 1938, pp. 283-284.)
1145. "VACUUMTECHNIK IM LABORATORIUM" [Book Review].—Mönch. (*Zeitschr. f. tech. Phys.*, No. 10, Vol. 19, 1938, pp. 325-326.)
1146. DIFFUSION ACTION AND ACTIVATION OF ZINC SULPHIDE.—Graue & Riehl. (*Angewandte Chemie*, 10th Dec. 1938, Vol. 51, No. 49, pp. 873-875.)
- Authors' summary:—(1) With the help of the newly developed emanation-charging method it was determined that the penetration of the emanation into precipitated, badly crystallised zinc sulphide does not occur through large pores but through pores of atomic dimensions. The diffuseness of the precipitated, unannealed zinc sulphide is thus chiefly determined by the presence of numerous irregularities in the atomic spacings. (2) With well crystallised, annealed zinc sulphide the emanation-charging method shows that irregular atomic spacings do not occur in this, or occur only in very small numbers. (3) At room temperatures no appreciable diffusion of the emanation occurs for well crystallised zinc sulphide, but already at 300° even the crystalline sulphide becomes permeable to the emanation atoms. At almost exactly the same temperature the free mobility begins of foreign-metal atoms (phosphorene atoms) in the crystalline sulphide. (4) Generally, the conclusion is reached that diffusion processes (such as may also play a rôle in catalysis) can occur, if the lattice structure is suitable, with great velocity even at temperatures well below the fusing point of the substance. (5) In well crystallised material neither macroscopic pores nor flaws are responsible for the diffusion of foreign atoms. It is rather to be concluded that the diffusion occurs in the inter-lattice spaces of the sound lattice.
1147. THE DECOMPOSITION OF ZINC SULPHIDE BY LIGHT AND ALPHA RAYS [and Variation of Optical and Electrical Properties].—Streck. (*Ann. der Physik*, Series 5, No. 1, Vol. 34, 1939, pp. 96-112.)
1148. ELECTRICAL INVESTIGATIONS ON ZINC-SULPHIDE-COPPER PHOSPHORS [Qualitative Observations of Internal Photoelectric Behaviour: Relations with Optical Phenomena: Similar Behaviour of Phosphorescence, Variation of Dielectric Constant, Secondary and Rectifier Currents].—Goos. (*Ann. der Physik*, Series 5, No. 1, Vol. 34, 1939, pp. 77-95.)
1149. A NEW METHOD OF MEASURING THE DECAY OF PHOSPHORESCENCE AND ITS APPLICATION TO THE ZnSCdSCu PHOSPHORS ON EXCITATION WITH ELECTRON BEAMS [Method based on Change of Dielectric Constant on Illumination, going Parallel with Phosphorescence and changing Capacity of Condenser].—Wollweber. (*Ann. der Physik*, Series 5, No. 1, Vol. 34, 1939, pp. 29-40.)
1150. THE ABSORPTION SPECTRUM OF LUMINESCENT ZINC SULPHIDE AND ZINC-CADMIUM SULPHIDE IN CONNECTION WITH SOME OPTICAL, ELECTRICAL, AND CHEMICAL PROPERTIES.—Gisolf. (*Physica*, Jan. 1939, Vol. 6, No. 1, pp. 84-96: in English.)
1151. FLUORESCENCE OF SOLIDS [Solutions of Naphthacene, etc., in Anthracene: Phenomena resembling Those with Zinc Sulphide containing Copper: Possible Explanation by Motion of Electrons in Crystal].—Bowen. (*Nature*, 17th Dec. 1938, Vol. 142, p. 1081.)
1152. THE FLUORESCENCE OF THE CRYSTALLINE LENS.—Le Grand. (*Comptes Rendus*, 5th Dec. 1938, Vol. 207, No. 23, pp. 1128-1130.)
1153. A SIMPLE XENON LAMP FOR THE SHORT-WAVE ULTRA-VIOLET.—von Ardenne. (See 1093.)
1154. OPTICAL CONSTANTS, ELECTRICAL RESISTANCE, AND STRUCTURE OF THIN METALLIC FILMS [of Gold and Silver evaporated onto Quartz: Anomalies caused Not by an Amorphous but by a Colloidal State: Films consist of Single but Normal Crystallites].—Krautkrämer. (*Ann. der Physik*, Series 5, No. 6, Vol. 32, 1938, pp. 537-576.)
1155. GAS ABSORPTION OF THIN METAL FILMS: AN ATTEMPT TO EXPLAIN THE ANOMALY OF THE OPTICAL CONSTANTS [Influence of Gas Absorption explains Variation of Optical Constants with Thickness and Age: Determination of Mass of Absorbed Gas from Optical Constants].—Kindinger & Koller. (*Zeitschr. f. Physik*, No. 3/4, Vol. 110, 1938, pp. 237-250.)
1156. THE SPUTTERING OF OXIDE-COVERED MAGNESIUM SURFACES [Experimental Proof that Low Sputtering Rate is not due to Charged Particles being returned to Cathode by Electric Field].—Ditchburn & Roulston: Güntherschulze & Betz. (*Proc. Camb. Phil. Soc.*, Oct. 1938, Vol. 34, Part 4, pp. 620-624.) See 4293 of 1937.

1157. PAPERS ON THE THEORY OF ADSORPTION.—Roberts: Dube. (*Proc. Camb. Phil. Soc.*, Oct. 1938, Vol. 34, Part 4, pp. 577-586: 587-598.)
1158. CURRENT HARMONICS ON THE A.C. SIDE OF CURRENT RECTIFIERS [Formula for Determination].—Fässler. (*Arch. f. Elektrot.*, 14th Oct. 1938, Vol. 32, No. 10, pp. 640-654.)
1159. THE CURRENT/VOLTAGE CHARACTERISTICS OF CAPACITATIVELY LOADED HIGH-VACUUM HOT-CATHODE RECTIFIERS [Calculations].—Ludwig. (*Arch. f. Elektrot.*, 10th Sept. 1938, Vol. 32, No. 9, pp. 607-621.)
1160. A THYRATRON-CONTROLLED THERMOSTAT [Continuous Control within ± 0.003 Degree in Water Bath].—Sturtevant. (*Review Scient. Instr.*, Sept. 1938, Vol. 9, No. 9, pp. 276-279.)
1161. PRE-STRIKING CONDITIONS IN A THYRATRON.—Wheatcroft & Hammerton. (*Phil. Mag.*, Nov. 1938, Series 7, Vol. 26, No. 177, pp. 684-694.) Extension of work referred to in 2589 of 1938.
1162. REGULATED TUBE RECTIFIERS USING MAGNETUDE CONTROL [Self-Regulating Thyatron Rectifying Equipment for Battery Charging].—Truckess. (*Bell Lab. Record*, Sept. 1938, Vol. 17, No. 1, pp. 24-27.)
1163. THE IGNITRON TUBE APPLIED TO A RECTIFIER CIRCUIT [Wide Application, particularly with Thyatron Control].—Okubo, Fukaya, & Tashiro. (*Electrotech. Journ.*, Tokyo, Nov. 1938, Vol. 2, No. 11, pp. 251-253.)
1164. B-TYPE SENDYTRON USING A NEW METHOD OF STARTING MERCURY ARC [Dust of Insulating Material on Mercury-Pool Surface, to accumulate Positive Ions: Relation to Malter Effect].—Watanabe & Kasahara. (*Electrotech. Journ.*, Tokyo, Nov. 1938, Vol. 2, No. 11, pp. 253-257.) See also 4609 of 1938 (for the A-type Sendytron).
1165. KENOTRON HEATING TRANSFORMERS [for Voltages up to 100 and 150 kV].—Sakakihara. (*Electrotech. Journ.*, Tokyo, Oct. 1938, Vol. 2, No. 10, p. 243.)
1166. THE SEPARATELY-DRIVEN D.C./A.C. CONVERTER IN A PUSH-PULL CIRCUIT [Theoretical and Experimental Investigation of Working: Very Large Cathode Choke: Various Types of Load: Degree of Loading determines Current and Voltage Form with Ohmic Load: Production of Sinusoidal Voltage].—Ostendorf. (*Arch. f. Elektrot.*, 10th June 1938, Vol. 32, No. 6, pp. 349-372.)
1167. A D.C. TRANSFORMER [Two Mechanical Commutators, on Same Shaft, linked by Transformer].—Lennox & DelBlieux. (*Elec. Engineering*, Sept. 1938, Vol. 57, No. 9, pp. 554-558.) For 100 and 300 kilowatt powers, giving 3000 volts.
1168. SELENIUM METAL RECTIFIERS.—Eristov & Stefanovski. (*Izvestiya Elektroprom. Slab. Toka*, No. 11, 1938, pp. 56-60.)
A description, complete with the operating data and characteristic curves, is given of selenium metal rectifiers manufactured in Germany and in the U.S.S.R. It is pointed out that since the secret process of forming rectifier elements is the property of a German firm (Süddeutsche Apparaten Fabrik GmbH, Nürnberg) it was necessary to carry out independent research work in the U.S.S.R. The results so achieved are said to be entirely satisfactory.
1169. DRY-PLATE RECTIFIERS [Selenium & Copper-Oxide] IN CURRENT-SUPPLY INSTALLATIONS [including for Communication Plant: Comparison with Other Rectifiers and Convertors].—Stange. (*T.F.T.*, Oct. 1938, Vol. 27, No. 10, pp. 363-373.)
1170. THEORETICAL CONSIDERATIONS ON RECTIFIER ACTION [Suggested Mechanism explaining Polarity of Copper-Oxide Rectifier].—Müller. (*Physik. Zeitschr.*, 15th Nov. 1938, Vol. 39, No. 22, pp. 793-795.)
1171. NOTE ON THE CONTACT BETWEEN A METAL AND AN INSULATOR OR SEMICONDUCTOR [Quantum-Mechanical Theory including Origin of Potential Barrier in Copper-Oxide Rectifiers].—Mott. (*Proc. Camb. Phil. Soc.*, Oct. 1938, Vol. 34, Part 4, pp. 568-572.)
1172. IMPROVING THE OUTPUT OF COPPER-OXIDE RECTIFIERS [Forced Ventilation and Its Effects].—Baudisch & Kafka. (*E.T.Z.*, 8th Sept. 1938, Vol. 59, No. 36, p. 970: summary only.)
1173. RADIATION MEASUREMENTS ON A HIGH-PRESSURE MERCURY LAMP [Spectral Distribution of Energy: Radiative Power of Quartz: etc.].—Rössler. (*Ann. der Physik*, Series 5, No. 1, Vol. 34, 1939, pp. 1-22.)
1174. LUMINESCENT DISCHARGE TUBES WORKING ON ORDINARY MAINS VOLTAGES.—Claude. (*Comptes Rendus*, 12th Dec. 1938, Vol. 207, No. 24, pp. 1206-1208.)
1175. THE EMISSION FROM THE END OF LUMINESCENT TUBES: GENERAL FORMULAE [for Discharge Tubes, Photoluminescent Tubes illuminated Terminally or Cylindrically].—Dunoyer. (*Comptes Rendus*, 5th Dec. 1938, Vol. 207, No. 23, pp. 1095-1097.)
1176. THE MEASUREMENT OF THE ENERGY DISTRIBUTION IN A SPECTRUM CONSISTING OF A CONTINUUM AND LINES [Method: Example of Low-Pressure Mercury Tube with Lining of Luminescent Material].—Rössler. (*Zeitschr. f. Physik*, No. 7/8, Vol. 110, 1938, pp. 495-501.)
1177. IGNITION POTENTIAL IN A LOW PRESSURE NEON TUBE [Calculated and Observed Values as Function of Time Constant of an Exponentially Increasing Voltage].—Fett. (*Phys. Review*, 1st Sept. 1938, Series 2, Vol. 54, No. 5, pp. 389-390.)

1178. NOTE ON THE ELECTRICAL DISCHARGE IN ARGON [Anomalous Current/Voltage Curves in Cathode Dark Space due to Presence of Positive Space Charge].—Newman. (*Phil. Mag.*, Nov. 1938, Series 7, Vol. 26, No. 177, pp. 719-722.)
1179. THE ABNORMAL CATHODE FALL OF THE GLOW DISCHARGE.—Druyvesteyn. (*Physica*, Oct. 1938, Vol. 5, No. 9, pp. 875-881: in English.)
1180. ELECTRON LIBERATION BY IMPACT OF POSITIVE IONS ON THE CATHODE OF A GLOW DISCHARGE: IV.—Güntherschulze, Bär, & Winter. (*Zeitschr. f. Physik*, No. 3/4, Vol. 111, 1938, pp. 208-211.)
1181. ELECTRONIC WAVES [with Consideration of Effects produced by Collisions between Cathode Rays and Matter and Constitution of Negative Glow in Gas Discharges, etc.].—J. J. Thomson. (*Phil. Mag.*, Jan. 1939, Series 7, Vol. 27, No. 180, pp. 1-32.)
1182. LOW-FREQUENCY SINGLE-ELECTRODE ["External-Electrode" or "Electrodeless"] DISCHARGE AND ITS APPLICATION [including Regulation of Length of Glow by Variation of Impressed Voltage].—Katayama. (*Electrotech. Journ.*, Tokyo, Oct. 1938, Vol. 2, No. 10, pp. 228-231.)
1183. LUMINOUS ASPECTS AND SINUSOIDAL ELECTRICAL OSCILLATIONS [of High Audio-Frequency] OF THE FLASH DISCHARGE IN THE SUBNORMAL REGION.—Ricamo. (*Nuovo Cimento*, March 1938, Vol. 15, No. 3, pp. 149-157.)
1184. THE LIGHT IMPULSE OF THE SPARK AND THE LOWERING OF THE SPARK VOLTAGE THEREBY.—Toepler. (*Physik. Zeitschr.*, 1st July 1938, Vol. 39, No. 13, pp. 523-530.)
1185. CALIBRATION OF SPARK-GAPS BETWEEN SPHERES [Comparison of Three Formulae connecting Breakdown Voltage, Striking Distance, and Sphere Diameter].—Toepler. (*Arch. f. Elektrot.*, 11th July 1938, Vol. 32, No. 7, pp. 485-486.)
1186. ANOMALY OF A.C. SPARK DISCHARGE BETWEEN LARGE ELECTRODES AT LARGE GAP SPACING.—Ishiguro & Goshō. (*Electrot. Journ.*, Tokyo, Sept. 1938, Vol. 2, No. 9, pp. 215-217.)
1187. CONFERENCE ON THE QUESTIONS OF ELECTRICAL DISCHARGE IN GASES AND ITS APPLICATIONS [including Vul's Researches, on Air at High Pressure as Insulator, and Effect of Added Complex Molecules (CCl₄): Pekar's, on Distribution of Electron Speeds in Plasma of Discharge: Sitnikov's, on Ionic Currents in the Magnetron: etc.].—(*Tech. Phys. of USSR*, No. 7, Vol. 5, 1938, pp. 561-564: in English.)
1188. THE MECHANISM OF THE NEGATIVE POINT-TO-PLANE CORONA NEAR ONSET [Negative Corona Current composed of Discrete Pulses: Their Properties and Derivation].—Trichel. (*Phys. Review*, 15th Dec. 1938, Series 2, Vol. 54, No. 12, pp. 1078-1084.)
1189. THE QUESTION OF THE CATHODE JUMP [Potential Jump in Front of Incandescent Cathode of Filamentary Discharge does not Exist: Potential rises first steeply, then slowly: Observations of Filamentary Discharge].—Haake & Walcher. (*Zeitschr. f. Physik*, No. 3/4, Vol. 111, 1938, pp. 174-182.)
1190. ELECTRON TEMPERATURE T_e IN A POSITIVE COLUMN DISCHARGE WITH ALTERNATING CURRENT (50 c/s): EXPERIMENTAL METHOD.—Uyterhoeven & Verburg. (*Comptes Rendus*, 27th Dec. 1938, Vol. 207, No. 26, pp. 1386-1388.)
1191. THE MEAN FREE PATH OF THE ELECTRONS IN A MERCURY-VAPOUR PLASMA: CONTINUATION OF ARGUMENT.—Klarfeld: Engel & Steenbeck. (*Tech. Phys. of USSR*, No. 8, Vol. 5, 1938, pp. 647-648: in German.) See 3469 of 1937.
1192. A THYRATRON COUNTER OF HIGH COUNTING SPEED [20 kc/s] AND ITS DEVELOPMENT AS A RECORDING CHRONOGRAPH.—Uffelmann. (*Journ. Scient. Instr.*, July 1938, Vol. 15, No. 7, pp. 222-226.)
1193. THE EXTINCTION OF DISCHARGES IN GEIGER-MÜLLER COUNTERS [Discussion in Terms of Townsend Theory].—May. (*Proc. Phys. Soc.*, 2nd Jan. 1939, Vol. 51, Part 1, No. 283, pp. 26-32.)
1194. THE INSTABILITY OF THE SMALLEST SELF-MAINTAINED CURRENTS IN [Corona] GAS DISCHARGES, PARTICULARLY IN GEIGER-MÜLLER COUNTERS [and Explanation on the "Hiatus" Hypothesis].—van Geel & Kerkum. (*Physica*, July 1938, Vol. 5, No. 7, pp. 609-618: in German.)
1195. CIRCUITS FOR THE CONTROL OF GEIGER-MÜLLER COUNTERS AND FOR SCALING AND RECORDING THEIR IMPULSES, and NEW VACUUM-TUBE COUNTING CIRCUITS.—Johnson: Reich. (*Review Scient. Instr.*, July 1938, Vol. 9, No. 7, pp. 218-222: pp. 222-223.)
1196. A PORTABLE RECORDING TUBE COUNTER CIRCUIT [using Neher-Harper Circuit feeding a 1-F-4 Power Pentode (shunted by Neon Lamp) to provide Recording Impulses of 10-12 mA].—Coven. (*Review Scient. Instr.*, July 1938, Vol. 9, No. 7, p. 230.)
1197. AN INTERMITTENT AMPLIFIER FOR THE RAPID COUNTING OF GEIGER-MÜLLER IMPULSES.—Kowarski & Winter. (*Journ. de Phys. et le Radium*, June 1938, Series 7, Vol. 9, No. 6, pp. 251-258.)
1198. A HIGH-SPEED COUNTER FOR ELECTRICAL IMPULSES [e.g. from Geiger Counters: Mains-Driven].—Severini. (*Alta Frequenza*, Aug./Sept. 1938, Vol. 7, No. 8/9, pp. 646-653.)
1199. THE CAUSE OF SUDDEN STOPPAGE IN COUNTER DISCHARGES [Statistical Fluctuations in the Electron Supply].—Schade. (*Naturwiss.*, 19th Aug. 1938, Vol. 26, No. 33, pp. 546-547.)

1200. METHOD OF EMPLOYING ORDINARY MECHANICAL COUNTING DEVICES FOR PHENOMENA IN RAPID SUCCESSION [instead of "Scale-of-Two" Arrangements, etc.: "Dead Times" Difficulty obviated by Periodic Interruption of Counter Circuit].—Kwal & Lesage. (*Comptes Rendus*, 2nd Nov. 1938, Vol. 207, No. 18, pp. 779-780.)
1201. COMPENSATION CIRCUIT FOR EXACT VOLTAGE CONSTANCY BY MEANS OF STABILISING TUBES.—Aulmann. (*Zeitschr. f. tech. Phys.*, No. 10, Vol. 19, 1938, pp. 320-322.)
 "The usual voltage-stabilising tubes, working with a glow or corona discharge in a rarefied gas, generally have a current/voltage characteristic which rises more or less steeply, so that during fluctuations of current the voltage does not remain strictly constant. This defect can be remedied, for exact investigations, by the compensation circuit shown in Fig. 1, which can be loaded by the taking of current within certain limits (up to a few milliamperes in the case of corona-discharge tubes)." An added footnote mentions that a similar circuit, but for a glow-discharge stabiliser, is mentioned in a "Stabilovolt" pamphlet.
1202. NEON STABILISER [Use of a Single Neon "Nightlight," with a Resistor, to minimise Voltage Fluctuations in H.T. Supply to Oscillators, etc.].—Thomas. (*Wireless World*, 21st July 1938, Vol. 43, pp. 55-56.)
1203. NEON-CONTROLLED STABILISER [for maintaining a Constant H.T. Voltage].—Riddle & Downes. (*Wireless World*, 13th Oct. 1938, Vol. 43, pp. 333-335.)
1204. ENERGY REGULATORS FOR HEATING CIRCUITS.—Sunvic Controls Ltd. (*Journ. Scient. Instr.*, Oct. 1938, Vol. 15, No. 10, p. 346.)
1205. THE THOMA REGULATING TRANSFORMER [with Continuous Adjustment of Voltage].—Gänger. (*E.T.Z.*, 15th Dec. 1938, Vol. 59, No. 50, pp. 1353-1355.)
1206. WIDE-RANGE MOTOR SPEED CONTROL.—Schmitt. (*Journ. Scient. Instr.*, Sept. 1938, Vol. 15, No. 9, p. 303.)
1207. CUPALOY, A NEW ALLOY WITH HIGH MECHANICAL STRENGTH AND HIGH ELECTRICAL CONDUCTIVITY.—Brace. (*E.T.Z.*, 6th Oct. 1938, Vol. 59, No. 40, p. 1082: summary only.)
1208. THE VARIATION WITH TEMPERATURE OF THE ELECTRICAL RESISTANCE OF CARBON AND GRAPHITE BETWEEN 0°C AND 900°C; and THE THERMAL AND ELECTRICAL CONDUCTIVITIES OF CARBON AND GRAPHITE TO HIGH TEMPERATURES.—Collier, Stiles, & Taylor: Powell & Schofield. (*Proc. Phys. Soc.*, 2nd Jan. 1939, Vol. 51, Part I, No. 283, pp. 147-152: 153-172.)
1209. A NEW TESTING INSTRUMENT FOR TELEGRAPH RELAYS: THE GLOW-DISCHARGE-LAMP RELAY METER [giving Accurate Values of Relay Times].—Schiweck & Weillbach. (*T.F.T.*, Oct. 1938, Vol. 27, No. 10, pp. 359-362.)
1210. THE DESIGN OF A POLARISED TELEGRAPH RELAY.—Jensen. (*Journ. I.E.E.*, July 1938, Vol. 83, No. 499, pp. 117-142.)
1211. HIGH-SPEED MOTION-PICTURE PHOTOGRAPHY [Camera for 4000 Pictures per Second: for Work on Relays, etc.].—Herriott. (*Bell S. Tech. Journ.*, July 1938, Vol. 17, No. 3, pp. 393-405.)
1212. A METHOD FOR DIMINISHING THE STICKING OF MERCURY IN CAPILLARIES.—Rosenberg. (*Review Scient. Instr.*, Aug. 1938, Vol. 9, No. 8, pp. 258-259.)
1213. ON DRILLING SMALL HOLES IN GLASS.—Heatley. (*Journ. Scient. Instr.*, Oct. 1938, Vol. 15, No. 10, pp. 340-341.)
1214. THE [Thermal] EMISSIVITY OF HEATED SURFACES.—Wilson. (*BEAMA Journal*, Oct. 1938, Vol. 43, No. 16, pp. 91-95.)
1215. ELECTRONIC EMISSION FROM VACUUM TUBE AS SUBSTITUTE FOR BATTERY [e.g. for Bias, or to oppose a Varying Current of about One Milliampere so that Its Variations may be read on Sensitive Microammeter].—Taft. (*Review Scient. Instr.*, Sept. 1938, Vol. 9, No. 9, p. 282.)
1216. A DIRECT-VOLTAGE AMPLIFIER [Mains-Operated, Portable: Amplification Ratio about 600: for All Frequencies from 0 to 10 000 c/s].—Wheatcroft. (*Journ. Scient. Instr.*, Oct. 1938, Vol. 15, No. 10, pp. 333-336.)
1217. CHOKON, A NEW RADIO COMPONENT.—Iinuma. (*See 924.*)
1218. ON THE TERMINOLOGY USED IN CONNECTION WITH ELECTROLYTIC CONDENSERS.—Nelepets. (*Izvestiya Elektroprom. Slab. Toka*, No. 6, 1938, pp. 56-58.)
1219. VARIOUS METHODS OF TESTING ELECTROLYTIC CONDENSERS.—Nelepets. (*Izvestiya Elektroprom. Slab. Toka*, No. 11, 1938, pp. 50-55.)
 Tests of electrolytic condensers are discussed:—(1) Measurement of the residual direct current (a suitable circuit is shown). (2) Capacity measurement (it is suggested that this should be done by the bridge method; the ballistic galvanometer method is considered totally unsuitable for this purpose). (3) Determination of losses (various methods are discussed for determining losses expressed as $\tan \delta$, $\cos \phi$, and equivalent series resistance r_{oe}). (4) Overload tests (of dry and wet condensers). (5) Resistivity to humidity. (6) Resistivity to cold and heat. (7) Life tests: it is suggested that these should be carried out under artificial conditions to reduce the time necessary.
1220. MEASUREMENT OF RELATIVE AND TRUE POWER FACTORS OF AIR CAPACITORS.—Astin. (*See 1111.*)
1221. NEW INSULATING TEXTILES FOR THE ELECTRICAL INDUSTRY [made from Fibre Glass].—de Piolenc. (*Bull. de la Soc. franç. des. Élec.*, Dec. 1938, Vol. 8, No. 96, pp. 1033-1037.)

1222. THE TEMPERATURE DEPENDENCE OF THE MECHANICAL STRENGTH OF QUARTZ GLASS.—Dawühl & Rix. (*Zeitschr. f. tech. Phys.*, No. 10, Vol. 19, 1938, pp. 294-296.)
1223. THE PASSAGE OF CURRENT THROUGH PORCELAIN AT HIGH TEMPERATURES.—Schaudinn. (*Elektrot. u. Masch.bau*, 11th Sept. 1938, Vol. 56, No. 37, p. 484: summary of VDE lecture.) See also 4110 of 1938.
1224. TROLITUL [Superstyrex] AS AN INSULATING MATERIAL.—Scott. (*E.T.Z.*, 28th July 1938, Vol. 59, No. 30, p. 810.) Summary of the German version of the paper referred to in 3875 of 1937.
1225. TESTS WITH [Ozone-Proof] RUBBER AS INSULATION FOR H.T. LINES AND CABLES.—Bormann. (*E.T.Z.*, 8th Sept. 1938, Vol. 59, No. 36, pp. 960-963.)
1226. ON THE PRODUCTION OF INSULATING MATERIALS IN THE U.S.S.R. AND THE U.S.A.—Walter. (*Izvestiya Elektroprom. Slab. Toka*, No. 8/9, 1938, pp. 1-5.)
1227. SPECIFICATIONS AND TESTING REGULATIONS FOR NON-CERAMIC, RUBBER-FREE INSULATING MOULDING MATERIALS.—VDE. (*E.T.Z.*, 6th Oct. 1938, Vol. 59, No. 40, pp. 1071-1072: 15th Dec. 1938, Vol. 59, No. 50, pp. 1357-1358.)
1228. "DIE KUNSTSTOFFAUSWAHL" [Choice of Synthetic Plastic Materials: Book Review].—Brandenburger. (*E.T.Z.*, 3rd Nov. 1938, Vol. 59, No. 44, p. 1196.)
1229. LAMINATED PLASTICS FOR RADIO.—McDonough. (*Electronics*, Oct. 1938, Vol. 11, No. 10, pp. 8-11.)
1230. ON THE PROBLEM OF CREEP [Surface-Leakage] PATH FORMATION ON INSULATING MATERIALS.—Nerz. (*E.T.Z.*, 15th Sept. 1938, Vol. 59, No. 37, p. 996: summary only.)
1231. ON THE THERMAL BREAKDOWN OF SOLID INSULATORS [Wagner's Theory].—Shimizu. (*Jap. Journ. of Engineering, Abstracts*, Vol. 16, 1938, pp. 83-84.)
1232. THE ELECTRICAL BREAKDOWN OF ROCK SALT AT HIGH TEMPERATURES [Breakdown is Purely Thermal even when Short Impulses (to reduce Heating) are used: von Hippel's Supposition is Incorrect].—Walther & Inge. (*Tech. Phys. of USSR*, No. 5, Vol. 5, 1938, pp. 335-354: in English.)
1233. THE BEHAVIOUR OF POLAR MOLECULES IN SOLID PARAFFIN WAX [deduced from Measurements of Loss Angle of Condenser containing Material under Test].—Sillars. (*Proc. Roy. Soc., Series A*, 6th Dec. 1938, Vol. 169, No. 936, pp. 66-83.) Extension of work by Jackson (2813 of 1935).
1234. THE CONSTRUCTION OF MOLECULAR MODELS OF DIELECTRICS.—Hartshorn. (*Proc. Phys. Soc.*, 1st Sept. 1938, Vol. 50, Part 5, No. 281, pp. 852-855: Demonstration.)
1235. ELECTRICAL CONDUCTION IN QUARTZ, PERICLASE, AND CORUNDUM AT LOW FIELD STRENGTH [Exponential Increase of Conductivity with Temperature].—Rochow. (*Journ. of Applied Phys.*, Oct. 1938, Vol. 9, No. 10, pp. 664-669.)
1236. ELECTRICAL ACTIONS IN A SYSTEM OF ISOTROPIC BODIES [Mathematical Treatment of Effect of Induction in Interior of Dielectrics].—Roy. (*Comptes Rendus*, 2nd Nov. 1938, Vol. 207, No. 18, pp. 757-759.)
1237. RELAXATION TIME AND MOLECULAR FORM [Measurements on Organic Substances indicate, on Debye's Theory, Ellipsoidal Form of Molecules].—Miyamoto & Budó. (*Physik. Zeitschr.*, 1st Aug. 1938, Vol. 39, No. 15, pp. 587-588.)
1238. ANOMALOUS DISPERSION AND FREE ROTABILITY [of Polar Molecules in H.F. Electric Field: Theory, after Debye].—Budó. (*Physik. Zeitschr.*, 15th Oct. 1938, Vol. 39, No. 20, pp. 706-711.)
1239. THE CHANGE IN DIELECTRIC CONSTANT ON SOLIDIFICATION OF HOMOPOLAR LIQUIDS [is always an Increase, if correctly Measured].—Guillien. (*Comptes Rendus*, 17th Aug. 1938, Vol. 207, No. 7, pp. 393-395.)
1240. ELECTRIC BREAKDOWN OF LIQUID DIELECTRICS [Experimental Investigation: Current/Voltage Curve is No Criterion, since Breakdown Voltage has No Connection with Conductivity, so that Breakdown has No Relation to the Electric Current: etc.].—Toriyama & others. (*Electrot. Journ.*, Tokyo, July 1938, Vol. 2, No. 7, pp. 157-160.)
1241. THE DESIGN AND TEMPERATURE RISE OF AIR-COOLED COILS [for Electro-Magnets].—Golding. (*BEAMA Journ.*, Dec. 1938, Vol. 43, No. 18, pp. 163-168.)
1242. A NEW METHOD FOR OBTAINING A UNIFORM MAGNETIC FIELD [Spherical Magnet].—Clark. (*Review Scient. Instr.*, Oct. 1938, Vol. 9, No. 10, pp. 320-322.)
1243. MUMETAL MAGNETIC SHIELDS [for Transformers, C-R Tubes, etc.].—Randall & Sowter. (*Journ. Scient. Instr.*, Oct. 1938, Vol. 15, No. 10, pp. 342-344.)
1244. MAGNETIC SHIELDS, and MAGNETIC SHIELDS FOR TRANSFORMERS.—Ellwood: Gustafson. (*Bell Lab. Record*, Nov. 1938, Vol. 17, No. 3, pp. 93-96: pp. 97-99.)
1245. INTRODUCTION TO THE PHYSICS OF EDDY CURRENTS [and Screening Action].—Hameister. (*T.F.T.*, Sept. 1938, Vol. 27, No. 9, pp. 343-346.)
1246. CURRENT-SURGE TRANSFORMERS FOR THE MAGNETISATION OF PERMANENT MAGNETS, and MAGNETISING BY CONDENSER DISCHARGE.—Redepenning: Dietz. (*AEG-Mitteilungen*, Dec. 1938, No. 12, pp. 553-557: *Bell Lab. Record*, Oct. 1938, Vol. 17, No. 2, pp. 59-61.)

1247. LONG-THROW MAGNETS.—Dollmann. (*E.T.Z.*, 8th Dec. 1938, Vol. 59, No. 49, p. 1326.)
1248. CONTROL OF MAGNETIC QUALITY BY SURFACE TREATMENT [and the Abnormal Permeabilities produced in Nickel and Iron Wires reported by Wall].—Warren: Kussmann: Wall. (*Engineer*, 30th Dec. 1938, Vol. 166, p. 731.)
1249. INFLUENCE OF MECHANICAL TREATMENT ON THE CHARACTERISTICS OF SHEETS OF FERROMAGNETIC MATERIALS.—Chiodi. (*La Ricerca Scient.*, 15th/31st Aug. 1938, Series 2, 9th Year, Vol. 2, No. 3/4, pp. 158-160.)
1250. THEORY OF THE IDEAL MAGNETISATION CURVE.—Sauter. (*Ann. der Physik*, Series 5, No. 7, Vol. 33, 1938, pp. 672-681.)
1251. ON THE POSSIBILITY OF AN ANALYTICAL REPRESENTATION OF THE MAGNETISATION CURVE BY MEANS OF EMPIRICAL FORMULAE.—Irdi. (*L'Électrotec.*, 25th July 1938, Vol. 25, No. 14, pp. 482-486.)
1252. "PROBLEME DER TECHNISCHEN MAGNETISIERUNGSKURVE" [Göttingen Conference: Book Review].—Becker & others. (*E.T.Z.*, 1st Sept. 1938, Vol. 59, No. 35, p. 955; *Rev. Gén. de l'Élec.*, 10th Sept. 1938, Vol. 44, No. 10, pp. 289-290.)
1253. "MAGNETISM. PHYSICS IN INDUSTRY: LECTURES" [Book Review].—(*Wireless Engineer*, July 1938, Vol. 15, No. 178, p. 378; *Zeitschr. f. tech. Phys.*, No. 7, Vol. 19, 1938, p. 215.) Six lectures delivered before the Manchester District Branch of the Institute of Physics in 1937.
1254. A GENERALISATION OF THE THEORY OF FERROMAGNETISM.—Bitter. (*Phys. Review*, 1st July 1938, Series 2, Vol. 54, No. 1, pp. 79-86.)
1255. TEMPERATURE VARIATION OF THE ELASTICITY MODULUS OF FERROMAGNETIC SUBSTANCES [Theory: Anomaly of Fe/Ni with 42% Ni probably due to Volume Magnetostriction].—Döring. (*Ann. der Physik*, Series 5, No. 5, Vol. 32, pp. 465-470.)
1256. DOMAIN THEORY OF FERROMAGNETICS UNDER STRESS: PART III—THE REVERSIBLE SUSCEPTIBILITY.—Brown. (*Phys. Review*, 15th Aug. 1938, Series 2, Vol. 54, No. 4, pp. 279-287.)
1257. CHANGE OF THERMAL ENERGY WITH ADIABATIC CHANGE OF MAGNETISATION IN IRON, NICKEL, AND CARBON STEEL [Measurements].—Hardy & Quimby. (*Phys. Review*, 1st Aug. 1938, Series 2, Vol. 54, No. 3, pp. 217-223.)
1258. THE FERROMAGNETIC CURIE POINT AS A PHASE TRANSITION OF THE SECOND KIND.—de Boer & Michels. (*Physica*, Aug. 1938, Vol. 5, No. 8, pp. 775-776.)
1259. THE MAGNETISATION OF FERROMAGNETIC COLLOIDS [Determination of Magnetisation Curve: Agreement with Theory].—Elmore. (*Phys. Review*, 15th Dec. 1938, Series 2, Vol. 54, No. 12, pp. 1092-1095.)
1260. FERROMAGNETISM AND ELECTRICAL PROPERTIES: PART IX—CURIE POINT AND ELECTRICAL RESISTANCE [of Nickel].—Bittel & Gerlach. (*Ann. der Physik*, Series 5, No. 7, Vol. 33, 1938, pp. 661-671.)
1261. NICKEL AND ITS ALLOYS IN THE ELECTRICAL INDUSTRY.—Balley. (*Elektrot. u. Maschbau*, 4th Sept. 1938, Vol. 56, No. 36, p. 472: summary only.)
1262. THE MAGNETIC SUSCEPTIBILITY OF GOLD/COPPER, GOLD/SILVER, SILVER/COPPER, AND COPPER/NICKEL ALLOYS.—Broniewski & others. (*Ann. de Physique*, July/Aug. 1938, Series II, Vol. 10, pp. 5-19.)
1263. MAGNETIC PROPERTIES OF COPPER AMALGAMS.—Bhatnagar & others. (*Current Science*, Bangalore, Dec. 1938, Vol. 7, No. 6, pp. 279-280.)
1264. THE MAGNETIC PROPERTIES OF BRASS WITH ADMIXTURE OF IRON.—Kuznecov. (*Journ. of Tech. Phys.* [in Russian], No. 9, Vol. 8, 1938, pp. 815-825.)
1265. INVESTIGATIONS ON MAGNETICALLY ORIENTED BISMUTH [Measurement of Anisotropy of Resistance Variations of a Briquette of Magnetically Oriented Bismuth Powder].—Altma. (*Ann. der Physik*, Series 5, No. 6, Vol. 32, pp. 489-506.)
1266. VARIATION IN THE LONGITUDINAL INCREMENTAL PERMEABILITY DUE TO A SUPERIMPOSED CIRCULAR FIELD [Ferromagnetic Material as Solenoid Core: Large Inductance Variations as Function of Core Current and Degree of Twisting].—Webb. (*Nature*, 29th Oct. 1938, Vol. 142, p. 795.)
1267. DRIFT OF MAGNETIC PERMEABILITY AT LOW INDUCTIONS AFTER DEMAGNETISATION [Measurements].—Patterson. (*Journ. of Applied Phys.*, Oct. 1938, Vol. 9, No. 10, pp. 646-653.)
1268. INVESTIGATIONS ON MAGNE-CRYSTALLIC ACTION: VI—FURTHER STUDIES ON PARAMAGNETIC CRYSTALS.—Krishnan, Mookherji, & Bose. (*Proc. Roy. Soc.*, Series A, 10th Oct. 1938, Vol. 168, No. 932, p. S 124: abstract only.)
1269. THE MAGNETIC ANISOTROPY OF $\text{CuSO}_4 \cdot 5\text{H}_2\text{O}$, IN RELATION TO ITS CRYSTAL STRUCTURE: PART II.—Krishnan & Mookherji. (*Phys. Review*, 1st Oct. 1938, Series 2, Vol. 54, No. 7, pp. 533-539.)
1270. MAGNETIC ANISOTROPIES AND THE VALENCIES OF PARAMAGNETIC ATOMS IN CRYSTALS [Measurements for Manganite show that Its Manganese Atoms cannot be Trivalent].—Krishnan & Banerjee. (*Nature*, 15th Oct. 1938, Vol. 142, p. 717.)
1271. MAGNETIC ALLOYS AND PROBLEMS OF METALLIC STRUCTURE [Short Account of Present Views and Recent Work].—Stoner. (*Nature*, 17th Sept. 1938, Vol. 142, pp. 518-520: from British Association Symposium.)
1272. THE ACTIVATION AND COMPOSITION OF THE ELEMENTARY MOMENT IN FERROMAGNETIC ALLOYS.—Ferrer. (*Comptes Rendus*, 5th Dec. 1938, Vol. 207, No. 23, pp. 1091-1093.)

1273. THE ALLOYS OF IRON WITH THE METALS OF THE PLATINUM GROUP.—Fallot. (*Ann. de Physique*, Oct. 1938, Series 11, Vol. 10, pp. 291-332.)
1274. THE DECOMPOSITION OF THE ELEMENTARY MOMENT OF FERROMAGNETIC SUBSTANCES AND GYROMAGNETIC PHENOMENA.—Fotter. (*Comptes Rendus*, 27th Dec. 1938, Vol. 207, No. 26, pp. 1390-1391.)
1275. FERROMAGNETIC COMPOUNDS OF CHROMIUM [with Sulphur: Curie Points: Specific Magnetisations].—Bates & Taylor. (*Proc. Phys. Soc.*, 2nd Jan. 1939, Vol. 51, Part I, No. 283, pp. 33-36.)
1276. MAGNETIC SUSCEPTIBILITIES AND RELATED PROPERTIES OF RARE EARTH CRYSTALS: I.—Kynch & Penney. (*Proc. Roy. Soc.*, Series A, 22nd Dec. 1938, Vol. 169, No. 937, p. S 149: abstract only.)
1277. THE LIMITING SENSITIVITY OF AN A.C. METHOD OF MEASURING SMALL MAGNETIC MOMENTS.—Johnson. (*Review Scient. Instr.*, Sept. 1938, Vol. 9, No. 9, pp. 263-266.)
1278. MAGNETIC RESISTANCE VARIATION OF PURE METALS [Experiments confirm Theory].—Kohler. (*Naturwiss.*, 23rd Sept. 1938, Vol. 26, No. 38, p. 630.)
1279. MEASUREMENTS OF MAGNETIC VISCOSITY IN IRON.—Heaps. (*Phys. Review*, 15th Aug. 1938, Series 2, Vol. 54, No. 4, pp. 288-293.)
1280. MAGNETIC AFTER-EFFECT [Physical Theory].—Koch. (*Naturwiss.*, 29th July 1938, Vol. 26, No. 30, pp. 493-494.)
1281. THEORY OF MAGNETICALLY NEUTRAL SOLUTIONS: A NEW POSSIBILITY OF DETERMINING THE NUMBER OF MAGNETONS.—von Auwers. (*Zeitschr. f. Physik*, No. 3/4, Vol. 110, 1938, pp. 267-270.)
1282. THE PRINCIPAL MAGNETIC SUSCEPTIBILITIES OF NEODYMIUM SULPHATE OCTAHYDRATE AT LOW TEMPERATURES [Results bearing on Crystalline Field Theory].—Jackson. (*Proc. Roy. Soc.*, Series A, 22nd Dec. 1938, Vol. 169, No. 937, p. S 159: abstract only.)
1283. PARAMAGNETIC RELAXATION [Theory].—Debye. (*Physik. Zeitschr.*, 15th Aug. 1938, Vol. 39, No. 16, pp. 616-618.)
1284. EFFECT OF WATER ON THE VALUES OF THE MAGNETIC CONSTANTS OF THE RARE EARTHS.—Cabrera. (*Comptes Rendus*, 5th Dec. 1938, Vol. 207, No. 23, pp. 1077-1080.)
- STATIONS, DESIGN AND OPERATION**
1285. PRACTICAL APPLICATION OF AN ULTRA-HIGH-FREQUENCY RADIO-RELAY CIRCUIT [18 Months' Experience of the New-York/Philadelphia Circuit with Relays at New Brunswick and Arney's Mount: Equipment: Telegraph, Teletype, and Facsimile Operating Procedure: Interference: Three Short Fading Periods in a Year (Cancellation of Refraction Field by Diffraction Field?): etc.].—Smith, Kroger, & George. (*Proc. Inst. Rad. Eng.*, Nov. 1938, Vol. 26, No. 11, pp. 1311-1326.)
1286. A DECIMETRE-WAVE RADIO LINK BETWEEN EINDHOVEN AND NIMEGUEN [50 km Distance, Free Optical Path: Waves of about 25 cm, with Paraboloid-of-Revolution Reflectors (Amplification Factor around 20, compared with about 3.5 given by Yagi Aerials): Modulation at Constant Amplitude but Varying Ratio of Times of Oscillation and Quiescence: Reception using Triode oscillating between 110 and 130 cm].—von Lindern & de Vries. (*Philips Transmitting News*, Sept. 1938, Vol. 5, No. 3, pp. 67-78.) For the Eindhoven/Tilburg service on waves above 1 m, with which this is compared, see 4366 of 1937.
1287. THE ELECTRICAL CONDITIONS FOR WIRE-BROADCASTING SEPARATING FILTERS ["Weiche" (Shunting-Switch): to direct the Flow of L.F. and R.F. Currents over the Telephone Network].—Waldow. (*T.F.T.*, Oct. 1938, Vol. 27, No. 10, pp. 373-378.)
1288. WIRE BROADCASTING [Review of Systems in Use or Proposed].—Walmsley. (*P.O. Elec. Eng. Journ.*, Oct. 1938, Vol. 31, Part 3, pp. 213-215.)
1289. HIGH-FREQUENCY ATTENUATION ON OPEN-WIRE LINES [and the Influence of Sleet and Frost].—Curtis. (*Bell Lab. Record*, Dec. 1938, Vol. 17, No. 4, pp. 121-124.)
1290. DUPLEX SIMULTANEOUS RADIO-TELEPHONY [on the Persistence of Hearing Principle: Successive Good and Bad Frequencies of Interruption, from 10 to 2000 per Second: Circuits dispensing with Mechanical Commutation].—Marro. (*L'Onde Elec.*, Oct. 1938, Vol. 17, No. 202, pp. 458-464.) For previous work see 2778 of 1937.
1291. DEVICES FOR WIDENING THE DYNAMIC RANGE.—Govyadinov & Sobolev. (*Izvestiya Elektroprom. Slab. Toka*, No. 12, 1938, pp. 28-35.)
- A report is presented on an experimental investigation of the following compandor systems: (a) potentiometer systems (Midwest Co.), (b) systems with automatic regulation of amplification (RCA), (c) systems with automatic regulation of grid bias (RCA), and (d) voltage-divider systems (also used in U.S.A.). Bridge systems and systems with variable efficiency of sound-reproducing or sound-recording devices are considered unsatisfactory, and therefore are not included in this investigation. In each case a complete circuit diagram, with the component values, is given and the operation of the system is discussed. The experimental results obtained are shown in a number of curves, and methods are also indicated for adjusting the systems.
1292. VOICE-FREQUENCY VOLUME CONTROL [Present Means for minimising Difficulties of Manual Operation (Programme Meters, Compressors and Limiters, Expanders and Noise Reducers: the Dangers of Too Great Reliance on Limiters): the New Requirements of Semi-Automatic Operation: Measurement of High-Speed Meter Characteristics: etc.].—Jefferson & Colchester. (*Marconi Review*, Jan./March 1939, No. 72, pp. 15-33.) Cf. also Wright and Norwine, 792 of February.

1293. ON IMPROVING THE ARTICULATION QUALITY OF A TRANSMISSION CHANNEL BY THE USE OF SPECIAL FREQUENCY CHARACTERISTICS.—Tetelbaum & Vollner. (*Izvestiya Elektrom. Slab. Toka*, No. 11, 1938, pp. 43-50.)
The authors describe experiments with a transmission system and an artificial source of noise to determine whether the intelligibility of the circuit can be improved by modification of the frequency characteristics at the transmitting and receiving ends. They find that for interference equivalent to normal atmospherics a large improvement in articulation, equivalent to that given by trebling the transmitted power, can be obtained by accentuating the high frequencies before transmission. The receiver should not have a corresponding high-frequency attenuation, unless the noise has specially prominent high-frequency components.
1294. THE PRESENT POSITION OF TRANSOCEANIC NEWS TRANSMISSION [General Account: Single-Sideband Traffic: Multiple Reception: Variable Antenna Characteristic].—Kotowski. (*E.N.T.*, Nov. 1938, Vol. 15, No. 11, pp. 327-336.)
1295. GERMANY'S BROADCASTING SYSTEM, and THE PRESENT POSITION OF GERMAN BROADCASTING TECHNIQUE.—Heilmann: Semm. (*T.F.T.*, Nov. 1938, Supp. Number, Vol. 27, pp. 443-448: pp. 448-452.)
1296. BROADCAST NETWORKS IN INDIA.—Frome. (*Electrotechnics*, Bangalore, April 1938, No. 11, pp. 72-76.)
1297. A TENTATIVE STANDARD OF MEDIUM-WAVE BROADCAST TRANSMISSION SERVICE FOR INDIA, and THE MEDIUM-WAVE SHORT-WAVE SITUATION IN INDIA AND ABROAD.—Sreenivasan. (*Electrotechnics*, Bangalore, April 1938, No. 11, pp. 104-110: pp. 138-143.)
1298. NATIONAL BROADCASTING STATION 2CY, AT CANBERRA.—(*Journ. Inst. Engineers, Australia*, Nov. 1938, Vol. 10, No. 11, pp. 419-423.)
1299. BROADCASTING HOUSE, ABERDEEN.—(*World-Radio*, 23rd Dec. 1938, Vol. 27, pp. 20 and 21.)
1300. A RADIO-TELEPHONE SET FOR SMALL VESSELS.—Browne. (*Bell Lab. Record*, Sept. 1938, Vol. 17, No. 1, pp. 21-23.)
- GENERAL PHYSICAL ARTICLES**
1301. POYNTING'S LAW: DISCUSSION AT AN INFORMAL MEETING OF THE I.E.E.—(*Electrician*, 30th Dec. 1938, Vol. 121, p. 790.)
1302. A COMPREHENSIVE FUNDAMENTAL ELECTRICAL FORMULA [dispensing with Magnetic Quantities: Forces acting on Elementary Electric Charges at Rest or in Uniform or Accelerated Motion].—Drysdale. (*Nature*, 3rd Dec. 1938, Vol. 142, pp. 995-996.)
1303. SPIN OF ATOMIC PARTICLES [and the Division into "Odd" (Fermi-Dirac) and "Even" (Einstein-Bose) Particles: the "Phonon" and the "Exciton": etc.].—Frenkel. (*Science*, 16th Dec. 1938, Vol. 88, Supp. p. 8.)
1304. GRAVITATIONAL CONSTANT, DIELECTRIC CONSTANT, AND COSMIC CONSTANT.—Labocchetta. (*La Ricerca Scient.*, 15th/30th Nov. 1938, Series 2, Year 9, Vol. 2, No. 9/10, pp. 628-629.)
1305. THE ELECTRODYNAMICS OF MATERIAL MEDIA.—Eckart. (*Phys. Review*, 1st Dec. 1938, Series 2, Vol. 54, No. 11, pp. 920-923.)
1306. ON FLUCTUATION IN ELECTROMAGNETIC RADIATION [Recalculation for Quantised Electromagnetic Field].—Born & Fuchs. (*Proc. Roy. Soc.*, Series A, 22nd Dec. 1938, Vol. 169, No. 937, p. S 157: abstract only.)
1307. ON THE HAMILTON-JACOBI THEORY AND QUANTISATION OF GENERALISED ELECTRODYNAMICS.—Weiss. (*Proc. Roy. Soc.*, Series A, 6th Dec. 1938, Vol. 169, No. 936, pp. 119-133.)
1308. "THE FUNDAMENTAL PRINCIPLES OF QUANTUM MECHANICS, WITH ELEMENTARY APPLICATIONS" [Book Review].—Kemble. (*Current Science*, Bangalore, Dec. 1938, Vol. 7, No. 6, pp. 288-289.)
1309. ON THE PROBLEM OF POTENTIAL BARRIERS AND THE SOLUTION OF THE SCHRÖDINGER EQUATION.—Datzeff. (*Ann. de Physique*, Dec. 1938, Series 11, Vol. 10, pp. 583-673.)
1310. THE EFFECT OF THERMAL AGITATION ON THE INTENSITY OF REFLECTION OF CATHODE RAYS FROM CRYSTALS.—Coster & van Zanten. (*Physica*, Jan. 1939, Vol. 6, No. 1, pp. 17-26: in English.)
1311. THE PRESENT STATUS OF THE VALUE OF e/m .—Birge. (*Phys. Review*, 1st Dec. 1938, Series 2, Vol. 54, No. 11, pp. 972-973.)
- MISCELLANEOUS**
1312. REMARKS ON THE USE OF THE FOURIER INTEGRAL [and the Danger of Error when It is applied, with Approximations, to Physical Problems].—David. (*Bull. de la Soc. franç. des Elec.*, Nov. 1938, Vol. 8, No. 95, pp. 951-960.)
1313. SOME REMARKS ON LEAST SQUARE [Straight-Line Relation determined with Both Usual Errors taken into Consideration: Comparison with Old Method].—Goto. (*Electrotech. Journ.*, Tokyo, Oct. 1938, Vol. 2, No. 10, pp. 223-227.)
1314. NOTE ON THE USE OF PROBABILITY PAPER [for representing Statistical Data].—Selwyn. (*Proc. Phys. Soc.*, 1st Nov. 1938, Vol. 50, Part 6, No. 282, pp. 914-918.)
1315. NEW METHODS FOR THE APPROXIMATE SOLUTION OF SYSTEMS OF $p \geq 2$ EQUATIONS WITH p UNKNOWNNS.—Platone. (*La Ricerca Scient.*, 15th/30th Nov. 1938, Series 2, Year 9, Vol. 2, No. 9/10, pp. 564-587.)
1316. "THEORIE INVARIANTIVE DU CALCUL DES VARIATIONS," and "L'AFFINITÉ" [Book Reviews].—de Donder. (See 1337.)

1317. THE TRACING OF LIGHTNING "NESTS" [Points predisposed to Lightning Strokes] BY THE DIVINING-ROD EXPERT [and the Selection of Earthing Points: Possible Physical Causes of the Divining-Rod Deflection: Investigations by the Prague Union for Divining-Rod and Earth-Radiation Research: Positive Results].—Fritsch. (*E.T.Z.*, 29th Dec. 1938, Vol. 59, No. 52, pp. 1397-1400.)
1318. RADIESTHESIS: A SURVEY OF MAINLY FRENCH RESEARCH IN METHODS OF DIVINING [including Turenne's Field and Laboratory Work].—Macbeth: Turenne. (*Electrician*, 30th Dec. 1938, Vol. 121, pp. 779-780 and 782: to be concluded.)
1319. EFFECTS OF RADIATIONS ON PYROELECTRIC CRYSTALS [Tourmalin]: POSSIBILITY OF THEIR UTILISATION AS DETECTORS OF INFRA-RED RADIATIONS.—Ta. (*Comptes Rendus*, 28th Nov. 1938, Vol. 207, No. 22, pp. 1042-1044.)
1320. CRITERIA FOR THE APPRAISEMENT, COMPARISON, AND MEASUREMENT OF THE GRAIN AND RESOLVING POWER OF PHOTOGRAPHIC EMULSIONS [and the Interferential Resolvometer].—Ronchi: Bruscaioni. (*La Ricerca Scient.*, 15th/30th Nov. 1938, Series 2, Year 9, Vol. 2, No. 9/10, pp. 588-596.)
1321. AN INTERPRETATION OF THE BENHAM COLOUR PHENOMENA [Chromatic Top] IN TERMS OF THE HYSTERESIAL AUGMENTATION THEORY OF PROFESSOR BURRIDGE.—Naidu. (*Current Science*, Bangalore, Dec. 1938, Vol. 7, No. 6, pp. 273-276.)
1322. ABSORPTION AT HIGH [and Ultra-High] RADIO-FREQUENCIES OF Δ_1 AND Δ_2 DIHYDRO-NAPHTHALINE.—Cavallaro & Lucchi. (*La Ricerca Scient.*, 15th/30th Nov. 1938, Series 2, Year 9, Vol. 2, No. 9/10, pp. 630-632.)
1323. A NOVEL USE OF SHORT [Micro-] WAVES FOR NAVIGATION IN FOGGY WEATHER [French System of controlling Fog-Guns by 90 cm Beam Signals: Interference from Motor Boats avoided by Use of Modulated Intermediate Frequency of 125 kc/s].—(*Hydrographic Review*, Nov. 1938, Vol. 15, No. 2, p. 139.)
1324. ELECTRICAL METHODS OF MEASURING THE MOISTURE OF DISPERSE BODIES [e.g. Soil: Short-Wave Apparatus: Results on Various Sands: Anomalous Effect (Not Due to Conductivity) when Concentration of Moistening Electrolyte is High].—Alexandrov & Mikhailov. (*Tech. Phys. of USSR*, No. 8, Vol. 5, 1938, pp. 622-632: in English.)
1325. ELECTRIC MICROMETERS [for High-Precision Work such as Block Gauges: Condenser-Change Principle: Sensitivity about 50 μ A per 0.0001 mm Displacement].—Tugami & Kato. (*Jap. Journ. of Engineering, Abstracts*, Vol. 16, 1938, p. 65: in English.)
1326. INDUCTIVE INTERFERENCE BETWEEN URBAN POWER DISTRIBUTION AND COMMUNICATION CIRCUITS [and the Shielding Effects of Buildings, etc.].—Noda & Nisiyama. (*Electrotech. Journ.*, Tokyo, Oct. 1938, Vol. 2, No. 10, pp. 231-235.) Already referred to in 3092 of 1938.
1327. A STUDY OF THE VIBRATION OF THE LATHE [with Condenser-Micrometer and Oscillograph].—Tanaka. (*Jap. Journ. of Engineering, Abstracts*, Vol. 16, 1938, p. 66.)
1328. A NEW CHRONOGRAPH AND ITS APPLICATIONS [Measurement of Projectile Velocities: Rotating Fluorescent Drum illuminated by Image of Electric Spark].—Aoki. (*Jap. Journ. of Engineering, Abstracts*, Vol. 16, 1938, pp. 65-66.)
1329. A POSITION REGULATOR FOR PAPER SLITTERS [using only one Photocell and giving Wider Range of Control].—Gulliksen. (*Elec. Engineering*, Nov. 1938, Vol. 57, No. 11, pp. 634-636.)
1330. PAPERS ON THE GENERAL ELECTRIC RECORDING SPECTROPHOTOMETER, INCLUDING ITS USE IN PRINTING INDUSTRY.—Hardy, Michaelson, & others. (*Journ. Opt. Soc. Am.*, Oct. 1938, Vol. 28, No. 10, pp. 360-397.)
1331. COLOUR MATCHING IN THE PAPER INDUSTRY [using Balanced Photocells].—Deeter. (*Electronics*, Sept. 1938, Vol. 11, No. 9, pp. 18-19.)
1332. PHOTOELECTRIC COLORIMETRY USING SELENIUM PHOTOELEMENTS [Survey].—Lange. (*Chemiker-Zeitung*, 12th Oct. 1938, Vol. 62, No. 82, pp. 737-741.)
1333. PHOTOELECTRIC COLORIMETERS [and the Alleged Difficulties in the Use of a Single Cell].—Klopsteg: Hare & Phipps. (*Science*, 7th Oct. 1938, Vol. 88, p. 336.) Prompted by the paper dealt with in 4665 of 1938.
1334. A PHOTOELECTRIC PROJECTION PHOTOMETER FOR THE MEASUREMENT OF STELLAR MAGNITUDES FROM PHOTOGRAPHS.—Mehlin. (*Review Scient. Instr.*, Nov. 1938, Vol. 9, No. 11, pp. 374-375.)
1335. PHOTOTUBES COUNT BEER CASES AND KEGS IN NEW YORK BREWERIES UNDER CONDITIONS DESTRUCTIVE TO MECHANICAL COUNTERS.—(*Electronics*, Sept. 1938, Vol. 11, No. 9, p. 13.)
1336. ELECTRICAL SERVICES IN LARGE BUILDINGS [Scheme of Co-operation with Architect for Telephone, Heat Control, Television & Other Wiring].—McDonald & Carter. (*P.O. Elec. Eng. Journ.*, Oct. 1938, Vol. 31, Part 3, pp. 183-190.)
1337. PUBLICATIONS UNDER THE AUSPICES OF THE BELGIAN INSTITUTE OF RADIO-SCIENTIFIC RESEARCHES [Book Reviews].—de Donder & others. (*Rev. Gén. de l'Élec.*, 22nd Oct. 1938, Vol. 44, No. 16, p. 494.) See also 907, 921, & 1316, above, and 623 of 1936 & 4243 of 1938.

Some Recent Patents

The following abstracts are prepared, with the permission of the Controller of H.M. Stationery Office, from Specifications obtainable at the Patent Office, 25, Southampton Buildings, London, W.C.2, price 1/- each

ACOUSTICS AND AUDIO-FREQUENCY CIRCUITS AND APPARATUS

493 846.—Public-address systems, particularly for use on board ship.

Guided Radio Corporation. Convention date (U.S.A.) 28th May, 1936.

497 319.—Negative-resistance "potentiometer" back-coupling for a low-frequency amplifier.

A. A. Fayers. Application date 12th March, 1937.

AERIALS AND AERIAL SYSTEMS

493 758.—Capacity-loaded aerial, tilted to secure a directional effect, for transmitting or receiving television signals.

E. C. Cork; M. Bowman-Manifold; and J. L. Pawsey. Application date 9th February and 30th June, 1937.

493 860.—Multiple-section transmission-line for coupling a long-wave or short-wave aerial, at will, to a common receiver.

Marconi's W.T. Co.; N. M. Rust; and J. F. Ramsay. Application date 15th April, 1937.

495 019.—Collapsible short-wave aerial for use on stratosphere balloons, and designed to be discarded and replaced when necessary.

O. Bormann and J. Pintsch Ges. Convention date (Germany) 13th March, 1936.

495 489.—Feed-line for a short-wave aerial combined with a rejector or attenuator circuit for undesired signals.

E. C. Cork and J. L. Pawsey. Application date 23rd June, 1937.

495 977.—Short-wave aerial consisting of the flared-out ends of the two elements of a concentric transmission line.

Standard Telephones and Cables (assignees of Le Matériel Téléphonique Soc. Anon.). Convention date (France) 21st July, 1936.

DIRECTIONAL WIRELESS

493 708.—Directive radio system for determining velocity, such as the ground speed of an aeroplane in flight.

The British Thomson-Houston Co. Convention date (U.S.A.) 9th April, 1936.

494 263.—Direction-finder in which a constantly-rotating aerial produces an indication of the critical "minimum" position on the fluorescent screen of a cathode-ray tube.

Marconi's W.T. Co. and S. W. H. W. Falloon. Application date 23rd April, 1937.

494 541.—Polyphase arrangement of the field coils of a radiogoniometer as used for direction-finding.

C. Lorenz Akt. Convention date (Germany) 26th November, 1936.

494 564.—Optical system for producing a bearing "trace" in a direction-finder of the constantly-rotated type.

Telefunken Co. Convention date (Germany) 24th June, 1937.

494 801.—Aerial system for producing overlapping beams as used for aerial navigation and for blind landing.

Standard Telephones and Cables (assignees of Le Matériel Téléphonique Soc. Anon.). Convention date (France) 31st December, 1936.

494 822.—Aerial system for producing an overlapping beam for use in air navigation.

C. Lorenz Akt. Convention date (Germany) 16th April, 1937.

495 145.—Push-pull valve-operated visual indicator for direction-finding and "blind-landing" systems.

Standard Telephones and Cables (assignees of Le Matériel Téléphonique Soc. Anon.). Convention date (France) 17th December, 1936.

RECEIVING CIRCUITS AND APPARATUS

(See also under Television)

493 622.—Reducing harmonics in a mixing valve of the electron-coupled type for use in a superhet set.

Marconi's W.T. Co. Convention date (U.S.A.) 13th April, 1936.

493 671.—Negative feed-back circuits for controlling the efficiency of an amplifying system and making its "gain" independent of the working frequency.

Standard Telephones and Cables (assignees of H. S. Black; S. T. Meyers; R. S. Caruthers; and A. L. Stillwell). Convention date (U.S.A.) 5th December, 1936.

493 757.—Means for preventing undesired local oscillations due to the "induction" effect of the space-charge in a mixing-valve of a superhet receiver.

N. V. Philips' Lamp Co. Convention date (Germany) 14th June, 1937.

493 862.—Variable reactance for the remote tuning control of a wireless receiver.

Marconi's W.T. Co. and J. F. Ramsay. Application date 15th April, 1937.

493 864.—Means for periodically blocking the passage of a signal through a wireless receiver at a frequency sufficiently high to reduce the effect of "static" interference.

Baird Television and D. M. Johnstone.

494 024.—Reverse feed-back which varies automatically with the signal strength in order to ensure a properly-balanced tone-control.

E. K. Cole and A. E. Falkus. Application date 6th May, 1937.

494 026.—Precision control for the driving motor used for automatically tuning a superhet receiver.

The General Electric Co.; W. H. Peters; S. G. Hunter; and A. A. Chubb. Application date 10th and 20th May, 1937.

494 682.—Circuit designed for a valve of the so-called "beam" or lateral-control type.

Telefunken Co. Convention date (Germany) 28th April, 1936.

494 688.—Minimising the effect of static interference by suppressing certain of the higher signalling frequencies, and then restoring the normal balance.

Marconi's W.T. Co. Convention date (U.S.A.) 29th April, 1936.

494 939.—Wireless receiver with means for automatically expanding the volume range of the audio frequencies.

Aga-Baltic Radio Akt. Convention date (Sweden) 30th April, 1937.

TELEVISION CIRCUITS AND APPARATUS

FOR TRANSMISSION AND RECEPTION

493 620.—Arrangement of electromagnetic scanning-coils in a cathode-ray television receiver.

Ferranti and I. N. Vaughan-Jones. Application date 13th April, 1937.

493 687.—Line of light-sources energised by radio-frequency currents of different frequencies for scanning in television.

Standard Telephones and Cables (assignees of A. M. Skellett). Convention date (U.S.A.) 4th June, 1937.

493 695.—Ultra-short-wave signalling systems utilising transmission lines of the so-called dielectric guide type, coupled directly to a transmitting or receiving aerial.

O. Bormann and J. Pintsch Ges. Convention date (Germany) 6th March, 1936.

493 774.—Locating and producing a local image of a distant object by projecting infra-red radiation from it on to an Iconoscope tube or electron camera.

W. J. Rickets and A. L. Rawlings. Application date 13th April, 1937.

493 843.—Back-coupled valve circuit for producing currents or voltages of desired wave-form, suitable for scanning in television.

Standard Telephones and Cables and B. Newsam (addition to 453 887). Application date 14th April, 1937.

493 868.—Means for minimising "afterglow" on the luminous screen of a cathode-ray tube as used for transmitting television signals.

Radio-Akt. D. S. Loewe. Convention date (Germany) 16th April, 1936.

494 254.—Separating the synchronising impulses from the picture-signals by a balanced-bridge arrangement in a television receiver.

Fernseh Akt. Convention date (Germany) 23rd April, 1936.

494 298.—Optical lens system for preserving and utilising to better advantage the light emitted from the fluorescent screen of a cathode-ray television receiver.

Radio-Akt. D. S. Loewe. Convention date (Germany) 22nd April, 1936.

494 365.—Method of "interlaced" scanning used for televising from a continuously-moving cinema film.

Farnsworth Television Inc. Convention date (U.S.A.) 18th July, 1936.

494 375.—Luminescent screen for a cathode-ray television receiver of the velocity-scanning type.

N. V. Philips' Lamp Co. Convention date (Holland) 9th November, 1936.

494 502.—Preventing the fluorescent screen of a cathode-ray tube from being burnt before the time-base voltages are fully developed.

Ferranti; M. K. Taylor; and H. Wood. Application date 30th May, 1938.

494 554.—Arrangement of the spiral apertures in a mechanical system for interlaced scanning.

Radio-Akt. D. S. Loewe. Convention date (Germany) 22nd February, 1937.

494 677.—Television receiver with means for preventing negative synchronising impulses developed on the grid of the "separator" valve from reaching the anode.

Baird Television and A. H. Gilbert. Application date 28th April, 1937.

494 757.—Amplifier for television signals with means for compensating for frequency-distortion due to attenuation and transit-time.

British Thomson-Houston Co. Convention date (Germany) 26th February, 1936.

494 791.—Arrangement and alinement of the control and focusing electrodes of a cathode-ray television receiver.

Electrical Research Products Inc. Convention date (U.S.A.) 10th October, 1936.

494 967.—Cathode-ray television receiver in which the picture is projected through a "relay" screen of varying transparency under the action of the electron stream.

Fernseh Akt. Convention date (Germany) 2nd May, 1936.

494 979.—Adapting a standard type of broadcast set to receive television signals.

F. R. W. Stafford and Belling & Lee. Application date 8th June, 1937.

495 331.—Method of deriving synchronising impulses for use in television from A.C. supply mains.

Baird Television and V. A. Jones.

495 646.—Cathode-ray television receiver in which the received picture is reproduced on an incandescent screen.

Marconi's W.T. Co. and L. M. Myers. Application dates 14th May and 25th August, 1937.

495 724.—Interlaced scanning system in which the apparent "drift" of the scanning lines is avoided.

A. D. Blumlein. Application date 7th June, 1937.

495 740.—System of picture-transmission, including "still" pictures, using a comparatively narrow frequency-band.

Electrical Research Products Inc. Convention date (U.S.A.) 24th December, 1936.

496 647.—Method of matching a television transmitter or receiver to the aerial over a wide band of signal frequencies.

E. C. Cork and J. L. Pawsey. Application date 1st May, 1937.

497 116.—Time-base circuit for a television receiver, in which an additional high or intermediate frequency amplifier is utilised for separating synchronising impulses from the picture signals.

Philips' Lamp Co. Convention date (Holland) 30th December, 1936.

497 605.—Double modulation system for generating and locking-together the synchronising-impulses used in television.

Farnsworth Television Inc. Convention date (U.S.A.) 11th July, 1936.

TRANSMITTING CIRCUITS AND APPARATUS

(See also under Television)

493 667.—Increasing the efficiency of a combined Class B and Class C power-amplifier, as used in the final stage of a radio transmitter.

N. V. Philips' Lamp Co. Convention date (Holland) 22nd October, 1936.

493 837.—Method of reducing static interference by transmitting a message in fragments which are expanded and contracted by a scanning process.

F. C. P. Henroteau. Convention date (Belgium) 11th February, 1937.

494 588.—Wireless telephony transmitter with voice-operated control through a pair of microphones.

Marconi's W.T. Co. and E. E. Zepler. Application date 27th April, 1937.

495 058.—Multi-carrier transmission system in which a magnetic core with a high temperature-permeability coefficient is used to regulate the gain of the amplifiers.

Standard Telephones and Cables; A. W. Montgomery; and A. H. Roche. Application date 7th May, 1937.

CONSTRUCTION OF ELECTRONIC-DISCHARGE DEVICES

493 714.—Electron-multiplier in which the target electrodes are made concave, cylindrical, or spherical in shape.

Fernseh Akt. Convention dates (Germany) 11th April and 20th October, 1936.

493 882.—Arrangement of the "gun" electrodes in a cathode-ray tube to facilitate the control of the electron stream.

H. R. Lubcke. Application date 17th April, 1937.

493 907.—Electrode arrangement for a thermionic valve producing a directed "beam" of electrons.

Marconi's W.T. Co.; M. Rust; and G. F. Brett. Application date 11th February, 1937.

493 968.—Electrode arrangement for reducing "Schott" effect in an electron multiplier.

Cie des Compteurs, etc., à Gaz. Convention date (France) 28th August, 1936.

494 100.—Spring mounting for the cathode of an indirectly-heated valve.

Standard Telephones and Cables and D. H. Black. Application date 19th April, 1937.

494 208.—Target electrode, made of phosphor-bronze oxidised and heated in caesium-vapour, for an electron multiplier.

The General Electric Co.; W. H. Aldous; and L. R. G. Treloar. Application date 27th October, 1937.

494 230.—Short-wave electron-oscillator constructed to operate with a cold cathode and secondary-emission electrodes.

Telefunken Co. Convention date (Germany) 20th April, 1936.

494 273.—Short-wave generator depending upon the alternate release of secondary electrons from two cathode surfaces in a predetermined rhythm.

Telefunken Co. (addition to 494 230). Convention date (Germany) 9th May, 1936.

494 351.—Controlling the path of the discharge stream through an electron multiplier, particularly in order to abstract positive ions.

Farnsworth Television Inc. Convention date (U.S.A.) 16th May, 1936.

494 620.—Arrangement of the target electrodes in an image-dissector tube for use in television.

Farnsworth Television Inc. Convention date (U.S.A.) 2nd November, 1936.

494 803.—Ultra-short-wave valve in which the emissive power of the cathode is varied along its length according to the position of the loops and nodes of a standing wave.

Standard Telephones and Cables (assignees of Le Matériel Téléphonique Soc. Anon.). Convention date (France) 15th March, 1937.

SUBSIDIARY APPARATUS AND MATERIALS

493 861.—Potentiometer with a constant-voltage section for supplying the target electrodes of an electron multiplier.

Marconi's W.T. Co. and G. B. Banks. Application date 15th April, 1937.

494 857.—Resonator circuits with distributed capacity and inductance for building-up and measuring the frequency of ultra-short waves.

J. Pintsch Akt. Convention date (Germany) 31st January, 1936.

495 009.—Method of mounting a piezo-electric crystal-oscillator in an evacuated glass bulb.

Fab. Italiana Magneti Marelli. Convention date (Italy) 22nd March, 1937.

495 240.—Loud speaker in which a "free" conical diaphragm co-operates with two or more non-parallel partitions to emphasise the higher frequencies.

Philips' Lamp Co. Convention date (Holland) 14th January, 1937.

495 404.—Thermionic valve circuit of the relaxation or "multivibrator" type with means for stabilising a selected frequency.

Telefunken Co. Convention date (Germany) 12th May, 1936.

495 594.—Loud speaker horn designed to be mounted with one side against the ceiling of a room.

Standard Telephones and Cables (assignees of E. C. Wenle). Convention date (U.S.A.) 13th November, 1936.

495 784.—Loud speaker with means for reducing attenuation due to out-of-phase conditions in the sound-wave.

A. I. Abrahams. Application date 18th May, 1937.

497 341.—Vibrating-contact full-wave rectifier for supplying H.T. voltage to a wireless set.

Marconi's W.T. Co. Convention date (U.S.A.) 16th June, 1936.