

THE WIRELESS ENGINEER

VOL. XV.

SEPTEMBER, 1938

No. 180

Editorial

Distribution of Magnetic Flux in an Iron Powder Core

IN order to increase the permeability of the space inside high-frequency coils, cores are sometimes employed consisting of finely divided iron embedded in insulating material, each iron particle thus being insulated from the neighbouring particles. It has been suggested* that at very high frequencies the flux distribution in such a core is not uniform, but that, due to the effect of eddy currents, the flux density falls off towards the centre. It is well known that currents circulate in the mass, passing through the iron particles as conduction currents and from particle to particle as displacement currents in the dielectric. If of sufficient magnitude such currents must affect the flux distribution, and it is an interesting question to consider the frequency that must be reached before the effect becomes appreciable. The problem can be idealised by assuming the iron particles to be approximately cubes of the same size arranged uniformly with their faces either parallel or normal to the magnetic flux. Neighbouring cubes will be separated by a layer of insulation the thickness of which, as compared with the sides of the cubes, can be calculated from the space factor. An axial alternating flux will induce an e.m.f. in a

* See article by E. R. Friedlaender in this number.

circular path made up of a large number of such insulated cubes; such a path will have a resultant resistance equal to the sum of all the resistances of the individual cubes, and a resultant series capacitance equal to the capacitance of all the layers of insulation in series. On the assumption of a uniformly distributed magnetic flux the resultant circulating current can be calculated, and it is then a simple matter to see if it produces at the centre a magnetising force comparable with that necessary to produce the assumed uniform induction B . Another and more rigorous line of approach would be to determine the law governing the propagation of energy into the core from its surface, for all the energy in the core must be propagated into it just as the energy is propagated along a transmission line. This latter would necessitate an elaborate calculation which one would not undertake until one had determined by the former simple method whether the effect was appreciable or not.

Consider a ring of radius x , of radial thick-

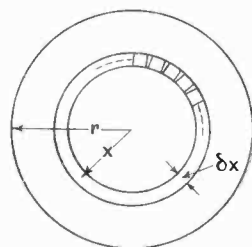

ness δx and 1 cm. axial length. Let the volumetric space factor be α^3 , so that of the total circumference of the ring, a fraction α is in iron and a fraction $(1 - \alpha)$ in dielectric. Of the gross cross-sectional area of the ring, δx , the iron cubes and the condensers between them will only occupy a fraction α^2 . For the resistance of the ring we have $R = \rho \frac{2\pi x \cdot \alpha}{\alpha^2 \cdot \delta x} = \frac{2\pi\rho}{\alpha} \cdot \frac{x}{\delta x}$ ohms where ρ is the specific resistance of the iron. For the capacitance of all the elementary condensers in series, we have

$$C = \frac{\kappa\alpha^2\delta x}{4\pi(1-\alpha)2\pi x} \cdot \frac{1}{9 \times 10^{11}} \text{ farads,}$$

where κ is the dielectric constant of the insulating material. If the maximum apparent magnetic induction (assumed uniform) is B , the e.m.f. induced in the ring is $E_x = 4.44fB \cdot \pi x^2 \cdot 10^{-8}$ volts.

To find the current we have $\delta I = E_x/\sqrt{R^2 + 1/\omega^2 C^2}$, but on substituting actual values it is found that R is negligible compared with $1/\omega^2 C^2$ and we can put $\delta I = E_x\omega C$. Substituting for E_x and C we obtain the formula

$$\delta I = 1.2f^2 B \kappa \alpha^2 / (1 - \alpha) \cdot x \delta x 10^{-20}$$

For the whole circular core of radius r we integrate this expression and obtain for the total circulating current

$$I = 0.6f^2 B \kappa \alpha^2 / (1 - \alpha) \cdot r^2 \cdot 10^{-20}.$$

We must now make some assumptions and we put $\alpha = 0.85$, corresponding to a volumetric space factor α^3 of 0.613, and $\kappa = 6$ for the dielectric material, which is probably on the high side. We assume a core of 2 cm. diameter. We then have

$$I = 18f^2 B 10^{-20} \text{ ampere.}$$

The maximum value of the magnetic induction B' produced at the centre of the core by this circulating current, assuming the core to be very long or toroidal, is given by the formula

$$B' = \sqrt{2}(4\pi/10)I\mu = 31.4f^2 B\mu 10^{-20}.$$

Putting μ at the high value of 20 we have

$$\frac{B'}{B} = \frac{6.3}{10^{18}} f^2.$$

If $f = 10^8$ ($\lambda = 3$ metres) $B'/B = 6.3/100$, so that the effect of the circulating currents is 6.3 per cent. of the original flux density, and since it depends on the square of the frequency, it is reduced to 1.6 per cent. for a wavelength of 6 metres. Since the effect also depends on the square of the radius of the core it would be 6.3 per cent. for a 6 metre wave with a core 4 cm. diameter. It is seen that this result is not appreciably dependent on the permeability or resistivity of the iron; it is mainly a dielectric phenomenon and depends on the insulating matrix in which the iron particles are embedded, on the space factor and on the resulting permeability of the core. We are forced to the conclusion that, if the particles were properly insulated from each other, any want of uniformity of the magnetic induction in the core would only become appreciable when the wavelength was reduced below about 6 metres. We imagine that one of the difficulties of manufacture is to ensure that each particle of iron has a coating of insulating material. There will probably be a tendency for the particles to form little groups in metallic contact with each other, thus not only increasing the effective particle size but forming contact resistance paths in parallel with the capacitive paths. Measurements of the apparent resistivity and permittivity of core materials have shown that in some cases the results bear no relation to those calculated on the assumption that the particles are effectively insulated from each other.

This investigation was prompted by the interesting article by Mr. Friedlaender which we publish in this number. It is there suggested that the inductance of coils with powder cores is not greatly affected by the presence of a brass insert at the centre for the purpose of securing or adjusting the core because of the unequal distribution of the flux. The above investigation indicates that this can only be due to imperfect insulation of the iron particles.†

† The current number of the *Marconi Review* contains an interesting article on "Iron-dust Cored Coils at Radio Frequencies," by C. Austin and A. L. Oliver.

G. W. O. H.

Iron Powder Cores*

Their Use in Modern Receiving Sets

By E. R. Friedlaender

SUMMARY.—The use of iron cores in this country is far below that in other countries. The reason for this is discussed and a general review is given of the development of "mass" cores which partly explains the reluctance of the English designer. Some lines of design are discussed, more particularly I.F. filters and push-button tuning. In automatic tuning Radio Normandie's change of wavelength has demonstrated the superiority of coil designs with movable iron powder cores.

CORES of insulated iron powder have been known as far back as 1887, in which year Oliver Heaviside published his papers in *The Electrician*. He examined the laws of the mutual inductance of two coils and varied the M by means of a movable iron core; he says ". . . I used iron dust, worked up with wax into solid cores (one wax to 5 or 6 iron by bulk) and the residual effect is far smaller, scarcely recognisable." The core was of cylindrical shape and Heaviside recognised the importance of a very fine division of the iron powder.

The year 1902 saw the first patents for the use of iron cores in wireless sets. The German Patent No. 143510 claims the idea of using iron powder in connection with coils for wireless purposes. In 1902 the American John Stone Stone mentioned the use of iron cores in circuits for "space telegraphy," but it took another year before he saw and claimed the definite advantage of iron cores in coils. In the latter patent he spoke of the increased selectivity.

There was a standstill in the development until 1924. Other wireless components developed quickly enough to keep pace with the demands on circuit selectivity. Later on, air coils were improved to such an extent that with the raw material available iron cores could not bring about an increase of coil quality. The years 1925-1927 brought improvements in the production of finely divided Permalloy and carbonyl iron. The development had a great "speed up" which only came to a standstill quite recently. New production methods for the cores

* MS. accepted by the Editor, April, 1938.

followed and the use of iron cores in wireless sets on a commercial scale commenced in 1933.

The design of wireless sets followed quite different lines in this country, on the Continent and in U.S.A., the extremes being Germany on the one hand and the U.S.A. on the other. The German monopoly prices for valves were and are prohibitive and forced the manufacturer to avoid the slightest loss in the electrical design. Ceramic materials and Trolitul are largely employed. Iron cores are used to increase the coil quality as far as possible and not merely to reduce the size of the coil. This principle allows the use of the most favourable core types, even if the price of the core is somewhat higher than the price of an inferior type.

The other extremists are the U.S.A. The industry there does mostly assembly work, the diagrams and components being bought from mass manufacturers. The first aim was reduction in size and saving in copper and screening material, a reduction in the coil quality in comparison with an air coil not being regarded as too troublesome. That did not do much good to the American industry, and the cores mostly employed are still of the lowest quality. A trend towards high quality cores has been noticeable lately.

The designer in this country takes up a position between these two extremes. He regards most losses in a set as a portion of the total loss and as each single loss usually represents only a tiny fraction of the total, he tends to neglect it. Without efficient production of iron cores in this country for a long time they had to be imported. The

first batches of cores had tolerances of plus or minus 10 per cent. in permeability, the mechanical limits being also considerable. The production managers were not too pleased with the wide limits and were very reluctant to take further risks in this direction. Furthermore, the whole design had to be cheap and too good a coil was not demanded as it requires small limits throughout the whole production and made the latter more costly in the eyes of quite a number of manufacturers. Even although cores with permeability tolerances of not more than 2 per cent. plus or minus generally and plus or minus 1 per cent. against surcharge are now available and manufactured in this country, the same attitude still holds. Although the highest quality is required in most cases, inferior types of cores are still used, and it is interesting to observe how slowly the more efficient core types are coming into use.

Before speaking of the core quality it may be of interest to see what core properties are required by the modern designer, how the demands can be met, and what electrical properties are available. From the production point of view the following are of vital interest:—

- (1) small mechanical tolerances ;
- (2) small electrical tolerances ;
- (3) stability, i.e. no drifting of the coil inductance through alteration of the core permeability ;
- (4) no deformation if the core is fitted near a heat developing source ;
- (5) mechanical strength ;
- (6) the core must not be affected by humidity.

Points 1, 4, 5 and 6 are governed by the mechanical method of the core production itself and one can say that the requirements of the designer can easily be met. Tolerances of plus or minus 0.006in. in press direction and 0.003in. at right angles to it are normal tolerances and smaller tolerances can be guaranteed against surcharge. The heat resistance of cores on the market goes up to 225 deg. C. and the cores do not break even when dropped on the concrete floor of factories.

The question of small electrical tolerances is much more difficult to answer and is

closely linked up with the requirement of high stability. It may be as well to recall the definitions of permeability and quality.

We distinguish between the specific and the effective permeability. The specific permeability as measured on a toroid core with evenly distributed coil winding is the actual permeability of the core material. The specific permeability of to-day's cores is between 14 and 20.

The effective permeability* is defined as the factor by which the self-inductance of a given coil is increased through the introduction of the iron core:—

$$\mu_{\text{eff}} = L_{\text{core}} : L_{\text{air}}$$

For the designer only the limits of the effective permeability are of interest.

The electrical quality Q of the coil, sometimes called its magnification factor or figure of merit, is important in circuit design. It is a misrepresentation to speak of the Q of a core ; the core itself has no Q and the figure which is given is the Q of the coil with its core.† In the formula

$$Q = \omega L/R$$

R stands for the effective resistance, which covers the ohmic resistance and the various losses.

There is a distrust as soon as Q figures in connection with cores are mentioned. It does not even help to say that the coil is made up from litz wire of so many strands. The insulation, the plaiting itself, the whole design of the coil and the different methods of measurement are the cause of fantastic discrepancies in Q figures quoted by the manufacturers. Comparative measurement under working conditions is therefore recommended ; it would be a simple matter to agree to a standard core, a tolerance of 5 per cent. plus or minus the Q of this standard core being generally acceptable.

As already pointed out, the designer is only interested in using iron cores if either the coil price is reduced by employing cores or a definite gain in Q is secured. The first condition can be ruled out. The material for the cores is very expensive and its production a monopoly. Experiments with

* The same effect would be obtained if the coil were immersed in a medium of this permeability.—Editor.

† And yet the author in the next paragraph and elsewhere speaks of the Q of the core.—Editor.

substitute materials have not so far had great success, and the weight of the core raw material is still a decisive part of the calculation. The second condition can be fulfilled. The commercial savings compared with the air coil consist of:—

- (a) less copper ;
- (b) less screening material ;
- (c) smaller space ;
- (d) higher gain and higher selectivity.

To arrive at a most favourable Q for the coil, the losses must be kept very low and more particularly the reduction of losses in the coil itself by the use of an iron core must not be counterbalanced by the losses occurring in the iron core itself. It is therefore necessary to examine separately

- (1) the losses in the coil winding, and
- (2) the losses in the iron core.

Fewer turns and a smaller coil diameter are the characteristics of the iron cored coil, thus reducing the length of the wire required and the ohmic resistance. Square cross sections were at first used for the core but it was quickly recognised that the circumference of a circle is shorter than that of a square of the same area, and consequently square cores have nearly disappeared.

The losses in the iron core itself are mainly due to eddy currents, the hysteresis and other losses being very small indeed. The hysteresis losses do not exceed about 1 per cent. of the total losses and little trouble is taken to avoid them. The main contingent of the losses has its cause in the eddy currents circulating within each single iron powder particle and in those flowing in the mass of the core. They are caused in different ways and can best be classified as follows:—

- (1) eddy currents in each particle ;
- (2) eddy currents caused by faulty resistance of the insulation ;
- (3) eddy currents caused by insufficient production methods ; and
- (4) capacitive eddy currents.

A very fine division of the powder is necessary to bring down the eddy currents in a single particle to a value which makes possible its employment for high frequency cores. The best powder available is the

carbonyl iron of a grade in which the diameter of the nearly spherical particle is not more than 3μ . Many ways have been tried to find other suitable materials but those discovered are only suitable for second-class cores. The monopoly of the carbonyl iron production keeps the prices for iron cores unnecessarily high.

The other three groups deal with eddy currents over the whole cross section of the core, thus giving rise to a kind of skin effect in the core itself and a displacement of lines of force takes place. This is easily proved experimentally. A cylindrical core frequently used in this country has the following dimensions: outside diameter $\frac{3}{8}$ in., length $\frac{1}{2}$ in. It can be provided with a centre bore of say 0.12 in. dia. and naturally the effective permeability will drop, but it will not drop as much as the permeability of a solid cylindrical core with reduced outside diameter, the same length and with the same amount of iron powder (the same weight).

The view of Polydoroff cannot be shared that the drop is only negligibly small if the wall thickness is more than $\frac{1}{3}$ of the outside diameter of the core and that the electrical properties of the core decrease very considerably as soon as this wall thickness is not maintained. Cores with the same amount of iron as the forementioned core with $\frac{3}{8}$ in. outside diameter and 0.12 in. bore (which would fulfil Polydoroff's requirements) have been arranged differently with a wall thickness of 0.22 only of the outside diameter. Such cores are in use in this country with considerable success.

The theoretical problem set by this "skin effect" demands examination of the three causes of eddy currents over the whole core. An iron powder core has always been defined as a core in which every iron particle is insulated from its neighbouring particle. The insulator in the core has not only to insulate the particles but has also to consolidate the core and give it sufficient mechanical strength. This limits the choice of insulators available; those used are far from ideal and have a certain conductivity, which together with the iron particles causes the core to be a conductor, in which eddy currents arise. Time and again manufacturers have tried to overcome these difficulties and special insulators plus a second material which only had binding

properties are described in the different patents. The internal resistance is sometimes taken as proportional to the Q of the core, but this is only of very limited validity. A core which is well insulated, has an internal resistance of 10 megohms (per cm. cube). Different binders are used, one being urea formaldehyde. A core was on the market which showed a very good resistance, but lost that resistance in the humidity test, as the urea formaldehyde was not well cured and absorbed water.

The simplest method of improvement would be an increase in the percentage of the insulator, compared with the iron powder. A new difficulty arises here as a certain amount of iron had to be present in unit volume to obtain a given permeability. Another help would then be to increase the pressure and get the necessary amount of iron into the core in this way. But there are limits to the pressure increase. The amount of binder is never more than 10 per cent. and is usually even below this percentage in weight of the insulated powder. The insulation between the particles is very thin and breaks down if too high a pressure is applied. A compromise must, therefore, be made, and the resulting insulation is far from ideal.

Theoretically each particle in the core is insulated from the other particles. Is this really so in the core material of to-day? The mixing methods are very crude and it can be ascertained that large clusters of iron particles in the insulated powder have a common coat of insulator or binder and make up a larger body in which the particles have contact with each other, thus helping to increase the eddy current losses under the first heading.

The insulating and binding materials, mostly of the artificial resin type, have dielectric properties as well, and the core can be considered as one condenser, made up from a multitude of small condensers, the binder being the dielectric. Capacitive eddy currents can flow which add to the losses.

The same capacitive condition prevails between the particles of the coil surface on one hand and the coil winding on the other. Coils should, therefore, never be wound on to the core directly but should be spaced by tape or formers, sectional Trolitul formers giving the best results.

A further increase in core qualities is not to be expected unless a new raw material with revolutionising properties is found.

The different core types can be divided into three main groups:—

- (1) Cores with closed magnetic path, enclosing the coil as a whole (pot or cup shaped cores);
- (2) Cores filling the places of main concentration of the field of force but only partly enclosing the winding (reel or bobbin type, E plus I type, and H type);
- (3) Cores filling only the centre of the coil (cylindrical cores).

The cores of the first group have an effective permeability of 3.5 to 5 and are particularly suitable for I.F. circuits of 450 to 480 kc/s. They allow very close screening and occasionally do not need screening at all. They are the most expensive cores and are the heaviest. Different types are available which permit variations of the coil self-inductance up to plus or minus 8 per cent. The means of adjustment are either alteration of an air gap or of the cross section of the core or combinations of both methods. The pot-shaped core has very rarely been used in this country on account of its price, but promises to be used far more in the coming season. The cores give a very good Q up to 1,000 kc/s. Beyond this frequency the curve shows a considerable drop which makes the core unsuitable for H.F. tuning circuits.

The second group comprises cores which are particularly good for tuning circuits of the medium wave range. The effective permeability is 3 to 4. Very efficient types of adjustable cores are on the market, using for example an alteration in the length of the mean magnetic path to get sufficient variation of the self-inductance, the aim being to have a linear relation between the inductance and the movement of the core.

The next and last group is the cheapest, with the lowest weight of core. The cores are mostly of cylindrical cross section and a cheap method of adjustment is to move the core relatively to the winding until the required self-inductance is obtained, the core being then fixed in position by sealing or the like. The effective permeability is about 2. The most efficient cylindrical cores are solid

but very often centre holes are provided for supports. Since, as we have already said, a displacement of the lines of force due to eddy currents takes place in the core, the bore is of less influence than would be expected at first sight.

The cores of the third group are mostly used in this country and many manufacturers are satisfied with the Q attained when using them in I.F. stages and even tuning coils. They give sufficiently good results for the long wave range where a more expensive coil would be waste of money.

An externally threaded cylindrical core has long been proposed as means for easy adjustment. These cores have not proved too satisfactory and the type with an inserted threaded brass rod is preferred. This core type gained new importance in connection with the pretuning of sets.

The drop in Q due to the insertion of the brass stem into the core and therewith into the coil can be reduced by a carefully designed joint between the core and the threaded stem, as usually a compromise must be made between mechanical and electrical design. Where circuits with flat curves are in use, the brass stem may penetrate through most of the core, thus guaranteeing the accurate positioning of the thread with regard to the core. Limits of 0.003in. with regard to eccentricity are thus obtainable. On the other hand, where high electrical qualities are required the joint must be designed in such a way as to give the necessary guidance and hold for the stem without the latter tilting over. For cores with rather larger outside-diameter a joint has been designed in which the stem is embedded in insulating material which in its turn is secured to the core, thus removing the disturbing brass stem as far as possible from the core proper and the coil.

Having chosen the group of cores he wants to use, the designer has next to decide on the particular type. The number of different core types in each group is confusing. The question arises, whether the different dimensions have any influence on the electrical design. It is entirely wrong to employ too great a quantity of iron in the core, as the Q does not increase beyond a certain limit. On the other hand, one should not go too low with the weight.

Generally speaking for cylindrical cores the core diameter should not exceed 0.5in. and should not be smaller than 0.375in. These figures are only a guide; in special cases cores with a diameter of 0.290in. have been successfully employed, but as a rule such a low diameter should be avoided and if the core becomes too expensive for the job it is better to provide a central bore rather than go below 0.375in. diameter. This central bore can be used for the necessary support of the coil.

A slightly larger cross section is valuable for the pot-shaped core which encases the coil winding completely. The diameter of the centre portion is particularly important where a high Q is required, and the type is not chosen only for its screening qualities. The inside coil diameter should never be chosen at random, but careful experiments should be carried out in this direction. With regard to the central bore the same applies as for the cylindrical core.

Next comes the wire. One would think that the question solid wire or stranded wire has been disposed of long ago. But it is not so, and there are still manufacturers who maintain that the use of litz wire is too costly. They submit that easier winding, easier soldering and a lower price give advantage to the solid wire.

Solid wire should only be used for reaction coils and, if economies are very important, for the long wave range. Stranded wire of 45 to 47 S.W.G. gauge should be employed, and the number of strands for the different jobs should vary between 7 and 30.

It is superfluous to dwell on the design of tuning circuits which employ iron cores. Numerous designs are on the market and are well known. It may be remarked that a slight trend towards higher Q values can be observed, and it is possible that more iron cored tuning coils will be found in next year's receivers.

A more interesting subject is the I.F. circuit. Some designers still use the frequency of 120 kc/s, and for this frequency a cylindrical core with solid wire of 42 S.W.G. gauge gives a sufficiently good filter curve. The frequency band mostly used for I.F. lies in the neighbourhood of 465 kc/s, 455 kc/s being now standardised in the U.S.A. The best core would be the pot-shaped core, but cylindrical cores are

frequently used for reasons of cheap production.

The three factors of the dynamic resistance L/CR can be chosen by the designer in this case, but in designing the filter it must not be forgotten that the coil with the highest Q does not give the best performance for the complete filter and that the ratio L/C is very important. Capacitances of 100 to $125\mu\mu F$ are best employed in this connection.

Quite a number of designers are afraid to make the filter too good and argue that the oscillator frequency may drift and so move the intermediate frequency to the side band of the filter. If the curve is flatter this does not matter so much. They even go so far as to choose a very flat pre-selection curve if they do not employ pulling-in circuits. This opinion is not shared by other designers, who consider the oscillator circuit to be stable enough under up-to-date design.

The great change in I.F. filter design would be introduced by abandoning the trimmer adjustment. The problem is to build an I.F. filter with high gain at a low price. Trimmers have always been a costly item, and adjustable iron cores combined with silver sprayed fixed condensers promise to take their place. The silver condensers are to-day supplied with astonishingly small tolerances and low losses. The movable iron core takes the task of adjusting the tolerances of winding and condenser and the whole arrangement can be made cheaper. The range of adjustment of movable cores is large enough to meet the requirements of this design.

Selectivity control is frequently required and can easily be obtained in the I.F. stage. Different arrangements are known to this end. They mostly alter the positions of the coils relatively to each other and this includes a certain risk of detuning. Iron cores can be arranged between the two coils and the coupling factor can be influenced by the moving of said core, thus eliminating any danger of detuning.* The arrangements work efficiently and are cheap.

Nearly every factory contemplates the production of one or more sets with automatic tuning for the next season. Different

* We should expect the reverse to be the case. —Editor.

kinds of design are chosen and three main groups for automatic tuning can be discriminated:—

- (1) motor-driven ;
- (2) mechanically operated ;
- (3) pre-tuned.

Only the last one is of interest in connection with this article. The alteration in the wavelength of Radio Normandie was an acid test for pre-tuning. The wavelength was altered from 259.5 m. to 212.6 m. or by 18 per cent. Before going further into the question of the response to this wavelength alteration the prevailing systems of pre-tuning ought to be described.

1. The tuning condenser is switched off and padding condenser and trimmers are connected across the tuning coil by means of push-button devices or rotating switches.

2. The whole tuning circuit is cut off and separate circuits consisting of coil and trimmer plus padding condenser are connected.

3. The whole tuning circuit is cut off and separate circuits consisting of coils with movable iron cores and fixed condensers are connected.

Groups 1 and 2 make use of trimmer condensers and Group 3 of adjustable iron cores. In Group 1, all data are fixed, as the self-inductance of the coil is given and the condenser set takes only the place of the tuning condenser. Group 2 and 3 have advantages in so far as the designer can vary all the three values which affect the dynamic resistance, viz., L , C , and R . Time and again designers have tried to find devices to maintain the same value of the time constant L/R over the whole tuning range. Polydoroff developed his permeability tuning on these lines without, however, being able to introduce the system into the set-producing industry. Here the problem comes up again and the same ratio can at least be provided for a certain number of selected stations.

Between the two last-mentioned groups there is a fundamental difference which is brought out by the Radio Normandie change. It is better to consider the last group first and examine how far the pre-tuned frequency can be altered without exchanging components. The iron core mostly used for this design is the cylindrical

core with threaded brass stud which makes possible alterations of the self-inductance in a ratio of 2 : 1. In the tuned circuit

$$L = 1/\omega^2 C$$

It follows that halving the self-inductance of the coil by withdrawing the iron core means increasing the resonance frequency to 1.41 of its former value. Of course, Q decreases somewhat, but even in this extreme case of an alteration in wavelength of 18 per cent. the core has not to be withdrawn completely.

Let us now examine the other case. The trimmer is usually set to a capacitance of between 10 and 20 $\mu\mu F$. From this fact it will be seen that no halving of the capacitance is possible as the padding condenser has to be considered as well. It will be impossible for this reason to alter the pre-tuned circuit without exchanging the fixed condenser, and that is what happened. The only firm with a pre-tuned set on the market had to exchange the fixed condensers for the Normandie channel. The work is done by dealers who are entitled to charge for the labour involved, and the firm supplies the new fixed condensers. In no case will the dealer be able to get the money for his work, as the sets are all newly bought and the dealer will not dare to scare off his customer.

That is not the end of our examination. We have learned that the alteration obtainable with trimmer adjustment is relatively small and rather narrow channels are covered. The possibility of alterations from 100 per cent. down to 71 per cent. of the channel wavelength by use of iron cores makes it possible to have well overlapped channels even when employing six channels only. When employing nine channels, the customer will be able to have two stations pre-tuned which lie fairly close together.

Designers have recognised this, and it can be expected that still more manufacturers will turn to automatic tuned sets, employing movable iron cores for pre-tuning purposes.

Note Added in proof, August, 1938.

Since this article has been written, trimmers have been offered on the market which have a much greater ratio than hitherto known. The disadvantage is that the useful range of these trimmers is covered by $\frac{3}{4}$ of a turn of the screw which holds the unit

together (these trimmers, of course, do not need padding condensers). The obvious disadvantage of this type is that it can only be used for rather broad input circuits. The same ratio which is covered by the removal of the core from the coilwinding by means of a $\frac{5}{16}$ in. long 4BA thread is compressed in this type of trimmer to the fraction of one turn of the screw.

Fundamentals of Radio

By F. E. Terman. Pp. 458 + VIII. 278 Figs. McGraw-Hill Publishing Co., Aldwych, London, W.C.2. Price 21/-.

The author explains in the preface that this is an abridged version of his "Radio Engineering," reduced to about a half the text, simplified in treatment, and with an increased number of problems of a simple type suitable for the class room. It presupposes an elementary knowledge of alternating current circuit theory. It deals solely with the radio of to-day and never refers to that of yesterday. A student will have to go elsewhere to obtain any historical background or any knowledge of the development of the subject during the past fifty years. This may be an advantage in that it will enable the student to distinguish between what is present practice and what is only of historical value. However this may be, the present volume contains over four hundred pages of essential material, well arranged, clearly described, and well illustrated. It is the result of years of experience in teaching the subject. It concentrates on fundamental concepts, introduces no more mathematics than is absolutely necessary for a clear understanding of the phenomena, and shows a wise discrimination in what is included in a book intended to cover a year's course in radio.

The book gives evidence of great care in its preparation, but there are occasional inconsistencies. Frequency is always expressed in kilocycles and never in kilocycles per second; it is sometimes kc and sometimes Kc; microfarad is sometimes μf and sometimes μF and a million is sometimes m and sometimes M, but these are minor points. It should be explained that when the author speaks of a wave being vertically polarised, he, in common with the majority of radio engineers, refers to the plane of the electric field. In optics—quoting from a standard textbook—"the electrical displacement takes place perpendicular to the plane of polarisation . . . the magnetic force is in the plane of polarisation." This is the classical usage, and it is dangerous to use the opposite convention without clearly emphasising the fact that one is purposely doing so. This matter has been discussed before. Unfortunately, polarisation was the only word which we looked up in the index and we were referred to p. 235; it should be p. 335. Although the line diagrams are very good, the same cannot be said of all the photographs; Fig. 178, a series of photographs purporting to show successive stages in the assembly of a broadcast receiver, could surely have been omitted with advantage.

G. W. O. H.

Time Constants for A.V.C. Filter Circuits*

By *K. R. Sturley, Ph.D., A.M.I.E.E.*

SUMMARY.—The time constants of the series and parallel type of filter, used for decoupling the A.V.C. bias from the grid circuit of the R.F. controlled valves, are examined. The usual definition of time constant is taken, viz., the time required for the voltage to rise to 63.2 per cent. or fall to 36.8 per cent. of its maximum value. Calculations become very cumbersome when the filter has more than three stages and the investigations are limited to this number, but there is every indication that the results are equally applicable to larger numbers of stages.

The charge time constant of the series three stage filter is found to be

$$R_2(C_2 + C_3 + C_4) + R_3(C_3 + C_4) + R_4C_4$$

where R_2 is the first series resistance leading from the A.V.C. diode and C_2 the capacitance following R_2 . The error introduced in this expression by wide variations of component values is proved to be small in the case of the two stage filter, the time constant of which is obtained by making R_4 and C_4 equal to zero.

It was assumed for discharge that all capacitors were charged initially to the maximum voltage. The series three stage filter gives a discharge time constant of

$$C_4(R_4 + R_3 + R_2 + R_1) + C_3(R_3 + R_2 + R_1) + C_2(R_2 + R_1) + C_1R_1$$

where C_1 and R_1 are the coupling capacitance and D.C. load resistance of the A.V.C. diode.

The parallel three stage filter charge time constant is that of the parallel arm with the largest CR product, whilst for discharge it is

$$C_4(R_4 + R_1) + (C_3 + C_2 + C_1)R_1$$

where R_4 and C_4 are the components of the arm at which the time constant is measured. The above expression is not applicable for all component variations and its limitations are discussed. In the practical case the resistances R_4 , R_3 and R_2 , and the capacitances C_4 , C_3 and C_2 will be very nearly equal and under these conditions the formula has no reservations.

Experiments on typical filters are described and the results prove the theoretical investigations to be correct. An important outcome of the tests on the parallel filter is that the time constant due to each arm of the filter depends only on that arm, the arm across which the time constant is measured and the resistance common to both. Any other arm merely adds its own quota to the time constant and its effect is independent of all arms except the time constant arm. Thus the most complicated filter may be simplified for theoretical examination to a modified two stage filter and the total time constant is the sum of the separate time constants due to each separate arm.

A typical series and parallel filter network is finally examined and the latter is shown to be superior to the former, giving a lower charge and discharge time constant for the same filtering action.

IN receivers using automatic volume control for limiting the gain of the radio frequency stages, voltages other than the D.C. bias component in the A.V.C. circuit must be filtered. Instability and, in the superheterodyne receiver, whistles will be produced if R.F. voltages are present, whilst volume contraction of the modulation will occur if the audio-frequency components are not removed. A.V.C. filter circuits generally consist of resistances and capacitances and the time constant of such circuits must not be so high as to delay appreciably the application or release of the D.C. bias component; a value of $\frac{1}{10}$ second is generally regarded as a maximum.

The purpose of this paper is to examine the time constants of the two types of filter circuits used in practice, viz:

(1) The series filter in which the filter circuit for each valve leads back to the filter circuit of the preceding valve, and

(2) the parallel filter in which each filter circuit leads back to the source of A.V.C. bias.

A typical A.V.C. circuit with a single filter is shown in Fig. 1, where V_1 is the R.F. valve, to the anode of which is connected by capacitive coupling the diode supplying the A.V.C. bias. The diode generally has a delay voltage to prevent the production of A.V.C. bias when the R.F. input voltage is small. It will be

* MS. accepted by the Editor, November, 1937.

noted that the conditions governing the application of bias are different from those governing its release. In the first case the diode can be regarded as a low resistance D.C. generator and may be replaced by a D.C. voltage equal to the carrier peak voltage minus the delay voltage on the diode†

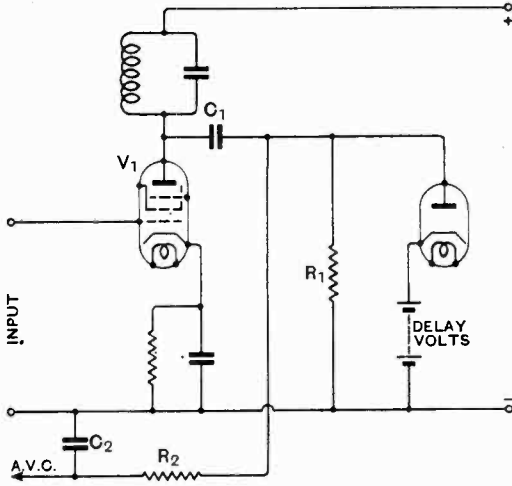

Fig. 1.

multiplied by the rectification efficiency of the diode. In the second case the diode is non-conductive and the charge accumulated on capacitors C_1 and C_2 must leak away through R_1 and R_2 respectively.

The charge condition will first be considered and the effect on the time constant of additional filters in series connection will be examined.

1. Single Stage Filter

The equivalent circuit is that of Fig. 2, where V is a fixed D.C. voltage.

The voltage time relationship for V_2 is of the well-known form.

$$V_2 = V \left[1 - e^{-\frac{t}{R_2 C_2}} \right]$$

and the time constant is given by

$$T = R_2 C_2$$

2. Two Stage Series Filter

This form of filter is represented in Fig. 3

† It is assumed that the modulation envelope is not rectified.

and the current and voltage charge relationships are given below.

$$V = i_2 R_2 + i_3 R_3 + \int \frac{i_3 dt}{C_3} \quad \dots (1)$$

$$\int \frac{(i_2 - i_3) dt}{C_2} = i_3 R_3 + \int \frac{i_3 dt}{C_3} \quad \dots (2)$$

Solving for i_2 in (2)

$$i_2 = i_3 C_2 \left[\frac{1}{C_2} + \frac{1}{C_3} + R_3 D \right] \quad \dots (2a)$$

where $D = \frac{d}{dt}$

and inserting this expression for i_2 in (1).

$$V = i_3 C_2 R_2 \left[\frac{1}{C_2} + \frac{1}{C_3} + R_3 D \right] + i_3 R_3 + \int \frac{i_3 dt}{C_3} \quad \dots (3)$$

Replacing $i_3 dt$ by q_3

$$V C_3 = q_3 \{ R_2 C_2 R_3 C_3 D^2 + [R_2(C_2 + C_3) + R_3 C_3] D + 1 \} \quad \dots (4)$$

$$\text{Hence } q_3 = V C_3 - [A_1 e^{k_1 t} + A_2 e^{k_2 t}] \quad \dots (5)$$

where

$$k_1 ; k_2 = \frac{-[R_2(C_2 + C_3) + R_3 C_3]}{2R_2 C_2 R_3 C_3} \pm \frac{\sqrt{[R_2(C_2 + C_3) + R_3 C_3]^2 - 4R_2 C_2 R_3 C_3}}{2R_2 C_2 R_3 C_3}$$

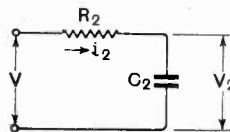

Fig. 2.

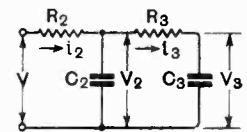

Fig. 3.

The value of A_1 and A_2 in equation (5) may be obtained from initial conditions, for when

$$t = 0 ; q_3 = 0 ; i_3 = 0$$

$$A_1 + A_2 = + V C_3$$

$$A_1 k_1 + A_2 k_2 = 0$$

$$A_1 = \frac{-k_2}{k_1 - k_2} V C_3 ; A_2 = \frac{+k_1}{k_1 - k_2} V C_3$$

Equation (5) becomes

$$q_3 = V C_3 \left[1 - \frac{1}{k_1 - k_2} (k_1 e^{k_2 t} - k_2 e^{k_1 t}) \right] \quad (6)$$

but $q_3 = V_3 C_3$

$$\therefore V_3 = V \left[1 - \frac{1}{k_1 - k_2} (k_1 e^{k_2 t} - k_2 e^{k_1 t}) \right] \quad (7)$$

$$i_3 = \frac{dq_3}{dt} = \frac{VC_3 k_1 k_2}{k_1 - k_2} (\epsilon^{k_1 t} - \epsilon^{k_2 t})$$

$$= \hat{i}_3 \frac{R_3 C_3 k_1 k_2}{k_1 - k_2} (\epsilon^{k_1 t} - \epsilon^{k_2 t}) \dots \dots (8)$$

where $\hat{i}_3 = \frac{V}{R_3}$

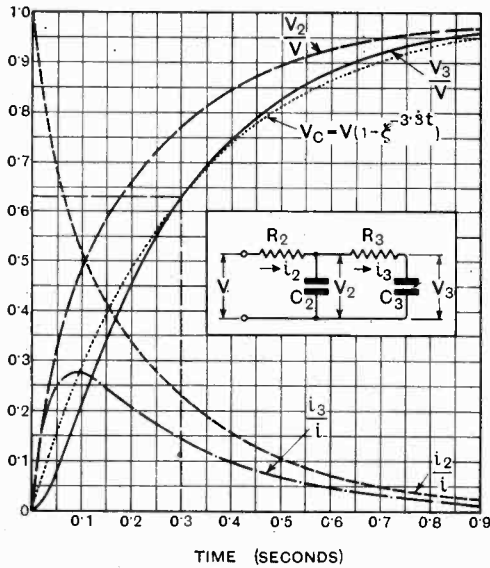

Fig. 4.—Voltage-time and current-time curves for the charge condition in a two-stage A.V.C. filter. In the circuit, $R_2 = R_3 = 1 M\Omega$,

$$C_2 = C_3 = 0.1 \mu F, i = \frac{V}{R_2} = \frac{V}{R_3}$$

From equation (3) and by noting that

$$k_1 k_2 = \frac{I}{R_2 C_2 R_3 C_3} \text{ and}$$

$$k_1 + k_2 = - [R_2 (C_2 + C_3) + R_3 C_3] k_1, k_2$$

we get

$$i_3 = \hat{i}_2 \frac{I}{k_1 - k_2} \left[\left(k_1 + \frac{I}{R_2 C_2} \right) \epsilon^{k_1 t} - \left(k_2 + \frac{I}{R_2 C_2} \right) \epsilon^{k_2 t} \right] \dots (9)$$

where $\hat{i}_2 = \frac{V}{R_2}$

$$V_2 = V - i_2 R_2$$

$$= V \left[1 - \frac{I}{k_1 - k_2} \left(\left[k_1 + \frac{I}{R_2 C_2} \right] \epsilon^{k_1 t} - \left[k_2 + \frac{I}{R_2 C_2} \right] \epsilon^{k_2 t} \right) \right] \dots (10)$$

In order to examine the voltage-time and current-time relationships, curves for $R_2 = R_3 = 1 M\Omega$ and $C_2 = C_3 = 0.1 \mu F$ — the values of k_1 and k_2 are -3.82 and -26.18 respectively — are plotted in Fig. 4.

If the definition of time constant, i.e., the time taken for the voltage across the capacitor to rise to 63.2 per cent. of the maximum, is applied to the two-stage filter it will be observed that the time constant T is equal to 0.3 seconds and is given by $R_2(C_2 + C_3) + R_3 C_3$.

The dotted curve in Fig. 4 is the capacitor voltage-time curve obtained by plotting

$$V_c = V [1 - \epsilon^{-\frac{t}{RC}}]$$

where $RC = 0.3$. This curve has a faster initial rise than the V_3 curve but intersects the latter at $V_3 = 0.632 V$. The close similarity between the curves is such as to justify the extension of the time constant definition to the filter.

It is necessary now to examine the effect of variation of the capacitances and resistances forming the filter on the shape of the V_3 curve. To make comparison possible the curves are plotted with

$$\frac{\text{Time}}{R_2(C_2 + C_3) + R_3 C_3}$$

as the ordinate. In Fig. 5 it is assumed that R_3 only is varied and that the values of R_2, C_2 and C_3 are the same as for Fig. 4.

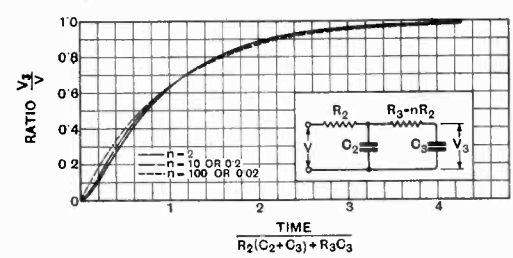

Fig. 5.—Voltage-time curves for two-stage A.V.C. filter for various values of resistance R_3 .

The curves for all values of $n = \frac{R_3}{R_2}$ very nearly pass through the point $V_3 = 0.632 V$, thus indicating that the time constant of a two-stage filter closely approximates to $R_2(C_2 + C_3) + R_3 C_3$. An interesting though expected result is that the curves more

nearly approach the charge curves for a single RC stage as the value of n recedes from 2 and the greatest departure is obtained when $n = 2$. This offers further justification of the extension of the time constant definition to cover the two-stage filter.

Curves showing the effect of variation of the ratio $m = \frac{C_3}{C_2}$ are not plotted because a series of curves identical to those in Fig. 5 is obtained. The curve for $m \left[\frac{C_3}{C_2} \right] = K$ is the same as that for $n \left[\frac{R_3}{R_2} \right] = \frac{1}{K}$. It will therefore be assumed that the charge time constant of the two-stage filter is given by $R_2(C_2 + C_3) + R_3C_3$ for any values of resistance and capacitance.

3. Three-Stage Series Filter

Similar equations for the charge current and voltage-time relationships can be obtained for the three-stage filter shown in Fig. 6.

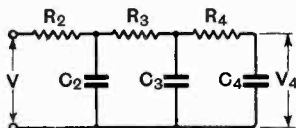

Fig. 6.

The following equation for the charge q_4 on condenser C_4 is obtained.

$$\{D^3R_2C_2R_3C_3R_4C_4 + D^2[R_2C_2(R_3[C_3 + C_4] + R_4C_4) + R_2C_3R_4C_4 + R_3C_3R_4C_4] + D[R_2(C_2 + C_3 + C_4) + R_3(C_3 + C_4) + R_4C_4] + 1\}q_4 = VC_4 \dots \dots (II)$$

This gives a solution for q_4 of the form,

$$q_4 = VC_4 - [A_1e^{k_1t} + A_2e^{k_2t} + A_3e^{k_3t}] \quad (I2a)$$

$$\text{or } V_4 = V - \frac{1}{C_4} [A_1e^{k_1t} + A_2e^{k_2t} + A_3e^{k_3t}] \quad (I2b)$$

where k_1, k_2, k_3 are solutions of the cubic equation in D (expression II) and

$$A_1 = \frac{VC_4 k_2 k_3}{(k_1 - k_2)(k_1 - k_3)}$$

$$A_2 = \frac{VC_4 k_1 k_3}{(k_2 - k_1)(k_2 - k_3)}$$

$$A_3 = \frac{VC_4 k_1 k_2}{(k_3 - k_1)(k_3 - k_2)}$$

Fig. 7.—Voltage-time and current-time curves for the charge condition in a three-stage filter. In the circuit, $R_2 = R_3 = R_4 = 1 M\Omega, C_2 = C_3 = C_4 = 0.1 \mu F,$
 $i = \frac{V}{R_2} = \frac{V}{R_3} = \frac{V}{R_4}$

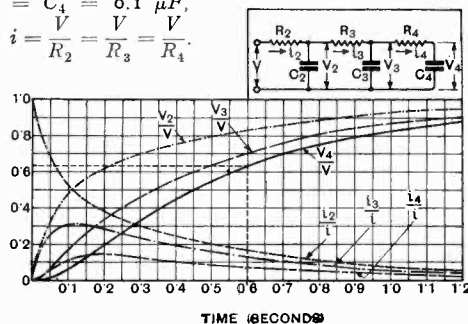

Expressions similar to I2a may be obtained for the other currents and voltages, and curves are plotted in Fig. 7 for values of $R_2 = R_3 = R_4 = 1 M\Omega; C_2 = C_3 = C_4 = 0.1 \mu F$, which gives values of $k_1 = -2, k_2 = -32.5, k_3 = -15.43$. In accordance with the definition given above the time constant of the three-stage filter is 0.6 seconds or $R_2(C_2 + C_3 + C_4) + R_3(C_3 + C_4) + R_4C_4$. It appears probable from the results on the two-stage series filter that the time constant expression,

$$T = R_2(C_2 + C_3 + C_4) + R_3(C_3 + C_4) + R_4C_4 \quad (I3)$$

gives a good approximation to the actual time constant whatever the values of resistance or capacitance.

The charge conditions for single-, two-, or three-stage series filters have been examined and it is necessary now to consider the discharge conditions. An important assumption will be made; that all capacitors in the filter are charged initially to a voltage V .

4. Single-Stage Filter

The equivalent discharge circuit for a single-stage filter is given in Fig. 8.

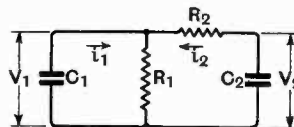

Fig. 8.

The coupling capacitor C_1 to the diode D.C. load resistance may be considered as in parallel with R_1 and charged to a voltage V equal to that on C_2 .

The voltage and current relationships are

$$\left. \begin{aligned} V - \frac{i_2 dt}{C_2} &= i_2 R_2 + (i_1 + i_2) R_1 \\ V - \frac{i_1 dt}{C_1} &= (i_1 + i_2) R_1 \end{aligned} \right\} \quad (14)$$

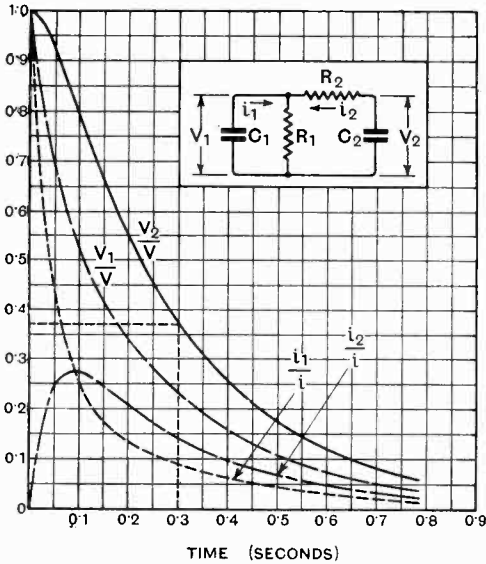

Fig. 9.—Voltage-time and current-time curves for the discharge condition of a single-stage filter. In the circuit, $R_1 = R_2 = 1\text{ M}\Omega$, $C_1 = C_2 = 0.1\ \mu\text{F}$, C_1 and C_2 initially at voltage V .

Solving for “ i_2 ” and replacing $i_2 dt$ by q_2 where q_2 is the loss of charge on C_2 .

$$\{D^2 C_2 R_2 C_1 R_1 + D(C_2(R_2 + R_1) + C_1 R_1) + 1\} q_2 = VC_2 \quad \dots (15)$$

The solution of (15) is

$$q_2 - VC_2 = A_1 e^{k_1 t} + A_2 e^{k_2 t}$$

$$\text{Where } k_1; k_2 = \frac{-[C_2(R_2 + R_1) + C_1 R_1]}{2R_1 C_1 R_2 C_2}$$

$$\pm \frac{\sqrt{(C_2(R_2 + R_1) + C_1 R_1)^2 - 4R_1 C_1 R_2 C_2}}{2R_1 C_1 R_2 C_2}$$

When $t = 0$; $q_2 = 0$; $i_2 = 0$

$$\text{thus } A_1 = \frac{VC_2 k_2}{k_1 - k_2}$$

$$\text{and } A_2 = \frac{-VC_2 k_1}{k_1 - k_2}$$

$$\text{Thus } q_2 = VC_2 \left\{ I + \frac{I}{(k_1 - k_2)} [k_2 e^{k_1 t} - k_1 e^{k_2 t}] \right\}$$

$$\begin{aligned} \text{hence } V_2 &= V - \frac{q_2}{C_2} \\ &= \frac{V}{k_1 - k_2} [k_1 e^{k_2 t} - k_2 e^{k_1 t}] \quad \dots (16) \end{aligned}$$

$$\text{and } i_2 = \frac{dq_2}{dt} = \frac{VC_2 k_1 k_2}{k_1 - k_2} [e^{k_1 t} - e^{k_2 t}] \quad \dots (17)$$

Similarly

$$\begin{aligned} V_1 &= \frac{V}{k_1 - k_2} \left[\left(k_1 + \frac{I}{R_1 C_1} \right) e^{k_2 t} \right. \\ &\quad \left. - \left(k_2 + \frac{I}{R_1 C_1} \right) e^{k_1 t} \right] \quad \dots (18) \end{aligned}$$

$$\begin{aligned} i_1 &= \frac{V}{R_1} \cdot \frac{I}{k_1 - k_2} \left[\left(k_1 + \frac{I}{R_2 C_2} \right) e^{k_2 t} \right. \\ &\quad \left. - \left(k_2 + \frac{I}{R_2 C_2} \right) e^{k_1 t} \right] \quad \dots (19) \end{aligned}$$

It will be noticed that the voltage expressions (16) and (18) are the discharge counterparts of expressions (7) and (10) when $R_1 = R_2$ and $C_1 = C_2$. The current in (17) is the same as the current in (8). The voltage and current-time curves are plotted in Fig. 9 for values of $C_1 = C_2 = 0.1\ \mu\text{F}$ and $R_1 = R_2 = 1\text{ M}\Omega$. The

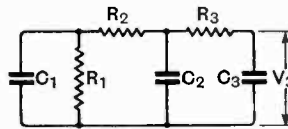

Fig. 10.

values of k_1 ; k_2 and k_3 are the same as for the charge condition for the two stage series filter. The voltage V_2 falls to 36.8 per cent. of its maximum value in 0.3 seconds so that the time constant of the circuit is given by $T = C_2(R_2 + R_1) + C_1 R_1$. Comparison with the charge condition shows the time constant to be increased by the factor $R_1 (C_1 + C_2)$.

5. Two-Stage Series Filter

The following equation is obtained for q_3 the loss of charge on C_3 .

$$\begin{aligned} \{D^3 [C_3 R_3 C_2 R_2 C_1 R_1] + D^2 [C_3 R_3 (C_2 (R_2 + R_1) \\ + C_1 R_1) + C_3 R_2 C_1 R_1 + C_2 R_2 C_1 R_1] \\ + D [C_3 (R_3 + R_2 + R_1) + C_2 (R_2 + R_1) \\ + C_1 R_1] + 1\} q_3 = VC_3 \quad \dots (20) \end{aligned}$$

This gives a solution for q_3 of the form

$$q_3 = VC_3 - [A_1\epsilon^{k_1t} + A_2\epsilon^{k_2t} + A_3\epsilon^{k_3t}]$$

or $V_3 = \frac{I}{C_3} [A_1\epsilon^{k_1t} + A_2\epsilon^{k_2t} + A_3\epsilon^{k_3t}] \dots (21)$

The values of $k_1, k_2, k_3, A_1, A_2,$ and A_3 are identical to those given for the charge condition for the three-stage series filter and it will be observed that when $C_3 = C_2 = C_1$ and $R_3 = R_2 = R_1$; V_3 is the discharge counterpart of V_4 (expression 12b).

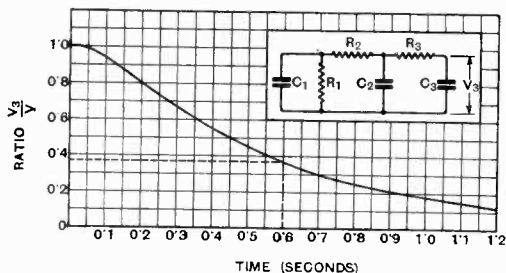

Fig. 11.—Voltage-time curve for the discharge condition of a two-stage filter. $R_1 = R_2 = R_3 = 1 M\Omega, C_1 = C_2 = C_3 = 0.1 \mu F.$ All capacitors charged initially to voltage $V.$

The curve of voltage (V_3) — time is given in Fig. 11 and the time constant equals 0.6 seconds or $C_3(R_3 + R_2 + R_1) + C_2(R_2 + R_1) + C_1R_1.$ This time constant is greater than that for charge by the factor $R_1(C_1 + C_2 + C_3).$

6. Three-Stage Series Filter

The expression for the loss of charge q_4

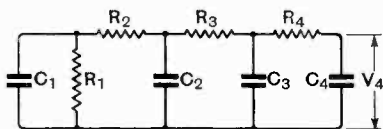

Fig. 12.

on the capacitor C_4 is given by

$$\begin{aligned} & \{D^4[C_4R_4C_3R_3C_2R_2C_1R_1] + D^3[C_4R_4[C_3R_3(C_2(R_2 + R_1) + C_1R_1) + C_2R_2C_1R_1] \\ & \quad + C_4R_3C_2R_2C_1R_1 + C_3R_3C_2R_2C_1R_1] + \\ & D^2[C_4R_4(C_3(R_3 + R_2 + R_1) + C_2(R_2 + R_1) + C_1R_1) + C_4R_3(C_2(R_2 + R_1) + C_1R_1) \\ & \quad + C_4R_2C_1R_1 + C_3R_3[C_2(R_2 + R_1) + C_1R_1] + C_3R_2C_1R_1 + C_2R_2C_1R_1] \\ & \quad + D[C_4(R_4 + R_3 + R_2 + R_1) + C_3(R_3 + R_2 + R_1) + C_2(R_2 + R_1) \\ & \quad + C_1R_1] + 1\}q_4 = VC_4 \dots \dots \dots (22) \end{aligned}$$

Solving for q_4 in the above

$$q_4 = VC_4 - (A_1\epsilon^{k_1t} + A_2\epsilon^{k_2t} + A_3\epsilon^{k_3t} + A_4\epsilon^{k_4t})$$

OR

$$V_4 = \frac{I}{C_4} (A_1\epsilon^{k_1t} + A_2\epsilon^{k_2t} + A_3\epsilon^{k_3t} + A_4\epsilon^{k_4t}) \dots \dots (23)$$

Where k_1, k_2, k_3 and k_4 are the roots of (22) and the initial conditions give

$$\left. \begin{aligned} A_1 &= \frac{VC_4k_2k_3k_4}{(k_2 - k_1)(k_3 - k_1)(k_4 - k_1)} \\ A_2 &= \frac{VC_4k_1k_3k_4}{(k_1 - k_2)(k_3 - k_2)(k_4 - k_2)} \\ A_3 &= \frac{VC_4k_1k_2k_4}{(k_1 - k_3)(k_2 - k_3)(k_4 - k_3)} \\ A_4 &= \frac{VC_4k_1k_2k_3}{(k_1 - k_4)(k_2 - k_4)(k_3 - k_4)} \end{aligned} \right\} \dots (24)$$

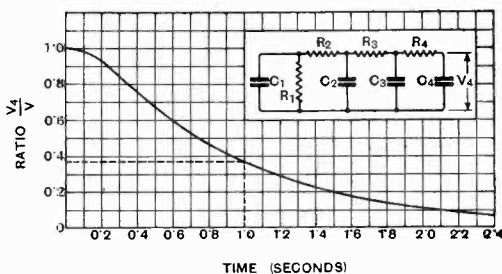

Fig. 13.—Voltage-time curve for the discharge condition of a three-stage filter. $R_1 = R_2 = R_3 = R_4 = 1 M\Omega, C_1 = C_2 = C_3 = C_4 = 0.1 \mu F.$ All capacitors charged initially to $V.$

If $R_1 = R_2 = R_3 = R_4 = 1 M\Omega$

and $C_1 = C_2 = C_3 = C_4 = 0.1 \mu F,$ values of

$$k_1 = -1.21; k_2 = -10;$$

$$k_3 = -23.479; k_4 = -35.311$$

and $A_1 = 1.24 C_4, A_2 = 0.121 C_4, A_3$

$$= -0.0278 C_4, A_4 = -0.334 C_4,$$

are obtained. The voltage (V_4) — time curve is plotted in Fig. 13, and it will be

noted that V_4 falls to 36.8 per cent. of its maximum after 1 second, or the time constant

$$T = C_4(R_4 + R_3 + R_2 + R_1) + C_3(R_3 + R_2 + R_1) + C_2(R_2 + R_1) + C_1R_1$$

It is convenient at this point to tabulate the values of time constants for the charge and discharge conditions according to the number of stages.

No. of Stages.	Charge Time Constant.	Discharge Time Constant.
1	R_2C_2	$C_2(R_2 + R_1) + C_1R_1$
2	$R_2(C_2 + C_3) + R_3C_3$	$C_3(R_3 + R_2 + R_1) + C_2(R_2 + R_1) + C_1R_1$
3	$R_2(C_2 + C_3 + C_4) + R_3(C_3 + C_4) + R_4C_4$	$C_4(R_4 + R_3 + R_2 + R_1) + C_3(R_3 + R_2 + R_1) + C_2(R_2 + R_1) + C_1R_1$

It is clear that the discharge time constant for a given filter will always be greater than that for charge by the factor $R_1(C_n + \dots + C_1)$ where n is the number of stages. If it is assumed that C_1 is small compared with the other capacitors (it is usually about $\frac{1}{1000}$ of the capacitors forming the filter) then R_1 is the important factor and it should be made small in comparison with the filter resistances if the discharge and charge time constants are to approach each other. This condition, viz., $R_1 < R_2$, should be fulfilled* if distortion due to the A.V.C. diode is to be reduced. It is generally not possible to make R_1 much less than $\frac{1}{2} R_2$ so that the discharge time constant will always be the most important factor in determining the time delay of A.V.C. filter circuits.

It is necessary now to take the case of the parallel filter, but only the discharge condition has to be considered since for charge the time constant will be that of a single R.C. stage.

7. Two-Stage Parallel Filter

The circuit for the two-stage parallel filter is given in Fig. 14, and the expression for " q_3 " the loss of charge on capacitor

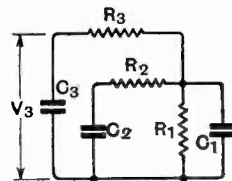

Fig. 14.

C_3 is given by

$$\{D^3[C_3R_3C_2R_2C_1R_1] + D^2[C_3R_3(C_2(R_2 + R_1) + C_1R_1) + C_3R_1C_2R_2 + C_2R_2C_1R_1] + D[C_3(R_3 + R_1) + C_2(R_2 + R_1) + C_1R_1] + 1\}q_3 = VC_3 \dots \dots (25)$$

solving for q_3

$$q_3 = VC_3 - [A_1\epsilon^{k_1t} + A_2\epsilon^{k_2t} + A_3\epsilon^{k_3t}]$$

$$\text{or } V_3 = V - \frac{q_3}{C_3} = \frac{1}{C_3} [A_1\epsilon^{k_1t} + A_2\epsilon^{k_2t} + A_3\epsilon^{k_3t}] \dots \dots (26)$$

where k_1, k_2 and k_3 are the roots of the cubic equation in D in (25).

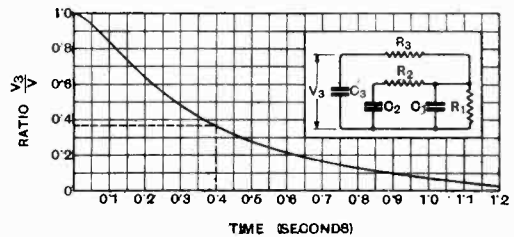

Fig. 15.—Calculated voltage-time curves for the discharge condition of a two-stage parallel filter $C_1 = C_2 = C_3 = 0.1 \mu F$, $R_1 = R_2 = R_3 = 1 M\Omega$. All capacitors initially charged to V .

The values of A_1, A_2 and A_3 obtained from the initial conditions, $t = 0$; $q_3 = 0, i_3 = 0, i_1 = \frac{V}{R_1}$ are

$$\left. \begin{aligned} A_1 &= \frac{VC_3 \left[k_2k_3 - \frac{1}{C_3R_3C_1R_1} \right]}{(k_3 - k_1)(k_2 - k_1)} \\ A_2 &= \frac{VC_3 \left[k_1k_3 - \frac{1}{C_3R_3C_1R_1} \right]}{(k_3 - k_2)(k_1 - k_2)} \\ A_3 &= \frac{VC_3 \left[k_2k_1 - \frac{1}{C_3R_3C_1R_1} \right]}{(k_1 - k_3)(k_2 - k_3)} \end{aligned} \right\} (27)$$

For $R_1 = R_2 = R_3 = 1 M\Omega$ and $C_1 = C_2 = C_3 = 0.1 \mu F$, the values of k_1, k_2 and k_3 are $-2.68, -10$; and -37.32 respectively and the values of A_1, A_2 and A_3 are $1.076 C_3, 0$, and $-0.076 C_3$ respectively. The result $A_2 = 0$ is to be expected since C_3R_3 and C_2R_2 circuits are identical.

The voltage (V_3) — time curve, plotted in Fig. 15 gives a time constant of 0.4 seconds,

* See "Distortion due to Delayed Diode A.V.C." *Wireless Engineer*, Jan., 1937.

a value which would be obtained by assuming the time constant expression to be

$$T = C_3(R_3 + R_1) + C_2R_1 + C_1R_1 \quad (28)$$

This expression clearly cannot hold for all values of C and R ; for example, when R_2 is infinite the effect of C_2 must be negligible. In an attempt to find a more comprehensive formula a theoretical investigation of a simplified two-stage filter with different component values was undertaken. The value of C_1 was assumed to be zero. The results are plotted in Figs. 16a to 16g.

The curves in Fig. 16a show the effect of variation of R_3 and R_1 in terms of R_2 . Except for certain values of $\frac{R_3}{R_2}$ in the region $\frac{R_1}{R_2} = 1$ the formula

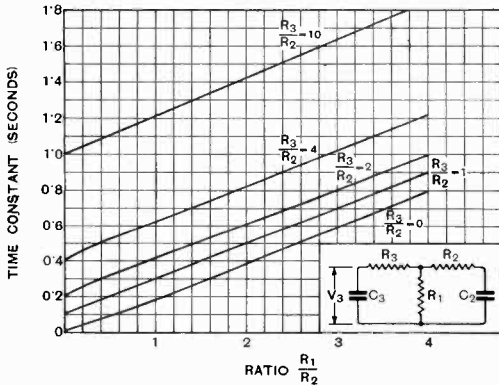
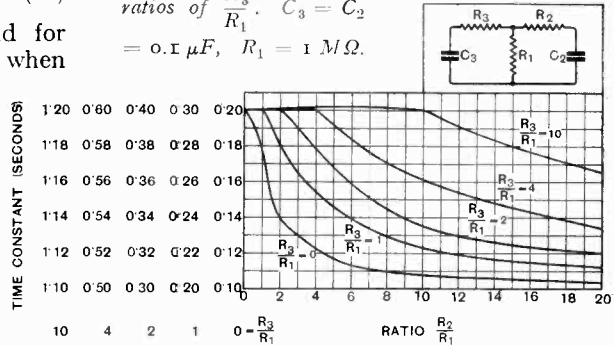

Fig. 16a.—Calculated ratio $\frac{R_1}{R_2}$ - time constant curves for parallel two-stage filter with different ratios of $\frac{R_3}{R_2}$. $C_3 = C_2 = 0.1 \mu F$, $R_2 = 1 M\Omega$.

$$T = C_3(R_3 + R_1) + C_2R_1 \quad (29)$$

for the time constant is very nearly correct. The greatest error, about -1.4 per cent. occurs when $\frac{R_3}{R_2} = 0$, decreases to zero at $\frac{R_3}{R_2} = 1$, increases to about +6 per cent. at $\frac{R_3}{R_2} = 2$ and then progressively decreases until at $\frac{R_3}{R_2} = 10$ the error is less than +2 per cent.

Fig. 16b.—Calculated ratio $\frac{R_2}{R_1}$ - time constant curves for parallel two-stage filter with different ratios of $\frac{R_3}{R_1}$. $C_3 = C_2 = 0.1 \mu F$, $R_1 = 1 M\Omega$.



The variation of time constant produced by variation of R_3 and R_2 in terms of R_1 is shown in Fig. 16b. Expression 29 is shown to be very nearly correct when $\frac{R_2}{R_1}$ is less than $\frac{R_3}{R_1}$, but when $\frac{R_2}{R_1}$ exceeds $\frac{R_3}{R_1}$ the time constant is more correctly expressed as

$$T = C_3(R_3 + R_1) + C_2R_1f\left(\frac{1}{R_2}\right)$$

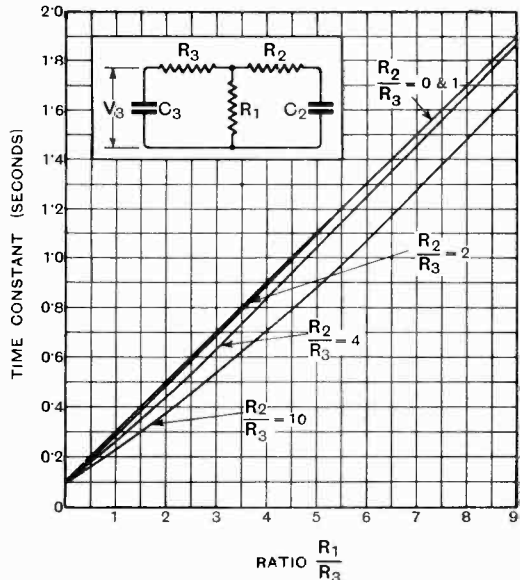

Fig. 16c.—Calculated ratio $\frac{R_1}{R_3}$ - time constant curves for parallel two-stage filter with different ratios of $\frac{R_2}{R_3}$. $C_3 = C_2 = 0.1 \mu F$, $R_3 = 1 M\Omega$.

Attempts to find a simple formula covering this case were not successful.

In Fig. 16c curves are plotted for variation of R_1 and R_2 with respect to R_3 . These are in good agreement with expression 29 for all values of $\frac{R_1}{R_3}$ when $\frac{R_2}{R_3}$ is not greater than 2. As R_2 is increased the effect of $C_2 R_2$ is diminished and the time constant of the filter approaches $C_3 (R_3 + R_1)$.

The resistance R_1 is varied in Fig. 16d and expression (29) is found to be very nearly true for all values of $\frac{C_2}{C_3}$ except in the region of $R_1 = R_3 = R_2$. Here the error increases from zero at $C_2 = C_3$ to about

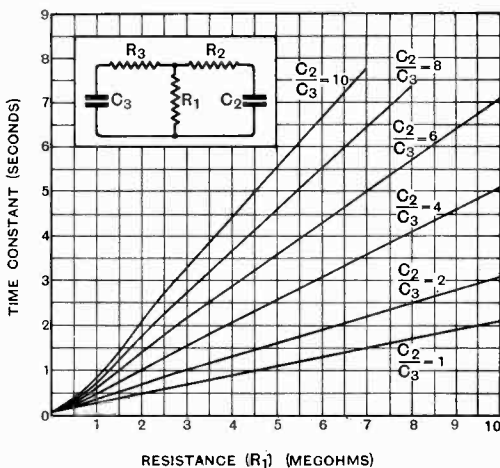

Fig. 16d.—Calculated resistance R_1 -time constant curves for parallel two-stage filter with different ratios of $\frac{C_2}{C_3}$, $R_3 = R_2 = 1 M\Omega$, $C_3 = 0.1 \mu F$.

30 per cent. when $C_2 = 10C_3$. The error rapidly diminishes as R_1 is increased and is less than 10 per cent. when $R_1 = 2R_2 = 2R_3$ and $C_2 = 10C_3$.

In Fig. 16e the effect of varying R_1 for certain fixed values of C_3 is shown and the time constant expression is correct for all values of R_1 and C_3 .

The curves in Fig. 16f show the effect of varying C_2 for certain fixed values of R_2 . Expression 29 is only true when $R_2 = 0$. As R_2 is increased the effect of C_2 is decreased until when $R_2 = 10R_1 = 10R_3$, the time constant is practically unaffected by C_2 .

The capacitor C_3 is varied for the curves in Fig. 16g and expression 29 is approximately true for all values of $C_3 > C_2$ and all values of R_3 . The error is greatest when $R_3 = 0$; is zero when $R_3 = R_1 = R_2$ and

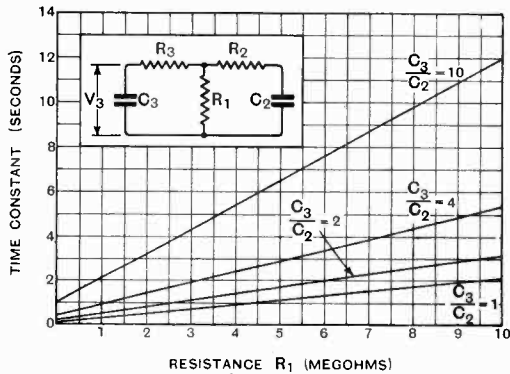

Fig. 16e.—Calculated resistance R_1 -time constant curves for parallel two-stage filter with different ratios of $\frac{C_3}{C_2}$, $C_2 = 0.1 \mu F$, $R_2 = R_3 = 1 M\Omega$.

is about 2.5 per cent. for values of $\frac{R_3}{R_1} > 2$. As C_3 is increased the error becomes progressively less.

It is clear from the above results that expression 29 gives a very good approxi-

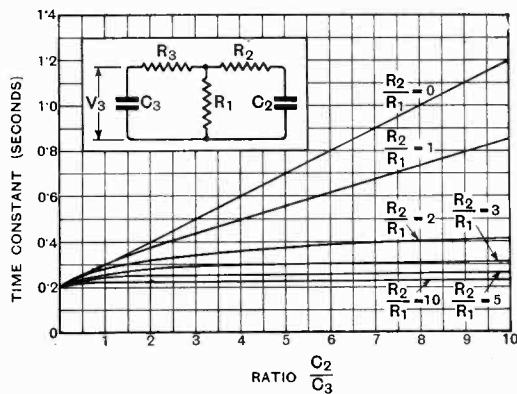

Fig. 16f.—Calculated ratio $\frac{C_2}{C_3}$ -time constant curves for parallel two-stage filter with different ratios of $\frac{R_2}{R_1}$, $C_3 = 0.1 \mu F$, $R_3 = R_1 = 1 M\Omega$.

mation to the time constant of the simplified two-stage parallel filter as long as R_2 and C_2 are not much larger than the other

resistance and capacitance components of the filter. However if R_2 and C_2 are large, the time constant at C_3 is of little interest, as that at C_2 is the controlling factor. Under these conditions the formula is applicable to C_2 with a reasonable degree of accuracy.

8. Three-Stage Parallel Filter

The circuit is that of Fig. 17, and the loss of charge q_4 on C_4 is given by

$$\begin{aligned} & \{D^4[C_4R_1C_3R_3C_2R_2C_1R_1] + D^3[C_4R_4[C_3R_3(C_2(R_2 + R_1) + C_1R_1) + C_2R_2C_1R_1 \\ & \quad + C_3R_1C_2R_2] + C_4R_1C_3R_3C_2R_2 + C_3R_3C_2R_2C_1R_1] \\ & + D^2[C_4R_4[C_3(R_3 + R_1) + C_2(R_2 + R_1) + C_1R_1] + C_4R_1(C_3R_3 + C_2R_2) \\ & \quad + C_3R_3[C_2(R_2 + R_1) + C_1R_1] + C_3R_1C_2R_2 + C_2R_2C_1R_1] \\ & + D[C_4(R_4 + R_1) + C_3(R_3 + R_1) + C_2(R_2 + R_1)] + 1\}q_4 = VC_4 \dots \dots (30) \end{aligned}$$

The solution of this equation is

$$\begin{aligned} q_4 &= VC_4 - (A_1\epsilon^{k_1t} + A_2\epsilon^{k_2t} + A_3\epsilon^{k_3t} + A_4\epsilon^{k_4t}) \\ \text{or } V_4 &= V - \frac{q_4}{C_4} = \frac{I}{C_4} [A_1\epsilon^{k_1t} + A_2\epsilon^{k_2t} \\ & \quad + A_3\epsilon^{k_3t} + A_4\epsilon^{k_4t}] \dots \dots (31) \end{aligned}$$

where k_1, k_2, k_3 and k_4 have their usual significance. The values of $A_1, \text{etc.},$ are obtained from the initial conditions $t = 0,$

$$q_4 = 0, i_4 = 0, i_3 = 0, i_1 = \frac{V}{R_1}$$

as shown in the appendix.

$$\begin{aligned} A_1 &= VC_4 \frac{\left[k_2k_3k_4 + \frac{I}{C_4R_4C_3R_3C_1R_1} \right] (I + k_1C_3R_3)}{(k_2 - k_1)(k_3 - k_1)(k_4 - k_1)} \\ A_2 &= VC_4 \frac{\left[k_1k_3k_4 + \frac{I}{C_4R_4C_3R_3C_1R_1} \right] (I + k_2C_3R_3)}{(k_1 - k_2)(k_3 - k_2)(k_4 - k_2)} \\ A_3 &= VC_4 \frac{\left[k_1k_2k_4 + \frac{I}{C_4R_4C_3R_3C_1R_1} \right] (I + k_3C_3R_3)}{(k_1 - k_3)(k_2 - k_3)(k_4 - k_3)} \\ A_4 &= VC_4 \frac{\left[k_1k_2k_3 + \frac{I}{C_4R_4C_3R_3C_1R_1} \right] (I + k_4C_3R_3)}{(k_1 - k_4)(k_2 - k_4)(k_3 - k_4)} \end{aligned} \dots \dots (32)$$

The voltage (V_4) - time curve is plotted in Fig. 18 for values of $R_1 = R_2 = R_3 = R_4 = 1 M\Omega$ and $C_1 = C_2 = C_3 = 0.1 \mu F$ and $C_4 = 0.2 \mu F$. The value of C_4 is increased to prevent equal values of k_3 and k_4 . Two equal roots in the differential equation 30 give a solution of the form

$$q_4 = VC_4 - [A_1\epsilon^{k_1t} + A_2\epsilon^{k_2t} + (A_3 + A_4t)\epsilon^{k_3t}]$$

and the values of $A_1, \text{etc.},$ have to be re-

calculated. Since this occurs for one particular set of R and C values only it was not investigated. For the above R and C filter components, the following values of $k_1, A_1, \text{etc.},$ were obtained.

$$\begin{aligned} k_1 &= -1.586, k_2 = -10; k_3 = - \\ & \quad 6.75, k_4 = -46.66. \\ A_1 &= 1.138 C_4, A_2 = 0; A_3 = - \\ & \quad 0.1163 C_4, A_4 = -0.0217 C_4. \end{aligned}$$

The curve in Fig. 18 gives a time constant of 7.08 seconds which—significantly—is almost equal to $C_4 (R_4 + R_1) + (C_3 + C_2 + C_1) R_1.$

9. Experimental Verification

To check the calculations, apparatus, a diagram of which is shown in Fig. 19, was constructed for measuring the discharge time constant of the series and parallel three-stage filter. A battery B was used to charge the filter F , the negative end of which was connected to the grid of an L.F.

amplifier valve V_1 . The grid cathode circuit of the valve V_1 was completed through the resistance R_2 , a potentiometer R_3 for initial adjustment of bias and a tone generator operating at 1000c/sec. The potential divider, made up of R_1 and R_2 , was made of wire wound resistances accurately adjusted to give 0.368 of the battery voltage across R_2 . The output from V_1 was connected to

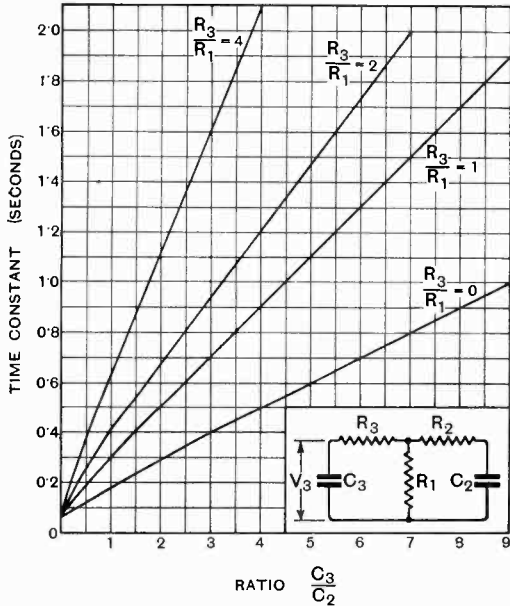

Fig. 16g.—Calculated ratio $\frac{C_3}{C_2}$ - time constant curves for parallel two-stage filter with different ratios of $\frac{R_3}{R_1}$. $C_2 = 0.1 \mu F$, $R_1 = R_2 = 1 M\Omega$.

a Marconi Double Pen Recorder and the bias potentiometer R_3 was set just to operate the recorder when the grid of V_1 was connected to the movable arm of R_3 . Under normal conditions the negative voltage across the filter rendered the recorder inoperative until equal to the voltage across R_2 . Thus the recorder noted the point at which the filter

output voltage fell to 0.368 of its maximum value.

The double pen recorder consisted of an L.F. amplifier followed by a detector valve containing a relay in its anode circuit. Attached to the relay was a pen which marked on a paper tape driven by a synchronous motor at 10 cms/sec. The output from valve V_1 was connected to the input of the recorder L.F. amplifier so that this pen marked the end of discharge only and the second pen relay was used to mark the beginning of discharge. The double pole double throw switch S in Fig. 19 was used to connect the second pen relay to a battery

Fig. 18.—Voltage-time curves for the discharge condition of a three-stage parallel filter. $C_1 = C_2 = C_3 = 0.1 \mu F$, $C_4 = 0.2 \mu F$, $R_1 = R_2 = R_3 = R_4 = 1 M\Omega$. All capacitors initially charged to V .

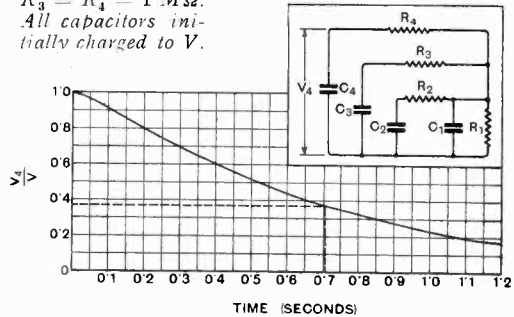

at the same time as the charge battery was disconnected from the filter. Careful tests failed to reveal any serious time error due to operating the beginning and end of discharge from two different contacts.

The results obtained for the three-stage

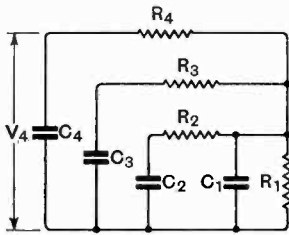
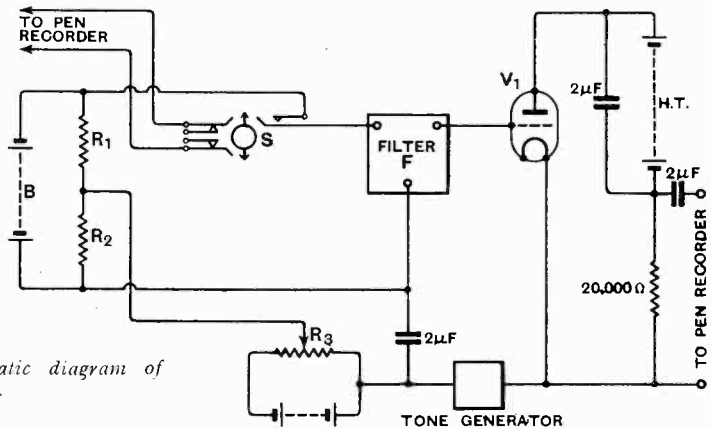

Fig. 17.



(Right) Fig. 19.—Schematic diagram of apparatus.

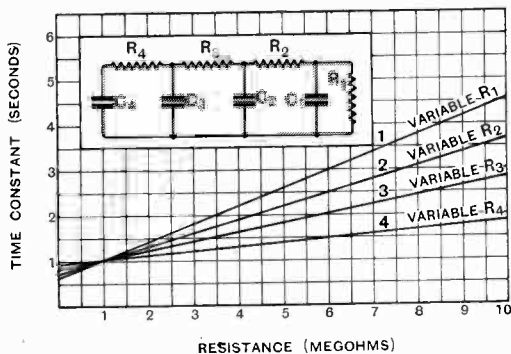

Fig. 20a.—Measured resistance variation-time constant curves for series three-stage filter.

C_1	C_2	C_3	C_4	Curve
0.1	0.097	0.11	0.0905	
R_1	R_2	R_3	R_4	
Var.	1.13	0.955	1.03	1
1.13	Var.	0.955	1.03	2
1.13	0.955	Var.	1.03	3
1.13	0.955	1.03	Var.	4

$R - M\Omega. C - \mu F.$

series filter in discharge are given in Figs. 20a and b and the expression

$$T = C_4(R_4 + R_3 + R_2 + R_1) + C_3(R_3 + R_2 + R_1) + C_2(R_2 + R_1) + C_1R_1$$

is found to be correct for all variations of one particular capacitance and one particular resistance. A similar series of curves (not given in the paper) was obtained for the charge conditions of this filter confirming that the charge time constant is given by

$$T = R_2(C_2 + C_3 + C_4) + R_3(C_3 + C_4) + R_4C_4$$

It seems certain therefore that the above time constant expressions give a good approximation to the true value of time constant for all values of capacitance and resistance. The curves in Fig. 5 showing the effect of variation of the capacitance and resistance components of the series two-stage filter indicate that the above expressions will not give the exact time constant value in every case though the departure from the true value will be small and probably not greater than about 5 per cent.

The results for the parallel three-stage filter are given in Figs. 21 a, b, c, d, and e.

Fig. 21a shows that variation of C_4 and R_1 produce a variation of time constant according to the expression $T = C_4(R_4 + R_1) + A$

where A is a constant depending on the components of the other filter arms.

The curves in Fig. 21b indicate the effect of variation of C_2 and R_2 upon the time constant and these give results which are almost identical with those given in Fig. 16f for the two-stage simplified filter. The correspondence between these two sets of curves (it should be noted that $R_1 = 0.955 M\Omega$ as compared with $1 M\Omega$ for Fig. 16f) suggests therefore that the effect of any parallel filter arm on the time constant is quite independent of any other, and to prove this the curves in Fig. 21c were obtained. The difference between the full and dotted lines is almost exactly equal to C_1R_1 .

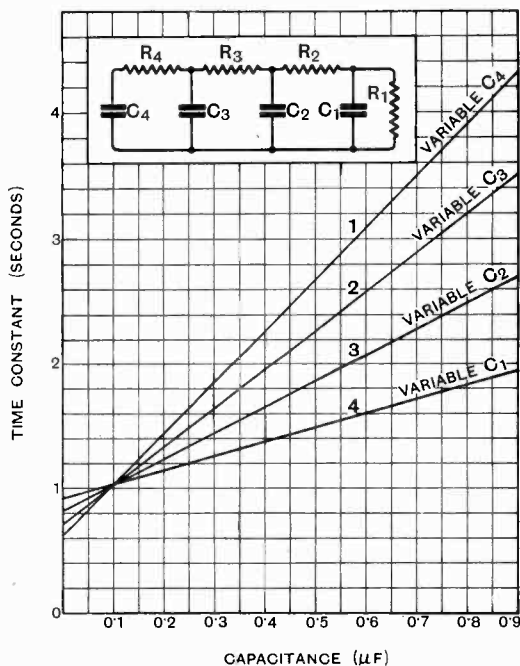

Fig. 20b.—Measured capacitance variation-time constant curves for series three-stage filter.

R_1	R_2	R_3	R_4	Curve
1.13	0.955	1.03	1.01	
C_1	C_2	C_3	C_4	
0.097	0.11	0.0905	Var.	1
0.097	0.11	Var.	0.0905	2
0.097	Var.	0.11	0.0905	3
Var.	0.097	0.11	0.0905	4

$R - M\Omega, C - \mu F.$

Variation of C_1 and R_1 gives the curves in Fig. 21d and these show the time constant to be given by

$$T = C_4(R_4 + R_1) + (C_3 + C_2 + C_1)R_1.$$

In the curves in Fig. 21e the effect of C_2 and R_1 is shown for $C_1 = 0$ (this would be equivalent to the practical form of filter). The time constant expression is given by

$$C_4(R_4 + R_1) + (C_3 + C_2)R_1,$$

except for large values of C_2 in the region of $R_1 = 1 M\Omega$. If due allowance is made for the extra C_3 arm of the filter the curves are almost identical to the calculated ones in Fig. 16d. The most important point arising out of the experimental results is that each parallel arm produces an effect which is dependent only on its own components and those of the arm at which the time constant is taken. This means that all arms except the time constant arm and the particular arm under investigation may be removed and the problem solved as in the case of the simplified two-stage filter.

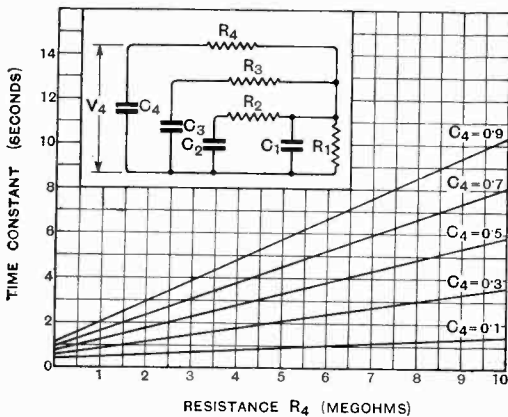

Fig. 21a.—Measured resistance (R_4) variation-time constant curves for parallel three-stage filter with different values of capacitance C_4 .

R_1	R_2	R_3
0.92	0.96	0.96
C_1	C_2	C_3
0.097	0.11	0.0905

$R - M\Omega, C - \mu F.$

If each arm is so treated and the time constants due to each arm added together the result will be the time constant of the com-

posite filter. For example, taking C_4, R_4, R_1 and C_1 a time constant is obtained of $C_4(R_4 + R_1) + C_1R_1$, the added time con-

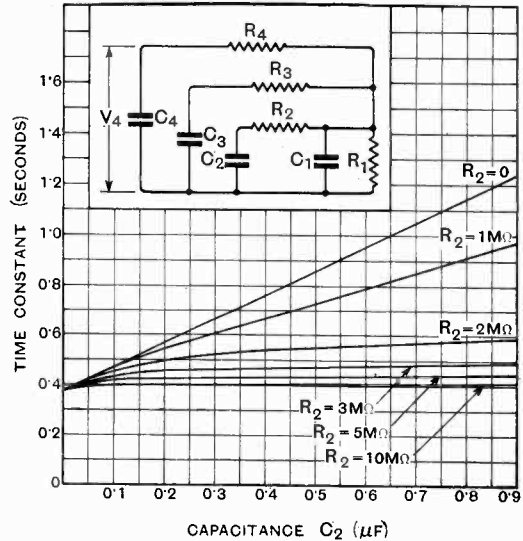

Fig. 21b.—Measured capacitance C_2 variation-time constant curves for parallel three-stage filter with different values of resistance R_2 .

C_1	C_3	C_4
0.11	0.097	0.0905
R_1	R_3	R_4
0.955	1.13	1.03

$R - M\Omega, C - \mu F.$

stant due to C_1 being C_1R_1 . In the same way C_4, R_4, R_1, R_2 and C_2 gives a time constant of

$$T = C_4(R_4 + R_1) + C_2R_1 f\left(\frac{I}{R_2}\right);$$

the time constant due to C_2R_2 being $C_2R_1 f\left(\frac{I}{R_2}\right)$.

Similarly with C_3R_3 the added time constant is $C_3R_1 f\left(\frac{I}{R_3}\right)$. The total time constant is

$$\text{therefore } C_4(R_4 + R_1) + C_1R_1 + C_2R_1 f\left(\frac{I}{R_2}\right) + C_3R_1 f\left(\frac{I}{R_3}\right).$$

In most practical cases the values of R_4, R_3, R_2 , and C_4, C_3 and C_2 will be nearly equal, so that the formula $T = C_4(R_4 + R_1) + (C_3 + C_2 + C_1)R_1$ will be applicable.

It is now possible to assess the relative

merits of the series and parallel type of filter. To reduce distortion from the A.V.C. valve the minimum A.C. resistance in parallel with the diode D.C. resistance R_1 should not be less than $2R_1$. For the two-stage series filter $R_2 = 2R_1$ and for the parallel filter $\frac{I}{R_2} + \frac{I}{R_3} = \frac{I}{2R_1}$. If each controlled valve is to be filtered equally from the next $C_2 = C_3 = C$ (C_1 may be neglected) and $R_2 = R_3$ for both types of filters. Thus for the two-stage series filter the discharge time constant

$$= C_3(R_3 + R_2 + R_1) + C_2(R_2 + R_1) = 5CR_1 + 3CR_1 = 8CR_1$$

and for the parallel filter

$$R_2 = R_3 = 4R_1$$

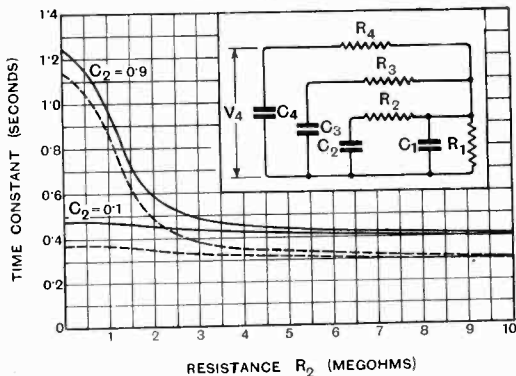

Fig. 21c.—Effect of filter section $C_1 R_1$ on the time constant curves for parallel three-stage filter. Full lines—with $C_1 R_1$, dotted lines—without $C_1 R_1$.

C_1	C_3	C_4
0.11	0.097	0.0905
R_1	R_3	R_4
0.955	1.13	1.03

$R - M\Omega, C - \mu F.$

and the time constant

$$= C_3(R_3 + R_1) + C_2R_1 = C(5R_1) + CR_1 = 6CR_1$$

The parallel filter is therefore superior to the series filter since for the same filter action it gives a lower time constant. The superiority is still more marked in the case of the three-stage filter for then the time con-

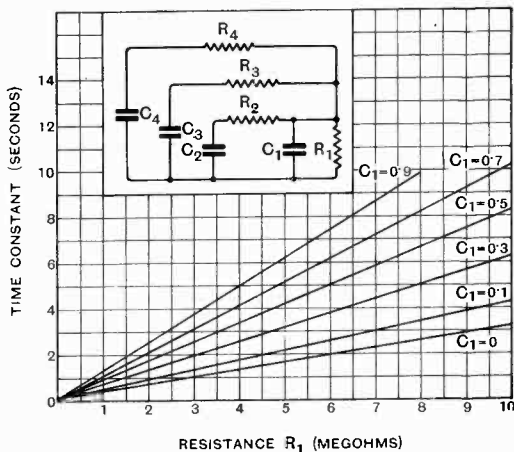

Fig. 21d.—Measured resistance variation (R_1) - time constant curves for parallel three-stage filter with different values of capacitance C_1 .

R_2	R_3	R_4
0.92	0.96	0.96
C_2	C_3	C_4
0.097	0.0905	0.11

$R - M\Omega, C - \mu F.$

stants of parallel and series filters are in the ratio of 9 to 15. If however in the series

Fig. 21e.—Measured resistance R_1 - time constant curves for parallel three-stage filter with different values of capacitance C_2 and capacitance $C_1 = 0$.

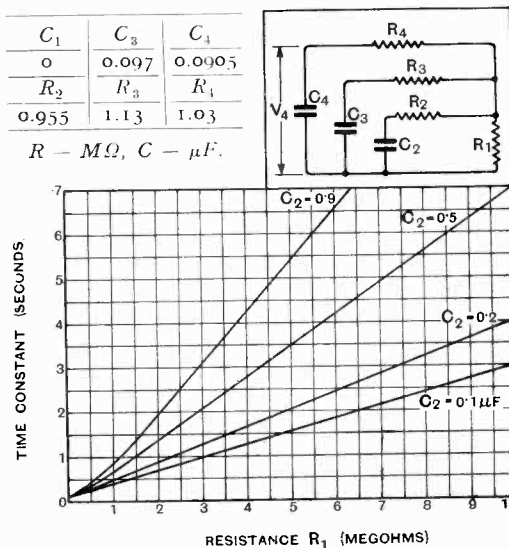

filter each valve is not equally filtered the advantage of the parallel filter is reduced, but even when $R_3 = 0$ the two-stage parallel filter discharge time constant is less than the series filter. In the charge condition the parallel filter is always better than the series filter. For example, the parallel two-stage filter gives a charge time constant of $4CR_1$ as compared with $6CR_1$ for the series counterpart.

The author, in concluding, wishes to thank the Marconi Company for permission to

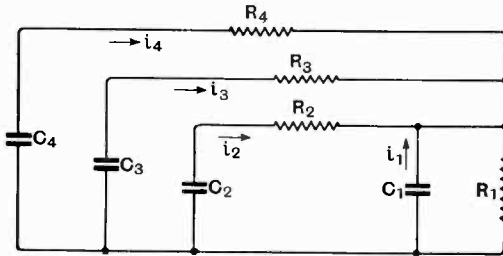

Fig. 22.

publish the experimental results which were obtained in the Marconi School of Wireless Communication and Mr. K. G. Britton who assisted in the experimental measurements.

Appendix

The current and voltage time relationships for the three-stage parallel filter are as follows:

$$V = \frac{q_4}{C_4} + i_4 R_4 + (i_4 + i_3 + i_2 + i_1) R_1 \quad \dots (1)$$

$$V = \frac{q_3}{C_3} + i_3 R_3 + (i_4 + i_3 + i_2 + i_1) R_1 \quad \dots (2)$$

$$V = \frac{q_2}{C_2} + i_2 R_2 + (i_4 + i_3 + i_2 + i_1) R_1 \quad \dots (3)$$

$$V = \frac{q_1}{C_1} + (i_4 + i_3 + i_2 + i_1) R_1 \quad \dots (4)$$

where q is the loss of charge and all capacitances are charged to V initially.

Differentiating (1) and (4) and adding

$$\frac{i_4}{C_4} + Di_4 R_4 = \frac{i_1}{C_1} \quad \dots (5)$$

From (1) and (2)

$$\frac{q_4}{C_4} + i_4 R_4 = \frac{q_3}{C_3} + i_3 R_3 \quad \dots (6)$$

The expression for q_4 is

$$q_4 = VC_4 - [A_1 \epsilon^{k_1 t} + A_2 \epsilon^{k_2 t} + A_3 \epsilon^{k_3 t} + A_4 \epsilon^{k_4 t}] \quad \dots (7)$$

thus

$$i_4 = \frac{dq_4}{dt} = - [A_1 k_1 \epsilon^{k_1 t} + A_2 k_2 \epsilon^{k_2 t} + A_3 k_3 \epsilon^{k_3 t} + A_4 k_4 \epsilon^{k_4 t}] \quad \dots (8)$$

but the initial conditions give

$$t = 0; q_4 = 0; i_4 = 0; i_3 = 0; i_2 = 0; i_1 = \frac{V}{R_1}$$

Thus from (7) and (8)

$$VC_4 = A_1 + A_2 + A_3 + A_4 \quad \dots (9)$$

$$0 = A_1 k_1 + A_2 k_2 + A_3 k_3 + A_4 k_4 \quad \dots (10)$$

From (5)

$$\frac{V}{R_1 C_1} = - [A_1 k_1^2 + A_2 k_2^2 + A_3 k_3^2 + A_4 k_4^2] \quad \dots (11)$$

since when $t = 0; i_4 = 0$.

Let the expression for q_3 be

$$q_3 = VC_3 - [B_1 \epsilon^{k_1 t} + B_2 \epsilon^{k_2 t} + B_3 \epsilon^{k_3 t} + B_4 \epsilon^{k_4 t}]$$

then $i_3 = \frac{dq_3}{dt} = - [B_1 k_1 \epsilon^{k_1 t} + B_2 k_2 \epsilon^{k_2 t} + B_3 k_3 \epsilon^{k_3 t} + B_4 k_4 \epsilon^{k_4 t}]$

Replacing these expressions in (6) and equating the constant factors multiplying the same exponential term

$$B_1 = \frac{A_1 \left[\frac{1}{C_4} + k_1 R_4 \right]}{\left[\frac{1}{C_3} + k_1 R_3 \right]} \quad \dots (12)$$

B_2, B_3 and B_4 yield similar expressions.

From initial conditions

$$i_3 = - [B_1 k_1 + B_2 k_2 + B_3 k_3 + B_4 k_4] = 0$$

$$\text{or } \frac{A_1 k_1 (\alpha + k_1 \beta)}{(\alpha + k_1 \beta)} + \frac{A_2 k_2 (\alpha + k_2 \beta)}{(\alpha + k_2 \beta)} + \frac{A_3 k_3 (\alpha + k_3 \beta)}{(\alpha + k_3 \beta)} + \frac{A_4 k_4 (\alpha + k_4 \beta)}{(\alpha + k_4 \beta)} = 0$$

where $\alpha = R_4 C_4$ and $\beta = R_3 C_3$

By replacing $A_1 k_1 (\alpha + k_1 \beta)$ by $A_1 k_1 [\alpha + k_1 \beta + k_1 (\alpha - \beta)]$, etc., and noting that $A_1 k_1 + A_2 k_2 + A_3 k_3 + A_4 k_4 = 0$ this expression becomes

$$\frac{A_1 k_1^2}{\alpha + k_1 \beta} + \frac{A_2 k_2^2}{\alpha + k_2 \beta} + \frac{A_3 k_3^2}{\alpha + k_3 \beta} + \frac{A_4 k_4^2}{\alpha + k_4 \beta} = 0 \quad \dots (13)$$

Equations 9, 10, 11 and 13 enable the values of A_1 , etc., to be calculated. The solution is of the form $A_1 = \frac{N_1}{D}$, where

$$D = \frac{\beta(k_2 - k_1)(k_3 - k_1)(k_4 - k_1)(k_3 - k_2)(k_4 - k_2)(k_4 - k_3)}{(\alpha + k_1 \beta)(\alpha + k_2 \beta)(\alpha + k_3 \beta)(\alpha + k_4 \beta)}$$

$$\text{and } N_1 = \frac{(k_3 - k_2)(k_4 - k_2)(k_4 - k_3)}{(\alpha + k_2 \beta)(\alpha + k_3 \beta)(\alpha + k_4 \beta)}$$

$$\left[VC_4 k_2 k_3 k_4 + \frac{V}{R_1 C_1 \beta R_4} \right]$$

thus

$$A_1 = \frac{VC_4 \left[k_2 k_3 k_4 + \frac{1}{R_1 C_1 R_3 C_3 R_4 C_4} \right] (\alpha + k_1 R_3 C_3)}{(k_2 - k_1)(k_3 - k_1)(k_4 - k_1)} \quad \dots (14)$$

A_2 is found by replacing k_1 by k_2 and k_2 by k_1 in expression (14) and A_3 and A_4 may be similarly obtained.

An Elevated Transmitter for Testing Direction Finders*

By *R. H. Barfield, M.Sc., A.M.I.E.E.*

(Radio Department, National Physical Laboratory)

ABSTRACT.—The measurement of the extent to which a radio direction-finder is subject to polarisation error is most satisfactorily achieved by taking bearings on downcoming waves of known angles of incidence and polarisation. This paper gives a description of an apparatus used at the Radio Research Station, Slough, for this purpose, consisting of a low power transmitting source with a dipole aerial erected at the top of a tower, 70ft. high. The aerial is rotatable so that waves of any desired polarisation can be obtained. This installation is suitable for use on wavelengths below 70 metres, at which the minimum useful angle of incidence is 80 deg. With wavelengths of 15 metres and below, it is possible to work with angles of incidence of 45 deg. or less, while still retaining the requisite distance of two wavelengths between transmitter and receiver.

Introduction and Principles

THE measurement of the extent to which a radio direction finder is subject to polarisation error, that is the error in bearing which varies with the state of polarisation of the wave, is most satisfactorily achieved by taking bearings on downcoming waves of known angles of incidence and polarisation. The apparatus employed for this purpose at the Radio Research Station, Slough, for several years past, consists of a low power transmitter with a dipole aerial erected at the top of a tower. The essential features of the apparatus are that the dipole aerial remains permanently in position at the top of the tower while the box containing the oscillator and batteries can be raised or lowered, as required, by ropes operated from the ground. Also, by means of other ropes, the aerial can be rotated about a horizontal axis to give variable polarisation and this horizontal axis can itself be rotated about a vertical axis so that receivers lying in any direction from the tower can be tested. The advantages of this arrangement are that since the transmitter can easily be taken down without climbing the tower it is a simple matter to alter the working wavelength during the course of the experiments, and the transmitter can be conveniently stored in a weather-proof building except

actually at the time that experiments are being made.

The wooden tower supporting the apparatus is of the self-supporting open lattice type of square cross-section; it is approximately 70 feet high with a base measuring 9ft. × 9ft. tapering to 3ft. × 3ft. at the top.

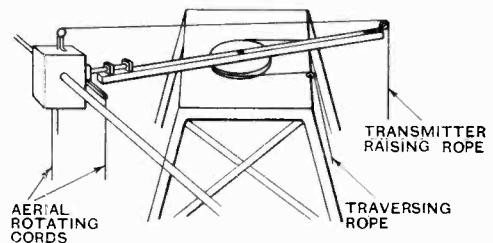

Fig. 1.—Rotatable structure carrying elevated transmitter and dipole aerial.

The mechanical structure carrying the transmitter and mounted at the top of the tower is illustrated in Fig. 1 and by the photographs in Fig. 4. This consists of a horizontal wooden turntable on which is bolted a horizontal wooden arm long enough to project beyond the top of the tower at each end. The two sections of the dipole aerial (Fig. 2) consisting of 7ft. lengths of $\frac{3}{4}$ in. diameter aluminium rod, are fixed at their inner ends to the opposite sides of an open wooden box forming a housing compartment, into which the transmitting unit fits when it is pulled

* MS. accepted by the Editor, April 1938.

into its working position. This housing box is fixed to a horizontal bearing mounted at one end of the wooden arm so that the aerial can be rotated about a horizontal axis.

By means of a ball and socket arrangement working between a fixed and moving plate on the bearing, the system registers into semi-fixed positions at angles of 30 deg., 45 deg. and 60 deg. on each side of the vertical and also in the horizontal and vertical positions, so that these positions may be quickly and certainly attained for experimental purposes.

When raising or lowering the transmitting unit the aerials are horizontal and the open end of the housing faces downwards, as shown in Fig. 4(b); the interior has two brass contact pieces which are connected to the two halves of the aerial and is tapered so that the transmitting unit may be pulled up easily into it but will fit tightly when pulled home. The closed end or top of the housing has a central hole to allow the rope used for raising the transmitter to pass through. The rope passes up from the ground through this hole, over a pulley and then along the top of the beam to the other end where it passes over another pulley and descends again to the ground (see Fig. 1).

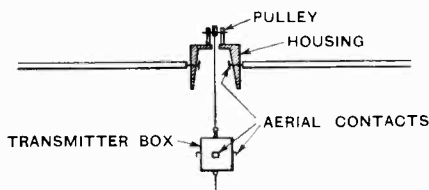

Fig. 2.—Method of housing transmitter.

The transmitting unit is contained in a box measuring 10in. \times 10in. \times 8in. and comprises a two-valve modulated oscillation generator. The power supply is obtained from a 90-volt H.T. battery and non-spillable 2-volt accumulator. The circuit diagram is shown in Fig. 3. The aerial contacts consist of brass plates $\frac{1}{4}$ in. square set at an oblique angle so that they are forced against the similarly aligned aerial contacts when the transmitting unit is pulled into position. They are duplicated in the manner shown so that contact will be made for any position in which the transmitting box enters its

housing thus obviating troubles due to the unavoidable spinning of the box on its rope.

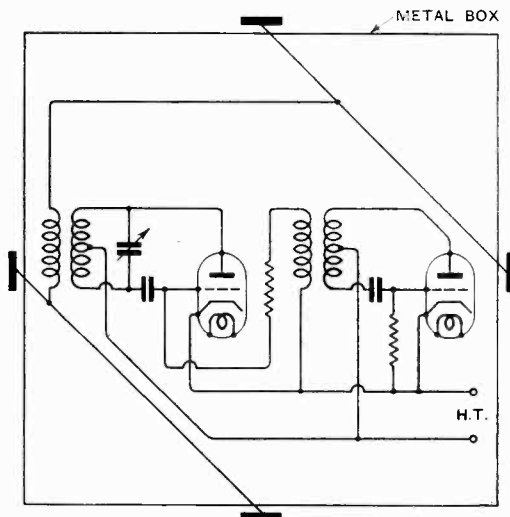

Fig. 3.—Circuit diagram of transmitter.

When it has been firmly pulled "home" the lower end of the rope is made fast under tension to a cleat fixed to the bottom of the tower, so that the unit is kept firmly in place, and since the pulley on the back end of the beam lies on the line of the horizontal axis about which the housing turns, it is possible for rotation to take place without any tightening or loosening of this rope.

The rotation of the dipole is effected by means of two cords attached to a short wooden arm fixed to the wooden housing and parallel to the dipole so that when the arm is in its horizontal position the apparatus is in the correct condition for hauling up or lowering the transmitter. A third cord is fixed to the bottom of the transmitting unit and hangs down to the ground when the transmitter is in position. To lower the transmitter it is necessary to pull this cord to free it from its housing at the same time paying out the rope on which the transmitter is suspended. This cord is also used to keep the transmitter clear of the tower structure as it ascends and descends.

The rotation of the system about its vertical axis is effected by means of a traversing rope which passes round a groove in the circumference of the wooden turntable (see Fig. 1). Both ends of this rope

pass over pulleys fixed to one of the horizontal edges of the top of the tower and thence descend to the ground.

Method of Operation

The direction finder to be tested is first erected on the ground at the correct distance from the foot of the tower to give the required angle of incidence. The orientation of the transmitting system is then adjusted by means of the traversing rope until the horizontal beam points in the direction of the receiver. The transmitter is hauled up into position after setting it to the correct

wavelength and switching it on. The aerial is then rotated to the required angle which may be measured from the ground by means

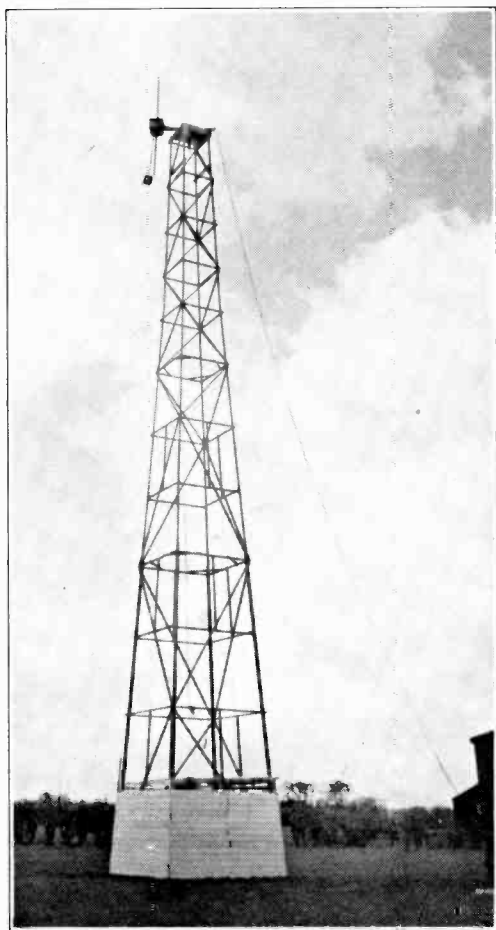

Fig. 4(a).—View of transmitter being hauled into position in its housing at the top of the tower.



Fig. 4(b).—Close-up view of transmitter, housing and dipole aerial.

of some simple sighting device or may be set to one of the pre-selected angles by means of the registering mechanism on the horizontal bearing already referred to.

It is usual in practice to take bearings on the two symmetrical positions of the aerial about the vertical giving the same polarisation angle and then to take half the total change in bearing as giving the true polarisation error. By this process site errors are eliminated as well as certain possible types of instrumental error in the direction finder.

Application of Apparatus

The apparatus is most frequently employed for measuring the polarisation error of a direction finder for various angles of inci-

dence and polarisation. In this case it must be assumed that the wave arriving at the receiver from the tower transmitter is similar in all important respects to a downcoming wave as received from a distant source. Unfortunately, this assumption is not rigidly true since owing to the proximity of the source the waves are not strictly plane at the receiver; also their rate of attenuation is such that there may be an appreciable difference in field strength between points whose distance apart is comparable with the dimensions of the receiving aerial system.

A large amount of experience with aerials of different sizes and on different wavelengths has shown, however, that where the distance of the source from the receiver is greater than two wavelengths, the assumption that the true polarisation error is being measured is substantially justified, while for distances considerably less than one wavelength the assumption does not hold good and the apparent polarisation error is greater than the true polarisation error. On a wavelength of 15 metres and below it is possible therefore to work with an angle of incidence of 45 deg. or less while still retaining the requisite distance of two wavelengths so that in such cases a direct determination of the standard wave error is possible. For longer wavelengths, however, the minimum angle of incidence will be greater than 45 deg. For $\lambda = 50$ metres, for example, the angle of incidence must be greater than about 75 deg. to fulfil these conditions. The standard wave error can be obtained in these

circumstances by applying a correction, depending on the law for the system connecting polarisation error with angle of incidence. An analysis of this law for various types of Adcock system has been given by the present author in a previous publication.*

Acknowledgments

The work described above was carried out for the Radio Research Board, and this paper is published by permission of the Department of Scientific and Industrial Research. The author desires to acknowledge the co-operation of Mr. F. E. Lutkin, who carried out the mechanical design work.

Radiolympia

THE National Radio Exhibition at Olympia, which closes on Saturday, September 3rd, provides an annual opportunity to review the progress made in the design of British broadcast and television receivers, components and laboratory and testing apparatus associated with the design and maintenance of receivers.

In the October issue of *The Wireless Engineer* it is hoped to include a technical survey of the Show with special emphasis on the apparatus and advances in design which will appeal to the radio engineer.

* *Journ. I.E.E.*, April 1935, Vol. 76, No. 460, pp. 423-447.

Book Reviews

Fundamentals of Engineering Electronics

By W. G. Dow. Pp. XIV + 604, with 200 Figs. Chapman and Hall, Ltd., 11, Henrietta Street, London, W.C. Price 25/-.

The author is a Professor of Electrical Engineering at the University of Michigan, and the volume under review is an outgrowth of courses of lectures which were introduced about eight years ago. Although it deals both with the internal behaviour of electronic devices and with circuit analysis, the former is the primary objective. According to the Preface, reasoning from purely physical concepts has been used rather than mathematical formulation, wherever the latter could be avoided without loss of definiteness. The first three chapters deal with the triode in a very thorough manner and in case anyone might be misled by what we quoted about mathematical formulation, we had better

say that a chapter is devoted very largely to con-formal transformations. Then follows a chapter on electron ballistics—a chapter of fundamental importance—followed by one on the cathode-ray tube in which these ballistics find a practical application. A chapter on space-charge flow leads up to one on triodes, tetrodes and pentodes. Several chapters are devoted to cathode phenomena, atomic layers, work functions, Maxwellian distribution, etc. Three chapters deal with amplifier circuit principles, class B and push-pull amplifiers and various types of oscillators. This concludes Part I, which has been mainly concerned with valves. Part II is entitled "Electrons, Atoms, and Radiation," and opens with two chapters on atomic energies and energy levels for particular elements, followed by two on photoelectric phenomena and electromagnetic waves. Subjects of great im-

portance in connection with the modern developments in rectifiers are dealt with in the last four chapters, the headings of which are, "Electric Arcs and Glow Discharges," "Plasma Boundary Regions," "Mercury-vapour Rectifiers," and "Single-phase Circuits containing Rectifying Elements." There is a very extensive bibliography both of text books and periodical literature. At the end of every chapter a number of problems are given suitable for class use. The author states that the book has been specially designed for use in a full-year course for undergraduate or graduate students, but we can hardly imagine an undergraduate course in electrical engineering into which so much electronics either could be or should be introduced. As a post-graduate course the book provides a feast of most excellent material, well arranged, very carefully and clearly explained and well illustrated. The book is conveniently divided into 285 sections. The author expresses the hope that the book will find a place as a reference work for engineers in industry; we feel sure that this hope will be realised as the book becomes known. G. W. O. H.

British Association Mathematical Tables. Vol. VI. Bessel Functions, Part I. Functions of orders zero and unity. Pp. 288 + XX. University Press, Cambridge. Price, 40/-.

Five volumes of various mathematical tables have been published by the British Association since 1931, but the present volume is in no sense a continuation of these. It represents the crowning accomplishment of a task first discussed fifty years ago, a task which has kept the Committee in being throughout most of this period, but it is only Part I of this accomplishment, and much remains to be done. The volume is inscribed to Professor Alfred Lodge by his colleagues on the Committee, but a subscript to the Preface records his death before its publication.

Bessel's equation for a real variable x is

$$x^2 \frac{d^2y}{dx^2} + x \frac{dy}{dx} + (x^2 - n^2)y = 0$$

One solution of this is denoted $J_n(x)$. If $n = 0$

$$J_0(x) = 1 - \frac{x^2}{2^2(1!)^2} + \frac{x^4}{2^4(2!)^2} \dots$$

whereas, if $n = 1$,

$$J_1(x) = \frac{x}{2} - \frac{x^3}{2^3(1!)2!} + \frac{x^5}{2^5(2!)3!} \dots$$

These are the functions of orders zero and unity, the values of which have been calculated to 11 decimal places for values of x from 0, 0.001, 0.002, and so on up to 24.98, 24.99, 25.00. This constitutes Table I and occupies 170 pages.

Table II gives the values of x for which either J_0 or J_1 passes through zero. Table III gives the values of the other solutions of the Bessel equation designated $Y_0(x)$ and $Y_1(x)$ which are also obtained by summing series; these are not given to the same accuracy as the J functions, but still to 9 decimal places. Table IV gives the zeros of the Y functions. Table V gives the values of auxiliary functions for use in calculating J and Y for large values of x . If the sign of x^2 in the coefficient of y in the Bessel equation is negative, the solutions are designated $I_0(x)$ and $I_1(x)$; these are tabulated in Table VI. Tables VII to X give various auxiliary functions, coefficients, asymptotic series, etc.

A list is given of errors discovered in various published tables, a bibliography of which is given. Great care has been taken and it is stated that "there is every reason to believe that the tables are completely free from error." "It is a striking testimony to the painstaking skill of the compositors and readers at the Cambridge University Press that not a single compositor's error was found in 280 pages of tables, or just under a million figures. No praise can be too high for perfect work such as this." In reviewing the work as a whole we would re-echo this final sentence. G. W. O. H.

THE publishers of *The Wireless Engineer*, Iliffe and Sons Ltd., have just issued new editions of two well-established handbooks. They are: **Wireless Servicing Manual**, by W. T. Cocking, now in its fourth edition, and the third edition of R. Keen's manual, **Wireless Direction Finding**. Cocking's servicing manual, price 5/-, which is a reliable, practical guide on servicing for both amateur and professional, has been revised and enlarged by some 50 pages. For many years Keen's manual, which costs 25/-, has been regarded as the standard work on direction-finding, and the new edition, which contains 800 pages and 500 illustrations, has been thoroughly revised and much new matter included.

The **Radio Laboratory Handbook**, by M. G. Scroggie, B.Sc., A.M.I.E.E., which has just been published by Iliffe and Sons Ltd., at 8/6, is the only authoritative handbook on the equipment of a wireless laboratory. It should be particularly valuable to students and teachers in technical colleges for, although it covers all that is necessary for advanced work and should, therefore, appeal to laboratory engineers, a high degree of previous knowledge is not assumed.

Correspondence

Television I.F. Amplifiers

To the Editor, *The Wireless Engineer*.

SIR.—In his article entitled "Television I.F. Amplifiers," Mr. Cocking develops an equation (7) for the gain of a stage incorporating a pair of coupled, parallel-damped, tuned circuits, namely

$$A = \frac{gxyk\sqrt{R_1R_2}}{\sqrt{\{(1-x^2)^2 - x^2y^2(1-k^2) - x^4k^2\}^2 + 4x^2y^2(1-x^2+x^2k^2)^2}} \dots (a)$$

If this equation is differentiated with respect to x and the differential coefficient so found be equated to zero, an equation of the eighth degree in x is formed; the substitutions $u = 1 - k^2$, and $v = x^2$ reduce this to the quartic

$$3v^4u^2 - 4v^3(2u - u^2v^2) + v^2\{(2 + uv^2)^2 + 2u(1 - 4v^2)\} - 1 = 0 \dots (b)$$

among the roots of which are the values of v (and hence of x) at which the troughs and the peaks occur in the response-frequency curve.

The solution of this equation yields the following results:—

Trough.

$$x = \sqrt{\frac{1}{2} \left\{ \frac{1}{3} \left(\frac{2}{u} - y^2 \right) + \sqrt{\frac{1}{9} \left(\frac{2}{u} - y^2 \right)^2 + \frac{4}{3u}} \right\}} \dots (c)$$

Peaks.

$$x = \sqrt{\frac{1}{2} \left\{ \left(\frac{2}{u} - y^2 \right) \pm \sqrt{\left(\frac{2}{u} - y^2 \right)^2 - 4} \right\}} \dots (d)$$

From (d) the condition for the existence of two peaks is

$$y \leq \sqrt{\frac{1}{2} \left(\frac{1}{u} - \frac{1}{\sqrt{u}} \right)} \dots (e)$$

At the critical value of damping given by (e) the maximum response occurs at

$$x = u^{-\frac{1}{2}} = (1 - k^2)^{-\frac{1}{2}} \dots (f)$$

When $y = 0$, i.e., when the circuits are undamped, the results are:—

Trough.

$$x = \sqrt{\frac{1}{3u} (1 + \sqrt{1 + 3u})} \dots (g)$$

Peaks.

$$x = (1 \pm k)^{\frac{1}{2}} \dots (h)$$

Equation (g) is rather interesting, showing that the influence of coupling is to move the trough from $x = 1$.

Comparison of these equations with those given in the article shows that subsequent to equation (7) Cocking's results are in error.

L. JOFEH,
Television Research Department,
A. C. Cossor, Ltd.
London, N.5.

does not appear possible. I accordingly adopted what may be called a graphical method which is fully explained in the article and which does give a very simple solution of the problem. It is admittedly not an exact method, since it involves interpolation from the curves given, but it is sufficiently accurate for practical purposes, the errors involved being far smaller than the deviations introduced into a practical amplifier by stray couplings, especially those which lead to regeneration.

Mr. Jofeh's solutions of my equation (7) for the peak and trough frequencies when the coupling is greater than optimum are extremely interesting and will be useful to those desiring to make use of this condition. In my article I did not envisage the use of appreciable overcoupling, for a considerable experience of it in many types of apparatus has led me to the belief that it is an unsatisfactory condition. In general, with most types of coupled circuits equal peak height is only secured when both circuits are tuned precisely to the same frequency or both circuits are equally damped. It is possible to satisfy neither condition in practice with sufficient accuracy to give equal peak heights and to maintain this equality over a long period, because of the instability of components and the effects of regeneration. I am, of course, speaking of ordinary apparatus and not equipment built to laboratory standards.

In conclusion, I agree that my solutions are not precise, but I submit that the errors involved in the approximations are negligibly small.
London, N.14. W. T. COCKING.

SIR,—I do not agree that the results following equation (7) in my article "Television I.F. Amplifiers" are in error, as stated by Mr. Jofeh, but I would be the first to admit that they are approximate. A precise solution of the circuit equations in a sufficiently simple form for the determination of circuit values to give a required performance

On the Behaviour of Resistors at High Frequencies

To the Editor, *The Wireless Engineer*.

SIR,—I have read with great interest Mr. Hartshorn's article on "The Behaviour of Resistors at High Frequencies," published in the July, 1938, issue of *The Wireless Engineer*.

The experimental confirmation of Prof. Howe's theory, as set forth in the Editorial of the June, 1935, number of your journal, is truly striking. I am of the opinion that this theory could be used in a still more advantageous manner.

By adopting Mr. Hartshorn's notation the ratio R'/R can be calculated according to Howe's theory as a function of the parameter $f.C_d.R$. C_d is the total distributed capacitance which takes into account the distributed capacitance $l.C$ (according to Howe) and the capacitance of the various elements of the resistor with respect to neighbouring objects. To find C_d , Mr. Hartshorn relies in part on capacitance measurements and in part on calculations of various kinds. As the capacitances concerned are fairly small it is obvious

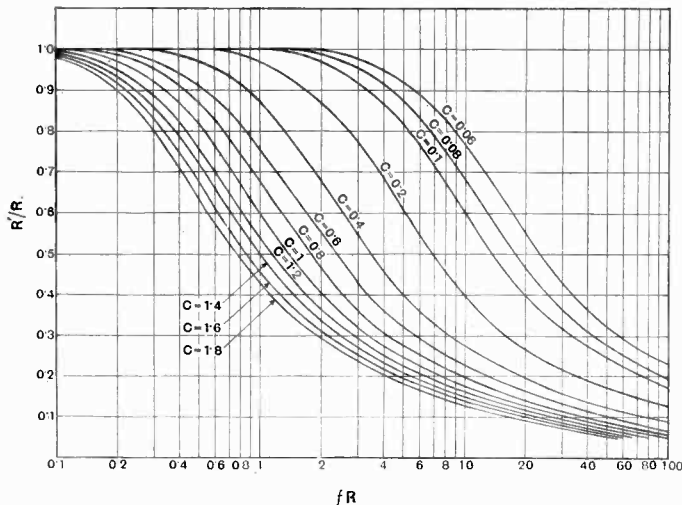

Fig. 1.

that these measurements and calculations are somewhat delicate.

The ratio R'/R , calculated according to Howe's method, can be plotted against the parameter $f.R$ instead of $f.C_d.R$, giving a series of curves each of which is valid for a given value of C_d . This has been done in Fig. 1, in which the capacitances are expressed in $\mu\mu F$, the frequencies in Mc/s and the resistances in $M\Omega$.

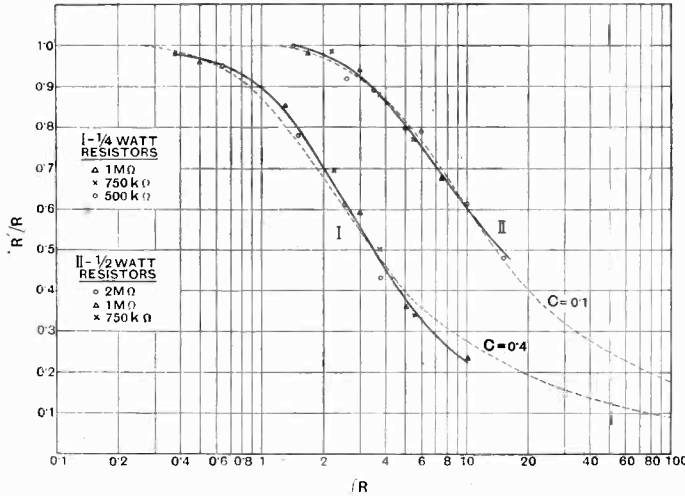

Fig. 2.
(Right) Fig. 3.

Let us now suppose we have a series of resistors having the same distributed capacitance C_d . On measuring the ratio R'/R for different values of the parameter $f.R$, the various measured values of R'/R , if Howe's theory holds good, should lie along a single curve corresponding to the capacitance C_d . If this operation gives good results we have:

- (1) An experimental proof of Howe's method;
- (2) A method for finding, solely by means of measurements of resistance, the distributed capacitance of the resistor.

By good fortune I have at this moment at my disposal the results of a series of measurements systematically made on the resistors to be found at present on the market in Italy, for frequencies up to 7.5 Mc/s. These data will shortly be published by Mr. Bressi, of this laboratory, to whom I am grateful for having kindly placed them at my disposal. I have thus been able to construct diagrams of the type of those in Figs. 2 and 3.

Each curve is obtained from measurements on resistors of different nominal value, but of the

same make, of the same type and of equal heat dissipating capacity. The data obtained from the diagrams and those relative to the geometric measurements of the resistors are set out in the table below.

The different resistors in a set have different windings: as they follow sufficiently closely the theoretical curves it may be deduced that the type of winding has but little influence on the behaviour, at least for the values of the parameter $f.R$ on which the experiments were made.

But it rests confirmed that the essential datum is the total distributed capacitance C_d dependent essentially on the geometric dimensions.

Many other observations of practical interest for the improvement of these resistances may be deduced from the systematic construction of curves of the type described.

I would not neglect to mention that it happens that an anomalous resistor having a capacitance different from that of the type to which it belongs is sometimes met with. An example, not very accentuated, is the resistor 2 MΩ of Fig. 3.

Turin. PAOLO PONTECORVO,
Istituto Elettrotecnico Nazionale
"Galileo Ferraris."

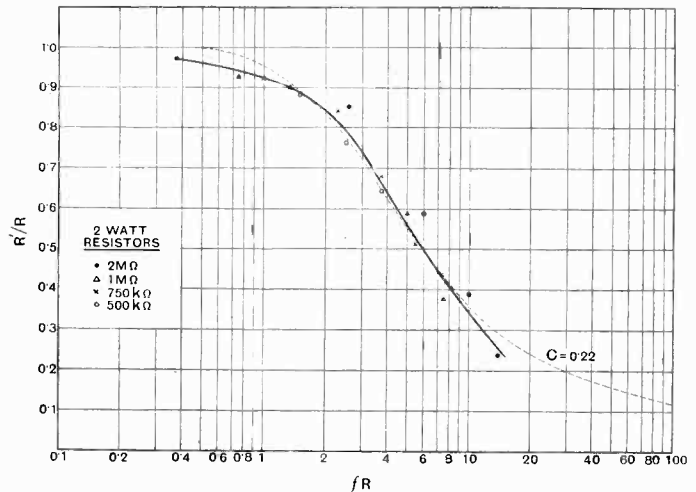

	$2l$ (cm).	d (cm).	$2l/d$	C_d ($\mu\mu F$).	C_d/l ($\mu\mu F/cm$)
$\frac{1}{4}$ W	0.6	0.44	1.36	0.4	1.34
$\frac{1}{2}$ W	2.1	0.44	4.8	0.1	0.096
2 W	2.9	0.95	3.05	0.22	0.152

Abstracts and References

Compiled by the Radio Research Board and reproduced by arrangement with the Department of Scientific and Industrial Research

For the information of new readers it is pointed out that the length of an abstract is generally no indication of the importance of the work concerned. An important paper in English, in a journal likely to be readily accessible, may be dealt with by a square-bracketed addition to the title, while a paper of similar importance in German or Russian may be given a long abstract. In addition to these factors of difficulty of language and accessibility, the nature of the work has, of course, a great influence on the useful length of its abstract.

	PAGE		PAGE
Propagation of Waves	502	Directional Wireless	516
Atmospherics and Atmospheric Electricity	505	Acoustics and Audio-Frequencies	517
Properties of Circuits	505	Phototelegraphy and Television ...	519
Transmission	507	Measurements and Standards ...	522
Reception	510	Subsidiary Apparatus and Materials	524
Aerials and Aerial Systems ...	513	Stations, Design and Operation ...	526
Valves and Thermionics	514	General Physical Articles	527
		Miscellaneous	527

PROPAGATION OF WAVES

3445. A NOTE ON CERTAIN GUIDED WAVES IN SLIGHTLY NON-CIRCULAR TUBES [Theory: Attenuation Constants first Diminish and then Increase Indefinitely with Increasing Frequency].—S. A. Schelkunoff. (*Journ. of Applied Physics*, July 1938, Vol. 9, No. 7 pp. 484-488.)
3446. RADIO-INTERFEROMETRY WITH MICRO-WAVES EXPERIMENTS ON LAKE ALBANO.—A. Lo Surdo, E. Medi, & G. Zanotelli. (*La Ricerca Scient.*, 15th/31st May 1938, Series 2, 9th Year, Vol. 1, No. 9/10, pp. 475-483.)
- Authors' summary:—"The present research yields, for the first time, an interferometric method with micro-waves which is completely similar to the optical analogy. In the conditions of the test (which are susceptible of improvement) it is possible to make evident a variation of velocity of 1/200 000 [or a corresponding variation in the length of the "optical" path]; that is, when referred to the velocity in a vacuum, a variation of 1.5 km/s." Distances across the lake ranged between about 2000 and 3000 metres, so that with the wavelength of 15.2 cm employed the path might amount to as much as 20 000λ. The transmitter and receiver were provided with cylindrical parabolic reflectors. The interferometer mirror was represented by the surface of the lake, which is well screened from the wind by its position in a volcanic crater. The transmitter was at a height of 193-111 m above the surface of the water, while the receiver height ranged from 193 m to almost zero.
- The writers conclude: "The strength of reception and the clearness of the fringes obtained in our experiments have shown the certainty that this method can be applied to still longer optical paths, with increased sensitivity, when the topographical conditions are favourable." The possible application of the method to the study of the propagation of radio waves in the atmosphere is mentioned.
3447. STABILITY OF TWO-METRE WAVES [Year's Continuous Records over 60-km Path (Lawrenceville/Deal) show Fading up to 20 db, contrary to Usual Belief that U-S-W Fading occurs only when Attenuation is Large: Several Types of Fading: More Pronounced Fading, and Tendency towards Higher Fields, at Night (Max. Fields around 10 p.m.): Halving the Path reduces Fading Range in Db to One Fifth: Agreement with Authors' Previous Formula: etc.].—Burrows, Decino, & Hunt. (*Proc. Inst. Rad. Eng.*, May 1938, Vol. 26, No. 5, pp. 516-528.)
3448. A STUDY OF ULTRA-HIGH-FREQUENCY WIDE-BAND [Television] PROPAGATION CHARACTERISTICS [81-86 and 140-145 Mc/s Transmissions from Empire State Building: Comparison of Vertical, Horizontal, and Circular Polarisation: etc.].—R. W. George. (*Proc. Inst. Rad. Eng.*, June 1938, Vol. 26, No. 6, pp. 666: summary only.)
3449. PROPOSED SOC. DES RADIOÉLECTRICIENS TESTS ON PROPAGATION OF ULTRA-SHORT WAVES, BY BALLOON CARRYING SEVERAL TRANSMITTERS WORKING ON 4-8 m WAVES.—Bedeau & David. (*L'Onde Elec.*, June 1938, Vol. 17, No. 198, p. 321.)
3450. AN ULTRA-SHORT-WAVE TELEPHONE SERVICE OVER 145 KILOMETRES.—Bell Tel. Laboratories. (*See 3786.*)
3451. CHANGES IN THE TRANSMISSION CONDITIONS OF A LIMITING WAVE (10 m) IN THE YEARS 1935-1937.—E. Fendler. (*Hochf. tech. u. Elek. akus.*, July 1938, Vol. 52, No. 1, pp. 18-23.)
- For previous work see Burkård, 1281 of April. Reception in Germany of signals on wavelengths 10-10.71 m during the years 1935-1937 is here described. The times at which reception was

possible from North America, Europe, and the Southern Hemisphere are shown diagrammatically in Figs. 2, 3 and 4-6 respectively. In general, it is found that in summer communication was only possible for distances between 600 and 1500 km; for transoceanic traffic 10 m transmission appears to be governed by the F_2 region, whereas European communication is made possible in summer by increased density of ionisation in E_1 region (Fig. 7). Several phenomena indicate ionisation increase in all regions from 1935 to 1937.

3452. LIMITING WAVES [around 10 m] AND THE IONOSPHERE: II.—O. Burkard. (*Hochf. tech. u. Elek. akus.*, July 1938, Vol. 52, No. 1, pp. 23-26.)

For previous work see 1281 of April. In the present paper, observations of the "Dellinger effect" on 8.2.36, 14.2.36, 8.4.36, are discussed with particular reference to the changes in the number of received signals on limiting waves, their audibility and range. Data are given in Table 1; the results are shown in graphical form (Figs. 2-6) and a curve of the normal daily variation is given for comparison (Fig. 1). It is found that before the fade-out more signals are received than normally; there is then a quick drop and after about 20 min. a rise to traffic density above normal. A period of about half an hour in the subsequent decrease of traffic density is indicated (Fig. 4). No change in the range of the received stations is noted; the increased ionisation of the Dellinger effect seems to be wholly in the E region, while the F region remains unaffected.

3453. THE APPLICATION OF MAXIMUM-USABLE-FREQUENCY GRAPHS [as published monthly in *Proc. I.R.E.*] TO COMMUNICATION PROBLEMS.—Smith, Kirby, & Gilliland. (*Proc. Inst. Rad. Eng.*, June 1938, Vol. 26, No. 6, p. 673: summary only.)

3454. AN INVESTIGATION OF THE PROPAGATION OF SHORT WAVES OVER THE PATH MOSCOW/TOMSK.—N. D. Bulatov. (*Izvestiya Elektrom. Slab. Toka*, No. 5, 1938, pp. 41-43.)

From November 1936 to March 1937 observations were kept of the reception in Tomsk of short impulses (50 impulses per second, of 10^{-4} sec. duration each) transmitted from Moscow on wavelengths from 24 m to 60 m. A large number of oscillograms of received impulses are shown and these serve as a basis for a discussion of short-wave transmission over long distances.

The main conclusions reached are as follows:—(1) The most important factor determining the possibility of short-wave transmission over long distances is the critical frequency of layer F_2 ; this should be taken into consideration in allotting the operating frequencies of radio transmitters. (2) For a given distance and time of transmission, account should be taken of the number of possible reflections and of the height of the reflecting layer; the angle of radiation of the transmitting aerial should be chosen accordingly. (3) At the receiving station,

distortion can be considerably reduced by the use of special aeriels.

3455. THE EFFECT OF THE ELEVEN-YEAR SUNSPOT CYCLE ON SHORT-WAVE COMMUNICATION [as indicated particularly by Behaviour (1928-1937) of 16 m Wave on Indian Beam Circuit to London, depending on Changes in F_2 Electron Density].—K. W. Tremellen. (*Marconi Review*, July/Sept. 1938, No. 70, pp. 43-44.)

3456. DEVIATIONS OF SHORT RADIO WAVES FROM THE LONDON/NEW-YORK GREAT-CIRCLE PATH.—C. B. Feldman. (*Proc. Inst. Rad. Eng.*, June 1938, Vol. 26, No. 6, pp. 664-665: summary only.) See also 2181 of June.

3457. RESULTS OF A THEORY OF THE PROPAGATION OF ELECTROMAGNETIC WAVES OVER A SPHERE OF FINITE CONDUCTIVITY.—B. van der Pol & H. Bremmer. (*Hochf. tech. u. Elek. akus.*, June 1938, Vol. 51, No. 6, pp. 181-188.) Summarising account of work dealt with in 3102 of August and back references, with curves showing numerical results.

3458. ATTENUATION AND GROUP RETARDATION IN THE IONOSPHERE [Calculations from the Appleton-Hartree Formula].—G. Millington. (*Proc. Phys. Soc.*, 1st July 1938, Vol. 50, Part 4, No. 280, pp. 561-580.)

From the author's summary:—"Expressions are derived from the Appleton-Hartree formula for the specific attenuation and group velocity at any given height, in a layer with a vertical electronic gradient, for a wave of any given frequency at vertical incidence in the presence of an oblique magnetic field. They are then used to study the over-all attenuation and group retardation of a wave which either is reflected from the layer, or penetrates through it to be returned from a denser layer above," a definite type of layer being assumed. "The analysis shows that . . . the attenuation and group delay for a wave near to the critical escape frequency occur mainly in the region of maximum density in the layer, and also justifies the use of absorption and equivalent-height measurements to deduce an estimate of the collisional frequency of the electrons in this region. The problem is worked out in detail for one frequency for the extraordinary wave . . . and for a parabolic and a sine-squared law of electronic density. The work falls into four main sections: (a) the derivation of the integrals from the Appleton-Hartree formula; (b) the effect of the type of the layer on the form of the integrals; (c) the application of a graphical method of integration, involving the initial transformation of the integrals to a form in which they can be accurately evaluated; (d) the detailed working out of a numerical example, with a discussion of the general conclusions to be drawn from it." [The absorption coefficient is assumed to be so small that powers

above the first can be everywhere neglected; the Lorentz polarisation term is taken to be zero.]

3459. ABSORPTION OF RADIO WAVES IN THE IONOSPHERE [Investigation of Elastic Collisional Processes in Light of Quantum Mechanics: Disagreement with Majumdar's Conclusions].—B. B. Ray. (*Sci. & Culture*, Calcutta, June 1938, Vol. 3, No. 12, pp. 679-682.)

From his results (1289 of April: see also 3121 of August) Majumdar argues that the F layer is completely ionised and that collisions in the E layer are also between electrons and ions, the positive ion density there being (because of electron-attachment to neutral molecules) about 100 times that of the electrons. On this last assumption the collisional frequency becomes 8×10^4 for the E layer and agrees, in order of magnitude, with the experimental value. The present writer, however, shows that the collision frequency calculated quantum-mechanically, on the assumption of encounters between electrons and neutral molecules, is of the same order of magnitude as that calculated by Majumdar on the assumption of encounters between electrons and ions only. "The question arises which of the two collisional processes is actually responsible for the absorption of the radio waves in the E layer. If we examine the assumptions on which Majumdar bases his calculations, we find that the reason of his obtaining the very large value of the collisional cross-section of the ions (so high in fact that it outweighs the effect of the number of neutral molecules exceeding that of the ions by a factor of the order of 10^6) lies in his simplifying assumptions regarding the ionic field," which "agrees rather too closely to the coulomb field. It is of course to be expected that the probability of elastic collision between electrons and positive ions will be larger than that between electrons and neutral molecules; but the ratio between the two cannot be so high as 10^6 as is demanded by Majumdar's hypothesis. It therefore seems reasonable to conclude that . . . the absorption of radio waves at least in the E layer is due primarily to elastic collision between electrons and neutral molecules."

3460. PROPAGATION OF WAVE-PACKETS IN A STRATIFIED DOUBLY-REFRACTING IONOSPHERE.—H. G. Booker. (*Science*, 13th May 1938, Vol. 87, p. 426: Nat. Ac. of Sci. Meeting, Washington: summary only.)

See also 1286 of April. "The level of reflection of the magneto-ionic component is the level where the wave-packet as a whole is travelling horizontally, and is given by the condition that the root of the quartic equation for q corresponding to the upgoing magneto-ionic component should be equal to a root corresponding to a downcoming magneto-ionic component. The critical electron-density required for reflection of a magneto-ionic component can easily be as much as 25% in excess of the erroneous value which would be calculated by putting the angle of refraction equal to $\pi/2$ in Snell's Law."

3461. ON THE TOTAL REFLECTION OF ELECTROMAGNETIC WAVES IN THE IONOSPHERE [treated by an Application of the "Method of Characteristics" (Hadamard, Debye) to Lorentz Microscopic Equations, instead of by Usual Application of Maxwell's Equations with Simplifying Assumptions (Doubtfully Valid) of Zero Refractive Index and Negligible Damping].—S. N. Bose. (*Indian Journ. of Phys.*, April 1938, Vol. 12, Part 2, pp. 121-144.) The method of treatment is applicable also to the propagation of light in a material medium.
3462. CHARACTERISTICS OF THE IONOSPHERE AT WASHINGTON, D.C., MARCH, 1938 [During Day (All Seasons) F₁ and F₂ Layers exist as Two Types of Ionisation, or Ionisation from Two Different Sources, requiring only Physical Separation to make them Manifest: at Night, F Region consists of only One Layer, involving only One Type of Ionisation, even during Ionosphere Storm].—Gilliland & others. (*Proc. Inst. Rad. Eng.*, May 1938, Vol. 26, No. 5, pp. 640-643.) This regular feature will not be referred to in future Abstracts except for special reasons.
3463. THE IONOSPHERE AT HUANCAYO, PERU, NOVEMBER AND DECEMBER, 1937 [investigated by Continuous Operation of Apparatus covering 16 Mc/s to 0.516 (at first only 3.3) Mc/s].—H. W. Wells & H. E. Stanton. (*Terrest. Magnetism*, June 1938, Vol. 43, No. 2, pp. 169-171.)
- It is proposed to publish ionospheric data in this form each quarter. In the present paper, "evidence of predominance of free electrons over ions at the level where the waves penetrate the E region is presented by magneto-ionic double refraction. Both doubly-refracted wave-components are recorded in the morning between 5^h and 8^h, and in the evening between 16^h and 20^h. The normal frequency difference between the two wave-components is approximately 420 kc, which is in close agreement with calculated values based upon the intensity of the Earth's magnetic field and neglecting effects of heavy ions. This indicates that the number of heavy ions does not exceed the number of electrons by more than 100 times and may be appreciably less during the above-mentioned intervals."
3464. STUDIES ON THE IONOSPHERE AT ALLAHABAD [Various Types of Reflection: Diurnal Variation of Electron Density: Occasional Unusual Condition for Reflection of Extraordinary Wave].—B. D. Pant & R. R. Bajpai. (*Proc. Roy. Soc.*, Series A, 7th July 1938, Vol. 167, No. 928, p. S 78: abstract only.)
3465. MAGNETIC AND IONOSPHERIC STORMS [Relationship between the Severe Magnetic Storm of 16th April 1938 and the Disturbances of Radio Propagation].—T. W. Benington. (*Wireless World*, 23rd June 1938, Vol. 42, pp. 564-565.)

3466. DISCUSSION OF S. CHAPMAN'S NOTE ON RADIO FADE-OUTS AND THE ASSOCIATED MAGNETIC VARIATIONS.—J. H. Dellinger: Chapman. (*Terrest. Magnetism*, June 1938, Vol. 43, No. 2, p. 179.) See 2195 of June.
3467. DISTURBANCES OF THE IONOSPHERE AND OF THE PROPAGATION OF WAVES DURING THE GREAT AURORAL DISPLAY OF 25TH JANUARY, 1938.—B. Beckmann. (*Funktech. Monatshefte*, June 1938, No. 6, pp. 185-189.) For the full paper on these observations see 2669 of July: cf. also 3112 of August, for Herzogstand observations.
3468. THE AURORA BOREALIS AND DIRECTION-FINDING.—German Aeronautical Research Establishment. (See 3635.)
3469. POSSIBLE PRESENCE OF METASTABLE ATOMS OF NITROGEN (^{2}P) IN THE HIGH ATMOSPHERE [Spectrum of Diffuse Aurora shows Intense Sharp Line at 3470 A.U., probably due to Atomic Nitrogen: Mechanism of Excitation in Aurora probably in Two Stages (1) Electronic Bombardment, (2) Afterglow].—R. Bernard. (*Nature*, 25th June 1938, Vol. 141, p. 1140.)
3470. A NEW NITROGEN LINE [3471 A.U.: Related in Intensity Variations with Vegard-Kaplan Bands: Light of Night Sky may be emitted in Lower Regions of Upper Atmosphere].—J. Kaplan. (*Nature*, 25th June 1938, Vol. 141, pp. 1139-1140.)
3471. THE BRIGHTNESS OF THE TWILIGHT SKY AND THE DENSITY AND TEMPERATURE OF THE ATMOSPHERE.—E. O. Hulbert. (*Journ. Opt. Soc. Am.*, July 1938, Vol. 28, No. 7, pp. 227-236.)
3472. SOUNDING THE ATMOSPHERE BY A LUMINOUS RAY: II [Suggested Method subjected to Simple Tests, using Philips "Philora" High-Pressure Mercury Lamp and Parabolic Mirror].—J. Duclaux. (*Journ. de Phys. et le Radium*, June 1938, Series 7, Vol. 9, No. 6, pp. 259-261.) For the original suggestion see 861 of 1937.
3473. PRELIMINARY REPORT ON A RADIOMETRIC METHOD OF MEASURING ULTRA-VIOLET SOLAR INTENSITIES IN THE STRATOSPHERE [by Exploring Balloons: practically No Ozone below 14 km, 15-30% below 19 km: etc.].—Coblentz & Stair. (*Science*, 13th May 1938, Vol. 87, p. 426: summary only.)
3474. EXPERIMENTAL METHOD FOR COMPARISON OF THE ABSORPTION OF LIGHT BY THE LOWER ATMOSPHERE AND BY THE WHOLE ATMOSPHERE.—A. & E. Vassy. (*Comptes Rendus*, 20th June 1938, Vol. 206, No. 25, pp. 1893-1895.)
3475. THE ALTITUDE OF THE ATMOSPHERIC LAYER WHERE D LINES ARE EMITTED: THE ORIGIN OF SODIUM ATOMS PRESENT IN THIS LAYER [Upper Limit of Layer about 60 km: Sodium may come from Seas or Volcanic Eruptions].—G. Déjardin & R. Bernard. (*Comptes Rendus*, 4th July 1938, Vol. 207, No. 1, pp. 81-83.)
3476. CORONA EFFECT UPON TRAVELLING-WAVE PHENOMENA [Effect, on Fundamental Equations, of Increase of Effective Diameter by Corona Formation and Increase of G by Corona Loss].—S. Hayashi. (*Electrot. Journ.*, Tokyo, July 1938, Vol. 2, No. 7, p. 172.)
3477. TRANSMISSION LINE TRANSIENTS [recorded] IN MOTION PICTURES [and Voltage-Distance-Time Models].—L. F. Woodruff. (*Elec. Engineering*, July, 1938, Vol. 57, No. 7, pp. 391-400.)
3478. A NOTE ON LONGITUDINAL WAVES IN DEGENERATE GAS [and an Estimation of Central Density of Earth from Velocity of Seismic Waves].—F. C. Auluck. (*Sci. & Culture*, Calcutta, June 1938, Vol. 3, No. 12, p. 682.)

ATMOSPHERICS AND ATMOSPHERIC ELECTRICITY

3479. "DER SCHUTZBEREICH VON BLITZABLEITERN" [Protective Range of Lightning Conductors: Book Review].—A. Schwaiger. (*Electrician*, 15th July 1938, Vol. 121, p. 70.)
3480. LUNAR DIURNAL VARIATION IN EARTH-CURRENTS AT HUANCAYO AND TUCSON.—W. J. Rooney. (*Terrest. Magnetism*, June 1938, Vol. 43, No. 2, pp. 107-118: in English.)
3481. THE VARIATION OF THE ELECTRICAL CONDUCTIVITY OF THE ATMOSPHERE WITH HEIGHT [from Aeroplane Measurements up to about 16 000 ft: Positive and Negative Conductivities are equal between 1000 and 10 000 ft, Negative greater than Positive at Higher Altitudes: the Question of a Connection between Precipitation and High Potential Gradient: etc.].—D. C. Rose. (*Canadian Journ. of Res.*, June 1938, Vol. 16, No. 6, Sec. A, pp. 107-130.)
3482. THE ELECTRIC CHARACTERISATION OF DAYS AT THE HUANCAYO MAGNETIC OBSERVATORY FOR THE TWELVE YEARS 1925-1936.—O. W. Torreson. (*Terrest. Magnetism*, June 1938, Vol. 43, No. 2, pp. 149-153.)
3483. TERRESTRIAL MAGNETIC ACTIVITY: V—1935 AND 1936, WITH PRELIMINARY VALUES TO MARCH 1938 [and Discussion of Recent Sharp Increase].—J. Bartels. (*Terrest. Magnetism*, June 1938, Vol. 43, No. 2, pp. 131-134: in German, with English summary.)

PROPERTIES OF CIRCUITS

3484. INDUCTIVE COUPLING AT ULTRA-SHORT WAVELENGTHS [the Error of using Too Large Coil Diameters: Investigations with 3/8 Inch Diam. Coils: Frequency Changes due to Close Coupling].—A. Binneweg, Jr. (*Communications*, June 1938, Vol. 18, No. 6, pp. 24 and 35.)

3485. CONCENTRIC NARROW - BAND - ELIMINATION FILTER [for Ultra-Short Waves: Transmission Line used in New Way (not merely as Reactive Elements)—Standing Waves utilised: gives Simultaneous Transmission & Reception on Same Aerial for Police-Communication Systems: Special Form ($\lambda/4$ Line shortened by 0.065λ and tuned to Antiresonance by Shunt Capacitor) suitable for Tank Circuits requiring High Driving-Point Impedance: etc.].—L. M. Leeds. (*Proc. Inst. Rad. Eng.*, May 1938, Vol. 26, No. 5, pp. 576-589.)
3486. EQUIVALENT PARAMETERS OF RESONANT LINES.—Neimann. (*See* 3509.)
3487. TO WHAT EXTENT CAN THE DAMPING IN AN AUDION CIRCUIT BE ELIMINATED BY RETRO-ACTION?—Kautter. (*See* 3543.)
3488. THE REPRESENTATION OF TCHEBICHEFF FUNCTIONS OF ANY ORDER BY MEANS OF LISSAJOUS' FIGURES.—Blaum. (*See* 3808.)
3489. AN OPERATIONAL TREATMENT OF NON-LINEAR DYNAMICAL SYSTEMS [Application of Laplacian Transform, hitherto used for Linear Systems, to the Non-Linear Case: the Calculation of Free and Forced Vibrations].—L. A. Pipes. (*Journ. Acoust. Soc. Am.*, July 1938, Vol. 10, No. 1, pp. 29-31.)
3490. FREQUENCY DIVISION BY VALVE GENERATORS AND RELAXATION-OSCILLATION GENERATORS ["Kippgeneratoren"].—E. Hudec. (*TFT*, May 1938, Vol. 27, No. 5, pp. 185-191.)
 Author's summary:—Frequency division can be accomplished by the control of a "kipp" generator or of a valve generator. Whilst forced "kipp" oscillations have been investigated very thoroughly and precise data have been given for the design of their circuits, for forced valve-oscillations only the fundamental possibility of frequency division has been shown, for the case, unimportant in practice, of a weak back-coupling (Winter-Gunther, 1931 Abstracts, p. 265). In the present paper, the conditions for synchronisation between control frequency and divided frequency are drawn up, providing a basis for the calculation of strongly back-coupled valve generators applicable to frequency division. At the end, the forced valve oscillations are compared with the forced "kipp" oscillations, and dividing limits are placed on their respective fields of use.
 The paper is made up of the following parts: (1) the natural frequency of a valve generator, (2) the course of the anode and grid currents and voltages for strong back-coupling, (3) the control of a self-excited valve generator by a frequency which is a whole multiple of the natural frequency, (4) the synchronisation of the valve generator when the control frequency departs from a whole multiple of the natural frequency, (5) the region of synchronisation, and (6) comparison of the forced valve oscillations with the forced "kipp" oscillations [and the superior constancy of the former—if designed on the lines indicated in (5)—in the face of variations of voltages and valve constants].
3491. FREQUENCY DEMULTIPLICATION AND MULTIPLICATION.—R. Golicke. (*E.N.T.*, May 1938, Vol. 15, No. 5, pp. 134-145.)
 Circuits are here described which serve to multiply and demultiply control frequencies. § I deals with frequency demultiplication by "kipp" circuits with one valve, which are synchronised by the frequency to be demultiplied so that their own natural frequency becomes the desired fraction of this frequency. Fig. 1 shows a "kipp" circuit with a glow lamp, Fig. 2 one with a double-grid valve, Fig. 3 one with a multiple-grid valve (pentode or hexode). Circuits with modulation retroaction (Fig. 5, 9) are designed to make the synchronisation reliable and independent of the demultiplication ratio. These circuits may also be used for the demultiplication of variable frequencies. § II gives circuits for frequency multiplication by distortion of a fundamental oscillation to produce the desired overtones in preference to the unwanted ones. Damped oscillations may be used whose natural frequency is near that of the required multiplied frequency and which are switched on and off in step with the fundamental oscillation. Fig. 11 shows a circuit with the a.c. voltage (whose frequency is to be multiplied) on the anode. The conditions required for successful working are discussed and compared with similar phenomena in the super-regenerative receiver. Fig. 13 gives a circuit for frequency multiplication and heterodyne. In § III (circuit Fig. 19) a "very accurate" heterodyne frequency meter is described, "in which all frequencies from 20 kc/s to 25 Mc/s are obtained by demultiplication and multiplication of a control frequency of about 200 kc/s, variable by 1%."
3492. CURRENT CIRCUITS WITH CAPACITY VARIABLE WITH TIME [Graphical Method for Circuit with Constant Ohmic Resistance, D.C. Voltage, and Linearly-Varying Capacity: Extension to Any Type of Capacity Variation].—H. Ziegler. (*Arch. f. Elektrot.*, 10th June 1938, Vol. 32, No. 6, pp. 405-418.)
3493. THEORY OF THE BOUCHEROT CIRCUIT [transforming Constant-Voltage System into Constant-Current System: Effect of Saturated Choke Coil on Characteristics: Numerical-Graphical Method].—G. Hauße. (*Arch. f. Elektrot.*, 10th June 1938, Vol. 32, No. 6, pp. 398-400.)
3494. RECTIFIER FILTER DESIGN [Low-Pass "L" Section Smoothing Filters (for Receivers and Transmitters) for Single-Phase Full Wave, Single-Phase Full Wave Bridge, Three-Phase Half Wave, & Other Systems].—H. J. Scott. (*Electronics*, June 1938, Vol. 11, No. 6, pp. 28-30.)
3495. BAND-PASS EFFECT IN WAVE-FILTERS TERMINATED BY NEGATIVE RESISTANCES.—S. P. Chakravarti. (*Phil. Mag.*, July 1938, Series 7, Vol. 26, No. 173, pp. 173-186.)
 Experiments are described relating "to the 'band-pass' effect obtained when symmetrical low-pass and high-pass filter sections are terminated by stable negative resistances of magnitude equal to their maximum characteristic impedances in the transmission band. The cut-off frequencies of the

resulting band-pass arrangement depend upon the values of elements in the original filter section. Amplitude and non-linear distortions are inappreciable in the resulting band-pass arrangement. Effect of increasing the number of original filter sections . . . is to shift the position of the transmission band in the frequency spectrum, to reduce the band-width, and to increase gain in the band." The advantages of this method of obtaining a band-pass arrangement are found to be lower cost, better characteristics, and simpler design than a composite band-pass filter and an associated amplifier, for the same gain in the transmission band.

3496. FILTERS FOR HARMONIC SUPPRESSION IN SHORT-WAVE RADIO TRANSMITTERS.—Gonovskii. (See 3519.)

3497. ON THE TIME DELAY OF A SIGNAL IN AN ELECTRIC FILTER.—V. G. Vol'pian. (*Izvestiya Elektroprom. Slab. Toka*, No. 4, 1938, pp. 24-31.)

It is shown that when a voltage corresponding to a modulated carrier frequency is applied to a filter, the voltage at the output of the filter follows the variations of the input voltage but with a certain time delay τ depending on the phase displacements introduced by the filter. A general formula (11) is derived for determining the τ of a filter section, and this is simplified for T and π sections of high-pass, low-pass, and band-pass filters. In each of the above cases not only elementary but also series and shunt derived sections are considered, and the results obtained are shown in a tabular form (Table 1). The accuracy of these results was confirmed experimentally by a comparison of oscillograms of signals at the input and output sides of filters.

3498. ON CERTAIN GENERAL PROPERTIES OF PASSIVE NETWORKS [and the Calculation of the Frequency Characteristic of a Transformer].—V. S. Grigor'ev. (*Izvestiya Elektroprom. Slab. Toka*, No. 4, 1938, pp. 40-44.)

A mathematical analysis is presented of the operation of a network with several pairs of input and output leads, such as for example a transformer with several windings. A system of equations (1) determining the operation of such a transformer is given and from this, by the method of determinants, are found various operating constants such as the input impedance of a winding, the current in this winding, the voltage across a pair of output terminals, the current through a loading impedance, the ratio of the output voltage to the input voltage, etc. As an example, the frequency characteristic of a transformer with two windings is determined.

3499. HIGH-FREQUENCY WORKING ATTENUATION OF LAMINATED-CORE TRANSFORMERS [Theory].—T. Erb. (*Hochf.tech. u. Elek.akus.*, June 1938, Vol. 51, No. 6, pp. 202-205.)

An equivalent circuit for the laminated-core transformer, due to Wolman (1930 Abstracts, p. 228) is theoretically investigated to find simple approximations to the working attenuation above Wolman's limiting frequency. A relation (eqn. 11) is found which gives the optimum inductance for a

given frequency band. The effects which restrict the range of use of h.f. transformers are discussed (§ VII).

3500. METHOD OF SCHEMATIC REPRESENTATION OF MECHANICAL OSCILLATING SYSTEMS [based on Representation of a System with One Degree of Freedom as a Dipole].—J. Brillouin. (*Revue d'Acoustique*, Sept./Dec. 1937, Vol. 6, Fasc. 5/6, pp. 129-146.) See also Firestone, 1934 Abstracts, p. 204.

3501. BRIDGED-T AND PARALLEL-T NULL CIRCUITS FOR MEASUREMENTS AT RADIO FREQUENCIES.—Tuttle. (See 3736.)

3502. SOME APPLICATIONS OF NEGATIVE FEEDBACK, WITH PARTICULAR REFERENCE TO LABORATORY EQUIPMENT.—Terman & others. (See 3727.)

3503. CONTRIBUTION TO THE STUDY OF THE DISTORTIONS OF MODULATION DUE TO THE TRANSMISSION CIRCUITS OF MODULATED HIGH FREQUENCIES.—Varaldi - Balaman. (See 3673.)

3504. CHARACTERISTIC IMPEDANCE OF GROUNDED AND UNGROUNDED OPEN-WIRE TRANSMISSION LINES [Effect of Grounding investigated Theoretically and Experimentally].—R. D. Duncan, Jr. (*Communications*, June 1938, Vol. 18, No. 6, pp. 10-12.)

3505. LOSS FACTOR OF A SYSTEM OF CIRCUITS SUCH THAT THE ELECTRIC CIRCUIT AND THE MAGNETIC CIRCUIT PRODUCED BY IT MAY BE MUTUALLY REVERSED IN SPACE.—T. Nakai. (*Nippon Elec. Comm. Eng.*, April 1938, No. 10, p. 192.)

3506. SIX-PLACE LC PRODUCT TABLE [Numerical & Logarithmic Values, and Corresponding Frequencies].—H. R. Hesse. (*Electronics*, June 1938, Vol. 11, No. 6, pp. 31-32.)

3507. TIME-CONSTANT CHARTS FOR SERIES CIRCUITS.—Hygrade Sylvania. (*Communications*, June 1938, Vol. 18, No. 6, pp. 20, 22, 24.)

TRANSMISSION

3508. ON THE DESIGN OF HIGH-POWER OSCILLATORS FOR ULTRA-SHORT WAVES.—A. B. Ivanov. (*Izvestiya Elektroprom. Slab. Toka*, No. 4, 1938, pp. 6-10.)

It is pointed out that while in long-wave oscillators the value of the anode load can be adjusted by varying the amount of impedance connected between the anode and the filament of the valve, and also by varying the resistance R_2 introduced by the coupling between the tuned circuit and the aerial, in ultra-short-wave oscillators the variation of the first factor is limited by the inter-electrode capacity, and the necessary adjustments of the anode load can therefore be made only by varying R_2 . In the present paper the effect of this variation on the efficiency of the oscillator is investigated. A formula (5) is derived giving the maximum theoretical efficiency of the oscillator, and the optimum operating conditions are discussed. Conditions are also established for (a) mini-

imum ratio of anode dissipation to aerial power, and (b) maximum aerial power with a given filament emission. The discussion is illustrated by a numerical example for the case of a 3 kw valve operating on a wavelength of 5 m.

3509. EQUIVALENT PARAMETERS OF RESONANT LINES.—M. S. Neimann. (*Izvestiya Elektroprom. Slab. Toka*, No. 4, 1938, pp. 1-6.)

A theoretical investigation is presented of the operation of a resonant line used for the frequency control of an ultra-short-wave oscillator; i.e. of a line consisting of two concentric tubes, one quarter-wavelength long, short-circuited at one end and open-circuited at the other. It is shown that when such a line is either directly connected or inductively coupled to an oscillator it is equivalent to a parallel resonant circuit. Formulae are derived for determining the lumped resistance, capacity, and inductance of this circuit in terms of the attenuation per unit length β and characteristic impedance ρ of the line. Formulae are also derived for determining β and ρ in terms of the geometrical dimensions of the line.

3510. THE THEORY OF AUTO-OSCILLATORS WITH A RESONANT LINE CONNECTED TO THE GRID OR ANODE CIRCUIT.—M. S. Neimann. (*Izvestiya Elektroprom. Slab. Toka*, No. 5, 1938, pp. 7-13.)

Continuing the work dealt with in 3509, above, a theoretical discussion is presented of the operation of an oscillator with two inductively-coupled tuned circuits, one of which represents the equivalent circuit of a resonant line. Different methods for connecting these circuits to the anode and the grid of the valve are considered, and exact as well as simplified formulae (p. 12) are derived for determining the frequency of the oscillator. Various factors affecting the stability are discussed and it is suggested that in order to counteract the instability of the circuit to which the resonant line is coupled, the circuit should be detuned as much as possible from the line and the coupling coefficient between the two reduced to a minimum. The maximum permissible detuning and the minimum coupling coefficient are determined for the cases when the resonant line is connected (a) to the anode circuit and (b) to the grid circuit. The discussion is illustrated by a numerical example.

3511. GENERATING MODULATED MICRO-WAVES [Electron-Multiplier Device with Photoelectric Cathode and Additional Grid and Anode beyond Last Multiplying Electrode, yielding Barkhausen-Kurz Oscillations modulated by Kerr Cell or Other System acting on Cathode].—V. A. Babits. (*Electronics*, June 1938, Vol. 11, No. 6, pp. 50 and 52.) From Budapest.

3512. A SENSITIVE METHOD OF DETECTING THE DEPHASING EFFECTS CONNECTED WITH ELECTRON PATH TIMES IN SHORT-WAVE VALVES.—Rocard. (In paper dealt with in 3522.)

3513. ON THE THEORY OF POLYPHASE OSCILLATORS.—Y. Ito & S. Katsurai. (*Electrot. Journ.* Tokyo, July 1938, Vol. 2, No. 7, 160-164.)

The fundamental equation of a polyphase oscillating system, taking the form of cyclic

simultaneous equations, is derived, and a solution found from which the theory of the generation of polyphase oscillations is established. It is shown that in the transient state the n -phase oscillator can generate n kinds of n -phase oscillations, among which the oscillations of least damping build up to the maximum amplitude, while the others are damped down or do not exist in the steady state. When $n = 1$ the theory represents that of the single-phase oscillator, and when $n = 2$, that of the push-pull oscillator. For papers by the same workers on the 3-split magnetron, see 3162 (end) and 3163 (& back references), both of August.

3514. NEW OBSERVATIONS OF IONISED-GAS OSCILLATORS IN A MAGNETIC FIELD [Various Electrode Arrangements giving Oscillations: Observations on Form of Discharge under Different Conditions: Secondary Electrons may play Large Part in Oscillation Production].—T. V. Jonescu. (*Comptes Rendus*, 4th July 1938, Vol. 207, No. 1, pp. 54-57.) For previous work see 2954 of 1936 and 2917 of 1937.

3515. THE CURRENT DISTRIBUTION OVER THE ANODE SURFACE OF THE TWO-SPLIT MAGNETRON [determined with Special Magnetron with Multi-Strip Cylindrical Anode: Investigation of the Dynatron Régime].—O. Harr. (*IET*, May 1938, Vol. 27, No. 5, pp. 167-177.)

"Experimental researches published up to now have concerned themselves almost exclusively with transit-time oscillations, whose best working conditions have been determined chiefly empirically. In the present work it has been sought to provide experimental foundations, hitherto lacking, for the various existing theories of dynatron oscillation, which would allow one of these theories to be shown as the correct one. The investigations were deliberately confined to the case of the falling characteristic, since it is clear that this simple case must be completely cleared up as regards its oscillation mechanism before one can hope to extend the theory to the far more complex problem of the transit-time oscillations."

As a means of investigating this mechanism, the writer considers Kilgore's method of observing the electron paths in a gas-filled tube (3768 of 1936) to be of little real value: in the first place a gas-filled tube cannot be compared directly with a high-vacuum tube, and in the second, the cathode of the special tube, emitting only from a single slit, was very large compared with the cathode of an ordinary magnetron, so that the field conditions were quite abnormal. He considers that there is no way to determine accurately the whole electron path, and concentrates therefore on observing the current distribution on the halves of the anode, in order to deduce from this how many paths land on a particular point and to draw conclusions as to the course of the paths.

Author's summary:—"The experimental investigation of the current distribution in the two-slit magnetron shows that oscillation régimes with static falling characteristics set in when the magnetic field strength is such that the magnetron characteristic $I_a = f(H)$ begins to descend; and

that these regions of oscillation extend to very great field strengths (actual measurements were taken up to 4 times the critical field). In the region of critical field strength (descending part of magnetron curve) the falling characteristic can be explained in all important points by the theory given by Zuhrt [1320 of 1937]. At higher magnetic fields the cycloidal course of the electron paths must be taken into account to explain the falling characteristic. The experiment shows a gradual transition of one region into the other." The current-distribution results in the critical-field region (p. 176, Fig. 18) explain the well-known observation that the edge of a half-cylinder gets red hot at two points 180° apart.

3516. ON THE QUESTION OF THE MULTI-WAVE PROPERTY OF HABANN [Split-Anode Magnetron] GENERATORS.—F. W. Gundlach. (*TFT*, May 1938, Vol. 27, No. 5, pp. 177-179.)

Author's summary:—"It is pointed out that the Habann generator can produce several frequencies simultaneously. For the investigation of this multi-wave propensity a method is described in which the frequency mixture produced by the Habann generator is made to form standing waves along a Lecher pair [embedded in Trolit for rigidity combined with electrical homogeneity] and is analysed by the measurement of the current distribution along the wires." The experiment demonstrated the fact that the magnetron excited two frequencies (actually 54 and 368 Mc/s) and that each of these frequencies modulated the other. In fact, the 54 Mc/s oscillation was only detected by its modulation of the 368 Mc/s carrier: its presence could not be shown directly either by wavemeter or from the current distribution, probably owing to its own weakness and to the insensitivity, at the lower frequencies, of the instruments used.

"The appearance of the dual-wave property in the Habann oscillator is for practical purposes, as a general rule, undesirable; it can be obviated in the following way. The lowest frequency which can establish itself is determined by the design of the resonant system. On the other hand, the Habann tube can excite frequencies up to a certain higher limit which is determined by the electron transit-time effects; this higher limit can be regulated by selecting certain values of anode voltage and magnetic field [see Gundlach, 2769 of July: a paper under the same title will appear in *E.N.T.*]. In this way the Habann tube can always be so arranged that it can only excite the lowest natural frequency of the circuit, so that the transmitter will behave completely as a one-wave transmitter. It must only be remembered that for low frequencies the anode voltage and magnetic field-strength must be made small, and that consequently the generated power will be reduced."

3517. THE PROPERTIES AND USE OF THE MAGNETIC-FIELD VALVES [Comprehensive Survey with 70 Literature References up to 1937].—H. Awender. (*Funktech. Monatshefte*, June & July 1938, Nos. 6 & 7, pp. 173-183 & 201-210.)

3518. COMMUNICATION BY PHASE MODULATION [including New Receiver using Off-Neutralised Crystal Filter: Propagation Characteristics: Power Gain of 4:1 at Transmitter, but Increased Microphonicity at Receiver: etc.].—M. G. Crosby. (*Proc. Inst. Rad. Eng.*, June 1938, Vol. 26, No. 6, p. 662; *Science*, 1st July 1938, Vol. 88, Supp. p. 8: summaries only.)

3519. FILTERS FOR HARMONIC SUPPRESSION IN SHORT-WAVE RADIO TRANSMITTERS.—I. S. Gonorovski. (*Izvestiya Elektroprom. Slab. Toka*, No. 4, 1938, pp. 10-18.)

The operation of a push-pull output stage directly connected to a transmission line is examined, and the suppression of harmonics by means of by-pass filters is discussed separately for the cases of the second and the third harmonics. Various types of filter are considered and methods are indicated for designing these. The effect of the filters on the operation of the transmission line is also discussed and formulae are determined for obtaining the voltages generated across the various components of the filters.

The discussion is concluded by a report on experiments conducted with a view to suppressing the second harmonic in the 15 kw Moscow radio transmitter when the latter was operating on wavelengths of 43 m and 29 m.

3520. THE OPERATION OF AN OSCILLATOR WITH A RECTIFYING LOAD.—I. S. Gonorovski. (*Izvestiya Elektroprom. Slab. Toka*, No. 5, 1938, pp. 17-23.)

In considering the operation of an oscillator it is necessary to take into account losses in the grid circuit which can be regarded as a rectifying load connected to the oscillator. The author therefore presents a theoretical investigation in which the following points are discussed:—(a) the operating conditions of an oscillator working into a rectifying load as distinct from those of an oscillator with a linear load; (b) the conditions which it is necessary to impose on the oscillating circuit in order to ensure an efficient operation of the oscillator with a rectifying load; (c) the effect of the parameters of the rectifying load on the operation of the oscillator. The discussion under the last heading is extended to the case of an intermediate amplifying stage in a radio transmitter working into the grid-filament circuit of the following stage.

3521. INTERNAL INDUCTANCE OF COILS AND ITS INFLUENCE ON THE TEMPERATURE COEFFICIENT OF THE COIL.—Tj. Douma. (*Philips Transmitting News*, June 1938, Vol. 5, No. 2, pp. 47-62.) Concluded from 2716 of July.

3522. VALVE OSCILLATORS STABILISED BY THEIR OWN CIRCUIT [Frequency independent of Internal Resistances of the Valve: Stabilities of 10^{-5} to 10^{-6} obtainable (but only for Waves above about 200 m) by Practical Circuit of Fig. 7: Behaviour below 200 m furnishes the Most Sensitive Method of detecting Dephasing Effects due to Electron Path-Time Influences].—Y. Rocard. (*Journ. de Phys. et le Radium*, June 1938, Series 7, Vol. 9, No. 6, pp. 237-240.)

3523. PIEZO-OSCILLATORS OF HIGH FREQUENCY STABILITY.—Pontecorvo. (See 3718.)

3524. GRID-CURRENT FLOW AS A FACTOR IN THE DESIGN OF VACUUM-TUBE POWER AMPLIFIERS.—W. L. Everitt & K. Spangenberg. (*Proc. Inst. Rad. Eng.*, May 1938, Vol. 26, No. 5, pp. 612-639.)

Further development of the work dealt with in previous papers and a book (1747 of 1936 and 720 of February), which considered plate-circuit operating conditions only. The present paper takes into account the effect of the losses in the grid circuit, shows how the characteristics of this circuit can be computed, and proposes a modification of the "optimum condition."

3525. A HIGH-EFFICIENCY MODULATING SYSTEM [Class C Amplifier drives Aerial Load through Impedance-Inverting Network: Sideband Currents supplied by Class B Amplifier].—A. W. Vance. (*Proc. Inst. Rad. Eng.*, June 1938, Vol. 26, No. 6, p. 676: summary only.)

3526. MODULATION-DEPTH MEASURING INSTRUMENT.—Philips Company. (See 3728.)

3527. HIGH-EFFICIENCY MODULATION SYSTEMS [including the Writer's System evolved from That of Doherty].—R. L. Fortescue. (*World-Radio*, 29th July & 5th Aug. 1938, Vol. 27, pp. 12-13 & p. 13.)

3528. A 50-KILOWATT BROADCAST STATION UTILISING THE DOHERTY AMPLIFIER AND DESIGNED FOR EXPANSION TO 500 KILOWATTS [Station WHAS].—W. H. Doherty & O. W. Townner. (*Proc. Inst. Rad. Eng.*, June 1938, Vol. 26, No. 6, p. 663: summary only.)

3529. THE TRANSMISSION OF TELEGRAPH SIGNALS BY THE IMPULSE SYSTEM IN LONG-DISTANCE WIRELESS COMMUNICATION.—Hudec. (See 3793.)

3530. A VERSATILE REMOTE-CONTROL CIRCUIT: FILAMENT AND PLATE CONTROL, FREQUENCY-CHANGING, SPEECH CIRCUIT, MONITORING AND OVERMODULATION INDICATION, ON A TWO-WIRE LINE.—M. L. Hilliard. (*QST*, July 1938, Vol. 22, No. 7, pp. 37-39.)

RECEPTION

3531. NEW GEAR FOR RADIO-CONTROL SYSTEMS [e.g. for Model Aircraft]: A NEW GAS TRIODE AND A NEW RELAY AT LAST PERMIT ONE-TUBE OPERATION [Raytheon Gas-Filled Triode QY-4 combined with Sigma Relay].—R. A. Hull. (*QST*, July 1938, Vol. 22, No. 7, pp. 44-45.)

In a super-regenerative circuit the new triode gives a plate-current change of at least 1 mA on even a very weak signal: the relay weighs about 2 oz, has 8000 ohms resistance, and operates "with extraordinary reliability" on a current change of the order of 1.2 mA.

3532. DECODERS OPERATING ON THE ELECTRICAL RESONANCE BASIS.—N. A. Livshits. (*Automatics & Telemechanics* [in Russian], No. 4, 1937, pp. 29-55.)

A general discussion is presented of decoders in which the principle of electrical resonance is utilised.

Such decoders can be divided into two units, the selector unit which selects the necessary signal and the operating unit which operates on reception of a signal from the selector. In the first part of the paper various systems employed in the operating unit are considered, including the use of a combined double-diode and triode valve (DDT valve). This is followed by a discussion of selectors employing combinations of filters and selecting one or two frequencies. In the latter category separate consideration is given to selectors with one operating unit responding to a combination of the two frequencies and to selectors with two operating units, each responding to one of the two frequencies.

3533. FREQUENCY MULTIPLICATION AND DEMULTIPLICATION CIRCUITS AND THEIR RELATION TO SUPER-REGENERATIVE CIRCUITS.—Golicke. (In paper dealt with in 3491, above.)

3534. THE INPUT IMPEDANCE OF CONVERTER TUBES [Outer Grid may exhibit Negative Resistance from 2-20 Metres, for Amplification or Oscillation Purposes: Super-Regenerative Receiver by Oscillating in Outer Grid with Quench Frequency on Inner].—J. R. Nelson. (*Proc. Inst. Rad. Eng.*, June 1938, Vol. 26, No. 6, pp. 671-672: summary only.)

3535. THE EFFECT OF APERIODIC INTERFERENCE ON THE RECEPTION OF FREQUENCY-MODULATED SIGNALS.—V. B. Pestryakov. (*Izvestiya Elektroprom. Slab. Toka*, No. 5, 1938, pp. 29-41.)

The operation of a receiver designed for reception of frequency-modulated signals is considered in detail, and formulae are derived determining the voltages at various stages of the receiver when a frequency-modulated e.m.f. is applied to its input terminals. The passage through the receiver of a frequency band corresponding to a series of short and irregular impulses (such as those due to shot effect, thermal movement of electrons, atmospheric, etc.) is also studied, and separate consideration is given to the circuits with and without a current limiter. In each case the integral voltages at the output of the receiver due to interference are determined, and a comparison is made with those obtained in receiving amplitude-modulated signals.

The main conclusions reached are as follows:— (a) when a current limiter is used, the wider the frequency band employed for transmission the higher the gain in the signal/noise ratio as compared with reception of amplitude-modulated signals; (b) when no current limiter is used and the frequency detector is of the usual, non-push-pull type, the advantage gained is only that due to a more efficient operation of the radio transmitter; and (c) if no current limiter is used, but the frequency detector is of the push-pull type, interference is reduced on the reception of unmodulated signals, but greatly increases with the increase of modulation, and at full modulation the advantage in comparison with the reception of amplitude-modulated signals is of the order of $2\sqrt{2}$.

3536. ULTRA-SHORT-WAVE HIGH-FIDELITY ADAPTOR [primarily for Television Sound Transmissions].—W. T. Cocking. (*Wireless World*, 12th May 1938, Vol. 42, pp. 419-422.)

3537. ULTRA-SHORT-WAVE WIRING [and Some Obscure Causes of Interaction, particularly Couplings in the Earth Connection: a "Radiated" Symmetrical Earth Wiring].—P. D. Tyers.—(*Wireless World*, 12th May 1938, Vol. 42, pp. 414-415.)
3538. DESIGN TRENDS IN THE FIELD OF MOBILE [Car, Police, & Aircraft] RECEIVERS IN AMERICA.—L. M. Clement & F. X. Rettenmeyer. (*Funktech. Monatshefte*, June 1938, No. 6, pp. 165-172: to be contd.) With particular attention to the prevention of interference from vibrating-reed devices, ignition system, etc. See also 1379 of April & 2725 of July.
3539. RECEPTION OF TELEVISION SOUND PROGRAMME ON SUB-HARMONIC 14.46 m, and DO "SUB-HARMONICS" EXIST?—Patten & others. (*World-Radio*, 24th June & 1st July 1938, Vol. 27, p. 7: pp. 8 & 9: correspondence & comments.) See also *ibid.*, 29th July, p. 10.
3540. SIFTING THE EVIDENCE [on Reception on Sub-Harmonics: the Question of "Break-Through" and "Beats": etc.].—(*World-Radio*, 8th July 1938, Vol. 27, p. 8.) But see also *ibid.*, 15th July, p. 8.
3541. RECEPTION ON HARMONICS [Observations due to Phenomenon Not Associated with a Particular Harmonic but with a "Peculiar Effect near 100 m Wavelength"].—E. W. B. Gill. (*World-Radio*, 1st July 1938, Vol. 27, p. 8.)
3542. ELIMINATION OF BROADCAST STATION CARRIER BEATS [and the Consequent "Flutter" in Signal Intensity].—Friend. (See 3794.)
3543. TO WHAT EXTENT CAN THE DAMPING IN AN AUDION CIRCUIT BE ELIMINATED BY RETROACTION? [Theory].—W. Kautter. (*E.N.T.*, May 1938, Vol. 15, No. 5, pp. 129-134.)
For previous work see 1933 Abstracts, pp. 622-623. The circuit here discussed, with simplified forms for theoretical discussion, is shown in Fig. 1 a-c. The derivation of the equations is given in § II, which deals with (1) the l.f. voltage on the audion grid; (2) modulation decrease; (3) increase of carrier voltage on the audion grid in spite of constant l.f. output; (4) the connection between the "actual attenuation" ψ , or the saving in input voltage for constant l.f. output, and the "adjusted attenuation" ψ_0 , or the decrease in effective conductivity; (5) the decrease in the average steepness of the characteristics with the a.c. grid voltage, due to (a) curvature of the characteristics, (b) displacement of the working point; (6) curves showing the amount of possible decrease in attenuation; this leads to the desired connection (eqn. 11) between ψ and ψ_0 , for which curves are shown in Fig. 2. Fig. 3 shows the modulation decrease produced by cutting off sidebands, for various ratios of h.f. to l.f., Fig. 4 the relative increase of a.c. voltage on the grid required to give the same l.f. output for various values of the actual decrease in attenuation. The physical meaning of the equations is generally discussed in § I, with numerical examples.
3544. DESIGN FORMULAS FOR DIODE DETECTORS [Superiority of "Envelope" Type over "Average" Type: Ideal Diode—Definition, and Behaviour in Various Circuits, with Formulae: "Inward" and "Outward" Modulation: Analysis of Non-Linear Distortion: Its Reduction (Bias Voltage, Output Circuit of Uniform Conductance, etc.): Automatic Volume Control: Losses in Rectification, and Simple & Useful Method of Measurement: etc.].—H. A. Wheeler. (*Proc. Inst. Rad. Eng.*, June 1938, Vol. 26, No. 6, pp. 745-780.)
3545. THE DISTORTION IN [Diode] DETECTION [and Its Increasing Importance with Peak Modulation Depths of 100%: Disadvantages of Various Remedies: "Sylvania" or "Infinite Impedance" Method, and Necessary Precautions: etc.].—M. Chauvierre. (*L'Onde Élec.*, June 1938, Vol. 17, No. 198, p. 321: summary only.)
3546. A SINGLE-SIDEBAND [Reduced Carrier] RECEIVER FOR SHORT-WAVE TELEPHONE SERVICE [employing Triple Detection].—A. A. Roetken. (*Proc. Inst. Rad. Eng.*, June 1938, Vol. 26, No. 6, p. 673: summary only.) See also 3791. below.
3547. BALANCE AND CONTROL AT HOME [Effect, on Quality of Reproduction, of Resonance & Echo Characteristics of Listening Room: Making the Best of Local Conditions: etc.].—R. H. Wallace. (*Wireless World*, 28th April & 5th May, Vol. 42, pp. 370-371 & 395-396.)
3548. AMPLIFIER NOISE [Thermal and Shot, Ripple and "Modulation Hum," Heater Hum, Inductive Pick-Up, Valve Defects, etc.].—H. D. McD. Ellis & H. S. Walker. (*World-Radio*, 8th July 1938, Vol. 27, pp. 10-11.)
3549. ON THE INVESTIGATION OF THE LIABILITY TO INTERFERENCE OF MAINS-DRIVEN BROADCAST RECEIVER INSTALLATIONS, and ON THE INVESTIGATION OF THE INTERFERENCE-PRODUCING PROPERTIES OF ELECTRICAL APPARATUS DRIVEN OFF THE POWER MAINS.—F. Dohnal: K. Durst. (*Mittel. des tech. Versuchsamtes*, Vienna, Vol. 26, Year 1937, pp. 39-51: pp. 51-60.)
3550. INTERFERENCE FROM NEON SIGNS [the Mechanism of Its Production, and the Prevention of Radiation].—F. R. W. Strafford. (*Wireless World*, 26th May 1938, Vol. 42, pp. 458-460.)
3551. ROAD SURFACE AND INTERFERENCE ["Popping" Sound (lasting roughly 3 Seconds) on Short-Wave Reception traced to Motor Vehicles on Concrete Road: absent on Tarmacadam Road, made from Ironworks' Slag and Tar].—(*World-Radio*, 8th July 1938, Vol. 27, p. 7.) But see also *ibid.*, 22nd & 29th July, pp. 9 & 9.

3552. USE OF FEEDBACK TO COMPENSATE FOR VACUUM-TUBE INPUT-CAPACITANCE VARIATIONS WITH GRID BIAS [causing Detuning of Input Circuits of I.F. Stages of Superhet Receiver], and CONTROL OF THE EFFECTIVE INTERNAL IMPEDANCE OF AMPLIFIERS BY MEANS OF FEEDBACK.—R. L. Freeman; H. F. Mayer. (*Proc. Inst. Rad. Eng.*, June 1938, Vol. 26, No. 6, p. 666; p. 670: summaries only.)
3553. AERIAL COUPLINGS [in Broadcast Receivers: a Comparison of Four Different Methods, leading to Preference for Hazeltine Coupling and Coupling with Primary detuned to Natural Frequency below the Lowest Frequency of the Wave-Band].—Zanetti. (*L'Onde Elec.*, June 1938, Vol. 17, No. 198, p. 320: summary only.)
3554. THE AERIAL CONNECTION [to a Radio Receiver: the Problems involved, and the Measurement of the Effects of This Connection].—M. G. Scroggie. (*Wireless World*, 23rd & 30th June 1938, Vol. 42, pp. 548-549 & 579-581.)
3555. THE DESIGN CALCULATIONS FOR THE OSCILLATOR CIRCUIT IN A SUPERHETERODYNE RECEIVER.—I. Zakarias. (*Bull. Assoc. suisse des Elec.*, No. 14, Vol. 29, 1938, p. 377: in French.) Summary only of a German article in a "Tungsram" journal.
3556. SUPERHET ALIGNMENT [Detailed Description of Trimming Operations].—(*Wireless World*, 16th & 23rd June 1938, Vol. 42, pp. 537-539 & 553-555.)
3557. CHOOSING SHORT-WAVE COIL VALUES [for Short-Wave Receivers: the Assessment of Stray Capacities: etc.].—(*Wireless World*, 12th May 1938, Vol. 42, pp. 416-418.)
3558. AUTOMATIC SELECTIVITY CONTROL RESPONSIVE TO INTERFERENCE.—J. F. Farrington. (*Proc. Inst. Rad. Eng.*, June 1938, Vol. 26, No. 6, p. 664: summary only.)
3559. AUTOMATIC TUNING SYSTEMS [in America].—W. E. Felix. (*Wireless World*, 16th June 1938, Vol. 42, pp. 526-529.)
3560. THEORY OF THE DISCRIMINATOR CIRCUIT FOR AUTOMATIC FREQUENCY CONTROL.—H. Roder. (*Proc. Inst. Rad. Eng.*, May 1938, Vol. 26, No. 5, pp. 590-611.)
- In the theory given by Foster & Seeley (2543 of 1937) some simplifying assumptions were made. In the present paper a complete theory is presented, resulting in formulae for calculating gain, frequency-control sensitivity, pull-in width, adjacent-channel attenuation, etc.; they bear a very close relationship to those for an ordinary two-tuned-circuit i.f. transformer. Non-linear a.f. distortion is found in the case where the channels for signal and automatic frequency control are common; it is, however, small. The poor selectivity for most a.f.c. transformers is traced to the loading effect of the diodes: a circuit in which the a.f.c. and signal channels are separated is preferable if better selectivity is desired: this involves an extra diode and gives, in addition, more a.f.c. sensitivity and less envelope distortion, but a rather smaller signal gain.
3561. A CONSTANT-VOLUME AMPLIFIER FOR COMPENSATING FADING NOT CONTROLLABLE BY ORDINARY AUTOMATIC GAIN CONTROL.—Arman & Hutton-Penman. (*See 3792.*)
3562. A RELAY-RECTIFIER COMBINATION WITH AUTOMATIC FADING COMPENSATION [primarily for Use with Short-Wave Receiver without AVC, for the Morse-Inker Recording of Time Signals: Circuit & Schematic Explanation of Action].—B. Metzger. (*Hochf.tech. u. Elek.akus.*, June 1938, Vol. 51, No. 6, p. 194.)
- The circuit can be carried out either with a separate diode and triode or with a single duodiode-triode valve. The signal current rectified in the diode produces (across the resistance R) a voltage drop which affects the grid of the triode, charging it negatively so that the anode current (which in the absence of signals holds the relay open) is interrupted, and the relay closes: the negative charge is several times greater than the minimum necessary to block the anode current. "With a 4-valve 1-circuit battery-driven short-wave receiver, with an output about 150 mw maximum, combined with this relay-rectifier, I have . . . successfully recorded many European stations and, in favourable conditions, some overseas stations as far distant as 11 000 km."
3563. SIMPLIFIED VOLUME EXPANSION [Automatic Contrast Expansion: Advantages: Necessary Precautions].—F. E. Henderson. (*Television*, July 1938, Vol. 11, No. 125, pp. 440 and 448.)
3564. MINIMISING RECEIVER FREQUENCY DRIFT: AN EASILY CONSTRUCTED CAPACITY COMPENSATOR FOR OVERCOMING "WARM-UP" EFFECTS.—C. S. Mayeda. (*QST*, July 1938, Vol. 22, No. 7, pp. 21-22 and 72, 74.)
3565. ADVANTAGES AND DISADVANTAGES OF THE SINGLE-SPAN SUPERHETERODYNE RECEIVER.—H. Richter. (*Rad., B., F. für Alle*, June 1938, No. 196, pp. 95-97.)
3566. MORE ABOUT MAGNETIC TUNING [particularly for Remote Control: Application to Multi-Circuit Receivers].—L. de Kramolin. (*Wireless World*, 7th July 1938, Vol. 43, pp. 5-7.) For previous work see 1388 of April.
3567. SHORT-WAVE THREE [6.5-86 m, Battery-Operated].—H. B. Dent. (*Wireless World*, 12th & 19th May 1938, Vol. 42, pp. 410-413 & 443-444.)
3568. A CAR RADIO.—J. W. Alexander. (*Philips Tech. Review*, April 1938, Vol. 3, No. 4, pp. 112-118.)
3569. CLOCK [as Auxiliary or Integral Part of Broadcast Receiver] IS CONTROLLED BY SIGNALS OVER RADIO [Infrasonic Modulations at Selected Intervals, acting on Reeds in Path of Light Ray].—W. van B. Roberts: R.C.A. (*Sci. News Letter*, 18th June 1938, Vol. 33, p. 397.)

3570. SOME NOTES ON IRON-DUST CORED COILS AT RADIO FREQUENCIES [particularly Ferrocart: Comparison of Various Core Shapes and Methods of Inductance Adjustment: Pot Type of Core, and the Importance of Building-Up so that Flux follows Direction of Layering: Choice of Wire Gauge and Stranding: etc.].—C. Austin & A. L. Oliver. (*Marconi Review*, July/Sept. 1938, No. 70, pp. 17-31.)
3571. IRON-CORED COILS IN HIGH-FREQUENCY TECHNIQUE [including the AEG Two-Part "X" Core for Fine Adjustment].—G. Kiessling & W. Wolff. (*TFT*, April 1938, Vol. 27, No. 4, pp. 145-146.)
3572. BARRETTERS [Mathematical and Practical Treatment].—J. G. W. Mulder. (*Philips Tech. Review*, March 1938, Vol. 3, No. 3, pp. 74-79.) Including the guarding against starting surges by a semiconductor resistance in series with the barretter proper.
3573. FEATURES OF 1939 RECEIVERS [Push-Button Tuning: High Fidelity: Band-Spread Tuning for Short Waves].—D. D. Cole & others. (*Communications*, June 1938, Vol. 18, No. 6, pp. 15-18.)
3574. "MALLORY-YAXLEY RADIO SERVICE ENCYCLOPEDIA: 2ND EDITION" [Book Review].—(*Communications*, June 1938, Vol. 18, No. 6, p. 32.)
3575. BROADCASTING MARCHES ON [Some Data: 87½ Million Sets estimated in Use: etc.].—A. R. Burrows. (*World-Radio*, 22nd July 1938, Vol. 27, p. 6.)

AERIALS AND AERIAL SYSTEMS

3576. RECEIVING AERIALS.—J. Grosskopf. (*TFT*, April 1938, Vol. 27, No. 4, pp. 129-137.)
- The problem of receiving-aerial theory, even when simplified by practically permissible assumptions, is not always treated correctly. Thus the solutions of the homogeneous problem are often used as solutions to the line equations, whereas here it is a question of an inhomogeneous problem (this point has been pointed out by Colebrook—1932 Abstracts, pp. 526-527—but is often not properly understood: it forms the basis of the difference between transmitting and receiving aerials). A perfectly sound treatment of the subject has been given by Colebrook in an earlier paper (*E.W. & W.E.*, Vol. 4, 1927), but his results give no clear physical picture of the special phenomena occurring in a receiving aerial.
- For a long time the calculation of directive transmitting aerials has been facilitated by a method of particular physical clarity, consisting in a phase-correct integration of the contributions of the aerial elements to the total field strength. A similar treatment has in a few cases been applied already to receiving aerials (Bruce, and Bruce, Beck, & Lowry—1932 Abstracts, p. 96, and 1433 of 1935), "not, however, always correctly, and without exact foundations. It is a particularly illuminating method, and is also very adaptable to special conditions such as aerial shape and form of field, and it gives—without laborious calculation—a rapid picture of all the properties of the aerial, including the directive action. The method is established in the present paper and applied to a few special cases."
3577. A NEW ANTENNA SYSTEM FOR NOISE REDUCTION [even with Aerial itself in Area of Interference].—V. D. Landon & J. Reid. (*Proc. Inst. Rad. Eng.*, June 1938, Vol. 26, No. 6, p. 669: four lines only, no explanation.)
3578. INDOOR OR FRAME AERIAL? [Experimental Investigation of Relative Merits as regards Signal Pick-Up and Susceptibility to Interference].—F. R. W. Stratford. (*Wireless World*, 14th July 1938, Vol. 43, pp. 31-32.)
3579. BEAMSCOPE [Special Aerial incorporated in General Electric Receiving Sets].—(*Communications*, June 1938, Vol. 18, No. 6, p. 39.)
3580. THE AERIAL CONNECTION.—Scroggie. (*See* 3554.)
3581. SIMPLE DERIVATION OF THE RADIATION FROM A DIPOLE [Calculation using Fundamental Electromagnetic Laws and Method of Successive Approximation: Examples of Pendulum Oscillation and Waves on Lecher System: Calculation of Radiation Resistance and Field-Strength in Oblique Direction].—H. G. Möller. (*Hochf. tech. u. Elek. akus.*, July 1938, Vol. 52, No. 1, pp. 26-29.)
3582. A METHOD OF SHORT-WAVE FIELD-INTENSITY MEASUREMENT BASED UPON SINGLE HALF-WAVELENGTH ANTENNA.—Nakagami & Miya. (*Nippon Elec. Comm. Eng.*, April 1938, No. 10, p. 191.) *See also* 2750 of July.
3583. A TEN-METRE ROTATABLE ALFORD BEAM: EXTENDED DOUBLE ZEPPEL AND REFLECTOR REQUIRING NO SPECIAL SUPPORTS [Turning Radius only 3½ Feet].—D. C. Wallace. (*QST*, July 1938, Vol. 22, No. 7, pp. 32-33.)
3584. SOME IDEAS ON DIRECTION INDICATORS FOR ROTATABLE ANTENNAS [including Impending Production of D.C. Selsyn Instrument for Such Remote-Indication Purposes].—(*QST*, July 1938, Vol. 22, No. 7, pp. 47-50.)
3585. MARCONI-T.C.M. HIGH-FREQUENCY CABLES [Coaxial, with Trolitul-Disc Insulation of Centre Conductor in Lead-Tube Outer Conductor (Steel-Tape Armoured when desired): for connecting Aerial Systems to Radio Receiving Stations, for Multi-Channel Carrier or Television Transmission: with Methods of Testing and Installation].—E. W. Smith & R. F. O'Neill. (*Marconi Review*, July/Sept. 1938, No. 70, pp. 32-42.)
3586. THE OPERATING CHARACTERISTICS OF RADIO-FREQUENCY TRANSMISSION LINES AS USED WITH RADIO BROADCASTING ANTENNAS, and DESIGN AND TESTS OF COAXIAL-TRANSMISSION-LINE INSULATORS.—C. G. Dietsch: W. S. Duttera. (*Proc. Inst. Rad. Eng.*, June 1938, Vol. 26, No. 6, p. 663: p. 664: summaries only.)

3587. CHARACTERISTIC IMPEDANCE OF GROUNDED AND UNGROUNDED OPEN-WIRE TRANSMISSION LINES [Effect of Grounding investigated Theoretically and Experimentally].—R. D. Duncan, Jr. (*Communications*, June 1938, Vol. 18, No. 6, pp. 10-12.)
3588. PARTIALLY-SCREENED HARMONIC AERIALS [Calculations of Directional Characteristics and Radiation Resistances].—H. E. Hollmann & A. Thoma. (*Hochf.tech. u. Elek.akus.*, June 1938, Vol. 51, No. 6, pp. 195-202.)
Calculations of the directional characteristics and radiation resistances of the various types of partially-screened aerials (Figs. 1-4) are here given. § I deals with the case of screened middle zones with free half-wave ends (§ I 1) or quarter-wave ends (§ I 2), the screening being obtained with concentric tubes. In § II the case when the parts of the aerials oscillating in opposite phase to that of the ends are neutralised by short oscillating wires (Fig. 4b) is discussed. The results are given in graphical form and compared with the known formulae for aerials in which the parts of opposing phase are suppressed, and for ordinary dipoles.
3589. A NEW TYPE OF ANTI-FADING AERIAL [at Radio Tupi, Brazil: Triangular Stayed Mast supporting (from 3-Armed Top Framework) a 3-Wire Symmetrically Disposed Plain Vertical Aerial: Ratio of Half Free Natural Wavelength to Physical Length of Radiator is 93%].—N. Wells. (*Marconi Review*, July/Sept. 1938, No. 70, pp. 12-16.)
The object, very satisfactorily attained, being to eliminate the capacity effect of the stays as regards current distribution, to reduce the h.f. voltages across the stay insulators, and to present an almost perfectly uniform wave impedance throughout the entire height of the radiator. It was found unnecessary to insulate the mast.
3590. A CONSIDERATION OF THE RADIO-FREQUENCY VOLTAGES ENCOUNTERED BY THE INSULATING MATERIAL OF BROADCAST TOWER ANTENNAS [and the Protection against High Static or Induced Lightning Voltages without Use of Elaborate Insulation].—G. H. Brown. (*Proc. Inst. Rad. Eng.*, June 1938, Vol. 26, No. 6, p. 611: summary only.)
3591. ELECTRICAL PROPERTIES OF AERIALS FOR MEDIUM AND LONG WAVE BROADCASTING.—W. L. McPherson. (*Elec. Communication*, July 1938, Vol. 17, No. 1, pp. 44-65.)
Conclusion of the comprehensive survey dealt with in 3204 of August. From p. 52 onwards the paper gives a discussion of some experimental data, from various sources, on real and model aerials, including "cigar-shaped" and self-supporting towers, and of the light thrown by these measurements on the applicability of the general method of treatment already described.
3592. THE KDKA LOW-ANGLE ANTENNA ARRAY.—R. N. Harmon. (*Proc. Inst. Rad. Eng.*, June 1938, Vol. 26, No. 6, p. 667: summary only.) See also 1876 of May.
3593. WIND PRESSURE UPON TRANSMISSION TOWERS [for Overhead Lines: Wind-Tunnel Tests on Component Beams, Tower Models, etc.: Comparison with Results in Great Britain].—Tachikawa & Osako. (*BEAMA Journal*, June 1938, Vol. 42, No. 12, pp. 193-196.)
3594. "THE RADIO ANTENNA HANDBOOK" [Book Review].—Technical Staff of *Radio*. (*Electronics*, June 1938, Vol. 11, No. 6, p. 90.)

VALVES AND THERMIONICS

3595. THE PASSAGE OF ELECTRONS THROUGH AN ELECTRICAL CYLINDER LENS [designed to pass the Whole Stream through a Slit].—Gaedcke. (*Zeitschr. f. tech. Phys.*, No. 7, Vol. 19, 1938, pp. 204-206.)

"In the course of investigations on an electron-optical electric cylinder lens, the question arose as to the ratio of the thermal electron stream passing through a slit in a diaphragm to the amount of stream arriving at the electrodes, as a function of the potentials applied to the individual electrodes." In order to obtain a concentration of the lines of force which would yield a good value for this ratio, a special shape for the electrodes was arrived at after tests with an electrolytic trough. The anode *A* (Fig. 1) with its slit *O* was made funnel-shaped, as in the 1925 experiments of Rogowski & Grosser, and behind the filament *F* (a thoriated tungsten wire of diameter small compared to its length) a concave screen *S* was arranged. Finally, behind the anode slit a carbon-coated cage *K* was set to pick up the electrons arriving through the slit. The various electrodes were made of brass sheet and were provided with lugs so that they could be slid along two parallel glass rods.

"After this form of anode had been found to be favourable, it was retained (with the anode slit *O* 1.5 mm wide) during further measurements. The anode/filament gap was 4 mm, while the distance of the screen *S* from the filament, and the shape of the screen, were varied within wide limits. It was thus found that the dependence of the various currents on the screen potential was the same for a slightly curved screen at a short distance from the filament as for a more curved screen at a greater distance." The curves of Figs. 2-5 were taken with a screen of fixed (15 mm) radius of curvature at two different distances from the filament (2 mm and 6 mm): they show the variations of the anode current I_a , the cage current I_k , and the screen current I_s , as the screen voltage U_s is varied from negative values (ranging from about -100 to -350 volts) to positive (about +160 to +300 volts).

"From the curves we recognise two maxima for the cage current: for two different potentials on the screen, specially large numbers of electrons come through the anode slit. Examination by the opposing-field method showed that only at the maximum corresponding to a negative screen potential (thanks to the most favourable field form between filament and slit) do the electrons come with uniform velocities through the slit. . . ." Increasing the negative screen potential sharply reduces the total stream, so that to make the most of this maximum the factor to vary is the ratio screen-potential/anode-potential. For certain

correct values of this ratio (1:3 for a filament/screen gap of 2 mm, 9:10 for a gap of 6 mm) practically the whole of the emission passes through the slit, and the anode shows no heating-up.

The final section describes an investigation of the distribution of electron directions after passing through the slit, by replacing the cage by a fluorescent screen at a distance of 12 cm. In the conditions for the optimum passage through the slit, the image on the screen is that shown in Fig. 7, so that in such conditions the electrons leave the slit in a highly divergent condition.

3596. ELECTROLYTIC FIELD-PLOTTING TROUGH FOR CIRCULARLY SYMMETRIC SYSTEMS.—M. Bowman-Manifold & F. H. Nicoll. (*Nature*, 2nd July 1938, Vol. 142, p. 39.)
3597. THE RAYTHEON GAS-FILLED TRIODE QY-4 AND ITS USE IN A SINGLE-VALVE RECEIVER FOR DISTANT CONTROL [e.g. of Model Aircraft].—Raytheon. (See 3531.)
3598. THE BEHAVIOUR OF AMPLIFIER VALVES AT VERY HIGH FREQUENCIES [Study of the Four "Characteristic Admittances" of an Amplifier Valve, and Their Significance and Measurement at Ultra-High Frequencies].—M. J. O. Strutt & A. van der Ziel. (*Philips Tech. Review*, April 1938, Vol. 3, No. 4, pp. 103-111.)
3599. AN ELECTRON-MULTIPLIER BARKHAUSEN-KURZ VALVE FOR GENERATION AND MODULATION OF MICRO-WAVES.—Babits. (See 3511.)
3600. TECHNICAL APPLICATIONS OF SECONDARY EMISSIONS [including the Development of the Hot-Cathode Secondary-Emission Amplifier Valve Type 4696].—J. L. H. Jonker & M. C. Teves. (*Philips Tech. Review*, May 1938, Vol. 3, No. 5, pp. 133-139.) See also 2334 of June.
3601. SECONDARY ELECTRON EMISSION [Determination of Capacity for S.E.: Relation between δ and the Energy of Primary Electrons: etc.].—H. Bruining. (*Philips Tech. Review*, March 1938, Vol. 3, No. 3, pp. 80-86.)
3602. ON THE EMISSION OF SECONDARY ELECTRONS FROM SOLID BODIES [Eindhoven Thesis, 1938].—H. Bruining. (At Patent Office Library, London: Cat. No. 78 661: 132 pp.)
3603. THERMIONIC EMISSION FROM CARBON [Measurements at Various Temperatures: Values of Constants in Empirical Emission Formula].—A. L. Reimann. (*Proc. Phys. Soc.*, 1st July 1938, Vol. 50, Part 4, No. 280, pp. 496-500.)
3604. TYPE 254 GAMMATRON TRIODE FOR ULTRA-HIGH FREQUENCIES [Anode Dissipation 100 Watts: No Internal Insulators: Tantalum Elements, Nonex Envelopes, and Tungsten Supports].—(*Electronics*, June 1938, Vol. 11, No. 6, p. 82.)
3605. A PUSH-PULL ULTRA-HIGH FREQUENCY BEAM TETRODE [giving 10 Watts Useful Output at Frequencies around 250 Mc/s].—A. K. Wing. (*Proc. Inst. Rad. Eng.*, June 1938, Vol. 26, No. 6, pp. 676-677: summary only.)
3606. STUDY OF AN ELECTRON OSCILLATION TUBE WITH EXTERNAL FILAMENTS [similar to McPetrie's "Reversed Diode": Results "Not Wholly Satisfactory"].—S. Nakamura. (*Nippon Elec. Comm. Eng.*, April 1938, No. 10, p. 193.) See also 82 of January.
3607. PAPERS ON THE MAGNETRON.—(See under "Transmission.")
3608. THE ACORN VALVE [Applications and Most Suitable Circuits].—(*Wireless World*, 7th July 1938, Vol. 43, pp. 2-4.)
3609. STUDY OF SPACE CHARGE EFFECTS IN ELECTRON TUBES.—Salzberg & Haefl: Fay & others. (*Electronics*, June 1938, Vol. 11, No. 6, p. 66.) On the papers dealt with in 1428 & 1429 of April and 1885 of May.
3610. ON THE EFFECT OF SPACE CHARGE IN A VALVE ON THE INTER-ELECTRODE CAPACITY.—G. A. Zeitlenok. (*Izvestiya Elektroprom. Slab. Toha*, No. 5, 1938, pp. 13-17.)
- The effect of the space charge on the capacity between the grid and the cathode of a valve is investigated separately for valves with flat and with cylindrical electrodes. In each case the distribution of potential between the electrodes in the presence of the space charge is examined, and from this the capacity current is determined and formulae (5b and 8) are derived showing that under these conditions the capacity of flat electrodes is increased in the ratio of 4 to 3, while in the case of cylindrical electrodes the increase is somewhat higher, depending on the radii of the electrodes.
3611. CURRENT-DISTRIBUTION FLUCTUATIONS IN MULTI-ELECTRODE RADIO VALVES [New Source of Fluctuation Noise introduced by Current Division between the Electrodes].—C. J. Bakker. (*Physica*, July 1938, Vol. 5, No. 7, pp. 581-592: in English.)
- "Since these [multi-electrode] tubes are usually working under space-charge conditions, it is clear that the current which has passed the control grid, and which is the same as the current in the cathode lead, contains a shot effect according to eqn. 4. When this current is to be distributed over two electrodes with a positive potential—screen grid and anode in a pentode valve—a new source of fluctuations is introduced by this current division." Formulae are derived and confirmed by experiment. "It may be noticed from eqn. 21 that for a given value of I_a and F_a^2 the anode noise factor F_a^2 may be lowered by reducing the screen-grid current. This has led to the construction of special valves" (a paper by Ziegler is mentioned). A footnote mentions that this equation 21 has also been reached, by a different reasoning, by Schottky (2783 of July).
3612. USE OF FEEDBACK TO COMPENSATE FOR VACUUM-TUBE INPUT-CAPACITANCE VARIATIONS WITH GRID BIAS, and THE INPUT IMPEDANCE OF CONVERTER TUBES.—Freeman: Nelson. (See 3552 & 3534.)

3613. GRID-CURRENT FLOW AS A FACTOR IN THE DESIGN OF VACUUM-TUBE POWER AMPLIFIERS.—Everitt & Spangenberg. (See 3524.)
3614. DESIGN FORMULAS FOR DIODE DETECTORS.—Wheeler. (See 3544.)
3615. THE 6L7 [Mixer Valve, All-Metal 5-Grid] AS AN R.F. AMPLIFIER [and Its Advantages over a Normal Tetrode or Pentode].—RCA. (*Television*, July 1938, Vol. II, No. 125, pp. 436 and 447.)
3616. THE SPECIAL SUITABILITY OF THE TYPE I-A-6 MULTI-GRID VALVE FOR D.C. AMPLIFIERS FOR MEASUREMENT OF IONISATION CURRENTS, ETC.—Tatel & others. (See 3763.)
3617. POWER TUBE CHARACTERISTICS [and Their Graphical Plotting by Cathode-Ray Tube, over Wide Ranges of Voltage & Current without Danger of Overheating].—E. L. Chaffee. (*Electronics*, June 1938, Vol. II, No. 6, pp. 34-37 and 42.)
3618. THE OPERATING CHARACTERISTICS OF POWER TUBES [Method of calculating Performance from Static Characteristics: 60-Cycle Test Method: Effect of Anode and Grid Secondary Emission and Grid Primary Emission on Valve Performance].—E. L. Chaffee. (*Journ. of Applied Physics*, July 1938, Vol. 9, No. 7, pp. 471-482.)
3619. "RUNDUNKRÖHREN: EIGENSCHAFTEN UND ANWENDUNG" [Broadcast Valves: Properties and Use: Book Review].—L. Ratheiser. (*Funktech. Monatshefte*, May 1938, No. 5, p. 160.) In a Telefunken series of books.
3620. VALVE NOMENCLATURE [Suggested New System].—R. McV. Weston. (*Wireless World*, 28th April 1938, Vol. 42, pp. 386-387.)
3621. CONCERNING "PERVEANCE" [Origin of Term: Its Occasional Employment and Lack of Official Recognition].—Kusunose. (*Electronics*, June 1938, Vol. II, No. 6, p. 60.)
3622. THE SEALING OF METAL LEADS THROUGH HARD GLASS AND SILICA.—B. Jonas. (*Philips Tech. Review*, April 1938, Vol. 3, No. 4, pp. 119-124.)
3623. "ENGINEERING ELECTRONICS" [Book Review].—D. G. Fink. (*Television*, July 1938, Vol. II, No. 125, pp. 408 and 420.)
3624. "GLASS WORKING FOR LUMINOUS TUBES" [also Useful in Field of Valve Construction: Book Review].—H. Eccles. (*Electronics*, June 1938, Vol. II, No. 6, p. 59.)
3626. STATUS OF INSTRUMENT LANDING SYSTEMS [Results of Experience with Bureau of Standards, Airways Division, Washington Institute of Technology, Bureau of Air Commerce, Lorenz, Bendix, and Other Systems: Comparative Advantages of Vertical and Horizontal Polarisation (e.g. Liability of Vertical Polarisation to give Discontinuity in Glide Path due to Reinforcing Steel in Runway, etc.): Fundamental Elements for a Uniform System, agreed by Subcommittee].—W. E. Jackson. (*Proc. Inst. Rad. Eng.*, June 1938, Vol. 26, No. 6, pp. 681-699.)
3627. AN INSTRUMENT LANDING SYSTEM [Glide Path formed by Magnetic Field surrounding Two Horizontal Multi-Conductor Cables under or above Ground Surface: Indication by Crossed Pointers of D. C. Milliammeters].—E. N. Dingley, Jr. (*Communications*, June 1938, Vol. 18, No. 6, pp. 7-9 and 30, 31.)
3628. AIR-TRACK SYSTEM OF AIRCRAFT INSTRUMENT LANDING, and DEVELOPMENT OF AN ULTRA-HIGH-FREQUENCY TRANSMITTER [500 W, 90-125 Mc/s] FOR AIRCRAFT INSTRUMENT LANDING.—Davies, Kear, & Wintermute: Kibler. (*Proc. Inst. Rad. Eng.*, June 1938, Vol. 26, No. 6, p. 662: p. 669: summaries only.)
3629. THE USE OF ADCOCK AERIALS FOR ULTRA-SHORT-WAVE [3.5-8 m] DIRECTION FINDING [Tests with Aircraft show Max. Errors of 1° up to 100 km and 3° up to 150 km, Altitude being 2000 m].—Lehmann. (*Rev. Gén. de l'Élec.*, 9th July 1938, Vol. 44, No. 2, p. 34: paragraph only.)
3630. THE LORENZ ULTRA-SHORT-WAVE BEACON AND THE POSSIBILITIES OF ITS APPLICATION.—W. Hahnemann & E. Kramar. (*Lorenz-Berichte*, June 1938, No. 1/2, pp. 3-28.) German version of the paper dealt with in 2361 of June.
3631. THE LORENZ LONG-WAVE U-ADCOCK DIRECTION FINDER [Its Development from the H-System: the "Coupled" U, the "Balanced" U, and the "Balanced & Coupled" U Systems: Use of Insulated Earth Net System: Results on Trailing Aerials: etc.].—K. Koschmieder. (*Lorenz-Berichte*, June 1938, No. 1/2, pp. 41-54.)
3632. THE ZZ METHOD OF BLIND APPROACH.—M. Douglas-Hamilton. (*Aeroplane*, 20th April 1938, Vol. 54, No. 1404, pp. 480-482.)
3633. A HOMING DEVICE USING A MODULATION SYSTEM.—M. P. Dolukhanov. (*Izvestiya Elektroprom. Slab. Toka*, No. 5, 1938, pp. 24-29.)

DIRECTIONAL WIRELESS

3625. DETECTION OF AN OBSTACLE AND MEASUREMENT OF ITS DISTANCE BY SHORT OR ULTRA-SHORT WAVES [Modification of Method using Transmitter whose Frequency varies with Time, by employing a Wave of Fixed Frequency modulated by a Frequency varying with Time: Use of 16 cm Wave with Modulation varying linearly from 15 to 20 Mc/s].—Comp. Gén. de T.S.F.: Moueix. (French Pat. 821 007, pub. 25.11.1937: *Rev. Gén. de l'Élec.*, 25th June 1938, Vol. 43, No. 26, p. 205D.)

In the latest models of homing device the I.f. voltage from the local source is used for modulating the incoming signal instead of reversing its phase. In the present paper a mathematical analysis of the operation of such a system is presented, and the following main conclusions are reached:—(a) it is essential that for satisfactory operation of the system simultaneous reception on two aerials (loop and

vertical) should be employed; (b) a push-pull modulator meets the requirements of the system; and (c) a non-push-pull modulator would be satisfactory in operation provided that the e.m.f. obtained from the vertical aerial is 15 to 20 times greater than that from the loop; otherwise the sensitivity of the indicator will vary according to whether the deviation is to the right or left of the true course.

3634. "FUNKNAVIGATION IN DER LUFTFAHRT" [Radio Navigation in Aviation: Book Review].—P. von Handel & K. Krüger. (*E.T.Z.*, 23rd June 1938, Vol. 59, No. 25, p. 684.)

3635. THE AURORA BOREALIS AND DIRECTION-FINDING [Description of Aurora and Abnormal Conditions observed on 25.1.38 in Short-Wave Direction-Finding].—German Aeronautical Research Establishment. (*Hochf.tech. u. Elek.akus.*, June 1938, Vol. 51, No. 6, pp. 205-206.)

ACOUSTICS AND AUDIO-FREQUENCIES

3636. THE MOBILITY METHOD OF COMPUTING THE VIBRATION OF LINEAR MECHANICAL AND ACOUSTICAL SYSTEMS: MECHANICAL-ELECTRICAL ANALOGIES.—F. A. Firestone. (*Journ. of Applied Physics*, June 1938, Vol. 9, No. 6, pp. 373-387; summary only in *Journ. Acoust. Soc. Am.*, July 1938, Vol. 10, No. 1, p. 83.)

3637. METHOD OF SCHEMATIC REPRESENTATION OF MECHANICAL OSCILLATING SYSTEMS.—Brillouin. (See 3500.)

3638. AN OPERATIONAL [Laplacian Transform] TREATMENT OF NON-LINEAR DYNAMICAL SYSTEMS.—Pipes. (See 3489.)

3639. METHOD FOR DETERMINING THE "KLIRR" FACTOR OF AMPLIFIERS.—F. Schuhfried. (*Hochf.tech. u. Elek.akus.*, June 1938, Vol. 51, No. 6, pp. 191-193.)

The principle of the method is that used by Graffunder, Kleen, & Wehnert (1051 of 1936) to study single valves, in which a sinusoidal voltage is superposed on the distorted voltage to be investigated, with the same frequency and amplitude as the fundamental of the distorted voltage but opposed in phase (circuit Figs. 1, 5). The fundamental is thus eliminated; the sum of the squares of the overtone amplitudes and the fundamental itself can be separately measured and the "klirr" factor at once deduced. The phase-shifter is described in § III (circuit Fig. 2); the voltage measurement (§ IV) requires an instrument of high internal resistance to indicate the sum of the squares of the amplitudes. A valve voltmeter with quadratic characteristic is used; a cubic characteristic is also suitable. The practical procedure of measuring the "klirr" factor is described in § V, an experimental test of the apparatus in § VI, where cathode-ray oscillograms of the voltage under test and its overtones are given in Figs. 8, 9 and results by this method compared with those obtained from a harmonic analyser. The accuracy of the method is governed by that of the valve voltmeter used.

3640. TO WHAT EXTENT CAN THE DAMPING IN AN AUDION CIRCUIT BE ELIMINATED BY RETRO-ACTION?—Kautter. (See 3543.)

3641. FINITE SOLID ACOUSTIC FILTERS [Metal Rod loaded at Equal Intervals with Heavy Metal Collars: a Low-Pass Filter with Cut-Off at 2000 c/s and No Further Transmission up to 12 650 c/s].—R. B. Lindsay & A. B. Focke. (*Journ. Acoust. Soc. Am.*, July 1938, Vol. 10, No. 1, pp. 41-44.)

3642. AN AUDIO-FREQUENCY-RESPONSE CURVE TRACER [using Cathode-Ray Tube with Long-Persistence Screen, permitting Simultaneous Observation and Comparison of Several Different Curves: 20-15,000 c/s: Linear or Logarithmic Scale].—J. B. Sherman. (*Proc. Inst. Rad. Eng.*, June 1938, Vol. 26, No. 6, pp. 700-712.) With specimen oscillograms showing effect of baffles on loudspeaker characteristics and the increased detail available by scale expansion.

3643. AN ELECTRO-ACOUSTIC TESTER [for Loudspeakers].—General Electric Company. (*Wireless World*, 19th May 1938, Vol. 42, p. 439.)

3644. ON SOME DISPUTED POINTS IN RADIO-ELECTRIC ENGINEERING: TO WHAT EXTENT DOES THE STUDY OF A LOUDSPEAKER IN THE PERMANENT RÉGIME ALLOW THE PREDICTION OF ITS BEHAVIOUR IN THE TRANSIENT RÉGIME? [Refutation of Voigt's Arguments in *Wireless World* Correspondence].—P. David; Voigt. (*L'Onde Élec.*, June 1938, Vol. 17, No. 198, pp. 309-319.)

In this correspondence (beginning with the letter dealt with in 3746 of 1937) "Mr. Voigt maintains that the usual method of testing loudspeakers, namely the plotting of their frequency curve in the permanent régime, signifies nothing. The arguments of his contradictors have been very varied, but we have been surprised to find in them some grave omissions—to such an extent that Mr. Voigt remains, at the end, practically entirely in possession of his original position: he continues to maintain that the amplitude/frequency response curve is not enough, and must be completed by something else which may be called 'the response in the transitory régime.' We would like, therefore, to recapitulate here Mr. Voigt's arguments and the British discussion, and to add to it some personal comments which seem to us likely to throw light on the question." The problem is far more general than it would appear as set out by Voigt; it is found in all kinds of mechanical and electrical systems, as well as in acoustics, and the question of the relations between "permanent" and "transient" régimes has presented itself under a thousand different forms; these difficulties are not new. In particular, the writer recalls the analogous problem of atmospherics and their action on circuits whose selectivity is measured "in the permanent régime," which "caused much ink to flow between 1920 and 1930." He concludes: "In short, the usual method of testing loudspeakers in the permanent régime is sufficient, in practice, to define them even in the transient régime: and we may continue to use it without compunction."

3645. HORN-TYPE LOUDSPEAKERS: A QUANTITATIVE DISCUSSION OF SOME FUNDAMENTAL REQUIREMENTS IN THEIR DESIGN [and the Development of a Dual-Drive Compound-Horn Loudspeaker, with Entirely Separate High- and Low-Frequency Systems but Common Magnetic Circuit].—F. Massa. (*Proc. Inst. Rad. Eng.*, June 1938, Vol. 26, No. 6, pp. 720-733.)
3646. CORRECTION TO "THE RÔLE OF THE SPEAKER IMPEDANCE IN RESONANCE IN A CLOSED PIPE."—PHELPS. (*Journ. Acoust. Soc. Am.*, July 1938, Vol. 10, No. 1, p. 75.) See 2371 of June.
3647. THE VIBRATIONS OF SYMMETRICAL PLATES AND MEMBRANES.—Colwell, Friend, & Stewart. (*Journ. Acoust. Soc. Am.*, July 1938, Vol. 10, No. 1, pp. 68-73.)
3648. THE ACOUSTIC LABYRINTH [Advantages: Constructional Details].—L. J. Snell. (*Wireless World*, 2nd June 1938, Vol. 42, pp. 485-486.)
3649. THE ACOUSTICAL CONDUCTIVITY OF ORIFICES [Measurements on Various Orifices: Equations for Calculation of Orifice Conductivity: Method for Determining Shape of Wave-Front near Constriction in Cylindrical Tube: Results for Thin Circular Orifices].—N. W. Robinson. (*Proc. Phys. Soc.*, 1st July 1938, Vol. 50, Part 4, No. 280, pp. 599-615.)
3650. NEW SEIGNETTE-ELECTRICS [Acid Potassium Phosphate and Arsenate with Electrical Properties similar to those of Rochelle Salt].—G. Busch. (*Helvetica Phys. Acta*, Fasc. 4, Vol. 11, 1938, pp. 269-298: summary pp. 359-360: in German.)
3651. BALANCE AND CONTROL AT HOME.—Wallace. (See 3547.)
3652. AUDITORIUM ACOUSTICS AND REVERBERATION, and AUDITORIUM ACOUSTICS AND INTELLIGIBILITY.—A. Th. van Urk: R. Vermeulen. (*Philips Tech. Review*, March 1938, Vol. 3, No. 3, pp. 65-73: May, No. 4, pp. 139-146.)
From the second paper: "In many cases it may be doubted whether modern architecture, with its preference for simple lines and smooth surfaces, is always as efficient from the standpoint of acoustics as it pretends to be."
3653. THE ACOUSTICAL DESIGN OF BROADCASTING STUDIOS [including B.B.C. Experiences with Different Constructions of Ceiling and Wall].—J. McLaren. (*World-Radio*, 15th July 1938, Vol. 27, pp. 10-11.) Continued from 2836 of July.
3654. STAGE AMPLIFICATION [the Difficulty of Preserving the Illusion of Naturalness: etc.].—A. Black. (*Wireless World*, 2nd June 1938, Vol. 42, pp. 482-484.)
3655. "TWO-CHANNEL" PICK-UP [with the Two Elements coupled by "Special Low-Pass Filter" of a Semicrystallised Substance: Gradually Rising Curve at Lower Frequencies].—Audak Laboratories. (*Communications*, June 1938, Vol. 18, No. 6, p. 41.) See also *Electronics*, June 1938, Vol. 11, No. 6, pp. 17 and 19.
3656. A NEW HIGH-FIDELITY REPRODUCER [Pick-Up] FOR LATERAL DISC RECORDS [Light Weight, with New Way of obtaining Low Mechanical Impedance: Diamond Stylus], and LATERAL DISC RECORDING FOR IMMEDIATE PLAY-BACK WITH EXTENDED FREQUENCY & VOLUME RANGE.—H. J. Hasbrouck. (*Proc. Inst. Rad. Eng.*, June 1938, Vol. 26, No. 6, pp. 667-668: p. 668.)
3657. A NEW METHOD FOR THE RECORDING OF WIDE FREQUENCY BANDS [e.g. 30-13 000 c/s: by Division into 2 Parts, Each with Its Sound Track (Disc or Film), the High-Frequency Part being subjected to Frequency Shifting before Recording: Both Tracks used simultaneously in Reproduction].—H. Etzold. (*Funktech. Monatshefte*, June 1938, No. 6, pp. 184-185.) A still wider band can be dealt with by division into 3 or more parts: thus television signals could be recorded.
3658. ON DISTORTION IN SOUND REPRODUCTION FROM PHONOGRAPH RECORDS, and "TRACING" DISTORTION IN SOUND REPRODUCTION FROM PHONOGRAPH RECORDS.—J. A. Pierce & F. V. Hunt. (*Journ. Acoust. Soc. Am.*, July 1938, Vol. 10, No. 1, pp. 14-28: p. 84—summary only.)
3659. HOME RECORDING [Various Systems: the Adoption of the Lateral Method: etc.].—H. Andrewes. (*Wireless World*, 14th & 21st July 1938, Vol. 43, pp. 24-27 & 50-53.)
3660. DIRECTIVITY OF SOUND SOURCE [measured] BY IMPULSIVE WAVES [with Advantage of Freedom from Disturbances due to Reflection, Interference, etc.].—S. Chiba & S. Morita. (*Electrol. Journ.*, Tokyo, July 1938, Vol. 2, No. 7, p. 171.)
3661. FREE FIELD CALIBRATION OF MICROPHONES [Non-Resonant Probe Tube Device].—W. West. (*Nature*, 2nd July 1938, Vol. 142, p. 39.) See also 3239 of August, and 1934 Abstracts, p. 156.
3662. THE CALCULATION OF THE TRANSMISSION PROPERTIES OF UNIFORM CONDUCTORS [Overhead Lines and Cables: the Errors resulting from Use of Approximate Formulae: Transformation of the Strict Equations, and Tables of Functions, for Simplicity in Application].—E. Haak. (*TFT*, May 1938, Vol. 27, No. 5, pp. 179-184.)
3663. THE LONDON/BIRMINGHAM COAXIAL CABLE SYSTEM: PART IV—TEST RESULTS AND COMMERCIAL OPERATION.—A. H. Mumford. (*P.O. Elec. Eng. Journ.*, July 1938, Vol. 31, Part 2, pp. 132-136.) For previous parts see 1973 of May and 2470 of June.

3664. A SOUND EFFECTS MACHINE WITH HIGH-IMPEDANCE MIXING.—M. J. Weiner. (*Electronics*, June 1938, Vol. 11, No. 6, pp. 56 and 58.)
3665. ACOUSTICAL OUTPUT OF AIR SOUND SENDERS [Membrane and Diaphone Types, for Fog Signals: the Absolute Measurement of Sound at Great Intensities, by Raleigh Disc or Crystal Microphone: Results].—O. Devik & H. Dahl. (*Journ. Acoust. Soc. Am.*, July 1938, Vol. 10, No. 1, pp. 50-62.)
3666. AUTOMATICALLY REGULATED DEAF AID.—W. W. Kenyon. (*Wireless World*, 14th July 1938, Vol. 43, pp. 28-29.)
3667. EXPERIMENTAL INVESTIGATIONS ON THE PHOTOMODULATION OF A.C.-HEATED INCANDESCENT LAMPS IN THE AUDIO-FREQUENCY RANGE.—Köhler. (See 3828.)
3668. A PROJECTED VOCABULARY AND DEFINITIONS OF THE PRINCIPAL TERMS USED IN ACOUSTICS, and REPORT ON THE FIRST INTERNATIONAL CONFERENCE OF SUBCOMMITTEE I "VOCABULARY" OF THE COMMITTEE I.S.A. 43 "ACOUSTICS," PARIS, JULY 1937.—(*Revue d'Acoustique*, Sept./Dec. 1937, Vol. 6, Fasc. 5/6, pp. 147-166: pp. 167-177.)
3669. SUPERSONIC CENTRIFUGE [combining Action of Centrifugal Field and Supersonic Elastic Vibrations, destructive to Cells: Biological Application].—P. Girard & N. Marinenco. (*Comptes Rendus*, 27th June 1938, Vol. 206, No. 26, pp. 2000-2002.)
3671. THE FINE STRUCTURE OF TELEVISION IMAGES [and the Relations (Width & Spacing of Lines, etc.) to yield a System Theoretically Ideal and Practically Optimum: Separation necessary between Picture and Sound Carriers: etc.].—H. A. Wheeler & A. V. Loughren. (*Proc. Inst. Rad. Eng.*, May 1938, Vol. 26, No. 5, pp. 540-575.)
- "Flat" fields, equally necessary, for different reasons, at transmitter and receiver, are best obtained by scanning lines of cosine-squared transverse distribution, generated by a circular spot designed to secure this distribution. The resulting vertical "width of confusion" is $\sqrt{2}$ times the pitch of the scanning lines. The two scanning spots together have a horizontal "width of confusion" $\frac{4}{3}$ times the line pitch. Equal horizontal and vertical "width of confusion" requires all the electrical filters to pass uniformly the components out to the nominal cut-off frequency f_c at which one-half period corresponds to the "width of confusion." Practical filter design considerations and the avoidance of spurious pulses in the image require that the filters have a gradual cut-off between f_c and $2f_c$, while they may have complete cut-off beyond $2f_c$.
3672. A THEORETICAL ANALYSIS OF SINGLE-SIDE-BAND OPERATION OF TELEVISION TRANSMITTERS [by Detuning the Transmitter to Suppress One Band partially and to Increase the Band Width for the Other].—L. S. Nergaard. (*Proc. Inst. Rad. Eng.*, June 1938, Vol. 26, No. 6, pp. 672-673: summary only.)
3673. CONTRIBUTION TO THE STUDY OF THE DISTORTIONS OF MODULATION DUE TO THE TRANSMISSION CIRCUITS OF MODULATED HIGH FREQUENCIES [of Special Interest for Television].—P. Varaldi-Balaman. (*L'Onde Elec.*, June 1938, Vol. 17, No. 198, pp. 283-302.)

PHOTOTELEGRAPHY AND TELEVISION

3670. TELEVISION IN NATURAL COLOURS [Theoretical Analysis of the Problem, and Comparison with Natural-Colour Cinematography].—H. Pressler. (*TFT*, April 1938, Vol. 27, No. 4, pp. 137-141.)

The writer concludes that fundamentally the problem of television in colours is no more difficult than that of films in colour: in fact, in certain points the former has the advantage over the latter (e.g. the linearity of light control in transmitter and receiver, compared with the far from linear "blackening curve" which corresponds to this). As regards sensitivity, about 2.5 lux are required during the $\frac{1}{25}$ th sec. exposure of the film: an iconoscope requires about 7 lux (3790 of 1937: see also 1070 of March) and the recent "semi-conductor" camera about $\frac{1}{2}$ lux (1946 of May): so that there is no great difference in the difficulty of the two problems as regards the provision of sufficient illumination on the subject.

The writer compresses so much into his five pages that there are no less than 32 literature references; many of these deal with colour photography and its allied subjects and have therefore not been dealt with in these Abstracts.

In a paper by Fayard & the writer (2481 of 1937) entitled "Special Properties of Oscillating Circuits coupled by Long Lines," many common circuits were treated, and for each of them formulae were established allowing the linear distortions of the modulated high frequencies to be calculated and the correcting processes to be indicated. "Each particular case being treated separately, the length and complexity of the calculations seems to us likely to constitute an obstacle to the popular use of the method indicated. For this reason we have set ourselves to establish a general theory leading to some simple relations. These will allow the engineer, in any particular case met with in practice, to arrive at the conditions necessary for minimum distortion. In the first part of this study we shall show the way in which linear and phase distortions spoiling the modulation are introduced as a result of the transmission circuits carrying the modulated high frequencies. We shall also calculate the importance of these distortions. In the second part we shall establish a group of relations allowing the rapid calculation of these distortions for all the various cases which may occur in practice, and shall show how they can be corrected." The treatment is not claimed to be the complete

solution of the problem: in particular, losses have been neglected throughout, the efficiencies of the various components being taken as equal to unity, which is far from being true in the case of the long feeders used in television.

3674. TELEVISION TRANSMISSION TECHNIQUE: III—THE DISTORTION OF A TELEVISION IMAGE BY THE ATTENUATION & TRANSIT-TIME DISTORTION OF THE TRANSMISSION PATH.—F. Ring. (*Funktech. Monatshefte*, June & July 1938, Supp. pp. 46-47 & 54-55.) The present instalment deals with carrier-frequency transmission over cable. For previous parts see 2875 of July and 3285 of August.
3675. COAXIAL CABLES [Discussion of Brillouin's Analysis of Effects of Irregularities, leading to Experiments on Tolerable Level of Consequent Parasitic Signals (Saphores): Self-Supporting Return Conductors, Styroflex and Drying-Out, Spiral Copper Conductors, etc. (Rühl): Diameters: Eiffel Tower Cable: etc.].—Société française des Électriciens. (*Rev. Gén. de l'Élec.*, 18th June 1938, Vol. 43, No. 25, pp. 789-799.) For Brillouin's paper see 2900 of July.
3676. MARCONI-T.C.M. HIGH-FREQUENCY CABLES.—Smith & O'Neill. (See 3585.)
3677. THE LONDON/BIRMINGHAM COAXIAL CABLE SYSTEM: PART IV—TEST RESULTS AND COMMERCIAL OPERATION.—Mumford. (See 3663.)
3678. ON SINGLE-CHANNEL SYNCHRONISING IN TELEVISION [for Interlaced Scanning: the Search for a Synchronising System combining the Necessary Vertical-Change Accuracy in Time with the Smallest Possible Susceptibility to Interference: Experiments leading to the New German Standard Signal: "Rückfront" Synchronisation].—von Oettingen, Urtel, & Weiss. (*TFT*, May 1938, Vol. 27, No. 5, pp. 158-166.)
- By the "rear-front" or "preparatory" process of synchronisation is meant one in which the mixture of synchronising signals is already so arranged at the transmitter that the "selecting" signal precedes, in time, the synchronising front; with the result that no special device is required at the receiving end to arrange this sequence. It is shown that with the "one-level" system employed (equal amplitudes for "vertical" and "horizontal" impulses) the full band width of the transmission channel can be made use of for the definition in time of the vertical change.
3679. SYNCHRONISATION IN TELEVISION TECHNIQUE [Discussion of Various Possible Methods, leading to the New German Standard Signals].—G. Faust. (*Funktech. Monatshefte*, June 1938, No. 6, Supp. pp. 41-43.) With literature references, including the papers by Banneitz (2872 of July) and von Oettingen & others (3678, above).
3680. STANDARDISATION OF THE SYNCHRONISING SIGNALS IN GERMAN TELEVISION BROADCASTING.—F. Banneitz. (*TFT*, May 1938, Vol. 27, No. 5, p. 157.) As 2872 of July.
3681. SYNCHRONISING IN TELEVISION [Use of "Sync-Separator" is Unnecessary with Gas-Triode Saw-Tooth Oscillators if Proper Precautions are taken].—C. Tibbs. (*Wireless World*, 21st July 1938, Vol. 43, pp. 46-48.)
3682. ANOTHER METHOD OF INTERLACING: HOW THE BARTHÉLÉMY SYSTEM WORKS.—Barthélémy. (*Television*, July 1938, Vol. 11, No. 125, pp. 395-396.) See also 3382 of 1937.
3683. THE DU MONT TELEVISION SYSTEM [with Actual Transmission of Scanning Voltages: Consequent Advantages—High Interlace Ratios, Simpler Receivers, etc.].—T. T. Goldsmith, Jr. (*Proc. Inst. Rad. Eng.*, June 1938, Vol. 26, No. 6, pp. 666-667: summary only.)
3684. SWEEP CIRCUIT [for Electrostatic or Electromagnetic Deflection, with Upper Frequency Limit about 100 kc/s (somewhat Higher than obtainable with Gaseous Tubes): Special Type of Multivibrator Circuit, using a Twin-Triode Valve: Possible Use as Multivibrator for generating Synchronising Impulses for Television].—J. L. Potter. (*Proc. Inst. Rad. Eng.*, June 1938, Vol. 26, No. 6, pp. 713-719.)
3685. FREQUENCY DIVISION BY VALVE GENERATORS AND RELAXATION-OSCILLATION GENERATORS.—Hudec. (See 3490.)
3686. THE RECORDING OF TELEVISION SIGNALS BY DIVISION OF FREQUENCY BAND INTO SEVERAL PARTS, EACH WITH ITS RECORDED TRACK: USING FREQUENCY SHIFTING, BEFORE RECORDING AND DURING REPRODUCTION, FOR THE HIGHER FREQUENCIES.—Etzold. (See 3657.)
3687. TRANSVERSE CONTROL OF A CATHODE-RAY BEAM INCLUDING THE EFFECT OF SCATTERING FIELDS [Theory].—H. E. Hollmann & A. Thoma. (*E.N.T.*, May 1938, Vol. 15, No. 5, pp. 145-153.)
- The scattering fields considered are those beyond the edges of the plate condenser or magnet poles with lines of force as shown in Fig. 1a. Their effect is discussed theoretically by using the approximations (1) of replacing them by the tangents at their points of inflexion (Hintenberger, 3120 of 1937); (2) of considering them as cubical parabolas; and (3) of considering that the field through which the electrons enter the transverse field increases linearly, while the exit field is a cubical parabola. The static sensitivity (§ 1) and the ultradynamic transverse control are calculated (§§ 2, 3); the static sensitivity is derived from the ultradynamic deviation formula (§ 5). The ultradynamic correction factor is calculated in § 6 and shown in Fig. 4 for parabolic scattering fields. § 7 deals with the ultradynamic deviation with asymmetrical scattering fields (Fig. 5). In § 8 the relations to Hintenberger's theory are discussed; the latter is

found to be only a special case of complicated general conditions.

3688. ELECTROSTATIC DEFLECTION [and the Causes and Elimination of Image Area Distortion and Astigmatism].—O. S. Puckle. (*Wireless World*, 28th April 1938, Vol. 42, pp. 375-376.)
3689. ELECTROSTATIC ELECTRON MULTIPLIER [with Particular Emphasis on Electron-Optical Aspect of Design: Electron Trajectories by Electrolytic Tank and by Sphere-on-Rubber-Membrane Device: etc.].—V. K. Zworykin & J. A. Rajchman. (*Proc. Inst. Rad. Eng.*, June 1938, Vol. 26, No. 6, p. 677: summary only.) For the rubber-membrane method see also 2884 of July.
3690. THE IMAGE ICONOSCOPE [Six to Ten Times Greater Sensitivity by Use of Electron Image of Scene, projected on to Scanned Mosaic, permitting Better Photocathodes and Secondary-Emission Image-Intensification at Mosaic], and RECENT IMPROVEMENTS IN THE DESIGN AND CHARACTERISTICS OF ICONOSCOPES [Recent Doubling or Trebling of Sensitivity and Picture-Signal Output: "Dark Spot" diminished by Cylindrical Envelope: Sandblasting of Mosaic: etc.].—Iams, Morton, & Zworykin: Janes & Hickok. (*Proc. Inst. Rad. Eng.*, June 1938, Vol. 26, No. 6, p. 668: pp. 668-669: summaries only.)
3691. CONTRAST IN KINESCOPES [Tests on Psychological Effect of Various Factors harmful to Contrast: Halation the Most Detrimental: Analytical Study of Halation, leading to Methods of Great Reduction: Experimental Confirmation].—R. R. Law. (*Proc. Inst. Rad. Eng.*, June 1938, Vol. 26, No. 6, pp. 669-670: summary only.)
3692. NEGATIVE-ION COMPONENTS IN THE CATHODE-RAY BEAM [studied by Mass-Spectrographic Methods: the Formation of "Black Spot" in Television Receiving Tubes: Efficiency of Clean-Up of "Batalum" Getter: Various Types of Screen Discolouration due to Negative Ions, Positive Ions, and Electrons: Formation of Latent Image on Bombarded Screen: etc.].—C. H. Bachman & C. W. Carnahan. (*Proc. Inst. Rad. Eng.*, May 1938, Vol. 26, No. 5, pp. 529-539.)
3693. RESOLVING LIMITS OF THE ELECTRON MICROSCOPE.—M. von Ardenne. (*Electronics*, June 1938, Vol. 11, No. 6, p. 60.) Summary of a paper in *Zeitschr. f. Physik*.
3694. INCANDESCENT PICTURES: RECENT PROGRESS [with Very Thin Tantalum Sheet].—L. S. Kaysie. (*Television*, July 1938, Vol. 11, No. 125, p. 406.)
3695. MEASUREMENTS AT COMPOSITE PHOTOCATHODES.—P. Görlich. (*Zeitschr. f. Physik*, No. 5/6, Vol. 109, 1938, pp. 374-386.)

The writer has already (1545 of April) described transparent alloy cathodes. He has now superposed these on composite caesium-oxide cathodes and measured the spectral distribution. The scheme of

the composite cells is shown in Fig. 2; Figs. 3-10 give the spectral distribution from the composite caesium-oxide cathode and from transparent (antimony or bismuth)/caesium films superposed on this composite cathode by two different methods. These curves show the presence of electrons from the lower layer although the stratified structure is practically unaltered. A discussion of the emission mechanism is given.

3696. CHARACTERISTICS OF THIN METALLIC FILMS [used as Front Electrode of Photocell, or where Photoelectric Effect on Back of Film is utilised: Research on Relation between Electrical Conductivity and Light Penetration, for Films of Different Kinds & Thicknesses].—Y. Saito. (*Electrot. Journ.*, Tokyo, July 1938, Vol. 2, No. 7, p. 171.)
3697. THE CONNECTION BETWEEN CONTACT POTENTIAL AND WORK FUNCTION.—W. Heinze. (*Zeitschr. f. Physik*, No. 7/8, Vol. 109, 1938, pp. 459-471.)

A discussion is first given of the difficulties occurring in measurement of the electron work function by the known methods. The contact potential and the work functions of two conductors, tungsten and tantalum, are then measured in the same valve and compared. The work function is determined from the emission equation by measuring the temperature variation of the saturation current extrapolated to a zero external field. The contact potential is measured as the voltage corresponding to the intersection of initial- and saturation-current characteristics. Fig. 1 shows the electrode arrangement, Fig. 2 the circuit. The correction to be applied to the contact potentials measured with cylindrical electrodes to obtain the value for a plane system is given in Fig. 4. Numerical results are given and confirm the theoretical relation between contact potential and work function.

3698. VIDEO AMPLIFIER DESIGN [and the Overcoming of Difficulties of Instability (Motor-Boating) and Mains-Voltage Fluctuations: Plate-Filtering and Automatic Cathode-Bias Circuits].—A. W. Barber. (*Communications*, June 1938, Vol. 18, No. 6, pp. 13 and 30.)
3699. TELEVISION I.F. AMPLIFIERS [First Detector Circuit: Sound I.F. Amplifier and Picture I.F. Amplifier (and the Use of Magnetite-Plug Tuning): etc.].—E. W. Engstrom & R. S. Holmes. (*Electronics*, June 1938, Vol. 11, No. 6, pp. 20-23.) One of a series of papers—cf. 2876 of July.
3700. WIDE-BAND AMPLIFIERS FOR TELEVISION [Max. Uniform Amplification obtainable by Single Valve is Much Greater than That given by Usual Simple Circuits: Wave-Filter Concepts leading to Practical Wide-Band Circuits].—H. A. Wheeler. (*Proc. Inst. Rad. Eng.*, June 1938, Vol. 26, No. 6, p. 676: summary only.)
3701. ULTRA-SHORT-WAVE HIGH-FIDELITY ADAPTOR [primarily for Television Sound Transmissions].—W. T. Cocking. (*Wireless World*, 12th May 1938, Vol. 42, pp. 419-422.)

3702. ON SIMPLIFYING THE R.F. CIRCUITS OF A TELEVISION RECEIVER.—A. A. Raspletin. (*Izvestiya Elektroprom. Slab. Toka*, No. 4, 1938, pp. 31-39.)

Various systems used in television receivers are discussed with a view to arriving at simplified r.f. circuits which would make such receivers more suitable for mass production. The following main conclusions are reached regarding vision reception:— (1) The most suitable circuit is one operating on the autodyne principle. (2) Aperiodic amplifiers should be used in the intermediate frequency system; the intermediate frequency should be so displaced with regard to the band width of the amplifiers as to suppress one of the side bands. (3) Amplification up to several volts should be used at the intermediate frequency; in addition several stages of video-frequency amplification should also be employed.

With regard to reception of the sound signals it is suggested that the greatest simplification would be obtained by the use of a separate receiver, although from a theoretical point of view a circuit with a common intermediate-frequency channel should be preferable.

3703. THE TYPE TK-1 TELEVISION RECEIVER.—N. I. Dozorov. (*Izvestiya Elektroprom. Slab. Toka*, No. 5, 1938, pp. 46-58.)

A detailed description of a television receiver incorporating a number of the latest circuits and devices ensuring high-quality reception, developed in Russia to meet the demand of such apparatus.

The following are brief particulars of the receiver:—

Over-all dimensions 102 × 63 × 39 cm; picture size (in a mirror) 18 × 14 cm; frequency range 40 to 84 Mc/s; band width at video frequencies 1.5 Mc/s; band width at audio frequencies 7000 c/s; sensitivity of the video channel 1 mv. Number of lines in the image 343; line frequency 8575; frame frequency 25. Separate intermediate frequency channels for sound and television signals, both with automatic volume control. Three stages of video-frequency amplification with two correcting circuits for higher frequencies. Three stages of audio-frequency amplification with a tone control. Each of the two scanning circuits comprises a blocking oscillator, discharge valve, amplifier, and various correcting circuits. The receiver employs 33 valves (including the cathode-ray tube) and is designed for a.c. mains operation; the total power consumption is of the order of 350 watts.

3704. OUTSIDE TELEVISION BROADCASTS.—T. C. Macnamara & D. C. Birkinshaw. (*Television*, July 1938, Vol. 11, No. 125, pp. 414-416.) Conclusion of the long summary referred to in 2870 of July.
3705. OUTSIDE BROADCASTS IN TELEVISION.—T. C. Macnamara. (*World-Radio*, 22nd July 1938, Vol. 27, pp. 10-11.)
3706. THE DERBY TELEVISION BROADCAST: HOW IT WAS DONE.—T. C. Macnamara. (*Television*, July 1938, Vol. 11, No. 125, pp. 409-410.)

3707. MECHANICAL TELEVISION PROVES ITSELF [Scophony Demonstration of Trooping of the Colour].—(*Television*, July 1938, Vol. 11, No. 125, p. 412.)

3708. THE TELEVISION DEMONSTRATIONS OF THE GERMAN STATE POST OFFICE AT THE INTERNATIONAL EXPOSITION, PARIS, 1937: PART II.—G. Flanze & A. Gebirts. (*Funktech. Monatshefte*, June 1938, No. 6, Supp. pp. 43-46.) For Part I see 3286 of August.
3709. WORLD RADIO CONVENTION, SYDNEY, NEW SOUTH WALES, APRIL 1938: ADDRESSES, NOTES ON PAPERS, ETC.—(*Rad. Review of Australia*, May 1938, Vol. 6, No. 5; *Rad. Retailer of Australia*, 8th & 15th April 1938, Vol. 14, Nos. 11 & 12.)
3710. "TELEVISION: A STRUGGLE FOR POWER" [based on Fights for Control in History of Wireless and the "Movies": Book Review].—Waldrop & Borkin. (*Electronics*, June 1938, Vol. 11, No. 6, p. 59.)
3711. A RADIO NEWSPAPER: NEW FACSIMILE APPARATUS FOR THE HOME [RCA Victor Equipment].—(*Television*, July 1938, Vol. 11, No. 125, pp. 388-389.) See also Adam, *Genie Civil*, 23rd July 1938, pp. 80-83.

MEASUREMENTS AND STANDARDS

3712. INTERNAL INDUCTANCE OF COILS AND ITS INFLUENCE ON THE TEMPERATURE COEFFICIENT OF THE COIL.—Tj. Douma. (*Philips Transmitting News*, June 1938, Vol. 5, No. 2, pp. 47-62.) Concluded from 2716 of July.
3713. A RIGID AND ELECTRICALLY UNIFORM LECHER-WIRE SYSTEM EMBEDDED IN TROLITUL.—Gundlach. (In paper dealt with in 3516, above.)
3714. A VERY ACCURATE HETERODYNE FREQUENCY METER WITH 20 KC/S-25 MC/S RANGE BASED ON FREQUENCY MULTIPLICATION AND DIVISION.—Golicke. (In paper dealt with in 3491, above.)
3715. A FREQUENCY METER WITH RANGE TO 1000 MC/S.—W. Guckenbug. (*Hochf. tech. u. Elek. akus.*, June 1938, Vol. 51, No. 6, pp. 189-190.)

This frequency meter (circuit Fig. 1) is based on the heterodyne method, and uses harmonics of the fundamental frequency up to the 100th for the measurement. They are obtained by multiplying the fundamental frequency, which can be varied in the ratio 1:2 and be distorted by over-control in a valve which also serves as a mixing valve, with a large negative bias so that the anode current consists of short impulses. The circuit is shorted so that the amplitudes of the harmonics do not decrease too rapidly. Constructional data are given (§ II); the instrument is calibrated so that the unknown wavelength is given as the difference of two neighbouring interference wavelengths (§ III). The attainable degree of accuracy is discussed (§ IV); the instrument may also be used to detect oscillations of very small intensity (§ V).

3716. FREQUENCY MEASURING EQUIPMENT [Type 482C: embodying High- and Medium-Frequency Interpolating Oscillators, Five Multivibrators and Synchronous Clock, Master Oscillator, and Power Supply: Four Methods of Use for Frequency Measurement, giving "Over-All Uncertainty" (Greater than Probable Error) ranging from 1 Part in 10^5 for Least Accurate to 5 Parts in 10^7 for Most Accurate Method].—N. Lea & K. R. Sturley. (*Marconi Review*, July/Sept. 1938, No. 70, pp. 1-11.)
3717. THE BRIDGE-STABILISED OSCILLATOR [Crystal-Controlled, of Extremely High Stability against Power Supply Fluctuations and Changes in Circuit Elements: during Long Trial Runs, No Short-Time Frequency Variations greater than ± 2 Parts in 100 Million].—L. A. Meacham. (*Proc. Inst. Rad. Eng.*, June 1938, Vol. 26, No. 6, pp. 670-671: summary only.)
3718. PIEZO-OSCILLATORS OF HIGH FREQUENCY STABILITY OBTAINED BY THE SIMULTANEOUS USE OF POSITIVE AND NEGATIVE FEEDBACK.—P. Pontecorvo. (*Alta Frequenza*, June 1938, Vol. 7, No. 6, pp. 365-381.)
Further development of the work dealt with in 3261 of 1937: for Vecchiacchi's paper, quoted, see 2923 of 1937. Author's summary: "A new type of piezo-oscillator is proposed, in which the voltage at the electrodes of the quartz is used to provide [current-controlled] negative feedback between the anode and grid circuits. It is shown how it is always possible to make the oscillator function on the series-resonance frequency of the quartz, and the paper discusses the dependence of the frequency variations on the various sources of instability (circuit elements, supply voltages, etc.). It is brought out that the oscillations produced are particularly free from harmonics, and it is shown how it is possible to obtain the curve of impedance of the quartz as a function of the frequency, and consequently the coefficient of resonance of the quartz plate employed. Finally, results obtained on an experimental model of the proposed circuit are described."
The circuit is particularly suitable for fairly low frequencies (10^5 c/s): owing to the smallness of the harmonic content, the frequency change produced by supply-voltage fluctuations is very small (10^{-8} for a 15% fluctuation of anode voltage).
3719. APPLICATION OF QUARTZ CRYSTALS TO A WAVE ANALYSER [with Experiments on 3-Electrode Crystal, leading to Equivalent Circuit and Applications].—L. B. Arguimbau. (*Proc. Inst. Rad. Eng.*, June 1938, Vol. 26, No. 6, pp. 659-660: summary only.)
3720. ON THE EFFECT OF A LAYER OF GOLD DEPOSITED ON A QUARTZ CRYSTAL ON THE LOGARITHMIC DECREMENT OF THE CRYSTAL.—V. I. Ust'yanov. (*Izvestiya Elektroprom. Slab. Toka*, No. 4, 1938, pp. 44-48.)
A report on an experimental investigation carried out in connection with the preparation of a frequency standard. Layers of gold of various thicknesses were deposited on a crystal by cathode sputtering, and for each layer (19 layers in all were experimented with) the logarithmic decrement δ was determined by the resonance method, i.e. by exciting the crystal with a band of frequencies containing the resonant frequency of the crystal. The circuit developed for this purpose is described and the formula used for calculating δ is quoted. The results obtained are given in a table and a curve is plotted (Fig. 5) showing the relationship between δ and the thickness of the layer of gold.
3721. THE VELOCITY OF PROPAGATION OF ELASTIC WAVES IN PIEZOELECTRIC CRYSTALS [Calculations giving Formula for Velocity, and Numerical Value for Product of Frequency and Thickness of Plate].—E. Baumgardt. (*Comptes Rendus*, 20th June 1938, Vol. 206, No. 25, pp. 1887-1890.) For previous work see 2855 of July.
3722. "PIEZOELEKTRIZITÄT DES QUARZES" [Book Review].—A. Scheibe. (*Zeitschr. f. tech. Phys.*, No. 7, Vol. 19, 1938, p. 215.)
3723. INTERNAL FRICTION IN SOLIDS: V—GENERAL THEORY OF MACROSCOPIC EDDY CURRENTS [in Vibrating Ferromagnetic Metals: Calculations for All Frequencies for Longitudinal and Transverse Vibrations].—C. Zener. (*Phys. Review*, 15th June 1938, Series 2, Vol. 53, No. 12, pp. 1010-1013.)
3724. A BEARING-TYPE HIGH-FREQUENCY ELECTRODYNAMIC AMMETER [Oscillating-Ring Ammeter (Turner & Michel) with Quartz-Fibre Suspension replaced by Special Jewel Bearings: used with Photoelectric Oscillation Timer: Calibration: Use for Standard of Current (Performance calculable from Measurements of Length, Mass, & Time): for plotting Frequency Characteristics (up to 42 Mc/s) of Thermocouple-Ammeters: etc.].—H. R. Meahl. (*Proc. Inst. Rad. Eng.*, June 1938, Vol. 26, No. 6, pp. 734-744.) For Turner & Michel's paper see 1106 of March.
3725. A METHOD OF SHORT-WAVE FIELD-INTENSITY MEASUREMENT BASED UPON SINGLE HALF-WAVELENGTH ANTENNA.—Nakagami & Miya. (*Nippon Elec. Comm. Eng.*, April 1938, No. 10, p. 191.) See also 2759 of July.
3726. A STABILISED AMPLIFIER FOR MEASUREMENT PURPOSES [Original Calibration (with Associated Indicating Instruments) maintained within Two-Tenths per Cent of Full Scale over Eight Weeks' Use: Two Stabilising Feedbacks employed, Independent but Complementary].—H. A. Thompson. (*Elec. Engineering*, July 1938, Vol. 57, No. 7, pp. 379-384.) Including a Discussion.
3727. SOME APPLICATIONS OF NEGATIVE FEEDBACK, WITH PARTICULAR REFERENCE TO LABORATORY EQUIPMENT [e.g. Direct-Reading Voltmeter consisting of Amplifier/Thermocouple Combination, with Feedback stabilising the Current through Thermocouple: Production of Stabilised Negative Resistances with Various Applications: etc.].—Terman, Buss, Hewlett, & Cahill. (*Proc. Inst. Rad. Eng.*, June 1938, Vol. 26, No. 6, pp. 674-675: summary only.)

3728. MODULATION-DEPTH MEASURING INSTRUMENT [particularly for the Measuring Signal of a Signal Generator : Simple Diode Method as Substitute for Cathode-Ray Oscillograph].—Philips Company. (*Electronics*, June 1938, Vol. II, No. 6, p. 62 and 64, 66.) Summary of a *Philips Setmakers' Bulletin* article.
3729. CAPACITANCE AND POWER-FACTOR TESTING EQUIPMENT [with Uniformity of Scale Accuracy over Wide Range, by Use of Truly Logarithmic Standard of Capacitance with Multiplying Ratio Arms].—H. W. Sullivan, Ltd. (*Journ. Scient. Instr.*, July 1938, Vol. 15, No. 7, pp. 240-241.)
3730. AN APPARATUS FOR DETERMINING THE ELECTRICAL VOLUME RESISTIVITY OF INSULATING GLASSES [by Balanced-Current (Null) Method].—E. Seddon. (*Journ. Scient. Instr.*, July 1938, Vol. 15, No. 7, pp. 226-231.)
3731. ALL-WAVE MODULATED TEST OSCILLATOR [10-2000 m, by 6-Position Ganged Switch : Constructional Details].—(*Wireless World*, 5th May 1938, Vol. 42, pp. 392-394.)
3732. CHOKE AND TRANSFORMER TESTING [Routine Factory Methods].—(*Wireless World*, 30th June 1938, Vol. 42, pp. 570-571.)
3733. NEW POSSIBILITIES FOR ELECTRICAL MEASURING INSTRUMENTS [by Use of New Permanent-Magnet and High-Permeability Materials, Ceramic Dielectrics, etc.].—K. Fischer. (*E.T.Z.*, 2nd June 1938, Vol. 59, No. 22, pp. 593-594 : summary only.)
3734. ELECTRICAL CONTROL OF GALVANOMETER CHARACTERISTICS [Three Rheostats control Effective Stiffness of Suspension, Effective Damping, and Effective Moment of Inertia].—O. H. Schmitt. (*Journ. Scient. Instr.*, July 1938, Vol. 15, No. 7, pp. 234-237.)
3735. AMPLIFIER-DETECTOR WITH LUMINOUS INDICATION, FOR USE AS ZERO-INDICATOR FOR BRIDGE MEASUREMENTS [using the 6E5 "Magic Eye" : for Voltages of a Few Millivolts and Frequencies 50 c/s to 100 kc/s]. A. Ferrari-Toniolo. (*Alta Frequenza*, June 1938, Vol. 7, No. 6, pp. 427-432.)
3736. BRIDGED-T AND PARALLEL-T NULL CIRCUITS FOR MEASUREMENTS AT RADIO FREQUENCIES [with Certain Advantages over Bridge Circuits].—W. N. Tuttle. (*Proc. Inst. Rad. Eng.*, June 1938, Vol. 26, No. 6, p. 675 : summary only.)
3737. "RADIO-FREQUENCY ELECTRICAL MEASUREMENTS" [Book Review].—H. A. Brown. (*Television*, July 1938, Vol. II, No. 125, p. 408.)
- SUBSIDIARY APPARATUS AND MATERIALS**
3738. ELECTROLYTIC FIELD-PLOTTING TROUGH FOR CIRCULARLY SYMMETRIC SYSTEMS.—Bowman-Manifold & Nicoll. (*Nature*, 2nd July 1938, Vol. 142, p. 39.)
3739. RESOLVING LIMITS OF THE ELECTRON MICROSCOPE.—von Ardenne. (*Electronics*, June 1938, Vol. II, No. 6, p. 60.) Summary of a paper in *Zeitschr. f. Physik*.
3740. TRANSVERSE CONTROL OF A CATHODE-RAY BEAM INCLUDING THE EFFECT OF SCATTERING FIELDS.—Hollman & Thoma. (See 3687.)
3741. NEGATIVE-ION COMPONENTS IN THE CATHODE-RAY BEAM.—Bachman & Carnahan. (See 3692.)
3742. THE INTERACTION BETWEEN AN ELECTRON BEAM AND A PLASMA [Analysis of Dynamic Behaviour of Plasma by Effect on Beam of Intensity So Small that Interaction between Beam Electrons may be Neglected : Change in Energy of Beam Electrons comes from Plasma Electrons only].—Druyvesteyn. (*Physica*, July 1938, Vol. 5, No. 7, pp. 561-567 : in English.)
3743. THE PASSAGE OF ELECTRONS THROUGH AN ELECTRICAL CYLINDER LENS [designed to pass the Whole Stream through a Slit].—Gaedcke. (See 3595.)
3744. ELECTROSTATIC DEFLECTION [and the Causes and Elimination of Image Area Distortion and Astigmatism].—Puckle. (*Wireless World*, 28th April, 1938, Vol. 42, pp. 375-376.)
3745. APPLICATIONS OF CATHODE-RAY TUBES : II [including the Recording of Several Curves on One Oscillogram].—van Suchtelen. (*Philips Tech. Review*, May 1938, Vol. 3, No. 5, pp. 148-152.)
3746. CATHODE - RAY TUBE APPLICATIONS.—Batcher. (*Electronics*, June 1938, Vol. II, No. 6, p. 69.) Notice of an article in *Instruments*.
3747. INCREASE OF THE RESOLVING POWER OF THE MASS SPECTROGRAPH [by replacing Object Slit by Diminished Image of a Slit produced by Small Radial Electric Field before Usual Electric Field : Theory giving Conditions for Double Focusing and Attainable Resolving Power].—Herzog & Hauk. (*Physik. Zeitschr.*, 15th June 1938, Vol. 39, No. 12, pp. 463-466.)
3748. DYNAMIC CHARACTERISTICS OF GLOW DISCHARGE TUBES [Oscillographs for Various Current Wave Forms : Explanation of Form of Characteristics on Basis of Time Taken for Ionisation and Deionisation of Gas].—Reich & Depp. (*Journ. of Applied Physics*, June 1938, Vol. 9, No. 6, pp. 421-426.)
3749. A NEW TRANSIENT VISUALISER [avoiding the Defect (Indistinctness of Starting Portion of Trace of Rapidly Varying Transient) of Usual Arrangement where Time-Sweep and Transient-Generating Voltages are both produced by Same Relaxation Oscillator].—Fukuda. (*Electrot. Journ.*, Tokyo, July 1938, Vol. 2, No. 7, p. 170.)

3750. OBSERVATION OF DUPLEX PHENOMENA [on Cathode-Ray Oscillograph: e.g. Input & Output Voltages of an A.F. Amplifier: Two Amplifier Valves biased alternately by Rectangular-Wave-Form Voltage from Multi-vibrator].—Chiba & Oka. (*Electrot. Journ.*, Tokyo, July 1938, Vol. 2, No. 7, p. 170.) Further: if, instead of a linear sweep-voltage for the horizontal time base, another voltage under examination is used, two Lissajous' figures can be obtained.
3751. A SWEEP CIRCUIT USING A TWIN-TRIODE VALVE, WITH UNUSUALLY HIGH MAXIMUM FREQUENCY.—Potter. (See 3684.)
3752. THE REPRESENTATION OF TCHEBICHEFF FUNCTIONS OF ANY ORDER BY MEANS OF LISSAJOUS' FIGURES.—Blau. (See 3808.)
3753. CATHODE SPUTTERING [and Its Variation with Residual-Gas Pressure: Existence of a Pressure giving Maximum Sputtering: Zone Formation: Sputtered Particles form a Pseudo-Gas: Preparation of Thin Metallic Films: etc.].—Bose. (*Indian Journ. of Phys.*, April 1938, Vol. 12, Part 2, pp. 95-108.)
3754. CHARACTERISTICS OF THIN METALLIC FILMS.—Saito. (See 3696.)
3755. THE SEALING OF METAL LEADS THROUGH HARD GLASS AND SILICA.—Jonas. (*Philips Tech. Review*, April 1938, Vol. 3, No. 4, pp. 119-124.)
3756. A NEW TYPE VACUUM SEAL [Lead-In Structure using Porcelain Bushings sealed to Kovar (Fenico) by a Glass serving as Bonding Agency].—Bahls. (*Elec. Engineering*, July 1938, Vol. 57, No. 7, pp. 373-378.)
3757. "GLASS WORKING FOR LUMINOUS TUBES" [also Useful in Field of Valve Construction: Book Review].—Eccles. (*Electronics*, June 1938, Vol. 11, No. 6, p. 59.)
3758. FLUORESCENCE [a Survey of Its Phenomena].—de Groot. (*Philips Tech. Review*, May 1938, Vol. 3, No. 5, pp. 125-132.)
3759. PHOTOLUMINESCENT PROPERTIES OF SYNTHETIC FLAVINE.—Dhéré & Castelli. (*Comptes Rendus*, 27th June 1938, Vol. 206, No. 26, pp. 2003-2005.)
3760. OSCILLOGRAPH-DESIGN CONSIDERATIONS.—Mezger. (*Proc. Inst. Rad. Eng.*, June 1938, Vol. 26, No. 6, p. 671: summary only.)
3761. OSCILLOGRAPH FILM CAMERA FOR BRIEF RECORDS.—Small. (*Journ. Scient. Instr.*, July 1938, Vol. 15, No. 7, pp. 238-239.)
3762. PROGRESS IN HIGH-FREQUENCY CINEMATOGRAPHY [Survey].—Thun. (*Zeitschr. V.D.I.*, 4th June 1938, Vol. 82, No. 23, pp. 697-700.)
3763. D.C. AMPLIFIER WITH A STANDARD TUBE [for Measurement of Ionisation Currents down to 10^{-13} A: Reasons for Choice of Type 1-A-6 (Stable Emission—No Oxide-Coated Cathode—Correct Arrangement of Grids, with Input Grid led-out at Top): etc.].—Tatel, Moncton, & Luhr. (*Review Scient. Instr.*, July 1938, Vol. 9, No. 7, pp. 229-230.)
3764. A STABILISED AMPLIFIER FOR MEASUREMENT PURPOSES.—Thompson. (See 3726.)
3765. BARRETTERS [Mathematical and Practical Treatment].—Mulder. (See 3572.)
3766. THE VOLTAGE STABILISATION OF MAINS-DRIVEN APPARATUS UNDER VARYING LOAD [where Currents are Too Large for Use of Glow-Discharge Stabilisers (e.g. Modulation Systems for Television): Some Valve Circuits and Their Advantages and Disadvantages].—Bastelberger. (*Funktech. Monatshefte*, June 1938, No. 6, pp. 161-165.) It is first assumed that the mains voltage itself is steady; but at the end of the paper the case where this also is subject to fluctuation is considered.
3767. METHODS FOR THE PARAMETRIC STABILISATION OF VOLTAGES AND CURRENTS [Survey of Methods based on Temperature-Coefficient of Materials, Gaseous-Discharges, and Valves: the Use of Special Volt/Ampere Characteristics for Investigation of Systems with Non-Linear Elements].—Mikhailov. (*Automatics & Telemechanics* [in Russian], No. 1, 1938, pp. 45-66.)
3768. COPPER-OXIDE RECTIFIERS OF SOVIET MANUFACTURE FOR FILAMENT AND ANODE SUPPLIES TO RADIO TRANSMITTERS.—M. A. Spitsyn. (*Izvestiya Elektroprom. Slab. Toka*, No. 4, 1938, pp. 19-23.) After a brief survey of the theory of copper-oxide rectifiers a description is given of the 4 kv, 1 A and 36 v, 225 A rectifier units developed in Russia.
3769. DRY-PLATE RECTIFIERS OF LARGE OUTPUT IN COMMUNICATION TECHNIQUE [e.g. for Filament-Heating and Anode Supply of Radio Transmitters].—Maier. (*Zeitschr. f. Fernmeldetechn.*, 16th May 1938, Vol. 19, No. 5, pp. 71-73.)
3770. RECTIFIER FILTER DESIGN.—Scott. (See 3494.)
3771. IRON-CORED COILS IN HIGH-FREQUENCY TECHNIQUE [including the AEG Two-Part "X" Core for Fine Adjustment].—Kiessling & Wolff. (*TFT*, April 1938, Vol. 27, No. 4, pp. 145-146.)
3772. SOME NOTES ON IRON-DUST CORED COILS AT RADIO FREQUENCIES.—Austin & Oliver. (See 3570.)
3773. SPONTANEOUS EVOLUTION OF THE MAGNETIC PROPERTIES OF FERRIC HYDROXIDE [occurs more rapidly with increased Basicity of Medium].—Chevallier & Mathieu. (*Comptes Rendus*, 27th June 1938, Vol. 206, No. 26, pp. 1955-1958.)

3774. A SIMPLE MAGNETIC APPARATUS FOR PHASE-TRANSFORMATION STUDIES OF FERROUS ALLOYS.—Buehl & Wulff. (*Review Scient. Instr.*, July 1938, Vol. 9, No. 7, pp. 224-228.)
3775. MAGNETIC ANISOTROPY OF FERROMAGNETIC CRYSTALS IN WEAK FIELDS AND REVERSIBLE SUSCEPTIBILITY [Calculations].—Kondorsky. (*Phys. Review*, 15th June 1938, Series 2, Vol. 53, No. 12, p. 1022.)
3776. CONTROL OF MAGNETIC QUALITY BY SURFACE TREATMENT.—Wall. (*Engineer*, 17th June 1938, Vol. 165, pp. 667-669: to be continued.)
3777. ON LOSSES IN MAGNETIC MATERIALS [New Investigations on the Changes in the "After Effect" (Viscosity) Losses in a Mechanically Treated Alloy as the Internal Tensions and Inhomogeneities are removed by Heating].—Goldschmidt. (*Helvetica Phys. Acta*, Fasc. 4, Vol. 11, 1938, pp. 329-338: in German.)
3778. HIGH-FREQUENCY WORKING ATTENUATION OF LAMINATED-CORE TRANSFORMERS.—Erb. (See 3499.)
3779. AN APPARATUS FOR DETERMINING THE ELECTRICAL VOLUME RESISTIVITY OF INSULATING GLASSES [by Balanced-Current (Null) Method].—Seddon. (*Journ. Scient. Instr.*, July 1938, Vol. 15, No. 7, pp. 226-231.)
3780. LIFE OF IMPREGNATED PAPER CONDENSERS [Limitations of the Inverse Fifth Power Formula published by Dubilier Corporation].—Katzman. (*Electronics*, June 1938, Vol. 11, No. 6, p. 54.)
3781. THE PREPARATION OF ELECTRICAL INSULATING FOILS FROM SYNTHETIC MATERIALS, and EXPERIENCES WITH WIRE INSULATING VARNISHES ON A SYNTHETIC RESIN BASE.—Hagedorn: Nowak. (*Chemiker-Zeitung*, 9th July 1938, Vol. 62, No. 55, pp. 491-492: summaries only.)
3782. VDE PROVISIONAL SPECIFICATIONS, ETC., FOR MICA PRODUCTS.—(*E.T.Z.*, 30th June 1938, Vol. 59, No. 26, pp. 705-707.)
3783. THE ADSORPTION OF VAPOUR AT PLANE SURFACES OF MICA: II—HEATS OF ADSORPTION AND THE STRUCTURE OF MULTIMOLECULAR FILMS.—Bangham & Mosallem. (*Proc. Roy. Soc.*, 16th June 1938, Vol. 166, No. A.927, pp. 558-571.)
3784. RECENT DEVELOPMENTS IN ELECTRICAL INSULATING MATERIALS [Ebonites with Little Surface Deterioration by Light: "Loaded" Ebonites (Relatively Low Power-Factor when loaded with Silica): Synthetic Resins (including "Perspex"): Ceramics: Liquids & Waxes].—Hartshorn. (*Journ. Scient. Instr.*, July 1938, Vol. 15, No. 7, pp. 217-222.)
3785. VOLTAGE/TIME CHARACTERISTICS OF PHENOL RESINS [Regular Results obtained by Author's New Method, suitable for Commercial Purposes].—M. Yokoyama. (*Electrol. Journ.*, Tokyo, July 1938, Vol. 2, No. 7, p. 172.)

STATIONS, DESIGN AND OPERATION

3786. AN UNUSUAL ULTRA-SHORT-WAVE TELEPHONE LINK [between Observatory on Mount Palomar (S. California) and the 145 km Distant California Institute of Technology (Pasadena): Comparison of Vertical & Horizontal Polarisation: etc.].—Bell Tel. Laboratories. (*Funktech. Monatshefte*, June 1938, No. 6, pp. 189-190: long summary only.) The optical path is blocked by several peaks of an intervening mountain range.
3787. TELEPHONE COMMUNICATION FOR THE SCILLY ISLANDS [including the St. Just/St. Mary's Ultra-Short-Wave Teleprinter/Telephone Circuits].—Barker & Shearing. (*P.O. Elec. Eng. Journ.*, July 1938, Vol. 31, Part 2, pp. 101-103.)
3788. THE INTRODUCTION OF ULTRA-SHORT-WAVE RADIO LINKS INTO THE TELEPHONE NETWORK.—Mumford & Thorn. (*P.O. Elec. Eng. Journ.*, July 1938, Vol. 31, Part 2, pp. 93-100.)
3789. TWO TO FIVE TIMES INCREASE OF SIGNALS IN U-S-W POLICE WIRELESS BY USING VERTICAL-ROD AERIAL FOR RECEPTION AS WELL AS TRANSMISSION, WITH HELP OF CONCENTRIC NARROW - BAND - ELIMINATION FILTER.—Leeds. (See 3485.)
3790. SERVING THE FISHING FLEETS [Apparatus at G.P.O. Wick Radio Station: Multi-Channel Working].—Ainslie. (*Wireless World*, 9th June 1938, Vol. 42, pp. 504-506.)
3791. A SHORT-WAVE SINGLE-SIDE-BAND RADIO-TELEPHONE SYSTEM [for Transoceanic Service].—Oswald. (*Proc. Inst. Rad. Eng.*, June 1938, Vol. 26, No. 6, p. 673: summary only.) See also 3546, above.
3792. THE APPLICATION OF A CONSTANT-VOLUME AMPLIFIER TO A SHORT-WAVE SINGLE-SIDE-BAND TRANSATLANTIC RADIO CIRCUIT [to compensate for Fading (often Selective) not controllable by Ordinary Automatic Gain Control: Tests on "Relay & Selector" Type (as used on the "Auto Technical Operator") and "Valve & Rectifier" Type].—Arman & Hutton-Penman. (*P.O. Elec. Eng. Journ.*, July 1938, Vol. 31, Part 2, pp. 104-107.)
3793. THE TRANSMISSION OF TELEGRAPH SIGNALS BY THE IMPULSE SYSTEM IN LONG-DISTANCE WIRELESS COMMUNICATION [for the Elimination of Fading and Echo Errors in Printing Telegraphy: Useful Output of a Transmitter multiplied 5 to 10 Times].—E. Hudec. (*TFT*, April 1938, Vol. 27, No. 4, pp. 119-129.)

Based on the principle of transmitting only the

beginning and end of a signal, originally applied by the writer to the elimination of the same troubles in phototelegraphy (1537 of April and 1977 of May.)

3794. ELIMINATION OF BROADCAST-STATION CARRIER BEATS [between Stations on Same Channel; seldom exceed Few Cycles per Second but cause Severe "Flutter": Only Remedy is to eliminate Last Trace of Difference in Carrier Frequencies: Suggested Continuous Emission, from Governmental Central Station, of 100 kc/s Master Oscillation to replace (after Necessary Frequency Transformation) All Local Oscillators: Other Valuable Uses—Television & Facsimile Synchronisation, etc.].—Friend. (*Proc. Inst. Rad. Eng.*, June 1938, Vol. 26, No. 6, pp. 786-787.)
3795. FACTORS AFFECTING THE SELECTION OF A RADIO-BROADCASTING-TRANSMITTER LOCATION.—Lodge. (*Proc. Inst. Rad. Eng.*, June 1938, Vol. 26, No. 6, p. 760: summary only.)
3796. BROADCASTING STATIONS POSTE DE PARIS P.T.T. (VILLEBON) AND POSTE RADIO-MONDIAL (ESSARTS-LE-ROI: SHORT-WAVE).—(*L'Onde Elec.*, June 1938, Vol. 17, No. 198, pp. 321-323.)
3797. THE ROME BROADCASTING CENTRE FOR MEDIUM WAVES, SANTA PALOMBA [Two Separate Transmitters for Different Waves, with Provision for Combining to form One 500 kW (Aerial Power) Transmitter: Series Modulation: Negative Feedback for Correction of Distortion: Power Supply: Aerial & Earth System: etc.].—Banfi. (*Alta Frequenza*, June 1938, Vol. 7, No. 6, pp. 382-417.)
3798. BROADCASTING STATIONS LS-I, BUENOS AIRES.—Coram & others. (*Elec. Communication*, July 1938, Vol. 17, No. 1, pp. 66-71.)
3799. FOUR SHORT-WAVE BROADCAST TRANSMITTERS, TYPE KVFH 10/12A, FOR BRITISH INDIA.—(*Philips Transmitting News*, June 1938, Vol. 5, No. 2, pp. 42-46: in German & English concurrently.)
3800. L.M.T. LABORATORIES 7-FREQUENCY RADIO-PRINTER.—Devaux & Smets. (*Elec. Communication*, July 1938, Vol. 17, No. 1, pp. 22-34.) See also 3414 of August.
3801. A VOGAD FOR RADIOTELEPHONE CIRCUITS [Voice-Operated Gain-Adjusting Device to allow for Amplitude Variations due to Characteristics of Lines and Individual Voices].—Wright, Doba, & Dickieson. (*Proc. Inst. Rad. Eng.*, June 1938, Vol. 26, No. 6, p. 677: summary only.)
3802. PROGRAMME METERS.—Mayo. (*World-Radio*, 24th June 1938, Vol. 26, pp. 10-11.)
3803. THE BATTLE OF CAIRO: AMERICAN AMATEURS RETAIN ALL FREQUENCIES AFTER TERRIFIC FIGHT... EUROPEAN HAMS SHORT-CHANGED BY GREEDY GOVERNMENTS: EUROPEAN BROADCASTING INVADES 7 Mc/s BAND IN LATE 1939.—Warner & Segal. (*QST*, July 1938, Vol. 22, No. 7, pp. 9-12 and 45-46, 104, 106.)
3804. SOME RESULTS OF THE CAIRO CONFERENCE ON RADIOCOMMUNICATIONS, and CAIRO TELECOMMUNICATION CONFERENCES.—(*Bull. Assoc. suisse des Elec.*, No. 11, Vol. 29, 1938, pp. 282-285: *Elec. Communication*, July 1938, Vol. 17, No. 1, pp. 3-15.)

GENERAL PHYSICAL ARTICLES

3805. THE ETHER—FACT OR FICTION? [Researches on Spectra produced by High-Speed Hydrogen Ions], and AN EXPERIMENTAL STUDY OF THE RATE OF A MOVING ATOMIC CLOCK.—Ives: Ives & Stilwell. (*Electronics*, June 1938, Vol. 11, No. 6, pp. 13-15: *Journ. Opt. Soc. Am.*, July 1938, Vol. 28, No. 7, pp. 215-226.)
3806. ABSOLUTE DEFINITION OF THE MODULUS OF ELASTICITY.—Labocchetta. (*La Ricerca Scient.*, 15th/31st May 1938, Series 2, 9th Year, Vol. 1, No. 9/10, pp. 492-494.)
3807. A NEW [Mechanical] DEMONSTRATION OF THE PHENOMENON OF BEATS.—Richards. (*Proc. Phys. Soc.*, 1st July 1938, Vol. 50, Part 4, No. 280, pp. 616-617: Demonstration.)

MISCELLANEOUS

3808. THE REPRESENTATION OF TSCHEBYSCHIEFF [Tchebicheff] Functions of Any Order by means of Lissajous' Figures.—Blum. (*Zeitschr. f. tech. Phys.*, No. 7, Vol. 19, 1938, pp. 187-194.)
- Author's summary:—This work deals with the well-known Lissajous' figures. The parametrical equations are first transformed into their mathematical form, and some special cases of the curve equations for various frequency ratios are discussed. The Lissajous' figures are then described as the projections of a revolving glass cylinder on which sine curves are marked.
- The derivation and application of Tchebicheff polynomials [see for example 3267 of 1935] are described briefly, and their representation as a special projection case of the glass cylinder is explained. Between Lissajous' figure and Tchebicheff polynomial there thus exists a mathematical connection, which is used graphically in a very simple way to represent in a complete state Tchebicheff polynomials which ordinarily can only be obtained point by point by elaborate calculation. The Lissajous' figures give easily not only the well-known Tchebicheff polynomials [which are of integral orders] but also other, far more general expressions which we will call "Tchebicheff functions" [since they yield, on working out numerically, series of hypergeometrical type, and therefore cannot be called polynomials] and which are almost impossible to obtain by calculation. The process

- for the plotting of the functions and polynomials is described more fully and illustrated and discussed with the help of some examples.
3809. PROOFS OF SOME FORMULAE FOR THE GENERALISED HYPERGEOMETRIC FUNCTION AND CERTAIN RELATED FUNCTIONS.—Mac-Robert. (*Phil. Mag.*, July 1938, Series 7, Vol. 26, No. 173, pp. 82-93.)
3810. "ANGLE-TRUE" OR "CONFORMAL" REPRESENTATION [and Its Use in Communication Engineering].—Schulz. (*TFT*, April & May 1938, Vol. 27, Nos. 4 & 5, pp. 146-154 and 191-197.)
3811. THE ANALYTICAL GEOMETRY OF "ACROGRAMS" [Curves of the Extremities of Vectors] APPLICABLE TO THE REPRESENTATION OF THE RÉGIMES OF ALTERNATING-CURRENT APPARATUS.—Blondel. (*Rev. Gén. de l'Élec.*, 11th, 18th, & 25th June 1938, Vol. 43, Nos. 24, 25, & 26, pp. 739-750, 773-785, & 803-818.)
3812. "BRITISH ASSOCIATION FOR THE ADVANCEMENT OF SCIENCE: MATHEMATICAL TABLES: VOL. 6—BESSEL FUNCTIONS, PART I" [Book Review].—(*Zeitschr. f. tech. Phys.*, No. 7, Vol. 19, 1938, p. 213.)
3813. THE GRAPHICAL SOLUTION OF ORDINARY DIFFERENTIAL EQUATIONS [satisfying Given Initial Conditions: Equations of Applied Mathematics].—Bailey & Somerville. (*Phil. Mag.*, July 1938, Series 7, Vol. 26, No. 173, pp. 1-31.)
3814. ON THE THEORY OF A NON-LINEAR PARTIAL DIFFERENTIAL EQUATION OF THE ELLIPTIC-PARABOLIC TYPE [treated by Writer's "Fourier Method" for Unique Solution].—Siddiqi. (*Indian Journ. of Phys.*, April 1938, Vol. 12, Part 2, pp. 109-119.)
3815. "LE CALCUL SYMBOLIQUE D'HEAVISIDE ET SES APPLICATIONS A L'ÉLECTROTECHNIQUE" [Book Reference].—Janet. (*Rev. Gén. de l'Élec.*, 9th July 1938, Vol. 44, No. 2, p. 60.)
3816. AN OPERATIONAL [Laplacian Transform] TREATMENT OF NON-LINEAR DYNAMICAL SYSTEMS.—Pipes. (See 3489.)
3817. HERTZ, THE DISCOVERER OF ELECTRIC WAVES.—Blanchard. (*Proc. Inst. Rad. Eng.*, May 1938, Vol. 26, No. 5, pp. 505-515.)
3818. WORLD RADIO CONVENTION, SYDNEY, NEW SOUTH WALES, APRIL 1938: ADDRESSES, NOTES ON PAPERS, ETC.—(*Rad. Review of Australia*, May 1938, Vol. 6, No. 5: *Rad. Retailer of Australia*, 8th & 15th April 1938, Vol. 14, Nos. 11 & 12.)
3819. THE ACTIVITIES OF THE PHYSIKALISCH-TECHNISCHE REICHSANSTALT IN THE YEAR 1937.—Erk. (*Zeitschr. V.D.I.*, 9th July 1938, Vol. 82, No. 28, pp. 829-832.)
3820. "FORSCHUNG UND PRÜFUNG: 50 JAHRE PHYSIKALISCH-TECHNISCHE REICHSANSTALT" [Research and Testing: Book Review].—Stark (Edited by). (*Zeitschr. f. tech. Phys.*, No. 7, Vol. 19, 1938, p. 213.)
3821. THE 40TH MEETING OF THE VDE, COLOGNE, MAY 1938: PAPERS READ BEFORE THE TECHNICAL GROUPS.—(*E.T.Z.*, 23rd June 1938, Vol. 59, No. 25, pp. 670-682.)
3822. THE "VOLPI CENTRE OF ELECTROLOGY": A NEW INSTITUTION FOR THE IMPROVEMENT OF ELECTRICAL KNOWLEDGE BY CULTURAL EXCHANGES BETWEEN ITALIAN AND FOREIGN SCIENTISTS.—(*Bollettino del Centro Volpi di Elettrologia*, English Edition, March 1938, Vol. 1, No. 1.) This Bulletin contains English summaries of recent Italian researches. The Centre has been founded by Count Volpi di Misurata, who "has presented the magnificent Vendramin-Calergi Palace in Venice to serve as its home."
3823. THE RÔLE OF THE ENGINEERING LIBRARY: WHAT SHOULD IT CONTAIN AND HOW SHOULD IT BE USED?—Craver. (*Elec. Engineering*, July 1938, Vol. 57, No. 7, pp. 291-294.)
3824. MAXIMUM CONVENIENCE IN CITATIONS [from Scientific Periodicals].—Shields. (*Science*, 1st July 1938, Vol. 88, pp. 11-12.)
3825. THE ECONOMIC STATUS OF THE ENGINEER [including U.S.A. Bureau of Labour Statistics].—Sorensen. (*Elec. Engineering*, July 1938, Vol. 57, No. 7, pp. 281-285.)
3826. THE BROADCASTING ACADEMY IS COMING!—(*Rad., B., F. für Alle*, June 1938, No. 196, pp. 89-90.) Based on Kriegler's recent address on the training of personnel.
3827. ANNUAL ENERGY CONSUMPTION OF BROADCAST RECEIVERS AND BROADCASTING STATIONS IN GERMANY [267 Million and 5.8 Million Kilowatt-Hours respectively].—Dennhardt. (*Rad., B., F. für Alle*, June 1938, No. 196, p. 103: summary only.)
3828. EXPERIMENTAL INVESTIGATIONS ON THE PHOTOMODULATION OF A.C.-HEATED INCANDESCENT LAMPS IN THE AUDIO-FREQUENCY RANGE.—H. Köhler. (*E.N.T.*, May 1938, Vol. 15, No. 5, pp. 154-161.)
- For theoretical work see 3442 of August. Here the modulation is investigated experimentally, using practical lamps of various types, and compared with the theory. The experimental arrangement used is shown in Fig. 1; various light filters were used whose transparency as a function of frequency is given in Fig. 2. Fig. 3 gives curves of the degree of modulation as a function of frequency. Tabulated results are given (Tables 1-6). The "klirr" factor as a function of frequency is shown in Fig. 4; Figs. 5 & 6 give the calculated and measured curves of the "klirr" factor and degree of modulation as a function of the modulation depth of the filament current. Fig. 7 shows the relative light yield as a function of filament temperature, Fig. 8 the variation of degree of modulation as a function of spectral frequency. Good agreement with theory is found for vacuum lamps. The degree of modulation may be increased by filling with helium or hydrogen and shortening the filament.

Some Recent Patents

The following abstracts are prepared, with the permission of the Controller of H.M. Stationery Office, from Specifications obtainable at the Patent Office, 25, Southampton Buildings, London, W.C.2, price 1/- each.

ACOUSTICS AND AUDIO-FREQUENCY CIRCUITS AND APPARATUS

485 005.—Public address or like system in which the loud-speaker volume is automatically regulated by the applause, laughter, or other "masking" sounds coming from the audience.

H. Boucke. Convention date (Germany) 12th November, 1935.

485 557.—Arrangement of microphones for combining sounds picked up from a number of spaced sources.

R. R. Glen. Application date 19th October, 1936.

AERIALS AND AERIAL SYSTEMS

485 062.—Stream-lined aerial, particularly suitable for a motor-car with an all-metal body.

A. Opel, Akt. Convention date (Germany) 11th July, 1936.

485 979.—Frame aerial for direction-finding with a coupling arrangement for preventing open-aerial or "vertical" pick-up.

Telefunken Co. Convention date (Germany) 9th October, 1936.

DIRECTIONAL WIRELESS

483 888.—Short-wave oscillation-generator, the anodes of which serve as the dipoles of a multiple directional aerial.

Telefunken Co. Convention date (Germany) 6th May, 1936.

484 590.—Direction-finder in which a local-oscillator valve combines the pick-up from a frame and vertical aerial so as to give a direct indication of the bearing of a distant beacon station.

Standard Telephones and Cables and C. W. Earp. Application date 6th November, 1936.

484 774.—Maintaining the sensitivity of a directional receiver constant, irrespective of its distance from a navigational beacon transmitter.

Telefunken Co. Convention date (Germany) 14th September, 1936.

485 583.—Direction-finder with automatic correction for re-radiation and "mast-effect" over a wide range of frequency.

Marconi's W.T. Co. (communicated by the Telefunken Co.). Application date 20th November, 1936.

RECEIVING CIRCUITS AND APPARATUS

(See also under Television.)

483 918.—Thermionic valve circuit in which a combination of positive and negative feed-back is used to increase the stability of operation.

Standard Telephones and Cables; N. Lawrence; and M. M. Levy. Application date 27th October, 1936.

484 013.—Mains-fed receiver with an additional rectifier connected in parallel with the A.C. supply to produce biasing voltages.

J. E. Rhys-Jones; J. O. G. Barrett; and The Plessey Co. Application date 3rd December, 1936.

484 102.—Two-stage amplifier with negative feedback and a common cathode connection.

Standard Telephones and Cables, and A. H. Roche. Application date 30th October, 1936.

484 137.—Wireless receiver with automatic selectivity control, regulated by the amplitude of the prevailing interference.

Hazeltine Corporation (assignees of H. A. Wheeler). Convention date (U.S.A.) 21st July, 1936.

484 332.—Application of negative feed-back to make the overall "gain" of a valve independent of the working frequency, to modify its output impedance, and to prevent non-linear distortion.

The General Electric Co. and L. I. Farren. Application dates 31st December, 1936 and 29th January, 1937.

484 423.—Amplifier with negative feed-back and predetermined impedance values over a wide range of frequencies.

The General Electric Co. and L. I. Farren. Application dates 11th January and 9th December, 1937.

484 487.—Decoupling or filter circuit for a valve amplifier in which two series inductances are mutually coupled together to provide a compensating or balancing voltage.

Marconi's W.T. Co. and E. E. Zepler. Application date 5th November, 1936.

484 656.—Resistance-capacity coupling for a band-pass amplifier with means for preventing phase-shift and self-oscillation.

Telefonakt, L. M. Ericsson. Convention date (Sweden) 7th December, 1936.

484 701.—Valve with variable-impedance load, particularly for use in automatic tuning control.

Marconi's W.T. Co. Convention date (U.S.A.) 3rd October, 1935.

484 956.—Wireless cabinet consisting of a single-piece moulding, say of artificial resin, formed with projections to support the circuit components.

N. V. Philips' Lamp Co. Convention date (Germany) 3rd September, 1936.

484 980.—Valve amplifier with negative feed-back arranged to provide a large variation of "gain" without alteration of the applied grid bias.

Standard Telephones and Cables (assignees of J. O. Smethurst. Convention date (U.S.A.) 30th March, 1937.

485 285.—Automatic fine-tuning and selectivity-control device which is arranged to be thrown out of action by the main tuning knob during inter-station adjustment.

L. L. de Kramolin. Convention date (Germany) 13th August, 1935.

485 362.—Switch-tuned receiver for selecting different programmes fed on separate carrier waves through a wired-distributing system.

C. Lorenz Akt. Convention date (Germany) 6th November, 1936.

485 613.—Aerial coupling for a wireless receiver with means for automatically controlling the "gain" or signal-to-noise ratio.

Hazeltine Corporation (assignees of A. W. Barber). Convention date (U.S.A.) 21st January 1937.

485 626.—Amplifier valve in which the electron stream is divided between a number of separate anodes.

E. P. Rudkin. Application date 20th November, 1936.

486 071.—System of automatic fine-tuning in which the receiver is muted during the adjustment period.

E. K. Cole (communicated by AGA-Baltic Radio Akt). Application date 8th September, 1937.

TELEVISION CIRCUITS AND APPARATUS

FOR TRANSMISSION AND RECEPTION.

483 935.—Method of reducing the highest picture frequency, without loss of quality, in a television system using intensity modulation.

J. Briza. Application date 15th January, 1937.

483 999.—Saw-toothed oscillation-generator for accurately scanning a trapezoidal surface in television systems.

Telefunken Co. Convention date (Germany) 28th October, 1935.

484 003.—Television system in which a photographic film is scanned both by a rotating disc and a cathode-ray tube.

A. Castellani and "Safar." Application date 28th October, 1936.

484 157.—Producing high-voltage saw-toothed oscillations, suitable for scanning, from a comparatively low source of voltage.

M. Geiger and Telefunken Co. Application date 28th October, 1936.

484 202.—Method of obtaining automatic volume control in a television receiver.

H. E. Kallmann and R. E. Spencer. Application date 30th September, 1936.

484 218.—Reducing the shunting effect of the input capacity of a valve of the so-called "cathode follower" type, particularly when amplifying television signals.

Electric and Musical Industries and W. S. Percival (addition to 448 421). Application date 9th November, 1936.

484 404.—Combined sound and vision receiver of the superhet type, with a low-pass amplifier for handling the intermediate frequencies.

W. S. Percival. Application date 2nd November, 1936.

484 412.—Means for discriminating between the line and frame synchronising impulses in a television receiver, and for separating both from the picture signals.

Murphy Radio and H. A. Fairhurst. Application date 4th November, 1936.

484 574.—Electron discharge tube in which a charge image of the picture to be televised is formed on a single-sided photo-electric screen of the mosaic type.

Baird Television and V. Jones. Application date 5th November, 1936.

484 575.—Cathode-ray television transmitter fitted with a photo-sensitive screen consisting of a "mosaic" of small particles of selenium.

Baird Television and D. M. Johnstone. Application date 5th November, 1936.

484 598.—Amplifying the output current from an Iconoscope tube by means of an electron-multiplier designed to reduce the Schrott effect.

Fernseh Akt. Convention date (Germany) 9th November, 1935.

484 706.—Television-scanning device wherein a ray of light is passed through a stack of "stepped" glass plates, which imposes a graded time-lag on the emerging ray.

O. von Bronk. Application date 8th October, 1936.

484 913.—Cathode-ray television transmitter in which a grid is located close to the photo-electric mosaic screen in order to increase the acceleration of the scanning stream.

Ferusch Akt. Convention date (Germany) 14th November, 1935.

485 119.—Photo-electric screen provided with a metal-coated margin for producing synchronising impulses in television.

Radio-Akt D. S. Loewe. Convention date (Germany) 18th November, 1935.

485 120.—Saw-toothed oscillation generator for television scanning in which the discharge of the main condenser is accelerated by secondary-emission in the control valve.

Standard Telephones and Cables and D. H. Black. Application date 16th November, 1936.

485 132.—Method of generating synchronising-impulses by means of an "amplitude filter" in a cathode-ray transmitter of the iconoscope type.

Radio-Akt D. S. Loewe. Convention date (Germany) 18th November, 1935.

485 309.—Method of illuminating the tuning controls of a television receiver so as to facilitate their operation in a darkened room.

E. K. Cole and A. R. Knipe. Application date 5th February, 1937.

485 412.—Cathode-ray television receiver in which amplifying electrodes of the secondary-emission type are interposed between the control grid and the fluorescent screen.

Cie d'Usines a Gaz. Convention date (France) 23rd May, 1936.

485 437.—Method of producing strong thin metal sheets for use as rotating-disc scanners in television.

Radio-Akt D. S. Loewe. Convention dates (Germany) 7th August, 1936 and 9th July, 1937.

485 453.—Cathode-ray television transmitter in which the usual "mosaic" screen is replaced by a heavy-metal oxide film capable of storing electric charges.

Telefunken Co. Convention date (Germany) 19th August 1935.

485 598.—Generating synchronising-impulses in a cathode-ray television transmitter by means of an auxiliary electrode mounted around the margin of the photo-sensitive screen.

Radio-Akt D. S. Loewe (addition to 485 119). Convention date (Germany) 25th November, 1935.

485 622.—Mechanical scanning system in which an image of the illuminated aperture is first formed in the space between the rotating disc and screen, before the real image is projected on to the screen.

S. L. Clothier and H. C. Hogencamp. Convention date (U.S.A.) 18th November, 1935.

485 924.—Generating precisely-timed signals, such as the frame, line, and "blinking" impulses used in television, from a single low-frequency source.

Philco Radio and Television Corporation. Convention date (U.S.A.) 23rd November, 1935.

485 934.—Saw-toothed oscillation-generator for television scanning in which a tuned circuit energised by the "flyback" stroke prevents the oscillator from responding to unwanted impulses.

The British Thomson-Houston Co. and D. J. Mynall. Application date 26th November, 1936.

TRANSMITTING CIRCUITS AND APPARATUS

(See also under Television.)

484 016.—Carrier-wave signalling system comprising a number of substations each fitted with means for automatically selecting and calling any of the other stations.

Standard Telephones and Cables (assignees of N. Monk). Convention dates (U.S.A.) 18th and 20th December, 1935.

484 078.—Modulating system comprising an electron-multiplier oscillation-generator with means for controlling the electron flow between the target electrodes.

Marconi's W.T. Co. (assignees of C. H. Brown and W. van B. Roberts). Convention date (U.S.A.) 28th October, 1935.

484 488.—Arrangement for automatically monitoring or supervising the percentage modulation of a carrier-wave transmitter.

Marconi's W.T. Co. and O. E. Keall. Application date 5th November, 1936.

484 588.—Keying circuit for a wireless transmitter, in which an absorber-valve is associated with a "sub-absorber" valve, so that the grid voltages are in phase-opposition.

Marconi's W.T. Co. and N. H. Clough. Application date 6th November, 1936.

484 824.—Method of modulation in which the usual sinusoidal form of carrier wave is replaced by a square-topped oscillation in order to prevent non-linear distortion.

The General Electric Co.; L. I. Farren; and E. P. George. Application date 22nd December, 1936.

484 867.—Magnetron oscillator with concentric and parallel groups of electrodes, the inner group being stabilised in frequency by a loosely-coupled flywheel circuit.

Telefunken Co. (addition to 483 336). Convention date (Germany) 10th July, 1936.

485 353.—Repeater stations for automatically relaying ultra-short-wave signals beyond the normal "optical" range.

Marconi's W.T. Co. (assignees of W. L. Knotts and H. H. Beverage). Convention date (U.S.A.) 25th September, 1936.

485 428.—Split-anode magnetron oscillator for handling centimetre waves.

Marconi's W.T. Co. (assignees of E. G. Linder). Convention date (U.S.A.) 25th July, 1936.

485 470.—Series-modulated carrier-wave transmitter in which the carrier-wave output varies automatically with the percentage modulation.

Marconi's W.T. Co.; N. H. Clough; and E. Green. Application date 19th November, 1936.

485 479.—Selective wired-wireless system distributing a number of programmes on different carrier waves.

R. E. H. Carpenter and P. P. Echersley (addition to 423 673). Application date 27th November, 1936.

485 620.—High-powered oscillation-generator operating by the secondary emission produced by the impact of an electron stream on a single "target" electrode of cylindrical shape.

Farnsworth Television Inc. Convention date (U.S.A.) 27th January, 1936.

485 959.—Modulating system, particularly for television, which utilises a method of "impedance inversion" through quarter-wave transmission lines.

Philco Radio and Television Corporation. Convention date (U.S.A.) 10th June, 1936.

CONSTRUCTION OF ELECTRONIC-DISCHARGE DEVICES

483 890.—Ultra-short-wave magnetron valve designed to operate as a frequency multiplier or divider.

N. V. Philips Lamp Co. Convention date (Holland) 5th June, 1936.

484 099.—Multi-stage electron-multiplier in which resistances for "grading" the biasing potentials are mounted inside the glass tube.

Marconi's W.T. Co. Convention date (U.S.A.) 30th October, 1935.

484 160.—Secondary emission oscillation-generators of the "double resonance" type.

Marconi's W.T. Co. (assignees of W. van B. Roberts). Convention date (U.S.A.) 28th October, 1935.

484 452.—Use of an alloy of copper and zirconium for making the cathode and other electrodes of a valve and for preventing the liberation of gas after the valve has been exhausted.

N. V. Philips' Lamp Co. Convention date (Germany) 5th October, 1936.

484 748.—Coating the anode and other electrodes of a valve with soot or carbon to prevent secondary emission.

N. V. Philips' Lamp Co. Convention date (Holland) 24th March, 1936.

484 790.—Arrangement of the "gun" electrodes used for generating, accelerating, modulating, and focusing the electron stream in a cathode-ray tube.

Electrical Research Products Inc. Convention date (U.S.A.) 30th December, 1936.

484 600.—Electrode arrangement of a short-wave amplifier or oscillator utilising secondary emission.

N. V. Philips' Lamp Co. Convention date (Holland) 23rd February, 1937.

484 944.—Magnetron valve of the split-anode type fitted with a "low work function" filament of thoriated tungsten.

The M-O Valve Co. and E. C. S. Megaw. Application date 23rd March, 1937.

485 073.—Magnetron valve with inner and outer groups of "split" electrodes, the outer group being so arranged that no part of it directly faces the "gaps" between the inner group.

Telefunken Co. Convention dates (Germany) 17th and 20th August, 1936.

485 111.—Arrangement of the control-grid or Wehnelt cylinder in a cathode-ray tube so as to increase the modulation and concentration of the electron stream.

Ferranti and J. C. Wilson. Application date 16th November, 1936.

485 298.—Increasing the lateral deflection of the electron stream in a cathode ray tube by using control electrodes which are subdivided and cross-connected.

Telefunken Co. Convention date (Germany) 17th December, 1935.

485 427.—Electron multiplier in which the electron stream is driven to and fro, between target electrodes, over oppositely-curved paths, by an external magnetic winding.

N. V. Philips' Lamp Co. Convention date (Germany) 28th July, 1936.

485 438.—Electrode arrangement for a short-wave generating valve of the magnetron type.

A. Helbig. Application date 13th August, 1937.

485 439.—Indirectly-heated cathode, partly coated with insulating material, for an electron discharge tube.

N. V. Philips' Lamp Co. Convention date (Holland) 1st September, 1936.

485 548.—Non-inductively wound heating-filament for the cathode of a cathode-ray tube.

V. Zeilline; A. Zeilline; and V. Kliatchko. Convention date (France) 22nd December, 1936.

486 063.—Compact arrangement of the "gun" and focusing electrodes in a cathode-ray tube.

N. V. Philips' Lamp Co. Convention date (Holland) 15th June, 1936.

SUBSIDIARY APPARATUS AND MATERIALS

484 310.—Arrangement of the electrodes and biasing voltages in a photo-electric cell of the "soft" or gas-filled type.

Marconi's W.T. Co. and E. W. B. Gill. Application date 6th November, 1936.

484 359.—Method of producing a dry-contact rectifier free from deleterious "black" copper oxide.

Standard Telephones and Cables, Ltd. (communicated by Nippon Electric Co.). Application date 14th May, 1937.

484 482.—Light valve in which the application of a voltage across a narrow gap alters the curvature of an enclosed film of liquid.

C. H. Matz. Application date 3rd November, 1936.

484 524.—Chokes for suppressing radio interference from the neon lamps used for advertising and like signs.

The General Electric Co. and J. B. L. Foot. Application date 4th February, 1937.

484 704.—Loud speaker in which a double cone is combined with one or more curved horns which terminate in an annular mouthpiece.

R. R. Glen. Application date 7th October, 1936.

484 705.—Loud speaker fitted with a second cone, arranged parallel with the main cone or diaphragm, in order to modify the backwardly-radiated sounds.

R. R. Glen. Application date 7th October, 1936.

485 006.—Circuit arrangement for maintaining the operating conditions of a "triggered" valve relay constant, over long periods of time, and in spite of variations in the supply-voltage or valve characteristics.

B. M. Hadfield. Application date 12th November, 1936.

485 135.—Method of making a multiple-plate piezo-electric unit.

The Brush Development Co. Convention date (U.S.A.) 2nd September, 1936.

485 264.—Electron-microscope in which an image of the object to be examined is first produced on a photo-electric cathode and is then enlarged by an electron lens.

Zeiss Ikon Akt. Convention date (Germany) 2nd October, 1936.

485 528.—Method of preparing a sensitised selenium electrode for a photo-electric cell.

The British Thomson-Houston Co. (addition to 439 774). Convention date (U.S.A.) 29th May, 1937.

485 529.—Preparing and coating the sensitised electrode of a photo-electric cell.

The British Thomson-Houston Co. Convention date (U.S.A.) 29th May, 1937.

485 530.—Construction of light-sensitive cell in which a number of semi-transparent metallic layers are sputtered on to a foundation layer of selenium.

The British Thomson-Houston Co. Convention date (U.S.A.) 29th May, 1937.

485 550.—One-piece diaphragm for a loud speaker produced by moulding, and subsequent varnishing and hot-pressing.

J. A. Briscoe; J. H. Nelson; Celestion Ltd.; and Murphy Radio. Application date 18th August, 1936.

485 618.—Filter-circuit with individually-screened reactances, for cutting-out interference due to very high frequencies.

E. C. Cork and J. L. Pawsey. Application date 18th November, 1936.

485 948.—High-frequency transmission cables of the so-called "dielectric guide" type.

Siemens and Halske Akt. Convention date (Germany) 24th December, 1935.

486 049.—Filter circuit with means for eliminating any non-sinusoidal or harmonic components from the output.

B. M. Hadfield. Application date 1st February, 1937.