

EXPERIMENTAL WIRELESS

& The WIRELESS ENGINEER

2/6
NET

A JOURNAL OF
RADIO RESEARCH
AND PROGRESS

VOL. IV
No. 49

IN THIS ISSUE

OCT.
1927

EDITORIALS. THE SCREENED VALVE—THE WIRELESS EXHIBITION.
THE SHIELDED PLATE VALVE AS AN H.F. AMPLIFIER.

By R. T. BEATTY, M.A., B.E., D.Sc.

CALCULATION OF THE POLAR CURVES OF EXTENDED AERIAL SYSTEMS.
By E. GREEN, M.Sc.

RADIO-FREQUENCY TRANSFORMERS.

By N. W. McLAHLAN, D.Sc., M.I.E.E., F.Inst.P.

AMPLIFICATION BY MEANS OF THERMO-RELAYS AND PHOTO-ELECTRIC CELLS
By JAMES TAYLOR, M.Sc., Ph.D., A.Inst.P.

MEASUREMENTS OF A "STALLGY" CORE WITH D.C. AND A.C. EXCITATION.
By L. B. TURNER, M.A., M.I.E.E.

H.T. FILTER CIRCUITS FOR D.C. MAINS.

By J. H. OWEN HARRIES.

CIRCLE DIAGRAMS FOR L.F. INTERVALVE TRANSFORMERS.

By PROF. FELIX E. HACKETT, Ph.D.

AND OTHER FEATURES.

PUBLISHERS

WILSON & SONS LTD, DORSET HOUSE, TILDERS, LONDON EC4

www.americanradiohistory.com



LABORATORY EQUIPMENT

Illustration shows a group of Standards and Measuring Instruments recently supplied by us to a leading British firm, manufacturing Low Loss Coils and Variable Condensers, for use in their London Research Laboratory. All are of "G.R." make, except the two meters. Extreme left:

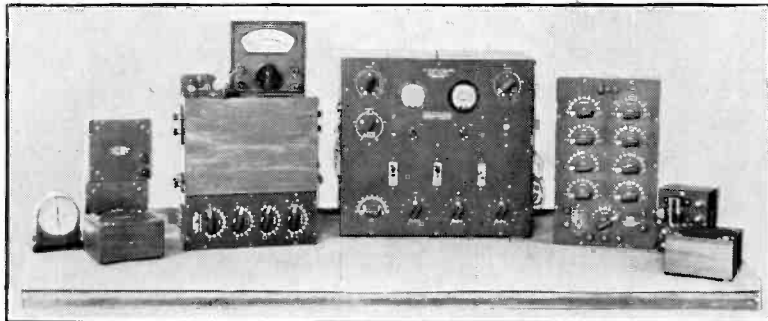

Three Inductance Standards; Left, Capacity Bridge with Decade Resistance; Centre, Vacuum Tube Beat Frequency Oscillator; Right, Decade Bridge; Extreme right, Audio Oscillator and another Inductance Standard.

We have a complete range of Electrical and Radio Research Laboratory Measurement Instruments. The demand now is not "how cheap" but "how good," in regard to radio components. Only those firms who are prepared to turn out components of real efficiency, and thoroughly capable

of advertised performance, robustness, long life, etc., will survive the next season or two. To this end we respectfully direct the attention of the manufacturing trade to the COMPLETE RANGE of "G.R." Laboratory Instruments. We have already supplied many leading British Firms and Government Research Departments, many G.P.O. Radio Research Stations, etc. All enquiries will receive the personal attention of our Managing Director, Mr. C. L. Lyons, MEMBER I.R.E., and will be treated with the strictest confidence.

To Amateurs and Home Constructors: Catalogue of over 130 "G.R." advanced Radio COMPONENTS sent, post free, on request. In view of the above announcement it will be readily understood why "G.R." Components are both different and better. If your local Stockist does not handle "G.R." Parts, we will send them post free on receipt of retail price, per return. "G.R." Parts cover the whole field. Do not purchase any components for your New Receiver, Eliminator, etc., until you have studied our Catalogue. Not only a Catalogue, but an education.

CLAUDE LYONS Ltd., 76, Oldhall Street, LIVERPOOL. (See further advt. page 12.)

DICTIONARY OF WIRELESS TECHNICAL TERMS

Definitions of Terms and Expressions
commonly used in Wireless
Telephony & Telegraphy

Compiled by S. O. PEARSON, B.Sc., A.M.I.E.E

For all those experimenters and research workers who are accustomed to read widely in wireless subjects, the DICTIONARY of WIRELESS TECHNICAL TERMS will prove a valuable little book of handy reference. The volume is well-illustrated and can be recommended to every young student.

PRICE 2/- BY POST 2/3

From all leading booksellers or direct from:

ILIFFE & SONS LTD.,

Dorset House, Tudor Street, London, E.C.4

STANDARD TABLES and EQUATIONS in RADIO - TELEGRAPHY

By Bertram Hoyle, M.Sc.Tech., A.M.I.E.E.

THIS BOOK is extremely valuable to the advanced radio worker. It saves time and ensures a high degree of accuracy in working out all the necessary mathematical calculations after obtaining experimental data. Many of the tables have never been published in so complete a form before, and all of them can be relied upon to be absolutely accurate within the limits indicated. The volume is undoubtedly of the greatest assistance to the busy radio research worker.

Price 9/- Post Free 9/5

Obtainable from the Publishers of
"EXPERIMENTAL WIRELESS"

ILIFFE & SONS LTD., Dorset House, Tudor St., London, E.C.4.

Kindly mention "Experimental Wireless" when replying to advertisers.

Components of Distinction & Quality

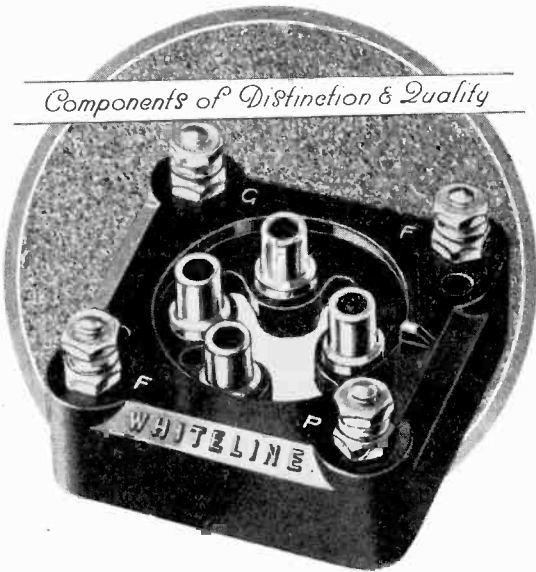

White Line Valve Holder

A great advance over all previous types of "Spring" valve holders. Inter-electrode capacity is reduced to a minimum and is constant. Thus the "Whiteline" holder is admirably suited for super-heterodyne and short-wave receivers. The springs are so designed that while the initial amplitude to any given shock is as large as required, the damping is quick and gentle. Made of genuine Bakelite and supplied with terminals soldering tags and fixing screws. Overall dimensions of base 1½ ins. square.



L.F. TRANSFORMERS
 List 284 Ratio 3-1 22/6
 List 285 Ratio 6-1 25/-
 Also in Multi-ratio giving 18, 3, 306, 45, and 6 to 1
 List 286 27/6
 Also **LOW FREQUENCY CHOKE**
 List 287 20/-

THE "WHITELINE" FOR SAFETY

LIST 282 2/3

Send 1d. in stamps for the new Bowyer-Lowe Catalogue



UNIVERSAL H.F. CHOKE
 List 288 9/-



A BOOK THAT EVERY EXPERIMENTER SHOULD HAVE

"THE BOWYER-LOWE STANDARD 7 & 8-Valve SUPER-HETERODYNE"
 How to Build and Operate
 By A. E. BOWYER-LOWE

Price 2/-

Send your remittance for a copy to-day
BOWYER-LOWE CO., LTD
LETCHWORTH



506

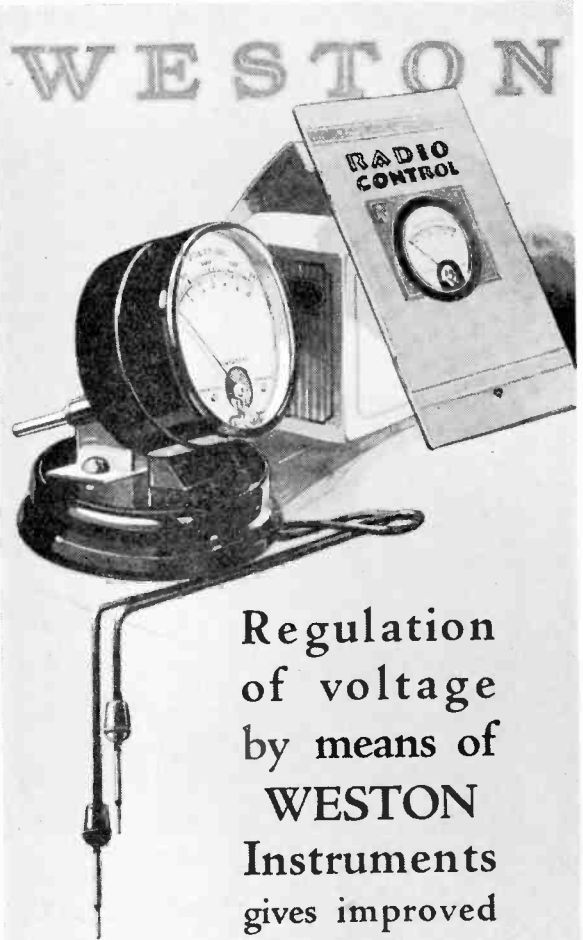

Regulation of voltage by means of **WESTON Instruments** gives improved reception

To obtain maximum results from your receiver you must be sure that the H.T., L.T. and G.B. voltages are regulated correctly. For an exact measurement of these variable voltages use a Weston Pin-Jack Voltmeter with high-range stand. Only the Weston standard of accuracy and reliability is sufficiently fine to be of any use for such measurements.

The Weston free booklet "Radio Control" explains the necessity for accurate electrical control of your radio receiver and gives much helpful advice. Let us have your name and address.

MODEL 506 Pin-Jack Voltmeter complete with high range stand and testing cables £2:10:0

WESTON
 STANDARD THE WORLD OVER
 Pioneers since 1888

Weston Electrical Instrument Co. Ltd.
 15, Gt. Saffron Hill,
 London, E.C. 1

Kindly mention "Experimental Wireless" when replying to advertisers.

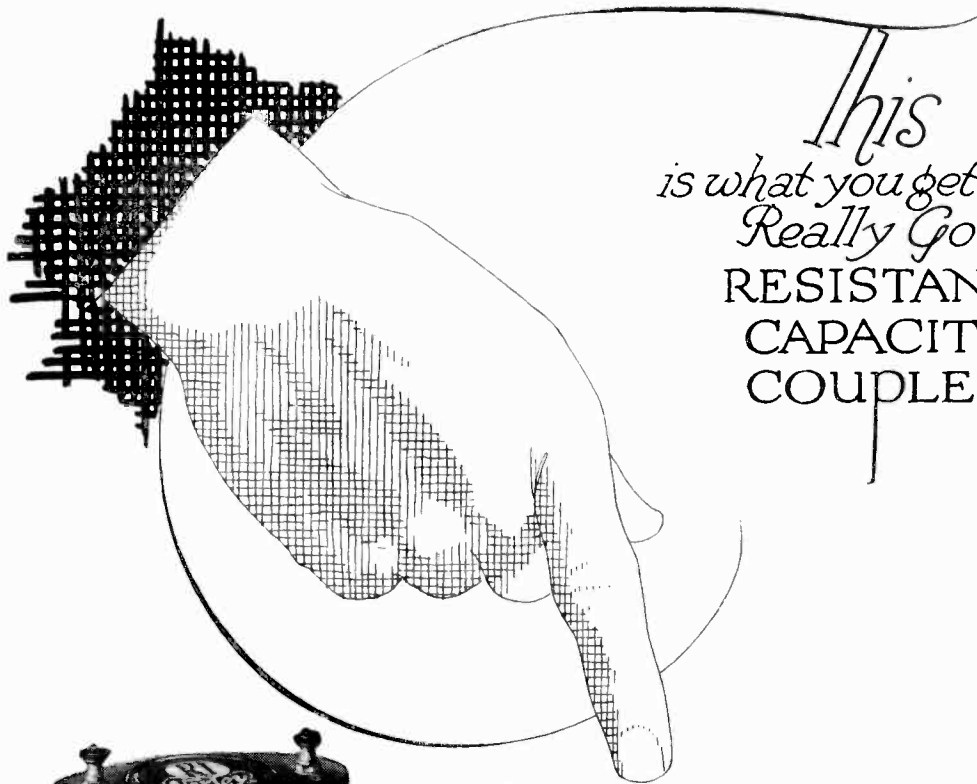

This
is what you get with a
Really Good
RESISTANCE
CAPACITY
COUPLER



TYPE A—Suitable for use after Valves with A.C. Resistance (Impedance) of 15,000—40,000 ohms **20/-**

TYPE B—Suitable for use after Valves with A.C. Resistance (Impedance) of 50,000—100,000 ohms **22/6**

Write for our new Booklet "Low Frequency Amplification." Price 1/-

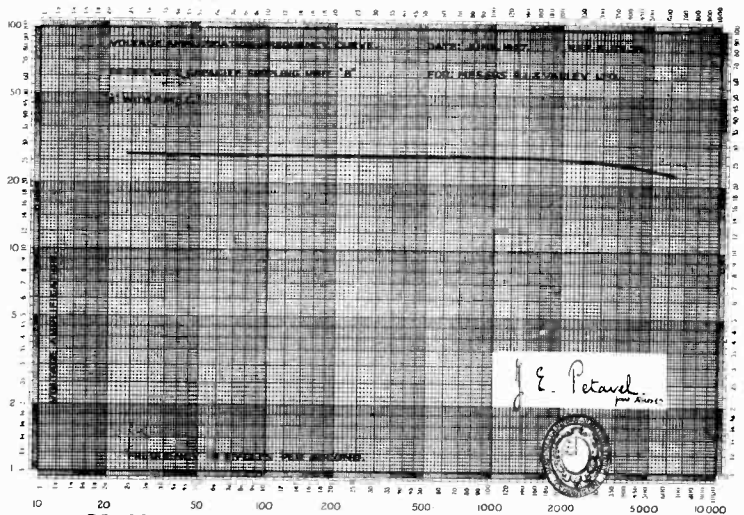

Uniform Amplification at all frequencies

The efficiency of this perfectly designed component is backed by the authoritative seal of the National Physical Laboratory.

The new R.I. and Varley Resistance Capacity Coupler is beautifully finished, and every detail is perfectly matched and accurately balanced.

We have specialised in every form of L.F. Amplification, and invite you to write for our leaflet "L.F. Transformers" (free), giving particulars of our new Straight Line Super Transformer.

THE MARK OF BETTER RADIO

Kingsway House, 103, Kingsway, London, W.C.2.

Telephone: Holborn 5303

Kindly mention "Experimental Wireless" when replying to advertisers.



C.C. Output Unit



H.F. Choke

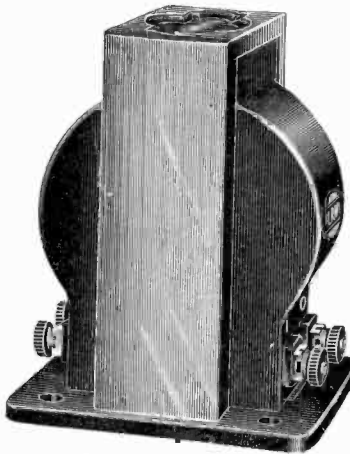

"G" Type Transformer



Power Transformer



"F" Type Transformer



L.F. Choke

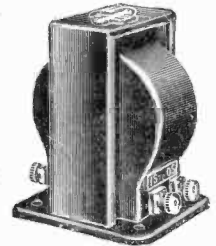

Smoothing Choke

The Family Seven

Not another Igranitic Circuit but the range of Igranitic Transformers and Chokes.

"F" Type Transformer.

A successor to the popular "E" Type L.F. Transformer. Considerable improvements in design although the same external appearance. Ratio $3\frac{1}{2} : 1$. An excellent Transformer at a moderate price. Price 18/-

Power Transformer for H.T. Supply Unit.

A highly efficient Transformer suitable for full-wave rectification similar to those employed in the well-known Igranitic H.T. Supply Units. Suitable for operating off A.C. to the voltages and aperiodics stated. Separate winding giving 4 volts for lighting filament of Rectifying Valve. Output, 250 volts to each anode, 75 milliamps 100-110 and 200-220 volts A.C., 40-60 cycles. Price £2 5 0
115-125 and 230-250 volts A.C., 40-60 cycles.

"G" Type Transformer.

The latest Igranitic L.F. Transformer. A notable advance on anything previously produced. Has exceptionally large iron core and a very high primary inductance. Made in two ratios $3.6 : 1$ and $7.2 : 1$. Former for first and single stages and the latter for second stages. Price 30/-

Smoothing Choke for H.T. Supply Unit.

Has high inductance and very effective for smoothing purposes. Completely enclosed in an attractive metal shield with suitable terminals. Specially suitable for use with Power Transformer. Price 25/- each

"C.C." (Choke Capacity) Output Unit.

A filter for use after the last valve of a receiver. Prevents anode current passing through loud speaker, thus protecting its windings and preventing demagnetisation. Improves quality. Prevents low frequency oscillation. Long loud speaker leads permissible Price £1 1s. 6d.

H.F. Choke.

An exceptionally compact H.F. Choke. Effective from 3,000 metres to lowest broadcast wavelengths. Very small external field, low self-capacity and high inductance. Mounting bracket provided. Enclosed in Bakelite case. Price 5/-

L.F. Choke.

A high maximum induction Choke which may be used for intervalve coupling or as an output Choke owing to facilities for varying the inductance by connecting coil sections in series or parallel. Very low self-capacity and ample iron core, shielded. Price 27/-

Some interesting booklets on radio matters can be obtained by writing us for publication J.289—a postcard will bring them.



IGRANIC ELECTRIC CO., LTD.
149, Queen Victoria Street, London

Works : BEDFORD

BRANCHES

Birmingham, Bristol, Cardiff, Glasgow, Leeds, Manchester, Newcastle-on-Tyne

Kindly mention "Experimental Wireless" when replying to advertisers.

EXPERIMENTAL WIRELESS

and The WIRELESS ENGINEER

A Journal of Radio Research and Progress

Technical Editor :
Prof. G. W. O. HOWE, D.Sc., M.I.E.E.

Editor :
HUGH S. POCOCK.

Assistant Editor :
F. H. HAYNES.

VOL. IV. No. 49.

OCTOBER, 1927.

MONTHLY.

CONTENTS OF THIS ISSUE.

	PAGE
EDITORIALS	585
CALCULATION OF THE POLAR CURVES OF EXTENDED AERIAL SYSTEMS. By E. GREEN, M.Sc.	587
SOME MEASUREMENTS OF A "STALLOY" CORE WITH SIMULTANEOUS D.C. AND A.C. EXCITATION. By L. B. TURNER, M.A., M.I.E.E.	594
RADIO-FREQUENCY TRANSFORMERS. By N. W. McLACHLAN, D.Sc., M.I.E.E., F.Inst.P.	597
THE PROPERTIES OF THE CIRCLE DIAGRAM FOR TELEPHONIC FREQUENCY INTERVALVE TRANSFORMERS. By Prof. FELIX E. HACKETT, Ph.D.(Dublin)	601
MATHEMATICS FOR WIRELESS AMATEURS. By F. M. COLEBROOK, B.Sc., A.C.G.I., D.I.C.	605
H.T. FILTER CIRCUITS FOR D.C. MAINS. By J. H. OWEN HARRIES	613
THE SHIELDED PLATE VALVE AS A HIGH-FREQUENCY AMPLIFIER. By R. T. BEATTY, M.A., B.E., D.Sc.	619
CORRESPONDENCE	626
THE AMPLIFICATION OF SMALL CURRENTS BY MEANS OF THE THERMO-RELAY AND THE PHOTO-ELECTRIC CELL. By JAMES TAYLOR, M.Sc., Ph.D., A.Inst.P.	627
ABSTRACTS AND REFERENCES	634
ESPERANTO SECTION	642
SOME RECENT PATENTS	644

The Editor is always prepared to consider suitable articles with a view to publication. MSS. should be addressed to the Editor, "Experimental Wireless and the Wireless Engineer," Dorset House, Tudor St., London, E.C.4. Especial care should be taken as to the legibility of MSS. including mathematical work.

Published Monthly, on the first of each month.

Editorial Offices : 139-40, FLEET STREET, LONDON, E.C.4. Telephone : City 4011 (3 lines).

Advertising and Publishing Offices : DORSET HOUSE, TUDOR STREET, LONDON, E.C.4.
Telegrams : "Experiwyr, Fleet, London." Telephone : City 2847 (13 lines).

COVENTRY : Hertford St. BIRMINGHAM : Guildhall Buildings, Navigation St. MANCHESTER : 199, Deansgate.
Telegrams : "Cyclist, Coventry." Telegrams : "Autopress, Birmingham." Telegrams : "Iliffe, Manchester."
Telephone : 5210 Coventry. Telephone : 2970 and 2971 Midland. Telephone : 8970 and 8971 City.

Subscription Rates Home and Abroad : One Year, **32/-** ; six months, **16/-**, post free ;
single copies, **2/8**, post free.

Kindly mention "Experimental Wireless" when replying to advertisers.

A VERSATILE GALVANOMETER

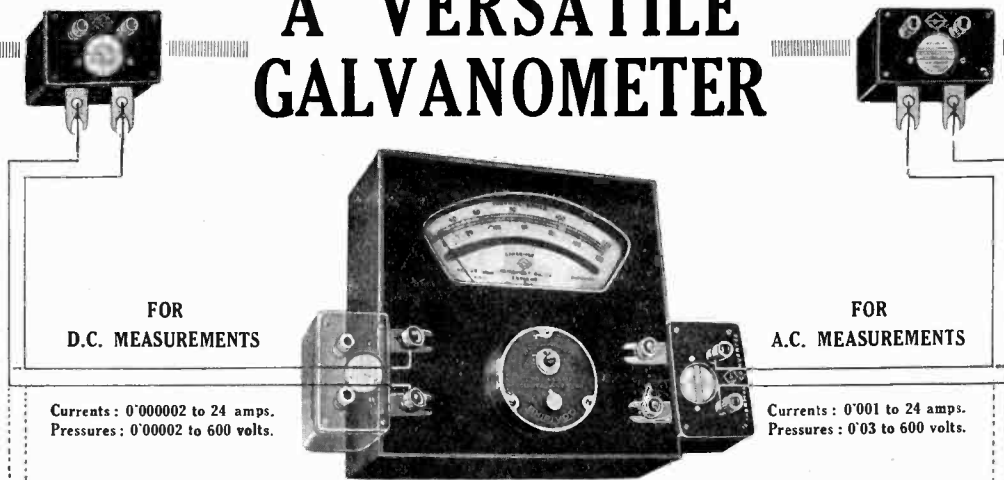

FOR
D.C. MEASUREMENTS

Currents : 0'000002 to 24 amps.
Pressures : 0'00002 to 600 volts.

FOR
A.C. MEASUREMENTS

Currents : 0'001 to 24 amps.
Pressures : 0'03 to 600 volts.

This Unipivot Galvanometer can be applied to a large variety of measurements. By fitting a millivolt scale (0-120) for D.C. and a thermal scale (0-120) for A.C. work, it can be used for measurements of current or pressure of either type over a range which can be varied by the use of easily attached interchangeable accessories. Descriptive List No. 909-S on request.

CAMBRIDGE INSTRUMENT CO LTD.

WORKS: LONDON & CAMBRIDGE Head Office: 45, GROSVENOR PLACE, LONDON, S. W. 1. Showrooms

3088

ACCUMULATORS "ELITE"

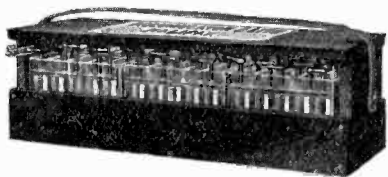

The Elite of all—

The World's Best High
Tension Accumulator
and of British Manufacture

The Unique Semi-Oil
Submerged feature of the
"Elite," absolutely prevents
surface leakage losses. The
battery lasts a life-time.

H.T. ACCUMULATORS, 60 volts
type, 02, Semi-oil, Submerged.
Complete, as illustrated. Price **22/6**

Write for lists. Sold on approval.

ACCUMULATORS ELITE, Bedford St.,
HALIFAX.

Telephone: 4304. Telegrams: "Elite, Halifax."

London Distributor:
CECIL POHLMAN, 77, Gt. Portland St.,
LONDON, W.1.

Kindly mention "Experimental Wireless" when replying to advertisers.

EXPERIMENTAL WIRELESS & The WIRELESS ENGINEER

VOL. IV.

OCTOBER, 1927.

No. 49.

Editorials.

Screened Valves.

THE use of screened valves for radio-frequency amplification is now claiming the attention of many of the advanced workers in the radio field. In our present issue two articles deal in a fundamental manner with the problem and several papers on the subject have been published in recent issues of the *Wireless World*. No one can read these without being impressed with the possibilities of further development in the design and use of thermionic valves. Finality appears as far off as ever; a few months ago the three-electrode valve with a carefully designed neutrodyne circuit seemed to be as near to the ideal as one could hope to attain, although all those who worked at the problem knew that the solution was not all that could be desired. Now we foresee thousands of enthusiasts during the coming winter taking down their neutralised high-frequency stages and exploring the possibilities of screened valves.

One must not imagine, however, that the screened valve is an entirely new invention. Valves with two grids have been used for many years, especially in Germany where their properties were investigated both theoretically and experimentally by W. Schottky in the Siemens laboratories. Such double-grid valves were used in two entirely different ways. The first was due to Langmuir of the General Electric Co. of America, who in 1913 inserted a second grid between the filament and the usual control grid.

This second grid was given such a positive potential with respect to the filament that the electron emission was near saturation. The positive potential of this grid may be regarded as counteracting the negative potential of the space charge, and it is commonly known as the space-charge grid or screen. The effect is to make the i_a-v_g characteristic steeper, *i.e.*, to increase the mutual conductance, at the same time decreasing the internal resistance. It is claimed by Wirtz in the *Taschenbuch der Drahtlosen Telegraphie* that the amplification is three times that obtained with the three-electrode valve.

The second method of using an additional grid was introduced by W. Schottky of Messrs. Siemens and Halske in 1916 and it is this invention of Schottky which forms the basis of the screened valve. The additional grid was introduced between the ordinary control grid and the anode and was connected to a point on the H.T. battery so that its potential was somewhat less than that of the anode which it screened. Schottky called it the anode-screen grid because the additional grid screened the control grid from the alternating potential of the anode. Such valves had a very high internal resistance and a steep characteristic; they could be worked with a lower anode voltage than the three-electrode valve.

These valves are known in Germany as SS valves (Siemens-Schottky).

Although little use has been made of these

valves in this country, they have been used to some extent in Germany. Von Ardenne's book on the construction of resistance-coupled amplifiers has a chapter on screened valves and their application to amplifiers, but the conclusions to which he comes are not at all in accord with the views underlying the latest developments.

Although Schottky pointed out in January, 1921, that by suitable design of the leads in the bulb and also of the socket the capacity between the grid and anode circuits can be so reduced that there is no danger of self-excitation due to back-coupling, interest in the subject has only recently been aroused by the work of Hull and Williams in America. These two workers have improved the screening by making the screening grid enclose the anode as much as possible, thus making it impossible for any electron to reach the anode without running the gauntlet of the small meshes in the screen. In the language of Schottky they have decreased the "Durchgriff" between the control grid and the anode. They have thus carried the ideas of Schottky as far as possible with results which open up new possibilities in radio-frequency amplification, as will be seen by a perusal of the articles on the subject in this issue.

National Wireless Exhibition, Olympia, 1927.

AT the time this issue appears the annual wireless show at Olympia will be in progress, and this provides a unique opportunity for getting a general impression of the development of practical wireless apparatus, though, of course, the bulk of the exhibits are confined to the more popular side of broadcasting. Engaged on work of some specialised character it is often difficult to keep in touch with what is being done in the wider practical applications of the science, so that a visit to the Exhibition is well worth while as an opportunity for bringing our knowledge up to date in this respect.

Wireless as applied to broadcasting has been passing through a period of evolution during the past few years, and to-day it is, in the main, becoming more stabilised, although the appearance of new apparatus such as the screened valves, to which we

referred above, remind us that we cannot stand still and consider any phase of development as approaching finality. In addition to the screened valves, the attention of the manufacturers of broadcast apparatus appears to have been devoted mainly to the simplification of broadcast receivers and improvement of quality of reproduction. There was a time when even the broadcast receiver which was developed for the use of the layman was a veritable mass of knobs and controls, but to-day a process of weeding out of unnecessary or auxiliary tuning devices has cleaned up the appearance of the panel of the set to a surprising extent. To take only one example, the temperature at which filaments of valves should operate is no longer as critical as formerly, and it has been possible, as a result, to dispense with individual filament rheostats for the valves, and, in many modern receivers, fixed or semi-fixed resistors, not visible on the panel, replace the row of knobs which was characteristic of the early sets.

In attending to quality, it is interesting to note that the development of suitable valves has served as an impetus to manufacturers to put out resistance coupling units in the endeavour to improve quality of reception.

Loud-speakers have also received considerable attention, and this is illustrated by the growing popularity of the free coil drive type and the numerous types of cone loud-speakers which are fast proving their superiority over the ordinary horn type of instrument.

It has been recognised for some time that one of the essentials of good quality is adequate H.T. supply for the anodes of the valves, and we have as a result a large variety of units designed for supplying current from the mains for the receiver; and valves which have their filaments heated from the mains direct. The competition with manufacturers of H.T. eliminators has also given an impetus to the manufacturers of batteries, both primary and secondary, and surprising improvements have been brought about in these products.

We hope in our next issue to deal individually with some of the outstanding exhibits of the Show.

Calculation of the Polar Curves of Extended Aerial Systems.*

By E. Green, M.Sc.

AERIAL systems consisting of a large number of wires in the same plane properly associated and excited so that the currents are always in the same phase, have very marked directional properties, provided the dimensions of the system are large compared with the wavelength. These aerial systems were originated and developed practically, together with the necessary feeding system, by Mr. C. S. Franklin, of the Marconi Company, during the years 1922 and 1923. Mr. Franklin worked out the complete theory, and calculated the directional effect and energy magnification possible, and verified the results experimentally. I was asked by Mr. Franklin to check his calculations, and during this work developed the methods of calculation and ways of thinking of the working which are given in the following paper.

The case considered is that of a line of aerials, the adjacent ones separated by a small fraction of a wavelength, and the whole system extending in a straight line several wavelengths long. Such a system is represented in Fig. 1, each vertical aerial (shown as a dot) has an equal current in it, and the phase is the same in all the aerials. This will be the case if each aerial or group of adjacent aerials is fed from a common transmitter by cables of equal electrical lengths. At a distant point *P* the current in each aerial, if it acted alone, would produce a certain alternating strength of electric field, which can be represented by an elementary vector. When all the aerials are present (each with an equal current) the vector representing the resultant field strength at *P* is obtained by summing up these elementary vectors. For

distant points in the direction *OA* at right angles to the system, the field due to each aerial will be in phase and the elementary vectors are in a straight line as shown in Fig. 1(a). The resultant is therefore *OR*. For a distant point *P* in any direction θ the elementary vectors of field intensity are not in phase. Thus, starting from the end *B*,

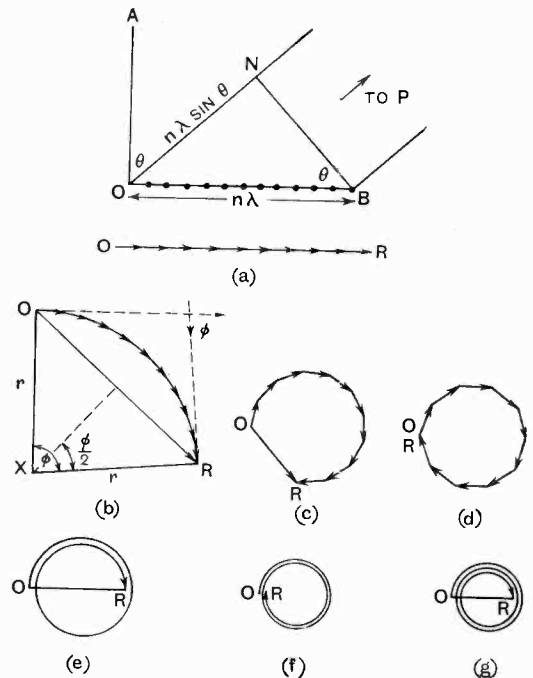

Fig. 1.

with the direction of *P* as shown, the elementary vectors due to consecutive aerials will lag in phase by a constant amount. Hence they take the form of Fig. 1(b). Since the elementary vectors are of equal length and change in direction by equal amounts, they form practically an arc of a circle, and we shall treat them as such. The resultant field strength is therefore represented by the straight line *OR*. (Fig. 1(b)).

* [We would draw the attention of readers interested in this subject to a paper by Ronald M. Foster entitled "Directive Diagrams of Antenna Arrays," published in the April number (Vol. V., No. 2) of the *Bell System Technical Journal*. This article gives many references to previous work on the subject.—Ed.]

To find the value of OR for any angle θ we proceed as follows: Note first that the length measured along the arc OR is a constant and equal to OR in Fig. 1(a) = E , say.

Second, the angle $OXR (= \phi)$, subtended by the arc at the centre of the circle, is by the geometry of the circle equal to the angle of phase difference between the first and last vectors. Now from Fig. 1 the lag of the vector due to O behind that due to B is

$$ON = n\lambda \sin \theta$$

in distance where $n\lambda$ is the length OB of the aerial system.

If lag in distance is λ the lag in phase is 2π radians (or 360°). Hence

$$\phi = \frac{2\pi n \lambda \sin \theta}{\lambda} = 2\pi n \sin \theta \dots (1)$$

If r equals radius of circle, we have

$$\text{Length of arc } OR = r\phi \text{ (radians)}$$

$$\text{Length of st. line } OR = 2r \sin (\phi/2)$$

Therefore

$$\frac{\text{Field intensity in direction } \theta}{\text{Field intensity in direction } OA} = \frac{\text{st. line } OR}{\text{arc } OR}$$

$$= \frac{2r \sin \frac{\phi}{2}}{r\phi \text{ (rad.)}} = \frac{\sin \frac{\phi}{2}}{\phi/2} \dots (2)$$

$$\text{Resultant } OR = \frac{E \sin \frac{\phi}{2}}{\phi/2}$$

If we calculate the value of this expression for various values of θ we shall be able to plot the polar curve of the system. This has been done in Fig. 2 for a system 2λ long. But we can get a good general idea from a direct consideration of the forms assumed by the vector diagrams. As the angle θ increases from 0° the angle ϕ steadily increases. The vector diagram first takes the form of Fig. 1(b), then that of Fig. 1(c), then that of Fig. 1(d). In this last the resultant is zero. Clearly this occurs when the first and last vectors differ by 2π in phase, i.e., when

$$2\pi n \sin \theta = 2\pi$$

or

$$\sin \theta = 1/n \dots \dots (3)$$

For a system two wavelengths wide ($n=2$) this gives $\sin \theta = \frac{1}{2}$ and $\theta = 30^\circ$. Up to this

point the resultant field intensity has therefore steadily decreased from its value at $\theta=0^\circ$. For further increase of θ the elementary vectors begin to overlap and the resultant OR increases to a maximum approximately when OR becomes the diameter of the circle. (Fig. 1(e)). This occurs when the first and last vectors have 3π difference in phase,

$$\text{i.e., } 2\pi n \sin \theta = 3\pi, \sin \theta = 3/2n.$$

For a system 2λ wide ($n=2$) this gives

$$\sin \theta = \frac{3}{4}, \therefore \theta = 49.5^\circ.$$

The relative magnitude of this first side maximum is independent of the width of the system. We have

$$\frac{\text{Intensity at this angle } \theta}{\text{Intensity at } 0^\circ}$$

$$= \frac{OR}{\frac{1}{2} \text{ circumference}} = \frac{d}{\frac{3}{2}\pi d}$$

$$\text{Resultant } OR = \frac{2}{3\pi} E = .212E.$$

The next stage of the vector diagram is that of Fig. 1(f), where the resultant intensity is zero again, when $\phi = 4\pi = 2\pi n \sin \theta$. For $n=2$ this gives $\sin \theta = 1$, $\theta = 90^\circ$.

In this particular case this completes the curve, since each quadrant is the same. One-half of the exact curve is shown in Fig. 2. The back half is exactly the same.

For wider aerial systems the next form is shown in Fig. 1(g). Here

$$2\pi n \sin \theta = 5\pi, \therefore \sin \theta = \frac{5}{2n}$$

and

$$OR = \frac{2}{5\pi} E = .127E$$

We can now see the general rule. This is given in the table below.

$\sin \theta =$	0	$\frac{2}{2n}$	$\frac{3}{2n}$	$\frac{4}{2n}$	$\frac{5}{2n}$	$\frac{6}{2n}$	$\frac{7}{2n}$	$\frac{8}{2n}$	$\frac{9}{2n}$
Intensity of field ...	1	0	$\frac{2}{3\pi}$	0	$\frac{2}{5\pi}$	0	$\frac{2}{7\pi}$	0	$\frac{2}{9\pi}$
If $n=10, \theta=$	0	$5\frac{1}{2}^\circ$	$8\frac{1}{2}^\circ$	$11\frac{1}{2}^\circ$	$14\frac{1}{2}^\circ$	$17\frac{1}{2}^\circ$	$20\frac{1}{2}^\circ$	$23\frac{1}{2}^\circ$	$26\frac{1}{2}^\circ$ etc.

The series ends when $\sin \theta = 1$, i.e., $\theta = 90^\circ$. For example, if width of system is

10 wavelengths the values of θ are given in the last line of the table. There will be side loops corresponding to all odd numbers between 3 and 19 inclusive, *i.e.*, 9 in all. A drawing of half the polar curve is given in Fig. 3.

[The position of the minima is given accurately in the above table, but the position and value of the side maxima are

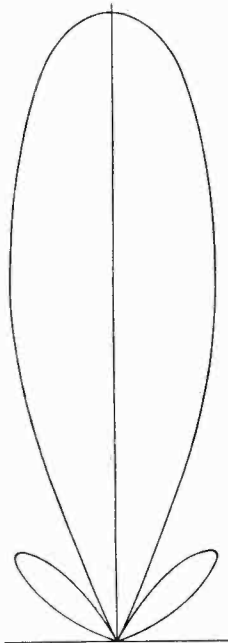

Fig. 2. Polar curve of system 2λ wide.

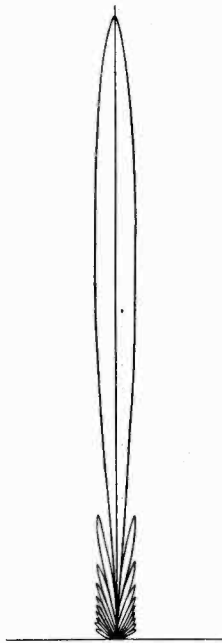

Fig. 3. Polar curve of system 10λ wide.

only approximate, more especially as regards the first. The accurate positions of the side maxima are given by

$$\frac{d}{d\phi} \left(\frac{\sin \frac{\phi}{2}}{\phi/2} \right) = 0$$

or

$$\frac{\cos \frac{\phi}{2}}{\phi/2} - \frac{\sin \frac{\phi}{2}}{(\phi/2)^2} = 0$$

that is

$$\tan \frac{\phi}{2} = \frac{\phi}{2}$$

This gives values for $\phi/2$ of 1.43π , 2.45π , 3.47π , etc., instead of 1.5π , 2.5π , 3.5π , given by the approximate calculation.

For the first side maximum we get the value $.217E$ instead of $.212E$, and for $n=2$ the angle of the first side maximum comes out at 46° instead of 49.5° . The approximate calculation is therefore good enough for most purposes.]

By placing another set of aerials at a quarter wavelength behind the first set, as shown in Fig. 4, we can reflect practically all the energy that would go in this direction. The shape of the polar curve in front is not appreciably affected, but the energy in it for a given input will be doubled.

[The accurate polar curve for the system with reflector can be obtained by multiplying the polar curve of the extended aerial alone, by the heart-shaped polar curve given by a system consisting of a single aerial, and a single reflector wire a quarter wavelength behind it. The reflector wire is assumed to carry a current equal to that in the aerial wire and leading it by 90° . The equation of the curve is

$$r = \cos \frac{\pi}{4} (1 - \cos \phi)$$

The values of r for various values are given in the table below:—

$\theta=0^\circ$	30°	45°	60°	90°	135°	180°
$r=1$.994	.974	.924	.707	.225	0

From these it will be seen that the statement that the reflector only slightly affects the polar curve in front is true.

The polar curve for the extended aerial and reflector will be

$$r = \frac{\sin (n\pi \sin \theta)}{n\pi \sin \theta} \cos \left\{ \frac{\pi}{4} (1 - \cos \theta) \right\}$$

It should be noticed that an extension of

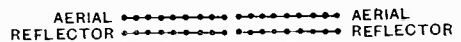

Fig. 4.

the aerial system in the vertical plane to one wavelength or more of height (providing the current is in the same phase throughout) will result in a concentration in the vertical plane. This can be effected by making each vertical aerial unit a number of independent half-wave aerials as shown in Fig. 9(c), and keeping the currents in all of them in the

same phase by the appropriate feeding system. The current distribution in the aerials is shown by the dotted lines. It is not uniform, but the polar curve of intensity in the vertical plane at right angles to the system can be calculated approximately in a manner similar to that used for the horizontal plane. It must be remembered, however, that even a small vertical aerial is directional in the vertical plane, its polar curve being as shown in Fig. 9(a), *O* being the pole. If the aerial system is $n\lambda$ in height, and we assume a good conducting earth (thus making it equivalent to a system $2n\lambda$ in height in free space) the intensity at an angle θ will be proportional to

$$\frac{\sin(2\pi n \sin \theta)}{2\pi n \sin \theta} \cdot \cos \theta.$$

The cosine factor is due to the fact that the intensity of field due to a vertical aerial is proportional to the cosine of the altitude, *i.e.*, proportional to $\cos \theta$.

Fig. 9(b) gives the approximate shape of the curve for a system one wavelength in height, near a good conducting earth, or for one, two wavelengths in height in free space.

Energy Magnification of an Extended System as compared with a Single Aerial.

The accurate way to calculate the energy magnification is as follows: Assume a certain intensity of field I is to be provided at the receiver, then in the case of the single aerial we can find the intensity of field at all points on the surface of the sphere (or hemisphere when dealing with a system near earth) which has its centre at the transmitter, and passes through the receiver. We can therefore sum up the total energy that passes through the surface of this sphere per second. This power must be provided at the transmitter. Let it be represented by A . In the same way we can calculate the power B required by the extended system to give the same intensity of field at the receiver. It follows directly that if the same power is provided for the single aerial and for the extended system the available power at the receiver for the extended system will be A/B times that for the single aerial. This fraction A/B may be called the energy magnification or power magnification of the extended system as compared with the single aerial. It will be

seen that this calculation is a laborious process involving integration over the surface of a sphere, but we can arrive at an approximate value of the "energy magnification" of an extended system as compared with a single aerial of the same height and gain an insight into the methods of calculation by comparing the power radiated in the two cases through an equatorial zone *MN* of unit depth (Fig. 5(a)) instead of through the whole sphere. The ratio thus found would be approximately true, for the zones of the sphere through which most of the energy

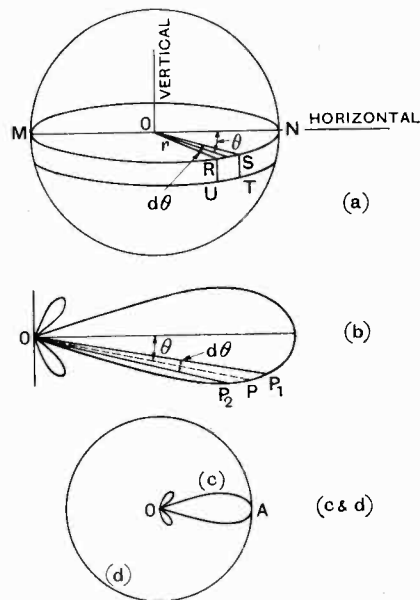

Fig. 5.

passes (*i.e.*, those lying near the equatorial plane), and would therefore give approximately the ratio of the total powers required in the two cases.

Energy Magnification due to an Extension in Width of the Aerial System.

Let the polar curve of intensity in the equatorial plane for the extended system be as shown in Fig. 5(b).

OP represents the intensity of the field in the direction θ at a distance r . The power radiated in this direction will be proportional to OP^2 .

The area of the element *RSTU* of the zone through which this intensity of energy

is radiated is $r.d\theta$ (since the depth of the zone was taken as unity). Hence the power radiated out through the zone within the angle $d\theta$ is proportional to $r.d\theta.OP^2$; and since r is constant, the energy is proportional to $OP^2.d\theta$. Now the area of the triangle OP_1P_2 of the polar curve of field intensity is $\frac{1}{2}OP^2d\theta$. Therefore the energy radiated through the angle $d\theta$ can be represented by the area of the polar figure contained within the angle $d\theta$. And by summation the total power radiated in all directions through the zone is represented by the total area enclosed within the polar curve of intensity of electric field.

Fig. 5(c) is the polar curve of intensity for a system two wavelengths wide with reflector. Let its area be c . A single vertical aerial radiates equally in all directions in the horizontal plane. Hence its polar curve of intensity is a circle, and to give the same intensity as the two-wavelength system it must have the radius OA . Let the area of this circle be d .

Hence, to give equal intensity at A we have:—

$$\frac{\text{Energy for } 2\lambda \text{ system}}{\text{Energy for single aerial}} = c/d$$

Or conversely for equal power input to the aerial system:—

$$\frac{\text{Power at receiver for } 2\lambda \text{ system}}{\text{Power at receiver for single aerial}} = d/c$$

i.e., energy magnification, $m = d/c$

This works out as 12.6 for a system two wavelengths wide with reflector. Other cases can be worked out in a similar fashion, and it will be found that if the width of the system is doubled the energy magnification is approximately doubled, and so on. That this will be so can be seen from two different points of view. Firstly, let us consider the effect of doubling the width of the system on the area of the polar curve. The greater part of the area is contained in the main loop, and we shall confine our attention to this. (For width 2λ , about 6 per cent. is in the side loops.)

The length of the line OP (Fig. 5(b)) is given by:—

$$\frac{\sin \frac{\phi}{2}}{\phi/2} = \frac{\sin (\pi n \sin \theta)}{\pi n \sin \theta}$$

where n is the width of the system in wavelengths; and for small values of θ , such as are represented in the main loop, we can replace $\sin \theta$ by θ without serious error.

Hence

$$OP = \frac{\sin (\pi n \theta)}{\pi n \theta}$$

Now double the value of n and halve the value of θ and the value of OP is unaltered. The small angle $d\theta$ must also be halved, and so therefore must the area of the triangle OP_1P_2 . Hence the area of the main loop is halved (for the same maximum value) and the energy magnification is approximately doubled.

Secondly, we can consider the more direct physical effect of doubling the width of the system. Take an extended system consisting of aerial and reflector that requires a total input W to give an intensity of field I at the receiver, and therefore available energy at the receiver proportional to I^2 . Two such



Fig. 6.

systems placed side by side as in Fig. 6 have little direct action on each other so that an energy input W to each will give the same currents as before. Hence if each system has energy input W they simply add their field intensities and the resultant field intensity now becomes $2I$, therefore for an input energy $2W$ we have an available energy at the receiver proportional to $(2I)^2 = 4I^2$. Hence with total energy W to the system of double extent, the energy at the receiver is proportional to $2I^2$; *i.e.*, its value is doubled when the width of the system is doubled, and so on.

Thus for a system ten wavelengths wide with reflector the energy magnification will be about 63. We can take an average figure of 6.3 for each wavelength of width. For the extended system without reflector the energy magnification per wavelength of width will be about 3.2. The reflector multiplies this figure by 2.

The polar curve for reception of such an extended system will be an exact replica of that for transmission. This can be seen by

working it out in detail, though it follows directly from fundamental principles. The energy magnification as compared with a single aerial of the same height will therefore be the same as that given above. The total magnification for the system using equal extended systems at transmitter and receiver as compared with single aerials at both ends will be m^2 . For systems two wavelengths in width this is 160, while for those ten wavelengths in width it is $63^2=4,000$.

If the atmospherics at the receiving end come more or less equally distributed from all directions this full magnification will be obtained. If they come chiefly from outside the receptive angle of the system, the gain will be greater, while if they come inside this angle the gain will be less.

The accurate calculation by the method indicated of the energy magnification for aerial systems several wavelengths long and one or more wavelengths in height gives the following results: As compared with a small single aerial, the extended system with reflector gives an energy magnification of 10 for each square wavelength of surface. If the height of the system is m , and its width n , the energy magnification will be $10mn$. Thus if the system is ten wavelengths long and two wavelengths high, the energy magnification will be $10 \times 20 = 200$. Two such systems, one as receiver and one as transmitter, will therefore have an effective energy magnification of $200^2 = 40,000$.

That is to say, with two such aerials, one as transmitter and one as receiver, and one kilowatt input to the transmitter, we get a certain strength of signal at the receiver. Then working over the same distance with single aerials at both transmitter and receiver we should have to supply 40,000 kilowatts to the transmitter to obtain the same strength of signal at the receiver.

If we consider an aerial system of fixed extent in the horizontal plane, we see that the energy magnification per wavelength of extension in height as compared with a system of negligible height will be $10/6.3 = 1.6$. This is smaller than the figure (*i.e.*, 3.2) per wavelength extension in the horizontal plane, for two reasons:—

1. Even a small vertical aerial has considerable directional properties in the vertical plane, the intensity being propor-

tional to the cosine of the altitude. (See Fig. 9(a).)

2. The area of the zones through which the energy is radiated also decreases as the cosine of the altitude.

Other Aerial Systems.

The same method of calculating the polar curves can be applied to other extended systems. Thus we may have a line of aerials like those shown in Fig. 7, but fed so that their effects added up in phase in the direction OB . This would require that starting from O the phase of the currents in

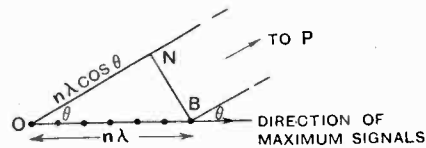

Fig. 7.

consecutive aerials would lag by a constant amount. In particular the phase of the current in B would have to lag

$$n\lambda \times \frac{2\pi}{\lambda} = 2\pi n \text{ radians } (=n \cdot 360^\circ)$$

behind that in O .

To find the polar curve in this case we shall measure the angle θ from the direction OB , the direction of maximum intensity. A similar line of argument to that used in the previous case will show that the vector diagram starts as a straight line for $\theta = 0^\circ$ and bends into a circular form as θ is increased. We have only to determine the angle of lag ϕ between the vector field intensities produced by the extreme elements at a distant point P for any angle θ . This angle ϕ will be the angle subtended by the circular arc of the vector diagram, and as before the resultant intensity of field for that direction as compared with that in the direction OB will be

$$\frac{\sin \frac{\phi}{2}}{\phi/2}$$

We have then (a) the current in B lags $2\pi n$ radians behind that in O ; (b) For the direction θ the effects from O have to travel a distance ON greater than the effects from B . $ON = n\lambda \cos \theta$, and in phase angle it is

equal to

$$\frac{2\pi n \lambda \cos \theta}{\lambda} = 2\pi n \cos \theta \text{ radians.}$$

The resultant phase difference ϕ for the angle will be the difference between these two effects, and is therefore

$$2\pi n - 2\pi n \cos \theta = 2\pi n (1 - \cos \theta) = \phi.$$

With this definition of ϕ all the Figs. 1(b) to 1(g) apply to this case also. We shall have a minimum wherever $\phi = 2\pi, 4\pi, \text{etc.}$, i.e., when :—

$$n(1 - \cos \theta) = 1, 2, 3, \text{etc.}$$

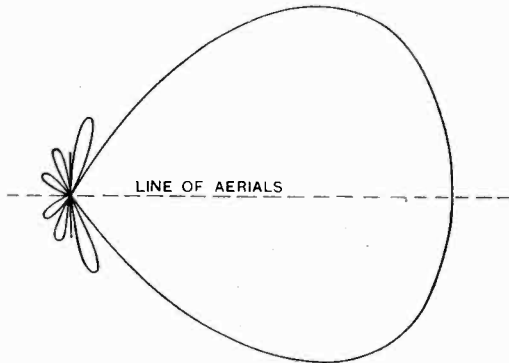

Fig. 8.

Minimum for

$$\cos \theta = \left(1 - \frac{1}{n}\right), \left(1 - \frac{2}{n}\right), \left(1 - \frac{3}{n}\right), \text{etc.}$$

There will be a maximum when

$$\phi = 0, 3\pi, 5\pi, 7\pi, \text{etc.}$$

Maximum for

$$\cos \theta = 1, \left(1 - \frac{3}{2n}\right), \left(1 - \frac{5}{2n}\right), \text{etc.}$$

Values of maxima $1, \frac{2}{3\pi}, \frac{2}{5\pi}, \text{etc.}$

The limit of these series is fixed by the fact that $\cos \theta$ cannot have a greater negative value than -1 , which it reaches when $\theta = 180^\circ$. Hence the polar figure consists of one main maximum at $\theta = 0^\circ$ and a series of side maxima steadily decreasing in value as θ increases from 0° to 180° on either side of the line OB .

The polar curve for the case $OB = 2\lambda$ is given in Fig. 8. It is a unidirectional figure,

unlike that for the single line of aerials previously treated which by itself was bi-directional. For $OB = 2\lambda$ ($n = 2$) we shall

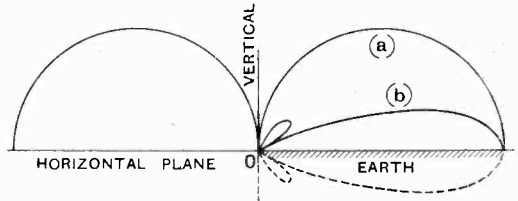

Fig. 9a.

Fig. 9b.

have minima and maxima as given in the table.

TABLE OF MAXIMA AND MINIMA FOR $OB = 2\lambda$.

$\cos \theta =$	1	$\left(1 - \frac{1}{n}\right)$	$\left(1 - \frac{3}{2n}\right)$	$\left(1 - \frac{2}{n}\right)$	$\left(1 - \frac{5}{2n}\right)$	$\left(1 - \frac{3}{n}\right)$	$\left(1 - \frac{7}{2n}\right)$	$\left(1 - \frac{4}{n}\right)$
$\cos \theta =$	1	$\frac{1}{2}$	$\frac{1}{3}$	0	$-\frac{1}{3}$	$-\frac{1}{2}$	$-\frac{2}{3}$	-1
$\theta =$	0°	60°	75.5°	90°	104.5°	120°	138.5°	180°
Intensity of field =	1	0	$\frac{2}{3\pi}$	0	$\frac{2}{5\pi}$	0	$\frac{2}{7\pi}$	0

It will be noticed that the first minimum comes 60° on either side of the main maximum instead of 30° on either side for the two-wavelength front, with reflector previously treated.

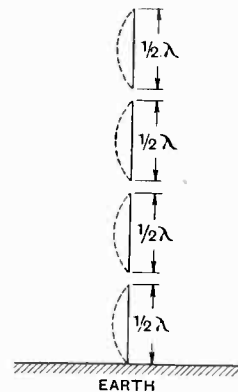

Fig. 9c.

Other points to be noticed with this system are :—

First, that it gives a concentration of energy in the vertical plane as well as in the

horizontal plane even when the vertical height of the aerials is small, the energy being concentrated into a cone with the line of aerials as its axis.

Secondly, notice that to halve the angle at which the first minimum occurs, we have to increase the length of the system approximately four times and so on. For we saw that the value of θ for the first minimum was given by

$$\cos \theta = 1 - \frac{1}{n}$$

and when θ is small we can replace it by

$$1 - \frac{\theta^2}{2}, \text{ which gives us } \frac{\theta^2}{2} = \frac{1}{n}$$

thus proving the statement.

To find n to give $\theta=30^\circ$ we have

$$\cos 30^\circ = .866 = 1 - \frac{1}{n}$$

$$n = \frac{1}{.134} = 7.46$$

The aerial system using a reflector only requires to be two wavelengths wide to give the first minimum at 30° .

Some Measurements of a "Stalloy" Core with Simultaneous D.C. and A.C. Excitation.

By L. B. Turner, M.A., M.I.E.E.

SMALL chokes and transformers are widely used in association with triodes in such a way that the core has to carry simultaneously a steady and an alternating magnetic flux. The presence of the steady component of current in the winding may profoundly influence the behaviour of the choke as regards the alternating P.D. In many wireless telephone receivers such a choke is employed—

(a) in the smoothing mesh of a rectifier supplying high-tension D.C. from A.C. mains;

(b) in association with a condenser preventing anode current from passing through the loud-speaker; and

(c) as an iron-cored choke or transformer in one or more stages of the low frequency amplifier.

In each case the winding has to pass a steady direct current and at the same time to offer the greatest possible impedance to alternating P.Ds. applied to it. In case (a), the alternating P.D. is constant in magnitude and frequency, and it is not essential

to good performance that the impedance shall be indefinitely great. But in cases (b) and (c), the alternating P.D. fluctuates over wide ranges of amplitude and over the whole range of acoustic frequencies, and it is essential for good performance that at all

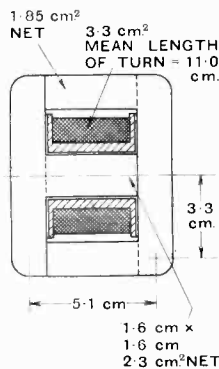

Fig. 1.

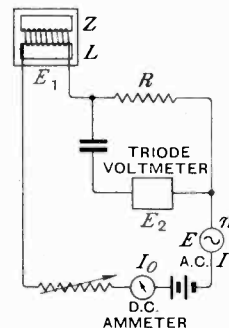

Fig. 2.

amplitudes and frequencies the impedance shall be indefinitely great compared with the anode A.C. resistance of the triode. It is common knowledge that, especially in case

(c), the design of the choke actually employed is very often such that it does not meet the condition for good performance.

The writer has had occasion to measure the behaviour of the choke shown in Fig. 1. As this choke is of a size and type much employed in the ways named above, and in others, the measurements were extended to cover a wide range of values, and are here presented in a form conveniently applicable to designers' calculations.*

The measurements were made as shown

call $Z = E_1/I$ the "impedance" of the choke (sensibly equal to its "reactance"), and $L = Z/2\pi n$ its "inductance," where E and I are the R.M.S. values of the alternating quantities. E_2 , and sometimes E_1 , were measured with a suitable triode voltmeter.

I is found as E_2/R ,

and L as $(1/2\pi n) \cdot R \cdot (E_1/E_2)$.

In most of the measurements R/Z was small enough to allow the approximation $E_1 \doteq E$.

The choke tested was wound with 2,500

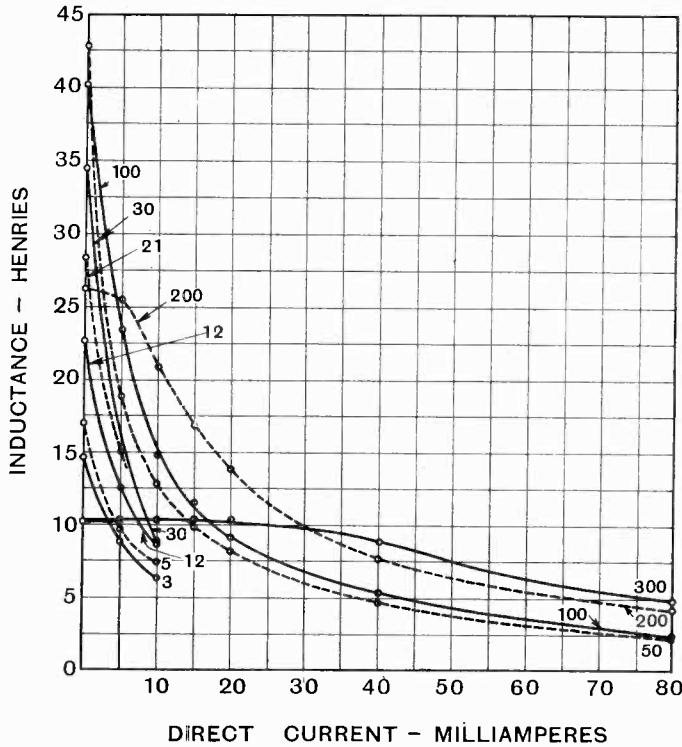

Fig. 3. The numbers against the curves indicate in volts the R.M.S. value of the alternating P.D. across the choke at 90 cycles per second.

in Fig. 2, and the results are plotted in Fig. 3. The applied alternating E.M.F. E being substantially sinoidal, it follows that the alternating current I is not sinoidal; but for our purposes we may, as is usual,

* The core stampings and bobbin used in the actual choke tested are both readily obtainable. The former are Messrs. Sankey's standard transformer stampings Nos. 5, 14 and 15; and the latter is Messrs. Edison Bell's standard moulded transformer bobbin No. 150.

turns of copper wire, S.W.G. 32 D.W.S., D.C. resistance about 80 ohms. The frequency n was 90 cycles/sec. Since the cross-section of steel within the bobbin is about 2.3 cm.², with this number of turns and at this frequency the maximum alternating flux density in C.G.S. units is about 44 E , where E is in volts.* The makers' curves for "Stalloy" show a maximum permeability at a flux

* In the rest of the core it is less, viz., about 28 E .

density of 4,000. Hence when $I_0=0$, we should expect the inductance to be a maximum when E has a value somewhat above $4,000/44=90V$. It will be seen in Fig. 2 that the measured inductance values were highest (about 40H) with 50V and 100V, and fell off progressively (towards about 10H) with the voltages lower than 50 and higher than 100.

In the Table, the results of Fig. 3 are put in a form convenient in calculating the performance, for any specified service, of various windings on this core; and the figures may be easily adapted to other fairly similar cores of the same material. As an illustration, let us use the Table to find the inductance of a 2,500-turns winding, with a direct current of 8mA and an applied alternating P.D. of 100V. at 90 cycles/sec. The D.C. excitation is $(8/1000) \times 2500 = 20$ ampere-turns. The A.C. voltage per 1,000 turns per 1,000 cycles/sec. is

$$100 \times (1,000/90) \times (1,000/2,500) = 445.$$

The Table therefore gives an inductance of about 2.9H for 1,000 turns, and therefore $2.9 \times (2,500/1,000)^2 = 18.1H$ for 25,000 turns. This agrees with Fig. 3, which shows 17.9H for the specified values.

TABLE.

Inductance in henries of the specified "Stalloy" core if wound with 1,000 turns, when the D.C. excitation is 0, 5, - - - 160 ampere-turns, and the alternating P.D. per 1,000 turns and per 1,000 cycles/sec. is 13, 22 - - - 1,300 volts (R.M.S.).

A. C. volts (R. M. S.) per 1,000 turns and per 1,000 cycles/sec.*	D.C. excitation in ampere- turns.						
	0	5	10	20	40	80	160
13	2.3	1.9	1.5	1.1	—	—	—
22	2.7	2.1	1.7	1.3	—	—	—
53	3.6	2.7	2.2	1.6	—	—	—
90	4.5	3.4	2.7	—	—	—	—
130	5.5	4.0	3.0	1.8	—	—	—
220	6.8	4.4	3.4	2.3	1.5	0.9	0.5
440	6.4	5.2	4.2	2.9	1.7	1.0	0.5
900	4.2	4.2	4.1	3.7	2.6	1.5	0.8
1,300	1.7	1.7	1.7	1.7	1.6	1.6	1.0

* Maximum flux-density in central core is 10.8 times the number in this column.

Radio-Frequency Transformers.

Their Application to Screened Valves.

By N. W. McLachlan, D.Sc., M.I.E.E., F.Inst.P.

THE use of an intervalve radio-frequency transformer for wavelengths within the band 300 to 600 metres has always seemed to possess possibilities which have only been realised in practical form recently. Some three or more years ago, efforts to construct radio-frequency transformers usually met with little success. This was due to improper design which was associated with two undesirable features, namely, (1) high resistance secondary winding, (2) large mutual and self-capacities of the windings. To get a basis for design it is essential to examine the theory of the instrument. This indicates that the resistance of the secondary winding should be small as also should the self and mutual capacities. It was not until the advent of Mr. S. Butterworth's classical analysis of coil resistance,* that satisfactory radio frequency intervalve transformers were constructed. The complete theory in which self and mutual capacity effects are embodied is somewhat extensive and uninteresting, the analysis serving to mask the physical

closely coiled, this assumption does not lead to serious errors.*

The analysis is equally valid for screened valves and for neurodyned three-electrode valves. The usual circuit in which the neurodyne connections are omitted is shown in Fig. 1. This is reduced to an equivalent

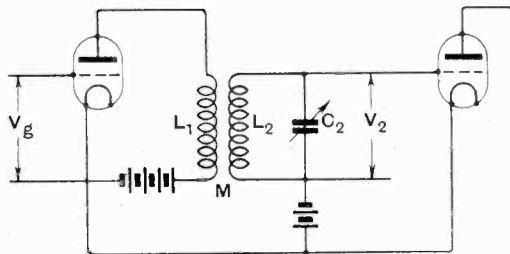

Fig. 1. Showing radio-frequency transformer connections with neurodyne arrangement omitted.

significance of the problem. Moreover, it is proposed herein to make the subject more presentable by neglecting these capacities. Practical measurements show that, provided care is exercised in the design, e.g., the primary should not be made of thick wire

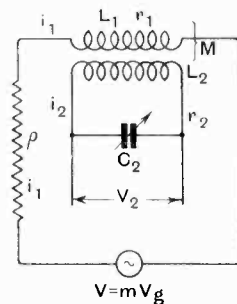

Fig. 2. Equivalent circuit of valve V_1 of Fig. 1. $V = mV_g = g_0V_g$, where "g" is the mutual conductance.

circuit in Fig. 2. Needless to say, we shall neglect feed-back effects due to the valves preceding and succeeding the transformer.

From Fig. 2 we obtain the following circuital equations:—

$$(r_1 + \rho)i_1 + j\omega L_1 i_1 + j\omega M i_2 = V = mv_g \dots (1)$$

$$r_2 i_2 + j\omega L_2 i_2 + j\omega M i_1 - \frac{j i_2}{\omega C_2} = 0 \dots (2)$$

From (1)

$$i_1(\rho + j\omega L_1) + i_2 \cdot j\omega M = V \dots (3)$$

since r_1 is small compared with ρ .

From (2)

$$i_1 \cdot j\omega M + i_2(r_2 + j\omega L_2 - j/\omega C_2) = 0 \dots (4)$$

Solving equations (3) and (4) we have:—

$$i_2 \{ (-\omega^2 L_1 L_2 (1 - k^2) + \rho r_2 + L_1 / C_2) + j(\omega L_2 \rho - \rho / \omega C_2) \} = -j\omega M V \dots (5)$$

Where $M^2 = k^2 L_1 L_2$ and we neglect $\omega L_1 r_2$ in comparison with $\omega L_2 \rho$.

* The mutual capacity can be represented approximately as an equivalent secondary capacity.

* E.W. & W.E., Vol. 3, p. 203.

From (5) we get (scalar value)

$$i_2 = \frac{\omega MV}{\{(-\omega^2 L_1 L_2 (1 - k^2) + \rho r_2 + L_1 / C_2)^2 + [\rho / \omega C_2 (\omega^2 L_2 C_2 - 1)]^2\}^{\frac{1}{2}}} \quad (6)$$

At resonance $\omega^2 L_2 C_2 = 1$, so that (6) becomes

$$i_2 = \frac{\omega M C_2 V}{k^2 L_1 + \rho r_2 C_2} \quad \dots (7)$$

The voltage across the grid and filament of the succeeding valve is equal to that across C_2 . At resonance this voltage is

$$V_2 = i_2 / \omega C_2 = \frac{MV}{k^2 L_1 + \rho r_2 C_2} = \frac{k(L_1 L_2)^{\frac{1}{2}}}{k^2 L_1 + \rho r_2 C_2} \quad (8)$$

Putting $L_2 / L_1 = s^2$, equation (8) becomes

$$V_2 = \frac{skL_2 V}{k^2 L_2 + \rho r_2 C_2 s^2} = \frac{L_2 V}{(k/s)L_2 + s/k(\rho r_2 C_2)}$$

$$= \frac{L_2 V}{aL_2 + \frac{\rho r_2 C_2}{a}} \quad \dots (9)$$

where $a = k/s$.

In practice the values of L_2 and C_2 are fixed according to the waveband to be covered by the receiver. For any given frequency this fixes the value of r_2 . As the wavelength varies, say from 300 to 500 metres, r_2 decreases in value, but C_2 increases. In practice the product λr_2 over the range 300 to 500 metres is substantially constant for a low loss coil. But $\lambda = 1885 (L_2 C_2)^{\frac{1}{2}}$ so that $r_2 C_2^{\frac{1}{2}}$ is constant and therefore the product $C_2 r_2$ increases with the wavelength. Thus the transformer design must be based on some particular wavelength. In equation (9) everything is constant except a . Differentiating (9) with respect to " a " we find that the maximum value of V_2 is obtained when the two terms in the denominator are equal, that is when

$$aL_2 = \frac{\rho r_2 C_2}{a}$$

or

$$a = \left(\frac{\rho r_2 C_2}{L_2}\right)^{\frac{1}{2}} \quad \dots (10)$$

Now at resonance the impedance of the secondary winding of the transformer is a dynamic resistance whose value is

$$R_2 = L_2 / r_2 C_2 = \omega^2 L_2^2 / r_2.$$

Substituting this value of R_2 in (10) we obtain the optimum value of

$$(k/s) = a = (\rho / R_2)^{\frac{1}{2}} \quad \dots (11)$$

Since $a = k/s$ it follows that if either k or s

is fixed, the optimum value of the variable one is found from (10). Thus when s is fixed, the optimum value of

$$k = s (\rho / R_2)^{\frac{1}{2}} \quad \dots (12)$$

Also the optimum value of

$$s (k = const.) = k (R_2 / \rho)^{\frac{1}{2}} \quad \dots (13)$$

Substituting the value of a from (11) and also $\frac{L_2}{r_2 C_2} = R_2$ in (9) we find

$$V_2 = V/2 \left(\frac{R_2}{\rho}\right)^{\frac{1}{2}} = \frac{mv_g}{2} \left(\frac{R_2}{\rho}\right)^{\frac{1}{2}} \quad \dots (14)$$

which is the maximum possible value of V_2 .

In designing the transformer if we know k it is possible to find the correct value of s by calculation; also s can be found experimentally, using a tapped primary. Conversely, if we know s it is possible to find k not only by calculation, but by experiment. Care, however, must be exercised that the conditions, *i.e.*, the various coefficients or factors involved, are not such that a value of k greater than unity and an absurd value of s is required to give the maximum transformer amplification. In other words, one cannot wind a primary indiscriminately and with any type of valve, and expect to find the optimum coupling.

Equation (13) can be written

$$V_2 = A \frac{m}{\rho^{\frac{1}{2}}} \quad \dots (15)$$

where

$$A = \frac{v_g R_2^{\frac{1}{2}}}{2}$$

By taking a certain coil at a definite frequency so that A remains constant, we can, by calculating the ratio $m/\rho^{\frac{1}{2}}$, obtain some idea of the utility of various valves in combination with transformers designed for maximum magnification. This has been done in Table I, where a series of values of this ratio are given for a variety of valves. The valve parameters are those published by the manufacturers, but of course one would expect to find variations in practice. It is clear that, except in the case of the DE5, the higher the internal A.C. valve resistance the greater is the ratio $m/\rho^{\frac{1}{2}}$ and therefore the magnification. For completeness the optimum values of s^* (assuming $k=1$) have

* Under certain conditions s may be considered as the turns ratio. For these transformers the inductance \propto turns² \times a variable parameter depending on length of coil, etc., so that s is not the turns ratio. As an easy way of viewing the problem s can be regarded as approximating to the turns ratio.

been given, also the maximum magnification with this ratio. If k is less than unity s decreases, *i.e.*, the primary inductance increases. From the table we also see that s decreases as the valve resistance increases. This is necessary so that the equivalent

and that the equivalent transformer ratio is s/k . Thus (16) can be written

$$V_2 = mv_g \cdot s/k \left(\frac{R_1}{\rho + R_1} \right) \dots (18)$$

From (11) the optimum value of k/s is $(\rho/R_2)^{1/2}$. Since

$$R_1 = \frac{k^2}{s^2} R_2$$

the optimum value of R_1 is $\rho R_2/R_2 = \rho$, *i.e.*, the magnification is a maximum when the dynamic primary resistance is equal to the internal valve resistance—which we might have anticipated. To secure this condition the value of s must vary with the internal valve resistance.

Screened Valves.

With a screened valve both the values of " m " and " ρ " are considerably larger than for a three-electrode valve. The data pertaining to a screened valve and a suitable radio-frequency transformer are given in Table II. The valve taken is that already described by the author in the *Wireless World*.* It is assumed to work with a grid bias of about -1 , an anode voltage of 120, and a screen voltage of 80, at which point on the characteristic the internal resistance and magnification factor are approximately 2×10^5 ohms and 100 respectively.

TABLE I.
DATA FOR VARIOUS VALVES AND TRANSFORMERS.

Valve.	ρ	$m/\rho^{1/2}$	S (optimum).	Max. magnification per stage.
DE ₃	2.2×10^4	4.7×10^{-2}	4.5	15.5
DE ₃ B	5×10^4	7.6×10^{-2}	3	25
DE ₅	7×10^3	8.4×10^{-2}	8	28
DE ₅ B	3×10^4	11.6×10^{-2}	3.8	38
DEH610	6.5×10^4	15.7×10^{-2}	2.6	52

primary impedance of the transformer suits the valve. This can be seen more clearly by the aid of Fig. 3 which represents the equivalent primary circuit of valve and transformer. The transformer impedance

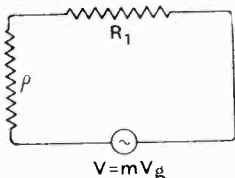

$$R_1 = \frac{k^2}{s^2} R_2 = \frac{k^2}{s^2} \cdot \frac{L_2}{C_2 r_2}$$

Fig. 3. Showing equivalent primary circuit of transformer and valves. The optimum value of $R_1 = \rho$.

at resonance is a dynamic resistance R_1 , and the formula for the magnification is identical with that of a resistance-coupled stage. Thus magnification in anode circuit = $m \cdot R_1 / (\rho + R_1)$ where R_1 is the equivalent primary resistance. The voltage on the grid of the succeeding valve is

$$V_2 = mv_g \left(\frac{R_1}{\rho + R_1} \right) \times \text{equivalent transformer ratio (16)}$$

The value of R_1 and the ratio can be found by transforming equation (9) which becomes

$$V_2 = mv_g \cdot \frac{a^2 R_2}{a(\rho + a^2 R_2)} \dots (17)$$

where $a = k/s$ and $R_2 = L_2/C_2 r_2$.

Thus we see that

$$R_1 = a^2 R_2 = \frac{k^2}{s^2} R_2$$

TABLE II.

DATA REGARDING SCREENED VALVE AND TRANSFORMER.

Valve.	ρ (internal resist.)	$m/\rho^{1/2}$	S (optimum).	Magnification per stage.
Screened Valve S625	2×10^5	2.24×10^{-2}	1.48	70

The data in Table II. show the superiority of the screened valve over the three-electrode valves cited in Table I. There is one point of importance to which reference must be made, namely, the stability of the circuit with a magnification of 70. Assuming a cascaded amplifier, this valve would, at wavelengths from 300 to 500 metres, be too high for stability, so that the transformer would require amended design with this in view. If the aerial loading coil were coupled

* 31st August, 7th and 14th September, 1927.

direct to the grid of the valve this might in some cases ensure sufficient damping to prevent self-oscillation due to feed-back. It is certain, however, that precautions should be taken to screen the transformer electrostatically and electromagnetically from the grid and aerial circuits.

Screened Valve and Tuned Anode.

The comparatively small value of the turns ratio for a screened valve, viz., 1.48, makes one curious to know whether the transformer has an advantage over the plain tuned anode. The magnification with the latter, using our secondary low loss coil, is found from equation (17) by putting $a=1$. This gives

$$V_2 = mV_g \left(\frac{R_2}{\rho + R_2} \right) \dots (19)$$

Taking the magnification ratio $\frac{\text{Transformer}}{\text{Tuned anode}}$

we get from (14) and (19)

$$\frac{Tr}{T.A} = \frac{\rho + R_2}{2(\rho R_2)^{\frac{1}{2}}}$$

Putting $L_2 = 200\mu\text{H}$ and $r_2 = 2$ ohms at 7.5×10^5 cycles (400m.) we find $R_2 = 4.4 \times 10^5$.

Hence, with $\rho = 2 \times 10^5$ the ratio $Tr/T.A. = 1.08$. Thus the best transformer has an advantage in magnification of only 8 per cent. over the tuned anode.* Which device is preferable is largely a matter of design. The tuned anode necessitates an additional condenser and grid-leak. To secure maximum amplification the losses in these should be a minimum. On the other hand, the amplification with low loss coils is too high for stability unless the aerial damping is adequate.† Hence the losses in leak and condenser are of less importance in practice.

Selectivity of Transformer.

A transformer gives a gain in selectivity over a tuned anode (*barring feed-back effects*), but this gain is not so marked with the screened valve as it is with the three-electrode valve. The equivalent primary

* The ratio, of course, for any given valve depends on R_2 . The value of r_2 in a receiver might be greater than 2 ohms, owing to losses due to neighbouring components. Some valves received recently have a larger internal resistance than that quoted here. Moreover, the calculated data apply to this particular valve and are not standard.

† See *Wireless World*, 31st August and 7th September, 1927.

capacity is $C_2 s^2$ when k is unity. Thus the primary circuit is virtually a tuned anode of inductance L_1 and capacity $C_2 s^2$, as shown in Fig. 4. The capacity being larger than C_2 means enhanced selectivity over a tuned anode using the same (secondary) inductance and capacity. This was shown in detail in a former article in this Journal.* With a screened valve s^2 (taking k as unity)

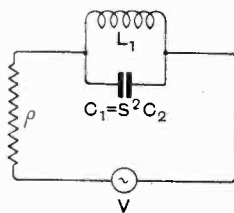

Fig. 4.

Equivalent primary circuit of transformer when $k = 1$.

is a fraction of that with a three-electrode valve, so that the primary condenser is greater in the latter case. Thus the selectivity of the transformer is comparatively more marked with the three-electrode valve than with a screened valve.

Since the dynamic resistance $R_2 = L_2 / C_2 r_2$, it is clear that its value at any given frequency decreases with increase in the condenser C_2 ($L_2 C_2 = \text{const.}$). By reducing R_2 in this way it is possible to stabilise a screened valve with tuned anode and at the same time enhance the selectivity. Another particularly effective method is to increase the grid bias. In practice, owing to variable condensers usually being limited in capacity for covering a certain waveband, it may be preferable to use a transformer with a value of s^2 larger than the optimum, *i.e.*, too large a turns ratio. The equivalent primary dynamic resistance is reduced owing to the increase in equivalent primary capacity. The variation in anode voltage is decreased as also is the valve damping, whilst the selectivity is enhanced. In point of fact, a transformer with a tapped primary is very useful in practice, for it is possible to find by experiment a ratio (*i.e.*, value of s^2) which gives stability. It must be realised that when there is a tendency to self-oscillation with a low transformation ratio the increased selectivity due to a higher ratio may not be appreciably apparent. Where a high magnification per stage is imperative there is, of course, no reason why the neutrodyne principle should not be used, although this defeats the object for which the screened valve was designed.

* *E.W. & W.E.*, September, 1926.

The Properties of the Circle Diagram for Telephonic Frequency Intervolve Transformers.

By Professor Felix E. Hackett, Ph.D. (Dublin).

AN important advance in the theory of the performance of intervalve transformers was made by the work carried out in the National Physical Laboratory recorded by Mr. Dye in a most interesting series of articles.*

The investigation was directed to examine the performance of the transformer under conditions of use by measuring the effective primary resistance and reactance of the transformer suitably connected over a range of audio frequencies. It was somewhat of a surprise to find that plotting the resistance against the reactance a good circle was obtained (Fig. 2). This result suggested that the effect of the transformer could be represented by a simple circuit. It was shown how the values of an inductance (L),

which is somewhat simpler, as it avoids the cumbersome expressions which are commonly used when dealing with parallel circuits. It has also the advantage of making use of the whole range of observations so that there is greater precision in the result.

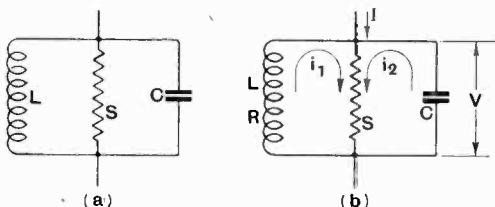

Fig. 1.

a small condenser (C) and a large resistance (S) all in parallel could be determined which would be equivalent to the action of the transformer. It is by no means easy to carry out the measurement of an inductance of many henries with a resistance of many thousands of ohms, but the way in which the simple circuit supplied all the theoretical demands is convincing proof that the difficulties were surmounted and accuracy attained.

The calculation of the constants of the equivalent circuit was made by a method of continued approximation based on observations at two frequencies. In this note another method of calculation is submitted

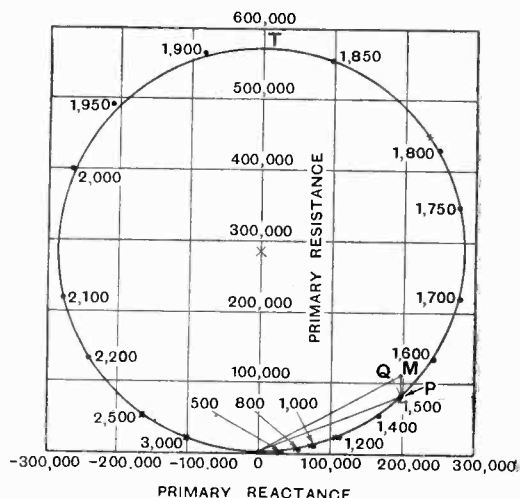

Fig. 2.

The Inductance and Equivalent Capacity of a Transformer.

We shall, in the first instance, illustrate the method by applying it to the simplest kind of circuit, Fig. 1(a), which can give a circle diagram and then to the circuit, Fig. 1(b), which was found to represent the observations more closely. The notation in Dye's paper is modified slightly by writing Y for the effective resistance instead of R_0 and X for the effective reactance instead of $L_0\omega$.

From the usual formula for parallel circuits we have for Fig. 1 (a)

$$\frac{I}{Y + jX} = \frac{I}{jL\omega} + \frac{I}{S} + jC\omega$$

* Dye. E.W. & W.E., Sept., Oct., Nov., 1924.

or $\frac{Y-jX}{Y^2+X^2} = \frac{-j}{L\omega} + \frac{1}{S} + jC\omega$

Hence $\frac{Y}{X^2+Y^2} = \frac{1}{S} \dots \dots (1)$

$\frac{X}{X^2+Y^2} = \frac{1}{L\omega} - C\omega \dots (2)$

The essential part of the method consists in retaining the equations in this form instead of, as usual, solving for X and Y. If we plot Y against X (1) shows that the graph is a circle whose equation is $SY=X^2+Y^2$, touching the X-axis at the origin and having its centre on the Y-axis at the point S/2. Its diameter is easily seen to be S the value of Y (Y) when the circuit is non-reactive. This occurs at the point of resonance when $LC\omega^2=1$ from (2).

"Such a circle although approximately representing the performance of the primary of transformer cannot quite do so since the inductance L has in practice a resistance R which is shown by the fact that the actual graph does not touch the X-axis at the origin but gives a relatively small value of R corresponding to frequency ω . Now this resistance R, although of little consequence to the lower portion of the circle, has a considerable influence on the diameter of it. A further effect is to cause the circle to be displaced horizontally by a small amount so that its centre lies to the left of the R-axis. The experimental results are sufficiently accurate to show this as will be seen from a close inspection of the points in Fig. 2."*

A closer approximation to the experimental and the actual case is given by Fig. 1 (b), where the inductance now includes a resistance R.

Before discussing this circuit we note that on writing $1/L\omega - C\omega = P$

$\frac{X}{X^2+Y^2} = \frac{1}{L\omega} - C\omega = P$

It will now be shown that notwithstanding the inclusion of R the value of P can still be calculated by this equation to a very close approximation. The ease of this calculation enables a series of values of P for different frequencies to be obtained without much trouble. These can then be used to find L and C.

*Dye. *Loc. cit.*

Returning to the circuit 1(b) we have

$\frac{1}{Y+jX} = \frac{1}{R+jL\omega} + \frac{1}{S} + jC\omega$

giving,

$\frac{Y}{X^2+Y^2} = \frac{R}{R^2+L^2\omega^2} + \frac{1}{S} \dots (3)$

$\frac{X}{X^2+Y^2} = \frac{L\omega}{R^2+L^2\omega^2} - C\omega \dots (4)$

The next step is the deduction of L and C from the observed values of the effective resistance Y and effective reactance X at different frequencies. This is easily done by re-writing (4) thus

$\frac{X}{X^2+Y^2} = -\frac{R}{L\omega} \cdot \frac{R}{R^2+L^2\omega^2} + \frac{1}{L\omega} - C\omega$

Putting $R/L\omega = a$ it follows that we have

$P = \frac{X}{X^2+Y^2} + \frac{a}{R(1+a^2)} \div \frac{X}{X^2+Y^2} (5)$

Trial calculations using the values obtained by Dye show that the error in neglecting the second term is less than 0.1 per cent. For instance, taking $L = 8.68$ H, $R = 1,000$ ohms when $\omega = 9,424$, $a = 1/83$, we find that the second term is 2×10^{-9} , while the first term inserting $X = 198,500$ ohms and $Y = 85,000$ ohms is 4.25×10^{-6} . The error in taking P as equal to the first term is about 0.05 per cent. It obviously diminishes for higher frequencies.

We can then use the approximate formula (5) with confidence. It has been applied to the calculation of a series of values of P from the table of effective resistances and reactances given by Dye* for frequencies ranging from 50 to 3,000. If we write $\omega = 2\pi n$

$P = \frac{1}{L\omega} - C\omega = \frac{1}{2\pi Ln} - 2\pi Cn$

or $Pn = -2\pi C.n^2 + (2\pi L)^{-1}$

Plotting Pn against n^2 , we get a straight line whose intercept is $(2\pi L)^{-1}$ and whose slope is $-2\pi C$. This has been done in Fig. 3.

The points lie closely on a straight line where it passes through the resonance even frequency, showing that the equivalent

*E.W. & W.E., Sept., 1924, Table I. p. 695.

simple circuit represents very closely indeed the performance of an intervalve transformer.

By reading from the graph or by a corresponding calculation from the observations to have greater accuracy, we find

$$L = 9.10 (8.68) \text{ H. } C = 820 (825) \mu\mu\text{F.}$$

The values in brackets are those recorded by Dye, which were obtained by a continued approximation from observations at two frequencies. The origin of the greater discrepancy for L has not been investigated.

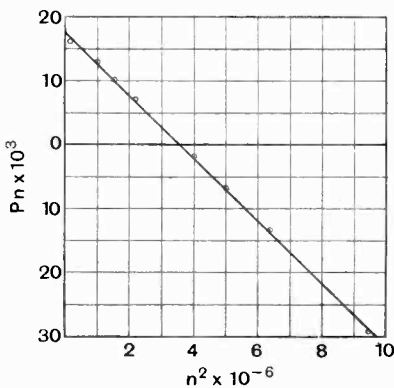

Fig. 3.

The Diameter of the "Circle."

The results of the general examination of the performance of an intervalve transformer is then conveniently represented by means of the diagram of Fig. 2, which we have seen is practically a circle. The intercept on the axis, corresponding to the diameter of a circle in the simplest case (1A), is the important constant. It is really the effective resistance Y , when the equivalent circuit (1B) is non-reactive ($X = 0$). If we write (4) in the form

$$\frac{X}{X^2 + Y^2} = \frac{\omega L}{R} \left[\frac{R}{R^2 + L^2 \omega^2} - \frac{RC}{L} \right] \quad (7)$$

and put the expression in the brackets equal to zero, by substituting in (3), we have

$$\frac{1}{Y} = \frac{1}{S} + \frac{RC}{L} \quad \dots \quad (8)$$

The value of Y , can be read off from the graph and using the values of C and L , S can be found, assuming that R is the D.C. resistance of the primary. This relation has been used by Dye to interpret the effects of added capacity or shunt resistance in a series

of illustrations. It may be noted that the frequency ω , at which the circuit is non-reactive is given by

$$LC\omega^2 = 1 - CR^2/L$$

The Circle-Diagram.

This interesting method of treating the problem of the intervalve transformer may not obtain its due appreciation owing to a difficulty hitherto omitted from the discussion. The circle-diagram is not accurately a geometrical circle. We have yet to show how it deviates from the geometrical form and why it is so close to it. The graphical construction below exhibits the relationship to the circle perhaps more clearly, but the equations (3) and (7) enable us to make the account more complete. Combining them, we derive

$$\frac{Y - XR/L\omega}{X^2 + Y^2} = \frac{1}{S} + \frac{RC}{L} = \frac{1}{Y},$$

$$\text{or } X^2 + Y^2 - YY, + XY, R/L\omega = 0 \quad (9)$$

From this equation, we can deduce the characteristics of the graph given by plotting reactance (Y) against resistance (X). Since frequencies below 1,000 are confined to a small portion of the circle-diagram near the origin (Fig. 2), we see that for almost the whole graph $R/L\omega$ does not exceed $1/50$ and decreases in value round the circumference. For any small range of frequencies equation (9) shows that the graph is a circle with its centre $Y/2$ from the X -axis but displaced to the left of the Y -axis by $Y, R/2L\omega$. The amount of this displacement is therefore less than $1/50$ of the radius. Small as it is, the fact has been noted by Dye in the quotation already given. It does not influence the radius to any appreciable extent which may therefore be taken as constant and equal to $Y/2$.

Though it is therefore sufficiently accurate to refer to the graph as a circle, there are two points of difference which it is important to notice as they may occasion difficulties to anyone who assumes in consequence that it has all the properties of a circle. In the present instance these differences are insignificant, but in other circuits of a similar kind they might be perceptible. The graph is not closed; it begins at $Y = R$ for frequency 0 and ends at $Y = 0$ for frequency ∞ . Since R has a relatively small

value, this is not apparent in Fig. 2. Again owing to the way in which the curve is described the diameter is not truly the maximum value of Y which is really a little to the left of the axis and is 0.01 per cent. greater than Y ,—a truly negligible quantity.

The Crank Diagram.

As there are some who prefer to use crank or vector diagrams, we shall conclude this note by showing how some of the foregoing results may be derived by this method.

Let us take I as the "line" current, and i_1 and i_2 as the cyclic currents through the inductance and condenser in Fig. 1(B). The sum of the vectors OA , AB and BC represents the potential drop (V) over the resistance S due to the currents I , i_1 and i_2 , Fig. 4. If we took I as a constant and equal to unity, OC would be the effective impedance and would therefore be given by plotting resistance along OA and reactance normal to OA . We have to show that the point C moves nearly in a circle.

Produce OC to cut BA in D ; draw CE parallel to BA cutting OA in E . Then we can prove that E is a fixed point.

Since the voltage over the condenser is V , OC represents $j i_2 / C \omega$ and is normal to BC .

The inductive drop in L has a phase angle α with the total drop V . Its vector is at right angles to its current vector AB and OC is also normal to BC so that the angle CBA is α . We have

$$CD = CB \tan \alpha = S i_2 \cdot \frac{R}{L \omega}$$

$$OC = \frac{i_2}{C \omega}$$

or
$$\frac{CD}{OC} = \frac{S R C}{L} = \frac{EA}{OE}$$

This proves that E is a fixed point for all values of V corresponding to a constant value of I which may conveniently be taken as unity. The angle at C is $\pi/2 + \alpha$ and differs but slightly from a right angle since α is about 1° . (In the diagram, for clearness of representation, it is taken about 9° .) The point C will, therefore, lie nearly on a circle described on OE as a diameter.

When the circuit is non-reactive, the point C moving on the circle coincides with E . OE then represents Y, I , where

$$\frac{SI}{Y, I} = \frac{OA}{OE} = 1 + \frac{EA}{OE} = 1 + \frac{SRC}{L}$$

This equation gives the graphical derivation of the "diameter of the circle" and it can be put in the same form as (8).

Notation.

Fig. 4 has been drawn using the accepted anti-clockwise rotation of vectors. This leads to a curious difference from Fig. 2. To make the diagrams correspond we have to turn Fig. 4 through a right angle and look at it through the paper. This difference would be removed if in Fig. 2 reactance

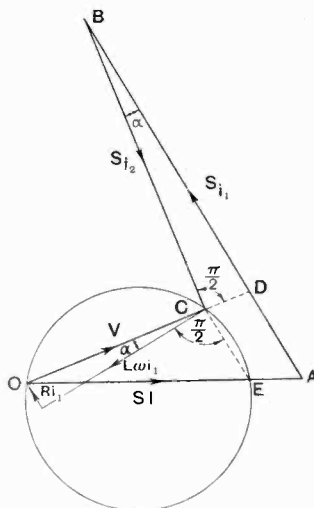

Fig. 4.

had been plotted vertically so that the diameter of the circle and resistance were horizontal. On the other hand, this method would have the inconvenience of plotting reactance denoted by X along the Y -axis. The anti-clockwise convention and the X -notation for reactance are, however, firmly entrenched in current literature. It is, perhaps, asking for the moon, to hope that the present conventions may be altered so that Y could be written for reactance and X used as an alternative to R for resistance. Impedance would then be written $Z = X + jY$ which would be closer to common mathematical usage. The writer has much pleasure in acknowledging the co-operation of Mr. P. O'Callaghan, A.R.C.Sc.I., in the preparation of this article.

Mathematics for Wireless Amateurs.

By *F. M. Colebrook, B.Sc., A.C.G.I., D.I.C.*

(Continued from page 566 of September issue.)

PART III (CONTINUED).

12. Vector Functions and the Differentiation of Vectors.

NOW we come to a section which links up directly with alternating current phenomena and thus with wireless telegraphy.

Let \mathbf{v} be a vector of magnitude v and direction θ relative to the fixed unit vector of reference ν parallel to the bottom edge of the paper, *i.e.*,

$$\mathbf{v} \cdot \nu = v \cos \theta$$

Now either or both of v and θ may depend in some specified manner on some independent variable, t for instance (time), being functions of the independent variable in the ordinary sense of the word. Thus if v is $f(t)$ and $\theta = \phi(t)$,

$$\mathbf{v} \cdot \nu = f(t) \cos \phi(t)$$

and this equation completely defines the vector. Two important special cases are

$$\mathbf{v} \cdot \nu = v_0 \cos \omega t$$

and

$$\mathbf{v} \cdot \nu = v_0 e^{-kt} \cos \omega t$$

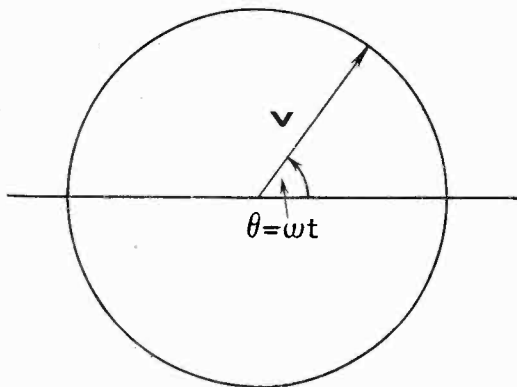

Fig. 32.

In the first case the vector is constant in magnitude and rotates with constant angular velocity (ω radians per second), and in the second case the magnitude of the

vector decreases exponentially while it rotates with constant angular velocity ω . These vectors are illustrated in Figs. 32 and 33. The locus of the end of the first vector is a circle and that of the second an

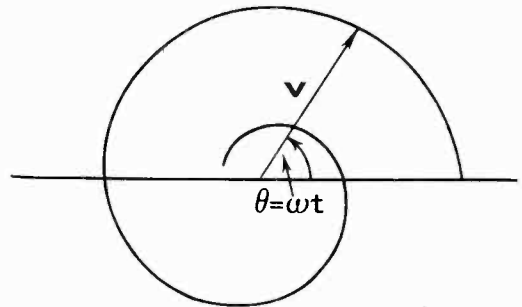

Fig. 33.

equiangular spiral. The reason for the latter name will appear later. It has already been pointed out that a vector of the first type can be used to represent an alternating current or potential difference. Similarly a vector of the second type can be used to represent what is known as a "damped oscillation," the word "damped" being used in the sense of "decreasing"—presumably by derivation from the effect of water on a fire.

Leaving these special cases for a moment, consider the perfectly general case illustrated in Fig. 34, where the variation of the vector is such that its end point moves along the dotted line. Let OV and OV' represent the vector at the instants t and $t + \delta t$. If $\delta \mathbf{v}$ be the change in \mathbf{v} in the interval δt , then OV' is the vector $\mathbf{v} + \delta \mathbf{v}$, whence it follows that VV' represents the vector $\delta \mathbf{v}$. Now the differential coefficient of \mathbf{v} with respect to t is defined in exactly the same way as in the corresponding case of a scalar function, *i.e.*,

$$\frac{d\mathbf{v}}{dt} = \lim_{\delta t \rightarrow 0} \frac{\delta \mathbf{v}}{\delta t}$$

The first thing to notice is that the D.C. of a vector is a vector, since $\delta \mathbf{v}$ is a vector. It therefore has both magnitude and direction. Further VV' is a chord of the locus and it is easy to see that in the limit when t tends to zero this chord will coincide in direction with the tangent to the locus at the point V . The direction of the vector $d\mathbf{v}/dt$ is thus the direction of the tangent to the locus of \mathbf{v} at the instant t .

For the complete specification of $d\mathbf{v}/dt$, i.e., for the determination of the scalar product $(d\mathbf{v}/dt) \cdot \mathbf{v}$, it is necessary to know both

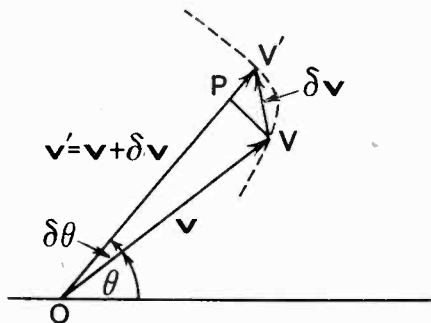

Fig. 34.

its magnitude and direction. These will obviously depend on the nature of the time variation of the magnitude and direction of the vector \mathbf{v} , and the vector $d\mathbf{v}/dt$ can be expressed very simply in terms of these two separate variations. On OV' mark the point P such that $OP=OV$ in magnitude. Then PV' represents the change in the magnitude of \mathbf{v} . Further, the angle POV or $\delta\theta$ represents the change in the direction of \mathbf{v} . The vector $\delta \mathbf{v}$ or VV' is the sum of the vectors VP and PV' . Let \mathbf{v}_1 be the unit vector in the direction of \mathbf{v} , i.e.,

$$\mathbf{v} = v\mathbf{v}_1 \quad \text{or} \quad \mathbf{v}_1 = \mathbf{v}/v$$

(see Para. F, Section 10, June, 1927). The magnitude of VP is approximately $v\delta\theta$ and its direction is approximately perpendicular to \mathbf{v} . The unit vector perpendicular to \mathbf{v} is $j\mathbf{v}_1$, or $j\mathbf{v}/v$. As a vector therefore VP can be written approximately

$$VP = v\delta\theta j\mathbf{v}/v$$

Again the magnitude of the vector PV' is δv , and if $\delta\theta$ is very small its direction will be very approximately that of \mathbf{v} . As a vector therefore it is approximately $\delta v\mathbf{v}/v$.

We have thus the approximate equation

$$\delta \mathbf{v} = \delta v (\mathbf{v}/v) + jv\delta\theta(\mathbf{v}/v)$$

and dividing through by δt

$$\begin{aligned} \frac{\delta \mathbf{v}}{\delta t} &= \frac{\delta v}{\delta t} \frac{\mathbf{v}}{v} + jv \frac{\delta\theta}{\delta t} \frac{\mathbf{v}}{v} \\ &= \left(\frac{1}{v} \frac{\delta v}{\delta t} + j \frac{\delta\theta}{\delta t} \right) \mathbf{v} \end{aligned}$$

So far this is an approximation only. But notice that all the approximations are such that the statements become more and more correct as δt decreases in magnitude and become exact in the limit when δt tends to zero. All the statements could be made exact with vanishing differences, but this rigid demonstration would take up rather a lot of valuable space. In the limit when δt tends to zero we have

$$\frac{d\mathbf{v}}{dt} = \left(\frac{1}{v} \frac{dv}{dt} + j \frac{d\theta}{dt} \right) \mathbf{v}$$

which determines $d\mathbf{v}/dt$ completely if dv/dt and $d\theta/dt$ are known. In general $d\mathbf{v}/dt$ is thus expressible in the form $(a + jb)\mathbf{v}$ where a and b are known functions of t .

The expression assumes a very simple form in the two special cases mentioned above. In the first, since the vector is constant in magnitude, dv/dt is zero. Also, since $\theta = \omega t$, $d\theta/dt = \omega$ and is a constant. Therefore for a vector of constant magnitude rotating with constant angular velocity ω

$$d\mathbf{v}/dt = j\omega \mathbf{v}$$

a vector perpendicular to \mathbf{v} and ω times as large. Geometrically this expresses the fact that the tangent to a circle is perpendicular to the radius. Notice that

$$\frac{d^2\mathbf{v}}{dt^2} = j\omega \frac{d\mathbf{v}}{dt} = (j\omega)^2 \mathbf{v} = -\omega^2 \mathbf{v}$$

and in general

$$d^n \mathbf{v} / dt^n = (j\omega)^n \mathbf{v}$$

For the second case, that of a vector of exponentially decreasing magnitude rotating with constant angular velocity, $d\theta/dt$ is ω as before,

and since

$$v = v_0 e^{-kt}$$

$$dv/dt = -kv_0 e^{-kt} = -kv$$

so that

$$\frac{1}{v} \frac{dv}{dt} = -k$$

Therefore $\frac{d\mathbf{v}}{dt} = (-k + \omega j)\mathbf{v}$

and in general $\frac{d^n \mathbf{v}}{dt^n} = (-k + \omega j)^n \mathbf{v}$

(Notice that since $d\mathbf{v}/dt = (-k + \omega j)\mathbf{v}$ the tangent to the locus at \mathbf{v} makes with \mathbf{v} a constant angle $\tan^{-1} -\omega/k$. This is the reason for the name "equiangular spiral" given to this locus.)

These two special cases have very important applications to alternating current theory, and the next two instalments will be devoted to the development of these applications. The matter must be left for the present in favour of a brief account of the companion subject of the differential calculus, *i.e.*, the integral calculus.

13. The Integral Calculus.

Indefinite Integration.

It is rather unfortunate that the word "Integration" is used in two different senses, but this will not matter very much as long as the two ideas are clearly distinguished right from the start. We will take the simpler of the two first, generally called for the sake of distinction "indefinite integration," though there is in fact nothing really indefinite about it. Integration in this sense is simply the inverse of differentiation. The integral with respect to x of any given function of x is the most general function of x of which it is the differential co-efficient. The integral of $f(x)$ with respect to x is written

$$\int f(x) dx^*$$

and its definition is

$$\frac{d}{dx} \left\{ \int f(x) dx \right\} = f(x)$$

Any function of x which fulfills this definition can be called an integral of $f(x)$ but *the*

* At this point the reader may want to raise an agitation against this apparent violation of the integrity of dy/dx , which he has been told to regard as an inseparable unity. But the " dx " under the integral sign is not, in fact, the dx from dy/dx trying to lead a separate existence. It is merely an agreed shorthand for "with respect to x ." Certain text-books use a notation which implies the separate existence of dy and dx , but this is liable to be misleading and the writer has carefully avoided it.

integral will be taken to mean the most general function which fulfills the definition. For instance $x^{n+1}/(n+1)$ is an integral of x^n for

$$\frac{d}{dx} \left(\frac{x^{n+1}}{n+1} \right) = x^n$$

but the most general function which satisfies the condition is

$$\frac{x^{n+1}}{n+1} + C$$

where C is any constant number whatever, so that this will be regarded as *the* integral of x^n . In general any two integrals of the same function can only differ by a constant in view of the definition given above, and the simplest form together with an arbitrary constant will be taken as the integral.

So far so good. It all seems plain sailing. Any table of differential coefficients will immediately furnish an equal number of integrals. For instance, since

$$\frac{d\epsilon^x}{dx} = \epsilon^x, \int \epsilon^x dx = \epsilon^x + C$$

Again $d \log x/dx = 1/x$

whence $\int \frac{1}{x} dx$ or $\int \frac{dx}{x} = \log x + C$

and so on for all the standard forms of differential coefficient which have already been discussed. Space cannot be spared for the enumeration of them but the reader is advised to make himself familiar with the more important standard forms.

Outside the comparatively few standard forms, however, the difficulties begin. Differentiation is a comparatively simple matter. There is the fundamental formula to start with and rules for combinations of functions to simplify its application. For the inverse process, however, there is practically speaking no guide at all and no such rules for dealing with combinations, no rules that is to say which will inevitably succeed. What then is there to help? Only inspired guesswork. That, of course, lends a certain fascination to the business but its practical limitations need hardly be pointed out.

However, there are one or two general propositions which may simplify matters a little, and these we will briefly pass in review.

(A) A Constant Factor.

It is easy to show that a constant factor can be placed outside the sign of integration, *i.e.*,

$$\int a f(x) dx = a \int f(x) dx$$

for

$$\frac{d}{dx} \int a f(x) dx = a f(x)$$

by definition, and by the rules of differentiation

$$\begin{aligned} \frac{d}{dx} a \int f(x) dx &= a \frac{d}{dx} \int f(x) dx \\ &= a f(x) \end{aligned}$$

(B) The Integration of the Sum or Difference of Functions.

This is comparable with the corresponding proposition in differentiation and can be immediately derived therefrom. If P and Q are functions of x , then by definition

$$d/dx \int (P \pm Q) dx = P \pm Q$$

also by the rules of differentiation

$$\begin{aligned} \frac{d}{dx} \left\{ \int P dx \pm \int Q dx \right\} &= \frac{d}{dx} \int P dx \pm \frac{d}{dx} \int Q dx \\ &= P \pm Q \end{aligned}$$

therefore

$$\int (P \pm Q) dx = \int P dx \pm \int Q dx$$

The proposition can obviously be extended the sum or difference of any *finite* number of functions. As an example

$$\frac{1}{x^2 - a^2} = \frac{1}{2a} \left\{ \frac{1}{x-a} - \frac{1}{x+a} \right\}$$

by elementary algebra. Therefore

$$\begin{aligned} \int \frac{dx}{x^2 - a^2} &= \frac{1}{2a} \left\{ \int \frac{dx}{x-a} - \int \frac{dx}{x+a} \right\} \\ &= \frac{1}{2a} \{ \log(x-a) - \log(x+a) \} + C \\ &= \frac{1}{2a} \log \frac{x-a}{x+a} + C \end{aligned}$$

C being an "arbitrary constant" of integration. This example also illustrates the application of the bundle of sticks idea to integration. Where possible, a complicated function should be separated out into the sum or difference of a number of simpler functions.

(c) Changing the Variable.

(i.) Suppose $f(x)$ be expressible in the form $\phi(u)(du/dx)$ where u is some other function of x .

For example, $\sec^2 x / (a^2 - b^2 \tan^2 x)$. Let $u = b \tan x$. Then $du/dx = b \sec^2 x$, as already shown, so that

$$\frac{\sec^2 x}{a^2 - b^2 \tan^2 x} = \frac{1}{b} \frac{1}{a^2 - u^2} du$$

Now it is easy to show that

$$\int \phi(u) \frac{du}{dx} dx = \int \phi(u) du$$

for the R.H.S., which we will call F for short, is a function of a function of x , so that

$$\frac{dF}{dx} = \frac{dF}{du} \frac{du}{dx}$$

Also by the definition of integration

$$dF/du = \phi(u)$$

Therefore

$$dF/dx = \phi(u) (du/dx) = f(x)$$

whence by definition

$$F = \int f(x) dx$$

For the above example

$$\begin{aligned} \int \frac{\sec^2 x dx}{a^2 - b^2 \tan^2 x} &= \int \frac{1}{b} \frac{1}{a^2 - u^2} \frac{du}{dx} dx \\ &= \int \frac{1}{b} \frac{1}{a^2 - u^2} du \\ &= \frac{1}{2ab} \log \frac{a-u}{a+u} + C \quad (\text{See (b) above}) \\ &= \frac{1}{2ab} \log \frac{a-b \tan x}{a+b \tan x} + C \end{aligned}$$

Thus, inspired guesswork is only required to furnish the substitution $u = b \tan x$, and thereafter all is plain sailing. This is characteristic of a large number of processes of integration.

(ii.) The substitution of a single letter for a group, as in the above, seems a reasonable method of simplification. In some cases, however, the reverse process can be used with advantage, *i.e.*, the substitution of some simple group for the variable x . Thus in $\int f(x) dx$, if we put $x = \phi(u)$, then $f(x)$ becomes a function of the variable u , say $F(u)$, and the integral becomes $\int F(u) dx$. Now it can

be shown much as in the previous case that

$$\int F(u) dx = \int F(u) \frac{dx}{du} du$$

and this form will be much simpler than the original if the substitution has been well chosen. For example, in $f(x) = 1/\sqrt{a^2-x^2}$ let $x = a \sin u$. Then

$$\frac{1}{\sqrt{a^2-x^2}} = \frac{1}{\sqrt{a^2-a^2 \sin^2 u}} = \frac{1}{a \cos u}$$

Also $dx/du = a \cos u$, therefore

$$\int \frac{dx}{\sqrt{a^2-x^2}} = \int \frac{1}{a \cos u} \cdot a \cos u \cdot du = \int du = u + C = \sin^{-1} x/a + C$$

Trigonometrical substitutions of this kind will nearly always afford a simplification in binomial surd functions such as

$$\sqrt{a^2-x^2}, \sqrt{a+x}/\sqrt{a-x},$$

and so on.

(D) Integration by Parts.

Another very useful dodge is derived from the differential formula—

$$\frac{d(uv)}{dx} = u \frac{dv}{dx} + v \frac{du}{dx}$$

It applies to cases in which the function to be integrated can be put in the form

$$I = \int f(x) dx = \int P.R dx$$

P and R being functions of x , one of which at least, say R , is easily integrable. Suppose

$$\int R dx = Q, \text{ i.e., } R = dQ/dx$$

Then

$$I = \int P \frac{dQ}{dx} dx$$

Now it can be shown that

$$\int P \frac{dQ}{dx} dx = PQ - \int Q \frac{dP}{dx} dx$$

for, differentiating this equation and remembering the definition of an integral,

$$P \frac{dQ}{dx} = \frac{dPQ}{dx} - Q \frac{dP}{dx}$$

which is the "differential of a product"

formula already quoted above. As an example—

$$\begin{aligned} \int x \cos x dx &= \int x(d \sin x/dx) dx \\ &= x \sin x - \int \sin x dx \\ &= x \sin x + \cos x + C \end{aligned}$$

Or again,

$$\begin{aligned} \int x e^x dx &= \int x(d e^x/dx) dx = x e^x - \int e^x dx \\ &= x e^x - e^x + C \end{aligned}$$

So much for a brief outline of the subject of "indefinite" integration. The above formulæ are practically all one has to go on. The rest is inspired guesswork of an intuitive kind, but fortunately the intuitive faculty required increases with practice and experience. A few examples are given at the end of this section, but far more should be worked by any serious student, for integration, like genius, is nine parts perspiration to one of inspiration. Examples are easily made up and the work can be made self-checking by differentiation of the result.

14. Definite Integration.

Now we come to the more practically important of the two ideas associated with the word "integration." What we are concerned with now is the evaluation of expressions such as

$$\begin{aligned} Lt._{\delta x \rightarrow 0} f(a) + f(a + \delta x) + f(a + 2\delta x) + \text{etc.} \dots \\ f(b - \delta x) + f(b) = Lt._{\delta x \rightarrow 0} \sum_{x=a}^{x=b} f(x) \delta x \end{aligned}$$

i.e., the limit when δx tends to zero of the sum of all terms such as $f(x) \delta x$ when x increases by steps of δx from a lower value a to an upper value b .

But first readers will probably want to know how such cumbersome-looking expressions come into practical politics at all. Let Fig. 35 represent $f(x)$ plotted against x for the range a to b of x . It will be assumed that there is no minimum or maximum value of $f(x)$ in this range, i.e., $f(x)$ either decreases or increases uniformly from a to b . If $f(x)$ is not in fact of this character the range can be divided up into sub-ranges in each of which the limitation applies, and the following discussion can then be applied to each of these separately. Suppose we require to calculate the area included between the

ordinates at a and b and the curved line representing $f(x)$. One method that suggests itself is to divide up the area into n strips each of width δx . The area of any strip, such as that shown in the figure, lies between that of the shorter and that of the taller of the two rectangles, *i.e.*, between $y\delta x$ and $(y + \delta y)\delta x$, and the corresponding limits of the total area will be the sums of these

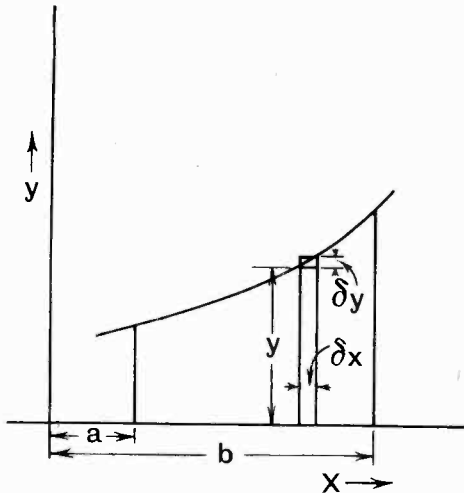

Fig. 35.

expressions for all the strips, *i.e.*, the total area will lie between

$$\sum_{x=a}^{x=b} y \delta x \text{ and } \sum_{x=a}^{x=b} (y \delta x + \delta y \delta x)$$

the difference between these limits being

$$\sum_{x=a}^{x=b} \delta y \delta x = \delta x \sum_{x=a}^{x=b} \delta y = \delta x \{f(b) - f(a)\}$$

(since the sum of all the separate increments of y is the difference between the ordinates at a and b , *i.e.*, $f(b) - f(a)$).

It is clear that by making δx sufficiently small either calculation will give the area required to a high degree of accuracy. Further, since the difference between the two is $\{f(b) - f(a)\} \delta x$, which tends to zero as δx tends to zero, it follows that the area is given *exactly* by

$$\text{Lt. } \sum_{x=a}^{x=b} y \delta x \text{ or } \text{Lt. } \sum_{x=a}^{x=b} f(x) \delta x$$

Here, then, is one way in which the expression given at the beginning of this section will arise in practice.

Again, suppose we are told that the velocity of a moving body is known as a certain function of time, say $f(t)$, and we are asked to calculate the distance it will travel in the interval between the instants $t=a$ and $t=b$. There is no question of simply multiplying the time interval $b-a$ by the velocity, because the latter is not constant. As in the above case, however, an approximation could be obtained by dividing the interval into a large number of smaller equal intervals δt , calculating the velocity $f(t)$ at the beginning of each interval and multiplying by δt to get the distance travelled in the short interval. Upper and lower limits for the distance travelled could then be calculated for the whole interval precisely as shown above, and the difference between these could be made as little as desired by sufficiently decreasing δt . The exact result would be, as before

$$\text{Lt. } \sum_{t=a}^{t=b} f(t) \delta t$$

There is therefore very good reason for trying to find some means of evaluating this limit of a sum, and a combination of the ideas of the differential calculus and of indefinite integration will show how this can be done.

It will be assumed that the function $f(x)$ and its integral are finite and continuous over the range a to b of x . Further, let $F(x)$ be the integral of $f(x)$, *i.e.*, $f(x)$ is the differential co-efficient of $F(x)$ with respect to x . The range a to b is divided into the n intervals δx , *i.e.*, $n\delta x = b - a$. By definition

$$\text{Lt. } \frac{F(x + \delta x) - F(x)}{\delta x} = f(x)$$

Therefore for any value of δx greater than zero in magnitude

$$\frac{F(x + \delta x) - F(x)}{\delta x} = f(x) + h$$

where h is a quantity which tends to zero when δx tends to zero. This can be written

$$F(x + \delta x) - F(x) = f(x)\delta x + h\delta x$$

By hypothesis this is true for all values of x between a and b , whence

$$\begin{aligned} F(a + \delta x) - F(a) &= f(a)\delta x + h_1\delta x \\ F(a + 2\delta x) - F(a + \delta x) &= f(a + \delta x)\delta x + h_2\delta x \\ F(a + 3\delta x) - F(a + 2\delta x) &= f(a + 2\delta x)\delta x + h_3\delta x \\ &\text{etc.} \qquad \qquad \qquad \text{etc.} \qquad \qquad \qquad \text{etc.} \\ F(b - \delta x) - F(b - 2\delta x) &= f(b - 2\delta x)\delta x + h_{n-1}\delta x \\ F(b) - F(b - \delta x) &= f(b - \delta x)\delta x + h_n\delta x \end{aligned}$$

By addition

$$F(b) - F(a) = \sum_{x=a}^{x=b-\delta x} f(x) \delta x + \delta x \sum h_n$$

Therefore

$$Lt. \sum_{\delta x \rightarrow 0}^{x=b-\delta x} f(x) \delta x = F(b) - F(a) - R$$

where

$$R = Lt. \sum_{\delta x \rightarrow 0} \delta x h_n$$

Now the quantities h_n are finite by hypothesis. Let h be the largest value reached by any of them for any value of δx between δx and zero. Then

$$| \delta x \sum h_n | \succ | n \delta x h |$$

(the vertical strokes mean that magnitude only is being considered, and \succ means "not greater than.") Therefore, since $n \delta x = b - a$

$$| Lt. \sum_{\delta x \rightarrow 0} \delta x h_n | \succ | Lt. (b-a)h | = (b-a) Lt. h = 0$$

since the limit of all the h quantities is zero when δx tends to zero. Therefore, finally, since R is zero,

$$Lt. \sum_{\delta x \rightarrow 0}^{x=b-\delta x} f(x) \delta x = Lt. \sum_{\delta x \rightarrow 0}^{x=b} f(x) \delta x = F(b) - F(a)$$

The expression on the left is usually written in the more compact form

$$\int_a^b f(x) dx$$

and is called the "definite integral" (or, in practice, just "the integral") of function x with respect to x from a to b . Thus we have

$$\int_a^b f(x) dx = F(b) - F(a)$$

where $F(x)$ is the integral of $f(x)$ with respect to x in the first sense of the word,

i.e.,
$$F(x) = \int f(x) dx$$

In the actual calculation of definite integrals $F(b) - F(a)$ is written

$$\left[F(x) \right]_a^b$$

so we have

$$\int_a^b f(x) dx = \left[\int f(x) dx \right]_a^b = \left[F(x) \right]_a^b = F(b) - F(a)$$

As an example

$$\int_a^b dx/x = \left[\log x \right]_a^b = \log b - \log a = \log (b/a)$$

Notice that there is no need to include the arbitrary constant of integration in $F(x)$ for it would automatically disappear in taking the difference of the limiting values. Notice, further, that

$$\int_a^b f(x) dx$$

is not in general a function of x , but is a function of the limits a and b . It will only be a function of x if x or any term depending on x appears in the limits.

15. The Mean Value of a Function.

Another important application of definite integration is the determination of the mean value of a function over a certain range of the variable. In terms of area the mean value of the function is the height of the rectangle of base $(b-a)$ the area of which is equal to that enclosed by the curve $y=f(x)$ and the ordinates at a and b . In terms of the variable velocity example also given above, it would mean the equivalent constant velocity, equivalent in the sense that the moving body would travel the same distance in the same time. In general terms, therefore, the definition of y_m , the mean value of $f(x)$ over the range a to b of x , is

$$(b-a)y_m = \int_a^b f(x) dx \text{ or } y_m = \frac{1}{b-a} \int_a^b f(x) dx$$

Two important special cases are (i.) the mean value of an alternating current $i = i \sin \omega t$ over a period (*i.e.*, $2\pi/\omega$), and (ii.) the mean value of the square of the same alternating current over the same period. These will be considered later.

Here, then, ends the account of definite integration and, with it, the whole of the general discussion of the mathematical foundations of alternating current analysis. The remaining instalments will be devoted entirely to specific applications to actual problems. The fundamental ideas have been presented in a very condensed form, but the necessarily limited space at my disposal has precluded a very detailed exposition. This very limitation can, however, be turned to good account by any serious student of the subject, who will find in the development of the detail the best possible means of familiarising himself with the important fundamental ideas.

Examples.

1. Given that $\mathbf{v} \cdot \mathbf{v} = v_0 e^{kt} \cos(\omega t + \psi)$ find $d\mathbf{v}/dt$ and $d^2\mathbf{v}/dt^2$ in terms of \mathbf{v} and a vector operator. Also find $(d\mathbf{v}/dt) \cdot \mathbf{v}$ and $(d^2\mathbf{v}/dt^2) \cdot \mathbf{v}$.

2. Find the following integrals:—

- i. $\int \frac{dx}{ax+b}$
- ii. $\int \frac{(ax+b) dx}{cx+d}$
- iii. $\int \sec x \tan x dx$
- iv. $\int \frac{dx}{a^2+x^2}$ (put $x = a \tan \theta$)
- v. $\int \frac{\epsilon^x dx}{1+\epsilon^{2x}}$ (put $\epsilon^x = u$)

3. Integrate by parts:—

- i. $x^2 \log_e x$
- ii. $(\log_e x)^2$
- iii. $\tan^{-1} x$

4. Show that:—

- i. $\int_a^b f(x) dx = - \int_b^a f(x) dx$
- ii. $\int_a^c f(x) dx = \int_a^b f(x) dx + \int_b^c f(x) dx$

5. Find the value of

- i. $\int_0^\pi \sin \theta d\theta$
- ii. $\int_0^{2\pi} \sin \theta d\theta$
- iii. $\int_0^{2\pi} \sin^2 \theta d\theta$

Remember that $\sin^2 \theta = \frac{1}{2}(1 - \cos 2\theta)$.

6. Show that the curve $x^2 + y^2 = a^2$ is a circle. Find the area included between the x axis and that part of the curve for which y is positive, and hence show that the area of the whole figure is πa^2 .

Answers to Examples in September issue.

- 1. i. $2ax + b; 2a; 0$.
- ii. $-(b/x^2) - (2c/x^3); (2b/x^3) + (6c/x^4); -(6b/x^4) - (24c/x^5)$.
- iii. $30 \cos x + 30 \cos 2x + 30 \cos 3x; -30 \sin x - 60 \sin 2x - 90 \sin 3x; -30 \cos x - 120 \sin 2x - 270 \cos 3x$.
- iv. $\epsilon^{ax} (a \sin bx + b \cos bx); \epsilon^{ax} \{(a^2 - b^2) \sin bx + 2ab \cos bx\}; \epsilon^{ax} \{(a^3 - 3ab^2) \sin bx + (3a^2b - b^3) \cos bx\}$.
- v. $a^x \log_e a; a^x (\log_e a)^2; a^x (\log_e a)^3$.
- vi. $a^x \{\log_e a \log_e (\sin x) + \cot x\}; a^x \log_e a \{\log_e a \log_e (\sin x) + 2 \cot x - \operatorname{cosec}^2 x\}; a^x \log_e a \{(\log_e a)^2 \log_e (\sin x) + 3 \log_e a \cot x - 2 \operatorname{cosec}^2 x + 2 \operatorname{cosec}^2 x \cot x\}$.
- 2. $Q = 10e^{-t/cR}$.
- 3. $i = 10 \sin 5\pi t$.
- 4. i. $2ax + by; bx + 2cy; 2a; 2c; b; b$.
- ii. $\epsilon^{ax+by} (a \sin xy + y \cos xy); \epsilon^{ax+by} (b \sin xy + x \cos xy); \epsilon^{ax+by} \{(a^2 - y^2) \sin xy + 2ay \cos xy\}; \epsilon^{ax+by} \{(b^2 - x^2) \sin xy + 2bx \cos xy\}; \epsilon^{ax+by} \{(ab - xy) \sin xy + (1 + ax + by) \cos xy\};$ the same.
- 5. i. Max. when $x = 1$ and min. when $x = -1$;
- ii. the same.

H.T. Filter Circuits for D.C. Mains*

By J. H. Owen Harries.

Introduction.

ABOUT two years ago the writer wished to employ in his business receivers capable of deriving their H.T. supply from D.C. electric mains. He tried many of the "battery eliminators" then on the market, but without any success. They worked on some mains and in some houses, but failed to operate at all well in other instances. In consequence it was decided to thoroughly examine the whole subject, and, after some time, a satisfactory instrument was evolved.

The data obtained and its application to design is the subject of this article.

1. Nature of "Ripple."

It is frequently stated that the A.C. ripple superimposed on the D.C. voltage from public mains is caused by the passing of the bars of the commutator of the generating machine under the brushes. Then, obviously, the frequency of the ripple must equal the R.P.S. of the generator multiplied by the number of bars in the commutator. A consideration of a modern large generator will show that this must equal about 1,000 cycles at least, which is a treble note on the piano. But tests on a "bad" main, such as the writer's local one on the East Coast, showed that by far the loudest interference was a hum of about 50 cycles or so, in addition to a general "mush" of other frequencies.

This can easily be accounted for by assuming an unevenness of the generator's output occurring once per revolution and from such causes as a worn or damaged commutator bar, or irregularities in the field flux. Other irregularities would cause other frequencies, and, indeed, may be the cause of the radio frequency "mush" observed by many others as well as by the writer. The frequencies would also heterodyne each other. Then, too, the ripples of the other generators and motors on the line all have their effects.

As will be obvious from this (and as has been shown to be the case by experiment)

no two mains (or even different parts of the same main) have ever the same frequencies (or wave-form) of ripple.

It follows, then, that to filter an H.T. supply from these mains by means of an instrument required to work on all supplies equally satisfactorily, one cannot employ a "band" filter of any sort, but must endeavour to produce one having a good efficiency from at least 50 cycles upwards.

2. A Fallacy.

Before proceeding to the actual filter circuits, a common misapprehension must be mentioned. In descriptions of wireless sets (in popular handbooks in particular) it is frequently stated that the impedance of $1\mu F$ and $2\mu F$ condensers are "negligible" at audio frequencies. This might, perhaps, be stated in connection with the old types of L.F. amplifier whose efficiency fell off so very badly at the lower notes, but is certainly incorrect with modern receivers, in many positions in their circuits. In explanation, at the frequency of 50 cycles a $1\mu F$ condenser has a reactance of about 3,330 ohms, and a $2\mu F$ has 1,660 ohms.

As will be shown, this has a considerable effect on H.T. eliminator practice.

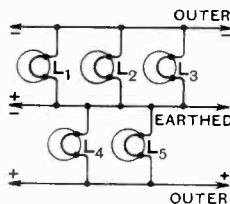

Fig. 1.
Three-wire distribution.
 $L_1 L_2 L_3 L_4 L_5 =$ Lamps.

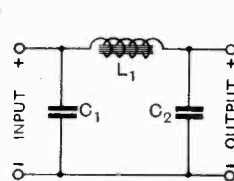

Fig. 2.
First circuit tested.
 $C_1 = 2\mu F.$ $C_2 = 2\mu F.$
 $L_1 =$ about 70 henries.

3. Supply Main Connections.

"Three-wire distribution" is usually employed. This is shown in Fig. 1, the lamps representing the method of tapping houses off each outer.

* Received by the Editor, February, 1927.

4. First Circuit Tried.

The investigations were commenced by testing the frequently published circuit of Fig. 2.

This was tried in the laboratory, which has the negative lead of the mains earthed.

Very little "hum" was found to pass, and the writer must admit that he thought that the problem was solved.

5. Effect of Supply with Positive of Mains Earthed.

Further tests in other houses, however, undeceived him. It was found that the trouble was always experienced where the positive of the mains was earthed.

A consideration of Fig. 3 will show the reason.

This diagram shows the circuit of Fig. 2 in use on a positively earthed main with a wireless set. The latter is earthed at E_2 (through C_3 to prevent the mains short-circuiting). The mains are earthed at E_1 (by the electric light company, under Board of Trade regulations).

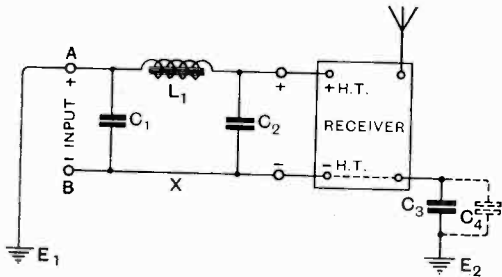

Fig. 3. Filter in use on positively earthed mains. $C_3 = 1\mu F$. $E_1 =$ Company's earth. $E_2 =$ wireless earth. $C_4 =$ stray capacities to earth. Other values as in Fig. 2.

Assume for the moment that the path of the ripple current through L_1 and C_2 is of infinitely high impedance. Then the ripple E.M.F. across AB will cause an A.C. current to flow from E_1 through C_3 and the wireless set back to B , setting up P.D.s across C_3 . Since all apparatus in the set may be considered to have a capacity to earth (represented by C_4) in parallel with C_3 , these "ripple P.D.s" will be amplified by the valves and so interfere with the signals being received.

As mentioned in Section 2, the usual value of the impedance of C_3 is by no means

negligible. C_4 is so small as to have a negligible effect.

To reduce the P.D.s across C_3 and C_4 to the minimum, we can place a very high impedance at X in the path of the stray current. A large inductance may be employed, and will incidentally increase the

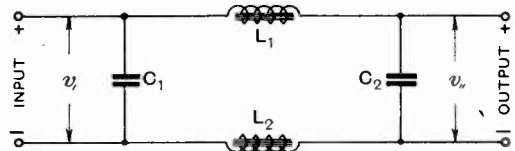

Fig. 4. Basic filter circuit.

$L_2 =$ extra inductance. $v_i =$ ripple volts at input. $v_u =$ ripple volts at output.

normal efficiency of the filter as well. This will be further referred to later.

This final arrangement is the basis of the circuit which is in use very successfully to-day. Fig. 4 gives it in essentials.

6. Determination of Practical Values of Circuit Constants.

Referring to Fig. 4, the efficiency of the filter is dependent, obviously, on the percentage $v_u/v_i \times 100$ where,

$v_i =$ the ripple volts across the input,

$v_u =$ the ripple volts at the output.

This ratio depends on the relative impedances of the chokes and condensers in the filter, and since none of these quantities can be made either infinitely large or infinitely small, the percentage (which we will call m_1) can never equal zero.

Therefore the designer must take as his object the reduction of m_1 to such a value that v_u has a negligible effect on the wireless set in use.

He may also design for efficient results at about 50 cycles only, knowing that the efficiency must rise with frequency in the case of the filter given (since the reactance of an inductance varies as the frequency, and that of a condenser inversely). In the writer's experience, 50 cycles seems low enough to work to, but, of course, this may vary with the purpose in hand.

The critical value of m_1 mentioned above varies enormously with different receivers, so it was decided to commence a stringent series of tests to determine the correct

values of the several impedances respectively from which m_1 could be calculated, thus obtaining data for future use.

A type of receiver known to be very sensitive to interference from the mains was chosen, and tests were performed on different mains and many different houses on them.

The receiver principally used was an O-V-2 transformer-coupled set. The L.F. valve's H.T. was direct off the filter, and the leaky-grid detector was given about 40v. through a resistance. (See Section 8.) Many other sets were also tried.

After some time satisfactory values for the chokes and condensers were found.

The actual chokes used for L_1 and L_2 (Fig. 4) could be L.F. transformers with primary and secondary in series, or any good choke having sufficient inductance. The values of the latter given in Fig. 5 are the lowest possible for satisfactory operation. Larger ones can always be used.

When these tests were made many of the high inductance chokes now on the market were not yet manufactured, and the writer used those made by Messrs. A. J. Stevens, of Wolverhampton, quite successfully. Also Messrs. Burndept's transformers acted well. These names are mentioned as a guide, as it is often difficult, even nowadays, to obtain an L.F. choke of given inductance. Makers, for some obscure reason, seldom seem to know the figure for their own products.

7. Value of C_1 .

It was not found advisable to employ a higher value of C_1 (Fig. 4) than $1\mu F$. There was no increase in the filtering action noticeable by altering it, and at $2\mu F$ surges of current were heavy enough to blow 3.5 volt torch bulbs in circuit as fuses. Incidentally, these surges were interesting as they seldom seemed to occur, except on certain parts of the main, and generally coincided with a breakdown of the cables, a by no means very unusual occurrence on some country supplies.

8. Output of Filter.

It is well known that the impedance of the source of common H.T. to an amplifier must be of low value, or a reaction effect may be produced and oscillations commence.

Therefore, a mains filter unit must have

an output impedance which is low also, and a condenser (C_2 in Fig. 4) is shunted across it.

Calling this output impedance Z_0

$$\frac{1}{Z_0} = \frac{1}{Z_1} + \frac{1}{Z_2}$$

Where Z_1 =the impedance of C_2

Z_2 =the impedance of $L_1 L_2$ and C_1 in series.

The value of Z_2 is very high compared to Z_1 (about 120,000 ohms) and so may be neglected.

Then $Z_0=Z_1$ =about 1,660 ohms at 50 cycles with $C_2=2\mu F$.

With more than two efficient stages of L.F. amplification this impedance was found to cause violent oscillation. Fortunately, this may be easily stopped by introducing a resistance into the anode circuit of the further valves. Since these usually do not require as high an H.T. voltage as the last two, the D.C. volt drop on this is immaterial. The resistance is shunted by a $2\mu F$ condenser, as shown in Fig. 5, to keep the impedance low here also.

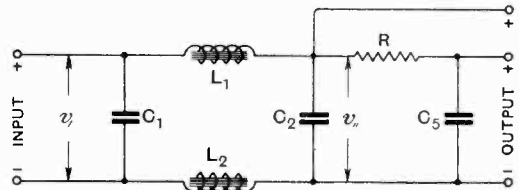

Fig. 5. Filter for multi-stage amplifier.

C_2 and $C_3=2\mu F$ each. $C_1=1\mu F$. L_1 and $L_2=200$ henries each. $R=50,000$ to $500,000$ ohms usually. v_1 and v_2 = as before. D.C. resistance of chokes = about 2,000 ohms each.

The oscillations seem not to be confined to the set itself, but to occur in the oscillatory circuit formed by the chokes and condensers of the filter. As might be expected, the introduction of a low resistance, such as a lamp, across the filter damps the circuit, and so reduces its tendency to oscillation.

9. The Final Circuit.

This is shown in Fig. 5, and the values of the inductance and capacities given.

Referring back to Section 6, we can now proceed to calculate m_1 from the data summarised in Fig. 5.

10. Equation for Value of m_1 .

Now, $m_1 = \frac{v_u}{v_i} \times 100$ as previously explained, and the object of the filter is to reduce this percentage as much as possible. Let us redraw Fig. 5, as in Fig. 6.

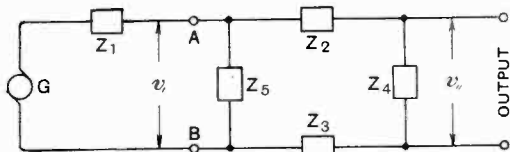

Fig. 6. Circuit for Fig. 5 redrawn.

G=generator at power station. Z_1 =line impedance of mains. Z_5 =impedance of C_1 . Z_2 =impedance of L_1 . Z_3 =impedance of L_2 . Z_4 =impedance of load and in C_2 in parallel. AB=input terminals of filter. v_i =input ripple volts. v_o =output ripple volts, as before.

In the first place, the magnitude of v_i is proportional to $Z_1 + Z_0/Z_0$ where Z_0 = the input impedance of the whole filter.

Now:—

$$\frac{I}{Z_0} = \frac{I}{Z_5} + \frac{I}{(Z_2 + Z_3 + Z_4)}$$

but $Z_2 + Z_3 + Z_4$ is large compared to Z_5 and so may be neglected.

Then $Z_0 = Z_5$ for practical purposes.

From this, one would expect that the lower the value of Z_5 (equals the larger the capacity of C_1) the lower the value of v_i , and therefore the higher the efficiency of the filter, provided always that Z_1 has an appreciably high value.

Experiment, however, has shown that it makes practically no difference (to the low frequency ripple anyway) in most cases; the inference being that Z_1 is small compared

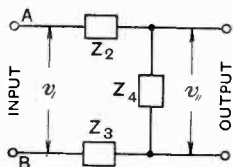

Fig. 7.

with Z_5 . In any case the former is bound to vary very greatly in practice, and so it seems wisest to base our design on the worst possible case where Z_1 is negligible.

Then Z_5 will make no difference to the

value of v_i , and may be neglected in the calculations. Its value is settled, however, by the reasons given in Section 7.

This then leaves us with the filter circuit of Fig. 7.

Here obviously:—

$$m_1 = \frac{Z_4}{Z_2 + Z_3 + Z_4} \times 100 \quad \dots (1)$$

11. Equation for Stray Currents.

The effect, already mentioned in Section 5, must also be taken into account, as (1) gives no data for the relative size of Z_3 .

We may neglect Z_5 for the reason given in Section 10 and the circuit of Fig. 4 may be redrawn for this calculation as in Fig. 8.

The impedance of the stray capacities of the wireless set to earth are negligible compared to that of C_3 . (See Section 5.)

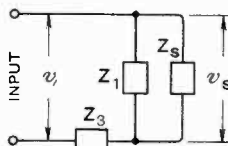

Fig. 8. Simplified circuit of Fig. 4.

Z_3 =impedance of L_2 (in Fig. 4). $Z_1=L_1$ and C_2 in series (Fig. 4). Z_s =impedance of wireless earth lead blocking condenser (Fig. 3, C_3). v_s =stray volts across it. v_i =input ripple volts, as before.

Now the efficiency of the filter as regards the stray ripple is proportional to m_2 where

$$m_2 = \frac{v_s}{v_i} \times 100$$

Therefore from Fig. 8 we can see that:—

$$m_2 = \frac{Z_{s2}}{Z_{s2} + Z_3} \times 100 \quad \dots (2)$$

where

$$\frac{I}{Z_{s2}} = \frac{I}{Z_s} + \frac{I}{Z_1} \quad \dots (3)$$

12. Calculation of m_1 and m_2 .

If we find, from (1) and (2) (the various "Z" values are, of course, to be added vectorally) the values of m_1 and m_2 for the stringently tested filter of Fig. 5, these will serve as a useful basis of comparison for design in the future.

Since the value of the load resistance will vary considerably in different instances,

and the inductance of the chokes will not be quite constant, there will be no object in working to more than "slide rule" accuracy. Then the figures for Fig. 5 will be as follows:—

$$m_1 = 1.4 \text{ per cent.}$$

$$m_2 = 6 \text{ per cent.}$$

The detailed calculations are given in the appendix.

13. Use of Only One Choke.

In view of these conclusions, the stray current difficulty on positively earthed mains might be expected to be overcome by putting the choke (where only one is in use, Fig. 2) in the minus lead at *X* in this figure.

Since the writer found this out, he discovered that an eliminator just marketed by a very well-known firm employs this method, but, of course, it suffers from the disadvantage of necessitating a change back to the more usual connections when the mains are negatively earthed.

Further, the method used by the author increases the value of the denominator of the equation (1) as well, and guards against the fact that the "earthed" main is sometimes at a distinct potential above the ground.

14. Case where Set is not Earthed.

Here Z_s (and therefore m_s) will be very large and a hum will usually occur on positively earthed mains.

15. General Considerations.

No trouble has been found by the writer due to saturation of the iron cores of the chokes used, though as much as 20 milliamps or more were passed through them at times.

When using a frame aerial receiver, such as a superheterodyne, the directional effect of the loop aerial is often lost due to the earthing effect (as regards H.F. currents) of the mains unit.

This trouble may be overcome by placing an H.F. choke in each lead from the filter. Over the wavelength band from 200 to 3,000 metres any good commercial chokes have been found satisfactory.

Care should be taken when testing a receiver off a mains unit that any hum

noticed is not induced direct into the receiver circuits from the house wiring. Obviously under these conditions, the efficiency or otherwise of the filter will have no effect on the interference. If lead sheathed cables (with the sheaths earthed) are used in the house wiring, no trouble is, as a rule, experienced.

Care also should be taken that the field of the chokes in the filter does not induce the hum in the same way. For this reason the unit should not stand too close to any transformers, etc., in the receiver.

In connection with the design of the chokes to a given inductance, there is some useful data in *E.W. & W.E.*, Vol. 1, page 153.

16. Filters for Giving both H.T. and L.T. Supplies.

If the dimensions and cost of chokes to carry up to one, to one and a half amperes required by the L.T. circuits of most modern loud-speaker sets are calculated (remembering that in addition to avoiding saturation of the core, the ohmic resistance must be correct for the circuit), it will be found that both are so large as to make the filter scarcely a practical commercial proposition.

Of course, one may get round the difficulty by means of using the valve filaments in series, and by using the .06 amp type, but such makeshifts have several disadvantages.

As far as is known at the present time, there is only one make of eliminator to give 1 to 1½ amps or so at 6 volts from D.C. mains, on the market. Its cost of about £60 puts it beyond the reach of most people.

In conclusion, the writer would like to forestall a probable avalanche of letters to the effect that very many people obtain perfect results with the simplest of apparatus—so simple, indeed, as to be scarcely worthy of the name of a filter at all. To these he would reply that he only wishes all supply mains were as amenable as theirs. This unfortunately is not the case!

APPENDIX.

Calculation of m_1 for Fig. 5.

Neglecting the D.C. resistance of the chokes as its effect is negligible, we have:—

$$\omega = 2\pi f = 6.18 \times 50$$

$$Z_2 = L_1 \omega j = 60,000j$$

$$Z_3 = L_2 \omega j = 60,000j$$

Taking the resistance of the load as 10,000 ohms, we have :—

$$\frac{I}{Z_4} = \sqrt{\left(\frac{I}{10,000}\right)^2 + \left(-C_2\omega j\right)^2}$$

$$= \frac{I}{Z_4} = \sqrt{\left(\frac{I}{10,000}\right)^2 - .0006j^2}$$

$$Z_4 = -1,650j \text{ ohms about.}$$

Equation (1) is :—

$$m_1 = \frac{Z_4}{Z_2 + Z_3 + Z_4} \times 100$$

Substituting

$$m_1 = \frac{-1,650j}{60,000j + 60,000j - 1,650j} \times 100$$

neglecting j

$$m_1 = \frac{-165,000}{120,000 - 1,650} \text{ per cent.}$$

$$= 1.4 \%$$

Calculation of m_2 .

From Fig. 5 we have :—

$$Z_1 = L_1\omega j - \frac{j}{C_2\omega}$$

$$= 60,000j - 1,660j$$

$$= 58,340j$$

Then from equation (3)

$$\frac{I}{Z_{S_2}} = \frac{I}{Z_1} + \frac{I}{Z_5}$$

$$\frac{I}{Z_{S_2}} = \frac{I}{58,340j} + \frac{I}{-3.330j}$$

$$\frac{I}{Z_{S_2}} = .000171j - .0003j$$

$$Z_{S_2} = -3,400j$$

(We may notice, in passing, that if the circuit Z_1Z_5 resonates to a ripple frequency, Z_{S_2} —and in consequence m_2 —would become very large at this frequency.)

From equation (2)

$$m_2 = \frac{Z_{S_2}}{Z_{S_2} + Z_3} \times 100$$

Substituting

$$m_2 = \frac{-3,400j}{60,000j - 3,400j} \times 100$$

neglecting j

$$m_2 = \frac{3,400}{566}$$

$$= 6 \text{ per cent.}$$

The load across C_2 and the resistance of the chokes has been neglected, as in the case under consideration their effect is negligible compared with the experimental errors.

Students who wish to work these out for other filters are referred to Captain P. P. Eckersley in *E.W. & W.E.* for January, 1924, and the letter from H. J. Barton-Chapple in February, 1924, in the same journal, for particulars of A.C. calculations.

The Shielded Plate Valve as a High-Frequency Amplifier.

By R. T. Beatty, M.A., B.E., D.Sc.

THE direct amplification of high frequency currents by the use of three-electrode valves presents great difficulties on account of the instability of multi-stage circuits and the small amplification obtainable per stage. These undesirable results are, as is well known, due to capacity currents fed back from the output to the input side through the capacity which exists between the grid and plate of the valve. If this capacity could be reduced to zero, perfect stability could be obtained in multi-stage amplifiers at all frequencies, and the voltage amplification per stage could be raised to a high value by the use of tuned plate circuits of low decrement. Although this ideal has not yet been reached, valves can now be obtained by the public in which the capacity between the electrodes has been reduced to such a low value as to promise a new era in the art of high frequency reception, and in view of the great interest of the subject to all wireless amateurs, the present account of the properties and uses of such valves has been written.

1. Properties of a Valve with completely Shielded Plate.

In such a valve, a fourth electrode or shield, made of wire gauze, is employed and envelops the plate as completely as possible, so that the lines of electric force which in a three-electrode valve run from the plate to the grid, are now intercepted by the shield (Fig. 1). The shield is kept at a fixed positive potential. Since these lines do not pass through the shield, no effect can be produced on the grid by variations in plate potential: in other words, the plate-grid capacity is zero, and no current can be fed back from the plate to the grid: the valve is a truly unidirectional device.

Strictly speaking, since the shield must be perforated to allow electrons which start from the filament to reach the plate, some lines of force which start from the plate must pass through the shield and reach the grid,

giving rise to a small residual plate-grid capacity. It will be worth while, however, to assume for the moment that it has been possible to make the shielding complete so that we may realise the results which would be obtained under such ideal conditions. We will also assume that the plate and shield are constructed of a material which does not emit secondary electrons when bombarded by the electrons from the filament; that is that they simply absorb any electrons which reach them. Afterwards, in Section 4, we

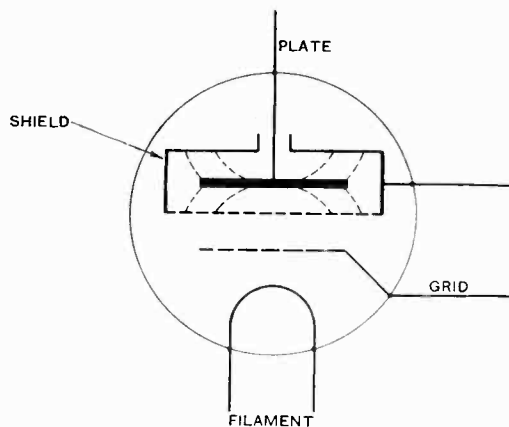

Fig. 1.

will take into account the minute capacity which, unfortunately, cannot be eliminated owing to the exigencies of manufacture, and also see how the behaviour of the valve is modified by the production of secondary electrons.

With these two assumptions in mind we may now consider the flow of electrons from filament to shield under the action of a fixed difference of potential between these two electrodes. A fraction of these electrons will pass through the openings in the shield and be caught by the plate *whatever its potential may be*, provided only that the lowest value of its potential is a few volts above that of the filament. If I_p be the

plate current and V_p the plate potential, it follows that $d I_p / d V_p = 0$, and the differential resistance (or internal resistance), which is the reciprocal of this quantity, is infinite.

The properties of the valve may accordingly be summed up by the two equations,

$$C_{pg} = 0 \quad \dots \quad \dots \quad (1)$$

$$R_v = \infty \quad \dots \quad \dots \quad (2)$$

where C_{pg} is the plate-grid capacity and R_v is the differential resistance of the valve.

2. Valve Specified by a Single Characteristic Curve.

If we make the usual proviso that sufficient grid bias is applied to keep the grid current zero, then since R_v is infinite, the only numerical constant relating to amplification which the valve possesses is its mutual conductance g . That is, when the shield is kept at a suitable positive potential and the relation is plotted between grid volts and plate current, the potential of the plate being immaterial provided only that it is at least a few volts above that of the filament, the resultant curve specifies the valve completely as regards the variation in plate current to be obtained by varying the grid potential. In the case of a three-electrode valve as we vary the voltage applied to the plate from one valve to another in steps we obtain a set of characteristic curves, but as mentioned above in the case of a shielded plate valve, variations of plate voltage are without effect and consequently the usual set of curves is replaced by a single characteristic. If the instantaneous values of the plate current and grid voltage be I_p and V_g then

$$d I_p / d V_g = g \quad \dots \quad \dots \quad (3)$$

and g , the mutual conductance, is the slope of the characteristic curve.

If we limit ourselves to the straight portion of the characteristic and apply an alternating E.M.F. of instantaneous value v_g to the grid, then the resulting alternating plate current has the instantaneous value i_p given by

$$i_p = g \cdot v_g \quad \dots \quad \dots \quad (4)$$

3. Voltage Amplification.

If a resistive load of magnitude R ohms be inserted in series with the plate, the potential

drop across it due to v_g is $v_p = R i_p$: substituting for i_p from eq (4) we get

$$v_p = R \cdot g \cdot v_g \quad \dots \quad \dots \quad (5)$$

and the voltage amplification m is given by

$$m = v_p / v_g = R \cdot g \quad \dots \quad (6)$$

and is limited only by the maximum value of R which can be obtained. The resistive load may be formed by a tuned plate circuit (Fig. 2) with large coil and small condenser.

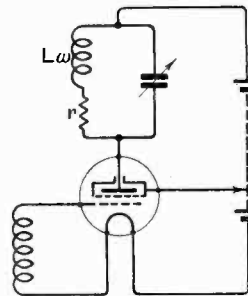

Fig. 2.

The largest values of equivalent resistance $L^2 \omega^2 / r$ of such rejector circuits which can be ordinarily obtained in amplifier circuits, are given in column 2 of the subjoined table and the corresponding values of m are given in column 3, assuming a mutual conductance of 0.4 milliamp per volt.

TABLE I.
 $g = 0.4 \text{ mA/volt.} \quad R_v = \infty$

Frequency kilocycles	$R = L^2 \omega^2 / r$ ohms	$M = R \cdot g$
100	4×10^5	200
1,000	10^5	40
10,000	10^4	4

These calculated values for single stage amplification are truly remarkable. Let us now investigate the experimental results: It will be shown below that with actual apparatus, including commercial valves and valve components and with quite simple circuits, amplifiers can be built in which the amplification per stage approaches the values given in Table I, and in which perfect stability is assured at all frequencies.

4. Hull's Shielded Plate Valve.

In deducing equations (1) and (2) two assumptions have been made (a) that the plate is completely shielded, (b) that no secondary electrons are emitted from the plate or the shield. An experimental type of valve constructed by Hull* at Schenectady almost fulfils the first condition as is shown by Curve 1, Fig. 3, in which the sum of plate and shield currents is plotted against plate voltage: the line is practically horizontal showing that the flow of electrons from filament to grid is affected only to a minute

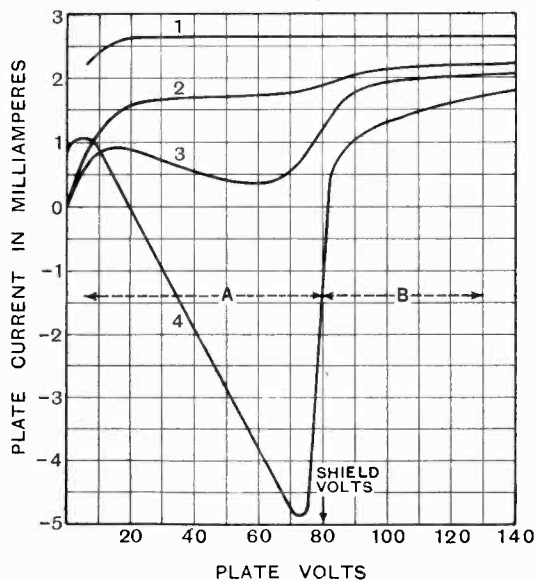

Fig. 3.

extent by the potential of the plate and consequently that very few lines of force reach from plate to grid. This result was achieved by making the shield of thin plates placed edge on to the incoming electrons like an open Venetian blind (Fig. 5). When plate current is plotted against plate volts with 80 volts (marked by an arrow) on the shield and with polished nickel electrodes Curve 3, Fig. 3 is obtained. The region A shows a negative characteristic due to emission of secondary electrons from the

* Hull and Williams, *Physical Review*, 27, 4, April, 1926, p. 432. The curves in Fig. 3 are substantially those given in this paper.

plate: as the plate potential is increased the primary electrons move faster and set free more secondary electrons from the plate so that the plate current diminishes. When the plate potential exceeds 80 volts

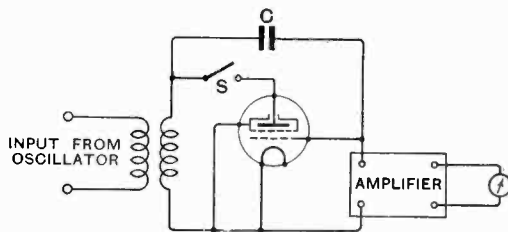

Fig. 4.

the secondary electrons are pulled back to the plate and the negative characteristic disappears: the positive slope in region (B) is due to the cloud of secondary electrons surrounding the shield of which more and more are pulled to the plate, as the plate potential is increased. These statements are verified by an experiment in which plate and screen were coated with colloidal nickel black which acts as a trap for the secondary electrons: as Curve 2 shows the negative characteristic disappears, and all lines become more nearly horizontal. The other extreme is shown in Curve 4 where the slopes have been accentuated by coating the electrodes with a layer of high secondary emission: these negative characteristics are, of course, familiar in the case of the dynatron invented by Hull many years ago.

On the right of the 80-volt ordinate the curves become straight in the vicinity of 130 volts and the differential resistances given by Curves 2, 3, 4, are respectively 7×10^5 , 5×10^5 , 10^5 ohms.

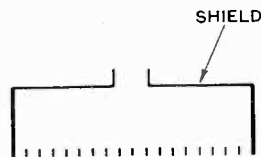

Fig. 5.

The residual plate-grid capacity was measured in the following way (Fig. 4). An oscillator was inductively connected to the plate of the valve, the shield being directly connected to the cold filament. The signal produced in this way was transmitted to an

amplifier and detector partly through the plate-grid capacity and partly through a very small condenser C composed of a cylinder of inner diameter 2.5 mm. with a thin wire (.125 mm. diameter) along the axis. The reading of the milliammeter in series with the plate of the detector was noted and then by means of the switch S the valve was cut out and the reading brought to the same value as before by sliding the wire of the condenser C farther into its surrounding cylinder. In this way the value of the plate-grid capacity could be calculated and it worked out at the very small value of $0.006\mu\mu F$. This remarkably low value should be compared with the ordinary values for three-electrode valves which vary between 2 and $50\mu\mu F$.

shown in Fig. 2: we get the well-known expression

$$\frac{mR \cdot g}{1 + (R/R_v)} \dots \dots (9)$$

At frequencies of and above 1,000 kilocycles the ratio R/R_v may be neglected in comparison with unity: at lower frequencies m will be appreciably smaller than its value for a valve whose differential resistance is infinite since at such frequencies R can be built up to values comparable with R_v as is evident from Table I.

On measuring the amplification actually produced in a circuit arranged as in Fig. 2 with a signal applied between the grid and the filament, Hull found values at 1,000 and 10,000 kilocycles agreeing with those cal-

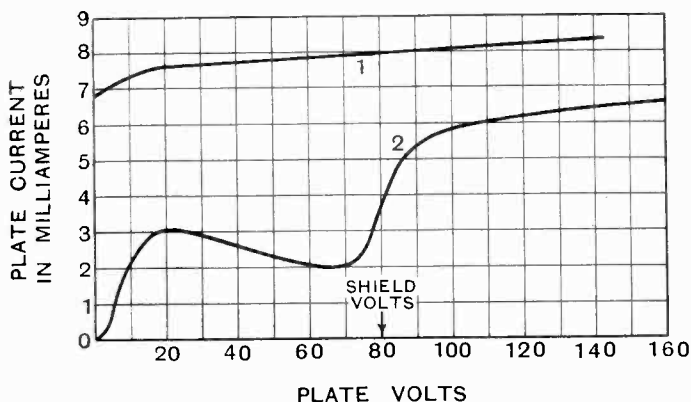

Fig. 6.

Equations (1) and (2), which are only true for a theoretically perfect valve, now become

$$C_{pg} = 0.006\mu\mu F \dots (7)$$

$$R_v = 5 \times 10^5 \text{ ohms} \dots (8)$$

and a proviso must be made that the potential of the plate be kept above that of the shield, otherwise R_v will fall to a low or even a negative value on account of the presence of secondary electrons emitted by the plate and shield. If it were not for these secondaries the plate swing could be extended to within a few volts of the filament potential as mentioned in Section 2.

Since R_v is not infinite in this valve the expression for the voltage amplification given in eq (6) must be modified to allow for the shunting effect of the plate resistance on the resistance of the plate rejector circuit

calculated in Table I, and by using a special low loss coil at 10,000 kilocycles composed of a self-supporting spiral of copper tube the figure for m was raised from 4 to 7. He also showed that by careful screening a four-stage cascade amplifier could be built up using in each stage a tuned plate system connected to the following grid through a condenser and grid-leak, the total amplification for four stages being a million at 1,000 kilocycles. No sign of instability or regenerative action was noticed; this being due to the extremely small value of the internal feed-back.

Such results are impressive, but as this particular valve has not so far emerged from the laboratory stage, we will not dwell on it further but will consider a type which is now available to the wireless amateur.

5. Commercial Shielded Plate Valve.

(A) *General Characteristics.*

Shielded plate valves can now be obtained in which a compromise has been made between the complications requisite for almost perfect shielding and the simplicity necessary for manufacture. The valves are double ended, the filament and grid leads being at one end, the plate and shield at the other. The shield is a disc of coarse wire

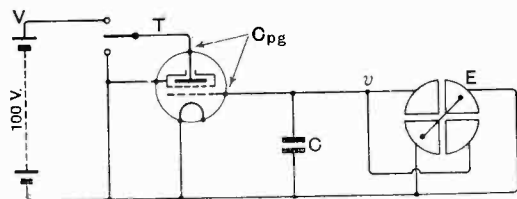

(a)

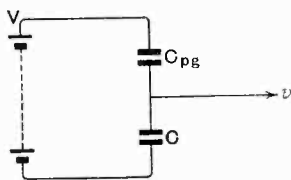

(b)

Fig. 7.

gauze lying between the disc-shaped plate and the grid. Fig. 6 (1) gives the relation between plate volts and total current to plate and shield, the grid being connected to the negative end of the filament, and the shield being kept at 80 volts. The slope of this curve is greater than in Hull's valve, the reason being that the coarse shield does not screen the plate so effectively, so that an increase in plate potential causes more electrons to be pulled through the grid. Curve (2) shows the plate current only, the differential resistance R_v which is obtained from the slope of this curve is 1.25×10^5 ohms in the vicinity of $V_p = 150$ volts. The mutual conductance is 0.8mA/volt, this high value being due to the open mesh of the shield.

The plate-grid capacity was determined in the following simple way, (Fig. 7): A potential V of about 100 volts was suddenly applied to the plate through a tapping key T ,

the shield being earthed and the filament unlighted. The grid was connected to one pair of quadrants of a Lindemann quartz fibre electrometer and a capacity C was placed between grid and filament. Since the arrangement is equivalent to the simplified diagram shown in Fig. 7(b) with C and C_{pg} in series we have

$$(V - v)/v = C/C_{pg}$$

Where v is the potential shown by the electrometer: A variable $50\mu\mu\text{F}$ condenser was used for C .

The value thus found for C_{pg} was $0.1\mu\mu\text{F}$: this is much larger than the value $0.006\mu\mu\text{F}$ given by Hull's valve but nevertheless is a great improvement on the grid-plate capacities of three-electrode valves.

(B) *Voltage Amplification from Grid to Plate.*

This was measured for the circuit shown in Fig. 8.

The untuned grid circuit was excited by inductive coupling from an H.F. oscillator and the grid voltage measured by a Mouillin voltmeter M . The coil of the tuned plate circuit was of a well-known commercial type in which a single layer coil is screened by a copper pot. The voltage induced across the coil was measured by a cathode-ray oscillograph shunted by a megohm, a $1,000\mu\mu\text{F}$ condenser being inserted in the lead from the lower end of the coil. Table II gives the results obtained.

TABLE II.

Frequency kilocycles.	$m = v_p/v_g$
500	58
1,000	36
1,500	30
2,000	23
3,000	17
4,000	13

(c) *Stability of Single Stage Amplifier with Tuned Grid and Tuned Plate Circuits.*

The circuit shown in Fig. 8 is stable since a low resistance input is used; if, however, this is replaced by a tuned grid circuit, as in Fig. 9, instability is possible and it is of great interest to see how low the decrements of the two circuits can be made before oscillations set in.

It can be shown, though the proof* is too long to insert here, that the amplifier shown in Fig. 9 will be stable provided that H is less than 2, where

$$H = \frac{C_{pg}\omega \cdot g}{L_1^2\omega^2 \left(\frac{r_2}{L_2^2\omega^2} + \frac{1}{R_v} \right)} \dots (10)$$

The amplification may be divided into two parts:—

1. The amplification from grid to plate;
 2. The amplification produced by the tuned-grid circuit on a signal injected into the grid coil from an untuned coupling coil in series with the aerial, and these amplifications are

$$(a) m_2 \text{ (from grid to plate)} = \frac{g}{r_2 \left(\frac{1}{L_2^2\omega^2} + \frac{1}{R_v} \right)} \dots (11)$$

$$(b) m_1 \text{ (due to grid circuit)} = \frac{L_1\omega}{r_1} \dots (12)$$

and the total amplification is $m_1 m_2 F$ where F is a multiplying factor due to the reaction through the grid plate capacity: equations (11) and (12) are well-known expressions: (11) is identical with (9) given above.

If $H=2$, the amplifier is on the verge of self-oscillation and F is very large, as H decreases F decreases also, and when

and we will call this condition one of negligible reaction.

These results enable us to calculate the largest values of m_2 which can be realised in single-stage amplification before instability sets in. For simplicity we assume that

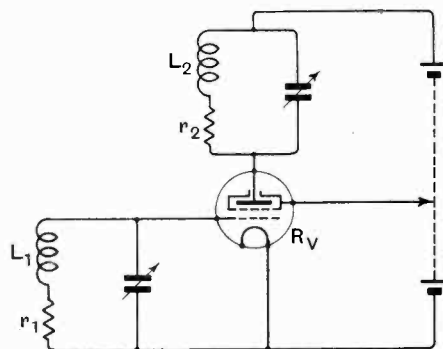

Fig. 9.

in equation (10) identical coils are used in the grid and anode circuits, that is, that

$$\frac{r_1}{L_1^2\omega^2} = \frac{r_2}{L_2^2\omega^2}$$

and we then work out the least value which each term can have in the two cases

$$(1) H = 2; \quad (2) H = 0.625.$$

The constants as ascertained in Section 5(A) are—

$$\begin{aligned} C_{pg} &= 0.1 \mu\mu\text{F} \\ g &= 8 \times 10^{-4} \text{ amp/volt.} \\ R_v &= 1.25 \times 10^3 \text{ ohms} \dots (13) \end{aligned}$$

The results are given in Table III.

The figures in Tables II. and III. are plotted in Fig. 10.

Curve 1 gives the maximum grid-plate amplifications that can be obtained with the amplifier shown in Fig. 9 at the limit of stability. Curve 2 gives the corresponding value when the reaction is negligible. The experimental values with a screened tuned-plate circuit (Fig. 8) given in Table II. are shown in Curve 3.

Curve 3 overshoots the stability limit Curve 1 in the region between 500 and 800 kilocycles: as the frequency is increased the curve drops towards Curve 2 indicating negligible reaction. The variation of tuning of the amplifier over the complete range of 500 to 4,000 kilocycles

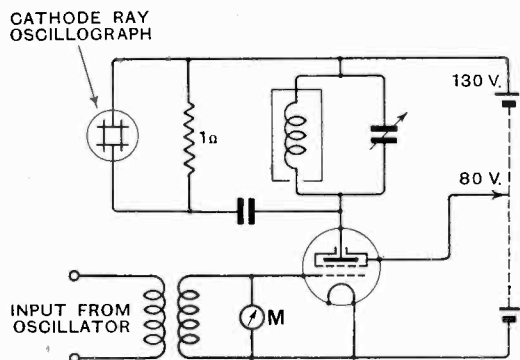

Fig. 8.

$H = 0.625$, F has the value 1.2 (these results are proved in the paper referred to above). When $F = 1.2$ the increase in amplification due to internal feed-back is only 20 per cent.

* See a forthcoming paper by the writer in the *Philosophical Magazine* on "Resonant Circuits with Reactive Coupling."

was, of course, not carried out with the same plate coil throughout: the region was divided into four ranges and a suitable coil used for each range.

TABLE III.

Theoretical maximum values of voltage amplification from grid to plate:—

1. At limit of stability when $H = 2$;
2. With negligible reaction when $H = 0.625$.

Frequency kilocycles.	$L_2^2 \omega^2 / r_2$		m_2	
	$H = 2$	$H = 0.625$	$H = 2$	$H = 0.625$
500	1.27×10^5	6.11×10^4	51	33
1,000	8.1×10^4	4.06×10^4	39	25
2,000	5.35×10^4	2.8×10^4	30	19
5,000	3.16×10^4	1.69×10^4	20	12
10,000	2.16×10^4	1.17×10^4	15	8.5

From the coincidence of Curves 1 and 3 in the vicinity of 800 kilocycles, it follows that an amplifier, as shown in Fig. 9, should be on the point of self-oscillation when tuned

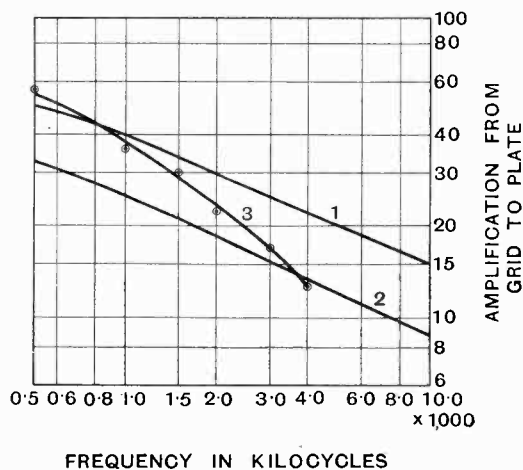

Fig. 10.

near this frequency. It was found actually that using similar screened coils for L_1 and L_2 oscillation could easily be produced by increasing the filament current so as to raise the value of the mutual conductance. The system also became unstable at this frequency

by raising the copper screens slightly so as to allow a small amount of induced reaction between the grid and anode coils.

Apart from the screening of the coils, no special precautions were taken with the circuits except that the grid and plate leads were kept well separated: the necessity for this spacing is shown by the following experiment: one end of a short wire was fastened to the plate lead and the other brought within half an inch of the grid lead whereupon the extra plate-grid capacity so produced (a fraction of $1 \mu\mu\text{F}$) was sufficient to set up self-oscillation.

(D) Total Voltage Amplification Obtainable.

We have only considered so far the amplification from grid to plate but this must be multiplied by the corresponding amplification from injected signal to grid to get the total effect. This is the quantity called m_1 in equation (12). m_1 was found experimentally for each of the screened coils used in the grid circuit in Fig. 9 and the results are given in the second column of Table IV.

TABLE IV.

Frequency kilocycles.	m_1	m_2	$m_1 m_2$
500	80	51	4,100
1,000	80	36	2,900
1,500	83	30	2,500
2,000	79	23	1,800
3,000	78	17	1,300
4,000	76	13	990

The third column contains the values of m_2 , borrowed from Table II,* and the total amplification, omitting the additional effect due to reaction, appears in the final column. It is unusual to include the effect given by the grid circuit in the expression for the amplification but it is quite justifiable since in designing for stability we must take both the grid and plate circuits into consideration.

The questions of selectivity and of multi-stage amplification raise some extremely interesting points and it is hoped to deal with these in a future paper.

* Except in the case of the first row: the system is unstable at this frequency as will be seen by reference to Fig. 10 and the value 51 for m_2 given by Curve 1 has been used instead of the unstable value 58 given by Curve 3.

Correspondence.

Letters of interest to experimenters are always welcome. In publishing such communications the Editors do not necessarily endorse any technical or general statements which they may contain.

The Performance of Reflexed Valves.

To the Editor, E.W. & W.E.

SIR,—May I be allowed to point out two rather unfortunate errors in the otherwise excellent article by Mr. D. Kingsbury in your issue for September?

In the first place, it is stated that the form of the voltage wave occurring at the terminals of the secondary of the A.F. transformer, is either as in Fig. 3(b) or 3(c), depending, among other things, on the R.F. transformer connections. Reversing the R.F. transformer connections can, however, only have the effect of reversing the phase of the high-frequency input to the rectifier, and it can easily be seen, *e.g.*, by turning Fig. 3(a) upside down, that this has no influence on the phase of the low-frequency output.

Secondly, with reference to Fig. 3(d) and 3(e), Mr. Kingsbury states that in (d) :—

“the mean of the combined wave (dotted line) is positive in respect to the mean of the basic A.F. and R.F. waves (full line)”;

and in (e) that :—

“the mean of the combined wave is negative in respect to the basic waves.”

That this is incorrect can be easily demonstrated by redrawing Figs. 3(d) and 3(e) on squared paper, and calculating the areas above and below the thick line. These will be found equal, thus showing, as would be expected, that when the two waves are combined the new mean is the same as the means of the separate waves.

The change in the anode current which was found to result on shorting the transformer secondary, can easily be explained as due to the combined waves overrunning on to the bend of the characteristic, although this need not have been enough to produce noticeable distortion, or even the “reflex interference note.”

Dulwich, S.E. 21.

W. S. PERCIVAL.

To the Editor, E.W. & W.E.

SIR,—I have to thank you for forwarding to me Mr. Percival's letter pointing out certain errors in my article on Reflex Circuits in the September issue.

Needless to say I welcome all such criticism since it brings us nearer complete understanding of these very interesting and, in my opinion, by no means defunct circuits.

I have given Mr. Percival's letter consideration, and there is no doubt that on both counts he is correct.

In regard to his second point, it was the radio-frequency transformer which was shorted when receiving signals and not the audio-frequency

transformer as stated in my article. This undoubtedly gives the rise and fall in anode current observed, and but for a further complicating feature I should probably not have misinterpreted the results obtained.

I was at the time using a voltage-doubling type of H.T. supply rectifier which, while having the advantage of supplying comparatively high voltages when only small anode currents are required, has the disadvantage of high apparent internal resistance. (I actually deduced the resistance of this particular rectifier to be some 56,000 ohms.) With liberal capacity across the output terminals of such a rectifier no ill effects are observed under working conditions, but—and this is the complication—any small change in bias or filament temperature produces only a transitory change in current in accordance with the valve characteristics, followed by a very much smaller change in steady current.

I apparently misread the transient rise and fall in anode current as being due to a shift in the mean grid potential of the valve, whereas it was actually due to the cessation of the D.C. component of the crystal output flowing through the audio-frequency transformer primary.

I do not think the main issue of the derivation of the reflex interference note is affected, and since the observed changes in anode current actually helped me to trace the matter out, the coincidence of effects was indeed a fortunate one.

Pulborough, Sussex.

D. KINGSBURY.

BOOK REVIEW.

ITALIAN WIRELESS YEAR BOOK AND DIRECTORY, 1927.

The second edition of the *Radio Annuario Italiano*, the only Italian Wireless Directory, contains a mass of information useful alike to the amateur and the trader. A brief review of the progress of radio-telephony and telegraphy in Italy is followed by a summary of the Laws and Regulations passed since 1903 and information concerning tariffs and general statistics. There is a comprehensive list of the commercial and official land stations in Italy and her Colonies and of the broadcasting stations of Europe. The first part concludes with various useful notes on wireless matters, including codes and abbreviations used in morse transmissions, and particulars of the personnel and functions of the Ministry of Communications and other Ministries and Corporations concerned with Wireless Telegraphy and Telephony.

The second section of the book comprises a Directory of Wireless Traders, Manufacturers and Agents. The book is published by *Radio Novita*, Via Porto Maurizio 12, Rome, price 35 lire or 9s. 6d., post free.

The Amplification of Small Currents by means of the Thermo-Relay and the Photo-Electric Cell.

By James Taylor, M.Sc., Ph.D., A.Inst.P.

Introduction.

THE present article describes a method for the magnification of the deflections of a galvanometer mirror as developed at Utrecht by Moll and Burger, for the measurement of extremely small currents. This method of amplification by means of the "thermo-relay"* is not so widely known in England as it deserves to be, and it is hoped that the following description of the method will prove of interest and use to those engaged in precision measurements for wireless research and other purposes. Further, a new and similar method of amplification utilising the properties of the photo-electric cell will be described.

As a rule mirror galvanometers of the suspended coil and suspended magnet type are used for the measurement of very small currents. Electrostatic methods in which an electric charge and a time are measured simultaneously (from which the current which is equal to the charge divided by the time, may be deduced) are also used in some types of work, but are not generally applicable.

Suspended coil instruments are most frequently used because they are preferable from many points of view to the suspended magnet types. In order to make a galvanometer sensible to very small currents it is usual to increase the number of turns of wire upon the moving coil. This has the great disadvantage of increasing the bulk of the moving parts and augmenting the resistance of the galvanometer. The result of increasing the inertia of the coil is to make the galvanometer sluggish in action, that is,

to give it a long time period, and for many types of work it is impossible to use a long period instrument. Further, owing to the high resistance of the galvanometer it cannot be used in relatively low resistance circuits, for its introduction would entirely disturb the circuit conditions and most of the electrical energy of the circuit would be absorbed in the galvanometer system itself.

By utilising the thermo-relay method, however, it is possible to equal and surpass the performance of the most sensitive galvanometer whilst retaining a short time period and a comparatively low circuit resistance if required.

The possibilities of these particular methods have been but little explored and it is not impossible that their range of usefulness on the technical side may be considerable.

The thermo-relay is dependent for its efficiency upon certain new types of thermocouples introduced in recent years and largely developed by Moll (see Moll, *Proc. Phys. Soc. Lond.*, xxxv., p. 258, 1923; Moll and Burger, *Phil. Mag.*, Vol. I., Sept., 1925), consequently some preliminary remarks about thermocouples in general, and especially those used for the measurement of radiation are necessary. The subject of thermoelements is of importance in the technical branches of wireless so that no apology is needed for the introduction of the subject here.

Thermo-elements.

Let us suppose that we have a piece of copper wire AB joined at its ends A and B (see Fig. 1) to iron wires AD and BC respectively and a galvanometer (low resistance) or other current indicator is connected between the ends C and D of the iron wires, there will be no current indicated by the galvanometer DC provided the junctions A and B of the copper and iron wires are

* [Illustrated pamphlets and price lists of these thermo-relays have recently been issued in English by the makers, P. J. Kipp & Sons of Delft.

A short description of the use of the Moll & Burger vacuum thermo-relay for amplifying galvanometer deflections was given by Prof. A. V. Hill in the *Journal of Scientific Instruments*, Vol. IV, p. 4, October 1926.—Ed.]

at the same temperature. If, however, *A* and *B* are at different temperatures a current will be indicated by the galvanometer. This is the basal experiment in thermo-electricity which was discovered as long ago as 1821 by Seebeck. In the above described example the current flows from the copper to the iron at the hot junction and from the iron to the copper through the cold junction.

Such a combination of two metals which gives rise to an electromotive force and a current (if the circuit is closed) when there is a difference of temperature between the two metallic junctions, is called a thermocouple or thermo-element. Almost any two metals may be used but some combinations are much more efficient than others. Certain simple experimental laws relative to the behaviour of thermo-elements have been discovered. The greater the temperature difference between the hot and cold junctions (within certain defined limits) the greater is

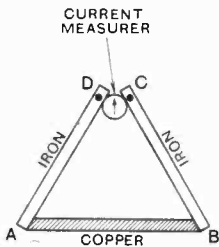

Fig. 1.

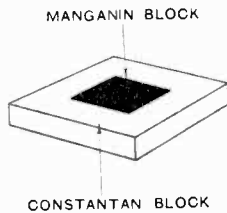

Fig. 2.

the electromotive force generated in the circuit. Thermo-elements may be used in series and a battery is thus formed of which the total electromotive force is equal to the algebraic sum of the electromotive forces of the component elements. We see as a consequence that the ends of a thermocouple may be connected to a galvanometer, or soldered, without interfering with the circuit electromotive force conditions. This result is of experimental importance.

The electromotive forces obtained from thermocouples are small; in the case of the iron copper couple for example with the cold junction at 0°C. and the hot junction at 100°C. the voltage set up in the circuit is only slightly greater than a thousandth of a volt.

Thermocouples have received sundry uses for the measurement of alternating current

(employed as current converters) and for the measurement of radiation intensities. Batteries consisting of small rods of antimony and bismuth arranged so that the alternate junctions are all at one side, and blackened, as in the Melloni Thermopile, have been employed for the measurement of infra-red radiation, but the performance is uncertain at best and many difficulties are encountered in use.

The sensitivity of a thermocouple composed of a given pair of metallic components, depends upon the difference of temperature between the two junctions set up by a given cause heating one of the junctions. Thus, if radiation were falling upon one of the junctions, the temperature of this "irradiated" junction would rise indefinitely, in the ideal case where no heat losses are experienced. In practice the case is different. Heat is lost by convection of heat in the surrounding air, by conduction through the metal components, and by radiation.

Originally thermo-elements were always constructed in air, but nowadays they are very frequently mounted in an evacuated vessel so that a considerable increase in the sensitivity and reliability is obtained, due to the diminution in the heat losses to the surrounding air, and the absence of erratic air movements in the vicinity of the couple.

The loss of heat by conduction through the metal components of the element may be decreased by reducing the cross section of the component strips. This entails, however, a concurrent increase in the electrical resistance of the system so that the reduction of the heat conductivity should only be carried down to a certain "optimum" point.

Another point of great importance in connection with a thermo-element is the time required for it to give a reading that can be taken as approximately the equilibrium value. The equilibrium value takes, theoretically of course, an infinite time to be arrived at, but for practical purposes the "quickness" of a thermo-element may be defined as the time required to reach a value 99 per cent. of the real equilibrium value.

The quickness depends upon a variety of circumstances. It is less the greater the heat capacity of the elements which are heated. It is further greatly improved when the element is surrounded by air, for this

brings about a quicker temperature equilibrium of the system. Nevertheless the increase of sensitivity gained by enclosing the element in vacuum more than counterbalances the disadvantage of a somewhat smaller quickness.

Moll and Burger (*loc. cit.*) have constructed thermo-elements fulfilling the required conditions for accurate and quick performance. To this and a special metal foil called

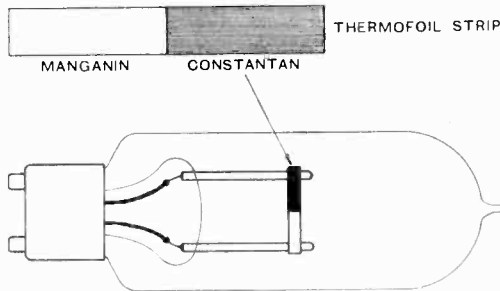

Fig. 3.

thermofoil was first made (see Moll, *loc. cit.*). (Moll's first thermocouple was constructed in 1914.) A rectangular section is cut out from the middle part of a block of constantan (see Fig. 2) and into this section an exactly-fitting block of manganin is silver-soldered in such a manner that a minimum of solder is used. (This method is employed because the composite block so formed is perfectly symmetrical and can be rolled out uniformly much more easily than bars of simpler construction.) The thickness of the bar is reduced by successive rollings until it is of the order of a few microns* (a micron is a thousandth part of a millimetre). Strips of this foil of the required width can be cut out across the section. They are blackened on one side by a varnish of colloidal carbon so that efficient absorption of radiation falling on the strip occurs. The strip is soft-soldered upon the leads of a small lamp-bridge which is then mounted in a glass bulb, and evacuated (see Fig. 3, which shows one type of this kind of thermo-element).

These sort of thermocouples (see Moll and Burger, *loc. cit.*) have a quickness of about 2 or 3 seconds and a resistance of from 10 to 20 ohms.

* The thickness of the thermofoil used for vacuum elements is from 1 to 1.5μ . 0.9μ is the thinnest that has so far been used.

The Thermo-relay.

The thermo-relay is simply a composite thermo-element of the same type. The strip of thermofoil consists of three parts (see Fig. 4), *AB* and *CD* being of constantan and *BC* of manganin. The foil is blackened upon one side and mounted in an evacuated vessel as above described. (Fig. 5 shows a thermo-relay.)

It is easily seen then that the thermo-relay consists of two similar junctions in series, and opposing each other.

In practice the relay is connected in series with a galvanometer which may conveniently be of the suspended-coil mirror type.

If now the image of a source of light is thrown upon the portion *BC* of the strip, there will result—as a rule—a deflection of the galvanometer, indicating that a current, due to the unequal heating of the junctions *B* and *C*, is flowing in the circuit. By adjusting the relay in a direction perpendicular to the direction of the light beam (that is in the direction of the strip) the galvanometer deflection may be reduced to zero. This state is attained when the junctions *B* and *C* are symmetrically heated and the electromotive force from the one is exactly equal and opposite to that from the other. This then is the principle of the method for the magnification of small deflections of a galvanometer mirror.

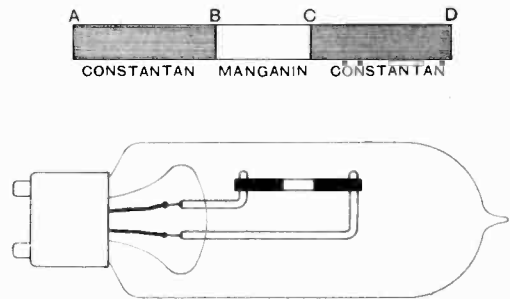

Figs. 4 and 5.

In practice the method is usually employed in the following manner: The first circuit (see Fig. 6) in which the small current to be measured flows, is connected in series with a suspended coil galvanometer of the Moll type (resistance about 40 ohms). Other types of galvanometer, or a string galvanometer (in which the mirror rotates),

may of course conveniently replace the Moll instrument. Fig. 6 gives a diagrammatic representation of the apparatus. A source of light, for example a half-watt ten-volt lamp, supplied from accumulators so that it maintains a constant intensity, illuminates a rectangular slit mounted upon a convergent lens which converges the transmitted beam upon the mirror of the first galvanometer. The beam is reflected from the galvanometer mirror and is then further

length until no deflection of the second galvanometer, which is connected in series, is produced.

If now the mirror of the first galvanometer suffers a deflection due to a small current passing through its coil, a displacement of the beam of reflected light through twice the angle of movement of the galvanometer takes place, the position of the image upon the relay is altered, unsymmetrical heating of the junctions *B* and *C* occurs, and

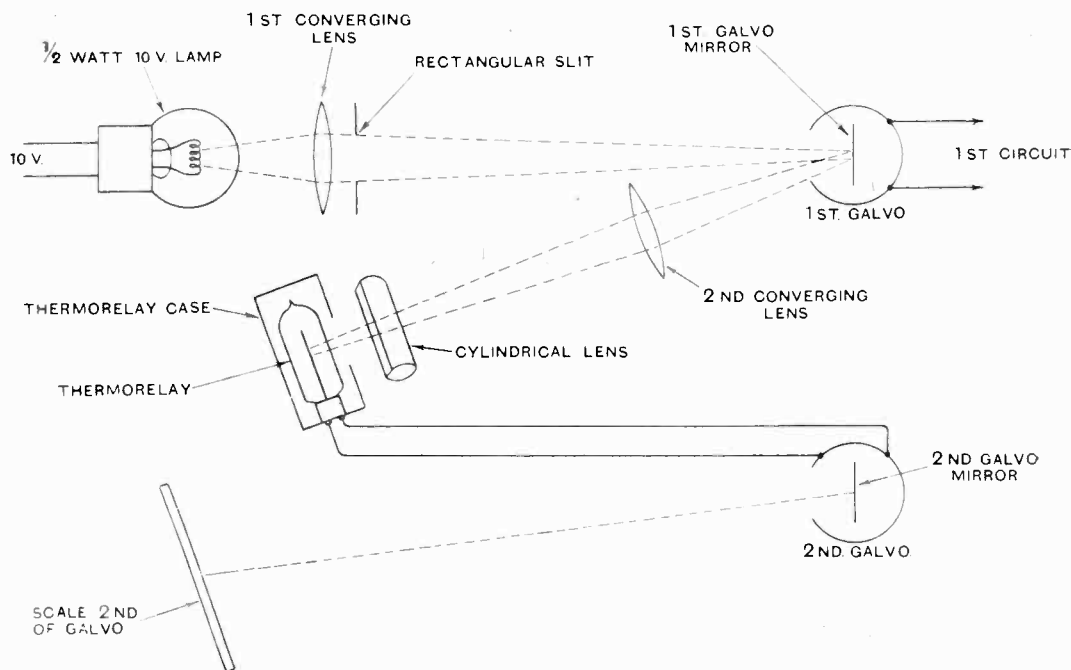

Fig. 6.

concentrated by means of a second converging lens so that it forms an image of the rectangular slit on the thermo-relay strip. By means of a cylindrical lens the image is concentrated to a line of light and adjustment is made so that the linear image of the rectangular slit falls on and along the part *ABCD* of the strip.

It is to be noted that the adjustment is made so that the strip is at the focus for the infra-red radiation which, as is well known, is chiefly effective in producing the heating effect of the junctions. The relay is usually mounted in a case provided with a fine screw lateral movement so that it can be adjusted in the direction of the strip

the second galvanometer registers a deflection that is greatly in excess of that of the first galvanometer.

For small rotations of the mirror of the first galvanometer, that is, for cases in which the displacement of the image on the thermo-relay strip is not large, the second galvanometer reading is directly proportional to the rotation of the first galvanometer. That is to say, for small currents, the amplification is linear.

Utilising such a method, amplifications of a hundred and in some cases five hundred may be obtained and, owing to the thinness of the relay strip, the time period for response of the instrument is short. Indeed

if an aperiodic galvanometer of small period is employed the final deflection is reached after two and a half or three seconds.

Currents in the first galvanometer circuit of as little as 10^{-11} amperes may produce one mm. deflection of the light spot of the second galvanometer (scale about one and a half metres from the galvanometer). This is not to say, however, that currents of such an order can be accurately measured by the method; the performance is limited by the Brownian Movement of the coil of the first galvanometer. In recent years the Brownian Movement has been recognised as of first rate importance and has received considerable attention both in its practical and theoretical aspects. As is well known, all particles of matter, whether small beyond the limits of microscopic examination, or large, participate in an erratic and haphazard movement brought about by the universal temperature kinetic energy (energy of motion) of the molecules and atoms of all substances.

Now, the galvanometer coil though of proportions gigantic relative to atoms, to molecules, and to the particles of colloidal solutions, is nevertheless actuated by a Brownian Movement, produced by the perpetual and discontinuous bombardment of the coil by the molecules of the surrounding air, and from other causes.

Ising, and Ornstein (Ising, *Phil. Mag.* 7, 827, 1926. Ornstein, *Zts. of Phys.* 41, 11/12, 848, 1927) have shown that this produces a movement of rotation which although exceedingly minute comes notwithstanding into the range of possible measurement by the present method.

With the Moll galvanometers referred to above, the average rotation of the coil due to the Brownian Movement is of about the same magnitude as that produced by a current of 10^{-11} amperes, consequently on either side of this value the coil is actuated by erratic small changes of position, and measurements of currents of this order have no precise significance.

The higher the resistance of the galvanometer coil the less is the Brownian Movement.

In utilising the method great care must be taken to protect the system from electrostatic charge effects, contact electromotive forces, and extraneous temperature differences

of variable nature, for the first galvanometer system is extremely sensitive to such effects. Apart from the advantage gained by the fairly low resistance of the circuit, there is a further advantage in that there is no material or electrical energy coupling between the first galvanometer system and the amplifier.

It is, of course, not possible to use the system for alternating current of period comparable with the period of response of the apparatus (about 3 seconds), for in that case a true indication of the time-current course would not be obtained. For the purpose of measuring very small currents of a direct or integrated nature the system lends itself admirably and has possible uses in the measurement of very feeble signals.

The first galvanometer may, of course, be used in connection with a vacuum junction for the measurement of very weak alternating currents.

The Photo-electric Cell Method.

We must now describe the method of current amplification using the photo-electric cell.

Photo-electric cells have come into the limelight recently because of their applications in television.

In general terminology all vacuum or gas-filled metal electrode cells, or selenium cells, are termed photo-electric cells because their function by means of an electrical charge brought about by the effect of light. In the present article it is only the first type of cells that concerns us.

When light falls upon a metal, electrons or negative particles of electricity are given off from the surface of the metal, to the surrounding space. This loss of electricity from the metal causes it to acquire a positive charge which increases as more electrons are emitted. Finally, however, emission is stopped because of the electrical attraction between the positively charged body and the negatively charged electrons, which tends to prevent the escape of the electrons. The action will continue nevertheless provided the metal is kept negatively charged or put into a suitable electric field (this can be effected by placing a positively charged conductor near to the metal and maintaining a positive difference of potential between them), helping the electrons to escape from the metal surface.

In the case of ordinary metals such as copper and iron, an appreciable electronic emission is brought about only by the action of ultra-violet light, but with the alkali metals sodium, potassium, rubidium and caesium, ordinary light is effective in producing a considerable photo-electric effect (*i.e.*, a giving off of electrons). Consequently alkali metals are employed for the sensitive types of photo-electric cells.

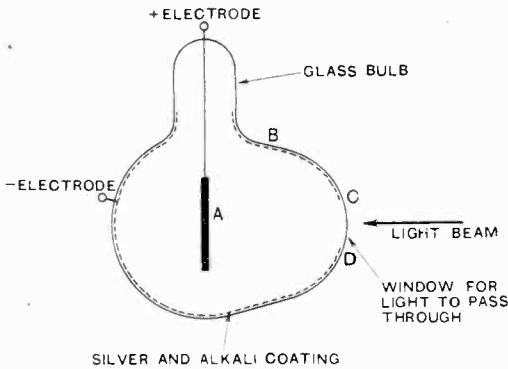

Fig. 7.

As is well known the alkali metals oxidise very rapidly in air (often taking fire) so that it is not possible to use them exposed to the atmosphere. They must consequently be enclosed in vacuum or in an inert gas that does not attack them.

Fig. 7 shows diagrammatically a typical form of photo-electric cell. A metal electrode *A* is mounted in a glass bulb *B* which is silvered on the inside except for a small part *CD* through which the light can enter. A layer of alkali metal, potassium or caesium, is distilled upon the silver surface, and the bulb is either evacuated or filled with an inert gas.

Fig. 8 shows the experimental circuit employed. The cell is connected in series with a battery *B* and a galvanometer *G*, the cathode of the photo-electric cell (that is the negative pole) being the alkali metal surface. When light enters into the cell through the window and falls on the alkali metal surface *B*, electrons are given off by the photo-electric action of the light and these are collected by the positively charged electrode *A*. A current is indicated by the galvanometer *G* and if the voltage of the battery *B* is adjusted to be sufficiently high

and the cell is a vacuum one, there will be a saturation current arrived at. This saturation current is found to be (within wide limits) proportional to the intensity of the light falling upon *B* and, for a given intensity, is greater the less the wavelength of the light producing the effect.

Such cells may be made still more sensitive by introducing a rare gas such as helium or argon into the tube, to a pressure of a few mms. of mercury. The electrons originally given off at the metal surface of *B* acquire a velocity under the action of the electric field between *A* and *B* and collide with atoms of the rare gas in such a way as to frequently split the gas atom into two portions, one of which is an electron and the other the residue of the atom, a positive ion. These new electrons in their turn produce further electrons, so that very considerable magnification of the original current may be obtained in this way. The extent of the magnification depends upon the voltage of the battery *B* and is greater the higher the voltage. Indeed, at sufficiently high voltages, a visible glow discharge may pass through the cell. This, of course, must be avoided, and in any case the performance of the cell is unreliable and unsteady if the battery voltage is in the vicinity of this "sparking" or discharge value.

In a recent communication to the *Journ. Opt. Soc. Am.* (May, 1926, Vol. 12, No. 5, p. 521), Null, following a suggestion of

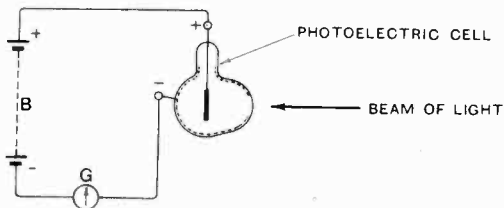

Fig. 8.

Tykociner and Kuntz, has described a method for the linear amplification of galvanometer deflections by the photo-electric cell, closely analogous to the thermo-relay method described above.

The image of the rectangular slit (no cylindrical lens is used) is projected upon a triangular slit which is placed before the window of the photo-electric cell (see Fig. 9) in such a way that an increased deflection

of the mirror of the first galvanometer brings about an increased illumination of the cathode of the cell, and a consequent increase of the photo-electric emission, resulting in an increase of the deflection of the second galvanometer.

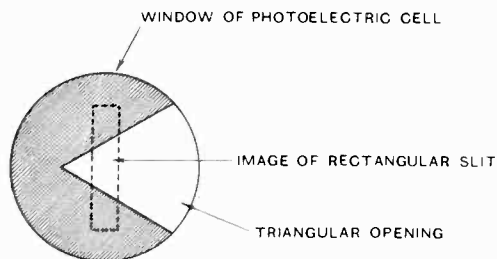

Fig. 9.

Null found, using one of the ordinary type of Kuntz cells, that a very accurate linear amplification was obtained. In his experiments only a weak beam of light was used (about 7×10^{-3} lumens), and the amplification was 1.85 mms. deflection of the second

galvanometer per minute of arc. He points out that by increasing the light intensity ten times and making the angle of the slit twice as large (it was $17^{\circ}15'$) and increasing the distance between the galvanometer and the photo-electric cell three times (distance was about 105 cms.) an amplification corresponding to 1.85 mm. deflection per second of arc of the first galvanometer could be obtained (60 times larger than the previous figure).

The amplification factor can, of course, be varied at will by altering the intensity of the light source or the angle of the slit.

The method has the advantage that there is no lag in the photo-electric cell, and no trouble is caused due to small temperature changes. Null points out that the method is applicable for the linear amplification of very short period instruments. Further, by amplification of the photo-electric cell current by means of a three-electrode valve he was able to amplify the movements of the syphon recorder used in ocean cable signal reception.

Abstracts and References.

Compiled by the Radio Research Board and reproduced by arrangement with the Department of Scientific and Industrial Research.

PROPAGATION OF WAVES.

WEITERE MITTEILUNGEN ÜBER DIE AUSBREITUNG VON KURZWELLEN (Further results on the propagation of short waves).—E. Quäck. (*Elektrische Nachrichten-Technik*, 4, 7, pp. 308-312, and *Zeitschr. für Hochfrequenz*, 30, 2, pp. 41-42.)

In an earlier paper (*Zeitschr. für Hochfrequenz*, 28, 6, p. 177; see Editorial *E.W. & W.E.*, May, 1927, p. 257) the author reported the occurrence of double signals during oscillographic reception of short waves at Geltow, when the time of arrival of the echo signal after the main signal permitted the conjecture that the echo signal had travelled in the opposite direction round the earth. The present paper gives the results of further observations at Geltow, when signals were not only received

The different paths believed to be taken by the waves in the case of a triple echo effect is shown diagrammatically.

The figure refers to the beam transmission from Rio de Janeiro, and it is remarkable that waves should take a path round the earth in the opposite direction to the direct signal, when the transmitter is not only directional but works with a reflector. The wavelength is 15.66 metres; the range in which double signals have been detected up to now is between 14 and 34 metres. While echo signals that have taken the opposite way round the earth are found in the daytime, it seems that those due to the waves completely encircling the earth chiefly occur when the great circle between transmitter and receiver lies in twilight. The energy the signals still possess after repeatedly encircling the earth is astonishing, and it is concluded that many more encirclings occur than have been observed.

For the practical application of short waves, however, ways and means must be found of eliminating the disturbances caused by the double signals, also their systematic observation will contribute to elucidating our views on short-wave propagation.

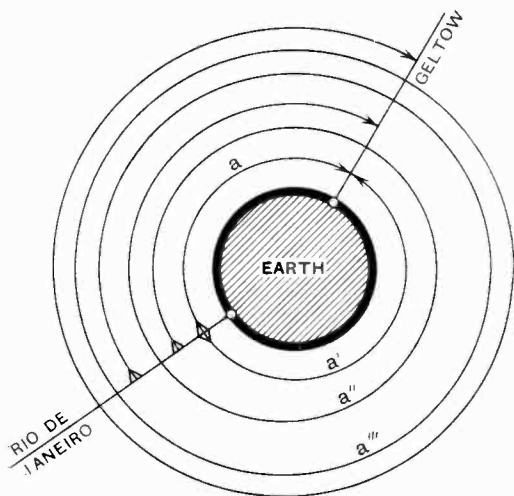

- Where *a* is the path taken by the direct signal,
- a'* the path taken by the signal travelling the opposite way round the earth,
- a''* the path taken by the signal travelling in the same direction as the direct ray, but journeying further once completely round the earth, and
- a'''* a similar path to this latter except that the waves encircle the earth twice before being recorded.

twice, but several times, the differences in the time of arrival of the additional echo signals (practically always about .137 sec.) corresponding to a journeying of the waves in the same sense as the direct signal, but further right round the earth, either once or a succession of times, before being recorded.

IONISATION IN THE UPPER ATMOSPHERE.—E. O. Hulburt. (*Nature*, 6th August, 1927, p. 187.)

Re-examination of the causes of ionisation in the upper atmosphere, owing to the more definite information about that ionisation recently obtained from experiments with wireless waves together with theories of their propagation over the surface of the earth.

Of the more important agencies which may conceivably cause the ionisation of the earth's upper atmosphere—namely, ultra-violet light and α and β particles of solar origin, the penetrating radiation of cosmic origin, and the ionising radiations from terrestrial sources, the sun's ultra-violet light is chosen as deserving first consideration, owing to the diurnal variation in the ionisation.

Calculation, however, assuming classical pressures for the constituent gases of the upper atmosphere, leads to results which are at variance with nighttime wireless data, and assuming greater than the classical pressures, still conflicts with Appleton's observations on 400 metres, which give an electron density of the order of 10^3 at about 100 km. for a June night (the calculation wiping out all nighttime ionisation below 130 km.). Like this, an irregularity in the pressure-height curve may be supposed showing a maximum at about 100 km., or an ozone layer may be assumed at this height, which disintegrates slowly to oxygen during the night, thereby maintaining the ionisation; or again, such hypotheses may be discarded and, assuming classical pressures, the existence of other agencies of ionisation considered, besides ultra-violet light which are effective by night as well as by day.

The author details the many possibilities that may have to be reckoned with before theory on the ionisation of the upper atmosphere is brought into satisfactory accord with the requirements of wireless experiment.

THE EXISTENCE OF MORE THAN ONE IONISED LAYER IN THE UPPER ATMOSPHERE.—E. V. Appleton. (*Nature*, 3rd September, 1927, p. 330.)

Brief discussion of the results of many determinations of the equivalent height of the Kennelly-Heaviside layer, made at Peterborough, during systematic observation of wireless waves deviated by the upper atmosphere; for the past year and a half.

The results in question are that while the early summer observations of 1926 showed the nighttime height of the deviating layer, for wavelengths of 400 metres, to be usually 90-130 km., those made during the period, October, 1926, to May, 1927, gave heights of an entirely different order of magnitude—namely, 250-350 km.—for the three hours before dawn. The evidence indicates that at these hours the ionisation in the Kennelly-Heaviside layer is sufficiently reduced by recombination to permit of its penetration by waves of this frequency, reflection taking place, however, at an upper layer which is richer in ionisation. With the advent of sunrise at a height of 100 km. or so, the Kennelly-Heaviside layer is formed again and deviation by the lower layer is suddenly re-established. As the day proceeds, the experimental results further suggest that another region of ionisation is formed below the Kennelly-Heaviside layer, which, while causing attenuation of the waves, does not very materially affect the height at which they are deviated.

DISCUSSION ON LONG DISTANCE RECEIVING MEASUREMENTS AT THE BUREAU OF STANDARDS IN 1925 (L. W. Austin).—G. W. Pickard. (*Proc. Inst. Radio Engineers*, 15, 6, June, 1927, pp. 539-540.)

The remarks refer to Mr. Sreenivasan's discussion of Dr. Austin's paper in the Proceedings for last February, and raise the question whether 1926 was not an exception to the general rule, apparently showing, for distant long-wave stations, an inverse instead of a direct relation between sunspots and day reception.

ATMOSPHERIC OZONE AND SOLAR VARIABILITY.—H. Clayton. (*Nature*, 30th July, 1927, p. 153.)

A brief survey of the correlation that has been found between solar changes and terrestrial phenomena, including the amount of ozone in the earth's atmosphere and variation of radio reception.

ZUR FORTPFLANZUNG ELEKTROMAGNETISCHER WELLEN LANGS LEITERN (On the propagation of electro-magnetic waves along conductors).—E. Roessler. (*Elektr. Nachr.-Technik*, 7, 4, pp. 281-295.)

By increasing the ratio of wavelength to the distance apart of double leads (two wires or earth and wire), the telegraph equation eventually loses its validity since radiation comes in. Mathematical treatment of the borderline region between

conduction and radiation presents considerable difficulty, also its investigation experimentally is not easy. The importance of this region, however, has increased enormously with the employment of short waves. For instance, if the wavelength of a perpendicular antenna be diminished by exciting it in ever higher harmonics, the radiation will lose more and more in significance and the conduction of energy along the wire play the chief part. A limiting value must eventually be approached which has been theoretically calculated by Sommerfeld (*Wied. Ann.* 67, 233, 1899). However in all mathematical treatment of the subject hitherto, the conductors have been considered infinitely long. It is here shown that this assumption cannot be fulfilled in practice and that the values found experimentally differ considerably from the theoretical ones. The divergence can be already demonstrated with Lecher wires or high tension leads of ordinary dimensions. With right definition, however, the concepts of the telegraph equation can be generalised as is illustrated by reference to an antenna.

DU MILIEU ÉTHÉRÉ (On the ether medium).—L. Garrigue. (*Q.S.T. Français et Radio Electricité Réunis*, June, 1927, pp. 22-23.)

Philosophical discussion resulting in the conclusion that the earth is enveloped by two kinds of ethereal waves: waves rolling in from outer space which push the earth towards the sun, and waves emanating from the earth itself which drive back the previous waves to the upper atmosphere. The author states that it is in this struggle, where one of the combatants has energies that are variable in time and space, that we shall find the explanation of the regular propagation of the Hertzian wave from our transmitting stations and also of its irregularities such as fading. It is also stated that the reason why our wireless waves travel better by night than day is because at night they are not broken by the Hertzian waves from the sun. A further contribution is promised.

ATMOSPHERIC ELECTRICITY.

EXTRACT FROM THE ANNUAL REPORT OF THE DIRECTOR (L. A. BAUER) OF THE DEPARTMENT OF TERRESTRIAL MAGNETISM, CARNEGIE INSTITUTION OF WASHINGTON, FOR THE YEAR 1925-1926.—(*Journ. Franklin Institute*, July, 1927, p. 139.)

"While, on the average, there is a very high correlation from year to year during the 11-year solar cycle between sun-spottedness and the earth's magnetic disturbances, the correlation does not seem to be indicative of immediate cause and corresponding effect, but rather that sunspots, solar prominences, etc., and magnetic storms are all effects of one, as yet undiscovered, cause which may simultaneously affect the condition of the entire sun. However, there is another type of disturbance shown by fluctuations in the earth's magnetism, earth-currents, atmospheric electricity, and polar lights, revealing a double periodicity in the course of the year, which has not yet been satisfactorily explained by changing sun-spottedness or changing efficiency of a given sun-spot area

during the year. We are dealing here with effects resulting from the annual motion of the earth around the sun. It may turn out that because of the fact that the earth acts like a great magnet and behaves like a great electroscope, we have brought to us daily on the strips of paper wound around the recording drums of magnetographs and of electrographs, photographic evidences of solar and cosmical changes which other means fail to reveal to us in their entirety. And judging from reports received during the present period of marked increased solar activity, radio-reception measurements may effectively supplement the magnetic and the electrical data."

POTENTIALS DURING THE SOLAR ECLIPSE.—E. Owen and H. Jones. (*Nature*, 23rd July, 1927, p. 120.)

A diagram is shown giving the potentials recorded on 28th, 29th and 30th June, at a point 215 cm. above the ground. It is seen that during the eclipse there was a change from a positive to a negative potential, this change being probably due to the heavy rain which fell at the time.

PROPERTIES OF CIRCUITS.

A MATHEMATICAL STUDY OF RADIO-FREQUENCY AMPLIFICATION.—V. Smith. (*Proc. Inst. Radio Engineers*, 15, 6, June, 1927, pp. 525-536.)

There are two general methods of radio-frequency amplification, tuned and untuned. The latter is seldom used except in superheterodyne circuits in conjunction with one or more tuned units or a band pass filter to provide the selectivity. Theoretically, this untuned superheterodyne with a band pass filter is the best type possible. However, the voltage amplification of the untuned type of transformer is at present very unsatisfactory, as valve and winding capacities are exceedingly troublesome.

There are two methods of tuning in circuits. We may either tune the frequency to the circuits or the circuits to the frequency. The first is the superheterodyne method and the second is the common method of the neutrodyne and similar circuits.

It is this latter type that the mathematical discussion given here particularly concerns. Throughout a steady state is assumed, leaving transients for further consideration. This assumption permits the application of the ordinary vector methods of alternating current theory.

MEASUREMENTS OF RADIO-FREQUENCY AMPLIFICATION.—S. Harris. (*Proc. Inst. Radio Engineers*, 15, 7, July, 1927, pp. 641-648.)

Description of a method of measuring high-frequency amplification, applying accurately only to non-regenerative receivers. The method has the advantages that the measurements are independent of the values of the input and output voltages and do not require the removal of the stage in question from the receiver, being made under actual operating conditions. The same arrangement can be used for studying the gain-per-stage, the over-all characteristics of a receiver and valve detection coefficients.

GRID SIGNAL CHARACTERISTICS AND OTHER AIDS TO THE NUMERICAL SOLUTION OF GRID RECTIFICATION PROBLEMS. Part II.—W. Barclay. (*E.W. & W.E.*, September, 1927, pp. 552-558.)

L'AMPLIFICATION BASSE FRÉQUENCE À IMPÉDANCE (Low frequency impedance amplification).—P. Olinet. (*Q.S.T. Français et Radio Electricité Réunion*, June, 1927, pp. 29-34.)

Mathematical study of a system connected by impedance, comparing it with a resistance-connected arrangement. The characteristics of the resistance circuit arrangement are high plate tension, absolute purity and low amplification. In the case of impedance it is found, on the contrary, that the system operates with normal tension, that of the battery being wholly applied to the plate, while the amplification is of the same order of magnitude as with resistance. While the purity is less than with the resistance system, it remains excellent if care is taken to keep far from the saturation point of the iron core.

HYSTERESIS IN VACUUM TUBE OSCILLATORS.—L. S. Taylor. (*Journ. Franklin Institute*, August, 1927, pp. 227-230.)

The paper deals with a further investigation of the groups of low-frequency oscillations produced when a condenser and resistance are placed in the grid circuit of a triode oscillator. These groups of oscillations are called by the author "zules." An empirical formula for their frequency and a theoretical study of their production are given in a previous paper by the author (*Journ. Frank. Inst.* 203, 351, 1927). The theory is experimentally checked here by means of observations with a cathode-ray oscillograph with a linear time axis. The envelope of the grid potential variations over the "zules" and the hysteresis action taking place through the depression of grid potential are indicated by various diagrams.

THE VACUUM TUBE OSCILLATOR.—D. Bourgin. (*Physical Review*, 29, 6, p. 912, June, 1927.)

Abstract of a paper presented at the Washington meeting of the American Physical Society, April, 1927.

The functional dependence of total filament-emitted current on grid and plate voltages is formally approximated by

$$i_p + i_g = A \{ 1 - \exp. \{ - (E_p + \mu E_g)^2 \} \}$$

for $E_p + \mu E_g > 0$, where A is the saturation value of the current and the other symbols are standard notation. This relation is made the basis for the "second order" treatment of the Hartley oscillator. By applying Kirchhoff's laws to the equivalent network, three simultaneous differential equations of the third order are derived connecting the variable grid and plate voltages and currents, and the current in the oscillatory circuit.

A VALVE AMPLIFIER FOR IONISATION CURRENTS. C. E. Wynn-Williams. (*Proc. Cam. Phil. Soc.*, July, 1927, pp. 811-828.)

A method of using a valve for amplifying ionisation currents 100,000 times is described, the system of compensation being applicable to other valve circuits, resulting in a much steadier zero.

ON A GRAPHICAL SOLUTION OF AN ELECTRIC CIRCUIT CONTAINING VARIABLE CONSTANTS.—I. Yamamoto. (*Journ. Inst. Elect. Eng., Japan*, No. 467, pp. 583-594.)

TRANSMISSION.

SOME PRACTICAL ASPECTS OF SHORT-WAVE OPERATION AT HIGH POWER.—H. E. Hallborg. (*Proc. Inst. Radio Engineers*, 15, 6, June, 1927, pp. 501-517.)

Propagation data over the frequency range of 3,000 to 30,000 kilocycles are submitted. A correlation is shown between wave frequency and angle of projection of the wave front, the effect of ionisation on the angle of projection is indicated, and some calculations are given of probable values of attenuation constant. The importance of frequency stabilisation is discussed and three typical circuits for utilising control crystals are described. Features of the design and adjustment of a 20kW power amplifier are outlined. Antenna and antenna feed systems are discussed and graphical results of comparisons of various antenna types are given.

RECEPTION.

L'AMPLIFICATION SANS LAMPE (Amplification without a valve).—F. Michaud. (*Q.S.T. Français et Radio Electricité Réunis*, June, 1927, pp. 9-15.)

Discussion of a new method of amplification utilising mechanical energy.

SPEECH CHARACTERISTICS.—G. G. F. Dutton. (*Wireless World*, 3rd August, 1927, pp. 143-144.)

Discussion of transients and their relation to good articulation in telephony.

VALVES AND THERMIONICS.

THE PERFORMANCE OF REFLEXED VALVES.—D. Kingsbury. (*E.W. & W.E.*, September, 1927, pp. 547-551.)

TRANSMITTING VALVES FOR ULTRA-SHORT WAVES. (*Wireless World*, 10th August, 1927, pp. 180-183.)

The characteristics of the American valve UX-852 are given, with suitable circuits for 5, 15 and 80 metres.

LES LAMPES DE PUISSANCE (Power valves). (*Q.S.T. Français et Radio Electricité Réunis*, June, 1927, pp. 27-28.)

It is shown that a good output valve must be able to carry satisfactorily a large negative grid tension and that the inclination of its characteristic to the horizontal must be considerable. The data are given of the new type of valve Philips B403 which answers to these requirements.

SPACE CHARGE AS A CAUSE OF NEGATIVE RESISTANCE IN A TRIODE.—L. Tonks. (*Physical Review*, 29, 6, p. 913, June, 1927.)

Abstract of a paper presented at the Washington meeting of the American Physical Society, April, 1927.

Oscillations occurring in a tuned circuit connected to grid and plate of a triode have been obtained by Gill when the grid potential was 40 volts and plate potential 8 volts. These were ascribed to unstable space charge in the tube. In the paper referred to here the mathematical theory for the case of plane parallel electrodes is first presented and later applied qualitatively to the case of cylindrical electrodes. The existence of a virtual cathode may cause negative resistance in both plate and grid circuit under emission limited operation, but for the case of space charge limited operation negative resistance is at most very small. The theory has a possible bearing on very short wave generation by the method of Barkhausen and Kurz.

THEORY OF THE SHOT EFFECT.—H. Wheeler. (*Physical Review*, 29, 6, p. 903, June, 1927.)

Abstract of a paper presented at the Washington meeting of the American Physical Society, April, 1927.

The shot effect, described by Schottky, is defined as the phenomenon of current fluctuations in a stream of electrons limited by random emission, as from a hot filament. Previous derivations of the magnitude of the shot effect have been based on equations deduced from the theory of probability. In the paper referred to here, a simple derivation of the equation $(I_0^2)_{\text{mean}} = eI_a/2RC$ (I_a = average space current), is given in terms of the familiar discharge current in a simple series circuit (R_1C_1L). This is followed by a Fourier integral derivation of the continuous frequency spectrum of the current fluctuations.

ELECTRON EMISSION AND DIFFUSION CONSTANTS FOR TUNGSTEN FILAMENTS CONTAINING VARIOUS OXIDES.—S. Dushman, D. Dennison and N. Reynolds. (*Physical Review*, 29, 6, p. 903, June, 1927.)

Abstract of a paper presented at the Washington meeting of the American Physical Society, April, 1927.

SURFACE LAYERS PRODUCED BY ACTIVATED NITROGEN.—C. Kenty and L. Turner. (*Physical Review*, 29, 6, p. 914, June, 1927.)

Abstract of a paper presented at the Washington meeting of the American Physical Society, April, 1927.

Among other results, it is found that active nitrogen causes a large reduction of the thermionic current from a tungsten filament.

O- and N-ENERGY LEVELS IN THE SECONDARY EMISSION OF HOT TUNGSTEN.—H. Kreff. (*Physical Review*, 29, 6, p. 908, June, 1927.)

Abstract of a paper presented at the Washington meeting of the American Physical Society, April, 1927.

MEASUREMENTS AND STANDARDS.

ON THE CONTROL OF THE FREQUENCY OF FLASHING OF A NEON TUBE BY A MAINTAINED MECHANICAL VIBRATOR.—W. A. Leyshon. (*Philosophical Magazine*, August, 1927, pp. 305-324.)

Theoretical and experimental discussion showing

that the action of a tuning-fork in holding constant the frequency of flashing of a neon tube may be considered, to a first approximation, as being due to the introduction of a sinusoidal voltage of constant frequency and variable phase into the neon-tube circuit, this voltage being introduced electromagnetically into the circuit by the motion of the prongs of the fork, and the phase of this voltage adjusting itself so that the frequency of flashing is equal to the frequency of vibration of the fork. The theory is applicable to the case of vibrators maintained electrostatically, e.g., a piezo-electric crystal in parallel with the condenser. Also a similar theory would explain, to a first approximation, the control of frequency of a multi-vibrator circuit by an introduced sinusoidal voltage.

QUANTITATIVE DETERMINATION OF RADIO RECEIVER PERFORMANCE.—H. D. Oakley. (*Journ. Amer. Inst. Elect. Engineers*, 46, 6, pp. 568-572.)

Description of apparatus developed to overcome the difficulties encountered in making quantitative measurements on receivers as a whole. The overall characteristics of receivers are classified and the method of making tests explained, the results obtained being shown by means of curves.

HIGH FREQUENCY RESISTANCE.—A. G. Warren. (*E.W. & W.E.*, September, 1927, pp. 522-534.)

A CONSTANT FREQUENCY SOURCE AND ITS FREQUENCY MEASUREMENT.—S. Pack. (*E.W. & W.E.*, September, 1927, pp. 535-546.)

THE PIEZO-ELECTRIC RESONATOR.—Y. Watanabe. (*Journ. Inst. Elect. Eng. Japan*, No. 466, pp. 506-528.)

From the properties of the motional admittance-circle diagram of the piezo-electric resonator, its electrical equivalent constants can be determined. In this paper the writer firstly deals with some new methods of measuring motional admittance that he has devised and then investigates the characteristics of the resonator for several special cases.

CHARACTERISTICS OF THE PIEZO-ELECTRIC COUPLER.—Y. Watanabe. (*Journ. Inst. Elect. Eng., Japan*, No. 466, pp. 529-537.)

The "coupler" consists of one piezo-electric resonator and two pairs of electrodes, one pair for vibrating the resonator, and the other for producing a potential difference across the secondary impedance connected between these electrodes. Such a coupler is used in a piezo-oscillator and this paper deals with its equivalent circuit, verifying by experiment the results obtained mathematically.

L'ETALONNAGE DES CIRCUITS INTERMÉDIAIRES DE MOYENNE FRÉQUENCE DANS LES POSTES À CHANGEMENT DE FRÉQUENCE (The calibration of intermediate circuits of medium frequency in receivers with change of frequency).—J. Quinet. (*Radio - Revue*, August, 1927, pp. 421-424.)

MESURE DES PERTES DANS LES ISOLANTS EN HAUTE ET MOYENNE FRÉQUENCE (Measurement of insulation losses at high and medium frequency).—J. Granier. (*Q.S.T. Français et Radio Electricité Réunis*, June, 1927, pp. 5-8.)

In an oscillatory circuit, resonance is the more distinct and amplification the greater, the smaller the damping; this latter arises in large part from the resistance of the coils, which increases with the frequency, but the quality of the condenser is not immaterial. This article outlines how its effect may be determined, numerical results being left for a later paper.

NOTE ON THE MEASUREMENT OF DIELECTRIC LOSSES AND PERMITTIVITY AT RADIO FREQUENCIES.—R. Wilmotte. (*E.W. & W.E.*, September, 1927, pp. 569-570.)

LA MESURE DES FAIBLES DÉPHASAGES AU PONT DE WHEATSTONE (Measurement of small phase displacements by means of the Wheatstone bridge).—J. Granier. (*Q.S.T. Français et Radio Electricité Réunis*, 37, pp. 79-82.)

SUBSIDIARY APPARATUS.

THE OSCILLOSCOPE: A STABILISED CATHODE-RAY OSCILLOGRAPH WITH LINEAR TIME-AXIS.—F. Bedell and H. Reich. (*Journ. Amer. Inst. Elect. Engineers*, 46, 6, pp. 563-567.)

Description of a method of using a cathode-ray oscillograph for the simultaneous observation of a number of variable quantities by means of a distributor. A linear time-axis, obtained by means of a gas-discharge lamp connected to a source of direct current through a resistance or valve, is stabilised by introducing into this circuit a small E.M.F. derived from the same source that supplies the unknown quantities under observation. The unknown quantities are thus shown in a form convenient for observation, appearing as stationary curves plotted with time as abscissa. The curves may be superposed about a common zero line, or displaced with reference to each other with separate zero lines.

A DEVICE TO DRAW CHARACTERISTIC CURVES OF VACUUM TUBES AUTOMATICALLY.—G. Campbell. (*Physical Review*, 29, 6, p. 913, June, 1927.)

Abstract of a paper presented at the Washington meeting of the American Physical Society, April, 1927.

Employing the usual circuit for obtaining characteristic curves, the grid-potential is varied continuously throughout the desired range by a modified W. G. Pye drum rheostat of the potentiometer type driven by a synchronous motor through speed reducing gears. A Leeds and Northrup recording pyrometer of the potentiometer type, connected across a standard resistance in the plate circuit, automatically draws the grid-potential plate current curve in rectangular co-ordinates.

SELECTIVE MORSE RECORDING.—G. C. Blake. (*Wireless World*, 17th and 24th August, pp. 213 and 251 respectively.)

Some further notes on the hot-wire microphone and audio-resonant selection (see *E.W. & W.E.*, August, 1927).

WIRELESS AUTO-ALARM DEVICES.—(*Electrical Review*, 26th August, 1927, pp. 362-364.)

Some details are given of new apparatus designed for the automatic reception of radio-telegraph signals from ships in distress at sea.

REMOTE INDICATING AERIAL AMMETER.—A. P. Castellain. (*Wireless World*, 10th August, 1927, pp. 162-164.)

Description of an instrument that does not increase aerial circuit resistance.

TRICKLE CHARGER FOR H.T. ACCUMULATORS.—N. Vincer-Minter. (*Wireless World*, 3rd August, 1927, pp. 147-149.)

RADIO BATTERY ELIMINATORS.—P. Tyers. (*Electrical Review*, 5th August, 1927, p. 217.)

Some observations on the identification of suitable types, and the reasons that necessitate the exercise of care in their selection.

COMPARAISON DES DIVERS TYPES DE CONDENSATEURS VARIABLES (Comparison between the different types of variable condensers).—C. Reinewald. (*Q.S.T. Français et Radio Electricité Réunis*, 37, pp. 64-66.)

DIRECTIONAL WIRELESS.

ON THE WIRELESS BEAM OF SHORT ELECTRIC WAVES (VII.) (A new electric wave projector).—S. Uda. (*Journ. Inst. Elect. Eng., Japan*, No. 467, pp. 623-634.)

When several wave directors are arranged along a line at intervals equal to or greater than a quarter wavelength, the wave energy is transmitted chiefly along this line, the row of directors forming what is called a "wave canal." The projection of the sharpest beam is effected by combining a trigonal reflector with a wave canal. The directivity can be improved by increasing the number of director rods in the wave canal: for instance, with 27 directors the radiated power is confined almost to an angle of 5 degrees.

APPAREILS INDICATEURS DONNANT PAR LECTURE DIRECTE LA DIRECTION D'UNE ONDE (Indicating apparatus from which the direction of a wave can be read off directly).—H. Busignies. (*L'Onde Electrique*, 6, 67, July, 1927, pp. 277-303.)

Apparatus of the "Hertzian compass" type is stated to have very special application and must not be confused with the radiogoniometer. The purpose of the radiogoniometer is to take bearings, for which use it is simple and practical, and the Hertzian compass offers no advantage over it, but the radiogoniometer cannot guide aircraft rationally towards its destination, which is claimed for the Hertzian compass, when adjusted to the wave of the transmitter at the landing station.

This paper discusses in detail two forms of the compass, together with the sensitivity, errors, etc. The apparatus, however, while working perfectly on the ground, has not yet become sufficiently evolved for installation on aircraft, and is still undergoing development (*cf. Radio-Revue* of last March, these Abstracts *E.W. & W.E.*, June, p. 372).

WIRELESS BEACONS.—(*Electrician*, 26th August, 1927, p. 251.)

Particulars are given of the first wireless beacon station to be put into regular commission which is situated at Round Island in the Scilly Isles. The set has a power of 500 watts and is operated on a wavelength of 1,000 metres. The beacon transmitter was designed by the Marconi Co. to the specifications of Trinity House. Similar installations for the assistance of navigation are now under construction at various points around the English coast.

THE POSSIBILITIES OF DIRECTIONAL RADIO TRANSMISSION.—J. H. Dellinger. (*Journ. Franklin Institute*, August, 1927, pp. 239-243.)

Abstract of address given before the Franklin Institute, 3rd March, 1927.

Considering first the limitations of directional radio, the author is of the opinion that the directing of radio waves in a very sharply defined beam, rendering individual communication possible, is never likely to be achieved. In the beam systems now utilised, the waves are not confined with extreme sharpness to the desired direction, and their chief advantage is an economic one rather than one of secret communication. The writer further says that the idea of transmission of substantial amounts of power to considerable distances by radio is ridiculous, also that picture telegraphy and television are not to be materially advanced by directional radio, all of which can best be carried on by the aid of conducting wires.

Coming now to the advantages, the writer allows that the remote control of distant objects, like machinery or ships, may be somewhat facilitated through the use of directional radio, but that this latter has attained its greatest success in the realm of navigational aids, and will unquestionably have a great future as an element in the safety of aviation.

GENERAL PHYSICAL ARTICLES.

ON THE WAVELENGTH OF THE GREEN AURORAL LINE IN THE OXYGEN SPECTRUM.—J. C. McLennan and J. H. McLeod. (*Proc. Royal Society*, A, 115, pp. 515-527, August, 1927.)

The spectrum of the aurora is characterised by two outstanding features: a set of bands and a strong narrow sharply-defined green line. As to the bands, several investigators have shown them to be identical with the so-called "negative" bands obtained with molecular nitrogen in the singly-ionised state. Nitrogen in this state must, therefore, be one of the main constituents of that portion of the upper atmosphere in which auroral displays occur. As to the line, while Prof. Vegard has put forward the view that it originates in solid nitrogen suspended in a state of fine division in the upper atmosphere, and excited in some way to luminescence, others have maintained that it is due to the presence of oxygen.

The purpose of the investigation described in this paper is to make a precise determination of the wavelength of the oxygen green line and compare the value obtained with Dr. Babcock's accurate determination of the wavelength of the auroral green line.

The two values are found to be in such remarkable agreement that the oxygen green line and the auroral green line are concluded to be identical.

The bearing of the result on the constitution of the upper atmosphere is that oxygen as well as nitrogen is present in the region where the auroral light is emitted.

DIE WELLENLÄNGE DER GRÜNEN NORDLICHTLINIE (The wavelength of the green auroral line).—G. Cario. (*Zeitschr. f. Physik*, 42, 1, pp. 15-21.)

The result of the author's measurement at Göttingen of the wavelength of the green line emitted by oxygen agrees so closely with Babcock's result for the auroral line that the identity of the two are regarded as established. The existence of oxygen in the upper atmosphere where the aurora originates, as well as nitrogen, appears therefore to be proved.

ZÜR FRAGE DES VORHANDENSEINS VON FESTEM STICKSTOFF IN DER ERDATMOSPHERE (On the question of the presence of solid nitrogen in the earth's atmosphere).—H. Pelzer. (*Annalen der Physik*, 83, 3, June, 1927, pp. 362-384.)

With reference to Vegard's hypothesis concerning the aurora, it is investigated mathematically whether the upper layers of the atmosphere, in radiation equilibrium with terrestrial and solar radiation, can have a temperature below the melting point of nitrogen (30°K). The conclusion reached is that this temperature (for the night side of the earth as well) could only be attained by making suppositions that could hardly prove true, and that therefore Vegard's hypothesis is to be rejected if only for thermo-dynamical reasons.

AN EFFECT OF SUNLIGHT ON THE ALTITUDE OF AURORA RAYS.—C. Strömer. (*Nature*, 3rd September, 1927, pp. 329-330.)

Facts are enumerated tending to show that sunlight has a remarkable action on the upper atmosphere, rendering the illumination caused by the electric rays forming the aurora borealis visible to much greater altitudes than ordinarily. To account for this, the author suggests it may be that the accumulated ionising effect of the sunlight and of the electric rays illuminates the atmosphere to a greater altitude than the electric rays alone, or perhaps also the ionisation lifts up the atmosphere by electric charge, as in Vegard's theory, or that such a lifting up may be the effect of a raising of the temperature in those regions.

THE SUN AS A RESEARCH LABORATORY.—G. E. Hale. (*Journ. Franklin Institute*, July, 1927, pp. 19-28.)

THE PHYSICAL FORM OF ETHER.—D. Meksyn. (*Philosophical Magazine*, August, 1927, pp. 272-300.)

THE PHYSICAL REALITY OF LIGHT QUANTA.—M. Planck. (*Journ. Franklin Institute*, July, 1927, pp. 13-18.)

THE INSTANTANEITY OF THE PHOTO-ELECTRIC EFFECT.—E. Lawrence. (*Physical Review*, 29, 6, p. 903, June, 1927.)

Abstract of a paper presented at the Washington meeting of the American Physical Society, April, 1927.

The paper referred to describes experiments which indicate that electrons start coming off a potassium surface the instant light falls on the surface and cease being emitted the moment the illumination is cut off, within a possible experimental error of 3×10^{-9} sec.

IONISATION BY COLLISIONS OF THE SECOND KIND IN MIXTURES OF HYDROGEN AND NITROGEN WITH THE RARE GASES.—G. Harnwell. (*Physical Review*, 29, 6, p. 906, June, 1927.)

Abstract of a paper presented at the Washington meeting of the American Physical Society, April, 1927.

INFLUENCE DE LA FRÉQUENCE SUR LES PERTES DANS LES ISOLANTS (Influence of the frequency on insulation losses).—J. Granier. (*Q.S.T. Français et Radio Electricité Réunis*, June, 1927, pp. 81-84.)

It is found that losses are chiefly of importance in insulators capable of absorbing moisture. The power lost is sensibly proportional to the frequency for all the waves employed in wireless telegraphy, but increases much less quickly than this at low frequency. The figures given in the tables that are reproduced can only show the order of magnitude, the properties of an insulator varying considerably from one specimen to another.

INSULATION AND SHORT WAVES.—C. Forbes-Buckingham. (*Electrician*, 12th August, 1927, pp. 192-193.)

Account of the search for an ideal insulator for radio equipment, discussing the difficulties in oscillation control due to the insulating material and the effect of loading ebonite.

INSULATORS AND INSULATION.—J. Strachan. (*Wireless World*, August, 1927, pp. 169-170.)

Discussion of materials suitable for use in wireless receivers.

MAXWELL'S THEORY OF THE LAYER DIELECTRIC. (*Journ. Amer. Inst. Elect. Engineers*, 46, 7, pp. 727-731.)

Discussion on Dr. Murnaghan's paper in *Journal A.I.E.E.* of last February, p. 109.

UNDAMPED EXTRA-SHORT ELECTROMAGNETIC WAVES OBTAINED WITH THE MAGNETRON.—K. Okabe. (*Journ. Inst. Elect. Eng., Japan*, No. 467, pp. 575-582.)

With the intensity of the magnetic field kept near its critical value and a high voltage applied to the anode, strong waves were obtained of length $\lambda_p = 2ct$, where c is the velocity of light and t the time required by the electrons to travel from cathode to anode. The length of the shortest wave obtained was 17 cm.

MAGNETIC PROPERTIES OF IRON IN HIGH FREQUENCY ALTERNATING CURRENT FIELDS.—J. Martin. (*Physical Review*, 29, 6, p. 906, June, 1927.)

Abstract of a paper presented at the Washington meeting of the American Physical Society, April, 1927.

A number of investigators have studied the losses due to eddy currents and hysteresis in iron when placed in high frequency alternating current fields, but the results obtained are in wide disagreement. Using a new method, the author has investigated the variation of this loss with frequency for several areas of cross section. He finds the loss to increase with frequency in the small samples and to decrease with frequency in the larger: at any particular frequency the loss is an inverse function of the area. This is due to the magnetic shielding effect of eddy currents in the large samples and the disagreement between previous investigations may thus be explained.

THE EFFECT OF WAVELENGTH ON THE DIFFERENCES IN THE LAGS OF THE FARADAY EFFECT BEHIND THE MAGNETIC FIELD FOR VARIOUS LIQUIDS.—F. Allison. (*Physical Review*, 30, 1, pp. 66-70, July, 1927.)

The method of the experiment affords a means of measuring the ratio of the speed of electric impulses along copper wires to the speed of light. The value obtained for the ratio was about 96 per cent.

MAXIMISATION METHODS FOR FUNCTIONS OF A COMPLEX VARIABLE.—W. van B. Roberts. (*Proc. Inst. Radio Engineers*, 15, 6, June, 1927, pp. 519-524.)

The maxima and minima of a function of a real variable are found by equating to zero the derivative of the function. In the case of a function of a complex variable, however, the derivative is a vector quantity, so that conditions may be imposed upon its direction as well as upon its magnitude. These various conditions lead to maxima and minima of the various aspects of the function. Rules are developed for setting up equations giving the various maximising conditions, and a simple example is given illustrative of the use of each rule.

A MECHANICAL SYNTHESIZER AND ANALYSER.—F. Kranz. (*Journ. Franklin Institute*, August, 1927, pp. 245-262.)

STATIONS: DESIGN AND OPERATION.

SHORT-WAVE COMMERCIAL LONG-DISTANCE COMMUNICATION.—H. E. Hallborg, L. A. Briggs and C. W. Hansell. (*Proc. Inst. Radio Eng.*, 15, 6, June, 1927, pp. 467-499.)

The development of short wave communication by the Radio Corporation of America is outlined, a summary of short wave installations, with call letters, wavelengths and services to which each installation is assigned, being given. Traffic charts showing the diurnal and seasonal characteristic of various wavelengths over typical circuits are shown. Technical problems inherent to the development of valves and transmitter circuits are discussed and methods for obtaining their proper operation at very short wavelengths described.

LES STATIONS DE BROADCASTING EUROPEENNES (European broadcasting stations).—Q.S.T. Français et Radio Electricité Réunis, June, 1927, pp. 85-86.)

A list of 218 broadcasting stations in all parts of Europe is given, classified in the order of increasing wavelength, beginning with Joenkoepping (201.3 m.) and ending with Koenigswusterhausen (4,000 m.).

LA STATION FRANÇAISE DE ZI-KA-WEI (The French station at Zi-Ka-Wei).—Q.S.T. Français et Radio Electricité Réunis, 37, pp. 59-63.)

Of the 20 stations on Chinese soil, 15 belong to China herself, while the remaining five are either French or American. After brief data concerning the Chinese stations, this article gives a detailed account of the French station at Zi-Ka-Wei, a small village 6 or 7 kilometres from Shanghai. The name Zi-Ka-Wei has become universally known owing to the part taken by its Observatory in the recent new determination of longitudes.

AMERICAN AIRCRAFT WIRELESS.—(*Wireless World*, 3rd August, 1927, pp. 139-140.)

Description of the apparatus on the "American Legion" transatlantic aeroplane, similar sets to which are being manufactured commercially for use on aeroplanes flying over the long-distance air-mail and other air routes in the United States.

AIRCRAFT RADIO EQUIPMENT.—(*Electrical Review*, 29th July, 1927, p. 198.)

Brief account of Marconi apparatus for use on transatlantic flight.

TRANSATLANTIC TELEPHONY.—(*Wireless World*, 31st August, 1927, pp. 274-275.)

Account of the two-way working on a single wavelength by means of speech-controlled relays.

MISCELLANEOUS.

REPORT OF COMMITTEE ON ELECTRICAL COMMUNICATION FOR THE PAST INSTITUTE YEAR.—H. P. Charlesworth. (*Journ. Amer. Inst. Elect. Engineers*, 46, 7, pp. 712-716.)

With regard to radio telegraphy, it is stated that long distance communication is rapidly changing from long waves generated by alternators or Poulsen arcs to short waves generated by valves. Within the last 18 months, transmitters up to 40kW. capacity operating on wavelengths of 30 to 15 metres, have been produced and put into service. These are replacing arc generators up to 500kW and alternators of 200kW capacity. Reliable continuous daylight communication has been obtained with wavelengths around 15 metres, notably between New York and Buenos Aires. During hours of darkness, wavelengths from 25 to 75 metres have been in use in both transatlantic and transpacific services. The greater reliability of the short waves is the result of almost complete immunity to summer static, also the new system is much more economical owing to the low power consumption compared with long wave transmission.

The report also contains brief paragraphs on transatlantic radio telephony, radio broadcasting, electrical transmission of pictures, and television.

WIRELESS BEAM STATIONS.—(*Electrician*, 2nd September, 1927, p. 287.)

On 25th August the announcement was made that the beam stations which have been built for the General Post Office by the Marconi Company at Grimsby and Skegness for communication with India have successfully passed their seven days' official test. The scheme to link up Great Britain with Canada, Australia, South Africa and India, by means of high-speed wireless telegraph services, decided upon by the Government in 1923, has thus been successfully completed.

It is further stated that before the end of next year there is every prospect of telephone subscribers in England being able to call up subscribers at any point in any of the Dominions by means of the beam system and that there is also the prospect of the transmission of written and printed matter, drawings and photographs.

GERMANY—RADIO TELEPHONY.—(*Electrical Review*, 12th August, 1927, p. 268.)

The first official attempt to speak by wireless telephone from Berlin to Buenos Aires, a distance of about 7,000 miles, was made during the evening of 3rd August. As there was no transmitter at Buenos Aires, speech passed in the outward direction only, and was uniformly good. The messages were spoken into a microphone at the Voxhaus, whence they were transmitted over land telephone lines to the Nauen wireless station, 20 miles north-west of Berlin, which radiated them by a special short-wave transmitter. The receiving station was at Villa Eliza, not far from Buenos Aires, the final stage being accomplished over the ordinary telephone lines. If the favourable results are fully confirmed, it is intended to institute a public service after proper equipment has been installed near Buenos Aires.

RUSSIA—LONG DISTANCE TELEPHONY.—(*Electrical Review*, 26th August, 1927, p. 350.)

The Mukden and Soviet authorities have concluded agreements for providing long-distance telephone services between Harbin and Chita and Harbin and Vladivostock. The total cost is estimated at \$1,500,000 which will be borne equally by the Russian and Mukden authorities.

With regard to broadcasting stations, it is reported in the *Review*, of 29th July, that there are now 56 in operation in Soviet Russia, of which five are in Leningrad and nine in Moscow.

LA TÉLÉPHONIE SANS FIL PAR ONDES LUMINEUSES. (Wireless telephony by luminous waves).—M. Chauvierre. (*Q.S.T. Français et Radio Electricité Réunion*, June, 1927, pp. 49-54.)

The last part of a serial article considering chiefly Ruhmer's experiments between 1902 and 1907.

TELEPHONE COMMUNICATION OVER POWER LINES BY HIGH FREQUENCY CURRENTS.—C. A. Boddie. (*Proc. Inst. Radio Engineers*, 15, 7, July, 1927, pp. 559-640.)

THE USE OF HIGH FREQUENCY CURRENTS FOR CONTROL.—C. A. Boddie. (*Journ. Amer. Inst. Elect. Engineers*, 46, 8, pp. 763-769.)

PRESENT STATUS OF THE INTERNATIONAL ELECTRICAL UNITS.—E. C. Crittenden. (*Journ. Amer. Inst. Elect. Engineers*, 46, 8, pp. 769-775.)

WIRELESS NOTES.—(*Electrician*, 26th August, 1927, p. 267.)

The Wireless Section of the U.S.A. Patent Office has doubled in size in the past six years. Applications for wireless patents number approximately 125 per month, as compared with about 60 per month in 1921.

Esperanto Section.

Abstracts of the Technical Articles in our last Issue.

Esperanto - Sekcio.

Resumoj de la Teknikaj Artikoloj en nia lasta Numero.

RICEVADO.

LA FUNKCIADO DE REFLEKSAJ VALVOJ. — D. Kingsbury.

La aŭtoro priskribas efekton, observitaj ĉe refleksitaj cirkvitoj, de maldolĉa kaj profunda tono, obtenita kiam la malaltfrekvencaj transformatoroj konektitaj estas krucigitaj, la efekto estante detektita egale per du transformatoroj de malsama tipo. La tiam diskutata efektojn de variado de anoda tensio kaj filamanta kurento, kaj sekvas la diversajn komponajn partojn de kurento kaj tensio necesigitaj en refleksa ricevado, kaj la

efektojn produktitajn per variado de ĉi tiuj tensioj.

La traktado provizas interesan analizon de refleksa funkciado, kaj la artikolo finiĝas per utilaj notoj pri utiligo de l'efekto priskribita en la alĝustigo de refleksa aparato.

DESEGNO KAJ KONSTRUO DE SUPERHETERODINA RICEVILO.

Mallonga noto korektanta eraron en Fig. 13 de l'artikolo de S-ro. P. K. Turner pri ĉi tiu temo en antaŭaj numeroj, kaj reproduktanta la korektitan figuron.

**KRAD-SIGNALAJ KARAKTERIZOJ KAJ ALIAJ HELPOJ
JE LA NUMERA SOLVO DE KRAD-REKTIFAJ
PROBLEMOJ.**—W. A. Barclay.

Daŭrigita el la antaŭa numero, en kiu la aŭtoro konsideris la derivon kaj utiligon de kurvoj (obtenitaj el la kradsignala karakterizo de valvoj), al kiu li donis la nomon de Kradsignalaĵaj Karakterizoj. En la nuna parto li traktas pri plisimplaj metodoj derivi ĉi tiujn kurvojn kaj montras metodon uzantan duon-logaritme liniumitan paperon, per kio T-forma kursoro estas aplikebla al la logaritmaj kurvoj por provizi rektan montron de la informo donita de la kradsignalaĵaj karakterizoj. Mallonga matematika pruvo de la metodo estas donita.

MEZUROJ KAJ NORMOJ.

ALTFREKVENCA REZISTECO.—A. G. Warren.

La aŭtoro unue konsideras la ekzemplon de indukta bobeno en altfrekvenca cirkvito, kaj la malfacilaĵojn je altfrekvencaj mezuradoj, kaŭze de (1) neaplikebleco de metodoj taŭgaj por malaltaj frekvencoj, kaj (2) la "malpureco" de la kvantoj mezurotaj. La efeto de distribuita kapacito estas diskutita kaj bone ilustrita per vektoroj de la kurento en diversaj partoj de la cirkvito.

La aŭtoro tiam traktas pri rezisteco de bobeno kaj pri l'efeto de alta frekvenco ĉe la rezisteco, kun aludo al la bone konata laborado de Howe kaj de Butterworth pri ĉi tiu temo. Diskutante praktikajn metodojn mezuri altfrekvenca rezisteco, oni esprimas preferon por kalorimetra metodo, per kio la kurento en la bobeno estas mezurebla, la varmeco produktita determinebla, kaj la rezisteco kalkulebla. Eraroj de kalorimetraj mezuroj estas diskutitaj, kaj la aŭtoro priskribas metodon kun la distingaj trajtoj, ke la komenco rapido de la temperatura altiĝo de diversaj partoj de la bobeno estas mezurita, tiel ebligante la eliminon de efektoj de variaĵoj de eksteraj termaj kondiĉoj, kaj la determinon de la rezisteco de diversaj partoj de la bobenoj. Oni donas detalojn pri kelkaj preparaj esploroj necesaj, kaj pri metodo determini la komencan rapidon de temperatura altiĝo. Tipaj eksperimentaj rezultoj estas montritaj kaj diskutitaj; kurvo aparte interesa montranta la distribuon de perdo en eksperimenta bobeno.

Plua etendo de la metodo de l'aŭtoro estas fine priskribita, ebligante facilan mezuron de la proporcio de alta je malalta frekvenca rezisteco.

**NOTO PRI LA MEZURADO DE DIELEKTRIKAJ PERDOJ
KAJ PERMESECO JE RADIO-FREKVENCOJ.**—
Raymond M. Wilnotte, B.A.

Oni montras, ke je ĉiuj mezuroj kun malgranda kapacitoj (de grandeco de 100 aŭ 200 μF) la korekto por randa efeto povas esti tiel granda kiel 5 procento, kaj la utiligo de ŝirmilo kaj garda ringo estas rekomendita. Pontaj aranĝoj por malaltaj frekvencoj estas montritaj por utiligo kun garda ringo, kaj altfrekvenca metodo estas ankaŭ priskribita, kun notoj pri la konstruado de la garda ringo, farado de mezuroj, k.t.p.

HELPA APARATO.

**KONSTANTA FREKVENCA FONTO KAJ ĜIA FREKVENCA
MEZURADO.**—S. W. C. Pack.

La fonto priskribita estas valve subtenita ton-forko, kaj en la unua parto de la artikolo la principoj

de la subtenado estas ripetitaj, inkluzive la utiligo de transformatoroj. La afero de konstanteco estas tiam pritraktita, la ĉefa faktoro de variado estante temperaturo, pro kio kaŭzo la muntita forko devus esti an ĉelo de konstanta temperaturo.

La aŭtoro tiam priskribas, kun ilustraĵo, la muntadon kaj enfermigon de forko de 128 cikloj, kun rimarkigoj pri la desegno de la funkcia valva cirkvito, alĝustigo de pozicio de la funkciiga bobeno, elekto de valvo, k.t.p.

Simpla traktado pri la teorio de la valve subtenita forko estas tiam donita, la traktado estante sugestita de Prof. E. Mallett kaj plivaste pritraktita de l'aŭtoro, kun notoj pri mekanikaj konsideroj, generita elektro-mova forto, movada impedanco, kalkulado de forkaj konstantoj, k.t.p.

La aŭtoro laste traktas pri metodo determini la frekvencon de la subtenitaj vibradoj, la metodo priskribita utiligante fonikan radan motoron. La konstruado de la fonika rado kaj ĝiaj funkciigaj bobenoj estas priskribita kaj ilustrita, kun diagramo de la kompleta cirkvito por subteni kaj determini la frekvencon.

ANĀ REKTIKATORO POR BATERIA ŜARGADO.—
C. O. Browne.

Detaloj estas donitaj de simpla silenta kaj nesparkanta instrumento uzante vibrantan anĉon kaj hidrangan tasan kontakton. La konstruado de la anĉo estas priskribita kaj ilustrita, kun notoj pri la alĝustigo, kaj diagramo de konektiloj por duononda rektifado, k.t.p. Sugestita aranĝo por plenonda rektifado estas ankaŭ montrita.

DIVERSAĴOJ.

RESUMOJ KAJ ALUDOJ.

Kompilata de la *Radio Research Board* (Radio-Esplorada Komitato), kaj publikigita laŭ aranĝo kun la Brita Registara Fako de Scienco kaj Industria Esplorado.

MATEMATIKO POR SENFADENAJ AMATOROJ.—F. M. Colebrook.

Daŭrigita el antaŭaj numeroj. La nuna parto daŭrigas la traktadon de la Diferenciala Kalkuluso, traktante pri diferencigo de la sumo de nombro da funkcioj, diferencigo de funkcio de funkcio, normaj formoj, sinsekva diferencigo, krizaj valoroj, k.t.p.

LIBRO-RECENZOJ.

Recenzoj estas donitaj pri la jenaj verkoj:—
Navigational Wireless (Navigada Senfadeno) de S. H. Long, D.Sc., M.I.E.E. (Eldonistoj, Chapman & Hall, Londono.)

Esperimental Radio (Eksperimenta Radio) de R. R. Ramsey. (Eldonistoj, University Book Stores, Bloomington, Ind., Usono.)

Erratum.

The third paragraph of the Abstract of the paper entitled "Gittergleichrichtung," appearing on page 573 of the September number of *E.W. & W.E.* should read:—

"The increase in grid tension necessary to raise the grid current e -fold (where e is the base of the Napierian logarithm) is called the temperature tension."

Some Recent Patents.

The following abstracts are prepared, with the permission of the Controller of H.M. Stationery Office, from Specifications obtainable at the Patent Office, 25, Southampton Buildings, London, W.C.2, price 1/- each

MULTI-STAGE VALVES.

(Application date, 24th February, 1926.
No. 271,558.)

Two sets of filament-grid-plate electrodes F, G, D are arranged side by side in the same bulb, and are held in position partly by wires S mounted as usual in the glass stub, and partly by wires S_1 depending from a glass pillar M . The lead-in wires to one set of electrodes are taken to the ordinary pins F_1, F_2, G_1, P_1 of a standard valve-mount as shown in Fig. 1, whilst the other set are taken to screw terminals mounted on the sides of the brass cap.

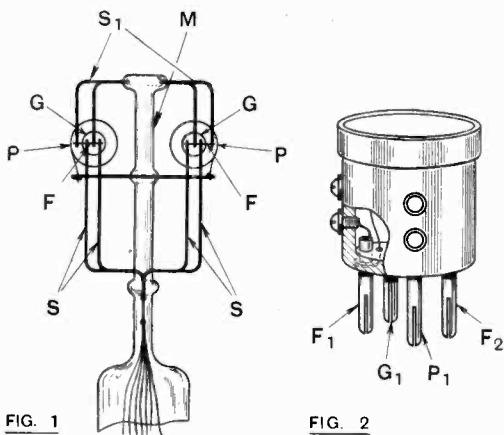

FIG. 1

FIG. 2

The latter set of terminals are duplicated in order to allow selected electrodes to be connected either in series or in parallel to the external circuits. Thus the filaments may be fed in series or in parallel as desired, the valve may be connected up either for push-pull or cascade amplification, and the grids may be used independently as in dual or reflex amplification. These and other external circuit variations can be rapidly and conveniently effected without removing the valve from its holder. Patent issued to T. W. Lowden.

PHOSPHORESCENT FILAMENTS.

(Convention date (Austria), 21st May, 1926.
No. 271,401.)

The inventor, A. Just, states that certain sulphides, particularly such as exhibit the property of phosphorescence, possess an electron-emission equal to that of the alkaline-earth coatings or the thoriated-tungsten filaments usually employed for the dull-emitter type of valve. The sulphides of zinc, calcium, strontium and barium, mixed with traces of heavy metal sulphides, are stated to be suitable.

A metal filament of platinum or platinum iridium is first coated with calcium containing traces of copper or bismuth, and the coating is then converted by any known sulphurising process. Or the sulphides may be first applied to the wire as a direct coating, and then fixed in position by heating to incandescence in an atmosphere of nitrogen.

DIRECTIVE SIGNALLING.

(Convention date (Japan), 29th December, 1925.
No. 263,755.)

Directional effects are secured by combining a main oscillator or transmitting aerial T with a system of reflecting conductors R and "directing" conductors D in the manner shown in plan in the figure. The reflectors R are tuned to a frequency equal to or less than that of the signalling frequency, whilst the "directors" D are tuned to a higher frequency than that of the radiated wave.

Under these circumstances the current induced by the oscillator T in the directors D "leads" the voltage, whilst in the case of the reflectors R the

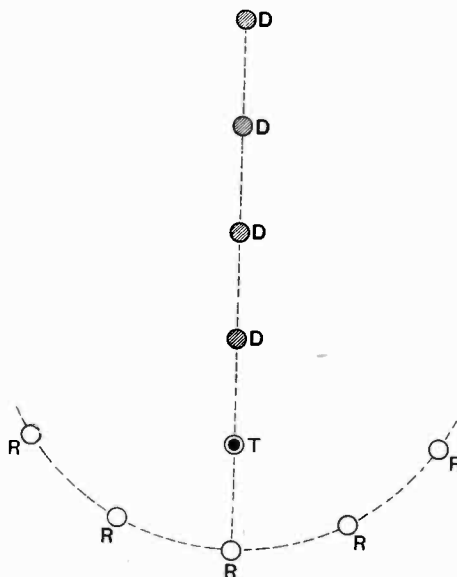

current "lags" behind the voltage. For this reason the Japanese inventor, Hidetsugu Yagi, states that the array of conductors R acts as a reflecting system, whilst the directors arranged along the line $D-D$ serve as a wave duct or channel "favouring" the passage of the wave. In this way a definite path of maximum radiation or reception is secured.

HIGH-ANGLE RADIATION.

(Convention date (U.S.A.), 9th May, 1925.
No. 251,946.)

In this patent the British Thomson-Houston Co., as assignees of E. F. W. Alexanderson, describe an aerial system which is designed to radiate energy at a high angle to the horizon, and with a

eighth the signal wavelength above ground. In Fig. 2 the wires are replaced by vertical loops, the sides of which contain series condensers calculated to neutralise the effective inductance of the wires. In both cases the radiators are energised centrally from a power source *O* through leads containing phase-adjusting means *P*, *P*₁.

By adjusting the phase-changing devices *P*, *P*₁,

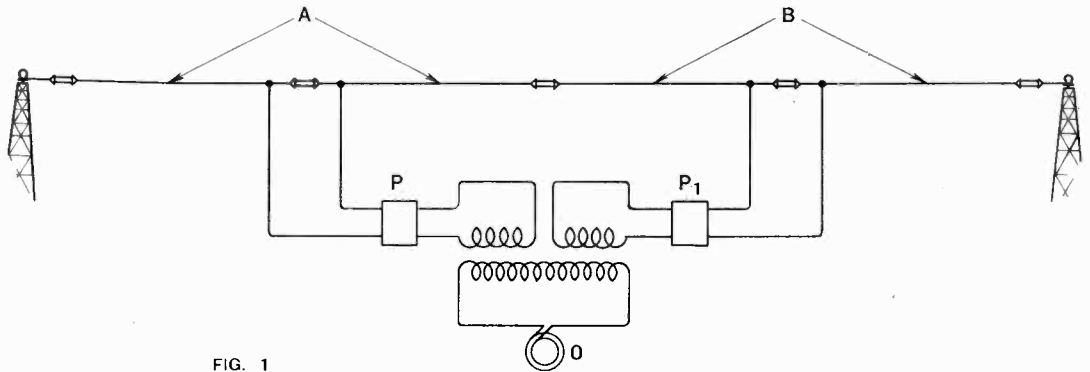

FIG. 1

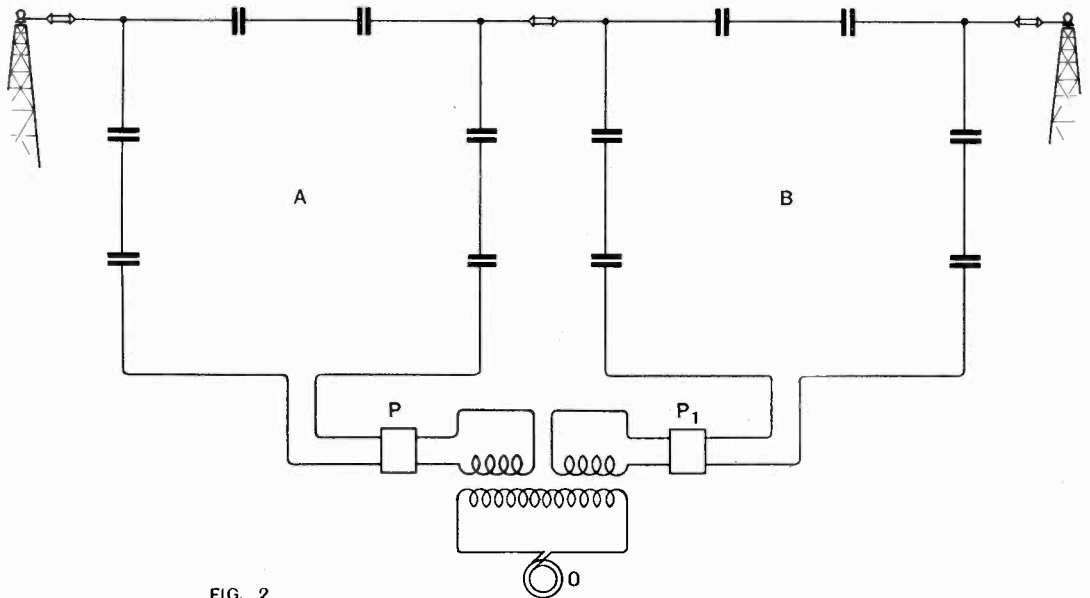

FIG. 2

substantial degree of horizontal polarisation, as distinct from the more usual type of vertically-polarised wave.

The simplest form of aerial is shown in Fig. 1, whilst an alternative arrangement is illustrated in Fig. 2. In Fig. 1 the radiators consist of two horizontal wires *AB*, spaced apart by half a wavelength and mounted at a height of at least one-

eighth the signal wavelength above ground. In Fig. 2 the wires are replaced by vertical loops, the sides of which contain series condensers calculated to neutralise the effective inductance of the wires. In both cases the radiators are energised centrally from a power source *O* through leads containing phase-adjusting means *P*, *P*₁. By adjusting the phase-changing devices *P*, *P*₁,

adjusted to flow clockwise simultaneously, all radiation from the vertical sides is neutralised and the system becomes equivalent to that of Fig. 1.

By using a "bank" of horizontal antennæ, the radiated beam is narrowed both in the horizontal and vertical directions.

AN ANTI-MICROPHONIC VALVE.

(Application date, 8th March, 1926. No. 271,584.)

Microphonic noise is frequently traced to the action of the springs used for tensioning the valve filament. In order to avoid this source of trouble,

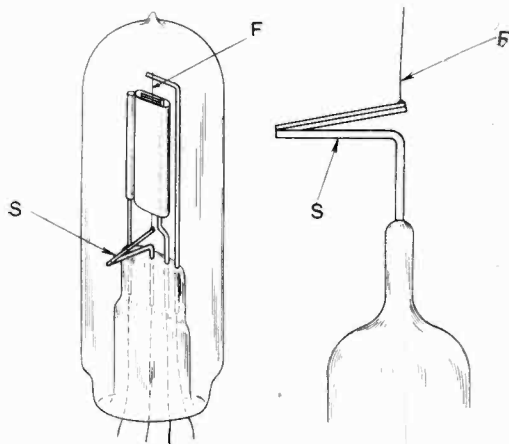

Mr. E. Y. Robinson utilises a bimetallic strip *S*, shown separately in the side figure, which is so arranged that it is heated to substantially the same temperature as, or proportionately to, the filament, and supports the latter so as to keep it straight without actually tensioning it.

The strip may be heated either by radiation from the filament or by passing current through it. As shown, it is connected between the lower end of the filament and the lead-in wire. As the filament *F* expands under heat, the upper end of the strip *S* curls downwards so as to take up the slack. In the case of a filament of the hair-pin type the compensating strip is hooked under the bight of the loop and is supported in a suitable mounting near the nib end of the valve.

WAVE AERIALS.

(Application date, 10th January, 1927. No. 272,117.)

Standard Telephones and Cables, Ltd., describe an aerial system comprising a series of vertical wires *a* each having a height corresponding to an odd integral multiple of half the signal wavelength. The vertical elements are spaced apart by half a wavelength, and are connected in series by horizontal conductors *b*, so that the currents and

voltages induced in each vertical are in phase with each other, but are in opposition to those in adjacent verticals, as shown by the arrows.

When the aerial system is in alignment with the direction of propagation of the signal wave, a directional effect is secured similar to that obtained in the case of the Beverage aerial, and depending upon the cumulative action of the induced "line" current and the external or ether-wave energy. Usually the line-wave velocity lags the space-wave velocity by an appreciable amount, and in order to avoid this limitation, the height of successive verticals may be gradually diminished to re-establish the desired phase-relation.

The receiver is coupled to the centre of the antenna line as shown, giving a bi-directional effect. The far ends may be free or grounded. In the former case the total length is an integral odd multiple of half a "wire" wavelength, whilst in the latter it is an integral even multiple. Alternatively a multiple-section antenna may be folded

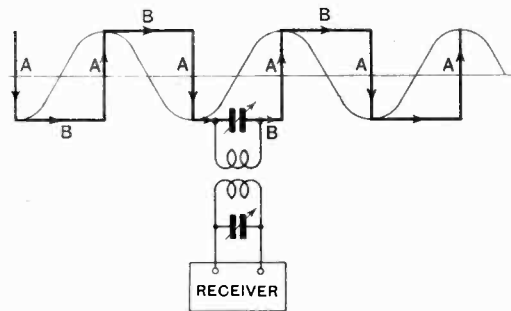

(a)

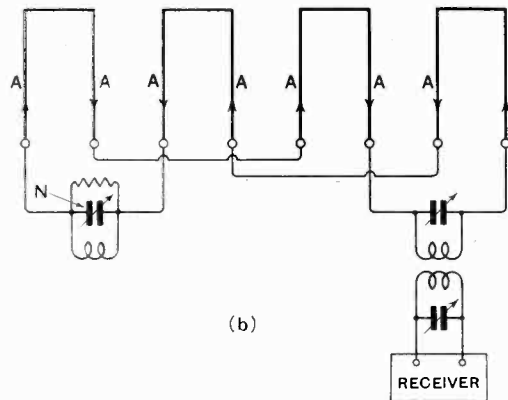

(b)

back on itself as shown in (b) thus avoiding the necessity of making any ground connection.

In this arrangement the system is non-directional, and the spacing of adjacent verticals is made an integral multiple of one-quarter the signal wavelength. The surge impedance network *N* absorbs end-reflection effects.

SAFETY DEVICE FOR VALVE SETS.

(Convention date (U.S.A.), 13th May, 1925.
No. 252,181.)

The resistance of a tungsten wire filament in an atmosphere of hydrogen is comparatively low at normal operating temperatures, but rises automatically to a high value when the filament current exceeds a certain critical value.

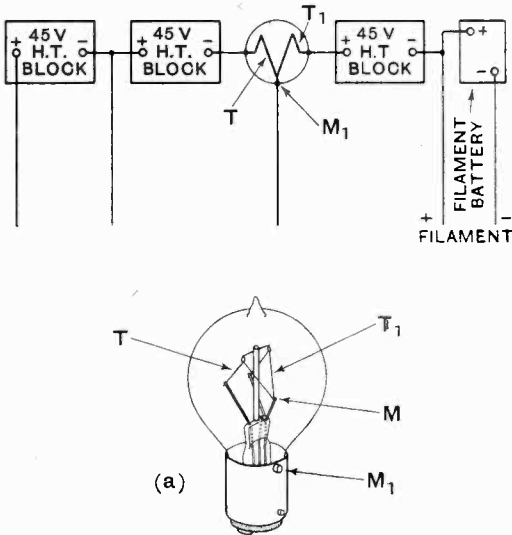

The British Thomson-Houston Co. utilises this property to provide a safeguard against damage due to accidental short-circuiting in a multivalue receiver. The safety lamp is inserted between two of the H.T. supply units, so that one-half T_1 of

The mid-point M of the filament is taken to an external terminal M_1 on the lamp holder as shown. In this way any dangerous rush of current is automatically prevented, and valve filaments and transformer windings are safeguarded. Incidentally the glowing of the tungsten wire gives a visible warning to disconnect the H.T. batteries before they are badly damaged.

PREVENTING FADING.

(Convention date (U.S.A.), 2nd January, 1926.
No. 263,876.)

As the result of observations it is found that short-wave signals will sometimes "fade" differently at points separated by no more than 500 feet. The effect is more pronounced with greater distances, and in the case of receiving aerials separated by several miles, it becomes quite common. In such cases it is noticed that the phase-relationship of the waves between the points in question will reverse several times a minute.

This affords a clue to the method now suggested by the Marconi Co. as a means of eliminating or minimising fading in short-wave signalling systems. In brief, it consists in combining the signals received on two or more separated aerials in such a way as to be independent of the signal phase in space. If, for instance, the phase relationship is maintained, then fortuitous reversals may give a "null" effect in the combined receiving circuit even if signal voltages do in fact exist in each of the separated aerials. On the other hand, by removing any fixed phase-relationship, signals will be heard in the common detector circuit so long as any signal voltage is being induced in either aerial.

The figure illustrates an arrangement in which a periodical phase reversal is introduced both at the transmitting and receiving ends. Of the two transmitting aerials T, T_1 , the first is coupled to the high-frequency source O in the ordinary way,

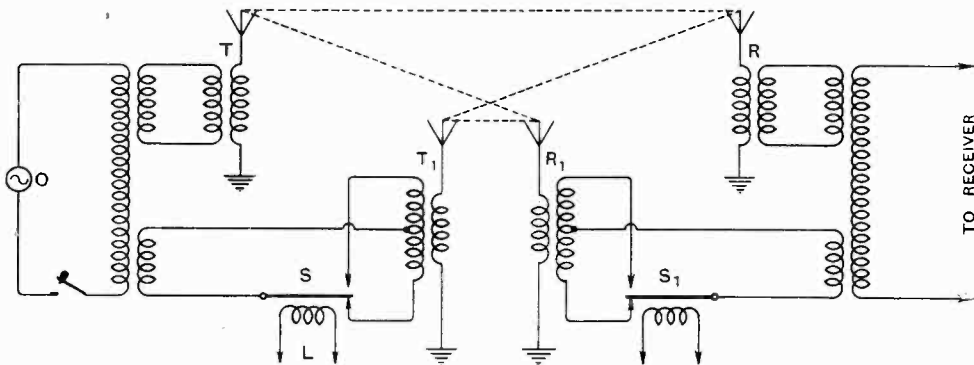

the tungsten filament is inserted between the 45° volt lead to the detector plate and the low tension supply, whilst the other half T lies between the 135-volt lead to the last amplifier and that carrying the detector plate voltage. A short-circuit between the 135-volt lead and the filament supply therefore includes both limbs T and T_1 of the safety filament in series.

whilst the second is connected through a tapped coil, the upper and lower segments of which are alternately brought into circuit by means of a switch S operated from a 60-cycle source. A similar switching arrangement S_1 is used in connection with the distant receiving aerials R, R_1 , both of which feed the common receiver circuit shown.

SMALL CAPACITY CONDENSERS.

(Application date, 27th January, 1926.
No. 271,920.)

Relates to small variable condensers of the type used for neutralising or balancing high-frequency amplifiers. The two interacting capacity elements are helical in form and are arranged to have a variable degree of overlap.

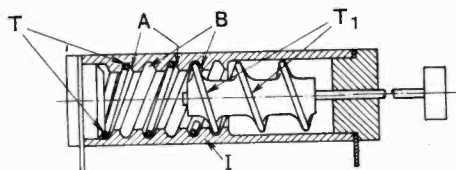

The first element *T* is a metal helix running from one end of an insulating tube or holder *I* in a set of spiral grooves *A*. The other element *T*₁ takes the form of a worm moving to and fro in a second set of parallel grooves *B*. Both the elements are substantially circular in cross-section. The tube *I* may have a screwed end-piece for mounting in a panel, or both ends may be pointed to fit into a clip-holder. Patent issued to B. Hesketh.

AERIAL COUPLING SYSTEMS.

(Application date, 27th February, 1926.
No. 271,577.)

The energy received upon one or more pairs of aerials *A*, *A*₁ and *B*, *B*₁ is rendered cumulative for each pair of intermediate feeders *W*₁, the currents in these being again combined vectorially

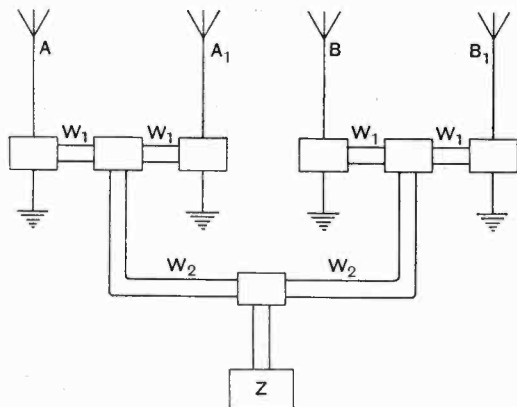

in feeders *W*₂, until finally collected in a terminal tank circuit *Z* which is connected across the input of the receiving set. The system is shown to be equivalent to a balanced three-wire circuit with the neutral wire removed. By this arrangement maximum transference of energy either from the

aerial to a receiver, or from a source of power to a transmitting system, is ensured, when the various impedances are suitably matched. Patent granted to G. A. Mathieu.

THERMIONIC-POWER GENERATORS.

(Application date, 5th March, 1926. No. 271,960.)

Thermionic generators of the water-cooled anode type, as used for high-powered transmission, are liable to be seriously damaged by any sudden rush of current due, for instance, to some disturbance in the power supply or oscillatory circuits.

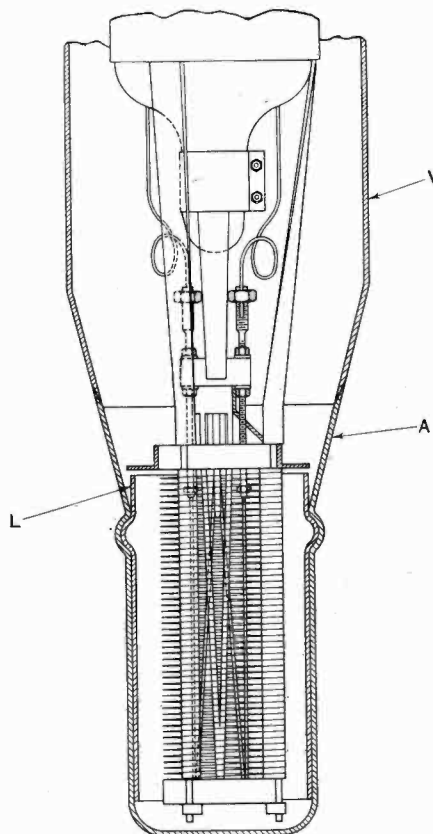

According to this invention, the Standard Telephones and Cables Co. provide a lining *L* of a refractory material such as molybdenum, to the metal anode *A*, which is sealed as usual to the vitreous bulb or envelope *V*. The molybdenum may be contiguous with the anode as shown, or may be separated from it by spacers, the intervening zone being evacuated. The lining serves to prevent the formation of local "hot spots" on the copper anode, which give rise to excessive production of vapour and consequent rupturing of the valve by arcing.

Your Choice

CAV

RADIO BATTERIES

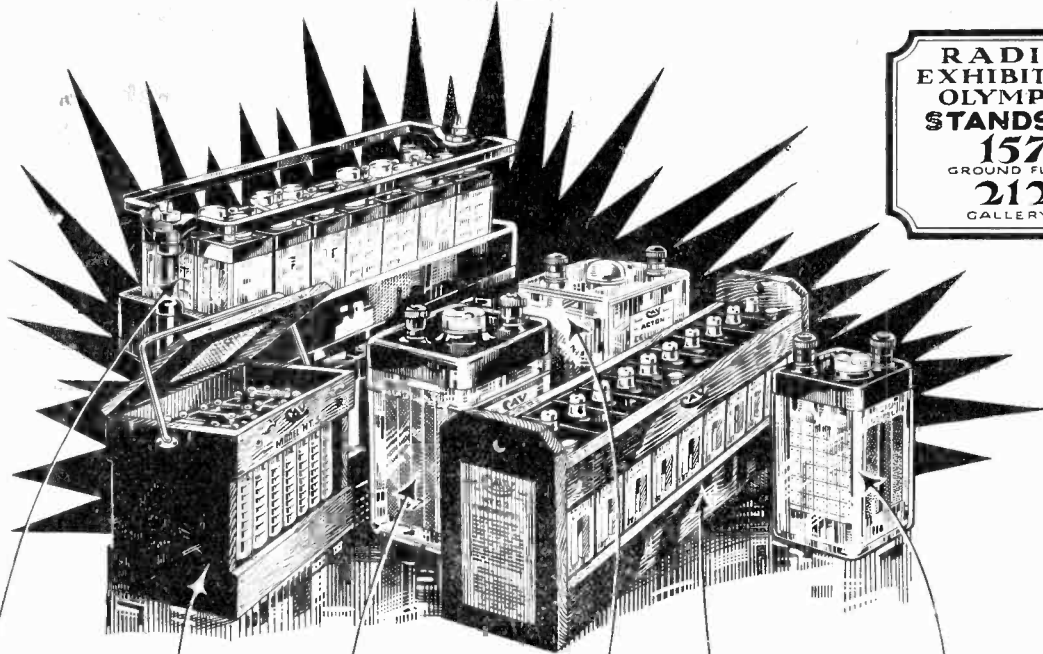

**RADIO-EXHIBITION
OLYMPIA
STANDS No 157
GROUND FLOOR
212
GALLERY**

THERE IS A TYPE FOR EVERY RADIO USER

60-volts. H.T.3. 2500 Milliamp hrs.
The original H.T. Accumulator of compact design. Every cell air spaced and embedded in hard wax. Tappings can be taken from any cell. Obtainable in 30, 60 and 90-volt units.
60-volt. Fully charged. £3 : 0 : 0

42-volts. H.T.18. 5000 Milliamp hrs.
A large capacity battery of sound constructional design. Suitable for large receiving sets, public address systems and small transmitters.
£3 : 17 : 6

ACTON CELLULOID.
Supplied in all capacities, this range of low tension batteries is offered at competitive prices, while the quality is in every way representative of our 36 years experience in battery manufacture.
2-volt. 30 amp. actual. 13/6

ACTON GLASS.
The "Acton Glass" low tension range provide an alternative to the celluloid cased battery, and is also suitable for tropical climates. All capacities supplied.
2-volt. 48 amp. actual. 16/-

A.G.M. MASS PLATE.
This 20 amp. 2 volt mass plate cell is ideal for Sets not taking more than 4 amperes. The charge can be spread over months without danger of sulphation.
Supplied dry charged 5/-

20 volts. H.T.G.2. 2500 Milliamp hrs.
The ideal High Tension supply for the average Broadcast Receiver. Any voltage obtained by coupling a suitable number of units. A 10-volt tapping point provided.
Supplied dry charged 15/-

FREE COPY OF BATTERY CHARGING INSTRUCTION BOOKLET SUPPLIED ON APPLICATION.

CAVandervell & Co., Ltd.
ACTON, LONDON, W. 3.

Depots at BELFAST, BIRMINGHAM, BRISTOL, COVENTRY, DUBLIN, GLASGOW, LEEDS, MANCHESTER & NEWCASTLE.
Service Agents throughout the Country.

Kindly mention "Experimental Wireless" when replying to advertisers.

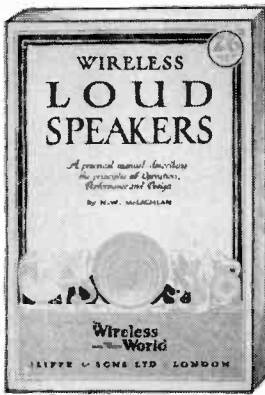

WIRELESS LOUD SPEAKERS

By *N. W. McLachlan, D.Sc.*

A PRACTICAL MANUAL DESCRIBING THE PRINCIPLES OF OPERATION, PERFORMANCE AND DESIGN

THIS Book describes the major principles of the design of modern loud speakers—chiefly of the large diaphragm type—and some associated circuits. It is clearly written and fully illustrated by numerous diagrams and photographic reproductions. A chapter showing how to construct a loud speaker will appeal to many experimenters.

A Résumé of the Contents :

General Acoustic Principles, Loudness of Reproduction and its Influence on Quality, Resonance causing Blurring of Complex Sounds, Principles and Description of Horn-type Loud Speakers, Lateral Motion of Air, Effect of Horn Length, Principles of large Diaphragm Shape, Cone Diaphragms, Reflectors, Room Resonances, Standing Waves, Acoustic Shadows, etc., etc.

From all Booksellers, or direct from :

ILIFFE & SONS LTD., Dorset House, Tudor Street, London, E.C.4

PRICE :

2/6

net

By post 2/8



SPECIAL STUDENTS' LIBRARY EDITION

FIFTY YEARS of ELECTRICITY

By *J. A. FLEMING, M.A., D.Sc., F.R.S.*

The Memories
of an Electrical Engineer

IN this volume the author places before the general reader a review of the chief triumphs of applied electricity during the last half-century.

Dr. Fleming's name gives to the book an authority which those interested in the subject will appreciate. The author has a word to say upon every phase of applied electricity, and besides giving a critical account of the activities of the past fifty years, he indicates the trend of present research and suggests the course of future progress and development. Every student should make a point of obtaining a copy of this new edition of what may be regarded as a classic of technical literature.

*Obtainable from all leading Booksellers
or direct from the Publishers :*

ILIFFE & SONS LTD., Dorset House, Tudor Street, London, E.C.4

Crown 4to
371 Pages
111 Plates
Cloth Bound

PRICE

15/-

Net.

By Post

15/9.

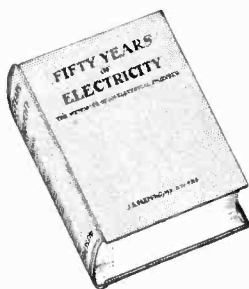

Kindly mention "Experimental Wireless" when replying to advertisers.

Set Builders! Buy

Utility

GUARANTEED
COMPONENTS

and Build Better Sets.

Up-to-date design, finest materials, and skilled workmanship have placed "Utility" Wireless Components in the front rank. Moreover, for your complete security—every one is guaranteed! You can buy none better at ANY price!

YOUR local Dealer can supply

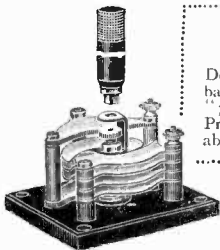

"UTILITY" NEUTRODYNE CONDENSERS

Designed to mount above or below baseboard. Ball-bearing spindle, no "play" no risk of misadjustment. Price, complete with detachable key ... each **5/-**

"UTILITY" MICRO-DIAL.

We illustrate a new easier-to-read model with aluminium dial and hair-line cursor. Reads clockwise or anti-clockwise.

Price. each **7/6**

Not intended to supersede last year's model.



"UTILITY" LOGARITHMIC CONDENSERS

Two light thimbles with walls only 1/32" thick have reduced the solid dielectric to the minimum. One hole fixing. Vernier pattern is fitted with our Micro-Dial.

Capacities .0002 to .0005.
Prices from **7/6**

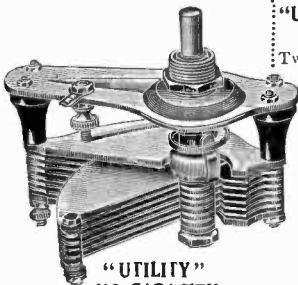

"UTILITY" NO-CAPACITY CHANGE-OVER SWITCH.

Compact, reliable, and electrostatic capacity reduced to the minimum. Contacts of the switches have a rubbing, self-cleaning action. Six sizes standardised, charging over 1, 2, 3, 4, 5 & 6 contacts respectively. Knob and Lever pattern from ... each **3/- & 3/6**

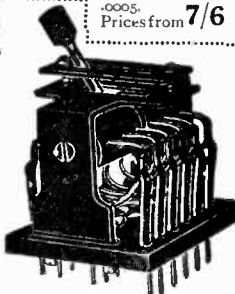

Write the makers for a complete list and if you have any difficulty in obtaining, order direct from

WILKINS & WRIGHT LTD
KENYON ST. *Utility* BIRMINGHAM

For Purity with Volume use this Dubilier R.C. Unit

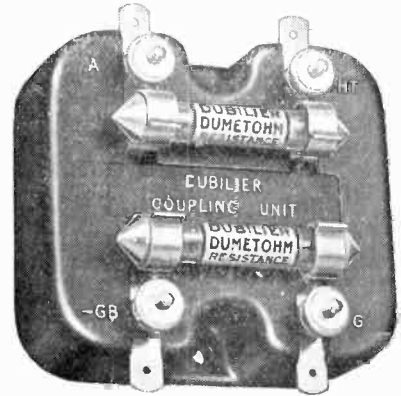

THE whole secret of distortionless L.F. Amplification lies in employing Resistances which maintain constant characteristics under varying conditions of temperature and load, in conjunction with valves of high amplification factor specially designed for R.C. Coupling.

The Dumetohms used in the Dubilier R.C. Unit not only have the required constancy in operation but they have no self-capacity and no self-inductance, the resistance elements consisting of a straight thin rod "of a metallic nature."

For the purest possible L.F. amplification use Dubilier R.C. Units employing Dumetohms of $3M\Omega$ in the Grid and $1M\Omega$ in the Anode and a valve such as the B.T.H. Co.'s B8.

You will find that amplification is perfectly uniform from below 50 up to 10,000 cycles.

But be sure your R.C. Unit is made by Dubilier.

Price 7/- Each



TC18
Advt. of the Dubilier Condenser Co. (1925), Ltd.,
Ducon Works, Victoria Road, North Acton, W.3.

Kindly mention "Experimental Wireless" when replying to advertisers.

Piezo Electric Quartz Crystals

Messrs. R. A. WEBER beg to advise all commercial Wireless Manufacturers and interested Radio Transmitters that they are now in a position to supply QUARTZ OSCILLATORS FROM STOCK. Any wavelength from 50 metres upwards by return, and EVERY CRYSTAL SUPPLIED GUARANTEED TO OSCILLATE WITHOUT REACTION.

Our electrical testing department is under the supervision of an A.M.I.E.E., who has carried out years of research work bearing on the Piezo Electric behaviour of Quartz, and apparatus is installed, whereby

WE CAN GUARANTEE TO WORK CRYSTALS TO A STATED WAVELENGTH WITHIN LIMITS OF ONE PART IN A THOUSAND.

We have supplied Crystals to some of the largest and best known Radio Manufacturers, and during the last three months alone have supplied considerably OVER 100 CRYSTALS TO VARIOUS GOVERNMENT DEPARTMENTS.

If required, Crystals can be supplied mounted complete, ready for use, in special dustproof holders.

PRICES FROM £3 EACH.

Full details and quotation for any wavelength on request.

We also specialise in *PRECISION QUARTZ RESONATORS*.
Details and Prices on application.

Four years' research work on Quartz Oscillators and Resonators, together with over 30 years' experience in the optical working of QUARTZ, places us in a position to meet your special needs.

R. A. WEBER, MANUFACTURING OPTICIANS and
QUARTZ CRYSTAL SPECIALISTS,
Works : 303, Hither Green Lane, LONDON S.E.13

Journal of Scientific Instruments

(Published on the 15th day of each month).

PRODUCED BY THE INSTITUTE OF PHYSICS, WITH THE CO-OPERATION OF THE NATIONAL PHYSICAL LABORATORY.

PRICE : SINGLE COPIES, 2s. 6d. ANNUAL SUBSCRIPTION, 30s. including Postage. Send subscriptions to the CAMBRIDGE UNIVERSITY PRESS, Fetter Lane, London, E.C.4.

CONTENTS OF AUGUST ISSUE.

ON THE USE OF THE ELECTROMAGNETIC RECEIVER IN ACOUSTICAL MEASUREMENTS. By T. S. LITTLE.

A VARIABLE BI-FILAR SUSPENSION FOR QUARTZ FILAMENTS. By W. H. DEARDEN.

A NOVEL HIGH-SPEED CAMERA. By E. B. WEDMORE. (Report received from the British Electrical and Allied Industries Research Association.)

NOTE ON THE SIMPLIFIED PRESENTATION OF STEREOGRAMS. By NOEL DEISCH.

THE VALVE FILAMENT AT CONSTANT VOLTAGE. By E. H. W. BANNER.

NEW INSTRUMENTS :

THE CAMBRIDGE MAGNETIC BRIDGE PERMEAMETER. BRITISH INSTRUMENT-MAKING LATHES.

LABORATORY AND WORKSHOP NOTES :
BLANKING THIN METAL. By THE TAYLOR-HOBSON RESEARCH LABORATORY.

AN IMPROVED BRIDGE KEY. By E. H. W. BANNER.

CONTEMPORARY PUBLICATIONS :
JOURNAL OF THE OPTICAL SOCIETY OF AMERICA AND REVIEW OF SCIENTIFIC INSTRUMENTS.

CORRESPONDENCE. REVIEWS.

This journal is devoted to the needs of workers in every branch of science and manufacture involving the necessity for accurate measurements. Its scope includes Physics and Chemistry, Optics and Surveying, Meteorology, Electrical and Mechanical Engineering, Physiology and Medicine.

Volume IV. commenced with the October number. This volume only will contain 15 parts and the Annual Subscription will be 37/6. Vols. I., II. and III. can be obtained complete, bound in cloth, for 35s. each.

BUYERS' GUIDE.

ACCUMULATORS.—Accumulators Elite, Bedford Street, Halifax. C. A. Vandervell & Co., Ltd., Acton, London, W.3

COILS.—Igranic Electric Co., Ltd., 149, Queen Victoria Street, E.C.

COIL HOLDERS.—Igranic Electric Co., Ltd., 149, Queen Victoria Street, E.C.

CONDENSERS.—Bowyer-Lowe Co., Ltd., Letchworth. Claude Lyons, Ltd., 76, Oldhall Street, Liverpool. Dubilier Condenser Co. (1925), Ltd., Ducon Works, Victoria Road, North Acton, W.3. L. Holzman, 109, Kingsway, W.C.2. Igranic Electric Co., Ltd., 149, Queen Victoria Street, E.C. Marconiphone Co., Ltd., 210, Tottenham Court Road, W.1. W. G. Pye & Co., "Granta Works," Montague Road, Cambridge. Wilkins & Wright, Ltd., Kenyon Street, Birmingham.

CRYSTALS.—Quartz Oscillators, Ltd., 1, Lechmere Road, London, N.W.2.

GALVANOMETERS (CAMBRIDGE UNIPIVOT).—Cambridge Instrument Co., Ltd., 45, Grosvenor Place, S.W.1.

GRID LEAKS.—Dubilier Condenser Co. (1925), Ltd., Ducon Works, Victoria Road, North Acton, W.3. Igranic Electric Co., Ltd., 149, Queen Victoria Street, E.C.

H.F. CHOKES.—Claude Lyons, Ltd., 76, Oldhall Street, Liverpool. R.I. & Varley, Ltd., 103, Kingsway, W.C.2.

MASTS.—J. & J. Laker Co., Beckenham, Kent.

MEASURING INSTRUMENTS.—F. C. Heyberd & Co., 9, Talbot Court, Eastcheap, E.C. Sifam Electrical Instrument Co., 10a, Page Street, Westminster, S.W.1. Weston Electrical Instrument Co., Ltd., 15, Great Saffron Hill, E.C.1.

PERIODICALS.—"Journal of Scientific Instruments," "Institute of Physics," 90, Great Russell Street, W.C.1.

PIEZO-ELECTRIC CRYSTALS.—Adam Hilger, Ltd., 24, Rochester Place, London, N.W.1. R. A. Weber, 303, Hither Green Lane, S.E.13.

RESISTANCES (ANODE).—R.I. & Varley, Ltd., 103, Kingsway, W.C.2.

RESISTANCES (FILAMENT).—Igranic Electric Co., Ltd., 149, Queen Victoria Street, E.C.

SUPERHETERODYNE COMPONENTS.—Bowyer-Lowe Co., Ltd., Letchworth.

SWITCHES.—Wilkins & Wright, Ltd., Kenyon Street, Birmingham.

TERMINALS (SPECIAL TYPE).—Igranic Electric Co., Ltd., 149, Queen Victoria Street, E.C. Pettigrew & Merriman (1925), Ltd., 2 & 4, Bucknall Street, New Oxford Street, W.C.1.

TRANSFORMERS.—Bowyer-Lowe Co., Ltd., Letchworth. Claude Lyons, Ltd., 76, Oldhall Street, Liverpool. Ferranti, Ltd., Hollingwood, Lancs. Igranic Electric Co., Ltd., 149, Queen Victoria Street, E.C. R.I. & Varley, Ltd., 103, Kingsway, W.C.2. W. G. Pye & Co., "Granta Works," Montague Road, Cambridge.

VALVES.—A. C. Cossor, Ltd., Highbury Grove, London, N.5. General Electric Co., Ltd., Kingsway, W.C. Marconiphone Co., Ltd., 210, Tottenham Court Road, W.1. Metro-Vick Supplies, Ltd., 145, 147, Charing Cross Road, W.C.1. The Mullard Wireless Service Co., Ltd., Mullard House, Denmark Street, London, W.C.2.

VOLTMETERS.—Cambridge Instrument Co., Ltd., 45, Grosvenor Place, S.W.1. Sifam Electrical Instrument Co., 10a, Page Street, Westminster, S.W.1.

WAVEMETERS.—Claude Lyons, Ltd., 76, Oldhall Street, Liverpool.

WAVE TRAPS.—Peto Scott Co., Ltd., 62, High Holborn, W.C.2.

Kindly mention "Experimental Wireless" when replying to advertisers.

*You must have a
precision instrument*

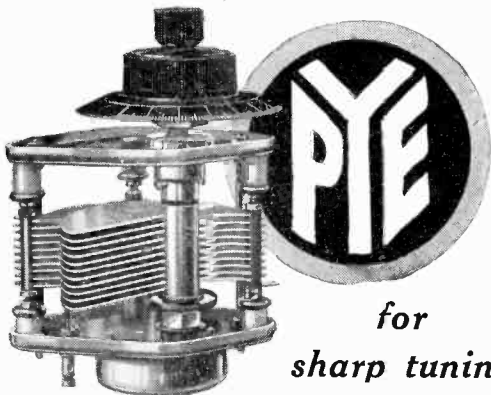

for
sharp tuning

Modern radio circuits call for critical tuning—critical tuning demands precision condensers—precision condensers mean Pye condensers for accuracy and reliability. Pye precision condensers are scientific instruments made one at a time with great care. You need them to get the best from your set.

PRICES—'0001, '0002, '0003 Mfd. **17/6** each.
'0005 Mfd. **18/6** "
'00075 Mfd. **22/6** "

At Olympia visit Stand No. 136.

W. G. PYE & Co..

"Granta Works," Montague Rd.,
CAMBRIDGE.



SEEN THESE NEW PRICES?

Just take a glance at them—they will interest you. Makes you wonder how a condenser that contains so many advantages can be made at such a price! Hydra Condensers operate at high voltages with no danger of breakdown, have high megohm resistance and low variation, and are neat, rigid and compact. Use Hydra Condensers in your set and your eliminator because they work in a background of dead silence, and are made by a firm who have been manufacturing condensers for 28 years.

REVISED PRICES:

Capacity.	Tested on 500 volts D.C.
'001 to '009 mfd.	1/6
'01 to '05 mfd.	1/9
'06 to '1 mfd.	1/9
'25 mfd.	2/-
'5 mfd.	2/3
1'0 mfd.	2/6
2'0 mfd.	3/6
3'0 mfd.	4/3
4'0 mfd.	5/3
5'0 mfd.	7/3
6'0 mfd.	8/3
8'0 mfd.	11/-
10'0 mfd.	14/-

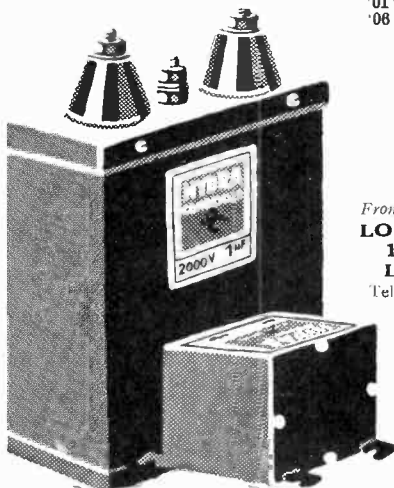

From all good dealers or direct:
LOUIS HOLZMAN
109, Kingsway
London, W.C.2
Telephone: Holborn 62c9

**BE SURE AND SEE
THE HYDRA
EXHIBIT
AT WHITELEY'S
EXHIBITION
OCT. 4th to 11th**

BE WARNED

in time!
TEST YOUR SET

SIFAM

RADIO METERS
Tell you everything
you should know
about your
set

**NEW
MODEL
POCKET VOLTMETER**

HIGH RESISTANCE
4,000 OHMS.

9/6



MODERN Radio demands more than the sensitiveness of the human ear to regulate the tonal quality of reception. Use Sifam Radio Meters, they have set a new standard of accuracy for controlling plate and filament current, which enormously improves the performance of any set. Trace distortion, avoid waste of expensive batteries and prevent sudden failures.

Ask your dealer to show you the complete range of instruments.

Dept. E.

SIFAM ELECTRICAL INSTRUMENT CO., LTD.
10a, Page Street, Westminster, London, S.W.1.

M.B. 17

A PRECISION INSTRUMENT

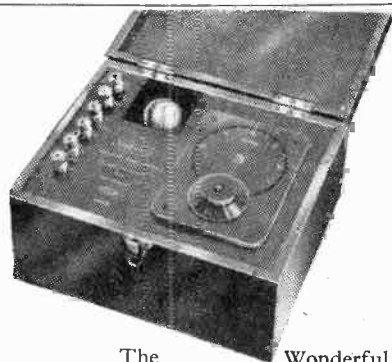

The Wonderful
EMERALD WAVEMETER

Patent Nos. 28566/25; 30172/25; 10326/26.

**A PRECISION INSTRUMENT OF LABORATORY STANDARD
DIRECT READING. NO CHARTS REQUIRED**
Every instrument calibrated against a Quartz Crystal specially tested by the N.P.L. Accurate to one-sixth of one per cent.

EXTREMELY versatile in its many applications, and undoubtedly the best wavemeter ever offered to the public, this splendid instrument should be in the hands of every radio enthusiast. A folder giving full details is available and will be sent free on application. Price **£11**. Can be obtained by easy payments if desired.

DON'T DELAY—WRITE TO-DAY.
PETO-SCOTT Co. Ltd., 77, City Road, LONDON, E.C.1

P.S. 9525

Kindly mention "Experimental Wireless" when replying to advertisers.

PREPAID PARAGRAPH ADVERTISEMENTS.

The charges for prepaid advertisements are as follows:—

AUCTIONEERS' & OFFICIAL ANNOUNCEMENTS.—Advertisements under this heading are inserted at a charge of 11s. per single column inch.

TRADE & MISCELLANEOUS.—2s. for 12 words and 2d. for each additional word.

PRIVATE SALE & EXCHANGE.—Advertisements are inserted in this section at the rate of One Penny per word; minimum charge per advertisement One Shilling. All advertisements, without exception, must be prepaid to ensure insertion. Single letters or figures are charged as words, and a compound word as two words. The advertiser's name and address are charged for.

"Box" replies, care of these offices, are charged 6d. extra to cover postages. The following words must appear at end of advertisement: "Box EXPERIMENTAL WIRELESS OFFICES," for which usual rate will be charged. (Advertisers need not include our full address.) When replying to a "Box No." advt., address your envelope: Advertiser, Box —, EXPERIMENTAL WIRELESS & WIRELESS ENGINEER, Dorset House, Tudor Street, London, E.C.4.

Advertisers who wish to separate their announcements into distinct paragraphs must have not less than 12 words in any one paragraph, followed by the word "Below"—which is charged for.

Remittances should be made by Postal Order or Stamps, and sent to the Advertisement Manager, EXPERIMENTAL WIRELESS & WIRELESS ENGINEER, Dorset House, Tudor Street, London, E.C.4.

ORDERS & CHEQUES should be made payable to ILIFFE & SONS, LTD., and crossed "and Co." Treasury Notes, being untraceable if lost in transit, should not be sent as remittances.

ALL ADVERTISEMENTS MUST BE PREPAID.

OUR DEPOSIT SYSTEM.

We will receive from intending purchasers the purchase money of any article advertised or sold by our advertisers, and will acknowledge its receipt to both the Depositor and the Vendor, whose full names and addresses must be given. Unless otherwise arranged beforehand between the parties, it is understood that all goods are sent on approval, and that each person pays carriage one way if the goods are returned. The deposit is retained by us until we are advised of the completion of the purchase, or of the articles having been returned and accepted. In addition to the amount of the deposit, a fee of 1s. for the sum of £1 and under, and 1s. 6d. for amounts in excess of £1 to cover postage, etc., must be remitted at the same time, and sent to the Advertisement Manager, EXPERIMENTAL WIRELESS & WIRELESS ENGINEER, Dorset House, Tudor Street, London, E.C.4. In cases of persons not resident within the United Kingdom, double fees are charged.

The fee should be sent in Stamps or by Postal Order as a separate amount.

The amount of the deposit must be sent either by Postal Order or Registered Letter. (Cheques cannot be accepted.)

In cases of exchanges, money to the value of the article should be deposited by each party. We cannot receive the articles themselves.

FOR SALE.

Teletrol for Remote Control. Simple to install. One wire only for any number of Loud Speakers. Indispensable for extension to sick rooms. Patented. Price 35/- with instructions.—Baily, Grundy & Barrett, Ltd., 2, St. Mary's Passage, Cambridge. [0143

PATENTS (EXPERIMENTAL WORK)

Patents and Trade Marks—British and Foreign—Gee & Co. (H. T. P. Gee, Member R.S.G.B. and A.M.I.R.E.).—51-52, Chancery Lane, London, W.C.2. Phone: Holborn 1525. [0139

Patents and Designs Acts, 1907 & 1919. The Proprietors of British Patent No. 227224 are prepared to sell the patent or to licence British Manufacturers to work thereunder. It relates to improvements in thermionic valves.—Address: B. W. & T., 112, Hatton Garden, London, E.C.1. [0144

THAT BOOK YOU WANT!

FOYLES can supply it. 1,250,000 Volumes (Second-hand and New) on all Technical subjects, Applied Science, and on every other conceivable subject in stock. It unable to call and examine the carefully classified departments, write for Technical and Applied Science Catalogue 627 (free), mentioning requirements and interests. Books sent on approval. **INSTALMENT PAYMENTS** can be arranged if desired (Gt. Britain only).

A SPECIAL OFFER
WIRELESS TELEGRAPHY AND TELEPHONY.
By ECCLES. A Handbook of Formulae, Data and Information likely to be helpful to designers and investigators in Radio-telegraphy. Also gives brief accounts of the position of modern thought and speculation. Pubd. at 18s. Offered, practically new, at 7/6. Postage 9d. Sent on approval. Quote Offer 627.

BOOKS PURCHASED

Foyles for Books

119-125, Charing Cross Road, London, W.C.2

FOR ECONOMY

Appleby's

THE CROFT, LONDON N.W.10

THE ORIGINATORS OF "SQUARE DEAL" PART EXCHANGE BY MAIL

"Known in Radio When Radio was hardly known."

Kindly mention "Experimental Wireless" when replying to advertisers.

LAKER STEEL MASTS

are 100% efficient—

They are made by engineers and supplied to H.M. Government, the B.B.C., and to Colonial and foreign stations throughout the world.

There are 50,000 "Laker" masts in daily use.

By mass production we are able to offer a wonderfully efficient and handsome steel mast at the extraordinarily low price of

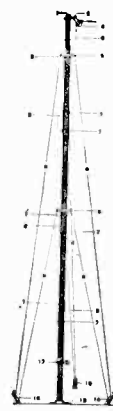

30ft. 22/6

Complete as Illustrated

Send 1/- extra for post carriage. We pay the rest Always bear in mind that an efficient aerial is the most important factor in good radio reception

J. & J. LAKER CO.

Engineers

BECKENHAM, KENT

THE ABC OF THE Super-Het **8d** (POST FREE)

88 pages, 17 designs, diagrams or large photographs, including complete schematic and point to point wiring charts of the best Superonic receiver (cheap to build) set designed. No guesswork—works well at once. Only book of its kind at present in existence. Described by "Wireless World" as "A fascinating booklet. A lucid description of the operation of the Super-Het."

CLAUDE LYONS (G.R. Quality Parts) (Dept. X.), 76, Oldhall St., Liverpool.

INDEX TO ADVERTISERS.

	PAGE
Accumulators "Elite"	6
Appleby	12
Bowyer-Lowe Co., Ltd.	2
Cambridge Instrument Co., Ltd.	6
Dubilier Condenser Co. (1925), Ltd.	9
Ferranti, Ltd.	Cover iv
Foyle	12
Holtzman, Louis	11
Igranic Electric Co., Ltd.	4
"Journal of Scientific Instruments"	10
Laker, J. & J., Co.	12
Lyons, Claude, Ltd.	Cover ii & 12
Mullard Wireless Service Co., Ltd., The	1
National Radio Exhibition	Cover iii
Peto-Scott Co. Ltd.	11
Pye, W. G. & Co.	11
R.I. & Varley, Ltd.	3
Sifam Electrical Instrument Co., The	11
Vandervell, C. A., & Co., Ltd.	7
Weber, R. A.	10
Weston Electrical Instrument Co., Ltd.	2
Wilkins & Wright, Ltd.	9

A Wireless message to you

The great Wireless opportunity of the year.

Will show you how to get 5G.B. on your set.

Wonderful B.B.C. Exhibit.

The latest developments in Wireless.

Sets for the Million or the Millionaire.

Every Stand packed with interest.

The Royal Air Force Band in attendance.

Dancing on specially prepared floor.

THE NATIONAL RADIO EXHIBITION

OLYMPIA

OLYMPIA NEW HALL

ADMISSION DAILY 1/6

SEPTEMBER 24th TO OCTOBER 1st

11 A.M. TO 10-30 P.M. (TUESDAY SEPT 27th UP TO 5 P.M. - 2/6)

DANCING

Kindly mention "Experimental Wireless" when replying to advertisers.

CHARGE YOUR L.T. BATTERIES OFF THE A.C. LIGHTING MAINS

By means of the

FERRANTI TRICKLE CHARGER

Incorporating the Westinghouse Patent Metal Rectifier.

55/-

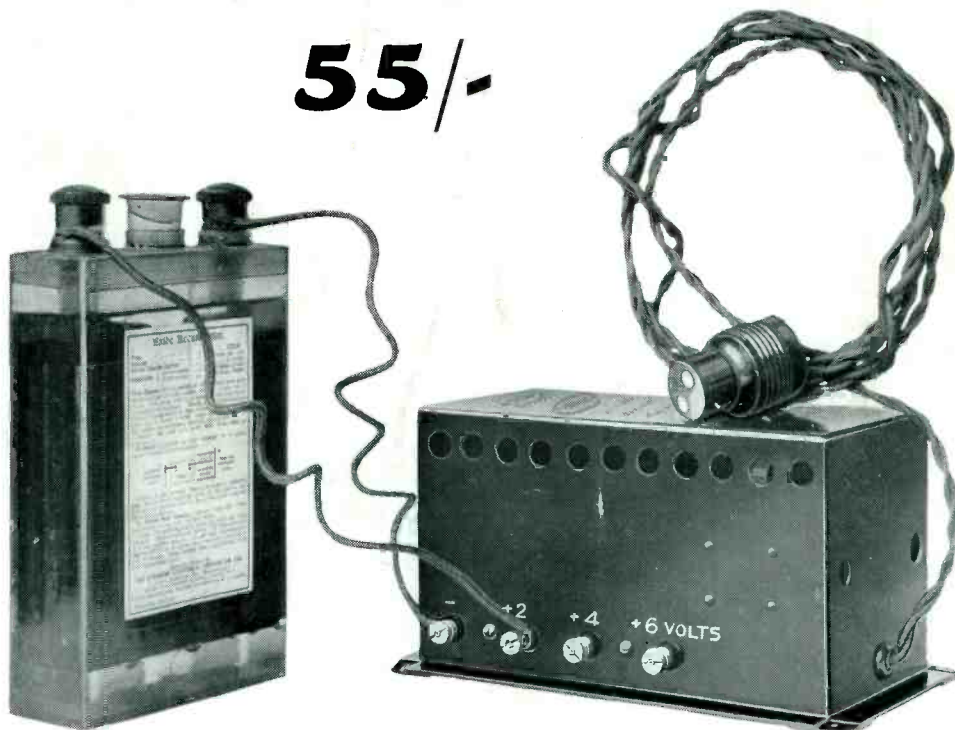

Insert the plug in any lamp holder and connect the Accumulator to the Terminals of the Trickle Charger as shown.

Terminals are provided for 2, 4 and 6 volts.

ASK YOUR DEALER ABOUT IT

FERRANTI ELECTRIC
LIMITED
Toronto, Canada

FERRANTI LTD.
Hollinwood, Lancashire

FERRANTI INC.
130, W. 42nd Street
New York, U.S.A.