

# EXPERIMENTAL WIRELESS & The WIRELESS ENGINEER

---

VOL. III.

DECEMBER, 1926.

No. 39.

---

## Editorial.

### The Inauguration of the Canadian Beam Service.

THE past month has been one of great interest and satisfaction to the British radio engineer. For many years we have lived under a cloud, for although it was in England that the first developments of radio took place and although the first signals to bridge the Atlantic were radiated from Cornwall, we seemed to have fallen behind in the large scale applications of this new means of communication. Germany had its Nauen, France its Sainte Assise, the United States their Rocky Point, while we had a succession of commissions and committees. This was the more humiliating because of the obvious applicability of this new means of communication to the special needs of our widely scattered Empire and also because of our previously unchallenged leadership in transoceanic communication due to the pioneer activities of our submarine cable engineers. Whether we have ultimately lost in any way by our policy—or rather by the effects of our lack of policy—is open to question. Development has been so rapid that, had an Imperial chain of stations been erected a few years ago when great pressure to this end was brought to bear on the Government, the stations would now be obsolete or rapidly becoming so.

The position is now entirely changed. With the erection of the Rugby Station we took our place among the countries able to

communicate with the farthest points on the earth's surface by means of high-power long waves. Whatever may have been said about the cost of the station—and we have heard it described by a leading foreign radio engineer as the most expensive station ever erected—no one has ever questioned its technical excellence. With the opening on 21st October of the short-wave beam service between this country and Canada, we have taken our place in the very front rank of the nations in the use of radio communication. The new system differs from the old in two respects, viz., in the shortness of the wavelength and in the use of a directed beam.

There has been some discussion as to whether the priority in the discovery of the wonderful ranges obtainable with wavelengths below 100 metres belongs to Senatore Marconi or to those enthusiastic amateur transmitters who were confined to such wavelengths to keep them out of mischief. Whatever views one may hold on this point, one cannot question the claim of the Marconi Company to have developed the beam system to a high stage of technical excellence. The stations have been erected by the Company for the Post Office under guarantees which everyone regarded as extremely stringent. The Canadian service was subjected to tests between 7th and 14th October and, we understand, more than fulfilled the guarantees. In this country the transmitting station is at Bodmin and the receiving station at North

Petherton near Bridgwater; in Canada the transmitting station is at Drummondville, 30 miles east of Montreal, and the receiving station at Yamachiche, 25 miles north of Drummondville. The English stations are operated by land line from the G.P.O. in London, whilst the Canadian stations are connected in the same way to the office of the Canadian Marconi Company in Montreal. For the Canadian service it was stipulated that communication at a speed of 500 letters per minute each way (excluding repetitions) should be possible during a daily average of 18 hours. During the seven days' test the average reached was 600 letters per minute, and for many hours it was possible to work at a speed of 1,250 letters per minute in each direction. If this can be maintained and, apart from occasional electrical storms of exceptional severity, we see no reason why it should not, it represents a great increase in our means of transatlantic communication. It is stated that the speed is limited at present by the permissible speed of signalling over the land-line connections at each end and by the mechanical limitations of the present transmitting and recording apparatus.

Improvements in these links in the chain will enable the overall speed to be increased.

It is too early yet to expect very detailed information as to the improvement due to the beam system as compared with non-

directed short-wave transmission, but it has been stated that the Canadian signals are about a hundred times as strong due to the use of the beam system. One will await with interest some data on the fading experienced with the Canadian service.

A number of other beam stations are nearing completion, those for South Africa being on the same sites as those for Canada. The stations for India and Australia are being erected on the east coast, viz., at Tetney near Grimsby and at Winthorpe near Skegness. These are all being erected for the Post Office as a part of the Imperial scheme. In addition to this, however, the Marconi Company are erecting a beam station at Dorchester for communicating with North and South America under the terms of a licence permitting them to conduct wireless telegraph services with certain Continental countries and with foreign countries outside Europe.

The most interesting experiment will be the Australian beam service; here the distance is nearly half-way round the globe and the probability of the directional system being superior to the non-directional decreases as one approaches the Antipodes. Our doubts on this point will soon be resolved, however, as we understand that the stations for this service are rapidly approaching completion.

# A New Method of obtaining Frequency Stabilisation of a Transmitter by means of an Oscillating Quartz Crystal.

By C. W. Goyder (2SZ—2HM).

[R351

**T**HIS article describes a method developed by the writer of employing the oscillating quartz crystal to obtain a constant frequency at a transmitter, which has considerable advantages over the method of pure high-frequency amplification at present in general use.

The principle involved is that when two high frequency oscillators of nearly the same frequency are coupled together there is a tendency for them to synchronise.\* This effect is readily noticeable when an attempt is made to calibrate an oscillating receiver with a heterodyne wavemeter which is placed too close to the receiving set. When the frequency of oscillation of the receiver and wavemeter are approximately equal, this tendency to synchronise causes both oscillations to shift slightly from their original frequency to a position in which the frequency difference is less. If the oscillations are strong they will actually synchronise, giving a frequency in between the two original frequencies, the actual value of which is dependent upon the relative strengths of the two oscillations.

being produced. Over this range the frequency of oscillation of the receiver is held in step with that of the transmitting station, due to the synchronising effect. In this case the latter frequency is fixed while the receiver frequency is variable.

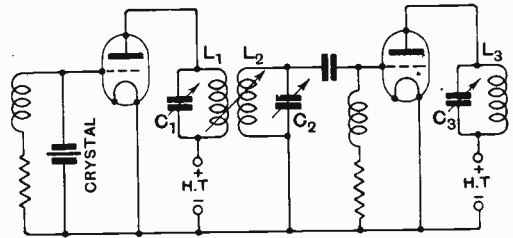
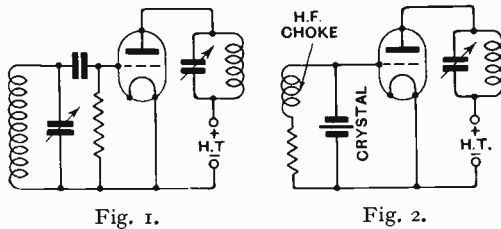

Fig. 3.

In Fig. 1 is shown a circuit of the tuned-plate, tuned-grid type, which is perhaps the best for short wave transmission. Below 200 metres there is no need to couple the coils directly to produce oscillation due to the coupling through the capacity of the valve and further stray coupling. The ordinary circuit for an oscillating quartz crystal is shown in Fig. 2. The frequency of oscillation is fixed by the dimensions of the crystal.

These two circuits are combined in Fig. 3 with variable coupling between  $L_1 C_1$  and  $L_2 C_2$ . If now  $L_2 C_2$  is varied so that its frequency passes through that of  $L_1 C_1$ , there will be a region over which the frequency of  $L_2 C_2$  is the same as that of  $L_1 C_1$ , due to the synchronising effect of the frequency in  $L_1 C_1$ , which is superimposed. The effect of limited inductance or capacity variations in the self-excited circuit will not affect its frequency. Over this range the self-excited circuit has all the properties of the crystal oscillator. The reaction of  $L_2 C_2$  on the crystal circuit cannot alter the frequency of oscillation of the crystal.

In the case of an oscillating receiver close to a broadcasting station it is found that there is quite a large range over which the tuning condenser may be moved without a beat note

\* For the theory of this effect see the *Proc. Cambridge Phil. Soc.*, Vol. 21, page 231, "The Automatic Synchronisation of Triode Oscillators," by E. V. Appleton.

The range over which the two frequencies remain in step will depend upon their relative strengths. In practice the undesired frequency variations occurring in a transmission station are due to variations

transmitter.\* In Fig. 5 is shown a practical arrangement of this new method.

Using the old method shown in Fig. 4—

1. There is a tendency for self-oscillation to occur in the amplifying valves unless

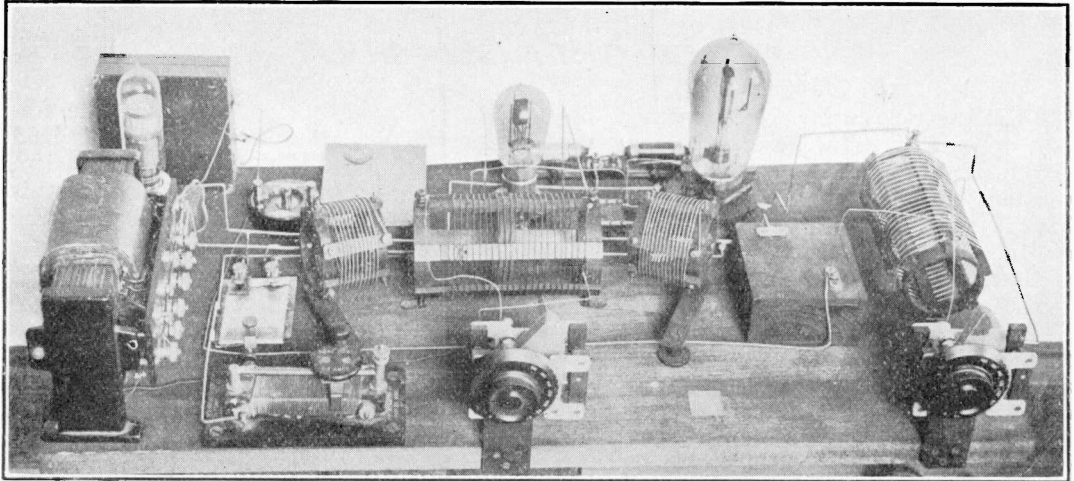

Crystal oscillator and amplifier used for stages A and B of main transmitter, or as a low-power transmitter, with the circuit of Fig. 3. H.T. and L.T. are obtained from the transformer on the left.

in the H.T. supply voltage, keying and external variations, such as the swinging of the aerial in the wind. The magnitude of these variations is usually less than  $\pm 1,000$  cycles. It is quite simple to obtain synchronism over a range of  $\pm 2,000$  cycles or more, thereby allowing a reasonable factor

neutrodyning or some similar complication is introduced.

2. It is difficult to get sufficient H.F. amplification to excite the grids of the amplifying valves to their full extent. This results in a low efficiency and heating of the anode. This is especially troublesome on the

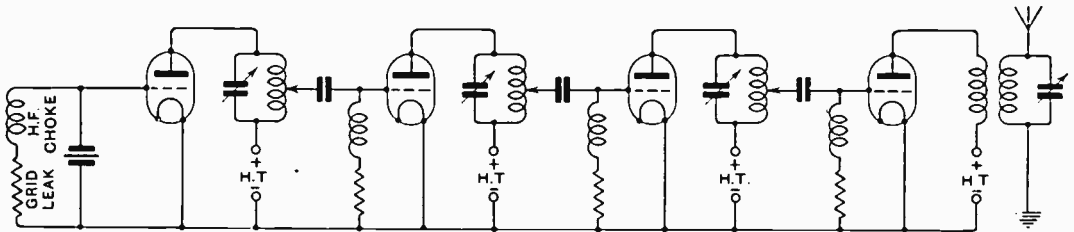

Fig. 4.

of safety. The undesired frequency variations mentioned above will thereby be prevented, due to the stabilising effect of the oscillating crystal.

The advantages of this method are very apparent in practice. In Fig. 4 is shown a pure high frequency amplifier, such as is generally employed in a crystal controlled

short waves where high frequency amplification is always difficult: also where harmonics are amplified to get higher frequencies.

3. There is also the disadvantage that a failure in any part of the amplifying system renders the whole transmitter inoperative.

\* See page 167, E.W. & W.E., March, 1926.

Using the new method shown in Fig. 5, the stages are required in the oscillating condition. The difficulties of neutralisation are non-existent. As each stage is a self-excited unit there is no question of under-excitation. The efficiency is, therefore, much higher.

The failure of any part of the crystal or amplifying stages only removes the stabilising effects of crystal control. The final stage will continue functioning as a self-excited transmitter until the stabilising crystal frequency is again superimposed. It is evident that the reliability of this type of transmitter is no less than that of the final self-excited unit.

As all transmitting circuits have a grid circuit to which the crystal controlled unit

### Practical Details.

The wavelength for which the transmitter is desired determines whether the fundamental or the harmonic of the crystal is necessary. It is obviously beneficial to use the fundamental where possible, as the amplification required will not be so great as in the case of harmonic operation.

Quartz crystals have been ground to a frequency corresponding to 20 metres but in this case the thickness would be less than 0.2 of a millimetre. This is not a practical proposition. The writer has used crystals operating on their fundamental down to 45 metres. The 45-metre band seems to be the lower limit for fundamental operation. The crystal for this wavelength is between 0.3 and 0.4 millimetre thick, depending

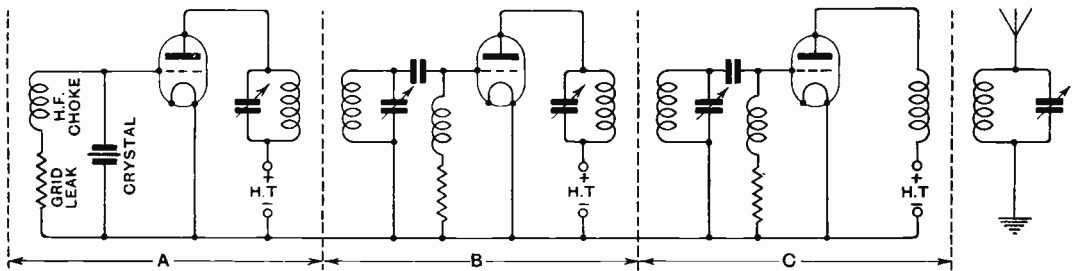

Fig. 5.

may be coupled, it is obvious that this method is of a purely additional nature, no changes need be made in the existing transmitter.

The amplification required for a given output from the last stage is greater using the method of Fig. 4 than in the method of Fig. 5. This is partly due to the inefficiency of the former method and also to the difference in principle. In Fig. 5 the frequency of the transmitter is only controlled over a certain limited range. Experimentally, it is found that it is possible to use one stage less amplification and yet control the same output in the last stage.

For the short wavelengths, where it is not possible to use the fundamental of a crystal due to the mechanical difficulties, the amplifiers may be operated on harmonics of the previous stages.

The same advantages are maintained using harmonic operation of the circuits.

on the type of quartz used. Naturally, great care must be taken in handling the crystal and the voltage on the crystal oscillator valve must not be raised above 300 volts, but even with these limitations it is worth while to work the crystal on the fundamental for the 45-metre band. The reason for this will be more apparent later.

For the amateur bands this leaves the 45 and the 90-200 metre band for fundamental operation of the crystal and the 32 and 23-metre band for harmonic operation.

### Harmonic Operation.

When harmonic operation is employed it is difficult to give accurate figures for the power which will be required in the successive amplifiers. This is partly due to the fact that it is not possible to determine what strength the harmonics will be in the various circuits. Also, on the short wavelengths in question, many effects come into play

which cannot be foreseen, such as stray coupling between coils, etc.

From various experiments, using a power of up to 300 watts in the output stage (*i.e.*, the stage coupled to the aerial) it seems necessary to employ a power ratio\* of 1:3

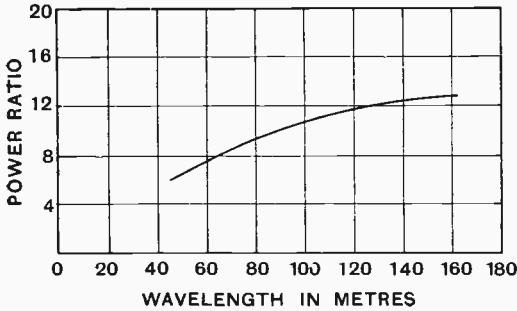

Fig. 6.

in the last crystal amplifier and output stage (between B and C, Fig. 5). This holds roughly whether the second, or third, harmonic is used. If the fourth harmonic is used a power ratio of 1:2 should be allowed. In these experiments the harmonics were augmented by using a high grid bias on the amplifying valve. Owing to the impossibility of determining the wave form

In general the power required in the successive amplifiers is about one-third that required when harmonic operation is used. It varies slightly, however, with the wavelength employed. With the lower wavelengths the power ratio has to be decreased slightly, due to the lower efficiency and due to the more uncertain conditions.

A graph shown in Fig. 6 gives roughly the power ratio required between the last amplifier and the output stage for the different wavelengths tried. It is seen that it is possible to work with a power ratio of 1:6 to 1:12. To be able to control, say, 300 watts in the output stage with a power of only 50 watts in the previous stage, is very unusual. For example, using a master oscillator, it has been found by many experimenters that it is necessary to use a power ratio of 1:1 to 1:3 to get sufficient control on the short wavelengths.

It is not difficult for any amateur to add a unit, such as is shown in Fig. 3, to his existing transmitter and thereby convert to crystal control. For the majority, using a power of 50 watts or less, it is only necessary to add a single crystal oscillator as in Fig. 2.

In Fig. 7 is shown the circuit diagram of

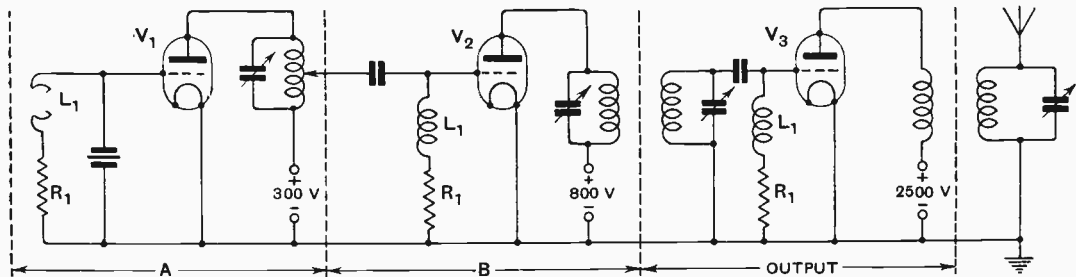

Fig. 7.  $L_1$ , H.F. choke.  $R_1$ , grid-leak.  $V_1$ , receiving type power valve.  $V_2$ , 40-watt type valve.  $V_3$ , 250-watt valve.

of these high frequency oscillations, it is mainly a matter of experiment with a closed circuit and a hot wire ammeter or visual indicator which is tuned to the harmonic required, and the grid bias of the amplifier is then varied to give the maximum indications.

### Fundamental Operation.

Using the fundamental of the crystal the conditions are more definite.

\* 100 watts in stage B and 300 watts in stage C is termed a "Power Ratio" 1:3.

the transmitter at present in use for the 45 and 90-metre band, using the fundamental of the crystal. It has been tested with a power input of up to 300 watts to the output stage. This is the maximum available.\*

\* Recently the writer has successfully applied this method to an amateur station using a power of 1kW. Harmonic operation with the combination of valves shown in Fig. 8 was used. A higher voltage on the output stage was the only difference. The power ratio mentioned was found approximately correct.

In Fig. 8 is shown the circuit arrangement for the 32-metre band using harmonic operation. The second harmonic of the crystal is at present employed.

In each case it will be noticed that the first amplifier *B* is used as a pure high frequency stage. This is found convenient as there is no trouble with self oscillation in this stage and it simplifies the adjustment.

To obtain sufficient control using the harmonic of the crystal the extra stage *C* must be added. The same voltage is used for stage *C* and for the output, but the grid bias of stage *C* is increased until the power drops to the required figure. This method accentuates the harmonics; this is required.

is in the output stage that the capacity and inductance changes occur which it is desired to overcome. Between the subsidiary stages of the crystal amplifier (such as *B* and *C*, Fig. 8) the ratio may be increased slightly as the conditions are more stable. As the power is low in these stages it is not such an important factor to obtain high ratios.

For the successful operation of this method it is vital that the inductances be of good design. On these high frequencies a poor dielectric will heat up; this either softens it, allowing the wire to move, or changes its specific inductive capacity, which in turn causes a large capacity and inductance

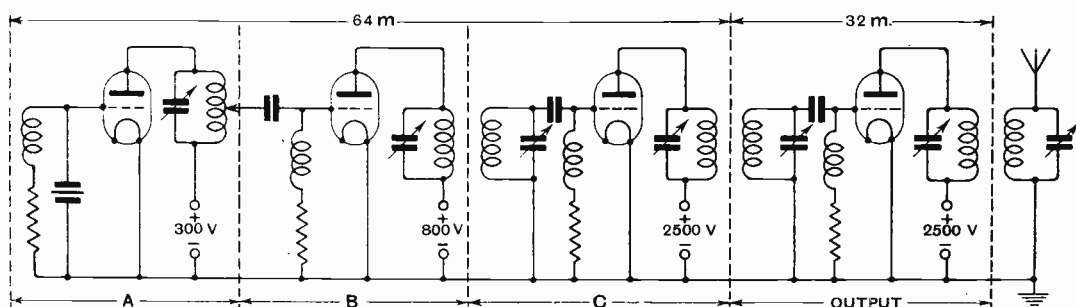

Fig. 8.

The crystal oscillator and first amplifier (*i.e.*, *A* and *B*) are always left running while the set is keyed, by cutting off the power to the final stages.

#### Some General Considerations.

It is evident from the properties of this method that the amount of control exercised on the output by the crystal stage is dependent upon the power in the crystal stage. The power ratios given have been found sufficient to hold the output stage in synchronism with the crystal amplifier over the range of capacity and inductance variations which are usually found in transmitters. It may vary with individual cases. In the case of a transmitter on a ship where the rolling of the ship produces large capacity changes in the aerial system, it might be necessary to decrease the power ratio.

So far, the main consideration has been the power ratio between the last stage of the crystal amplifier and the output, as it

change. The crystal amplifier will not be able to control this large change unless the power is considerably increased. It was found that an inductance wound on wooden strips boiled in paraffin wax was quite suitable for the 90-metre band. On 32 metres the wood heated to such an extent that the wax melted. The frequency drift due to this amounted to several thousand cycles. A self-supporting coil, wound with copper strip, or one wound on good quality ebonite, is quite satisfactory. Similar precautions should be taken with high frequency chokes.

From all aspects, it is the low power station which can profit most by crystal control. Difficulties, such as just mentioned, prominent with powers of over  $\frac{1}{2}$  kW, are not noticeable with low powers. Design need not be so strictly considered. The cost of a crystal oscillator using a receiving type power valve is not great. It is suitable for controlling 50 watts or so in the output stage.

Another factor which has been found important is that of filament temperature. If the filaments of the amplifiers are under run it is difficult to get any control whatever. The rated values for the filament are usually satisfactory, but with dull-emitter valves it is best to experiment with higher values as the emission may have fallen off.

output (considering Fig. 7) is varied until it passes through that of the crystal oscillator. The beat note in the receiver increases considerably in strength when the two frequencies are synchronised. As the frequency of the output circuit is gradually decreased by varying the grid tuning condenser and approaches synchronism with the crystal oscillator, a beat note will naturally be formed between the two oscillations. This then disappears as they synchronise. There will then be a range over which no beat note is obtained. There will come a point where the oscillations again fall out of step producing another beat note. The output condenser should be set in the middle of the band in which no beat note is obtained. This position is indicated by a minimum reading of the milliammeter in the plate circuit of stage *B*. The other stage in Fig. 8 is similarly adjusted. If the stages are not properly synchronised a whole series of rough beat notes will be heard in an oscillating receiver as the tuning condenser is varied. When the set is working correctly, beat notes will only be obtained when the receiver is tuned to a harmonic of the transmitter. This beat note will have all the characteristics of a crystal oscillator.

The coupling between the stages is fairly loose when fundamental operation is being used but for harmonic operation it should be as tight as possible. From this it follows that the ratio of inductance to capacity should be kept high. Only a small parallel capacity should be added.

In general, if the coupling is correct and the set is in synchronism there will be no movement of the milliammeter in the plate circuit of the crystal oscillator as the set is keyed.

Inductive coupling between the stages has been considered throughout as it was found to be the most satisfactory. Various methods of capacity coupling were tried but the results were inferior.

When constructing a holder for a quartz crystal, ebonite should be avoided as the sulphur in the ebonite slowly oxidises the metal surfaces. The metal surfaces and the crystal should be kept clean. Carbon bisulphide or carbon tetrachloride (which is non-inflammable) may be used. For experimental work, where the crystal may be changed frequently, it has been found

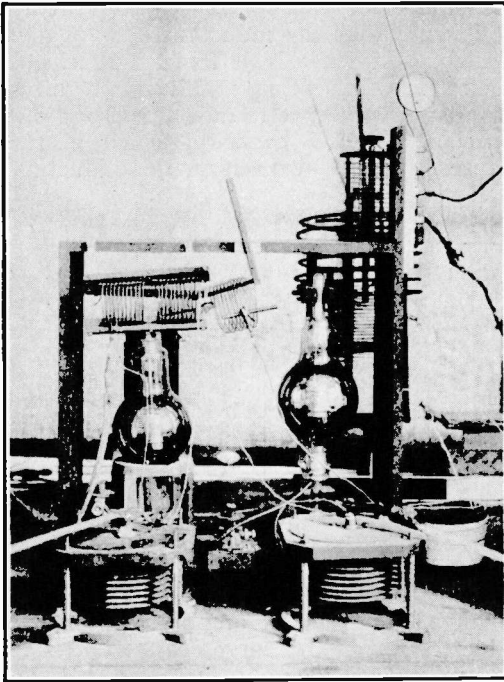

*Amplifier C, Fig. 8, and the output stage.*

### Adjustment.

In common with all circuits of this kind, a little patience is necessary at first until the behaviour of each circuit is understood.

The first step is to set the crystal oscillator working (*A*, Fig. 7). A tap from the grid circuit of *B* is taken to the plate inductance of the crystal oscillator and the plate inductance of *B* is tuned to resonance (indicated by the minimum value of the plate current). The wavelength is then found on a wavemeter or oscillating receiver. The crystal oscillator is now switched off. The amplifier is adjusted roughly to this wavelength. The crystal is switched on and a beat note is obtained in the receiver. The frequency of the



more convenient to use a large metallic surface for the electrode which is connected to earth and a small movable electrode, weighing two or three ounces, just resting on the crystal for the other.

If a crystal is required for permanent operation and is not likely to be moved for some time, it is necessary to attach a very small piece of mica to each corner on both sides of the crystal so that there is a small air gap between the crystal and the metallic surface. It has been found that the crystal sometimes sticks to the metallic surface unless this is done. It is apparently necessary to have a small air film between the surfaces for successful operation. This gradually gets squeezed out as the crystal oscillates, until the surfaces come into direct contact and then stick. This is mainly noticeable when the surfaces are very true.

The advantages of crystal control mentioned below may help those who are not fully acquainted with the subject to decide whether to make the change.

The main feature of the oscillating quartz crystal is, of course, that its frequency of oscillation is constant. This is due to the mechanical nature of the oscillation, which is dependent on the linear dimensions of the crystal, as in the case of a tuning fork, rather than on any electrical resonance of inductance and capacity.

This allows a transmitter to maintain a constant frequency despite aerial swaying, etc. It also solves the keying problem which is so difficult on the short waves. The set may be keyed in the most economical manner, as the methods which produce frequency changes in a self-excited set cannot do so when the frequency is maintained constant by a crystal.

Any irregularity in the H.T. supply to a self-excited transmitter on the short waves, due to imperfect smoothing, causes the quality of the emitted wave to be rough and broadly tuned. When using a crystal controlled transmitter on a supply of this kind the rough note and spreading of the wave is entirely absent. If the 50-cycle supply is used with a full wave rectifier, a smoothing capacity of  $\frac{1}{2}\mu\text{F}$  is ample to give a pure note. With a self-excited circuit a capacity of at least  $4\mu\text{F}$  would be necessary to give a note of similar purity. The saving effected in this way goes a long way to counterbalance

the expense of the crystal amplifier. The extent to which this property of crystal control may be utilised is well illustrated by the fact that some commercial stations on the short waves using crystal control employ the "self-rectification" circuit throughout (*i.e.*, for the amplifiers and output). This means that no separate rectification whatever is used. The amplifying stages have two valves, one connected on each side of a split secondary supplying the A.C. H.T. voltage (see Fig. 9). The quality of the note obtained is excellent. Only a small percentage modulation is present, quite negligible for morse working.

This property of crystal control is due to the following reason:—

The quality of a carrier wave depends upon two factors: the percentage of frequency

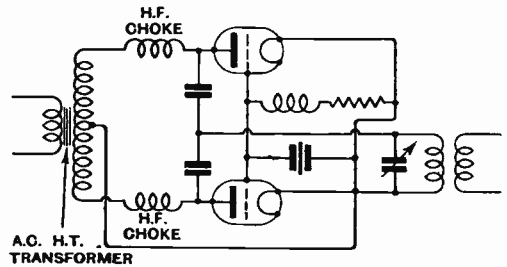

Fig. 9. In the subsequent circuits the crystal is replaced by the grid coil and condenser.

modulation (*i.e.*, the periodic variation of the frequency caused by H.T. voltage variations) and on the percentage of amplitude modulation (*i.e.*, the actual variation in strength produced by the varying voltage supplied to the transmitting valve). Of these the former is by far the most important on wavelengths below 200 metres or so. The variation in voltage supplied to the valve causes its internal resistance to vary, this in turn causes a small frequency change.

With crystal control the most important factor is eliminated, as the crystal holds the frequency constant despite the changes due to H.T. voltage variations. The amplitude modulation present is then the only factor influencing the quality of the carrier wave. This is a minor point.

It has been shown that it is not possible to modulate a self-excited circuit on wavelengths below 500 metres without getting

frequency modulation and consequent distortion of speech and music.\* The quartz crystal is the best solution of this problem, especially for the short wavelengths.

The constant frequency of a crystal transmitter allows the use of grid control modulation with considerable success, as the usual accompanying frequency modulation is absent. The output stage should be modulated. The grid bias should be adjusted so that the modulation only swings the grid potential along the straight part of the characteristic curve of the valve.

### Conclusion.

Using pure high frequency amplification,

\* "Some Studies in Radio Broadcast," *Proceedings, I.R.E.*, February, 1926.

the crystal frequency is the only frequency which can be emitted. Large changes of inductance or capacity in the amplifiers only reduce the radiation. Using this new method the crystal stabilises the frequency only over a certain finite range which is made sufficient to cover any inductance or capacity changes likely to be met in a transmitter.

This is the fundamental difference between the two methods.

Many modifications of both methods have been tried. The new method described has decided advantages from the point of view of simplicity, flexibility, efficiency and reliability.

It has been in use at the writer's station 2SZ for the past six months with considerable success.

## Opening of the I.E.E. Session.

### Dr. Eccles' Presidential Address.

[R060

THE opening meeting of the I.E.E. Winter Session, 1926-27, took place on 21st October, when Dr. Eccles, the new President for the current year, delivered his Presidential Address.

Before calling upon the new President to take the chair, the retiring President, Mr. R. A. Chattock, presented the premiums awarded for papers read during the 1925-26 Session. In the Wireless Section these were awarded to:—

Mr. J. Hollingworth; Dr. R. L. Smith-Rose and Mr. R. H. Barfield (jointly); Messrs. R. A. Watson Watt and J. F. Herd (jointly).

These awards were all made on papers describing work carried out under the auspices of the Radio Research Board.

To the disappointment, doubtless, of many wireless members present, the new President did not deal specifically with high frequency engineering, with which he has been so closely connected. He pointed out that in the circumstances two courses were open, one to deal with a specialistic subject, and the other to review electrical engineering and practice in its most general terms. He had decided to take the latter course, and proposed to trace and compare the main

lines of modern electrical development under the general headings: (1) Electrical supply industrial; (2) General use of electricity; (3) Communications; (4) Electrical trade.

In the first two sections the various statistics quoted went chiefly to show that British electrical development was backward.

In communication, Britain was shown to occupy a leading position in the ownership and operation of cable routes.

In connection with wireless the presentation of facts was chiefly in statistical form, the subject being reviewed under the heads of Long Range Telegraphy and Telephony; Short Wave Stations; Other Purposes. In the first connection particularly it was shown that the British Empire was as well equipped as any country, while the only long distance telephony service existing was between America and the new British Station at Rugby.

As regards Broadcasting, the statistics quoted again showed the British position to be satisfactory and to compare favourably with other countries.

The first meeting of the Wireless Section was held on 3rd November, when the Section Chairman, Prof. C. L. Fortescue, delivered his inaugural address, an account of which is given on page 740.

# The Absolute Measurement of Resistance at Radio Frequencies.

By *Raymond M. Wilmotte, B.A.*

[R240

**T**HERE are many methods in existence for measuring the high frequency resistance of coils. They all possess their pitfalls, some of which are obvious, while others require much experience to be noticed.

In general these methods depend on the measurement of the impedance of a circuit at or near its resonant frequency. In all these cases assumptions must be made regarding the constancy of the amplitude or frequency or both of the E.M.F. induced into the circuit under investigation. Besides these assumptions, there are always pitfalls due to unknown stray capacities, mutual inductances, eddy current losses, dielectric losses, etc., which are to a very large extent unknown.

There exists a class of methods in which all these sources of error are eliminated. If a current is passed through a coil having resistance, the whole of the energy dissipated will be liberated as heat. An obvious way of measuring the resistance of a coil is, therefore, to measure the current and the heat evolved in it. Unfortunately the measurement of the heat evolved is very difficult and usually gives rise to large experimental errors. Many attempts have been made, however, by a number of investigators. T. P. Black, L. W. Austin, H. Abrahams, G. W. O. Howe and L. Lehrs have been the chief workers in this field. The following briefly describes the methods used by them.

T. P. Black used a method similar to that employed later by J. A. Fleming, but Black used it on coils and Fleming on straight wires. The method consisted of putting the coil (which was in the form of a long solenoid) inside a sealed glass vessel, which was connected by means of a capillary tube to another exactly similar vessel, but which contained a straight wire. A small drop of mercury was inserted in the capillary tube. It is obvious that, when the heat generated in the wire equals that generated in the coil,

the mercury will remain stationary. High frequency currents were passed through each and their relative values adjusted until no motion of the mercury was observed. A knowledge of the ratio of the currents gives the ratio of the resistances of the wire and the coil, for the heat evolved is proportional to the product of the square of the current and the resistance.

L. W. Austin placed two similar coils in similar vessels in oil. Through one coil the high frequency current was passed and through the other direct current. The oil was stirred and the equality of temperature noted by means of thermo-junctions connected in opposition in the two vessels. When the temperatures of the two vessels are equal, the galvanometer connected to the thermo-junctions must, of course, show zero deflection. Much of the accuracy would depend on the effectiveness of the stirring.

H. Abrahams measured the direct current resistance of the coil before and after passing the high frequency current. The rise in temperature of the copper of the coil could thus be found. He repeated the experiment, using direct current and thus obtained the ratio of the direct to alternating resistance of the coil. Few details are available of these experiments of Abrahams, but it would appear that very large currents would be required to obtain a reasonable accuracy.

G. W. O. Howe measured the temperature of a coil, after passing the high frequency current, by means of a thermo-junction placed outside the coil near the centre turn. He then found the direct current, which produced the same effect. It will be noticed that the magnetic field falls off very rapidly just outside a single layer coil. (This is shown in an article by the author on parasitic losses in coils in the May number of *E.W. & W.E.*) The eddy currents produced in the thermo-junction will therefore form no appreciable source of error.

L. Lehrs enclosed the coil in a vessel connected to an extremely sensitive manometer and adjusted to high frequency and direct currents, so that no change could be seen on the manometer on switching from one to the other.

We see that there is no lack in the variations of the methods used and the results obtained give varying degrees of accuracy.

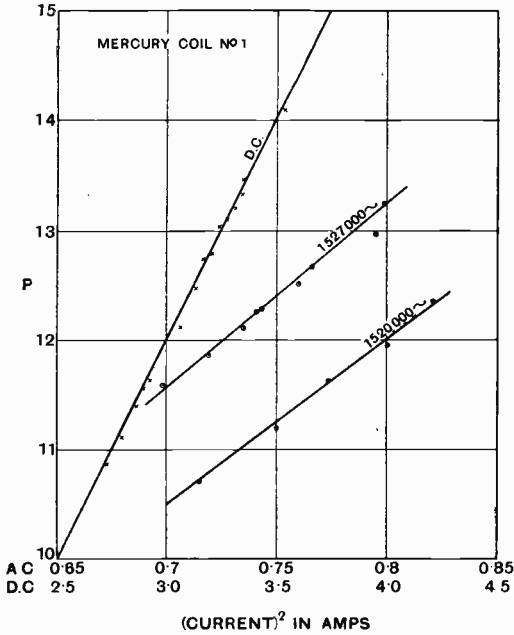

Fig. 1. Straight lines obtained experimentally with coil 1, from which the resistance can be calculated.

A source of error in those methods may arise from the fact, that the heat emitted at high frequencies is not the same for all the turns of the coil, but will be greater for the outside turns (where the magnetic field is large and produces eddy currents in the wires) than for the centre ones. This will be an important cause of error in the methods of Austin and Howe, the latter however only used long solenoids and in this case the error would be much minimised. Another source of error is due to the change in temperature of the air during the experiments or slight inequality of the vessels in the differential methods; the former would occur in the method of Abrahams and the latter in those of Black and Austin.

The method of Lehrs seems the most

accurate, but it is probably accurate only when the coil is of small dimensions. In fact nearly all these methods suffer from this.

Now, to test the accuracy of ordinary methods of measuring resistance, it is advisable to measure a coil, in which the sources of error inherent in the methods are large. For this purpose the dimensions of the coil should be large (so that stray capacities may also be large), the resistance of the coil should be low (so that unknown losses may produce an appreciable percentage of the total) and the frequency should be high.

Most of the investigators mentioned above were not trying to check existing methods of measurement, so that they were not particularly interested in measuring coils of large dimensions and low resistance. In order to do this the author has used the following method:—

A coil was made of glass tubing filled with mercury. One end of the coil was stopped and the other terminated in a capillary tube, on which were two marks at a distance of a few centimetres. The coil thus formed behaved as its own thermometer. When the mercury stood at one mark, the mean temperature of the coil was absolutely definite and quite independent of the temperature of the air.

High frequency current was passed and the time  $T_H$ , which the mercury took to move from one mark to the other was noted. The current was stopped, and the time  $T_C$  taken for the mercury to fall from the top mark to the lower one was also noted.

Assuming Newton's law of cooling, it is easy to prove that, if the temperature of the air remains constant during the experiment, the rate at which heat is produced in the coil is proportional to

$$\coth \frac{K}{2} T_H + \coth \frac{K}{2} T_C$$

where  $K$  is a constant depending on the coil.\*

This expression will be called  $P$  and is proportional to  $I^2 R$ .

It will be seen that  $P$  is independent of the temperature of the air. Also, if  $P$  is plotted against the square of the current, a straight line passing through the origin should result. This was found to be the

\*  $\coth x = \text{hyperbolic cotangent of } x = \frac{e^x + e^{-x}}{e^x - e^{-x}}$

case. Moreover the slope of that line is proportional to the resistance.

By repeating the experiment with direct current, the ratio of the alternating to direct current resistance of the mercury coil was found.

The coil acts as an exceedingly sensitive thermometer, so that the distance between the marks on the capillary tube represented

They were of somewhat ungainly appearance, owing to the difficulty of accurately bending and fusing together long lengths of glass tubing. However, they served their purpose, for regularity in the dimensions did not enter the question.

Coil 1 had 9 turns and overall dimensions of 11 × 11 × 8 cms. Coil 2 had 15 turns and overall dimensions of 16 × 16 × 22 cms.

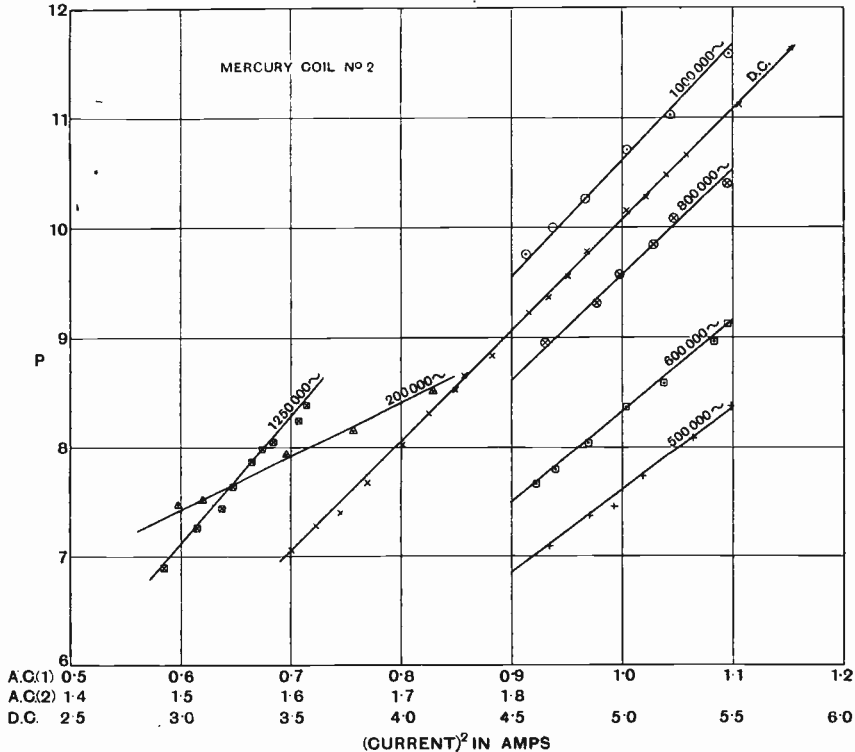

Fig. 2. Straight lines obtained experimentally with coil 2, from which the resistance can be calculated.

a difference of temperature of only 1/4°C. and the energy dissipated in the coil only of the order of one watt, allowing a comparatively small current (of the order of one ampere) to be used. This is important for, especially at high frequencies, uncertainty exists in the absolute value of a current measured by thermo-junctions, if the current is at all large. An instrument may compare accurately two currents of the same frequency, but may be in error when comparing a large current at radio frequency with direct current.

Two mercury coils were made and measured.

In Fig. 1 is shown the straight lines obtained when *P* is plotted against the square of the current. Fig. 2 gives the same straight lines obtained for coil 2. Fig. 3 shows the resistance of coil 2 plotted against the square root of the frequency. This method of plotting was chosen to obtain a flat curve, in which any small irregularity might show up.

Having thus found the resistance of the coils, by what may be termed an absolute method, there remained the checking of the ordinary methods of measurement. The coils were measured by two forms of the

variation of resistance method. In method 1 the mercury coil was put in series with a condenser and a thermo-ammeter (Fig. 4). An E.M.F. was induced from an oscillatory circuit directly into the mercury coil. The

1 gives results slightly too high. The difference is small, however, and, when great accuracy is not required and the resistance is not too low, method 1 should be sufficiently good.

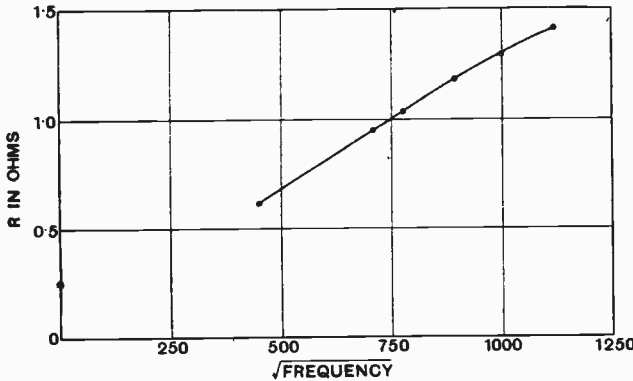

Fig. 3. Variation of effective resistance of coil 2 with the square root of the frequency.

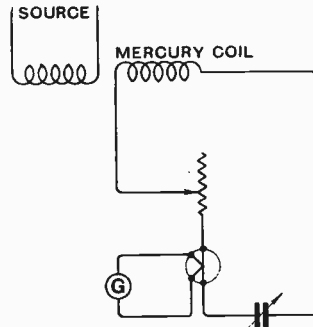

Fig. 4. Method 1 of the resistance variation method of measurement.

circuit was tuned and the resistance varied. By noting the change in deflection of the thermo-ammeter, the resistance of the circuit was calculated. From this was subtracted the resistance of the thermo-ammeter and the calculated resistance of the leads.

In method 2, the E.M.F. was induced in another coil (Fig. 5). The resistance was measured as in method 1 with the two coils in series. The mercury coil was then taken out of the circuit and the resistance again measured. The difference gives the resistance of the mercury coil. The results are given in the following table:—

Those readers who are interested in these experiments will find them described in more detail in the *Proceedings of the Royal Society A.*, Vol. 109, p. 508, 1925.

The difference between methods 1 and 2 is small and not of great importance for the usual resistances measured. Experiments show that it does not lie in the condenser,

Mercury Coil.	Frequency kC.	Method of Measurement.		
		(1)	(2)	Thermal.
No. 1	1,527	0.99	0.99	0.98 <sub>3</sub>
"	1,250	1.09	0.91	0.90 <sub>3</sub>
No. 2	1,250	1.49	1.41	1.41 <sub>2</sub>
"	1,000	1.34	1.29	1.29 <sub>2</sub>
"	800	1.19	1.18	1.17 <sub>2</sub>
"	600	1.07	1.04	1.03 <sub>5</sub>
"	500	0.97	0.96	0.95 <sub>2</sub>
"	200	0.62	0.62	0.62 <sub>4</sub>

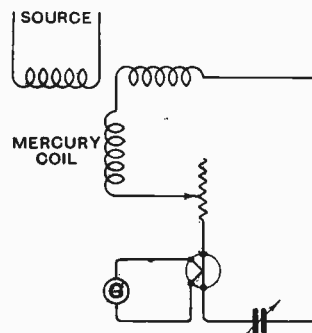

Fig. 5. Method 2 of the resistance variation method of measurement.

It will be seen that method 2 gives accurate agreement to within 0.01 ohm, while method

which, from these results, has a series resistance of less than 0.01 ohm corresponding to a power factor of less than  $10^{-4}$ . Reaction back onto the oscillator appears to be the cause of the discrepancy. The error due to this may, in certain cases, reach

unexpectedly high values and care should be taken to ensure that the current in the tuned circuit of the oscillator remains *absolutely* constant throughout the measurement.

It should be emphasised, that it is only by taking every precaution, that the resistance variation method, and for that matter any method, gives accurate results and the circuit must be arranged with care, if appreciable and sometimes large errors are to be avoided.

Besides giving an absolute basis for checking ordinary methods of measurement of resistance, this thermal method gives the power factor of condensers. This appears to be so low in good condensers, that direct measurement fails and only gives an upper limit which, in the particular case considered, was  $10^{-4}$ .

An interesting application of the method described above would be the absolute measurement of current at very high radio frequencies. Up to a frequency of about 1,000 kilocycles, small currents of the order of two amperes can be measured with fair certainty, for the thermal element of the ammeter can be made so thin that the skin effect can be neglected and the eddy current

effect on the thermo-junctions is still negligible. At higher frequencies and for larger currents it is difficult to be absolutely certain of the magnitude of these effects.

If the resistance of a portion of an electrical circuit could be calculated and the heat generated in it measured, the current could also be measured from absolute principles. Now, the resistance at any frequency of a straight cylindrical conductor, screened for the whole of its length by a concentric metallic shield connected to one of its ends, is amenable to calculation.

The suggested method is now obvious. The straight conductor would be mercury in glass or preferably quartz. It would be calibrated with direct current as in the case of the coils and the heat generated measured by the expansion of the mercury. In practice it would probably be found useful to surround the shield with ice so as to keep the temperature as uniform as possible. The effect of the dielectric constant of the glass or quartz could be allowed for, but the dielectric loss in the medium would be a source of error, which would probably be made small by designing the system so as to make the potential gradient at the surface of the mercury small.

---

# Television.

A paper by Mr. J. L. BAIRD read by Lt.-Col. J. R. YELF before the Radio Society of Great Britain on Tuesday, 26th October, 1926.

[R586.04

THE word Television is derived from the Greek *tele* (at a distance) and the Latin verb *video* (I see), so that the literal meaning is "seeing at a distance." This mixture of Latin and Greek is repugnant to classical minds and several alternatives, such as Teleopsis, have been recently suggested.

The word Television is already, however, part of the English language. It is used in the Patent Office, and appears in Murray's *New English Dictionary* and the *Encyclopædia Britannica*.

Some confusion still exists even in technical circles as to the exact meaning of the word, and it is still not infrequently misused to describe photo-telegraphy. Television means the transmission of an image of an object or scene by telegraphy or wireless telegraphy with such rapidity that it appears instantaneously to the eye of the observer at the receiving station, or it might more briefly be defined as "vision by telegraphy."

It is frequently stated that by a speeding up of photo-telegraphy until sixteen photographs were sent per second, television would be achieved. This is quite inaccurate. What would be achieved would be a cinematographic reproduction by telegraphy or telekinematography, a very different and much simpler thing than television which is the transmission of the actual living scene while it is happening.

The history of television is linked up with the history of Selenium, and may be said to date from the discovery of the light sensitive properties of that element.

Selenium is a metal, and has an enormous resistance to electricity. This property made it useful in the construction of high resistances used in telegraphy, and such resistances were employed at the terminal station of the Atlantic cable, a little village in the West of Ireland called Valentia. One afternoon the attendant, a Mr. May, was surprised to see his instruments behaving

in a very erratic manner. It was a day of bright sunshine, and the sunlight fell occasionally upon his selenium resistances. He found every time the sunlight touched the selenium the needle of his instrument moved. The phenomenon was investigated and the light sensitive properties of selenium disclosed.

Selenium then gave a means of turning light into electricity, and the scientists of these days were quick to see in the selenium cell a means of providing vision by telegraphy.

A great number of devices were invented, and many of these were to a great extent perfectly feasible schemes, except for one point, and that was that selenium was much too slow in its action and too insensitive.

For over thirty years television remained at a standstill. "Time lag," as the sluggishness of selenium was called, proved a fatal barrier.

Selenium is not, however, the only means of turning light into electricity. Another discovery was made in 1888 by Hertz. Hertz found that the sparks which he was using in his experiments passed more readily when ultra violet light fell across their path. This discovery of Hertz led to the construction of what are known as photo-electric cells. These cells turn light into electricity, and are instantaneous in their action.

The development of these cells seemed to offer a substitute for the sluggish selenium, and an attempt was made to substitute them in the television apparatus.

Another difficulty at once made its appearance. The cells, although they were fast enough, would not respond to the very small light available. Shadows could be sent, for with shadows the light from a powerful lamp can be directed straight on to the cell. But where television is concerned, only the light reflected from the scene is available, and this light is very small indeed.

The three-electrode valve provides an



immensely powerful amplifier, but the amplification obtainable is limited, a stage is reached when irregularities in the emission from the first valve become audible and if the signal is not heard before this point is reached further amplification is useless, enormous amplification is obtainable before this stage is reached, but the response from the cell is very far below the limit. With an ordinary potassium cell a further amplification of something like a thousand times would be required.

In examining television devices the logical starting point would appear to be a consideration of the already existing very perfect

travel impulses which are dependent upon the intensity of the light falling on the hexagonal cell. Exactly how these impulses are generated is not at present fully understood, but they are almost certainly due to the presence of a light sensitive substance named visual purple, which flows through the hexagonal cells. The images which we see are thus built up of an extremely fine mosaic of microscopic hexagons of varying degree of light and shade. The number of these hexagonal cells is stupendous. In a normal human eye there are several millions.

The early inventors endeavoured to construct artificial eyes by substituting selenium for visual purple and building an artificial retina out of a mosaic of selenium cells, each of these cells being connected by wires to a shutter. This shutter opened when light fell on the cell connected with it and allowed a spot of light to fall on a screen. In this way each cell controlled a spot of light, the image being reproduced by a mosaic formed of these spots.

Models on these lines were actually made by several inventors. Rignoux and Fournier, two French scientists, constructed such a machine. This apparatus was intended only to demonstrate the principle, and had no pretensions towards presenting an instrument for television. The transmitting consisted of a wall covered with selenium cells, 64 fairly large cells being used. From each of these cells two wires ran to the receiving screen, which was made up to 64 shutters, each shutter controlled from its respective cell, and thus when a strong current from a brilliantly lighted cell at the transmitter arrived at the receiving station the shutter was opened and light was allowed to fall on the corresponding part of the receiving screen. By covering the transmitting wall with large stencils, letters of the alphabet were transmitted, and could be recognised.

Ernst Rhumer also, whose brilliant pioneer work in connection with wireless telephony is so well known, constructed a similar apparatus, and many other workers have been attracted by this system, but the thousands of cells, shutters and wires necessary made the practical adaptation of such schemes out of the question, and an endeavour was made to solve the problem in quite a different manner. Instead of using

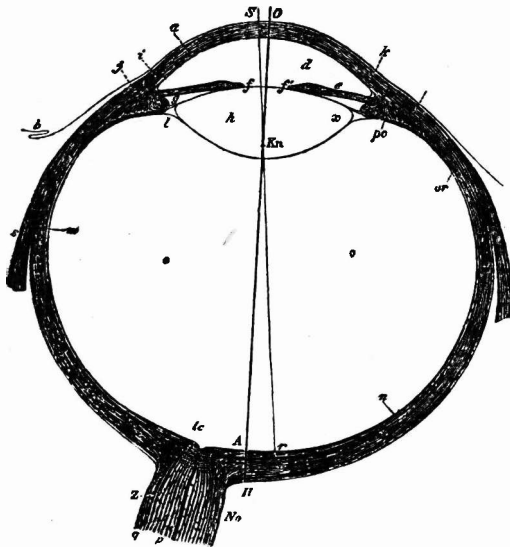

Fig. 1. Section through the human eye.

television system which nature has provided in the eye and the optic nerve. Fig. 1 shows a sectional drawing through a human eye. An image of the scene viewed is cast by the crystalline lens on to the retina at the back of the eye. This image has to be conveyed to the brain, and Nature's method of solving her television problem has formed the basis of many of the first television schemes. A clue to the solution of the problem is found in a close examination of the screen, which is called the retina. The surfaces of this is found to consist of a mosaic made up of an enormous number of hexagonal cells, and each of these cells is directly connected to the brain by a number of nerve filaments along which

a separate cell for each point of the picture it was produced to use only one cell, every point of the picture to fall in succession on this single cell, and the varying current from the cell to be transmitted to the receiving station, there to control a point of light traversing a screen exactly in step with the traversal of the image across the cell. The point of light was bright at the high lights, dim at the half tones, and completely out at the black parts of the image, the process to be carried out with such rapidity that, owing to persistence of vision, the eye would see, not a succession of spots, but the image as a whole instantaneously.

reflected in a zigzag path across a screen by means of two mirrors vibrating at right angles in the same way as the mirrors at the transmitter.

Fig. 2 shows another device of a more interesting character, that suggested in 1907 by Boris Rosing, a Russian professor. His transmitting arrangement was similar in principle to others, but his receiving device was very original, as he dispensed altogether with mechanical parts, and used instead the cathode ray. The rays can be produced in the form of a thin pencil-like discharge, and this pencil of rays can be moved in any direction, either magnetically or electrically.

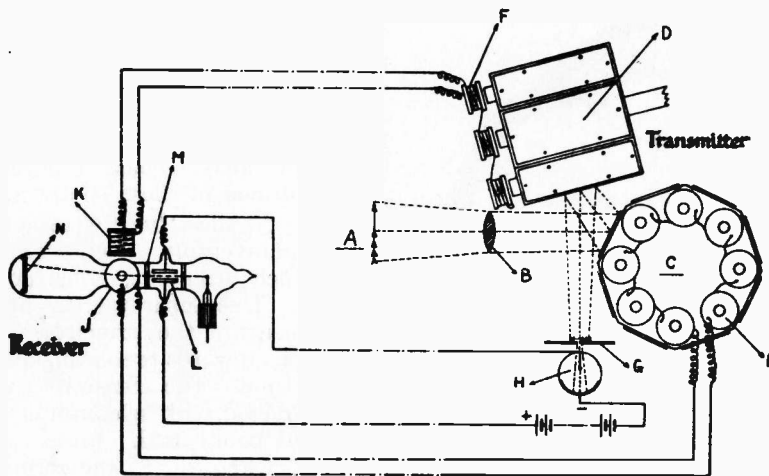

Fig. 2. Principle of Rosing's apparatus.

A great number of devices to accomplish this object were invented, and it will be possible to describe only a few of the most representative.

In the arrangement due to Jan van Szczepanik at his transmitting station two mirrors were employed vibrating at right angles to each other, the image being projected by a lens first on to one mirror and from this mirror on to the second one, which in turn reflected it on to a selenium cell. The results of the combined motions of the mirrors was to cause the image to travel over the cell in a zigzag path, and the current from the cell was transmitted to the receiving station, where it controlled the intensity of a spot of light, this point of light being

It has no weight, and therefore no inertia, and there is thus no limit to the speed at which it can travel. When this ray strikes a plate of fluorescent material a brilliant spot of light is produced, so that, by using the cathode ray in conjunction with a fluorescent screen, we can get a receiving device capable of following almost any speed.

Rosing used as his transmitter two mirror polyhedrons revolving at right angles to each other, their combined motion causing an image of the object to be transmitted to pass over a light sensitive cell. The varying current from the cell was transmitted to the receiver, and here it passed through a magnet which deflected the cathode ray away from an aperture placed in its path, the amount of

the ray which passed through being proportional to the current passing through the magnet coil. This ray was caused to traverse a fluorescent screen by currents to the mirror polyhedrons.

Mr. Campbell Swinton, independently of Rosing, devised a cathode ray system in which the cathode ray was used at both receiving and transmitting stations. This system was described in *Nature* three weeks before Rosing's patent was accepted in England.

I will give only a brief description of Mr. Campbell Swinton's device as a full account has already been given to this society by the inventor himself.

The transmitter consisted of a mosaic of little cubes of potassium, each cube insulated from the others, upon this mosaic was projected an image of the scene to be transmitted and the mosaic was traversed by a cathode ray, each cube discharging as the ray travelled across it, the discharge being proportional to its illumination. The fluctuating current thus produced controlled the intensity of a cathode ray at the transmitter, this cathode

ray at the receiver, the ray being caused to traverse a fluorescent screen by magnets which are energised from an alternating current transmitted from a motor which moves the mirrors at the transmitter.

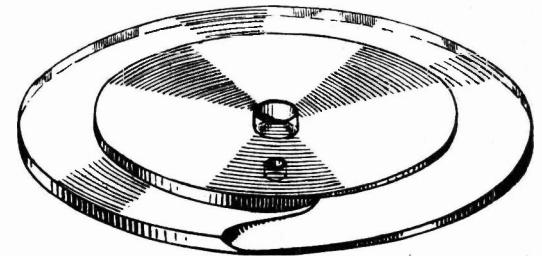

Fig. 4. The glass disc used in the Jenkins' apparatus.

In the U.S.A. Mr. Jenkins, whose name is, like that of Monsieur Belin, known in

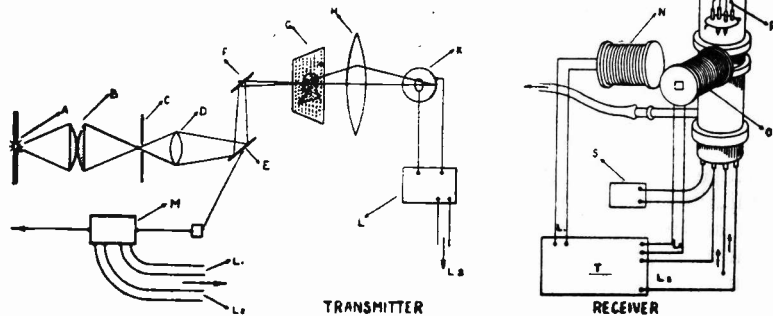

Fig. 3. Diagram showing the principles of apparatus due to MM. Belin and Holweck.

ray traversing a fluorescent screen in synchronism with the ray at the transmitter, mechanical exploring devices being thus dispensed with at both receiver and transmitter.

The apparatus of MM. Belin and Holweck is shown in Fig. 3. They are reported to have recently succeeded in sending shadows with

connection with photo-telegraphy, has, in conjunction with Mr. Moore, also succeeded in transmitting shadows. To cause their image to traverse the cell they use a prismatic disc. This consists of a circular glass disc (Fig. 4) the edge of which is ground into a prismatic section, the section varying continuously round the circumference. Light passing

through the disc is therefore bent backwards and forwards as the section changes, and by passing the image through revolving discs of this nature, it is made to traverse a photo-electric cell. The current from this cell is transmitted to the receiving station, where it controls the light from a lamp invented by Mr. Moore. This lamp changes its intensity instantaneously in proportion to the current, and its varying light is caused to traverse a screen by a similar device to that at the transmitter.

In transmitting the shadow of an object we can use unlimited light, whereas in

progress was being made. The difference between shadow transmission and true television was, I knew, immense, but how difficult the task would prove I did not realise until actually attempting it. For quite a long time no results of any kind in the transmission of the actual object could be obtained. After twelve months' continuous experimenting, however, I succeeded in sending outlines of simple objects in black and white. The step from shadows to reflected light had been taken. Although what was now done might in one sense be described as television, because it was the

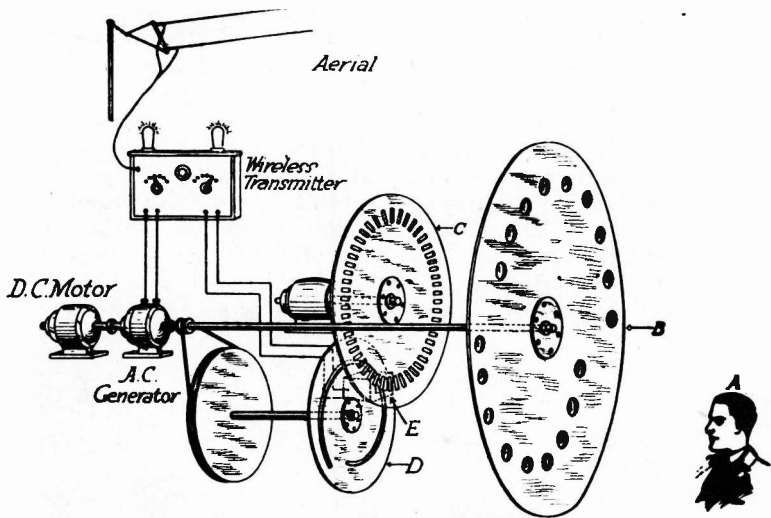

Fig. 5. Principles of the first Baird transmitter.

transmitting images of the actual object itself, only an infinitesimal light is available. To provide a sensitive device capable of responding instantaneously to this infinitesimal light was then the outstanding problem to be solved before television could be accomplished. About four years ago I decided to focus the whole of my attention on the problem of television, and realising that the first step towards the solution was the transmission of shadows, my early efforts were along those lines. The transmission of shadows proved a fairly simple matter, and some six months' experimenting enabled me to transmit crude shadowgraphs. Crude as they were, and certainly only shadows, it was very encouraging at that time to see upon the screen a definite indication that

transmission of actual objects, though only an outline and as crude black and white effects, television in the true sense of the word was still a long way off. True television means the transmission of the image of an object with all gradations of light, shade and detail, so that it is seen on the receiving screen as it appears to the eye of an actual observer. Figs. 5 and 6 shows the mode of operation of my first machine.\*

A. The object to be transmitted is placed in a powerful light. For convenience I used originally a metal filament projection lamp of 1,000 candle-power; when a dummy's head is being transmitted this is quite

\* A model of the machine on which these first results were obtained was shown.

suitable, but it is much too bright to be comfortable for a human face: in fact, even a 500 candle-power lamp at a short distance has a most unpleasant effect on the eyes, and we now use a bank of 10 ordinary 40-watt lamps at about two feet from the sitter. These lamps are controlled by a resistance and give ample illumination without distressing the person being transmitted.

The lens disc *B* contains two sets of lenses in staggered formation, each lens casts a single strip of an image of *A* across the aperture *E* as the disc revolves, and as there are two sets of eight lenses the picture is

amplified, a three-valve low frequency amplifier being used, the amplified current controls the glow discharge lamp *K*.

This lamp shines through a rectangular slot in front of which revolves a slotted disc and a lens disc similarly arranged to those at the transmitter.

These discs revolve in synchronism with the corresponding discs at the transmitter, and their combined action projects the spot of light formed at the intersection of the spiral and the slot on to the screen *F*.

This spot of light traverses the screen in exact synchronism with the traversal of the

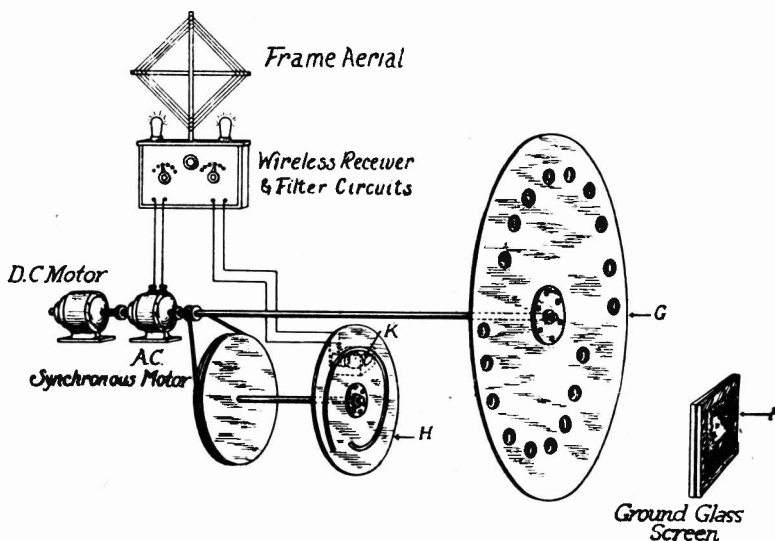

Fig. 6. The first Baird receiver.

divided into eight strips to obtain a finer subdivision, a rotating spiral slot *F* passes in front of the slot *E*. This slot rotates once for every four revolutions of the lens disc so that four times the number of strips are obtained. The slotted disc *E* revolves at 4,000 r.p.m. and interrupts the light at a high frequency.

The combined action of these revolving discs is then to cause an image of the object being transmitted to fall in a succession of little areas on to the light sensitive cell and thus generate a fluctuating current proportional to their light or shade.

This fluctuating current is transmitted to the receiving station by wire or by wireless.

At the receiving station the current is

image over the cell at the transmitter and also varies its brilliance in accordance with the intensity with which the cell is illuminated. The spot of light is thus bright at the high light and dim at the shadows and the operation is gone through with such rapidity as to cause the whole image to appear instantaneously to the eye due to persistence of vision.

Demonstrations were given at Selfridges in 1925, these being the first public demonstrations to be given of television, although many of the audience had very little thought of what it was about, the idea being prevalent that this machine heralded the disappearance of all personal privacy, and was, in fact, a kind of telescope that had merely to be

focused on any desired spot and its fortunate possessor would see exactly what was going on there, through brick walls and round corners. One lady anxiously asked if her privacy could be protected by pulling down



Fig. 7. Photograph of an image on the television screen.

blinds. When it was explained to her that there was no more danger of her being seen unaware than there was of a private conversation being overheard by the ordinary telephone, her relief was great.

This demonstration at Selfridges attracted a considerable amount of attention, but a great deal of ground had still to be covered before it would be possible to have true television and see, for example, the living face with half-tone and detail.

The machine went back to the laboratory at Frith Street and was entirely remodelled, the optical system was improved, and the mechanical imperfections as far as possible

eliminated. The effect of these alterations was greatly to improve the clearness of the images, but although much more sharp and distinct, they still remained mere black and white effects, without detail and without gradation of light and shade. The human face, for example, appeared on the screen as an oval of vivid white, and, if the mouth was opened, a flickering black spot appeared in the middle of this white oval. The trouble did not lie in the mechanical or optical part of the apparatus, but on the electrical side of the problem, and essentially in the light sensitive cell. I made many attempts to improve this, including the construction of a cell made from visual purple out of a human eye. There was considerable difficulty in obtaining the eye, but at length I was fortunate in finding a surgeon with a keen scientific interest who supplied a fresh human optic. This cell when first constructed gave a quite appreciable reaction to light.

At the present time, owing to the patent situation, I am not at liberty to give technical details of the device finally developed, but towards the end of 1925 the difficulties



Fig. 8. At the transmitting end.

were successfully overcome, and the images of various objects, including the living human face, were transmitted with half-tones and details. These images were at that time

very defective. The general effect has been compared to the earliest cinematographs, a continuous flickering being present and the images lacking in clearness and badly liable to distortion.

A photograph of one of the first images seen on the Televisor is given in Fig. 7. It is very imperfect but is the first of its kind.

These defects were chiefly due to the

The transmitter at 2TV is shown in Fig. 9. This is an ordinary telephony transmitter working on 200 metres with a power of 250 watts. Instead of sending out telephony, however, we send out these image sounds which some of you have heard. We have a licence for another transmitting station for our Harrow Laboratory, but we are only using this as a receiving station at present.

In conclusion, I will endeavour to answer

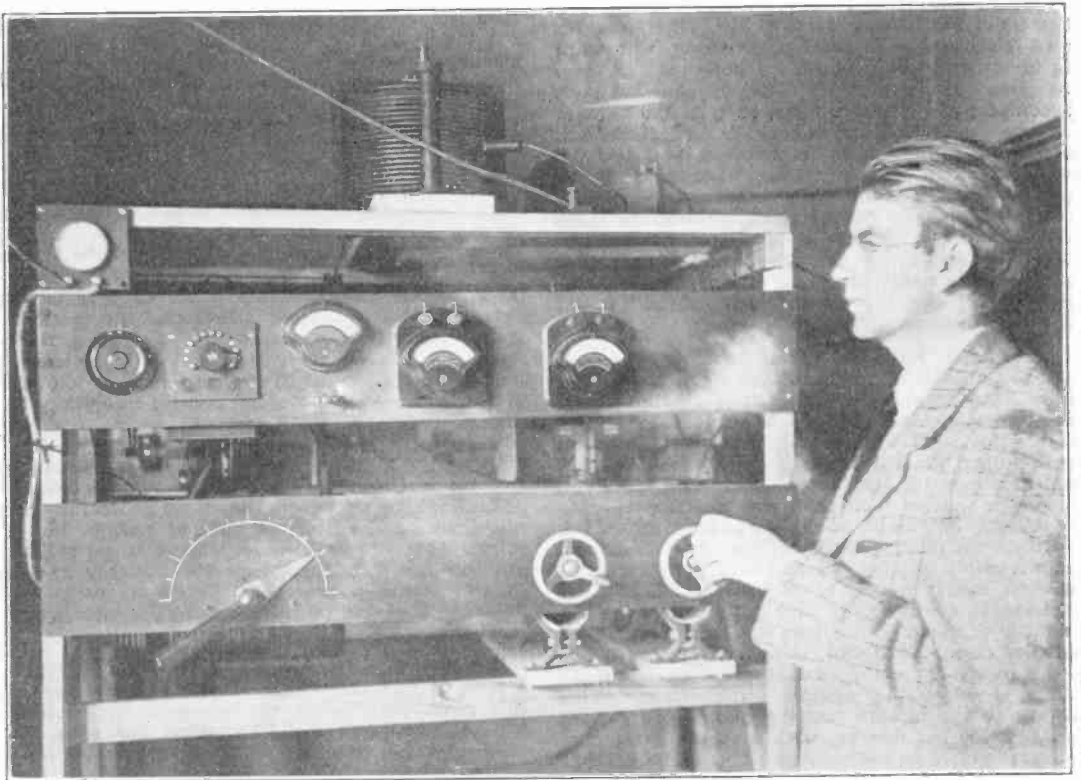

Fig. 9. *The experimental transmitter 2TV.*

mechanical and electrical imperfections in construction. They are being steadily eliminated.

Fig. 8 shows subjects being televised to Harrow from 2TV. Some of you who have been working on 200 metres will have heard his face going through the ether as an unpleasant rasping sound. Different faces give different notes, and it is quite possible to distinguish between two different faces by their sounds.

a question which is very often asked, that is when are televisors to be available to the public? The answer to this question depends upon many considerations. The step from the laboratory to a marketable commodity entails a very considerable amount of development work and also financial organisation. If, however, we decide to place on the market an apparatus capable of receiving images of such restricted views as the head and shoulders of the person speaking into

the microphone, I think it is safe to state that such machines will be in the hands of the amateur experimenter before the end of the ensuing year.

Wireless telephony owes its present state of development in no small measure to the activities of the amateur, and unquestionably, the future development of television will be at least equally influenced by his co-operation.

### DISCUSSION.

**Mr. A. Hinderlich:** One statement made was that Mr. Baird was placing the results of his researches at the disposal of amateurs who want to investigate this problem. I hope that we shall be given some account in detail of what has been accomplished—the bare facts, such as the number of dots per second and the number of gradations of light that have been transmitted, and also the weak spots in the apparatus, whether it is the photo-electric cell or some other part, so that research could be concentrated in order to solve the problem as quickly as possible. I hope that Mr. Baird will find it possible to add to his paper and give that sort of detail with regard to those portions of the apparatus which at the present time are in most need of improvement.

**A Visitor:** I think Mr. Baird and Colonel Yelf are to be heartily congratulated upon the results they have obtained. The historical summary of the previous work on the subject is extremely interesting. There are a number of technical points upon which I, as an amateur in this subject, am anxious to get information, and possibly, although Colonel Yelf does not wish to reply to questions, Mr. Baird may be induced to send a written communication. In Fig. 5 a disc was shown with a number of lenses arranged in a spiral fashion, and it seemed to me that that is just the equivalent of having a single fixed lens and a number of small spiral holes arranged on a much smaller disc. No doubt, however, Mr. Baird has some reason for using what appears at first sight to be a somewhat clumsy arrangement. With regard to the rapidly rotating disc, which rotates 4,000 times per minute, with a view to chopping up the light, I do not quite see how this scheme is going to be used if a large number of impulses are being sent. Supposing, for example, 100,000 impulses are being sent per second. That would make a picture a few square inches in size, and the chopping up effect would have to be at least 10 times as rapid. That would be 1,000,000 per second, and one seems to get at once to a speed at which it would be impossible to rotate the disc rapidly enough. I am sorry that we did not hear more details of the actual apparatus that is being used at present, but no doubt the patent situation is responsible for that.

**Lieut.-Colonel Yelf:** I very much regret that I am quite unable to reply to technical questions. Mr. Baird told me, however, that he would certainly answer any questions that were put to him, on paper or in any other fashion. As I have said, he was very sorry that he could not get here in person.

I cannot do more than to ask you to write to him or to see him, and I am sure he will clearly explain all these technical things.

**Mr. Maurice Child:** In order to get my remarks on record, and in order that we shall not miss an opportunity, as a Society, to make it known that we are alive to the forces which may be acting, and sometimes do act, against our interests as pure experimentalists, I want to raise the question—which no doubt Mr. Baird will answer, either in correspondence or in the Press—of the necessity which I gather from this paper has arisen for him to obtain a licence from the Postmaster-General to conduct his experiments on television. The 1904 Act very specifically lays down that it shall not apply in any way to the use of electrical machinery or the use of waves for the control of electrical machinery other than for the transmission of messages. I am afraid I have not quoted it absolutely correctly, but it is very nearly that. Now, it is important that we, as a Society, should watch the working of that Act very closely while it is still law. Of course, it may be that Mr. Baird has required a licence in order to use his apparatus for telegraphic or telephonic purposes as well as the transmission of pictures. As I read the Wireless Act, I think it is not absolutely necessary in law that he should obtain a licence to conduct experiments in wireless television, the wireless transmission of pictures, or the transmission of images. It is not necessary in law to obtain a licence when we want to control a boat by the use of Hertzian waves. We can control machinery at distances by the use of Hertzian waves, and we can generate those waves in any way we like without the necessity of going to the Postmaster-General for permission. Whether it is necessary or desirable in the future that some control should be taken by the State is another matter, but I submit that we, as a Society, have to be careful not to allow little things like this possibly to slip in and create a precedent. That is really my object in speaking on this point in the interests of the Society.

**The Chairman (Brig.-Gen. Sir H. Capel Holden):** I hope it is clearly understood by everybody, in this room that unless the television transmitter can see you—and the transmitter has only the powers of the human eye, so to speak—nothing will be transmitted, and therefore, the control of television is very complete. It is rather curious, I think, that the apparatus invented by Mr. Baird should depend to a certain extent, if not entirely, upon what might almost be called a defect in the human eye; that is, the fact that the human eye has its limitations in seeing intervals of light and darkness—if I may put it quite simply—and is not able to pick up a number of pictures at more than a definite rate. I am talking now of a number of different pictures. We see this in the everyday application of the cinematograph. We know that the standard number of pictures per second—*i.e.*, the minimum—which is necessary to give you a continuous picture, or what appears to be a continuous picture to the eye, is 16. If it were not for that fact I think that the present ideas and apparatus for the transmission of objects—television, in fact—would not be practicable at all.



My own feeling is this, that if television is to come to stay it will come in some very simple and unexpected way. I remember that when the telephone was invented people, such as Reis and others who had been working on similar lines before, had not realised that a simple piece of apparatus such as the Bell telephone—which is still, I was going to say, unimproved, or very little improved—could possibly be made to record the variations and fluctuations of the human voice. The telephone, as we all know, passed the stage of being a curiosity a long while ago. At the same time, speaking as one who can remember the original telephone and the reception it had from scientific men, I can say that those who had not seen it said it did not exist, and those who did see it marvelled at it and said they did not understand how it could possibly work in the way that it did. Before sitting down I might just remind you that at the time of the Jubilee of the electric telegraph the late Sir William Preece, at the *Conversazione* held at the Natural History Museum, South Kensington, showed an apparatus which did exactly what we have been asked to picture in the future. My recollection of it is this. There were two rooms

at the Natural History Museum in which the apparatus was situated, and one was asked to send one's friend to one end of the line, and to speak to him or her from the other end. One person did so, and another sat down at the table with the ordinary telephone receiver and transmitter. Beside the transmitter in front of the speaker there was a black velvet curtain, and having called up one's correspondent at the other end, and having received the reply signal in the ordinary way, the curtain went up, one saw one's friend sitting at the telephone and heard him, or her, speak. This was the gigantic success of the evening, but unfortunately, Sir William Preece, or the people who were responsible for the entertainment, omitted to state that the whole thing was a fake and that all one was doing was merely to look through a piece of thick plate glass, somebody having taken your friend right through the Museum and back again to the other side of the glass. The disastrous part of it was that some of the most prominent papers of the country had leading articles about it the next day, not having been warned that the whole thing was a conjuring trick, if you like to call it so.

---

# Wireless Development Since the War.

I.E.E. Wireless Section—Chairman's Address.

[R599

## Abstract.

**T**HE opening meeting for the new session of the I.E.E. Wireless Section was held on 3rd November, the chair being taken by the Institution President, Dr. Eccles.

The first business was the moving, by Mr. E. H. Shaughnessy, of a vote of thanks to the retiring Section Chairman, Major B. Binyon, for his services during the previous session. Reference was particularly made to the work of Major Binyon in the recent new constitution of the Wireless Section, and to the high professional status now conferred by membership of the Section. The vote was seconded by Dr. R. L. Smith-Rose, and carried with acclamation, when Major Binyon briefly replied.

The President then introduced the Section Chairman for the new session—Prof. C. L. Fortescue—who proceeded to deliver his inaugural address.

He too made reference to the new constitution of the Wireless Section, and to the value of membership as a mark of professional standing. It had been further decided to inaugurate local Wireless Sections at the Institution Centres throughout the country, and one had already been started in the South Midland Centre at Birmingham.

The papers read before the Section constituted a record of current wireless development. It was notable that there had been recently no paper on short wave working, and he hoped that something of the kind might be given this session. Several papers read were of interest to line engineers, and it was to be hoped that there might be close co-operation between this activity of the main Institution and the Wireless Section to cover the complete field of electrical communication.

The outstanding feature of the past twelve months had been the opening of the Rugby Station. Whether or not this was the last long wave station, it was a monument to the engineering solution of practical problems. The continued development of Broadcasting

was satisfactory, and great service had been rendered by this agency during the General Strike. The transmission of pictures was now developed to the extent of establishing a regular service. It was doubtful if the value of this was recognised, and it was possible that in the near future it might be more advantageous to transmit a sheet of print as a picture than by the present methods. Considerable possibilities of television were also opened up.

The Chairman then turned to a critical review of the development of wireless in the past seven years. In 1919, he said, most of the war-time developments were well known, but little had been applied commercially. He proposed to discuss progress in the matter of Transmitters, the Transmitting Medium, and Receivers.

## Transmitters.

The position of the arc generator remained unchanged. The necessity for coupled circuits had already been recognised and it had been shown by P.O. engineers that the use of coupled circuits did a great deal to clean up the emission from an arc generator. It was unlikely that the arc could now compete with H.F. alternators and valve transmitters.

As regards H.F. alternators, the Alexanderson form, using a frequency equal to that of the aerial, required revolution at about twice the normal commercial speeds. The Latour machine in France approached more nearly to commercial forms. In Germany an alternator had been designed generating at 10kC frequency, and had been used with transformers for C.W. transmissions at 500kC (600 metres). Little information was available as to the working performance of alternators, but it was apparently satisfactory.

The development of the power-valve for transmission had followed the lines foreshadowed in 1919. Silica valves up to 25kW anode dissipation had been made, while the water-cooled type had become possible

by the improvement of technique, rendering it practicable to seal nickel into glass. These and silica valves were both permanently sealed and suffered the same disadvantage as the glass type in the matter of filament renewal. An alternative type, initiated in Britain but developed in France, used ground-glass seals, and was permanently connected to the pumps. The disadvantages of this were less serious than at first appeared, since any filament renewal at a transmitting station involved the use of pumps.

Practice varied as to the rating of valves, but anode dissipation with safe anode voltage appeared to be the most desirable standard to specify. This problem was allied to that of valve amplification factor and grid mesh.

The Rugby system of tuning fork control appeared to be likely to become standard. Looking ahead a number of transmitters might be controlled by one or two forks at a central standardising establishment.

Modulation for both morse and telephony had been perfected in detail. For the latter especially, the demand was for freedom from distortion, and the modern microphones, while less sensitive, satisfied this requirement. All emissions could be regarded as a carrier and sidebands—hand-speed morse corresponding to a narrow band, high-speed morse and telephony to wider bands. Telephony could now be conducted with the carrier and one sideband suppressed, and it was possible that the same might be done for high-speed morse.

### The Transmitting Medium.

In 1919 the need for a reflecting layer theory was already recognised. Down to 1,000 metres the Austin Cohen formula gave sufficient accuracy, but with waves of below 100 metres there were new factors, especially that of skipped distance. The present theory was that the layer was not a layer, but a region where the mean free path of electrons became a few centimetres. The effect of the waves on light electrons was discussed by the lecturer and illustrated by slides. The refraction was less with long waves. At about 200 metres wavelength there appeared to be a critical or resonance effect, marking the change of effective index of refraction from long to short waves. The loss of energy due to absorption by the layer

was small. Refraction into space was perhaps more important, but he doubted the extent of this action.

Generally the effect was that with long waves the direct ray did not fall off rapidly. The upward ray was quickly reflected, and at about 10,000 metres regions of poor reception caused by this interference were definitely established. At greater distances the effects were complicated by multiple reflections. With short waves the direct wave fell away rapidly, and the effect beyond the skip was due to the returned waves coming down with just sufficient bend to arrive back at the earth at the receiving station. These waves would always be liable to changes in the layer, and short waves were always likely to be subject to marked fading. The matter was one in which the mathematical physicist, the geophysicist and the wireless engineer were all interested.

### Receivers and Reception.

The lecturer then turned to the matter of the receiver. As regards special aerials the Beverage antenna had given good results, though its theory was still uncertain. It was generally thought its action was due to standing waves being set up by the horizontal component of the incoming wave, but it was pointed out that, even if there were no horizontal component, the vertical field would still tend to produce this result.

Receiver selectivity still depended on the balance between negative and positive reactance. The design of a receiver depended on the width of band to be received. For telephony all side bands up to 5,000 cycles were necessary, while the argument for high-speed telegraphy was similar.

There had been no important changes in the aspects of amplification, but the importance of neutralising electrode capacity was now fully appreciated. The alternative problem of shielding the grid had been tried, and good results had so far been obtained.

Atmospherics still imposed a lower limit on reception, and work on their wave form had shown the shapes of these impulses to be capable of expression as an infinite number of *sine* wave terms. A receiver of any band width will thus absorb the energy present for that band. No limiting device yet gave much change of the signal/atmospheric ratio, and the only other remedy was

increase of power. How far this could be carried was a matter for the urgent attention of the authorities concerned.

As regards high frequency measurements, the most important was that of frequency itself, and this could now be made with an accuracy of 1 in 100,000. This accuracy was not in excess of that required in practice, since the allocation of broadcasting frequencies involved no aural heterodyne at  $1\frac{1}{2}$  million cycles. Stations on the same wavelength must therefore be identical. The quartz oscillator was an important contribution to frequency stability.

### **Broadcasting.**

As regards Broadcasting itself, in 1919 this was not in existence, although morse broadcast of news was already well known. In both Great Britain and America, post-war amateur interest had centred on telephony, and astonishing developments had occurred in five years. The problem of programmes would never be settled until every receiver had a choice of three programmes. In this connection transmitters near populous areas might need review.

Whatever the future progress under the Broadcasting Corporation, the Broadcasting Company had rendered great public service. Opinion was agreed that the controlling body must have a strong standing for the sake of both national and international arrangements.

As regards the interference from commercial traffic, especially on spark signals, the lecturer offered a suggestion of solution. The standard to be considered must be that of the number of individuals benefited. In this view the advantage was with broadcasting, which called for a lessening of interference from commercial coast work. This objection did not, of course, apply to distress or emergency signals. The lessening of this interference was largely a financial concern. Might it not be possible to apply some of the surplus broadcasting revenue to the reduction of this commercial interference?

---

On the motion of the President, Prof. Fortescue was cordially thanked for his address, which was ordered to be published in the Journal of the Institution.

# Further Notes on the Laws of Variable Air Condensers

(With special reference to Aerial Tuning Condensers).

By *W. H. F. Griffiths.*

[R381·4

**I**N a recent issue of *E.W. & W.E.\** the present author developed a number of formulæ for the determination of the plate shapes necessary in order that variable condensers of the rotating plate type shall have definite laws connecting wavelength (or frequency) and angular movement.

The laws dealt with were the following :—

No.	Capacity Law (the generally accepted nomenclature)	Law of Wave-length (or frequency)	Plate shape given by :—
1	Ordinary straight line law (of capacity)	—	$R_1$
2	Square law (of area only)	—	$R_0$
3	Corrected square law	Straight line law of wave-length	$R_2$
4	Inverse square law	Straight line law of frequency	$R_3$
5	Exponential law	Uniform percentage change of both wave-length and frequency	$R_4$

Examples of plate shapes were also given for condensers to suit these laws and having quite normal values of residual capacity. In these examples a residual capacity value of  $36\mu\mu\text{F}$  (at zero scale reading) was assumed, the actual minimum value of the condenser being augmented by coil distributed capacity, inter-electrode valve capacity, lead capacities, etc., to give this resultant residual value.

If the condensers to be designed are,

however, to be used as aerial tuning condensers in parallel with aerial loading inductances or in other circuits where appreciable values of capacity are constantly in parallel with them, their plate shapes will be very different from those of the examples given in the previous article. As the ratio of maximum to minimum capacity becomes smaller, the plate shape naturally becomes

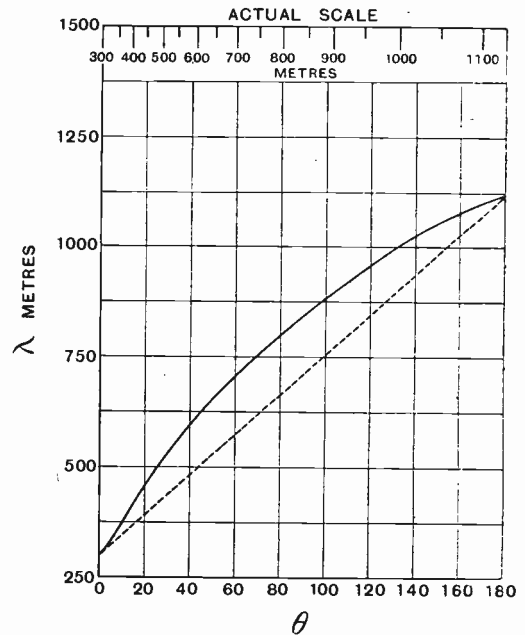

Fig. 1.

more nearly semi-circular, so much so that, in some cases of parallel tuning of large aerials, a variable condenser having ordinary semi-circular plates will give a wavelength law more nearly linear than that obtained by the use of corrected square law plates, designed for condensers having residual capacities of lower values.

If a variable condenser having minimum and maximum values of  $16\mu\mu\text{F}$  and  $480\mu\mu\text{F}$

\* January, 1926.

respectively is connected in a circuit whose augmenting capacities amount to, say,  $20\mu\mu\text{F}$  only, its effective residual and maximum values are  $36\mu\mu\text{F}$  and  $500\mu\mu\text{F}$ . An ordinary semi-circular plate condenser having these values (and augmented to this extent) will give the wavelength curve,  $50\sqrt{C}$ , shown by the full line curve of Fig. 1, far removed from a linear law. The same condenser used in circuits having initial augmenting capacities of  $84\mu\mu\text{F}$  and  $284\mu\mu\text{F}$ , produces the wavelength curves of Figs. 2 and 3 respectively. From these curves it will be seen that a semi-circular plate condenser will give a fair approximation to an even scale of wavelength if its zero is sufficiently "set up" by a comparatively large value of constant parallel capacity.

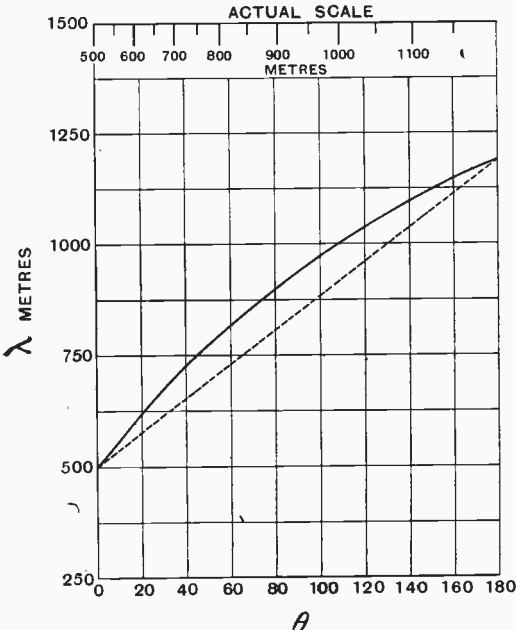

Fig. 2.

In order to visualise more clearly the wavelength scales corresponding to these three curves, scale graduations at 50-metre intervals have been included in Figs. 1, 2 and 3.

It is interesting to design the plate shapes that will be necessary in order to make these wavelength scales absolutely uniform using formula (13) of the previous notes.

$$R_2 = [114.6\{2ka_2(a_2\theta + b_2) + K\}]^{\frac{1}{2}}$$

where

$$k = \frac{\text{Total plate area} - 180K}{\text{Maximum capacity} - \text{Residual capacity}}$$

$$K = \frac{r^2}{114.6} \text{ (r being the radius of the central cut-away portion of fixed plates.)}$$

$$a_2 = \frac{\sqrt{\text{Maximum cap.}} - \sqrt{\text{Residual cap.}}}{180}$$

and

$$b_2 = \sqrt{\text{Residual capacity.}}$$

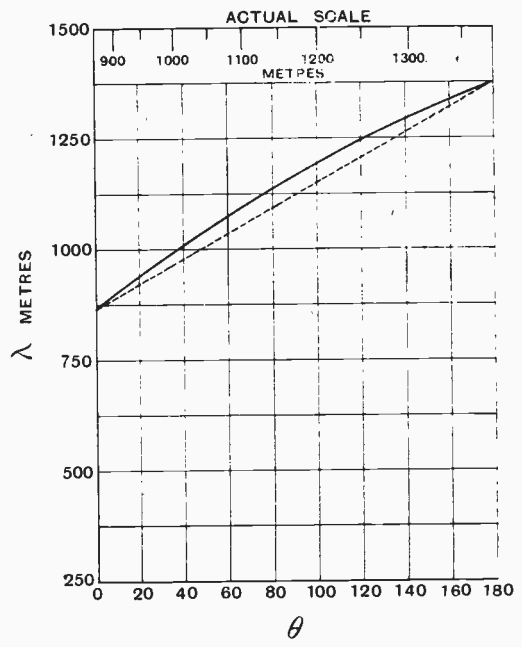

Fig. 3.

The radii of these plates at various angles  $\theta$  are given in the table on next page; in each case the minimum capacity of the actual condenser itself is taken to be  $16\mu\mu\text{F}$  and the maximum value  $480\mu\mu\text{F}$ , the three cases being for added constant capacity values of  $20\mu\mu\text{F}$ ,  $84\mu\mu\text{F}$  and  $284\mu\mu\text{F}$ .

The total plate area is in each case assumed to be 20 square centimetres.

The plate shapes drawn from these values are given in Fig. 4, A, B and C; semi-circles have been drawn in on these shapes to facilitate comparison. In Fig. 5 the radii are plotted against angular displacement. Since all these plates have been designed

to give the same total area their radii at 90 degrees are equal and the curves therefore all cross at this point *O*. As the ratio

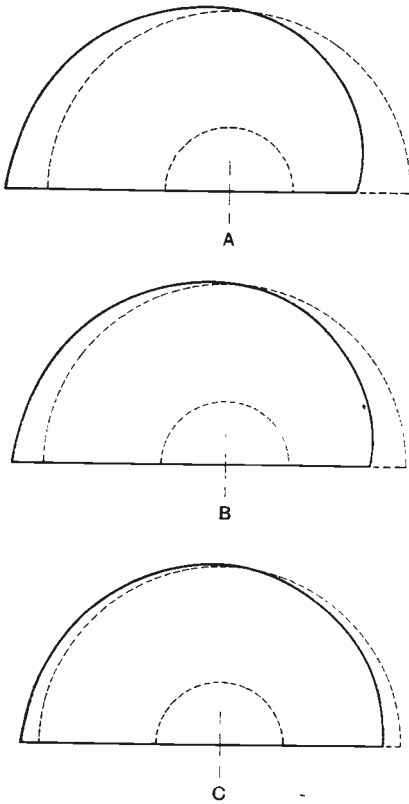

Fig. 4.

of maximum to residual capacity becomes less, the curves become flattened and more nearly horizontal, a horizontal line *OD*

THE RADII OF PLATES AT VARIOUS ANGLES  $\theta$

$\theta$ deg.	Radius A	Radius B	Radius C
	Max. Cap. 500 $\mu$ F. Resid. Cap. 36 $\mu$ F.	Max. Cap. 564 $\mu$ F. Resid. Cap. 100 $\mu$ F.	Max. Cap. 764 $\mu$ F. Resid. Cap. 300 $\mu$ F.
	cms.	cms.	cms.
0	2.49	2.85	3.19
10	2.62	2.94	3.23
20	2.76	3.02	3.27
30	2.89	3.11	3.32
60	3.24	3.35	3.45
90	3.56	3.57	3.57
120	3.85	3.78	3.69
150	4.12	3.98	3.81
180	4.37	4.17	3.92

through the point *O* being, of course, the curve corresponding to an ordinary semi-circular plate of the same area, and therefore for a condenser of the same capacity.

In Fig. 6 two curves are given from which corrected square law plate shapes can be at once roughed out for any capacity provided that the ratio of maximum capacity to minimum capacity does not exceed 15.

The required total plate area being known, the plate radius ( $R_{90}$ ) at 90 degrees is first found from

$$R_{90} = \sqrt{\frac{2 \text{ (total plate area)}}{\pi}}$$

and the radii at  $0^\circ$  and  $180^\circ$  are then directly determined after reading the ratios  $R_{180}/R_{90}$  and  $R_{90}/R_0$  from the curves of Fig. 6.

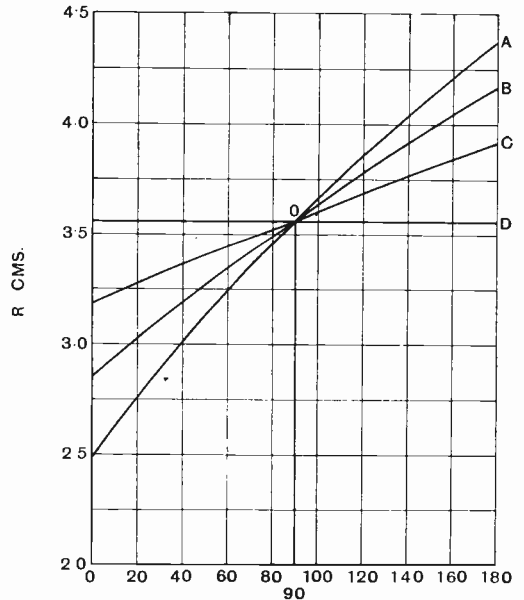

Fig. 5.

It should be noted that both of these ratios become unity when the ratio of maximum capacity to residual capacity is reduced to unity, *i.e.*, when the capacity change is made infinitely small the corrected square law plate becomes an ordinary semi-circular plate.

From a knowledge of the radii at  $0^\circ$ ,  $90^\circ$  and  $180^\circ$ , a corrected square law plate may be sketched out with fair accuracy if

the ratio of the resultant (augmented) capacities at  $180^\circ$  and  $0^\circ$  is not greater than 15.

Although it is a relatively easy matter to design plates for condensers to conform to definite laws when such condensers are to be connected in *parallel* with other "zero augmenting" capacities, it is rather more difficult to design suitable plates for use in variable condensers to be used in *series* with constant fixed capacities, such as is the case with series aerial tuning condensers. It is important to be able to obtain definite "laws" from such variable condensers, also, for the reason that the accuracy and constancy of a large variable condenser is often

plate condenser of  $500\mu\mu\text{F}$  maximum capacity and  $36\mu\mu\text{F}$  residual capacity, and the corresponding curve of resultant

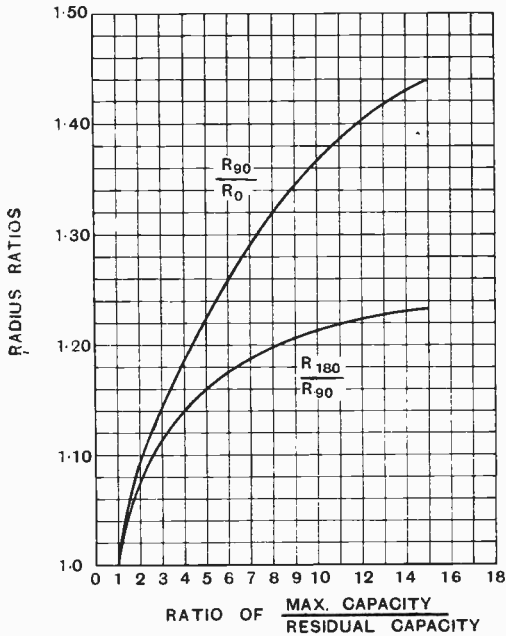

Fig. 6.

improved considerably by the addition of a low value *fixed air condenser of great constancy* in series with it. The chief objection to a series fixed condenser is its alteration of the "law" of the variable condenser with which it is associated. This, of course, is the case even with the linear law of capacity condenser of the ordinary semi-circular plate type as the curves of Fig. 7 show. This figure gives the capacity curve  $C$  of an ordinary semi-circular

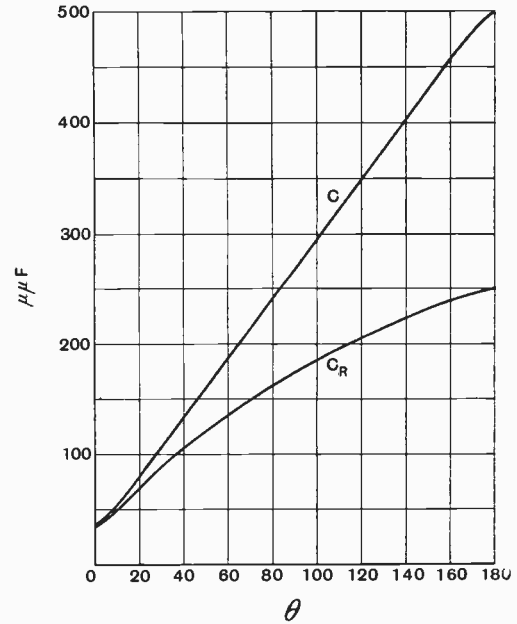

Fig. 7.

capacity  $C_R$  when a  $500\mu\mu\text{F}$  constant value condenser is added in series with it. Since the wavelength of an oscillatory circuit

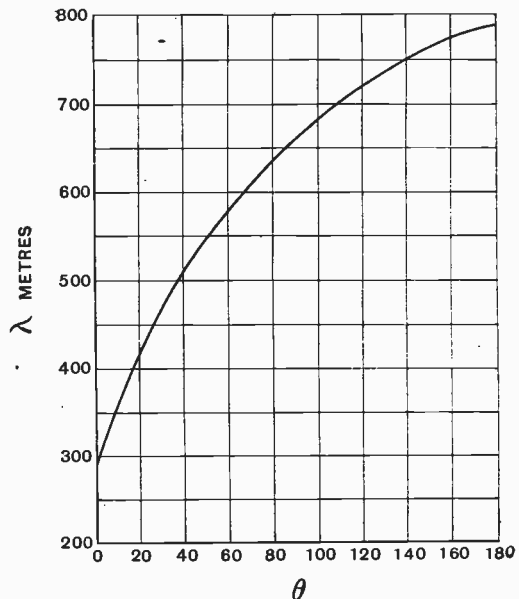

Fig. 8.



is proportional to the square root of its capacity it follows that the curve of wavelength plotted against degree scale reading will, in this case, be very far from ideal. The wavelength curve  $\lambda = 50\sqrt{C_R}$  obtained with this resultant capacity is given in Fig. 8.

The design of a plate shape to give a straight line law of capacity when the variable condenser for which it is intended is used in series with a fixed capacity will now be proceeded with. This will be followed by a similar treatment of all the other special laws useful in wireless engineering.

**Plate Shape for Straight Line Law of Capacity (with fixed series capacity).**

Let  $C$  be the capacity of a variable condenser,  
 $C_f$  the capacity of a constant value condenser in series with  $C$ ,  
 and  $C_R$  the resultant capacity of the two condensers in series.

In order that  $C^R$  shall increase uniformly with angular rotation of plates, the law

$$C_R = a\theta + b \quad \dots \quad (27)$$

must be satisfied.

But

$$\frac{1}{C} = \frac{1}{C_R} + \frac{1}{C_f} = \frac{C_f - C_R}{C_f C_R}$$

$$\therefore C = \frac{C_f C_R}{C_f - C_R}$$

Hence, from (27), writing  $C_s$  for  $C$  in this particular case,

$$C_s = \frac{C_f (a_s\theta + b_s)}{C_f - (a_s\theta + b_s)} \quad \dots \quad (28)$$

where  $a_s$  and  $b_s$  are constants depending upon the maximum and augmented residual capacities of the variable condenser and upon the value of  $C_f$ .

When  $\theta = 0$ ,  $C_s$  must obviously equal the residual capacity of the condenser, and so:—

$$\text{Residual capacity} = \frac{C_f b_s}{C_f - b_s}$$

from which

$$b_s = \frac{C_f (\text{Residual capacity})}{C_f + \text{Residual capacity}} \quad \dots \quad (29)$$

And when  $\theta = 180$ ,  $C_s$  must be the maximum

capacity of the variable condenser, and so:—

$$\text{Maximum capacity} = \frac{180C_f a_s + C_f b_s}{C_f - (180a_s + b_s)}$$

from which

$$a_s = \frac{1}{180} \left\{ \frac{C_f (\text{Max. cap.})}{C_f + \text{Max. cap.}} - b_s \right\} \quad (30)$$

For any desired values of maximum and residual capacities and with any value of fixed series capacity therefore, the capacity at any scale position required to give a straight line law of resultant capacity can be directly calculated from equation (28).

$C_s$  is, of course, a composite capacity consisting of the residual capacity plus that due to actual plate area in operation, and the part due to actual operative plate area is, naturally, equal to:—

$C_s$  — Residual capacity.

Therefore, from equation (28), the area of the plate at any angle  $\theta$  will be given by:—

$$A_s = k \left\{ \frac{C_f (a_s\theta + b_s)}{C_f - (a_s\theta + b_s)} - \text{Res. cap.} \right\} \quad (31)$$

where  $k$  is a constant depending upon the total plate area.

This, however, neglects to take account of that semi-circular portion of the moving plate which is rendered inoperative by the cut-away portion of the fixed plates round the central spindle of the condenser. A term must be added to compensate for this.

The inoperative area is always a sector of a circle of radius  $r$  and is

$$\frac{\theta}{2 \times 57.3} \cdot r^2$$

and this may be written  $K\theta$  where the constant  $K = r^2/114.6$ .

The complete expression for plate area now becomes:—

$$A_s = k \left\{ \frac{C_f (a_s\theta + b_s)}{C_f - (a_s\theta + b_s)} - \text{Res. cap.} \right\} + K\theta \quad (32)$$

when  $\theta = 180$ ,  $A_s$  is, of course, the total plate area, and if this is given, the value of the constant  $k$  may be found, for:—

$$\begin{aligned} \text{Total plate area} \\ = k \{ \text{Max. cap.} - \text{Res. cap.} \} + 180K \end{aligned}$$

from which the constant

$$k = \frac{\text{Total plate area} - 180K}{\text{Max. capacity} - \text{Res. Capacity}} \quad \dots \quad (33)$$

From equation (5) of the original article\* the radius  $R$  at any angle  $\theta$  is:—

$$R_s = \sqrt{114.6 \frac{dA_s}{d\theta}}$$

and, from (32)

$$A_s = k \left\{ \frac{C_f(a_s\theta + b_s)}{C_f - (a_s\theta + b_s)} - \text{Res. cap.} \right\} + K\theta$$

$$\therefore \frac{dA_s}{d\theta} = \frac{ka_s C_f^2}{\{C_f - (a_s\theta + b_s)\}^2} + K \quad \dots (34)$$

Therefore the radius of the uniform resultant capacity variation plate at any angle  $\theta$  is given by:—

$$R_s = \left[ 114.6 \left\{ \frac{ka_s C_f^2}{\{C_f - (a_s\theta + b_s)\}^2} + K \right\} \right]^{\frac{1}{2}} \quad (35)$$

As an example, a condenser having a maximum value of  $500\mu\mu\text{F}$  and an augmented residual value of  $36\mu\mu\text{F}$  has been taken, (these values are those of the ordinary condenser for which the curves of Figs. 7 and 8 were plotted), and a fixed capacity of  $500\mu\mu\text{F}$  is assumed to be connected in series with it. The total plate area permissible is assumed to be 20 square centimetres and the centre "cut-away" radius  $r$  of fixed plates to be 1.2 centimetres. It is required

$\theta$ deg.	$R_s$ (cms.)
0	2.74
10	2.80
30	2.92
50	3.06
70	3.22
90	3.40
110	3.66
130	3.88
150	4.18
170	4.52
180	4.73

to give a resultant uniform capacity scale.

The capacity curve  $C_s$  for this condenser calculated from (28) is given in Fig. 9

\* The radius of the plate at any angular position  $\theta$  may be found in the following manner:—

For small angular increments,  $\delta\theta$ , the incremental areas may be regarded as sectors of circles of radius  $R$ , and as the area of a sector of a circle is:—

$$\frac{\alpha}{2 \times 57.3} \cdot R^2 \quad (\text{Radian} = 57.3 \text{ degrees}).$$

$$\therefore \delta A = \frac{\delta\theta}{2 \times 57.3} \cdot R_s^2$$

From this

$$R = \sqrt{\frac{114.6 \delta A}{\delta\theta}}$$

and by making the angular increments  $\delta\theta$  infinitely small the exact value of  $R$  is obtained thus:—

$$R = \sqrt{114.6 \frac{dA}{d\theta}}$$

together with its required resultant capacity curve  $C_R$  from (27). The tabulation below gives the radii ( $R_s$ ) of the required plate calculated from formula (35) and Fig. 10 shows the plate shape drawn using these radii.

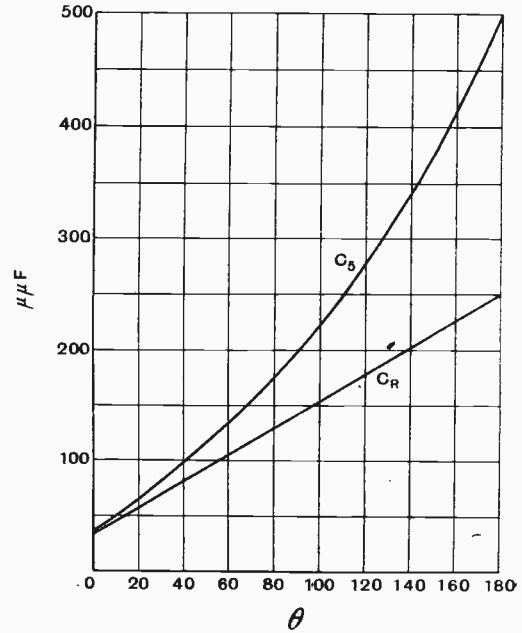

$$C_s = \frac{C_f(a_s\theta + b_s)}{C_f - (a_s\theta + b_s)}$$

Fig. 9.

Beneath this plate shape is drawn the ordinary semi-circular plate of equal area for the condenser when the series capacity is increased to infinity (short-circuited).

In this case

$$C_1 = (a_1\theta + b_1)$$

where  $b_1 = \text{Residual capacity}$

and  $a_1 = \frac{\text{Max. capacity} - \text{Res. capacity}}{180}$

$$A_1 = k \{ (a_1\theta + b_1) - \text{Residual capacity} \} + K\theta$$

$$\frac{dA_1}{d\theta} = ka_1 + K$$

$$\therefore R_1 = [114.6 \{ ka_1 + K \}]^{\frac{1}{2}}$$

which, of course, being constant, is the radius of a true semi-circle.

Fig. 11 gives the wavelength curve  $\lambda = 50\sqrt{C_R}$  obtained with the condenser having plates of radii  $R_s$  for comparison

with that of Fig. 8 obtained when using an ordinary semi-circular plate condenser in series with the same fixed capacity.

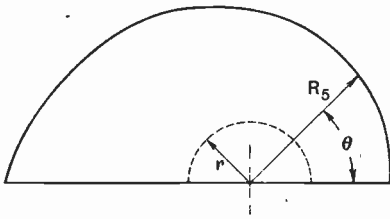

$$R_5 = \left[ 114.6 \left\{ \frac{ka_5 C_f^2}{\{C_f - (a_5 \theta + b_5)\}^2} + K \right\} \right]^{\frac{1}{2}}$$

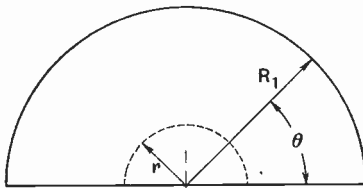

$$R_1 = \left[ 114.6 \{ka_1 + K\} \right]^{\frac{1}{2}}$$

Fig. 10.

**Plate Shape for Corrected Square Law of Capacity (with series fixed capacity).**

The same method may be employed to design a plate to give a uniform wavelength scale to a series variable condenser.

Employing similar notation to that of the previous case the resultant capacity of the variable and fixed capacities in series will have to be such that:—

$$C_R = (a\theta + b)^2 \dots \dots (36)$$

and

$$C = \frac{C_f C_R}{C_f - C_R}$$

$$\therefore C_s = \frac{C_f (a_s \theta + b_s)^2}{C_f - (a_s \theta + b_s)^2} \dots (37)$$

as before, when  $\theta = 0$ ,  $C_s =$  Residual capacity,

$$\therefore \text{Residual capacity} = \frac{C_f b_s^2}{C_f - b_s^2}$$

from which the constant

$$b_s = \sqrt{\frac{C_f (\text{Residual capacity})}{C_f + \text{Residual capacity}}} \quad (38)$$

and when  $\theta = 180$ ,  $C_s =$  Maximum capacity,

$$\therefore \text{Maximum capacity} = \frac{C_f (180a_s + b_s)^2}{C_f - (180a_s + b_s)^2}$$

from which the constant

$$a_s = \frac{1}{180} \left\{ \sqrt{\frac{C_f (\text{Max. cap.})}{C_f + \text{Max. cap.}}} - b_s \right\} \quad (39)$$

As in the previous case, the capacity due to the actual operative plate area is equal to  $C_s -$  Residual Capacity. Therefore, from (37) the area of the plate in operation at any angle  $\theta$  will be given by:—

$$A_s = k \left\{ \frac{C_f (a_s \theta + b_s)^2}{C_f - (a_s \theta + b_s)^2} - \text{Res. cap.} \right\} + K\theta \quad (40)$$

the term  $K\theta$  being added to compensate for the inoperative centre portion of the plate as in the previous case.

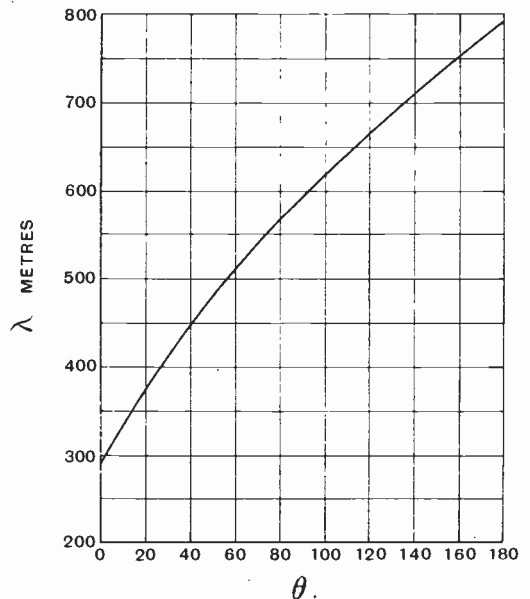

Fig. 11. (See also Figs. 14, 17 and 20.)

The area constants  $k$  and  $K$  have the same values as in all previous cases.

As before, the plate radii are found from the expression

$$R_s = \sqrt{114.6 \frac{dA_s}{d\theta}}$$

$$A_s = k \left\{ \frac{C_f (a_s \theta + b_s)^2}{C_f - (a_s \theta + b_s)^2} - \text{Res. cap.} \right\} + K\theta$$

$$\therefore \frac{dA_s}{d\theta} \text{ (for the whole area expression)}$$

$$= \frac{2ka_6C_f^2(a_6\theta + b_6)}{\{C_f - (a_6\theta + b_6)^2\}^2} + K \quad (41)$$

Therefore the radius of the resultant uniform wavelength variation plate at any angle  $\theta$  is given by:—

$$R_6 = \left[ 114.6 \left\{ \frac{2ka_6C_f^2(a_6\theta + b_6)}{\{C_f - (a_6\theta + b_6)^2\}^2} + K \right\} \right]^{\frac{1}{2}} \quad (42)$$

Radii are quite quickly calculated from this expression and as an example a plate having the same total area as before and for the same values of maximum and residual capacity has been calculated for use with the same value of series fixed capacity.

- Maximum capacity = 500  $\mu\mu\text{F}$ .
- Augmented residual capacity = 36  $\mu\mu\text{F}$ .
- Series fixed capacity = 500  $\mu\mu\text{F}$ .
- Total plate area = 20 square cms.
- $r$  = 1.2 cms.

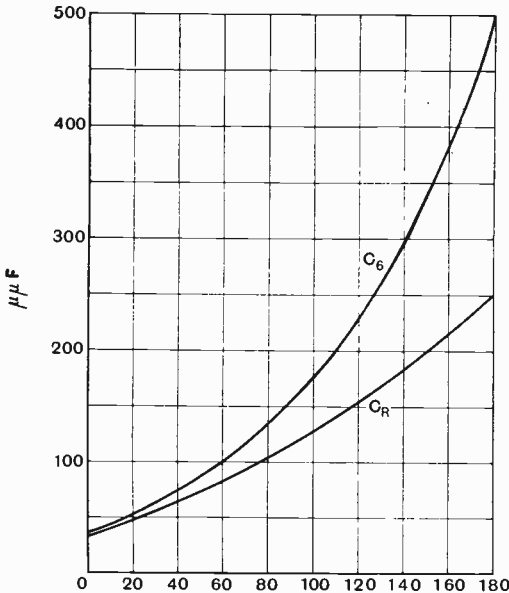

$$C_6 = \frac{C_f(a_6\theta + b_6)^2}{C_f - (a_6\theta + b_6)^2}$$

Fig. 12.

The capacity curve  $C_6$  for the variable condenser calculated from (37) is given in Fig. 12 together with the curve of resultant capacity ( $C_R$ ) of the two condensers in series from (36).

The tabulation below gives the radii ( $R_6$ ) of the required plate calculated from (42) and Fig. 13 shows the plate shape drawn using these radii together with an ordinary corrected square law plate for comparison. Fig. 14 gives the wavelength curve  $\lambda = 50\sqrt{C_R}$  for this condenser for comparison with those of Fig. 8 for an ordinary semicircular plate condenser and Fig. 11 for a straight line law of resultant capacity condenser.

$\theta$ deg.	$R_6$ (cms.)
0	2.16
20	2.35
40	2.56
60	2.78
100	3.37
140	4.25
160	4.85
180	5.66

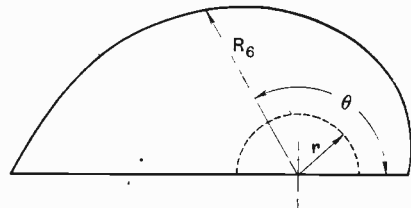

$$R_6 = \left[ 114.6 \left\{ \frac{2ka_6C_f^2(a_6\theta + b_6)}{\{C_f - (a_6\theta + b_6)^2\}^2} + K \right\} \right]^{\frac{1}{2}}$$

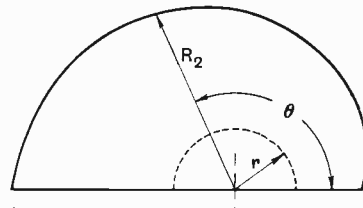

$$R_2 = \left[ 114.6 \{ 2ka_2(a_2\theta + b_2) + K \} \right]^{\frac{1}{2}}$$

Fig. 13.

**Plate Shape for Inverse Square Law of Capacity (with series fixed capacity).**

Employing the same notation for actual variable condenser capacity, fixed series capacity and resultant capacity, it may be stated that in order to obtain a uniform scale of frequency

$$C_R = \frac{I}{(a\theta + b)^2} \quad \dots \quad (43)$$

and

$$C = \frac{C_f C_R}{C_f - C_R}$$

$$\begin{aligned}
 \therefore C_1 &= \frac{C_f(a_7\theta + b_7)^2}{C_f - [1/(a_7\theta + b_7)^2]} \\
 &= \frac{C_f}{C_f(a_7\theta + b_7)^2 - 1} \dots (44)
 \end{aligned}$$

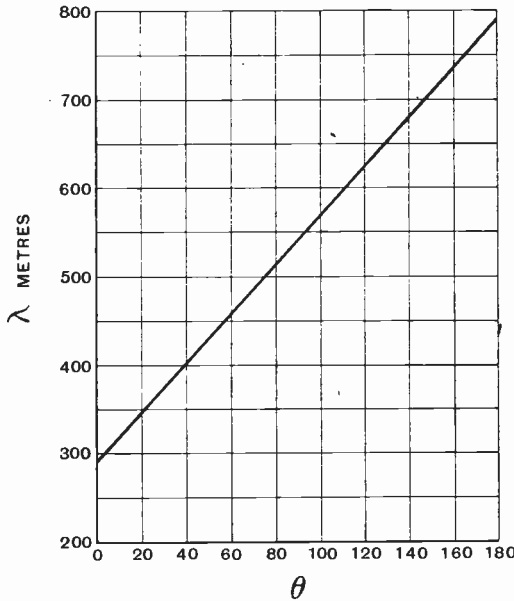

Fig. 14. (See also Figs. 11, 17 and 20.)

The values of the constants  $a_7$  and  $b_7$  may be found from a knowledge of the values of the maximum and augmented residual capacities of the variable condenser and the value of the series fixed capacity.

When  $\theta=0$ ,  $C_7$  must be the maximum capacity

$$\therefore \text{Maximum capacity} = \frac{C_f}{C_f b_7^2 - 1}$$

from which:—

$$b_7 = \sqrt{\frac{1}{\text{Maximum capacity}} + \frac{1}{C_f}} \quad (45)$$

and when  $\theta=180$ ,  $C_7$  must be the augmented residual capacity.

$$\therefore \text{Residual capacity} = \frac{C_f}{C_f(180a_7 + b_7)^2 - 1}$$

from which:—

$$a_7 = \frac{1}{180} \left\{ \left( \frac{1}{\text{Res. cap.}} + \frac{1}{C_f} \right)^{\frac{1}{2}} - b_7 \right\} \quad (46)$$

As in the previous cases the part of  $C_7$  which is due to the operative plate area, is  $C_7$ —Residual capacity, and therefore the plate area in operation at any angle  $\theta$  must, from (44), be:—

$$\begin{aligned}
 A_7 &= k \left\{ \frac{C_f}{C_f(a_7\theta + b_7)^2 - 1} - \text{Res. cap.} \right\} \\
 &\quad + K(180 - \theta) \dots (47)
 \end{aligned}$$

in this case the term to be added to compensate for loss of active area round the condenser spindle being, for obvious reasons,  $K(180 - \theta)$ .

The constants  $k$  and  $K$  have the same values as previously, they are, in fact, unaffected by the law of the plate.

$$\frac{dA_7}{d\theta} = - \left[ \frac{2a_7 k C_f^2 (a_7\theta + b_7)}{\{C_f(a_7\theta + b_7)^2 - 1\}^2} + K \right] \quad (48)$$

Therefore

$$R_7 = \left[ 114.6 \left\{ \frac{2a_7 k C_f^2 (a_7\theta + b_7)}{\{C_f(a_7\theta + b_7)^2 - 1\}^2} + K \right\} \right]^{\frac{1}{2}} \quad (49)$$

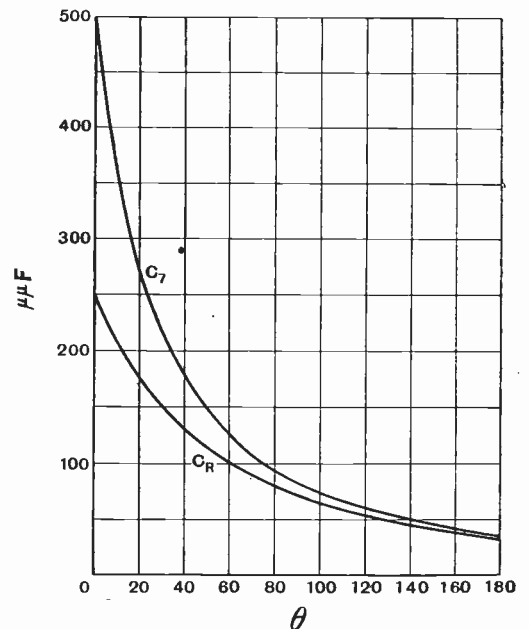

$$C_7 = \frac{C_f}{C_f(a_7\theta + b_7)^2 - 1}$$

Fig. 15.

The minus sign obtained when differentiating merely indicates that the area is decreasing with increasing values of  $\theta$  and can be ignored in forming the expression for  $R_7$ .

To facilitate comparison with the previously designed plates, the plate radii have been computed using the above formula (49) from the same data as before.

- Maximum capacity = 500  $\mu\mu\text{F}$ .
- Augmented residual capacity = 36  $\mu\mu\text{F}$ .
- Series fixed capacity = 500  $\mu\mu\text{F}$ .
- Total plate area = 20 square cms.
- $r$  = 1.2 cms.

The capacity curve  $C_7$ , for the variable condenser of this example, calculated from (44), is given in Fig. 15 which also gives the curve of resultant capacity,  $C_R$ , of the two condensers in series from (43).

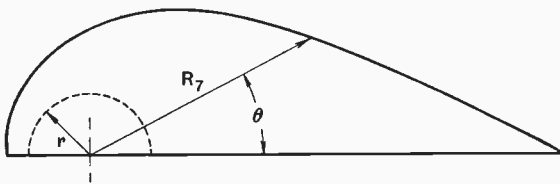

$$R_7 = \left[ 114.6 \left\{ \frac{2a_7 k C_f^2 (a_7 \theta + b_7)}{\{C_f (a_7 \theta + b_7)^2 - 1\}^2 + K} \right\} \right]^{\frac{1}{2}}$$

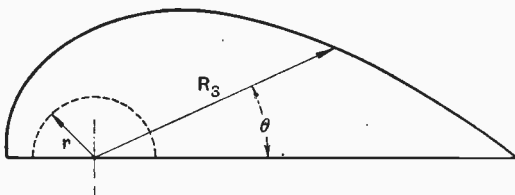

$$R_3 = \left[ 114.6 \left\{ \frac{2ka_3}{(a_3 \theta + b_3)^3} + K \right\} \right]^{\frac{1}{2}}$$

Fig. 16.

$\theta$ deg.	$R_7$ (cms.)
0	9.25
10	6.95
20	5.57
30	4.65
60	3.32
90	2.42
120	2.02
150	1.78
180	1.62

The tabulation here gives the radii ( $R_7$ ) of the required plate calculated from (49) and Fig. 16 is a scale drawing of the plate shaped by these radii together with an ordinary inverse square law plate (when  $C_f = \infty$ ) for comparison.

Fig. 17 gives the frequency curve

$$f = \frac{3 \times 10^8}{50 \sqrt{C_R}}$$

for this condenser for comparison with those of Figs. 8, 11 and 14 obtained with condensers having other plate shapes, although of the same area and, therefore, of the same total capacity and capacity range.

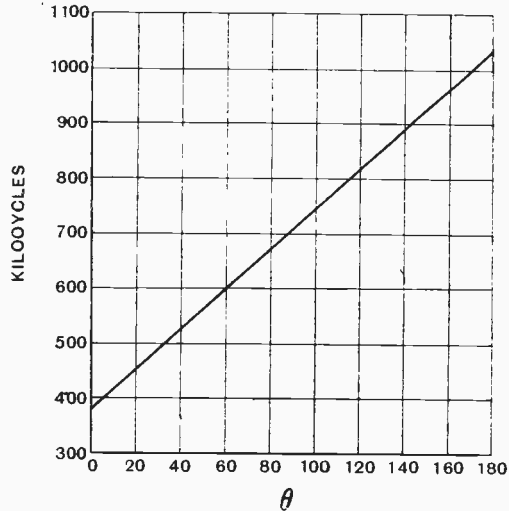

Fig. 17. (See also Figs. 11, 14, and 20.)

### Exponential Law of Capacity (with series fixed Capacity).

The fourth type of condenser remaining to be treated in this manner is that which gives a uniform percentage change of wavelength or frequency throughout its entire scale. This type of condenser has already been fully explained by the author in a previous article and a plate shape formula given. If such a law is, however, to be satisfied by a variable condenser while in series with another capacity of fixed value the resultant capacity  $C_R$  of the two condensers in series must follow the exponential law:—

$$C_R = a \epsilon^{b\theta} \quad \dots \quad (50)$$

and

$$C = \frac{C_f C_R}{C_f - C_R}$$

$\therefore$

$$C_3 = \frac{C_f a_3 \epsilon^{b_3 \theta}}{C_f - a_3 \epsilon^{b_3 \theta}} \quad \dots \quad (51)$$

When  $\theta = 0$ ,  $C_3 =$  Residual capacity.

∴ Residual capacity =  $\frac{C_f a_s}{C_f - a_s}$

from which

$a_s = \frac{C_f(\text{Residual capacity})}{C_f + \text{Residual capacity}} \quad (52)$

and when  $\theta = 180$ ,  $C_s = \text{Maximum capacity}$ .

∴ Max. cap. =  $\frac{C_f a_s \epsilon^{180 b_s}}{C_f - a_s \epsilon^{180 b_s}}$

from which

$a_s \epsilon^{180 b_s} = \frac{C_f(\text{Maximum capacity})}{C_f + \text{Maximum capacity}}$

and, equating logarithms,

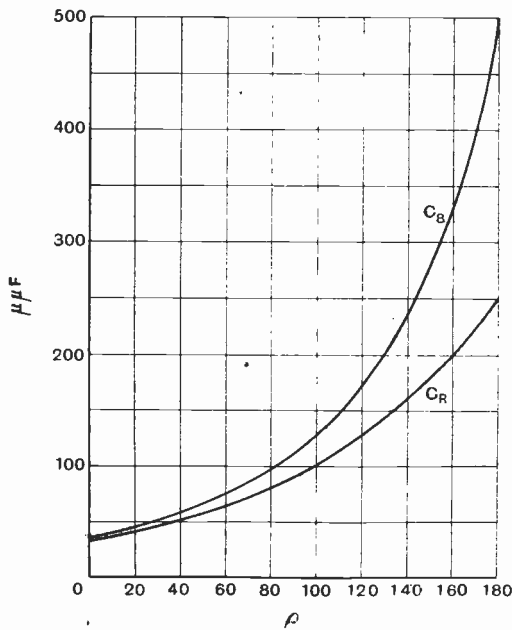

$C_s = \frac{C_f a_s \epsilon^{b_s \theta}}{C_f - a_s \epsilon^{b_s \theta}}$

Fig. 18.

$\log a_s + 180 b_s \log \epsilon = \log \left\{ \frac{C_f (\text{Max. capacity})}{C_f + \text{Max. capacity}} \right\}$

∴  $b_s = \frac{1}{78.174} \left[ \log \left\{ \frac{C_f (\text{Max. cap.})}{C_f + \text{Max. cap.}} \right\} - \log a \right] \quad (53)$

The expression for plate area in operation at any angle  $\theta$  may now be formed directly from (51)

$A_s = k \left\{ \frac{C_f a_s \epsilon^{b_s \theta}}{C_f - a_s \epsilon^{b_s \theta}} - \text{Res. cap.} \right\} + K \theta \quad (54)$

∴  $\frac{dA_s}{d\theta} = \frac{k C_f^2 a_s b_s \epsilon^{b_s \theta}}{(C_f - a_s \epsilon^{b_s \theta})^2} + K \quad \dots (55)$

Therefore

$R_s = \left[ 114.6 \left\{ \frac{k C_f^2 a_s b_s \epsilon^{b_s \theta}}{(C_f - a_s \epsilon^{b_s \theta})^2} + K \right\} \right]^{\frac{1}{2}} \quad (56)$

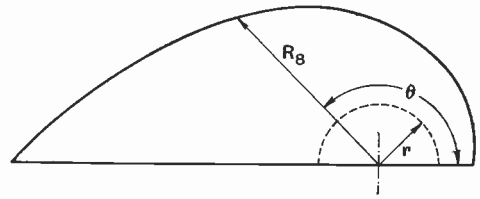

$R_3 = \left[ 114.6 \left\{ \frac{k C_f^2 a_s b_s \epsilon^{b_s \theta}}{(C_f - a_s \epsilon^{b_s \theta})^2} + K \right\} \right]^{\frac{1}{2}}$

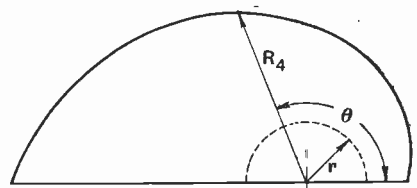

$R_4 = \left[ 114.6 \left\{ k a_s b_s \epsilon^{b_s \theta} + K \right\} \right]^{\frac{1}{2}}$

Fig. 19.

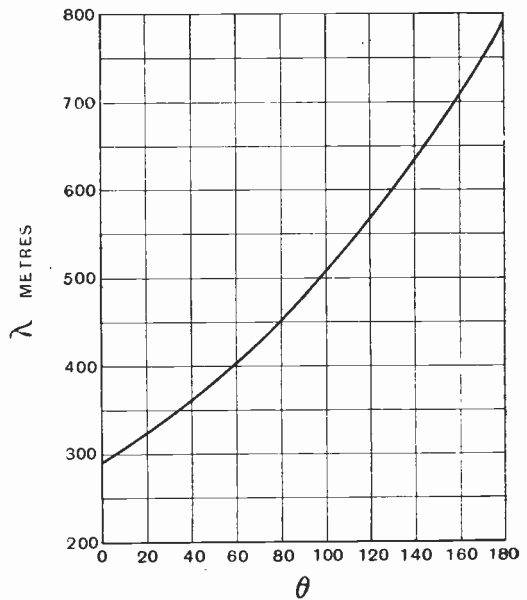

Fig. 20.

(See also Figs. 11, 14, and 17).

With the same data as before, an example of this plate shape has been calculated and the results given in the capacity curves of Fig. 18 and in the actual scale drawing of Fig. 19 ( $R_s$ ).

$\theta$ deg.	$R$ (cms.)
0	1.82
20	1.96
40	2.15
60	2.38
90	2.85
120	3.57
150	4.74
180	7.16

The radii, calculated from formula (56), which were used in drawing this plate shape, are tabulated here and the curve of wavelength plotted against degree scale reading obtained,

when using a condenser having plates of this shape, is given in Fig. 20.

**Effect of Varying the Value of Series Capacity.**

A variation of the ratio of series capacity to variable condenser capacity has, of course, a very marked effect upon the plate shape, and, since all the design examples have been

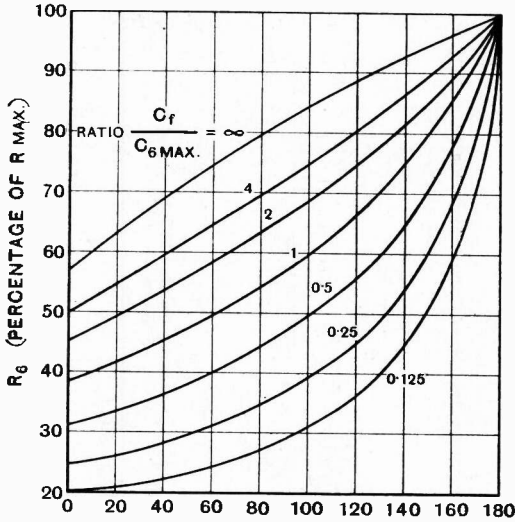

Fig. 21.

taken with this ratio equal to unity it will, perhaps, be desirable to illustrate, by means of the curves of Fig. 21, the extent of this plate shape variation. In this figure are

plotted curves showing the relation between  $R_s$  and  $\theta$  for corrected square law plates of a variable condenser having the same values and plate area as before but designed to be "law-suited" to various values of series capacity,  $C_f$ , infinity, 2,000, 1,000, 500, 250, 125 and  $62.5F\mu\mu$ .

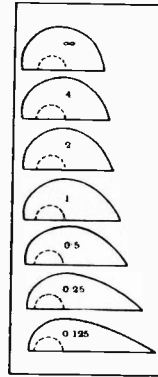

Fig. 22.

The radii are given as percentages of the maximum radius (at 180 degrees) as this latter dimension usually determines the permissible plate area. The actual plate shapes corresponding with these curves are given in Fig. 22.

**Conclusion.**

In conclusion it is thought that a summary of the formulæ and their constants will prove useful and these have therefore been tabulated overleaf in a form which facilitates comparison not only between the laws given in this article but also with those of the previous article.

It should be remembered that if the value of the series fixed capacity has not been predetermined or estimated with accuracy (as may, for instance, be the case in an aerial series tuning circuit) its effective value, if too large, may be suited to the law of the special condenser by the adjustment of a large capacity variable condenser in series with the latter. Also, if the residual capacity of a variable condenser designed to suit any particular law, is, in practice, found to be slightly lower than its estimated value, a small variable condenser of simple design may be paralleled with it and adjusted until the law is exactly satisfied.

It will be seen, therefore, that, if the estimation of the values of the fixed series capacity and the residual capacity of the variable unit cannot be made exactly, it is better to under estimate deliberately the former and over estimate the latter so as to render these law satisfying adjustments possible.

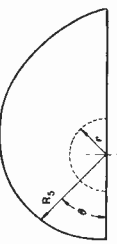
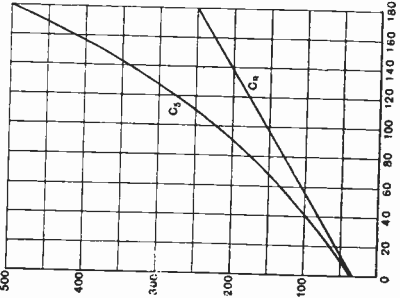
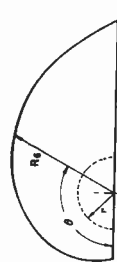
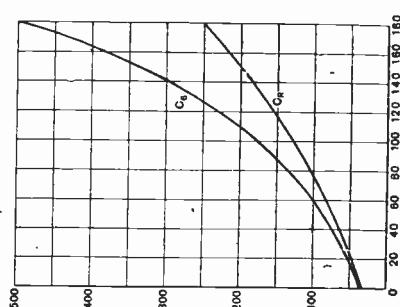
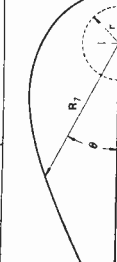
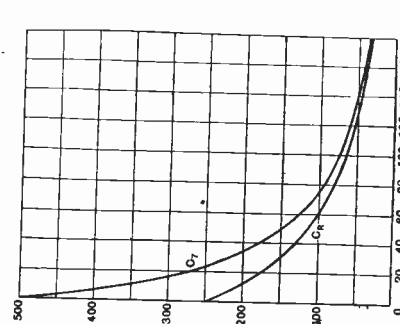
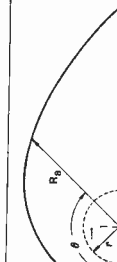
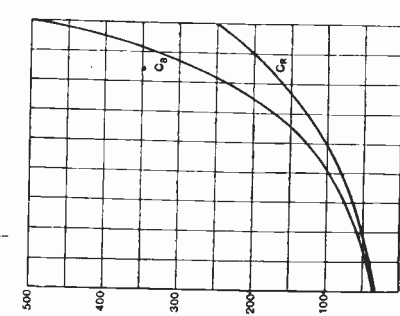

TABLE GIVING A SUMMARY OF FORMULÆ AND THEIR CONSTANTS.

<p>Plate design for constant capacity change (with series capacity).</p>			$C_s = \frac{C_f(a_2\theta + b_2)}{C_f - (a_2\theta + b_2)} \dots (28)$ $A_s = k \left\{ \frac{C_f(a_2\theta + b_2)}{C_f - (a_2\theta + b_2)} - \text{Res. cap.} \right\} + K\theta \dots (29)$ $R_s = \left[ 114.6 \left\{ \frac{ka_2 C_f^2}{(C_f - (a_2\theta + b_2))^2} + K \right\} \right]^{\frac{1}{2}} \dots (30)$ <p>Constants—</p> $a_s = \frac{I}{180} \left\{ \frac{C_f(\text{Max. cap.})}{C_f + \text{Max. cap.}} - b_s \right\} \dots (31)$ $b_s = \frac{C_f(\text{Residual capacity})}{C_f + \text{Residual capacity}} \dots (32)$	<p>Plate design for constant wavelength change (with series capacity).</p>			$C_s = \frac{C_f(a_4\theta + b_4)}{C_f - (a_4\theta + b_4)} \dots (37)$ $A_s = k \left\{ \frac{C_f(a_4\theta + b_4)}{C_f - (a_4\theta + b_4)} - \text{Res. cap.} \right\} + K\theta \dots (38)$ $R_s = \left[ 114.6 \left\{ \frac{2ka_4 C_f^2 (a_4\theta + b_4)}{(C_f - (a_4\theta + b_4))^2} + K \right\} \right]^{\frac{1}{2}} \dots (39)$ <p>Constants—</p> $a_s = \frac{I}{180} \left\{ \frac{C_f(\text{Max. cap.})}{C_f + \text{Max. cap.}} - b_s \right\} \dots (40)$ $b_s = \sqrt{\frac{C_f(\text{Residual capacity})}{C_f + \text{Residual capacity}}} \dots (41)$	<p>Plate design for constant frequency change (with series capacity).</p>			$C_s = \frac{C_f}{(a_7\theta + b_7)^2 - I} \dots (44)$ $A_s = k \left\{ \frac{C_f}{(a_7\theta + b_7)^2 - I} - \text{Res. cap.} \right\} + K(180 - \theta) \dots (45)$ $R_s = \left[ 114.6 \left\{ \frac{2a_7 k C_f^2 (a_7\theta + b_7)}{(C_f (a_7\theta + b_7)^2 - I)^2} + K \right\} \right]^{\frac{1}{2}} \dots (46)$ <p>Constants—</p> $a_s = \frac{I}{180} \left\{ \frac{I}{\text{Res. cap.}} + \frac{I}{C_f} - b_s \right\} \dots (47)$ $b_s = \sqrt{\frac{I}{\text{Maximum capacity}} + \frac{I}{C_f}} \dots (48)$	<p>Plate design for constant percentage change of wavelength or frequency (with series capacity).</p>			$C_s = \frac{C_f a_6 e^{b_6 \theta}}{C_f - a_6 e^{b_6 \theta}} \dots (51)$ $A_s = k \left\{ \frac{C_f a_6 e^{b_6 \theta}}{C_f - a_6 e^{b_6 \theta}} - \text{Res. cap.} \right\} + K\theta \dots (52)$ $R_s = \left[ 114.6 \left\{ \frac{ka_6 b_6 e^{b_6 \theta}}{(C_f - a_6 e^{b_6 \theta})^2} + K \right\} \right]^{\frac{1}{2}} \dots (53)$ <p>Constants—</p> $a_s = \frac{C_f(\text{Residual capacity})}{C_f + \text{Residual capacity}} \dots (54)$ $b_s = \frac{I}{78.174} \left[ \log \left\{ \frac{C_f(\text{Max. cap.})}{C_f + \text{Max. cap.}} \right\} - \log a \right] \dots (55)$
--	---	---	--	--	--	--	--	---	---	---	--	---	---	---	--

COMMON CONSTANTS:—

$$k = \frac{\text{Total plate area} - 180K}{\text{Max. capacity} - \text{Res. capacity}}$$

$$K = \frac{I}{114.6}$$

# Mathematics for Wireless Amateurs.

By *F. M. Colebrook, B.Sc., A.C.G.I., D.I.C.*

[510

(Continued from page 680 of November issue.)

## 6. The Solution of Equations.

(A5) (continued). *The General Equation of the nth Degree.*

AS stated in the preceding instalment, the most general form of the equation of the *n*th degree in one unknown quantity is

$$ax^n + bx^{n-1} + cx^{n-2} + dx^{n-3} + \text{etc., etc.} + k = 0$$

where the coefficients *a, b, c, etc.*, can have any sign and any numerical value. First let us see how such a number as that on the left-hand side of this equation can be built up. By multiplying together *n* simple numbers of the form *x-a, x-β, x-γ, etc.*, it can be shown that

$$\begin{aligned} &(x-a)(x-\beta)(x-\gamma), \text{ etc. } \dots n \text{ factors} \\ &= x^n - (a+\beta+\gamma + \dots)x^{n-1} \\ &\quad + (a\beta + \beta\gamma + \gamma\delta + \dots)x^{n-2} \\ &\quad - (a\beta\gamma + \beta\gamma\delta + \dots)x^{n-3}, \text{ etc. } \dots \\ &\quad \quad \quad (-1)^n(a\beta\gamma\delta \dots) \end{aligned}$$

the coefficient of  $x^{n-1}$  consisting of minus the sum of all the *a, β* numbers, that of  $x^{n-2}$  being plus the sum of all the products two at a time of the *a, β* numbers, and so on. The coefficient of  $x^0$  (*i.e.*, the constant term not containing *x*) will be the sum of all the products *n* at a time, *i.e.*, the product of all the *a, β* numbers, and its sign will be plus if *n* is even and minus if *n* is odd, which fact is conveniently expressed by the factor  $(-1)^n$ . The reader can easily confirm this general formula by multiplying two, then three, then four, simple factors together and arranging the product in each case in the above manner. For shortness, put

$$\begin{aligned} (a + \beta + \gamma + \delta + \dots) &= -b/a \\ (a\beta + \beta\gamma + \gamma\delta + \dots) &= c/a \\ \text{etc., etc.,} & \\ (a\beta\gamma\delta \dots) &= (-1)^n k/a \end{aligned}$$

Then

$$\begin{aligned} &(x-a)(x-\beta)(x-\gamma) \text{ etc. } \dots n \text{ factors} \\ &= x^n + (b/a)x^{n-1} + (c/a)x^{n-2}, \text{ etc. } \dots k/a \end{aligned}$$

and multiplying each of these equal numbers by *a* will give

$$\begin{aligned} &a(x-a)(x-\beta)(x-\gamma) \dots n \text{ factors} \\ &= ax^n + bx^{n-1} + cx^{n-2} + dx^{n-3}, \text{ etc. } \dots k. \end{aligned}$$

The above complicated number of the *n*th degree in *x* can therefore be expressed as the product of *n* simple numbers of the form *x-a*, and the general equation can be written

$$\begin{aligned} &ax^n + bx^{n-1} + cx^{n-2} + dx^{n-3}, \text{ etc. } \dots k \\ &= a(x-a)(x-\beta)(x-\gamma) \dots n \text{ factors} = 0. \end{aligned}$$

As already explained, the equation will be satisfied when any of the individual factors are zero, *i.e.*, when  $x = a, \beta, \gamma, \text{ etc.}$  The numbers *a, β, γ, etc.*, are therefore the roots of the equation. Thus to solve the general equation of the *n*th degree, it is only necessary to break it up into its *n* simple factors; but this is easier said than done. In fact, generally speaking, it cannot be done. The only general method of solution is the graphical one already described, and even that is not much use from a theoretical point of view. Suppose *x*, for instance, represents the resonant frequencies of some coupled circuits, the coefficients of the equation being the electrical constants of the circuits. What one usually wants to know in such a case is the way the roots depend on the coefficients, *i.e.*, one wants *x* explicitly in terms of *a, b, c, etc.*, and the graphical method will only give the solutions for particular numerical cases in a form in which the individual coefficients have quite lost their identity.

However, certain general conclusions of some practical value can be drawn from the above discussion. The most important of these is that the general equation of the *n*th degree has *n* roots. Actually the above discussion only shows that an equation with *n* roots will be of the *n*th degree, but the converse is also true, though a rigid proof is rather beyond the scope of the present

series. The roots will not necessarily be all different. For instance, the roots of

$$x^2 - 4x + 4 = 0$$

are 2, 2, since  $x^2 - 4x + 4 = (x-2)(x-2)$ . This shows that the curve  $y = x^2 - 4x + 4$  cuts the  $x$  axis in two coincident points. If the left-hand curve in Fig. 11 (November issue) is moved up in the positive direction of the  $y$  axis the points in which it cuts the  $x$  axis will obviously come closer and closer together and will eventually coincide. In such a case the curve is said to touch the line tangentially.

Again, the roots will not necessarily be all real. If the upward movement of the curve referred to above is continued beyond the position in which it just touches the  $x$  axis, the curve will not cut the  $x$  axis at all. The corresponding quadratic equation can still be solved, however, but it will be found that  $b^2 - 4ac$  is now negative, so that  $\sqrt{b^2 - 4ac}$  is imaginary, and the roots will be of the form  $p + q\sqrt{-1}$ ,  $p - q\sqrt{-1}$ , as already explained. The curve represented by the general function may have several such bends, and any of these which do not come down below the  $x$  axis will give rise to similar pairs of complex roots of the form  $p \pm q\sqrt{-1}$ . It can be proved that any complex roots of the general equation will necessarily occur in such pairs, so that if  $p + q\sqrt{-1}$  is known to be a root, then  $p - q\sqrt{-1}$  must also be a root. The proof will be given later if space permits of a fuller discussion of complex and imaginary quantities, but the above description shows clearly how this fact arises.

The relationships between the roots and the coefficients, *i.e.*, the sum of the roots equals  $-b/a$ , etc., etc., may sometimes be of practical value even though the roots cannot be determined, and should therefore be noted.

The expression of the general function as the product of the root factors shows that if one root of an equation can be found in some way, *e.g.*, by "guesstimation," or by plotting the function over a likely range of values, then the degree of the equation can be lowered by one by dividing by the appropriate factor. (The method of division is illustrated in an appendix.) For instance, take

$$x^3 + 6x^2 - 3x - 4 = 0$$

Here the sum of the coefficient is zero, which means that  $x=1$  satisfies the equation (for the result of putting  $x=1$  is obviously the sum of the coefficients). This means that  $(x-1)$  is a factor of the number on the left-hand side, and by division it will be found that

$$x^3 + 6x^2 - 3x - 4 = (x-1)(x^2 + 7x + 4) = 0$$

so that the roots of the equation are 1, together with the roots of the quadratic

$$x^2 + 7x + 4 = 0$$

which can be found as described above.

An interesting special case of the general equation is

$$x^n - 1 = 0$$

or

$$x^n = 1$$

*i.e.*,

$$x = \sqrt[n]{1}$$

Since this equation must have  $n$  roots, we must conclude that there are  $n$  nth roots of unity. And so there are. For instance, consider

$$x^4 - 1 = 0.$$

Remembering the result already established for the factors of  $a^2 - b^2$ , *i.e.*,

$$a^2 - b^2 = (a-b)(a+b)$$

the equation can be broken up into factors thus:—

$$x^4 - 1 = (x^2 - 1)(x^2 + 1)$$

$$(x-1)(x+1)(x-\sqrt{-1})(x+\sqrt{-1}) = 0$$

so that the four fourth roots of unity are  $\pm 1$  and  $\pm \sqrt{-1}$ . The significance of this will be made clear when we come to the interpretation of complex numbers.

A great deal more might be said about the general equation of the  $n$ th degree, but it has already taken as much space as can be allowed for it. The important things to remember are that it has  $n$  roots, that any complex roots will occur in pairs differing only in the sign of the imaginary part, and that each root gives a factor of the equation.

(BI) *Simultaneous Equations for Two Unknown Numbers.*

It has been shown that, starting with some number represented by the letter  $x$ , some other number can be built up out of  $x$  and various other constant numbers, represented by  $a, b, c$ , etc., the more or less complicated

number which results being called a function of  $x$ . Similarly one could start with two numbers represented by the letters  $x$  and  $y$  and build up some other number of more or less complicated structure, the magnitude of which would depend on the magnitudes and signs assigned to  $x$  and  $y$ . Such a number could then be described as a function of  $x$  and  $y$ . Using a similar notation, any such number could be written  $F(x,y)$ . In a given case, for instance, the function might be defined—

$$F(x,y) = ax^2 + bxy + cy^2 + dx + ey + f$$

which is the most general form for a function of the second degree in  $x$  and  $y$  (second degree because no term contains more than two  $x$ 's or  $y$ 's multiplied together.) In the above case,  $x$  and  $y$  can be regarded as independent variables, which, between them, fix the value of the function. Suppose, however, that some particular value is assigned to the function, zero, for instance, so that

$$ax^2 + bxy + cy^2 + dx + ey + f = 0$$

then  $x$  and  $y$  are no longer independent variables, for if any given value is assigned to either, the other must have such a value or values that the sum of all the terms is zero. Obviously in the above case, if some given value is assigned to  $x$ ,  $k$  for instance, we have

$$ak^2 + bky + cy^2 + dk + ey + f = 0$$

which is a quadratic equation for  $y$ , so that for any given value of  $x$  there will in general be two values of  $y$  which will satisfy the original definition. Thus, whatever the form of the function  $F(x,y)$ , the equation

$$F(x,y) = 0$$

can be regarded as defining a relationship between  $x$  and  $y$ , just as the equation  $y=f(x)$  defines more explicitly a relationship between  $x$  and  $y$ . By means of the graphical method already described the relationship between the numbers  $x$  and  $y$  defined by  $F(x,y)=0$  could be represented by means of a line of more or less complicated shape. For instance, the general expression of the second degree written out above, if plotted for any particular set of values for the coefficients, will always give a curve belonging to one of the three kinds of curve that can be obtained by intersecting a cone and a plane. Such curves

are called conic sections. The parabola already referred to is one kind of conic section.

Two such functions of any character

$$F(x,y) = 0$$

$$G(x,y) = 0$$

plotted on the same diagram would give two lines or curves which would in general intersect one another at various points, as shown, for instance, on Fig. 12. The numbers  $x$  and  $y$  defined by any such point of intersection, since they satisfy both the functional relationships, are described as solutions of the simultaneous equations.

$$F(x,y) = 0$$

$$G(x,y) = 0$$

More generally, any corresponding values of  $x$  and  $y$ , whether real or complex or imaginary, which satisfy both the functional relationships, are called solutions of the simultaneous

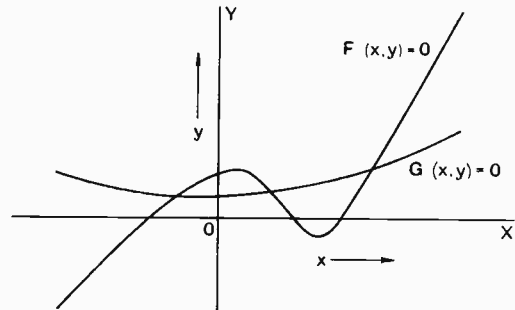

Fig. 12.

equations. Thus a general method for determining the real solutions of such simultaneous equations would be the plotting of both the curves to find the point or points of intersection, though any such graphical method would be very laborious in most cases and would have the disadvantages of lack of generality and restricted accuracy. However, the above discussion of the graphical point of view brings out one very important point. It was found that for one unknown quantity one equation is sufficient. Now it appears that if two unknown quantities have to be determined two equations are required. This suggests—though, of course, it does not actually prove—that for the determination of any given number of unknown quantities an equal number of independent equations are required. This is

so in fact, though a perfectly general proof is beyond the scope of this series.

Out of the infinite variety of possible forms of simultaneous equations for two unknown numbers a few of the most generally useful types will now be considered.

(B2) *Simultaneous Equations of the First Degree for Two Unknowns.*

This is the simplest case, both equations being rectilinear. As it introduces ideas of wide general utility it will be considered in the general form, though literal (*i.e.* letter) expressions tend to spread themselves out rather and look more fearsome than they are in fact. The general form will be

$$\begin{aligned} ax+by &= c \\ dx+ey &= f \end{aligned}$$

These lines being co-planar (*i.e.*, in one plane) will necessarily intersect at one point only. Even if they are parallel? Yes, for parallel lines intersect at infinity, which is only another way of saying that there is no sudden and catastrophic difference between lines which are very nearly parallel and lines which are quite parallel.

The important thing to realise about simultaneous equations is that although in general the *x*'s and *y*'s of the two equations are quite different and have nothing to do with each other, the *x*'s and *y*'s corresponding to a simultaneous solution, *i.e.*, to a point of intersection, are of necessity the same for both equations and can therefore be combined together without making any distinction between them.

The first thing to do is to make one of the unknowns, *y* for instance, appear in the same way in each equation. If the first equation is multiplied by the co-efficient of *y* in the second and *vice versa*, this result is obtained right away, for we have

$$\begin{aligned} eax+eby &= ec \\ bdx+bey &= bf \end{aligned}$$

Since the *x*'s and *y*'s in each equation are the same as far as the point of intersection is concerned, the equations can be subtracted from each other, giving

$$eax+eby-bdx-bey=ec-bf.$$

Remember that this derived equation is only true for *x, y* numbers which satisfy both the original equations.

From this equation ( $ea-bd$ )  $x=ec-bf$  so that

$$x = \frac{ec-bf}{ea-bd}$$

Now the point having this *x* co-ordinate lies on both lines. The corresponding *y* co-ordinate can therefore be found by putting this value for *x* in either of the original equations. Since, from the first,

$$y = -\frac{a}{b}x + \frac{c}{b}$$

then for the particular value of *x* above,

$$y = -\frac{a}{b} \frac{ec-bf}{ea-bd} + \frac{c}{b}$$

This expression for *y* can be simplified as already shown in connection with the manipulation of fractions and will give the result

$$y = \frac{af-cd}{ae-bd}$$

Alternatively, of course, the solution for *y* could be found by the same process as that used for the determination of *x*, and in some cases this might be preferable.

To take a simple numerical example of the general method

$$\begin{aligned} 2x+3y &= 4 \\ 7x+8y &= 9 \\ 16x+24y &= 32 \\ 21x+24y &= 27 \end{aligned}$$

and subtracting the second from the first

$$\begin{aligned} -5x &= 5 \\ \therefore x &= -1 \end{aligned}$$

Putting this value for *x* in the first equation gives

$$-2+3y=4$$

*i.e.*, therefore  $3y=6$   
 $y=2$

It will be found that these values for *x* and *y* will satisfy the second equation, which checks the accuracy of the solution.

(B2a) *The Special Case of Parallel Lines. The Meaning of "Infinity."*

Suppose co-efficients of the general equations are such that

$$\begin{aligned} a/d &= b/e \\ i.e., ae-bd &= 0 \end{aligned}$$

Then the solution for *x* becomes

$$x = \frac{ce-bf}{ae-bd} = \frac{ce-bf}{0}$$

Now we have already encountered the group  $a/h$  (page 497, August issue), and decided that it was something to which the ordinary laws of mathematics could not be applied without disastrous results. However, some rather more definite ideas on the subject must be introduced at this point, or the above equations will be left without a reasonable solution. Instead of jumping right over the precipice let us walk slowly up to the edge and look over, a very sensible proceeding which is frequently adopted in mathematics when there seems to be trouble ahead. Consider the group  $a/h$ , where  $h$  is a number which can be made smaller and smaller indefinitely. If,

$$\begin{aligned} h &= 1/1,000 & a/h &= 1,000a \\ h &= 1/10,000 & a/h &= 10,000a \\ h &= 1/100,000 & a/h &= 100,000a \end{aligned}$$

As  $h$  is made numerically smaller and smaller,  $a/h$  becomes numerically larger and larger. By making  $h$  sufficiently small,  $a/h$  can be made larger than any number we can name, however large it may be. This is expressed mathematically by saying that the limit of  $a/h$  when  $h$  tends to zero is infinity—not a very consistent form of expression perhaps, because infinity means without limit, greater than any limited number. In symbols the idea is written

$$\begin{aligned} \text{Lt. } a/h &= \infty \\ h &\rightarrow 0 \end{aligned}$$

The important thing to remember is that  $\infty$  is *not* a number, and almost anything is rather more than likely to happen if it is treated as a number.

In the above case therefore, the solution for  $x$  is infinity. For instance, if

$$\begin{aligned} 3x + 4y &= 5 \\ 21x + 28y &= 4, \end{aligned}$$

the solution for  $x$  is

$$x = (140 - 16)/(84 - 84) = \infty$$

and for  $y$   $y = (105 - 12)/(84 - 84) = \infty$

If these lines are actually plotted on a cartesian diagram, it will be found that they are parallel. This is what is meant by saying that parallel lines meet and intersect at infinity.

(B3) *An Electrical Application.*

Now, in case the more experimentally minded reader is beginning to lose interest

in  $x$ 's and  $y$ 's and the like, it will be well to apply the above to the solution of a simple D.C. circuit problem on the basis of Kirchhoff's Laws. For the circuit shown in Fig. 13 the summation of the potential differences will give

$$\begin{aligned} (i_1 - i_2)R_1 &= e \\ (i_2 - i_1)R_1 + R_2i_2 &= 0 \end{aligned}$$

i.e.,

$$\begin{aligned} i_1 - i_2 &= e/R_1 \\ R_1i_1 - (R_1 + R_2)i_2 &= 0 \end{aligned}$$

The solution for  $i_1$  is

$$i_1 = \frac{e(R_1 + R_2)/R_1}{(R_1 + R_2) - R_1}$$

which can be rearranged to give

$$i_1 = \left( \frac{1}{R_1} + \frac{1}{R_2} \right) e$$

i.e.,

$$i_1 = \frac{e}{R}$$

where

$$\frac{1}{R} = \frac{1}{R_1} + \frac{1}{R_2}$$

The solution of the simultaneous equations

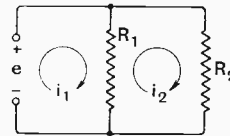

Fig. 13.

given above is therefore one way, though not the shortest, of arriving at the well-known expression for the resistance of two resistances in parallel.

(B.4) *Simultaneous Equations for Two Unknowns. One Equation Linear.*

This comes next in order of complexity to the case of two linear equations. The method of solution in this case is fairly obvious and will be best described by means of a practical example. Suppose

$$4x + 2y = 5$$

and

$$3x^2 - 4xy - 4y^2 = 0$$

are given as the two equations. The first is a straight line and the second a conic. In general a straight line will cut a conic in two points, but of course these points may be

imaginary and in some cases either or both may be at infinity. That, however, is by the way, and only indicates that there will be two solutions, *i.e.*, two pairs of values of  $x$  and of  $y$ , for the above equations. From the first equation we can find the value of  $y$  in terms of  $x$ , *i.e.*,

$$y = (5 - 4x)/2$$

and since at any points of intersection the  $x$ 's and  $y$ 's will be the same in the two equations, this value of  $y$  can be substituted in the second equation, *i.e.*,

$$3x^2 - \frac{4x(5-4x)}{2} - \frac{4(5-4x)^2}{4} = 0$$

which can be simplified to

$$-5(x^2 - 6x + 5) = 0$$

*i.e.*,  $-5(x-5)(x-1) = 0$

whence  $x = 1$  or  $5$

From the linear equation, if

$$x = 1, y = (5 - 4 \times 1) / 2 = \frac{1}{2}$$

and if

$$x = 5, y = (5 - 4 \times 5) / 2 = -7\frac{1}{2}$$

The solutions are therefore

$$\left. \begin{array}{l} x = 1 \\ y = \frac{1}{2} \end{array} \right\} \quad \left. \begin{array}{l} x = 5 \\ y = -7\frac{1}{2} \end{array} \right\}$$

In general terms, the value of  $y$  in terms of  $x$ , as determined from the linear equation, is substituted in the other equation which then becomes an equation in one unknown only, and if this latter equation can be solved the simultaneous solutions are easily obtained as shown.

(B5) *Simultaneous Equations for Two Unknowns. Both of Second Degree.*

In this case each equation will in general represent a conic. Two conics will intersect in four points, so that four solutions will have to be obtained, and in the perfectly general case the determination of the solutions will require the solving of a fourth power equation, which cannot always be done. There are, however, two special cases in which the solution presents no difficulty, and these will now be described very briefly. If one of the equations is homogeneous of the second degree, *i.e.*, contains only terms of the second degree ( $x^2, y^2$ , or  $xy$ ), for instance,—

$$y^2 - 11xy + 24x^2 = 0$$

then dividing this equation by  $x^2$  will give

$$(y/x)^2 - 11(y/x) + 24 = 0$$

which reduces it to a quadratic in  $y/x$ . This can be solved either by inspection or by the formula. In the given case we have by inspection

$$\{(y/x) - 3\} \{(y/x) - 8\} = 0$$

so that  $y = 3x$  or  $y = 8x$ .

These values for  $y$  substituted in the other equation will reduce it to a simple quadratic in  $x$  which can be solved in the ordinary way.

Again, if terms of the first degree are absent from *both* equations, as in

$$\begin{array}{l} 2x^2 + 3xy + 4y^2 = 2 \\ 5x^2 + 2xy + 2y^2 = 7 \end{array}$$

then out of these two equations a homogeneous equation can be constructed. Multiplying the first by the constant term of the second and the second by the constant term of the first and then subtracting,

$$\begin{array}{l} 14x^2 + 21xy + 28y^2 = 14 \\ 10x^2 + 4xy + 4y^2 = 14 \\ 4x^2 + 17xy + 24y^2 = 0 \end{array}$$

and from this point the solution proceeds exactly as in the previous case.

The subject of simultaneous equations for two unknowns is obviously capable of almost indefinite expansion, but most of the cases which permit of simple solution belong to one or other of the types considered above. A little practice and experience will soon enable one to judge whether any given equations are solvable or not. As an instance an unsolvable pair is included in the examples given below.

Equations having more than two unknown numbers are very frequently met with in electrical theory, such equations being obtained from the application of Kirchhoff's Laws to more or less complicated current networks. Some brief account of the way of dealing with such equations will therefore be given in the next instalment.

**Appendix. Division in Algebra.**

The division of one more or less complex group of symbols by another in algebra is carried out in very much the same way as the ordinary process of long division in

arithmetic. It can be illustrated by the case which arises in the text.

$$\begin{array}{r} x-1 \quad x^3+6x^2-3x-4 \quad (x^2+7x+4) \\ \underline{x^3-x^2} \phantom{-4} \\ 7x^2-3x \phantom{-4} \\ \underline{7x^2-7x} \phantom{-4} \\ 4x-4 \\ \underline{4x-4} \\ \hline \end{array}$$

If it is remembered that any ordinary number of several digits is really the sum of various multiples of powers of ten, e.g.,

$$4352 = 4 \times 10^3 + 3 \times 10^2 + 5 \times 10 + 2$$

which can be compared with

$$4x^3 + 3x^2 + 5x + 2$$

the identity of the above algebraic division with arithmetical division will be apparent.

**Answers to Examples in November Issue.**

1. (a)  $-3\frac{1}{3}$ ; (b)  $1\frac{2}{3}$ ; (c)  $(d-b) / (a-c)$ ; (d)  $(nb-md) / (mc-na)$ .
2.  $-1\frac{1}{3}$ , 0;  $-3, -5$ ; 0, 4;
3. (a) 3, 2; (b)  $-3, -2$ ; (c) 3,  $-2$ ; (d)  $-3, 2$ ;
4. (a)  $\pm\sqrt{2}$ ; (b) 3, 4; (c)  $(a-b), (a+b)$ ; (d)  $(b-a), (b+a)$ .
5. (Author apologises for a slip in this equation. As it stands it can only be solved graphically.)

6. (a)  $\pm 2, 4, 1$ ; (b)  $a, b, c, d, e$ ;
- (c)  $-b \pm \frac{\sqrt{b^2-4ac}}{2a}$ ,  $-e \pm \frac{\sqrt{e^2-4df}}{2d}$

**Examples.—General Equation of the nth Degree.**

1. Solve  $x^3-4x^2-39x-54=0$  given that  $-2$  is one solution.
2. Solve  $x^4-36x^3+193x^2-410x+600=0$  given that  $1-2\sqrt{-1}$  is one solution.
3. If  $a, b$ , and  $c$  are the roots of  $x^3+qx^2+rx=0$  find the value of  $(1/a)+(1/b)+(1/c)$ .

**Simultaneous Equations for Two Unknowns.**

4. Solve the equations
  - (a)  $10x+y/3=37$   
 $2x-y=-79$
  - (b)  $\frac{3}{3x-2y} = \frac{5}{2x+7y} = 2$
5. Solve
  - (a)  $x+y=5$   
 $x^2+y^2=13$
  - (b)  $3x^2+2xy-y^2=0$   
 $x^2+y^2+2x=12$
  - (c)  $x^2+3y^2=43$   
 $x^2+xy=28$
6. Solve
 
$$\begin{array}{l} x^2+3x+y=5 \\ 2y^2+x-4=0 \end{array}$$

(To be continued.)

## Introducing Sodium and Potassium into Discharge Tubes.

A Practical Method, and Some of its Applications.

By James Taylor, M.Sc., Ph.D., A.Inst.P.

[535.3

IT has been known for many years<sup>1</sup> that certain of the alkali metals may be introduced, in a very pure form, into discharge tubes, by a method depending upon a sort of electrolysis through the glass walls.

With the development of the technique of high vacuum it became possible to obtain lamps and electronic valves in which the

degree of vacuum was extremely high. In such lamps and tubes it is, of course, impracticable to utilise a gas discharge for the introduction of sodium or potassium, but the electronic emission from the filament may be employed in an analogous manner, to the same end.

The method has been described recently<sup>2</sup>

<sup>1</sup> E. Warburg, *Ann. d. Phys.*, Vol. 40, p. 1, 1890.

<sup>2</sup> R. C. Burt, *Phil. Mag.*, 49, 1, 168, 1925. *Journ. Opt. Soc.*, 11, 87, 1925.



and applied to certain physical problems, such as the investigation of the photo-electric effect of pure sodium.

### Introduction of Sodium into Lamps and Thermionic Valves.

The lamp into which it is wished to introduce sodium is placed with its lower part in molten sodium nitrate contained in a metal vessel, as shown in Fig. 1. Aluminium is a very suitable metal for the container to be made of. The sodium nitrate is maintained molten at a temperature of about  $350^{\circ}\text{C}$ . by means of a bunsen flame. It is wise to introduce a suitable thermometer into the

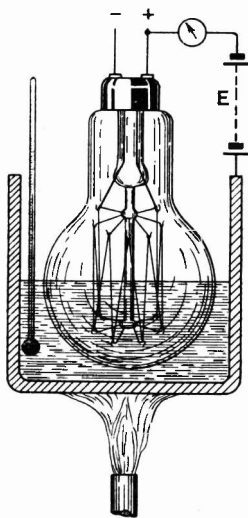

Fig. 1.

molten sodium nitrate, or into a hole in the side of the metal container, in order that the temperature may be maintained at the suitable value, and softening of the glass due to a too high temperature avoided. The lamp filament is made to function on the usual supply, and a source of potential of some 200 or 300 volts is connected between the positive terminal of the lighting circuit and the metal container. It is found as a rule that a current of a few milliamperes flows in the circuit from the metal container to the positive end of the filament, and this may be measured, if required, by means of a milliammeter, included in the circuit as shown in Fig. 1.

The action appears to be in the nature of

an electrolysis through the glass walls of the lamp, and is analogous to the ordinary electrolysis phenomena obtained in solutions of salts or in molten salts. The inner surface of the glass is bombarded by the electrons from the filament and becomes negatively charged, forming the cathode. The outer surface of the glass is positively charged from the potential  $E$ , and constitutes the anode. There are, of course, many free sodium ions in the molten nitrate, and under the electric field across the glass wall they migrate—since they are positively charged—to the cathode, that is to the inner surface of the glass, and are deposited there or vapourised into the lamp. The action may, of course, be progressive in such a way that the sodium of the glass is actually transferred inwards whilst sodium from the molten sodium nitrate takes its place.

After the action has proceeded for a short time, there is sodium vapour within the lamp, and this gives rise to a discharge of a very typical yellow colour. In a few hours sufficient sodium may be introduced to give a mirror of the metal on the inside of the glass.

If the lamp is made of lead glass it frequently becomes blackened, but even sodium glasses become brown due to a deposit of sodium in the colloidal state.

In a similar manner, but less readily, potassium may be introduced if molten potassium nitrate is substituted for the sodium nitrate.

It will be readily understood how this method can be employed for the introduction of very pure sodium or potassium into thermionic valves.

The method has been utilised for the construction of discharge tubes which have been used in connection with Tesla Coil installations<sup>3</sup> (the tubes were constructed by Kramer of Freiburg), and for helium tubes as detectors of electrical waves<sup>4</sup> (tubes constructed by Goetze of Leipzig). It is certainly a subject which merits further study. It is possible that by varying the nature and composition of the walls, other elements might be introduced in a state of great purity into such evacuated spaces.

<sup>3</sup> See Drude, *Ann. d. Phys.*, 16, 119, 1905.

<sup>4</sup> See Dorn, *Ann. d. Phys.*, 16, 784, 1905.

### Application to the Case of Neon Lamps and Discharge Tubes.

The commercial type of neon lamp is now very considerably used in wireless practice, and it promises to be still more utilised in the future. Nevertheless, the ordinary type of neon lamp has certain inherent drawbacks which handicap its employment.

Some time ago the present writer and Mr. Clarkson put forward a method of capacity and high resistance measurement utilising the neon tube.<sup>5</sup> In these and later publications<sup>6</sup> the inconstances of the neon lamps which gave rise to variations and unreliability were dealt with, and certain experiments, such as "over-running" the lamps and employing external ionising agents like half-watt lamps, etc., which ameliorated the conditions, were also described.

Notwithstanding these, no really satisfactory solution was arrived at, and the writer has for a considerable time sought a method for improving these types of discharge tubes for the purpose of capacity and resistance measurement, etc. It has been found that the chief sources of trouble arise from small quantities of electronegative gases, such as oxygen, contained as impurities in the neon-helium mixture, which is the filling gas of these lamps, and the occurrence of films of occluded gases on the surface of the electrodes. These causes of error may be almost entirely suppressed by the introduction of sodium into the discharge tubes, in a manner analogous to that described above.

The method of procedure is the same, except that the ordinary discharge of the neon lamp takes the place of the heated filament and supplies the electrons and ions

for the conduction of the current. It is usually sufficient to connect a further potential of 100 volts between the positive electrode of the neon lamp and the metal container, to cause introduction of the sodium. The voltage required for satisfactory working varies somewhat according to the lamp form.

The action of the sodium is twofold. It combines with any active gases, such as oxygen, and thus removes them; further, it is deposited upon the electrodes forming fresh, clean surfaces which reduce the troublesome time "lag" effects in the production of the discharge to a minimum. There is another advantage in that the potential required to drive the discharge tube is lowered by almost 40 volts, due to the introduction of the sodium on the electrodes.

The constants of the tube prove to be much more steady after this treatment, the range of capacity and resistance measurement is consequently considerably increased and the method is more accurate. It is also unnecessary to employ an additional external ionising agent as was recommended in the papers referred to.

By utilising a Philips' tungsten arc lamp (see photo) (the electrodes are small spheres of tungsten at a distance of a millimetre or two. The filling gas is neon at about half an atmosphere pressure) as discharge tube the author has been able to measure accurately by the method of timing flashes<sup>7</sup> by means of a stop-watch, capacities as low as 0.001 microfarads. The circuit resistance for these measurements was of the order of 100 megohms, so that very great care had to be taken to avoid leakage effects. The graphs giving the relation between the time of "flash" and the capacity value were linear, and, within the limits of experimental error, passed through the origin.

<sup>5</sup> Taylor and Clarkson, *Journ. Scient. Instrs.*, Vol. 1, No. 6, 1924. *E.W. & W.E.*, Vol. 2, No. 14, p. 97.

<sup>6</sup> *E.W. & W.E.*, Correspondence, Vol. 2, No. 14, p. 121; Vol. 2, No. 26, p. 915; *Journ. Scient. Instrs.*, Vol. 2, No. 5, p. 154, 1925.

<sup>7</sup> See *E.W. & W.E.*, Vol. 2, No. 14, p. 97; and Vol. 2, No. 26, p. 915.

## Abstracts and References.

Compiled by the Radio Research Board and reproduced by arrangement with the Department of Scientific and Industrial Research.

### R000.—WIRELESS IN GENERAL.

R040.—RADIO COMMUNICATION.—G. Marconi. (*Electrician*, 97, 29th October, 1926, p. 502.)

Abstract of the James Forrest lecture delivered at the Institution of Civil Engineers, 26th October, 1926.

### R100.—GENERAL PRINCIPLES AND THEORY.

R112.6.—SHORT-WAVE TESTS AT DEAL BEACH. (*Scientific American*, October, 1926, p. 306.)

An experimental station of the Bell Telephone Laboratories at Deal Beach, New Jersey, is investigating various phases of short-wave transmission. The power of the test transmitter varies from one kilowatt on the shorter waves to four kilowatts on the longer wave channels, operation usually taking place over a wavelength range of 16 to 111 metres. It is observed that short waves are attenuated more than long waves over distances up to 100 miles, but that at greater distances the signal strength of the short waves increases. In most instances, fading is found to be less marked on longer waves. The quality varies somewhat when the carriers and side bands fade simultaneously but the greatest variation occurs when the frequencies do not fade at the same time. For distances between a few hundred and a thousand miles there is little difference between over-land and over-water transmission. Day transmission is better than night on some of the shorter waves.

R113.—PROPAGATION DES ONDES COURTES.—R. Mesny. (*L'Onde Electrique*, 5, 57, pp. 434-463, September, 1926.)

Lecture delivered before the "Société des Amis de la T.S.F.," 11th May, 1926.

The author first recalls the observed facts characterising short wave propagation: long range; zones of silence; fading; influence of night and day, the season, and geographical position; and then gives the theories that have been put forward to explain them. After indicating the hypotheses on which physicists justify the existence of a conducting layer in the upper atmosphere, he studies the propagation of waves in an ionised medium, showing how they are reflected or refracted towards the earth, and deduces an approximate explanation of the phenomena observed. Lastly, he gives some particulars of the experiments verifying the theories and shows the manifest divergencies that still exist between the facts observed and the consequences of the theories proposed.

R113.—THE RELATIVE VALUES OF LONG AND SHORT WAVES IN WIRELESS COMMUNICATION (*E.W. & W.E.*, 3, 38, pp. 692-698, November, 1926.)

A discussion, opened by Dr. Eccles, before the Radio Society of Great Britain, at the first meeting of its 1926-27 session.

R113.—RECENT DEVELOPMENTS IN SHORT-WAVE WIRELESS TELEGRAPHY.—H. Rukop. (*E.W. & W.E.*, 3, 38, pp. 681-691, November, 1926.)

Concluding part of the translation of the Telefunken publication *Neuere Ergebnisse in der Drahtlosen Telegraphie mit Kurzen Wellen*, begun in the previous issue.

R113.—DIE BILDTELEGRAPHIE ALS UNTERSUCHUNGSMETHODE FÜR DIE AUSBREITUNG DER KUNZEN WELLEN (Picture telegraphy as a method of investigating the propagation of short waves).—H. Rukop. (*Elektrische Nachrichten-Technik*, 3, 8, pp. 316-318.)

In July, 1926, the Telefunken Company arranged a service of picture-telegraphy on the Telefunken-Karolus system between Nauen and Rome. The wavelength employed was about 39m. This service yielded not only valuable experience in picture transmission, but also interesting information on the propagation of short waves, a brief preliminary account of which is given here. The two chief effects that throw light on the propagation of short waves are found at certain hours of the night on the transmitted pictures, and are called the "multiple" and "wandering" effects, shown in the figures below:—

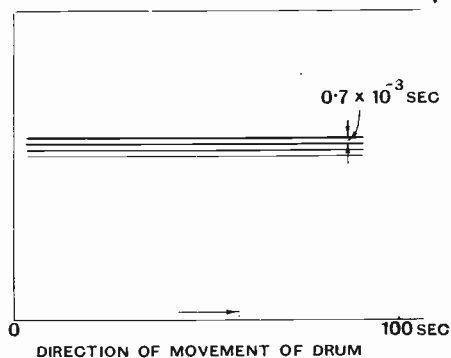

Fig. 1.—Multiple effect. Multiple reception of a line transmittance.

The multiple effect consists in a sign in the picture appearing displaced twice or more in the time axis. The displacement shown here amounts up to 3 mm., and occasionally fourfold repetition occurs. The simplest explanation consistent with our present knowledge of short waves is that transmission from the transmitter to the receiver takes place simultaneously along several paths of different length. From the velocity of the lines in the figure it follows

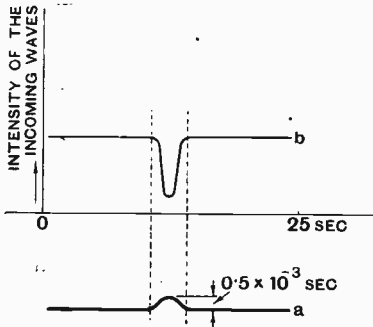

Fig. 2.—Wandering effect.

that a separation of two pictures by 1 mm. denotes a difference of length of path of about 200 km. In the case of four pictures, whose total distance apart is 3 mm., we are consequently dealing with path differences of 0, 200, 400 and 600 km. The pictures with a longer path are generally much weaker than those with a shorter one and there is usually a principal path, and that the shortest, with which the subsidiary paths may for a few seconds coalesce. When the multiple pictures occur, there is also as a rule marked fading, though this is not compulsorily linked with the multiple phenomena.

The wandering effect is shown by line *a* of Fig. 2, and is attributed to a transient lengthening and shortening of the transmission path. It is always strikingly accompanied by marked fading, as shown by line *b* in the same figure. Since, while this fading occurs, the transmission path varies by a distance corresponding to more than 2,000 periods and, as the figure shows, nothing remains of the original path, and the picture is perfectly simple, it is concluded that it is highly improbable that fading is due to interference. What is thought to be the most likely cause of fading is rapid alteration in the concentration of the ions or electrons, brought about either through purely mechanical means, *e.g.*, wind, or electrical discharges or a stream of radiation.

Further, owing to the variation of the length of path, one would expect a Doppler effect, *i.e.*, a transient alteration of the frequency at the receiver with the transmitting frequency constant, and this has been remarked during the tests (and also often previously).

The observations are being continued.

RI13.1.—*UBER DAS VERHALTEN VON EMPFÄNGUN BEI POLARISATIONSÄNDERUNGEN DER ELEKTRISCHEN WELLEN (FADINGSCHEINUNGEN) (Behaviour of receivers to changes of polarisation of electric waves (fading phenomena)).*—A. Esau. (*Zeitschrift für Hochfrequenz*, 28, 2, pp. 50-53, August, 1926.)

Fading may be caused by changing atmospheric conditions (*e.g.*, cold strata penetrating into warmer ones, bringing about dispersion of the wave energy) or by interference between direct and indirect rays, or by alteration of the plane of polarisation of a wave. This article deals only with the latter cause, and attempts to eliminate it by a suitable choice of the receiving circuit. Various antenna combinations are examined with reference to the relation between the energy received and the rotation of the plane of polarisation. The combinations all consist of a vertical and a horizontal antenna, both coupled to a circuit which is tuned to the incoming wave and connected to the grid of a valve functioning either as detector or amplifier. The simplest arrangement is a combination of a vertical open antenna and a horizontal frame. The energy picked up is independent of the plane of polarisation, and thus fading phenomena due to changes of polarisation are eliminated. The arrangement also permits the angle of rotation of the plane of polarisation to be determined and its transient changes. The other combinations considered reduce fading to a certain extent, but are less effective than the arrangement described.

RI13.2.—*SOME MEASUREMENTS OF SHORT WAVE TRANSMISSION.*—R. Heising, J. Schelleng and G. Southworth. (*Proc. Inst. Radio Engineers*, 14, 5, October, 1926, pp. 613-647.)

Quantitative data on field strength and telephonic intelligibility are given for transmission at frequencies between 2.7 megacycles (111 metres) and 18 megacycles (16 metres), and for distances up to 1,000 miles with some data at 3,400 miles. The data are presented in the form of curves and surfaces, the variables being time of day, frequency and distance. Comparisons are made between transmission over land and over water, between night and day effects, and between transmissions from horizontal and from vertical antennæ. Fading, speech quality and noise are discussed. The results are briefly interpreted in terms of current short wave theories.

RI13.8.—*SUR LA RECHERCHE D'UNE CORRESPONDANCE ENTRE LES PERTURBATIONS MAGNÉTIQUES ET LES PERTURBATIONS DANS LA PROPAGATION DES ONDES ELECTROMAGNÉTIQUES.*—C. Maurain. (*L'Onde Electrique*, 5, 57, September, 1926, pp. 483-487.)

A statistical study of the magnetic disturbance at the Val Joyeux observatory at the time of the principal variations in intensity of the long wave radio signals received at the Meudon observatory has been made during 1922-23-24. The result is that the mean value of the magnetic disturbance at the time of these variations is sensibly the same as the general mean value, showing that magnetic disturbances do not play an important part in

the production of these radio variations. If the statistics are referred only to the days on which the intensity variations occur for the two transmitters investigated, Bordeaux and Nantes, a mean magnetic disturbance is obtained greater than the general mean; but the number of these days in the three years is too few for one to be able to draw a conclusion from this particular result.

R113.8.—HAT DAS ERDFELD EINEN EINFLUSS AUF DIE WELLENAUSBREITUNGSVORGÄNGE? — (Does the Earth's Field Affect the Phenomena of Wave Propagation?)—A. Meissner. (*Elektrische Nachrichten-Technik*, 3, 9, September, 1926, pp. 321-324.)

Larmor's theory of the refraction of electric waves by means of the ions and electrons of the upper atmosphere was completed last year by taking account of the influence of the earth's field on electronic motion (Appleton, Nichols and Schelleng). As a consequence of this extension of Larmor's theory, calculation shows that the wave of length 214 metres must be a resonance wave, for which there is selective absorption and a corresponding shorter range. Taylor saw experimental confirmation of the extended theory in the decrease of the day range observed with waves in the neighbourhood of 200 metres.

The curve shows a distinct minimum with a wave of about 200 metres and the earth's field theory requires it at 214 metres. The explanation of this minimum through the influence of the earth's field leads however to contradictions. We must only seek the influence of the earth's field there where the electrons govern the phenomenon of wave propagation, *i.e.*, where wave transmission takes place through the upper layers of the atmosphere; *i.e.*, when it is a question of pure space radiation; this is the case by day however only with the

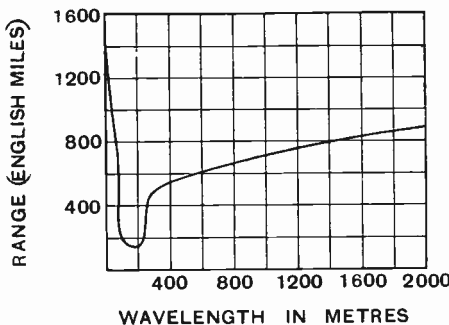

Fig. 1. Day ranges according to Taylor.

shortest waves—far below 150 metres. With waves above 150 metres, and therefore in the range of the critical wavelength of 214 metres, we have by day only surface waves, and the electrons hardly affect the propagation of surface waves greater than 100 metres, as has also been worked out by Elias (*Zeitschr. für Hochfrequenz*, 27, p. 66). According to Elias's calculations, the

electrons and ions of the atmosphere by day only produce absorption with waves down to 100 metres. The dielectric effect of the electrons and ions only begins to be felt with very short waves, below 20 or 30 metres, when absorption is less pronounced.

In Taylor's curve the day ranges are represented as a function of the wavelength: the figure below shows them as a function of the frequency.

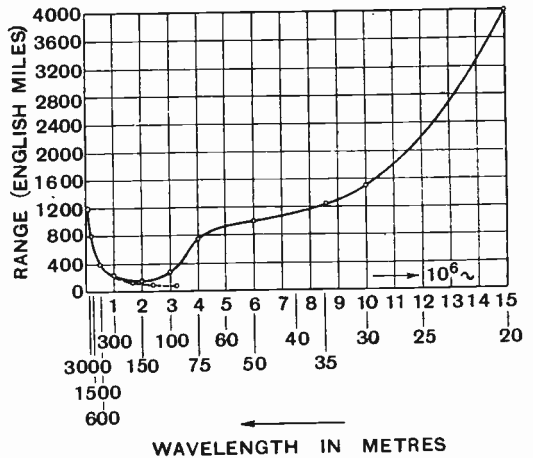

Fig. 2. Day ranges.

Here the curve no longer appears to represent a uniform phenomenon, disturbed only over a small range, but rather the interaction of two quite heterogeneous phenomena. Firstly, it is seen that the minimum is displaced still farther to the right, still farther from the critical frequency  $\lambda = 214$  metres required by theory. The two heterogeneous conditions are divided by the minimum. Evidently to the left of the minimum we have the range of the surface waves, and to the right the range of the space waves. The drop on the left is produced by the surface waves being absorbed by the ground or by the electrons and ions of the lower layers; the rise to the right of the minimum comes from the upper layers taking over more of the energy transference with increasing frequency. The minimum is the intersection of two curves: that of the surface waves falling from left to right, approximately inversely proportional to the square of the frequency or more as corresponding to the first power (the curve  $1/n^2$  is drawn in as it would presumably be if the ground losses were the deciding factor), and that of the space waves to the right of the minimum for which the values are not sufficiently clear for one to assign any definite function for the frequency relation. The result therefore is that from the day ranges here we can nowhere deduce the influence of the earth's field. If we wish to discover this, the experimental investigations in the neighbourhood of the critical wave  $\lambda = 214$  metres must be extended into the night hours, for only at night is energy transferred by space waves in strata

whose dielectric state is altered through ions and electrons. Accordingly transmissions were made at night with waves in the critical range  $\lambda = 175$ -265 metres, employing an aerial with the greatest possible space radiation. The arrangement is shown diagrammatically in the figure below.

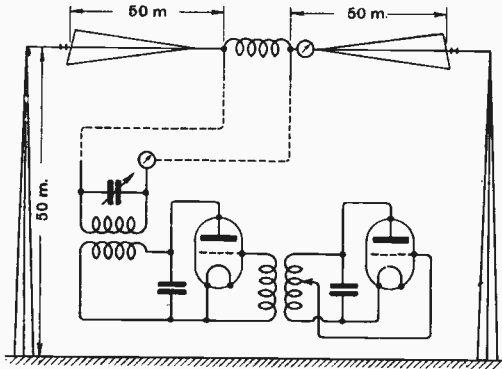

Fig. 3. Transmitting arrangement.

Numerical values are given and the method of carrying out the experiments is described. The waves were received at Prague, Kiel, Constance and Leningrad, and results obtained are shown graphically. An analysis of all the results is said to show no minimum anywhere in the range, and therefore, also with transmission by night, we cannot speak of special absorption and fading phenomena with a particular wave. Thus neither day nor night ranges, unfortunately, bring us experimental proof of the earth's field having an influence on wave propagation, that is so necessary for our theory.

RI13.8.—AURORA AND ITS EFFECT UPON RADIO SIGNALS.—W. Sutton. (*Q.S.T.*, October, 1926, 10, pp. 23-24.)

The writer, who is "in a position to keep a very close check upon the Aurora," is convinced that it has a decided and detrimental effect upon radio signals of certain frequencies, and attributes the poor reception complained of throughout Canada and the United States last winter to the increasing activity of auroral phenomena. The writer expresses the results of his observations as follows:—

"Strong Aurora kills signals from 35 metres up to 500, although the effect is only immediate on signals up to approximately 60 metres. As one goes up higher in wavelength the time lag is increased. The delay between the start of the Aurora and the disappearance or weakening of signals may be as long as 24 hours in the upper broadcast band. The signals also take much longer to come back to normality.

"Moderate Aurora makes quite a change on the skipped distance of 40-metre signals, and prevents real DX. As we go 10 metres higher the signals gradually fade out. In the broadcast band distance signals are coming in, but fading is very prominent, and no medium distant stations came through.

"Slight Aurora changes the skipped distance just slightly on the 40-metre band, and causes fading on medium distance broadcast stations, but distant stations are fairly steady. The 50-metre signals will push through but are much weaker. Intermittent Aurora, coming for a few hours and lifting for a day, and then coming back again, will cause a continued blanket on broadcast signals, but the short waves will break through whenever the Aurora has lifted."

The increased activity of auroral phenomena generally reported is thought to be linked up with the approaching sun spot maximum.

RI13.8.—THE RECURRENCE OF MAGNETIC STORMS.—H. Deslandres. (*Nature*, 30th October, 1926, pp. 621-622.)

A letter referring to Dr. Chree's in *Nature* of 4th September, showing the considerable difference in the methods employed by the two writers and that the results obtained could not be exactly the same.

RI21.—THE AERIAL-EARTH SYSTEM.—A. G. Warren. (*Wireless World*, 13th October, 1926, pp. 517-518.)

Discussion of half-wave tuning with potential rectification.

RI27.—FIELD DISTRIBUTION AND RADIATION RESISTANCE OF A STRAIGHT, VERTICAL, UNLOADED ANTENNA RADIATING AT ONE OF ITS HARMONICS.—S. Levin and C. Young. (*Proc. Inst. Radio Engineers*, October, 1926, 14, 5, pp. 675-688.)

The operation at the harmonics of the grounded antenna and of an ungrounded antenna at any distance above ground is considered as far as current, voltage and power distribution, electromagnetic field and radiation resistance are concerned. The antenna is always assumed to be a straight vertical wire and unloaded and the ground a perfect conductor.

RI32.—EIN VERGLEICH ZWISCHEN TRANSFORMATORENVERSTÄRKER UND WIDERSTANDSVERSTÄRKER (Comparison between transformer and resistance amplifiers).—M. von Ardenne. (*Zeitschrift für Hochfrequenz*, 27, 6, 1926, pp. 167-169.)

An investigation of the amplifying properties of a transformer amplifier (without resonance tuning) and a resistance amplifier, at a frequency of 1,000. To make a definite comparison possible, a formula is found for resistance amplifiers corresponding to the Barkhauser formula for the linear degree of amplification with transformer amplifiers. The investigation shows that, with the same assumptions, a greater degree of amplification can be obtained with resistance than with transformer coupling.

RI32 & RI34.75.—GRUNDSÄTZLICHES ÜBER ZWISCHEN FREQUENZVERSTÄRKER-SCHALTUNGEN (Principles of intermediate frequency amplifier circuit arrangements).—W. Range. (*Zeitschrift für Hochfrequenz*, 27, 6, pp. 169-172.)

The intermediate frequency amplifier is discussed

and four methods are given of avoiding the difficulties that arise in obtaining the right beat note of useful frequency with the heterodyne and input circuit (tuned to the distant transmitter and connected to the first rectifier) coupled together and slightly out of tune.

R132.1.—LOW-FREQUENCY INTERVALVE TRANSFORMERS.—P. Willans. (*Journ. Inst. Elect. Engineers*, 64, October, 1926, pp. 1065-1088.)

A paper read before the Wireless Section, 2nd June, 1926, summarised as follows:—

The theoretical expression for the voltage amplification of a valve followed by a transformer is developed in its simplest possible terms and various particular cases are considered. The importance of low leakage inductance for the uniform amplification of the higher frequencies is emphasised.

A practical verification of the theory is provided by actual measurements of the vector amplification ratio and comparisons with the theoretical equations, and graphical methods are given whereby the constants of a transformer can be deduced from these measurements and the amplification ratio extrapolated to frequencies beyond the range of convenient measurement.

A practical design of transformer is described in which low leakage inductance and self-capacity are ensured by a sectionalised and spaced construction, and a curve of amplification of this transformer is given.

Various questions relating to intervalve transformers are briefly considered, and circuits are described for increasing the amplification of low frequencies and the effective step-up ratio of the transformer.

The use of low-frequency reaction for correcting distortion is described and illustrated by measurements.

R132.3.—RECHERCHES SUR LES MEILLEURES CONDITIONS DE FONCTIONNEMENT D'UN AMPLIFICATEUR À RÉSTANCES.—M. Mercier. (*L'Onde Electrique*, 5, 56, August, 1926, pp. 413-424.)

Description of an investigation on the conditions of working of a resistance amplifier as concerns the best heating and plate tensions to employ and the best resistance to introduce in the plate circuit of intermediate valves. The results are shown graphically.

R132.8.—PRÉSENTATION D'UN APPAREIL "BIREFLEX."—A. Cazes. (*L'Onde Electrique*, 5, 56, August, 1926, pp. 425-428.)

A paper, introducing a "bireflex" instrument, summarised as follows: The first valves of an amplifier do little work. The output can be improved by making them play several parts. The employment of a frequency changer can make each valve work on three different frequencies. A second change of frequency enables the difficulties that subsist to be avoided.

R132.8.—BY-PASS CONDENSERS IN REFLEX RECEIVERS.—D. Kingsbury. (*Wireless World*, 20th October, 1926, pp. 546-550.)

An article showing how by-pass condensers in

reflex sets may be kept down to practical limits and in certain cases dispensed with, and giving reasons why general reception should be limited to 5,000 cycles on either side of the carrier wave and L.F. transformers designed accordingly.

R133.—ÜBER DIE SCHWINGUNGSERZUGUNG MIT HILFE VON RAUMLADEEFFEKTEN (On the generation of oscillations with the aid of space-charge effects).—E. Alberti. (*Elektrische Nachrichten-Technik*, 3, 9, September, 1926, pp. 328-332.)

An account of experiments on the generation of oscillations with four-electrode valves with control-grid negative. Several circuit-arrangements are possible, three of the most important being shown. The degree of efficiency for the amplifying valves type R used in the experiments amounts to 10 per cent. with optimum adjustment. There is almost absolute proportionality between space-charge grid tension and output. From measurements of the dependence of the frequency on the strength of the beating current, it is found that an alteration of the current strength of 1 per cent. corresponds to an increase of valve capacity of about .2 cm. With ordinary transmitting valves the increase is somewhat lower. On reducing the anode tension the oscillations stop at about 30 volts, while below 15 volts oscillations start again, which are probably to be explained in the Barkhauser-Kurz way.

R134.—THEORY OF DETECTION IN A HIGH VACUUM THERMIONIC TUBE.—L. Smith. (*Proc. Inst. Radio Engineers*, 14, 5, October, 1926, pp. 649-662.)

This paper presents some new ideas on detection by means of the high vacuum triode in connection with a grid-leak and condenser, which show the function of the grid-leak and detector as well as their proper values for best detection. Three main sources of distortion are shown to exist with this method of detection: two from the curvature of the grid characteristic—one due to the harmonics produced, and the other an amplitude distortion arising from the rectified grid-current not varying linearly with the input voltage—the third distortion being brought about by the grid-leak and condenser.

R134.—GRID POTENTIALS.—C. Stephenson. (*Wireless World*, 6th October, 1926, pp. 491-493.)

Discussion of the effect of filament circuit connections on the mean grid voltage of H.F. detector and L.F. valves.

R134.75.—SUPERHETERODYNE INTERFERENCE.—P. Tyers. (*Wireless World*, 13th October, 1926, pp. 521-522.)

A brief note showing how changing the intermediate frequency avoids local jamming.

R134.75.—ON THE ORIGIN OF THE SUPERHETERODYNE METHOD.—W. Schottky. (*Proc. Inst. Radio Engineers*, 14, 5, October, 1926, pp. 695-698.)

A short outline of how and when the idea of the superheterodyne method took shape in Germany.

R138.—ÜBER DEN AUSTRITT VON ELEKTRONEN AUS KALTEN METALLEN (Electronic emissions from cold metals).—F. Rother. (*Annalen der Physik*, 81, 4, pp. 317-372.)

R142.—COMBINED ELECTROMAGNETIC AND ELECTROSTATIC COUPLING AND SOME USES OF THE COMBINATION.—E. Loftin and S. Young White. (*Proc. Inst. Radio Engineers*, 14, 5, October, 1926, pp. 605-611.)

The energy-transfer characteristic of the normal forms of coupling employed in radio receivers transfers energy more readily at higher than lower frequency. This characteristic makes for higher efficiency and consequently greater tendency towards instability in commercial valve receivers on the high-frequency portion of the broadcast band.

The investigation of the combination of electromagnetic and electrostatic couplings was undertaken for the purpose of removing this undesirable characteristic, and this paper outlines some of the more salient observations made during the investigation as well as some uses made of the combination. One of these features is the employment of a method of coupling which has its frequency characteristic reversed in that its most efficient energy transfer takes place at the lowest frequency. By suitably combining this method of coupling with a coupling having the usual characteristic, it is possible to so design the combined coupling that the total energy transfer will vary in any desired manner with frequency.

R145.—A METHOD FOR MAXIMISATION IN CIRCUIT CALCULATION.—W. van B. Roberts. (*Proc. Inst. Radio Engineers*, 14, 5, October, 1926, pp. 689-693.)

Having found the expression for a current (or voltage or power, etc.) in terms of complex quantities representing the constants of a circuit, it is often desired to determine what value of some one of these complexes makes the absolute magnitude of the current (or voltage, etc.) a maximum or a minimum. Rather than reduce the expression to its absolute value first, and then maximise in the usual way, it is often much less tedious to differentiate the expression while in the complex form. The condition that the absolute value is an extremum is then not that the derivative is equal to zero, but that the derivative multiplied by a small increment of the independent variable gives to the dependent variable an increment which is at right angles to the vector representing the dependent variable itself. The condition of maximum obtained by this method is often in a form that is more compact and that has obvious physical significance. Two examples of the use of the method are given.

R148.1.—THE FREQUENCY CHARACTERISTICS OF TELEPHONE SYSTEMS AND AUDIO-FREQUENCY APPARATUS, AND THEIR MEASUREMENT.—B. Cohen, A. Aldridge and W. West. (*Journ. Inst. Elect. Engineers*, 64, October, 1926, pp. 1023-1064.)

A paper read before the Institution, 29th April, 1926.

R149.—SUR LA DÉTECTION PAR LES CONTACTS MÉTALLIQUES.—H. Pélabon. (*L'Onde Electrique*, September, 1926, pp. 464-475.)

The detection of electromagnetic waves by means of a metal-dielectric-metal contact has already been described (*L'Onde Electrique*, 5, 52, 1926, p. 141). Another solution of the problem is considered here, namely with the metals directly in contact. The apparatus employed is described for the case of the contact sphere-plane, two spheres, and a point and a plane, the results being given in detail. The case of the symmetrical detector is considered and the influence of the nature of the metals. The mechanism of detection is ascribed to the passage of electrons from one conductor to the other, the passage being easier in one direction than in the opposite direction.

R149.—SUR LE CONTACT RECTIFIANT.—A. Guillet. (*Comptes Rendus*, 183, 5, 2nd August, 1926, pp. 350-352.)

The fact appears now to be established that any bad contact inserted in a circuit is able to detect when a suitable electromotive force is applied to the circuit. A rectifying contact is thus comparable with a small unsymmetrical condenser that discharges across the insulation when one plate, the point in the case of the galena detector, receives a large enough charge of negative electricity. This is the point of view adopted by Mlle. Collet (*Annales de Physique*, 15, 1921, p. 265) and by M. Pélabon (*L'Onde Electrique*, 5, April, 1926, p. 141), but these physicists have given only qualitative indications as to the probable mechanism of the phenomenon. This article calls attention to certain general measurable facts calculated to assist the formulation of a definite theory.

## R200.—MEASUREMENTS AND STANDARDS.

R261.—THE THERMIONIC VOLTMETER.—W. Medlam and U. Oswald. (*E.W. & W.E.*, 3, 38, November, 1926, pp. 664-673.)

Concluding part of the article begun in the October issue.

## R300.—APPARATUS AND EQUIPMENT.

R320.—THE LENGTH OF THE HERTZ ANTENNA.—G. Lang. (*Q.S.T.*, 10, October, 1926, p. 16.)

The results are tabulated of experiments with Hertzian antennæ: vertical, horizontal, and with both vertical and horizontal sections. It is found that for vertical antennæ the wire length in feet is 1.40 times the fundamental wavelength in metres, and for horizontal antennæ the wire length in feet is 1.46 times the wavelength in metres—thus if we wish to operate at 40 metres with a horizontal antenna we multiply 40 by 1.46 and get 58.4 as the length of the necessary system. The table also shows the results of tests on antennæ of other forms, the constants for which are found to vary with the angle between the wires and ground.



R329.1.—THE CANADIAN BEAM SERVICE. (*Electrician*, 97, 22nd October, 1926, p. 474; 97, 29th October, 1926, p. 498.)

Details are given of the Bodmin transmitting and Bridgwater receiving stations, for communication between this country and Canada and South Africa, forming part of the short-wave imperial system.

R330.—RADIOTRON MODEL UX<sub>210</sub>. (*Q.S.T.*, 10, 9, September, 1926, pp. 33-36.)

A detailed account of this new valve, designed for use as an oscillator, modulator, or power amplifier in radio transmitting circuits or as a power amplifier with loud-speakers where high output is required. The valve data are given and characteristic curves shown.

R330.04.—MICROPHONIC NOISE.—F. Henderson. (*Wireless World*, 20th October, 1926, pp. 553-554.)

Some notes on its cause and cure.

R331.5.—ETUDE DES GAZ OCCLUS DANS LES TRIODES.—J. Groszkowski. (*L'Onde Electrique*, 5, 56, August, 1926, pp. 404-412.)

A study of the vacuum in valves and more particularly of the presence of gases occluded in the electrodes. The degree of vacuum in a triode can be estimated by means of an ionisation method depending upon the measurement of the "inverse" current due to the ions of the liberated gases. This article describes in detail this method, which has been improved and more especially adapted to the investigation of gases occluded in electrodes.

R.334.—LA SUPER-RÉACTION PAR LAMPE BI-GRILLE.—J. Sacazes. (*Q.S.T. Français et Radio Electricité Réunion*, 7, 30, September, 1926, pp. 51-55.)

Description of a simple circuit arrangement for super-reaction with the four-electrode valve.

R334.—LA LAMPE À DEUX GRILLES.—M. Chauvierre. (*Q.S.T. Français et Radio Electricité Réunion*, 7, 30, September, 1926, pp. 32-41.)

A brief survey of the general characteristics of four-electrode valves and their employment in the classic circuits.

R341.6.—A DISTINCTLY NEW RECTIFIER.—H. Sheldon. (*Scientific American*, 82, September, 1926, pp. 186-187.)

Description of a small compact rectifier of low internal resistance, consisting of a dry metal oxide between two electrodes, said to be able to rectify a large current on a very little voltage: about three amperes on a volt and a half.

R355.52.—LES RELAIS À ARC.—E. Fromy. (*L'Onde Electrique*, 5, 56, August, 1926, pp. 379-403.)

Partially exhausted tubes, more particularly mercury vapour bulbs, are now in current use for changing alternating into continuous current. They thus play the rôle of valve, behaving like

very powerful diodes. By the addition of extra control electrodes, either interior grid or exterior sheath, it is possible to transform gas-containing tubes into relays, just as that wonderful relay the triode valve has been formed from the electronic diode—the fundamental difference between the two types of relay, of course, being that in the ordinary valve the current is carried by electrons, while in the gas-containing tube it is carried by ions. This article describes at length the principle and operation of the new relays, defining the limits of their present usefulness. A bibliography of the subject is appended.

R376.3.—A NEW LOUD-SPEAKER. (*Electrician*, 97, 29th October, 1926, p. 510.)

A brief illustrated account of the "R.K." speaker, invented by Mr. Rice and Mr. Kellogg and made by the B.T.-H. Co. The sound is conveyed by a plain paper cone, with the natural frequency of vibration very low in the audible range, and the instrument is claimed to miss nothing and distort nothing.

On the same page a novel type of gramophone, called the "Panatropé," is outlined, which can be used as a wireless receiver.

R376.3.—ACOUSTIC REFLECTION.—N. McLachlan. (*Wireless World*, 13th October, 1926, pp. 506-508.)

An account of the influence of echoes on loud-speaker quality.

R383.—METALLISED HIGH RESISTANCE UNITS.—J. Morgan. (*Q.S.T.*, 10, 9, September, 1926, pp. 37-39.)

The history of the design of high resistance units is briefly traced, including the improvement introduced by engineers of the International Resistance Co., and the production of standard resistors described.

#### R400.—SYSTEMS OF WORKING.

R411.—SPARK COIL PORTABLE TRANSMITTERS.—F. Wilburn. (*Q.S.T.*, 10, 9, September, 1926, pp. 40-41.)

Illustrated description of a small portable transmitter with a pair of Ford coils connected in parallel for power supply.

R432.—REDUCTION OF INTERFERENCE IN BROADCAST RECEPTION.—A. Goldsmith. (*Proc. Inst. Radio Engineers*, 14, 5, October, 1926, pp. 575-603.)

The factors in station interference with broadcast reception are analysed, namely: signal field strength, receiver selectivity, and psychological reactions of the listeners.

Statistical data, correlating these factors with interference complaints from listeners in the vicinity of the 50-kilowatt broadcasting transmitter at Bound Brook are presented, these data being the results of a survey by a special interference reduction service.

The clearing up of complaints by this service, using simple methods which are described, indicates the feasibility of high-power broadcasting

stations, as well as the necessity for them owing to the requirement of reliable broadcasting service over large areas.

**R435.—SYSTÈME DE COMMUNICATIONS ÉLECTRIQUES SECRÈTES.**—J. Jammet. (*L'Onde Electrique*, 5, 56, August, 1926, pp. 365-378.)

Previous solutions of the problem of secret communications are said to be pretty complex and to secure only very relative secrecy. The author claims to have developed an absolutely secret method, of simple mechanism, and involving no new apparatus. This new principle appears to lie in the employment of a key that is without periodicity and therefore undecipherable. The working out of the system is explained in detail and diagrams are shown.

**R435.—TÉLÉGRAPHIE ET RADIOTÉLÉGRAPHIE SECRÈTE.**—Gen. Cartier. (*Radio Electricité*, 7, 112, 25th July, 1926, pp. 275-278; 7, 113, 10th August, 1926, pp. 297-301.)

A detailed description of the Vigenère cryptographic system, showing circuit diagrams.

**R500.—APPLICATIONS AND USES.**

**R536.—RADIO SAFEGUARDS MINERS.**—(*Scientific American*, 82, September, 1926, p. 223.)

A radio warning alarm has been developed to safeguard miners in the Pennsylvania coalfields against explosions of coal-dust and the deadly effects of gas accumulation. The device utilises the simplest of radio circuits comprising a valve, variable condenser, sensitive relay and alarm bells. The charged condenser plates only discharge when the air between them becomes more conducting due to a higher proportion of coal-dust. Each discharge of the condenser is accompanied by a closing of the relay circuit that rings a bell. The rate at which the bell rings gives an indication of the change of conditions to the operator in charge above, who can then regulate the ventilating system accordingly.

**R551.I.—ÉTABLISSEMENT D'UN NOUVEAU CANEVAS DE POSITIONS GÉOGRAPHIQUES.**—R. Jouaust. (*L'Onde Electrique*, 5, 57, September, 1926, pp. 429-433.)

An article giving some particulars of the new determination of longitudes that is being carried out under the auspices of the Unions Internationales d'Astronomie et de Géophysique, and showing the value of radio telegraphy for the accuracy of the results, in enabling the time at any given observatory to be communicated instantaneously to distant observers.

**R586.—SUR LE TÉLÉPHOTE APPAREIL DE TÉLÉVISION PAR TUBES À VIDE: RESULTATS EXPERIMENTAUX PRÉLIMINAIRES.**—A. Dauvillier. (*Comptes Rendus*, 183, 5, 2nd August, 1926, pp. 352-354.)

Among the numerous mechanical systems of monochrome television proposed up to the present,

those of Mihaly, Jenkins and Belin have recently effected the transmission of moving strongly contrasted shadows, and that of Baird, the transmission of a normal image. The author, however, is of the opinion that these ingenious systems are not capable of a simple and practical solution of the general problem, and that the only method that could give complete satisfaction is one based on the employment of a Braun tube as receiver subordinate to a mechanical analyser of the image to be transmitted. An outline of the method is given, but its development has not yet reached the stage of practical usefulness, a gain of sensitivity of the order of a thousand being required for the apparatus to be sufficiently affected.

**R586.—ELECTRIC TELEVISION.**—A. Campbell Swinton. (*Nature*, 118, 23rd October, 1926, pp. 590.)

A letter stating that the writer understands that more than one inventor in Paris is employing for receiving, that cathode ray arrangement that he believes he was the first to publish in a letter to *Nature* of 18th June, 1908. His ideas were further detailed in an address to the Röntgen Society on 7th November, 1911, and still further elaborated and brought up to date, with wireless methods applied, in a paper read before the Radio Society of Great Britain on 26th March, 1924. His plan, which was to use cathode rays as employed in the Braun oscillograph, both for transmitting and receiving, is at present only being applied for receiving, mechanical apparatus being still used for transmitting. He desires, however, to point out, that when the cathode ray is also applied to transmitting, it will be possible to dispense entirely with all moving material parts, as the alternating or intermittent electric currents employed for moving the two cathode ray beams synchronously at the transmitting and receiving stations respectively can be supplied by oscillating thermionic valves supplied by batteries.

In this way, he states, it should prove possible to have electric television of a satisfactory fine grain description without the employment of any mechanical motion or material parts whatever, as cathode rays are practically without weight and inertia, and can be deflected with perfect accuracy and synchronism at almost incredible speeds, while the accuracy of oscillating valves properly tuned is also wonderful.

**R800.—NON-RADIO SUBJECTS.**

**534.—RECENT DEVELOPMENTS IN THE RECORDING AND REPRODUCTION OF SOUND.**—S. Williams. (*Franklin Institute Journal*, 202, 4, October, 1926, pp. 413-448.)

**539.—KATHODENZERSTÄUBUNGSPROBLEME.**—A. v. Hippel. (*Annalen der Physik*, 80, 7, pp. 672-706.)

Description of a new method for investigating cathode sputtering which shows that sputtered metal particles consist very largely of uncharged atoms.

# Esperanto Section.

Abstracts of the Technical Articles in our last Issue.

## Esperanto - Sekcio.

Resumoj de la Teknikaj Artikoloj en nia lasta Numero.

### R000.—SENFADENO ĜENERALE.

R040.—LA RELATIVAJ VALOROJ DE LONGAJ KAJ MALLONGAJ ONDOJ JE SENFADENA INTERKOMUNIKADO. Diskutado antaŭ la Radio-Societo de Granda Britujo.

La diskutadon malfermis D-ro Eccles, kiu aludis al frua laborado je mallongaj ondoj. Longaj ondoj vojaĝas preskaŭ egalbone dum tago aŭ nokto, kaj la distanco de ricevado dependas nur de la potenco uzata. Mallongaj ondoj estas riceveblaj je proksimaj distancoj; poste sekvas distanco sensignala, post kiam signaloj estas denove haveblaj. Mezuroj de signalforteco de Heising, Schelling, kaj Southworth estas ankaŭ cititaj. Ĝenerale, post la sensignala distanco, la signaloj dum tempo plifortiĝas. Oni konkludas ke, por komercaj celoj, organizacioj kiuj bezonas nur kelkajn horojn ĉiutage alprenos mallongajn ondojn, sed komercaj organizacioj, kiuj konkuras kun kablo-kompanioj, trovas longajn ondojn pliofte fidindaj.

Admiralo Sir Henry Jackson daŭrigis la diskutadon, citante siajn proprajn observadojn pri mallongonda ricevado. Li emfazigis la helpon, kiun povus fari la amatoroj, dirante, ke ili devas labori sisteme, funkciantaj je unu ondlongo kun unu stacio dum unu-du semajnoj, poste je aliaj ondlongoj kaj stacioj.

Poste partoprenis en la diskutado S-roj. Gerald Marcuse, H. Bevan Swift, E. H. Shaughnessy, P. R. Coursey, M. Child, kaj Hogg.

S-ro Shaughnessy diris, ke kelkaj mallongondaj stacioj kun malgranda potenco entreprenas eksperimentan kaj komercan laboron, kaj estas tiel aranĝitaj, ke ili povas entrepreni trafikon dum la plej bonaj horoj de l'tago por mallongaj ondoj. Granda kampo por mallongondaj stacioj kredeble kuŝas en tiu direkto. S-ro Coursey aludis al la efekte de la antena formo, kaj al la ebleco de du-tri samtempaj sendoj je malsamaj ondlongoj, kiuj eble estos valoraj laŭ eksperimenta kaj komerca vidpunktoj.

D-ro Eccles respondis al la diskutado.

### R050.—RESUMOJ KAJ ALUDOJ.

Kompilita de la *Radio Research Board* (Radio-Esplorada Komitato), kaj publikigita laŭ arango kun la Brita Registara Fako de Scienca kaj Industria Esplorado.

### R064.—LA BERLIN'A SENFADENA EKSPozICIO.

Unue estas priskribo de la konstruaĵo speciale konstruita por enteni la ekspozicion, kaj de la apuda turo, kiu portos la antenon de la Berlina Brodkasta Stacio. Poste sekvas priskribo de

kelkaj montraĵoj speciale interesaj. Notindaj inter tiuj estas la multoblaj valvoj de la Loewe Radio-Kompanio. Tiuj-ĉi estas disvolvigitaj el la laborado de von Ardenne kaj Heinert, kiuj uzas anodajn rezistancojn kelkmeĝomajn kun valvoj de granda amplifa proporcio. En unu okazo du efektivaj valvoj kun kupliloj por altfrekvenca amplifado estas priskribitaj, kaj en alia okazo tri efektivaj valvoj kun kupliloj por malaltfrekvenca amplifado; en ĉiu okazo unu bulbo entenas la tuton. Presitaj estas fotografaĵoj de ĉi tiuj valvoj.

Poste priskribitaj estas kvarcaj resonatoroj muntitaj en vakua tubo, kun miksaĵo de helio kaj neono je malalta premo. Kiam la kvarca stangeto vibras, ĝia surfaco estas kovrita je luma ardo, kiu utilas kiel tre sentema rezonanca indikato. Arango de kvin tiaj resonatoroj, ĉiu estante malsimila je l'aliaj per unu parto en 1000, estas montrita por la kontrolo de frekvenca variado.

Sekvas priskribo de la "Protos" Laŭtparolilo de Siemens-Halske, kun fotografaĵaj ilustraĵoj. Estas ankaŭ cirkvita diagramo kaj fotografaĵo de la Lorenz "Neutro" kvarvalva aparato, kaj la artikolo finiĝas per priskribo de valvoj kun unuobla filamento, sed kun krado sur unu flanko kaj anodo sur alia. Tiuj-ĉi estas utiligeblaj anstataŭ du apartaj valvoj en ordinara duvalva kaskado, aŭ kun transformatoroj ĉecentre konekteblaj por "puŝ-tira" funkciado, ambaŭ arangoj estante montritaj diagrame.

### R200.—MEZUROJ KAJ NORMOJ.

R261.—LA TERMIONA VOLTMETRO.—W. B. Medlam and U. A. Oswald.

Daŭrigita kaj finita el la antaŭa numero.

En la nuna parto, la tria tipo, t.e., Rekta Krada Retroglitebla Tipo, estas unue pritraktita. Oni montras arangon por uzi la anodan mikroampermetron kun taŭga rezistanco kiel voltmetron por mezuri la kradan inklinon. Presitaj estas kurvoj kaj tabeloj de eksperimentaj rezultoj por montri la konduton de ĉi tiu tipo sub la ĝeneralaj rubrikoj antaŭe cititaj. Oni diras, ke normiga stabileco estas avantaĝo de ĉi tiu tipo.

Tipo IVA, poste diskutita, estas de la tipo Defleksa—kiel ĉe la Moullin'a instrumento—uzanta Anodkurvan Rektifadon kun kradrezistanco kaj kondensatoro, la negativa tensio estante aplikita tra la krada rezistanco por funkcii la valvon ĉe la anoda kurvo.

Tipo Va estas de la krada retroglitebla tipo, kun krada rezistanco kaj kondensatoro, la krada inkлина baterio denove funkcianta tra la krada rezistanco.

La lasta Tipo VIA estas nomita de l'aitoroj, la "Refleksa Voltmetro." Ĉi tiu uzas la defleksan

principon de la Moullin'a modelo—Tipoj I kaj II—kun aldono de alta rezistanco komuna je la krada kaj anoda cirkvitoj, tiel ke la volta perdo ĉe ĝi kaŭze de anoda kurento tra ĝi agas kiel aldona negativa inklino ĉe la krado. Ĉi tio permesas la aplikon de pligrandaj tensioj ĉe la krado antaŭ ol komenciĝas krada kurento. Oni ankaŭ montras, ke ĉi tiu refleksa ago estas aplikebla al la Tipo IVa retroglitebla voltmetro.

En la fina sekcio la aŭtoroj diskutas la taŭgecon de la diversaj tipoj por malsimilaj celoj, rekomendante la lastnomitan por ĝeneralaj celoj. Aldonaĵo pritraktas la alternkurentan normigon de la voltmetroj.

#### R400.—SISTEMOJ DE LABORADO.

R401.—LASTATEMPAJ DISVOLVIGOJ DE MALLONGONDA SENFADENA TELEGRAFIO.—H. Rukop.

Fina daŭrigo el antaŭa numero. La nuna parto traktas aparte pri la laborado de la Telefunken Kompanio je mallongonda interkomunikado, unue inaugŭrita inter Naŭen kaj Buenos Ajreso. Estas priskriboj pri la stacioj, kiuj sin okupas je la sendado, kaj pri la valvoj uzitaj, kun fotografaj ilustraĵoj. Tri sendiloj ĝis 2 aŭ 3 kilovatoj (antena potenco) estas uzitaj, dum kvara, uzanta akve-malvarmigatajn valvojn, povus generi ĝis ĉirkaŭ 16 k.v. de altfrekvenca potenco. Ondlongoj de 70 ĝis 13 metroj estas uzitaj.

Oni montras kurvojn de rezultoj atingitaj inter Germanujo kaj Buenos Ajreso, Germanujo kaj Javo, kaj Germanujo kaj Japanujo. Je kelkaj okazoj, du stacioj sendis samtempe per la sama

potenco, sed laŭ malsamaj ondlongoj. Apudaj grafikaĵoj montras la distribuon de taglumo kaj mallumo dum la eksperimentoj.

Oni diris ke, per taŭga serĉado por ondlongoj, per sendo samtempe per kelkaj sendiloj, k.t.p., oni povis starigi preskaŭ plene fidindan noktan servadon kun Buenos Ajreso; diagramo montras la relativajn trafikojn traktitajn dum ses monatoj en 1925a. La fina paragrafo resumas la nunan pozicion, kaj diras ke ondoj de 40 metroj kaj malpli montris sin multe superaj je ondoj de 40 ĝis 100 metroj, kaj ke klara optimumo estas rekonebla inter 26 kaj 18 metroj. Laborado pri la temo ankoraŭ progresas.

#### R500.—APLIKOJ KAJ UZOJ.

R545.009.2.—AMATORA LONGDISTANCA LABORADO.—H. N. Ryan.

La perioda kontribuajo pri ĉi tiu temo. La nuna noto pritraktas la "QRP" semajnon (organizitan de la Radio Societo de Granda Britujo) por la unua semajno en Novembro, kaj la funkciadon kaj procedon je interkomunikado.

#### R800.—NE-RADIAJ TEMOJ.

R510.—MATEMATIKOJ POR SENFADENAJ AMATOROJ.—F. M. Colebrook.

Daŭrigo el antaŭaj numeroj. La nuna parto traktas pri la solvo de Ekvacioj, sub la rubriko de Ekvacioj por Unu Nekonita Numero, la Linia Ekvacio por Unu Nekonita Numero, la Kvadrata Ekvacio, Ekvacioj redukteblaj je Kvadratoj, la ĝenerala Ekvacio de la *n*a Grado, k.t.p.

## Some Recent Patents.

[R008

The following abstracts are prepared, with the permission of the Controller of H.M. Stationery Office, from Specifications obtainable at the Patent Office, 25, Southampton Buildings, London, W.C.2, price 1/- each.

### AN UNDERGROUND AERIAL.

(Application date, 2nd December, 1925.  
No. 256,837.)

A form of shielded underground aerial is described in the above British Patent by J. D. Gibson and J. R. Gibson. The novelty of the invention, of course, lies in the particular construction of the aerial, which consists essentially of a conductor insulated from and surrounded by a metal shield. The general idea of the aerial can be obtained by referring to the accompanying illustration in which it will be seen that it comprises a conductor *C*, covered by insulating material *M*, and surrounded by a lead or similar metal sheath *L*. The sheath, however, is not continuous, but is divided into two portions, a small gap being left. The two ends of the sheath are then electrically connected with a copper wire or strip *W*, the surface of the insulating material where the break in the sheath occurs being further covered with other insulating material *I*. The imbedded end of the aerial is also covered with a lead cap *K*, while the other end is taken up through the ground to the receiver. In an alternative modification of the

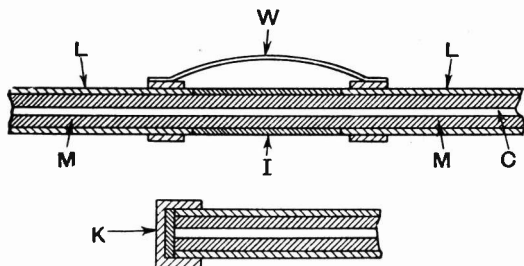

invention the free end of the aerial can terminate at the surfaces of the ground, and connection is made from this end with an ordinary lead to the set.

### A FLOATING BATTERY.

(Application date, 15th October, 1925.  
No. 258,739.)

A floating battery, *i.e.*, one which is connected across a source of supply from which energy is being drawn, is used in many branches of electrical engineering. A particular form of floating battery circuit is described in the above British Patent by E. Heese. The accompanying diagram shows an ordinary battery consisting of two cells *C*, connected to the supply mains *S* through a lamp resistance *L*, the current for the filament circuit of a valve receiver being taken across the two cells, *i.e.*, at *X* and *Y*. This, of course, is quite a normal circuit, and the novelty of the invention lies in the type of cells used, and the method of controlling

the charge and discharge current, either by hand-operated switches, or by automatic cut-outs. The specification states that the charging current may be made exactly equal to the discharge current, so that there is no tendency for the cells to over-

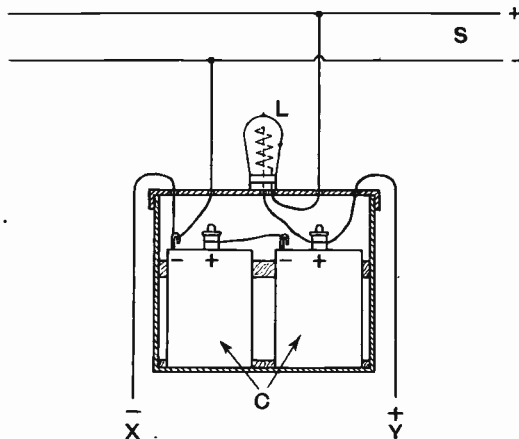

charge. One of the claims of the invention is for the use of a lead-copper accumulator, which is claimed to be almost indestructible, and can be kept in a charged condition for years without ill effects. Another type of cell which it is stated may be used is the rechargeable carbon-manganese dioxide-zinc cell. The illustration shows the floating battery connected to a source of direct current supply, but the invention also provides for the use of rectified alternating current, in conjunction with the floating battery described.

### REACTION REJECTOR CIRCUIT.

(Application date, 9th July, 1925.  
No. 258,969.)

It is customary to eliminate undesired signals by the use of rejector circuits, increased selectivity being obtained by using a reaction-rejector circuit, that is, a tuned circuit associated with a receiving system in which a negative resistance effect is produced so as to lower the effective resistance of that circuit, and, therefore, bring about greater selectivity of the whole system. Reaction-rejector circuits have been coupled to the ordinary receiving system either directly or inductively, and former arrangements have necessitated the use of a separate valve for bringing about the negative resistance effect. A patent, granted to Igranic Electric Limited and P. W. Willans, No. 258,969, gives details of a reaction-rejector circuit in which the low frequency or other amplifying valve is used for producing a negative resistance effect in the rejector circuit. The accompanying illustration should

make the invention quite clear. Here the detector valve  $V_1$  is coupled to an amplifying valve  $V_2$  by a low frequency transformer  $T$ , the anode circuit of the second valve containing the usual telephones  $P$ . The aerial circuit comprises an ordinary aerial inductance coupled to a tuned circuit connected between the grid and filament of the first valve  $V_1$ , a grid-leak and condenser being used for detection purposes. Between the grid of the second valve and the upper end of the secondary winding of the low

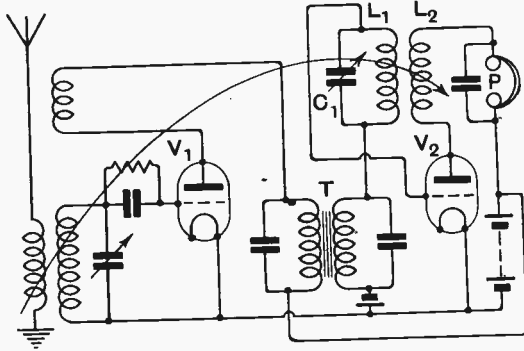

frequency transformer  $T$  a tuned circuit  $L_1 C_1$  is included. Coupled to the inductance  $L_1$  is another inductance  $L_2$ , which is also in the anode circuit of the second valve. The two inductances are coupled in such a way as to bring about a regenerative effect, thereby materially reducing the effective resistance of the circuit  $L_1 C_1$ . This circuit is then coupled to the aerial circuit or the input circuit of the first valve, where it acts as an ordinary rejector or absorption wave-trap, the circuit  $L_1 C_1$  being tuned to the undesired signal.

**A CRYSTAL AMPLIFIER.**

(Application date, 1st September, 1925.  
No. 259,005.)

A form of crystal amplifier which can easily be added to an existing crystal set is described in the above British Patent by J. S. Smith and S. C. Pearce. The accompanying illustration shows one

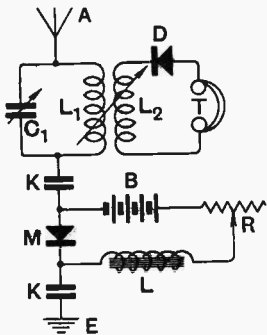

modification of the invention. A simple form of crystal circuit is shown, consisting of an inductance  $L_1$  tuned by a condenser  $C_1$ , in conjunction with the usual aerial  $A$  and earth connection  $E$ . Another inductance  $L_2$ , comprising the secondary circuit, is coupled to the aerial inductance, and is shunted by the usual telephones  $T$  and detector  $D$ . The connection between the earth and the lower end of the inductance  $L_1$  is broken by two condensers  $K$ , between which another crystal combination  $M$  is connected. This crystal combination

is energised by a battery  $B$  in series with a choke  $L$  and resistance  $R$ . It is stated that with suitable adjustment of the battery voltage, the resistance and contact pressure of the crystal combination can easily be found, when the rectified currents in the telephones will be considerably amplified.

**RESISTANCE AMPLIFIER.**

(Application date, 18th May, 1925.  
No. 258,315.)

A resistance amplifier in which the coupling between the anode and grids of the valves is by means of resistances is claimed in the above British Patent by S. B. Smith. By referring to the illustration it will be seen that the anode of one valve is coupled to the grid of the next valve by means of a potentiometer, the circuit being so arranged that the positive potential which would be conveyed to the grid from the anode of the preceding valve is balanced out by a negative potential derived from a bias battery. An amplifier of this type, of course, can be used for magnifying the effect of a direct current voltage applied between the grid and filament of the first valve. The action of the amplifier can be easily understood by referring to the accompanying illustration. The

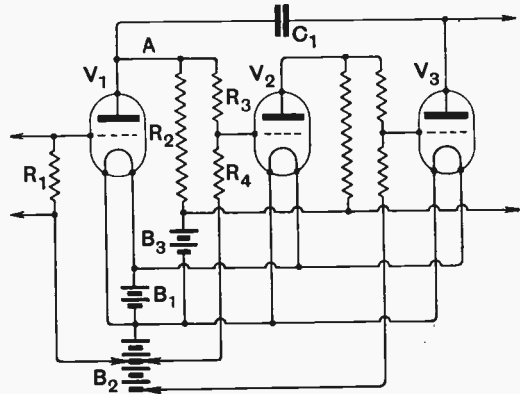

potentials to be amplified are applied across a resistance  $R_1$ , constituting the input circuit of the first valve. The lower end of this resistance is taken to a tapping on the bias battery  $B_2$ , so as to provide the grid of the first valve with a suitable bias voltage. A resistance  $R_2$  is included in the anode circuit of the valve  $V_1$ , the other side, of course, being connected to the positive terminal of the anode battery  $B_3$ . The anode  $A$  of the first valve is coupled to the grid of the second valve  $V_2$  through a resistance  $R_3$ , which comprises one-half of a potentiometer  $R_3 R_4$ . The ohmic value of these resistances is considerably greater than that of the anode resistance  $R_2$ . The other half of the potentiometer  $R_4$  is taken to the negative tapping on the bias battery  $B_2$ , this tapping being so arranged that the negative potential is more than sufficient to neutralise the positive potential conveyed from the anode  $A$  to the grid, thereby giving the grid a suitable negative potential. The other valves are coupled in a similar manner.

If there is any tendency for the amplifier to generate oscillations owing to stray capacity it may be stabilised by placing a condenser  $C_1$  between the anode of the valve  $V_1$  and the anode of the valve  $V_2$ , where the condenser acts, of course, as an ordinary anti-reaction capacity.

**A MAINS RECEIVER.**

(Application date, 29th June, 1925.  
No. 258,931.)

Some details of a system of utilising the electric light mains for the supply of power to a receiver is described in the above British Patent by S. Iredale. The accompanying illustration shows a modification of the circuit suitable for use with direct current mains. The supply mains DC are taken through two fuses  $F$  to a resistance  $R_1$ , and a floating battery  $B$ , from which the filament supply is drawn at  $LT$ . Another resistance  $R_2$  is connected between the supply mains, tapping points being provided at  $X$   $Y$  and  $Z$ . The two tapping points  $X$  and  $Y$  are respectively shunted by condensers  $C_1$  and  $C_2$ , alternative high tension voltages being available at  $M$   $W$  and  $O$ . In order

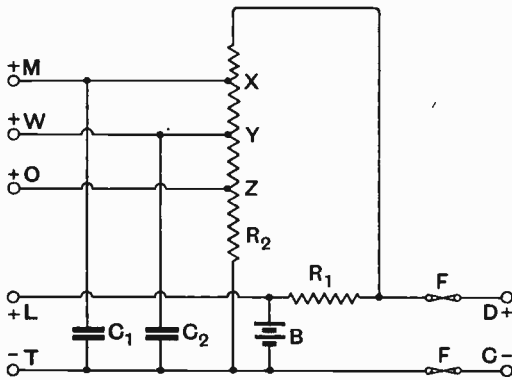

to prevent a short-circuit occurring through the earth connection a series condenser is placed in the earth lead to the set. Again, in order to prevent accidental shock to the wearer of the headphones, the latter are connected through an ordinary telephone transformer to the last valve circuit. The value of the resistance  $R_1$ , and the voltage of the battery  $B$ , of course, are determined by the particular requirement of the valve filaments. A similar circuit is also shown for use with A.C. mains, in which case rectifying valves are connected in the usual manner.

**CRYSTAL-VALVE CIRCUIT.**

(Application date, 25th June, 1925.  
No. 258,927.)

A receiver embodying a crystal rectifier and a reaction circuit controlled by a low frequency amplifying valve is described by J. Sieger in the above British Patent. By referring to the accompanying illustration it will be seen that the input circuit of the receiver comprises an inductance

such as a frame aerial  $L_1$  tuned by a variable condenser  $C_1$ . Potentials across this tuned circuit are rectified by a crystal detector  $D$  from which they are passed on by a low frequency transformer  $T$ , through an inductance  $L_2$  to the grid circuit of the valve  $V$ . The inductance  $L_2$  is coupled to the inductance  $L_1$ . The anode circuit of the valve

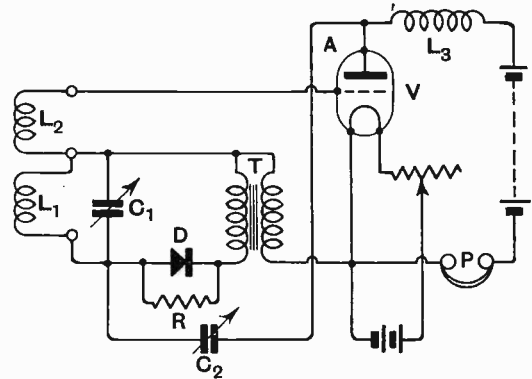

contains, in addition to the usual telephones  $P$ , a high frequency choke  $L_3$ . A reaction condenser  $C_2$  is connected between the anode  $A$  and one side of the inductance  $L_1$ . If the circuit is carefully followed out it will be seen that the two inductances  $L_1$  and  $L_2$  are connected respectively in the anode and grid circuits of the valve, capacity reaction, of course, being obtained by means of the variable condenser  $C_2$ . An additional feature of the invention is the use of a resistance  $R$ , which is connected across the detector  $D$  with a view to stabilising the set. Variation in contact pressure of the crystal detector, either intentionally or through vibration, would tend to alter the resistance of the input circuit of the valve, thereby causing the set to burst into oscillation when a critical reaction setting is employed. The use of a resistance in this manner is stated to overcome this difficulty quite effectively.

**A REISZ MICROPHONE.**

(Application date, 8th February, 1926.  
No. 258,476.)

The construction of one form of Reisz microphone is described in the above British Patent by E. Reisz. The novelty of the invention lies essentially in the use of a rubber or similar diaphragm, to which are fixed a number of separate carbon granules. The accompanying illustration shows one form of the microphone. Here the diaphragm consists of a sheet of rubber, which is not stretched, or only stretched to a very small extent, covered with a layer of carbon granules  $G$ .

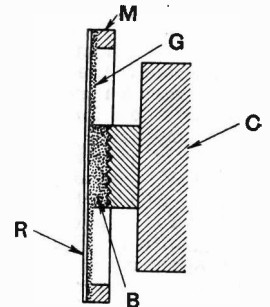

The diaphragm is prepared by coating it with rubber solution, and dusting over with carbon granules. Only sufficient solution is used to cause the granules to adhere to the diaphragm without causing them to adhere to themselves. Contact is made with the diaphragm by means of a metal ring *M*. Some larger granules *B* are placed between the granulated diaphragm and a solid carbon block *C*, connection to the microphone being made to the metal ring and the carbon block *C*. The specification states that the diaphragm is practically non-resonant, and a mathematical consideration of its time period is given.

which can thus be tuned to the mean of the low frequencies produced in the output circuit of the detector valve *V*<sub>1</sub>. The specification includes several other modifications of the invention, where a similar type of circuit is used for super-heterodyne reception, and also for side band reception, where an accurately constant frequency of local oscillation is, of course, an absolute necessity. The specification is very detailed, and should be carefully studied by all those who are interested in quartz crystal-controlled oscillators.

**IMPROVING SELECTIVITY.**

(Application date, 12th May, 1925.  
No. 256,689.)

**CRYSTAL-CONTROLLED RECEIVER.**

(Application date, 27th July, 1925.  
No. 258,707.)

The Western Electric Company Limited describe in the above British Patent, No. 258,707, a series of receiving systems utilising the piezo-electric

A method of improving the selectivity of wireless receiving systems is claimed in the above British Patent by A. G. Benstead and Rotax (Motor Accessories), Limited. The invention should be quite clear by reference to the accompanying

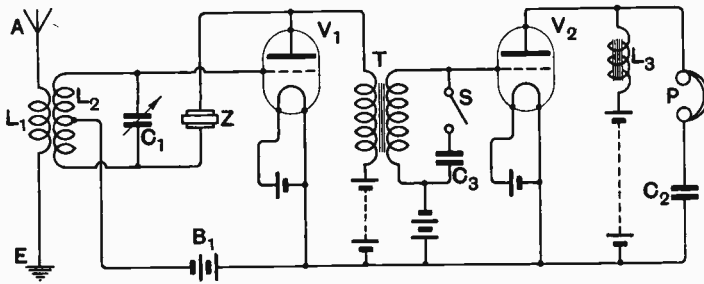

effect. The accompanying illustration shows one form of quartz crystal-controlled receiver in which the first valve *V*<sub>1</sub> produces oscillations controlled by a quartz crystal *Z*, held between two metallic plates. The input comprises an aerial *A*, inductance *L*<sub>1</sub> and earth *E*, the inductance *L*<sub>1</sub> being coupled to a centre tap inductance *L*<sub>2</sub>. The inductance *L*<sub>2</sub> is tuned by a variable condenser *C*<sub>1</sub>, and is connected between the grid of the valve and one side of the crystal, the other side of the crystal being connected to the anode. The centre tap of the inductance *L*<sub>2</sub> is not taken directly to the filament but through a bias battery *B*<sub>1</sub>, which is adjusted in such a manner that the valve *V*<sub>1</sub> operates on the desired portion of the curve. The locally produced oscillations combine with the received oscillations in the valve *V*<sub>1</sub>, where they are detected, and passed on by a low frequency transformer *T*, having a low impedance primary winding, and a high impedance secondary winding, to the grid circuit of a valve *V*<sub>2</sub>. The anode circuit of the valve *V*<sub>2</sub> contains a low frequency choke *L*<sub>3</sub>, across which the telephones *P* are connected through a condenser *C*<sub>2</sub>. A condenser *C*<sub>2</sub>, provided with a switch *S* is shown connected across the secondary of the transformer *T*. The object of this condenser is to provide a resonant circuit with the secondary winding of the transformer,

illustration. Here it will be seen that an ordinary aerial tuning circuit consists of an aerial *L*<sub>1</sub> tuned by a capacity *C*<sub>1</sub> in series with an aerial condenser *C*<sub>2</sub> forming the input circuit of a valve *V*. Loosely coupled to the inductance *L*<sub>1</sub> is a closed oscillatory circuit *L*<sub>2</sub> *L*<sub>3</sub>. A reaction coil *L*<sub>3</sub> in the anode

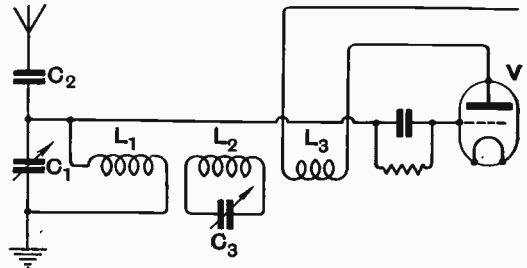

circuit of the valve *V* is then coupled to the inductance *L*<sub>2</sub> instead of the normal aerial inductance *L*<sub>1</sub>. The chief feature of the invention lies in the fact that the intermediate oscillatory circuit *L*<sub>2</sub> *C*<sub>3</sub> is electrically disconnected from the remainder of the circuit.