

EXPERIMENTAL WIRELESS & The WIRELESS ENGINEER

VOL. II.

APRIL, 1925.

No. 19.

Editorial Views.

H.F. Resistance.

IN accordance with the announcement made in our last month's issue, it will be found that considerable space is devoted this month to Professor Fortescue's paper on "Resistance in Wireless Circuits," read before the Radio Society of Great Britain on February 25, and to the discussion on it. The paper was an exceptionally interesting one, although it dealt with a subject with which all readers are supposed already to be conversant. None the less, we think that they will find considerable new matter for consideration in the paper. Unfortunately, some of the most interesting points will necessarily be lost in our report, since they depended upon actual demonstration. The apparatus exhibited at the reading of the paper, designed to draw a resonance curve automatically, was most interesting. Some of the figures given by Professor Fortescue as the results of actual tests on the high frequency resistance of commercial apparatus, will, we think, surprise readers.

These results, together with the article in our last issue on methods of measuring H.F. resistance, seem to us to point out a very useful series of measurements which might be made by some of our readers; a comprehensive set of results on both home-built and commercial coils.

The makers of coils frequently publish the values of self-capacity; but to the

best of our knowledge there is little information as to resistance. The measurements should be carried out in each case on a wave-length for which the coil is likely to be used, and it would probably be best to express the results as power factors. This is easily done, since the power factor is simply resistance divided by reactance, and the reactance is π 885 times the inductance (in microhenries) divided by the wave-length in metres.

We suggest this form for the results since, although the power factor of a coil is by no means constant, it does not vary nearly so much as the resistance.

The apparatus required for such tests is by no means elaborate, if approximate results only are required.

Using the Willans method, one needs only a wavemeter, a good condenser, and three or four H.F. resistors; the latter are very cheap to make.

The work involves finding the inductance of the coil, and its self-capacity is automatically found during the process. The greatest trouble is really the checking and tabulating of the results. We do not know whether any readers have the energy to spend a month or two's spare time on such work, but if they do we shall be only too pleased to assist in any way possible.

Classification.

With this issue we come to the end of our series on the Arrangement of Wireless Books

and Information. The purely wireless classification was in fact completed in last month's issue, and the list this month comprises excerpts from the main Dewey list, dealing with matters which (although not purely wireless) will often be needed for reference. We have also devoted some space under this heading to a few short notes on the actual routine of filing and indexing cuttings, and so forth. It will, we trust, be realised by those interested that our extensions of the classification, which throughout have been marked as such, must be regarded as provisional. We shall be much indebted to any readers who may be making use of the scheme, if they will write to us after some experience of the classification, letting us know of any difficulties they may find in deciding where items are to go, and giving us their views on any possible improvements.

The Paris Conference.

Immediately after the Easter holiday there will be held at Paris (as our readers are probably aware) an important Congress, at which it is proposed to found an International Union of Wireless Amateurs. The conference opens on Tuesday, April 14, with a general session, at which detailed arrangements will be made for the routine. On the following three days, the mornings will be devoted to visits to various centres of wireless interest in or near Paris. Wednesday's

visit is to the Eiffel Tower station, Thursday's that to the works of M. Belin, where visitors will be able to see the telegraphic and wireless transmission of photographs, and Friday's to the high-power station at Sainte-Assise. The congress meetings will be held in the afternoons, and are to deal with the following agenda:—

- (1) Detailed organisation of the proposed International Union of Amateurs ;
- (2) Standard organisation for international test work and communication ;
- (3) Proposals for the allotment of wavelengths for amateurs, and broadcasting ;
- (4) The possibilities of an auxiliary international language for wireless work ;
and such other matters as may arise.

It is to be noted that the power of voting on resolutions put forward is confined to the official delegates of the various countries—in the case of Great Britain to representatives of the Radio Society of Great Britain. At the same time, it appears that opportunity will be offered to all attending the conference to express their views if they desire.

Readers desiring to attend the conference should apply before April 7 to H. Epton, Esq., 17, Chatsworth Road, E.5, who is making arrangements for inclusive terms to cover travel and other expenses.

The Arrangement of Wireless Books and Information.

Part VII. and Last.

[R025·4

The last list of subjects is preceded by some practical hints on using the system.

BELOW we give, as a finale to our extension of the Bureau of Standards extension of the Dewey system, a few items from the Dewey tables themselves. We have selected these as being subjects with which wireless has been or is likely to be concerned, and considerations of space prevent us from dealing with them as fully as we wish.

Unfortunately the full tables form a rather large and expensive book,* and it is unlikely that many readers will be enthusiastic enough to purchase it. We shall always be pleased to send *short* extracts from it to anyone interested in a particular subject.

Using Dewey.

It would seem that this is an appropriate place to give a few words as to the practical use of the system.

The main idea, of course, is to preserve just what one wants from the large amount of published matter on wireless, and to arrange matters so that one can easily lay one's hand on all that one has on a certain definite subject. The information will usually fall under three headings:—

- (a) Books, or odd pages or chapters of books.
- (b) Cuttings from periodicals.
- (c) One's own notes.

The matter in class (a) at once brings up an important question: Shall we arrange the matter itself on the logical system, or shall we keep the matter in some arbitrary order and keep an index to it arranged logically?

* "The Dewey Decimal Classification and Relative Index." Grafton & Co., London, 36/- net.

Obviously we must adopt the latter principle as regards books, unless we are prepared actually to break up the books. It is therefore really more consistent to do this as regards all the matter, although it puts us to the trouble of writing index cards for them. At the same time, there are important advantages to be gained by keeping cuttings or isolated papers in logical order, since in this way all matter dealing with a particular subject is kept together. The fundamental difficulty is that in many cases the same article deals with various phases of a subject, or sometimes various subjects. Obviously the article itself can only be kept in one place, so we are again brought back to indexing, for an article can be *indexed* under as many heads as we like, on different cards.

The method finally recommended is as follows:—

(a) Books. These are kept in classification order. Where, as is usual, a book contains matter on various subjects, or phases of the same subject, it is placed under

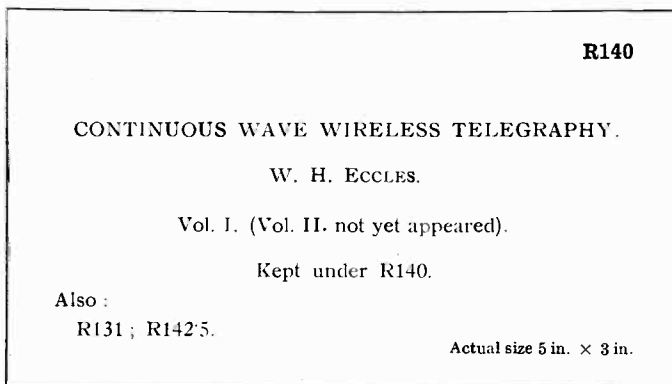

Fig. 1.

a general heading if there is a suitable one ; if not under that subject which it treats of most fully.

For example, a book dealing generally with valve receivers will probably contain matter covered by R341, R342, and R343. It will be filed under R340. On the other hand, a book such as Nottage's "Calculation and Measurement of Inductance and Capacity" contains matter on R145, R220, and R230. It is usually simplest to place the book itself under the first heading (R145), with index cards under each.

An important point arises in connection with fairly general text-books covering a wide range—such books as would usually go under R020. It will nearly always be found that one or two particular points are dealt with in a way that particularly appeals to the individual concerned. These should be indexed separately under their own headings.

For example, Morecroft's "Principles of Radio Communication" deals with a very wide range. Among the points which particularly interest the writer is his treatment of the self-capacity of coils, and a special reference to these pages is made in the index under R3821—Qualities of an Inductor.

(b) PERIODICALS. Those that we consider to have a sufficiently large percentage of permanently interesting matter are kept complete, each set being kept in order of appearance. Items of interest are indexed logically.

From other periodicals, the interesting matter should be cut, and kept in press-cutting books. Various schemes have been suggested by which the cuttings are mounted on stiff leaves to be held in loose-leaf binders so that they themselves can be arranged in logical order. But they have not been very successful, and our own preference is to get

a broad classification by opening up several press-cutting books—say one for each main class—and arranging cuttings in order as they come to hand, leaving the index to do the classification.

One important point as the selection of matter to be kept : do not be too exclusive. The enthusiast in DX reception is often tempted to scrap matter on the distortionless reception of broadcasting, and *vice versa*—only to find a year later that he wants it.

(c) ONE'S OWN NOTES. These are treated in the same way as cuttings. One caution, however, is necessary. Be careful to give a full title and date, and do not make the notes too abbreviated. Matter that is quite clear now, while it is fresh in the mind, may be practically unintelligible a year hence, if other branches of work have occupied us in the meanwhile.

The Index.

Lastly, as to the index itself. This is

obviously kept on cards. When making out a card for a book, start by putting the Dewey number in the top right corner. At the bottom give any other numbers in which the book is also indexed.

As an example, take Eccles' "Continuous Wave Wireless Telegraphy." This deals mainly with A.C. circuits, but also with valve characteristics, and is specially interesting to the indexer for, say, its treatment of capacity coupling.

Fig. 1 shows one of the three cards made for it. The others each have a different number in the top corner, the other two numbers being relegated to the bottom. A few notes on the size and scope of the book are often useful.

As an example of dealing with a cutting, we have selected the short article on "A New Method of Producing Ultra-Short Waves," by J. Taylor, B.Sc., in last month's issue. First suppose that this is cut out and kept in (say) Press-Cutting Book No. 4, on p. 78.

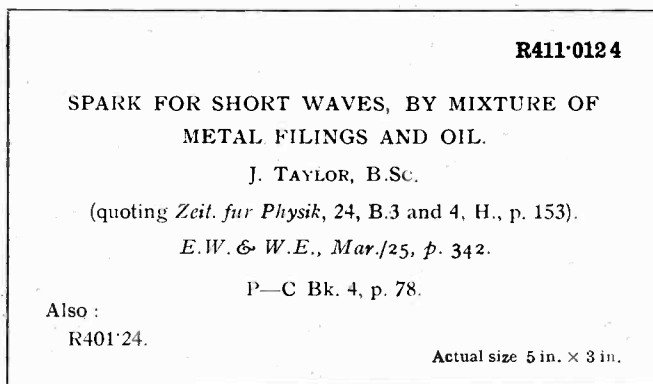

Fig. 2.

The card will be as Fig. 2, giving two references, to spark systems and extra-short wave systems respectively. As a rule, ignore the exact title of the article, or put it low down on the card, giving first the actual "meat"

for which the cutting is kept. If, by some miracle, it had been decided that *all* of E.W. & W.E. were worth keeping, the reference to year, month, and page would stand, that to the press-cutting book being deleted.

R800 Non-Wireless Subjects.

The following numbers, derived from the Dewey classification itself, should *not* be preceded by "R."

010	Bibliography.	Reserved for lists of books, etc.
020	Library economy.	
025	Management.	
025:3	Catalogues.	
025:4	Classification.	
069	Museums.	

300 Sociology.

330	Political Economy.
331	Labour, Employer, etc.
337	Protection and Free Trade.
340	Law.
341	International Law.
347	Patents.
355	Military Science.
360	Associations and Institutions.
362	Hospitals, etc.
368	Insurance.
370	Education, schools.
374	Home and Self-Education.
378	Colleges and Universities.

400 Philology, Language.

499	International languages.
-----	--------------------------

500 Science.

510	Mathematics.
510:8	Mathematical tables and instruments.
511	Arithmetic: computation
512	Algebra
512:8	Higher Algebra.
513	Geometry.
513:3	Solid Geometry.
513:8	Non-Euclidean Geometry.
514	Trigonometry.
516	Analytical Geometry.
516:12	Graphs, etc.
517	Calculus.
517:2	Differential.
517:3	Integral.
517:8	Imaginary quantities.
519	Probabilities.
519:6	Errors of observation.
519:8	Method of least squares.

520	Astronomy.	
525	The Earth.	
	525·4	Longitude measurement.
529	Chronology : science of time.	
	529·7	Horology.
	·76	Distribution of time.
530	Physics.	
531	Mechanics.	
532	Hydraulics, etc.	
533	Pneumatics.	
	533·85	Vacuum pumps, etc.
534	Sound; acoustics.	
535	Light; Optics.	
	535·3	Photo-electrics.
536	Heat.	
	536·33	Radiation in general.
537	Electricity.	
	537·1	Theory : nature.
	·2	Static.
	·4	Atmospheric.
	·6	Electro-dynamics.
	537·7	Electric measurements.
538	Magnetism.	
539	Molecular physics.	
	539·1	Theory : Molecular structure.
	·6	Intermolecular forces.
	·7	Radioactivity.
540	Chemistry.	
	548	Crystallography.
	549	Mineralogy.
	551·5	Meteorology.

600

Useful Arts.

610	Medicine.	
620	Engineering.	
621	Mechanical.	
	621·3	Electrical
	·31	Generation.
	·313	Dynamo-electric machinery.
	·313·2	D.C.
	·23	Dynamos.
	·24	Motors.
	·25	Converters.
	·3	A.C.
	·35	Converters.
	·355	Frequency Converters.
	·7-	Rectifiers.
	·314	Transformers, etc.
	·315	Condensers.
	·316	Details and parts.
	·317	Wiring and switchgear.
	·32	Lighting.
	·327	Lamps, etc. (includes valves)
	·35	Chemical electricity.
	·351	General, EMF, polarisation, etc.
	·352	Parts and accessories of batteries.
	·353	Primary cells.
	·354	Accumulators.
	·354·3	Battery Charging.
	·355	Lead accumulators.
	·356	Alkaline accumulators.
	·36	Thermopiles, etc.
	·37	Measurements.

	.374	Especial apparatus for testing:—
	.374·2	Resistance.
	.3	Voltage.
	.4	Current.
	.5	Work.
	.6	Power.
	.7	Frequency and wave-form.
	.9	Other.
	.38	Communication.
	.382	Telegraphy.
	.384	Wireless.
	.385	Telephony.
622		Mining.
623		Military engineering.
	623·7	Signals.
625		Railway and road engineering.
629		Various.
	629·13	Aviation.
	.2	Motor vehicles.
630		Agriculture.
640		Domestic Economy.
650		Commerce, Communication.
	655	Printing and Publishing.
670		Manufactures classed by materials.
	671	Metals.
	674	Timber.
	676	Paper.
	677	Textile.
	678	Rubber.
	679	Celluloid and other.
680		Mechanic trades.
	681	Watches and instruments.

700

Fine Arts.

770		Photography.
780		Music.
	781	Theory.
	782	Dramatic (Opera, etc.).
	783	Sacred.
	784	Vocal.
	785	Orchestral.
	786	Piano and organ.
	786·1	Piano.
	.5	Organ.
	787	Stringed instruments.
	788	Wind
	788·1—·4	Brass.
	.5	Flute, etc.
	.6—·9	Reed (oboes, etc.).
	789	Percussion (drums, etc.)
	789·9	Mechanical—Piano-player, Gramophone, etc.
790		Amusements, Hobbies, Sport, etc.

Harmonics.

[R146

An attempt to correct one or two common fallacies, together with a note on the use of wave-meters.

IT is a moot question whether harmonics are viewed as a curse or a blessing by the majority of my readers. But, whatever one's opinion, they are important, and there seem to be some misconceptions current about them, which we feel ought to be cleared up.

We have spoken above of an "impure source." This is not a reference to an originator of smoking-room anecdotes, but means a generator which gives a current not of pure sine form. Most generators actually are of this type, and as a rule the valve oscillator has a fine series of harmonics.

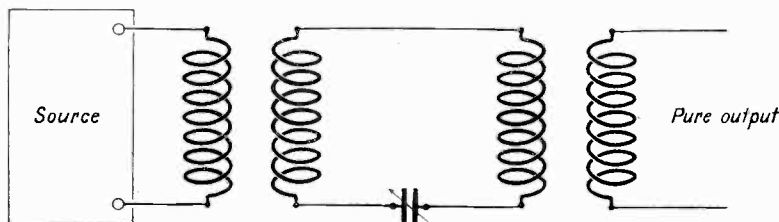

Fig. 1.

Firstly, what is a harmonic? Not so easy to define as it seems. Generally speaking, it is a current or voltage of a frequency, an exact multiple of some fundamental frequency, we are considering. For example, any current which is not a pure sine-wave may be considered to consist of a fundamental sine-wave component of the frequency we are tuned for or dealing with, together with sine-wave components of other frequencies, each of which is an exact multiple of the fundamental. Note this last clause. As we shall see later, the point is important.

There seems to be an idea that a circuit "tuned" to a frequency—say 1000kc (1000kc = 1000 kilocycles = 1000000 cycles = 300 metres)—is also tuned to the harmonic frequency, 2000kc or 150 metres. This is quite a mistake. A simple tuned circuit is a good *filter* for harmonics. Its reactance is zero to the fundamental frequency, but large to all others: it does not favour the harmonics at all; in fact, if we wish to get a pure sine-wave from a source containing harmonics, we can do it by a circuit such as Fig. 1, where the central circuit is tuned. We can, if desired, tune the intermediate circuit to one of the harmonics, when this one alone will pass on to the output circuit.

If the valve has a characteristic like Fig. 2, one may by careful handling cause the grid to swing only over a small range when the output will be as shown in the figure—very nearly a pure sine-curve; the harmonics will be small. It is more likely, however, that the grid will have a greater

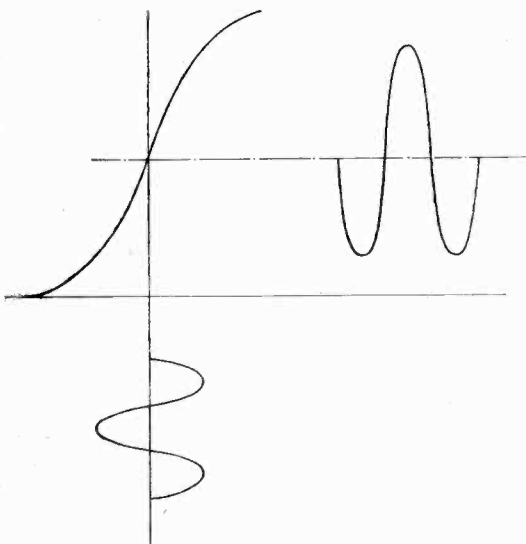

Fig. 2.

swing, as in Fig. 3, in which case the output will be as shown on the right. It is a flat-topped curve, containing a strong third

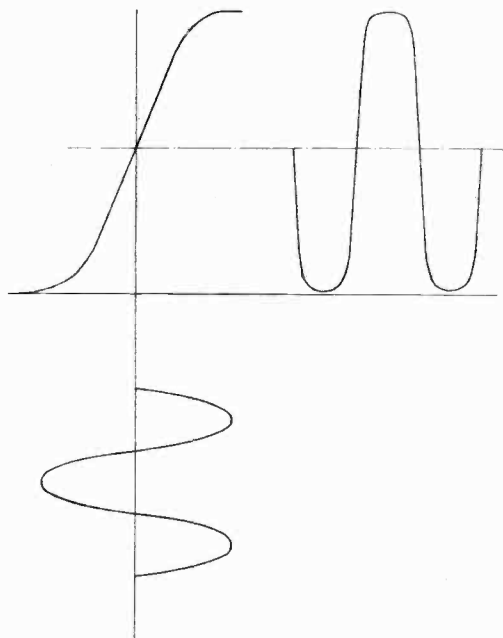

Fig. 3.

harmonic among others. It is notable that if the valve curve is symmetrical about the mid-line of the steady grid potential, the positive and negative half-waves of the output should be exactly similar. If this is so, there will be only odd harmonics: i.e., if the fundamental is of 1 000kc, the output will be a mixture of 1 000, 3 000, 5 000kc, etc., or 300, 100, 60 metres, etc.: *not* the other harmonics of 2 000, 4 000kc, etc.

But suppose the grid is biased or the H.T. altered, so that the grid swing is as shown in Fig. 4, we have a very different state of affairs. The positive and negative half-waves of the output are unequal, and the even as well as the odd harmonics will be present in the output.

The Aerial Circuit.

Next, the aerial circuit. Here there is a peculiar state of affairs. An aerial, because its inductance and capacity are distributed, is tuned to several frequencies at once. But, except in one particular case, the higher frequencies are *not* harmonics. Their frequencies are not exact multiples of the

fundamental except in the particular case where the aerial has neither inductance nor capacity in its circuit. *In every ordinary case, the "overtones" in an aerial are, at frequencies whose ratios to the fundamental depends on the amount of loading inductance and capacity.*

The reader may well ask, why then do I hear London on exactly one-fourth of its fundamental? The reason is simple: this harmonic—among others—is present in the valve output, and is to a certain extent forced on the aerial, especially if its frequency is *near* one of the aerial's natural overtones. It is a natural harmonic from the valve transmitter that is heard, not one of the aerial.

Wavemeter Harmonics.

Perhaps the most frequent encounter of the amateur with harmonics is in the use of the valve wavemeter. Most of these instruments emit a wave with many harmonics, which fact may be a convenience or the reverse according to circumstances. For example, in our own laboratory we use the harmonics of our standard wavemeter for

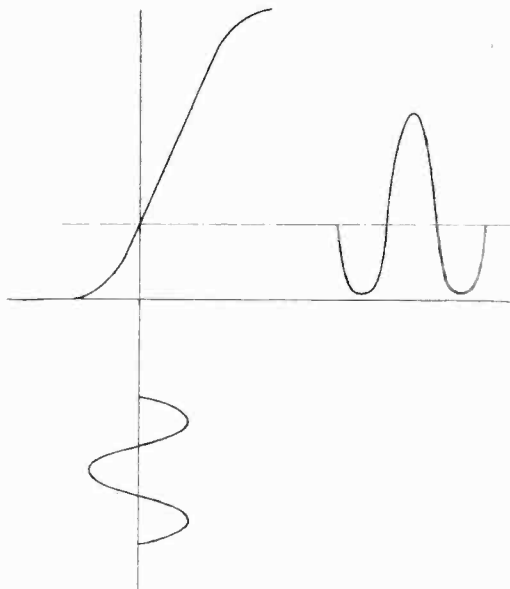

Fig. 4.

all frequencies above 3 000kc (wave lengths below 100 metres), which saves having a special instrument for these waves.

At the same time, the fact is sometimes an embarrassment, for it leads to a real difficulty

in finding what is the real tuning of an unknown wavemeter which is being calibrated—though, as will be shown later, the difficulty is easily got over. As the trouble is one which arises not only in calibration work, but also in the ordinary use of a wavemeter, we will go into it a little.

Assume that we are using a wavemeter to check another valve instrument—a transmitter or oscillating receiver. We set one instrument and swing the condenser of the other, listening for a chirp. Now, whenever

and the third of the other are both 33 metres; again at 150, when the third of one and the second of the other are both 50 metres, and further chirps at 200, 300 and 400 metres.

To make sure just what may happen in practice, we set a simple oscillating receiver to beat against our standard wavemeter, which is designed to emit a wave fairly rich in harmonics. We set the receiver to about 250 metres, and steadily increased the wave-length of the wavemeter, watching

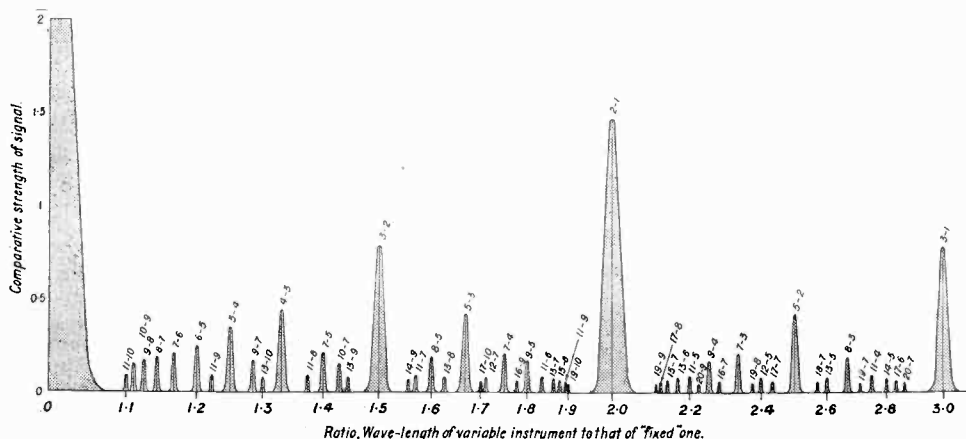

Fig. 5.

the frequency of the varying circuit crosses that of the one which is remaining fixed for the time, we get the chirp: but we also get it if our varying circuit is emitting harmonics, and one of these crosses the "fixed" frequency. Thus, if the circuit we are testing happens to be tuned to 100 metres, we shall get a chirp when our wavemeter crosses 100, 200, 300, . . . , etc. metres, for in each case there is a harmonic at 100 metres.

But there is more than this. In all probability the fixed instrument is also emitting harmonics, and we shall get a chirp whenever *any* harmonic of one "crosses" *any* harmonic of the other!

For example, suppose the fixed instrument is emitting on 100, 50, 33, and 25 metres, and the varying one on the same four harmonics—second, third, and fourth—as well as on its fundamental.

Then, as before, we shall get a chirp at 100 metres on the meter which we are varying. But we shall get another at 133 metres, when the fourth harmonic of one

only for the main beats of the receiver fundamental against wavemeter harmonics. We counted regular chirps every 250 metres up to 5000. Beyond that they began to get rather faint, and as we were bored we gave it up. It is evident that at least the first twenty harmonics are quite strong in this case.

To show what may be expected when both instruments are emitting harmonics, we have worked out the case of a varying meter giving up to the twentieth only, beating against a fixed oscillating receiver emitting up to the tenth only. We have only considered the case where the varying instrument is working at a fundamental wave-length above that of the fixed one. A little thought will show that a precisely similar state of affairs will exist for shorter wave settings also.

In Fig. 5 we show, along the base, wave-lengths to a logarithmic scale, the fundamental of the fixed receiver being considered as 1. The existence of a "peak" at any given frequency shows that there will be a chirp on passing through it, and we have tried to

show, by the height of the peaks, the loudness of the chirp, assuming that the actual strength of the harmonics decreases regularly—*i.e.*, the second weaker than the fundamental, the third weaker than the second, etc.

At the fundamental, 1 on the base line, the chirp is so strong as to be right off the map. It actually rises to 3.55 in the scale used. This is not only because the fundamental is the strongest emission in each case, but also because in this case each harmonic is beating against the corresponding one and adding to the noise. It is interesting to note that when we are off the silent point the note is not a pure one, for the second harmonic in beating set up a note an octave above that of the fundamental, the third harmonic is two octaves above, and so on, as can easily be seen by working it out.

chirp at each complete multiple, as 10, 11, 12, etc. And above 20 we shall get nothing if the varying instrument actually emits nothing above the twentieth harmonic. We have shown above each peak the two harmonics that are causing it.

Now suppose we want to find the true fundamental of the "fixed" instrument. If we can get down to this on the varying one there is little difficulty, owing to the overwhelming loudness of the beat between the two fundamentals. But if we cannot, we are faced with a most bewildering job in trying to decide which of the many beats we are actually hearing, and we have known of serious error being made in this way. The cure is easy. We take the varying instrument right up to the long waves, near its limit of harmonics, and find the wavelengths for two or three consecutive beats. The difference between two neigh-

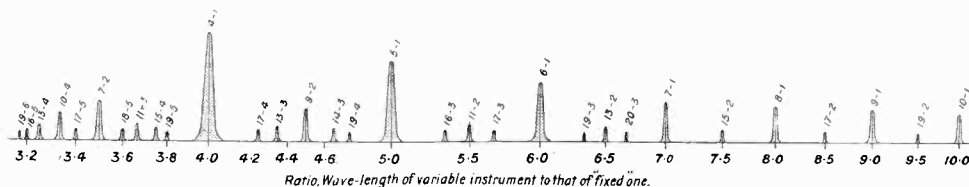

Fig. 5.

Let us assume that the fundamental is 100 metres. Then at 110 metres we shall get another chirp: the tenth harmonic of our instrument is 10 metres and the eleventh of the other is the same. Eventually we arrive at the results shown in our figure, which goes up to the tenth harmonic. Note that towards the end we are only getting chirps at 8, 8.5, 9, 9.5 times the fundamental. Above 10, we shall get even less—only a

bouring ones is the fundamental frequency.

It might be noted, in actual work with these harmonics, that they are sometimes very weak compared with the fundamental: in our own work we usually put the output through an L.F. amplifier, as we frequently have to test on through noise. Under these conditions the fundamental beat is unbearably strong, and the harmonics vary from medium to strong telephone strength.

The Rectifying Detector.

By *F. M. Colebrook, B.Sc., D.I.C., A.C.G.I.*

Part II.

[R149

An exhaustive investigation, theoretical and experimental, into one of the most difficult problems of the Wireless Engineer.

5. Continuous Wave Rectification Efficiency.

A rectifier is a device for transforming high-frequency alternating power into continuous or direct current power, or, in some cases, into a continuous E.M.F. Its merit will therefore be measured by the efficiency with which it performs these operations. This will depend very considerably on the circuit conditions. Four principal cases may be distinguished:—

- (A) Current rectification with a constant input potential.
- (B) Potential rectification with a constant input potential.
- (C) Current rectification with a constant input energy.
- (D) Potential rectification with a constant input energy.

The first two of these correspond roughly to any cases in which, by valve retroaction or any other means, the load imposed by the detector circuit can be partly or completely neutralised. The second two assume that the load of the detector causes a fall in available potential, when we must seek for the adjustment of the load due to the total detector circuit to equality with the effective internal resistance of the receiving circuit. (The practical means of realising this condition approximately have been considered by the author elsewhere.*)

The discussion of the constant input potential condition is comparatively simple. The object is to obtain the maximum continuous current power, regardless of the high-frequency power consumed in the process. We have

$$i_0 = \frac{E_c}{R_c + R} \quad \dots \quad (5.1)$$

It is well known that the maximum power will be obtained when $R = R_c$, i.e.,

$$P_o(max) = \frac{E_c^2}{4R_c} = \frac{i_0^2 R_c}{4} \quad \dots \quad (5.2)$$

i_0 being the current corresponding to the optimum load. (For reasons already given the R_c in this equation will not necessarily be the same as the apparent internal resistance at no load; but in practice it will not be very different.) From equation (4.14) the high-frequency power consumed under the same conditions can be determined. Calling this P_1 , the efficiency of conversion will be

$$\eta = \frac{E_c^2}{4R_c P_1} \quad \dots \quad (5.3)$$

In cases (B) and (D), where the object is a rectified potential difference, the corresponding figure of merit will be

$$\eta = E_c / P_1 \quad \dots \quad (5.4)$$

Both of these expressions will be illustrated by reference to typical rectifiers further on.

The consideration of case (C) is not quite so simple. Here the important factor will be, not the optimum load condition deduced

from the form of $\frac{dP_o}{dR}$, but the optimum transformation efficiency, deduced from

$$\frac{d}{dR} \left(\frac{P_o}{P_1} \right)$$

This important distinction can be emphasised by a study of the characteristic specified in section (c) of para. 3. This case is worthy of fairly full consideration because it represents the ideal crystal rectifier, to which actual specimens are a more or less close approximation. Taking the characteristic

$$i = a_1 e^e \text{ for } e > 0 \quad \dots \quad (5.5)$$

$$= 0 \text{ for } e < 0$$

* "More about Crystal Reception." *Wireless World*, July 23, 1924.

"What is the best Circuit for Crystal Reception?" *Wireless World*, April 30, 1924.

it can easily be shown that a back E.M.F. v_0 due to a load R will lead to equations 3.18 and 3.20, with v_0 substituted for e_0 . (If e_0 is not zero, as in the case of the characteristic given in section (D), the same equations will apply with $e_0 + v_0$ substituted for e_0).

The load equations are therefore

$$i_0 = \frac{a_1 E}{\pi} \left[\sqrt{1 - \frac{v_0^2}{E^2}} - \frac{v_0}{E} \left(\frac{\pi}{2} - \arcsin \frac{v_0}{E} \right) \right] \quad (5.6)$$

$$I_1 = \frac{a_1 E}{\pi} \left[\left(\frac{\pi}{2} - \arcsin \frac{v_0}{E} \right) - \frac{v_0}{E} \sqrt{1 - \frac{v_0^2}{E^2}} \right] \quad (5.7)$$

These equations cannot be solved directly but the general solutions can be obtained as follows. The expressions within the main brackets are functions of v_0/E , and can be plotted against v_0/E for any desired range of the argument. For known values of a_1 and E the values of i_0 and I_1 can be determined for any value of v_0/E , whence, i_0 and v_0 being known, R can be calculated. For illustration we will take the value 3.14×10^{-2} for a_1 , making $a_1/\pi = 10^{-2}$. The case will then be comparable with that of an ordinary crystal detector. The results are shown in Figs. 16 and 17. The curves show two important facts. For a constant

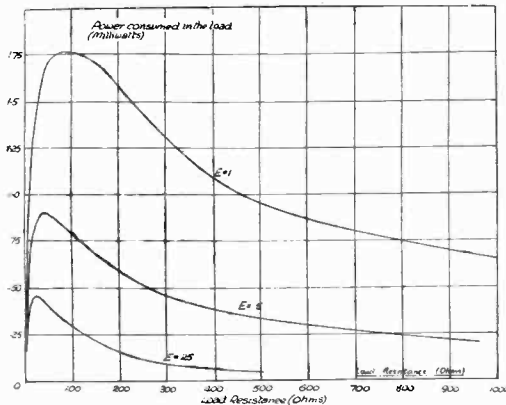

Fig. 16. Output power, in milliwatts, for various values of load resistance, for an ideal galena crystal.

input voltage, P_0 reaches a well defined maximum for values of R from 25 to 80 ohms. These figures can be compared with 63.6 ohms, the apparent internal resistance of the rectifier at no load and at large amplitudes. For a constant input energy, however, the curve showing the continuous

power developed in the load per unit high-frequency power consumed rises in the detector circuit steadily with R , indicating a maximum when R is exceedingly large. It is further noticeable that the energy efficiency decreases very rapidly with E , also that for small signal amplitudes the increase of energy efficiency with R is not very marked after a certain minimum value of R has been reached.

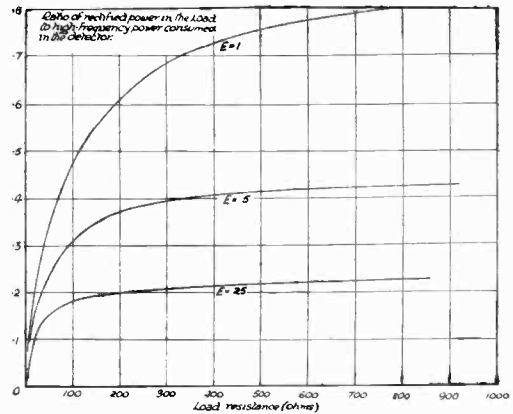

Fig. 17. Power efficiency corresponding to the curves of Fig. 16.

The above curves refer only to an ideally simple case. There is, however, sufficient qualitative similarity between the assumed characteristic and that of a good crystal detector to indicate the probable behaviour of the latter. The deductions are, moreover, consistent with experience, and explain what might otherwise appear to be the contradictory facts that though the internal resistance of most crystal detectors is comparatively low, particularly for large signal amplitudes, they appear to operate most efficiently in conjunction with telephones or other recording apparatus of high resistance. It should be pointed out that the actual continuous power obtained under these conditions is considerably less than that corresponding to the real optimum load for the detector considered by itself, but is greater than that which would be obtained with the former optimum load associated with a circuit of constant input energy.

The corresponding cases of potential rectification need not be given in detail. For the perfect rectifier assumed above the final steady state will be $E_c = E$ and $P_1 = 0$

for $R = \infty$, i.e., the efficiency is infinite after the steady state has been reached.

For completeness we will consider the other extreme case, corresponding very approximately to the operation of a crystal or other rectifier at very small amplitudes, i.e., the parabolic characteristic

$$i = a_1 e + a_2 e^2 \quad \dots (5.8)$$

The values chosen for illustration will be

$$a_1 = 10^{-4}$$

$$a_2 = .666 \times 10^{-3}$$

$$E = .1 \text{ V.}$$

These values will be comparable with those for a crystal. The load equations, derived as shown above, will be

$$i_0 = a_1 \left(\frac{E^2}{2} - \frac{a_1 v_0}{a_2} + v_0^2 \right) \quad \dots (5.9)$$

$$I_1 = a_1 E \left(1 - \frac{2a_2 v_0}{a_1} \right) \quad \dots (5.10)$$

The results are shown in the curves of Fig. 18. They show the same general characteristics as in the former case, but to a less marked extent. The optimum load for a constant input potential is about 12 500 ohms (compared with $1/a_1 = 10\ 000$ ohms, the internal resistance for no-load). The optimum load for a constant energy input is considerably higher, about 25 000 ohms. It will be seen that the optimum is very flat, and the efficiency only changes by a few per cent. when the load is increased up to 100 000 ohms.

It appears that for small amplitudes there may be an optimum load for both conditions. In practical cases, however, this optimum will again correspond with the use of high

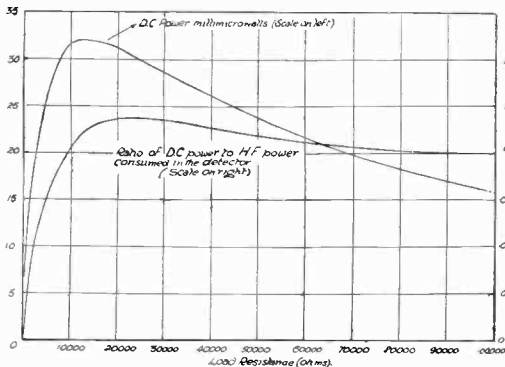

Fig. 18. Power efficiency curves for small input to an ideal galena.

resistance apparatus in series with the detector.

This completes the discussion of the efficiency conditions in relation to the rectification of a pure continuous wave. Its modification in the closely related case of the rectification of a modulated continuous wave will be considered later.

Experimental Results on C.W. Efficiency.

It has been pointed out that in the rectification of a continuous wave the maximum D.C. power would be obtained from a given signal amplitude when the D.C. load in series with the detector is equal to the apparent internal resistance of the detector. From the curves of Fig. 9 and

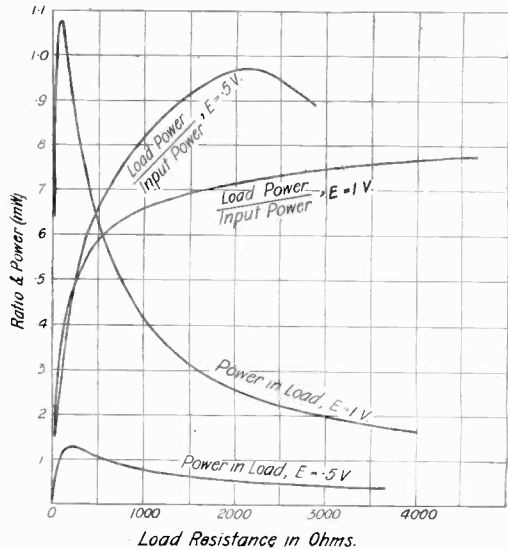

Fig. 19. For comparison with Figs. 16 and 17, curves are shown for output power and efficiency with the actual galena contact whose characteristics were given in Fig. 9.

Fig. 10 the variation of the D.C. power ($i_0 v_0$) with R can be calculated. Curves A and C of Fig. 19 show the results for the galena detector. It will be seen that the optimum is very pronounced and that the loads do not differ very greatly from the no-load internal resistance of the detector at the given amplitudes.

In Fig. 20 are given the corresponding curves for small signal amplitudes, calculated from the experimentally determined form of the dynamic characteristic. These latter curves emphasise a peculiar and interesting feature of a curved characteristic, namely,

that under certain conditions (depending on the ratio between the co-efficients) the apparent rectified E.M.F. may increase so rapidly with the load that the optimum is flattened out to a very marked extent.

It is believed that in many of the practical applications of crystal

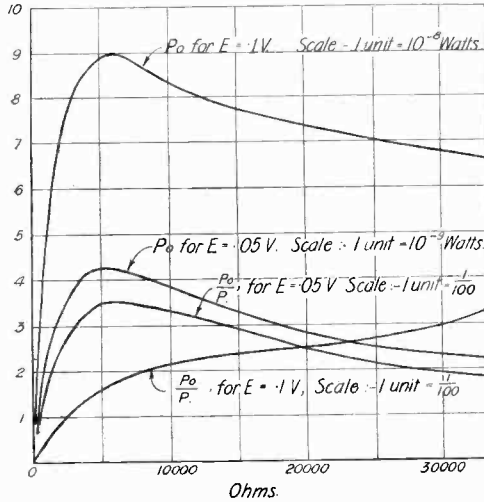

Fig. 20. The results of Fig. 19 extended for small input voltages.

detection the most important feature of the detector will be, not the optimum D.C. load corresponding to a constant input E.M.F., but the load condition which gives the highest efficiency of transformation of high-frequency power into D.C. power.

For the investigation of this matter it is necessary to know R_1 , the effective high-frequency resistance of the detector circuit under various conditions of load and amplitude. This means that it will be necessary to determine I_1 , the amplitude of the fundamental high-frequency component, under the given conditions. In cases where the form of the characteristic can be specified mathematically, I_1 can be calculated as shown in equation 4.14. Where it cannot be so specified, however, as in the case of a crystal detector at moderately large signal amplitudes, the only practicable means of determining I_1 is the somewhat laborious process of graphical analysis of the characteristic. From the form of the rectification characteristic at zero load the probable shape of the dynamic characteristic can be obtained with fair accuracy by the methods indicated in para. 3. From this

characteristic the actual form of

$$i = f(e - v_0)$$

(see equation 4.4), for a given value of $e = E \sin \omega t$ and some assumed value of v_0 , can be drawn and analysed by any of the usual methods into its continuous component i_0 and its fundamental component I_1 . Then, since

$$R_1 = \frac{E}{I_1}$$

and

$$R = \frac{v_0}{I_0}$$

we have R_1 in terms of R . The curves of Fig. 21 were obtained in this way. They confirm the statement made in Part I. that the high-frequency load imposed by a detector circuit would vary greatly with the magnitude of the D.C. load in series with the detector, even though the latter is short-circuited by a condenser. The variation of R_1 for the perikon detector was very similar, increasing from about 500 ohms at $R=0$ to about 3 800 ohms at $R=4 000$.

Having thus determined R_1 , the variation with R of P_0/P_1 (i.e., the efficiency of trans-

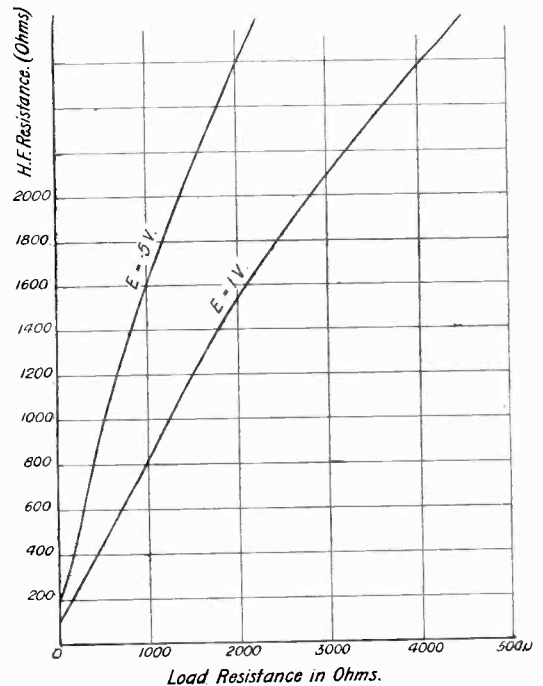

Fig. 21. Curves of H.F. resistance in terms of output load, by calculation from actual crystal results.

formation) can be calculated. The curves of Fig. 19 give the results for galena. It is seen that, as predicted in Part I., the best load resistance from the point of view of efficiency of transformation is very greatly in excess of that corresponding to the maximum D.C. power with a constant input E.M.F.

At small amplitudes the difference will not be so marked, since R_1 will not vary very greatly with R .

The following figures will give some idea as to the relative merits of the two types of detector for the rectification of a continuous wave. With the optimum load for a constant wave input potential the galena detector will give about 1 milliwatt for a high-frequency amplitude of 1 volt. Under the same conditions the perikon detector would give about .15 milliwatts. The galena detector will reach a transformation efficiency of 80 to 90 per cent. with a high resistance load (2 000 to 3 000 ohms). The corresponding figure for perikon would be about 60 to 70 per cent., with a somewhat higher resistance load (4 000 to 6 000 ohms). With a signal amplitude of .1 volt, the galena detector would give about .09 microwatts at the optimum load, and a transformation efficiency of about 3 per cent. with a higher resistance (30 000 ohms). For the same amplitude the perikon detector would give about .027 microwatts and a maximum transformation efficiency of about 8 per cent., both with a load of 20 000 ohms.

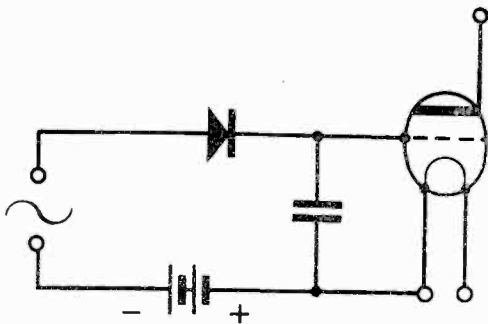

Fig. 22. A case of "potential" rectification, the valve being of negligible conductance for the D.C. output.

The figures cannot be regarded as anything more than particular values for these particular specimens, but they indicate the general order of the comparison between the two types of detector.

6. Potential Rectification (Infinite Load).

This has already been mentioned briefly, but is worthy of a little fuller consideration. From equation (4.10), i.e.,

$$i_0 = F(E) - v_0 F_1(E) + \frac{v_0^2}{2!} F_2(E) - \dots + (-1)^n \frac{v_0^n}{n!} F_n(E) + \dots \quad (6.1)$$

it can be seen that if R is increased

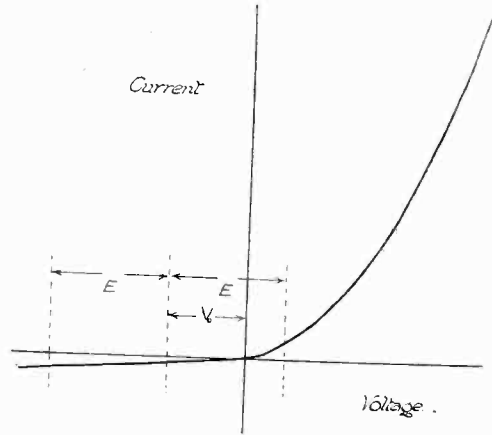

Fig. 23. The effect of a load of infinite resistance on detection.

indefinitely, i_0 will reach the limit zero, but v_0 may remain finite, being the solution of

$$F(E) - v_0 F_1(E) + \frac{v_0^2}{2!} F_2(E) - \dots = 0 \quad (6.2)$$

A practical example of such a case is that illustrated in Fig. 22, where a crystal detector is connected directly to the grid of a valve, the mean grid potential being sufficiently negative to prevent the flow of any continuous grid current. The process can be related to the detector characteristic as shown in Fig. 23. It is clear that a negative or positive potential charge will accumulate on the plates of the condenser until a value of potential change v_0 is reached, such that

$$\int_0^T \frac{1}{2} f(E \sin \omega t - v_0) dt = \int_0^T f(E \sin \omega t - v_0) dt, \quad \dots \quad (6.3)$$

under which condition the positive and

negative charges added in successive half cycles become equal. For a perfect rectifier, i.e., one in which the conductivity is finite in one direction and zero in the other, the above condition will only be reached when $v_0 = E$. The writer has determined the curves showing v_0 in terms of E for typical specimens of galena and perikon. In the former case it was found (see below) that for moderately large amplitudes (greater than about .4 volts) nearly perfect rectification is obtained, v_0 reaching as high a value as nearly $0.9E$. Perikon was nearly as effective, v_0 being about $0.7E$ for moderately large amplitudes. The curves will be given in the experimental results below.

EXPERIMENTAL RESULTS ON POTENTIAL RECTIFICATION.

The values of E_c corresponding to an infinite D.C. load were measured by means of the circuit shown in Fig. 24. It will be seen that the function of the valve is simply that of a fairly sensitive electro-static voltmeter. The potentiometer arrangement shown across the filament battery is used to balance the normal anode current out of the galvanometer. The valve is calibrated by applying known small changes of mean grid potential and observing the consequent changes of anode current. The curves of Fig. 25 show the results obtained.* The line $E_c = E$ is also drawn on the diagram for comparison. As shown in Part I., this would be the value of E_c corresponding to perfect rectification. The contact points used in these measurements were the same as those for which the E_c and R_c lines are

* We have taken the liberty of adding Fig. 25a (see next page), showing E_c/E in terms of E , the values being derived from Fig. 25.—Ed. E.W. & W.E.

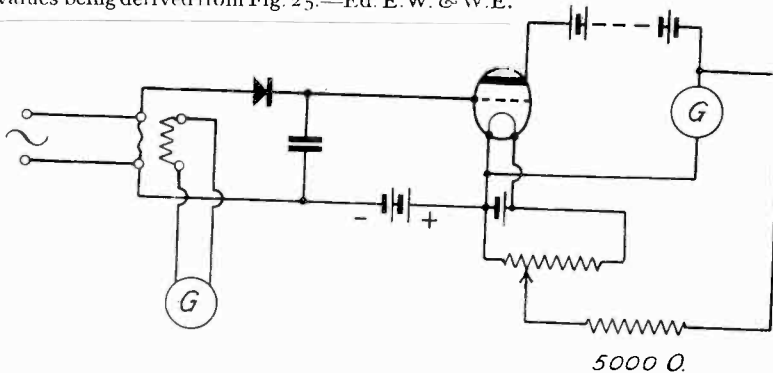

Fig. 24. To ascertain the magnitude of V_0 in Fig. 23, the circuit was as shown.

shown in Fig. 13. It will be seen that the open-circuit rectified E.M.F. is considerably greater than the no-load rectified E.M.F., as was predicted earlier. The curves would

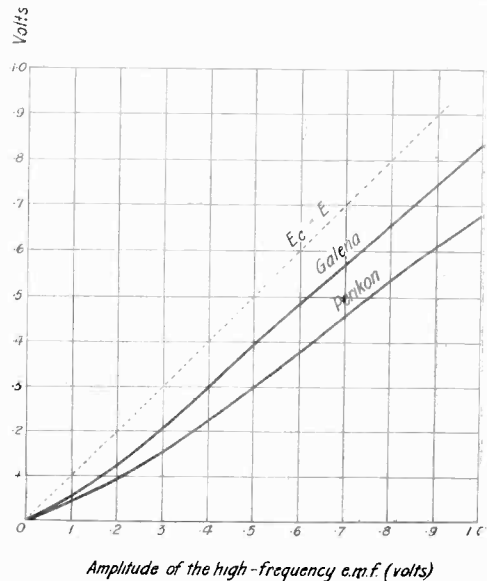

Fig. 25. Showing V_0 for various values of input voltage, in the case of infinite load.

suggest that galena is likely to be a far more sensitive open-circuit rectifier than perikon, but it must not be forgotten that the damping introduced by the latter into an oscillatory circuit is likely to be considerably less than that associated with the former, so that in practice it is probable that perikon is the more suitable detector for use in this way, especially as it has the additional advantage of comparative stability of contact.

7. The Rectification of a Modulated E.M.F.

Up to the present point the rectification of continuous waves only has been considered. This is, as it were, the fundamental case, and the other and more practically important applications of rectification

will be found to be based on the foregoing analysis.

An application of particular interest at the present time is that of speech- or music-modulated continuous waves. For the purposes of analysis, an E.M.F. of this character will be represented by

$$e = (E + m) \sin \omega t \quad \dots (7.1)$$

where m is some audio-frequency alternation of more or less variable character

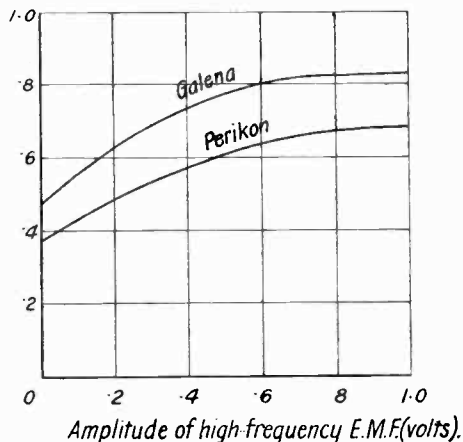

Fig. 25a. Derived from Fig. 25, this shows the actual ratio of input to output voltage.

and complex wave form. To fix ideas we will assume that for an appreciable period of time the fundamental frequency and wave form of m remain constant, the former being $n/2\pi$. Also, for simplicity, we will consider first the case in which there is no load in series with the rectifier. Under this condition, the equation

$$i_0 = F(E) \quad \dots \quad (7.2)$$

which refers to the rectification of a continuous wave, will be replaced by

$$i_0 + i_m = F(E + m) \quad \dots (7.3)$$

i_m being a current of the same fundamental frequency as m and of wave form as yet unspecified. Since $F(E)$ is in all practical cases a finite and continuous function of E , we have, by Taylor's theorem,

$$i_0 + i_m = F(E) + mF'(E) + \frac{m^2}{2!}F''(E) + \dots + \frac{m^n}{n!}F^n(E) + \dots \quad (7.4)$$

In practice m will be small compared with e . In fact, putting M and E for the corresponding amplitudes, M/E will rarely exceed about 15 per cent. in commercial telephony or broadcasting. Further, the curvature of the $F(E)$ line will generally be small. With a good crystal detector, operating at amplitudes of .4 volts or more, the curvature will be quite negligible. It follows from the above considerations that in the right hand side of equation (7.4), only the first two terms will be really significant, i.e.,

$$i_0 + i_m = F(E) + mF'(E) \quad \dots (7.5)$$

whence, in virtue of a well-known principle,

$$i_0 = F(E) \quad \dots \quad (7.6)$$

$$i_m = mF'(E) \quad \dots (7.7)$$

From these equations three deductions can be made.

(a) The continuous component of the rectified current is not affected by the modulation. It should be noted that this will not be the case if the third and subsequent terms of equation (7.4) are appreciable, for we should have

$$i_0 = F(E) + \frac{M^2}{4}F''(E) \quad \dots (7.8)$$

It can be shown experimentally that in practice $M^2/4 F''(E)$ is negligible compared with $F(E)$. The arrangement is as shown in Fig. 26. Briefly, it consists of the measurement of i_0 by means of a sensitive galvanometer. It will be found, on tuning the aerial to a broadcast transmission, that the modulation produces no effect on the magnitude of the continuous component.

(b) The second deduction is that under the assumed conditions the modulation frequency current will be a faithful reproduction of the modulation m . The important requirement for purity of reproduction is seen to be the straightness of the $F(E)$ line over the range of variation m . In this respect the average crystal detector is very satisfactory indeed.

(c) The third point to notice is that the sensitivity of a detector from the present point of view will depend chiefly on the slope of the $F(E)$ line, or, as it may be termed, the rectification characteristic at no load.

The above analysis can be illustrated by reference to an actual rectification characteristic as shown in Fig. 27. The variation of the amplitude E over the range m produces a variation MM' on the $F(E)$ line, and a consequent variation AA' in i_0 . The omission of all terms after the second in equation (7.4) is equivalent to stating that MM' is sensibly a straight line.

8. The Effect of a Modulation Load.

It is now necessary to consider the modifications introduced by the presence of telephones or any other modulation frequency load in series with the rectifier. The case is that illustrated in Fig. 6, except that the load must now be regarded as a general impedance whose D.C. resistance is R , and whose impedance at a frequency $n/2\pi$ is of magnitude Z_n and phase angle θ_n . In operator notation

$$\dot{Z}_n = R_n + jX_n \dots \dots \dots (8.1)$$

where

$$Z_n^2 = R_n^2 + X_n^2 \dots \dots \dots (8.2)$$

and

$$X_n/R_n = \tan \theta_n \dots \dots \dots (8.3)$$

The equations of para. 4 will still apply to the present case, with the following

modifications. In place of i_0 we shall have $i_0 + i_m$; in place of v_0 we shall have $v_0 + v_m$, v_m being the back E.M.F. due to the modulation-frequency currents flowing in the load; in place of the constant amplitude

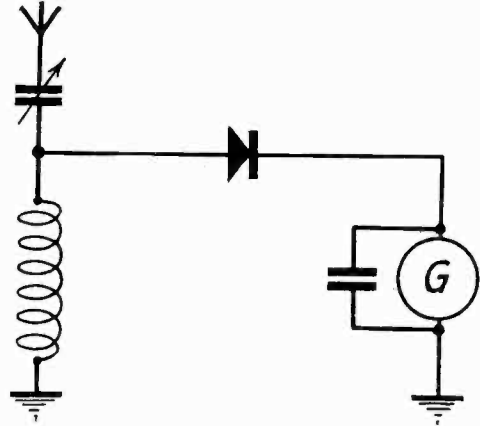

Fig. 26. To check the conclusion that the modulation should not affect rectification of the carrier wave, this circuit was used.

E we shall have the modulated amplitude $E + m$. The fundamental equation therefore becomes, making the same assumptions as in the no-load case,

$$i_0 + i_m = F(E + m) - (v_0 + v_m)F_1(E + m) + \frac{(v_0 + v_m)^2}{2!} F_2(E + m) - \dots \dots \dots + (-1)^n \frac{(v_0 + v_m)^n}{n!} F_n(E + m) + \dots \dots \dots (8.4)$$

$$= F(E) + mF'(E) - (v_0 + v_m)[F_1(E) + mF_1'(E)] + \frac{(v_0 + v_m)^2}{2!} [F_2(E) + mF_2'(E)] - \dots \dots \dots + (-1)^n \frac{(v_0 + v_m)^n}{n!} [F_n(E) + mF_n'(E)] - \dots \dots \dots (8.5)$$

i.e.,

$$i_0 + i_m = \left[F(E) - v_0 F_1(E) + \frac{v_0^2}{2!} F_2(E) - \dots \dots \dots + (-1)^n \frac{v_0^n}{n!} F_n(E) + \dots \dots \right] + m \left[F'(E) - v_0 F_1'(E) + \frac{v_0^2}{2!} F_2'(E) - \dots \dots \dots + (-1)^n \frac{v_0^n}{n!} F_n'(E) + \dots \dots \right] - v_m \left[F_1(E) - v_0 F_2(E) + \frac{v_0^2}{2!} F_3(E) - \dots \dots \dots + (-1)^n \frac{v_0^n}{n!} F_{(n+1)}(E) + \dots \dots \right] + (\text{terms in } v_m^2, v_0 v_m^2, v_m^3, \text{ etc.}) \dots \dots \dots (8.6)$$

In practice the last and subsequent groups of terms will be quite negligible by comparison with the first three groups. As far as the continuous component is concerned, this can be confirmed experimentally by

inserting a modulation frequency load in the circuit shown in Fig. 26. It will be found that, as before, the continuous component is not appreciably affected by the modulation. From equation (8.6) we have

$$i_0 = F(E) - v_0 F_1(E) + \frac{v_0^2}{2} F_2(E) - \dots + (-1)^n \frac{v_0^n}{n!} F_n(E) + \dots \quad (8.7)$$

and

$$i_m = m \left[F'(E) - v_0 F_1'(E) + \frac{v_0^2}{2!} F_2'(E) - \dots + (-1)^n \frac{v_0^n}{n!} F_n'(E) + \dots \right] - v_m \left[F_1(E) - v_0 F_2(E) + \frac{v_0^2}{2!} F_3(E) - \dots + (-1)^n \frac{v_0^n}{n!} F_{(n+1)}(E) + \dots \right] \quad (8.8)$$

For abbreviation, we will put

$$F'(E) - v_0 F_1'(E) + \frac{v_0^2}{2!} F_2'(E) - \dots + (-1)^n \frac{v_0^n}{n!} F_n'(E) + \dots = K_c \quad (8.9)$$

and

$$F_1(E) - v_0 F_2(E) + \frac{v_0^2}{2!} F_3(E) - \dots + (-1)^n \frac{v_0^n}{n!} F_{(n+1)}(E) + \dots = \frac{I}{R_{cm}} \quad (8.10)$$

$$i_m = K_c m - \frac{v_m}{R_{cm}} \quad (8.11)$$

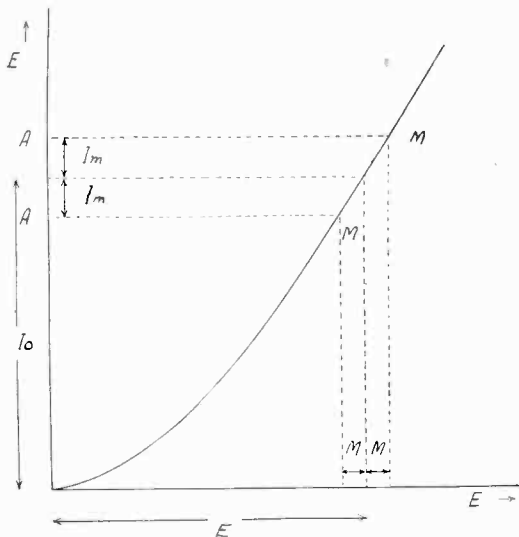

Fig. 27. If the detector characteristic is straight between M and M' , there will be no distortion in rectifying telephony.

It should be noted that R_{cm} and K_c depend only on the characteristic of the detector, the amplitude, and the D.C. load, and are independent of the character of the modulation and its amplitude. Using these abbreviations, equation (8.8) is seen to take the very simple form

From this point, having shown that the modulation frequency equation contains no important terms involving squares or products of m and v_m , it will be permissible to simplify the analysis by considering a single pure tone modulation only, since the general case will only be the sum of the separate harmonic components. We will assume therefore that

$$m = M \sin nt \quad (8.12)$$

By rearrangement of terms, and using vector notation, equation (8.11) becomes

$$I_n = \frac{K_c R_{cm} M}{Z_n + R_{cm}} \quad (8.13)$$

The physical significance of the various terms is now apparent. The term $K_c R_{cm} M$ is effectively a modulation frequency E.M.F. It is associated with an internal resistance R_{cm} , and acts in a circuit of which the impedance is Z_n .

In any case in which the exact form of the function $f(e)$ is known, the evaluation of the above quantities presents no difficulty. For instance, an ordinary crystal detector,

operating at amplitudes up to about 100 millivolts, can be represented very closely by

$$i = a_1 e + a_2 e^2 + a_3 e^3 + a_4 e^4 \quad \dots (8.14)$$

For this characteristic we have, as shown in the earlier part of the paper,

$$F(E) = \frac{1}{2} a_2 E^2 + \frac{3}{8} a_4 E^4 \quad \dots (8.15)$$

$$F_1(E) = a_1 + \frac{3}{2} a_3 E^2 \quad \dots (8.16)$$

$$F_2(E) = 2a_2 + 6a_4 E^2 \quad \dots (8.17)$$

$$F_3(E) = 6a_3 \quad \dots (8.18)$$

$$F_4(E) = 2 - a_4 \quad \dots (8.19)$$

$$F'(E) = a_2 E + \frac{3}{2} a_4 E^3 \quad \dots (8.20)$$

$$F_1'(E) = 3a_3 E \quad \dots (8.21)$$

$$F_2'(E) = 12a_4 E \quad \dots (8.22)$$

$$F_3'(E) = F_4'(E) = 0 \quad \dots (8.23)$$

Therefore

$$K_c = \left(a_2 E + \frac{3}{2} a_4 E^3 \right) - 3a_3 E v_0 + 6a_4 E v_0^2 \quad (8.24)$$

and

$$\frac{1}{R_{cm}} = \left(a_1 + \frac{3}{2} a_3 E^2 \right) - (2a_2 + 6a_4 E^2) v_0 + 3a_3 v_0^2 - 4a_4 v_0^3 \quad (8.25)$$

For the same characteristic the values of v_0 for given values of R can be determined by the reversed method of solution described in para. 5, so that the evaluation can be carried out completely. The process is illustrated below.

In the numerous practical cases in which the shape of the characteristic cannot be specified in mathematical form, the quantities K_c and R_{cm} can be determined in the following simple manner. It will be assumed that we have a family of curves giving i_0 in terms of E for various values of R . From such curves can be obtained the values of $\frac{\delta i_0}{\delta E}$ for a constant value of R , and $\frac{\delta i_0}{\delta v_0}$ for a constant value of E . Now from equation (4.10) for i_0

$$\left(\frac{\delta i_0}{\delta E} \right)_R = \left[F'(E) - v_0 F_1'(E) + \frac{v_0^2}{2!} F_2'(E) - \dots + (-1)^n \frac{v_0^n}{n!} F_n'(E) + \dots \right] - \left(\frac{\delta v_0}{\delta E} \right)_R \left[F_1(E) - v_0 F_2(E) + \frac{v_0^2}{2!} F_3(E) - \dots + (-1)^n \frac{v_0^n}{n!} F_{(n+1)}(E) + \dots \right] \quad (8.26)$$

or
$$\left(\frac{\delta i_0}{\delta E} \right)_R = K_c - \left(\frac{\delta v_0}{\delta E} \right)_R \frac{1}{R_{cm}} \quad (8.27)$$

whence, by re-arrangement of terms,

$$\left(\frac{\delta i_0}{\delta E} \right)_R = \frac{R_{cm} K_c}{R_{cm} + R} \quad \dots (8.28)$$

Further, from equation (8.7)

$$\left(\frac{\delta i_0}{\delta v_0} \right)_E = F_1(E) - v_0 F_2(E) + \frac{v_0^2}{2!} F_3(E) - \dots + (-1)^n \frac{v_0^n}{n!} F_{(n+1)}(E) + \dots \quad (8.29)$$

$$= \frac{1}{R_{cm}} \quad \dots \quad (8.30)$$

In either case, therefore, the determination of the quantities K_c and R_{cm} is a comparatively simple matter.

THE STRENGTH OF SIGNALS.

According to the report lately issued for last year by the Committee of the Privy Council for Scientific and Industrial Research, the apparatus developed at the National Physical Laboratory for the measurement of the strength of received wireless signals has been completed, and sets of apparatus erected at four places in Great Britain.

The strength of the signals sent out, under the auspices of the International Union, from European transmitting stations, is being measured each day. An endeavour is being made through the British National Committee of the Union to arrange for an increase in the number of transmitting signals suitable for measurement.

AUSTRIAN AMATEURS.

Austria, like several other European countries, is just realising that the wireless amateur should be encouraged and not hindered. As a result of the revised regulations, it is proposed to form an Austrian Club for Transmitting Amateurs, and the organisers wish to have the addresses of English amateurs willing to conduct tests with their members. British amateur transmitters who have a knowledge of German or Esperanto and who would be pleased to be put into communication with Austrian amateurs, are requested to write to the Hon. Secretary, Internacia Radio-Asocio, 17, Chatsworth Road, London, E.5.

Constructing a Suspended Moving Coil Galvanometer.

By R. W. Hardisty, Student I.E.E. (5MD). [621·374·4

"I always say that if you can measure that of which you speak, and express it by a number, you know something of your subject; if you cannot, your knowledge is meagre and unsatisfactory."—LORD KELVIN.

IT is proposed to describe in this article how a galvanometer reading to 0·1 or 0·01 microamp may be made with a lathe and a few metal tools. Detailed dimensions are not specified, as these will alter in individual cases, but the difficulties encountered, and the means of overcoming them, have been considered as of greater importance.

The lathe employed was a Drummond 4 in. "A" type model-maker's lathe. Readers acquainted with this machine will, no doubt, understand any references made to it.

The Magnet.

This was obtained from a large assortment on the scrap-heap of a local garage. The writer was told that it was originally a Bosch magneto magnet, at any rate it is of

exceptionally good quality steel. It is important to remember to look for a magnet with suitable fixing holes for the pole-pieces, as these cannot be afterwards drilled as the metal is dead hard.

The Pole Pieces.

These were made of wrought iron obtained from the local foundry. They were obtained in two pieces and bored with a boring bar specially constructed for the purpose.

It will be remembered that the Drummond is supplied without back gears, this renders the work exceedingly heavy. A slow speed on the cone-pulley was employed, however, and the magnet clamped, with pole pieces ready fitted, on to the cross-slide as shown in Fig. 1.

It should be noted that the sensitivity of the instrument will depend upon the ratio of the length to the breadth of the coil, for with a broad and short tunnel the lines of magnetic force will not only be less crowded together but also the end effects (as shown in the sketch) will be appreciable so that deflections for the same current will be different in different parts of the scale.

It was found in this case that a length of $2\frac{1}{2}$ in. and a breadth of $\frac{3}{4}$ in.— $\frac{7}{8}$ in., the tunnel being 1 in. in diameter, was sufficient. Better results would have been obtained with a narrower tunnel, but very careful fitting would have been necessary.

In order that the deflections shall be strictly proportional to the currents producing them, the tunnel must be provided

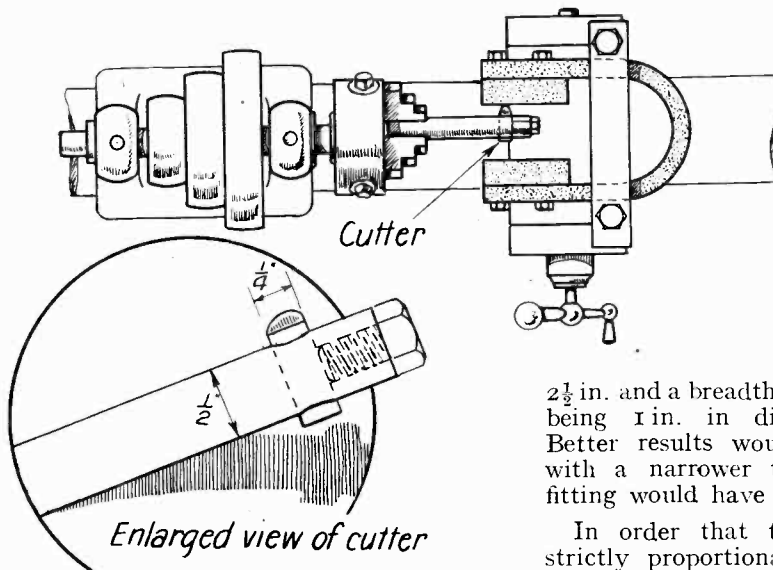

Fig. 1.

with a central core (see Fig. 2). This was made of wrought iron bar $\frac{1}{2}$ in. in diameter.

The central core is fixed to a brass back plate by two 4 BA screws and kept central by two distance pieces of $\frac{1}{4}$ in. brass rod.

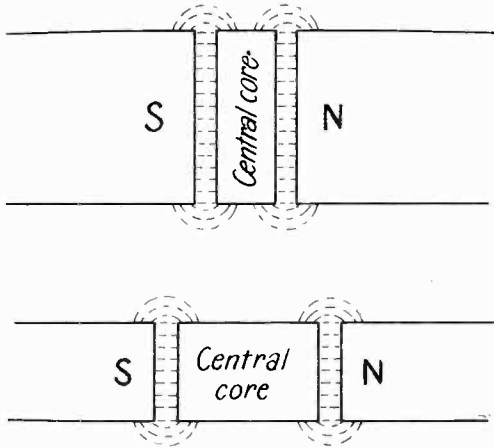

Fig. 2.

In the writer's instrument the whole magnet is supported by a brass pillar $\frac{3}{8}$ in. in diameter, which also carries the suspension arrangement.

The Base.

This is of brass, cast by the local foundry. A pattern was made in elm (this is not an ideal wood for the purpose, but it was the only wood available. A closer grained wood is preferable). As can be seen from the photograph, the base is made with a flange to support the outer case.

For the benefit of those who have not before made patterns for castings, the edges of the flange must be relieved so that the pattern may be drawn out of the mould without disturbing the sand.

When the casting is delivered it is covered with a very hard scale. This must be removed, and the only way to get it off is to dig the tool right under the scale, and take a heavy cut. Here difficulties arose, as the radius of the base was considerable, hence the peripheral speed was really far too great for the job. However, with patience and repeated sharpening of the tool, the scale was removed from the parts that would be visible in the finished state.

The base is next drilled with three holes for the levelling screws, and these holes are

tapped. A large hole is required for the main brass pillar, two for the terminals, which are bushed with ebonite, and two more, to enable the leads from the terminals to be brought through.

The Coil.

A piece of $\frac{1}{4}$ in. ebonite sheet is cut and filed till it is just slightly longer than the central iron core. The edges of this piece of ebonite should be filed to a slight bevel (for reasons which will be given later) and the corners carefully rounded off. Two more pieces of $\frac{1}{8}$ in. ebonite are now cut, larger than the above by $\frac{3}{16}$ in. all round, and screwed to it on either side. The coil former is now ready for winding.

The coils at present used are two. One is dead-beat, the other ballistic. The ballistic coil was constructed first. 250 turns of No. 40 s.w.g. enamelled wire were used in both cases. The gauge of wire is really immaterial, so long as the coil is light, but the writer had a large quantity of this wire, and it is easy to handle.

It is, of course, advantageous that the winding should be as neat as possible, so that a large number of turns may be put into a small space. A slight tension only should be put on the wire while winding.

The ends of the winding are brought out to opposite ends of the coil. One of these is soldered to the mirror support (described below), the other is soldered to a piece of 47 s.w.g. which is in turn soldered to a stiff piece of wire brought through an ebonite sleeve from one of the terminals in the front.

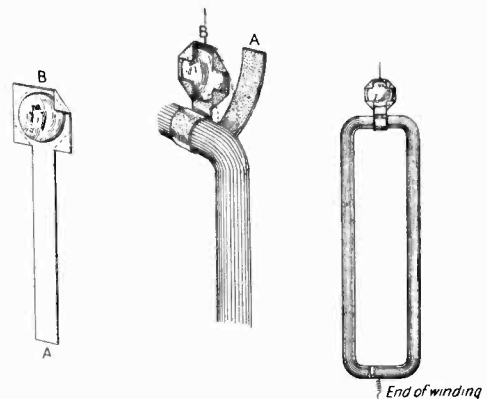

Fig. 3.

After winding, the whole former is dipped in a tin of molten paraffin wax. When this has set, an attempt may be made to remove the coil from the former, an operation which is facilitated by having the ebonite on a bevel. If any difficulty is experienced in removing the coil, it will be found that by

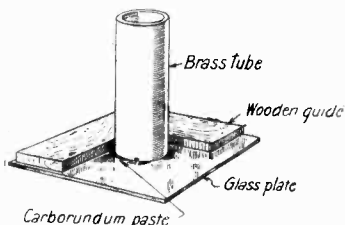

Fig. 4.

pressing in the winding on the longer sides, the coil will come off easily in most cases. The finished coil is shown in Fig. 3.

The coil is now tested for continuity, and a piece of copper foil cut as shown in the sketch, Fig. 3. This will be required to bind the coil and support the mirror, and to it the suspending wire will be soldered.

The piece of foil should be bent round the winding and soldered to itself. One end of the winding is soldered to the foil, and finally the suspending wire soldered on. (Fig. 3 B).

“Dead-beat” coils are often wound on copper formers. or several turns of wire—apart from the winding—may be put on and short-circuited. The currents induced in these turns, due to their motion with the coil, will react on the field of the permanent magnet and rapidly bring the coil to rest. The author has so far tried one “dead-beat” coil with only one short-circuited turn, but its behaviour has brought home to him the fact that the damping action of these turns is proportional to the percentage which they form of the total number in the actual coil (in this case 250). Ten or twenty turns would be likely to produce better damping.

The mirror is a microscope cover-glass, silvered by the glass works at a cost of 6d. It is secured by bending round the corners of the copper foil, and not stuck on.

Plane or concave mirrors (1 metre focus) can be obtained from scientific instrument makers for 2s. 6d., but owing to the liability to breakage when mounting the above method is probably cheaper.

The Suspension.

The equation for the torsional force on a wire of radius r twisted through an angle ϕ per unit length, the coefficient of rigidity of the material being n , is given by

$$\tau = \frac{1}{2} n \phi r^4 \pi$$

this force is, of course, balanced by the couple due to the current in the coil. It is therefore obvious that r must be made as small as possible.

In the case of this instrument, the suspending wire is of 47 S.W.G. Another piece of the same wire is used for the bottom lead to the coil. This, of course, need not be taut.

The Suspension Adjustment.

It is necessary in an instrument of this kind that the point of suspension should be adjustable in three directions.

The top of the brass pillar is drilled $\frac{1}{4}$ in. for a depth of about $\frac{1}{2}$ in. A 2 BA screw is tapped from the side into this hole.

A piece of ebonite rod is next turned up and a piece of $\frac{1}{4}$ in. brass rod is inserted in a hole at the end—a driving fit. About $\frac{1}{2}$ in.

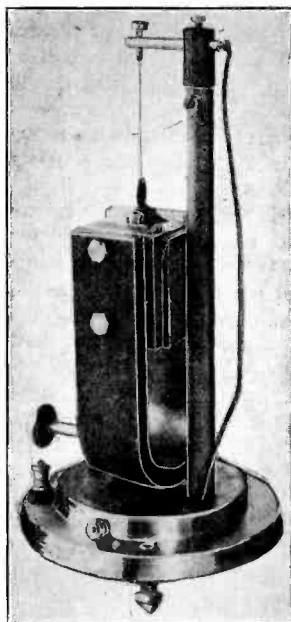

Fig. 5.

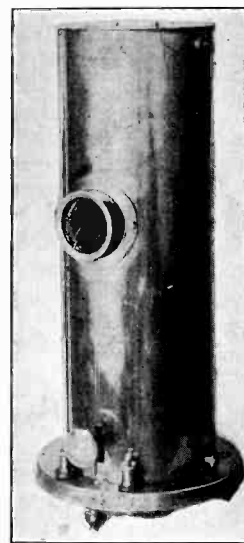

Fig. 6.

of this projects from the ebonite and fits the hole in the pillar. This provides for adjustment in the horizontal plane.

Another $\frac{1}{4}$ in. hole is drilled through the ebonite to support the brass rod carrying the suspending pin, and a second 2 BA is tapped into the top to clamp the forward and back adjustment. Finally a small pin, to which the suspending wire is attached, is arranged a push fit in the $\frac{1}{4}$ in. brass rod as shown in the photograph.

The suspension release consists of a T-shaped brass (not steel!) strip which is secured to the pole pieces by two set screws and carries a hole in the opposite end to which a string is attached. This string is wound on a winch arrangement in the front of the base of the instrument.

The main body of the case is of brass tube. Another piece of tube was procured $1\frac{3}{4}$ in. in diameter. A hole was next cut in the main tube to accommodate this (by drilling out a ring of holes, and filing to shape). A flange was constructed out of sheet brass, carefully bent to fit the curvature of the main tube, filed to fit the side tube, and finally soldered to the latter. The flange was then drilled for two screws to fix it to the main tube. Another flange is soldered on to the front of the side tube to support the glass window.

The glass window was cut out of a photographic plate by grinding out with a piece of tube the same size as the side tube, fed with carborundum compound on its end. Fig. 4 illustrates this method of cutting the glass. The circular piece of glass so formed was carefully ground on an emery wheel till it fitted the brass side tube. It was then secured inside by a ring of steel wire in the usual way.

The top of the case—as may be seen from the photograph—is of sheet brass, arranged to fit on to the main body with a bayonet catch and two screws.

The photographs (Figs. 5, 6 and 7) show the complete instrument with and without the brass case.

The Lamp and Scale.

By far the most convenient lamp for use with reflecting instruments of this kind employs a 6-volt 6 c.p. automobile bulb. The lamp, which is not shown in the photograph, was made from a piece of $1\frac{3}{4}$ in. brass tubing. A lens was provided to fit the front,

having a focal length of about 3 inches. (This lens was taken from an old bicycle lamp, and is consequently not corrected for chromatic aberration, etc.!).

A piece of fine wire is fixed perpendicularly at one of the unit planes (found by trial) so that it casts an image of its own size on the scale.

The whole lamp tube is supported by a U-piece at its point of balance, and can be rotated in two planes.

The scale is of paper, obtainable from Messrs. W. G. Pye & Co., Cambridge, for 6d.

General Performance.

Without any shunt the instrument reads 0.1 microamp easily. For ranges 0-1 milliamp

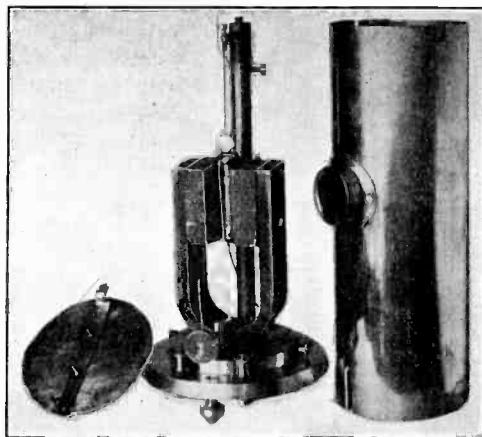

Fig. 7.

a shunt of about $\frac{1}{2}$ -1 ohm is used. (At present the writer has not been able to work out the shunts exactly, and this one was assembled at a moment's notice for some experimental work.)

The author hopes that this article has shown that such a galvanometer is well within the constructional power of the amateur with a lathe. The time and labour taken to construct the instrument has, in his opinion, been well repaid after only a few weeks' use. The base cost 10s. to cast; the only other item of importance is the case—about 7s. The total cost is under £2.

The Perfect Set.

Part VII: More about H.F. Amplification.

[R132]

In this instalment we consider the details of H.F. Coupling.

IN our last article, we opened up the question of H.F. amplification, and showed some of the points which cause such a radical difference in the design and performance of H.F. and L.F. amplifiers.

Perhaps the most important conclusion there drawn was that, owing to the "Miller effect"—the dependance of a valve's input impedance on the output load—we could not consider each part of the amplifier as a separate unit. It is therefore not practicable to do as we did for L.F. work: deal with the valve and the coupling as two quite separate things.

We can, however, begin by looking at the conditions of valve operation; and we can lay down the same three main requirements, for maximum efficiency, as in the case of L.F. work:

- (1) A length of "straight" characteristic sufficient to accommodate the grid swing.
- (2) No grid current.
- (3) Operation entirely on the straight part of the curve.

But in practice the effect produced by a departure from these conditions is very much less for H.F. As regards (1), the grid swing in most H.F. amplifiers is so small that any ordinary valve will handle it easily. The minimum filament heat is rather that below which the slope of the valve curves is too small rather than that below which the length of curve is too short. If by any chance we do fail to get a long enough curve, we lose some amplification, but the possibility is remote.

Again, as regards (2). The troubles produced in L.F. work by grid current are two: first, low input impedance, leading to bad amplification, and second, *irregular* input impedance leading to distortion (see earlier instalments). But in the H.F. stages, the input impedance is already low, very likely as low as 20 000 ohms; and the effect of a positive grid is more or less that of putting, say, 100 000 ohms across it: it will not make a lot of difference.

Point (3) is not now necessary to avoid L.F. distortion, but it has quite an important effect on amplification. The straight part of the valve characteristic is also the steepest part, and gives the best amplification.

Couplings.

Now as regards the coupling. There is a greater variety in H.F. than in L.F. circuits; not so much on account of the coupling itself as for the reason that various special steps are often taken to try and combine stability with high amplification.

Such couplings fall naturally into two main classes. There are those in which an attempt is made to balance out or otherwise compensate for the Miller effect; and there are those in which one simply tries to prevent such capacity effects from causing instability. We shall deal first with the latter.

In the days when amateurs devoted much attention to long-wave telegraphy, the resistance-coupled amplifier was considerably used. But for reasons shown in our last instalment, it is extremely difficult to get good amplification at short wave-lengths, and this form of coupling is now seldom used for H.F. work.

The choke amplifier has been used to a certain extent, but for short-wave work there are difficulties in the design of the choke, which must have high inductance and low self-capacity. It may be of interest, however, to note a design patented by Miller about a year ago, which was claimed to be effective for all radio frequencies, although no tuning is involved.

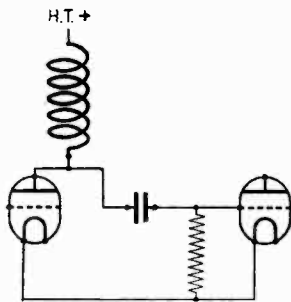

Fig. 1.

The circuit is a quite normal one, as shown in Fig. 1, the point being in the design of the choke. This consists of a slab coil of fine wire, shown natural size in Fig. 2, and containing about 5 000 turns. The inductance is of the order of 500 000 μ H, and the self-capacity is about 2.5 μ F. This choke has a natural frequency of about 150kC (2 000 metres), and at this point



Fig. 2.

like a resistance of 2 megohms. On either side of resonance the impedance gradually falls off; but at 20 000 metres it is still 45 000 ohms, and as low as 200 metres it is 40 000 ohms. At broadcast wave-lengths it would be about 80 000.

It will be noted that we cannot regard a choke as a pure inductance, but that we must take account of the fact that it has a natural tuned wave-length. This fact led naturally to the use of a tuned choke, intended to be operated always at its resonant frequency—in fact, the tuned anode circuit. When this is tuned it becomes (for H.F. currents of this frequency) a high resistance; but we have already given reasons why it is not usually exactly tuned.

A third form of coupling often used is the transformer, and it is quite common for this to be considered an entirely different type of circuit from the "tuned anode." But the kind of transformer which is probably the best is really extremely closely akin to the tuned anode circuit.

Fig. 3, for example, shows a typical "tuned anode" coupling. The theory is that since the rejector circuit A offers a high impedance to H.F. currents, there will be a fairly high H.F. voltage across it. One side of it is connected through condenser B, to the next grid, and the other through condenser C to the filament. As B and C offer only a low impedance to H.F., the H.F. voltage across A will be applied to the grid. Now suppose, as in Fig. 4, that we wind the coil with two windings, and connect anode to one and the next grid to the other, the conditions are identical. As the two windings have equal turns, there will be equal voltages across them, for the back E.M.F. in the first coil, caused by its self-inductance will be the same as the E.M.F. in the second, caused by the mutual inductance, and the same voltage as before will be applied to the

second grid. In practice there will be a slight difference, for there will be a few lines of force that do not cut both windings; the effect is a very slight drop in the grid voltage. Note that any variation of the condenser alters the current in the first winding, hence alters the magnetic field, and therefore the output voltage: in other words the condenser tunes both windings.

Now it would be just as easy to connect the upper end of the second winding direct to the filament instead of via condenser C. This leads to Fig. 5. But now the grid circuit is no longer connected to the + side of the anode battery, as it was before, hence the grid condenser is not necessary (unless, of course, valve No. 2 is a detector). We can therefore cut out B, and as a natural result can abolish the grid-leak, which (where this valve is not a detector) is only inserted because otherwise B would give an isolated grid. Making this change, and turning A upside down for simplicity in drawing, we get Fig. 6. This is a typical transformer coupling, and we therefore see that a transformer coupling, using a tight-coupled 1-to-1 transformer with tuned primary, is in its main action almost identical with tuned anode. What points of difference arise?

The tuned anode needs only one winding, but necessitates a leak and condenser.

The transformer needs two windings, but

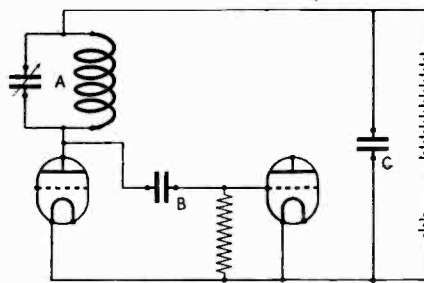

Fig. 3.

no leak nor condenser, and gives us the chance to use a ratio different from 1 to 1 if we desire. There is obviously little to choose as regards expense or space occupied.

Now as to their merits. It is obvious that if the second valve, as is often the case, is to be a grid current detector, the tuned anode circuit has the advantage of simplicity, and it will probably be considered that the possibility of a gain by having a different

turns ratio is not sufficient to warrant the extra trouble. It is appropriate to consider at this point the question as to what is the correct turns ratio. This depends on how closely the two windings are coupled and on the relative impedances of the input and output circuits of the transformer—in this case that of the anode circuit of the first valve and the grid circuit of the second. As a first approximation to the required ratio divide the grid impedance by the anode impedance, and take the square root of the result.

But we have already shown that the grid impedance is a very variable quantity; so that one cannot say very definitely what the best ratio is: it will depend on the valves, the wave-length, and the anode circuit of the second valve. The writer's own experience over broadcast ranges indicates that a step up of 1 to 1½ or 1 to 2 is distinctly

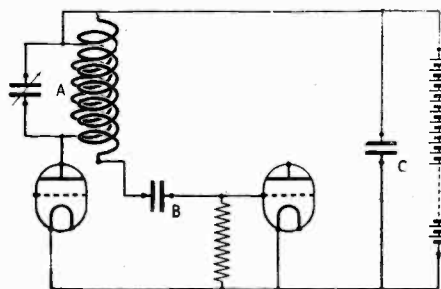

Fig. 4.

superior to 1 to 1; but if it is desired to try H.F. on the short waves of 50 to 100 metres, probably 1 to 1 or even a step down of 1½ to 1 would do better.

If, on the other hand, the coupling is not to be followed by a grid detector, the advantage is distinctly with the transformer. Firstly we have the power to alter the tunes ratio, as already explained; secondly, we do away with the grid condenser and leak. This is an advantage (apart from the saving in components) because the leak and condenser can never help amplification, and in some cases hinder it quite a lot. For if at any time a grid current flows, it will charge up the condenser, just as in a rectifying valve; and this charge may last quite a long time (1/1000 second is a long time in radio-frequency work). During this period the valve is operating with its grid considerably more negative than normal, and it may easily happen that it will not, under these

conditions, be amplifying nearly as well as it might.

In the previous comparison between tuned anode and transformer coupling, we have been treating of a transformer distinguished

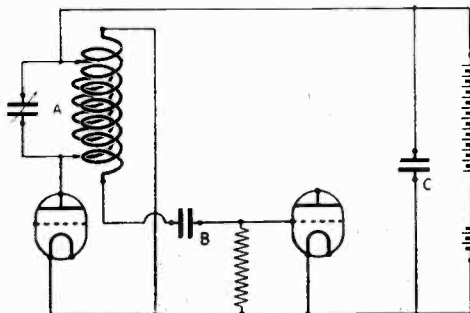

Fig. 5.

by two features: it is close-coupled, and one winding has a condenser across it. It must be realised that there are other types of transformer.

On the one hand, it is quite possible to use a loose-coupled transformer, as in Fig. 7. This is a highly efficient coupling here as it is elsewhere. It has, however, the disadvantage (often fatal) of needing three adjustments: the two condensers and the coupling. Its selectivity is, of course, extreme, and it is really not a practical proposition for ordinary work, though for special purposes it is unrivalled.

At the other extreme, we have the close-coupled transformer with no tuning arrangement at all. This, of course, has its own

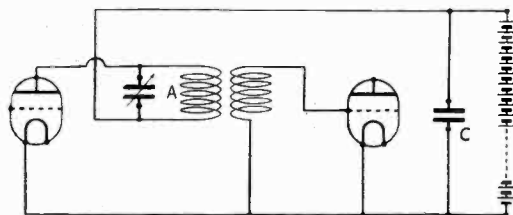

Fig. 6.

natural wave-length, due to its self-capacity, and if it is made in the usual way, it is fairly sharp in its tuning. This would necessitate having a large set of interchangeable transformers, so special steps are usually taken to make each transformer cover a wider band. A favourite method is to wind with resistance

wire. Or we may arrange the windings with tappings, and provide a switch—there are several such instruments on the market.

But for work with one, two, or three stages, our own opinion is that if an untuned or flat-tuned set is wanted the Miller choke already described is the best; while if we want selectivity the close-coupled tuned transformer is by far superior to other couplings. Further, we much prefer plug-in

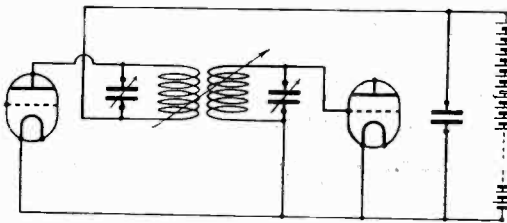

Fig. 7.

transformers to the tapped type, and in our own work we have finally settled on two types of transformer which have given every satisfaction.

The type which we will describe first is the less efficient, but can be made for any wave-length.

It simply possesses two windings, wound one over the other in the same slot. The former may be either an empty ebonite one of the usual one-slot type (various firms will supply these empty formers), or it can be built up of two large thin and one small thick ebonite discs: some of our transformers are built up on waxed cardboard formers, and appear quite efficient. The one important point is to keep down the self-capacity of each winding and the mutual capacity between the two. With this object in view, the windings are deep and narrow: we make it a rule that in no case is a winding less deep than $1\frac{1}{2}$ times its width, and prefer them deeper. Between the two windings there should be a space; in practice we wind on 20 turns or so of cotton thread.

Size of wire does not seem vitally important. We use as fine as 44 s.w.g. for long-wave transformers, but considerably larger—of the order of 32 s.w.g.—for short waves. Up to 600 metres, i.e., for windings of 50 to 100 turns or less, we often use a twin 40 s.w.g., each strand D.S.C., which seems very efficient: the two strands are joined at the ends. No effort is made to wind the wire on evenly, a "bad" criss-cross winding has

somewhat the effect of a honeycomb winding in keeping down self-capacity.

The two ends which lie close to one another, the outside of the inner winding and the inside of the outer, are connected to the low-potential points: the wide-apart ends go to anode and grid. This is important. It does not seem to matter which winding, primary or secondary, is put on first.

A few actual examples are:—

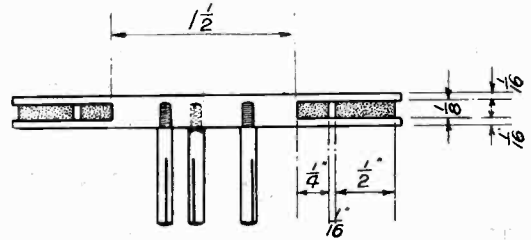

Fig. 8.

Turns.		Former Diameter.	
Prim.	Sec.		
50	100	$1\frac{1}{2}$	Broadcast range, and nearly 600 metres (·0005 condenser).
70	140	"	about 400-800
180	300	"	about 900-2 700
430	430	"	about 2 000-5 000 (for this and larger ones, step-up was sacrificed to keep the size down).

A more efficient type has the disadvantage of being cumbersome at long waves. It is composed simply of a honeycomb coil cut

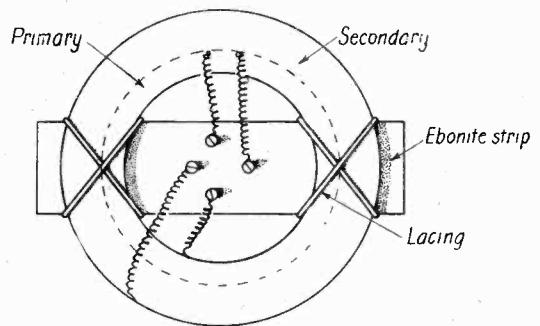

Fig. 9.

in the middle to divide it up into two windings. Unfortunately the standard honey-comb coils as sold have too many turns per layer, and the layers are too wide, to get the "edge on" effect that we want. But anyone who can rig up a coil winder, or buy one of the little hand winders on the market, can do extremely good work.

In our own case we stole the Meccano set of our son and heir, and made a winder geared 19 to 40, which, as calculation will show, gives approximately 5 turns per layer. Coils wound on this, about $\frac{1}{4}$ in. wide, are

quite efficient. For a 50 to 100 transformer we simply wind a 150-turn coil, slipping in a piece of paper as a marker under the 50th turn. When the coil is complete, the 50th turn is pulled out a little, cut, and leads soldered to the cut ends. The whole is mounted flat on a strip of ebonite carrying the contact plugs.

Now our allowance of space is used up. We must leave it to next month to discuss methods of getting stability in ordinary circuits, and special circuits designed to dodge the Miller effect altogether.

On Thermo-Junctions.

By *W. Gordon Edwards, Graduate, I.E.E.*

R251·2

IF the point of contact of two dissimilar metals be heated or cooled, a potential difference arises, in consequence of which an electric current flows, on completion of the circuit. Strictly speaking, it is not imperative that the metals be dissimilar, provided they are in a different molecular state and thus provide a different resistance to the passage of the heat and electricity. But since the force brought into play is proportional to the difference in the molecular states, it is customary to employ two very dissimilar metals or alloys.

Although the resulting current value is small, it becomes important in the design of sensitive electrical instruments, and the phenomenon is made use of commercially, as, in conjunction with a milli-volt-meter one has a ready means of employing it as a very sensitive and portable milliammeter. Duddell has incorporated the thermo-junction and movement in one instrument in his thermo-ammeter, where the ends of the moving coil are soldered to two bars of special alloy, closed by a silver plate.

There are two phenomena that should be considered, viz., the Peltier and the Thomson effects. These are respectively:—

1. The effect of the thermo-junction is perfectly reversible; if heating the junction produces an electro-motive force, then an electro-motive force produces heating.

2. The quantity of electricity that passes across a junction has a specific heat of its own.

Neglecting the Thomson effect and considering only the Peltier:—

Let P_2 = cold junction Peltier effect at an absolute temperature T_1

and P_1 = hot junction Peltier effect at an absolute temperature T_2

then, by the second law of thermo-dynamics

$$\frac{P_2}{T_2} = \frac{P_1}{T_1} = \frac{\text{work done by one unit of electricity}}{\text{difference of temperatures}}$$

Calling this work done "E,"

$$E = \frac{(T_2 - T_1) P_1}{T_1}$$

But $\frac{P_1}{T_1}$ is some constant "k"

therefore $E = k(T_2 - T_1)$ showing that the work done depends purely on the difference of temperatures of the junctions.

This is usually summed up as

$$\int_{T_1}^{T_2} Y dt$$

where Y is the thermo-electric power of the junction in question.

If the temperature difference is dependent on I^2R and $(T_2 - T_1)$ is called γ

$$E = K_1 \gamma = K_2 \cdot I^2 R$$

But with "r" as the galvanometer resistance, "i" (the current in the thermo-circuit) = E/r , and substituting for E from the above equation

$$i = \frac{K_2 I^2 R}{r}$$

or

$$I = \sqrt{\frac{ir}{K_2 R}}$$

Thus, if the current in the thermo-circuit were measured directly I is proportional to $\sqrt{\gamma}$ and the galvanometer scale would be divided accordingly. As, however, is shown below, separate calibration is much more desirable.

Various Types of Junction.

Thermo-junctions of various types, with heaters of different resistances, are made for commercial use by two or three well-known firms, but if cheapness be of more importance to the experimenter than sensitivity, he would be well advised to make his own. This can be done easily provided he exercises great care and considerable patience.

The heat can be communicated to the junction by means of:—

(1) Thermal conduction, *i.e.*, actual contact,

or

(2) Radiation and convection.

In the former case, the question of insulating the junction must not be lost sight of, and there is always a small potential drop there, due to the physical impossibility of constructing the mathematical point. This impossibility creates a reversal error—further, capacity troubles arise, so method (2) is preferable although it entails sacrificing some of the sensitivity; the form of convection currents is not constant and the instrument responds to change of position, *i.e.*, it has a different constant when on its back to when standing upright on account of the variation of convection with position. This is not so, however, in vacuum-enclosed instruments which are considerably more sensitive, as the cooling effects of convection currents and draughts are eliminated. Further, oxidation is prevented. Experiments go to show that a pressure of about 0.01 mm. is best and that below this nothing is gained, in fact the sensitivity grows less. However, these errors are of but secondary import unless research or standardising work is being undertaken.

The junctions require, most of all:—

- (1) High thermal E.M.F.
- (2) Materials that remain physically constant.
- (3) Good mechanical properties.
- (4) A minimum heat capacity.

It seems generally agreed that the form of curve for all possible thermo-junctions is as shown in Fig. 1, but usually the bend is never

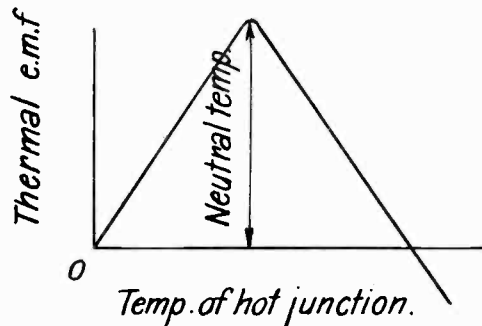

Fig. 1.

reached and it is safe to assume a straight line relationship over the ordinary working scale. The law of the curve is $E = a\theta + b\theta^2$ with one junction at $X^\circ\text{C}$, and the neutral point is always half-way along to the reversal point.

By the law of successive materials, as long as all the components are at the same temperature, it makes no difference to the thermo-force how many there be, and this permits the use of a film of Wood's metal, because its effect disappears, being the opposite on the one element to what it is on the other.

There are no temperature errors and the junctions can be used on either direct or alternating current. The change of resistance with frequency, due to skin effect, is negligible, and it is this which makes them invaluable at radio-frequencies where a hot-wire instrument would give a reading perhaps 8 per cent. too high.

The error due to eddy-currents in any nearby wire, strip or shunt is so small that the junctions could be enclosed in an iron case just as low frequency A.C. instruments, but the inductive effect of the leads cannot be disregarded. Those carrying current to the instrument must not run parallel to any others and if a lead be turned so that it runs alongside the apparatus there is a change with frequency. The idea is, to always run the wire straight out and have no bending for some distance. At 5 cms. distance the error is of the order of 1.5 per cent. Hidden capacities must also be looked for with coupled circuits and a possible electro-static leak, but can often be cut out by a judicious arrangement of short-circuiting

leads. It has been found that, if a temperature alteration be given to a junction in cyclic fashion, crystallisation obtains and, should this occur, erratic results are possible.

Applications of Thermo-Junctions.

Thermo-junctions are especially useful in measuring temperatures in inaccessible places, such as in a transformer, machine, coal bunker, etc., or reading at long distances and can be constructed to carry considerable current by using several wires in a squirrel-cage design. This system, however, is not

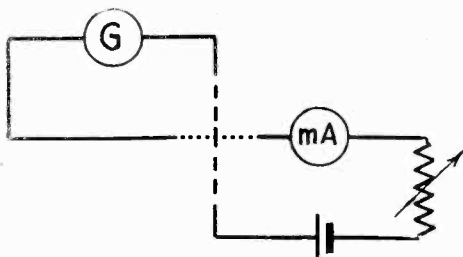

Two-way junction and connections.

to be recommended for amateur construction as the difficulty of achieving complete symmetry is very considerable.

Either the two-, or three-way type may be employed, the connections for both of which are as given. The three-way junction has a separate heating wire and the reversal error, known as the Peltier effect, is eliminated. It is easier to solder, there are two separate galvanometer circuits and we have what is practically a spare junction of equal capacity and under similar conditions to the one which may have burnt out, owing, for example, to a sudden rise in current caused by coming unexpectedly on to the resonance point.

The alternative type, already mentioned, having a separate heating wire not in contact with the junction, is the more favoured commercially, as by interchanging heaters it admits of a largely extended range, but here it is important that some means be provided so that the user can know definitely the position of the heater in relation to the junction.

The materials employed can be, say, No. 40 S.W.G. copper (bare) and No. 47 S.W.G. Eureka (bare), or iron-constantan junctions may be utilised, but the big temperature co-efficient and magnetic effect puts them out of court for very high frequency work. Copper-constantan has a

thermo-electro-motive force about 20 per cent. lower than iron-constantan, which is approximately 55 microvolts. With Manganin-constantan, however, the temperature coefficients nearly wipe out one another and this combination gives excellent results.

The composition of manganin is of the order of 84 parts copper, 4 nickel and 12 manganese, while Eureka (constantan) is 60 parts copper and 40 nickel.

The following table may be useful to the constructor in choosing his materials. It shows the thermo-E.M.F.'s against platinum in microvolts. One junction is at 0°C and the current flows across the other junction from the metal with the (algebraically) smaller value.*

Metal.	-190 ²	100 ²
Aluminium	+ 390	+ 380
Bismuth	+12 300	-6 500
Copper	- 200	+ 740
Iron	- 2 900	+1 600
Lead	+ 210	+ 410
Nickel	+ 2 200	-1 640
Silver	- 140	+ 710
Tin	+ 200	+ 410
Zinc	- 120	+ 750
Constantan	-	-3 440
Manganin	-	+ 570

Bismuth wire down to .05 mm. is procurable commercially, and some idea of its

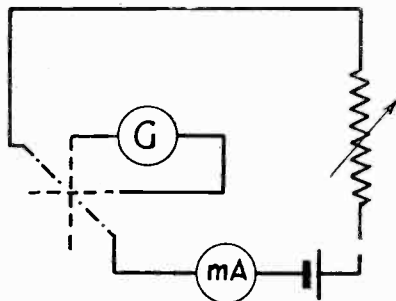

Three-way junction and connections.

resistance can be got from the fact that 0.1 mm. wire, 1 mm. long has a resistance of 0.11 ohm. Bismuth and platinum or bismuth and silver make splendid junctions, and an alloy of bismuth and about 5 per cent. tin gives a thermo-E.M.F. to lead of 44 microvolts per degree. Although such alloys cannot be nicely drawn, they are sometimes cast between smoked-glass

* See Watson's *Physics*.

plates. An alternate method is to heat the alloy to well above its melting point and hurl it while molten on to a flat glass plate; the metal runs out into small streams which when cold can be cut off and used instead of the castings mentioned.

A series of silver-constantan junctions is obtained by winding an open spiral of constantan wire and placing it half immersed, lengthwise, in a silver-plating bath. The investigators state that the thickness of the silver should be such that its area of cross section is of the order of 33 per cent. of the constantan core. Two

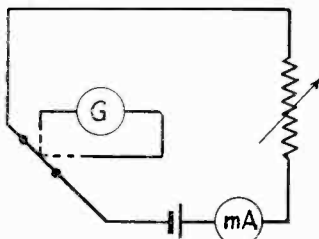

With separate heating wire.

lines of junctions result, and if one of these is exposed to the heater a remarkably good thermo-pile is formed, the line of demarcation being particularly sharp, but this is not so usual a method for home construction as that outlined below.

Constructing the Junction.

On an ebonite base affix four or six terminals (according to whether a two or three-way junction is chosen) of the plug-in variety, with screws at the top, to clamp the small pieces of copper to which the junction-wire ends are to be soldered.

Having decided, from published tables or otherwise, what combination of wires to employ, and on the arrangements for leading the current in and out, the copper pieces should be clamped into approximate position before the junction wires are soldered to them. It is now possible to pull taut gently the wires (which should have been previously cleaned by fine emery paper rolled round a match), and with them clamped in this position, the junction itself can be tackled. The smallest conceivable spot of solder and Fluxite is necessary and, if a soldering iron is to be used, it will be found quite sufficient to bring it near to the wires. Wood's alloy, with a melting point at about 66°C ., is to be recommended in place of solder, as it requires so much less heat.

If, however, it is decided to make the junction itself before affixing it on the base, it can be kept equally taut by laying weights on both wires, and, if this be done near to the point of contact, it prevents the spread of heat. Despite this advantage, it is usually more satisfactory to construct the junction *in situ*.

Yet another method is to twist gently the wires one over the other, placing them firmly on knife-edge electrodes and fuse together by electrical heating, the current

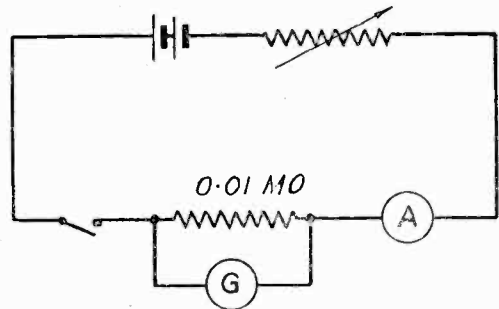

Circuit for standardising galvanometer.

being gradually brought up from zero until the two junctions separate, or again the twisted wire can be passed through an oxy-hydrogen flame.

When using in conjunction with a galvanometer, this latter must have first been standardised so as to read directly in microvolts, by a circuit similar to that given below and the following readings tabulated:—

- (a) Milliamperes.
- (b) Galvo reading.
- (c) Resistance shunt.

(d) Electro-motive-force per centimetre deflection, from which can be calculated the mean value of a deflection.

It will be found that (1) so sensitive is the combined junction and galvo that unless the screening is thorough, a capacity effect is noticeable, and the observer should keep as far away as possible.

(2) A long time must elapse between readings, due to the "creeping" action of the junction.

(3) If accurate reversal readings are required, *i.e.*, with current flowing in the opposite direction, the junction must be permitted to get quite cool.

(4) A serious error will ensue should the three wires (in the three-way type) not cross at the same place. It needs a magnifying glass to make quite certain that they do.

Resistance in Wireless Circuits. [R144]

A lecture to the Radio Society of Great Britain, delivered by Professor C. L. FORTESCUE on February 25 at the Institute of Electrical Engineers.

Introductory.

LET me at the outset express to you my very high appreciation of being asked to give this lecture. It is a great honour to be asked to take part in your proceedings and to come into line with the other distinguished lecturers you have had in the past. Let me also explain to you how it is that I came to choose such an exceedingly dull subject as resistance in wireless circuits. When your secretary's letter reached me, I was struggling with some experiments with a coil which, so far as I was able to calculate, should have had a resistance of about 67 ohms. That coil refused to function altogether, and I eventually found that it had a resistance of over 800 ohms. That coil I had no reason to suppose was as bad as it was. At the same time, I had other examples, of which I will speak in a moment, and I felt, therefore, that there was possibly some ground for a little discussion of the presence of these rather abnormal ohms and the effect of them in wireless circuits.

Resistance is as essential and as unavoidable in wireless circuits as in any other electrical apparatus, and the problem involved is the same, viz.: Firstly, to decide upon an appropriate value for the resistance of each part, and then to maintain it at that value. There is, however, the difference that, whereas in most electrical machinery the permissible rise of temperature places a limit on the resistance, in wireless circuits considerations of efficiency are generally the determining factors, except in large power transmitters where both limitations may be severely felt simultaneously.

The simplest measure of the resistance of a conductor is that given by the familiar Ohm's Law, viz.: the ratio of the steady voltage V to the steady current, I ; i.e., $R = \frac{V}{I}$.

The power wasted in heat in such a circuit is I^2R , and so an alternative measure is obtained, viz.: the power in watts generated as heat divided by the square of the steady current, i.e., $R = \frac{W}{I^2}$. When dealing with

wireless circuits, the first measure is ruled out, because a large share of the applied voltage is usually required to overcome the effects of inductance and capacity. The alternative measure derived from the power generated as heat may, however, be used with certain conventions. As pointed out in subsequent paragraphs of this paper, power is expended as heat in various ways, and it becomes necessary to extend the term "resistance loss" to include the whole heat generated by the presence of the current in the circuit. The effective resistance may then be defined as $R' = \frac{W'}{I^2}$, the current being measured in R.M.S. amperes.

In those circuits where an appreciable amount of power is radiated in the form of electromagnetic waves a further decision has to be made: shall this power expenditure be included when determining the effective resistance of the circuit? It is usual to speak of the effective resistance added to the circuit in this way as the radiation resistance of the circuit and to define it as $R'' = \frac{W''}{I^2}$, where W'' denotes the power radiated.

Many instruments, valves, etc., may also have to be considered as forming part of the circuits under consideration, and a still further addition to the resistance may arise from their presence. The power *absorbed* by any such device, divided by the mean square current, again gives the resistance that must be added. If it should happen that the device *supplies power* to the circuit instead of absorbing power from it, then the resistance must be regarded as a negative resistance. In the application of this idea of a negative resistance the power supplied is generally approximately proportional to the square of the current, and the negative resistance is then as much a constant of the circuit as the ordinary positive resistance.

The question immediately suggests itself: What will happen if the negative resistance exceeds the positive resistance? The answer

is that under these circumstances the power supplied to the circuit for any current I is greater than the power expended. The excess power causes an increase of the current, and this increase will continue indefinitely if the positive and negative resistances are really constant.

An oscillating valve just building up the current is an example of a negative resistance predominating. The current goes on increasing until a steady value is reached, when the output from the valve no longer exceeds the power expenditure owing to the negative resistance of the valve being not truly a constant and having fallen as the amplitude of the current has increased. Any device giving a negative resistance must necessarily

to one of them, the ratio of the powers absorbed from the two sources of electromotive force is approximately $1 + 160 \frac{L^2}{R^2}$,

where L is in millihenries and R is in ohms. Now, at a frequency of one million ($\lambda = 300\text{m}$) good design gives R/L as about 3 ohms per millihenry for inductances of a size suitable for use in a receiving circuit. This gives a ratio of powers absorbed of about 19 to 1. If the ratio of R/L could be reduced to 0.3 ohms per millihenry, this ratio would become about 180 to 1. When it is remembered that an interfering signal is often much stronger than the signal being received, the desirability of reducing the resistance relative to the inductance becomes obvious. The possi-

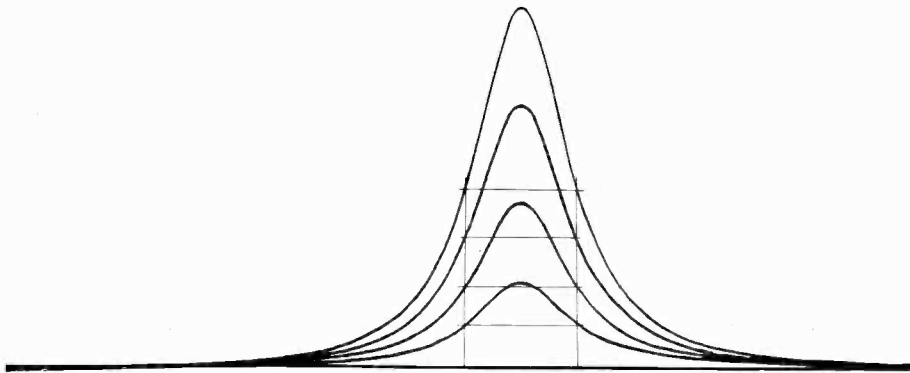

Fig. 1. Family of resonance curves of varying amplitude but equal damping.

have a limitation of this kind unless it is capable of supplying an infinite amount of power.

It follows, therefore, that in the most general case the total effective resistance of a wireless circuit at any instant may be of large or small magnitude, zero or negative, but it cannot be negative permanently.

The Practical Importance of Resistance.

This depends entirely upon the part of the installation. In the high frequency tuned circuits it is necessary to reduce the resistance to low values for the following reasons:—

(A) The selectivity, i.e., the sharpness of the tuning, of a receiving circuit is dependent upon the ratio of the resistance to the inductance. If two continuous waves differing in frequency by one kilocycle induce the same electromotive force in an aerial tuned

ability of doing this by reaction is discussed later.

The above conclusions apply very closely to modulated continuous wave (telephony), but not to spark or atmospheric interference. This interference is a problem to itself, and is only dependent to quite a small degree on the resistance of the circuits.

That aspect, which really is an aspect relating to the resonance curve, is one of the principal troubles of resistance. I am fortunate this evening in being able to show, by a simple piece of apparatus, an actual resonance curve as drawn out, so that you can form some working idea of the shape which such curves do take in practice. The curve is for the single layer coil and condenser on the lecture table. There is under the table an oscillator which is generating a continuous wave, and there is an arrangement of a rotating condenser—

rotated by means of an arm—which varies the frequency of the oscillator and at the same time causes a spot of light to move from right to left on the board. The horizontal scale, therefore, becomes a scale of change of capacity. Actually, the capacity change is a little under 30 per cent. of the whole capacity in the circuit. The coil has a resistance of a little over 8 ohms at the frequency of the experiment and the condenser is of about 700 picofarads capacity. The voltage is measured by a simple rectifying valve, connected with its grid and filament across the coil so that the rectified current is a measure of the square of the voltage across the coil. Passing the anode current of the rectifying valve through a Weston relay gives a vertical movement of the spot of light; and therefore the two movements combined give a resonance curve. [Prof. Fortescue then drew the resonance curve by tracing the movement of the light spot on the blackboard.]

(b) The efficiency of a transmitting aerial and the associated circuits as a radiator of electromagnetic waves depend upon the relative values of the effective resistance, which gives rise to waste of power as heat, and the radiation resistance, which determines the power radiated away usefully. The former must be reduced relatively to the latter if a reasonable efficiency is to be attained. As the frequency increases it becomes more and more difficult to reduce the wasteful resistance. Fortunately, however, the radiation resistance increases as the square of the frequency. This more than compensates for the difficulty of reducing the other resistances, and in practice it is easier to obtain a higher efficiency at the high frequency corresponding to a wave-length of 100 metres than at a wave-length of 10,000 metres. This is, perhaps, one of the advantages of short waves.

Closely related to the efficiency of an aerial as a radiator—if not identical with it—is its efficiency as an absorber of power from an incoming signal. A good receiver is a good radiator, and consequently if the radiation resistance is high and the wasteful resistance low, the aerial will absorb more energy, and incoming signals will be louder than when the conditions are reversed.

In telephone receivers and transformers the resistance is undesirable but relatively

unimportant, owing to the fact that the inductive effects usually predominate.

In grid-leaks the resistance must be high and definite—a condition by no means always attained—and, finally, in the insulating materials the resistance should be infinitely high.

The High Frequency Resistance of Inductances.

The losses of power in an inductance may be classified as follows:—

- (a) Conductor losses;
- (b) Dielectric losses;
- (c) Losses in surrounding conductors;
- (d) Losses at terminals and contacts;
- (e) "Dead end" losses.

With regard to (a), these are greater than they would be under steady current conditions, because the current is unequally distributed over the cross-section of the conductor. This unequal distribution arises from the general principle that high frequency currents always tend to distribute themselves so that no magnetic flux penetrates any conductors. In the case of a straight cylindrical wire the current, by this principle, tends to concentrate on the outer layer. For copper wire of a millimetre or more in diameter, and with wave-lengths not exceeding about 300 metres, the effective resistance

is about $\frac{640d}{\sqrt{\lambda}}$ times the steady current resistance, where d is the diameter of the wire in centimetres and λ the wave-length in metres. When coiled into an inductance, it will be more than this owing to the concentration of the current on to the inner surface of each turn.

The exact resistance under these circumstances is very difficult to determine. It is dependent upon the spacing of the turns of the coil and upon the ratio of the length and the depth of the winding to the diameter. With copper wires a rough guide to the best conditions is to choose a diameter of wire

given by $d = 0.6 \frac{\text{Length of winding}}{\text{Number of turns}}$. This is approximately true for both single and multiple layer coils, and the effective resistance of the coil is then about twice the effective resistance of the same length of wire when straight, i.e., about $1.300d/\sqrt{\lambda}$ times the steady current resistance. This rule may

be employed so long as the diameter of the wire in centimetres is greater than $0.01\sqrt{\lambda}$.

It is possible to obtain stranded conductors for inductances, i.e., conductors made up of a number of fine wires insulated from one another and arranged in a symmetrical manner in the conductor. If such conductors are used, very careful design is necessary both from the electrical and mechanical point of view. The object is to compel the current to distribute itself uniformly over the whole cross-section. This end can be

and with proper design will have a lower ratio of R/L than single layer coils. Below that wave-length the tendency is in favour of single layer coils, becoming more so as the wave-length is decreased. The multiple layer coil is a little more difficult to make unless special winding machines are available, and particular care has to be taken with the insulation of the individual wires, since it may be called upon to withstand the accumulated voltage of a number of turns of the coil.

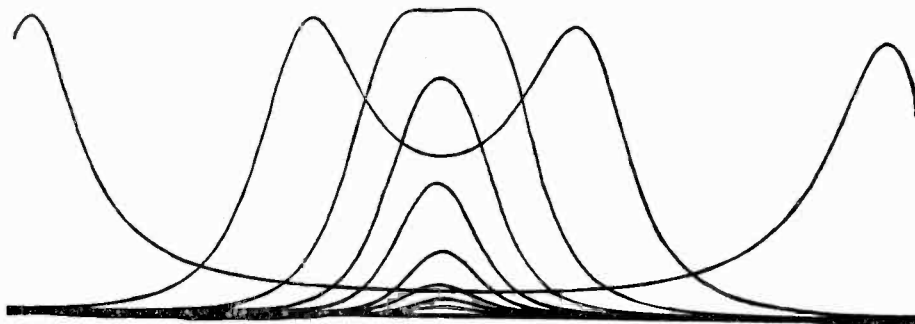

Fig. 2. Resonance curves of secondary current in coupled circuits with varying coupling. Note that increase of coupling beyond critical value does not increase the received power.

attained reasonably easily with wave-lengths of from 600 to 10 000 metres; but with wave-lengths below 300 metres the diameter of the individual strands has to be very small, and it is doubtful whether the additional cost is justified except possibly in large transmitting stations if space happens to be limited and first cost is relatively unimportant. An alternative method of securing a more uniform distribution is to employ a conductor in the form of a thin strip wound into a pancake coil. These coils, however, become rather large, and the losses in the inner turns, where the magnetic field is intense, may be surprisingly large, and in transmitting coils damage to the insulating supports has often resulted. It is a remarkable fact that no numerical investigation of the properties of pancake coils has ever been published, at least as far as I am aware.

The question as to whether single or multiple layer coils give the best results naturally arises at this point, but no definite answer covering all working conditions can be given. For wave-lengths exceeding 300 metres multiple layer coils are more compact,

With regard to the dielectric losses in inductances: these may occur in the insulation of the individual conductors or in the former supporting the coil. The loss in the insulation of the conductors may be avoided by having them air spaced. This, however, is not always practicable, and if it cannot be done, it is necessary either to keep the insulation quite dry or to impregnate it with a non-hygroscopic varnish of good dielectric properties. Good shellac varnish is largely used, but it has the serious disadvantage—with cotton insulation, at any rate—that the solvent always contains water which can never be driven off permanently. In a coil recently tested the dielectric loss between the turns of a single layer amounted to about 0.3 ohm out of a total resistance of about 2.0 ohms. This coil was shellac varnished, baked and then exposed to an atmosphere of 90 per cent. humidity for 30 hours. The resistance was less before varnishing, and with single layer coils which are not actually exposed to water it seems preferable to leave them unvarnished.

The dielectric loss in the former is important in some cases. In a variometer tested by

the writer recently a ratio of R/L of about 800 ohms per millihenry was found. This enormous loss was apparently due to the fact that the two parts of the outer winding were not directly in series, but were separated by the whole of the winding of the moving coil. Consequently the rather narrow strip of insulating material between the two halves of the outer coil was subjected to the whole voltage of the moving coil, and, being a moulded material—certainly not ebonite—the losses there were sufficient to render the variometer practically useless. When included in the circuit for which it was intended, the resistance and reactance were approximately equal! Troubles of this kind can be avoided by designing the former so that no part is exposed to a strong electric field and, of course, using a good ebonite instead of cheaper and perhaps more easily-moulded material.

The unfortunate owner or purchaser of such coils as this, who had not the means of measuring the resistance, would find, when working under normal conditions, that the reactance and the resistance in his circuits were about equal. I do suggest that in that connection there is a function which this Society could very well undertake, and that is to see that no members of your Society—or, for that matter, members of the public—should have instruments of this kind sold to them. Few amateurs have methods of measuring resistance within a moderate degree of accuracy, and it is very unfair to sell them instruments of this kind when, at a very small increase of cost—in fact, I am not sure any increase of cost need be involved—a reasonable coil could be supplied. Therefore, it does seem to me that it should be possible for the Society to organise some means of testing so that any manufacturer who desires can ask for apparatus to be listed and for the Society to give its approval or disapproval.

With regard to (c), the general fact that there must be losses in any conducting body placed in the field of an inductance is well known; there is, however, curiously little numerical information available. For instance, do the heavy brass terminals often fitted to an inductance add appreciably to the resistance? Does screening make any material difference? How far away from steel-work should coils be placed? And so on.

In this connection the following facts taken from measurements which I have made

are of interest. A single layer coil wound on a paxolin cylinder and having an inductance of 11500 microhenries was used, and the tests were made at a frequency of about 68000. The resistance of the coil at this frequency was about 28 ohms. Placing a piece of tinned steel sheet 13 in. \times 7 in. alongside the coil and about 1 in. from it increased the resistance of the coil by 32 per cent. Surrounding the coil by a piece of galvanised iron netting of 1 in. mesh in the form of a rectangle 15 in. \times 24 in. caused an increase of 176 per cent. On the other hand, placing a cylinder of brass 2 in. long and half inch diameter inside the coil half inch from the windings raised the resistance only 2 per cent. A heavy brass terminal outside the coil is thus harmless, but any steel near the coil is to be avoided. In connection with this last conclusion, a case is known to me in which moving the aerial tuning coil in a transmitting circuit up to within a few feet of a steel-framed valve panel led to an expenditure of something like 10 kilowatts in the valve panel itself!

The losses in contacts should be negligible if reasonable care is taken. This is by no means always done, and many switches make bad contact after continued use. This is mainly a mechanical question—the leading principles being freedom for the contact blades to adjust themselves as they become worn, and the absence of unnecessary restraint from the support.

The "dead end" losses occur when only a part of a coil is actually in use. There is a transformer action taking place, in consequence of which there is an electromotive force acting in the coils not in circuit. This leads to dielectric losses between turns, and if the current in the part in use is of very high frequency, there may even be resonance with the natural frequency of the "dead end," with the accompanying heavy conductor and dielectric losses and annoying coupled circuit effects which disturb the tuning. This difficulty is commonly avoided by using a switch which short-circuits all the contacts in turn as the corresponding parts of the inductance are cut out. This is bad design and frequently increases the resistance unnecessarily. There should generally be no short-circuit until at least two-thirds of the inductance is out of use, and then this whole two-thirds should be short-circuited from the free end to the contact, and not from stop to stop.

The High Frequency Resistance of Condenser.

The losses in this case—at least where reasonable designs are adopted—are entirely dielectric losses. Experiments with dielectrics show that what is termed the power factor is constant over a very wide range of frequencies. If C is the capacity in farads of a condenser made up with a dielectric having a power factor ϕ , the interpretation of this fact is that the product fCR is constant and equal to $\phi/2\pi$, where R' is the equivalent resistance in series with the capacity C , which would give rise to the same losses. For ebonite ϕ is about 0.014, and so, if $f=10^6$ ($\lambda=300\text{m}$),

$$R' = \frac{0.014}{2\pi} \cdot \frac{1}{10^6 C} = 2.2 \times 10^{-9} / C.$$

If, for example, $C=0.1$ microfarad, the equivalent resistance would be 0.22 ohm. But at a lower frequency, say 10^3 , and for a smaller capacity, say 300 picofarads, the equivalent series resistance would be nearly 700 ohms. This sounds a large figure, but in circuits where such a condenser would be used at this frequency, it would probably not be serious.

It will be noticed that the equivalent series resistance is directly proportional to the power factor. Hence, if this is found for various materials, it is merely a matter of a simple calculation to determine their behaviour in a condenser. Many measurements have been made with different materials—clear ruby mica is the best material known, and ϕ for good specimens appears to be as low as 0.0003. The impregnated manilla paper used for power cables has a value of ϕ in the neighbourhood of 0.011. Composite insulating materials give values up to 0.1, a figure applicable for paxolin, for example. Values as high as 0.4 have been recorded for paraffined paper.

As far as is known the figure for air is zero. There must, however, be some loss in an air condenser, owing to the fact that the supports for the vanes must be carried on solid insulators. If the whole capacity is C and the capacity of the metallic supports in the dielectric is C_1 , then the equivalent series resistance is $R' = \frac{\phi}{2\pi f} \cdot \frac{C'}{C^2}$.

For example, when $C=1000$ picofarads and C_1 is 3% of this—viz. 30 picofarads, and ebonite is used, for which $\phi=0.014$, $R'=0.017$ ohms (approx.) at a frequency of 10^6 .

The power factor might therefore be ten times as bad without introducing any serious resistance to most circuits. In the case of ebonite there is another effect to be considered, and that is the deterioration of the surface when exposed to bright light. The results are very variable, but cases are known in which the resistance between two terminals mounted near one another in ebonite, has fallen from an unmeasurable value to a value considerably less than one megohm after exposure to air and bright light. Thus with a condenser of 1000 picofarads capacity, if the surface resistance fell to 0.1 megohm, the

effective series resistance would be $\frac{1}{4\pi^2 f^2 C^2 R\phi'}$ where $R\phi'$, the resistance in parallel, is 0.25 ohm at a frequency of one million. This is a more important quantity, and if ebonite is used, the design should be so arranged that there are the fewest possible exposed surfaces between the supports for the two sets of vanes. But, even so, 0.25 ohm is not large compared to other resistances in million cycle circuits, and it may be said that for practical wireless work the dielectric loss in air condensers is not serious. The case is different from that of the inductance, because the amount of the dielectric involved is relatively less.

Resistance in Coupled Circuits.

The effects here are in general the same as in the case of single circuits, viz.: a widening out of the resonance curve. It is well known that with tightly-coupled circuits the resonance curve is a double-humped curve giving peak values for the current for two values of the frequency of the incoming signal. This is obviously a disadvantage, owing to the fact that an undesired signal may hit off one hump when the proper signal is being received on the other. As the coupling is reduced, the two resonant humps approach one another without change of amplitude, until a certain critical value of the coupling is reached. If the coupling is through a mutual inductance M , and if R_1^1 and R_2^1 are the resistances of the primary and secondary circuits, the critical value is when $2\pi fM = \sqrt{R_1^1 R_2^1}$. No value of M above this will increase the strength of the signal being received: it merely increases the probability of interference being experienced. Reduction of M below this value reduces the signal

strength, at the same time narrowing the resonance curve. The critical value giving the best signal is thus dependent on the resistances, since it becomes less and less as the resistances are reduced. Any reduction of M , however, brings the humps closer or narrows the resonance curve, and it follows, therefore, that the lower the resistances the better the selectivity. This is true for continuous wave and modulated continuous wave; but in the case of the single circuit it is not true for spark or atmospheric interference.

Reaction ; Negative Resistance.

Though officially discountenanced, reaction remains one of the most important problems in connection with receiving circuits. It is necessarily present in every

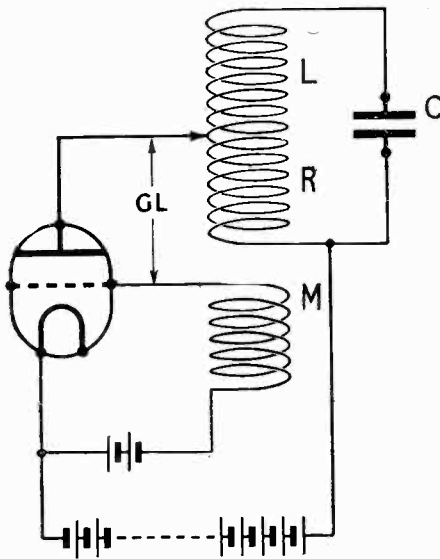

Fig. 3.

form of circuit where valves are employed, and it is now recognised that it is better to provide for it than to leave it uncontrolled and hope that its consequences will not be serious. Reaction arises from any form of coupling—other than through the electron current in the valve—between the circuits connected to the grid and anode respectively. It can be controlled by any form of coupling between the circuits, but the manner of obtaining this control is of great importance. Some arrangements will re-

quire the most careful adjusting and will be unstable and apt to break out into oscillations on the least provocation; others will be easy to adjust and stable when adjusted. A very good example of this is the simple grid-oscillating coupled circuit (Fig. 3). Assuming a negative bias to the grid, so that the grid currents are all negligibly small, then when this circuit is connected up it adds a resistance to the circuit. This is given approximately by:—

$$\text{Added Resistance} = \frac{b^2 L}{R_0 C} - \frac{b g_m M}{C}$$

where L and C are the inductance and capacity of the anode circuit respectively, M is the mutual inductance between grid and anode coils, b is the fraction of the whole voltage across the anode coil applied to the anode from the "anode tap," g_m is the mutual conductance and R_0 is the internal resistance of the valve at the anode.

So long as the second term of this expression is less than the first the damping of the anode circuit is actually increased by the presence of the valve. As the mutual inductance is increased, the second term will also increase and eventually equal the first term. At this point the valve is neutral and neither adds to nor subtracts from the resistance of the circuit. Further increase of M makes the expression negative, and the effective resistance of the anode circuit is reduced. This process can only be continued until $\frac{b g_m M}{C}$ exceeds $\frac{b^2 L}{R_0 C}$ by an amount equal to the resistance of the anode circuit. Beyond this point oscillations set in. For an easy and convenient adjustment, the second stage—i.e., the increase of M from the value at which the resistance is unaffected to that at which oscillations break out—should be comparable with or even equal to the value of M necessary at the beginning of this stage.

If M_1 is the mutual inductance when the valve is neutral, then

$$\frac{b g_m M_1}{C} = \frac{b^2 L}{C R_0}$$

If M_2 is the extra mutual inductance necessary to set up oscillations, $\frac{b g_m M_2}{C}$ must equal R_1 , the resistance of the anode circuit.

If M_2 is to be, say, equal to M_1 , so that the adjustment is not critical, it is necessary

that $\frac{b^2 L}{C R_0}$ should equal R_1 .

Typical numbers are: $L=1000$ microhenries, $C=500$ picofarads, $R_1=2.5$ ohms, $g_m=300 \times 10^{-6}$ amps per volt and $R_0=30000$ ohms. This makes $\frac{L}{R_0 C}=65$, and b must therefore be about 0.19. That is to say the anode tapping point should be only about one-fifth of the way up the inductance. With this tapping, the valve is neutral when $M=21$ microhenries (approx.) and oscillations will not set in until it has been increased to about 42 microhenries. There is thus a 100 per cent. variation available for adjustment. If the anode tap is not employed, the value of M which renders the valve neutral is 110 microhenries, and an increase of only 2.5 microhenries (i.e., only a little over 2 per cent.) leads to oscillation.

Such an arrangement is obviously an unmanageable one and should be avoided. The physical interpretation of these results is that the valve resistance must be regarded as being parallel with any circuit connected to the anode. This valve resistance in itself adds to the total effective resistance of a tuned anode circuit an amount $\frac{4\pi^2 f^2 L^2}{R_0}$

(approx.). If this is large compared to R_1 , the total mutual inductance required will also be large, and only a small adjustment will be necessary to deal with the small amount R_1 . But by introducing the anode tap, the added resistance of the valve becomes $b^2 \frac{4\pi^2 f^2 L^2}{R_0}$, and it is easy to reduce

this to a value equal to R_1 , as indicated in the numerical case taken just previously, so making the adjustment far less critical.

This conclusion necessarily applies to any valve circuit having a tuned anode impedance and employing reaction. The lower the resistance of the anode circuit the lower the tapping point should be. Where tuning is used in both grid and anode circuits, a further effect—the coupling due to the electrode capacities in the valve—has an influence on the mutual inductance necessary for oscillations; but the advantages of using the anode tap still remain, since it reduces both the resistance added to the anode circuit and the capacity coupling effect.

The reactive detector, in which there is only an inductance in the anode circuit, is a rather different but yet more important case. As far as considerations of easy control of reaction are concerned, there is no need for any tapping point on the inductance. If grid bias is used, with rectification on the anode slope, the added resistance is approximately $-g_m \frac{M}{C}$ ohms, and

so oscillations will set in when this is equal to the resistance of the circuit, i.e., when $M = \frac{R_1 C}{g_m}$. Provided that the value of the

mutual inductance actually used is only a little in excess of this, the control is not at all critical. It is advisable to obtain the necessary mutual? with the smallest convenient inductance in the anode circuit. That is to say, a few turns closely coupled are generally better than many turns loosely coupled.

Damped Electromotive Forces: Shock Effects.

Atmospheric interference and spark signals are alike in that they consist of intermittent groups of heavily-damped oscillations. If the resonance curve is taken with an electromotive force of this kind, it is found to be much wider than with a continuous wave. The circuit behaves in this respect as though its resistance had been very greatly increased. The value of the added resistance which would open out the resonance curve in this way can be calculated, and when found, can be added to the resistance of the circuit. This introduces an entirely new idea of resistance—a property given to the circuit because the applied electromotive force is a heavily damped one. It is no longer a constant of the circuit varying with every change of the damping and with the initial building up of the source of electromotive force, and it is a debatable question whether it is justifiable to use the term "resistance" for this effect.

What actually happens in the circuit is that the current for any tuning of the circuit is made up of a small component, which is a replica of the applied electromotive force, together with another component consisting of an oscillation having the natural frequency and the natural damping of the circuit. If reaction is used, it causes the natural oscillation to last for very much longer, but the part which is a replica of the

applied electromotive force is, in general, almost unaffected. The strength of spark signals may therefore be largely increased by using reaction, but there is no appreciable gain in selectivity. This phantom resis-

tance arising from the damping of the incoming waves can scarcely therefore be regarded as being in any way similar to the other effects in the circuits usually denoted by the term.

The Discussion.

Admiral SIR HENRY JACKSON: I think the Society is very much indebted to Professor Fortescue for his extremely interesting lecture, and the very satisfactory experiments and demonstrations he has given us as to the effects of resistance in circuits. Speaking generally, a great many of us do not think half as much about the resistance in our receiving circuits as we ought to do. After this lecture, I think it will come home to us as a very important point in getting selectivity and strength of signal. There is no doubt that everybody knows what resistance is, but I do not think they grasp the very great importance of it in the design of our receiving gear, and the points that Professor Fortescue has brought out are very useful indeed to us, not only in resistance, but the effects of the material in the condenser and other apparatus. Professor Fortescue also referred to a piece of bad apparatus which he had bought, but does not tell us the reason for this very high resistance, whether it was a matter of design or whether it was a matter of the material, perhaps too much varnish, or something of that sort. We should rather like to know the reason, as most of us, of course, use variometers, and we should like to be able to look at our own to see if they have that particular point in them. I think the Society might very well take up the point of trying to help in regard to the material which is bought. It is rather difficult thing for the Society to do—it means treading on other people's toes—but I think the idea is certainly well worthy of consideration. I should like to congratulate Professor Fortescue on his lecture, and to thank him very much for it.

Mr. C. F. PHILLIPS: I should like to add my thanks to those of Sir Henry Jackson for this lecture, because many of us have had the task of plotting resonance curves, but not of having seen them done for us with a little spot of light. Plotting a resonance curve in the usual manner on squared paper is perfectly easy, but it does take a tremendous lot of time, especially if a number of curves are required. Dealing with the question of resistance in radio circuits, Professor Fortescue's trend in this lecture has undoubtedly been to point out the deleterious effects of resistance. From the point of view of the members of this Society, who are interested in experimental work, and from the point of view of the Services, who are interested in highly selective methods of reception, the elimination of unnecessary resistance from radio circuits is extraordinarily important, as Professor Fortescue has shown. But I should like you to think what happens if one has the misfortune, for one's sins, to spend one's life designing circuits for the reception of telephony. It is a totally different problem, and it is extraordinarily difficult to get really good telephony and selectivity in the same instrument. There is no need for me to elaborate, because

Professor Fortescue pointed out that, in the case of a coil designed for a 300-metre wave-length, if the resistance per millihenry were of the order of 3 ohms, the amplitude, when 1 000 cycles off the carrier-wave frequency, was 1/10th the amplitude of the carrier-wave frequency. It is generally accepted that, for musical reproduction, it is necessary to have even amplitude for a minimum of 4 or 5 kilocycles each side of the carrier frequency. If one designed one's circuits with these 3-ohm coils, I ask you to imagine what would be the effect on the ear of music so delivered. The amplification of all the higher notes would be extremely small, and the amplification of the low notes would be such that they would be extremely loud. The question crops up in a most marked fashion in the design of those new and fashionable sets, and superheterodyne receivers. We all know what marvellous results they give in the way of amplification, if we try them on short-wave telegraphy, but those who have had the opportunity of trying them on telephony will have discovered that we cannot associate the degree of amplification possible with those circuits with any degree of purity of reception. If you consider for a moment the operation of the supersonic receiver, treating it as comprised of two distinct units—one a tuner-frequency changer and the other an amplifier specially designed to amplify on one frequency. Imagine that that amplifier is so designed that the chosen frequency is 30 kilocycles. Unless, in your transformers—presuming it to be transformer coupled—you provide for it to amplify evenly over a frequency band of 25-35 kilocycles, you must suffer the most extraordinary distortion on the reception of telephony. In order to enable the transformers to amplify evenly for a frequency band of 25-35 kilocycles, it is necessary to introduce into them a large amount of resistance. I point that out because it is not generally appreciated that supersonic receivers do not offer great advantages for broadcast reception, that the mere fact that they are capable of enormous amplification is another way of saying that they are designed to act on almost a single frequency, and the fact that they are so designed precludes their amplifying modulated telephony with any reasonable degree of even amplitude. With regard to the resistance inherent to inductance coils, we found, quite a long time ago, that we dared not use shellac varnish, probably for the reason that Professor Fortescue suggests, namely, the moisture content of the solvent. I should like to ask Professor Fortescue whether he does not think that, for coils designed not to carry power, the use of a really good wax impregnation is not in every way more desirable. Provided that you dry your coils properly first, you do at least coat them with a film which prevents moisture from re-

penetrating, and the power factor of most of the paraffin waxes is quite low. With regard to the resistance inherent to condensers, I have had the opportunity of measuring quite large numbers of condensers, and I am very glad to see that at last I have one supporter, and a very important supporter, who points out that the leakage resistance, if one may call it so, across insulating material is of very minor importance indeed. Finally, I should like to say how much I appreciate the extraordinarily clear exposition which has been given of things which, although well known to us, we do not appreciate from day to day as we should. It is a proper appreciation of elementary first principles that is so intensely important in design.

Mr. G. G. BLAKE: I am sure that Professor Fortescue's lecture has given us much food for thought. There is one thing that appealed to me very much (of course, one can obtain the same information, as Mr. Phillips has said, from resonance curves) I refer to the extraordinary increase in sensitivity that one can obtain by the use of reaction, and, therefore, the absolute necessity, if one wants to receive long-range wireless, of the use of reaction. There is one question I should like to ask Professor Fortescue, and that is with regard to ebonite changing under the influence of light. At the present moment I am carrying out experiments with selenium cells, and it would be rather interesting to know if any research work has been done to find which wave-lengths of light are answerable for these resistance changes in ebonite, and whether these changes take place primarily in the ultra-violet part of the spectrum. I should be very glad if Professor Fortescue could give some information on that point.

Mr. S. WARD: I am afraid that I cannot add very much to what has been said, owing to the fact that I have not carried out any very great amount of experimental work with high frequency resistance, but I must say that I appreciate very much the striking way in which Professor Fortescue has brought out the importance of this subject, and the splendid demonstrations he has given. I always feel that, to most people, a demonstration such as we have seen to-night does bring a thing of this nature home much more than it could be brought home by merely talking about it. If you see the actual effect of the various changes which have been made in a circuit, it can be appreciated very much better. The importance of reducing the coupling and increasing selectivity is very great, but, as Mr. Phillips has pointed out, the gain due to that is not always an advantage when you are receiving telephony. I am glad he has raised that point, because he is able to point

it out so much better than I am myself, owing to the fact that his research work has brought him into contact with that sort of thing much more closely than has mine.

Mr. J. H. REEVES: The middle one of the curves on the upper figure is of very great interest to me. As Mr. Phillips has pointed out, if we press things to extremes, we really want two sets of coils for any one wave-length. One has to be the coil which is to receive the single wave at the maximum amplitude, and the other the one which has to have the flat top to its resonance curve, and, of course, until amateurs recognise the importance of these two, the manufacturers who have to provide us with an all-round coil are precluded from giving us the ideal in every direction. Therefore, I think Professor Fortescue's remark, in bringing this home to the amateur, will enable us to encourage the manufacturers to produce an ideal coil for telephony and an ideal coil for C.W. reception. May their profits rise correspondingly. With regard to the flat hump in the curve, Professor Fortescue has pointed out that that is due to resistance in the circuit. It is a very funny thing, but some while ago, as you know, I found out that the use of rather finer wire in coils did give that flat hump, or rather, it gave me better definition. The point upon which I ask Professor Fortescue if he can throw light is as follows: Judging solely by improved definition of telephony, for I had no other measuring device available, I got that flat peak, but Professor Fortescue's lower curves show that reaction increases the sharpness of the peak. My experience was that with these fine wire coils the improvement in definition was maintained when reaction was pushed almost to the point of oscillation. I wonder if there is any explanation to that undoubted observation!

Mr. P. R. COURSEY: The importance of losses occurring in all parts of any radio apparatus has been very much emphasised by Professor Fortescue

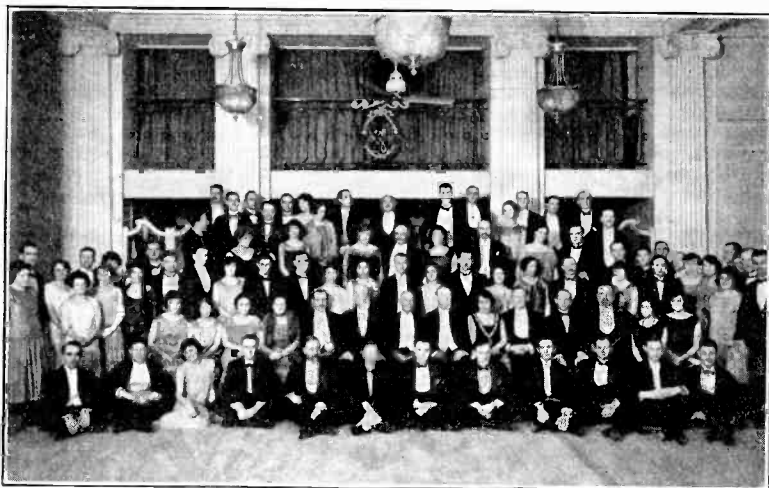

Our photograph shows the company at the recent dinner of the R. S. G. B. Sir Oliver Lodge and Admiral Jackson may be seen in the centre.

in the curves which he has shown. He has told us how to measure some of those losses, and has also indicated that, as a general rule, the losses in the condenser part of the circuit are reasonably small and could be neglected. That is certainly true, but when one really wants to measure those more or less negligible losses, and one wants to find out something about them, the difficulties of measurement are very much increased. I do not know whether he can suggest any really satisfactory way of doing it, but so far the only real way we have found is the good old thermal method. Unfortunately, that introduces great difficulties when the condenser is a small one intended purely for use in the receiving circuit, and is only practicable when the condenser is of sufficient size to justify its use under large currents and voltages. Then, however, although the thermal method becomes practicable, it is very clumsy. The power factor which Professor Fortescue mentioned for ruby mica is, unfortunately, one which is very liable to variation. Ruby mica, although a more or less definite material, is a very variable one, and power factors varying very widely on either side of the figure he has given, and often very much in excess of it, are only too easy to get. The figure of .0003 is a fairly good average, and the lowest I have had any definite measurement of is about .00017. The figure of .0002 to .00025 is one very easily reached under commercial manufacturing conditions, particularly when the condenser is a large one, designed to carry a good many thousand K.V.A. In the smaller sizes, however, the figure is often somewhat larger than that. Of course, the power factor of air is not zero when the currents are large, because, even before the visible corona appears, there seems to be some loss occurring in air. Where the voltage is sufficiently low for no corona to be visible, it is yet possible to measure power factors considerably in excess of .0003 and .00025, and that is due to the air and not to the insulated supports for the plates. The point has been mentioned about the increase of power factor due to leakage, and it is certainly a good one. It has been emphasised by Mr. Phillips, but in spite of those figures, which are quite true in the general case, it is possible to obtain ebonite which will give resistance losses considerably in excess of $\frac{1}{4}$ ohm at one million cycles simply due to leakage. A mere touch of a moist hand on its surface is quite sufficient to bring the losses, in some cases, up to very big figures, 20 or 30 times the figures which Professor Fortescue has mentioned. It is apparently some property of the material, and what precisely the nature of the surface is which causes that loss I do not think is very clear. That is merely another of the points which require investigation. The paper has shown us that there are a lot of points which require further investigation if we want to arrive at a real understanding where all the losses are in our radio apparatus. I am sure we all thank Professor Fortescue for bringing the matter so fully to our notice.

Mr. F. L. Hogg: I should like to add my thanks for the most interesting lecture I have heard for a long time. I should like to ask one practical question: Can Professor Fortescue give us any idea of the results of conducting experiments on these lines? On the short-wave receiver

now generally in use, it is the usual thing to use an untuned, or rather the miscalled untuned, or fixed tuned aerial circuit and a tuned secondary tightly coupled with reaction on the tuned secondary, the reaction being assumed in each case to be just on the point of oscillation, the fixed tune of the aerial circuit being somewhere above the maximum range of the secondary with full capacity across it. I should be very interested to know what sort of a resonance curve one would get for an input of varying frequency for the resonance settings of the secondary, *i.e.*, how much grid voltage one gets from a certain definite amount arriving at the aerial on any wave-length on each of the settings of the secondary condenser, because when this system of fixed tuning was first proposed it suddenly occurred to me that it is the wrong idea, because when you mistune the loose coupler you would be bound to get a ghastly signal strength. I have since come to the conclusion, however, that one loses an infinitesimal amount of signal strength and also a very large proportion of atmospherics and other interference. It is a fairly simple matter to tune in your primary when working on these short wave-lengths. It has been my experience—that in 99 cases out of 100 one gets a little worse condition when tuning the primary than with a fixed tuned primary because the signal static strength is so altered. I should be glad to have Professor Fortescue's opinion as to what the result of such an experiment would be. There is one other point, and that is with regard to taking radiation resistance curves of an aerial. Professor Fortescue has not mentioned this subject, but there is one point I should like to ask him. Suppose you take the radiation resistance of an aerial by the substitution method can he give us any idea of the error in the usual method of neglecting the inductance and increasing the capacity of the condenser to get a dummy circuit in resonance with the drive? What I am anxious to know is the order of the percentage of error by neglecting the inductance. Finally, I should like to ask Professor Fortescue if he can settle a little argument that has gone on in a certain society for a long time past with regard to such curves as he has shown us to-night. He reduced the incoming signal strength for an increased amount of reaction in each case and showed the curves under each other, but there is one school of thought, so to speak, which insists that if one has a certain fixed signal strength and plots these curves, the curve for maximum reaction will be of greater value at every point than any of the others, *i.e.*, that none of the curves will intersect it at the bottom. The other school of thought holds the reverse opinion, that the curves will intersect. I shall be glad if Professor Fortescue could settle that little argument.

The CHAIRMAN: I should just like to say a few words on a remark of Professor Fortescue in connection with the shellac varnish question. I think it was suggested that the Radio Society should look after, quite broadly, the quality of components that are sold generally, *i.e.*, that they should set up some means for having units tested and, generally, to improve the apparatus used for wireless reception. I may tell you that the Radio Society has been considering this question for a long time and has actually taken action in the

matter. As regards the question of ebonite, it may be news to some of you that the British Engineering Standards Association has now set up a Committee, which has already met once, for the purpose of standardising ebonite for radio purposes, and we hope very shortly that the work of this Committee will bear fruit, and that it will be possible to obtain ebonite that one can be quite certain of. Later on, I hope it will be possible to obtain components of the very best quality and be certain of them. As regards the shellac varnish question, it is interesting, although quite common knowledge, that even the so-called absolute alcohol contains from 3 to 5 per cent. of water which chemists have not been able to dissociate and that there is no such thing as absolute alcohol, because it contains water, but it is beyond me to understand how it is that you find when you have evaporated the alcohol in the varnish, you have not also got rid of the water; that appears to be the case in practice. Speaking again of shellac varnish, this has been replaced, for electrical purposes generally, by oil and other varnishes. The British Electrical Research Association has carried out a large number of researches on various insulating varnishes and probably it has a varnish at hand which will replace shellac and will not have the disadvantage which has been pointed out.

MR. MAURICE CHILD: My duty to-night is the very pleasurable one of proposing that we give to Professor Fortescue a very hearty vote of thanks for his most interesting lecture which has raised such an interesting discussion.

The vote of thanks was carried with acclamation.

Professor FORTESCUE, replying to the discussion, said: The Chairman has told us that the Society is already considering the proposal which I ventured to put forward for testing apparatus sold to amateurs. With regard to getting rid of water in shellac varnish, the situation is that it can be got rid of, but insulating materials are porous materials, and it comes back again afterwards. Mr. Phillips and Mr. Ward both raised a point with regard to telephony, and the figure of 3 ohms per millihenry and the 19—1 which I quoted represent about the best efficiency that can be obtained. There are many cases in which it is not obtained. I quoted one in which there were 800 ohms per millihenry. It is very general experience that there can be an improvement in what Mr. Reeves called the definition of a wireless telephone by reducing high frequency resistance to compensate for the loss by low frequency amplification which is apt to take place in other parts of the circuit. It is well known that in the transformer magnifier, the 250-cycle notes are not amplified to anything like the extent that the 1 000 and 2 000 cycle notes are. The same thing applies to the superheterodyne. Mr. Phillips has raised the question of wax. I have had some experience of wax and that experience has not been very favourable. It is possible to get a very bad

power factor with wax and cotton insulation, apparently if there is any considerable area of cotton and wax in contact. I am not sure what technique Mr. Phillips follows, but my own opinion is that the wax should be a wax of a rather low melting point and that the coil should be dried

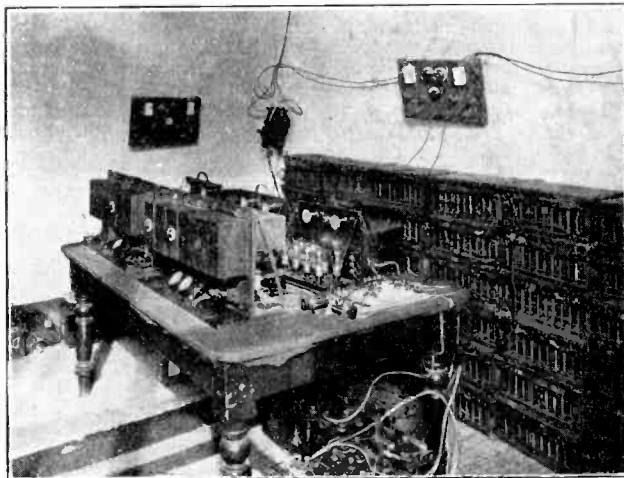

*The apparatus and power supply installed by the Marconi-
phone Company at the Ideal Home Exhibition at Olympia
for relaying the music of the band to all parts of the show.*

out at a temperature at which nearly all the wax will run off, leaving only a trace. Admiral Sir Henry Jackson referred to the variometer I mentioned. I think the loss there was a dielectric loss. It was one of the usual construction in which the circuit consists of one half of the outer coil, then the whole of the inner coil, and then the other half of the outer coil. Consequently, there is the whole voltage of the turns of the inner coil between the turns of the outer coil which are only separated by quite a small distance. I took a pocket knife and could scrape the moulding material away, and my impression is that it is a very inferior black stuff which has no resemblance to ebonite, and I think that was very largely the cause of the loss. I do not think it is a conductor loss at all. Mr. Reeves pointed out that there is no ideal curve and he referred to the coupled circuit resonance curves and suggested that definition might be improved in spite of considerable reaction. I think that is undoubtedly the case. Mr. Coursey made some interesting remarks about ruby mica, and there is no doubt that the power factor of ruby mica is a very variable quantity. Those of us who have had to use very good condensers know the extreme difficulty there is in obtaining really good ruby mica. It is only certain samples which will give a good power factor. I was extremely interested to hear that he has obtained values as low as .000 17 because that must have been a very difficult measurement to make. He also remarked on the corona losses and the losses in air condensers just before the corona. These, of course, are undoubtedly present but I was not contemplating the use of air condensers in a power circuit at near

the point at which corona loss sets in. Mr. Coursey asks about measuring the loss in a condenser but he did not mention the somewhat important point as to the frequency. Is it one thousand cycles or one million cycles?

Mr. COURSEY: At radio-frequency.

Professor FORTESCUE: I think the thermal method is the only way except comparing against the best condensers that one can obtain. If one obtains a number of condensers of different design and different spacing of vanes and with different insulation to prevent surface leakage and so on, and finds that they all agree within a very small amount, then, although it is not a rigid proof it is a reasonable assumption that the losses taking place are not very large. The measurements of the total resistance of circuits do not disagree to any appreciable extent from the calculated values, which shows that there are no large losses in the condensers. The thermal measurement is difficult because the values are very small and the lead-in wires to the chamber may very well give rise to losses which are greater than the losses in the condensers themselves. The leakage that Mr. Coursey mentions would have to be really very bad to introduce such large resistances as he suggests. I am amazed that any cases should have been observable in which the leakage should have been under 100,000 ohms between the plates. I am surprised that it should be so low as that, but when one comes

to making measurements of dielectrics one should not be surprised at anything! The possibilities are unlimited. A speaker raised the question of a tightly coupled aerial on short waves. I think what is happening there is that with a tightly coupled circuit single circuit tuning can be used without loss. The method of determining radiation resistance, spoken of, is entirely a matter of frequency, but on short wave-lengths, where the radiation resistance is a very large proportion of the total resistance in the circuit, the error need not be very great. On longer waves, where the radiation resistance is perhaps only less than one-tenth of the total resistance in the circuit, then I think the method of measuring radiation resistance suggested would be a little difficult and would not be so accurate. The same speaker raises the question whether the resonance curves with reaction would intersect with increase of reaction strength. No, I think not. The important point is not the question of intersecting; it is the relative values of the top values and the values at the side.

I should like to say how much I have appreciated the opportunity of giving this lecture and to thank Mr. Terry for the immense amount of trouble he has taken in getting the apparatus ready: I very much regret that one of his co-workers has unfortunately fallen a victim to influenza and is not here to give a hand with these demonstrations to-night.

The American Radio Relay League.

OWING to the fact that Mr. F. H. Schnell has been called to active duty in the U.S. Navy between April and October 1 of this year, Mr. F. E. Handy of Crono has been appointed acting traffic manager of the American Radio Relay League for the time being. Operator of two amateur stations and formerly assistant manager of the New England Division of the League, Mr. Handy has been very successful in other countries.

The traffic department of the League provides the only means by which messages may be sent to any part of U.S. or Canada, free of charge. The League's membership amounts approximately to twenty thousand amateurs, most of whom have transmitting stations. The efficiency of

the system has been increased by the appointment of official relay stations, whose owners are bound by promise to forward all messages received.

While Mr. Schnell is with the fleet Mr. Handy will conduct short-wave tests with amateurs, and also keep in touch with the A.R.R.L.'s Headquarters by wireless.

Mr. F. H. Schnell has been asked by the U.S. naval authorities to investigate the possibilities of utilising short-wave apparatus for communication between ships and naval stations.

This investigation through a civilian organisation is regarded as an appreciation of the development by amateurs of short-wave stations.

The Balkite Battery Charger.

621 : 354 : 3

MESSRS. BURNDIPT LTD. have submitted to us for test one of the "Balkite" Battery Chargers, for which they are agents in this country. Like many useful things, it hails from America, being manufactured by the Fansteel Products Co., Inc., of Chicago. The charger consists of a tantalum electrolytic rectifier with a small step-down transformer to enable it to be operated from the A.C. lighting mains. The whole is contained in a sheet-iron case with carrying handle, occupying a space of about 6½ in. by 6½ in. by 10 in.

The charger is supplied ready for use; it is only necessary to fill the cell with ordinary accumulator acid (sulphuric acid, Sp. Gr. 1.25), insert the plug-connector in a lighting socket and connect the output wires to the accumulator to be charged, taking care that the red-covered wire goes to the positive terminal and the black one to the negative terminal.

The printed instructions issued with the charger state that two tablespoonfuls of "Nujol" oil should be added to the rectifier cell to cover the acid, which should itself come within half an inch of the top of the cell. The purpose of the oil is presumably to arrest the escape of acid spray, but we have not found oil to be very satisfactory in its behaviour. A good deal of electrolysis takes place in the rectifier during operation, tending to make the oil froth excessively and even to overflow through the vent at the top of the cell. Even paraffin oil was found to froth considerably. It seems advisable, therefore, to use a very thin oil and very little of it, say about two teaspoonfuls or just enough to cover the surface of the acid.

The particular charger we have tested is rated to work off a 210-volt A.C. supply at 50 cycles and to charge a 6-volt accumulator at 2.5 amps. We find, however, that with an input of about 210 volts we scarcely obtain the rated output, and the current delivered to a 6-volt accumulator is only about 2 amps. Nevertheless, the charger does its work effectively and reliably without any noise. Accumulators have been left on charge overnight every night for several weeks, but the rectifier shows no signs of deterioration or change of any kind. It is of course necessary occasionally to add a little water to make up for the loss by electrolysis, as in the case of accumulators; the original acid should keep indefinitely.

As to constancy and efficiency, the Balkite rectifier is without many of the disadvantages of the old aluminium rectifier. For one thing, the sulphuric acid electrolyte has a very low resistance; and such troubles as creeping, crystallisation, precipitation or other deterioration are practically impossible. The potential drop across the rectifier cell appears to be quite low, and is certainly very much lower than is possible with an aluminium rectifier. Another important advantage of the low resistance electrolyte is the reduction of heating up during use. After an overnight run at 2-3 amps it becomes slightly warm. Warming up does not impair the working of a tantalum

rectifier, in fact it increases the current output somewhat. The power consumption from the mains is about 50 watts. A special replaceable fuse blowing at 4 amps is included in the D.C. output for safety.

With regard to the constructional details of the charger we have not much information, as everything is in a case which is not meant to be opened. The transformer has a centre-tapped secondary, as both halves of the cycle are rectified. There is only one cell, which we conclude contains a central lead electrode and two tantalum electrodes. Since this cell is made of a black opaque substance and has an opaque top sealed on, we have not been able to satisfy ourselves about the



The Balkite Battery Charger.

important question of the area of tantalum used; we imagine, however, that this is quite small.

In view of the simplicity of construction of the charger, the rather low D.C. current output, and the fact that no ammeter is provided, we feel that the price at present asked for the Balkite Battery Charger is rather high. Even the tantalum, which is certainly an expensive metal, is not enough to explain the cost.

With the small reservations indicated above, we consider the Balkite Charger a distinct success. Its ultimate value is of course bound up with the life of the tantalum, but as far as we can ascertain it should last for ever; time alone can decide this question definitely. This charging unit is probably as foolproof and yet effective as anything of its kind which has been put upon the market.

SWEDISH AMATEURS.

It is stated that the amateurs of Sweden are becoming more and more interested in transatlantic work. A cablegram was recently sent by *Radiobladet*, a leading Swedish wireless journal, to the American Radio Relay League, stating that the signals of sixty or more amateur stations in U.S. and Canada had been heard in Sweden by amateurs.

Radio 6NF.

An Amateur Station.

By Alfred D. Gay, F.C.S.

[R612

THIS station is situated at 49, Thornlaw Road, West Norwood, London, S.E.27, and is located fairly high above surrounding country. The aerial (Fig. 1) is practically unshielded north, south, east and west, and consists of two wires 85 ft. long, and of an average height of 50 ft.

The earth connection goes to two buried plates beneath the aerial and the main water pipes. On 200 metres a tuned counterpoise is used in conjunction with this system. The counterpoise consists of five wires, 75 ft. long and 10 ft. high, arranged fanwise underneath the aerial. On the 115 to 130 metre band the counterpoise is used alone with about two turns in the A.T.I. The

turns are used in the aerial, with a series condenser, and the rest of the coil, which consists of nineteen turns, is used as anode tap. The grid coil is wound with nineteen turns of 20 gauge D.C.C. wire.

The circuit now in use is the 1 DH, and gives by far the best results. (See Fig. 2.) Rectified A.C. is fed to the plate of a Mullard 0/40 at a pressure of 600 volts through a smoothing system, as shown in Fig. 3, four oil-immersed condensers being used across the output of the rectifiers, and six mica condensers of a capacity of one microfarad each across the chokes. The oil-filled condensers may be seen in the photograph (Fig. 4) beneath the larger rectifier unit. With a power of ten watts, the aerial current measures 0.9 amp H.W.

Full wave rectification is used, with eighteen tubes for each half-cycle. Each tube is 6 in. \times 1 in. with aluminium electrodes 4 in. \times $\frac{1}{2}$ in.; the lead electrodes are slightly larger. Sodium phosphate is giving very good results as an electrolyte, each tube being filled with a nearly-saturated solution leaving sufficient room for one inch of paraffin on the top to prevent creeping. This latter point is most important.

As a centre-tapped transformer was not obtainable, two transformers were used with their secondaries in series. These transformers were not designed for the same primary current, so their primaries had to be put in parallel with a balancing resistance in one of them. This arrangement can be seen on the wall, to the right of the photograph, Fig. 4.

The primary current for H.T., and filament heating for the power valve, are both derived from the same transformer. The main power to this transformer is controlled by a relay, which can be seen between the two

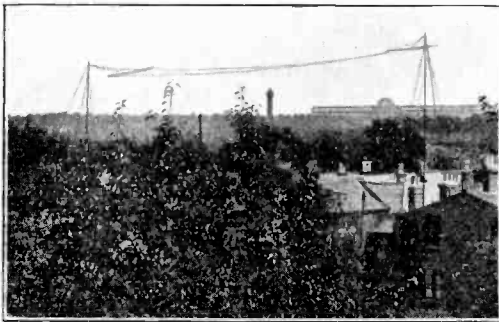

Fig. 1. 6NF's Aerial Equipment.

inductance in use can easily be picked out in the photograph of the transmitter. It is a rewind, ex-naval loose-coupler: incidentally the original wire on this tuner is being used to wind two large honeycomb coils of 400 and 500 turns each.

The plate and aerial coil are wound with 7/22 copper wire, spaced $\frac{1}{8}$ in. apart, on the 9 in. ebonite former. On 200 metres eight

ammeters on the A.C. control board shown in Fig. 5. This relay is actuated when the aerial switch is pulled over from "receive" to "send." For telephony two receiving valves in parallel are used as controls, the

results. Ammonium phosphate tends to become strongly alkaline after a while, allowing large currents to pass with no rectifying action. If this should occur, acidifying with phosphoric acid will make

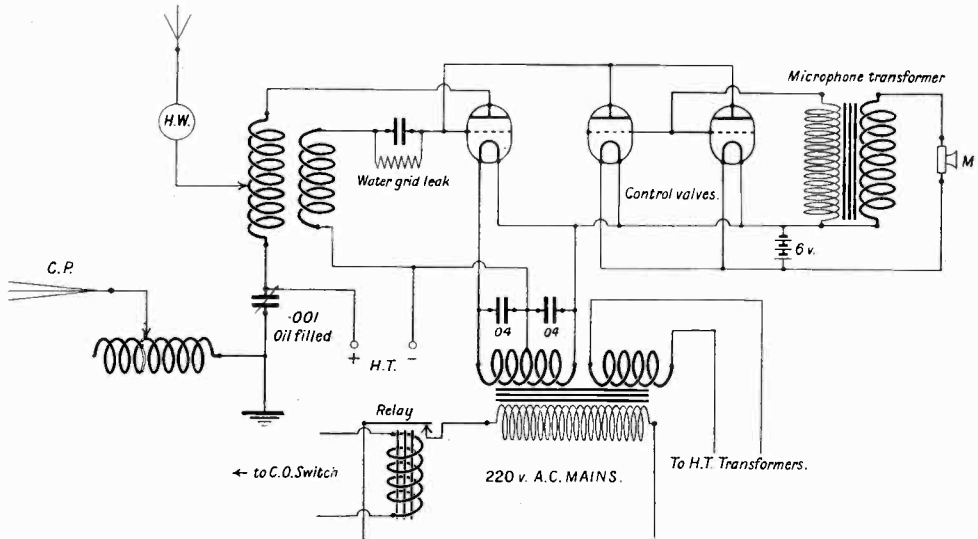

Fig. 2. The circuit in use.

system being the usual grid absorption. The filaments of the control valves is lit by an accumulator, whilst the power valve is lit from A.C., a centre tap winding being used for this purpose, the grid connections going to the centre tap as usual. This gives good results, and DX telephony has been done over 200 miles. The change-over switch can be seen to the left of the photograph with the H.W. ammeter mounted on one edge.

On the A.C. control board can be seen two transformers, one for general purposes, which supplies filament heating and various voltages up to 100 volts for the primaries of the H.T. transformers; and a 200-50 volt house-lighting transformer. This transformer is used for accumulator charging, and the chemical rectifiers can be seen in the right-hand bottom corner of the photograph standing in a bath of water. Various electrolytes have been tried, and sodium and ammonium phosphates give the best

the rectifier work normally once more. Borax does not seem to give very good results, the solution being rather weak. (The solubility of borax is only 41 grams per litre of water.) Sodium bicarbonate causes bad corrosion of the aluminium electrode, owing no doubt to the ease with which the solution disassociates into sodium carbonate and carbon dioxide. Sodium carbonate has a strong solvent action on aluminium.

In the writer's experience, full-wave rectification is much more economical than half-wave, and the circuit used is shown in Fig. 6. The two ammeters are not essential, but they give an interesting check on the working of the rectifier. Normally the A.C. current should not exceed the charging, or D.C.,

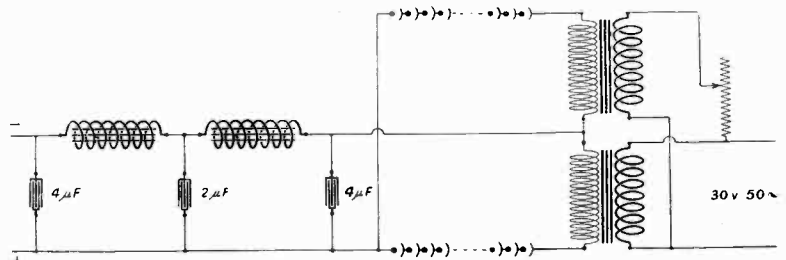

Fig. 3. The plate circuit.

current by more than one amp, which is fair, considering the ill-repute of nodon valves. With four 2 lb. jars, a 10-volt accumulator can be charged at 3-4 amps

loss of power. This fact can better be realised when it is possible to change from one method to another within a fraction of a second. Crystal reception is also provided for, and many interesting results have been obtained on all wave-



Fig. 4. A corner of the operating room. On the right can be seen the rectifying unit and the oil-filled condensers.

without heating up the electrolyte. The resistance controlling the charging rate, which is in the primary of the transformer, can be seen in the centre of the photograph (Fig. 5).

The receiver at 6NF has been specially designed for efficiency and flexibility. Any number of valves, from 1 to 4, can be used and switches are provided for changing circuits with the minimum of time and labour. Coupled circuits are used, and on short waves only one valve is generally employed.

Coils have been made for any wave-length, and can be seen hung above the receiver, which is shown in Fig. 7. The last L.F. valve has a switch to change to either choke or transformer coupling, depending whether the received signals are strong or weak.

Without the slightest doubt, choke amplification gives far better purity, with a very slight

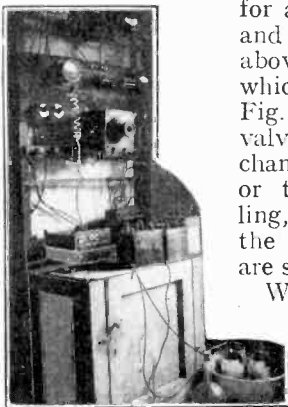

Fig. 5. The control board.

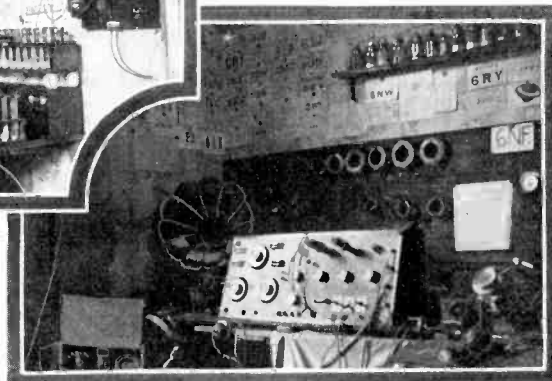

Fig. 7. The receiver. Note the specially wound coils on the wall and the Flewelling portable receiver on the left.

lengths using coupled circuits. Tuning in 2LO's carrier with a Weston galvanometer in circuit has thrown the needle right off the scale, which means that a current of about one milliamp must be flowing.

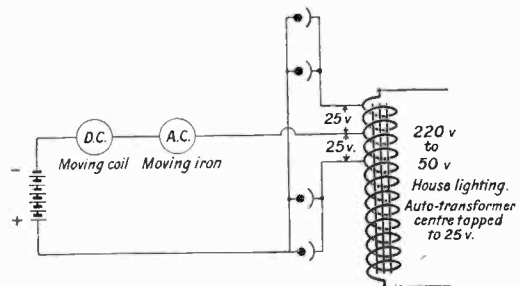

Fig. 6. The full-wave rectification circuit.

It might be thought that with all this switching the efficiency of a receiver would be low, but tests made against another tuner resulted in no detected difference. American amateurs have been heard as early as 11 p.m. G.M.T. In the left hand corner of the photograph can be seen a portable Flewelling receiver, which has given some good DX results without an aerial. It contains its own H.T. and L.T. and with a dull-emitter

valve is entirely self-contained. Stations such as 7EC (Denmark), oAA (Luxemburg) and 5BA (Newcastle), together with numerous French amateurs, have been heard without the use of an aerial.

So far as transmitting range is concerned 6NF has been reported by three stations in

Finland, three in Sweden, once from Gibraltar when using only 4.5 watts, and most other active European countries.

In addition, since this article was written, the station has been operating on 50 watts, and has been heard in eight districts in U.S.A., in India and in other countries.

The "Celestion" Loud Speaker.

[R376.3.009

THE "Celestion" loud-speaker is an interesting instrument of the hornless type, which appears to have one important point of design which differs from anything else on the market. This is that the large diaphragm is entirely free at the edge, being connected to the instrument only at the one central point, where it is fixed to the reed.

From our sketch the general lay-out of the magnetic system will be seen. The reed is of a curious shape, essentially a rectangle, with the centre part milled out. The diaphragm itself is approximately 9 in. across and is conical. It is made of special paper about .001 in. thick, stiffened on one side by a spiral, and on the other by radii, of what is we believe to be finely split bamboo, the rods being about $\frac{1}{2}$ millimetre square. After the diaphragm is complete it is stretched with a varnish which stretches the paper very tightly.

The whole is enclosed within a mahogany cabinet, the movement being attached to the back, while the diaphragm faces a hole in the front more or less filled in with ornamental tracery (as a protection). In action the loud-speaker is exceedingly good, being, in fact, the best hornless instrument that we have had yet. Its efficiency is practically equal to that of our horn type instrument, while its capacity for dealing with heavy loads is very little inferior.

The tone generally has an excellent quality, although the sample we tried is perceptibly lower in natural pitch than our own standard. It is probable that this would be preferred by many.

Our only criticism is one which is common to every hornless loud-speaker which we have yet tested. There is a certain lack of "roundness" or "fullness" in the rendering of full orchestral music. The point is extremely difficult to define accurately, and would not be noticed by anyone

except a very musical person using a first-class set. The "Celestion" is supplied in various woods and costs £6 10s.

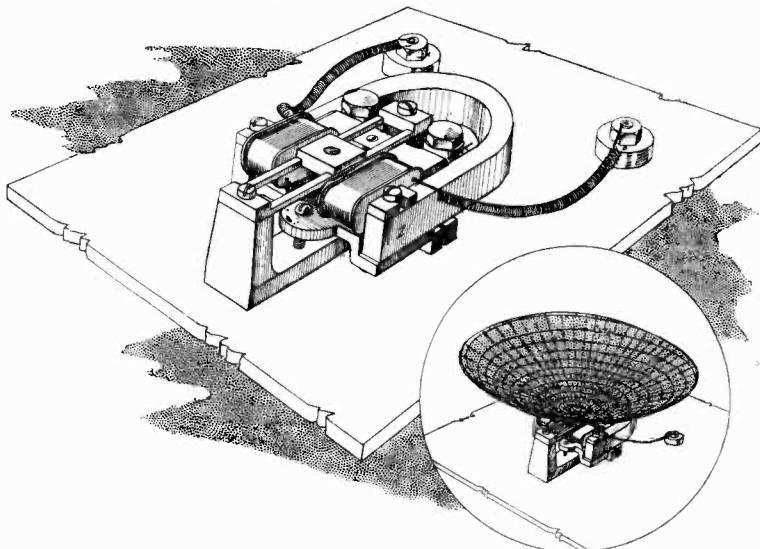

Showing the interior construction of the "Celestion" Loud Speaker. Note the conical diaphragm (inset).

ESPERANTO WIRELESS STATION.

On the completion of the station proposed to be erected for Esperantists on the top of one of the hills of Geneva, nearly the whole population of Europe will be able to listen to exclusively Esperanto programmes. Of the hills in the Geneva district the Salève will probably be selected.

In response to an appeal to the believers in the international language, a sum, approximating very nearly to the amount necessary for the erection of the station, has been forthcoming.

It is probable that the construction of the station will be entirely completed by the early summer of this year. When this is done Germany, Austria, Switzerland, Italy, France and Spain, to say nothing of enthusiastic British amateurs, and the smaller countries, will be enabled to listen to the broadcasting of the important news of the world in Esperanto.

The Effect of Stray Reactions on the Stability and Amplifying Power of Amplifiers.

By O. F. Brown, M.A., B.Sc.

[R342-6

An important article reviewing the causes of instability, with some notes on suggested methods of overcoming it.

THE process of adding additional stages of radio-frequency amplification to an amplifier usually breaks down after three or four stages are added

The latter class of couplings cannot, however, be so removed, since they depend upon the internal design of the valve itself. These small capacities exist between the grid and plate of the valve, and between filament and grid and filament and plate.

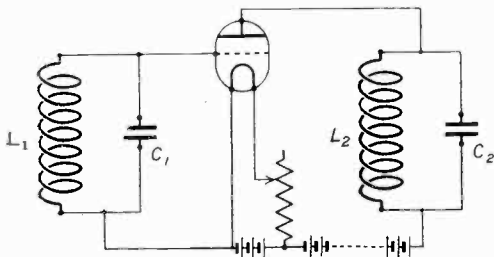

Fig. 1.

Fig. 1 represents diagrammatically the grid and anode circuits of one stage of a radio-frequency amplifier. It is clear that in studying the effect of the undesired capacities the small capacities between the filament and grid and filament and plate can be regarded as included in the capacities of the circuits L_1C_1 , L_2C_2 , since they are in parallel with the condensers C_1 and C_2 , which are usually large compared to the internal capacities of the valve. If, however, untuned coils are used in place of the tuned circuits L_1C_1 , L_2C_2 it must be remembered that the small inter-electrode capacities and the self-capacities of the coils will

through the amplifier becoming unstable and the component valves falling into self-oscillation.

For long waves stable amplifiers can be designed using resistance-capacity coupling or untuned transformers; but instruments of this nature are inefficient for short waves, and it is necessary to employ tuned intervalve circuits. The results obtained with two stages of tuned circuits are usually superior to those from several stages of amplification by valves coupled by resistances or untuned coils.

The explanation of this instability is to be found in the existence of back coupling between the grid and anode circuits of the valves comprising the amplifier.

These reactive effects can be divided into two main classes: (1) Effects due to unintentional stray couplings, both inductive or capacitive; (2) effects due to the small capacities existing between the electrodes and the internal connections of the valves themselves.

Many of the former class of undesired couplings can be removed by careful design and arrangement of the apparatus, or by electrostatic screening, though this latter method may materially reduce amplification.

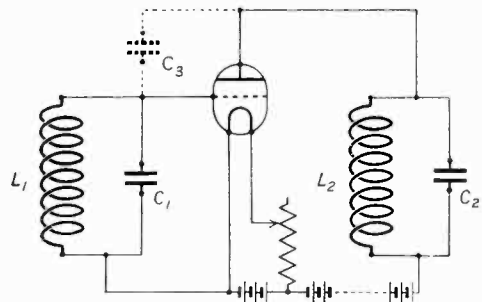

Fig. 2.

form a tuned circuit for some frequency, so that the intervalve couplings cannot be assumed to be untuned for all frequencies.

The chief form in which back coupling takes place between the circuits L_1C_1 and L_2C_2 is thus through the internal plate-grid capacity of the valve, including the connecting leads to the valve holder, which must necessarily be brought close together in connecting the apparatus to the valve.

This capacity is represented by C_3 in Fig 2. In any complete amplifier the disturbance due to reaction depends on the amplification factor of the instrument and the fraction of the amplified potentials which are fed back by the coupling (either electro-magnetic or capacitive) which is present.

Whether the reactions present in the amplifier produce a damping of the oscillations in the input circuit, or cause the valve to become unstable, depends on the

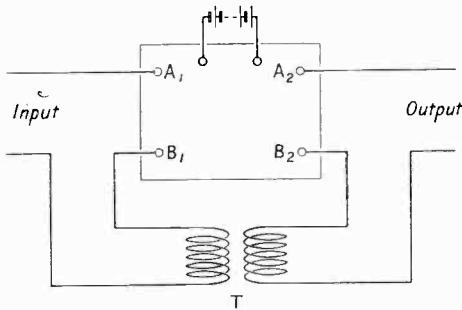

Fig. 3.

phase differences in currents and potentials produced as the disturbances pass through the amplifier.

The general case has been discussed by Professor Gutton* as follows: Let A_1B_1 be the input terminals of a high frequency amplifier, and A_2B_2 the output terminals. Let the current circulating in the input circuit produce between A_1 and B_1 a potential difference whose instantaneous value is given by

$$e_1 = E \sin(\omega t + \phi_1) \quad \dots (1)$$

When no coupling is present between the input and output circuits, a difference of potential will be produced between A_2B_2 , given by

$$e_1' = KE \sin \omega t \quad \dots (2)$$

where K represents the amplification factor of the amplifier and the angle ϕ_1 represents the sum of the changes of phase due to the intervalve circuits. K and ϕ_1 depend, of course, not only on the construction of the amplifier but on the nature of the input and output circuits.

If there is any stray coupling between the input and output circuits, either by a leakage of the magnetic flux in the coils of the amplifier or through capacity in the valves, relation (2) will be modified.

If I/N represents the fraction of the difference of potential at the output end which is brought back by the coupling to the input end, and ϕ_2 is the sum of the phase changes due to the various couplings in the amplifier, then a disturbance is brought back to the grid of the first valve in the form—

$$e_2 = K/N E \sin(\omega t - \phi_2) \quad \dots (3)$$

After amplification this in turn adds a component to the difference of potential

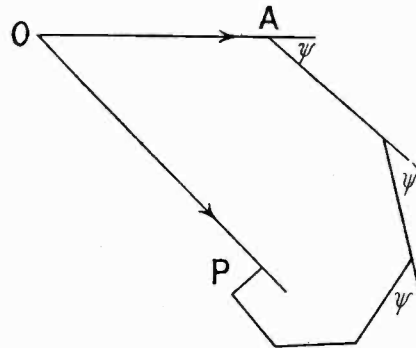

Fig. 4.

at the output end equal to—

$$\begin{aligned} e_2' &= K^2/N E \sin(\omega t + \phi_1 - \phi_2) \\ &= K^2/N E \sin(\omega t - \psi) \quad \dots (4) \end{aligned}$$

where ψ represents the sum of the various changes of phase. In the same way a fraction I/N of e_2' will be brought back to the input end of the amplifier, giving another potential component at the output and equal to

$$e_3' = K^3/N^2 E \sin(\omega t - 2\psi) \quad \dots (5)$$

which in turn gives rise to a new component:

$$e_4' = K^4/N^3 E \sin(\omega t - 3\psi) \quad \dots (6)$$

and so on. These various components of potential must be added geometrically, the results of such addition depending on the values of K/N and ψ .

In the case where $K/N < 1$ and ψ is less than $\pi/2$, the vector diagram showing the relations between the sine functions $e_2', e_2'', e_3',$ etc., is shown in Fig. 4. It is clear that the vector diagram forms a spiral which tends to a limit in the point P , where the vector OP represents the difference of potential at the output terminals of the amplifier. OP is finite and is greater for a given value of N , the smaller the angle ψ . Thus if K/N is near unity and ψ is small, a con-

* *L'Onde Electrique*, vol. 1, p. 261, 1922.

siderable increase in amplification is produced by the reactive coupling.

When $K/N < 1$ and ψ is greater than $\pi/2$, the vector diagram takes the form shown in Fig. 5. In this case OP is still finite, but the amplification is less than that obtained without reaction.

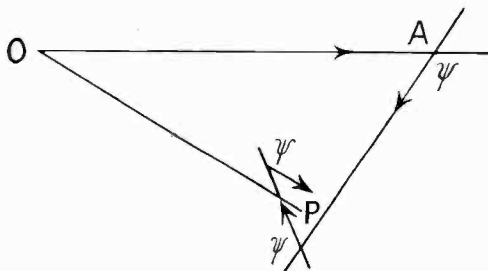

Fig. 5.

It may be pointed out that when the coupling is electromagnetic, it frequently may be possible to pass from the case where ψ is greater than $\pi/2$ to that where it is less by reversing the connections of coils used in the amplifier.

When $K/N > 1$ and $\psi < \pi/2$, the geometrical progression composed of the terms $e_1', e_2', e_3',$ etc., becomes divergent and there is no finite resultant (see Fig. 6); the amplification is increased indefinitely and the amplifier becomes unstable in its action.

The resultant increases more quickly the smaller the angle ψ . This angle depends on the frequency of the oscillations and on the coils and condensers in the amplifier. There is therefore one frequency for which it is zero, or a minimum: i.e., a frequency at which the retardations of phase are exactly compensated by advances of phase.

Oscillations therefore tend to be established at this particular frequency, which will be independent of the frequency applied to the input circuit. A very small accidental disturbance may indeed amplify itself and so give rise to oscillations of increasing magnitude.

The value of the coupling I/N which will produce instability is smaller the greater the value of the amplification factor; thus with a powerful amplifier a very small back coupling is sufficient to produce oscillations. For a given value of K , and with $\psi < \pi/2$ it has been seen that an increase of coupling leads first to an increase of

amplification (see Fig. 4) and then the production of self-oscillation (see Fig. 6).

In the case when $K/N < 1$ and $\psi > \pi/2$, the vectors $e_1', e_2', e_3',$ etc., have no finite resultant (see Fig. 7) and the amplifier is again unstable. It has been seen that a weak coupling when $\psi < \pi/2$ produces a diminution of amplification, and thus, when the coupling is increased, the amplifier may fall into oscillation without a preceding increase of amplification.

The mathematical analysis of the circuits of a multi-valve amplifier (with a view to the investigation of the changes of phase imposed on an oscillation passing through the amplifier) is difficult. The equations obtained are very cumbersome, and it is practically impossible to draw any general conclusions from them.

The most complete attempt at a solution would appear to be that made by Professor Fortescue.* The mathematical analysis of reaction of the output and input circuits of a single valve due to the internal capacities of the valve has been carried out, however, by many other workers including, in particular, Miller.† As may be expected, the results obtained, allowing for slightly different assumptions made in the analysis, are identical.

The input impedance of a valve due to the load in the plate circuits can be shown to consist of a real and an imaginary component representing an effective resistance and an effective capacity. The resistance component may be either positive or negative. In the former case the output circuit throws an additional load on the grid circuit; in the latter case the load on the grid is decreased, so that there is a tendency to oscillation. Whether the effective resistance is negative or positive depends on the nature of the load in the plate circuit. Miller shows that the effective resistance is positive: i.e., that the input circuit absorbs power from the plate circuit and there is no tendency to regeneration:

- (1) When the load in the plate circuit is a pure resistance;
- (2) When the circuit L_2C_2 is tuned to resonance with the incoming frequency (say ω)—for in this case the plate circuit

* "The Design of Multiple-Stage Amplifiers."—*Jour. of I.E.E.*, 58—65, 1920.

† Bureau of Standards Scientific Paper, No. 351.

L_2C_2 is equivalent to a large ohmic resistance ;

(3) When the frequency of the incoming oscillations is above the natural frequency of the plate circuit L_2C_2 . In this case the circuit has a capacitive reactance.

The effective resistance is negative, and there will be a tendency to regeneration when the reactance of the plate circuit is inductive, i.e., when the working frequency is below the natural frequency of the circuit L_2C_2 . In this case it can be shown that the tendency to regeneration is decreased when the self-induction of the coil L_2 is decreased, or the condenser C_1 in the grid circuit is increased, or, of course, if the capacity between the grid and plate is decreased.

Analysis thus shows that the phenomenon of reaction between the circuits is indefinite, since all the impedances involved depend in amplitude and phase upon the frequency of the incoming oscillations. The reactance of the tuned circuit L_2C_2 is inductive for frequencies below resonance frequency and capacitive for frequencies above. If self-excitation is not to occur, the condition of resonance for the circuit L_2C_2 must be chosen so low that oscillations which can arise and whose frequencies will be essentially determined by the resonant condition of the grid circuit reactance possess a higher frequency than that to which L_2C_2 is tuned.

In the case where the plate and grid circuits are tuned to exact resonance with each other it would appear that regeneration cannot take place when the circuits are actually in the resonant condition, since each circuit is equivalent to an ohmic resistance. But any attempt at tuning the circuits or any change in the coupling may put the circuits in a very favourable position for causing self-excitation.

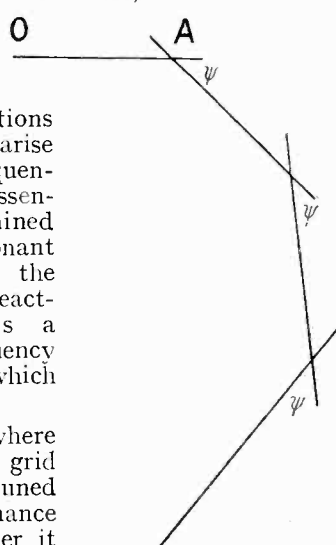

Fig. 6.

It is therefore necessary to consider the experimental methods which have been employed either to cure or to prevent self-excitation in an amplifier possessing tuned grid and anode circuits.

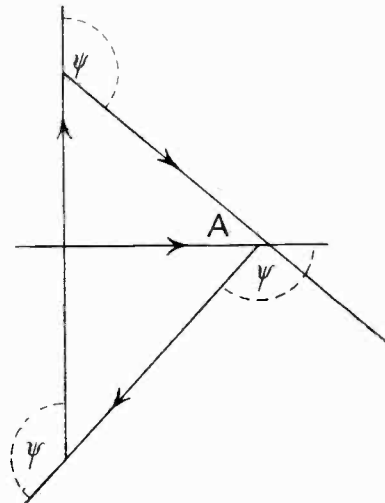

Fig. 7.

One class of methods used are those in which an additional damping in some form or other is introduced into the circuits which are likely to produce self-oscillation. Any method of this nature must involve loss of energy and inefficient amplification, and indeed some methods which have been employed to prevent oscillation aim directly at reducing the amplification, as for example decreasing the filament current or high tension voltage.

Among methods whereby an additional damping is introduced may be mentioned,

(1) Increase of grid potential, which involves increasing grid current and the introduction as it were of a finite resistance across the grid circuit.

(2) The introduction of a resistance into the circuits, or winding the intervalve transformers with resistance wire.

The underlying difficulty of any attempts of this nature appears to lie in the fact that a valve may, as shown by Gutton, generate oscillations although its amplification factor is small. Such methods as the above only appear to produce inferior circuits as regards selectivity and amplification, without in any way materially reducing the risk of self-excitation.

Another method by which an additional

damping factor may be applied to the grid circuit is by suitable arrangement of the

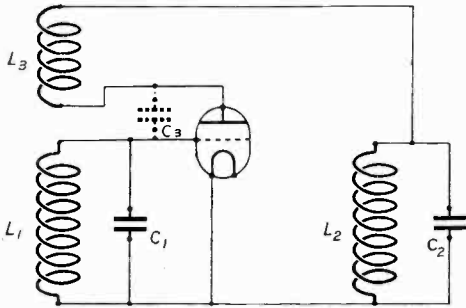

Fig. 8.

aerial circuit. The larger the aerial the less tendency there is towards oscillation. In the case of a tuned grid circuit coupled to the aerial, the tendency to oscillation is less the tighter the coupling, since the aerial circuit absorbs more energy. If the coupling is reduced or the aerial circuit is detuned, there is a greater tendency towards oscillation since the damping by the aerial circuit is decreased.

Another method by which the tendency to oscillation can be materially reduced is by increasing the value of the condenser and correspondingly decreasing the value of the self-induction of the coil in the tuned grid circuit.

As regards the reduction of undesired inductive couplings between the circuits, the following methods have been suggested:—

- (1) The enclosure of the coils of the circuits by metal box screens.
- (2) Winding the coils as practically closed rings.
- (3) Winding the coils on cylinders which are staggered in respect of each other, as suggested by Haseltine in his neutrodyne receiver.

In considering the methods which have been proposed for the prevention of oscillation, it may be stated that very little actual experimental data concerning the results are available. The object of the arrangements used is the balancing of the current through the stray and intervalve

grid-plate capacity represented by C_3 . Most of the arrangements suggested come from American sources. Usually they are described as applied to two or three valves, and several do not appear practical as far as applied to a complete multi-valve amplifier.

No evidence is available regarding the loss in amplification produced by them, but it is obvious that in many arrangements the loss must be considerable.

The simplest method is that shown in Fig. 8, in which reversed inductive reaction coupling is employed. In this arrangement the attempt is made to compensate for the capacity coupling through C_3 by the inductive coupling by the coil L_3 . In this method compensation therefore varies rapidly with the wave-length.

The arrangement of Fig. 9 is one of many variations of the neutrodyne circuit described by Haseltine, in which the compensation is carried out by means of the coil L_c and condenser C_c . The coil is so arranged that the potential across it is opposite in phase to the potential in L_2 . In practice the relative phases however in L_c and L_2

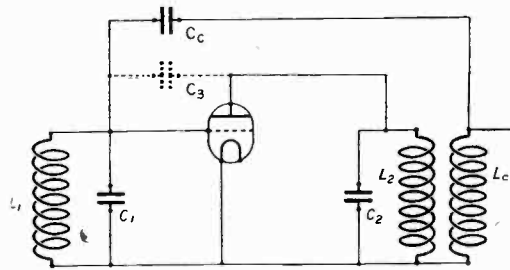

Fig. 9.

depend on the frequency, since it is impossible to make the inductive coupling between the coils sufficiently close to avoid leakage effects and at the same time avoid intercapacity coupling between the coils.

Another method of employing neutrodyne coupling is that of Fig. 10, in which the

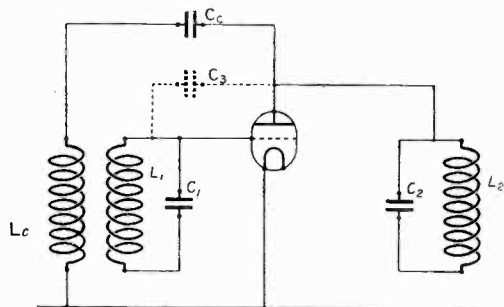

Fig. 10.

compensating coil is coupled closely to the grid circuit. This arrangement has the advantage of allowing any desired inter-valve coupling arrangement to be used in the plate circuit. The adjustment of C_c is critical, and the balance of the reaction effect of C_3 is obtained when

$$\frac{C_c}{C_3} = \frac{L_1}{M} = \sqrt{\frac{L_1}{L_c}} = \frac{N_1}{N_c} \quad \dots (7)$$

where M is the mutual induction between L_1 and L_c which is assumed to equal $\sqrt{L_1 L_c}$, and N_1 and N_c are the numbers of turns respectively in coils L_1 and L_c . It has been stated that with this arrangement a balancing effect can be obtained over a wide range of wave-lengths on the same adjustment.

In applying the neutrodyne arrangement to actual amplifiers, Professor Haseltine makes the balancing coil part of a specially

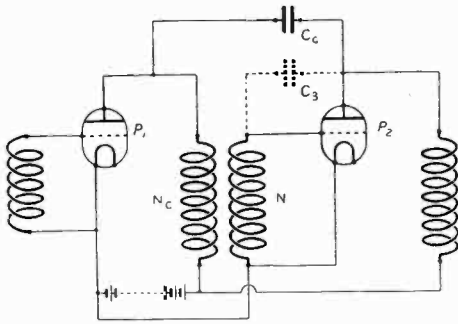

Fig. 11.

wound high frequency transformer as shown in Fig. 11. In an instrument he describes, these special transformers had 13 turns of No. 22 D.S.C. wire as primary winding wound on cylinders 2 3/4 in. in diameter, and a secondary winding of 55 turns of the same wire wound on cylinders 3 in. in diameter. The neutralising condensers had a maximum

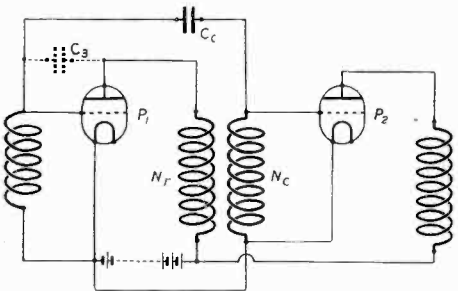

Fig. 12.

capacity of $1.5 \mu\mu\text{F}$. Professor Haseltine claims a radio-frequency amplification of about 11 per stage.

In Fig. 13 the disturbance it is desired to neutralise is assumed to be at P_2 in the plate

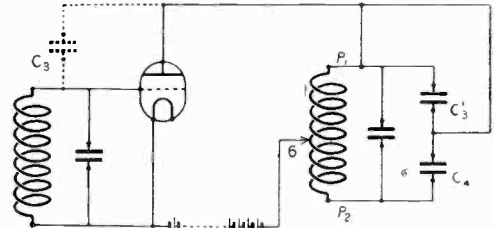

Fig 13.

circuit of the second valve, and the compensating condenser C_c is connected between the plates of the valves. In Fig. 12 it is assumed that the point at which the disturbance is to be neutralised is P_1 . In

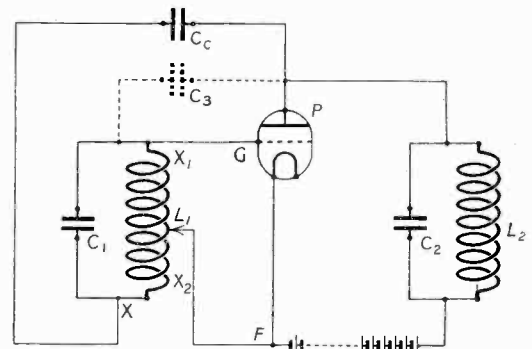

Fig. 14a.

this case the transformer formed by the coils $N_1 N_c$ has a step-down action, and the compensating condenser C_c is connected between the grids of the valves.

Another variation of the neutrodyne method consists in connecting the high tension battery to an intermediate point on the plate coil L_2 , as shown in Fig. 13. In this arrangement the potential of the end P_2 of the coil L_2 will be opposite to that of the end P_1 . The portion SP_2 then becomes the balancing coil. The reaction effects are balanced by the condenser C_4 . In order to make the necessary balancing capacity larger and of more convenient size, the introduction of a further condenser C'_3 to increase the interelectrode capacity C_3 has been suggested. The circuit $L_2 C_2$ is

coupled to the grid of the next stage either by coupling a coil to L_2 or by connecting P_1 to the next grid through a condenser. In this latter case S is moved nearer to P_2 , so as to increase the potential that can be applied to the next grid.

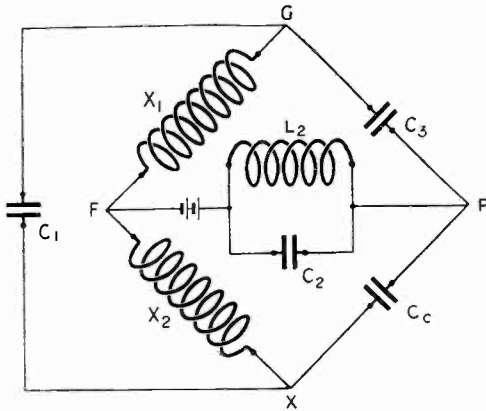

Fig. 14b.

Another general class of methods for preventing regeneration may be described as Wheatstone Bridge methods, in which the input and output circuits are isolated as far as reaction is concerned by being made portions of the diagonals of the bridge. This principle is employed in the Rice circuit which is very popular in America. In this arrangement the coil of the grid circuit is divided by the connection to the filament. The compensating condenser is connected to the lower end of the input circuit and to the plate of the valve. The arrangement is shown in Fig. 14a and the equivalent bridge diagram in Fig. 14b.

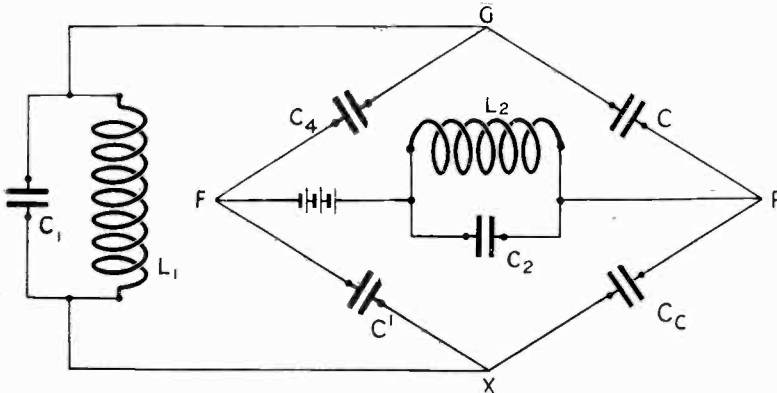

Fig. 15b.

When a balance is made between $C_2C_3X_1X_2$ the reactive currents through C_3 are compensated by the currents through C_2 . Thus the grid condenser C_1 is isolated from reaction by the circuit L_2C_2 , provided other stray capacity coupling is avoided.

It has been claimed that stable amplifiers with four or five stages of radio-frequency amplification have been constructed in this way.

Another bridge arrangement is shown in Fig. 15. In this arrangement the arms of the bridge are all capacitive. The coil L is a high frequency choke, but such that its distributed capacity provides a by-pass for radio-frequency currents. The capacity C_4

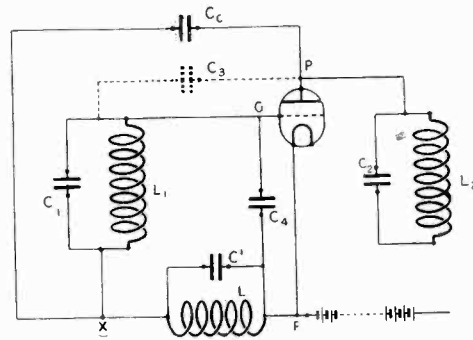

Fig 15a.

may be either a small condenser or the internal capacity between the grid and filament of the valve. The extra circuit elements are thus only the compensating condenser C_c and the coil L .

Many other arrangements for compensating for regenerative effects have been suggested,

but (as already stated) no reliable data are available concerning their effects, and it will also be seen that no very definite information is available which would tend to show whether the tendency to self-oscillation is due mainly to the internal design of the valve or valve holder or to the arrangement of the circuits in the amplifier.

Long-Distance Work.

By Hugh N. Ryan (5BV).

[R 545·009·2

IN this article I have two months' work to report, instead of the usual one month's. It happens, however, that most of the interesting long-distance work during the period covered by this article was performed during the first of the two months, owing to the considerable deterioration of weather conditions (from a DX point of view) which set in about the end of February.

I will therefore divide this article into two parts, dealing respectively with the two months concerned. This will help to preserve the general continuity of the series.

The first half, then, is the report which would normally have appeared last month, and covers the period from the middle of January to the middle of February.

JANUARY—FEBRUARY.

The country which, I suppose, occupied most of our interests during the latter half of January and the first half of February, was South America in general, and Brazil in particular. A number of our stations figured prominently in the opening up of communication with various countries in South America, but the laurels for the most interesting work—that with Brazil—go to 2NM.

A number of us had been hearing the call sign WJS for some time, without knowing who it was, and some of us had called him without receiving any reply. 2NM, however, succeeded in connecting with him, and found that the signals came from a small portable transmitter accompanying the Hamilton-Rice expedition in the wilds of Brazil. Of all the famous amateur achievements, this Brazilian contact, and last year's work with WNP, must rank as those of the most actual practical use, in that in each case an expedition, cut off from all other means of communication with the outer world, was kept in touch by amateur radio. Good business, N Emma!

As for the other South Americans, signals from Argentina, Chile and Mexico are now heard nightly in this country, and although

regular communication with these countries has yet to come, 2OD is leading the way in this direction.

There is little to be said about the United States, as our best stations are now in touch with all the Eastern half of the States as easily and regularly as they are with the mainland of Europe.

The stations I mentioned last month, as being in touch with large numbers of Americans, are still working at the same rate; and in this connection I must apologise for the omission from last month's list of two of our leading stations, 2JF and 2SZ. The number of Americans worked by each runs nearly into three figures.

Although the work with America has been so satisfactory, the same cannot, I think, be said of the work with Canada. One would have expected to find that Canadians would be even more keen to work us than Americans; very likely this is so, but the results are somewhat disappointing. From such detailed lists as have been sent to me, it would appear that on an average our stations work about five Canadians for every 100 Americans. This discrepancy seems too great to be accounted for by the greater number of stations working in America. Nearly every Canadian we work is in Nova Scotia, and most of these in Halifax.

It is to be hoped that our men will try, with the help of the Canadian coast amateurs, to reach further into Canada.

The only important developments on the Continent are the contacts of Spanish EAR2 and EAR6 with America, and of Mosul GHH (a British-operated station) with Australia.

As I dealt at such length with London stations last month, I will be very brief about them now. All the well-known Londoners are steadily working America, while 2OD, 2NM, 2SZ and 2KF occasionally work the Antipodes.

2KF recently told me that he had practically given up DX in favour of another line of experiment, but as I heard him working Australia a few hours later I am not convinced.

Those who often hear 2NM (and who does not?) will be interested to hear that a meeting of London transmitters recently presented him with an aerial ammeter, about a foot in diameter, and reading to 18 amperes.

6LJ still holds (and probably always will hold) the record for the number of Americans heard, but 6TM has taken from him the record for the number heard at one sitting, having heard 150 Americans in five hours.

5NN has also done very well in American reception, in addition to a great deal of two-way work. 2WJ has worked 70 Americans and an Australian, and has been heard in India. 6NH is added to the list of Londoners in touch with America. 6NF has, I think, the best log, having worked 127 Americans and seven Canadians. 6DW, who has not been transmitting for some time, has just started in again, and is doing some good work in reception. 6UV has been working quite a number of Americans, and has been heard in the States when using only seven watts on a receiving valve.

In the Isle of Wight 5TZ is putting strong signals into all parts of Europe, but has had no luck, so far, with America. 2IL of Southampton is working chiefly on telephony, which is heard at very good distances, and has been reported in Finland.

In the Eastern Counties, 5QV and 2LZ are keeping the work going. 2TO is in London at present, and therefore not working.

5QV is working a number of Americans to schedule, and has had a very interesting test with Czecho-Slovakian OKI, whom he worked after sunrise in England, the sun also being well up in Praha, where OKI is located. (By the way, I gave his location as Plzen last month, but he appears to have two QRA's, and I think he transmits from Praha.)

2LZ has worked a number of Americans. The call-sign 2MI, once familiar in London, has been re-allotted in Margate, and may be heard well in south-east England. He uses quite low power, as yet.

In the West the once famous and very active "gang" appears to have dwindled to one solitary station, 6RY. The loss of 5KO appears to have made a bad mess of DX in that part of the country. However, the one survivor mentioned is going as strong as ever, and is working America quite in last year's Western style. He has reached

as far as California, and has been heard in Argentina.

In the North I think the most interesting report is that of the confirmed reception of Japanese JFWA, Tokio, by 2AUI of Birkdale. We have been reading about this Japanese station, owned by Mr. Hiroshi Ando, in American papers for a long time, and are very glad that he has been heard over here. The reception was on the usual "detector and one-step" and an indoor aerial.

2JF is probably the "biggest noise" in the North, and has worked a very large number of Americans and an Australian. He has been received in the 7th American district (a rare accomplishment amongst British amateurs), curiously enough by 7JF.

2CC has now his new generator working, and is putting signals regularly into America. 5MO has worked Algiers, being the first British station to do so. He has also heard HVA, in Indo-China (this is, by the way, the station which heard 2KF last month).

In Scotland, 2TF has done most of the work this month, having worked a number of Americans, and exchanged calls with Australian 3BD. 2TF and 2OA both received A3BQ on February 9 (when he was also, by the way, quite strong in London).

Just too late for inclusion in last month's notes I heard of two more active Scottish stations, 5JK and 2VX, both of Aberdeen, who are, with the exception of 2JZ, the most Northerly British transmitters. Both are doing good DX work on 10 watts.

FEBRUARY—MARCH.

Before proceeding with the main part of this half of the report, I must devote a few lines to an achievement which actually belongs in the first half, but which I have put in here in order to report it in the light of later knowledge. I refer to the excellent work of 2OD in establishing telephonic communication with Australia and New Zealand. His first success in this direction was achieved early in February, at a time when we were just beginning to hear the New Zealanders again. It will be remembered that when they were heard last year, they appeared suddenly, lasted a few weeks and then faded away again. Many of us expected them, for purely seasonal reasons, to appear again for a similar period some time in February or thereabouts.

When they duly did so, therefore, there was much rejoicing among the "prophets," and we were all interested to see whether they would stay for a time similar to that of their early winter appearance. Unfortunately, as we know now, they did not. Whereas previously they appeared with almost clockwork regularity every morning, their appearances this time were extremely spasmodic. On one or two mornings their signals were of very great strength; but these mornings were rare.

At the time of writing (the middle of March) they still come through very occasionally. The Australians, on the other hand, never completely disappeared for long. Their signals did, however, improve very considerably about the same time as the re-appearance of the New Zealanders (though the Australians were, of course, heard almost entirely in the evenings and the New Zealanders in the mornings).

It was during this "good period" that 2OD worked Australian 3BQ on telephony and was heard in New Zealand, also on telephony. He repeated this achievement early in March, when conditions were not by any means so favourable.

This augurs well for the success of long distance telephony next winter, when it appears probable that all parts of the world will be linked by amateur telephony. But it will be a very long time indeed, I think, before the phone entirely displaces the key. I, for one, shall be sorry when it does, but there is certainly a great deal of very interesting phone work in store for us.

Another important achievement is the communication between this country and Japan, which was actually accomplished in January, but which has only just been confirmed. The honours this time go to the North, and are shared by 5DN (Sheffield) and 5MO (Newcastle). The Japanese station was JKWZ.

Apart from the important records already mentioned, steady work has been carried on by other stations, and I will briefly report the outstanding features of this.

In London 6NF again provides the "star turn." He has worked about 160 Americans, and has been heard in Cachar (near Calcutta) and on the Pacific Coast of America. 2DX now has both a 22-metre transmitter and a 22-metre licence, which would appear to be a somewhat rare combination. He tests at

12 noon and 12 midnight, and would be glad of reports.

2YQ has come to life again, and is working a number of Americans. 5GF, who has been trying for some months to acquaint the Americans with his presence "on the air," has now succeeded, having reached the 3rd and 8th U.S. districts on very low power. 5ZN, who is handicapped for transmission by lack of power supply, is making good use of his receiver, having heard a large number of distant stations, including "A's and 'Z's."

About the middle of February my own new 95-metre transmitter was at last made to work properly, after the series of mishaps I mentioned in the last report. It apparently decided to behave, as the first night's work brought forth some thirty reports from America. On that and a few subsequent nights about twenty Americans were worked, several before 11 p.m., so 5BV can at last be said to be "on the air" again, after several months' absence.

Mr. Somerset Murray, of Cambridge, has been conducting some interesting experiments on 20 metres, on which wave he has heard American 1XAM (Mr. Reinartz), at about 4 p.m., on a hastily-made single-valve set.

5DN, of Sheffield, has now received the reports of his low-power tests with U.S.A. which I mentioned some time ago. Their success is indicated by the fact that his signals (of less than 20 watts) reached as far as Kentucky.

5BA (Newcastle) is another of the old hands who has returned to the game after about a year's absence. He is working America regularly, as are 2CC and 6FG, also of Newcastle.

6KK of Blackpool has started DX fairly recently, and is at present only using 15 watts. With this he has worked most of Europe, and on several occasions has worked America.

In Worksop, two receiving amateurs, Messrs. Martin and Davidson, are doing good work, and doubtless looking forward to joining the transmitting ranks. Both receive Australia and New Zealand.

It will be interesting to note how far into the Spring we can keep the work going. Will all those engaged in DX please report to me by April 10th for next month's article.

For the Esperantists.

Extracts from E.W. & W.E., March, 1925.

Resumoj el Artikoloj en E.W. & W.E.

Marto, 1925.

[399(R800)]

LA REKTIFA DETEKTORO.

F. M. COLEBROOK, B.Sc., A.C.G.I.

[R49]
LA unua parto de artikolo pritraktanta la problemon de kristala rektifado. La aŭtoro de la artikolo komence montras ekzemplojn de "statikaj karakterizoj" de la galena kaj perikona kristaloj, kiujn la artikolo traktas.

Poste li diskutas tion, kion li nomas la "rektifa karakterizo" aŭ "dinama karakterizo."

Grava punkto trovita estas ke, kiam ajn ekzistas altrezistanca ŝarĝo laŭserie kun la kristalo, la trapaso de la kontinukurenta elemeta fluo tra ĉi tiu ŝarĝo naskas K.K. tension, kiu transiras la kristalon mem. Bedaŭrinde la tensio ĉiam iras laŭ tia direkto, ke ĝi malhelpas la rektifadon, kio montras, ke potenciometro helpas al ia ajn kristalo, kvankam ĝi estos necesa nur ĉe kelkaj.

La konduto de la kristalo rilate al sia elmeto estas ankaŭ pritraktita inĝenie, kaj oni ricevas la finan rezulton, ke la kristalo dum funkciado devus agi kiel generatoro posedanta difinitan internan rezistancon.

La aŭtoro poste pritraktas la temon de efikeco, speciale rilate al la plej bona rezistanco de la ŝarĝo. Dum kalkulado de l'efikeco, fariĝis necese ellabori la altfrekvenca rezistancan de l'kristalo.

La artikolo ankaŭ diskutas la utiligon de la kristalo kiel "potenciala" rektifikatoro, t.e., utiligo rekte en la krada cirkuito de l'valvo, kaj montras, ke ĝi povas esti tre efika.

Oni eksperimentis kun diversaj metaloj kiel kontaktfadenoj, kaj el la rezulto oni konkludis, ke ne estas grava diferenco. Variigita kontakt-premado ankaŭ faris malmultan diferencan en la efikeco, kvankam ĝi kaŭzis grandajn ŝanĝojn en la detektora rezistanco, kiu bezonas ŝanĝojn je la cirkuitaj konstantoj por konservi la saman efikecon.

La matematika analizo disvolvita por la ĉi-supra esploro estas ankaŭ uzata por esplori heterodinan kaj supersonan ricevadon. La granda sentiveco de bata ricevado estas klarigita, kaj (grava punkto) oni montras ke, je taŭgaj cirkonstancoj, la frekvenca ŝanĝo ĉe la supersona detektado, kiel ĉe la kristala, estas sendistorda.

PRINCIPOJ KAJ METODOJ RICEVI PROVIZON DE ALTA TENSIO PER KONTINU - KURENTAJ ĈEFTUBOJ PUBLIKAJ.

L. C. GRANT (2QP).

[R355]

Priskribo de ĝeneralaj principoj sekvotaj por utiligi ĉeftubojn de kontinua kurento kiel fonton de provizo por funkciigi valvoskatorojn. La artikolo montras, kiel oni povas malmultakoste funkciigi malfortan sendilon pere de la publika elektra provizo en okazoj kiam la valvoj bezonas platan tension de ne pli ol 500-600 voltoj.

La ordinara aranĝo de publika provizo estas per 3 fadenoj, kun la neŭtra aŭ meza fadeno konektita al tero. Tiurimede, la potenciala diferenco inter la pozitiva aŭ negativa kondukto kaj tero estas 250 voltoj. Ekzistas tamen la risko de akcidenta mallonga cirkuito pro alterigo de unu el la "eksteraj" kondukto—pozitiva aŭ negativa—kontraŭ kia risko oni devas kompreneble sin gardi. La artikolo montras, kiel atenti tiun aferon, por ke ne estu troa danĝero.

Por lumigado, unu-flanka provizo estas preskaŭ ĉie uzata. Kiam la pozitiva flanko estas uzata, iu lampo aŭ rezistanco de minimume 200 omoj estu konektita serie kun la pozitiva fadeno; tio evitas la eblecon de mallonga cirkuito ĉe la sendila flanko de la provizo. Karbona lampo de 32-kandelopovo aŭ metal-filamenta lampo taŭgas.

Kiam oni uzas la negativan flankon, la neŭtra aŭ alterigita kondukto fariĝas

pozitiva, kaj se ĝi estus konektita senpere al la valva anodo, ĝi alterigus la anodon. Kondensatoro de .05-.5mf. devus esti konektita serie kun la tera konektaĵo, kaj tiumaniere evitus metalan kontakton kun la tero.

Utiligante la du eksterajn flankojn, t.e., la pozitivaj kaj negativaj de la ĉeftubo, kiu liveros ĉirkaŭ 500 voltojn por anoda uzo, oni povas funkciigi 30-vatajn valvojn.

IZOLATOROJ POR ALTA FREKVENCO.

Multaj izolatoroj, kvankam bonegaj por ordinara uzado ne estas kontentigaj ĉe altfrekvencaj cirkuitoj pro la grandaj dielektrikaj perdoj.

Tiu artikolo enhavas rezultojn ricevitaj je radio-frekvenco de S-ro. R.V. Guthrie, de la Ŝtata Universitato de Iowa, kaj de Sroj. Preston kaj Hall, de la *Bureau of Standards*. Oni montras la rezultojn per faktoroj de potenco. Traktante eboniton kiel la unuan, oni povas trovi la proporciajn perdojn de aliaj materialoj, multobligante tiujn per 100.

La tabelo de rezultoj montras, ke Parafino, kun 00016, havas la plej malgrandan dielektrikan perdon, dum la perdo de ardezo estas tiom granda, ke ĝi tute ne taŭgas por radio-instrumentoj.

ERAROJ EN MEZUROJ.

P. K. TURNER.

[R800—R519]

Tre simpla klarigo kiel trovi la taksitan ĝustecon kaj plej probable veran valoron de mezurita kvanto. La aŭtoro komencas per konstato, ke nenia mezuro estas iam precize ĝusta, krom senintence, kvankam eraroj en mezuroj estas kelkfoje tre malgrandaj.

Ekzemple, eĉ post mezuro de kondensatoro, oni povas nur diri, ke ĝia kapacito estas proksimuma. Al tio kontribuas multaj aferoj. Eble eraro dum legado de l'instrumentoj, eble la kapacito de l'kondensatoro mem ŝanĝiĝas kun la vetero, k.t.p. Eĉ la norma kondensatoro ne estas absolute konstanta.

La aŭtoro diras, ke la probable eraro estas malpli granda, se oni faras kelke da mezuroj de la sama kondensatoro aŭ alia aparato, pro tio ke la meznombro de ĉiuj mezuroj estas pli ĝusta, ol ĉiu individua mezuro. Kiel ekzemplo, li citas ses mezurojn de kondensatoro, unue montrante la mezan kapaciton kaj poste la probable eraron.

Povas okazi aliaj ekzemploj, ne tiel simple

trakteblaj, ekz., se oni deziras trovi la altfrekvencon induktancon de bobeno. Se la bobeno havus nenian memkapaciton, ĝia induktanco estus trovebla per la formulo de induktanco, kapacito kaj endlongo. Tamen, ĉar ĝi ja havas memkapaciton, oni devas fari pro tio iom da kalkulado por ricevi la veran induktancon.

OLIVER HEAVISIDE, F.R.S.

[R697]

Mallonga skizo pri granda sciencisto, kies laboro dum multaj jaroj ricevis la rekonon, kiun ĝi meritis. Kvankam lia nomo estas mondnama per la esprimo "La Tavolo Heaviside," li estis la unua persono, kiu faris sisteman esploron pri "induktanco," kiun nomon li mem inventis. La termino "reaktanco" ankaŭ estas ŝuldata al li.

Dum sia laborado je fadena telegrafo, li montris, ke oni povas atingi plibonajn rezultojn per arta pliigo de l'induktanco de la linio. Malfeliĉe la telegraf-ingenieroj en ĉi tiu lando mokis la ideon, sed en Ameriko Pupin disvolvis ĝian praktikan aplikon per helpo de la Amerika Telegrafa kaj Telefona Kompanio, kaj tial la aldonaj bobenoj nun uzataj ricevis la nomon de Pupin anstataŭ de Heaviside.

Honoron oni faris al li, sed treege malfrue. En la jaro 1891a oni elektis lin Fratulo de la Reĝa Societo, kaj en la jaro 1922a li estis la unua ricevanto de la Medalo Faraday.

AMATORA STACIO—2GW.

[R412]

Priskribo de tre efika amatora stacio, posedata de S-ro. J. Allan Cash. Li priskribas diversajn antensistemojn, kiujn li provis; la nuna estas kaĝforma kun ses fadenoj, longa 50 futojn, kun 40-futa enirilo ankaŭ kaĝforma; kaj 12-fadena kontraŭpezo. Multspecajn aparatojn kaj cirkuitojn li utiligis, funkciajn je ondlongoj de 1000, 440 kaj 200 metroj.

Sekvas priskribo de la sendilo. La antena kurento estas nur 0.13 amperoj. Li jam trafis ĝis 1000 mejloj, per enmeto primaria 11 amp. La unuan nokton li komunikis kun Nederlando, Svedujo, kaj Suda Francujo, je 130 metroj. Kun 16 amp., tuta Europo ŝajnis esti en lia trafpo.

Kvankam li posedas du-valvan ricevan aparaton (Detektoro, kaj Malalta Frekvenco), li malofte uzas la duan valvon. Per unu valvo li ricevis multajn amerikajn amatorojn, Argentinan CBS, kaj KDKA.



Letters of interest to experimenters are always welcome. In publishing such communications the Editors do not necessarily endorse any technical or general statements which they may contain.

The late Dr. Heaviside's Work.

The Editor, E.W. & W.E.

STR,—It is pleasant to find in the current issue of E.W. & W.E. an appreciation of the late Dr. Oliver Heaviside. The article contains, however, one slight inaccuracy: Heaviside did not coin the word "reactance." He says (*Electromagnetic Theory*, Vol. I., p. 439): "The word reactance has been lately proposed in France."

By far the greater part of Heaviside's work must remain unknown to all who are not trained mathematicians. But it will be a great pity if his name remains known to the public only in connection with a short paragraph, in an article in an old *Encyclopædia Britannica*, on the possible existence of an electrified layer in the upper air.

Curiously, though Heaviside's work was read by

that then prevails) was pointed out last summer in an article on telephone diaphragm resonances in *The Wireless World and Radio Review* by a distinguished authority.

Workers using Wheatstone's bridge may not always realise that when a particular resistance is being measured by this instrument, the various balances that may be obtained differ amongst themselves in point of sensitivity. Heaviside early discussed this matter (*Electrical Papers*, Vol. I., p. 3). As this point is worth attention when careful measurements are being made, and as Heaviside's *Electrical Papers* is a scarce book, it may be permissible to give here the most important of his conclusions:—

a_1 , a_2 and b are the resistances of the variable arms; x is the resistance required; g that of the galvanometer and r that of the battery. If a_1b denote the junction of the resistances a_1 and b , and so on, then the battery runs from a_1b to a_2x , and the galvanometer from a_1a_2 to bx . Then the problem is to determine the best values of a_1 , a_2 and b , when x , g and r are fixed. "This is the case which occurs so often in practice, when we have a battery, a galvanometer and a resistance to be measured, and three sides of a bridge to which we may give any values we chose (within certain limits)" (*loc. cit.*).

For the best values of a_1 , a_2 and b , Heaviside gives

$$a_2 = \sqrt{xr \frac{x+g}{x+r}}; a_1 = \sqrt{gr}; b = \sqrt{xg \frac{x+r}{x+g}}$$

On the subject of the most sensitive condition of Wheatstone's bridge, however, reference should also be made to the late Lord Rayleigh's work (*Collected Papers*, Vol. IV.)

E. N. COLEMAN.

43, Winchester Street, S.W.

Low Power Work.

The Editor, E.W. & W.E.

STR,—I should be glad if you would publish the following details in E.W. & W.E., which paper I have been a continual subscriber since its inception.

On Sunday, February 1, and at a subsequently arranged test on Sunday, February 8, I worked with G2FN, of Nottingham, during bright sunlight.

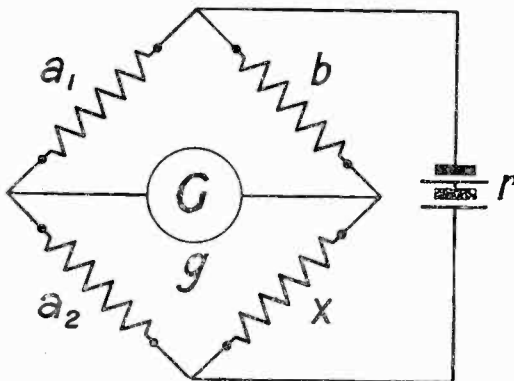

few of his contemporaries, he was in the first place a great teacher. He taught all who had ears to listen what Maxwell's researches meant in practice.

Among the least mathematical of Heaviside's researches, two ought to be known to every wireless experimenter. His explanation of the action of a permanent magnet in a telephone receiver is embodied in his statement (*Electrical Papers*, Vol. II., p. 156) that the mechanical force on the diaphragm varies as the square of the magnetic force in the gap between magnet and diaphragm. The significance of this fact for broadcast receiving (on account of the multiple forcing of the diaphragm

My input was 6 watts—i.e., 300 volts 20mA—on an L.S.1 valve, and aerial current .25. G2FN reported my signals almost QSA on a single valve, very steady C.W. and easy to read; while G2FN's signals, with a slightly higher radiation, were all over the house on a six-valve superhet on the first occasion; and yesterday, on a two-valve low-loss detector and one stage L.F., were R5.

The following are details of an extremely interesting test which I carried out on February 22 on exceptionally low power and during broad daylight.

At 12 noon, by prearranged schedule, I called 2TF, of Edinburgh, with the same input—6 watts—on C.W. and received a reply immediately. My aerial current was .15, and 2TF reported sigs. weak, but readable.

2TF was received at my station at R 6 to 4 on a seven-valve superhet, while 2TF was using two valves in his receiver.

The test had been arranged with 2FN, Nottingham, acting as intermediary, but although 2FN and I were in communication I was able to work through to 2TF direct.

After 2FN and I had got into touch, by prearrangement, 2FN switched on to speech and parts of this were received on a loud speaker, but QRM was bad and working continued on C.W. It was after this that I called 2TF, and received acknowledgement of reception of my signals.

I think that this is an exceptional range for such low power as I was using, i.e., six watts.

Incidentally, I have been received by two Finnish stations and all over the Continent on the same six watts at night.

The transmitting valve was an L.S.1 in an inductively-coupled, reversed feed-back circuit.

I put a good proportion of my success down to the inductively-coupled aerial circuit, where the wave is rendered absolutely steady, which is a considerable factor in reading a long-distance signal.

E. J. PEARCEY (2JU.).

Please note new address: 2JU, E. J. Pearcey, 19, Mendora Road, Fulham, London, S.W.6.

Call Signs.

The Editor, E.W. & W.E.

SIR,—The P.M.G. has allocated to me the call sign 5YK in place of my old one, 2AOK, which was issued with a licence for artificial aerial. I shall be very pleased to receive reports on my transmissions, which take place during the week-ends.

G. W. THOMAS.

169, Hill's Road,
Cambridge.

Counterpoise Earths.

The Editor, E.W. & W.E.

DEAR SIR,—I was very much interested in reading the two articles in a recent issue of your journal dealing with the question of the use of "counterpoise earths" for transmission and reception.

Having very carefully read the first, which you endorse as clearing up several doubtful points, I

proceeded to act on the advice offered and erected an earth screen.

Using this, I was able to increase the aerial current from 0.4 to 0.8 amps, with the same power input, on a wave-length of 97 metres. It should be mentioned that the effective height of the aerial was reduced from 40 to 32 ft.

Many attempts were made to connect with stations which are usually within easy range, but without success. Various circuits were also tried out but without any improvement. Finally, in complete disgust, I returned to the old circuit with the earth, and with 0.25 amps got a reply to my first call. I am not able at the time of writing to give the QSB of this station, as I have not received his address yet. Judging from the amount of fading, however, he was not within 1000 miles of me.

This experience may be of interest to Mr. M. C. Ellison, with whom I should like to get in touch if he is prepared to do any further tests on this subject.

D. DINKLER (2TF).

13, Lockharton Crescent,
Edinburgh.

DX Work.

The Editor, E.W. & W.E.

SIR,—We were seriously thinking of abandoning H.F. amplification below 150 metres for the past DX season when 2OA suggested the employment of an H.F. choke in the aerial circuit instead of a tuned circuit. On trial this was found to give considerably greater signal strength than a tuned circuit.

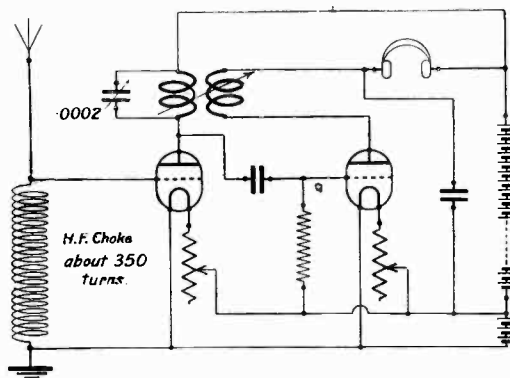

With the ordinary arrangement, the tuning of the aerial circuit is very broad when reaction is not coupled to it, owing to the high L/C ratio, so little selectivity is lost by using this arrangement as compared to the ordinary H.F. amplifier; and there is a gain as compared to the simple detector valve.

There is only one tuning control, so rapid searching is easy, while, at the same time, there is comparative immunity from jamming.

An ordinary 350 coil works quite well as a choke.

Repton, Derby.

E. C. BULLARD.
M. T. COODE.

ca

[R050

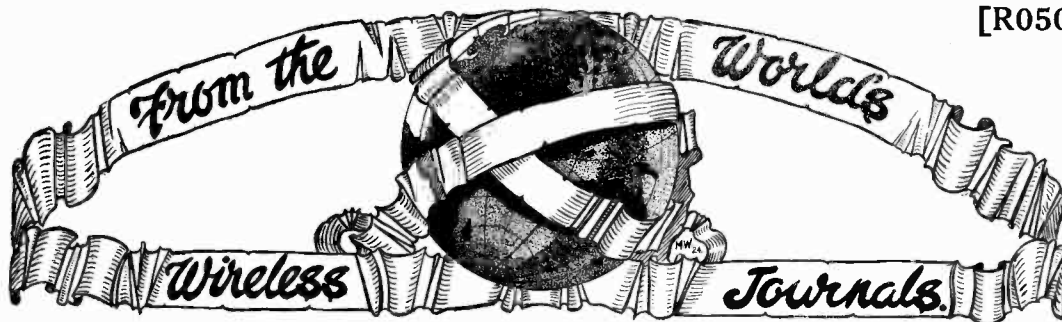

R100.—GENERAL PRINCIPLES AND THEORY.

R113.3.—A SUGGESTION FOR EXPERIMENTS ON APPARENT RADIO DIRECTION VARIATIONS.—L. W. Austin (*Proc. I.R.E.*, Feb., 1925);

The author describes briefly some of the effects already discovered in connection with the apparent directional shifts of long-wave stations. He suggests the systematic investigation of apparent shifts in direction as indicated on a frame receiver.

R113.4.—IONIZATION IN THE ATMOSPHERE AND ITS INFLUENCE ON THE PROPAGATION OF WIRELESS SIGNALS.—(*Proc. Phys. Soc. Lond.*, Feb. 15, 1925.)

A joint discussion held on November 28, 1924, under the auspices of the Physical Society of London and the Royal Meteorological Society.

A number of papers dealing with atmospheric ionisation, atmospheric, meteorological conditions, terrestrial magnetism and their bearing on the propagation of wireless waves were contributed by Dr. W. H. Eccles, Dr. C. Chree, Dr. E. V. Appleton and Dr. Sydney Chapman. There was also a general discussion. Owing to the large amount of matter involved, an extract cannot be given here, but those interested are referred to the Proceedings.

R113.5.—RECENT INVESTIGATIONS ON THE PROPAGATION OF ELECTROMAGNETIC WAVES—M. Baeumler (*Proc. I.R.E.*, Feb., 1925).

Since the summer of 1922, quantitative measurements have been carried out on the signal strengths of the American high-power stations WQK and WSO, using an objective measuring method. The object of these measurements is to study the propagation of electromagnetic waves. It has been shown that these phenomena can be studied only by continued measurements.

Curves are presented showing the field strengths on three successive days and nights, once each month, for the year February, 1923—January, 1924. In view of the agreement of the calculated values of field strength and the values actually found at night, it is concluded that the night value is to be regarded as the normal one and the day value as the abnormal or disturbed one. An explanation of the diminution of field intensity is given by assuming that the atmosphere is "electrically tubed" by day in consequence of the heating of the earth and the resulting vertical motion of masses of heated air. The waves are refracted, absorbed or reflected (and hence weakened) at the

boundary surfaces of masses of different densities. Diurnal and annual variations of field intensity can readily be explained by this theory. It was not possible to establish any difference between field intensity in a large city and in nearby open country.

The derivation of a universally applicable formula giving the field strength, while taking account of all absorption losses, is regarded as impossible at present. The empirically-determined absorption factor of the Austin-Cohen formula does not give results in agreement with measurement, but yields markedly smaller values of field intensity; on the other hand, the absorption factor found by L. F. Fuller gives values in good agreement with the results of measurement.

R113.7.—DAYLIGHT RADIO COMMUNICATION WINS.—(*Q.S.T.*, Mar., 1925.)

Some information is given regarding the recent experiments on 20-metre transmission carried out by stations 1XAM, 6TS, 4XE, NKF and others in America. It has been found possible to carry on communication at will over a distance of 1200 miles in daylight with powers less than one kilowatt. Signals are stronger on 20 metres by day than by night and it was found that signals on 20 and 40 metres faded out during the recent eclipse.

R141.1.—ON AN APPLICATION OF THE PERIODOGRAM TO WIRELESS TELEGRAPHY.—C. R. Burch, B.A., and J. Bloemsmas (*M.N.I.R.E.*, *Phil. Mag.*, Feb., 1925).

A mathematical paper discussing the response of a wireless receiver to morse signals and also to atmospheric. The effect of heterodyne detection is examined, and the shape of the resonance curve of the ideal receiver is discussed.

R200.—MEASUREMENTS AND STANDARDS.

R240.—A METHOD OF MEASURING AT RADIO-FREQUENCIES THE EQUIVALENT SERIES RESISTANCES OF CONDENSERS INTENDED FOR USE IN RADIO RECEIVING CIRCUITS.—C. N. Weyl and S. Harris (*Proc. I.R.E.*, Feb., 1925).

The desirability is shown of measuring at radio-frequencies the equivalent series resistance of condensers intended for radio-receiving circuits. For one thing, the power factor of a condenser does not necessarily remain independent of the frequency as is usually assumed. A method of making such radio-frequency measurements is

set forth in detail, and some preliminary results obtained by the method are shown. One of the tables of results gives a comparison between the old style and "low loss" air condensers. A representative value for the equivalent series resistance at 1 500 k.c. for the old style 500 μ F condenser is 0.97 ohm as against 0.73 for the "low-loss" type. Something is therefore gained in the latter, but not much.

R300.—APPARATUS AND EQUIPMENT.

R325-1.—THE MARCONI MARINE RADIO DIRECTION FINDER.—H. de A. Donisthorpe (*Proc. I.R.E.*, Feb., 1925).

A description of the circuits, construction, installation and use of the Marconi Bellini-Tosi marine radio direction finder is given. The method of determining "sense" as well as line of direction of a distant station is explained. The various forms of errors in reading and the methods of reducing or eliminating these are discussed. The paper concludes with a description of a number of cases where the Marconi direction finder has contributed to the safety of life at sea in stormy weather.

R344-3.—RECENT DEVELOPMENTS IN VACUUM TUBE TRANSMITTERS.—B. R. Cummings (*Proc. I.R.E.*, Feb., 1925).

This paper describes a number of valve transmitters recently developed for various commercial and governmental purposes by the General Electric Company of America; it is profusely illustrated with excellent photographs of the apparatus described. A particularly detailed description is given of a 20 kilowatt master-oscillator long-wave C.W. transmitter. Although parts of the paper are interesting as giving an idea of modern radio engineering practice, it seems that the amount of information contained relevant to radio science is not in proportion to the 59 pages which the paper occupies in the issue of the *Proceedings*.

R344-4.—SHORT ELECTRIC WAVES OBTAINED BY THE USE OF SECONDARY EMISSION.—E. W. B. Gill, M.A., B.Sc., and J. H. Morrell, M.A. (*Phil. Mag.*, Feb., 1925).

The grid and plate of a three-electrode valve are connected to adjustable Lecher wires and are given positive potentials with respect to the filament, the potential of the grid being higher than that of the plate. For certain values of emission, applied E.M.F. and adjustment of the Lecher wires, feeble oscillations are sustained which have a wavelength of the order of a metre. If the time taken by the electrons to travel from one electrode to another is comparable with the time of oscillation, the presence of a control electrode may be unnecessary for the maintenance of oscillations. The authors show theoretically how the oscillations are sustained under these conditions.

R388.—A PIEZO-ELECTRIC OSCILLOGRAPH.—C. E. Wynn-Williams, M.Sc. (*Phil. Mag.*, Feb., 1925).

Some experiments were made to determine the possibility of utilising the piezo-electric effect, or rather its converse, exhibited by certain crystals.

The effect is the relative movement, linear or torsional, of different parts of a crystal when the specimen is subjected to an electrostatic field in certain directions. The opening part of the paper is devoted to the theoretical considerations of oscillographs in general. It is pointed out that if an oscillograph has a natural frequency of oscillation this should be at least ten times the frequency to be investigated if distortion is to be avoided.

Quartz was tried first, but it was found that the piezo-electric effect was too small. In fact, the change in length of a quartz plate 5 cms long under an applied E.M.F. of 10 000 volts was only just measurable by a delicate method using the interference of light. Next rochelle salt (sodium potassium tartrate) was tried. This was found to be much more sensitive and was embodied in an oscillograph which the paper describes in detail. The electrostatic controlling voltage is applied to a specially prepared and mounted crystal of rochelle salt by means of tinfoil coatings stuck on to the surface of the crystal with shellac varnish or other suitable adhesive. By means of a light aluminium arm the torsional movement of the crystal is made to rotate a small mirror which controls a spot of light in the usual way. It is stated that the oscillograph is simple and compact, working with applied voltages of two or three hundred. Since the resistance of the crystal is very high, it acts almost entirely as an electrostatic device and takes little load from the circuit in which it is included. A newly prepared crystal shows no resonance peak, but crystals which have been in use for some months may show a maximum response as about 3 000 cycles. The method of preparing the crystals is of great importance and details of preparation are discussed in the paper.

R400.—SYSTEMS OF WORKING.

R431.—THE MCCAIG ANTI-STATIC DEVICES. PART II.—S. Kruse (*Q.S.T.*, Mar., 1925).

Further practical details of the static-reducing device described in the previous issue are given. Selective devices dependent upon audio-frequency tuning are also described. One interesting arrangement employs a thin strip of soft iron stretched across three bridges, very much after the manner of a sonometer, so that there are two equal sections each capable of vibration at the same audible frequency. One section is in mechanical communication with the movement of a Baldwin receiver actuated by the received signals. The other section of the iron band is connected to a second Baldwin receiver which acts as a generating magnetophone and is connected to an L.F. amplifier. A received heterodyne note of the correct resonant pitch causes the first band section to vibrate, the second band section vibrating in sympathy and causing the second Baldwin movement to generate currents which are amplified. Any aperiodic impulses or currents of the resonant frequency have little effect on the second band section and are therefore not passed on to the amplifier. A further device is described employing audio-frequency tuned transformers.



(The following notes are based on information supplied by Mr. Eric Potter, Patent Agent, Lonsdale Chambers, 27, Chancery Lane, W.C.2.)

[R008

A SYNTONIC "REINFORCER."

(Application date, June 20, 1923, and February 1, 1924. No. 223,625.)

THE above British Patent, due to Sir Oliver Lodge and E. E. Robinson, is illustrated by the accompanying diagram. The invention lies in the use of a free uncoupled low resistance oscillatory circuit which in the words of the specification is "stimulated by oscillations from any source or from any

the anodes and grid of valves, the cost of construction is materially lessened, as they are easier to work and also require no subsequent treatment for the release of occluded gas. An alloy which gives satisfactory results is an iron chromium alloy containing from 9 to 20 per cent. of chromium and less than 0.5 per cent. of carbon. It is further stated that an alloy of this type may be used for the filaments of dull emitter valves.

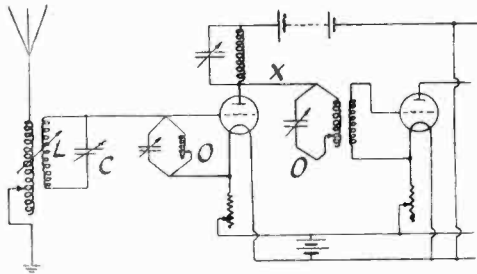

place where oscillating currents are passing . . . to work up oscillations of one definite frequency into considerable amplitude by sympathetic resonance." An important feature of the invention is that the "generator" or syntonic "reinforcer" must not be coupled to any tuned circuit in which oscillations are generated. Thus in the illustration LC represents the closed circuit of the tuning system. The special tuned circuit of low resistance is shown as O. Two "O" circuits are shown, the first being connected across the grid circuit of the first valve; the second circuit is used in conjunction with a tuned anode circuit, the oscillations being stimulated in it merely by being connected to the wire X. In this particular case the "O" circuit is coupled to the grid circuit of the next valve in the ordinary manner.

IMPROVED VALVE CONSTRUCTION.

(Application date, July 18, 1923. No. 223,306.)

H. J. Osborn and W. L. Turner describe in the above British Patent a system of valve construction employing alloys of chromium. It is stated that if certain chromium alloys are used for making

A MERCURY VAPOUR DISCHARGE DEVICE WITH A CONTROL ELECTRODE.

(Application date, October 12, 1923. No. 226,902.)

Dr. H. Konemann describes in British Patent No. 226,902 a rather interesting form of mercury valve lamp. The specification points out that with the ordinary three-electrode valve it is impossible to control a very large amount of current. In the case of the discharge device, such as a mercury tube, the conductive value of the ionic current is considerably greater than that of the ordinary electronic stream on a three-electrode valve. According to this invention, which is illustrated diagrammatically by the accompanying sketch, the control electrode is arranged as follows: The discharge device is contained within a vessel V provided with two electrodes A and C. The starting, or ignition, electrode I is also shown. The grid, or control electrode,

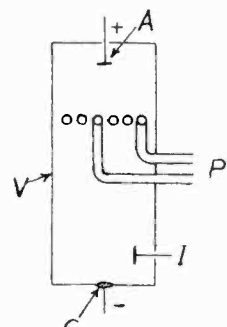

takes the form of a tube P. It has been found that if an ordinary grid is interposed between the electrodes, small drops of mercury are liable to form on the grid and interfere with the function of the device. This difficulty is overcome by passing a stream of hot air through the tube. It seems to us that there are considerable possibilities in a device of this description, and should prove excellent subject matter for amateur experimental work.

A REFLEX CIRCUIT.

(Application date, June 27, 1923. No. 226,843.)

The accompanying diagram illustrates one of the many types of reflex circuits, which in this case is claimed by J. Scott-Taggart, in British Patent No. 226,843. The mode of operation of the circuit should be obvious enough to require but little description. Essentially it consists of a high frequency amplifier operating on the tuned anode principle with a crystal rectifier, the rectified current from which is re-amplified by the first valve, whose output circuit is connected to a straight note magnifier. Several other modifications are shown in the specification, and the following are some of the chief claims: The first claim of the specification is for a reflex circuit with direct aerial coupling, in which the intervalve transformer is

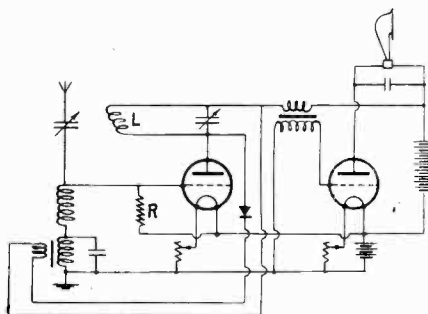

connected between the earth and the lower side of the aerial circuit. This seems to us rather an obvious thing to do. A claim is also made for shunting the secondary of this transformer with the condenser, which also would be expected. Another claim is made for the use of a crystal detector in conjunction with an intervalve transformer, both being connected across the tuned anode circuit. A further claim is made for the use of a resistance (marked R in the illustration) of about 100 000 ohms connected between the grid of the first valve and preferably the positive side of the filament battery. The object of this resistance is apparently to stabilise the circuit by increasing the damping. In another modification of the circuit, not illustrated, the second valve is used as a rectifier, in which case the telephone or loud-speaker is connected directly to the anode of the first valve. A claim is also made for the use of a choke coil in this circuit.

In view of the large amount of work done on such circuits from 1913 onwards, we doubt as to the validity of such claims as late as 1923.

AN IMPROVED MICROPHONE.

(Application date, July 25, 1923. No. 223,658.)

E. A. Graham describes in British Patent No. 223,658 an improved form of microphone, which is illustrated in the accompanying diagram. The novelty of the invention lies chiefly in providing a damped diaphragm, comparatively thick in relation to its diameter and with one or more microphone buttons attached to it. Referring to the illustration, it will be seen that the microphone itself is housed within a casing, which is made of two parts

A and B, which are conductively separated by an insulating ring R. The thick diaphragm D is attached to a strip of metallic foil F by a washer and nut N, the strip being clamped between two halves of the casing. The diaphragm is damped on either side by a quantity of non-sonorous material, such as "Sorbo" rubber, arranged in annular formation. The microphone buttons are quite normal, and consist of two carbon plates C, with a quantity of granules between them. The button is held in the back of the casing by means of a rod which passes through a longitudinal slot provided with a clamping screw W. The other side of the button is attached to the diaphragm by means of a metal link. The specification provides for the use of a

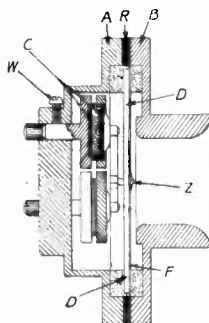

number of these buttons, which are linked together by means of a suitable yoke which is attached to the diaphragm.

AN EXTERNAL ANODE VALVE.

(Application date, September 27, 1923. No. 214,192.)

(Convention date, United States, April 13, 1923.)

M. J. Kelly and the Western Electric Company, Ltd., describe in British Patent No. 214,192 the construction of a high power external anode valve. The accompanying illustration shows diagrammatically its general form.

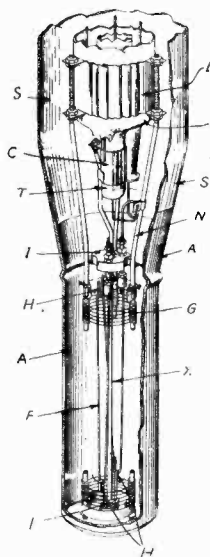

An anode A is fused to a glass portion S, the end of which is not shown in the diagram. Fused to the glass portion S is a re-entrant tube R, and, arranged co-axially within the re-entrant tube, is another tube T. The re-entrant tube R is used to support the grid, while the small tube is used to support the filament. A collar K is frictionally held on to the tube R. This collar supports three rods N, around which the grid G is formed. Another collar C is fixed in a similar manner to the tube T, and this collar supports a rod X. Fixed to each end of the rod X are two insulating members I, which are held in position by means of nuts. These blocks carry a number of hooks H, to which the filament F is attached. The leads from the grid and the filament are brought through the concentric tubes.

A VICKERS' WIRELESS CONTROL SYSTEM.

(Application date, August 22, 1923. No. 224,318.)

Captain C. B. Ryan and Vickers, Ltd., describe in British Patent No. 224,318 a system of control which is illustrated by the accompanying diagram. The invention relates to systems of control which function by virtue of periodic impulses of pre-determined frequency. According to this invention the received signals are heterodyned by a local oscillator O, provided with a coil L coupled to an aerial coil A. The output circuit of the receiving system includes a telephone or loud-speaker. The frequency of the control signals is set within very fine limits, as is also the frequency of the

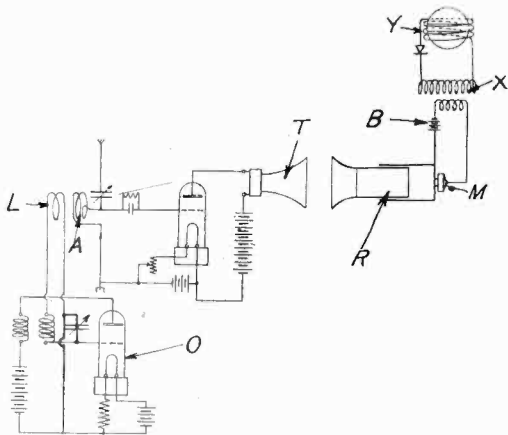

local oscillator. This ensures that the resultant heterodyne beat note of the signals is perfectly constant. In front of the telephone or loud-speaker is an acoustic resonator R, at the end of which there is a microphone M provided with a local battery B and a transformer X, which is connected to a tuned oscillating device Y. It will be seen that this system of control is very accurate in operation, and could only be rendered inoperative with the greatest difficulty. In the first place, the heterodyne beat note would have to be exactly duplicated; secondly, the impulse period has also to be found. Even if the exact H.F. component were discovered, this would be of no use without the group frequency as well, since the operating device Y is an arrangement such as a spring controlled weighted wheel, which has a natural frequency equal to that of the group frequency of the signals.

SELECTIVE RECEPTION.

(Convention date, United States, May 11, 1923. No. 215,787.)

British Patent No. 215,787, assigned to The British Thomson-Houston Co., Ltd., by E. F. W. Alexanderson, describes a selective system of reception depending upon directional aerials. The accompanying diagram illustrates both the circuit

employed and also the receiving diagram. It is well known that the receiving diagram of a plain vertical loop resembles a figure "8," as shown by E, while when combined with an ordinary open aerial, a heart-shaped or cardioid loop C results. In this arrangement, however, it will be seen that a

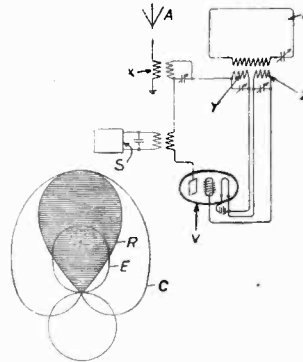

vertical aerial A and a loop aerial L are provided. Two high frequency coupling transformers X and Y are used to couple both the frame and the open aerial to the anode circuit of a valve V. In addition, another coupling transformer Z is coupled to the frame L and is connected to the grid circuit of the same valve. The anode circuit of the valve is connected to a receiving apparatus S. The receiving diagram which results from this combination is indicated by the shaded area R, and is obviously quite different from that obtained merely by vectorial addition. It will be seen that it is a maximum in the direction that the cardioid and figure "8" have their maxima. In a direction ninety degrees from this position it is zero, because the figure "8" is zero; and in a direction one hundred and eighty degrees from its maximum, it is also zero, because the cardioid is zero in that direction. The resulting diagram resembles one which would be obtained from a wave-aerial one wavelength long. The specification also provides for combining the resultants of two such systems through a third phase selector, which thereby gives even greater directivity.

AN AUDIO-FREQUENCY AMPLIFIER.

(Application date, May 16, 1923. No. 220,381.)

E. A. Graham and W. J. Ricketts describe in British Patent No. 220,381 a form of audio-frequency amplifier which is illustrated by the accompanying diagram. It will be seen that the anode circuit of a valve V contains the primary winding of an intervalve transformer T. The secondary winding of the transformer, instead of being connected to the grid and filament of the subsequent valve, is connected between the grid and a grid-leak R, the usual bias battery B being provided. A condenser C is connected between the anode of the first valve and the lower side of the secondary winding of the intervalve transformer. Another condenser K is also shown but in reality it is merely connected across one of the high tension batteries, separate batteries being shown. The

specification states that the arrangement gives a higher degree of amplification than is obtainable with the more usual arrangement. How far this statement is justified it is impossible to say without

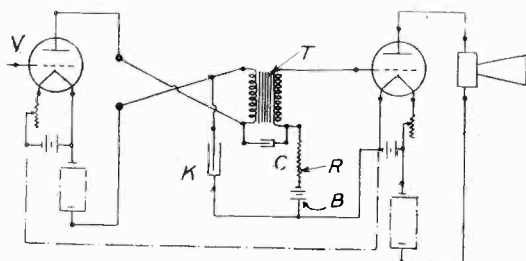

analysing the circuit mathematically, but it seems highly probable that this may be the case. From a practical point of view, the circuit should prove of interest to experimenters.

VALVE CONSTRUCTION.

(Convention date, Holland, October 21, 1922. No. 205,784.)

Naamlooze Vennootschap Philips' Gloeilampen-fabrieken describe in British Patent No. 205,784 an interesting form of valve

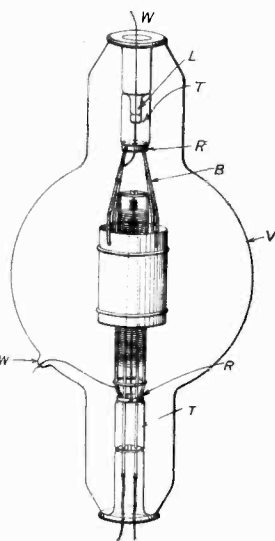

construction which is illustrated by the accompanying diagram. The object of the invention is to provide primarily a simpler form of mounting for the electrodes and also a method which overcomes many disadvantages which are inherent with the existing methods. Hitherto the grids and anodes have been welded to some form of collar which has been tied, or screwed on either directly to a tube, or by means of lugs on the tube. One of the disadvantages of this method is the comparative difficulty in freeing the supports from occluded gases. According to this invention, the envelope of the valve V is provided with a tube T, to which is fused a ring R. This ring is made of some alloy which has a co-efficient of expansion equal to that of the glass tube. A chrome iron alloy, containing from 10 to 50 per cent. of chromium, is mentioned as being suitable. The illustration shows the relatively small size of the ring compared with the more normal collar. Another feature of the invention is the provision of bars B, which support the electrode, but do not serve as the leading out wires. The leading out wires W

are welded to the bars B and are brought out of the valve in any convenient manner. One method of doing this is claimed in the specification, and consists in closing the hollow tube with a glass portion L, through which the wire passes. The patent specification is very detailed and contains many simple but ingenious points.

are welded to the bars B and are brought out of the valve in any convenient manner. One method of doing this is claimed in the specification, and consists in closing the hollow tube with a glass portion L, through which the wire passes. The patent specification is very detailed and contains many simple but ingenious points.

A PECULIAR RECEIVING SYSTEM.

(Application date, June 25, 1923. No. 223,630.)

A rather extraordinary system of reception is detailed in British Patent No. 223,630 by G. W. Hale and R. Lyle. The accompanying illustration shows one of the circuits given in the specification. The chief object of the invention appears to be that of providing a means for receiving wireless signals without connecting the telephones to the set. Referring to the illustration, the first part of the receiver appears to be a rather unusual form of high frequency amplifier and detector in which the aerial A is connected to a shunt reaction coil R. The remaining three valves act as ordinary audio-frequency amplifiers except that the valve F is coupled to valve G in exactly the same manner as that described in specification No. 220,381

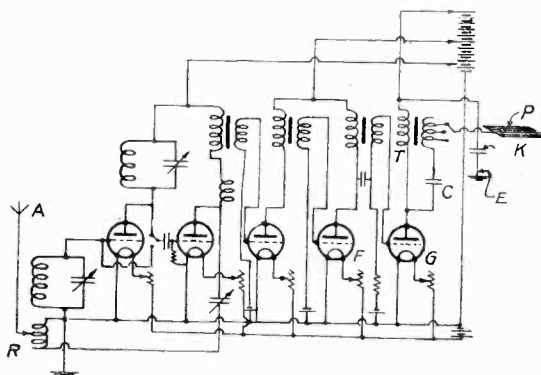

detailed above. The anode circuit of the last valve G contains a transformer T, which is tapped on the secondary, one side of the secondary being connected to the anode through a condenser C. A condenser K is shown connected between the earth and the low potential side of the primary winding of the transformer T. It is not quite clear if the earth connection shown at E is the same as the earth of the set, but if so, the condenser K is simply connected across the high tension battery. The tapped transformer is shown connected to an object P. This object P is a mesh or network of wires which, it is stated, can be placed between sheets of rubber, or stout paper, and concealed under carpets, or suspended beneath ceilings or similar inconspicuous places. It is stated that an intense electrostatic field is set up between the meshes and the earth. Further, it is stated that if a pair of insulated conductors is placed in the field, having unequal capacities to earth, a potential will be set up between them, and if the telephones be connected to them they will be rendered operative. The

specification also describes and claims a form of telephone which is essentially of the pot magnet type.

Ingenious as the scheme may be, we ourselves prefer to connect our phones to a receiver by means of two terminals!

A DAMPED DIAPHRAGM.

(Application date, June 13, 1923. No. 222,174.)

A. F. Sykes describes in British Patent No. 222,174 (which is one of a series of his patents relative to diaphragms), an interesting form of damping. The specification relates to diaphragms of all types and for all purposes; the modification most suited for telephones or loud-speakers being shown in the accompanying illustration. An ordinary diaphragm D is shown adjacent to the electromagnet M. A damping plate S is attached to the centre of the diaphragm by means of a

portion L—the space between the damping plate S and the diaphragm being filled with some non-sonorous substance such as vaseline, oil, petroleum jelly, or even rubber. Many modifications are described in the specification, including a composite,

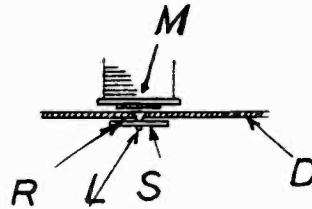

laminated, corrugated diaphragm, in which the corrugations are separated by a non-resonant substance. It seems that the specification contains considerable subject matter of interest to amateur experimenters.

SOME CORRECTIONS.

Unfortunately one or two clerical errors appeared in our last issue, and we shall be glad if readers will note them.

(1) Owing to a re-arrangement at the last moment, the words "by F. M. Colebrook" on the cover came above instead of below "The Rectifying Detector." It is, of course, the latter article which is by Mr. Colebrook, not the obituary note on Heaviside.

(2) Some Dewey Index numbers were omitted. They should be inserted as follows:—

P. 354 Series-parallel Switch R387

P. 363	Valve Designations	R130.30
P. 365	The Wireless Bill	R007.5
P. 367	New Valves Tested	R333.009
P. 369	Some Fixed Condensers	R381.009

(3) In the article on Error in Measurements (p. 360), the calculation given for finding the "probable error" actually finds what is known as the "mean error." We need not go into detail as to the distinction: the probable error is got by multiplying the mean error (as found by the method given) by two-thirds. In the example given, the probable error of a single reading will be 3.23, and that of the average 1.29; the percentage will be ± 0.87 per cent.