

**EVERYDAY**

OCTOBER 1991

# **ELECTRONICS**

INCORPORATING ELECTRONICS MONTHLY

£1.60

**PC-SCOPE  
INTERFACE  
USE YOUR PC AS A 'SCOPE**

**RIAA PREAMP  
UV EXPOSURE UNIT  
CENTURION TANK MODEL**



The No. 1 Magazine for Electronics & Computer Projects



**UNIDEN SATELLITE RECEIVER** Brand new units (model 8008) £60.00 ref 60P4V also some 7007s also £60.00 ref 60P5V

**SPECTRUM +2 COMPUTER** Built in data recorder, 128K, psu and manuals £59.00 ref 59P4V

**SPECTRUM +3 COMPUTER** Built in disc drive, 128K, psu and manuals £79.00 ref 79P4V

**AMSTRAD CPC464 COMPUTER** No manuals but only £79.00 ref 79P5V

**AMSTRAD CPC6128 COMPUTER** Again no manuals but only £149.00 ref 149P4V

**AMSTRAD GT65** Green screen monitor £49.00 ref 49P4V

**AMSTRAD PORTABLE PC'S FROM £149 (PPC1512SD), £179 (PPC1512DD), £179 (PPC1640SD), £209 (PPC1640DD). MODEMS £30 EXTRA. NO MANUALS OR PSU.**

**AMSTRAD PC BARGAIN!!!!!!**  
PC 1512DD COMPLETE WITH CGA COLOUR MONITOR, 2 DISC DRIVES, MANUALS ETC ONLY £249.00 REF 249P4V

**HIGH POWER CAR SPEAKERS.** Stereo pair output 100w each. 4ohm impedance and consisting of 6 1/2" woofer 2" mid range and 1" tweeter. Ideal to work with the amplifier described above. Price per pair £30.00 Order ref 30P7V.

**2KV 500 WATT TRANSFORMERS** Suitable for high voltage experiments or as a spare for a microwave oven etc. 250v AC input. £10.00 ref 10P93V

**MICROWAVE CONTROL PANEL.** Mains operated, with touch switches. Complete with 4 digit display, digital clock, and 2 relay outputs one for power and one for pulsed power (programmable). Ideal for all sorts of precision timer applications etc. £6.00 ref 6P18V

**FIBRE OPTIC CABLE.** Stranded optical fibres sheathed in black PVC. Five metre length £7.00 ref 7P29V

**12V SOLAR CELL.** 200mA output ideal for trickle charging etc. 300 mm square. Our price £15.00 ref 15P42V

**PASSIVE INFRA-RED MOTION SENSOR.** Complete with daylight sensor, adjustable lights on timer (8 secs -15 mins), 50' range with a 90 deg coverage. Manual override facility. Complete with wall brackets, bulb holders etc. Brand new and guaranteed. £25.00 ref 25P24V

PACK OF TWO PAR38 BULBS FOR ABOVE UNIT £12.00 REF 12P43V

**VIDEO SENDER UNIT** Transmit both audio and video signals from either a video camera, video recorder or computer to any standard TV set within a 100' range (tune TV to a spare channel). 12v DC op. £15.00 ref 15P39V Suitable mains adaptor £5.00 ref 5P191V

**FM TRANSMITTER** housed in a standard working 13A adapter (bug in mains driven) £26.00 ref 26P2V

**MINIATURE RADIO TRANSCIVERS** A pair of walkie talkies with a range of up to 2 kilometres. Units measure 22x52x155mm. Complete with cases. £30.00 ref 30P12V

**FM CORDLESS MICROPHONE.** Small hand held unit with a 500' range 2 transmit power levels reqs PP3 battery. Tuneable to any FM receiver. Our price £15 ref 15P42V

**10 BAND COMMUNICATIONS RECEIVER.** 7 short bands, FM, AM and LWDX local switch, tuning eye, mains or battery. Complete with shoulder strap and mains lead. NOW ONLY £19.00!! REF 19P14V.

**WHISPER 2000 LISTENING AID.** Enables you to hear sounds that would otherwise be inaudible! Complete with headphones. Cased. £5.00 ref 5P179V

**CAR STEREO AND FM RADIO.** Low cost stereo system giving 5 watts per channel. Signal to noise ratio better than 45db, wow and flutter less than .35%. Neg earth. £25.00 ref 25P21V

**LOW COST WALKIE TALKIES.** Pair of battery operated units with a range of about 150'. Our price £8.00 a pair ref 8P50V

**7 CHANNEL GRAPHIC EQUALIZER.** plus a 60 watt power amp! 20-21KHZ 4-8R 12-14V DC negative earth. Cased. £25 ref 25P14V

**NICAD BATTERIES.** Brand new top quality. 4 x AA's £4.00 ref 4P44V. 2 x C's £4.00 ref 4P73V, 4 x D's £9.00 ref 9P12V, 1 x PP3 £6.00 ref 6P35V

**TOWERS INTERNATIONAL TRANSISTOR SELECTOR GUIDE.** The ultimate equivalents book. Latest edition £20.00 ref 20P32V

**CABLE TIES.** 142mm x 3.2mm white nylon pack of 100 £3.00 ref 3P104V. Bumper pack of 1,000 ties £14.00 ref 14P6V

## VIDEO AND AUDIO MONITORING SYSTEM

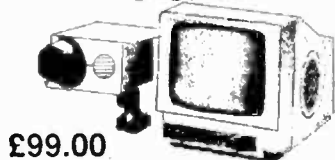

£99.00

Brand new units consisting of a camera, 14cm monitor, 70 metres of cable, AC adapter, mounting bracket and owners manual. 240v AC or 12v DC operation complete with built in 2 way intercom £99.00 ref 99P2V

**1991 CATALOGUE AVAILABLE NOW IF YOU DO NOT HAVE A COPY PLEASE REQUEST ONE WHEN ORDERING OR SEND US A 6" X 9" SAE FOR A FREE COPY.**

**GEIGER COUNTER KIT.** Complete with tube, PCB and all components to build a battery operated geiger counter. £39.00 ref 39P1V

**FM BUG KIT.** New design with PCB embedded coil. Transmits to any FM radio. 9v battery req'd. £5.00 ref 5P158V

**FM BUG** Built and tested superior 9v operation £14.00 ref 14P3V

**COMPOSITE VIDEO KITS.** These convert composite video into separate H sync, V sync and video. 12v DC. £8.00 ref 8P39V

**SINCLAIR C5 MOTORS** 12v 29A (full load) 3300 rpm 6"x4" 1/4"

O/P shaft. New. £20.00 ref 20P22V.  
As above but with fitted 4 to 1 inline reduction box (800rpm) and toothed nylon belt drive cog £40.00 ref 40P8V  
**SINCLAIR C5 WHEELS** 13" or 16" dia including treaded tyre and inner tube. Wheels are black, spoked one piece poly carbonate. 13" wheel £6.00 ref 6P20. 16" wheel £6.00 ref 6P21V  
**ELECTRONIC SPEED CONTROL KIT** for c5 motor. PCB and all components to build a speed controller (0-95% of speed). Uses pulse width modulation. £17.00 ref 17P3V  
**SOLAR POWERED NICAD CHARGER.** Charges 4 AA nicads in 8 hours. Brand new and cased £6.00 ref 6P3V.

AT 286 MOTHER BOARD  
640K RAM  
UPGRADABLE TO 4 M  
AT CASE  
AT POWER SUPPLY  
AT KEYBOARD  
MANUAL  
NO I/O CARDS

£139

**ELECTRONIC TICKET MACHINES** These units contain a magnetic card reader, two matrix printers, motors, sensors and loads of electronic components etc. (12"x12"x7") Good value at £12.00 ref 12P28V

**JOYSTICKS** Brand new with 2 fire buttons and suction feet these units can be modified for most computers by changing the connector etc. Price is 2 for £5.00 ref 5P174V

**GAS POWERED SOLDERING IRON AND BLOW TORCH** Top quality tool with interchangeable heads and metal body. Fully adjustable, runs on lighter gas. £10.00 ref 10P130V

**ANSWER MACHINES** BT approved remote message playback, integral push button phone, power supply and tape. Exceptional value at £45.00 ref 45P2V

**CAR IONIZER KIT** Improve the air in your car! clears smoke and helps to reduce fatigue. Case required. £12.00 ref 12P8V

**6V 10AH LEAD ACID** sealed battery by yuasha ex equipment but in excellent condition now only 2 for £10.00 ref 10P95V

**12 TO 220V INVERTER KITS** supplied it will handle up to about 15w at 220v but with a larger transformer it will handle 80 watts. Basic kit £12.00 ref 12P17. Larger transformer £12.00 ref 12P41V

**VERO EASI WIRE PROTOTYPING SYSTEM** Ideal for designing projects on etc. Complete with tools, wire and reusable board. Our price £6.00 ref 6P33V

**MICROWAVE TURNTABLE MOTORS.** Ideal for window displays etc. £5.00 ref 5P165V

**STC SWITCHED MODE POWER SUPPLY** 220v or 110v input giving 5v at 2A, +24v at 0.25A, +12v at 0.15A and +9v at 0.4A £5.00 ref 6P59V

**HIGH RESOLUTION 12" AMBER MONITOR** 2v 1.5A Hercules compatible (TTL input) new and cased £22.00 ref 22P2V

**VGA PAPER WHITE MONO** monitors new and cased 240v AC. £59.00 ref 59P4V

**25 WATT STEREO AMPLIFIER.** STK043. With the addition of a handful of components you can build a 25 watt amplifier. £4.00 ref 4P69V (Circuit dia included)

**LINEAR POWER SUPPLY** Brand new 220v input +5 at 3A, +12 at 1A, -12 at 1A. Short circuit protected. £12.00 ref 12P21V

**MAINS FANS** Snail type construction. Approx 4"x5" mounted on a metal plate for easy fixing. New £5.00 5P166V

**POWERFUL IONIZER KIT.** Generates 10 times more ions than commercial units! Complete kit including case £18.00 ref 18P2V

**MINI RADIO MODULE** Only 2" square with ferrite aerial and tuner. Superhet. Req's PP3 battery £1.00 ref BD716V

**HIGH RESOLUTION MONITOR.** 9" black and white Philips tube in chassis made for OPD computer but may be suitable for others. £20.00 ref 20P26V

**BARGAIN NICADS AAA SIZE 200MAH 1.2V PACK OF 10** £4.00 REF 4P92V, PACK OF 100 £35.00 REF 30P16V

**CB CONVERTORS.** Converts a car radio into an AM CB receiver. Cased with circuit diagram £4.00 ref 4P48V

**FLOPPY DISCS.** Pack of 15 3 1/2" DSDD £10.00 ref 10P88V. Pack of 10 5 1/4" DSDD £5.00 ref 5P168V

## BULL ELECTRICAL

250 PORTLAND ROAD HOVE SUSSEX  
BN3 5QT TELEPHONE 0273 203500  
MAIL ORDER TERMS: CASH PO OR CHEQUE  
WITH ORDER PLUS £2.50 POST PLUS VAT.

PLEASE ALLOW 10-14 DAYS FOR DELIVERY

NEXT DAY DELIVERY £8.00

FAX 0273 23077



**SONIC CONTROLLED MOTOR** One click to start, two click to reverse direction, 3 click to stop £3.00 each ref 3P137V  
**FRESNEL MAGNIFYING LENS** 83 x 52mm £1.00 ref BD827V  
**LCDDISPLAY.** 4 1/2 digits supplied with connection data £3.00 ref 3P77V or 5 for £10.00 ref 10P78V

**ALARM TRANSMITTERS.** No data available but nicely made complex transmitters 9v operation. £4.00 each ref 4P81V

**100M REEL OF WHITE BELL WIRE** figure 8 pattern ideal for intercoms, door bells etc £3.00 a reel ref 3P107V

**TRANSMITTER RECEIVER SYSTEM** originally made for nurse call systems they consist of a pendant style transmitter and a receiver with telescopic aerial 12v. 80 different channels. £12.00 ref 12P26V

**CLAP LIGHT.** This device turns on a lamp at a finger 'snap' etc. nicely cased with built in battery operated light. Ideal bedside light etc. £4.00 each ref 4P82V

**ELECTRONIC DIPSTICK KIT.** Contains all you need to build an electronic device to give a 10 level liquid indicator. £5.00 (ex case) ref 5P194V

**UNIVERSAL BATTERY CHARGER.** Takes AA's, C's, D's and PP3 nicads. Holds up to 5 batteries at once. New and cased, mains operated. £5.00 ref 6P36V

**ONE THOUSAND CABLE TIES** 175mm x 2.4mm white nylon cable ties only £5.00 ref 5P181V

**PC MODEMS** 1200/75 baud modems designed to plug into a PC complete with manual but no software £18.00 ref 18P12V

**ASTEC SWITCHED MODE POWER SUPPLY** 80mm x 165mm (PCB size) gives +5 at 3.75A, +12 at 1.5A, -12 at 0.4A. Brand new £12.00 ref 12P39V

**VENTILATED CASE FOR ABOVE PSU** with IEC filtered socket and power switch. £5.00 ref 5P190V

**IN CAR POWER SUPPLY.** Plugs into cigar socket and gives 3, 4, 5, 6, 7, 5, 9, and 12v outputs at 800mA. Complete with universal spider plug. £5.00 ref 5P167V

**CUSTOMER RETURNED** switched mode power supplies. Mixed type, good for spares or repair. £2.00 each, ref 2P292V

**DRILL OPERATED PUMP.** Fits any drill and is self priming. £3.00 ref 3P140V

**PERSONAL ATTACK ALARM.** Complete with built in torch and vanity mirror. Pocket sized, req's 3 AA batteries. £3.00 ref 3P135V

**POWERFUL SOLAR CELL 1AMP .45 VOLT** only £5.00 ref 5P192V (other sizes available in catalogue)

**SOLAR PROJECT KIT.** Consists of a solar cell, special DC motor, plastic fan and turntables etc plus a 20 page book on solar energy! Price is £8.00 ref 8P51V

**RESISTOR PACK.** 10 x 50 values (500 resistors) all 1/4 watt 2% metal film. £5.00 ref 5P170V

**CAPACITOR PACK 1.** 100 assorted non electrolytic capacitors £2.00 ref 2P286V

**CAPACITOR PACK 2.** 40 assorted electrolytic capacitors £2.00 ref 2P287V

**QUICK CUPPA?** 12v immersion heater with lead and cigar lighter plug £3.00 ref 3P92V

**LED PACK.** 50 red leds, 50 green leds and 50 yellow leds all 5mm £8.00 ref 8P52V

**FERRARI TESTAROSSA.** A true 2 channel radio controlled car with forward, reverse, 2 gears plus turbo. Working headlights. £22.00 ref 22P6V

**ULTRASONIC WIRELESS ALARM SYSTEM.** two units, one a sensor which plugs into a 13A socket in the area you wish to protect. The other, a central alarm unit plugs into any other socket elsewhere in the building. When the sensor is triggered (by body movement etc) the alarm sounds. Adjustable sensitivity. Price per pair £20.00 ref 20P34V. Additional sensors (max 5 per alarm unit) £11.00 ref 11P6V

**WASHING MACHINE PUMP.** Mains operated new pump. Noj self priming. £5.00 ref 5P18V

**IBM PRINTER LEAD.** (D25 to centronics plug) 2 metre parallel. £5.00 ref 5P186V

**COPPER CLAD STRIP BOARD** 17" x 4" of 1" pitch "vero" board. £4.00 a sheet ref 4P62V or 2 sheets for £7.00 ref 7P22V

**STRIP BOARD CUTTING TOOL.** £2.00 ref 2P352V

**3 1/2" disc drive.** 720K capacity made by NEC £60.00 ref 60P2V

**TV LOUDSPEAKERS.** 5 watt magnetically screened 4 ohm 55 x 125mm. £3.00 a pair ref 3P109V

**SPEAKER GRILLS** set of 3 matching grills of different diameters. 2 packs for £2.00 (6 grills) ref 2P364V

**50 METRES OF MAINS CABLE** £3.00 2 core black pre cut in convenient 2 m lengths. Ideal for repairs and projects. ref 3P91V

**4 CORE SCREENED AUDIO CABLE** 24 METRES £2.00 Pre cut in convenient 1.2 m lengths. Ref 2P365V

**TWEETERS** 2 1/4" DIA 8 ohm mounted on a smart metal plate for easy fixing £2.00 ref 2P366V

**COMPUTER MICE** Originally made for Future PC's but can be adapted for other machines. Swiss made £8.00 ref 8P57. Atari ST conversion kit £2.00 ref 2P362V

**6 1/2" 20 WATT SPEAKER** Built in tweeter 4 ohm £5.00 ref 5P205V

**5" X 3" 16 OHM SPEAKER** 3 for £1.00 ref CD213V

**ADJUSTABLE SPEAKER BRACKETS** Ideal for mounting speakers on internal or external corners, uneven surfaces etc. 2 for £5.00 ref 5P207V

**PIR LIGHT SWITCH** Replaces a standard light switch in seconds light operates when anybody comes within detection range (4m) and stays on for an adjustable time (15 secs to 15 mins). Complete with daylight sensor. Unit also functions as a dimmer switch! 200 watt max. Not suitable for fluorescents. £14.00 ref 14P10V

**2 MEG DISC DRIVES** 3 1/2" disc drives made by Sony housed in a 5 1/4" frame 1.2 meg formatted. £66.00 ref 66P1V

**CUSTOMER RETURNED** 2 channel full function radio controlled cars only £8.00 ref 8P200V

**WINDUP SOLAR POWERED RADIO!** FM/AM radio takes NICAD batteries complete with hand charger and solar panel 14P200V

**240 WATT RMS AMP KIT** Stereo 30-0-30 psu required £40.00 ref 40P200V

**300 WATT RMS MONO AMP KIT** £55.00 Psu required ref 55P200V

**ALARM PIR SENSORS** Standard 12v alarm type sensor will interface to most alarm panels. £16.00 ref 16P200V

**ALARM PANELS** 2 zone cased keypad entry, entry exit time delay etc. £18.00 ref 18P200V

**35MM CAMERAS** Customer returned units with built in flash and 28mm lens 2 for £8.00 ref 8P200V

**STEAM ENGINE** Standard Mamod 1332 engine with boiler piston etc £30ref 30P200V

SOME OF OUR PRODUCTS MAY BE UNLICENSEABLE IN THE UK

# EVERYDAY ELECTRONICS

INCORPORATING ELECTRONICS MONTHLY

ABC  
MEMBER OF THE ASSOCIATION  
OF PUBLISHERS

VOL. 20 No. 10 OCTOBER 1991

The No 1 Magazine for Electronic & Computer Projects

ISSN 0262 3617

PROJECTS... THEORY... NEWS...  
COMMENT... POPULAR FEATURES...

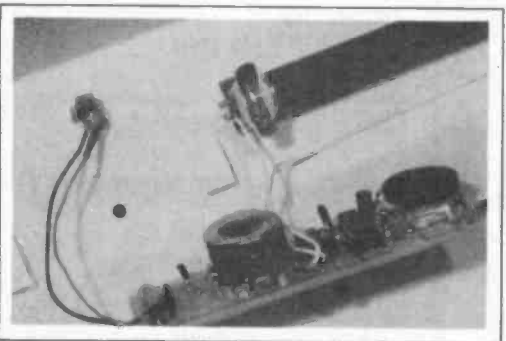
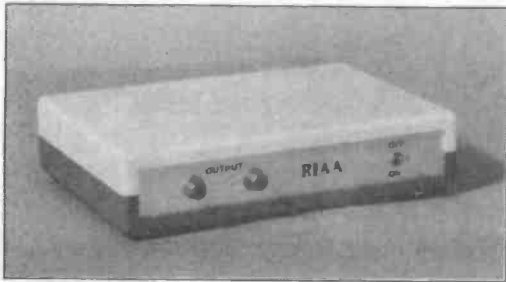

## Projects

- PC-SCOPE INTERFACE** by John Becker 620  
Use your PC compatible computer as an oscilloscope
- UV EXPOSURE UNIT** by R. M. Worthington 628  
Inexpensive project for p.c.b. making – the circuit will also power a fluorescent tube from a 12V supply
- RIAA PREAMPLIFIER** by Robert Penfold 638  
Use a record deck with virtually any audio equipment
- SIMPLE MODEL SERIES**
- 4-CENTURION TANK** by Owen Bishop 643  
Gun sounds and flashes from this scale model
- MODULAR DISCO LIGHTING SYSTEM** by Chris Bowes 661  
Part Six: VU Module

## Series

- MAGNETIC RECORDING** by Vivian Capel 633  
Part One: What is Magnetism? Why Use Bias?
- INTERFACE** by Robert Penfold 652  
The spot for all computer enthusiasts – PIO prototyping card
- AMATEUR RADIO** by Tony Smith G4FAI 660  
RSGB Video; First Novice Licences; Happy Memories
- ACTUALLY DOING IT** by Robert Penfold 668  
Various types of resistor and their uses.

## Features

- EDITORIAL** 619
- SIMPLE MODELS SERIES SPECIAL EASIWIRE OFFER** 642
- FOR YOUR ENTERTAINMENT** by Barry Fox 650  
Michael Faraday and Charles Babbage exhibitions
- SHOPTALK** with David Barrington 651  
Component buying for EE projects
- DOWN TO EARTH** by George Hylton 654  
Junction f.e.t.s
- ROBOT ROUNDUP** by Nigel Clark 657  
News from the world of robotics
- DIRECT BOOK SERVICE** 670  
Selected technical books and all the EE books by mail order
- PRINTED CIRCUIT BOARD SERVICE** 674  
P.C.B.s for EE projects

## FREE WITH THIS ISSUE

**MARCO TRADING 1992 CATALOGUE** Banded to all copies

**ADVERTISER'S INDEX** 680

**Readers Services • Editorial and Advertisement Departments** 619

© Wimborne Publishing Ltd 1991. Copyright in all drawings, photographs and articles published in **EVERYDAY ELECTRONICS** is fully protected, and reproduction or imitations in whole or in part are expressly forbidden.

Our November '91 Issue will be published on Friday, 4 October 1991. See page 611 for details.

Everyday Electronics, October 1991

# SPECIAL OFFER

**20 MEG IDE HARD DISC DRIVE  
CONNERS - CP 3024**

**COMPACT - 4.00" x 5.75" x 1.00"**

**LIGHTWEIGHT (1.1 lbs) - LOW POWER**

**SUITABLE FOR: LAPTOPS \* XT \* 286 \* 386  
AMSTRAD 1512/1640 (WITH OPTIONAL CARD)**

CP 3024 (20 MEG IDE DRIVE)	£ 97.00
IDE CARD (INCLUDING CABLE)	£ 20.00
XT/1512/1640 CARD (SUITABLE FOR XT/1512/1640)	£ 29.00
MOUNTING KIT (INCLUDING WHITE & BLACK BEZEL & LED)	£ 9.00

### SPECIAL DEAL 1

20 MEG + IDE CARD £112

### SPECIAL DEAL 2

40 MEG + IDE CARD £190

### SPECIAL DEAL 3

20 MEG + XT CARD £122

### SPECIAL DEAL 4

40 MEG + XT CARD £197

### \* ATTENTION AMSTRAD 1512/1640 USERS \*

WOULD YOU LIKE TO USE 1.2M OR 1.44M DRIVES ON YOUR COMPUTER. YOU CAN NOW WITH HOBBYKIT'S FLOPPY DISC CONTROLLER CARD. WILL ALLOW 2 EXTRA DRIVES OF ANY FORMAT IN YOUR COMPUTER

**SPECIAL PRICE £ 31.00**

### HARD DISC DRIVES

**20 MEG MFM OR RLL FROM £75**

### ADD ON CARDS

FDD CONTROLLER - 2xFDD - ANY FORMAT	£ 25.00
VGA CARD - 16 BIT - 256K	£ 39.00
TRIDENT SUPER VGA - 16BIT - 512K	£ 60.00
2 SERIAL / 1 PARALLEL / 1 GAMES PORT	£ 19.00
4 MB RAM CARD FOR AT WITH EMS USES 256K OR 1M - WITHOUT RAM	£ 63.00

### MOTHERBOARDS

AMI BIOS - ZERO RAM - SUPPORTS  
EMS 4.0 & SHADOW RAM

286 - 12 L/S 16 MHz	£ 70.00
286 - 16 L/S 21 MHz	£ 89.00

### 3 STATION NETWORK SYSTEM

ALL PARTS FOR 3 STATIONS SUPPLIED INCLUDING DRIVER SOFTWARE AND DATA - USES TWISTED PAIR CABLE - EXPANDABLE EASY INSTALLATION - APPROX 30 MINS. BY WELL KNOWN NETWORKING COMPANY 1 MB TRANSFER RATES  
**SPECIAL OFFER PRICE £ 57.00**

### FLOPPY DISC DRIVES

3.5" 1.44M INTERNAL	£ 45.00
3.5" 720K INTERNAL	£ 40.00
5.25" 1.2M INTERNAL	£ 45.00
5.25" 1.2M EXTERNAL	£ 47.00
5.25" 360K EXTERNAL	£ 27.00

### ACCESSORIES

5.25" ADAPTOR KIT FOR 3.5" FDD	£ 8.00
5.25" TRAY FOR 3.5" FDD	£ 5.50
POWER LEAD FOR 3.5" FDD	£ 3.00
IDC PIN TO EDGE CONNECTOR PCB	£ 4.00
SHORT F D D CONTROLLER CABLE 2'	£ 4.00
LONG F D D CONTROLLER CABLE 4'	£ 7.00
POWER SPLITTER	£ 4.50
HARD DRIVE CABLES	£ 6.00
MICRO 'T' SWITCH - RS232	£ 7.45

## HOBBYKIT

**CREDIT CARD HOTLINE**

**081 - 205 7485**

UNIT 19 CAPITOL INDUSTRIAL PARK  
CAPITOL WAY, LONDON, NW9 0EQ  
FAX NUMBER: 081 - 205 0603

## END OF LINES

**MODEMS - V22 BIS - 2400 BPS**  
AUTO DIAL - AUTO ANSWER - FULL DUPLEX  
AUTO REDIAL - TONE & PULSE DIALING  
BT APPROVAL - BAPT APPROVAL  
SUPPLIED WITH EAZILINK COMMS PACKAGE  
MC2400 - INTERNAL £ 65.00  
SM2400 - EXTERNAL £ 93.00

**3" - 180K EXT FLOPPY DISC DRIVE**  
REVERSIBLE - FDI BY AMSTRAD - BLACK  
COMPLETE WITH POWER SUPPLY  
**SPECIAL OFFER PRICE £ 30.00**

**3.5" - 720K EXT FLOPPY DISC DRIVE**  
NEW - GREY CASE - BY WELL KNOWN OEM  
**SPECIAL OFFER PRICE £ 26.00**

**3.5" - 1.44M INT FLOPPY DISC DRIVE**  
BLACK ONLY - BY WELL KNOWN OEM  
**SPECIAL OFFER PRICE £ 39.00**

**5.25" - 360K INT FLOPPY DISC DRIVE**  
NEW - GREY OR BLACK - WELL KNOWN OEM  
**SPECIAL OFFER PRICE £ 24.00**

**CGA CARD - FULL LENGTH -  
COMPOSITE OR TTL £ 12.00**

**12" VGA PAPER WHITE MONITOR**  
TILT & SWIVEL BASE £ 75.00

**60 MEG TAPE STREAMER**  
DC600 - 5.25" TRAY  
SUITABLE FOR ALL IBM COMPATIBLES  
**PRICE: £ 150.00**

### SOFTWARE

WORDSTAR 2000 LAN VOL 1 & 2	£ 35.00
ACCOUNT MASTER LAN	£ 30.00
SUPER CALC 4 LAN	£ 30.00
ABILITY PLUS	£ 30.00
PAYMASTER	£ 30.00
LINK MASTER	£ 30.00
SUPER CALC 2 FOR CP/M PLUS	£ 25.00
LOCOMAIL FOR PCW	£ 25.00

### PRINTER

**LQ 3500 24 PIN DOT MATRIX PRINTER**  
80 COLUMN - LETTER QUALITY  
SERIAL OR PARALLEL INTERFACE  
TRACTOR OR FRICTION FEED **£120.00**

**PLEASE ADD £ 3.00 TO ALL ORDERS  
TO COVER POSTAGE (UK) - OVERSEAS  
ORDERS CALL OR FAX FOR DETAILS**  
**★★ ALL PRICES  
INCLUDE V A T ★★**

# ELECTRONIC DARTS SCORER

*This article describes the design and construction of a microprocessor controlled darts scorer similar in specification and performance to commercially available units. The Darts Scorer has the following features: players scores displayed on individual 3-digit l.e.d. displays; home and away players scores entered via common keypad; facility to recall previously entered score; individual start scores can be entered for each player (to allow handicapping); correct facility available for incorrectly entered scores; functions as a digital clock when not being used for darts.*

*The construction of this unit should give the reader a useful insight into the design and construction of a typical "embedded" microprocessor application*



# FREE

WITH THE NOVEMBER ISSUE  
132 PAGES OF COMPONENTS,  
KITS, EQUIPMENT ECT.

WORTH £2.00

# 1992 GREENWELD

## ELECTRONIC COMPONENT CATALOGUE

## INFORMATION TECHNOLOGY AND THE NATIONAL CURRICULUM – A new twelve part series

*The series aims to help teachers, parents and students by exploring topics in and around the National Curriculum. Practical work is suggested which will reinforce and add interest to certain topics.*

*The series is designed as a resource from which ideas can be drawn as required. Where practical work is suggested, this will use simple equipment. For later levels, some specialised components will be needed but every effort has been made to keep costs to a minimum by using home-made parts wherever possible.*

## BICYCLE ALARM

*Requiring no external wiring this alarm will sound for just ten seconds if the bike is knocked or falls over but will sound continually should the bike be ridden or removed in a vehicle.*

# EVERYDAY ELECTRONICS

NOVEMBER ISSUE ON SALE FRIDAY OCTOBER 4, 1991

THE  
NEXT  
ISSUE



# NEW!

# JUST RELEASED after 5 years research

▶ THE ULTIMATE ◀

## XV2000 Video Companion

...keeping you in the picture for the 90's in style

**NOW AVAILABLE IN KIT FORM**



**EASY TO FOLLOW INSTRUCTIONS**

**LOOKS EVEN BETTER FROM THE BACK!**

**LOOK AT HIDDEN SATELLITE SIGNALS**



- ▶ MULTI-CHANNEL EXPANDABLE DECODER
- ▶ MODULAR—UP TO 6 CHANNELS: PICK 'N' MIX
- ▶ DIRECT AUTOMATIC INTERFACE TO SKY DECODER
- ▶ JUMBO INTEGRAL POWER SUPPLY—3 AMP
- ▶ BEAUTIFULLY STYLED CASE
- ▶ VIDEO LOOP THROUGH OR MODULATOR
- ▶ INTERFACES SIMPLY TO ALL TUNERS
- ▶ ADVANCED AUDIO ROUTING FOR FILMNET/CANAL PLUS—ESSENTIAL FOR '92—UNIQUE TO HI-TECH
- ▶ AUTOMATICALLY SWITCHES VIDEO BETWEEN MODULES
- ▶ AUTOMATICALLY SWITCHES AUDIO BETWEEN MODULES
- ▶ SUPPORTS WEGNER STEREO MODULE—11 CHOICES
- ▶ VIDEO AND AUDIO QUALITY REMAINS TOTALLY INTACT AS BROADCAST
- ▶ NO COMPROMISE—JUST PERFECTION
- ▶ SCART CONNECTION DIRECT TO TV/VIDEO
- ▶ ALL MODULES FULLY UPGRADEABLE

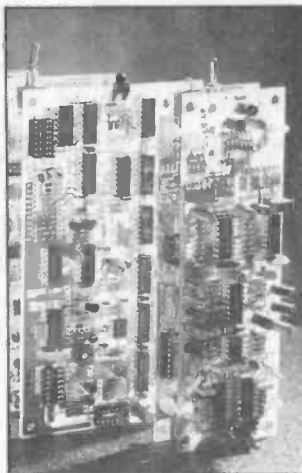

**MODULES AVAILABLE**

	ASSEMBLED/ TESTED	KIT
FILMNET VIDEO	£79.99	£36.99
FILMNET DIGITAL STEREO AUDIO (NEEDED '92)	£125.00	£89.99
TELECLUB	£125.00	£79.99
CANAL PLUS/RAI INC. AUDIO (DISCRETE)	£155.65	£99.99
SECAM TO PAL CONVERTER (SECAM)	£99.99	£69.99
DUAL SECAM—RAI/CANAL PLUS (DISCRETE/SECAM)	£216.52	£149.99
RTL4 (DUTCH/ENGLISH)	£79.99	£39.99
STEREO MODULE	£99.99	£74.99
IF UHF MODULATOR NEEDED (NO LOOP THRU)	£15.00	£15.00
<b>LEADS</b> (State make of tuner when ordering)		
VIDEO COMPANION XV2000 TO TUNER		£4.99
SCART LEAD		£6.99
SKY MOVIES DIAGRAM		£35.00

**ORDER NOW** ▶ ◀

**GET THAT PROFESSIONAL LOOK AT THE FINISH**

INNOVATION HOUSE · ALBANY PARK  
FRIMLEY ROAD · CAMBERLEY · SURREY · GU15 2PL

**TELEPHONE 0276-692040**

**FACSIMILE 0276-684716**

**OPEN MONDAY to FRIDAY · 9:00am – 7:00pm**

**SATURDAY · 10:00am – 4:00pm**

**BUILD IT YOURSELF AND SAVE POUNDS**



▶ ALL PRICES EXCLUDE VAT ▶ LEADS AND DELIVERY EXTRA ▶ SECURIOR DELIVERY EXTRA



# How to make the most of your hobby

Imagine the satisfaction of building your own electronic devices from simple projects through to complex circuits such as microcomputers. The pleasure of assembling your own PCBs; of seeing your skills and understanding grow as you explore the wealth of expert information packed into every page of the Modern Amateur Electronics Manual – this is the definitive book for the electronics enthusiast.



Simple step-by-step instructions, clear indexing and abundant illustrations make each project easy to understand. As Mr. Lawson of Fleetwood Nautical College and many enthusiasts like him said: "I'd be lost without the manual at my side."

Your manual will always be up-to-date, as supplements are added, each containing over 150 pages.

Whether you're starting with the basics or tackling advanced projects the Modern Amateur Electronics Manual will help you make the most of a truly absorbing hobby. To receive your copy on 10 days Free Approval, just complete the coupon or ring FREEPHONE.



## ORDER FORM – SEND NO MONEY

To: WEKA Publishing Limited **FREEPOST**  
The Forum 74–80 Camden Street London NW1 1YW Tel: 071-388 8400

**FREEPHONE** 24hr Order Hotline. Use your credit card on 0800 289762

**YES** please send me immediately on 10 days free approval  
**THE MODERN AMATEUR ELECTRONICS MANUAL**

(Order No 12000). If I decide to keep the manual, I shall then pay **only £39.95** plus £5.50 postage and packing at the end of the 10 day approval period. I shall also receive the appropriate Updating Supplements throughout the year. These are billed separately, priced at £20 plus £2.50 p&p, and can be discontinued at any time

(CAPITALS PLEASE)

NAME \_\_\_\_\_

ADDRESS \_\_\_\_\_

POSTCODE \_\_\_\_\_

SIGNATURE \_\_\_\_\_ AGE (if under 18) \_\_\_\_\_

### OVERSEAS ORDERS

All overseas orders have to be prepaid but will be supplied under a Money-Back Guarantee of Satisfaction. If you are an overseas customer send no money at this stage, but return the complete order form. Upon receipt of this we will issue a pro-forma invoice for you to pay against. Payment must be made in sterling.

We reserve the right to alter the price and page extent of future supplements. You will be informed as and when any such decisions are made.

From time to time we will tell you about other companies' products and services, which we feel you might be interested in.

Please tick here if you would prefer not to take part in this opportunity

### WEKA GUARANTEE

You risk nothing by ordering today – as this title is covered by WEKA Publishing's Guarantee of Satisfaction. If for any reason it fails to match your expectations simply return it in perfect condition and you will owe us nothing

*Elizabeth Evans*  
E. Evans – Publisher



WEKA PUBLISHING GROUP  
GERMANY · AUSTRIA · FRANCE · ITALY · USA · NETHERLANDS · SWITZERLAND · UNITED KINGDOM

350905



# SUPER SUMMER SALE FINAL BARGAIN OFFERS!!

**SALE  
MUST END  
SEPT 30th!!**

You've only a few more weeks to take advantage of our Super Summer Sale bargains!  
Look at this page for some of the outstanding offers still available - but only until Sept 30th!!  
So don't delay a moment longer - order now by post, phone, fax or in person!!

## JUST ARRIVED!! CABLE TV UNIT

**Z8939** Super 2 tone brown ABS sloping front box 250x202x100mm with 5 way switch bank and changeover switch containing electronics to demodulate coded signal from cable TV then convert to UHF for the aerial input. PCB contains UHF demodulator, video pre amp, stabilised power supply and conversion circuitry. Supplied with info sheet only..... **£6.95**

## ROCKER SWITCHES

Big parcel of 60,000 miniature and standard SP & DP illuminated and plain types available in mixed packs or individually. SAE for list.  
Sell lot for..... **£4,000**  
**K824** Pack of 25 rockers..... **£4.95**

## RESISTOR NETWORKS

A superb selection from 5 to 16 pin in SIL and DIL 1/4 million available - SAE for LIST  
Sell lot for..... **£1,000**

## MODEMS

**Z8936** Buzzbox DSL21 V21 (300 baud). Complete with external PSU, 5 pin DIN plug & instructions..... **£24.95**  
**Z8937** One-to-one V21/23 auto 300, 1200/75 75/1200 loads of features, 76 page manual, power supply and lead..... **£75.00**

## RELAYS

**Z2164** PCB relay with SPCO 8A 250V contact. Coil 15-30VDC..... **1k + 0.25**  
Only **75p** 100 + 0.35  
**Z2167** 12V PCB relay with 5A SP contact.  
Price **50p** 100 + 0.28 1k + 0.20

## TRANSUDCERS

A parcel of 5,000 piezo and electromagnetic. £500 the lot or send SAE for individual prices. Also available in packs:  
**K823** Pack of 10 assorted with info..... **£2.50**

## OPTO DISPLAYS

**Z5118** Giant 30mm fluorescent 2 char green star burst display 88x49x8mm by Futaba. With data..... **£2.00**  
**Z1463** 4 digit multiplexed 27mm LCD 50x30mm. Symbols include bar graph and weight symbols. With data. 13 pin connector..... **£2.00**  
**Z5119** Comms LCD. Massive 140x40mm display has 110 pins and shows a variety of symbols and power levels used in radio comms. No further info..... **£2.00**  
**Z4115** 8 digit 12.7mm high LCD and holder. These are 14 segment devices allowing alphanumeric display. Normally costing over £15.00 we are offering these for just..... **£4.95**  
**SALE PRICE £2.00**  
**Z4148** LCD as Z4115 but 6 digit, 50 pins. Trade price £10.86..... **£3.00**  
**SALE PRICE £1.50**  
**Z1732** Epson LCD 4 digit 8mm high..... **£2.00**  
**SALE PRICE £1.00**  
**Z1637** LCD Display - Direct drive 3 1/2 digit with LO-BATT 12.7mm high digits. DP voltage 4-12 RMS @ 32Hz type. Consumes only 25mA with all segments on. Trade price £7.97 each. Supplied with data but no edge connector.  
Price **£1.00** 10 + 1.52 25 + 1.30 100 + 0.85  
**SALE PRICE 75p**  
**10 + 0.50 100 + 0.40**  
**Z2119** LCD 4 digit 12.5mm high with low batt and clock symbol. Complete with edge connector. Can you believe the price?  
**SALE PRICE £1.00**  
**25 + 0.60 100 + 0.45 1k + 0.35**  
**Z5096** 16 character x 1 line. Very similar to our Z1814 but slightly larger character 6.3x3.15 (8x5 dots). Type LCM16166 by Sanyo. Supplied with data. On board Hitachi HD44780A00 chip.  
**SALE PRICE £8.00**

## BULK LED'S

**Z2089** 5mm Red **15/£1 100 + £3.68**  
**Z2092** 5mm Green **14/£1 100 + £4.37**  
**Z2093** 5mm Yellow **14/£1 100 + £4.37**

## EASIWIRE CLEARANCE OFFER!!!

The easy to use no-soldering wiring tool which makes construction of small electronic projects so simple!  
All included in the kit are: Wiring pen, Utility tool, Punched wiring board, Self adhesive sheet, Spring loaded terminals and jacks, Spare spool of wire. Excellent instruction book. Catalogue price £15.00  
**SALE PRICE £5.00**

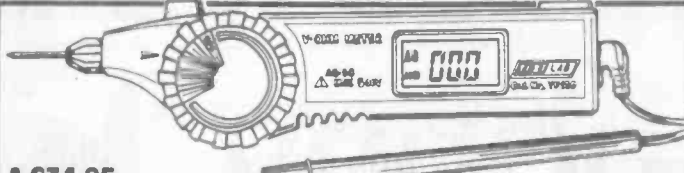

## A £34.95 AUTORANGING MULTIMETER

(1991 Catalogue)  
**LESS THAN  
1/3 PRICE!!  
YOURS FOR  
JUST**

- \* 3 1/2 digit 8mm LCD display
- \* Diode and continuity test
- \* Protective carrying case
- \* Automatic polarity and zero
- \* Fully autoranging
- \* Display hold facility
- \* Probe styling

**£16**

## LOGIC PROBE/PULSER

Top quality slim (18mm dia) precision instrument for troubleshooting and analysis of logic circuits. It works as a level detector, pulse detector and pulse stretcher. It is circuit powered, has LED indicators and comes with additional probe lead and clip, and instruction sheet. An excellent addition to your Test Gear at an unrepeatable price. We have purchased all available supplies and can offer this superb instrument for around half the normal selling cost.

**ONLY £10.00**

## COMPONENT PACKS

**K547** Zener Diodes. Glass and plastic. 250mW to 5W ranging from 3V to 180V. All readily identifiable, with list supplied.  
Price **100 for £4.50**  
**SALE PRICE £2.50**

**K517** Transistor pack. 50 assorted full spec. marked plastic devices PNP NPN RF AF. Type numbers include BC114, 117, 172, 182, 183, 198, 239, 251, 214, 255, 320, BF198, 255, 394, 2N3904 etc. etc. Retail cost £7.00 +..... **£2.75**  
**SALE PRICE £1.50**

**K575** Plastic Power pack. Mainly TO126 and TO220 transistors, SCRs, Triacs etc. All new full spec marked devices offering fantastic value. Lots of TIP and BD types..... **50/£7.50**  
**SALE PRICE £4.00**

**K576** Mixed pack of TO220 and 4 pin power mosfets with data and pinouts. Types may include: 2N7004/5/6/14, IRF620/10/720/820, IRF9520/9620, VN0300D etc..... **Pack of 25/£8.00**  
**SALE PRICE £4.50**

**K573** IC Pack - a mix of linear and logic chips, from 6 to 40 pin. All are new and marked, but some may not be full spec.  
Price **100/£6.75**  
**SALE PRICE £4.00**

**K544** Mullard Polyester Caps. Cosmetic Imperfections, electrically OK. Wide range of values from 0.01 to 0.47µF in 100, 250, 400V working..... **200/£4.75**  
**SALE PRICE £2.50**

**K804** Lamp Pack. A superb quality pack containing a wide variety of small lamps. Many different types - wire ended, bi-pin, slide, MBC, MES, LES, T wedge, mini flange etc in voltages from 2.5V to 220V. Most are marked with voltage/current..... **Pack of 50/£4.00**  
**SALE PRICE £2.50**

**K712** Crystals. Mostly HC60 and HC18U in a wide variety of frequencies from a few hundred kilohertz to many megahertz and the odd crystal oscillator module or two..... **20 for £4.95**  
**SALE PRICE £4.00**

**K586** This one's an absolute gem! Contains a selection of conventional and switch mode power supplies, including AA12531, 24215, 24311 + 7 others!! Parcel of 10 originally selling for £40 +..... **£15.00**  
**SALE PRICE £4.00**

**K539** LED Pack. Not only round but many shaped LEDs in this pack in red, yellow, green, orange and clear. Fantastic mix..... **100/£5.95**  
**SALE PRICE £3.95**

**K530** 100 Assorted Polyester Caps. All new modern components, radial and axial leads. All values from 0.01 to 1µF at voltages from 63 to 1000V..... **£3.95**  
**SALE PRICE £2.50**

**K582** Polystyrene Caps. An amazing range of values from a few pF to .01. Tolerances 1-20%. Voltages to 500V.  
Price **Pack of 200/£4.00**  
**SALE PRICE £2.00**

**K540** Resistor Pack. Mostly 1/4, 1/2 and 1/2W, also some 1 and 2W in carbon film, oxide etc. All have full length leads. Tolerances from 2 to 20%. Excellent range of values..... **500/£2.50**  
**SALE PRICE £1.50**

**K523** Resistor Pack. 1000 - yes, 1000 mainly 1/2W 5 & 10% carbon/ carbon film resistors with preformed leads for PCB mounting. Fair range of preferred values..... **Only £2.50**  
**SALE PRICE £1.25**

**K531** Precision Resistor Pack - High quality, close tolerance R's with an extremely varied selection of values mostly 1/2W and 1/4W tolerances from 0.1% to 2% - ideal for meters, test gear etc..... **250/£3.00**  
**SALE PRICE £1.50**

**K572** Resistor Networks. Both SIL and DIL in here, from 6 to 16 pin. Plenty of popular values like 1k, 4k7 and 10k, and a good sprinkling of many other values.  
Pack of 100..... **£4.50**  
**SALE PRICE £3.00**

**K520** Switch Pack. 20 different assorted switches - rocker, slide, push, rotary, toggle, micro etc. Amazing value!  
**£2.00**  
**SALE PRICE £1.50**

**K715** DIP Switch Pack Tremendous selection of DIP switches, mostly from Page 121 of 1991 catalogue. Everything from 1-9 way at an astonishingly low price! Pack of 20..... **£3.50**  
**SALE PRICE £2.00**

**K802** Pack of DIN41612 connectors. These popular PCB connectors come as 32/64/96 way. Both plugs and sockets, some with pins missing. Normally costing £1-£3 each Pack of 25..... **£8.00**  
**SALE PRICE £5.00**

**K555** Fuses. A marvellous selection of 15, 20, 25 and 32mm fuses both cartridge and wire ended in quickblow and ant surges varieties. May be anything from 32mA to 50A!! **100/£3.95**  
**SALE PRICE £2.50**

All 1 off prices include VAT, quantity prices do not. P&P £3.00 per order. Min Credit Card £12. Min CWO £12. Official orders from Education welcome, min invoice charge £15.00.

Payment is accepted by cheque, postal order, cash (including foreign currency bank notes) book tokens, Access, Visa, Connect.  
Our stores have enormous stocks of components and our trade counter is open from 9-5.30 Mon-Sat. Come and see us!  
Tel: (0703) 236363 Fax: (0703) 236307

**27D PARK ROAD, SOUTHAMPTON, SO1 3TB**

## BATTERIES

### Sealed Lead Acid

**Z8918** YUASA NP6-12. 12V 6Ah sealed lead acid battery. These have been regularly trickle charged whilst in store. Size 150x95x65mm. List price £28.00.  
**SALE PRICE £12.50 10 + 9.00**  
**Z8920** YUASA sealed lead acid battery NP10-6 6V 10Ah Size 150x95x50mm. List £18.00  
**SALE PRICE £8.00 10 + 6.00**

**Z4150** Ex mobile radio battery. 56x63x33mm case (sometimes damaged) contains 8xAA size rechargeable Nicads. These can be removed by breaking the case open. Each cell rate 1.25V 600mA..... **£3.00**  
**SALE PRICE £2.50**

**Z4149** As above but 84x66x33mm. There are again 8 cells but they are longer than AA size, being 73mm long, each cell rated 1.25V 900mA..... **£4.50**  
**SALE PRICE £3.00**

**Z1952** AA Nicads - 2 sleeved end to end. Easily split into 2 if required.  
Price **£1.50 25 + 1.10 100 + 0.75**  
**SALE PRICE £1.00**

### AAA Nicads by Sanyo

**SUPERDEAL PRICE!!** These superb quality batteries are rated 1.2V 200mAh, and may be charged at 20mA or quick-charged at 60mA. Normally costing around £1.50 each, we can offer these at the SUPERDEAL prices below:  
Order Code **Z117**  
**SALE PRICES £1.00**  
**25 + 0.75 100 + 0.60**

## POWER SUPPLIES

### Train controller and Switching Unit

This ready built versatile piece of equipment allows:  
\* Full forward and reverse control of trains using regulated and smoothed supply (1.5A).  
\* Requires 3 components (supplied) to be soldered into panel.  
\* Relay control of 5 separate circuits. (10A change over contacts; ideal for points operation).  
\* Powering of auxiliary equipment - 2 separate 5V 1A outputs.  
A mains powered panel 185x105mm contains all electronics. All voltages are fully stabilized and both input and output are fused.  
Connections, both input and output are by screw terminals which are clipped onto the on-board pins.  
The five 12V relays are controlled by transistor circuits which require only 5V 30mA, supplied by the on board power supply.  
Supplied uncased with circuit and wiring diagram. (SAE for free copy.)  
Suitable black ABS plastic case..... **£3.50**  
Order Code **Z8897** **£19.95**  
**SALE PRICE £9.95**

## SWITCH MODE PSU'S

**AA12531** Partially enclosed in steel case 160x104x45mm. 115V/230V 50/60Hz input. Output +5V@6A; +12V@0.15A.  
**SALE PRICE £6.95**  
Kit to convert to +12V@2.5A, +5V@2A.  
**SALE PRICE £3.50**

**BM41012** Totally enclosed steel cased unit 175x136x65mm with switched and fused IEC mains inlet. 115/230V 50/60Hz input. Outputs: +5V@3.75A; +12V@1.5A. 65 watts max.  
**incredible value at £12.95**  
**Z660** Astec switched mode PSU type AA7271. PCB 50x50mm will accept 8-14V input and give a stable 5V dc up to 2A output. The 6 transistor circuit provides current overload protection, thermal cut-out and excellent filtering.  
**SALE PRICE £3.00**

**Z8887** Made by STC, this 160x100mm panel is attached to an aluminium chassis. 165x102x65mm and has a single 5V 6A output. Supplied with connection details, we can offer these at a fraction of their normal cost!  
Price **Only £8.95**  
**SALE PRICE £7.95 100 + 4.50**

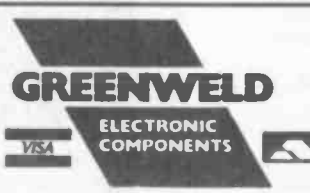

# MAGENTA ELECTRONICS LTD

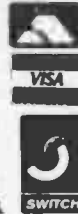

MAIL ORDER AND SHOP  
EE111  
135 Hunter Street  
Burton-on-Trent  
Staffs, DE14 2ST  
Tel: 0283 65435  
Fax: 0283 46932

All prices include VAT at 17½%  
Shop open 9-5 Mon-Fri; Add £2  
9-2 Saturday p&p to  
Official orders welcome all orders

## PORTABLE ULTRASONIC PEST SCARER

EE AUG '91

A powerful 23kHz Ultrasonic generator in a compact hand-held case. A MOSFET output drives a weatherproof transducer at up to 300V peak to peak via a special tuned transformer. Sweeping frequency output requires no setting up or alignment. Kit includes all components, PCB, transducer and case.

KIT REF 842 KIT PRICE £22.56

## D.C. MOTOR GEARBOXES

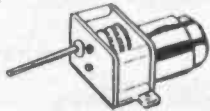

Ideal for Robots and Buggies. A miniature plastic reduction gearbox coupled with a 1.5-4.5 Volt mini motor. Variable gearbox reduction ratios are obtained by fitting from 1 to 6 gearwheels (supplied). Two types available:

**SMALL UNIT TYPE MGS £4.08**

Speed range 3-2200 rpm. Size 37x43x25mm

**LARGE UNIT TYPE MGL £4.65**

Speed range 2-1150 rpm. Size 57x43x29mm

**Supplying Electronics  
for Education,  
Robotics, Music,  
Computing and much,  
much more!**

**1991 CATALOGUE  
AVAILABLE PRICE  
£1.00 INC. P&P**

## STEPPING MOTORS

A range of top quality stepping motors suitable for driving a wide range of mechanisms under computer control using simple interfacing techniques.

**ID36 PERMANENT MAGNET MOTOR— £16.86**  
48 steps per rev

**MD200 HYBRID MOTOR— £17.10**  
200 steps per rev

**MD35 ½ PERMANENT MAGNET MOTOR— £12.98**  
48 steps per rev.

**MD38 PERMANENT MAGNET MOTOR— £9.15**  
48 steps per rev.

## HAMEG HM 203-7 OSCILLOSCOPE

New model just arrived. High quality reliable instrument made in W. Germany. Outstanding performance. Full two year parts and labour warranty. **£338**  
20MHz-2 channels 1mV sensitivity + £59.15 VAT  
Easy to operate and high performance Next Day Delivery £10.00  
(£5.00 must be cleared)

## EDUCATIONAL BOOKS & BOOK PROJECTS

### ADVENTURES WITH ELECTRONICS

The classic Easy to Follow book suitable for all ages. Ideal for beginners. No soldering, uses an S-DEC breadboard. Gives clear instructions with lots of pictures. 16 projects — including three radios, siren, metronome, organ, intercom, timer, etc. Helps you learn about electronic components and how circuits work. Component pack includes an S-DEC breadboard and all the components for the series.

**ADVENTURES WITH ELECTRONICS £5.75**  
**COMPONENT PACK (less book) £22.83**

### FUN WITH ELECTRONICS

From the USBORNE Pocket Scientist series — An enjoyable introduction to electronics. Full of very clear full colour pictures accompanied by easy to follow text. Ideal for all beginners — children and adults. Only basic tools are needed. 64 full colour pages cover all aspects — soldering — fault finding — components (identification & how they work). Also full details of how to build 6 projects — burglar alarm, radio, game, etc. Requires soldering — 4 pages clearly show you how.

The components supplied in our pack allows all the projects to be built and kept. The book is available separately.

**FUN WITH ELECTRONICS Book £2.95**  
**COMPONENT PACK (less book) £17.93**

### 30 SOLDERLESS BREADBOARD PROJECTS

A book of projects by R. A. Penfold covering a wide range of interests. All projects are built on a Verobloc breadboard. Full layout drawings and component identification diagrams enable the projects to be built by beginners. Each circuit can be dismantled and rebuilt several times using the same components. The component pack allows all projects in the book to be built one at a time.

Projects covered include amplifiers, light actuated switches, timers, metronome, touch switch, sound activated switch, moisture detector, M.W. Radio, Fuzz unit, etc.

**30 SOLDERLESS BREADBOARD PROJECTS Book 1 £2.95**  
**COMPONENT PACK £27.74**

### ENJOYING ELECTRONICS

A more advanced book which introduces some arithmetic and calculations to electronic circuits. 48 chapters covering elements of electronics such as current, transistor switches, flip-flops, oscillators, charge, pulses, etc. An excellent follow-up to Teach-In or any other of our series. Extremely well explained by Owen Bishop who has written many excellent beginners' articles in numerous electronics magazines.

**ENJOYING ELECTRONICS Book £3.60**  
**COMPONENT PACK £14.62**

Note — A simple multimeter is needed to fully follow this book. The M102 BZ is ideal. **£13.98**

### A FIRST ELECTRONICS COURSE

A copiously illustrated book that explains the principles of electronics by relating them to everyday objects. At the end of each chapter a set of questions and word puzzles allow progress to be checked in an entertaining way. An S-DEC breadboard is used for this series — soldering is not required.

**A FIRST ELECTRONIC COURSE BOOK £4.99**  
**PACK £22.83**

## EVERYDAY ELECTRONICS KIT PROJECTS

ALL KITS HERE HAVE BEEN FEATURED IN EE AND ARE SUPPLIED WITH MAGAZINE ARTICLE REPRINTS. SEPARATE REPRINTS ALSO AVAILABLE PRICE 80p EACH INCLUSIVE P&P. KITS INCLUDE CASES, PCB'S, HARDWARE AND ALL COMPONENTS (UNLESS STATED OTHERWISE) CASES ARE NOT DRILLED OR LABELS SUPPLIED UNLESS STATED.

Ref	Price	Ref	Price
842	£22.56	581	£9.59
841	£29.95	569	£14.24
840	£19.86	563	£71.47
839	£13.23	561	£11.65
838	£57.17	560	£22.41
835	£17.16	559	£15.58
834	£10.39	556	£32.39
833	£32.13	544	£8.94
815	£45.95	542	£13.17
814	£21.44	528	£30.80
812	£14.81	523	£30.21
800	£30.60	513	£31.93
796	£28.55	512	£10.07
790	£28.51	497	£21.41
769	£56.82	493	£49.95
744	£33.29	481	£6.25
740	£20.01	464	£9.60
739	£23.94	461	£9.15
734	£19.62	455	£5.86
730	£15.50	444	£7.08
728	£16.34	444	£8.63
724	£43.86	392	£22.37
722	£13.88	387	£40.82
719	£30.22	386	£6.31
718	£30.30	362	£9.91
715	£14.39	362	£15.02
707	£17.75	337	£27.59
700	£40.74	263	£6.49
584	£23.90	242	£6.50
		240	£7.85
		108	£10.76
		106	£8.94
		101	£7.15

## INSULATION TESTER

EE APRIL 85



A reliable electronic tester which checks insulation resistance of wiring appliances etc., at 500 volts. The unit is battery powered simple and safe to operate. Leakage resistance of up to 100 Megohms can be read easily. One of our own designs and extremely popular.

KIT REF 444

£22.37

## PET SCARER

EE MAY 89

Produces high power ultrasound pulses. L.E.D. flashes to indicate power output and level. Battery powered (9V-12V or via Mains Adaptor).

KIT REF 812

Mains Adaptor £2.02

£14.81

## DIGITAL COMBINATION LOCK

EE MAR '91

Digital combination lock with a 12 key keypad. 4 digit code operates 250V-16A SPCO relay. A special anti-tamper circuit allows the relay to be mounted remotely from the keypad without any loss of security. Can be operated in many modes (latching/unlatching, manual/automatic setting, continuous/momentary output, etc.). Article describes operation as Vehicle Immobilising security system. Low current drain. Kit includes drilled case.

KIT REF 840

£19.86

## DIGITAL LCD THERMOSTAT

EE MAY '91

A versatile thermostat with LCD read out. MIN/MAX temperature recording, clock and individually settable upper and lower switching points. Covers -10 to 110 degrees Celsius, accurate to within 0.1 degrees. Submersible probe on 3 meter lead. Kit includes punched and printed case. Save on energy bills by improved control of your hot water system. Also ideal for greenhouse soil temperature and aquarium control. Complete kit includes thermostat and probe, mains power supply and relay output, PCB's and punched and printed case.

KIT REF 841

£29.95

## 3 BAND SHORT WAVE RADIO

EE AUG 87

Covers 1.6-30 MHz in 3 bands using modern miniature coils. Audio output is via a built-in loudspeaker. Advanced design gives excellent stability, sensitivity and selectivity. Simple to build.

KIT REF 718

£30.30

## DIGITAL FREQUENCY 200 MHz METER

EE NOV 86

An 8 digit meter reading from AF up to 200 MHz in two ranges. Large 0.5" Red LED display. Ideal for AF and RF measurements. Amateur and C.B. frequencies.

KIT REF 563

£71.47

## ACOUSTIC PROBE

EE NOV '87

A very popular project which picks up vibrations by means of a contact probe and passes them on to a pair of headphones or an amplifier. Sounds from engines, watches and speech travelling through walls can be amplified and heard clearly. Useful for mechanics, instrument engineers and nosey parkers!

KIT REF 740

£20.01

## 4 CHANNEL LIGHT CHASER

EE Jan '90

A 1000W per channel chaser with zero volt switching, hard drive, inductive load capability, mic sound sensor and sophisticated 'beat' detector. Chase steps to music or auto when quiet. Variable speed and mic. sens. LED mimic on front panel. Switchable for 3 or 4 channels. P552 output. Ideal for rope lights, pin spots, disco and display lighting.

KIT REF 833

£32.13

## EE EQUALISER

EE MAY '87

A mains powered ioniser with an output of negative ions that give a refreshing feeling to the surrounding atmosphere. Negligible current consumption and all-insulated construction ensure that the unit is safe and economical in use. Easy to build on a simple PCB.

KIT REF 707

£17.75

## LIGHT RIDERS

EE OCT '86

Three projects under one title - all simulations of the Knight Rider lights from the TV series. The three are a lapel badge using six LEDs, a larger LED unit with 16 LEDs and a mains version capable of driving six main lamps totalling over 500 watts.

KIT REF 559 CHASER LIGHT £15.58

KIT REF 560 DISCO LIGHTS £22.41

KIT REF 561 LAPEL BADGE £11.65

## MICROCONTROLLER LIGHT SEQUENCER

EE DEC '90

A superb kit with pre-drilled painted and silk screen printed case for a really professional finish. This kit uses a microcontroller I.C. to generate 8-channel light sequences. Sequences are selected by keypad from over 100 stored in memory. Space for 10 user programmed sequences up to 16 steps long also available. 1000 watts per channel, zero volt switching, inductive load capability. Opto-isolated for total safety. Many other features. Complete kit includes case, PCBs, all components and hardware.

KIT REF 838

£57.17

## EE TREASURE HUNTER

EE AUG '89

A sensitive pulse induction Metal Detector. Picks up coins and rings etc., up to 20cms deep. Low "ground effect". Can be used with search-head underwater. Easy to use and build, kit includes search-head, handle, case, PCB and all parts as shown.

KIT REF 815

Including headphones

£45.95

## EPROM ERASER

EE OCT '88

Safe low-cost unit capable of erasing up to four EPROM's simultaneously in less than twenty minutes. Operates from a 12V supply. Safety interlock. Convenient and simple to build and use.

KIT REF 790

£28.51

## SUPERHET BROADCAST RECEIVER

EE MAR '90

At last, an easy to build SUPERHET A.M. radio kit. Covers Long and medium Wave bands, built in loudspeaker with 1 watt output. Excellent sensitivity and selectivity provided by ceramic I.F. filter. Simple alignment and tuning without special equipment. Kit available less case, or with pre-cut and drilled transparent plastic panels and dial for a striking see-through effect.

KIT REF 835

£17.16



# E.E. TREASURE HUNTER P.I. METAL DETECTOR

*A highly developed and acclaimed Magenta design giving excellent performance and reliability. Quartz crystal controlled circuit with MOSFET coil drive and high slew-rate DC coupled amplification. Detects a 10p coin at 20 cm and larger objects much deeper. Full kit includes ALL components, drilled and tinned PCB, search head, handle, case and all plastic parts. Some simple drilling is required.*

- Efficient CMOS design with low battery drain.
- Single winding search coil needs no sensitive adjustments.
- No 'ground effect' - works normally with search head immersed in sea water.
- Variable pitch audio output to lightweight headphones.
- Simple operation using single one-touch control.

- Powerful coil drive.
- Detects Ferrous and non-ferrous metal - Gold, Silver, Copper etc.
- 190mm diameter search coil gives large area coverage.
- Kit includes headphones.

**KIT REF. 815**  
**£45-95**



# DIGITAL CAPACITANCE METER

*A wonderfully easy to use instrument giving direct read-out of capacitors from 1pF to 1000uF. Quick and accurate to use even by absolute beginners. 1% accuracy circuit using close tolerance charging resistors and quartz crystal timing.*

- Kit includes punched and printed case, PCB, and all components.
- Large bright 5 Digit LED display.
- Direct read-out in uF, pF, nF.
- Calibration not required.



**KIT REF. 493..£49.95**

MAIL ORDER AND SHOP

EE110

135 Hunter Street

Burton-on-Trent

Staffs, DE14 2ST

Tel: 0283 65435

Fax: 0283 46932



# MAGENTA

**ELECTRONICS LTD**

# EVERYDAY ELECTRONICS

INCORPORATING ELECTRONICS MONTHLY

The No. 1 Magazine for Electronic & Computer Projects

**VOL. 20 No. 10      OCTOBER '91**

## IN THE MAIL

It is nice to know that many of our projects are very popular with readers, and that some projects get a wider recognition. Our recent feature *Better Use of Dry Cells* and the associated project *Dry Cell Recharger* triggered off some interest from *The Mail on Sunday* newspaper and a short piece appeared in the 18th August issue. This followed a discussion by *The Mail on Sunday* with our contributor Alan Tong and also with Mike Tooley. Alan was pictured holding a range of cells alongside a heading proclaiming "Battery men shocked by an £8 gadget."

For those that missed it, here is a snippet of what they said:—"A schoolboy project is causing fury in Britain's £250 million battery industry.

A 21-year-old graduate is claiming he has produced a gadget that will do what the industry has always said was impossible or dangerous. . . . *Recharge ordinary, disposable batteries.* Alan Tong, from Enfield, North London, has designed a charger which he says will recharge an ordinary battery safely up to 20 times. Do-it-yourself plans appear in the magazine *Everyday Electronics* showing how it can be made for about £8."

As we go to press other national media are showing interest in the project.

## QUESTIONS

Incidentally two questions about the *Dry Cell Recharger* have been asked time and time again. They are - "Can 9V (PP3 type) batteries be recharged?" and "Who can supply the 4.5V transformer?" The answer to the second question is easy - Electromail can supply and full details are given in this month's *Shop Talk*.

The first question is not quite so easy to answer: There is no doubt that batteries (as opposed to cells) can be recharged but this is not usually very successful and the amount of energy stored on recharge is not worthwhile (mainly due to the construction of the cells within the batteries). As we said in the first article - "A word about using PP3 9V batteries, don't. PP3's are the least efficient source of battery power. Avoid buying equipment that uses them."

It is also worth knowing that mains power is 5,000 times cheaper than batteries so a mains adaptor is a worthwhile investment when you can use one.



## SUBSCRIPTIONS

Annual subscriptions for delivery direct to any address in the UK: £18.50. Overseas: £23 (£40.50 airmail). Cheques or bank drafts (in £ sterling only) payable to Everyday Electronics and sent to EE Subscriptions Dept., 6 Church Street, Wimborne, Dorset BH21 1JH. Tel: 0202 881749. Subscriptions start with the next

available issue. We accept Access (MasterCard) or Visa payments, minimum credit card order £5.

## BACK ISSUES

Certain back issues of EVERYDAY ELECTRONICS are available price £1.80 (£2.30 overseas surface mail) inclusive of postage and packing per copy - £ sterling only please, Visa and Access (MasterCard) accepted, minimum credit card order £5. Enquiries with remittance, made payable to Everyday Electronics, should be sent to Post Sales Department, Everyday Electronics, 6 Church Street, Wimborne, Dorset BH21 1JH Tel: 0202 881749. In the event of non-availability one article can be photostatted for the same price. *Normally sent within seven days but please allow 28 days for delivery.* We have sold out of Jan, Feb, Mar, Apr, June, Oct, & Dec. 88, Mar & May 89 & Mar 90.

## BINDERS

Binders to hold one volume (12 issues) are available from the above address for £5.95 (£6.95 to European countries and £9.00 to other countries, surface mail) inclusive of post and packing. *Normally sent within seven days but please allow 28 days for delivery.*

Payment in £ sterling only please. Visa and Access (MasterCard) accepted, minimum credit card order £5. Tel: 0202 881749

## Editorial Offices:

EVERYDAY ELECTRONICS EDITORIAL,  
6 CHURCH STREET, WIMBORNE,  
DORSET BH21 1JH

Phone: Wimborne (0202) 881749

Fax: (0202) 841692. DX: Wimborne 45314.

See notes on Readers' Enquiries below - we regret that lengthy technical enquiries cannot be answered over the telephone.

## Advertisement Offices:

EVERYDAY ELECTRONICS ADVERTISEMENTS,  
HOLLAND WOOD HOUSE, CHURCH LANE,  
GREAT HOLLAND, ESSEX CO13 0JS.

Phone (0255) 850596

Editor: MIKE KENWARD

Secretary: PAMELA BROWN

Deputy Editor: DAVID BARRINGTON

Business Manager: DAVID J. LEAVER

Editorial: WIMBORNE (0202) 881749

Advertisement Manager:

PETER J. MEW, Frinton (0255) 850596

Classified Advertisements:

Wimborne (0202) 881749

## READERS' ENQUIRIES

We are unable to offer any advice on the use, purchase, repair or modification of commercial equipment or the incorporation or modification of designs published in the magazine. We regret that we cannot provide data or answer queries on articles or projects that are more than five years old. Letters requiring a personal reply must be accompanied by a stamped self-addressed envelope or a self addressed envelope and international reply coupons.

All reasonable precautions are taken to ensure that the advice and data given to readers is reliable. We cannot however guarantee it and we cannot accept legal responsibility for it.

## COMPONENT SUPPLIES

We do not supply electronic components or kits for building the projects featured, these can be supplied by advertisers.

We advise readers to check that all parts are still available before commencing any project in a back-dated issue.

We regret that we cannot provide data or answer queries on projects that are more than five years old.

## ADVERTISEMENTS

Although the proprietors and staff of EVERYDAY ELECTRONICS take reasonable precautions to protect the interests of readers by ensuring as far as practicable that advertisements are *bona fide*, the magazine and its Publishers cannot give any undertakings in respect of statements or claims made by advertisers, whether these advertisements are printed as part of the magazine, or are in the form of inserts.

The Publishers regret that under no circumstances will the magazine accept liability for non-receipt of goods ordered, or for late delivery, or for faults in manufacture. Legal remedies are available in respect of some of these circumstances, and readers who have complaints should first address them to the advertiser.

## TRANSMITTERS/BUGS/TELEPHONE EQUIPMENT

We would like to advise readers that certain items of radio transmitting and telephone equipment which may be advertised in our pages cannot be legally used in the U.K. Readers should check the law before using any transmitting or telephone equipment as a fine, confiscation of equipment and/or imprisonment can result from illegal use. The laws vary from country to country; overseas readers should check local laws.



# PC-SCOPE INTERFACE

JOHN BECKER

*How a PC-compatible computer can be used as one of the most versatile items of workshop test equipment.*

**T**HIS interface enables any PC-compatible computer to be used as an oscilloscope. It samples and stores waveforms of any shape and speed up to around 1MHz. The computer reads the memory store and plots the waveform within a screen window.

There is a choice of display modes, formatted wide or medium window, and high speed unformatted. The software is written in GW-Basic and may be used with colour or monochrome screens. Waveform frequency and amplitude are also calculated by the software and displayed on screen.

Three panel controls vary signal input and gain levels, and select the sampling rate. The effective input frequency range is around 1Hz to 500kHz, though waveform frequencies to either side of the range will still produce display results.

## INPUT AND ADC

The block and circuit diagrams for the project are shown in Fig. 1 and Fig. 2. In Fig. 2, the input signal is brought into the pre-amp and buffer stage around IC10. The signal is a.c. coupled by capacitor C5 and its level controlled from nil to maximum by VR3. Signals having a peak-to-peak voltage of up to 16V a.c. may be input. This limit is imposed by the working voltages of C3 and C5. VR1 varies the gain of the preamp from x1 to x11, and VR2 presets the midway output bias level.

Operating from a 5V d.c. power line, IC10 has a maximum output swing from approximately 1.5V to 4.5V.

From IC10, the signal goes to pin 11 of the high speed flash analogue-to-digital converter (ADC) IC6. This is a 6-bit ADC which is capable of almost instantaneous conversion at rates of up to 15MHz. Unlike many ADCs which require several clock pulses to complete the conversion, IC6 basically requires just one, although the transfer of the converted data to the output register is only carried out on the next conversion pulse.

The ADC has two current-controlled reference level inputs, at pins 9 and 10. VR4 and VR5 preset the upper and lower limits respectively and are adjusted to suit the maximum output swing from the preamp. No harm will be done if the input signal level exceeds the reference levels, although the resulting binary output code will be erroneous. They may be set for zero resistance if preferred, broadening the reference levels to 0V and +5V.

Contents of the ADC's conversion register are only presented to the outputs B1-B6 when the chip is enabled by the correct logic levels on pins 5 and 6. Binary 10, high and low respectively, enables the output. Any other code puts the outputs into a high impedance state, removing their effect from other devices which share the same lines. Pin 5 is held permanently high. Pin 6 is under control from other parts of the cir-

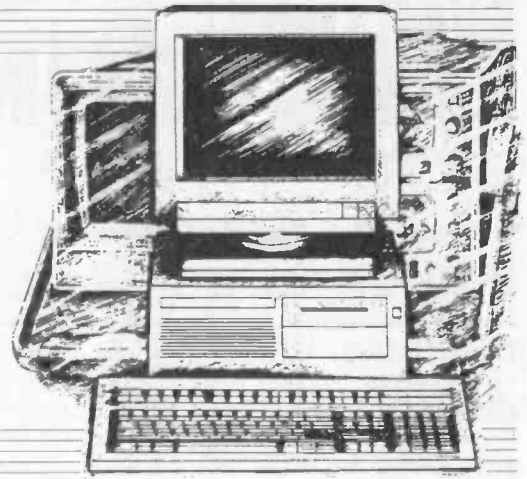

cuit and during sampling mode is held low, so routing the outputs to the 2048-byte memory IC4, and to the 8-channel gate IC7.

## CLOCKING AND COUNTING

ADC conversion, memory addressing and writing are triggered by the combined clock generator and counter around IC1. Fig. 3 shows details of the oscillator section, the basic rate of which is set here to 3.2768MHz by the crystal.

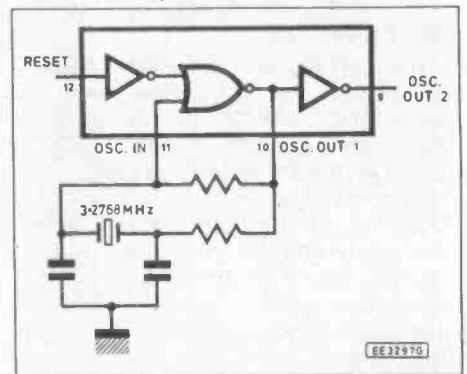
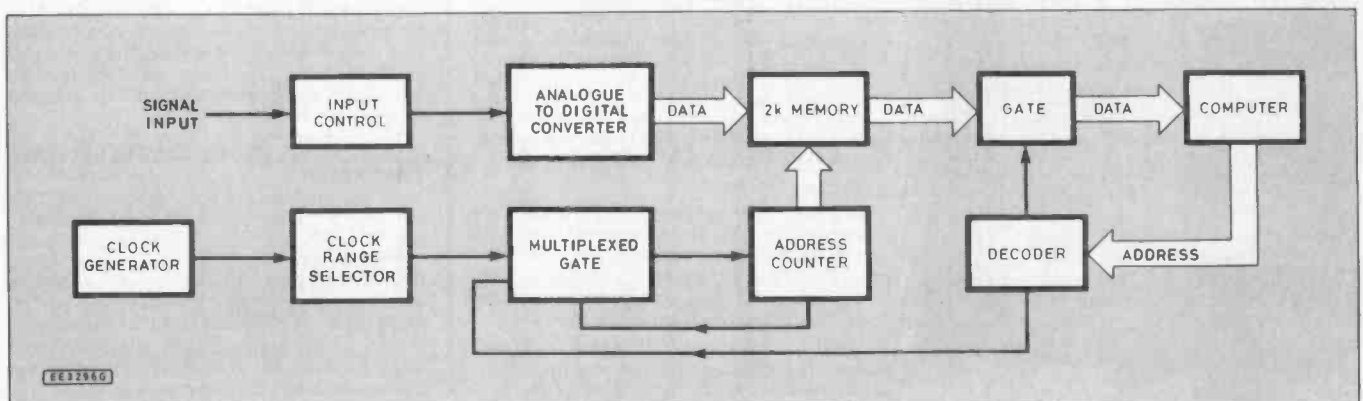

Fig. 3. Oscillator section of the 74HC60 14-stage counter i.c.

The oscillator drives a 14-stage binary ripple counter in which each stage successively divides the clock frequency by two. Stages Q4-Q14, though excluding Q11, are available as outputs. Switch S1 is wired to select any one of them, plus the original 3.2768MHz clock. Q14 produces the lowest frequency output, of 200Hz. The full range of output frequencies will be seen in line 50 of the software listing.

From S1, the selected clock rate is in-

Fig. 1. Block diagram for the PC-Scope Interface.





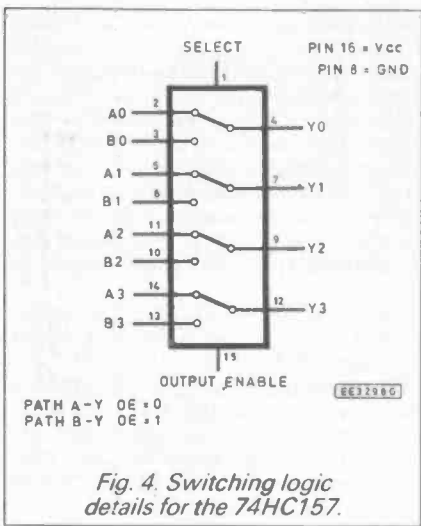
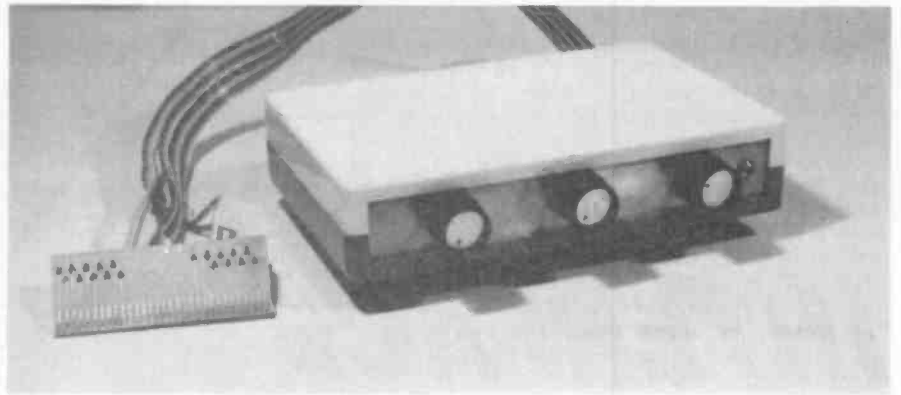

Fig. 4. Switching logic details for the 74HC157.



verted by IC9a and is fed to IC6 pin 7 as the ADC conversion pulse. Uninverted and via path A0-Y0 of the multiplexed gate IC2 (see Fig. 4), the clock is also fed to the 12-stage binary ripple counter

IC3. On receipt of the negative-going edge of each pulse on clock input pin 10, the count within IC3 is stepped on by one place. The first nine outputs of IC3, Q0-Q8, are connected to the memory IC4 as its

Fig. 2. Complete circuit diagram for the PC-Scope Interface.

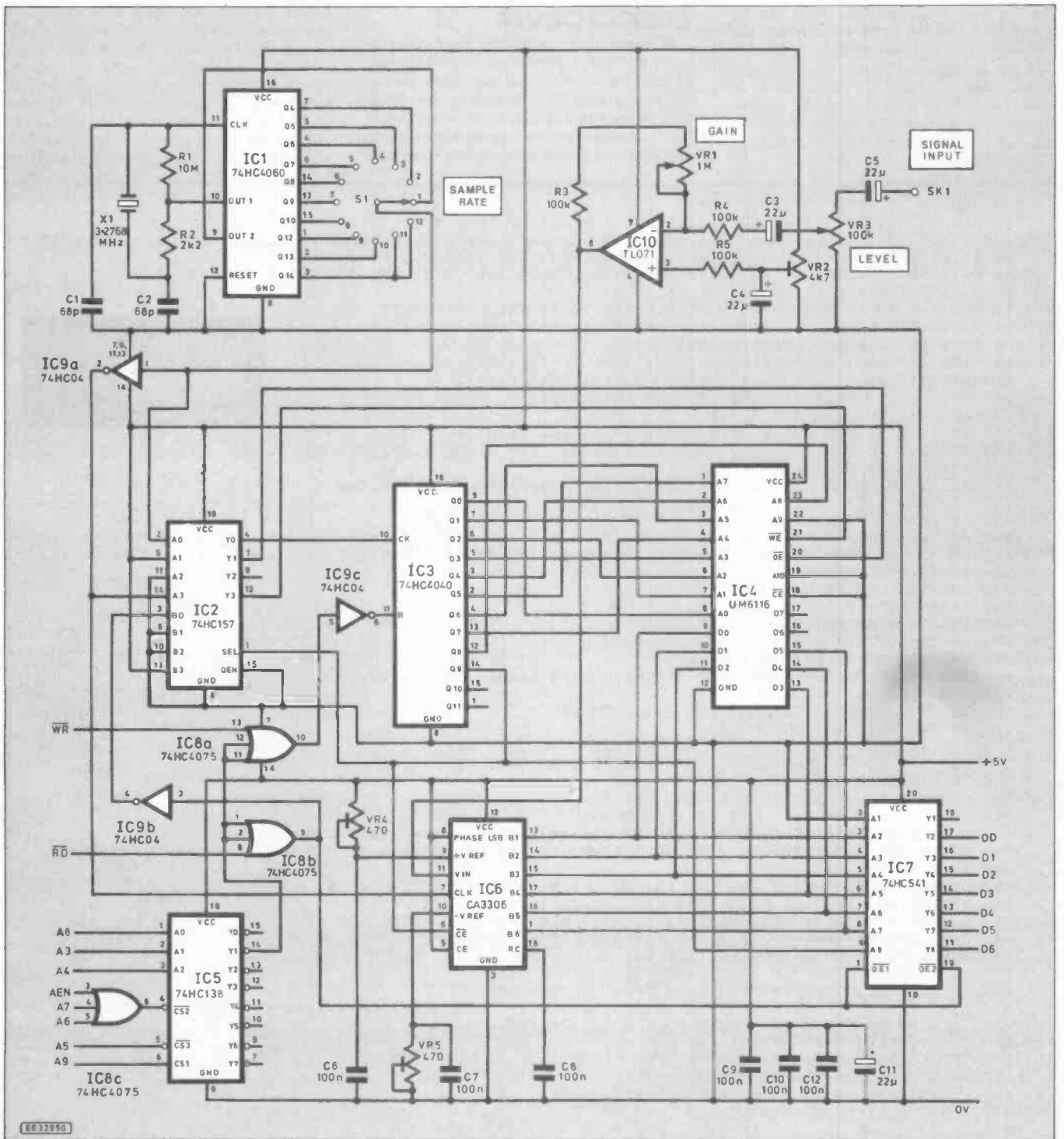

address lines. Q9 controls the path-block routing of gate IC2, provides a sync point for monitoring by the computer via IC7, and controls the active chip enable pin 6 of ADC IC6. Outputs Q10 and Q11 are not used.

The inverted clock signal from IC9a is also routed via IC2 path A3-Y3 to control the read/write operation of the memory. A low level on IC4 pin 21 sets the memory into write mode. Provided that the output enable (OE) pin of IC4 is simultaneously high, data presented from the ADC will be recorded at the address location set by counter IC3, overwriting any data previously stored at the same address. By using opposing phases of the clock pulse, synchronisation of the counter clocking and memory writing is timed so that the address is stable during the write function.

When the counter's Q9 output goes high, IC2 is set so that outputs Y0-Y3 are connected to paths B0-B3 instead of A0-A3. In this configuration, path B3-Y3 takes IC4 pin 21 low so holding the memory in read mode. Path B1-Y1 takes IC4 pin 20 high, so opening the memory's D0-D5 data outputs. The clock input to counter IC3 is now via path B0-Y0, opening it to triggering under computer control in conjunction with a dedicated decoding circuit.

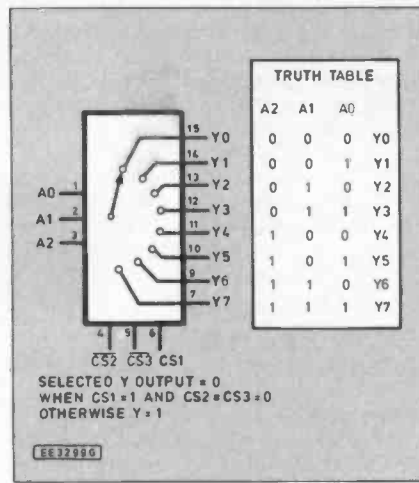

Fig. 5. Switching logic details for the 74HC138 3 to 8 line decoder.

## DECODING

PC-compatible computers have three or more expansion sockets any of which can be used for interface circuits. They are all on a common bus consisting of data, address, power and synchronisation lines. The expansion sockets can be accessed via any of 32 addresses between hex locations

\$0300-\$031F (decimal 768-799). Several extension cards can be used in parallel simultaneously, accessing them via different and dedicated addresses. This oscilloscope interface has basically been designed for accessing at address \$0300, though it will also respond to address calls at \$0301-\$0307. Additionally, the p.c.b. has been designed to allow a simple wiring change to be made allowing other addresses within the \$0300-\$031F range to be used.

Decoding of the address bus is performed by IC5 and IC8c. The binary equivalent of \$0300 is 1100000000 therefore, reading left to right, address lines A9-A0 must reflect this logic. The computer's address enable line AEN must also be low for the address to be valid. AEN and address lines A7 and A6 are ORed by IC8c. When all three lines are low, so too will be the output of IC8c. The combination of IC8c output low, A5 low and A9 high is the only one which will enable IC5 to respond to address codes on its A0-A2 inputs. Fig. 5 shows the chip's logic details.

When IC5 is disabled its Y0-Y7 outputs are all set high. When enabled, the output selected by the logic on IC5 A0-A2 will go low. Y1, as used and shown in Fig. 2, will go low when computer lines A3 and A4 are low and A8 is high. Since computer

```

10 REM EE PC SCOPE 03FEB91 S58
20 SCREEN 0:COLOR 15,4:SCREEN 1:COLOR 1,2:KEY OFF:DIM S(12),T(12)
30 PRINT "[d] d/a [s] sync [+] edge [w] window":LOCATE 2,28:PRINT"[h] hold"
40 L=768:M=90:T=M-32:S=M+32:F= 5:G=F+300:WW=2:W=1:SY=0:P=1:FF=F+1:GG=G
50 DATA 3276800,204800,102400,51200,25600,12800,6400,3200,800,400,200
60 DATA 0,1,2,4,8,16,32,64,256,512,1024
70 FOR A=1 TO 11:READ S(A):NEXT:FOR A=1 TO 11:READ T(A):NEXT
80 S$(0)="SYNC OFF ":S$(1)="SYNC ON ":G$(0)="-":G$(1)="+"
90 LOCATE 5,2:PRINT G$(P);S$(SY)
100 FOR A=F TO G STEP 50:LINE (A,T-1)-(A,T-5),1:NEXT
110 LINE (F,T-1)-(G+1,T-1),2:LINE (F,S+1)-(G+1,S+1),2
120 LINE (F,T)-(F,S),2:LINE (G+2,T)-(G+2,S),2
130 LOCATE 18,2:A=0:OUT (L),0
140 IF (INP(L) AND 64)=0 THEN A=A+1:IF A<1100 THEN 140
150 FOR B=1 TO 11:IF A>T(B) THEN NEXT:PRINT "** CHECK SWITCH":GOTO 130
160 VV=S(B):WW=B:LOCATE 18,2
170 PRINT"SWITCH POSITION";WW:PRINT:PRINT " SAMPLING RATE";VV;"Hz "
180 Z$=INKEY$:IF Z$="" THEN 300
190 IF Z$="d" THEN D=(D+1) AND 1
200 IF Z$="+" THEN P=(P+1) AND 1:LOCATE 5,2:PRINT G$(P);S$(SY)
210 IF Z$="s" THEN SY=(SY+1) AND 1:LOCATE 5,2:PRINT G$(P);S$(SY)
220 IF Z$<>"h" THEN 260
230 LOCATE 5,29:PRINT"HOLDING"
240 Z$=INKEY$:IF Z$="" THEN 240
250 LOCATE 5,29:PRINT " "
260 IF Z$<>"w" THEN 180
270 W=(W+1) AND 1:IF W=0 THEN 180
280 FOR A=FF TO 105:LINE (A,T)-(A,S),0:LINE (A+200,T)-(A+200,S),0:NEXT
290 GOTO 180
300 IF SY=0 THEN C=(INP (L) AND 63):GOTO 360
310 IF P=0 THEN A=1:GOTO 330
320 FOR A=1 TO 200:C=(INP (L) AND 63):IF C<36 THEN NEXT
330 FOR B=A TO 200:C=(INP (L) AND 63):IF C>28 THEN NEXT
340 IF P=1 THEN 360
350 FOR A=B TO 200:C=(INP (L) AND 63):IF C<36 THEN NEXT
360 FF=F+1:GG=G:IF W=1 THEN FF=105:GG=205
370 LINE (FF-1,T)-(FF-1,S),2:LINE (FF ,T)-(FF ,S),0:IF D=1 THEN 430
380 N=0:Y=255:C=C+T:FOR A=FF TO GG:B=(INP (L) AND 63)+T:IF B>N THEN N=B
390 IF B<Y THEN Y=B
400 LINE (A+1,T)-(A+1,S),0:LINE (A,M)-(A+1,M),3:LINE (A,C)-(A+1,B),1:C=B
410 NEXT:LINE (A,T)-(A,S),0:LINE (A+1,T)-(A+1,S),2
420 LOCATE 3,2:PRINT"PEAK MAX";64-(Y-T);" MIN";64-(N-T):GOTO 130
430 C=(C AND 32)*2+T:J=C:N=0:Y=0:KK=FF:KL=0:YK=FF:YL=0
440 FOR A=FF TO GG:B=(INP (L) AND 63)
450 IF B>36 THEN C=S:IF J<>C THEN Y=Y+1:YL=YK:YK=A
460 IF B<28 THEN C=T:IF J<>C THEN N=N+1:KL=KK:KK=A
470 LINE (A+1,T)-(A+1,S),0:LINE (A,J)-(A,C),1:J=C:NEXT:LINE (A+1,T)-(A+1,S),2
480 IF SY=0 OR Y=0 OR N=0 THEN LOCATE 3,2:PRINT " ":GOTO 530
490 IF P=0 THEN V=(YK-FF)/Y
500 IF P=1 THEN V=(KK-FF)/N
510 X=1000000!/VV:X1=1000000!/(X*V)
520 LOCATE 3,2:PRINT "FREQUENCY";INT(X1);"Hz "
530 LINE (A,T)-(A,S),0:GOTO 130

```

## LISTING ONE: MAIN PC-SCOPE PROGRAM

address lines A0-A2 are not used, IC5 will respond to any call within the eight code block \$0300-\$0307.

Output IC5 Y1 controls two inputs of the two OR gates IC8a and IC8b. The computer has separate write and read lines which are brought to the other respective inputs of the two OR gates. When a write or read call at any address between \$0300 and \$0307 is called by the computer, the OR gates respond accordingly. IC8a's output goes low in response to a correctly addressed write call, causing the output of the NAND gate IC9c to go high, so resetting counter IC3.

Several functions are controlled by calling a read operation via the selected address. The call sets IC8b's output low. This causes gate IC7 to open its outputs onto the computer data bus. Memory IC4 is already in read mode and so the computer reads its contents via IC7.

Simultaneously, IC9b output goes high and is fed via IC2 path B0-Y0 to the clock input of IC3. At this point, IC3 ignores the positive-going change. However, when the read call ends and the clock input level falls, the counter is clocked on one place by the negative-going edge. Data from the next memory location is then ready for reading on the next read call.

To ensure synchronisation between sampling blocks, the computer monitors the status of IC7 output D6. Although the memory and counter can only be accessed by the computer when gate IC2 is open on the B0-B3 paths, IC7 can be read at any time. The end of the sampling routine is

signified by IC3 Q9 output going high. When, via IC7, the computer registers this change it then starts its data retrieval. Repeatedly reading via \$0300, it alternately inputs the memory data and steps the counter. At the end of the reading routine, which may be of any length up to the full 2048 steps, the computer writes to \$0300, resetting the counter. Consequently, IC3 Q9 goes low and the next batch of signal data is input, converted and stored. When Q9 goes high again, data is once more available for reading.

## SOFTWARE

GW-Basic is the most widely used of the Basic languages available for PC-compatibles and is the dialect in which the software is written. The computer must be loaded with the GW-Basic control software package before Listing One can be run.

The listing is applicable to computers with colour or monochrome screens, though for the latter it may be necessary to omit the colour command statements. The program can be readily translated into other dialects as long as they allow access to the expansion sockets.

The expansion socket address location is held in variable L, shown in line 40 as 768 (\$0300). After an initialisation routine, the sampling starts at line 130 in which the address 768 is written to, resetting the counter. The unit will respond to this command irrespective of the status of gate IC2.

Signal sampling takes place at the rate set by S1. The time it takes between the counter being reset and its Q9 output going

high is monitored by the computer via IC7's D6 output, counting the number of read calls made until D6 goes high. Relating this number to the data in lines 50 and 60, the computer determines the position to which S1 is set. From this knowledge, subsequent input signal frequency calculations can be made and displayed.

## DISPLAY

Several display modes can be keyboard controlled while the program is running. Keyboard inputs are monitored in line 180. Pressing key "d" toggles the program between displaying the waveforms in analogue or digital format. Key "+" alternates the signal trace sync polarity between positive and negative edges, and key "s" turns sync on and off. The waveform trace may be frozen or run continuously by pressing key "h". Screen window size is controlled by key "w".

In all these keying instances, the opposite action of that previously triggered is set. Changes to any of the keyboard-entered factors may be made at any time, though they will only be acted upon immediately prior to each data input batch.

Drawing of the waveform data on screen begins at line 300. Action is taken in respect of synchronisation requirements. If sync is called for, the incoming data is searched until the nearest level relative to positive or negative triggering is found. Following sync assessment, data is repeatedly input and line-plotted on screen according to its amplitude and relative timing.

Examples of screen waveforms when operated in analogue and digital mode, with sync switched in and out.

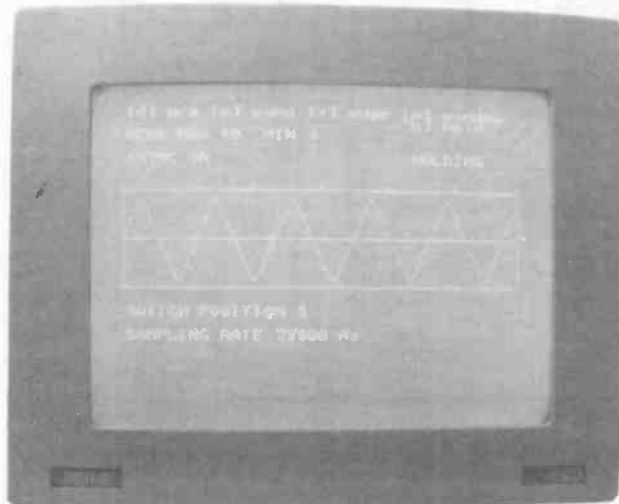
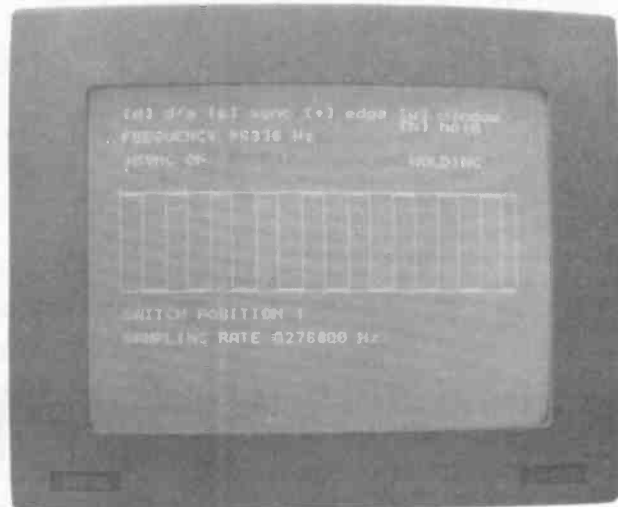
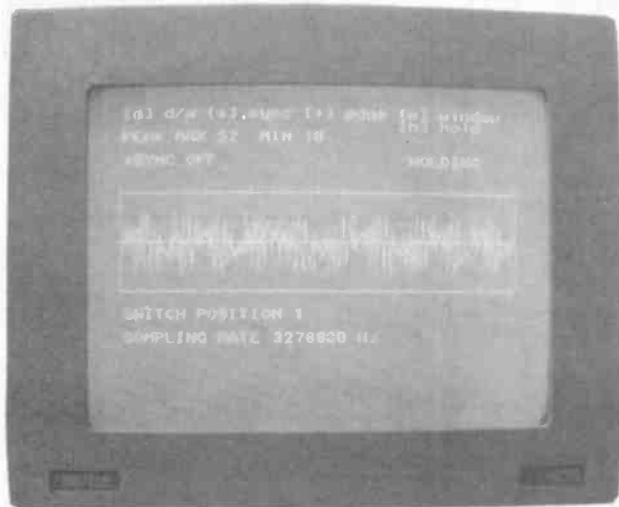



# PC-SCOPE INTERFACE

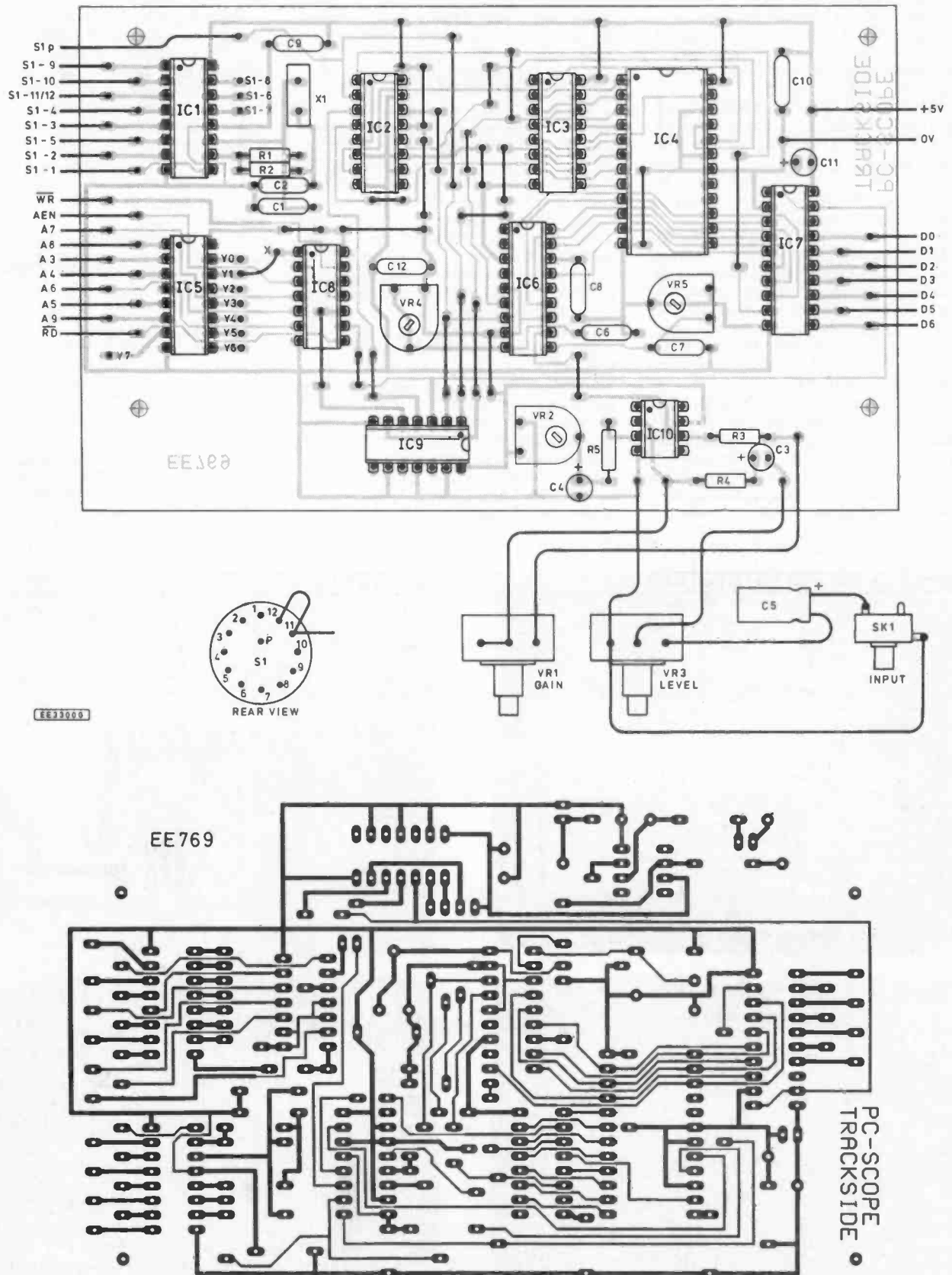

Fig. 6. Printed circuit board component layout, interwiring to off-board components and full size copper foil master pattern details.

# COMPONENTS

## Resistors

- R1 10M
- R2 2k2
- R3 to R5 100k (3 off)
- All 0.25W 5% carbon film

## Potentiometers

- VR1 1M lin. rotary
- VR2 4k7 min. horiz. preset
- VR3 100k lin. rotary
- VR4, VR5 470 min. horiz. preset (2 off)

## Capacitors

- C1, C2 68p polystyrene (2 off)
- C3 to C5, C11 22µ radial elect. 16V (4 off)
- C6 to C10 100n polyester (5 off)

## Semiconductors

- IC1 74HC4060
- IC2 74HC157
- IC3 74HC4040
- IC4 UM6116
- IC5 74HC138
- IC6 CA3306
- IC7 74HC541
- IC8 74HC4075
- IC9 74HC04
- IC10 TL071

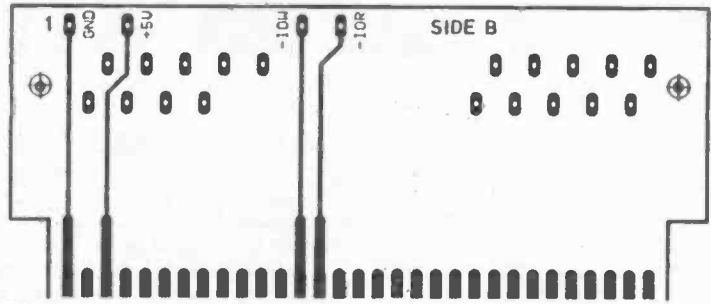
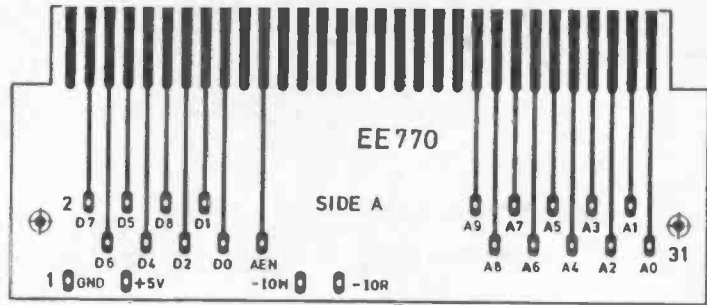

Fig. 7. Full size copper foil master patterns for the double-sided interface plug.

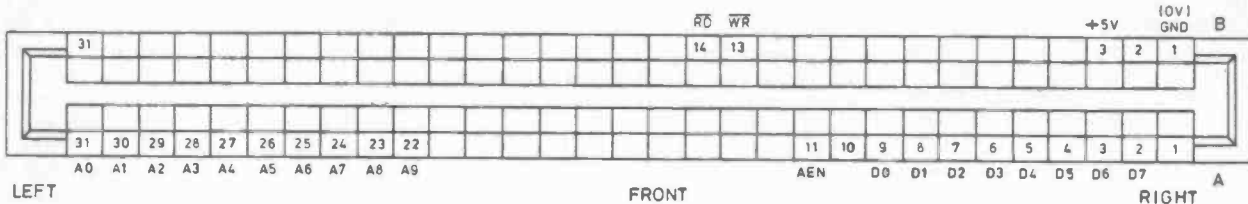

Fig. 8. PC expansion socket for the Amstrad 1640. For other PC's consult computer manual (see text).

## Miscellaneous

- S1 1P 12W rotary switch
- X1 3.2768MHz crystal
- I.C. sockets - 8-pin d.i.l., 14-pin d.i.l. (2 off), 16-pin d.i.l. (4 off), 18 pin d.i.l., 20-pin d.i.l., 24-pin d.i.l.; 3.5mm jack socket; knobs (3 off); plastic case 180 x 120 x 40mm; p.c.b. supports (4 off); ribbon cable (1 metre 20-way).
- Printed circuit boards available from the EE PCB Service, order codes EE769, EE770.

Approx cost guidance only

**£32**

(above right) Interface expansion plug side B.

(right) Layout of components inside the control case.

(below) Interface expansion plug side A.

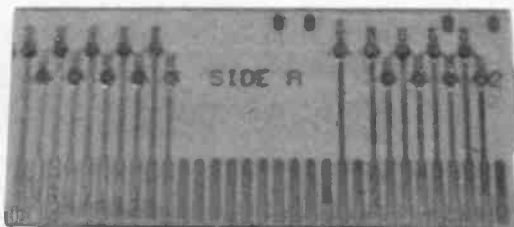
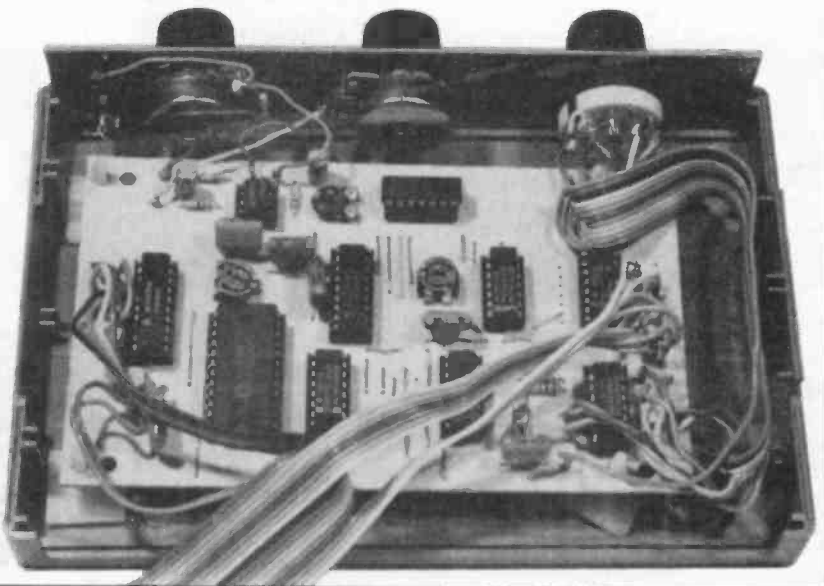
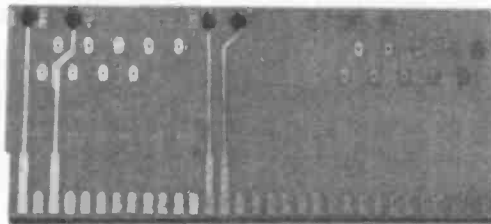

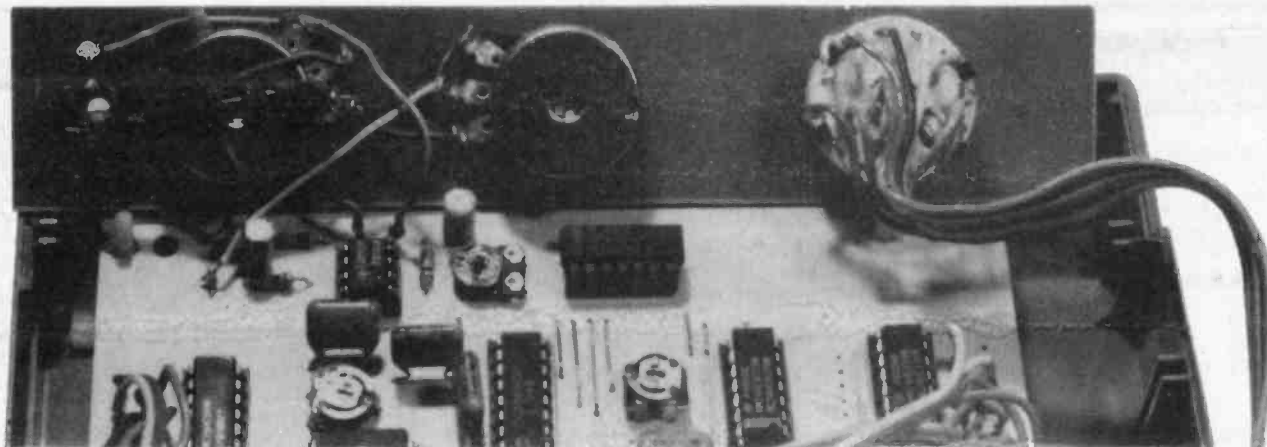

Wiring to the front panel control components. Note that the electrolytic capacitor C5 is wired directly between the Level control VR3 and the Input socket SK1.

In digital mode, the lines are drawn as vertical logic pulses of equal amplitude. In analogue mode they are plotted angularly and, being sampled waveforms, consist of a number of joined steps. Any signal may be plotted in either mode, with or without sync, irrespective of its type.

Frequency calculations are only made and displayed in digital mode and with the sync on. They will not be precise frequency values and should be regarded only as a guide. Displayed waveforms must be clearly defined for a reasonable frequency assessment to be made. Maximum and minimum amplitude factors are displayed only in analogue mode. They relate to the input values in decimal but may be expressed as voltages by simple calculation against the reference levels set on the ADC chip.

The timing factors quoted in line 60 apply to computers running at the same system speed as the Amstrad 1640 with which the prototype was proved. They are used to determine which setting of clock rate switch S1 has been selected, and hence affect the calculation of the input signal frequency. For machines running at other system speeds the factors will need changing, though will bear the same relationship to each other as shown in line 60. The correct factors can be readily found by comparing the calculated frequency displayed on screen with a known frequency source. They do not affect the correct operation of the rest of the program. The factors in line 50 are not affected by the computer system speed but relate to the unit's 3.2768MHz crystal clock.

An alternative routine may be used in place of the main program to give a faster sampling and display rate without the formatting frills written into the full display routine. By using Listing Two the unit will be read at the fastest practical rate, though will still be limited by the sampling rate set by S1. Data is displayed in a very simple format across the screen. The screen is cleared prior to each data batch being displayed.

#### LISTING TWO: FAST SAMPLING

```

10 REM PC SCOPE FAST SAMPLING
20 SCREEN 0:COLOR 15,4:SCREEN 1:COLOR 1,2
30 J=0:D=40:OUT (768),0
40 IF (INP(768) AND 64)=0 THEN 40
50 CLS:FOR A=1 TO 256:B=INP(768) AND 63:J=J+2
60 LINE (J-2,D+C)-(J,D+B),1:NEXT:C=B:NEXT:GOTO 30

```

## ASSEMBLY

There are two p.c.b.s for the project. The main control board is shown in Fig. 6 and is mounted in a box external to the computer. The second board, shown in Fig. 7, is simply a double-sided plug which is inserted into any of the computer expansion sockets to carry the wiring to the main board. The computer manual should be consulted for the correct orientation of the board in its chosen socket. Fig. 8 shows the orientation for the Amstrad 1640.

The unit is powered by the computer's +5V supply, delivered via the interface plug board.

Inter-track link wires on the component side of the main board should be soldered in first. Note especially the links under the IC4 and IC8 positions.

The link between points Y1 and X alongside IC5 sets the decoded address to the \$0300-\$0307 block. To code the unit for other address blocks point X may instead be linked to any one of Y3, Y5 or Y7, coding for \$0308-\$030F, \$0310-\$0317 and \$0318-\$031F respectively. Points Y0, Y2, Y4 and Y6 should be ignored.

Sockets should be used for all i.c.s and should be inserted next, followed by the presets and then the remaining components. Strict attention must be observed when soldering any part of the board, but especially so in those areas where tracks pass between i.c. pins. A fine-tipped soldering iron and thin solder wire (22 s.w.g.) should be used.

Inter-board wiring is best made using ribbon cable, allowing a maximum length of about one metre. Much greater lengths could cause logic signal problems for the computer, especially those operating at higher system speeds. Check all soldered joints with a magnifying glass.

## TESTING

Before inserting i.c.s or plugging into the computer, with a multimeter set on a low resistance range, check that no shorts exist between adjacent tracks on the plug-in board. Additionally check that no short exists between the +5V and 0V power lines. Still without i.c.s in place, plug the unit into the computer and switch on. If the screen does not display its normal response, immediately switch off and recheck the boards.

When satisfied, plug in the i.c.s, load GW-Basic and either the main routine or the shortened version. Set S1 to position 4, VR3, VR4 and VR5 for minimum resistance, VR1 for maximum resistance, and VR2 midway. Feed into the unit a sine or triangle wave signal of, say, 1kHz at 2V peak-to-peak, and run the program, changing the settings of the panel controls to suit the observed display. Increase the signal until its upper and lower peaks are flattened by the clipping action of the op.amp. Now adjust VR2 until the clipping is symmetrical!

Decrease the signal level until peaking just below the clipping level. Minutely adjust in turn both VR4 and VR5 to preset the ADC reference levels. The amplitude of the screen trace should increase as the relative conversion span changes. Increase the resistances until waveform clipping is again apparent, then back off the presets slightly until the clipping disappears. Minor adjustments may be beneficial once users are familiar with the unit's operation. □

Rear of the completed unit showing the entry/exit slot for the multicoloured expansion plug cable.

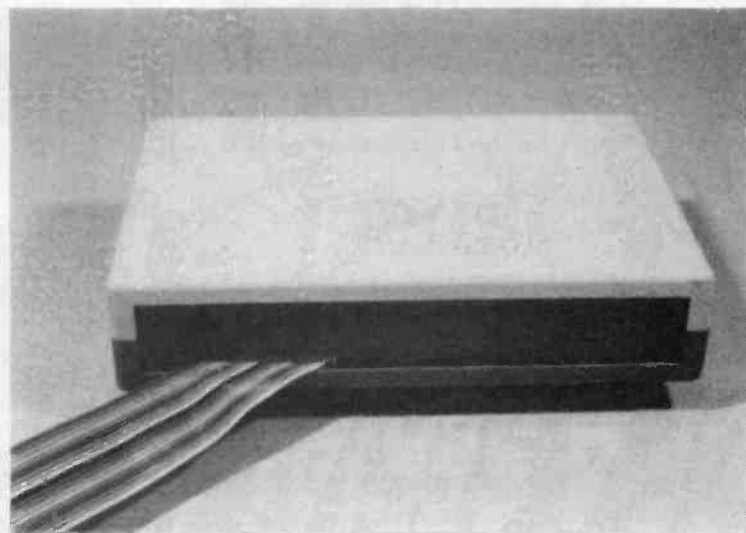



REALISTIC®

PROGRAMMABLE

# SCANNERS

### A) Realistic PRO-37

Our Best! 200 channels. Hyper scan doubles the scanning speed. Covers: 68-88, 108-136.975 (AM), 137-174, 380-512, 806-960 MHz. Two speed scan and search. Two second scan delay, priority function, lockout key, keyboard lock. LCD display, switchable backlight. Earphone jack, belt clip, BNC aerial jack. Memory backup. Requires 6 "AA" batteries. 20-9138 ..... £229.95

### B) Realistic PRO-35.

100 channels. Covers: 68-88, 108-136.975 (AM), 137-174, 406-512 MHz. Two-second scan delay, lockout and search function. Priority channel, backlit LCD display. Memory backup. BNC aerial jack, belt clip, earphone jack. Complete with rechargeable ni-cad battery pack and AC adapter/charger. 20-9136 ..... £179.95

### C) Realistic PRO-41

10 channels. Covers: 68-88, 137-174, 406-512 MHz. LCD channel display, review key to display frequencies. Manual and scan modes. Three-second scan delay, keyboard lock switch. Memory backup. Requires 5 "AA" batteries.

20-9301 ..... £99.95

# Tandy®

ALL THE ACTION  
AS IT HAPPENS!

InterTAN U.K. Ltd.,  
Tandy Centre,  
Leamore Lane, Walsall,  
West Midlands. WS2 7PS  
Tel: 0922-710000

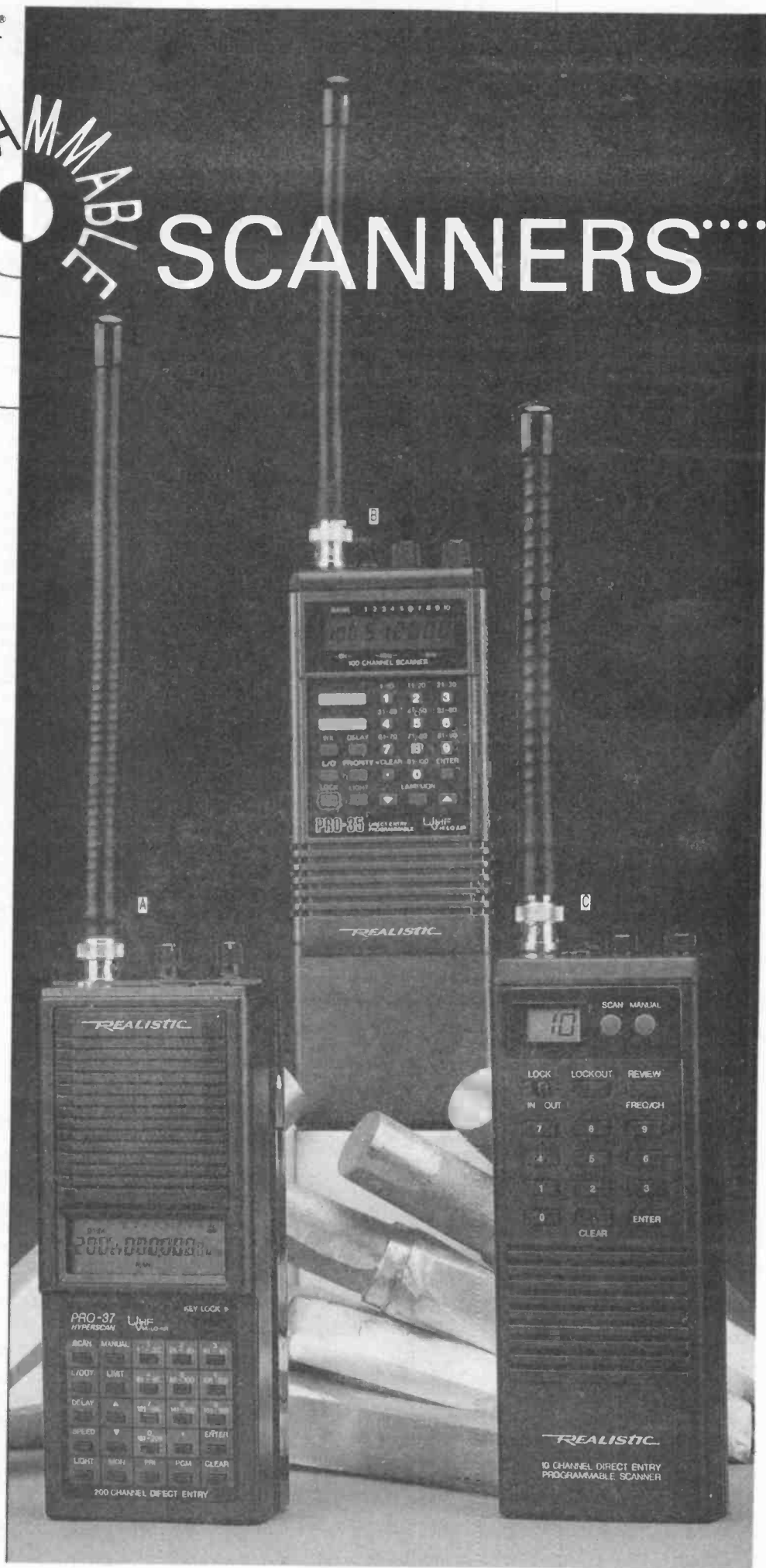

# UV

# EXPOSURE UNIT

**RICHARD WORTHINGTON**

An inexpensive method of producing your own printed circuit boards (up to 100mm x 250mm), with a built-in safety feature. Can also be used to drive 8W 12in fluorescent lighting tubes, from 12V supplies.

**P**ROBABLY the main disincentive from making your own p.c.b.s must be the cost of the ultra-violet exposure unit that is needed for fast and consistent results. However, now that the first ever surface-mount projects are appearing, there surely can't be a better time to get started.

This project therefore describes a safe and inexpensive UV Exposure Unit, suitable for the production of traditional or SMD printed circuit-boards up to 100mm by 250mm in size. It's easy to build, and runs off a 12V d.c. supply such as NiCad batteries, a lead/acid battery or a mains adaptor.

## HOW IT WORKS

The basic method of use is illustrated in Fig. 1. It would probably be difficult to build a device similar to commercial UV exposure units; to make the casing would require carpentry or metal-working skills for a start, then there's the problem of glass cutting, plus the usual mains safety considerations.

So, a different and more simple approach is used here: First, the unit is placed on top of the p.c.b. overlay transparency and photo-resist board. Tilt switches sense when the unit is stationary and horizontal

— this feature ensures that it is impossible to accidentally view the UV fluorescent tube when lit. A warning buzzer then sounds for ten seconds, before the fluorescent tube illuminates, exposing the area beneath the unit to ultra-violet light.

important safety features. The second section, based around transformer T1, generates the high voltage necessary to run the fluorescent tube.

To begin, when the unit is placed on a horizontal surface, such as a tabletop or the floor, all four mercury tilt switches "close". IC1a input is pulled low, so its output (pin 3) goes high and capacitor C1 slowly charges via resistor R2.

Meanwhile, since both inputs of IC1c are high, its output is low and the audio oscillator (based on IC1d) is free to operate. Oscillation is possible due to the hysteresis of IC1d (Schmitt trigger); the chosen values for R3 and C2 give a frequency of several hundred Hertz. There

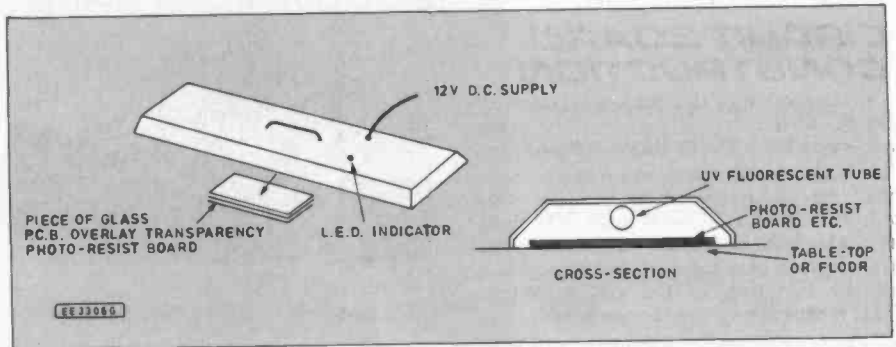

Fig. 1. Demonstrating the simplicity of using the unit. Once the photo-resist board "sandwich" is made up, the unit is placed over it and it is exposed to ultra-violet light.

## CIRCUIT DESCRIPTION

The circuit, shown in Fig. 2, consists of two main sections; the first is based around IC1 (4093BE) and provides several

is, therefore, an audible advance warning of when the fluorescent tube is about to light.

Eventually, as C1 charges up, the voltage at IC1b input reaches two thirds of the positive supply voltage. At this point IC1b changes state, its output now going low so that transistor TR1 conducts. The audio oscillator ceases, i.e.d. D3 lights, and the second section of the circuit (the UV fluorescent tube driver) is activated. If, however, the unit is picked up or knocked over, one or more tilt switches will "open", C1 discharges via D1, and the fluorescent tube instantly switches off.

## TRIGGER CIRCUIT

The second section uses a familiar blocking oscillator circuit to supply the UV fluorescent tube — this part of the circuit could be built on its own to drive an ordinary 8W fluorescent tube if required; simply omit TR1 and everything to the left of it, making a connection from +12V to R6.

Initially, capacitor C3 charges up until TR2 conducts. As current starts to

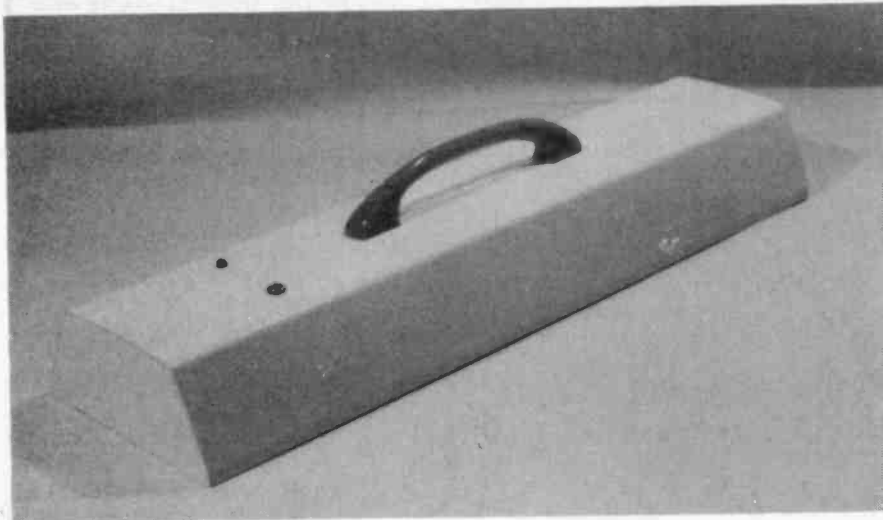

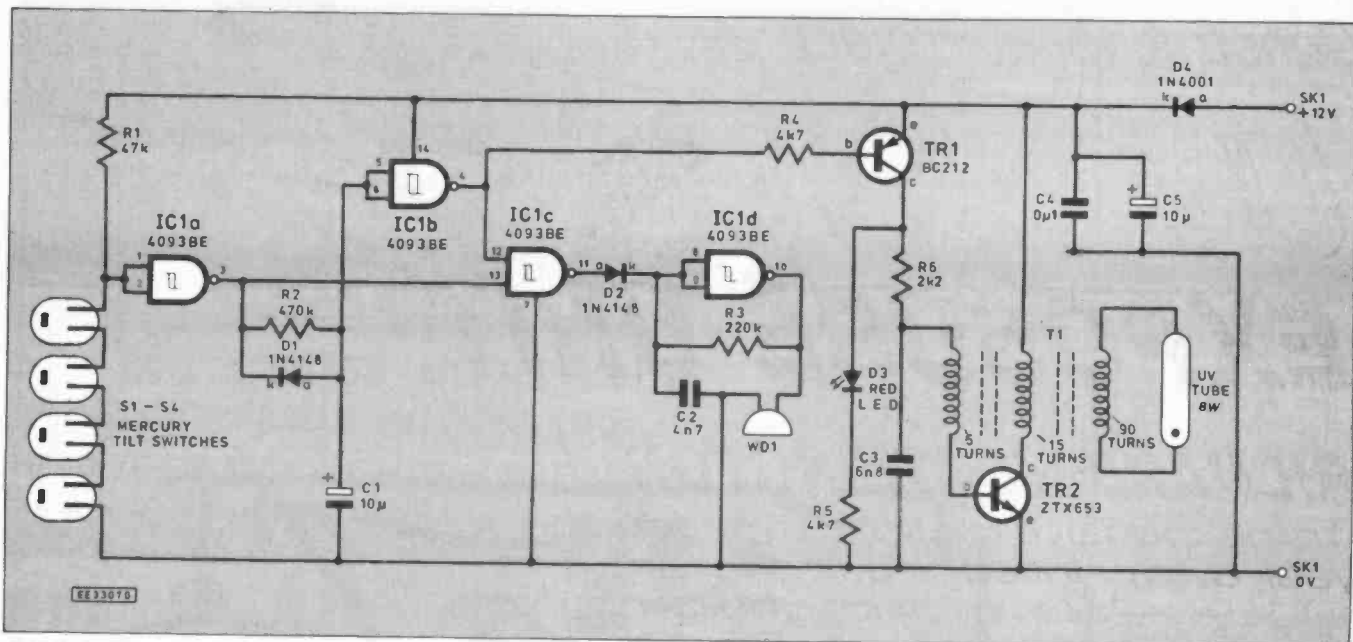

Fig. 2. Complete circuit diagram for the UV Exposure Unit. To drive an 8W 12in. fluorescent lighting tube, omit TR1, take D3a R6 to +V line and discard all components to the left of TR1.

flow through the collector coil winding, a pulse is induced in the base winding. This reverses the direction of charge on C3, switching off TR2 until C3 can recharge via R6, the process then repeats. The frequency of oscillation depends on the time constant of C3 and R6. A third "step-up" winding supplies the UV fluorescent tube.

### CIRCUIT BOARD CONSTRUCTION

Construction of this project is relatively simple with most of the circuitry being accommodated on the single-sided printed board (p.c.b.) shown in Fig. 4. This board may be purchased from the *Everyday Electronics PCB Service*, code 768. It is probably best to begin by assembling the transformer (see Fig. 3), making certain of the direction of the coil windings. The remainder of the circuit-board con-

struction is quite straightforward — but remember to leave sufficient length in the leads of tilt switches S1 to S4, and check that the ends with the contacts will be lowermost when the unit is fully assembled (see Fig. 6).

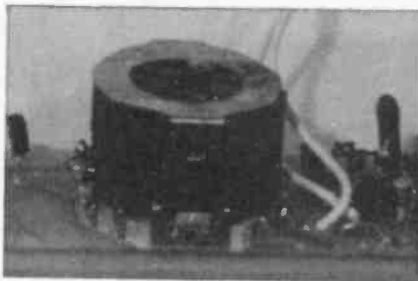

The completed trigger transformer T1.

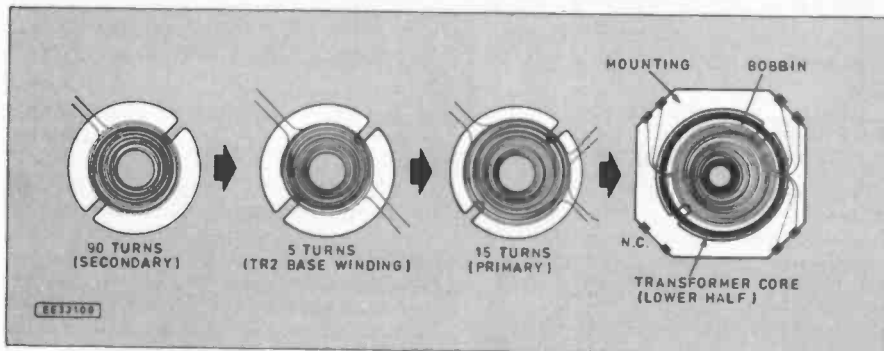
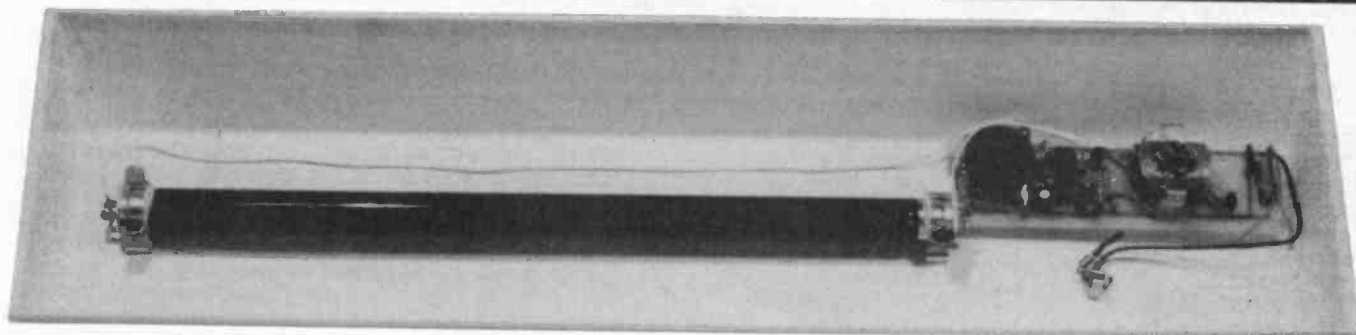

Fig. 3. Ferrite pot-core transformer winding details. Each winding is held in place by a layer of insulation tape. (below) The UV tube and circuit board installed in a piece of white angular "guttering".



## COMPONENTS

### Resistors

R1	47k
R2	470k
R3	220k
R4, R5	4k7 (2 off)
R6	2k2
All 1/4W ± 5% carbon film	

### Capacitors

C1, C5	10µ elect. 12V (2 off)
C2	4n7 polyester
C3	6n8 polyester
C4	0µ1 polyester

### Semiconductors

D1, D2	1N4148 signal (2 off)
D3	Standard red l.e.d.
D4	1N4001 1A 50V rec.
TR1	BC212 pnp silicon
TR2	ZTX653 npn silicon
IC1	4093BE quad 2-input NAND Schmitt

### Miscellaneous

T1	B65671 LR26 transformer core, plus bobbin & mounting
----	--

S1 to S4 mercury tilt switch (4 off)  
WD1 piezo sounder

Printed circuit board available from the *EE PCB Service*, order code EE768; 12 inch 8W UV fluorescent tube plus mounting clips; suitable casing and handle (see text); 2.5mm or 3.5mm jack socket, 14-pin i.c. socket, connecting wire, 32s.w.g. enamelled wire for winding T1.; 1mm solder pins; glue; solder etc.

Approx cost guidance only

**£20**  
excl. case



The piezo sounder, WD1 can be mounted in the centre of the tilt switches, supported by a small cube of wood or plastic. Also, note that the p.c.b. layout is designed for BC212, BC212A or BC212B as transistor TR1 (i.e. case style TO92c); transistor types BC212L, BC212LA and BC212LB use TO92e instead.

Next, before wiring in the completed p.c.b. or connecting the UV fluorescent tube, it is worth making a quick check for correct circuit operation; a 9V or 12V power source will do for now. Short out S1 to S4 and piezo transducer WD1 should sound for roughly ten seconds, ceasing at the same time as the l.e.d. (D3) lights.

The supply current should not significantly exceed approximately 500mA — otherwise disconnect the power recheck the direction of the transformer windings. A multimeter, set to an a.c. range of 500V or more, and connected between points C and D, can be used to confirm correct operation of the fluorescent tube driver. Once testing is complete, remove the shorting link from S1 to S4.

## MECHANICAL CONSTRUCTION

This leaves just the mechanical construction, which depends on the enclosure chosen for the unit. The prototype used a casing consisting of 45cm of (new) plastic guttering — yes, guttering. Not the grey, semicircular type, however; the modern sort is white (a better reflector of UV) and has a more angular cross section — apart from being much better looking, it's an ideal shape for mounting circuit boards! Alternatively, a piece of aluminium sheet, about 45cm by 18cm, can be bent to the same shape.

Whichever method is used, the ends of the casing will, of course, need to be closed off. For the prototype two pieces of scrap plywood were sawed and sandpapered to the correct shape, glued in place with impact adhesive, and painted white to match the casing (matt paint gives better results than gloss).

Next, four holes are drilled in the casing — for the l.e.d., the power socket and the handle. If the l.e.d. is mounted directly on the reverse of the circuit board, then just a hole of 5mm diameter is required (i.e. no l.e.d. mounting clip). A 2.5mm or 3.5mm jack socket is ideal for the power connection.

The fixings for the UV fluorescent tube itself consist of two metal clips, generally sold as "tool clips" or "Terry clips". The specified UV tube fits the half-inch size,

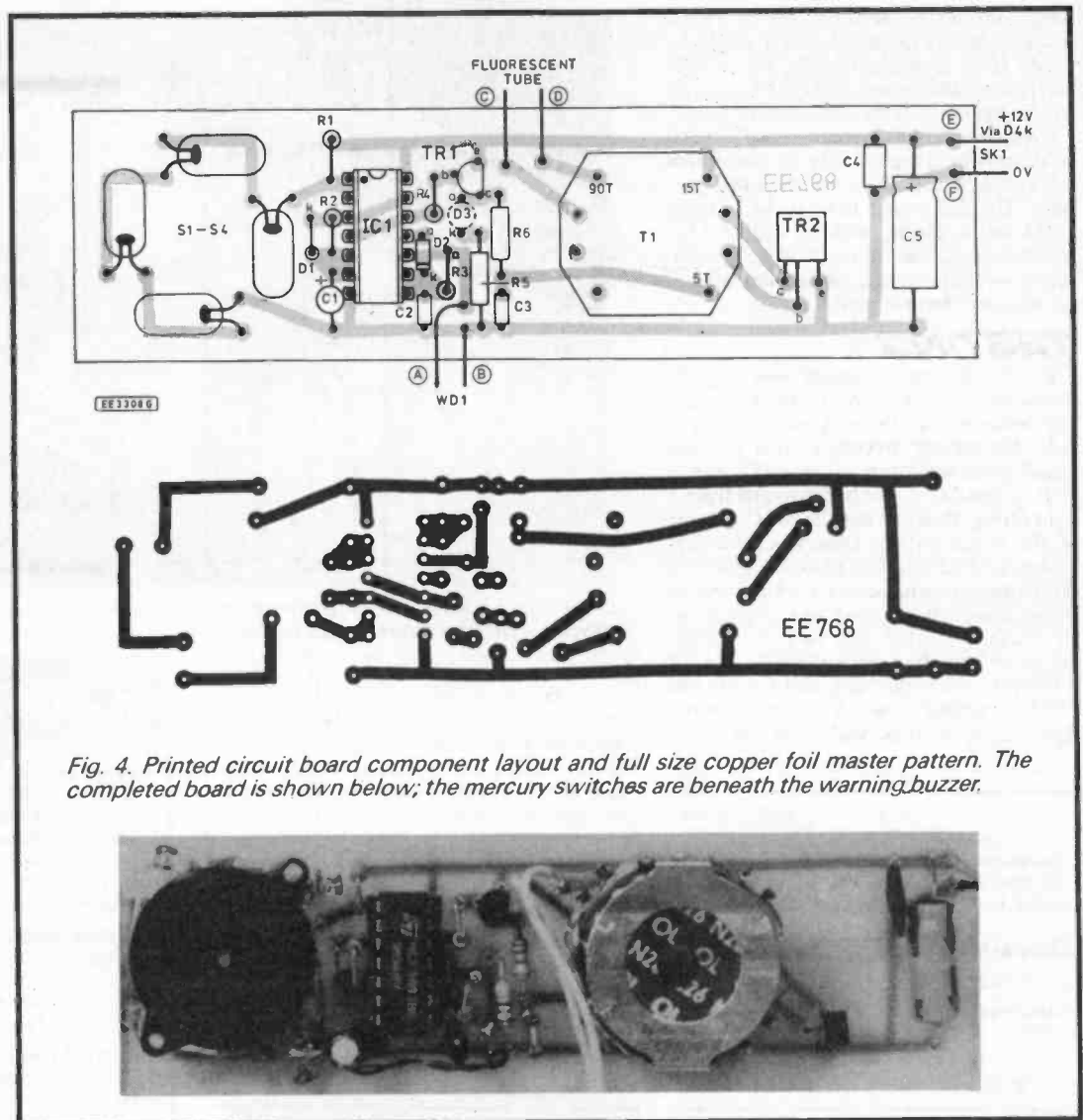

Fig. 4. Printed circuit board component layout and full size copper foil master pattern. The completed board is shown below; the mercury switches are beneath the warning buzzer.

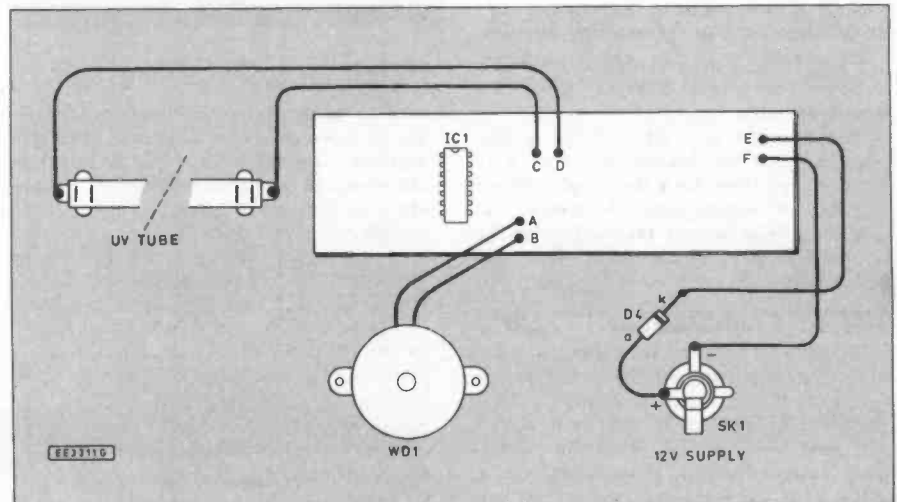
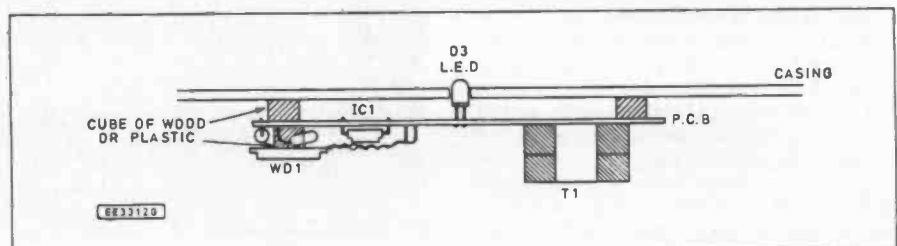

Fig. 5. Interwiring from the p.c.b. to the off-board components.

Fig. 6. Cross-section showing one method of mounting the circuit board in the case/reflector. Note the "light on" l.e.d. is mounted on the underside of the p.c.b.



which should be securely bolted (using nylon bolts) or glued to the casing. An elastic band looped across the top of each clip reduces the chance of the tube breaking free, in the event of the unit being dropped.

Commercial units typically have a metal reflector behind the UV tube, so aluminium foil could be used here for the same purpose. The foil would have to be securely glued to the casing, with no chance of it touching the circuit; this would help to ensure even illumination, particularly if large p.c.b.s are to be produced.

## TESTING

Finally, the unit is tested with the UV fluorescent tube in place. Ultra-violet light can be harmful to the eyes, so this complicates the testing procedure. If a conventional fluorescent tube — also 12 inch 8 watt, or similar — can be borrowed from a light fitting, then this may be used for some of the initial testing. Otherwise, the suggested method is to first place the unit on a flat surface, resting across a white sheet of paper. Prop up one end very slightly, so that some reflected light will be visible, scattered from the paper surface.

Connect the power and wait for the end of the warning tone. A violet coloured light should then be visible on the paper

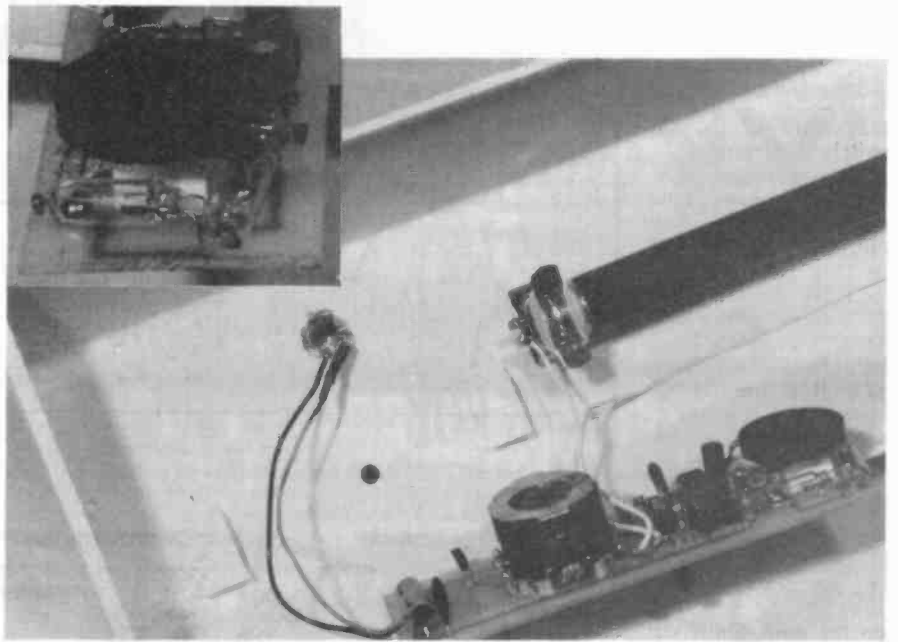

Close-up showing wiring to power-in socket and one end of the tube. Inset shows mercury "tilt" switches below buzzer.

Remove the light-proof protective covering from the photo-resist board, keeping the board out of bright light. Check that the piece of glass is clean, then sandwich the

NiCads, you'll need about nine "C" or "D" cells). After an exposure time of about 10 to 15 minutes, disconnect power then remove the photo-resist board (again, avoid bright light).

4. The board can be developed using sodium hydroxide, available from most ironmongers, and commonly sold as "caustic soda"; add about two teaspoons to one pint water, stirring until completely dissolved. The resulting solution will dissolve unwanted regions of the photo-resist coating and, as soon as the bare copper surface is visible in these areas, development is complete. The board should be washed under the cold water tap after this.

5. Ferric Chloride (Iron (III) Chloride) is used to etch away the unwanted copper regions. The dilution is about 250g ferric chloride to one pint water, and etching takes about twenty minutes. This time can be reduced, if necessary, by warming the solution. (NOTE: Avoid eye, mouth or skin contact with sodium hydroxide or ferric chloride.) Wash the board under a tap again.

6. The board should now show the desired pattern of copper tracks, but they are still coated with photo-resist. This is easily removed by exposing the whole board to UV, then immersing it in sodium hydroxide solution a second time. Once again wash it under a tap.

7. Finally, all that remains is to drill the holes, using a 1mm bit, and give the board a final cleaning before the start of assembly. □

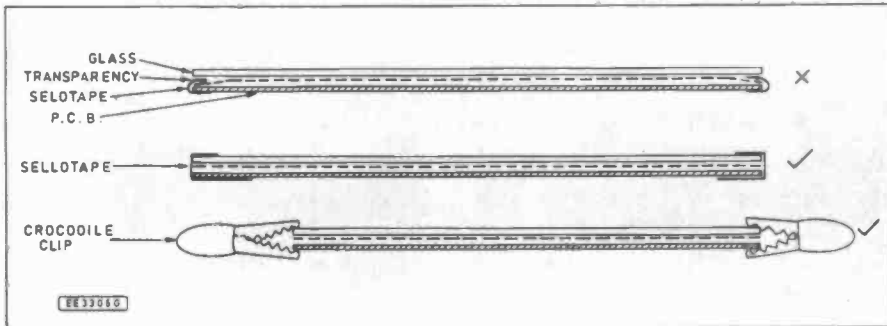

Fig. 7. Cross-section "sandwich" showing suggested method of preparing the photo-resist board for exposing the UV.

adjacent to the unit, probably increasing in intensity after a second or two, as the UV tube lights fully.

If nothing is seen (though the earlier tests, without the fluorescent tube, were satisfactory), then check the supply voltage and the tube connections. The most important thing is to always take care with the potential dangers of ultra-violet light and high voltages.

## PCB PRODUCTION

The topic of creating your own p.c.b.s is well covered in many articles and books — for example: the *Guide to Printed Circuit Boards* (EE April 1987) or *How to design and make your own P.C.B.s* (from the EE Direct Book Service). Here, therefore, is just a brief outline of the use of this UV Exposure Unit, starting out with a p.c.b. foil pattern from an article:

1. First of all, the foil pattern is photocopied onto clear film. Photocopy shops can be expensive for this, but the results should be satisfactory.

2. For the next stage, you'll need the completed UV Exposure Unit, photo-resist board, a piece of glass, plus the p.c.b. overlay transparency. (The glass, which should be about 100mm wide, can be borrowed from an old picture frame.)

Cut out the transparency so it is slightly smaller than the photo-resist board, taking care not to damage the photocopied image.

transparency — correct way up — between the glass and the board. Remember, it is vital to keep the transparency flat against the photo-resist board: probably the best method is either to Sellotape the edges of the glass and the board together, or to keep the glass and the board held together by a couple of crocodile clips (see Fig. 7).

3. Place the "sandwich" of glass/transparency/photo-resist board on a flat surface such as a tabletop, or the floor: With the UV Exposure Unit placed on top of this "sandwich", connect up a suitably rated 12V power supply (If you're using

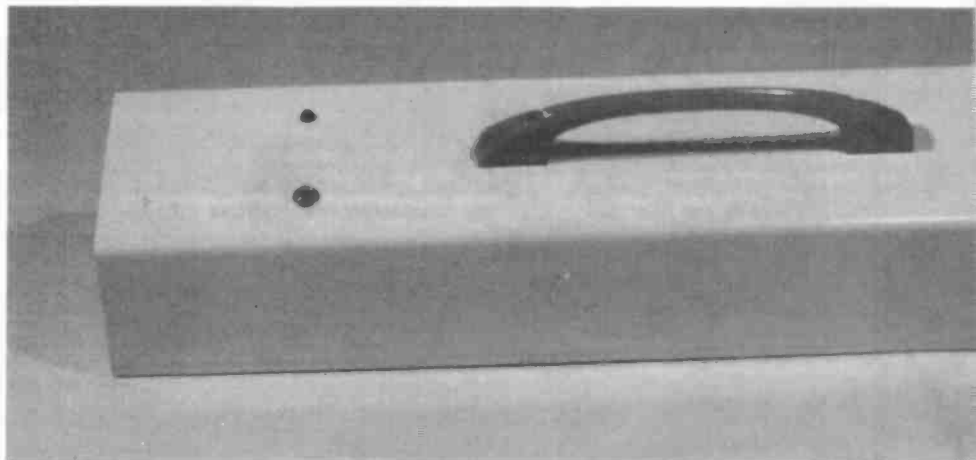



# Visual Audio Sales Limited

Electronic House, Front Street, Sacriston, Co. Durham, England DH7 6JT  
Tel: (091) 371 9999 Fax: (091) 371 0283

## LIGHTING

SL 280 Light Sequencer £59.00

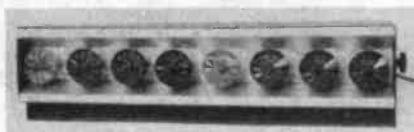

Self contained 8 light sequencer in a metal case. Built in sound detection circuit allows the speed of the sequence to react to the beat of the music. Lamps with red, green, blue and amber covers. Wall/ceiling mounted. 240V.

Sundancer £315.00



Sundancer in metal case for wall/ceiling mounting. Produces 7 flat beams of different coloured light which rotate to the beat of the music. Fan cooled, fused and with a thermal cut out. 240V. Bulb 500W.

Moonflower £299.00



Moonflower in a grey metal case with ceiling mounting bracket. Fan cooled with 150mm lens, built in sound to light controller to give multi-coloured beams of light to the music. Bulb 250W. Power 240V.

SCA1 Scanner £49.00



Par 36 single headed scanner in grey metal case. 220° rotation forward and reverse. Complete with transformer and PAR 36 bulb. 240V.

SCA2 Scanner £99.00

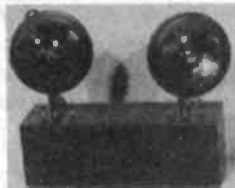

PAR 36 double headed scanner in grey metal case. 220° rotation forward and reverse on separate motors. Complete with transformer and PAR 36 bulbs. 240V.

SCA4 Scanner £159.00

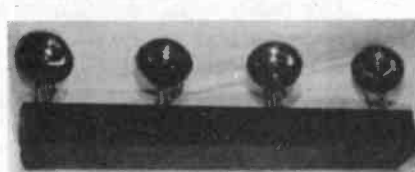

PAR 36 four headed scanner in grey metal case. 220° rotation forward and reverse on separate motors. Complete with transformers and bulbs. 240V.

FF1 Fluorescent Fitting £4.99



2', 600mm British made fluorescent fitting complete with 18 watt slimline tube. Wall, ceiling or cabinet fixing.

FF2 Fluorescent Fitting £5.99



3', 900mm British made fluorescent fitting complete with 30 watt slimline tube. Wall, ceiling or cabinet fixing.

RO80 Coloured Bulbs £5.90 per pack of 4



RO80 E.S. 60 watt bulbs in four colours; red, blue, green and amber. Supplied in packs of four.

## AUDIO

TT1 Turntable £9.99

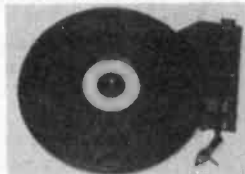

BSR 10" Belt driven turntable complete with ceramic cartridge. 12V d.c. 33 and 45 r.p.m.

TT2 Turntable £14.50

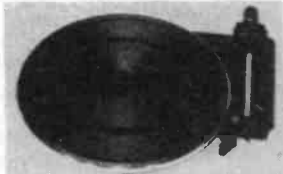

BSR 10" Belt driven turntable complete with metal arm, ceramic cartridge and electronic speed control. 33 and 45 r.p.m. 12V d.c.

TT3 Turntable £19.50



BSR 12" Belt driven turntable complete with ceramic cartridge and electronic speed control. 33 and 45 r.p.m. 12V d.c.

Portable Amplifier £39.00



Portable Amplifier with 25W per side output from built in amp and speakers. Complete with microphone socket. For use with your 'Walkman' or any source with small headphone jack. Can be powered by battery or a 12V adaptor, not included.

Power supply kit for converting to mains use £3.50

## ACCESSORIES

Speakers £11.50 per pair

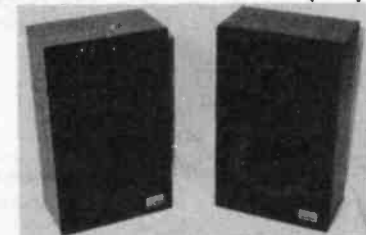

High Fidelity Speaker in veneer cases. 10 watt at 8 ohms.

Model Railway Controller £39.00

Model railway controller in grey metal case with off/direction control, brake and precision speed control. Complete with output and overload illumination. Outputs: 12V d.c., 16V ac and relay facility.



Connection Boxes



RAT 1 - Four 8 pin Bulgin Sockets in a metal case £16.90  
RAT 2 - Two 8 pin Bulgin sockets and four 3 pin shutter sockets and plugs in a metal case £17.90  
RAT 3 - One 8 pin Bulgin socket and four 3 pin shutter sockets and plugs in a metal case £15.90  
RAT 4 - White plastic four way, in line 13 amp extension board. Fused £4.95

Payment to be made with order plus £2.50 postage and packaging

1991/92 Catalogue now available £1 post free (Refundable on first order)

All prices include v.a.t.

Trade Enquiries Welcome



# MAGNETIC RECORDING

## Part 1: What is Magnetism?

VIVIAN CAPEL



*Life today would be difficult to imagine without magnetic recording: No audio or video recorders; no computer disks; no payphone cards; no bank cash cards or magnetic security pass cards. In spite of its universal use, magnetic recording and the principles of magnetism are still little understood by most people. In this short series we hope to answer some of the questions most often asked about Magnetic Recording.*

Life today would be difficult to imagine without magnetic recording. Audio and video cassette recorders make a major contribution to our entertainment. Even the long-playing record and the compact disc would be very difficult to produce without it as each side or at least each track would have to be recorded in one "take" directly on to the master, as in the old days of 78's. There could be no subsequent editing or mixing.

Floppy computer discs and hard drives would be unheard of, and there would be no payphone cards or magnetic security pass cards. These are just domestic uses, many industrial processes would likewise suffer without magnetic data recording and other applications.

Yet in spite of its universal use, magnetic recording, or even the principles of magnetism are little understood, certainly not as well as those of electronic circuits. In this series we hope to redress the balance a little, and give the reader a grasp of just what is involved in "magnetic recording".

### PRODUCING A MAGNETIC FIELD

It is fairly common knowledge that a magnetic field is produced when an electric current flows in a circuit. This field causes the rotor in an electric motor to turn when a current is passed through it, and it induces a voltage in an adjacent coil if it is passed through a winding of a transformer.

It is also accepted that a current is a flow of electrons along a conductor from a point where there is a surplus, the negative pole, to one where there is a deficiency, the positive. Now inside the atom, electrons are constantly orbiting the positive nucleus as satellites, so in effect we have minute electric currents circulating continually around the centre of the atom.

According to the above principle, each electron should and in fact does generate a tiny magnetic field as it orbits. In addition, the atoms spin, and this also produces a magnetic field. These magnetic-generating electron motions are called *magnetic moments*.

So all atoms produce internal magnetic fields, however, the total field or moment of the whole atom is the vector sum of all the

individual ones. In most cases, the different planes of orbit and spin cancel out so that the total field is zero. These materials are said to be *diamagnetic*, that is they have no detectable external magnetic properties.

With other materials some of the internal fields coincide and reinforce each other. These produce magnetic fields outside the atom or molecule and are called *paramagnetic*. The individual molecules or atoms are thus like very small individual magnets each having a North and South pole.

Now another well-known fact is that opposite poles attract, whereas like poles repel each other. So, in any conglomeration of paramagnetic molecules, the poles of each little magnet tries to find an opposite one, which it does, with the result that they form into rings, each ring consisting of a complete magnetic circuit.

Now the effect of this is that no field escapes, all fields are confined inside the lump which therefore exhibits no external magnetic field. If though the material is placed in an external magnetic field, it causes the rings of atoms to break up and form straight lines along the applied lines of magnetic force. Their magnetic fields now appear externally and actually reinforce the applied magnetizing force, so making it stronger.

What happens when the external force is removed? That depends on the material. If it is magnetically *soft*, most of the atoms breathe a sigh of relief and form up into rings again. If it is magnetically *hard*, most of the atoms stay in line, and a *Permanent magnet* is created.

Often, a sharp physical shock will "loosen" some atoms and they will go back into ring formation. That is why you

should never give a permanent magnet a hard knock, it will very likely lose a lot of its magnetism.

Materials that are magnetically hard are often physically hard too, and magnetically soft ones are physically soft, but there are exceptions.

### POLES APART

The magnetic field consists of lines of force that exit from one end of a magnet called the North pole and form a loop around the outside, to enter the other end which is the South pole. Inside the magnet the line of force continues through the material back to the exit point thus making a complete circuit.

Externally, the lines take the shortest path from pole to pole, but they mutually repel each other so they tend to balloon out with some lying close to the magnet and others at increasing distances from it. They can never cross, so unlike a reel of cable or ball of string started at the wrong end, they never get tangled up.

The poles of a magnet can be configured to direct or concentrate the field in a certain desired area, and the magnet itself can be shaped to have a similar effect. Thus, although the "natural" shape for a magnet is a straight bar, a common version is the horseshoe having poles that are physically close, thereby concentrating the field between them. The same effect is achieved in a recording head as we shall see in a later article.

The names given, the North and South poles, can be a little misleading though. More accurately they are North-seeking, and South-seeking poles. That is they are attracted to the earth's magnetic poles that

Table of Magnetic Properties

Property	Symbol	Formula	CGS unit	Ratio	MKS unit
Flux	$\phi$		Maxwell	10 <sup>8</sup> :1	Weber
Field Strength	H		oersted	12.5:10 <sup>3</sup>	Ampere-metre
Coercivity	H <sub>c</sub>		oersted	12.5:10 <sup>3</sup>	Ampere-metre
Flux Density	B		gauss	10 <sup>3</sup> :1	tesla
Permeability	$\mu$	$\frac{B}{H}$			
Reluctance	r	$\frac{L}{\mu a}$		(L = length; a = area)	

are near the geographic north and south respectively.

As opposite poles attract, this means that the magnetic pole near the earth's geographic north in the Arctic is really a magnetic *South* pole, and the pole near the geographic south in the Antarctic is the magnetic *North*. This is an example of one of those little-known facts about magnetic behaviour.

What perhaps is better known is that the magnetic and geographic poles do not exactly coincide. In England, compass needles point some 16 degrees West of true North which is nearer NNW.

As a Bar magnet is a string of molecular magnets aligned end to end, it follows that the magnet can be broken in half to form two magnets, whereupon each has its own North and South poles. These too can be halved and further divisions made theoretically down to molecular length.

The interesting fact is that the strength of the magnet is not diminished, each section has the same number of lines of force passing through it as the whole, providing the cross-section area remains the same. Furthermore, if two equal magnets are joined end-to-end, the strength is not increased. The lines merely link end-to-end to give the same number as for one. So there is no such thing as a formula for magnets in series!

## FLUX

Having got some idea of the basics of magnetism the time has now come to absorb a few technical definitions and expressions. Unfortunately many long-used terms have been changed so that older ones are encountered and are often still used, as well as the new ones, which makes it rather confusing. To be able to understand any description involving magnetism one really needs to be familiar with both systems and be able to convert one to the other.

The old system was the CGS, being based on the centimetre, gramme and the second. The new is the MKS, which uses the metre, the kilogramme and second. The MKS is clumsier, more difficult to understand, and definitely no improvement, but then, many of us think that about the whole metric system anyway.

Firstly, those lines of force or flux as they are also called. The symbol is  $\phi$  and the CGS unit is the *Maxwell* which simply denotes one line of force. The MKS unit is the *Weber*, defined as the force that produces an e.m.f. of one volt, when it is reduced to zero at a uniform rate across a coil of one turn in one second.

You can see why MKS units are considered more clumsy! To convert, one Weber equals  $10^8$  Maxwells. This illustrates another difference, that MKS units are usually much larger and so often have to be fractionalized.

One useful fact resulting from the combination of the above information is that the induced voltage across a coil of a given number of turns produced by a known flux of known frequency can be calculated. A fall from maximum to zero takes place in a quarter of a cycle so the frequency is 0.25Hz.

As this is impractically low we can multiply it by 100 to give 25Hz, and reduce the flux by the same factor to give the expression that a flux of one million lines of force or Maxwells (0.01 Webers) will produce one volt in a single turn at 25Hz. In a more practical coil of 100 turns the required flux is 10,000 Maxwells or 0.0001 Webers.

## FIELD STRENGTH

The stronger the magnetic field, the greater the number of lines there will be in a given area. The symbol is *H*, which refers to *field strength* in air (strictly a vacuum), and it describes the number of lines of force passing through a surface which is perpendicular to the direction of the lines.

The CGS unit is the *oersted* which straightforwardly is one line of flux per  $\text{cm}^2$ . The MKS unit is the *ampere-metre*, the conversion being 1,000 ampere-metres to 12.5 oersteds.

Thus, the MKS unit is actually smaller in this case because of the larger area involved. Field strength *H* particularly describes an *applied* field from a magnetic source, to distinguish it from the resulting field it *induces* in a magnetic substance.

The term *flux density*, symbol *B*, is used to describe the field induced in a material by an applied field. As with field strength it is defined by the number of lines of force passing through a surface of given area perpendicular to the direction of those lines. The CGS unit is the *gauss*, defined as the flux induced by a field of one oersted which as we have seen is one line of flux per  $\text{cm}^2$ .

The MKS unit is the *Tesla* which is a flux of one Weber per  $\text{m}^2$ , which is  $10^8$  lines of flux per  $\text{m}^2$ . Few induced magnetic fields extend over metres so we can reduce this to the more practical CGS unit based on the cm, by equating one Tesla to 10,000 gauss.

In some situations the flux density in air may be required such as when comparing the density with and without the presence of a magnetic substance. In such case the flux density is equal to field strength, and  $B = H$ .

## PERMEABILITY

Permeability is the magnetization capability of a paramagnetic substance, and the symbol is  $\mu$ . When a magnetizing field is applied to such a substance, a large number of its ring formations straighten out to produce an external field which is stronger than the applied one. The applied field can thus be considered as a sort of trigger.

In the case of ferrous metals the permeability can be several thousands which means that the induced fields are several thousand times greater than the applied one. This isn't really a case of something for nothing, the resulting fields were there all the time but concentrated within the molecular rings. By breaking the rings and straightening them out, the internal lines of force are merely compelled to seek an external path to complete their circuit.

The permeability is thus the ratio between the applied field *H* and the induced field *B*: so  $\mu = \frac{B}{H}$  or to find the induced field,  $B = \mu H$ .

In air, the field resulting from an applied force is just the force itself, no more or no less, so the permeability is one. Non-magnetic (diamagnetic) materials impede or resist the passage of lines of force, so the field within or through them is less than one.

This magnetic resistance is termed *reluctance*, because the material is reluctant to let the lines of force through. The symbol is usually *r* and the formula is:  $r = \frac{L}{\mu a}$  where *L* is the length and *a* is the area of the material. The permeability of the substance, being on the bottom line results in a low reluctance for high permeabilities and a high reluctance for low ones.

## SATURATION

The action of the applied magnetizing force is as we have seen, to make some of the internal molecular magnets break circle formation and line up to produce an external field. When the applied field is increased, more molecules line up, and the induced field becomes stronger. With high permeability materials, a small increase of the applied field produces a large increase in the induced field because the increase is multiplied by the permeability.

At a certain point, all the molecules in the material are lined up, and any further increase in magnetizing force cannot produce any more flux in the induced field. The material is then said to be *saturated*. However, as saturation point is approached with nearly all the molecules affected, the induced field increases at a reducing rate. The magnetization characteristic thus becomes curved toward saturation point.

When the magnetizing force is removed, the induced field does not drop to zero even with a "soft" magnetic material. While most of the molecules re-form into circles, some seem to like their new straight-line position and they stay there. So a certain amount of the induced field remains. The remaining magnetism is termed the *remanence* and the ability of a material to retain magnetism is called its *retentivity*.

The only way to bring a material at normal temperature to zero level after being magnetized, is to subject it to a reverse magnetic field. As it refuses to give up all its acquired magnetic flux peacefully it must be coerced.

The reverse field required to bring a material from saturation down to zero is thus termed its *coercivity*. The unit is the oersted or the ampere-metre, the same as for the initial magnetizing field, but the symbol is *H<sub>c</sub>*.

Well, with that insight into matters magnetic and the terms and units used to describe them, we are ready to explore the technicalities of magnetic recording.

## WHY USE BIAS

Magnetic recording tape consists of a polyester base on which particles of a "hard" magnetic material are deposited and held by a binder. They are needle-shaped, having a length of between 0.1  $\mu\text{m}$  to 0.5  $\mu\text{m}$ , and are oriented lengthways along the tape.

These become magnetic *domains*, each of which are magnetized by the record head to a level corresponding to that of the audio signal present at the instant of passing. When passing again in the replay mode, the external fields existing around each domain induce voltages in the head windings which correspond to the original audio signal.

This sounds nice and simple, but there are complications (aren't there always?). The problem is that the induced magnetic flux *B* is not proportional to the applied force *H* over its magnetization range. As the force increases, the induced flux rises gradually to start with, then it increases in a linear manner to a point where it slows down to the saturation level.

The characteristic curve so formed is the same for both magnetic polarities, so the South curve is a mirror image of the North curve but below the zero line as shown in Fig. 1. It can be seen that if a sine wave with excursions either side of zero were to be recorded against this characteristic there would be severe distortion at the regions near the zero points.

The curve in Fig. 1 illustrates the amount of flux induced in the material when it is first magnetized by an applied force. It is therefore known as the *initial magnetization curve*.

It is not the whole story though, as we saw earlier, some flux remains (*remanence*) when the applied force is removed. To bring it to zero we have to apply a reverse force. It can then be magnetized in the opposite direction to saturation whereupon the applied field must be reversed again to bring it back to zero. Then the cycle can be re-started although not from the same point as before.

If all that seems rather obscure, the best thing is to follow the process through with the aid of Fig. 2. As with Fig. 1, the horizontal axis is the applied force  $H$ , and the vertical, the resulting induced flux  $B$ .

We start at the centre  $a$ ; the applied force  $H$  is increased and the induced flux  $B$  follows suit, although with the previously noted curve at the commencement. It continues to point  $b$  which is the saturation level. This in fact is the initial magnetization curve of Fig. 1. Now force  $H$  is gradually reduced to nothing and the induced flux  $B$  also falls, but not to zero. Instead it achieves the level of  $c$ .

Force  $H$  is reversed, and  $B$  continues on down from  $c$ , until it does hit the zero line at  $d$ . Force  $H$  continues in the reverse direction, and  $B$  starts to reverse too, finally reaching saturation at  $e$ . Now force  $H$  is again reduced, and  $B$  once more falls back toward zero, but it only reaches  $f$  when  $H$  gets to zero.

Now  $H$  presses on in forward gear again, bringing  $B$  to zero at  $g$ . Here it is at its starting point, but at the expense of some forward field  $H$  to overcome its previous negative value, so,  $g$  is displaced along the  $H$  line as can be seen.

Continuing in the forward direction,  $H$  quickly induces  $B$  up to the saturation point  $b$  again. This is the true completion of the cycle, and further excursions follow the same path. It is known as the *hysteresis loop*, but not we hope because it caused readers hystericus trying to follow it!

### D.C. BIAS

With such a devious response to the magnetizing force it may be wondered how on earth a linear recording can possibly be made. Well, as we all know, it can, and we shall now see how it is done. The simplest method is by using *d.c. bias*, and this can take two forms.

The first is *d.c. bias from zero*. A direct current is passed through the record head, and the audio signal is superimposed on it. It thus increases and decreases the d.c. on alternate positive and negative half-cycles.

If the d.c. bias is set to the halfway point on the initial magnetization curve, the tips of the half-cycles will avoid both the bottom curve just above zero, and the top curve just below saturation. They thus use only the straight portion and a linear recording can be made as seen in Fig. 3.

A question that may be asked is why do we use the initial magnetization curve here instead of the hysteresis loop? Well, for this type of recording, the individual magnetic domains are magnetized to the required level to represent some point on the audio waveform, and are not thereafter demagnetized. So, the initial magnetization curve applies. The situation is different with the next type of bias which is *d.c. bias from saturation*.

With this, the tape is magnetized to saturation by a d.c. current through the erase head which always precedes the record head, or by a permanent magnet. The d.c. bias through the record head is of

opposite polarity to the saturation, so it partially demagnetizes the tape. As before, the audio is superimposed on the bias. So, the recording is made by varying the amounts of *demagnetization* instead of *magnetization* as with the first method.

What advantage is that? This, the curve which is thereby used is the demagnetization portion of the hysteresis loop, that is  $b, c, d, e$  of Fig. 2. It can be seen that this part of the curve has a longer straight portion than the initial magnetization part,  $a, b$ . So a larger audio signal can be recorded than with the d.c. bias from zero method. This can be shown if we reproduce just that part of the loop with an applied sine wave as shown in Fig. 4.

This then is the usual method employed when d.c. bias is used. But there is a snag. The number of magnetic molecules passing the head per unit of time is constantly varying as it is impossible to manufacture a tape with an equal number across its width at all points. They have all been brought to saturation, but a fixed number will be demagnetized for a given value of d.c. bias. So the remainder at saturation will be the original varying number minus a certain fixed number, hence the saturated remainder will also be a varying number.

This procession of saturated molecules of varying number past the playback head produces noise as the number fluctuates. So d.c. bias gives a high background noise, and is therefore unsuitable for hi-fi sound. It is used for many portable recorders in which tape noise is not important.

### A.C. BIAS

To overcome the noise problem, a totally different method of biasing is used for high quality reproduction. An a.c. wave several times the frequency of the highest audio frequency, is generated by a sine-wave os-

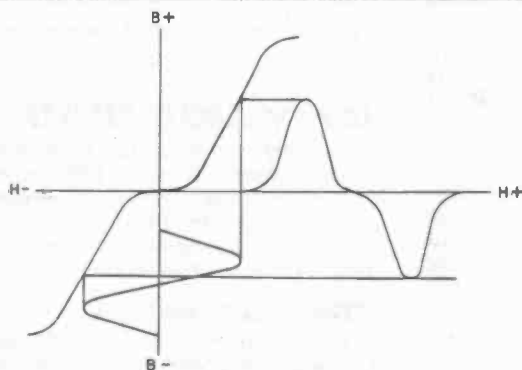

Fig. 1. Initial magnetisation curve. A recorded waveform crosses the non-linear portions and is severely distorted.

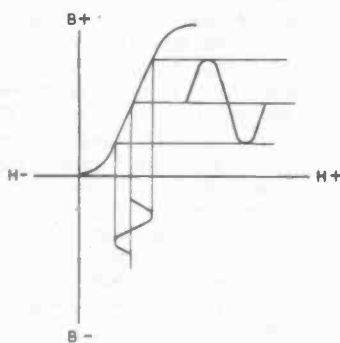

Fig. 3. D.C. bias from zero puts the operating point at the centre of the straight part of the initial magnetisation characteristic.

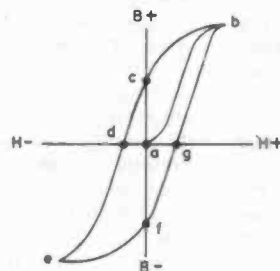

Fig. 2. Hysteresis loop. After initial magnetization  $a-b$ , the flux falls from saturation when field is removed  $b-c$ , then requires a reverse field to restore it to zero,  $c-d$ ; further applied reverse field builds up to saturation point  $e$ ; then a removal causes drop  $e-f$ . A forward field now reduces the flux to zero,  $f-g$ ; whereupon increased forward field raises the flux to forward saturation,  $g-b$ .

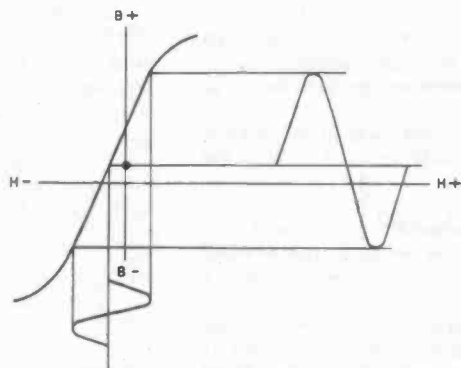

Fig. 4. D.C. bias from saturation uses the "back" of the hysteresis loop by biasing a previously saturated tape. The straight portion is much longer than that of the initial magnetisation curve.



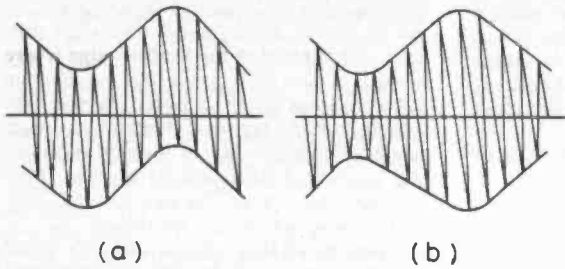

Fig. 5a. An audio frequency superimposed on h.f. wave as with a.c. bias. The amplitude of the h.f. does not change.

Fig. 5b. A modulated wave. The h.f. amplitude changes with the audio. This generates plus and minus sidebands which interact with the audio frequency and produce intermodulation distortion. Modulation of the bias waveform must thus be avoided.

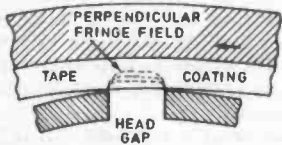

Fig. 7. The perpendicular field at the trailing edge tries to change the longitudinal magnetic orientation achieved in the gap. Short magnetic zones are more affected than long ones, so short-wavelength high-frequencies are partly erased while long-wavelengths are unaffected.

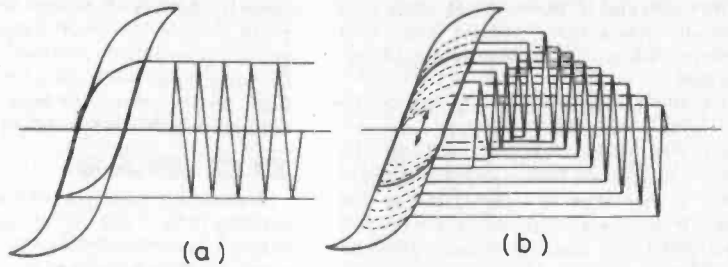

Fig. 6a. RF waveform produces a mini loop within the main hysteresis loop.

Fig. 6b. Mini recording loop moves up and down in sympathy with the audio modulations leaving the trailing gap edge magnetized with instant value corresponding to audio signal.

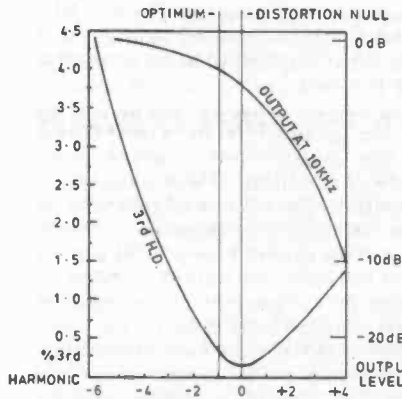

Fig. 8. Third harmonic distortion and 10kHz response plotted against bias level. Bias level for minimum distortion produces h.f. loss. Optimum for low distortion and good h.f. response is just below minimum distortion point.

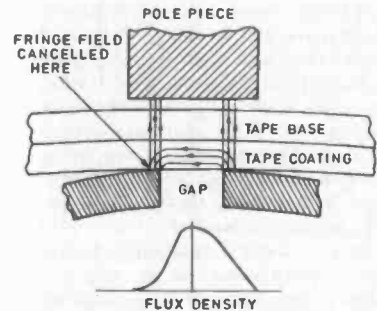

Fig. 9. Crossfield bias. An auxiliary signal field established between the head and a pole piece behind the tape. The direction of the flux reinforces the head flux at the leading edge but cancels it at the trailing edge. This eliminates the perpendicular field and so permits higher frequencies to be recorded. The asymmetrical flux distortion across the gap is shown.

cillator in the recorder, and the audio is superimposed on it.

At this point it is necessary to note the distinction between *superimposition* and *modulation*. In the case of superimposition, the high frequency bias carries the lower frequency audio on its back as it were, on both its positive and negative halves. At no time does the amplitude of the bias signal itself change, see Fig. 5a.

With modulation, the amplitude of the high frequency carrier does change, being squeezed at some points and stretched at others by the modulating signal, see Fig. 5b. This produces extra frequencies known as sidebands, which are the sum and difference of the carrier and modulation frequencies.

If the bias frequency is allowed to affect the recording amplifier, modulation can occur, which, if the bias frequency is low enough, could produce a spurious sideband within the audio range. To avoid this, the bias frequency is kept as high as possible and filters are usually included to keep the bias out.

## MINI LOOP

But now back to the recording process. Just how the a.c. method works has been a matter of some dispute, and various explanations have been offered. Some of these have used the initial magnetization curve as a basis of the theory, but as individual particles are both magnetized and demagnetized several times during the recording process, the hysteresis loop must be involved.

The first thing to appreciate is that the

record head gap is very wide compared to the magnetic particles for reasons we shall explore in a later article. So as they cross the gap, the particles are subject to several cycles of a.c. bias and so go through a number of successive magnetizing and demagnetizing cycles before leaving it. They thus follow several hysteresis loops except that the amplitude of the bias is insufficient to drive the particle to saturation point, in fact it is kept well short of saturation. We could therefore call it a *mini loop*.

Now the effect of superimposing audio on the bias is that the whole of the mini loop moves up and down in sympathy with the audio variations, within the main hysteresis loop. This is shown at Fig. 6a where a steady a.c. bias is producing a mini loop at a central position within the main one. In Fig. 6b audio is shown superimposed on the bias causing the mini loop to move up and down within the main loop.

When a particle eventually leaves the influence of the head gap, it remains magnetized to a level corresponding to some point on the loop that it reached at the instant of departure. We will call this the *final flux point*. It could be any part of the loop and it does not matter which, but all particles that follow leave the gap magnetized to the same point.

When the mini loop is stationary (when there is no audio signal), all successive particles are thus magnetized to the same degree. But when the mini loop moves vertically, the final flux point moves with it. Hence the magnetic level of successive par-

ticles varies according to the position of the mini loop which in turn is determined by the audio signal.

So we have magnetic domains along the tape having levels of flux equivalent to the audio waveform. Note that the bias itself is not recorded and it leaves no trace on the tape. It is merely a vehicle, providing a rapidly cycling loop that can be moved up and down, tracing varying levels of flux along the tape as it does so.

## FRINGE FIELD

The portions on either side of the gap in the recording head are magnetic pole pieces, so the flux flows from one side of the gap to the other. However, the gap contains a shim of non-magnetic material which offers a high reluctance, so the flux is diverted around the outside of the gap and so through the tape where it is wanted.

The flux path is thus roughly hemispherical. It emerges from one side of the gap perpendicularly to the tape, swings around to run along the tape parallel to the gap, then turns again to enter perpendicularly at the other side. The needle-shaped magnetic particles are longitudinally orientated and so are readily magnetized by the bias field over the central area of the gap. They go through several hysteresis cycles and acquire their final magnetization level just before the trailing edge of the gap where the applied field becomes perpendicular. This is known as the *fringe field*, see Fig. 7.

Now the perpendicular field tries to change the magnetic orientation. Long

magnetic zones have a high coercivity, are quite stable and resist the change, but short ones do not. Long zones correspond to long sound wavelengths which are associated with bass frequencies, whereas short zones are recorded by the short-wavelength high frequencies.

So, the high frequencies tend to be erased by the perpendicular fringe field whereas the bass ones are unaffected. This is one of the reasons for the limitation of high frequency response with magnetic recording.

## HOW MUCH BIAS

The technical descriptions of recording tapes often include a bias specification consisting of a plus or minus dB value. This is because different tape coating formulations have different optimum bias requirements. Recorders usually have an internal adjustment whereby the bias level can be set, and some decks have a user control.

If the bias is set too low, the straight portions of the mini-loop hysteresis cycle are restricted and large amplitude audio signals will encroach on the curved parts. The result is non-linear recording and distortion. If the setting is too high, the mini loop lengthens, and so large audio swings drive it toward saturation points which also result in distortion.

It follows that there is a value that gives minimum distortion, and indeed distortion measurements show a gradual increase either side of a low point. It would seem then that this is the obvious optimum point, but there is another factor.

As the bias level is increased so obviously does the flux density, and as the lines of force start out as a perpendicular fringe field, this means an increase in the fringe field at the trailing edge of the head-gap.

As we have seen, this field has the effect of erasing higher frequencies (h.f.). So, any increase in bias produces a loss of treble or high frequency response. The bias can thus be adjusted either for minimum distortion, or decreased a little from this point to give a better h.f. response at the expense of a small increase in distortion.

As the distortion null point is not sharp, a useful increase in h.f. can be obtained with only slightly increased distortion. If even more h.f. is required it can be obtained with more distortion by reducing the bias further.

The bias should not be increased beyond the distortion null point as this will both increase distortion and reduce h.f. Fig. 8 shows typical distortion and h.f. loss curves set against bias.

## CROSSFIELD BIAS

An ingenious method of avoiding h.f. loss due to the fringe field is to employ a secondary magnetic field set up between the record head and a pole piece situated at the back of the tape. Both sides of the gap are part of the same pole, which is North on one half-cycle and South at the other when the bias oscillation reverses.

Now the polarity across the gap is always opposite, so this means that the fringe field on one side of the gap is reinforced by the secondary field, while that on the other

is cancelled, being of opposite polarity. Reference to Fig. 9 will make this clear.

Polarity is arranged so that reinforcement takes place at the leading edge where the fringe field is harmless because the tape there still has to be recorded by the gap. The important region is the trailing edge; there cancellation occurs thereby eliminating the fringe field and its erasing effect on high frequencies. The asymmetrical flux distribution is also shown in Fig. 9.

Another version uses a separate head for bias positioned behind the tape, and slightly offset from the recording head. This has a similar effect in eliminating a fringe field.

The crossfield bias system began to appear on some open reel tape recorders just before the audio cassette became popular and open reel machines disappeared from the domestic scene. The physical layout of the compact cassette though made it virtually impossible to implement.

Had it been considered at the design stage, it would very likely have been possible to make a cassette with cut-away portions to accommodate a pole-piece behind the tape just as for the drive spindle. This would have achieved an improved high frequency response, and lower distortion as the bias could then have been set to the distortion null.

Since then though, improvements in tape formulation and record heads have achieved an acceptable high frequency response thereby reducing the attractiveness of the crossfield system. We will explore the record and playback heads next month.

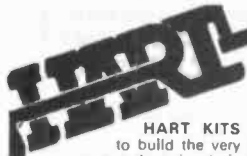

## HART AUDIO KITS – YOUR VALUE FOR MONEY ROUTE TO ULTIMATE HI-FI

LINSLEY HOOD 'SHUNT FEEDBACK' R.I.A.A. MOVING COIL & MOVING MAGNET PICKUP PREAMPLIFIER



This new circuit by John Linsley Hood uses latest generation integrated circuits in the sonically preferred shunt feedback configuration to give an accurate and musical sound, with the ability to use moving magnet and moving coil cartridges. The HART kit for this unit is exceptionally easy to build with all the specially selected components fitting directly on to the roller tinned fibreglass printed circuit board. Even the gold plated phono sockets mount directly on the board. Kit complete with fully machined case and a 1 metre length of miniature power supply cable is HART ref K1500. **£69.23**

ALPS PRECISION LOW-NOISE STEREO POTS.



All in 2-gang stereo format, with 20mm long 6mm dia. shafts. Now you can throw out those noisy, inaccurate PCB pots and replace with the best. If components only used selectively in the very top 1000 of World Class amplifiers. The improvement in track accuracy and matching really is incredible giving better tonal balance between channels and rock solid image stability. Values available are 10K and 100K Log, 100K Lin and 10K Special Balance. (Zero loss in centre position). Also now added to the range are two values in MOTORISED versions. These are 20K Log and 10K Special Balance with 8V DC drive motor. **£1.85**

2-Gang 100K ..... **£1.85**  
 2-Gang 10K Special Balance, zero cross talk and zero centre loss ..... **£10.71**  
 2-Gang 20K Log Volume Control MOTORISED ..... **£19.20**  
 2-Gang 10K Special Balance, MOTORISED, zero cross talk and 1% centre loss ..... **£19.98**

## HIGH QUALITY REPLACEMENT CASSETTE HEADS



Do your tapes lack treble? A worn head could be the problem. For top performance cassette recorder heads should be replaced every 1,500 hours.

Fitting one of our high quality replacement heads could restore performance to better than new! Standard inductances and mountings make fitting easy on nearly all machines (Sony are special, see below) and our TC1 Test Cassette helps you set the azimuth spot on. As we are the actual importers you get prime parts at lower prices, compare our prices with other suppliers and see! All our heads are suitable for use with any Dolby system and are normally available ex stock. We also stock a wide range of special heads for home construction and industrial users.

HC75 Standard Quality Stereo R/P Head ..... **£2.49**  
 HC66 High Quality Stereo R/P Head, Hard Permalloy construction with Hyperbolic Face for improved tape to head contact ..... **£7.98**  
 HS16 Sendust Alloy Stereo Head, High quality head with good frequency response and hyperbolic face for good tape to head contact ..... **£16.85**  
 HC605 SONY Special Stereo R/P head. This head has the unusual Sony mounting bracket and is suitable for mains powered domestic HiFi recorders ..... **£37.82**  
 HQ551 4-Track RECORD & Play Permalloy Head for auto-reverse car players or quadraphonic recording ..... **£14.90**

Many other SPECIAL cassette Heads in stock, see our LIST.

REEL TO REEL HEADS  
 999R 2/4 Record/Play 110µm Super Slant Tape Cartridge ..... **£13.68**  
 998E 2/4 Ease Head 1µm Universal Mount ..... **£11.98**

TAPE RECORDER CARE PRODUCTS  
 HART TC1 TEST CASSETTE Our famous triple purpose test cassette sets tape azimuth, VU level and tape speed ..... **£5.36**

DEMAGNETIZERS  
 DEM115 Electronics Cassette Tape Demagnetizer ..... **£8.91**

Our new SPRING '81 list is FREE in UK. Send for your copy now. Our vast customer welcome, but please send 2 IRCs if you want to get your copy surface post or 5 for airmail.

Ordering is easy. Just write or phone, with your requirements to sample the friendly efficient HART service. Payment by cheque, cash or credit card. A telephoned order with your credit card number will get your order on its way to you THAT DAY.

Please add part cost of carriage and insurance as follows: INLAND: Orders up to £20 - £1; Orders over £20 - £2.50. Express Courier, next working day - £9. OVERSEAS: Please see the ordering information with our lists.

HART KITS give you the opportunity to build the very best engineered hi-fi equipment there is, designed by the leaders in their field, using the best components that are available. With a HART KIT you not only get more performance for your money but also added free bonus of your own hands-on experience of modern electronic assembly. The HART combination of innovative circuit techniques, sound engineering design and professional grade components is your recipe for success in the quest for affordable ultimate audio fidelity.

Telephone or write for your FREELISTS giving full details of all our Kits, components and special offers. Featured this month is the:

### AUDIO DESIGN 80 WATT POWER AMPLIFIER



This fantastic John Linsley Hood designed amplifier is the flagship of our range, and the ideal powerhouse for your ultimate hi-fi system. This kit is your way to get EK performance at bargain basement prices. Unique design features such as fully FET stabilised power supplies give this amplifier World Class performance with startling clarity and transparency of sound, allied to the famous HART quality of components and ease of construction.

Useful options are a stereo LED power meter and a versatile passive front end giving switched inputs, with ALPS precision, low-noise volume and balance controls.

Construction is very simple and enjoyable with all the difficult work done for you, even the wiring is pre-terminated, ready for instant use! Complete details of the different versions are in our free lists.

RLH10 Reprints of latest 'Audio Design Amplifier' articles ..... **£2.70**  
 K1100CM HART Construction Manual with full parts lists ..... **£5.50**

Why not buy the reprints and construction manual to see how easy it is to build your own equipment the HART way. The FULL cost can be credited against your subsequent kit purchase.

## QUALITY AUDIO KITS

24hr SALES LINE  
 (0691) 652894  
 Fax: (0691) 662864

ALL PRICES INCLUDE VAT  
 AT 17.5%



HART ELECTRONIC KITS LTD.  
 6 PENYLAN MILL  
 OSWESTRY, SHROPSHIRE  
 SY10 3AF

# RIAA PREAMPLIFIER

ROBERT PENFOLD

*An inexpensive stereo pre-amp that will allow the use of a record deck with most audio equipment*

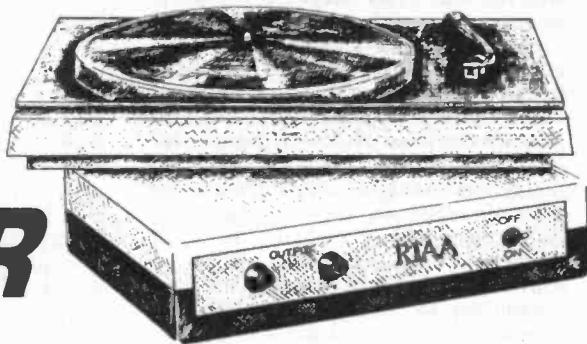

SUPPOSE that the gramophone record has had its day, and will probably be totally replaced by cassette tapes and compact discs at some time in the future. On the other hand, with countless millions of records now in circulation, and with much of the material they contain never likely to be reissued on cassette or compact disc, there is no immediate prospect of gramophone records becoming museum pieces.

There will be a need for record playing equipment for some time to come. Hi-fi amplifiers generally have an input for a record player, but this is something that is absent on some audio equipment.

This preamplifier project was inspired by a letter from a reader who required a preamplifier to enable a record deck to be used with a stereo radio cassette unit. However, there now seems to be an increasingly large amount of low cost audio equipment that does not have a built-in record deck or an input for one, and this preamplifier should enable any such equipment to be used with a record deck.

One obvious proviso is that the audio unit must have some form of spare input ("Aux", "Tuner", etc.) that the preamplifier can drive. Also, this preamplifier is only designed to operate with a magnetic pick-up, and will not operate with any other type. The output from a normal moving coil cartridge is too low to drive this preamplifier properly, but as this type of cartridge tends to be very

expensive there would be something of a mismatch if one was used in an inexpensive audio system. The unit will not work with ceramic or crystal pick-ups, but these seem to be something of a rarity these days.

## RIAA EQUALISATION

The output from a magnetic pick-up is quite low, and is mostly at a level of about 2 to 10 millivolts r.m.s. during volume peaks. This is far lower than the signal level most "Aux" and similar inputs are designed to receive. These vary somewhat in sensitivity, but generally something in the region of 200 millivolts r.m.s. to 2 volts r.m.s. is needed in order to drive them. An RIAA preamplifier must therefore provide a substantial amount of voltage gain.

There seems to be a common misconception that magnetic cartridges have an output characteristic that necessitates the use of equalisation in order to give a flat frequency response. This is not strictly true though, and a magnetic cartridge is fully compatible with the method of groove modulation used for gramophone records. Equalisation is needed, but only in order to counteract the tampering with the frequency response that is used during the recording process.

This manipulation of the frequency response takes the form of treble boost and bass attenuation. The treble boost provides a very basic form of noise reduction. Complementary treble cut must be used in the playback equipment in order to give an overall flat frequency response, and this reduces "hiss" type background noise. This "pre-emphasis" (the treble

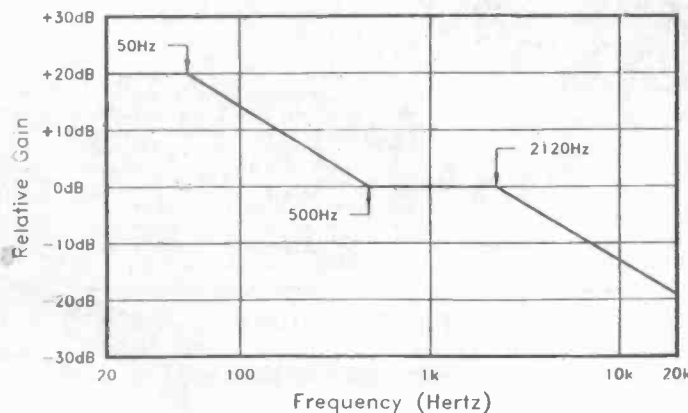

Fig. 1. The "ideal" or correct replay equalisation characteristic for an RIAA preamplifier.

boost) and "de-emphasis" (the treble cut) is a standard noise reduction technique that is used in radio, tape recording, etc.

The attenuation of the low frequency response is needed in order to prevent excessive groove modulation on strong bass signals. Remember that with a constant recording level, each halving of frequency results in a doubling of the groove modulation. Using attenuation of the bass frequencies prevents excessive groove modulations without having to cut back the modulation at other frequencies (which would severely reduce the signal to noise ratio).

The correct equalisation characteristic for an RIAA Preamplifier is shown in Fig. 1. There is a 6dB per octave roll-off above 2120Hz, and a 6dB per octave boost below 500Hz. In other words, above 2120Hz a doubling in frequency results in a halving of gain, while below 500Hz a halving of frequency results in a doubling of the voltage gain.

The response flattens out at 50Hz, and this avoids the problems with "rumble" that could otherwise occur. Also to counteract rumble, but of the sub-audio variety, the response is rolled-off below 20Hz. However, this attenuation is normally provided by the coupling capacitors anyway, and does not require any additional components. In practice the frequency response of Fig. 1 cannot be easily achieved. It is possible to obtain a close approximation though, and this requires only a fairly simple circuit.

## THE CIRCUIT

The full circuit diagram of the RIAA Preamplifier appears in Fig. 2. As the unit is for stereo operation it consists of two identical amplifiers. The one based on IC1 and IC2 handles the left hand channel, while the one based on IC3 and IC4 handles the right hand channel. Each preamplifier is based on two operational amplifiers used in the non-inverting mode. Operational amplifiers are well suited to an application of this type as they enable the required voltage gains and input impedances to be easily set, and they also make it easy to incorporate the equalisation into the circuit.

The basic non-inverting amplifier circuit is shown in Fig. 3a. R1 and R2 bias the input of the circuit to about half the supply voltage, and also set the input impedance. The latter is equal to the parallel resistance of these two resistors. The voltage gain of the circuit is equal to  $(R3 + R4)/R4$ .

Equalisation can be incorporated into the circuit by adding a capacitor in parallel



with one of the feedback resistors. In Fig. 3(b) there is a capacitor (C4) in parallel with R3, and this provides a 6db per octave roll-off above a certain frequency.

The reactance of a capacitor, which is effectively its resistance to a.c. signals, is frequency dependent. Each doubling of frequency provides a halving of the component's reactance. At low frequencies the reactance of C4 is too high to have a significant shunting effect on R3, but above a certain frequency the shunting of C4 starts to roll-off the response. The initial attenuation rate is quite low, but it soon reaches the full 6dB per octave.

Returning to Fig. 2, and the left hand channel circuit, R1 and R2 set the input impedance of the circuit at 50k. This is a good match for most magnetic pickups. Some have a recommended load impedance of 100k, and this can be obtained by using 200k resistors for R1 and R2 (as well as R8 and R9 in the right hand

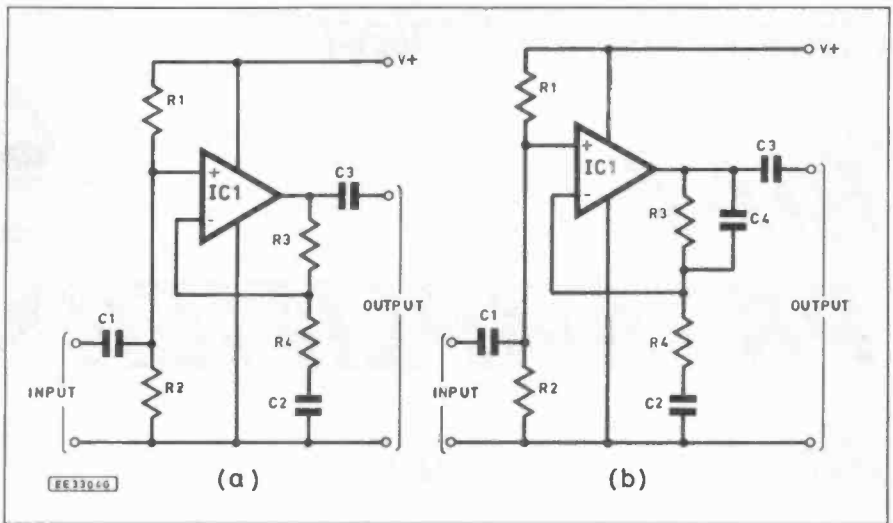

Fig. 3(a). The basic non-inverting amplifier circuit. (b) A non-inverting amplifier with simple equalisation.

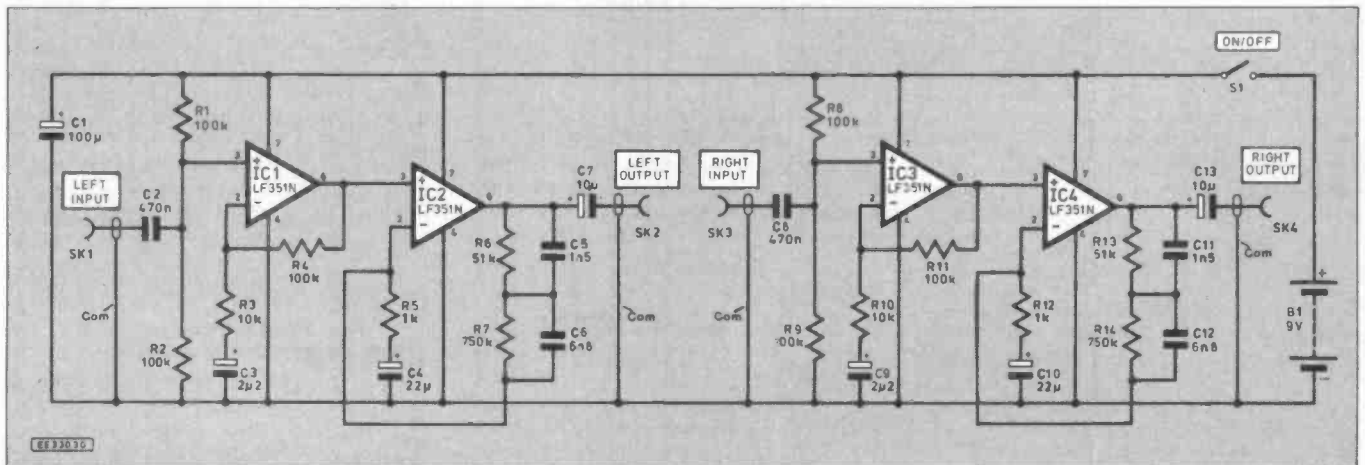

Fig. 2. The full circuit diagram for the RIAA Stereo Preamplifier.

channel). IC1 provides a voltage gain of about eleven times, which should ensure sufficient output from the unit to drive any normal audio equipment. However, if necessary the gain of the circuit can easily be raised or lowered by altering the values of R4 and R11.

Further voltage gain is provided by IC2, together with the equalisation. At low frequencies the voltage gain of the circuit is set by R6, R7, and R5 at just over 800 times. At frequencies above about 50Hz C6 shunts R7 and rolls off the response

at 6dB per octave. This continues until about 500Hz, where R6 prevents any further drop in gain. Above approximately 2120Hz C5 starts to shunt R6 significantly, and reintroduces the 6dB per octave roll-off. A single equalisation capacitor cannot be used due the flat response that is needed from 500Hz to 2120Hz. The required "kinked" response requires the use of at least two C-R circuits.

Power for the circuit is provided by a single 9 volt battery. This just about permits unclipped output levels of 2 volts r.m.s. to be achieved. The current consumption of the circuit is about 7.5 milliamps, and this can be provided by a

## COMPONENTS

### Resistors

R1, R2, R4, R8, R9, R11 100k (6 off)  
R3, R10 10k (2 off)  
R5, R12 1k (2 off)  
R6, R13 51k (2 off)  
R7, R14 750k (2 off)  
All 0.6W ± 1% metal film

See  
**SHOP  
TALK**  
Page

### Capacitors

C1 100µ axial elect. 10V  
C2, C8 470n polyester (2 off)  
C3, C9 2µ2 radial elect. 63V (2 off)  
C4, C10 22µ radial elect. 16V (2 off)  
C5, C11 1n5 polyester (2 off)  
C6, C12 6n8 polyester (2 off)  
C7, C13 10µ radial elect. 25V (2 off)

### Semiconductors

IC1, IC2, IC3, IC4 LF351N bifet op. amp. (4 off)

### Miscellaneous

SK1, SK2, SK3, SK4 Phono socket (4 off)  
S1 s.p.s.t. sub-min toggle switch  
B1 9 volt (PP3 size)  
8 pin d.i.l. i.c. holder (4 off); 0.1 inch pitch stripboard 31 holes x 36 strips; case approx 180 x 120 x 40mm (see text); battery connector; wire; solder; fixings; etc.

Approx cost  
guidance only

**£15**

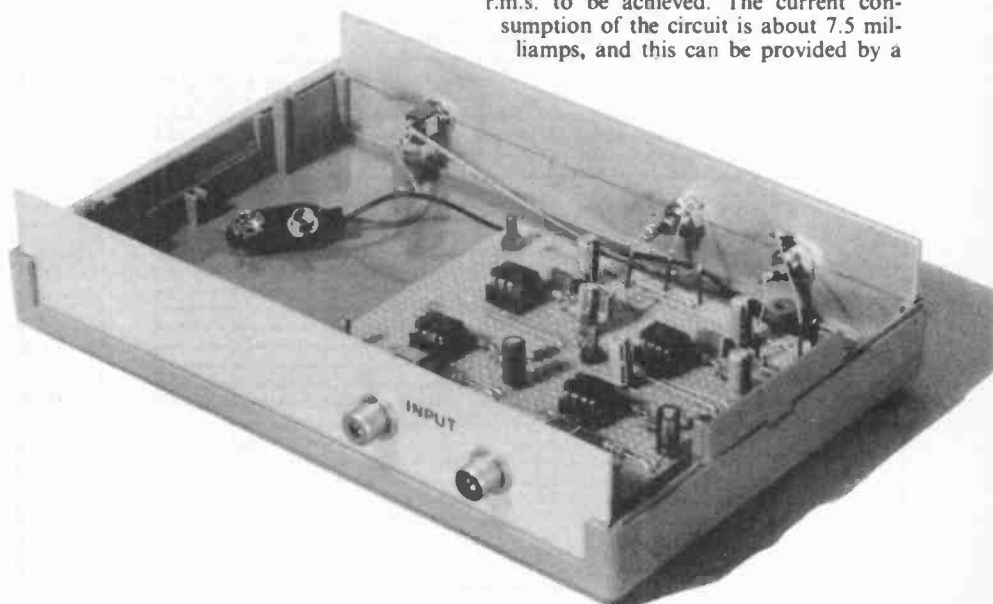

small (PP3 size) 9 volt battery. If the unit is likely to receive a great deal of use a higher capacity type, such as a PP9, would probably give significantly lower running costs.

## CONSTRUCTION

Apart from the controls, battery, and sockets, the components all fit onto the component panel. The layout of components and details of breaks required in the underside copper tracks is shown in Fig. 4.

This is a 0.1 inch pitch stripboard which has 31 holes by 36 copper strips. Stripboard is not sold in this size, and board of

the correct size must be cut down from a larger piece using a hacksaw.

Cut along rows of holes, and then file any rough edges to a smooth finish. Then drill the three mounting holes, which are 3.3 millimetres in diameter. These will accept 6BA or metric M3 mounting bolts. Next the twenty eight breaks in the copper strips are made. A special tool for this purpose is available, but a twist drill bit of about 5 millimetres in diameter will also do the job quite well. Be careful to fully cut through each strip, but do not cut into the board any deeper than is really necessary.

Fig. 4. Stripboard component layout and details of breaks required in the underside copper tracks.

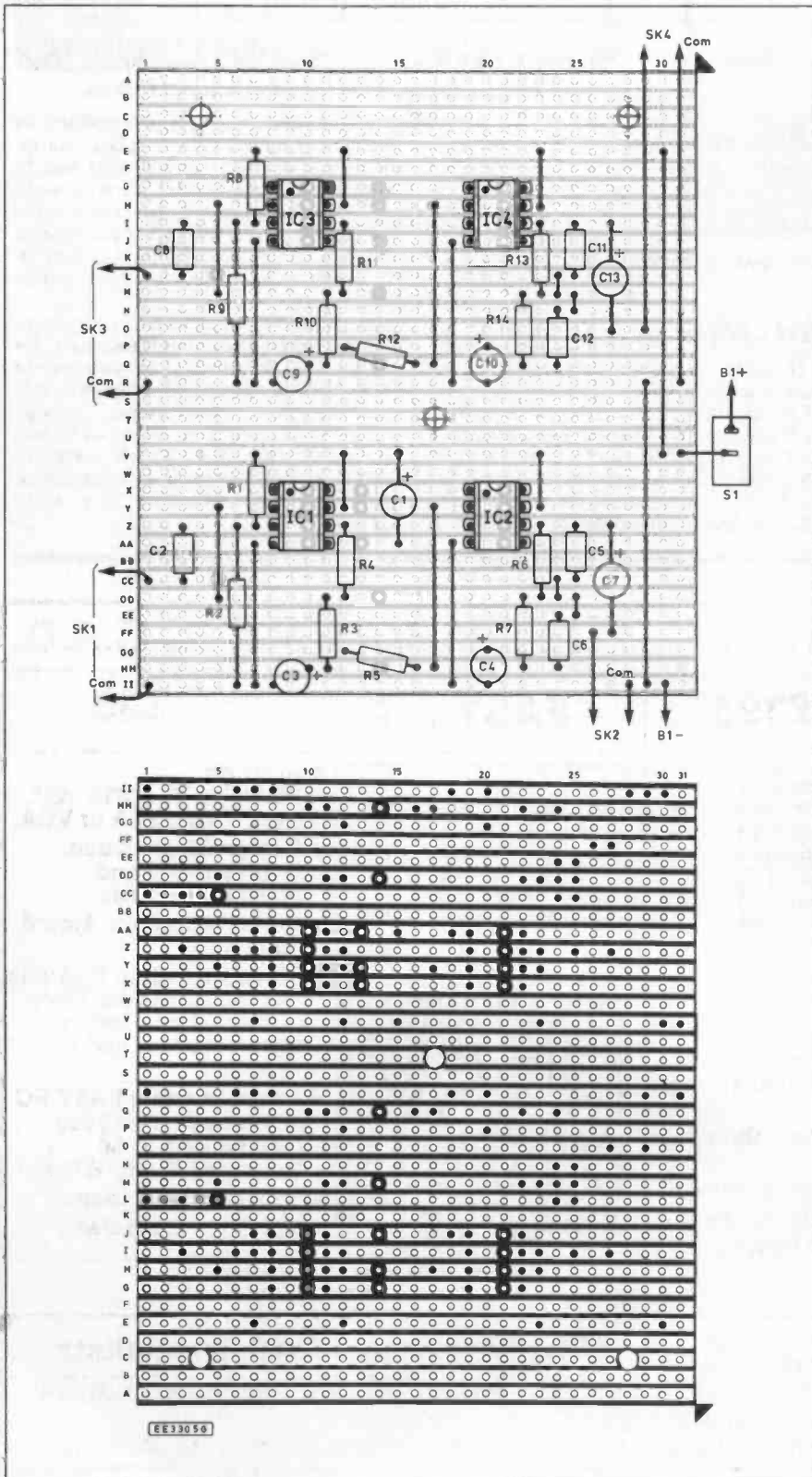

The board is then ready for the components, link wires, and solder pins to be added. The solder pins are fitted at points where connections to the off-board components will eventually be made. The single sided type are all that is needed in this case. Tin the tops of the pins with a generous amount of solder. The integrated circuits have f.e.t. input stages, but these are not of the MOSFET type, and consequently they are not especially vulnerable to damage by static charges. Despite this I would still recommend the use of holders for the integrated circuits.

## COMPONENTS

If the polyester capacitors are to readily fit into the layout they should be a printed circuit (vertical) mounting type having 0.3 inch (7.5 millimetre) lead spacing. C5, C6, C11, and C12 should preferably have a tolerance of five per cent or better, but in practice ten per cent types should give perfectly acceptable results.

Resistors R6, R7, R13, and R14 have unusual values, but 750k and 51k are in the E24 series of values, and are now stocked by most component retailers. However, values of 680k and 47k should give perfectly acceptable results if there are any supply difficulties.

The link wires are made from 22 s.w.g. tinned copper wire, and must be quite taut in order to ensure that they do not accidentally come into contact with each other or component leadout wires. Alternatively, they can be insulated with pieces of p.v.c. sleeving.

## CASE

There is some advantage in using a case of all metal construction for a circuit of this type. It can be earthed to the negative supply rail and will then screen all the components and wiring from mains "hum" and other electrical noise. However, provided the unit is not operated very close to any obvious sources of electrical noise (mains leads, loudspeakers, etc.), there should be no real problems with stray pick up even if a plastic case is used.

The prototype is housed in a plastic case having aluminium front and rear panels. Its outside dimensions are 180 by 120 by 40 millimetres, and this is sufficiently large to comfortably accommodate everything. If you use a high capacity battery a case having a larger height dimension might be required though.

It is preferable to choose a layout that keeps the wiring between the sockets to the board as short as possible. I achieved this by having the input sockets on the rear panel, the output sockets on the front panel, and the component panel mounted between them on the base panel of the case.

The board itself can be used as a template when marking the positions for the mounting holes in the base panel of the case. Some extra nuts or short spacers should be used over the mounting bolts, between the case and the board. If a metal case is used, this keeps the connections on the underside of the board clear of the casing so that short circuits are avoided.

Even with a plastic case the extra nuts or spacers should be included. Otherwise there is a strong possibility of the board being distorted and cracking as the mounting nuts are tightened. Phono sockets are now the most common type on audio equipment, but you can obviously use a different type of connector if it will fit in better with your other audio equipment.

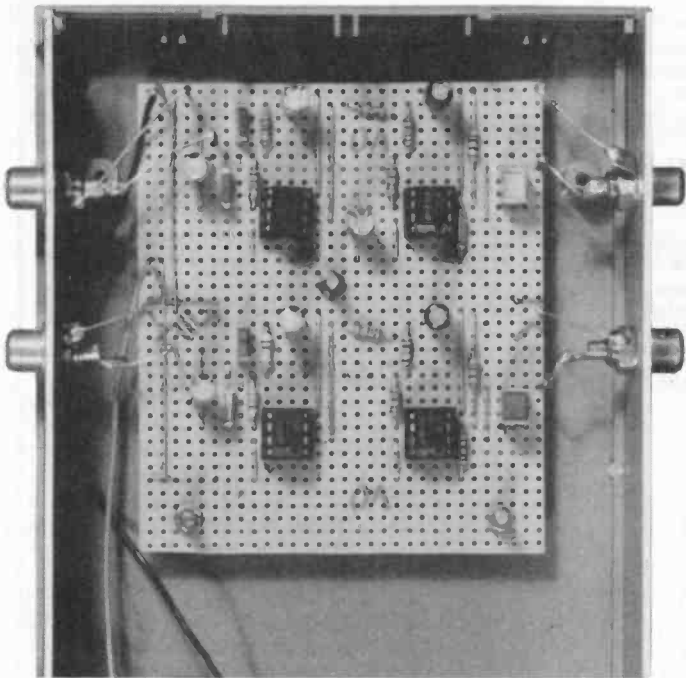

The completed circuit board showing the short wires soldered to the input and output sockets.

To complete the unit the battery clip and hard wiring is added. Provided the input wiring is quite short there is no need to use screened leads. On the prototype the wiring is all so short that I simply used pieces of 22 s.w.g. tinned copper wire, rather than the more usual multi-strand p.v.c. insulated connecting wire. The latter can be a bit awkward to deal with if very short lengths are involved.

### IN USE

In use the unit simply connects between the output of the record deck and the input of the amplifier (or whatever). The record deck will probably be fitted with a screened lead and plugs that can be connected to SK1 and SK3. A screened lead will be needed in order to couple the output from SK2 and SK4 to the input of the amplifier.

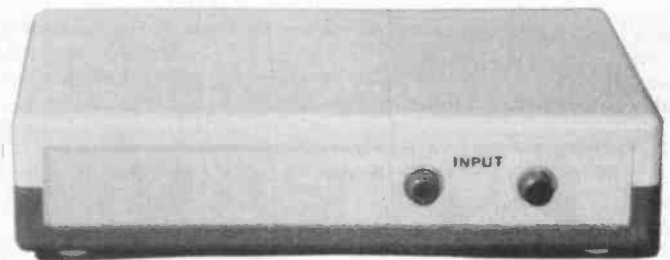

Rear view showing the input sockets.

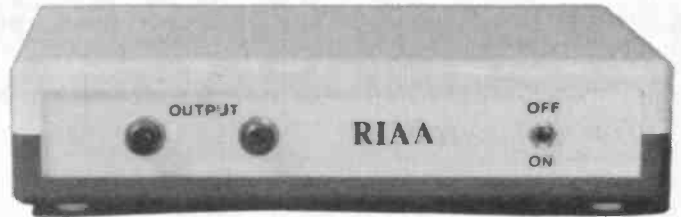

Front panel showing the phono output sockets.

In common with most preamplifiers of this type, there will be a so-called "warm-up" period of a few seconds after switch-on before the preamplifier starts to work properly. This is actually the time it takes for the capacitors to reach their normal operating charges, and for the d.c. levels in the circuit to settle down at their correct levels.

It is unlikely that the unit will have inadequate voltage gain, but if necessary, R4 and R11 can be increased in value (say to about 220k) in order to boost the gain. It is more likely that a high output cartridge will cause clipping and severe distortion on volume peaks. If this should occur, try making R4 and R11 lower in value (about 47k) in order to reduce the gain of the circuit. □

## DIGITAL SIMULATION

### PULSAR

£195

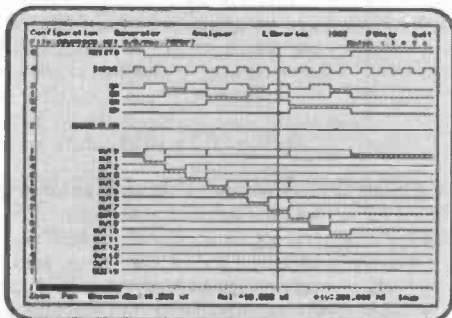

- At least A full featured Digital Circuit Simulator for less than £1000!
- Pulsar allows you to test your designs without the need for expensive test equipment.
- Catch glitches down to a pico second per week!
- Includes 4000 Series CMOS and 74LS Libraries.
- Runs on PC/XT/AT/286/386/486 with EGA or VGA. Hard disk recommended.
- Not Copy protected.

For full info' Phone, Fax or Write to:

**Number One Systems Ltd.**

REF: EVD, HARDING WAY, SOMERSHAM ROAD, ST.IVES, HUNTINGDON, CAMBS, PE17 4WR, ENGLAND.

Telephone: 0480 61778 (7 lines) Fax: 0480 494042

International: +44-480-61778 Fax: +44-480-494042

## PCB and SCHEMATIC C.A.D.

### EASY-PC

£98

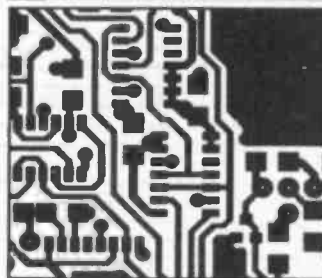
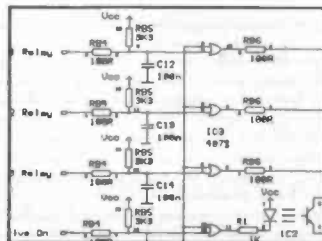

- Runs on PC/XT/AT/286/386 with Herc, CGA, EGA or VGA.
- Design Single sided, Double sided and Multilayer boards.
- Provides Surface Mount support.
- Standard output includes Dot Matrix / Laser / Inkjet printers, Pen Plotters, Photo-plotters and NC Drill.
- Award winning EASY-PC is in use in over 9000 installations in 50 Countries World-Wide.
- Superbly Easy to use.
- Not Copy Protected.

Options - 1000 piece symbol library - £38.00  
Gerber Import facility £98.00

**The Electronics CAD Specialists**

ACCESS, AMEX, MASTERCARD, VISA Welcome.

# SIMPLE MODEL SERIES SPECIAL EASIWIRES OFFER

## FREE EASIWIRES IF YOU BUY ANY FOUR MODEL KITS OR EASIWIRES FOR £5 WHEN YOU PURCHASE A PROJECT KIT.

The two companies mentioned below have large stocks of Easiwire solderless wire wrapping systems, as used to build all our *Simple Model Series* projects. They have agreed to make these available to EE readers who purchase complete kits of components for the projects, **INCLUDING** printed cards to cut out and assemble for each model. If you are prepared to buy *any four* of the six model kits that kick off the series then you can get your Easiwire **FREE**.

If you buy *any one* model kit you can purchase an Easiwire kit for just **£5**. (These kits were previously advertised by BICC-Vero at £15, including p&p). To get your kit and Easiwire simply fill in the appropriate coupon and send it with your cheque (or credit card details) to *either of the companies*.

**The six projects that kick off the series are:** Police Car (July '91); Musical Roundabout (Aug '91); Micro Micro - a dolls house microcomputer (Sept '91); Centurion Tank (Oct '91); Mini Microwave - dolls house microwave oven (Nov '91); Christmas Novelty Decoration (Dec '91). These models all play tunes or make noises or flash lights etc. They will each cost about £8 or less to build, the prices charged will be as given by EE in the "approximate cost box."



All prices include VAT

All the kits will be available separately as the projects are published and the £5 Easiwire offer will be available with each kit when each project is published.

Please fill in the appropriate coupon below, tick the relevant boxes and send your cheque/PO/credit card number with *one of the coupons* to:

**GREENWELD ELECTRONIC COMPONENTS**  
27 PARK ROAD,  
SOUTHAMPTON SO1 3TB  
Tel: 0703 236363  
Fax: 0703 236307

OR

**BULL ELECTRICAL**  
250 PORTLAND ROAD,  
HOVE, SUSSEX  
BN3 5QT  
Tel: 0273 203500  
Fax: 0273 23077

**SEND EITHER COUPON TO EITHER COMPANY - YOU CHOOSE YOUR SUPPLIER**  
Overseas readers please add £3 to cover the extra postage charge.

### FREE EASIWIRES

Please send me my FREE Easiwire kit. I understand that I must buy four model kits at the price given by EE - I enclose a cheque/PO for £20 for the kits ticked below *and* as a deposit on further kits  
Please debit my credit card as each kit is sent

Card No. ....

Ex. Date.....Signature.....

The kits I require are:  Police Car (July '91).....£5.95 plus £1 p&p  
 Musical Roundabout (Aug '91).....£7.95 plus £1 p&p  
 Micro Micro (Sept '91).....£2.50 plus £1 p&p  
 Centurion Tank (Oct '91).....£4.95 plus £1 p&p  
 Mini Microwave (Nov '91).....plus £1 p&p  
 Christmas Novelty (Dec '91).....plus £1 p&p

Tick four or more boxes.

Name.....  
Address.....

### £5 EASIWIRES

Please supply the Tank Kit on its own at £4.95 plus £1 p&p

Please supply an Easiwire at £5 with the above kit

Overseas readers please add £3 to cover the extra postage charge.

I enclose a cheque/PO for £.....  
(£5.95 or £10.95)

Please charge my credit card -

Card No. ....

Ex Date .....

Signature .....

Name .....

Address .....



**FLASH! BLEEP!! WHIRR!!!**

# CENTURION TANK



**OWEN BISHOP**

*A novel series which combines two hobbies in one - electronics and model-making. Simple electronics circuits combined with easy-to-assemble models that cover a wide range of interests.*

**T**HIS is a cardboard model of the very successful Centurion heavy cruiser tank, developed at the end of World War 2, just too late to take part in that conflict. Since then it has been in service with the armies of Australia, Britain, Canada, Denmark, India, Iraq, Israel, Jordan, Kuwait, Libya, Lebanon, Netherlands, New Zealand, South Africa, Sweden and Switzerland.

The Centurion first took part in combat in Korea in 1950 and was regarded as the best tank in the field, including those of US and USSR design. It has fought in Kashmir (1965), in the Middle East (Six Day War 1967, and in 1973), and in Vietnam

(1968). As well as being a superb fighting vehicle, the Centurion was designed with flexibility in mind. Versions of it have been adapted for other tasks including a bridgelayer, an armoured ramp carrier, and an armoured recovery vehicle.

The model is based on the Mark 5 Centurion built from 1952 until 1959, mainly by Vickers-Armstrong, until it was replaced by later versions up to Mark 13. All versions have a similar appearance and specifications, though later versions have increased cross-country and road ranges, improved armaments and additions such as infra-red night-fighting equipment. The model is constructed to 1/35 scale, one of

## PROJECT 4

the scales commonly used for military modelling in plastic.

### Centurion Specifications, Mark 5

Crew	4
Battle weight	50813kg
Overall length	983cm
Hull length	755cm
Max road speed	34.6km/h
Vertical obstacle	91cm
Maximum gradient	60 per cent
Maximum trench	335cm
Cross-country range	52.3km
Engine	Meteor Mk IVB
Cylinders	12

The electronics provides realistic sounds of gunfire, both of the 20-pounder main armament and one of the 0.30 Browning machine-guns. The sound effect is initiated by touching the antenna which is mounted on the turret. If the turret is pointing ahead or to the right at that time, a burst of machine gun fire is heard.

If the turret is pointing to the left, the 20-pounder fires and a red flash erupts from its barrel. This circuit can be fitted into almost any tank built on 1/35 scale from a plastic kit. Or it could provide background sounds for 20th Century military diorama.

### ASSEMBLING THE MODEL

Begin assembly with the track sections. Cut out and glue the sides of the track assemblies together in pairs using spacers at the top and bottom of each side.

Next cut out the hull. This is made from thin card to enable it to be folded neatly into the required shape. Before folding it, score along all fold lines, noting that two of the lines must be scored on the reverse side of the card since two of the folds are "concave". At this stage cut out, score and fold bridges of thick card; four of these have 10mm "legs" and four have 20mm "legs". Glue the body to one of the track assemblies. At the same time glue the bridges inside the body to strengthen it. The four bridges with longer "legs" are used to support the top of the body, the longer "legs" being needed to ensure firm attachment to the track assemblies.

The tracks are cut from thin flexible card.

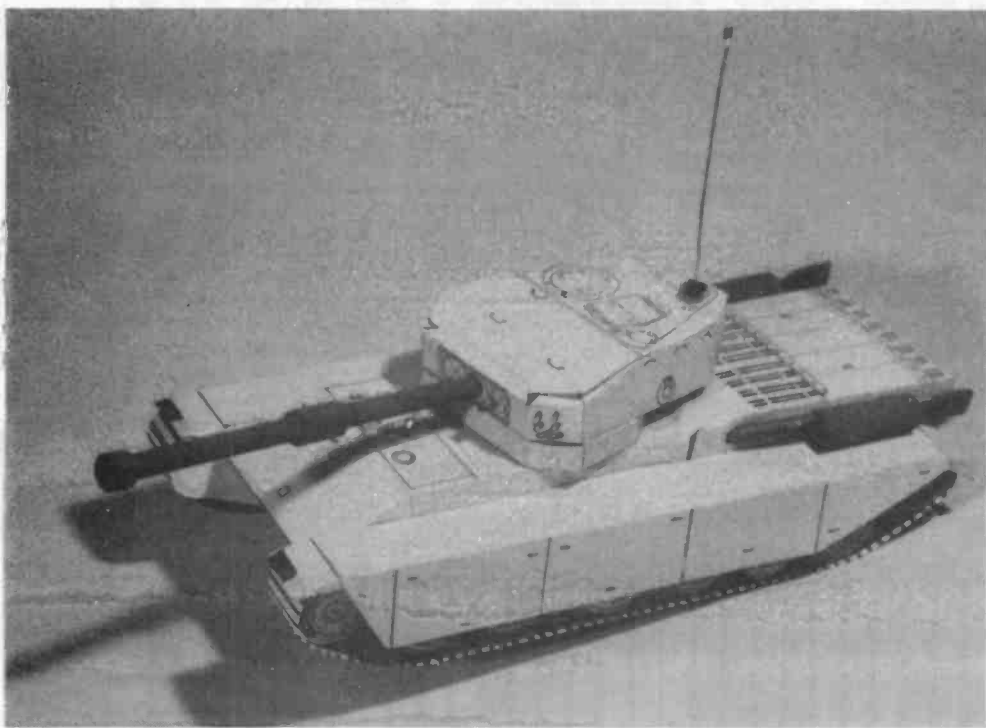

\* SCORE

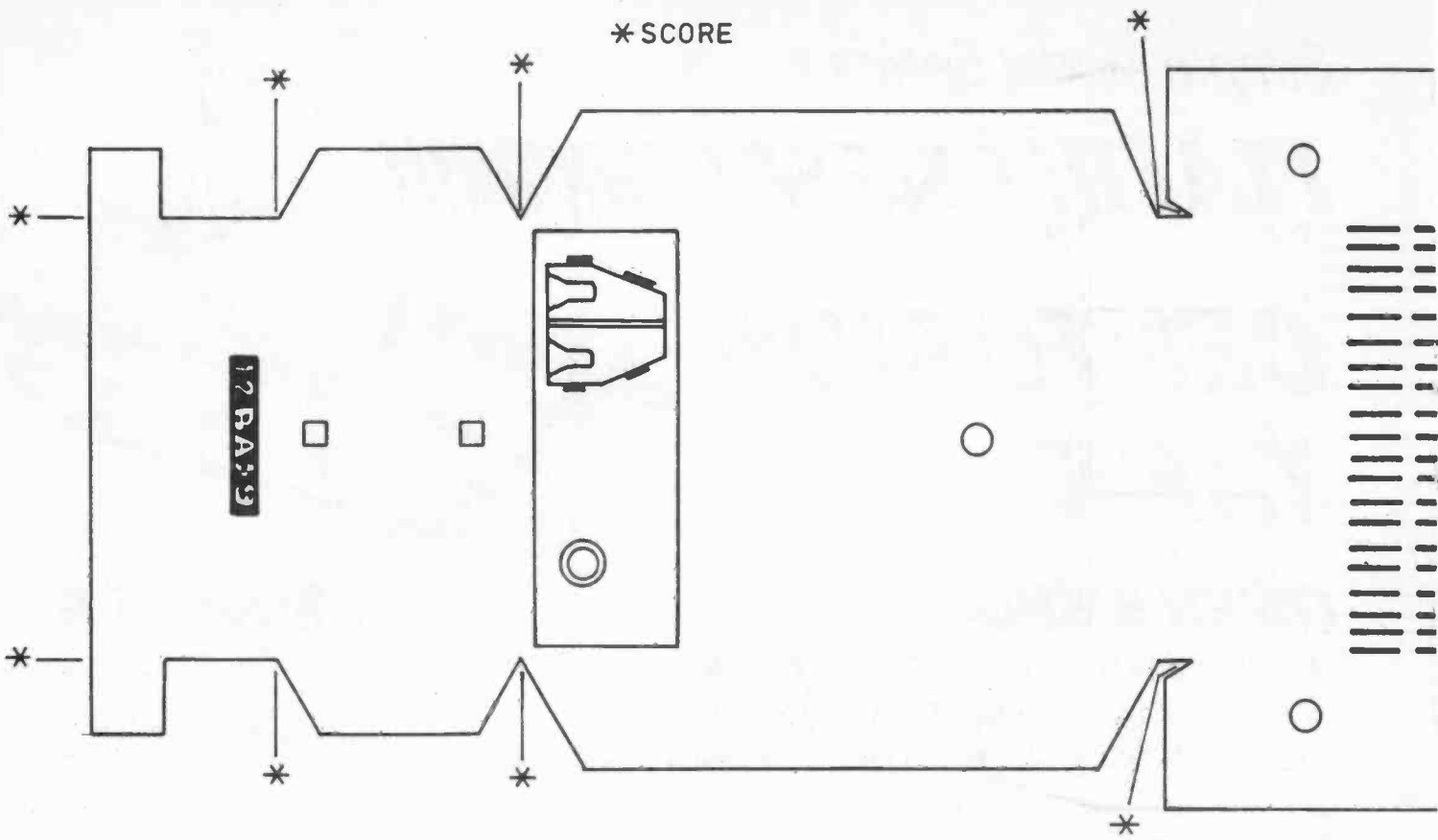

FRONT

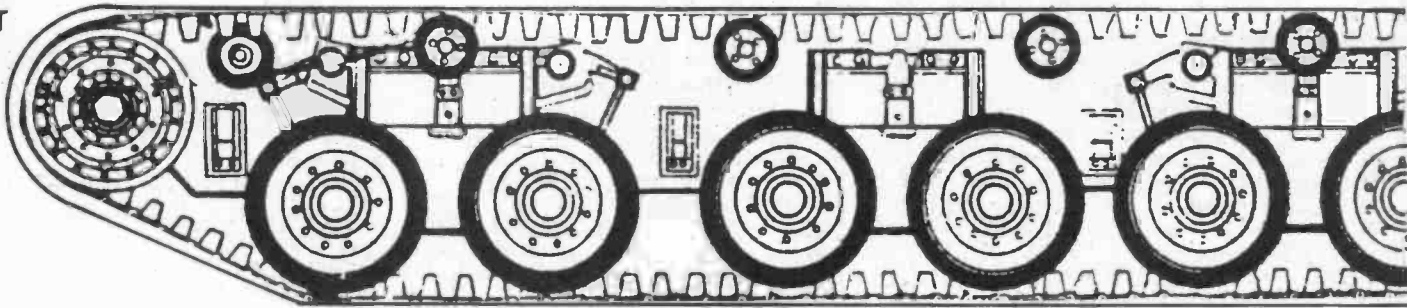

CUT 2

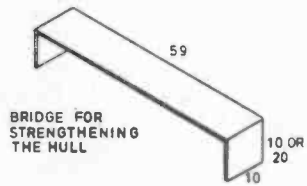

# CENTURION TANK

TRACK SPACER CUT 4

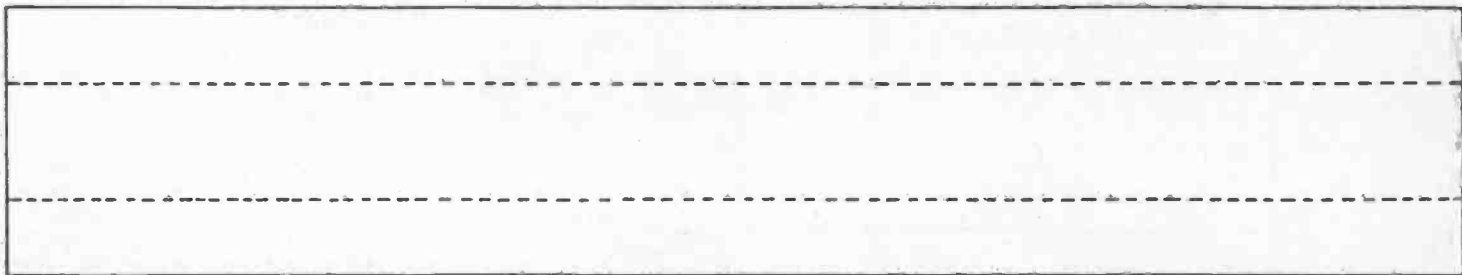

TRACK CUT 2



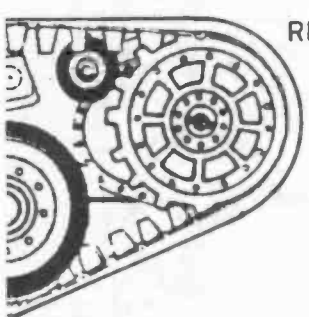
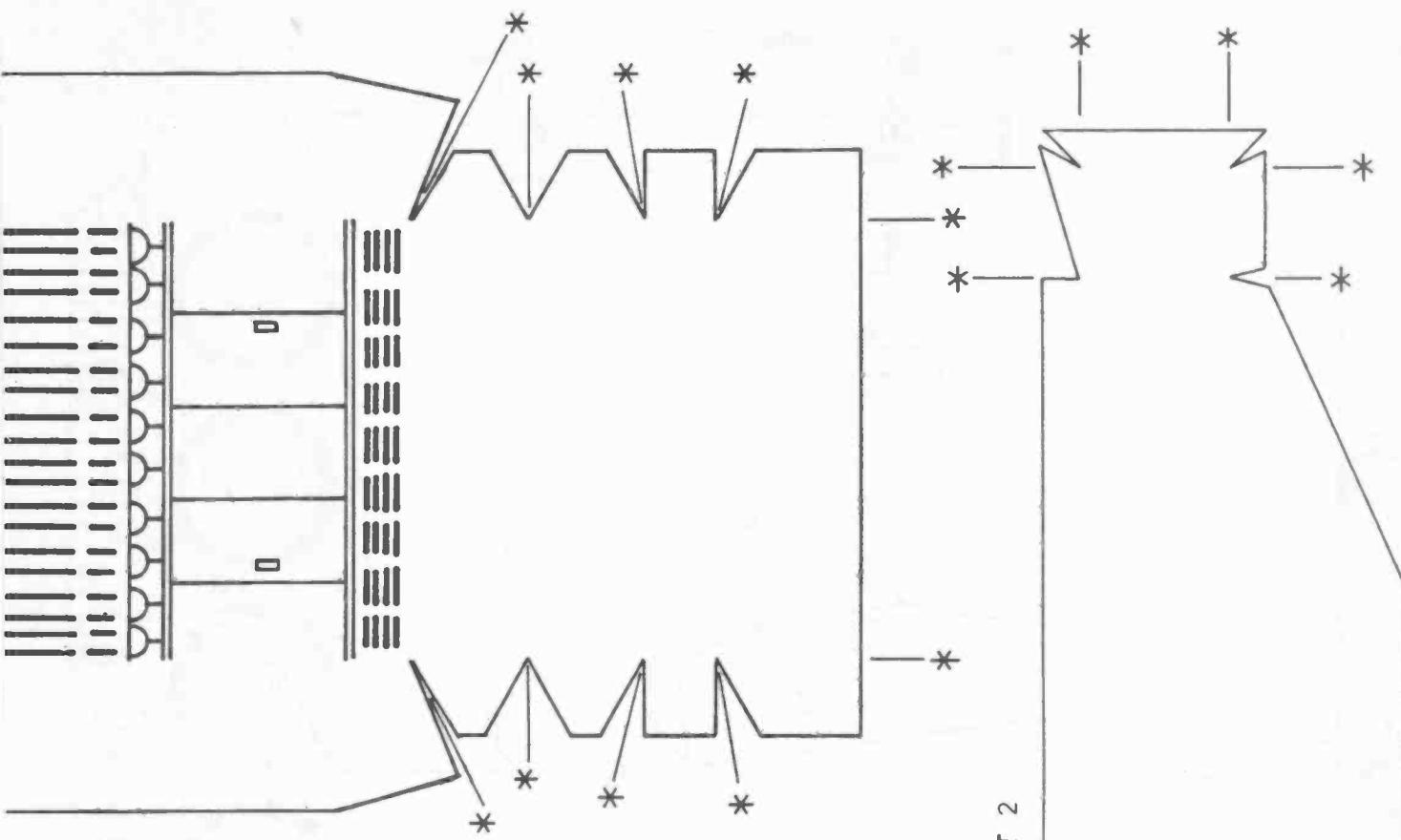

REAR

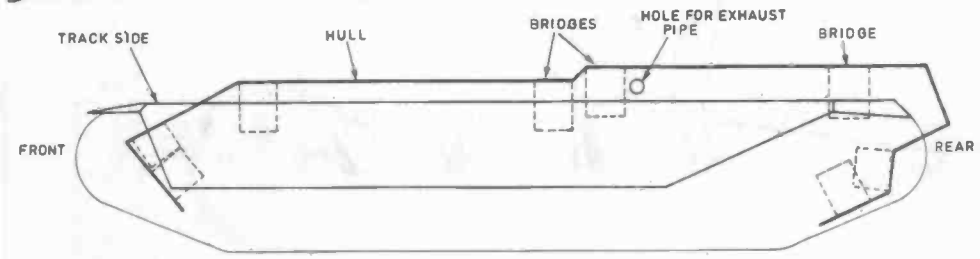
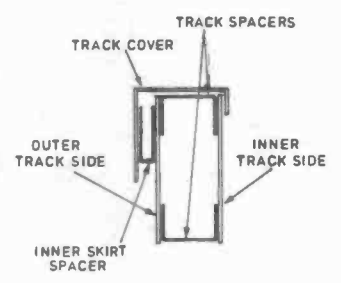

TRACK COVER & SIDE SKIRT CUT 2

NARROW SPACER BETWEEN TRACK & SKIRT CUT 2

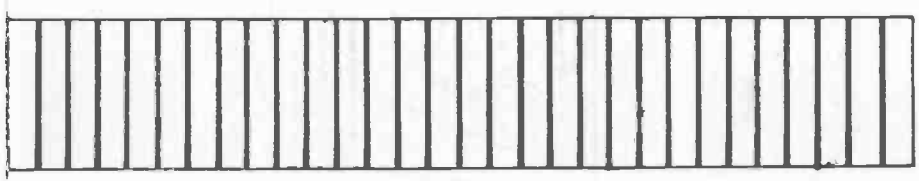
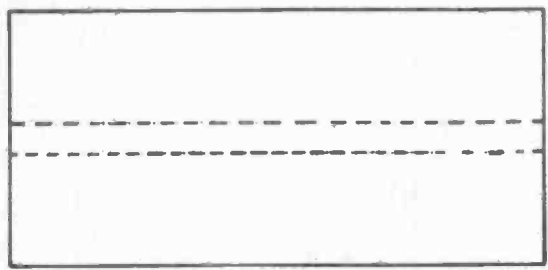

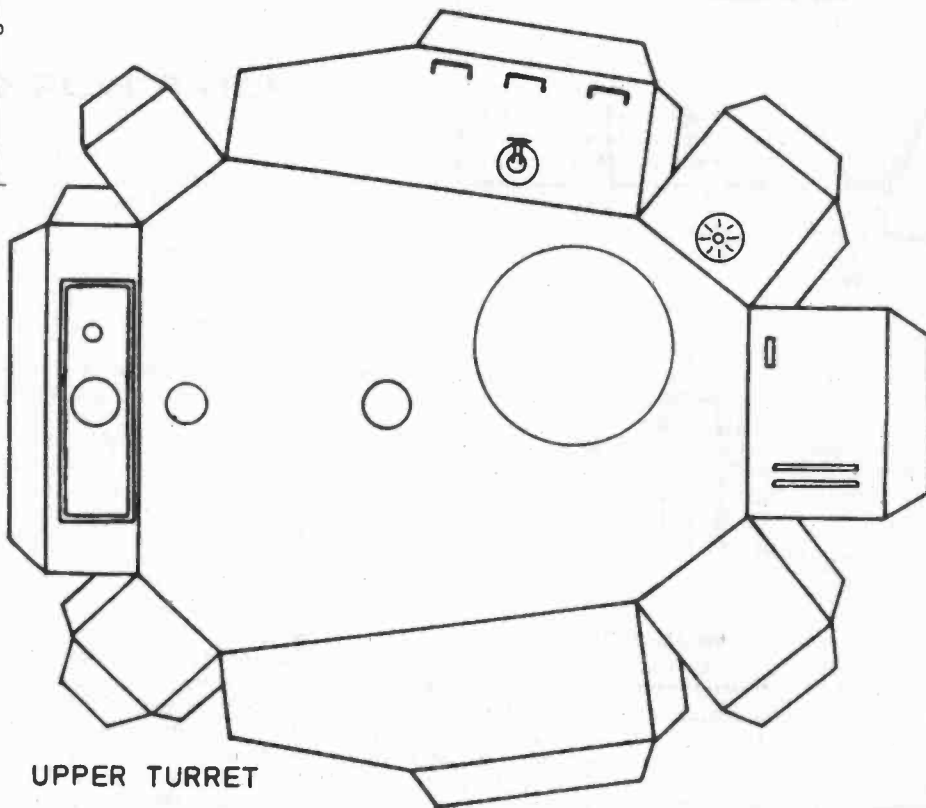
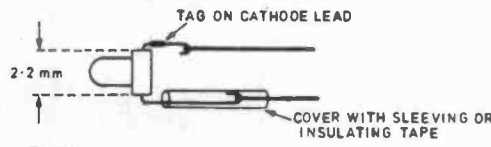
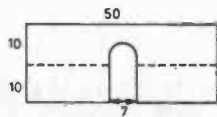
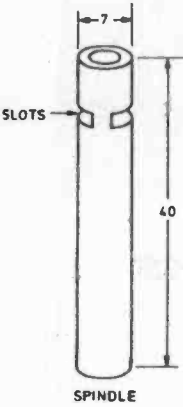
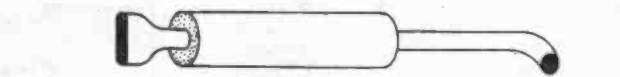
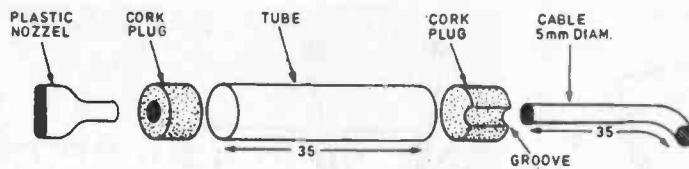
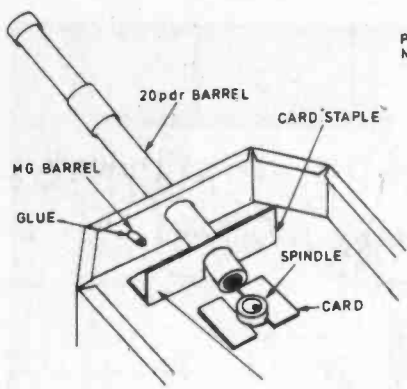

UPPER TURRET

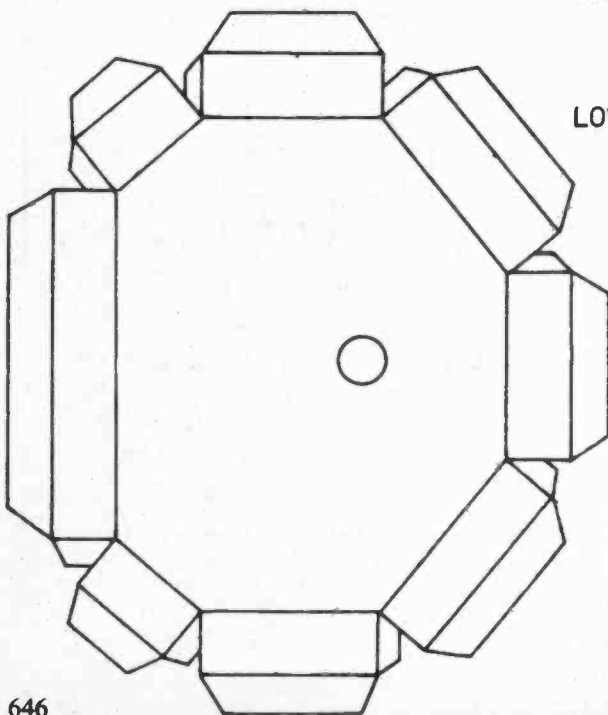

LOWER TURRET

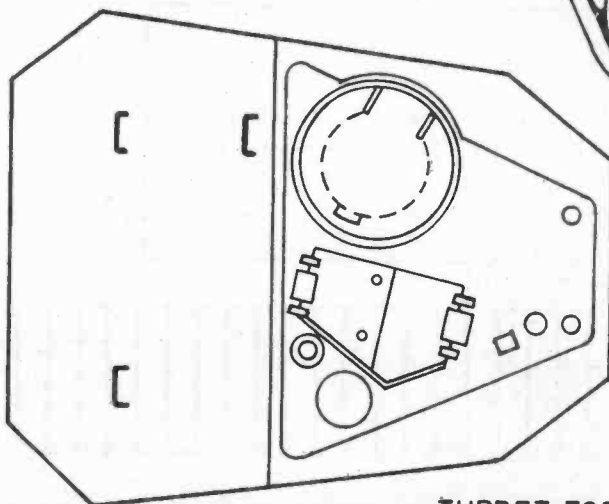

TURRET TOP

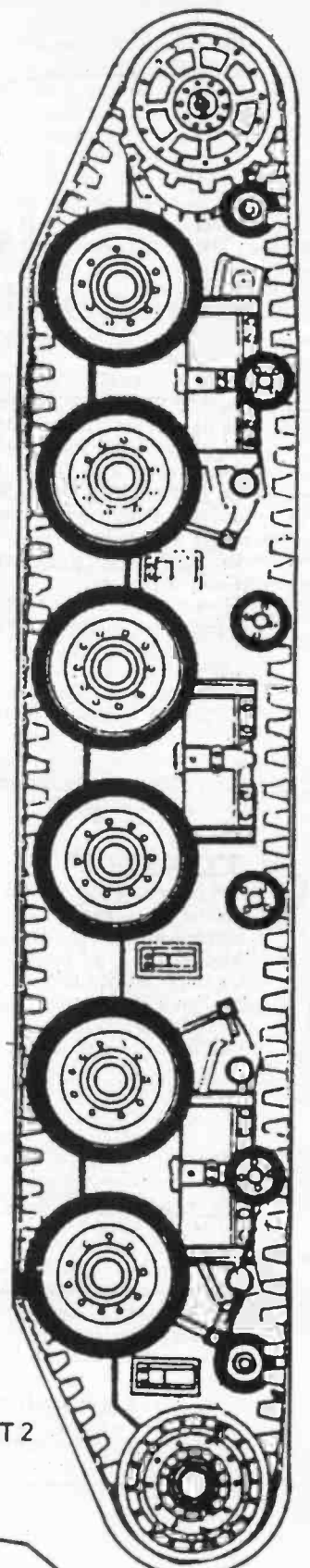

CUT 2

FRONT



They are about 1mm wider than the track assemblies. Glue these to the tops of the assemblies at the front ends of the upper spacers; wrap them tightly round the front ends of the assemblies and glue them all along the bottom spacers; wrap them round the rear ends of the assemblies and glue them to the rear ends of the upper spacers.

The track covers and side-skirts are cut out in one piece and folded into shape. Glue them to the upper spacers of the track assemblies. Glue a spacer between the outside of each track assembly and the inside of each side-skirt.

Cut the engine silencers from 10mm diameter tubing. We used light-gauge brass tubing, but the plastic barrels of two used pens or markers could be used instead. The advantage of using brass tubing is that one end of the tubing that is left over can be filed to a sharp circular cutting edge. This makes a cork-borer of exactly the right diameter for cutting out the four cork plugs from a large stopper.

Cut a groove in two of the plugs, and use these for wedging the cable firmly in the front end of the silencer tube. Push the plug fully into the silencer tube so that the plug is recessed about 0.5mm into the tube. Cut two nozzels from sheet polystyrene or similar stiff plastic. Bore a central hole in each of the two remaining plugs and glue the stems of the nozzels into these. Then push these plug into the rear end of the silencer tubes.

## TURRET

Paint the silencer assemblies, using matt enamel (e.g. Humbrol) in a camouflage colour, and allow them to dry before gluing them in place on the track covers, with the cables bent round, their ends passing through the holes in the sides of the hull.

The turret consists of an upper and lower part, the upper part having a roof. Cut out, score and fold the upper part. Glue the sides together by means of the tags. The roof is added later, after the circuit has been installed. Cut out, score and fold the lower part. Glue the sides together, then fold the remaining tags inward and glue them to the underside of the upper part.

The 20-pounder barrel is a length of polystyrene tube about 6-7mm in diameter. Push short pieces of flexible plastic tubing (we used home wine-maker's siphon tube) over the barrel to form the muzzle rim and the fume extractor. Paint the barrel assembly and allow it to dry before pushing it through the aperture in the front of the turret. It projects 122mm beyond the front of the turret. Secure it in place by gluing the cardboard staple to the turret floor. Secured in this way, the barrel inclines slightly upward.

Push a short length of plastic tube about 2.5mm diameter through the front of the turret, to the left of the barrel. This represents the barrel of the machine-gun. Fix it in place with a drop of glue applied from the rear and paint it in camouflage colour.

The turret spindle consists of a 40mm length of plastic tubing, as used for the barrel. Cut two slots in this as shown to grip two rectangles of thick card. When the rectangles are glued to the turret floor, they hold the spindle firmly and prevent it from turning.

## TURRET SWITCH

The switch consists of a stationary spring contact and a rotary moving contact, which is mounted on the turret spindle.

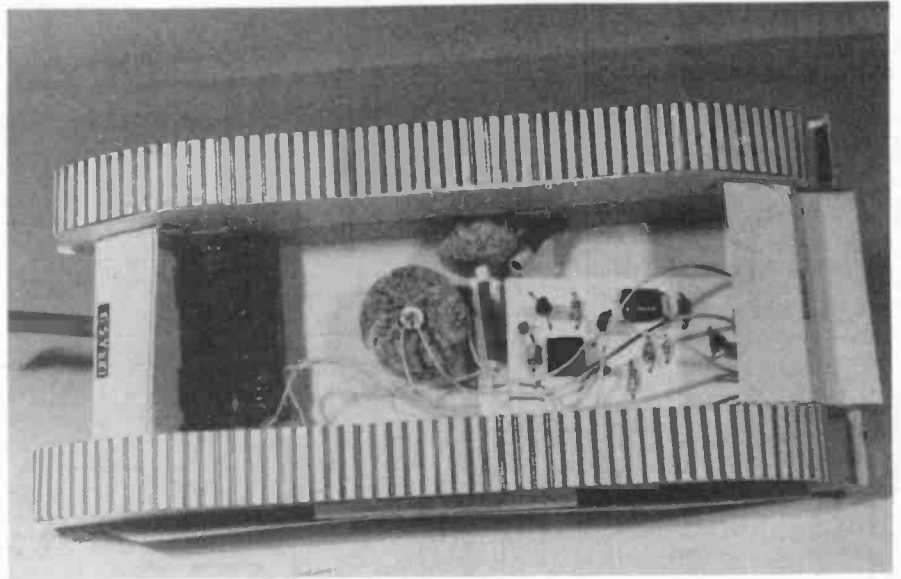

Apart from the contacts themselves, the switch is made of wood or cut from a large cork stopper. The stationary contact can be any piece of springy metal; we used a 40mm length of spring curtain rod, with the plastic sheathing removed except at the end where the rod was glued into a hole cut in the support.

Then connecting wire is pushed into the free end of the spring rod, and held in place by a short wedge of sharpened match-stick. The rotary part of the switch consists of a disc cut from a stopper which has a central hole bored to fit tightly on the spindle. The contact is a drawing-pin, with the connecting wire wound several times around the pin before the pin is pushed into the edge of the cork disc. The disc is pushed on to the spindle as far as possible, so that the turret is held firmly against the body. If necessary, a length of PVC insulating tape wrapped around the spindle helps to ensure a tight fit.

While the disc is being pushed on to the spindle, it is twisted so that the drawing pin will come into contact with the spring rod when the turret is turned to the left. Then, with the turret facing ahead, glue the stationary contact support to the bridge, with the spring rod touching the disc. This means that firm electrical contact is made with the drawing-pin when the turret is turned left.

## HOW IT WORKS

This circuit is based on a special sound-effects i.c. the UM 3562 (Fig. 1). This can produce three sound effects; machine gun, single-shot, and phaser. The third effect is not used in this model. The desired sound effect is selected by connecting pin 2 either to +3V for single-shot, to 0V for phaser, or leaving it unconnected for machine-gun. The frequency of the machine-gun is controlled by the value of R6.

When triggered by a low pulse at pin 4, the output at pin 5 produces the required signal. This is amplified by TR3 to drive the loudspeaker. TR3 consists of two npn transistors connected together as a Darlington pair. This gives the device a high gain, in the region of 10,000. If S1 is closed, to put the circuit into single-shot mode, TR3 also flashes the l.e.d. in the barrel of the 20-pounder.

Normally the circuit is triggered by a simple touch-switch circuit, which uses the Centurion's antenna as its touch plate. This circuit relies for its action on the presence of electromagnetic fields from nearby mains-powered equipment. The field alternates at 50Hz, inducing alternating potentials in the human body. When the antenna is touched, the alternating potentials are transferred to the gate of TR1.

The alternating potential causes the cur-

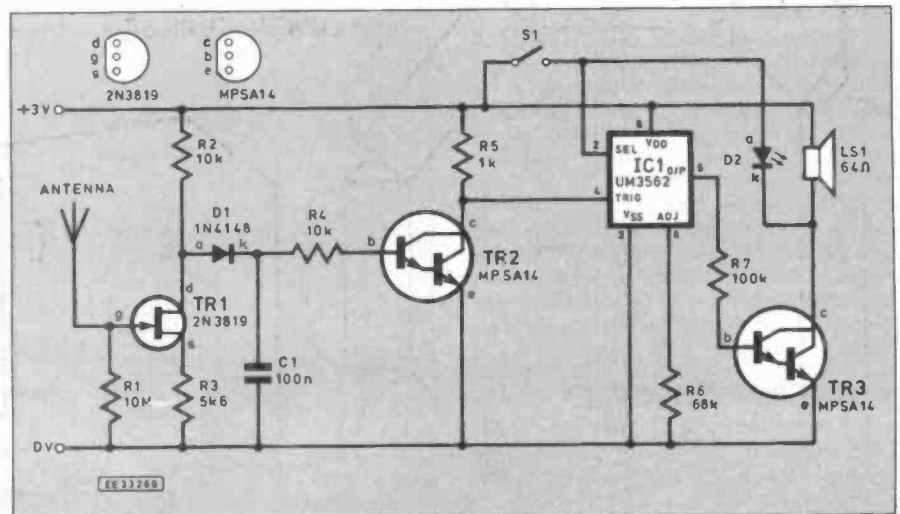

Fig. 1. Circuit diagram for the Centurion Tank sound generator.

# COMPONENTS

## Resistors

- R1\* 10M
- R2\*, R4\* 10k (2 off)
- R3\* 5k6
- R5 1k
- R6 68k
- R7 100k
- All 1/4W ±5% carbon.

## Capacitor

- C1\* 100n polyester

## Semiconductors

- D1\* 1N4148 silicon signal diode
- D2 sub-miniature light-emitting diode, red
- TR1\* 2N3819 junction f.e.t.
- TR2, TR3 MPSA14 Darlington transistor
- IC1 UM3562 three-gun sound generator

## Miscellaneous

- LS1 64-ohm miniature loudspeaker, 38mm diam
- 1mm socket, black; p.c.b. eyelet terminals (5 off); 8-way d.i.l. socket; tinned copper wire for antenna\*

\*Indicates parts not required if the alternative triggering circuit is used.

## Materials

Materials for making S1 (see text).  
 Printed model card — see Shop Talk and Special Offer page plus extra sheets of 250g/m<sup>2</sup> card or thin buff coloured card (250g/m<sup>2</sup>) approx half a sheet; medium white card (1mm, 650g/m<sup>2</sup>) for track assembly inner sides, bridges, etc; thick white card (2mm, 1500g/m<sup>2</sup>) for circuit card 77.5mm x 40mm; 7mm diam polystyrene tube, approx 200mm; 10mm diam brass or plastic tube, 70mm; Humbrol enamel in camouflage colour; double-sided self-adhesive pads or tape.

Approx cost guidance only

**£5**

rent through TR1 to vary and, as a result, the potential at the drain of TR1 rises and falls at 50Hz. As it rises, current flows through D1 and imparts charge to C1. As it falls, current is prevented from returning by the action of D1. Thus, the charge on C1 builds up for as long as the antenna is being touched.

The increased charge on C1 causes a current to flow to TR2, turning it on. This, like TR3, is a Darlington transistor so a small current flowing from C1 is sufficient to turn the transistor fully on. A relatively large current flows through R5, causing a fall in potential at the collector of TR2. Since there is a direct connection to pin 4 of the i.c., this fall triggers the i.c. into action, and the sound effect is produced. When the finger is removed from the antenna, current no longer flows through D1 and the charge on C1 falls, as current leaks away through the base of TR2.

## CIRCUIT CARD

Before commencing to build the circuit, note the remarks about the possible substitution of an alternative triggering circuit in the next section.

The circuit is assembled in the usual way (see previous articles in this series for more

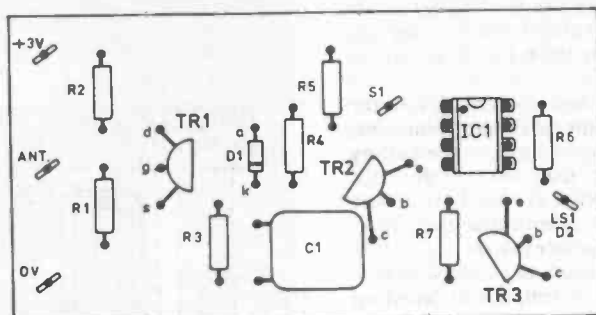

COMPONENT SIDE

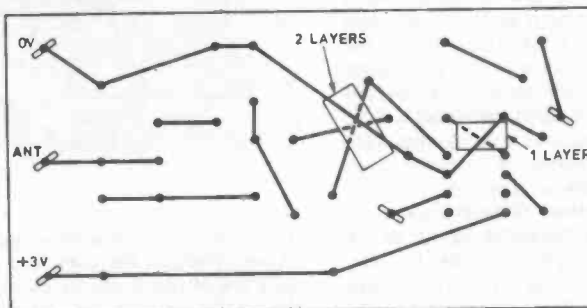

WIRING SIDE

EE13286

Fig. 2. Circuit card layout and wiring using Easiwire.

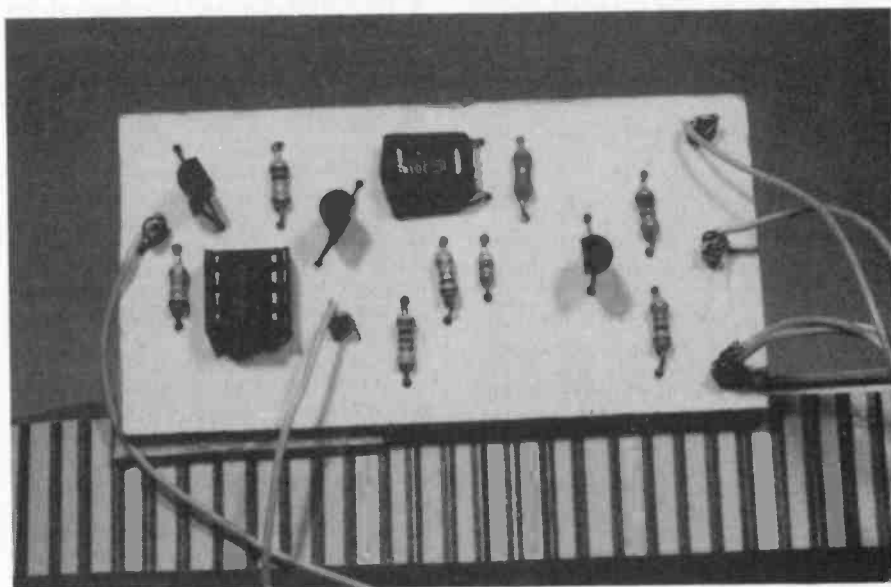
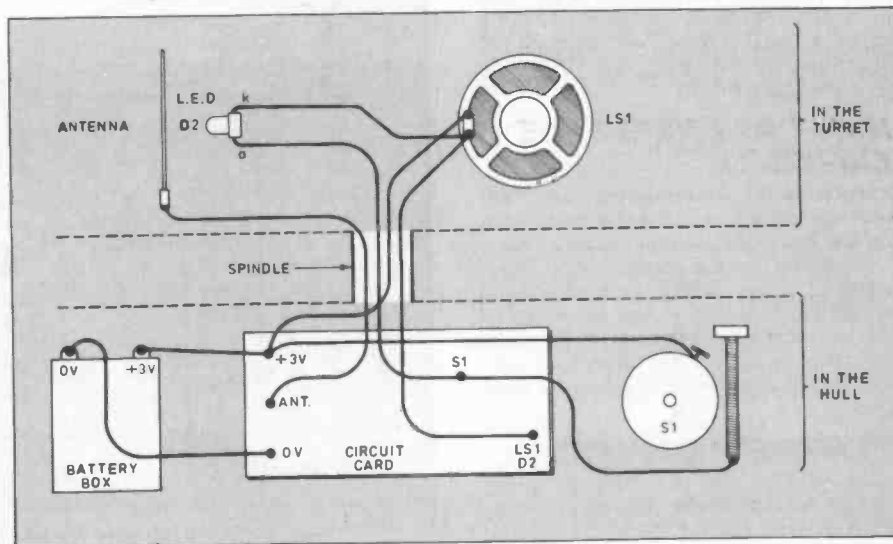

Fig. 3. Connections to the various off-board components etc.



details) by wire-wrapping (Fig. 2). Before wiring, it is advisable to glue the i.c. socket to the card and also to bend over the capacitor and glue the body of this to the card.

Test the circuit before installing it in the model. Note that the maximum permissible voltage for the i.c. is 3.6V, so the battery must have no more than two 1.5V dry cells. Current consumption is very low, 250µA when the circuit is quiescent so there is no need to provide a power switch.

The off-board connections are shown in Fig. 3, these may be temporarily wired up for testing. Check the operation of the i.c. by making a direct connection between pin 4 and the 0V terminal. If S1 is open, a burst of machine-gun firing is heard for as long as contact is made. If S1 is closed, a single shot (the 20-pounder) is heard each time contact is made. The l.e.d. glows at the same time. The volume of the sound will be considerably greater when the loudspeaker is mounted in the turret.

The triggering circuit is tested by touching the trigger terminal, when the machine-gun or single shot should be heard. When all is working correctly, remove the temporary connections and spray the underside of the board with p.c.b. lacquer to help hold the wiring in position.

## ALTERNATIVE TRIGGERING

The simple triggering touch-switch may not work unless there is mains-powered equipment switched on in the same room. This is normally no problem but if, for example, the tank is to be used outdoors, or in an out-building that has no mains supply, an alternative trigger circuit should be used. The same may apply if the circuit is being fitted to a tank built from a plastic kit, in which it may not be practicable to run a wire up to an antenna on the turret.

The circuit is modified by omitting R1 to R4, TR1, D1 and C1. It is then triggered by making contact between the base of TR2 and the positive supply. This is similar to the technique used to activate the model computer described last month. The switch contacts are the bare ends of two wires (Fig. 4) located at a convenient place on the model.

The wires are held in position by passing through holes drilled in a block of plastic or cardboard, glued to the inside of the hull or turret wall, with the bare ends projecting a millimetre or two from the model. One wire comes from the +3V supply and the other from the base of TR2. When both wires are touched at the same time by a finger, a small current flows through the finger-tip from the supply to TR2, turning it on and triggering the i.c.

## INSTALLING THE CIRCUIT

Assemble S1 as previously described. Glue the rim of LS1 to the rear floor of the

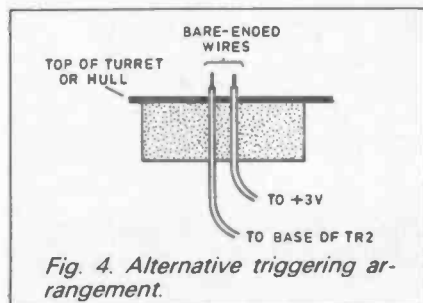
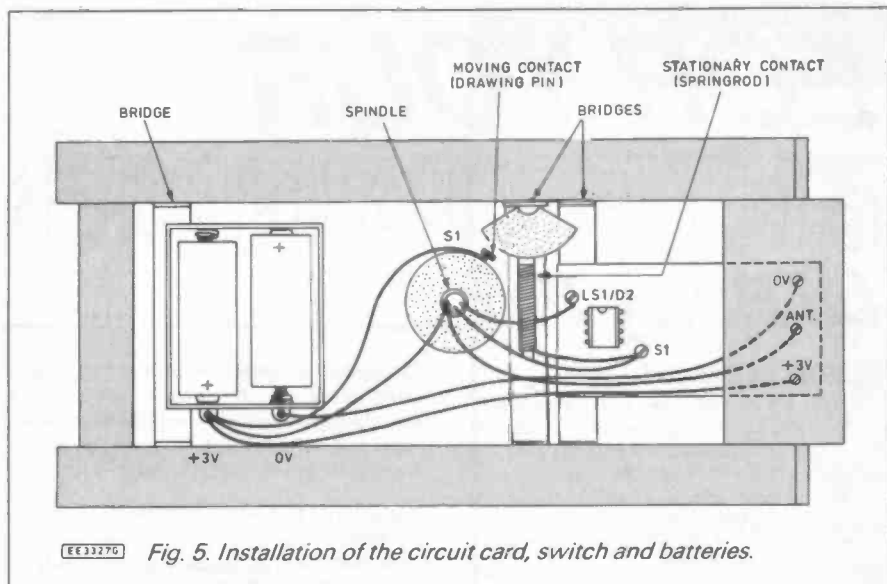

Fig. 4. Alternative triggering arrangement.



EE33270 Fig. 5. Installation of the circuit card, switch and batteries.

turret. If the antenna is to be detachable, it is best held in a socket mounted on the roof of the turret, at the rear. The card is best stiffened at this point by gluing a piece of thicker card inside. In the prototype we used a 1mm wander socket, but there are several other types of socket that can be adapted for this purpose. Or the antenna can be permanently mounted in a block of wood or cork glued to the inside of the roof.

A piece of stout tinned copper wire, about 90mm long is needed for the antenna. For the prototype we straightened a wire paper-clip to make this. One end is bent back on itself twice, and squeezed using pliers. This is to make it fit tightly in the socket. The other (upper) end is capped with a small block of rubber to prevent accidental eye injuries. Check that, when the turret roof is finally glued in place, bare metal of the socket cannot come into contact with bare metal of the loudspeaker. If necessary use insulating tape to prevent this.

Cut four lengths of thin insulated flex to run from the turret down into the hull and thread these through the turret spindle. Use wires of different colours or mark their ends with differently coloured inks to distinguish them. Thread one of these wires and a shorter wire (from LS1) through the barrel. Twist the ends of these wires around the terminal wires of the l.e.d. Use a collar of p.v.c. sleeving or a piece of insulating tape to prevent short-circuits between the terminal wires

Gently push the l.e.d. a few millimetres

into the muzzle of the barrel. Before fixing the circuit board and battery box in place, make the connections to the board as shown in Figs. 3 and 5. Check the operation of the circuit and, if all is working properly, fix the battery box and circuit board to the inside of the hull using double-sided self-adhesive pads or tape. Complete the model by gluing the turret roof in position.

The low power consumption of this circuit means that the cells may be left in the battery box for many hours without appreciable loss of power, but it is advisable to remove the cells if the model is not to be used for several days.

## ADDITIONS

The model provides scope for the keen model-maker to add further details. These include the smoke-dischargers on the front corners of the turret, and various bins and storage baskets, as seen on real tanks. It is also possible to cut around the edges of the hatches in the hull and turret so that they open.

A driver and tank commander from a 1/35 scale plastic tank crew kit further increases the realism.

Another authentic addition is the second Browning machine-gun mounted on top of the turret, on the rim of the circular hatch. □

Reference (for photos, scale drawings, history etc.) *Centurion In Action* by Stephen Tunbridge, published by Squadron Signal Publications, Carrollton, Texas (1976) ISBN 0 89747 046 X.

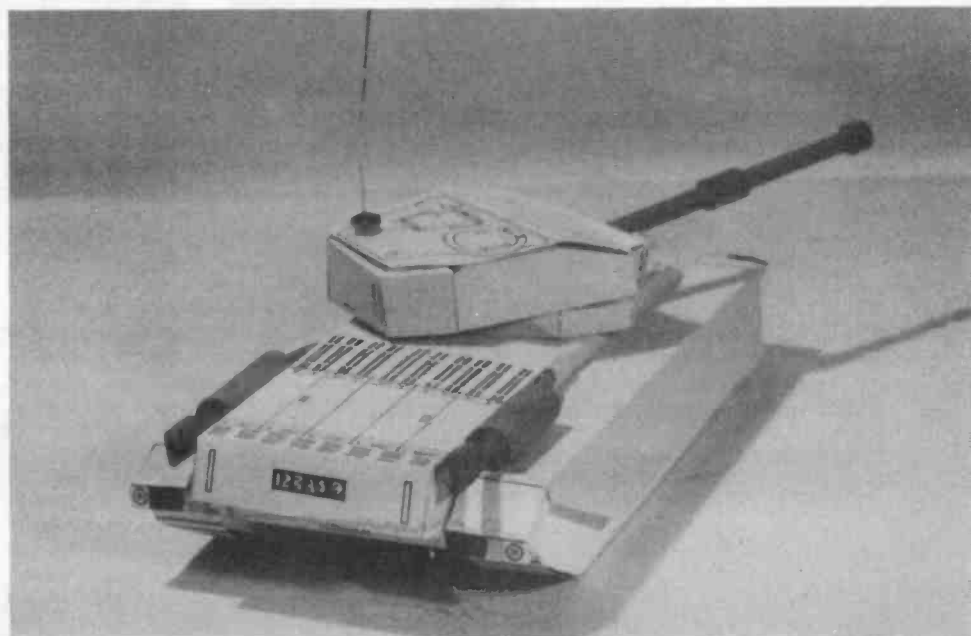

# FOR YOUR ENTERTAINMENT

by Barry Fox

## Father of Electricity

If you are in London, near Kensington, do be sure to visit the Science Museum for the exhibition *Michael Faraday and the Modern World*. It celebrates the bicenary of the birth of the father of electricity and runs until the end of this year.

The Royal Institution has loaned original equipment built and used by Faraday. The Science Museum has built working models which, at the push of a button, demonstrate the working principle of all Faraday's major discoveries.

All modern motors and generators rely on Faraday's recognition of the fact that a current flow produces magnetic fields which interact with the field of a magnet to produce a driving force. Faraday's discovery that when two coils are wound on an iron ring, a change in current in one produces a change in current in the other, is the basis of the old-fashioned children's electric shock coil and car ignition.

The same principle lets us step high a.c. voltages from the mains down to safe low voltages, for use in an electric razor, radio set or tape recorder. The national grid relies on transformers to step a.c. voltage up to high levels, so that less power is lost on long transmission lines. This is why Edison's early plans to distribute d.c. failed and Nikola Tesla, backed by George Westinghouse, made a.c. mains the world system.

Faraday started the Royal Institution's Friday evening meetings for members, at which he often talked. These meetings still continue as Friday Evening Discourses. He also started the

*Michael Faraday (1791-1867) from a lithograph by T. H. Muir, 1851.*

*Children from St Marks Catholic School, Hounslow, Middx, watching Faraday's Carbon Arc experiment.*



*Charles Babbage (1791-1871) from an engraving by Roffe.*

*Babbage's Difference Machine No. 2 built (full size) by the Science Museum from original designs dating from 1847 to 1849.*

Christmas lectures, which are now televised every year. And every year we have the *Faraday Lecture*, a spectacular illustrated talk which tours Britain with sponsorship by the likes of BT, the BBC or STC.

## Father of Computing

While at the Science Museum, you can also visit another bicentenary exhibition, *Making the Difference*, on the life and work of Charles Babbage.

Babbage is known as the father of computing, although modern computing was re-invented from first principles in ignorance of Babbage's work. "Pioneers" spent decades re-discovering Babbage's long-forgotten ideas.

Babbage designed mechanical calculating machines, which he called Analytical and Difference Engines, in the mid 19th century. But he never persuaded the Government, under Prime Minister Robert Peel, to put money into building them. "What shall we do to get rid of Mr Babbage and his calculating machine?", asked Peel in 1842.

This followed a row between Peel and Babbage. Then Babbage upset the naval establishment by proving that many of their navigation tables contained mathematical mistakes which had probably steered ships into rocks.

## Difference Engine

He did not publish details of his engines, but enough information survived

in his notes for the Science Museum to spend a year building a full sized Difference Engine. The aim was to try and prove whether it would have worked if Babbage had got the money. So the builders used tools and materials of the type available to Babbage.

The Difference Engine, now finished, consists of around 4000 moving cog wheels (excluding the printing mechanism), and weighs three tons. The operator turns a large handle, making the whole thing work like a giant mangle.

I have to say I was rather disappointed with my visit. Although there are some interesting old relics, most of the information is in small print on large placards. A string of computer companies (ICL, Rank Xerox, Hewlett Packard, Unisys etc) funded the project and there was obvious opportunity to compare the accuracy and speed of a Babbage Engine with the post-war mechanical adding machine, early electronic calculator and modern personal computer. But I found nothing so practical.

Most important, when I visited a couple of weeks after the official opening there was a complete muddle over what Computing Curator Doron Swade acknowledges to be the lynch pin of the whole exhibit - a working demonstration of the giant Engine, given by the engineers who built it and can explain how it works and answer questions. None of the staff knew why the demonstration I had come to attend wasn't happening, where the engineers were or when there would be a demonstration. Afterwards I

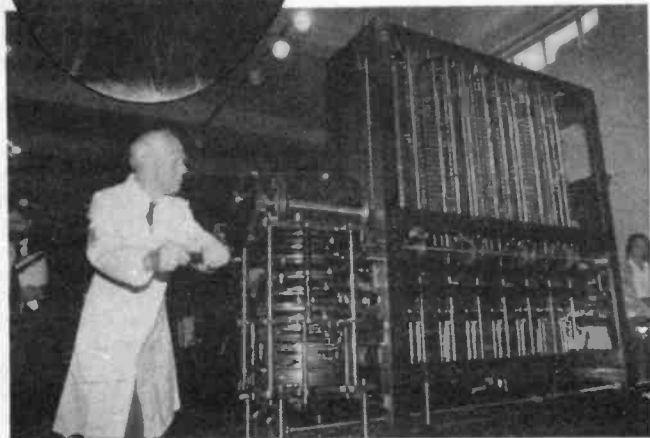



spoke with Curator Swade who was clearly appalled, and frustrated by the lack of backup he gets from some of the staff at the Science Museum.

"I have got the Engine built but I have not yet been able to get notices put up to tell people when it will be demonstrated" he admitted.

The engineers claimed that they had been there but been waiting for someone to ask them to give a demonstration. I saw no-one who looked even vaguely like an engineer waiting to be asked to perform. The Engine was securely locked inside a glass case.

Swade has kicked butt and confirms that the situation is this. The Engine should be demonstrated every day, at 11 am and 3 pm. The engineers should wear white coats so that they are easily recognised even when not turning the handle. There should be a notice to tell the public these times and warn of any changes or cancellations. I was left with confidence that if this doesn't happen, it will be over Swade's dead body.

It costs adults £3.50 to get into the Science Museum, after which the special exhibitions like those on Faraday and Babbage are free. Anyone can visit the

museum free between 4.30pm and 6pm any day of the week. But the museum does virtually nothing to publicize this happy fact.

Recently, when the Chartered Institute of Patent Agents tried to interest the Science Museum in staging an exhibition of invention, they were quoted a fee of £750,000 pounds. The CIPA went to the Design Centre instead who did it for a tenth of the price.

I have a distinct feeling that some of the people running, and working at, the Science Museum regard it as sheltered employment.

# SHOP TALK

with David Barrington

## Dry Cell Charger (Sept '91)

Before we move on to this month's constructional articles we would like to take up a point from last month's *Dry Cell Charger* project. We understand that many readers have been having problems sourcing a suitable mains transformer with a 4.5V secondary winding. The one used in the model was purchased from **Electromail**, P.O. Box 33, Corby, Northants NN17 9EL (☎ 0356 204555), code 196-381. £3.36 plus £2.85 p&p and VAT.

The 5VA transformer specified in the table (page 553) for "D"-cells is a *minimum* rating. The one used in the designer's model (see above) is rated at 6VA, but has two secondary windings rated at 3VA each. This means that for "D"-cell recharging the two secondaries will have to be wired or "strapped" in parallel, i.e. 0V tag to 0V tag and 4.5V tag to 4.5V tag.

## UV Exposure Unit

Most of the components required to build the *UV Exposure Unit* are standard items and should be available "off-the-shelf". However, the Siemens ferrite pot core transformer, the glass encapsulated mercury tilt switches and the 12in 8W ultra-violet fluorescent tube are "special" items and may not be available locally.

The pot core B65681 LR26 transformer (stock code 67126R), 8W UV tube (stock code UVT) and the miniature mercury tilt switches were purchased from **Electrovalue Ltd**, Dept EE, 28 St Judes Road, Englefield Green, Egham, Surrey TW20 0HB. (☎ 0784 33603). Other tilt switches can be used provided they can be accommodated on the board and be adjusted so that the contacts are closed when the unit is on a level surface.

The printed circuit board layout has been designed to take BC212, 212A and 212B transistors; types designated with suffix L, LA and LB use a different outline and will have to have their leads bent to fit on the board correctly. The small printed circuit board is available from the *EE PCB Service*, code EE768 (see page 674).

## PC-Scope Interface

It is most important that constructors of the *PC-Scope Interface* use the CMOS 74HC types for IC1, IC3 and IC8. Standard CMOS counterparts are too "slow" and unsuited to this high speed circuit.

The A-D Converter (ADC) chip CA3306 is only currently listed by **Cricklewood**

**Electronics**. The low power CMOS static RAM type UM6116 appears in most component suppliers catalogues. In most cases it is only listed as a 6116 device.

The 3.2768MHz crystal used in the clock/counter stage is fairly common now and should not prove troublesome to locate. It is usually found in catalogues under their "Timing Crystals" section for watches and clocks.

The main printed circuit board and double-sided plug board are both available from the *EE PCB Service*, see page 674. These should be ordered as EE769 (Main board) and EE770 (Expansion plug).

## Centurion Tank - Simple Model Series

The model and electronic circuit for the *Centurion Tank*, this month's *Simple Model Series* project, is built on *printed* card, which can be obtained from the EE Editorial Offices for the sum of £2.50 (including postage). The actual wiring of the "electronics" card is by the use of the "no soldering" Easiwire wire-wrapping system.

To help with assembly **Bull Electrical** (☎ 0273 203500) and **Greenweld Electronic Components** (☎ 0703 236363) have put together a complete kit, including cards, for the sum of £4.95 plus £1 post and packing.

The above mentioned companies have large stocks of the Easiwire wiring packs and have agreed to make these available to EE readers who order the model kits from them at a "special price" - see page 642. If you purchase any one single kit, an Easiwire pack will only cost £5. However, if you are prepared to order four or more of the listed kits they will supply an Easiwire pack *Free*.

## Modular Disco Lighting

Looking at the photographs of the *VU Sound Unit*, this month's *Modular Disco Lighting System* project, the capacitor C2 wired directly across the Sound Input jack sockets appears to be a "metallised polyester film" type.

This type is certainly rated at the required 250V and suitable for inclusion here.

The chassis mounting 7-way DIN sockets and plugs are fairly common place and stocked by most component advertisers, but the circular 10-pin video chassis "plug" and matching cable socket may prove difficult to locate. One source is **Electromail**. The case is the Maplin Blue case 233, code XY48C.

To some readers, the video sockets and case may appear too expensive an outlay. Alternatives can be used, but, for safety, the case **MUST** be all-metal and "Earthed".

The full range of bar i.e.d. driver i.c.s LM3914 (linear), LM3915 (log) and LM3916 (VU mode) seem to be popular stock lines and should be easily sourced. The same comment applies to the "common cathode" tricolour i.e.d.

The only current listing we have located for the BC307B transistor is from **Cricklewood** and **Greenweld Electronics**. An alternative pin-for-pin device is the BC251B.

The double-sided printed circuit board is available from the *EE PCB Service*, code EE767 (see page 674). be sure to order the "log" law potentiometer for VR1.

## RIAA Preamplifier

We cannot foresee any component buying problems for readers who undertake the construction of the *RIAA Preamplifier* project.

The wideband op. amp LF351N i.c. appears in the listings of most of our component advertisers as an "off-the-shelf" item. The E24 series of resistors now appears in most of our components catalogues and the "odd" values of 750k and 51k should not present any difficulties. As mentioned, you can, of course, use 680k and 47k types.

Remember to keep the leads from the circuit board to the input and output sockets as short as possible.

## CAMBRIDGE COMPUTER SCIENCE LIMITED

3.5" 720k Diskette Drives	£39.00 each
10MBYTE Winchester, used, 3 months Wty.	£42.00 each
5.25" Disk Drives, 80 TK, D5DD	£34.00 each
5.25" Disk Drives, 80 TK, D5DD, Used, No Wty (£15.00 drives sold on strictly "as is" basis)	£15.00 each
5.25" Disks, D5DD, 48tpi, boxes of 10 (free disk cleaner with 5 boxes)	£3.00/box
Lockable diskette boxes for 80" 3.5" or 100" 5.25" (state which)	£5.99 each
Small sized diskette boxes (lockable)	40" 3.5" £4.75, 50" 5.25" £4.99
Printer stands (suit 90/132 cols)	Basic £2.99, or with paper catcher £10.99
Digital multimeter, 14 ranges, inc leads & manual	£16.00 each
Apricot Disk drive PSU	£10.00 each
5V at 6A PSU	£4.80 each
5V at 10A PSU	£5.40 each
Ni-Cad AA £0.89, C £1.99, D £2.09, PP3 £4.99	Universal charger £5.99 each
Disk Drive Data lead BBC Micro to Disk Drive(s)	Single £2.00 Dual £4.00 each
Disk Drive Power lead BBC Micro to Disk Drive(s)	Single £2.00 Dual £4.00 each
27128 EPROMS (Ex equipment)	£1.20 each or £5.00/5
27128 EPROMS	£2.50 each
27C256-25 EPROMS	£3.50 each
256K Byte DRAM Modules, removed from equipment	£6.00 each
20 pin dll low profile IC sockets	£0.50/10 £4.00/100
24 pin dll low profile IC sockets	£0.35/10 £4.50/100
40 pin dll low profile IC sockets	£0.60/10 £5.00/100
Circuit tester, finds faults in TTL & CMOS logic circuits, inc leads	£8.00 each
Metal project boxes drilled & painted but unused 28 x 32.5 x 5cm	£2.50 each
Range of Aluminium & plastic project boxes (ask for list)	£3.50 each
Smoke detectors, small size	£4.00 each
Smoke detectors, large with escape light and pause feature	£8.00 each
Prices include postage. Add 50p (plus VAT) to orders below £5.00. All items new unless stated.	
Add 17.5% VAT to all prices. Send an SAE for our latest list or for more info.	
<b>Dept EE, 374 Milton Road, Cambridge CB4 1SU</b>	
Tel: 0223 424602, 0831 430496 or 0831 430552 (Please note mail order only)	

# INTERFACE

## Robert Penfold

AS PROMISED in last month's *Interface* article, the printed circuit design for the PIO Prototyping Card is included in this month's offering. The top (component) side of the board is shown in Fig. 1, while Fig. 2 shows the underside. No component overlay is included, as this is basically the same as the one for the PC prototyping card featured last month. The only difference is the addition of the 8255 chip which fits onto the 40-pin d.i.l. cluster (via a socket). This has the same orientation as the other integrated circuits, which means that pin one is at the top.

My original design required a through-plated board, or the integrated circuits to be soldered on both sides of the board. The design presented here is a modified version which is better suited to DIY construction. It only requires the integrated circuits (or their holders) to be soldered on the underside of the board.

Although pads for the integrated circuits are actually included on the top side of the board, they serve no useful purpose and can be omitted. They are only included because my printed circuit design program insists on pads being present on every copper layer of the board, whether or not anything actually connects to them.

Of course, the printed circuit through-pins should be soldered on both sides of the board. They should also be fitted *before* adding the socket for the 8255, as some of the pins actually fit under the latter.

It is also advisable to solder the pins near the edge connector on both sides of the board, whether or not they actually connect to tracks on both sides. This helps to firmly anchor them in place.

The chip select pin of the 8255 connects to output 0 of the address decoder, placing it at addresses &H300 to &H303 (plus echoes at &H304 to &H307). However, it

can obviously be rewired to one of the other outputs if necessary. Port B and the upper nibble of port A are brought out on the 25-pin D-connector, as are the 0V and +5V supplies.

The other twelve input/output lines are brought out to solder pins and can be used with prototype circuits built on the card, or wired to the D-connector, as preferred. The lines that are taken to the D-connector could also be wired to an on-board prototype circuit if necessary, and there is plenty of scope for altering the basic scheme of things to suit the prevailing circumstances.

### 8255 Programming

The operating mode of the 8255 is controlled by the control register at address &H303. There are three modes of operation called modes 0, 1, and 2. Mode 0 is the most simple, and is the only one we will consider here.

Port A and port B can each be set as eight inputs or eight outputs, but it is not possible to set lines individually as inputs or outputs. Port C can provide split operation, but only on the basis of having one nibble as a four-bit input and the other nibble as a four-bit output.

Bits five to seven of the control register are used to set the required operating mode. Bit seven is set to 1 to enable the operating mode to be changed, and the control register operates in a totally different manner if bit 0 is set to 0. This different method of use is not applicable to mode 0 operation though.

The following table shows how to set the required mode using bits 5 to 7 of the control register:

MODE	BIT 5	BIT 6	BIT 7
0	0	0	1
1	1	0	1
2	1 or 0	1	1

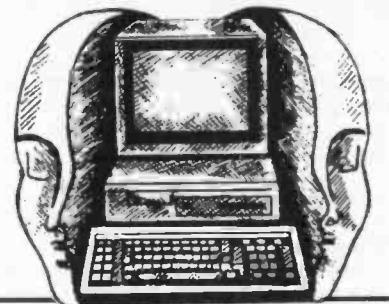

Note that this only applies to port A and the upper nibble of port C. The mode of port B and the lower nibble of port C is controlled by bit 2. This is set high for mode 1 operation, or low for mode 0 use (there is no mode 2 for these ports). In order to obtain mode 0 operation for all three ports it is therefore just a matter of setting bit 7 high, and bits 2, 5, and 6 low (i.e. write 128 decimal to the control register).

The functions of the ports are controlled by bits 0, 1, 3, and 4, which respectively control ports C lower, B, C upper, and A. Setting a bit to 1 sets the corresponding port as an input - setting it to 0 sets the corresponding port as an output.

The following table shows the decimal value needed to set each port as an output. Obviously 0 is always used to set a port as an input:

PORT	DECIMAL VALUE
C Lower	1
B	2
C Upper	8
A	16

Remember that bit seven must be set high when writing to the control register. Therefore, the total value written to the control register is 128 plus the values taken from the table for any ports that must be set as outputs. As an example, for mode 0 operation with ports C upper and A set as outputs (ports C lower and B set as inputs), the value written to the control register would be 152 (128 + 8 + 16 = 152).

For many applications, such as driving digital to analogue converters, reading sensor switches, etc., mode 0 operation should suffice. For anything more complex one of the other modes might be better, and it is worthwhile getting hold of a copy of the 8255 data sheet if you are going to make more than occasional use of the 8255 card. Maplin Electronic Supplies Ltd. can supply data sheets for all the integrated circuits that they supply, and the 8255 is included in their range.

I had originally planned to include details of A/D and D/A converters for the PC. However, as similar ground is covered in the *PC-Scope Interface* in this issue, I will leave this for the time being.

### New DOS For Old

As most PC users will no doubt be aware, a new version of MS/DOS (version 5.0) has recently been released. It radically departs from previous versions of MS/DOS in that an upgrade version is available. This has an installation program which de-installs the existing version of MS/DOS from a hard disk and then installs the new version. The upgrade version of MS/DOS 5.0 normally seems to retail at

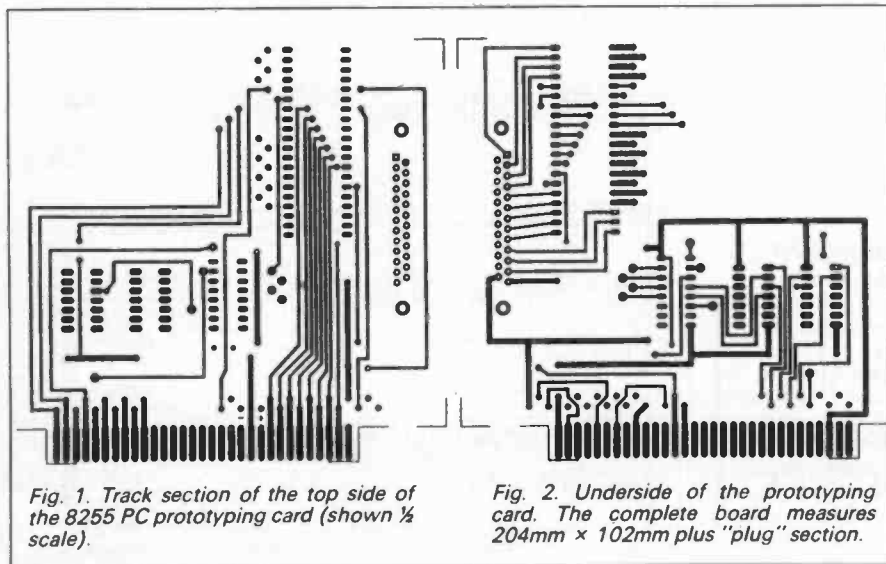

Fig. 1. Track section of the top side of the 8255 PC prototyping card (shown 1/2 scale).

Fig. 2. Underside of the prototyping card. The complete board measures 204mm x 102mm plus "plug" section.

about £50 to £60 plus VAT. In my opinion it is well worth the cost.

Although MS/DOS 5.0 has a lot of new commands and features, the main attraction for most users is that it requires less memory than some previous versions. In particular, with an 80286 or higher processor, MS/DOS can be loaded into high memory. This means that you can actually have about 635K of free conventional memory.

In practice there will be start-up programs run by the CONFIG.SYS and AUTOEXEC.BAT files that will eat up some of this memory, but I have about 600K of free RAM once my AT has booted-up. I find that a number of programs which gave memory problems running under MS/DOS 3.3 now run perfectly happily under MS/DOS 5.0.

### Shareware

In a previous *Interface* article I mentioned some PC shareware and public domain ("PD") programs of interest to electronics enthusiasts. Although the feedback from readers on this topic was totally underwhelming (i.e. no response at all), I understand that the shareware company mentioned in the article received a fair number of enquiries.

I mentioned a printed circuit design program called PC Route (disk No. 2531), which has now been updated and renamed. The latest version is called PC Trace. The change in name is presumably to avoid

people mistakenly thinking that this program is one which tells you the quickest route from where you are to somewhere else.

The new version has EGA graphics support, more printer drivers, variable pad sizes and track widths, and mouse support. The graphics still seem somewhat below the standards of commercial p.c.b. design software, and I have doubts as to whether this program can handle complex boards. However, it is still an interesting one to try if you are interested in this type of software.

I have mentioned the circuit analysis program called ACIRAN (Disk No.2609) in previous articles, and this has now been considerably updated. First and foremost, the restrictions on the trial version have now been removed. This means that circuits with up to 100 components and 500 nodes can be accommodated, and that up to 101 test frequencies can be used for each analysis.

Improvements have also been made which make it easier to get circuits into the program, and to modify them. There is actually provision for schematic capture, but you would need an expensive schematic drawing program to take advantage of it. Control of the program is via an improved menu system with optional mouse program.

ACIRAN is a powerful circuit analysis program, but unlike many programs of this type it is reasonably easy to use. It also has some powerful graphics capabilities, and will use super VGA modes if your computer

supports them. It is certainly a program that anyone who has a PC and is interested in electronics should give a try.

Some of the other programs I have mentioned recently have also been updated, including LSYSTEM (Disk No.2117) the logic analyser program, and TSQUARE (Disks Nos. 2562A to D) the CAD program. There is now quite a range of electronics, radio, and other technical software available from PD and shareware sources, much of which is well worth investigating.

The programs mentioned here are available from PDSL, Winscombe House, Beacon Road, Crowborough, Sussex, TN6 1UL (☎0892 663298). They may be available from other PD/shareware sources, but under different catalogue numbers. Presumably due to its specialised nature, many PD/shareware libraries do not seem to offer much software of this type.

If you are interested in printed circuit design software there are demonstration programs available from several companies. These are free or cost very little, and are mostly "crippled" versions of the real thing that enable you to thoroughly test the software.

Some of the low cost printed circuit design programs are very powerful indeed. There have been some spectacular price reductions over the last year. Printed circuit design software which would have cost many thousands of pounds not so long ago can now be yours for just one or two hundred pounds!

## HAVING INTERFACING PROBLEMS?

At last the best solution you are ever likely to find

### A COMPLETE SINGLE BOARD COMPUTER

- Z80 CPU
- Complete with BASIC ROM
- Keyboard
- 80 character 8 line display
- Battery backed (all functions)
- Two RS232 ports
- Two A/D ports
- Programming/Electronic advice for first three months
- Full technical manuals provided
- Software included for connection to other computers
- 30 day money-back guarantee
- Only £199 + VAT

Order direct or contact us for more information:

*Covend Electronics*

32 Poplar Grove, London W6 7RE  
Tel: 071 371 6497

## UPGRADE OR BUILD YOUR OWN IBM COMPATIBLE



MOTHERBOARDS				KEYBOARDS		
CPU	RAM	L/SPEED	PRICE	(ENHANCED 102 KEY)		
286-12	0K	16Mhz	£69	IBM - COMPATIBLE ..... £29		
286-16	0K	20Mhz	£79	<b>FLOPPY DRIVES</b>		
386-5X-16	OK	18Mhz	£155	1.2Mbyte 5.25" .....	£42	
386-25	OK	33Mhz	£285	1.44Mbyte 3.5" .....	£39	
386-33	64K cache	54Mhz	£390	<b>HARD DRIVES</b>		
<b>GRAPHIC CARDS</b>				44Mbyte Saagate IDE .....		£135
V.G.A	512K	16 BIT	£65	89Mbyte Saagate IDE .....		£235
V.G.A	1Mbyte	16 BIT	£95	<b>CASES</b>		
<b>ADD IN CARDS</b>				Desktop Case + 200W PSU .....		£64
FDD/HDD	(1:1)	.....	£49	Mintower case + 200W PSU .....		£74
I/O CARD 25,1P,1G	.....	.....	£28	<b>MONITORS</b>		
<b>BOOKS</b>				14" SVGA Multimode monitor .....		£210
Build your own 80286 IBM Compatible .....	£17.30	Build your own 80386 IBM Compatible .....		Write, Phone or Fax for a FREE Catalogue		
PC Upgrade Book .....	£12.95			All prices exclude VAT (Carriage at cost)		

### MANY OTHER PERIPHERALS AVAILABLE

**PANRIX**  
**ELECTRONICS**

93 KENTMERE APPROACH  
LEEDS LS14 1JW  
TEL: (0532) 650214  
FAX: (0532) 323937  
OPEN FROM 10am-6pm MON-SAT



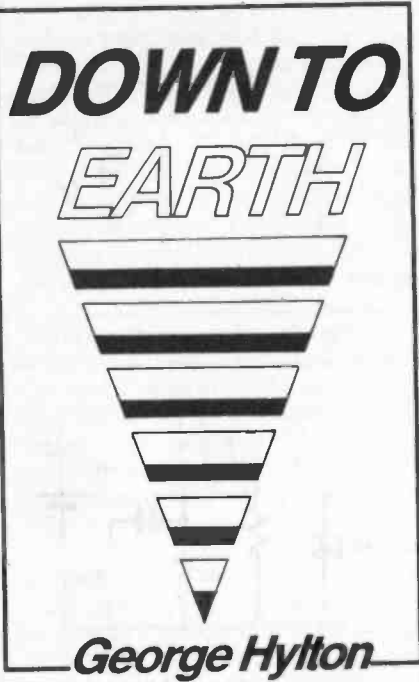

### Junction F.E.T.

IT'S ONLY too easy for the writer of a regular feature like *Down to Earth* to forget the needs of new readers. The editor once suggested that decibels might be a suitable topic. "But I did that a couple of years ago," I objected. "Well, do it again, a different way," he said. I did, and somebody expressed appreciation.

This is my reason for coming back to familiar "topics" from time to time. If you are new to electronics and are puzzled by some bit of theory, why not write to me about it? If it's a general point, the chances are that other readers have the same problem and would welcome an article about it.

Today, I'm taking a look at field effect transistors (f.e.t.s). However, as there are too many different kinds to be covered in a short article I'm concentrating on just one of them.

### Construction

The junction f.e.t. (Fig. 1) is really quite a simple device. A piece of *p*-type silicon is treated so as to create an *n*-type region called the *channel*. Electrons can flow from one end of the channel (called the *source* (s)) to the other (the *drain* (d)) when a battery is connected negative to source, positive to drain.

I say they *can* flow, because whether they do depends on what is done to a third connection, the *gate* (g). If the gate is made very negative with respect to the source, current flow is suppressed. The transistor is biased off. As the negative bias is reduced to zero, current flows freely.

This effect is graphed in Fig. 2. Here the curve labelled  $V_{GS}=0$  is for the unbiased condition and the one for  $V_{GS}=-2V$  is for the case when the gate is 2V more negative than the source.

A bias of  $-1V$  would give a similar curve between these two. For  $-3V$  the curve would be somewhere beneath the  $-2V$  curve, and so on. The curves are representative of a low-power *n*-channel junction f.e.t.

### Symbol

The symbol for an *n*-channel junction f.e.t. is added to Fig. 1 and Fig. 2. In my

opinion it's a thoroughly bad symbol, but we are stuck with it. The gate and channel (Fig. 1) form a *pn* junction diode, and the little arrow on the symbol shows the direction in which current flows if this diode is forward biased.

The only problem is that it never is, in normal operation of the f.e.t. It would have been much more sensible to add an arrow to the source lead showing the actual direction of current flow, as in the lower symbol on Fig. 2. I use this symbol for my own private diagrams but it's non-standard.

Reverting to Fig. 1, it looks as if the source and drain connections could be reversed. This is true for many junction f.e.t.s, known as symmetrical f.e.t.s. Others, however, don't work properly if the source and drain connections are reversed.

### P-Channel

It's possible to start with a block of *n*-type silicon and form a *p*-type channel. To make the f.e.t. work you then have to reverse the polarities of the applied voltages.

This gives two polarities of junction f.e.t., which correspond to their bipolar transistor equivalents. The *n*-channel f.e.t.s resemble *npn* transistors in the way the battery has to be connected, while *p*-channel corresponds to *pnp*.

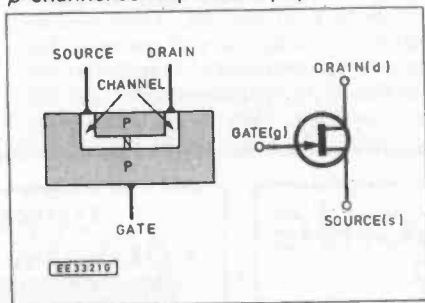

Fig. 1. Cross section through *n*-channel junction f.e.t.

### Input Impedance

The big difference is the input impedance. Since the f.e.t. is operated in such a way that the gate-source junction is reverse biased no current flows, apart from a very small leakage current. The resistance, looking into the gate, is very high. For most practical purposes it is infinitely high. For alternating currents it's not so high.

A f.e.t. also has an input capacitance. This may be only a few picofarads, but

can be significant at high frequencies and in some circumstances even at audio frequencies.

### F.E.T. Jargon

The  $V_{GS} = 0$  curve in Fig. 2 illustrates some important terminology. The point marked  $V_p$ , where the curve flattens out, marks a current ( $I_{DSS}$ ) which is quoted on data sheets. It is the drain current  $I_D$  which flows when the gate is shorted to the source, leaving the f.e.t. unbiased (Fig. 3a). In fact  $I_{DSS}$  is often quoted for some higher drain-source voltage than  $V_p$ , but this makes little difference.

The value of  $V_p$  is called the pinch-off voltage. "Pinch-off" refers to something that happens inside the f.e.t. and needn't bother us.

Unfortunately, the same term, pinch-off is also used for something else. If the gate is made just sufficiently negative to suppress drain current then this value of  $V_{GS}$  is often called the gate pinch-off voltage. All very misleading. It is better to borrow an old valve term and call it the "gate cut-off bias".

The region to the right of  $V_p$  is called the "saturation region", or the pinch-off region, or the pentode region. It is the region in which the f.e.t. can operate as a fairly linear amplifier.

The region to the left is where the f.e.t. can act as a voltage-controlled resistance. This region is sometimes called the triode region.

One essential for amplification is to set the drain current to a suitable value by applying a negative bias to the gate. There are lots of ways of achieving this but the simplest is to insert resistance ( $R_S$ ) into the source connection (Fig. 3b).

Flow of current sets up a voltage with the polarity shown. The source end is positive, and the common or "earth" end negative. Since the gate is returned to "common" it is made negative with respect to source.

This is still true when resistance is inserted into the gate lead, see Fig. 3c. Since no d.c. flows in  $R_G$  the bias voltage is unchanged. Applying an a.c. signal ( $V_{IN}$ ) to the gate causes the bias to wobble and this produces corresponding wobbles in the drain current  $I_D$ . A load resistance  $R_D$  in the drain lead drops a d.c. voltage.

As  $I_D$  is wobbled by the signal this voltage varies in sympathy. These a.c. variations can be extracted via a d.c. blocking capacitor C2.

If  $R_D$  is large enough this a.c. output is greater than the input signal. The f.e.t. is amplifying the signal voltage.

Fig. 2. Voltage and current relationships.

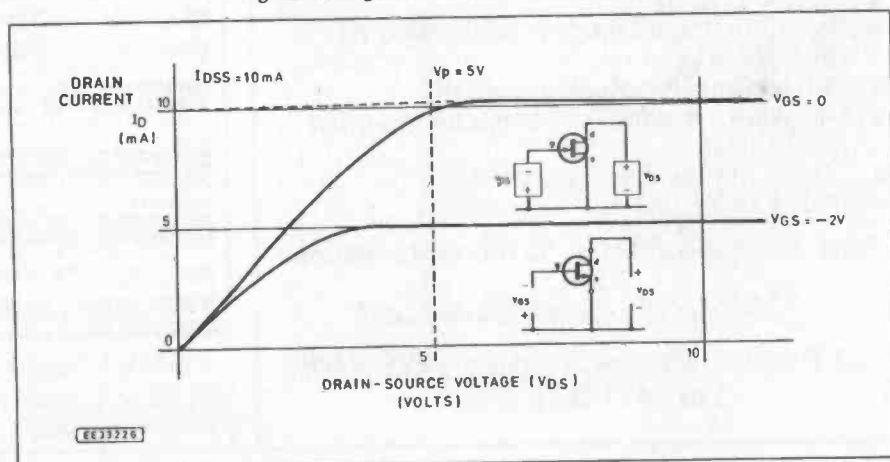



The gain is usually lower than for a bipolar transistor. However, the higher input impedance of the f.e.t. often enables a greater input voltage to be applied.

The bias resistance  $R_S$  is normally bypassed to a.c. by capacitor C3. Leaving out C3 reduces gain.

### Alternative Connections

This way of using a f.e.t. is known as *common-source* operation. The source, being a.c. connected by capacitor C3 to the zero voltage or "earth" line is used in common with the input signal, one terminal of which is also earthed. Since there are three terminals to a f.e.t., any one of which can be "earthed" to signal voltages it follows that there are two other possible connections, *common-gate* and *common-drain*.

The common-gate amplifier (Fig. 4) has about the same voltage gain as

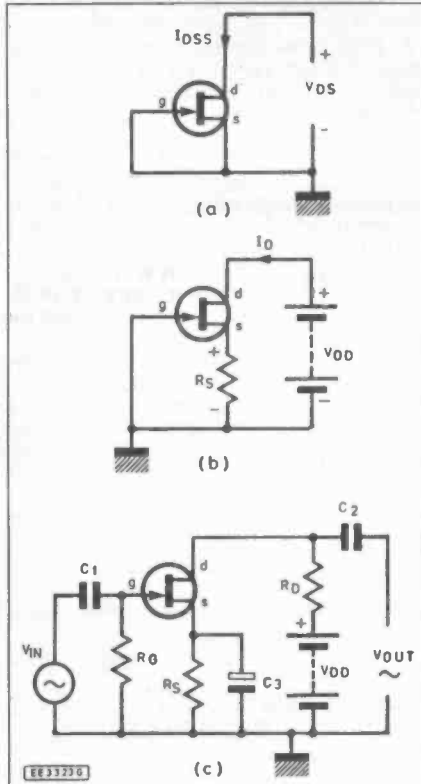

Fig. 3. Biasing arrangements.

the common-source circuit, but a much lower input impedance. It is used for radio frequency amplification, where it is more stable than the common-source circuit.

The common-drain circuit (Fig. 5) is usually called a "source follower". It has a very high input impedance but the gain is less than one. That is, there is no actual voltage gain. The drain is a.c. connected to "earth" via the battery, which has low impedance.

Despite the loss of voltage gain the source follower is very useful. It can handle signals from a very high-impedance source such as a capacitor microphone.

In this case, to avoid excessive bass cut, the value of  $R_G$  must be at least equal to the reactance of the microphone. If the microphone has a capacitance of 100pF then to work down to 16Hz  $R_G$  must be 100 megohms.

The f.e.t. source follower amplifier, is usually built into the microphone. The output impedance of such a source follower is low (say 1k) so it can drive signals into a screened cable with an appreciable capacitance.

### F.E.T. Parameters

As we have seen, applying an a.c. signal to the gate of a common-source amplifier causes variations in drain current. The drain currents of some f.e.t.s respond more to a.c. signals than others.

To describe how effectively  $I_D$  current is controlled by  $V_{GS}$  voltage, data sheets give a figure called the *forward transconductance*, or *mutual conductance*, often labelled  $g_{fs}$ . This transconductance is measured in units called milli-siemens (mS).

A figure of 1mS means that a change in  $V_{GS}$  of one volt produces a change in  $I_D$  of 1mA. The f.e.t. of Fig. 2 has a transconductance of about 2.5mS, since a change in  $V_{GS}$  of 2V causes a change in  $I_D$  of 5mA.

For small amplifier type f.e.t.s,  $g_{fs}$  commonly has values in the range 0.5-20mS. However,  $g_{fs}$  is large when  $I_D$  is large, so for a power f.e.t. whose drain current runs to several amperes  $g_{fs}$  can be hundreds of times larger.

For any f.e.t.,  $g_{fs}$  increases with  $I_D$ . It can be calculated from  $I_{DSS}$  and the cut-

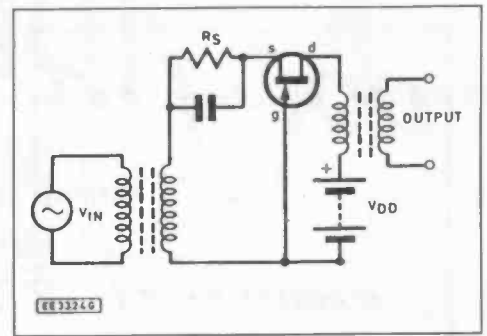

Fig. 4. Common-gate circuit.

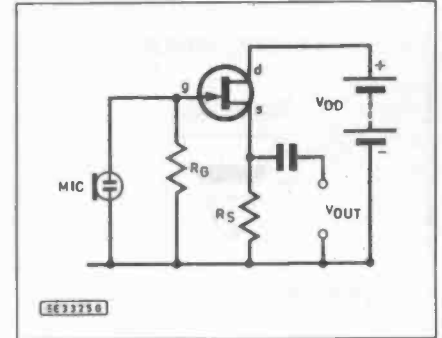

Fig. 5. Common-drain or source follower.

off value of  $V_{GS}$ . The voltage gain of a common source stage is  $g_{fs} \times R_D$  where  $g_{fs}$  is in mS and  $R_D$  in kilohms.

The value of  $g_{fs}$  quoted on data sheets is usually for the unbiassed condition ( $V_{GS} = 0$ ). This is not usually a practical working point. However, the value of  $g_{fs}$  at other bias voltages can be calculated from the zero bias value.

### Other Types of F.E.T.

The junction f.e.t. belongs to a class of f.e.t.s called depletion-mode f.e.t.s. For practical purposes this means that they need a reverse bias on the gate-source diode in normal amplifier service.

There is another class, called enhancement-mode f.e.t.s, which do not pass drain current until the gate is given a forward bias. The f.e.t.s used in CMOS integrated circuits are enhancement f.e.t.s. So are many high power f.e.t.s. That, however, is another story.

# EVERYDAY ELECTRONICS BINDERS

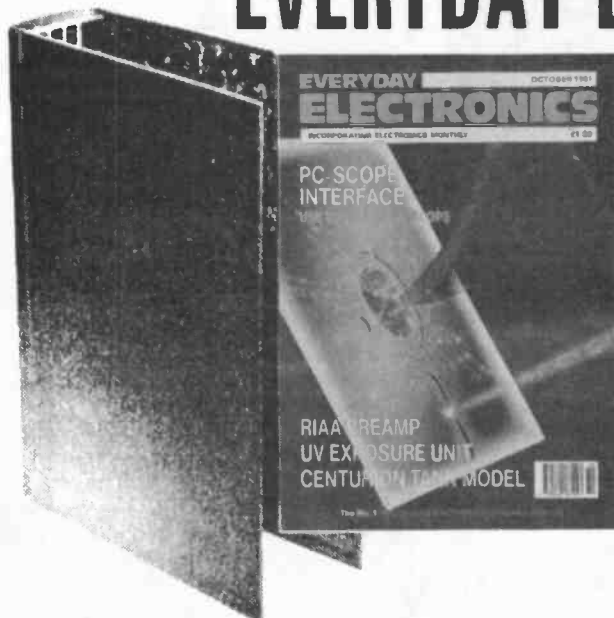

Don't let your valuable issues of EE get binned, burned or bitten (by the dog). Get one of our exquisite orange hard-back binders, slip each issue into it as you get them and you will always know where they are—we hope!

Binders to hold one volume (12 issues) are available from Everyday Electronics, 6 Church Street, Wimborne, Dorset BH21 1JH for £5.95 (£6.95 to European countries and £9.00 to other countries, surface mail) inclusive of postage and packing. Payment in £ sterling only please. Visa and Access (MasterCard) accepted, minimum order value £5.

Binders are normally sent within seven days of receipt of your order but please allow up to 28 days for UK delivery – more overseas.

## EXCLUSIVE OFFER

To Readers of **EVERYDAY ELECTRONICS** *Special Prices*  
**YOU SAVE ££'s ON SCOPES**

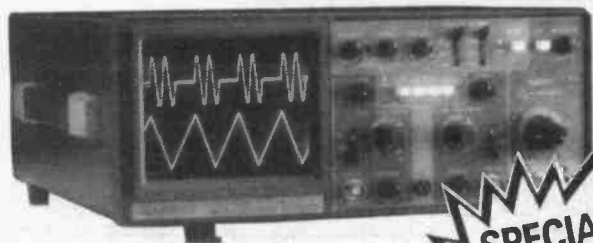

**SSI 2120**  
Dual Trace Oscilloscope

- ★ DC - 20MHz
- ★ 1mV Sensitivity
- ★ 0.5µS - 0.2S/DIV Timebase
- ★ Versatile Trigger
- ★ TV, ALT, DC/LF
- ★ X - Y Mode
- ★ CHI Output

**SPECIAL PRICE**  
Including Delivery and VAT

Normally £360.73  
You Save £61.73

**£299**

*Scopes supplied complete with Power Cord, Test Leads and Manual.*

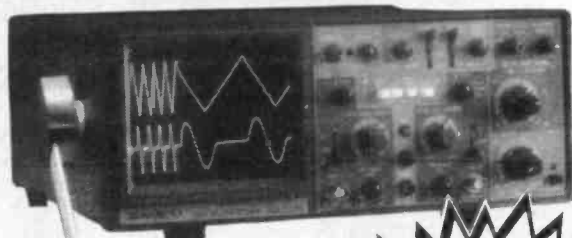

**SSI 2220**  
Dual Trace Oscilloscope  
As SSI 2120

**PLUS**

- ★ Dual Timebase with mixed Sweep Mode (Ideal for Pulse Waveforms)
- ★ Component Tester

**SPECIAL PRICE**  
Including Delivery and VAT

Normally £419.48  
You Save £70.48

**£349**

## AND ££'s ON DMM's

All with AC/DC Volts, Current and Ohms

**PLUS**

**SPECIAL PRICE**  
Including Delivery and VAT

**DT 9000**  
3½ Digit  
Normally £88.13  
You Save £19.13

**£69**

- ★ Auto Ranging
- ★ Bargraph
- ★ 17mm High Contrast LCD
- ★ REL and Hold Modes
- ★ Continuity and Overrange Buzzer
- ★ Capacitance
- ★ Diode and Transistor HFE
- ★ Frequency
- ★ 20A AC/DC Current
- ★ Full Overload Protection

*DMM's supplied complete with Battery and Test Leads.*

*Offer open to 31st October 1991 and is subject to availability.*

*Please allow 28 days for delivery.*

Multitest Ltd Tel: (0480) 403617

**BS110**

Passive Scope Probe with X1 and X10  
£13 each when ordered with Scope

Normally £18.21  
You Save £5.21

**£13**

### ORDER FORM

Name: .....

Address .....

Quantity	Type	Price Each	Total
	SSI 2120	£299	
	SSI 2220	£349	
	DT 9000	£69	
	DT870	£53	
	BS 110	£13	

TOTAL Incl. Delivery & VAT £.....

I enclose my Cheque No: .....

for £..... for the Total inclusive Price

or  
Please debit my Visa/Access Card\*

Card No:..... Expires.....

For £..... Date.....

Signed.....

Post this order form to:  
**Multitest Ltd., P.O. Box 4, St. Neots, Huntingdon, Cambs PE19 4QX**  
\* Please delete as appropriate



*Everyday Electronics, October 1991*

# ROBOT ROUNDUP

## Nigel Clark

It has been another year of change in the educational and small robot market with some new arms on the market and others disappearing. The following is a round-up of what is now on offer, as usual every effort is made to ensure that the information is accurate. The prices quoted (ex-VAT) are approximate and should only be taken as a guide. Most companies offer discounts to educational users so it is best to check with the suppliers for exact prices.

### ARMS

**A150 (Orme Systems Automation)** 5 axes plus gripper, options of electric, pneumatic, magnetic and vacuum, lift 2kg, reach 660mm. Servo-driven with optical encoders. On-board processor, with instructions entered by teach pendant or lead by hand using the LIMP mode. £11,000.

**A250 (Orme Systems Automation)** Same as A150 but faster and more accurate. £13,000.

**A460 (Orme Systems Automation)** Same as A150 but 6-axis plus gripper. Lift 3kg and reach 840mm. £20,000.

**Alpha II (UMI)** 5-axis plus a variety of grippers, stepper motor drive with steel cable transmission. Lift 1.36kg, reach 467mm. Control by on-board processor using teach pendant of computer through RS232 port. Basic MHS £8,800, upgraded RDS. Work cell available and can be networked with other UMI machines. £10,250.

**Atlas II (LJ Technical Systems)** 5-axes plus gripper, stepper-driven with toothed belts. Lift 1kg. On-board micro and teach pendant for stand-alone system. Wide range of operating software. Controllable from BBC and IBM-compatible machines. Work cell available. Arm costs £3,250, IBM interface £325.

**Beasty Plus (Commotion)** 3-axes plus gripper, servo-driven lift 75gms. Supplied in kit with instructions for building four different configurations and comprehensive user guide. Kit costs £120. Interface £35 extra.

**Bidriod (Hasfield Systems)** 5-axes plus gripper, bi-polar stepper motor drive with reinforced steel belt transmission. Lift 1kg, reach 480mm. Control by BBCs, Commodores, IMB and Nimbus. £1,500.

**EMU (LJ Technical Systems)** 4-axes plus gripper, servo-driven with direct mechanical linkages, lift 100gms, software for BBC, IBM and LJ's Emma. £375. Work cell extra.

**Gamma (Hasfield Systems)** 5-axes plus gripper, stepper motor drive with toothed belt transmission. Lift 1kg, reach 560mm. Pneumatic gripper optional. £6,000 to £8,000 depending on specification.

**Gryphon (Cybernetic Applications)** 5-axes plus gripper two fingered or vacuum options, lift 1kg, reach 640mm, stepper motor driven with potentiometer feedback. On-board controller with instructions entered by teach pendant, lead by the nose, simulator or off-line on an IBM. Can be networked with up to 7 Cybernetic robots and work cell. £4,500.

**Labman 450 (UMI)** 3-axes plus gripper, electrical, pneumatic, magnetic and vacuum options. Lift 1kg, reach 450mm. Designed for laboratories it can be linked to other Labman equipment such as decappers and vibrofeeders. On-board processor with instructions by teach pendant also has software for IBM allowing routines to be written off-line. Work cell available and can be networked with other UMI machines. £11,000.

**MA 2000 (TQ International)** 6-axes plus gripper, servo-driven with toothed belt transmission, pneumatic gripper. Lift 1kg. Software for BBC, IBM and Open University's Hektor. Was developed for Open University courses. Gripper is fitted to take pneumatic tools and wired for sensors. Can be linked with MA 3000. Sells at £5,500 for export including basic software, discounts available for UK.

**MA 3000 (TQ International)** 5-axes arm plus gripper. Larger but simpler version of MA 2000. Can be linked with MA 2000 as part of system. £11,400.

**Mentor (Cybernetic Applications)** 5-axes plus gripper. Servo-driven can lift 1kg. Reach 420mm. Can be controlled by model simulator. Software for BBC, IBM and Apple, can be networked with up to seven other Cybernetic machines and work cells. £1,200.

**Naiad (Cybernetic Applications)** 5-axes plus gripper, lift 50gms, reach 500mm, powered by water hydraulics. All axes driven by different kinds of hydraulic piston all cylinders being made of see-through plastic. Gripper can be powered by hydraulic or pneumatic piston for which compressed air supply provided at extra cost. As with mentor it can be controlled by simulator and networked with up to seven other Cybernetic machines and work cells. Software for BBC, IBM and Apple. £2,000.

**Neptune I (Cybernetic Applications)** 5-axes plus gripper. Electro-hydraulically powered (water). Lifts 2.5kgs, reach 1,120mm. Software for BBC, IBM and Apple and has on-board processor. As with Mentor control by simulator and networking with seven other Cybernetic machines and work cell available. £4,500.

**Neptune II (Cybernetic Applications)** 6-axes plus gripper. Rest of specifications same as for Neptune I with the extra facility that it can be controlled by the touch sensors which are on all axes plus accelerating and decelerating. £6,200.

**Rob3 (JMA)** 5-axes plus gripper, electrical, pneumatic and vacuum options, lift 250gms. Servo-driven with optical encoders. On-board processor with instructions entered by teach pendant and software for IBM. Can be networked with Rob3i. £3,000.

**Rob3i (JMA)** Bigger version of Rob3. Lift 500gms. £6,000.

**Scorbot ER III (Boxford)** 5-axes plus gripper, lift 1kg, reach 610mm. Powered by servo motors with optical encoders. Software for IBM and on-board processor. £3,750.

**Scorbot ER V (Boxford)** Same as ER III but faster with more complex software. £6,000.

**Scorbot ER VII (Boxford)** 5-axes plus gripper. DC servos, lift 2kg, reach 850mm, on-board processor. £9,000.

**Teachmover (UMI)** 5-axes plus gripper, stepper motor drive with steel cable transmission. Lift 454gms, reach 444mm. On-board processor with teach pendant. £1,990.

### SCARA ARMS

**Labman 350 (UMI)** 3-axes plus gripper with electrical, pneumatic, magnetic or vacuum options. Lift 200kg with a working area of 350 x 600mm. Can work with Labman peripherals. Work cell available and can be networked with other UMI machines. £3,000.

**Labman 900 (UMI)** Same as 350 except lift 2kg and work area 900mm x 400mm £7,000.

**Labman 1200 (UMI)** Same as 350 except lift 2kg and working area 1200 x 600mm. £16,000.

**RTX (UMI)** 6-axes plus gripper, servo-driven, lift 4kgs. Software for IBM. Work cell available and can be networked with other UMI machines. £5,800.

**RT 100 (UMI)** More robust version of RTX intended for light industry. Work cell available and can be networked with other UMI machines. £6,500.

**RT 100+** Faster and more accurate version of RT 100. £7,000.

**Serpent I (Cybernetic Applications)** 4-axis plus gripper, servo-driven with pneumatic power for vertical movement of gripper, height of arm set manually, software for BBC, IBM and Apple. Lift 1.5kg, reach 550mm. Can be networked with up to seven other Cybernetic machines and work cell. £3,300.

**Serpent II (Cybernetic Applications)** Same as Serpent I except that it has longer reach at 800mm. £3,350.

### OTHERS

**ICT1 Industrial Control Trainer (Flight Electronics)** Shows simple industrial processes with sensors, conveyor and assembly system. £2,000.

**Kestrel (Cybernetic Applications)** Gantry supported arm with 3-axes plus gripper, stepper driven, works in X, Y and Z co-ordinates, lift 2kgs with a frame of 833 x 626mm, vacuum or two-fingered gripper. Software for IBM can be networked with up to seven other Cybernetic machines and work cell.

**MPSR1 Sorter Unit (Flight Electronics)** Helps teach industrial control. Using gravity, coloured beads are channelled past two sensors for sorting. Can be interfaced with IBM. £450.

**Petra (LJ Technical Systems)** Standing for pneumatic/electronic training system. Collection of conveyors, pick and place arm with pneumatic gripper, component dispenser and sensor. Intended as an introduction to hybrid electronic/pneumatic devices. £2,250.

### MOBILES

**Jessop Turtle (Jessop-Ralph)** Also known as Edinburgh Turtle, it looks like an upturned mixing bowl. One of the earliest turtles controlled by a version of LOGO.

Powered by servos with optical encoders, includes pen. Linked to host computer by umbilical cord. Can be used with associated Turtle Trails. Software for BBC, Apple, Nimbus and IBM. £215 plus £23 for Trails.

#### **Lego Buggy** (*Lego and Resource*)

Two-wheeled servo-driven, built from Lego kit with Resource control board attached. Maze following, detecting obstacles, speed control and bar code reading can be done. Software in Buggy Basic, Control and Control IT. Kit and board £78.50, board alone £51.

#### **PIP** (*Swallow Systems*)

Battery-powered stand-alone mobile uses LOGO-like language. Two-wheeled driven by stepper motors. Can store 39 program steps which can be extended by repeat function, plays simple music. BBC and Nimbus leads for downloading programs. Can be "dressed up", pencil holder included. £195 or on rental at £8 per week.

#### **Roamer** (*Valiant Technology*)

Two-wheeled servo-driven stand-alone mobile uses LOGO-like language with instructions entered by keypad on top of the Smartie-shaped machines. Pen holders. Can be customised with kits and control box which are supplied extra. £150.

#### **Trekker** (*Clwyd Technics*)

Two-wheeled servo-driven with pen. Designed by children of North Wales secondary school. Software for BBC and Commodores. £150.

#### **Valiant Turtle** (*Valiant Technology*)

Two-wheeled servo-driven with pen remote-controlled via infra-red link designed to resemble a turtle. Uses version of LOGO and software for BBC, Apple and IBM. Microworlds available at extra cost. £260.

## CONTROLLERS

#### **SEQ** (*ProCom*)

Battery-powered with power supply alternative. LOGO-like instructions entered by a keypad, up to 40 instructions can be stored. All outputs and inputs have indicators. £90 power supply extra.

#### **Ezi-Dun** (*Commotion*)

One input and four outputs which can control up to three motors with simple on-off and reverse switches. L.E.D.S on all channels. No memory. £35.

#### **Valiant Controller** (*Valiant Technology*)

Eight inputs and eight outputs, uses LOGO-like language, sound and capacity for 650 instructions. £150.

## CONTROL PERIPHERALS

There are a growing number of packages enabling models to be controlled electronically or to react to their environments, most are collections of sensors as with the *Philip Harris Education* sensor range or *Commotion's* sensor package. Others are tied in with an interface as with *Commotion's* Control Box.

As collections can vary depending on the items included it is best to contact the distributor or manufacturer for full details.

*Philip Harris* produces a selection of **Blue Box** sensors backed up by its **EMU Easy Memory Unit** for storing information. For younger children there is the **First Senses** range, the **Universal Interface** can be used with Nimbus, BBCs and IBMs.

*Commotion's* collection includes a link for the BBC machines. It can also be interfaced with its Control Box which is BBC

## ADDRESSES

*Boxford*, Wheatley, Halifax, West Yorkshire HX3 5AF.

*Clwyd Technics*, Antelope Industrial Estate, Rhydynwyn near Mold, Clwyd.

*Commotion*, Redburn House, Stockingswater Lane, Enfield EN3 7TD.

*Cybernetic Applications*, West Portway Industrial Estate, Andover, Hampshire S10 3LF.

*Economats*, Epic House, Darnall Road, Attercliffe, Sheffield S9 5AA.

*Flight Electronics*, Flight House, Ascupart Street, Southampton SO1 1LU.

*Hasfield Systems*, The Old Rectory Stables, Hasfield, Gloucester GL19 4LG.

*Jessop-Ralph*, PO Box 925, London SE20 7EH.

*JMA*, Unit 15/16, Highfield Industrial Estate, Bradley Road, off Warren Road, Folkstone LT19 6DD.

*LJ Technical Systems*, Francis Way, Bowthorpe Industrial Estate, Norwich.

*NES Arnold*, Ludlow Hill Road, West Bridgford, Nottingham NG2 6ND.

*Orme Systems Automation*, PO Box 3, Stakehill Industrial Park, Middleton, Manchester M24 2RH.

*Philip Harris Education*, Lynn Lane, Shenstone, Lichfield WS14 0EE.

*ProCom*, 2 Churchill Road, Tavistock, Devon PL19 9BU.

*Resource*, Exeter Road, off Coventry Grove, Doncaster DN2 4PY.

*Stevenage Adventure Workshops*, 29 Lytton Fields, Knebworth, Herts SG3 6BA.

*Swallow Systems*, 32 High Street, High Wycombe HP11 2AQ.

*Testbed Technology*, The Science Park, Hutton Street, Blackburn BB1 3BY.

*TQ International*, Bonsall Street, Long Eaton, Nottingham NG10 2AN.

*UMI*, UMI House, 9-16 St James Road, Surbiton, Surrey KT6 4QN.

*Valiant Technology*, Gulf House, 370 Old York Road, Wandsworth, London SW18 1SP.

and Nimbus compatible. The Control Box package includes motors and lights as well as the sensors.

A similar package is being produced by *NES Arnold*. Called the **Microtec Pack**, it is based around the Microtech BBC interface. It is intended for younger pupils and its software has different levels of complexity.

**System Omega**, distributed by *Economats*, contains a power supply, three boards, sensors and outputs such as sounds and a counter. It is intended as a simple introduction to electronics.

## KITS

There are many types of modelling materials from which robotic devices can be built, for example **Meccano** and **Plawcotech** and even old cardboard boxes, but most need the addition of electronic parts to allow them to be controlled. The manufacturers mentioned here all supply kits with their own controllers designed for robotic projects.

The most well known are *Lego* with its **Lego Technic** series and **Fischertechnik**. *Lego* provides a variety of kits covering a range of complexity. Control can be provided by a simple hand-held controller with no memory as well as computer control from a BBC.

*Lego* have also developed kits for all levels of schooling complete with teacher packs and worksheets. The models include arms, an X-Y plotter and a buggy.

*Fischertechnik* was one of the first to develop kits for computer-controlled models, including collections developed on behalf of *Economats*, its main UK distributors, it offers a large range with some special kits to be used for teaching the Craft and Design Technology section of the National Curriculum.

There is also Nimbus and BBC software for the designing of control systems on screen. The kits include d.c. motors, potentiometers and switches to make a number of devices such as arms, a buggy and an ingenious simulation of a spot welder.

*Testbed Technology* provides a similar array of components and a BBC interface in its **Polymek** range. Course materials have been developed with pupil texts and teacher guides. The models can be controlled using *Testbed's* own Micro Control Language, available on ROM chip for the BBC.

*Stevenage Adventure Workpacks* offer collections of motors, gears and switches with plans for building devices and a circuit diagram for a simple BBC interface. The kits are intended as introductions to control technology.

*Ezi-Dun*, distributed by *Commotion*, has a basic kit of electronic and mechanical components and a special board which allows components to be connected without soldering. The kit works with the *Ezi-Dun* controller.

*Fischertechnik spot welder simulation.*





# Electronics Teach-In No5

Guide to Building  
Electronic Projects

On Sale September 27, 1991.

Price £2.95

Due to the demand from students, teachers and hobbyists we have put together a range of articles from past issues of *Everyday Electronics* that will assist those getting involved with the construction of electronic projects for the first time.

The book contains the complete *Project Development* for GCSE series.

## CONTENTS

### Features

First Steps in Project Building  
Building with Stripboard  
Getting Your Projects Working  
Choosing and Using Test Equipment  
Printed Circuit Board Design, Layout & Construction.  
Project Development for GCSE

### Data

Component Codes  
Component Identification and Polarity  
Circuit Symbols

### Projects

Digital Experimenters Unit  
Simple SW/MW Radio  
Quizmaster  
Lie Detector

**An invaluable resource for those teaching and studying GCSE electronics or technology courses.**

## ELECTRONICS TEACH-IN No.5 £2.95

GUIDE TO BUILDING  
ELECTRONIC PROJECTS

From the  
Publishers of  
EVERYDAY  
ELECTRONICS

Identifying components  
Circuit symbols  
Building with stripboard  
P.C.B. design, layout and construction  
Project development for GCSE  
Getting your projects working  
Choosing and using test equipment

**PLUS: SIMPLE PROJECTS TO BUILD**

Essential reading for GCSE Electronics and Technology Students

Available from your newsagent from  
September 27  
**ORDER YOUR COPY NOW**

# The ONE STOP Component Shop



▶ Massive Stocks

▶ Every kind of component available

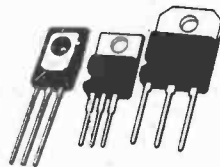

▶ Latest Semi-conductors & Transistors Available from All Over the World

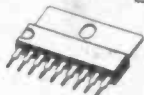

▶ Credit Card Telephone Orders a Speciality

**CRICKLEWOOD  
ELECTRONICS**

CREDIT CARD TELEPHONE HOTLINES  
Tel: 081 452 0161 & 081 450 0995  
40 Cricklewood Broadway, London NW2 3ET  
Fax: 081 208 1441 - Telex: 914977 CRICKEL G



AMERICAN EXPRESS

VISA

The new long awaited

## 160-page Cricklewood Catalogue

will be available

**FREE**

banded to the  
January 1992

issue of  
Everyday  
Electronics

# REPORTING

# AMATEUR RADIO

**Tony Smith G4FAI**

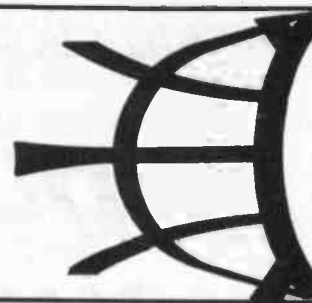

## RSGB VIDEO

I recently viewed the RSGB's new recruitment video *Amateur Radio for Beginners*, sponsored and produced by Yorkshire Television in support of the Society's Project YEAR (Youth into Electronics via Amateur Radio). Presented by Jim Bacon, G3YLA, a well-known weather forecaster on Anglia TV, this two part production is intended for public viewing arranged by local radio clubs affiliated to the RSGB.

Part 1, "Amateur Radio - The Hobby of the Space Age", starts off with shots of the RSGB's station, GB3RS, in contact by voice and TV with Dr Tony England, W00RE, on board the shuttle *Challenger*, back in 1985 when manned amateur radio first went into space.

Viewers are then taken to Surrey University's Spacecraft Engineering Research Unit, a project largely staffed by radio amateurs under Prof. M. N. Sweeting, G3YJO, which designs, builds, launches and operates small microsats.

The *UOSAT* control room follows and controls the progress of the satellites, and the unit provides unique learning opportunities for students from around the world, linking its projects with the professional and amateur communities, and with the thousand or so schools which actively track amateur satellites from their club stations.

We visit the White Rose Amateur Radio Society in Leeds and observe their varied activities, including visits by club speakers to local schools to explain what amateur radio is all about, putting pupils "on-the-air" to give them a taste of radio operating.

Practical demonstrations illustrate various amateur radio modes, speech, Morse, data, TV, facsimile, and so on, via conventional radio paths and via amateur satellites.

## BASIC INFORMATION

All the basic background to the hobby is brought to life. QSL cards and their uses; awards for operating skills and achievements; home construction and how to approach it; amateur radio rallies and flea markets and what can be found at them. Operating from home and in the car. The value of the hobby to the disabled and housebound; amateur radio and scouting; RAYNET, the Radio Amateur Emergency Network, providing communications in emergencies as well as assisting at large scale sporting events or other public occasions, when widespread communications and control is required.

And so it goes on. "Fox hunting" (radio direction finding) in China; contacts with foreign stations; "field days", memorable events with radio stations under canvas providing part of the competitive element of the hobby plus fun and a social side. Contacts with friends

locally. Worldwide contacts. Worldwide friendships.

The video stresses that while some of the radio equipment seen in this presentation is obviously expensive, beginners need not be deterred. Low cost simple sets and modest wire antennas will get the newcomer on-the-air, with contacts across the UK and with many other countries.

The message from this first part is that while amateur radio can be a hobby for life for those of any age, it also offers a useful addition to school curriculum science, while its practical engineering aspects can be very helpful in the early stages of a career in electronics, providing a useful background when studying for professional qualifications.

## NO PREVIOUS KNOWLEDGE

Part 2 - "How to become a Radio Amateur", points out that most newcomers have no previous electronic knowledge at all. Many books and courses are available, while one of the best ways to find out about amateur radio is to listen to existing amateurs on-the-air.

Short wave listening is an important part of the hobby, and many beginners make a simple receiver to start with, using just a handful of components. They go on to make simple low power transmitters and receivers suitable for amateur operation, using inexpensive wire antennas.

This sort of activity is the basis of the new amateur Novice licence which allows limited low power operation on the amateur bands. A full licence can be obtained later, enabling the holder to take part in any of the numerous activities available within the hobby.

The course for the Novice licence is described, with its emphasis on the practical approach. The reason for a licence is explained and demonstrated. Users of radio transmitters capable of causing interference to others, especially to the emergency services, must be licensed to ensure that potential causes of interference are controlled.

## BEGINNERS' PACK

The video urges newcomers to amateur radio to contact their local radio club who will be pleased to offer guidance and help. They are also advised to write to the Radio Society of Great Britain, Lambda House, Cranborne Road, Potters Bar EN6 3JE, for the Beginners Pack. This contains information on magazines, books, manuals, etc, details of the Novice licence, and how to contact local clubs.

Presenter Jim Bacon's last words put it all in perspective. "Keep it simple. Keep it cheap. And above all, make it fun." I strongly urge any readers with the slightest interest in radio communications to try to see one of the showings of

this video arranged by local clubs. And let me know what you think of it!

## FIRST NOVICE LICENCES

Of the 185 candidates who took the first Novice Radio amateur's examination in June 1983 (82.7 per cent) were successful. A number of these also passed the 5 w.p.m. Morse test, qualifying for the new Novice "A" licence (with both v.h.f. and h.f. facilities), while the remainder qualified for the Novice "B" (v.h.f. only) licence. Seven of the successful candidates, aged between 11 and 16, received their licences from Telecommunications Minister John Redwood at a special presentation on 25 July.

Unfortunately some candidates had difficulty in finding examination centres prepared to offer the Novice examination, presumably because of the lower than usual age limit. It is understood that the City & Guilds Institute is now urgently seeking to increase the number of centres willing to accept entries from young persons.

## HAPPY MEMORIES

Hearing the Science Museum's demonstration station on the air recently, celebrating the Morse bicentennial with the special call GB200SM, reminded me of a visit I once made to the museum. Many people have first encountered amateur radio at this station, usual call GB2SM. It has an impressive array of antennas on the museum roof 120ft above street level, and is comprehensively equipped to demonstrate most amateur modes and frequencies.

Some visitors are inspired by what they see and hear and go on to take up the hobby themselves. I was myself when I went there with my young son some 20 years ago. The operator was talking to a station in Singapore while we looked on. I called out, "I was in Singapore in the RAF", and the next moment I was swapping memories of that city with the Singaporean via the Science museum operator.

I came away determined that as soon as possible I would be able to talk to Singapore, or anywhere else come to that, through my own licensed radio station. My son and I enrolled in a local class, took the exams, and we went on the air for the first time, with consecutive class B call signs, on 2 October 1973.

With v.h.f. only licences at that time we couldn't reach Singapore of course but we certainly worked GB2SM a few times and told our story over the air for the benefit of visitors. We still go to the museum occasionally and always try to visit the station. It normally operates on Tuesdays, Wednesdays, Thursdays and Sundays, but owing to staff shortages it is not always possible to maintain this schedule.



# MODULAR DISCO LIGHTING SYSTEM

## Part Six: VU MODULE

CHRIS BOWES

Light up your party or disco road show with these easy-build effects modules.

**T**HIS month's module is the first of the effects modules which is designed to be operated by the sound output from the Disco. As a result it is the first module which can be used to provide pulses in time with the music and which can be used to provide the external pulses which are fed to the "EXT" pulse inputs to which mode all of the modules, other than the Simple Chasers, can be switched.

A number of disco systems are available commercially with "Sound-to-Light" features. These are usually based on the principle of separating the sound picture into a number of bands (often Treble, Mid and Bass) and providing an on/off output for each channel if the volume of sound available in that band exceeds a preset level threshold.

The VU Module described in this article works on a different principle by sampling the overall sound picture and controlling the outputs according to the total amount of sound produced by the disco system. This enables the lighting system to

be operated in a more versatile manner, which makes better use of the sophisticated control functions available within the module and through connection to the Masterlink Module.

### CIRCUIT DESCRIPTION

The full circuit diagram for the VU Module appears in Fig. 1. The power supply arrangements for this module are the same as for the rest of the effects modules in this series, with diodes D1 and D2 being included in order to allow connection of this module to any two output modules. Diode D3 is used to feed power to the Masterlink Module (if connected), i.e. D4 is the "Power On" indicator, a tantalum capacitor C1 is used to decouple the Logic gates in the module.

### SOUND SENSING

The heart of the sound detection part of the circuit is IC1, which is a LM3915 i.e.

Bar Driver i.e. The normal function of this type of i.c. is to provide a digital output to ten i.e.d.s, (used as the indicators in "digital" sound meters) which are sequentially switched off and on as the "volume" increases.

This integrated circuit exists in three forms, all of which provide similar functions but operating to different laws. These are: LM3914, which operates in linear steps; the LM3915, which operates in a logarithmic law with the i.e.d.s being switched at 3dB intervals and the LM3916, which operates in the VU mode with steps similar to that used in VU meters.

Any of these ICs can be used for this application, depending on which law of operation you prefer. The LM3915 version has been specified for this module, simply because of its logarithmic law, which tends to give a more spectacular display. There is, however, no reason why constructors should not experiment with different versions depending on availability and preference.

A simplified explanation of how this i.c. operates is that the incoming signal is presented to pin 5 of the i.c. It is then buffered and presented internally to the inputs of ten internal comparators, each of which are biased to a different level by

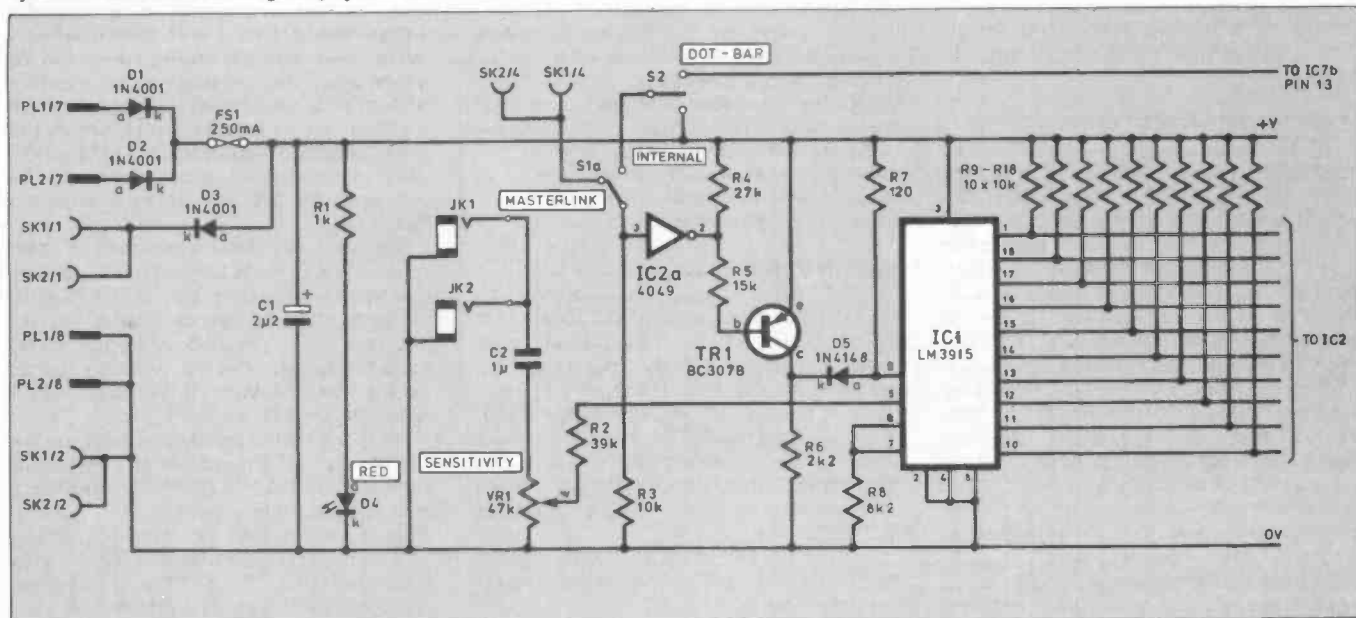

Fig. 1. Circuit diagram for the VU Module. Due to its size, the circuit has had to be split into three parts and is accommodated on three pages. Note that the Dot-Bar switch S2 and the Pattern switch S3 are both "centre-off" types.

means of an internally generated reference voltage and a chain of ten resistors. As the signal level increases each of the comparators is made to switch in turn and each acts as a current sink which would, in the normal manner of operation, draw current through the l.e.d. associated with that comparator's output.

Although the thresholds of the internal comparators can, in theory, be altered by adjusting the values of resistors R7 and R8 in the circuit shown in Fig. 1, this has attendant complications so a simpler method of adjusting the sensitivity of the module has been chosen. This takes the form of attenuating the incoming sound level. This has been achieved by feeding the signal from the two parallel jack sockets (JK1 and JK2) to potentiometer VR1, which is configured in the traditional volume control arrangement.

The output from the wiper (w) of the potentiometer is connected to the signal input of IC1 (pin 5) via resistor R2, which is included so as to allow the use of any loudspeaker output (including 100 volt line sources) as the sound source for this module. Capacitor C2 is included in the circuit so as to block any d.c. bias, which might exist on the loudspeaker output feed, from interfering with the operation of the module.

Two jack sockets are provided, wired in parallel, so as to provide an input and output feed connection within the module. This will allow the loudspeaker feed to be connected from the amplifier to the module and another cable used to continue the circuit to the loudspeaker.

### DOT/BAR MODE

The LM3914/5/6/ i.c.s have facilities for altering the output display mode, by means of the presence or absence of plus volts (+V) at pin 9. When pin 9 is connected to +V then the output operates in "Bar" mode. In this format each output becomes active as the signal exceeds the turn-on point of the associated comparator and remains active until the signal falls below the threshold.



When pin 9 is left "open circuit" the display operates in "Dot" mode, whereby each output is active only when the signal is within the range covered by the comparator associated with that particular output. In this mode only one output is active at any one time whereas in the "Bar" mode more outputs become active as the signal increases.

This latter function is adapted to suit the control environment of the Modular Disco Lighting System by means of the circuit consisting of IC2a, resistors R4, R5, R7, transistor TR1 and diode D5. IC2a is one sixth of a 4049 hex inverting buffer i.e., which is used in this circuit both to invert the signal from the control system of the Modular Disco Lighting System, and to provide buffering.

The inversion process is necessary because of the inversion provided by the action of TR1. By inverting the input via IC2a the inverting action of TR1 is negated, in so far as the control signals within the system are concerned and the action thus becomes compatible with the rest of the outputs to the system from the Masterlink Module. The use of TR1 is necessary in order to provide the remote (Logic Controlled) switching action to select the display mode of IC1 in accordance with the control regime used by the Modular Disco Lighting System.

Routing switches S1a and S2 are used to

control the input signals to the inverting buffer IC2a from the control signals available within the system. Switch S1 is the Masterlink in/out selector, which is used to transfer control of the display change signals from the internal switching of the VU Module to the Masterlink module's outputs.

When switch S1 is in the "master" position the Masterlink Module takes over all control functions. When it is in the Internal position the Dot/Bar display control functions are determined by the position of S2 and/or the output from the internal Auto selector function, to be described later.

Pins 1 and 10 to 18 of IC1 are the outputs of the i.c. which are normally connected to the anodes of the output indicating l.e.d.s (LED<sub>0</sub> to LED<sub>10</sub>), with the comparator circuits within IC1 acting as current sinks when active, thus drawing a current through their associated l.e.d. and causing it to light. In this application the outputs of the i.c. are not connected directly to the l.e.d.s and it is therefore necessary to provide some form of load into which the comparators can work. This function is provided by the load resistors R9 to R18, each of which are 10kilohm "pull up" resistors.

These resistors pull up the outputs from IC1, and hence the inputs of the invertors connected to them, to the Logic 1 level, except when the associated output from IC1

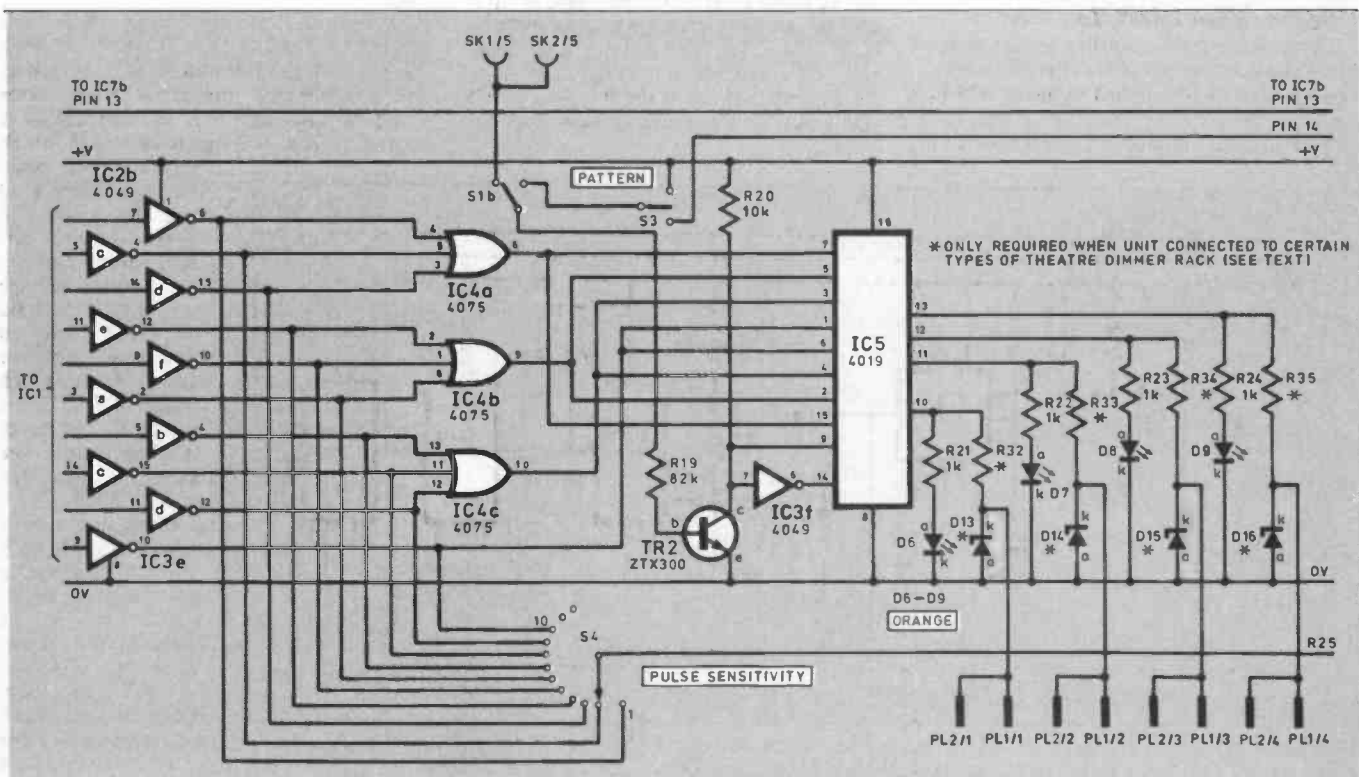



is active, in which case the action of the i.c. is to cause a current to flow through the associated resistor and force the output to 0 volts, which is the Logic 0 state. In the normal application of this type of i.c. resistor R8 would be used to control the brightness of the l.e.d.s in the display but, since there are no l.e.d.s connected to the outputs, R8 is used to set the current flowing through the outputs to the correct level.

## OUTPUT INDICATOR

The sound level sensing circuit IC1 provides ten individually switched outputs but the system is tailored to have only four output circuits. In order to utilise the ten outputs of IC1 to drive the standard four outputs of the system it is necessary to amalgamate several outputs from IC1 into a common channel. This is done in two stages by the next stage of the circuit.

As the outputs from IC1 are in the "wrong sense" (i.e. normally at Logic 1) it is first necessary to invert each of the signals. This is accomplished by the use of the inverting buffers (IC2b to IC3e). In each case the buffer inverts the Logic state, producing a Logic 1 output if the input is at Logic 0 and vice-versa.

The output signals obtained from the inverters connected to the first nine outputs of IC1 are further processed by combining them, in groups of three, so that each group produces a single signal by the use of the triple, three-input OR gates contained in the 4075 i.c. (IC4a, IC4b and IC4c). Thus O<sub>1</sub> to O<sub>3</sub> of IC1 are combined into one signal by IC4a. This results in the output of IC4a being at Logic 1 if the sound source is of a sufficient magnitude to cause any of the outputs O<sub>1</sub> to O<sub>3</sub> of IC1 to be active.

The same process is applied to the other outputs by combining O<sub>4</sub> to O<sub>6</sub> and O<sub>7</sub> to O<sub>9</sub> into two further control signals. The final output of IC1 (O<sub>10</sub>) is left uncombined and fed directly to the next stage of the signal processing circuitry.

## PATTERN REVERSING

In addition to the Dot/Bar pattern selection provided within IC1 a further pattern control circuit is included by using IC5 to reverse the order of the display outputs. Normally the outputs of O<sub>1</sub> to O<sub>3</sub> of IC1

are connected so as to drive Channel 1 of the module, with the other outputs following in sequence until Output O<sub>10</sub> is used to drive Channel 4 of the module. IC5 is a 4019 quad two-input multiplexer.

The outputs from IC4a, IC4b and IC4c together with output O<sub>10</sub> of IC1 are connected, in sequence, to the "B" inputs (B<sub>0</sub> to B<sub>3</sub>) and in reverse order to the "A" inputs (A<sub>3</sub> to A<sub>0</sub>) of IC5. The selection of whether the outputs are fed from the A or B inputs of the multiplexer is controlled by the Logic States of the S<sub>A</sub> (pin 9) and S<sub>B</sub> (pin 14) inputs. When S<sub>A</sub> is at Logic 1 the outputs are the same as their respective A inputs and when the S<sub>B</sub> input is in the Logic 1 state then the outputs correspond to their respective B input states.

Complications could arise in the event of the S<sub>A</sub> and S<sub>B</sub> inputs either being both at Logic 0 or both at Logic 1. In order to prevent this occurring an inverter (IC3f) is connected between pins 9 and 14 so as to ensure that this cannot occur.

The operation of the input is determined by the presence or absence of a voltage at the base of the transistor TR2. The base of TR2 is connected to the control voltages required by means of switches S1b and S3, which operate in the same manner as described for the Dot/Bar arrangement. R20 is a pull up resistor which is used to control the Logic state of the input to IC3f and the S<sub>A</sub> input of IC5.

When no voltage is present across the base/emitter junction of TR2, as happens when S3 is in the mid or "Normal" position, the transistor is not biased so no current is allowed to flow through the emitter/collector circuit and hence no current flows through R20. This causes the Logic state at the input of IC3f and the S<sub>A</sub> input of IC5 to be in the Logic 1 state. The outputs of IC5 thus follow the Logic states of their respective A inputs.

When a voltage is present at the base of TR2 it causes the transistor to be biased and thus conduct, causing a current to be drawn through the emitter/collector junction of TR2 and hence through resistor R20, forcing the input to IC3f and hence the S<sub>A</sub> input of IC5, to the Logic 0 state. This causes a Logic 1 state to exist at the S<sub>B</sub> input of IC5. The output states of the channels of the module are therefore made to correspond to those of the B inputs to IC5 and hence to the normal, ascending, sequence.

This explanation would indicate that the operation of the outputs is the reverse of what would be expected and occurs because the inputs to IC5 are reversed in order to facilitate the design of the p.c.b. This minor problem is, however, overcome by reversing the order of connection of the outputs so that Channel 1 of the module is driven by output O<sub>3</sub> of IC5 etc.

The output circuits and indicators of the VU Module are the same as that used for previous modules, with the l.e.d.s D6 to D9 indicating which outputs are live. As with previous modules the resistor and Zener diode networks formed by D13 to D16 and R32 to R35 are only required if the module is to be connected directly to certain types of commercial dimmer rack.

## PULSE OUTPUT

A major feature, designed into all of the modules except for the Simple Chaser and Simple Sweeper Modules, is the ability for sound driven modules, such as that featured in this month's module, to provide an output pulse, in response to the fluctuations in the sound signal from the Disco Deck, which can be used to drive the modules, including the Masterlink Module. In the VU Module the signal used to trigger this "External Pulse" signal is derived from the inverted outputs of IC1.

Each of the outputs from the inverter/buffer circuits connected to IC1 is fed to a contact on S4, which is a one-pole, ten-way rotary switch. The wiper or pole of the switch is connected to the base of TR3 via a base current limiting resistor, R25. The function of R25 is the same as for the other base current limiting resistors (R5 and R19) in that the presence of the resistor stops the base/emitter voltage (V<sub>BE</sub>) of the transistor from exceeding the maximum permitted value of approximately 0.7 volts.

If the base resistor were not present then the transistor would attempt to bring the input voltage (in this case V+ or 16 volts) down to the required 0.7 volts by dissipating the excess energy as heat. This would cause considerable damage to the transistor and possibly to the source of the voltage.

When the inverted output from the sound level sensing circuit which has been selected by the position of S4 goes active, current then flows through R25 and causes TR3 to conduct. This in turn causes a current to flow through resistor R26, which

together with resistor R27, diode D10 and capacitor C3 forms a trigger circuit which converts the positive voltage fed into the base of TR3 into a very short, negative going, pulse which triggers IC6a. This is a CMOS 555 timer (packaged into the same i.c. as it's partner IC6b).

Configured as a Monostable, IC6a is set to produce a positive going pulse, which lasts for a time period determined by the values of R28 and C4, every time it's input is triggered. This pulse is monitored

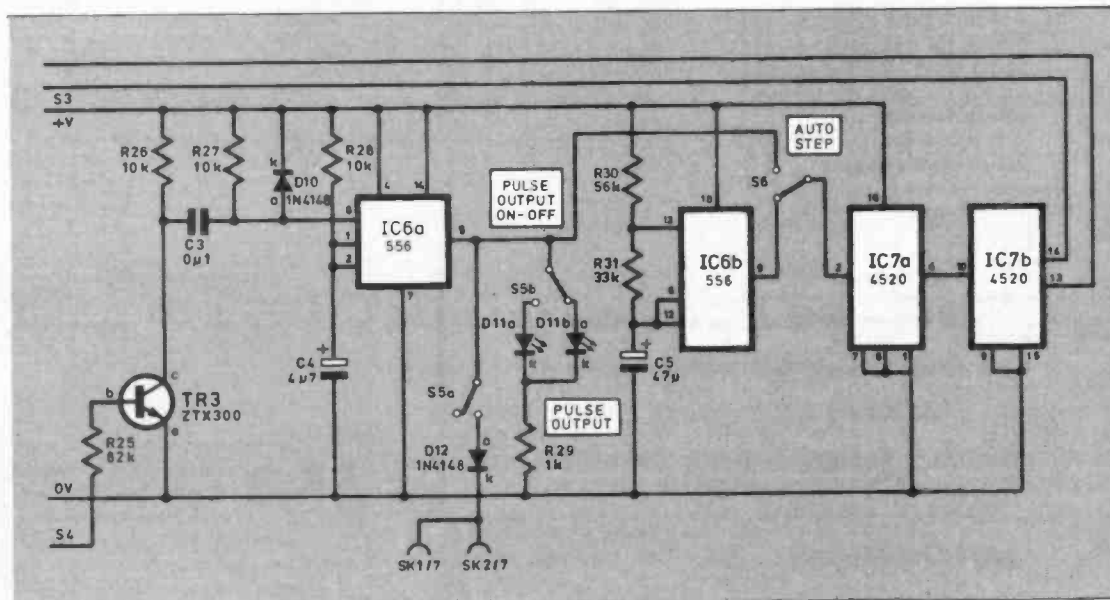

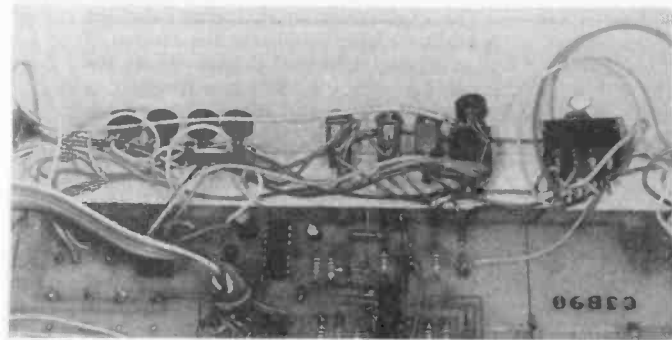

(above) Wiring to front panel l.e.d.s and switches.

Fig. 2 (right). Printed circuit board (double-sided) component layout. Zener diodes (D13-D16) and limit resistors (R32-R35) are optional components only required for certain theatrical dimmer racks.

## COMPONENTS

### Resistors

R1, R21-R24, R29	1k (6 off)
R2	39k
R3, R9-R18, R20, R26-R28	10k (15 off)
R4	27k
R5	15k
R6	2k2
R7	120
R8	8k2
R19, R25	82k (2 off)
R30	56k
R31	33k
R32-R35	(See text)

All 0.25W high stability types, unless otherwise stated.

### Potentiometer

VR1	47k rotary carbon, log.
-----	-------------------------

### Capacitors

C1	2 $\mu$ 2 tantalum, 25V
C2	1 $\mu$ polyester or similar, 250V
C3	0 $\mu$ 1 polyester
C4	4 $\mu$ 7 p.c.b. elect., 25V
C5	47 $\mu$ p.c.b. elect. 25V

### Semiconductors

D1-D3	1N4001 1A 50V rec. diode
D4	Standard red l.e.d.
D5, D10, D12	1N4148 signal diode (3 off)
D6-D9	Standard orange l.e.d. (4 off)
D11	Tricolour l.e.d. (common cathode type)
D13-D16	Zener diode (see text)
TR1	BC307B <i>pnp</i> transistor
TR2, TR3	ZTX300 <i>nnp</i> silicon transistor (2 off)
IC1	LM3915 logarithmic bar l.e.d. driver
IC2, IC3	4049 Hex inverting buffer (2 off)
IC4	4075 triple, three-input OR gate
IC5	4019 quad, two-input multiplexer
IC6	556 CMOS dual timer
IC7	4520 dual binary counter

### Switches

S1, S5	Miniature d.p.c.o. toggle (2 off)
S2, S3	Miniature s.p.c.o. centre-off toggle (2 off)
S4	Single-pole 10-way rotary
S6	Miniature s.p.c.o. toggle

### Miscellaneous

JK1, JK2	Standard jack socket, with matching plug (2 off)
PL1, PL2	Chassis mounting 10-way circular video plug, with matching cable socket (2 off)
SK1, SK2	Chassis mounting 7-way DIN socket, with matching plugs (2 off)
Aluminium case (Maplin "Blue Case 233"), size 250mm x 150mm x 75mm; 14-pin d.i.l. socket (2 off); 16-pin d.i.l. socket (3 off); 18-pin d.i.l. socket; plastic knobs for S4 and VR1 (2 off); l.e.d. clips (5 off); 250mA 20mm anti-surge fuse and p.c.b. fuse clips; self-adhesive pillars (4 off); solder pins; nuts & bolts; connecting wire; solder etc.	

Printed circuit board available from the EE PCB Service, code EE767.

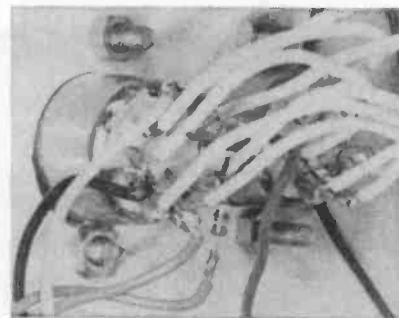
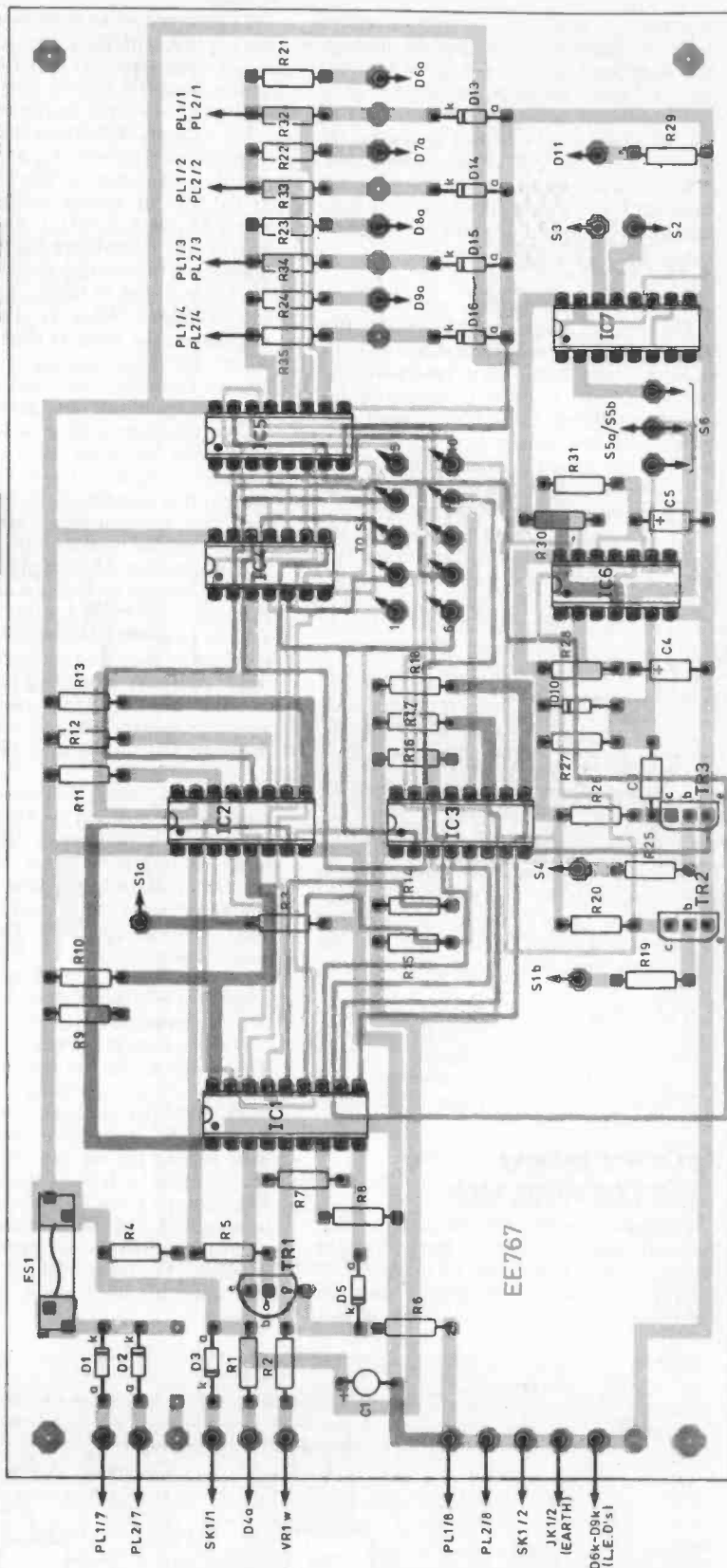

Diode D12 wired directly to pin 7.

Approx cost  
guidance only

**£51** excl case

by the tricolour l.e.d. D11 and can be switched to be fed to the other modules, via SK1 pin 7 of the Masterlink DIN sockets by switch S5. This switch is included so that more than one sound activated module can be included in the lighting rig and the required output switched in and out of the system so that the external pulse, which is used to operate the other modules when they are switched to the external pulse mode, may be selected.

Diode D12 is a blocking diode which is included to prevent any other output pulse from another module, which might also be selected, from interfering with the operation of the rest of the circuit. D11 is a tricolour l.e.d. which flashes on whenever an output pulse is produced by IC6a, IC6b. This l.e.d. contains two separate l.e.d.s (one red and the other green) within the same package. S5b is included so as to change the colour of the l.e.d. in order to show that not only is a pulse being generated but to indicate whether it is driving into the Masterlink connections or not.

## AUTO PATTERN CHANGE CIRCUIT

In addition to the Dot/Bar and reverse functions being selected by the appropriate switches and selected for control by the outputs from the Masterlink module, they can also be controlled automatically from within the module so that they change in a regular sequence. This is achieved by means of a counter circuit which is made up of both halves of a 4520 dual Binary counter, IC7. The two counters are cascaded so that the output O<sub>4</sub> of IC7a is used to feed pulses to the input of the other counter.

The auto pattern outputs are taken from the two highest outputs O<sub>2</sub> and O<sub>3</sub> which give a pattern, which changes after every 128 input pulses and every 256 input pulses respectively. The source of the pulses which drive the auto change circuit are selectable by means of switch S6 so that the pulses for this circuit can be obtained either from the output of the sound pulse circuit or from the other half of IC6, an astable circuit which produces pulses at a frequency governed by the values of R30, R31 and C5.

With the values shown the frequency produced by this circuit is approximately 0.2Hz. This is further divided by IC7 to give a pattern change approximately every 10 seconds and a pattern reversal approximately every 20 seconds. The given values are not critical and may be altered either for convenience or if a different frequency is required.

## CONSTRUCTION

Construction of this project is very similar to that of the other modules in this series. The components (with the exception of the switches, JK1, JK2, VR1 and diode D12) are all mounted on a double-sided printed circuit board (p.c.b.) as shown in Figs. 2, 3 and 4. A ready drilled and tinned p.c.b. can be purchased from the *EE PCB Service*, code EE767.

Although the operation of the circuit is not dependant on the order in which the components are assembled onto the p.c.b. it will probably be more convenient to install the components in ascending order of size. The integrated circuits should be installed in sockets wherever possible, since this will reduce the risk of damage occurring and make it possible for them to be installed as a final stage in the completion of the p.c.b.

This is easy where the i.c. pins make connections only to the underside of the p.c.b. Where connections are required to both sides of the p.c.b. the i.c.s can either be soldered directly onto both sides of the p.c.b. or a wire-wrap socket can be utilised and soldered both to the top and bottom tracks of the board by lifting the socket sufficiently clear of the p.c.b. to allow access for soldering the socket into place.

When fitting the i.c.s, or the sockets into which the i.c.s will fit, care should be taken to ensure that the "bump" on the i.c. or socket corresponds to the notch in the i.c., as shown in Fig. 2. This will aid installation of the i.c. with the correct polarity at the later stage of construction.

Care must also be taken to ensure that

all the polarised components, such as the transistors, diodes and polarised capacitors are inserted into the board with the correct orientation. Considerable damage will occur should this precaution not be observed.

Scrutiny of Fig. 2 will show that there are a small number of occasions when spaces are left on the board layout with empty holes not connected to components. This is intentional, since space and connections have been left for possible future developments of this module to accommodate the possibility of an additional display, utilising part of the circuitry of this module.

Installation of the board in the case will be greatly eased if the connecting points

where wires are attached to the p.c.b. are fitted with terminal pins during the course of installing the other components. Once the board has been completed any i.c.s which require fitting into their sockets should be installed and a careful visual check should be carried out to ensure that there are not broken or shorted tracks, that all of the components are installed in the correct places and that, where polarised components are used that they are installed the correct way round.

## CASE

The case design for the system described in this series is important, in so far that all

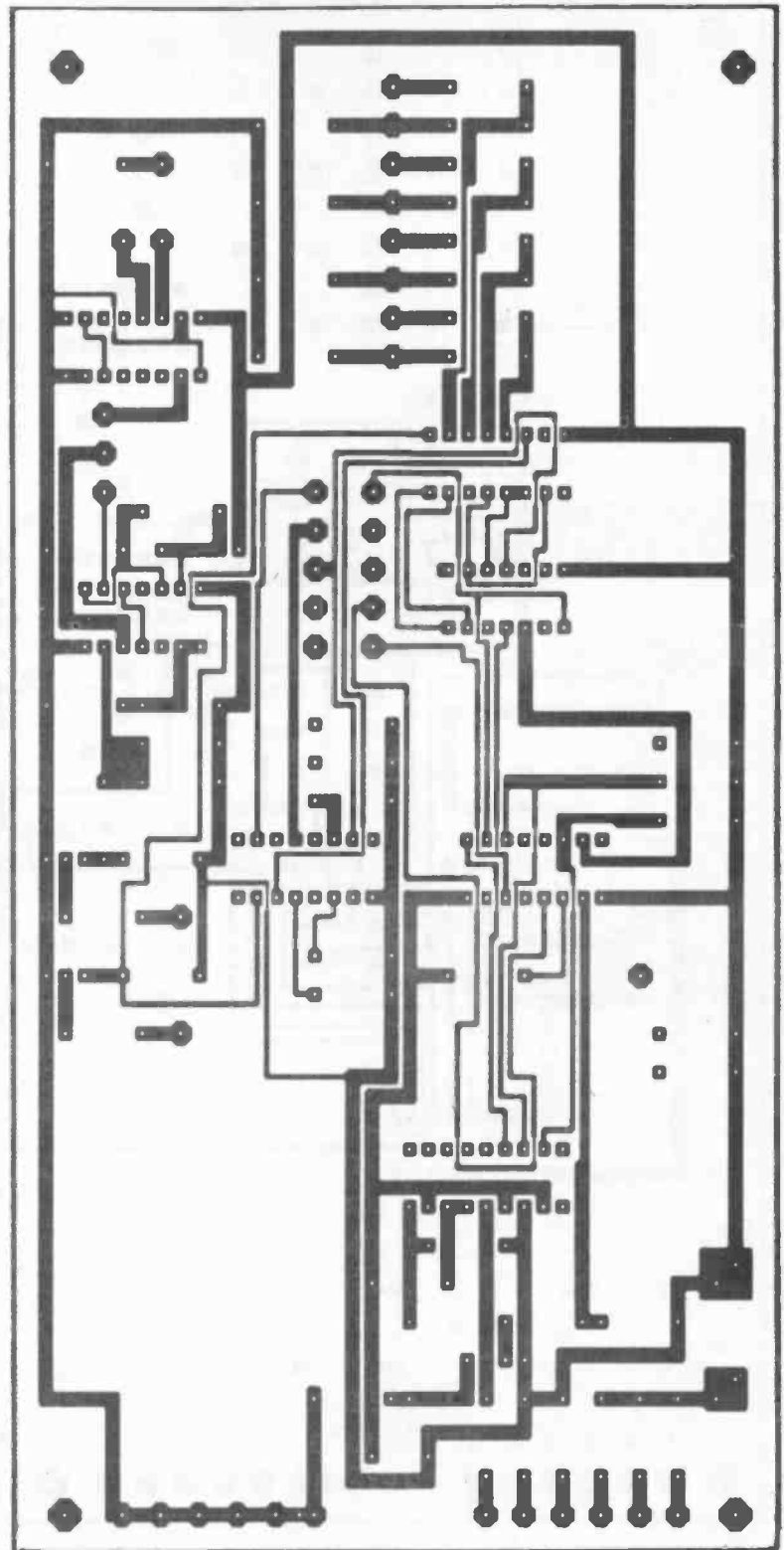

Fig. 3. Full size copper track master pattern for underside of board.

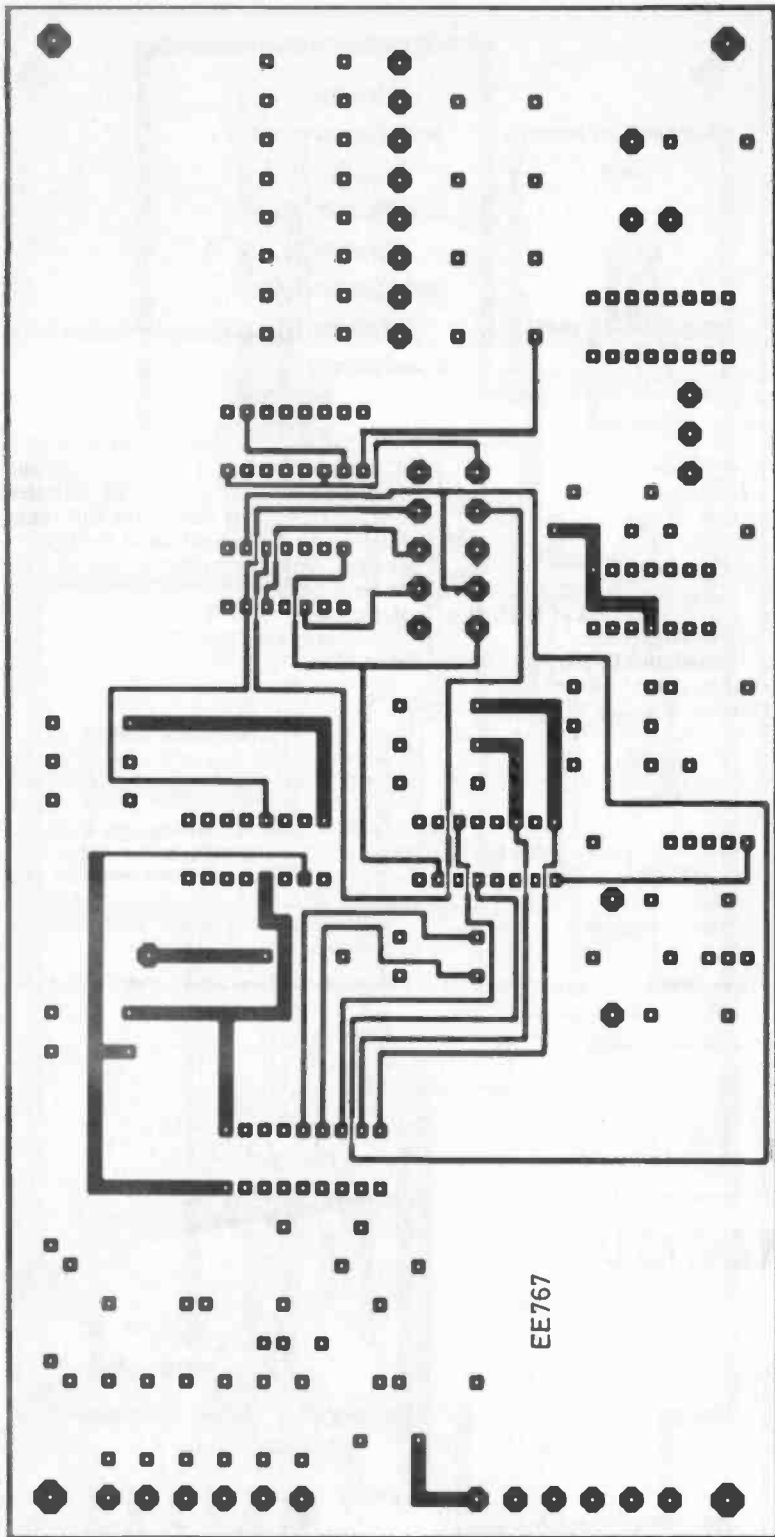

Fig. 4. Full size copper foil track master pattern for top, component side of the p.c.b.

of the modules are designed with a common appearance and to utilise the case specified in the components list. Prior to installing the p.c.b. and panel mounted components in the case it should be drilled and the panel markings completed.

Once this has been done, the case mounted components, such as the sockets and switches can be wired up to flying leads and then fixed into place. There are a great number of wired connections to be made in the module and use of as many different colours of wire as are available will make identification easier.

The l.e.d.s (D1, D6 to D9 and D11) should be fitted into the case by means of

l.e.d. clips and then wired to flying leads which are then soldered to the connection pins of the board. The cathodes (k) of all of the l.e.d.s are best commoned together with bare wire and then a single insulated wire used to connect them to one of the 0 volt connection points on the p.c.b.

Self adhesive standoffs should be inserted in the 4mm clear holes at the board corners and the coverings protecting the adhesive removed, so that the board can then be carefully offered into position in the case and the standoffs pressed onto the case interior to secure them into place. Once the p.c.b. has been secured in position the flying leads from the case mounted com-

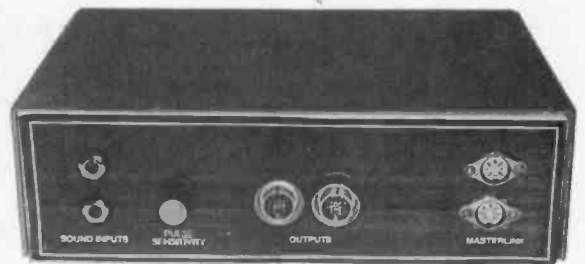

Rear panel showing socket/plug layout.

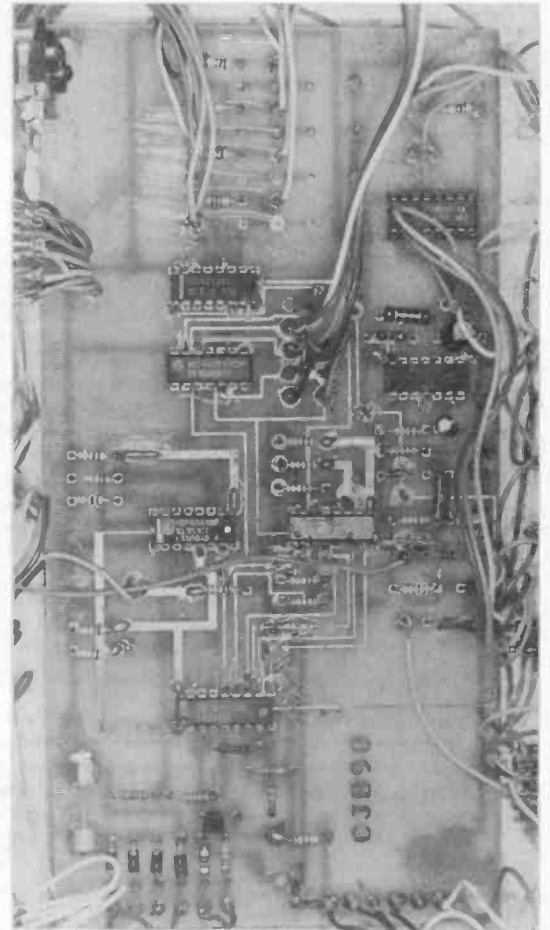

The completed prototype board showing component layout and topside copper tracks.

ponents can then be attached to the correct places on the board.

It should be remembered that it may be necessary to remove the board from the case for faulting finding and servicing. Care should therefore be taken when installing the leads to the case mounted components to ensure that sufficient wire is available to remove the board from the case should it be necessary so to do.

## TESTING

Once the p.c.b. has been connected up to the case mounted components a final check should be carried out to look for incorrect connections, incorrectly polarised components, short circuits and any other faults before testing out the unit. In order to test the module it will be necessary to connect it either to any of the compatible output modules, or to supply the correct voltage (+16 volts) to the power inputs of the p.c.b.

A suitable sound source should be connected into one of the jack sockets and the controls adjusted to ensure that the module operates in accordance with the circuit description and the "In Use" instruction given below. If any faults are found it will be necessary to check through the operation



of the circuit as given in the circuit description, in order to locate and clear the fault(s).

## IN USE

In order to use this module it is necessary to connect it to a suitable sound source. The unit has been designed to accommodate a wide range of sound sources, but it is intended that the module should be used predominantly with loudspeaker outputs (including 100 volt line outputs) from the disco sound system.

Although it is possible to utilise any sound source which is capable of driving the LM3915 i.c. it is possible that the low power outputs from sound sources such as un-amplified record decks, tape recorders and microphones may not be powerful enough to drive the unit directly. Given that these sources are also not sufficiently powerful to give an audible output either, it will be necessary in practice to amplify them anyway, so there should be no problem in finding a suitably powerful sound source with which to drive the module.

The VU Module described in this article is designed for use with **monaural sound sources only**. Two connecting jacks are provided, wired in parallel so that a loudspeaker feed from the amplifier may be plugged into one socket and another jack lead taken from the other jack to feed the loudspeaker.

Under no circumstances should two loudspeaker outputs be commoned together, such as would occur by plugging the outputs of two separate amplifiers or the twin outputs from a stereo amplifier into the two

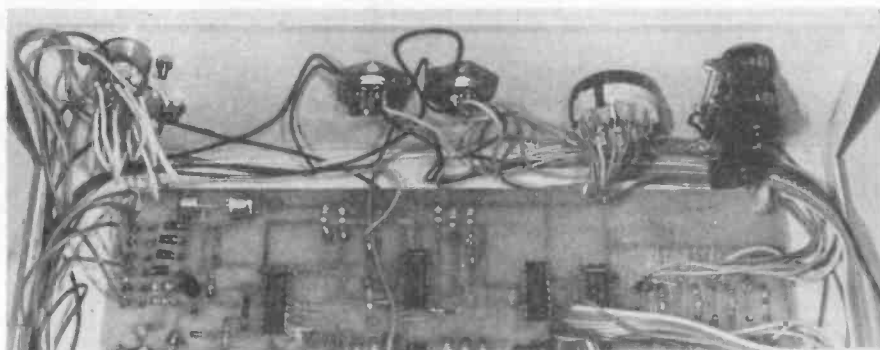

*Wiring to rear mounted components. Each pair of DIN sockets, output "plugs" and input jack sockets are wired in parallel so that only one of each need be connected to the circuit board.*

jack sockets of the module, since this is likely to cause serious damage to the amplifiers concerned. In practice the sound levels produced in the two outputs of stereo sound systems are sufficiently similar for an acceptable effect to be obtained by plugging the module into the output of ONE of the channels of the system only.

The module should also be plugged into the input(s) of at least one Switched Output Module or Dimmer Interface Module and the Masterlink connections between the modules in use should also be made if the external pulse facility is to be utilised, since the connections for this facility are bussed through the Masterlink sockets. Similarly the Masterlink unit, if required, should also be plugged into the equipment stack by using the Masterlink connections.

Once the connections described above have been made a suitable sound source

should be utilised to drive the module and potentiometer VR1 should be adjusted until the signal just causes the full range of output l.e.d.s to light up at the loudest passages. Once the correct setting of VR1 has been achieved then switch S4 can be rotated until a satisfactory pulsing of l.e.d. D11, in time with the music, is observed.

The control switches S1, S2, S3 and S6 can then be set to provide the control of the system you desire. If the External Pulse feature is to be utilised it is necessary not only to set switch S5 of the VU Module to the ON position, so as to send the pulses from the module through the Masterlink connection cable, but to set the "pulse" switches of the modules that you wish to drive to the "EXT" position.

Next Month: Super Chaser and Super Sweep.

# OUT NOW!

## SUMMER 1991 CATALOGUE

- 192 pages
- £££'s discount vouchers
- 100s new products
- New range kits
- Over 3000 lines
- Fast same day despatch

Available from most large newsagents or directly from **Cirkit**



£1.70  
plus 30p  
postage

# Cirkit

**CIRKIT DISTRIBUTION LTD**

Park Lane · Broxbourne · Hertfordshire · EN10 7NQ

Telephone (0992) 444111 · Fax (0992) 464457



# ACTUALLY DOING IT!

by Robert Penfold

**A** MAJOR PROBLEM for anyone taking up electronic project construction as a hobby is that they are not likely to be familiar with the various types of component. Clearly it is essential to accurately identify each component if a project is to be assembled correctly.

Many of the problems experienced by beginners can be overcome by studying component catalogues, and this is certainly one of them. A few of the larger component catalogues will provide you with a lot of general data and information on a massive range of components. By spending a few hours studying the catalogues you can learn a tremendous amount, and much of what you learn will be practical information that will be invaluable when constructing projects.

For the beginner one of the most important aspects of a good components catalogue is the numerous drawings and (or) photographs of the components. This enables you to become familiar with a wide range of components before you have actually bought anything.

Also, once you have bought the components for a project, the catalogue, together with the illustrations in the article which describes the project, should enable you to identify all the components without too much difficulty. If necessary, you can place components alongside illustrations in the catalogue in order to find a match.

As it has been pointed out many times before, a few component catalogues might cost you a few pounds, but it is money well spent. Apart from the data and other information provided in most catalogues, you will be unable to obtain all the components you need without resorting to some mail order suppliers. These days a few component catalogues have to be regarded as an essential part of the hobby.

## RESISTORS

Something that can be confusing for beginners, and can even cause some head scratching for those of us who have been in electronics for some time, is the vast range of components that are available. It is probably not the more specialised components that cause the difficulties, as their individualism makes it unlikely that they will be confused with anything else. It is the numerous variations on a particular type of component that causes the problems.

Look at the resistor section in a large component catalogue for instance, and you will probably find more than a dozen different types (including presets etc.) on offer. In fact, some catalogues list a dozen

or more different types of fixed value resistor. In some cases there is little physical difference between two types of component, just rather subtle electrical differences. Studying the illustrations will not help to sort things out in such cases.

In components lists you will usually find that the resistors are all specified as 0.25 watt (W), 5 per cent (%), carbon film types. If you look through some component catalogues you will find that some of them do not actually list any resistors which meet this specification. However, this does not mean that suitable resistors are not available from the company concerned. Resistor specifications in component lists are a sort of minimum requirement.

The wattage rating is the power that the component can dissipate without overheating. It has been interesting to see how the physical size of resistors have reduced over the years, while their power ratings have increased. To some extent this is due to the improvements in manufacturing processes, but to a large extent it seems to be due to the way power ratings are derived.

At one time the maximum power rating would produce a fairly low operating temperature, and the component could withstand an indefinite 100 per cent overload. These days it seems more normal for a resistor operating at its maximum power rating to get very hot indeed, and to be something not too far off burning up.

What this means in practice is that you should never use resistors having a *lower* power rating than that called for in the components list. On the other hand, it is quite safe to use a component which has a power rating that is *higher* than the one specified in the components list.

The only potential problem in doing this is that the higher power resistor might be too big to fit into the available space. If a 0.25W resistor is specified, then a miniature 0.33W or 0.6W type should be perfectly satisfactory, but something like an old 0.5W resistor will probably not fit into the layout.

## TOLERANCE

The percentage figure quoted for resistors (and some other components) is the tolerance rating. No component

has precisely its marked value, and in some cases there is a considerable discrepancy between the theoretical and actual values.

The tolerance rating is the maximum acceptable discrepancy. With a 10k 5 per cent resistor for example, its value must be no more than 5 per cent away from 10k, or between 9.5k and 10.5k in other words.

If a components list calls for 5 per cent resistors, but you can only find 1 per cent or 2 per cent types in a components catalogue, then these closer tolerance resistors are perfectly satisfactory substitutes. This would not normally be a good idea because close tolerance resistors tend to be much more expensive than ordinary 5 per cent or 10 per cent types.

However, some component suppliers have rationalised their resistor ranges, and now sell close tolerance resistors as their standard low power type. These resistors are sold at prices which are comparable to ordinary 5 per cent and 10 per cent types.

Of course, using (say) a 10 per cent resistor in place of a 2 per cent type would not be a good idea. It is unlikely that this would cause a complete malfunction of the circuit, although this is a possibility. It is more likely that the circuit would function, but with reduced performance (poor accuracy in the case of a test gear project for instance).

## COMPOSITION

When dealing with resistors you will inevitably encounter terms such as "carbon", "carbon film", and "metal film". These describe the physical

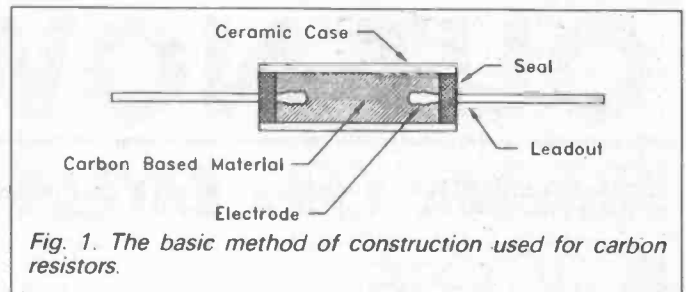

Fig. 1. The basic method of construction used for carbon resistors.

construction of the components, and these terms are not purely of academic importance. The values of all resistors change with ageing and with variations in temperature.

All electronic components, including passive types such as resistors and capacitors, produce electrical noise. The resistors which have a simple method of manufacture tend to have relatively poor stability with regard to their values, and also generate higher noise levels.

The most simple type of resistor is the carbon type. This is basically just a ceramic case with an electrode at each end, and a filling made from a substance that is a mixture of carbon and a ceramic material, see Fig. 1. Carbon has quite a low resistance – the ceramic material has a very high resistance. The value can be controlled by varying the percentage of ceramic material used, with higher ceramic contents giving higher values.

This type of resistor can be manufactured quite easily and cheaply, but carbon resistors are little used these days. The tolerances of these components tend

to be quite high, as does their noise level. Their stability is not very good either.

Most small resistors are now of the film variety. The cheaper ones use a carbon film, while the more expensive components have a metal film. These two types of resistor are very much the same in their general make up, and Fig. 2 shows the basic arrangement used.

The basis of the component is again a ceramic tube, but in this case the carbon or metal based material is in the form of a thin film covering the exterior of the tube. The interior of the tube is simply left empty. A pair of metal end caps provide connections between the film and the two leadout wires.

The value of a film resistor is governed by the composition of the film material,

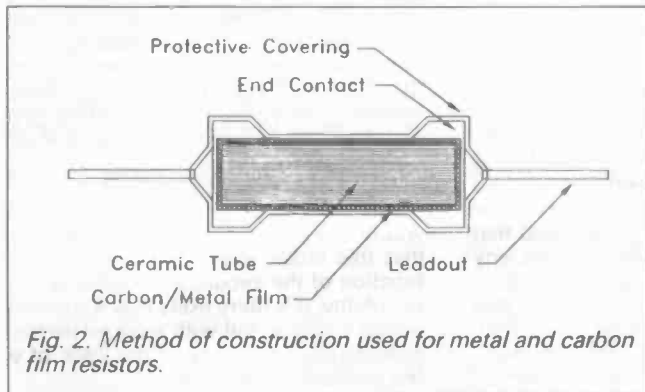

Fig. 2. Method of construction used for metal and carbon film resistors.

and also by the thickness of the film. This enables the values to be accurately trimmed to the required figure during the manufacturing process by cutting a groove into the film. This enables close tolerance resistors to be produced easily. Film resistors have lower noise levels and better stability than carbon types, with metal film types performing better than carbon film components in both respects.

Carbon film resistors are adequate for most purposes, and metal film types are normally only specified for critical applications. These include such things as low noise preamplifiers and attenuators in test equipment. Using a carbon or carbon film resistor in applications of this type should not cause a complete mal-

function of the circuit, but its performance will probably not live up to expectations.

#### WIREWOUND

There are actually a number of other resistor types, but most of these are highly specialised, and are the type of thing you will probably never use. Here we are talking in terms of special ultra-low noise and highly stable components, and very high value types where you must not touch the body of the component as this would significantly alter its value!

One further type of resistor you will find in most catalogues though is the wirewound variety. This is a very simple form of resistor which has the usual ceramic former, and a coil of resistance wire is wound onto this.

The value of the resistor is controlled by using different grades of resistance wire, and various lengths of wire in the coil. In order to avoid having a resistor that also acts as an inductor, the first half of the coil is wound in the opposite direction to the second half. The inductances of the two halves then cancel out each other, giving zero inductance.

It is easy to make high power resistors using this method of construction, and wirewound resistors generally have power ratings of about three watts or more. Carbon and metal types normally have power ratings of about 2W or less incidentally.

Wirewound types having power ratings as high as 25W are quite commonplace, and 100W components are available. These higher power types usually come fixed into an aluminium heatsink. Low power wirewound resistors do not seem to be manufactured, and there would presumably be no point in using this method of construction for low power components.

Where a high power resistor is needed there would seem to be little choice but to use a wirewound type. No other type of high power resistor seems to be available.

#### POTENTIOMETER

While on the subject of resistors I will take the opportunity to answer a couple of often asked questions about potentiometers. The first is simply "what is the difference between logarithmic ("log.") and linear ("lin.") potentiometers"?

With a linear potentiometer any two pieces of track of equal length will have about the same resistance. With the component at a mid-setting, there is a more or less equal resistance from the wiper (moving contact) to each track terminal.

In practice the linearity of most linear potentiometers is not very good, and adjustment towards the ends of the track usually has relatively little effect. This does not matter in most applications though.

If a linear potentiometer is used as a volume control it gives unsatisfactory results. Advancing it slightly causes a large increase in volume, while further advancing the control seems to have little effect. This is more due to the way in which the human hearing mechanism works than due to any fault in linear potentiometers.

Logarithmic potentiometers have a non-linear law which gives a more satisfactory control characteristic in volume control applications. Logarithmic potentiometers are used as volume controls, while linear types are used for practically all other applications.

The second question is "are preset resistors linear or logarithmic types"? This is a fair question, since few component catalogues specify the law for the ranges of preset resistors that are listed.

Actually both types are manufactured, but these days component retailers do not seem to stock the logarithmic type. Applications that require these are few and far between.

Unless a preset resistor is specified as being a logarithmic type, it can be assumed to be a linear component. Similarly, if a components list does not specify the law for preset resistors, it can be assumed that linear types are required.

**EVERYDAY ELECTRONICS**

INCORPORATING ELECTRONICS MONTHLY

The No. 1 Magazine for Electronic & Computer Projects

**NEWSAGENT ORDER FORM**

Please reserve/deliver a copy of Everyday Electronics for me each month

Signed.....

Name and Address.....  
(BLOCK CAPITALS PLEASE)

.....

.....

Everyday Electronics is published on the first Friday of each month and distributed by Seymour.

**Make sure of your copy of EE each month - cut out this form, fill it in and hand it to your newsagent.**

**EVERYDAY ELECTRONICS**

**SUBSCRIPTION ORDER FORM**

Annual subscription rates (1991): UK £18.50.  
Overseas £23 (surface mail) £40.50 (airmail)

To: Everyday Electronics, 6 Church Street  
Wimborne, Dorset BH21 1JH

Name.....

Address.....

.....

I enclose payment of £..... (cheque/PO in £ sterling only payable to Everyday Electronics)

Access or Visa No.

.....

Signature..... Card Ex. Date.....

Please supply name and address of card-holder if different from the subscription address shown above. Subscriptions can only start with the next available issue. For back numbers see the Editorial page.

# DIRECT BOOK SERVICE

The books listed have been selected by Everyday Electronics editorial staff as being of special interest to everyone involved in electronics and computing. They are supplied by mail order direct to your door. Full ordering details are given on the last book page. For another selection of books see next month's issue

## EVERYDAY ELECTRONICS DATA BOOK

**Mike Tooley BA**  
(published by EE in association with PC Publishing)  
This book is an invaluable source of information of everyday relevance in the world of electronics. It contains not only sections which deal with the essential theory of electronic circuits, but also deals with a wide range of practical electronic applications.

It is ideal for the hobbyist, student, technician and engineer. The information is presented in the form of a basic electronic recipe book with numerous examples showing how theory can be put into practice using a range of commonly available "industry standard" components and devices.

A must for everyone involved in electronics!  
256 pages **Order code DATA** £8.95

## Special Everyday Electronics Books

### ELECTRONICS TEACH-IN No. 3 - EXPLORING ELECTRONICS (published by Everyday Electronics)

**Owen Bishop**  
Another EE value for money publication aimed at students of electronics. The course is designed to explain the workings of electronic components and circuits by involving the reader in experimenting with them. The book does not contain masses of theory or formulae but straightforward explanations and circuits to build and experiment with. Exploring Electronics contains more than 25 useful projects, assumes no previous knowledge of electronics and is split into 28 easily digestible sections.  
88 pages (A4 size) **Order code Y13** £2.45

### ELECTRONICS TEACH-IN No. 4 INTRODUCING DIGITAL ELECTRONICS (published by Everyday Electronics)

**Michael J. Cockcroft**  
Although this book is primarily a City & Guilds Introductory level course (726/301), approximately 80% of the information forms a very basic introduction to electronics in general, it therefore provides an excellent introductory text for beginners and a course and reference book for GCSE students.

Full details on registering for C&G assessment, details of assessment centres, components required and information on the course in general are given.

The City & Guilds introduction to module 726/301 reads: "A candidate who satisfactorily completes this module will have a competence to identify basic components and digital integrated circuits and connect them together to form simple working circuits and logic units." This provides an excellent introduction to the book.  
112 pages (A4 size) **Order code Y14** £2.95

### ELECTRONICS TEACH-IN 88/89 - INTRODUCING MICROPROCESSORS

**Mike Tooley BA** (published by Everyday Electronics)  
A complete course that can lead successful readers to the award of a City and Guilds Certificate in Introductory Microprocessors (726/303). The book contains everything you need to know including full details on registering for assessment, etc. Starting with basic terminology, integrated circuits, logic families and numbering systems the text builds in stages, with revision and assessments built in, up to programming, languages, flow charts, etc. The course is ideal for the newcomer to the subject.  
80 pages (A4 size) **Order code Y188 89** £2.45

### ELECTRONIC PROJECTS - BOOK 1

Published by Everyday Electronics in association with Magenta Electronics.  
Contains twenty of the best projects from previous issues of EE each backed with a kit of components. The projects are: Seashell Sea Synthesiser, EE Treasure Hunter, Mini Strobe, Digital Capacitance Meter, Three Channel Sound to Light, BBC 16K Sideways Ram, Simple Short Wave Radio, Insulation Tester, Stepper Motor interface, Eprom Eraser, 200MHz Digital Frequency Meter, Infra Red Alarm, EE Equalliser Ioniser, Bat Detector, Acoustic Probe, Malnester and Fuse Finder, Light Rider - (Lapel Badge, Disco Lights, Chaser Light), Musical Doorbell, Function Generator, Tilt Alarm, 10W Audio Amplifier, EE Buccaneer Induction Balance Metal Detector, BBC Midi Interface, Variable Bench Power Supply, Pet Scarer, Audio Signal Generator.

128 pages (A4 size) **Order code EPT** £2.45



TEACH-IN No 5 OUT SOON - SEE PAGE 659

## Computers and Computing

### COMPUTERS AND MUSIC - AN INTRODUCTION

**R. A. Penfold**  
Computers are playing an increasingly important part in the world of music, and the days when computerised music was strictly for the fanatical few are long gone. Computer-based music systems in the past have tended to be either horrendously expensive, very crude, or both. These days, prices are much more modest and the potential of the equipment is much greater. Consequently a lot of musicians are being tempted into the unfamiliar territory of computer music systems.

If you are more used to the black and white keys of a synth keyboard than the QWERTY keyboard of a computer, you may be understandably confused by the jargon and terminology bandied about by computer buffs. But fear not, setting up and using a computer-based music making system is not as difficult as you might think.

This book will help you learn the basics of computing, running applications programs, wiring up a MIDI system and using the system to good effect, in fact just about everything you need to know about hardware and the programs, with no previous knowledge of computing needed or assumed. This book will help you to choose the right components for a system to suit your personal needs, and equip you to exploit that system fully.  
174 pages **Order code MC10** £7.95

### A CONCISE INTRODUCTION TO MS-DOS

**N. Kantaris**  
This guide is written with the non-expert, busy person in mind and, as such, it has an underlying structure based on "what you need to know first, appears first". Nonetheless, the guide is also designed to be circular, which means that you don't have to start at the beginning and go to the end. The more experienced user can start from any section.

The guide covers versions 3.0, 3.1 and 3.2 of both PC-DOS and MS-DOS as implemented by IBM and other manufacturers of "compatible" microcomputers, including the AMSTRAD PCs. It covers both floppy disc-based systems and hard disc-based systems.  
64 pages **Order code BP232** £2.95

### AN INTRODUCTION TO Z80 MACHINE CODE

**R. A. & J. W. Penfold**  
Takes the reader through the basics of microprocessors and machine code programming with no previous knowledge of these being assumed. The Z80 is used in many popular home computers and simple programming examples are given for Z80-based machines including the Sinclair ZX-81 and Spectrum, Memotech and the Amstrad CPC 464. Also applicable to the Amstrad CPC 664 and 6128.  
144 pages **Order code BP152** £2.75

### AN INTRODUCTION TO 68000 ASSEMBLY LANGUAGE

**R. A. & J. W. Penfold**  
Obtain a vast increase in running speed by writing programs for 68000 based micros such as the Commodore Amiga, Atari ST range or Apple Macintosh range etc., in assembly language. It is not as difficult as one might think and this book covers the fundamentals.  
112 pages **Order code BP184** £2.95

### THE ART OF PROGRAMMING THE ZX SPECTRUM

**M. James, B.Sc., M.B.C.S.**  
It is one thing to have learnt how to use all the Spectrum's commands and functions, but a very different one to be able to combine them into programs that do exactly what you want them to. This is just what this book is all about - teaching you the art of effective programming with your Spectrum.  
144 pages **Order code BP119** £2.50

### A Z80 WORKSHOP MANUAL

**E. A. Parr, B.Sc., DC. Eng., M.J.E.E.**  
This book is intended for people who wish to progress beyond the stage of BASIC programming to topics such as machine code and assembly language programming, or need hardware details of a Z80 based computer.  
192 pages **Order code BP112** £3.95

### NEWNES COMPUTER ENGINEER'S POCKETBOOK (Second Edition)

**Michael Tooley**  
An invaluable compendium of facts, figures, circuits and data. Indispensable to the designer, student, service engineer and all those interested in computer and microcomputer systems. It will appeal equally to the hardware or software specialist and to the new band of "software engineers". This data is presented in a succinct and rapidly accessible form so that the book can become part of an everyday toolkit.  
205 pages (hard cover) **Order code NE01** £10.95

### UNDERSTANDING PC SPECIFICATIONS

**R. A. Penfold**  
If you require a microcomputer for business applications, or a high quality home computer, an IBM PC or compatible is often the obvious choice. They are competitively priced, and are backed up by an enormous range of applications programs, hardware add-ons, etc. The main difficulty for the uninitiated is deciding on the specification that will best suit his or her needs. PCs range from simple systems of limited capabilities up to complex systems that can happily run applications that would have been considered beyond the abilities of a microcomputer not so long ago. It would be very easy to choose a PC system that is inadequate to run your applications efficiently, or one which goes beyond your needs and consequently represents poor value for money.

This book explains PC specifications in detail, and the subjects covered include the following: Differences between types of PC (XT, AT, 80386, etc.); Maths co-processors; Input devices (keyboards, mice, and digitisers); Memory, including both expanded (EMS) and extended RAM; RAM disks and disk caches; Floppy disk drive formats; and compatibility; Hard disk Drives (including interleave factors and access times); Display adaptors, including all standard PC types (CGA, Hercules, Super VGA, etc.); Contains everything you need to know if you can't tell your EMS from your EGA!  
104 pages **Order code BP282** £3.95



# Theory and Reference

## ELECTRONIC HOBBYISTS HANDBOOK

R. A. Penfold

Provides an inexpensive single source of easily located information that the amateur electronics enthusiast is likely to need for the day-to-day pursuance of this fascinating hobby. Covers common component colour codes. Details the characteristics and pinouts of many popular semiconductor devices, including various types of logic ICs, operational amplifiers, transistors, FETs, unijunctions, diodes, rectifiers, SCRs, diacs, triacs, regulators and SMDs, etc. Illustrates many useful types of circuits, such as timers and oscillators, audio amplifiers and filters, as well as including a separate section on power supplies. Also contains a multitude of other useful data.

88 pages

Temporarily out of print

## ESSENTIAL THEORY FOR THE ELECTRONICS HOBBYIST

G. T. Rubaroe, T. Eng (C.E.I.), Assoc. I.E.R.E.

The object of this book is to supply the hobbyist with a background knowledge tailored to meet his or her specific requirements and the author has brought together the relevant material and presented it in a readable manner with minimum recourse to mathematics.

128 pages

Order code 228

£2.50

## NEWNES ELECTRONICS POCKET BOOK

E. A. Parr

Newnes Electronics Pocket Book has been in print for over twenty years and has covered the development of electronics from valve to semiconductor technology and from transistors to LSI integrated circuits and microprocessors. To keep up to date with the rapidly changing world of electronics, continuous revision has been necessary. This new Fifth Edition takes account of recent changes and includes material suggested by readers of previous editions. New descriptions of op.amp. applications and the design of digital circuits have been added, along with a totally new chapter on computing, plus other revisions throughout.

315 pages (hard cover)

Order code NE02

£10.95

## ELECTRONICS - A "MADE SIMPLE" BOOK

G. H. Olsen

This book provides excellent background reading for our *Introducing Digital Electronics Teach-In* Book and will be of interest to everyone studying electronics. The subject is simply explained and well illustrated and the book assumes only a very basic knowledge of electricity.

330 pages

Order code NE10

£4.95

# Component Identification

## HOW TO IDENTIFY UNMARKED ICs

K. H. Recorr

Shows the reader how, with just a test-meter to go about recording the particular signature of an unmarked i.c. which should enable the i.c. to then be identified with reference to manufacturers' or other data. An i.c. signature is a specially plotted chart produced by measuring the resistances between all terminal pairs of an i.c.

Chart

Order code BP101

£0.95

## RADIO AND ELECTRONIC COLOUR CODES AND DATA CHART

B. B. Babani

Although this chart was first published in 1971 it provides basic information on many colour codes in use throughout the world, for most radio and electronic components. Includes resistors, capacitors, transformers, field coils, fuses, battery leads, speakers, etc. It is particularly useful for finding the values of old components.

Chart

Order code BP7

£0.95



## PRACTICAL DIGITAL ELECTRONICS HANDBOOK

Mike Tooley (Published in association with

*Everyday Electronics*)

The vast majority of modern electronic systems rely heavily on the application of digital electronics, and the *Practical Digital Electronics Handbook* aims to provide readers with a practically based introduction to this subject. The book will prove invaluable to anyone involved with the design, manufacture or servicing of digital circuitry, as well as to those wishing to update their knowledge of modern digital devices and techniques. Contents: Introduction to integrated circuits; basic logic gates; monostable and bistable devices; timers; microprocessors; memories; input and output devices; interfaces; microprocessor buses. Appendix 1: Data. Appendix 2: Digital test gear projects; tools and test equipment; regulated bench power supply; logic pulser; versatile pulse generator; digital IC tester; current tracer, audio logic tracer, RS-232C breakout box; versatile digital counter/frequency meter. Appendix 3: The oscilloscope. Appendix 4: Suggested reading. Appendix 5: Further study.

208 pages

Order code PC100

£6.95

## ELECTRONIC MODULES AND SYSTEMS FOR BEGINNERS

Owen Bishop

This book describes over 60 modular electronic circuits - how they work, how to build them, and how to use them. The modules may be wired together to make hundreds of different electronic systems, both analogue and digital. To show the reader how to begin building systems from modules, a selection of over 25 electronic systems are described in detail, covering such widely differing applications as timing, home security, measurement, audio (including a simple radio receiver), games and remote control.

200 pages

Order code BP266

£3.95

## FROM ATOMS TO AMPERES

F. A. Wilson

Explains in crystal clear terms the absolute fundamentals behind electricity and electronics. Really helps you to discover and understand the subject, perhaps for the first time ever.

Have you ever: Wondered about the true link between electricity and magnetism? Felt you could never understand the work of Einstein, Newton, Boltzmann, Planck and other early scientists? Just accepted that an electron is like a little black ball? Got mixed up with e.m.f. and p.d.? Thought the idea of holes in semiconductors is a bit much?

Then help is at hand with this inexpensive book, in as simple a way as possible and without too much complex mathematics and formulae.

244 pages

Order code BP254

£3.50

# Testing and Test Gear

## TRANSISTOR RADIO FAULT-FINDING CHART

C. E. Miller

Used properly, should enable the reader to trace most common faults reasonably quickly. Across the top of the chart will be found four rectangles containing brief description of these faults, viz - sound weak but undistorted, set dead, sound low or distorted and background noises. One then selects the most appropriate of these and following the arrows, carries out the suggested checks in sequence until the fault is cleared.

Chart

Order code BP10

£0.95

## HOW TO USE OSCILLOSCOPES AND OTHER TEST EQUIPMENT

R. A. Penfold

This book explains the basic function of an oscilloscope, gives a detailed explanation of all the standard controls, and provides advice on buying. A separate chapter deals with using an oscilloscope for fault finding on linear and logic circuits. Plenty of example waveforms help to illustrate the control functions and the effects of various fault conditions. The function and use of various other pieces of test equipment are also covered, including signal generators, logic probes, logic pulsers, and crystal calibrators.

104 pages

Order code BP267

£3.50

# Project Building

## HOW TO GET YOUR ELECTRONIC PROJECTS WORKING

R. A. Penfold

We have all built projects only to find that they did not work correctly, or at all, when first switched on. The aim of this book is to help the reader overcome just these problems by indicating how and where to start looking for many of the common faults that can occur when building up projects.

96 pages

Order code BP110

£2.50

## HOW TO DESIGN AND MAKE YOUR OWN P.C.B.s

R. A. Penfold

Deals with the simple methods of copying printed circuit board designs from magazines and books and covers all aspects of simple p.c.b. construction including photographic methods and designing your own p.c.b.s.

80 pages

Order code BP121

£2.50

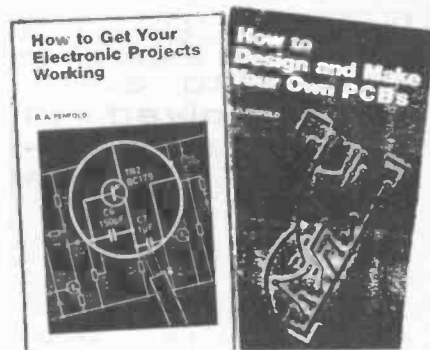

## A BEGINNERS GUIDE TO MODERN ELECTRONIC COMPONENTS

R. A. Penfold

The purpose of this book is to provide practical information to help the reader sort out the bewildering array of components currently on offer. An advanced knowledge of the theory of electronics is not needed, and this book is not intended to be a course in electronic theory. The main aim is to explain the differences between components of the same basic type (e.g. carbon, carbon film, metal film, and wire-wound resistors) so that the right component for a given application can be selected. A wide range of components are included, with the emphasis firmly on those components that are used a great deal in projects for the home constructor.

166 pages

Order code BP285

£3.95

## BEGINNER'S GUIDE TO BUILDING ELECTRONIC PROJECTS

R. A. Penfold

Shows the complete beginner how to tackle the practical side of electronics, so that he or she can confidently build the electronic projects that are regularly featured in magazines and books. Also include examples in the form of simple projects.

112 pages

Order code 227

£1.95

## ELECTRONIC SCIENCE PROJECTS

O. Bishop

These projects range in complexity from a simple colour temperature meter to an infra-red laser. There are novelties such as an electronic clock regulated by a resonating spring, and an oscilloscope with solid-state display. There are scientific measuring instruments such as a pH meter and an electro-cardiometer. All projects have a strong scientific flavour. The way they work, and how to build and use them are fully explained.

144 pages

Order code BP104

£2.95

## ELECTRONICS SIMPLIFIED - CRYSTAL SET CONSTRUCTION

F. A. Wilson, C.G.I.A., C.Eng., F.I.E.E., F.I.E.R.E., F.B.I.M.

Especially written for those who wish to participate in the intricacies of electronics more through practical construction than by theoretical study. It is designed for all ages upwards from the day one can read intelligently and handle simple tools.

80 pages

Order code BP92

£1.75

# Audio and Music

## PRACTICAL MIDI HANDBOOK

R. A. Penfold

The Musical Instrument Digital Interface (MIDI) is surrounded by a great deal of misunderstanding, and many of the user manuals that accompany MIDI equipment are quite incomprehensible to the reader.

The *Practical MIDI Handbook* is aimed primarily at musicians, enthusiasts and technicians who want to exploit the vast capabilities of MIDI, but who have no previous knowledge of electronics or computing. The majority of the book is devoted to an explanation of what MIDI can do and how to exploit it to the full, with practical advice on connecting up a MIDI system and getting it to work, as well as deciphering the technical information in those equipment manuals.

128 pages

Order code PC101

£6.95

## MUSICAL APPLICATIONS OF THE ATARI ST's

R. A. Penfold

The Atari ST's are now firmly established as the computers to use for electronic music applications. The range and sophistication of these applications are much greater than most people may realise, but there are still a lot of misconceptions about just what can and cannot be achieved. This book will help you sort out the fact from the fallacy and to get the most musically from the ST's.

A wide selection of topics are covered, including the internal sound chip, MIDI, applications programs such as sequencing and score writing, etc; simple but useful add-on projects and MIDI programming.

90 pages

Order code BP246

£6.95

## AN INTRODUCTION TO LOUSPEAKERS AND ENCLOSURE DESIGN

V. Capel

This book explores the various features, good points and snags of speaker designs. It examines the whys and wherefores so that the reader can understand the principles involved and so make an informed choice of design, or even design loudspeaker enclosures for him or herself. Crossover units are also explained, the various types, how they work, the distortions they produce and how to avoid them. Finally there is a step-by-step description of the construction of the *Kapellmeister* loudspeaker enclosure.

148 pages

Order code BP256

£2.95

COMPUTERS AND MUSIC. See Computers section opposite

# Circuits and Design

## PRACTICAL ELECTRONIC BUILDING BLOCKS - BOOK 1

## PRACTICAL ELECTRONIC BUILDING BLOCKS - BOOK 2

R. A. Penfold

These books are designed to aid electronic enthusiasts who like to experiment with circuits and produce their own projects, rather than simply following published project designs.

**BOOK 1** contains: Oscillators - sinewave, triangular, squarewave, sawtooth, and pulse waveform generators operating at audio frequencies. Timers - simple monostable circuits using i.c.s, the 555 and 7555 devices, etc. Miscellaneous-noise generators, rectifiers, comparators and triggers, etc.

**BOOK 2** contains: Amplifiers - low level discrete and op-amp circuits, voltage and buffer amplifiers including d.c. types. Also low-noise audio and voltage controller amplifiers. Filters - high-pass, low-pass, 6, 12, and 24dB per octave types. Miscellaneous - i.e. power amplifiers, mixers, voltage and current regulators, etc.

**BOOK 1** 128 pages **Order code BP117** £1.95  
**BOOK 2** 112 pages **Order code BP118** £1.95

## MODERN OPTO DEVICE PROJECTS

R. A. Penfold

In recent years, the range of opto devices available to the home constructor has expanded and changed radically. These devices now represent one of the more interesting areas of modern electronics for the hobbyist to experiment in, and many of these have useful practical applications as well. This book provides a number of practical designs which utilize a range of modern opto-electrical devices, including such things as fibre optics, ultra bright i.e.d.s and passive IR detectors etc.

While many of these designs are not in the "dead simple" category, they should be within the capabilities of anyone with a reasonable amount of experience in electronics construction and some of the more simple designs are suitable for beginners.

104 pages **Order code BP194** £2.95

## ELECTRONIC ALARM CIRCUITS MANUAL

R. M. Marston

One hundred and forty useful alarm circuits, of a variety of types, are shown in this volume. The operating principle of each one is explained in concise but comprehensive terms, and brief construction notes are given where necessary.

Aimed at the practical design engineer, technician and experimenter, as well as the electronics student and amateur.

124 pages **Order code NE11** £12.95

## DIGITAL LOGIC GATES AND FLIP-FLOPS

Ian R. Sinclair

This book, intended for enthusiasts, students and technicians, seeks to establish a firm foundation in digital electronics by treating the topics of gates and flip-flops thoroughly and from the beginning. This is not a constructor's book in the sense of presenting circuits to build and use, it is for the user who wants to design and troubleshoot digital circuitry with considerably more understanding of principles.

Topics such as Boolean algebra and Karnaugh mapping are explained, demonstrated and used extensively, and more attention is paid to the subject of synchronous counters than to the simple but less important ripple counters.

No background other than a basic knowledge of electronics is assumed, and the more theoretical topics are explained from the beginning, as also are many working practices. The book concludes with an explanation of microprocessor techniques as applied to digital logic.

200 pages **Order code PC105** £8.95

## ELECTRONIC CIRCUITS FOR THE COMPUTER CONTROL OF ROBOTS

Robert Penfold

Robots and robotics offer one of the most interesting areas for the electronics hobbyist to experiment in. Today the mechanical side of robots is not too difficult, as there are robotics kits and a wide range of mechanical components available. The micro controller is not too much of a problem either, since the software need not be terribly complex and many inexpensive home computers are well suited to the task.

The main stumbling block for most would-be robot builders is the electronics to interface the computer to the motors, and the sensors which provide feedback from the robot to the computer. The purpose of this book is to explain and provide some relatively simple electronic circuits which bridge this gap.

92 pages **Order code BP179** £2.95

## ELECTRONIC POWER SUPPLY HANDBOOK

Ian R. Sinclair

This book covers the often neglected topic of electronic power supplies. All types of supplies that are used for electronics purposes are covered in detail, starting with cells and batteries and extending by way of rectified supplies and linear stabilisers to modern switch-mode systems, IC switch-mode regulators, DC-DC converters and inverters.

The devices, their operating principles and typical circuits are all dealt with in detail. The action of rectifiers and the reservoir capacitor is emphasised, and the subject of stabilisation is covered. The book includes some useful formulae for assessing the likely hum level of a conventional rectifier reservoir supply.

136 pages **Order code LC103** £7.95

## HOW TO USE OP-AMPS

E. A. Parr

This book has been written as a designer's guide covering many operational amplifiers, serving both as a source book of circuits and a reference book for design calculations. The approach has been made as non-mathematical as possible.

160 pages **Order code BP88** £2.95

## MICRO INTERFACING CIRCUITS - BOOK 1

## MICRO INTERFACING CIRCUITS - BOOK 2

R. A. Penfold

Both books include practical circuits together with details of the circuit operation and useful background information. Any special constructional points are covered but p.c.b. layouts and other detailed constructional information are not included.

Book 1 is mainly concerned with getting signals in and out of the computer; Book 2 deals primarily with circuits for practical applications.

**BOOK 1** 112 pages **Order code BP130** £2.75  
**BOOK 2** 112 pages **Order code BP131** £2.75

## SENSORS AND TRANSDUCERS

Keith Brindley

There are a considerable number of transducers. Look through any electronic components catalogue and you'll find a wide variety of types, and each type has many versions. It's not easy to choose a transducer correctly for a particular function. In many specifications, terms and procedures are referred to which might deter you from using one that is, in fact, the best for the job. Yet, opting to use a transducer merely because it is easier to interface into the measuring system is not the answer. A greater knowledge of all types of transducers capable of doing the task is the ideal, and only then can a totally satisfactory decision be made to use one in particular.

179 pages **Order code NE17** £14.95

## 50 SIMPLE LED CIRCUITS

R. N. Soar

Contains 50 interesting and useful circuits and applications, covering many different branches of electronics, using one of the most inexpensive and freely available components - the light-emitting diode (LED). Also includes circuits for the 707 common anode display.

64 pages **Order code BP42** £1.95

**BOOK 2** 50 more i.e.d. circuits **Order code BP87** £1.95

# DIRECT BOOK SERVICE ORDERING DETAILS

Please state the title and order code clearly, print your name and address and add the required postage to the total order.

Add 75p to your total order for postage and packing (overseas readers add £1.50 for countries in Europe, or add £2.50 for all countries outside Europe, surface mail postage) and send a PO, cheque, international money order, (£ sterling only) made payable to Direct Book Service or credit card details, Visa or Mastercard (Access) - minimum credit card order is £5 - quoting your name and address, the order code and quantities required to DIRECT BOOK SERVICE, 33 GRAVEL HILL, WIMBORNE, DORSET BH21 1RW (mail order only).

Although books are normally sent within seven days of receipt of your order, please allow a maximum of 28 days for delivery. Overseas readers allow extra time for surface mail post.

Please check price and availability (see latest issue of *Everyday Electronics*) before ordering from old lists.

Note - our postage charge is the same for one book or one hundred books!

## MORE BOOKS NEXT MONTH

Direct Book Service is a division of Wimborne Publishing Ltd

# Radio, TV, Satellite

## AN INTRODUCTION TO AMATEUR RADIO

I. D. Poole

Amateur radio is a unique and fascinating hobby which has attracted thousands of people since it began at the turn of the century.

This book gives the newcomer a comprehensive and easy to understand guide through the subject so that the reader can gain the most from the hobby. It then remains an essential reference volume to be used time and again. Topics covered include the basic aspects of the hobby, such as operating procedures, jargon and setting up a station. Technical topics covered include propagation, receivers, transmitters and aerials etc.

150 pages **Order code BP257** £3.50

## SIMPLE SHORT WAVE RECEIVER CONSTRUCTION

R. A. Penfold

Short wave radio is a fascinating hobby, but one that seems to be regarded by many as an expensive pastime these days. In fact it is possible to pursue this hobby for a minimal monetary outlay if you are prepared to undertake a bit of d.i.y. and the receivers described in this book can all be built at low cost. All the sets are easy to construct, full wiring diagrams etc. are provided, and they are suitable for complete beginners. The receivers only require simple aerials, and do not need any complex alignment or other difficult setting up procedures.

The topics covered in this book include: The broadcast bands and their characteristics; The amateur bands and their characteristics; The propagation of radio signals; Simple aerials; Making an earth connection; Short wave crystal set; Simple t.r.f. receivers; Single sideband reception; Direct conversion receiver.

Contains everything you need to know in order to get started in this absorbing hobby.

88 pages **Order code BP275** £3.95

## AN INTRODUCTION TO SATELLITE TELEVISION

F. A. Wilson

As a definitive introduction to the subject this book is presented on two levels. For the absolute beginner or anyone thinking about purchasing or hiring a satellite TV system, the story is told as simply as such a complex one can be in the main text.

For the professional engineer, electronics enthusiast, student or others with technical backgrounds, there are numerous appendices backing up the main text with additional technical and scientific detail formulae, calculations, tables etc. There is also plenty for the DIY enthusiast with practical advice on choosing and installing the most problematic part of the system - the dish antenna.

104 pages **Order code BP115** £5.95

## AN INTRODUCTION TO AMATEUR COMMUNICATIONS SATELLITES

A. Pickford

Communications and broadcast satellites are normally inaccessible to individuals unless they are actively involved in their technicalities by working for organisations such as British Telecom, the various space agencies or military bodies, even those who possess a satellite television receiver system do not participate in the technical aspects of these highly technological systems.

There are a large number of amateur communications satellites in orbit around the world, traversing the globe continuously and they can be tracked and their signals received with relatively inexpensive equipment. This equipment can be connected to a home computer such as the BBC Micro or IBM compatible PCs, for the decoding of received signals.

This book describes several currently available systems, their connection to an appropriate computer and how they can be operated with suitable software.

102 pages **Order code BP270** £3.95

## AERIAL PROJECTS

R. A. Penfold

The subject of aerials is vast but in this book the author has considered practical aerial designs, including active, loop and ferrite aerials which give good performances and are relatively simple and inexpensive to build. The complex theory and mathematics of aerial design have been avoided.

Also included are constructional details of a number of aerial accessories including a pre-selector, attenuator, filters and tuning unit.

96 pages **Order code BP105** £2.50

## INTERNATIONAL RADIO STATIONS GUIDE

P. Shore

Provides the casual listener, amateur radio DXer and the professional radio monitor with an essential reference work designed to guide him or her around the ever more complex radio bands. This new edition has been completely revised and rewritten and incorporates much more information which is divided into the following sections:

Listening to Short Wave Radio; Choosing a Short Wave Radio Receiver; How to Use the IRSG; Abbreviations; Country Codes; Worldwide Short Wave Radio Stations; European, Middle Eastern and African Long Wave Radio Stations; European, Near and Middle Eastern and African Medium Wave Radio Stations; Canadian Medium Wave Radio Stations; USA Medium Wave Radio Stations; Broadcasts in English; Programmes for DXers and Short Wave Listeners; UK FM Radio Stations; Time Differences From GMT; Wavelength/Frequency Conversion.

226 pages **Order code BP255** £5.95

1991-1992

# HENRY'S

## ALL NEW COLOUR CATALOGUE

PLUS Test Instruments, Security, and Component Supplement

WITH **£90.00** WORTH OF PURCHASE VOUCHERS FREE and £2.00 OFF first purchase

To obtain Henry's new catalogue send envelope, minimum size C4 (12 1/2" x 9"), self addressed with £2.65 stamps affixed OR send £4 ch/po with request for catalogue, (Export £6) to the address below. Also available for callers. Trade/Industry/Education. Attach notepaper request for FREE catalogue with trade price lists.



AROUND 350 PAGES COVERING

- Components
- Fans ■ Relays
- Public address
- Security ■ CCTV
- Test instruments
- Speakers ■ Disco
- Power supplies
- In car ■ Cables
- Inter comms
- CB ■ Tools etc.
- Accessories for TV-Video
- Telephones, Computer, Audio etc.

**HENRY'S** OPEN 6 DAYS A WEEK  
404 EDGWARE ROAD, LONDON, W2 1ED  
Sales: 071-258 1831 Fax: 071-724 0322  
**Audio and Electronics Specialists**

## TK FOR KITS

### DISCO SEQUENCER

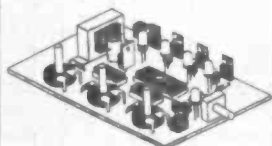

Four channels (up to 1kW each) to drive Rope lights, Pin-spots etc. (Resistive/Inductive loads) with 30 different eye-catching sequences. Variable speed and sequence change frequency AND built in audio input. Ideal for mobile or permanent displays. Complete KIT (less box)

**XK141 26.95**

Don't forget our other value for money DISCO KITS

DL8000	8-channel 80 programme sequencer	46.95
DL3000	3-channel sound to light	21.95
XK124	High power strobe with audio input	17.95
XK139	4-channel sequencer	14.50

### SINGLE CHANNEL INFRA RED REMOTE CONTROL

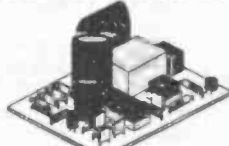

A simple yet highly versatile Infra Red remote control kit with a multitude of uses in the home or car. Operates from 9-15V dc or 240V ac and switches a 3A relay on and off alternately each time the transmitter is operated at ranges up to 20ft (6m). Responds only to the transmitter frequency. Great for lights, TV, alarm controls etc.

**XK134 11.95**  
Suitable transmitter complete with box (9V PP3 battery required)

**XK135 5.95**

For more channels use our popular MK12/MK18 IR transmitter receivers

MK9	4-way keyboard	3.35
MK10	16-way keyboard	9.75
MK12	16 Channel Receiver	21.95
MK18	IR Transmitter	9.75

SEND 9x6 SAE for our latest KIT LIST which includes details on more exciting kits such as Programmable Lock, Voice Record/Playback, Touch Dimmers, Temperature Controller, etc.

### SUPERSENSITIVE MICROBUG



Only 45x25x15mm, including built-in mic. 88-100MHz (standard FM radio). Range approx. 300m depending on terrain. Powered by 9V PP3 (7mA). Ideal for surveillance, baby alarm etc. **XK128 7.25**

ORDERING INFORMATION. Prices INCLUDE VAT but please add 1.25 P&P (UK). Overseas Customers: divide total order by 1.175 then add P&P. Europe 3.50, elsewhere 10. Send PO/cheque/VISA/MASTERCARD No. with order. GIRO NO. 529314002. Local Authority and education orders welcome. Office Hours: Mon-Fri. 9.30 am - 5 pm. Shop Hours: Tues - Thurs. 10 am - 5 pm Sat. 10 am - 1 pm.

ORDERS: 081-567 8910 24 HOURS

**TK ELECTRONICS** 13 BOSTON ROAD, LONDON, W7 3JL



Whether your requirement for surveillance equipment is amateur, professional or you are just fascinated by this unique area of electronics SUMA DESIGNS has a kit to fit the bill. We have been designing electronic surveillance equipment for over 12 years and you can be sure that all of our kits are very well tried, tested and proven and come complete with full instructions, circuit diagrams, assembly details and all high quality components including fibreglass PCB. Unless otherwise stated all transmitters are tuneable and can be received on an ordinary VHF FM radio.

**UTX Ultra-miniature room transmitter.** Smallest room transmitter kit in the world! Incredible 10mm x 20mm including mic. 3-12V operation. 500m range. **£16.45**

**MTX Micro-miniature room transmitter.** Best selling micro-miniature room transmitter. Just 17mm x 17mm including mic. 3-12V operation. 1000m range. **£13.45**

**STX High-performance room transmitter.** High performance transmitter with a buffered output stage for greater stability and range. Measures 22mm x 22mm including mic. 6-12V operation. 1500m range. **£15.45**

**VT500 High-power room transmitter.** Powerful 250mW output providing excellent range and performance. Size 20mm x 40mm. 9-12V operation. Range 3000m. **£16.45**

**VXT Voice activated room transmitter.** Triggers only when sounds are detected. Very low standby current, variable sensitivity and delay with l.e.d. indicator. Size 20mm x 67mm. 9V operation. 1000m range. **£19.45**

**QTX180 Crystal controlled room transmitter.** Narrow band FM transmitter for the ultimate in privacy. Operates on 180MHz and requires the use of a scanner receiver or our QRX180 kit (see catalogue). Size 20mm x 67mm. 9V operation. 1000m range. **£40.95**

**SCRX Subcarrier scrambled room transmitter.** Scrambled output from this transmitter cannot be monitored without the SCDM decoder connected to receiver. Size 20mm x 67mm. 9V operation. 1000m range. **£22.95**

**SCDM Subcarrier decoder unit for SCRX.** Connects to receiver earphone socket and provides decoded audio output to headphones. Size 32mm x 70mm. 9-12V operation. **£22.95**

**HVX400 Mains powered room transmitter.** Connects directly to 240V a.c. supply for long term monitoring. Size 30mm x 35mm. 500m range. **£19.45**

**ATR2 Micro size telephone recording interface.** Connects between telephone line (anywhere) and cassette recorder. Switches tape automatically as phone is used. All conversations recorded. Size 16mm x 32mm. Powered from line. **£13.45**

**UTLX Ultra-miniature telephone transmitter.** Smallest telephone transmitter kit available. Incredible size of 10mm x 20mm. Connects to line (anywhere) and switches on and off with phone use. All conversations transmitted. Powered from line. 500m range. **£15.95**

**TLX700 Micro-miniature telephone transmitter.** Best selling telephone transmitter. Being 20mm x 20mm it is easier to assemble than UTLX. Connects to line (anywhere) and switches on and off with phone use. All conversations transmitted. Powered from line. 1000m range. **£13.45**

**STLX High-performance telephone transmitter.** High power telephone transmitter with buffered output stage providing excellent stability and performance. Connects to line (anywhere) and switches automatically with phone use. All conversations transmitted. Powered from line. Size 22mm x 22m. 1500m range. **£16.45**

**TKX900 Signalling/tracking transmitter.** Transmits a continuous stream of audio pulses with variable tone and rate. Ideal for signalling or tracking purposes. High power output gives range up to 3000m. Size 25mm x 63mm. 9V operation. **£22.95**

**CD600 Professional bug detector/locator.** Multicolour bargraph readout of signal strength with variable rate bleeper and variable sensitivity used to detect and locate hidden transmitters. Switch to AUDIO CONFIRM mode to distinguish between localised bug transmission and normal legitimate signals such as pagers, cellular, taxis etc. Size 70mm x 100mm. 9V operation. **£50.95**

### ★★★ SPECIAL ★★★

**DLTX/LRX Radio control switch.** Remote control anything around your home or garden, outside lights, alarms, paging systems etc. System consists of a small VHF transmitter with digital encoder and receiver unit with decoder and relay output. momentary or alternate. 8way d.i.l. switches on both boards set your unique security code. TX size 45mm x 45mm, RX size 35mm x 90mm. Both 9V operation. Range up to 200m. Complete system (2 kits) **£50.95**  
Individual transmitter DLTX **£19.95**  
Individual receiver LDRX **£37.95**

A build-up service is available on all of our kits if required. UK customers please send cheques. PO's or registered cash. Please add £1.50 per order for P&P. Goods despatched ASAP allowing for cheque clearance. Overseas customers send sterling bank draft and add £5.00 per order for shipment. Credit card orders welcome on 0827 714476.

OUR LATEST CATALOGUE CONTAINING MANY MORE NEW SURVEILLANCE KITS NOW AVAILABLE. SEND TWO FIRST CLASS STAMPS OR OVERSEAS SEND TWO IRC'S.

**SUMA DESIGNS**  
THE WORKSHOPS  
95 MAIN ROAD  
BAXTERLEY, Nr ATHERSTONE  
WARWICKSHIRE CV9 2LE

0827  
714476



# PCB SERVICE

Printed circuit boards for certain constructional projects are available from the PCB Service, see list. These are fabricated in glass fibre, and are fully drilled and roller tinned. All prices include VAT and postage and packing. Add £1 per board for airmail outside of Europe. Remittances should be sent to **The PCB Service, Everyday Electronics, 6 Church Street, Wimborne, Dorset BH21 1JH.** Cheques should be crossed and made payable to **Everyday Electronics (Payment in £ sterling only).**

*We do have some older boards in stock - please enquire.*

**NOTE:** While 95% of our boards are now held in stock and are dispatched within seven days of receipt of order, please allow a maximum of 28 days for delivery - overseas readers allow extra if ordered by surface mail. Please check price and availability in the latest issue. Boards can only be supplied on a payment with order basis.

PROJECT TITLE	Order Code	Cost
Downbeat Metronome Phasor	DEC '88 629	£4.84
	631	£5.64
Continuity Tester	FEB '89 619	£2.67
Sound-to-Light Interface	MAR '89 637	£6.24
Midi Pedal	639	£7.00
Midi Merge	640	£3.00
Audio Lead Tester	641	£5.77
Light Sentinel - Main Board	APR '89 632	£9.20
Remote Interface (4 boards)	633	£4.59
4-Channel Auto-Fade Interface	642	£6.80
Electron A/D Interface	MAY '89 645	£4.84
Spectrum EPROM Programmer	JUN '89 628	£7.87
Bat Detector	647	£4.95
Programmable Pocket Timer	JUL '89 648	£3.82
Electronic Spirit Level	AUG '89 649	£3.85
Distance Recorder	651	£5.23
Xenon Beacon	SEP '89 650	£4.13
Power Supplies - Fixed Voltage	654	£4.08
Variable Voltage	655	£4.48
Music on Hold	OCT '89 646	£3.85
Power Supplies - 25V 700mA	656	£4.35
30V 1A	657	£4.55
EE Seismograph - Control	658	£4.08
Detector	659	£4.22
Logo/Logo & Spectrum	660	£6.49
Wash Pro	NOV '89 643	£3.83
Biofeedback Monitor - Front End	661	£4.52
Processor	662	£4.56
Logo/Logo & Spectrum Interface	664	£5.60
EEG Electrode Impedance Meter	DEC '89 665	£3.98
Biofeedback Signal Generator	JAN '90 666	£4.08
Quick Cap Tester	FEB '90 668	£3.92
Weather Station		
Anemometer - Freq./Volt Board	670	£3.94
Optional Display	669	£3.73
Wind Direction	673/674	£4.22
System Power Supply	675	£3.59
Prophet In-Car Ioniser	676	£3.18
EE Weather Station	MAR '90	
Display Driver	672 & 678	£4.22
Display and Sensor	671	£4.47
Fermostat Mk2	677	£4.28
Superhet Broadcast Receiver-Tuner/Amp	679/680	£4.22
Stereo Noise Generator	APR '90 681	£4.24
Digital Experimenter's Unit - Pulse Generator	682	£4.46
Power Supply	683	£3.66
Enlarger Timer	684	£4.28
EE Weather Station		
Rainfall/Sunlight Display	685	£4.27
Rainfall Sen and Sunlight Sen	686/687	£4.16
Amstrad Speech Synthesiser	MAY '90 689	£4.68
80 Metre Direct Conversion Radio	JUN '90 691	£4.95
Mains Appliance Remote Control		
Infra-Red Transmitter	692/693	£4.75
Mains Appliance Remote Control	JUL '90	
Encoder Board A	694	£6.61
Encoder Board B	695	£4.78
The Tester	696	£4.15
Mains Appliance Remote Control	AUG '90	
Mains ON/OFF Decoder	697	£4.55
(5 or more 697's ordered together £3.25 each)		
Simple Metronome	698	£3.94
Hand Tally	SEP '90	
Main Board (double-sided) and Display Board	699, 700	£10.95
Alarm Bell Time-Out	701	£4.10
Mains Appliance Remote Control		
Temperature Controller (p.c.b. only)	702	£5.20

PROJECT TITLE	Order Code	Cost
Ghost Waker	OCT '90 703	£4.32
Frequency Meter	704	£5.25
Freq. Meter/Tachometer	NOV '90 705	£3.98
EE Musketeer (TV/Video/Audio)	706	£5.78
Colour Changing Christmas Lights	DEC '90 707	£4.39
Microcontroller Light Sequencer	708/709	£10.90
Versatile Bench Power Supply Unit	710	£4.24
Teach-In '91, Part 1 - L200 Module	711	£3.93
Dual Output Module	712	£4.13
LM723 Module	713	£4.21
Spatial Power Display	JAN '91 714	£5.33
Amstrad PCW Sound Generator	715	£5.03
Teach-In '91, Part 2 - G.P. Transistor Amp	717	£3.77
Dual Op.Amp Module	718	£3.83
Intercom (Teach-In '91 Project 2)	719	£4.41
Analogic Test Probe	720	£3.24
MARC Phone-In	FEB '91 721	£6.87
Teach-In '91 Part 3 - TBA820M Amplifier	723	£4.05
High Quality Power Amp	724	£4.93
Bench Amplifier (Teach-In '91 Project 3)	725	£4.45
Gingernut 80m Receiver		
R.F. section (726), Voltage Regulator (727)	726/7/8	£3.06
Audio Amplifier (728)		per board
	all 3 together	£8.16
Pocket Tone Dialler	MAR '91 729	£4.36
Battery To Mains Inverter	730	£4.97
Simple Basic Alarm	731	£4.50
Car Code Lock (pair)	732a/b	£4.69
Teach-In '91 Part 4 - Sinusoidal Oscillator	733	£4.39
8038 Oscillator	734	£4.15
Waveform Generator (Teach-In '91 Project 4)	735	£4.72
Humidity Tester	APR '91 716	£4.97
Model Train Controller (double-sided)	736	£9.75
Electronic Die (Teach-In '91 Project 5)	737	£4.93
Teach-In '91 Part 5 - Digital Counter Module	738	£4.35
Modular Disco Lighting System	MAY '91	
Switched Power Output Module	739	£5.91
Digital LCD Thermostat-Control Board	740	£4.05
-Power/Relay Board	£5 for pair 741	£3.76
Pulse Generator (Teach-In '91 Project 6)	742	£4.97
Teach-In '91 Part 6 - Timer Module	743	£4.62
Digilogue Car Tachometer	JUN '91 744	£5.63
Modular Disco Lights - Simple Chaser	745	£5.00
Sweeper Module	746	£5.17
Automatic Light Control - PSU Board	747	£4.88
Logic Board	748	£5.17
Radio Receiver (Teach-In '91 Project 7)	749	£4.57
Teach-In '91 Part 7 - R.F. Amplifier Module	750	£4.23
Modular Disco Lights - Masterlink	JULY '91 752	£6.36
Ultrasonic Proximity Meter		
Display Unit (753) & Sensor Unit (754)	753/754	£7.06
Disco Lights (Teach-In '91 Project 8)		
PSU and Pre-amplifier	755	£4.54
Low, Mid, High Filter/Triac (set of 3 boards)	756	£11.00
Teach-In '91 Part 8 - Solid State Switch Module	757	£4.24
Mod. Disco Lights - Pattern Gen	AUG '91 760	£6.79
Teach-In '91 Part 8 - Light Sensitive Switch	761	£4.74
Opto-Link (Teach-In '91 Project 9) - Transmitter	762	£4.85
Receiver	763	£4.88
764	£3.77	
Portable PEsT Scarer		
Capacitance Meter	SEP '91 751	£5.17
Modular Disco Lights - Dimmer Interface	765	£8.17
Mod. Disco Lights	OCT '91	
VU Sound Module (Double-sided)	767	£8.68
UV Exposure Unit	768	£4.63
PC-Scope Interface - Main Board	769	£6.95
Expansion Plug (Double-sided)	770	£5.96

## EE PRINTED CIRCUIT BOARD SERVICE

Order Code Project Quantity Price

Name.....

Address.....

I enclose payment of £..... (cheque/PO in £ sterling only payable to Everyday Electronics) Access (MasterCard) or Visa No.

Minimum order for credit cards £5

Signature..... Card Ex. Date.....  
Please supply name and address of card-holder if different from the address shown

BLOCK CAPITALS PLEASE



# Finally... an exceptional PCB and Schematic CAD system for every electronics engineer!

**B**oardMaker 1 is a powerful software tool which provides a convenient and professional method of drawing your schematics and designing your printed circuit boards, in one remarkably easy to use package. Engineers worldwide have discovered that it provides an unparalleled price performance advantage over other PC-based systems.

BoardMaker 1 is exceptionally easy to use - its sensible user Interface allows you to use the cursor keys, mouse or direct keyboard commands to start designing a PCB or schematic within about half an hour of opening the box.

## HIGHLIGHTS

### Hardware:

- IBM PC, XT, AT or 100% compatible.
- MSDOS 3.x.
- 640K bytes system memory.
- HGA, CGA, MCGA, EGA or VGA display.
- Microsoft or compatible mouse recommended.

### Capabilities :

- Integrated PCB and schematic editor.
- 8 tracking layers, 2 silk screen layers.
- Maximum board or schematic size - 17 x 17 inches.
- 2000 components per layout. Symbols can be moved, rotated, repeated and mirrored.
- User definable symbol and macro library facilities including a symbol library editor.
- Graphical library browse facility.
- Design rule checking (DRC)- checks the clearances between items on the board.
- Real-time DRC display - when placing tracks you can see a continuous graphical display of the design rules set.
- Placement grid - Separate visible and snap grid - 7 placement grids in the range 2 thou to 0.1 inch.
- Auto via - vias are automatically placed when you switch layers - layer pairs can be assigned by the user.
- Blocks - groups of tracks, pads, symbols and text can be block manipulated using repeat, move, rotate and mirroring commands. Connectivity can be maintained if required.
- SMD - full surface mount components and facilities are catered for, including the use of the same SMD library symbols on both sides of the board.
- Circles - Arcs and circles up to the maximum board size can be drawn. These can be used to generate rounded track corners.
- Ground plane support - areas of copper can be filled to provide a ground plane or large copper area. This will automatically flow around any existing tracks and pads respecting design rules.

### Output drivers :

- Dot matrix printer
- Compensated HP laser printer
- PostScript output.
- Penplotter driver (HPGL or DMPL).
- Photoplot (Gerber) output.
- NC (ASCII Excellon) drill output.

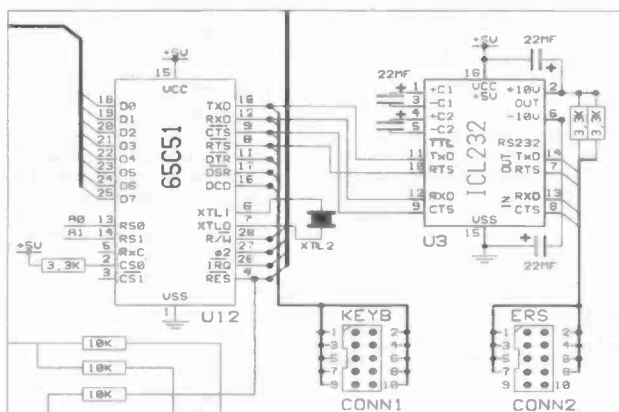

Produce clear, professional schematics for inclusion in your technical documentation.

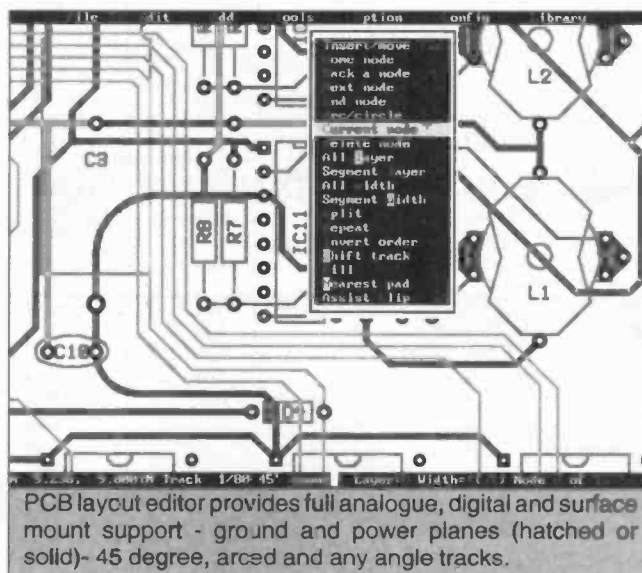

PCB layout editor provides full analogue, digital and surface mount support - ground and power planes (hatched or solid)- 45 degree, arced and any angle tracks.

**£95**

Despite its quality and performance, BoardMaker 1 only costs £95.00. Combine this with the 100% buy back discount if you upgrade to BoardMaker 2 or BoardRouter and your investment in Tsien products is assured. Price excludes carriage and VAT.

**Don't take our word for it. Call us today for a FREE demonstration disk and judge for yourself.**



**Tsien (UK) Limited**  
 Cambridge Research Laboratories  
 181A Huntingdon Road  
 Cambridge CB3 0DJ  
 Tel 0223 277777  
 Fax 0223 277747

All trade marks acknowledged

## VARIABLE VOLTAGE TRANSFORMERS

INPUT 220/240V AC 50/60  
OUTPUT 0-260V

	P&P
0.5KVA 2.5 amp max	£29.00 £3.76 (£38.48 inc VAT)
1KVA 5 amp max	£37.40 £4.26 (£48.94 inc VAT)
2KVA 10 amp max	£54.00 £5.48 (£69.89 inc VAT)
3KVA 15 amp max	£71.50 £6.24 (£91.34 inc VAT)
5KVA 25 amp max	£128.50 (Carriage on request)

Buy direct from the Importers. Keenest prices in the country

### COMPREHENSIVE RANGE OF TRANSFORMERS-LT-ISOLATION & AUTO

(110-240V Auto transfer either case with American socket and mains lead or open frame type. Available for immediate delivery

### ULTRA VIOLET BLACK LIGHT

	P&P
4ft 40 watt £10.44 (carriage only)	(£12.27 inc VAT)
2ft 20 watt £7.44 + £1.25 p&p	(£10.21 inc VAT)
13in 10 watt £5.80 + 75p p&p	(£7.70 inc VAT)
12in 8 watt £4.80 + 75p p&p	(£6.52 inc VAT)
5in 6 watt £3.96 + 50p p&p	(£5.24 inc VAT)
6in 4 watt £3.96 + 50p p&p	(£5.24 inc VAT)

For either 6in, 9in or 12in tubes £5.50 + 55p p&p  
For 13in tubes £6.00 + 75p p&p

### 230V AC BALLAST KIT

For either 6in, 9in or 12in tubes £5.50 + 55p p&p  
For 13in tubes £6.00 + 75p p&p

### 400 WATT UV LAMP

Only £34.00 + £2.50 p&p £42.89 inc VAT

### 175 WATT SELF BALLASTED BLACK LIGHT MERCURY BULBS

Available with BC or ES fitting. Price inc VAT & p&p £20.27

### 12 VOLT BILGE PUMPS

Buy direct from the importers

500 GPH 15ft head 3 amp £16.36

1750 GPH 15ft head 9 amp £26.65

PRICES INCLUDE P&P & VAT

### EPROM ERASURE KIT

Build your own EPROM ERASURE for a fraction of the price of a made-up unit. Kit of parts less case includes 12in 8 watt 2537 Angstrom Tube Ballast unit, pair of 6pin leads, neon indicator, on/off switch, safety microswitch and circuit £14.00 + £2.00 p&p (£18.80 inc VAT)

### SUPER HY-LIGHT STROBE KIT

Designed for Disco, Theatrical use etc.

Approx 16 joules. Adjustable speed £48.00 + £2.00 p&p (£58.75 inc VAT)

Case and reflector £22.00 + £2.00 p&p (£28.20 inc VAT)

SAE for further details including Hy-Light and industrial Strobe Kits

## SERVICE TRADING CO

57 BRIDGMAN ROAD, CHISWICK, LONDON W4 5BB

081-995 1560

ACCOUNT CUSTOMERS MIN. ORDER £10

Showroom open Monday/Friday

## "BOFFINS SPECIAL" - UNIQUE OFFER

Surplus Precision Medical Unit, internally in excellent condition. Designed primarily to inject a precise controllable amount of fluid from a medical syringe (latter not supplied). Contains overall silicone rubberable components. Dual Micro Processor Boards and EPROMS. Escap Precision 12V DC Motor with 300:1 Gear Box and optical encoder coupled to a precision threaded drive mechanism. Mains supply with 12 x 1.5V Ni-Cad A.A. cells back up. L.C.D. Digital read-out 17mm high with legends. Audible warning.

These are sold for the dismantling of the exceptional quality components. Register no Cicuits available. Ridiculously low price: £16.00 + £4.00 p&p (£23.50 incl VAT).

### WIDE RANGE OF XENON FLASHTUBES

#### GIANT BLOWER EXTRACTOR UNIT

Twin output centrifugal blower 1 HP, 240V AC motor, output approx 3800 c.f.m. Size: Length 100cm, height 27cm, Depth 28cm. Fixing plate 106 x 33cm. Price £125 + VAT. Ex-warehouse.

#### TORIN CENTRIFUGAL BLOWER

230V AC, 2.800 RPM, 0.9 amp, 130mm diameter, impeller outlet 63 x 37mm, 30 sec to continuous use, 150mm long. Price £17.50 + £2.50 p&p (£23.50 inc VAT)

#### SHADED POLE GEAR MOTORS

In the following sizes: 9RPM, 12 RPM, 80 RPM, 160 RPM, 110V AC or 240V AC with capacitors (supplied). Price inc VAT & p&p £14.96

#### GEARED MOTORS

71 RPM 20lb inch torque reversible 115V AC input including capacitor and transformer for 240V AC operation. Price inc VAT & p&p £23.50.

#### SOLID STATE EHT UNIT

Input 230/240V AC. Output approx 15KV. Producing 1.0mm spark. Built-in 10 sec timer. Easily modified for 20 sec, 30 sec to continuous use. Designed for boiler ignition. Dozens of uses in the field of physics and electronics, eg supplying neon or argon tubes etc. Price less case £8.50 + £1.00 p&p (£11.16 inc VAT) NMS

#### HEAVY DUTY MOTOR

Crouzet 115V/230V AC heavy duty 1RPM motor. Anticlockwise type 82/015. Size 68mm, diameter x 55mm long. Shaft 6mm diameter x 20mm long. Price inc VAT & p&p £18.96

#### RHEOSTAT

50W 2 ohm 5W ceramic power rheostat. Price inc VAT & p&p £10.61

#### MICROSWITCH

Pye 15 amp changeover lever microswitch, type S171. Brand new. Price 5 for £7.05 inc VAT & p&p

NMS = NEW MANUF SURPLUS

R&T = RECONDITIONED AND TESTED

## MISCELLANEOUS ITEMS

Camera returns: 35mm Auto	
Flash/ Wind-on, minor faults - easily repairable.....	£6.00 ea or 2 for.....£10.00
Dictaphone cassette, mech/record erase playback heads, 6V solenoid, motor, hall effect switch.....	£2.00 ea*
T.V./Printer stands.....	£3.95 ea
Kic-Verro Easiwire construction bit.....	£4.95 ea
TTL/CMOS short circuit snopper.....	£4.95*
Dot matrix LCD 10x2 lines.....	£3.75 ea*
Dot matrix LCD 16 x 1 lines with data.....	£4.95*
2 digit 16 segment VF display with data.....	£2.95 ea*
4 digit intelligent dot matrix display.....	£6.00*
17 segment V.F. display with driver board and data.....	£2.99 ea*
8 digit liquid crystal display.....	£1.75 ea*
4 digit LCD with 7211 driver chip.....	£3.50 ea*
Digital clock display.....	£2.50*
11 key membrane keypad.....	£1.50 ea*
Keyboard 392mm x 180mm/100 keys on board + LCD + 74HC05/80C49 easily removable.....	£4.95
C.B. aerial eliminators.....	£2.95 ea*
19" 3U sub rack enclosures.....	£8.95
12V stepper motor, 48 steps per rev, 7.3° step angle.....	£3.95 ea*
Stepper motor board with 2 slotted opto + 2 mercury tilt switches.....	£3.95 ea*
1000 mixed 1/4 watt 1% resistors.....	£4.95 ea
250 electrolytic axial + radial caps.....	£4.95 ea
250 mixed resistor networks.....	£4.95 ea
240V 90mm square fans.....	£3.95 ea*
115V 4 inch square fans.....	£3.95 ea*
12V 60mm square fans.....	£3.95 ea*
Solar cell modules 0.45V 700mA.....	£2.95 ea*
B.B.C. Micro to disc drive lead.....	£1.50*
Car Burglar alarm vibration auto entry/exit delay.....	£5.95 ea*
Single zone alarm panel auto entry/exit delay housed in domestic light socket.....	£9.95 ea*

## P.S.U.'s, TRANSFORMERS, COMPONENTS

P.C. P.S.U. 50 watt 115-230V input + 5V 4A + 12V 2.5A output with built in fan, IEC inlet + on off.....	£9.95 ea
ASTEC 60 Watt 115/230V input/outputs + 5V 3.75A + 12V 1.5A - 12V 0.75A case IEC inlet/on/off switch.....	£12.95
STC P.S.U. 240V input 5V 6A output (converts to 12V 3A details available).....	£5.95 ea
240V input 5V 10A output (converts to 12V 5A no details).....	£5.95 ea
600W line output transformers.....	£1.25 ea
240V in 0-12V 0.75A out transformer.....	£1.75*
240V in 0-28V 62VA out transformer.....	£2.75
Transformer + PCB gives 2x7.5V 32VA with skt for 5 or 12V regulator, will power floppy drive.....	£3.75 ea
Ultrasonic transducers (transmit + receive).....	£1.50 pair
3 to 16V Piezoelectric sounders.....	50p*
9VDC electro-mechanical sounder.....	50p*
24V DC electro-mechanical sounder.....	50p*
2A 250V keyswitch 3 position key removable in two positions.....	£1.50*
DIL switches PCB MT 3/4/6 way.....	35p*
5V SPCO SIL reed relay.....	40p*
5V 2PCO DIL miniature relay.....	60p*
12V 2PCO or 4PCO continental relay.....	60p*
12V 10A PCB MT (to make contact).....	95p*
100 uA panel meter.....	£1.00 ea
3 to 12V electro magnetic acoustic transducer with data.....	75p*
2.4576/8.8329/21.10 MHz crystals.....	50p ea
Bridges 25A 200V.....	£1.00
2A 100V.....	50p*

### QUANTITY DISCOUNTS AVAILABLE PLEASE RING

ALL PRICES INCLUDE V.A.T PLEASE ADD £2.00 p&p EXCEPT ITEMS

MARKED \* WHICH ARE 50P

SAE FOR BULK BUYING LIST

TRADE ONLY

PAYMENT WITH ORDER TO

Dept EE, COMPELEC,

11 Windsor Close,

St. Ives, Huntingdon,

Cambs PE17 6DW

Tel/Fax: 0480 300819

## WE HAVE THE WIDEST CHOICE OF USED OSCILLOSCOPES IN THE COUNTRY

TEKTRONIX 2445 Four Trace 150MHz Dual TB	£1200
TEKTRONIX 485 Dual Trace 350MHz	£1000
TEKTRONIX 2225 Dual Trace 50MHz Delay Sweep	£350
TEKTRONIX 2215 Dual Trace 60MHz Delay Sweep	£450
TEKTRONIX 475 Dual Trace 200MHz Delay Sweep	£350
TEKTRONIX 465 Dual Trace 100MHz Delay Sweep	£450
SCHLUMBERGER/ENERTEC 5218 Three Trace 200MHz Delay Sweep	£350
PHILIPS PM3717 Dual Trace 50MHz Delay Sweep	£250
HITACHI V650R Dual Trace 60MHz Delay Sweep	£480
HITACHI V352F Dual Trace 35MHz	£250
HITACHI V212 Dual Trace 20MHz	£260
LEADER 1020 Dual Trace 20MHz	£275
TRO CS1022 Dual Trace 20MHz	£180
COULD 051100 Dual Trace 50MHz TV Tr	£180
TELEQUIPMENT D66 Dual Trace 25MHz	£150
SCOPLEX 14015 Dual Trace 15MHz	£150
COULD 1425 Digital Storage Dual Trace 20MHz with Cursor	£150

COULD OS500 - 20MHz DUAL TRACE 2mV/cm. SMALL LIGHTWEIGHT. UN-USED. BOXED WITH 2 PROBES ONLY IN £250. Used with copy of manual £200

THIS IS JUST A SAMPLE - MANY OTHERS AVAILABLE

RACAL/DANA Wideband Level Meter 5002	£1000
RACAL/DANA LAIIR LCR Databridge 9541	£300
WAYNE KERR LCR Meter 4210	£550
WAYNE KERR Automatic Component Bridge 8605	£450
WAYNE KERR Universal Imp Bridge 9502	£150
WAYNE KERR Component Tester B424	£125
FARNELL Synthesized Oscillator DSG1 - 0.0001Hz - 99.99kHz	£275
FARNELL Automatic Mod Meter AM1	£250
MARCONI TF2098 AM/FM 10kHz-510MHz Sig Gen	£300
MARCONI TF2015 AM/FM 10-520MHz Sig Gen with TF2171	£400
MARCONI TF2015 without Synchroniser TF2171	£250
MARCONI TF2016 AM/FM 10kHz-120MHz Sig Gen with TF2173	£350
MARCONI TF2016 without Synchroniser TF2173	£175
MARCONI TF2356/2357 Level Osc/Meter 20MHz - the pair	£950
HP 8620C Sweeper/Multiframer 10-150MHz	£300
MARCONI 5009 Mod/Meter 10MHz-150kHz	£350

MARCONI SANDERS Signal Sources	From	£300
6070A 400-1200 MHz	6056 2-40GHz	
6055/6055B 950-2150MHz	6057 45-85 GHz	

TEKTRONIX 491 Spec Trm Analyser 1.5-12.4GHz	£750
HP 141T Spectrum Analyser System with B555A & IF Plug-in 10MHz-18GHz	£3250
HP 140 Spectrum Analyser System with B554 & IF Plug-in 500kHz-1250MHz	£1750
HP 140 Spectrum Analyser System with B553 & IF Plug-in 1kHz-110MHz	£1400
HP Spectrum Analyser 182 with B558B 0.1-1500MHz	from £2250

Used Equipment - With 30 days guarantee. Manuals supplied if possible.

This is a VERY SMALL SAMPLE OF STOCK. SAE or telephone for lists. Please check availability before ordering. CARRIAGE all units £18. VAT to be added to total of goods and carriage.

## STEWART OF READING

110 WYKHAM ROAD, READING, BERKS RG6 1PL

Tel: 0734 268041 Fax: 0734 351696

Callers welcome 9am to 5.30pm MON-FRI (UNTIL 8pm THURS)

BRUEL & KJÆER SOUND LEVEL METER 2206 - 1/3 MIC WITH CARRYING CASE £160 each OTHER B&K EQUIPMENT AVAILABLE

DERRTRON TA120 with VPS Vibrator	£1500
Uninterruptable PSU Un used from AVO RMZ15L2 AC/DC Breakdown Tester	£250
TEKTRONIX Waveform Monitor type 528	£600
RACAL INSTRUMENTATION RECORDERS Store 4D and Store 7D	from £750
KEITHLEY 224 Programmable Current Source	£1000
FERROGRAPH RTS Recorder Test Set	from £1500
THORBY PSU PL30M40 50V 2A Quad Mod Digital	£200
7000P BEHN PDA 0.40V-0.50A Metered	£300
FARNELL PSU H30 1000 0.30V 0.100A	£750
FARNELL PSU H30 25 0.25V 0.25A	£600
TELEQUIPMENT C71 Curve Tracer	£250
MARCONI TF2700 Universal Recorder Battery	from £175
MARCONI TF2357A Automatic Distortion Meter 400Hz/1kHz	£100
MARCONI MOD Meters TF2300, TF2308, TF2303	£175
RACAL 9915 Freq Counter 10-520MHz Crystal Oven	from £1000
MANNESMANN TALLY Ply 3 X Ply Tester R5252	£350

AVO MULTIMETERS TEST SET Not. 8X 95x £65 each 8 Mk5 with Carrying Case £90 8 Mk6 with Carrying Cast £120 ALL METERS SUPPLIED WITH BATTERIES AND LEADS

PHILIPS PM6622 Universal Timer/Counter, 80kHz 9 Digit	£150
FEEDBACK SF606 Sweep Func. Gen. Sine/Sq/Tri 0.1Hz-1MHz	£150
FEEDBACK F600 Func. Gen. Sine/Sq/Tri 0.1Hz-100kHz	£45
AVO VALVE CHARACTERISTIC METER MV. 1	£70
LEADER LM1968 Two Ch Op Ampmeter 500-5000Hz 1mV-300V	£180
IKUSUJI AN/23 AC Voltmeter Dual Ch 10Hz-500kHz 500uV-100V	£75
SOLARTRON 7045 Multimeter 4 1/2 Digit 50 Ranges Auto Man	£95
Large Range of BENCH POWER SUPPLIES available	from £40
X-Y PLOTTERS various models	from £25-£400

### NEW EQUIPMENT

HAMEG OSCILLOSCOPE HM1005 Triple Trace 100MHz Delay Timebase	£792
HAMEG OSCILLOSCOPE HM604 Dual Trace 60MHz Delay Sweep	£510
HAMEG OSCILLOSCOPE HM203-7 Dual Trace 20MHz Component Tester	£630
HAMEG OSCILLOSCOPE HM205-3 Dual Trace 20MHz Digital Storage	£610

All other models available - all oscilloscopes supplied with 2 probes

BLACK STAR EQUIPMENT IP&P all units £51

APPOLLO 10-100MHz Counter/Timer Ratio/Period/Time Interval etc

APPOLLO 100-100MHz (as above with more functions)

METECOR 100 FREQUENCY COUNTER 100MHz

METECOR 600 FREQUENCY COUNTER 600kHz

METECOR 1000 FREQUENCY COUNTER 1kHz

JUPITOR 500 FUNCTION GEN. 0.1Hz-500kHz Sine/Sq/Tri

ORON COLOUR BAR GENERATOR Pal/TV/Video

All other Black Star equipment available

OSCILLOSCOPE PROBES Switched X1 X10 P&P £31

Carbon Film resistors 1/4W 5% E24 series 0.51 R to 10MΩ	1p
100 off per value - 75p even hundreds per value totalling 1000	£6.00p
Metal Film resistors 1/4W 10R to 1 MΩ 5% E12 series - 2p. 1% E24 series	3p
Mixed metal/carbon film resistors 1/4W E24 series 1R to 10MΩ	1 1/2p
1 watt mixed metal/Carbon Film 5% E12 series 4R7 to 10 Megohms	5p
Linear Carbon pre-sets 100mW and 1/4W 100R to 4M7 E6 series	7p

Miniature polyester capacitors 250V working for vertical mounting

.015, .022, .033, .047, .068, 0.1 - 5p, .012, 0.15, .022 - 6p, .047 - 8p, .068 - 8p, 1.0 - 12p

Mylar (polyester) capacitors 100V working E12 series vertical mounting

1000p to 8200p - 3p, .01 to .068 - 4p, 0.1 - 5p, .012, 0.15, .022 - 6p, .047/50V - 8p

Submin ceramic plate capacitors 100V wkg vertical mountings. E12 series

2% 1.8pf to 47pf - 3p, 2% 56pf to 330pf - 4p, 10% 390p-4700p

Disc/polyester ceramics 50V E12 series 1P0 to 1000P, E6 Series 1500P to 47000P

Polystyrene capacitors 63V working E12 series long axial wires

10pf to 820pf - 4p, 1000pf to 10,

## Build or Upgrade your own I.B.M Compatible

### MOTHERBOARDS

286 12Mhz up to 4Mb .....	£85.00
286 16Mhz up to 4Mb, IDE, 2 Serial, 1 Parallel on board .....	£115.00
386sx 20Mhz up to 8Mb, IDE, 2 Serial, 1 Parallel on board .....	£299.00
386 25Mhz up to 8Mb (Special offer till 1st August) .....	£369.00
386 33Mhz up to 32Mb (128k.cache) .....	£492.00
486 25Mhz up to 64Mb .....	£1463.00

phone for the latest memory price.

### HARD DRIVES

<b>Seagate</b>	
44Mb IDE 28ms 3.5" .....	£140.00
89Mb IDE 19ms 3.5" .....	£245.00
124Mb IDE 18ms 3.5" .....	£319.00
<b>Plus Developments</b>	
52Mb IDE 9ms 3.5" .....	£179.00
104Mb IDE 9ms 3.5" .....	£359.00
Many more hard drives available	

### FLOPPY DRIVES

5.25" 1.2Mb Floppy drive ..	£50.00
3.5" 1.44Mb Floppy drive ..	£50.00

### CARDS

16 Bit VGA 256k .....	£65.00
16 Bit VGA 1024k .....	£130.00
IDE HDD/FDD controller, 2 serial & 1 parallel ports, games port ..	£32.50

### Books

PC Configuration Hndbk	£21.95
Programmers Reference	
Manual for the IBM PC ....	£22.35
Catalogue .....	free

### MONITORS

Samsung 14" mono VGA	£95.00
Tystar 14" SVGA colour ..	£210.00
(1024 x 768)	

This is just a small sample of our range. We have many other parts and books available, including modems, network cards, software, printers etc... Complete machines also supplied. Full details in our catalogue, write or call for your copy now. All our parts come with a one year warranty and are fully tested before despatch. All prices Plus VAT

**Knowles & Associates**

43 Victoria Avenue  
Hull, HU5 3DN.  
Telephone: 0482 448224

## PROCOM Electronics

F.M. Wireless microphone .....	£14.99
Gas Iron .....	£14.99
Gas Iron Bits .....	£5.99
25 way 'D' cover .....	10 for £3.50
12 Volt Relays DPDT .....	75p 5 for £3.00
12 Volt Relays 4PDT .....	95p 5 for £4.00
3U Sub-frame racks (flat pack) quantity discount .....	(£2 p&p) £6.99
2N3055 .....	10 for £4.99
3-16V Piezo Sounders .....	2 for £1.00
Mercury tilt switch .....	99p 5 for £4.00
L.E.D. Clock module 12/24 hrs c/w data (mains transformer not supplied) .....	£2.50
12 Volt Solenoids. (Dim 20mm x 20mm) .....	95p 10 for £8.00
Philips 9" Colour Monitor (Scart) (S/H) .....	(£10 p&p) £110.00
Hitachi 9" Mono Monitor (Comp video) (S/H) .....	(£10 p&p) £49.99
CCD Colour Cameras from (S/H) .....	(£7 p&p) £225.00
20 Meg Hard Disc Drive M.F.M., low level format (S/H) ..	(£7 p&p) £85.00
Pocket Multimeter, 14 ranges .....	£7.99
Multimeter 20k $\Omega$ /V Transistor check .....	£19.99
Digital Multimeter 3 1/2 digit diode check 10A d.c. current ..	£21.99
Top quality box jointed Japanese long nose pliers .....	£6.99
Top quality box jointed Japanese oblique cutters .....	£6.99
Stereo headphone (mini) .....	£1.99
Hex switches (RS337-093) .....	£0.75
IEC filtered/fuse carrier chassis plug .....	£2.00
AA NiCads .....	4 for £3.60



ALL PRICES VAT INCLUSIVE

Access and Visa taken, min. order £5.00

VISA

ALL POSTAGE & PACKING £1.00 (unless otherwise stated)

13 Clarence Arcade  
Stamford Street  
Ashton Under Lyne  
Lancashire OL6 7PT

Shop Hours:  
Mon-Sat: 9.30 am-6.00 pm  
(closed Tues. morning)

Telephone 061-343 2782

## electronize CAR ELECTRONICS KITS

### NEW CODED IR REMOTE CONTROL

Our latest addition allows control of our alarms from outside the vehicle. Both transmitter and receiver use a chip designed specially for car security systems with 59,046 code combinations. You can even set your own code, with several vehicles on the same code or several transmitters for one vehicle if required.

The code transmitter, supplied complete with battery, is housed in a purpose made case to attach to your key-ring. A high power infra-red emitter gives a range of up to 5 metres.

**CODE TRANSMITTER**      DIY parts kit £13.95      Assembled £17.95

The low profile receiver is designed to sit on the dashboard top and contains all the electronics to amplify and decode the infra-red signal. It also has a high intensity red L.E.D. which pulses continuously, when armed, to warn off intruders and a green L.E.D. which flashes to tell you the system has been disarmed. (When used with our Volt Drop or Micro-Pressure alarms a simple modification can remove the entry delay if required.)

**CODE RECEIVER**      DIY parts kit £21.35      Assembled £26.55

### MICRO-PRESSURE CAR ALARM

This new type of alarm is triggered by a unique pressure sensing system. As any vehicle door is opened air is drawn out, causing a minute drop in air pressure. A sensor detects this sudden pressure change and sets off the alarm. An electronic filter is tuned to a very low frequency which, with adjustable sensitivity, avoids false alarms.

- ★ Operates on all doors and tailgate - no switches needed.
- ★ Automatically armed 40 seconds after leaving vehicle.
- ★ 10 second entry delay with audible warning. (No delay version available)
- ★ Sounds horn or siren intermittently for 30 seconds - then re-arms.
- ★ Easy fitting - only 3 wires to connect - no holes to drill.
- ★ Controlled by ignition switch, hidden switch or remote control above.

**MICRO-PRESSURE ALARM**      DIY parts kit £15.95      Assembled £22.35

Also available :-

**VOLT DROP CAR ALARM**      DIY parts kit £14.90      Assembled £20.95

120dB PIEZO SIREN (optional for the above alarms)      Assembled £11.95

**MICRO-PRESSURE TRIGGER**      DIY parts kit £10.95      Assembled £14.95

**EXTENDED CDI IGNITION**      DIY parts kit £22.75      Assembled £28.45

All the above include cable, connectors and clear easy to follow instructions.

All kits include case, PCB, everything down to the last washer, even solder.

All prices now include post, packing and VAT on U.K. orders. Same prices apply to all European countries. For delivery outside Europe please add £3.

Telephone orders accepted with VISA or ACCESS payment.

Order direct (quote ref. E1A) or send for more details from :-

**ELECTRONIZE DESIGN**      Tel. 021 308 5877

2 Hillside Road, Four Oaks, Sutton Coldfield, B74 4DQ



## The UK Distributor for Standard Toroidal Transformers

- \* 106 types available from stock
- \* Sizes from 15VA to 625VA

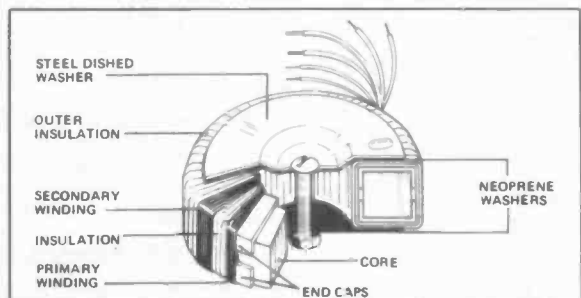

Write or phone for free Data Pack

**Jaytee Electronic Services**

143 Reculver Road, Beltinge, Herne Bay, Kent CT6 6PL  
Telephone: (0227) 375254



NATIONAL  
COLLEGE OF  
TECHNOLOGY

**DISTANCE LEARNING COURSES**

The National College of Technology offer a range of packaged learning short courses for study at home or in an industrial training environment which carry national BTEC awards. Study can commence at any time and at any level enabling you to create a study routine to fit around existing commitments. Courses on offer include:

- Analogue Electronics
- Digital Electronics
- Fibre/Optoelectronics
- Programmable Logic Controllers

Tutor support and BTEC certification are available as options with no travelling or college attendance required. These very popular courses which are ideal for vocational training contain workbooks, audio cassette lectures, PCB's, instruments, tools, components and leads as necessary to support the theoretical and practical training. Whether you are a newcomer to electronics or have some experience and simply need an update or certification, there is probably a distance learning course ready for you. Write or telephone for details to:

National College of Technology  
NCT Ltd., PO Box 11  
Wendover, Bucks  
Tel: (0296) 624270

**LOW COST UHF RADIO SWITCHING**

**AS USED BY THE PROFESSIONAL SECURITY MARKET**

Incorporating the latest Surface Acoustic Wave technology, the system consists of a small "zero-power", UHF transmitter with digital encoder and a UHF receiver unit with digital decoder and 3 relay outputs. 2 alternate and 1 momentary. 8-way DIL switches on both boards set the unique security code. Many applications including lighting, alarms, the "automatic home", etc.

Size:	Tx 45 x 30mm	Rx 55 x 65mm
Supply:	Tx 3-12V	Rx 5-12V
Range:	Up to 200m	

Complete System (2 kits).....	<b>£29.99</b>
Individual Transmitter.....	<b>£15.99</b>
Individual Receiver.....	<b>£19.99</b>

Please allow 28 days for delivery  
Cheques/POs to:

**BLB Electronics**

341 Darwen Road, Bromley Cross, Bolton BL7 9BY

**ADVERTISERS INDEX**

N. R. BARDWELL.....	678	MAGENTA ELECTRONICS.....	616/7/8
BK ELECTRONICS.....	Cover (iii)	MAPLIN ELECTRONICS.....	Cover (iv)
BLB ELECTRONICS.....	680	MARAPET.....	679
BULL ELECTRICAL.....	Cover (ii)	MAURITRON TECH. SERV'S.....	678
CAMBRIDGE COMP. SCIENCE.....	651	MULTITEST.....	656
CIRKIT DISTRIBUTION.....	667	NATIONAL COLLEGE OF TECH.....	680
COMPELEC.....	676	NUMBER ONE SYSTEMS.....	641
COVEND ELECTRONICS.....	653	OMNI ELECTRONICS.....	680
CRICKLEWOOD ELECTRONICS.....	659	PANRIX ELECTRONICS.....	653
CR SUPPLY COMPANY.....	676	PROCOM ELECTRONICS.....	677
ELECTRONIZE DESIGN.....	677	QUANTEK ELECTRONICS.....	679
ESR ELECTRONIC COMP.....	613	RACKZ PRODUCTS.....	679
GREENWELD ELECTRONICS.....	615	SERVICE TRADING CO.....	676
HART ELECTRONIC KITS.....	637	SHERWOOD ELEC. COMP.....	679
HENRY'S AUDIO ELECT.....	673	STEWART OF READING.....	676
HIGH-Q ELECTRONICS.....	680	SUMA DESIGNS.....	673
HI-TECH.....	612	TANDY.....	627
HOBBYKIT.....	610	TECHNICAL INFO. SERVICES.....	679
ICS.....	679	TK ELECTRONICS.....	673
JAYTEE ELECTRONIC SERVICES.....	677, 679	TSIEN.....	675
JPG ELECTRONICS.....	678	VISUAL AUDIO SALES.....	632
KNOWLES & ASSOCIATES.....	677	WEKA.....	614

**OMNI ELECTRONICS**

174 Dalkeith Road, Edinburgh EH16 5DX 031 667 2611

**A COMPREHENSIVE RANGE WITH SERVICE SECOND TO NONE**

OUR MUCH EXPANDED, BETTER ILLUSTRATED CATALOGUE COSTS £1.50 - INCLUDES VOUCHERS TO USE AGAINST FUTURE PURCHASES. TO RECEIVE A COPY PLEASE SEND YOUR REMITTANCE WITH THE VOUCHER BELOW.

Do you have your copy yet?

Please send me a copy of the 1990/91 OMNI catalogue. Payment of £1.50 enclosed

NAME.....  
ADDRESS.....  
TELEPHONE.....

Open: Mon.-Thurs. 9.15 - 6.00  
Friday 9.15 - 5.00  
Saturday 9.30 - 5.00



**NEW FROM HIGH-Q 30VELLEMAN KITS**

Added To Our Range

NOW "130" KITS AVAILABLE For all Electronic Enthusiasts

Sole UK Importers • Trade Enquiries contact below

NEW KITS INCLUDE:

- CAR ACCESSORIES
- CAR ALARM
- POWER SUPPLIES
- AUDIO TIMERS
- CODELOCK
- COUNTERS
- DIMMERS
- HOUSEHOLD APPLICATIONS
- SENSORS
- DIGITAL CONTROLLED PRE-AMPLIFIER
- COMMUNICATIONS
- 1-CHANNEL INFRA-RED RECEIVER
- ALARMS
- LIGHT-EFFECTS
- COMPUTER INTERFACE
- GADGETS
- MEASURING DEVICES
- 15-CHANNEL INFRA-RED TRANSMITTER

For 1991 Catalogue & Price List, please sent 75p (UK) or £2.00 (Overseas) to:

**HIGH-Q-ELECTRONICS**

P.O. BOX 142, Hatfield, Herts AL9 7JH  
Tel: 0707 263562 Fax: 0707 276746



**OMP POWER AMPLIFIER MODULES-TURNABLES-DIMMERS-LOUDSPEAKERS-19 INCH STEREO RACK AMPLIFIERS**

**OMP POWER AMPLIFIER MODULES**

Supplied ready built and tested

**OMP POWER AMPLIFIER MODULES** Now enjoy a world-wide reputation for quality, reliability and performance at a realistic price. Four models available to suit the needs of the professional and hobby market, i.e. Industry, Leisure, Instrumental and Hi-Fi etc. When comparing prices, NOTE all models include Toroidal power supply, Integral heat sink, Glass fibre P.C.B. and Drive circuits to power compatible Vu meter. Open and short circuit proof.

**THOUSANDS OF MODULES PURCHASED BY PROFESSIONAL USERS**



**OMP100 Mk 11 Bi-Polar** Output power 110 watts R.M.S. into 4 ohms, Frequency Response 15Hz - 30KHz -3dB, T.H.D. 0.01%, S.N.R. -118dB, Sens. for Max. output 500mV at 10K, Size 355 x 115x65mm. **PRICE £33.99 + £3.00 P&P.**

**NEW SERIES II MOS-FET MODULES**



**OMP MF 100 Mos-Fet** Output power 110 watts R.M.S. into 4 ohms, Frequency Response 1Hz - 100KHz -3dB, Damping Factor, >300, Slew Rate 45V/uS, T.H.D. Typical 0.002%, Input Sensitivity 500mV, S.N.R. -125dB, Size 300 x 123 x 60mm. **PRICE £39.99 + £3.00 P&P.**

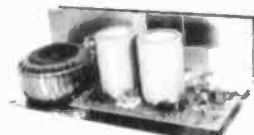

**OMP/MF200 Mos-Fet** Output power 200 watts R.M.S. into 4 ohms, Frequency Response 1Hz - 100KHz -3dB, Damping Factor >300, Slew Rate 60V/uS, T.H.D. Typical 0.001%, Input Sensitivity 500mV, S.N.R. -130dB, Size 300 x 155 x 100mm. **PRICE £62.99 + £3.50 P&P.**

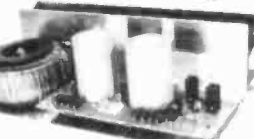

**OMP/MF300 Mos-Fet** Output power 300 watts R.M.S. into 4 ohms, Frequency Response 1Hz - 100KHz -3dB, Damping Factor >300, Slew Rate 60V/uS, T.H.D. Typical 0.0008%, Input Sensitivity 500mV, S.N.R. -130dB, Size 330 x 175 x 100mm. **PRICE £79.99 + £4.50 P&P.**

NOTE:— MOS-FET MODULES ARE AVAILABLE IN TWO VERSIONS: STANDARD — INPUT SENS. 500mV BAND WIDTH 100KHz, PEC (PROFESSIONAL EQUIPMENT COMPATIBLE) — INPUT SENS. 775mV, BAND WIDTH 50KHz, ORDER STANDARD OR PEC

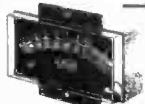

**Vu METER** Compatible with our four amplifiers detailed above. A very accurate visual display employing 11 L.E.D. diodes (7 green, 4 red) plus an additional on/off indicator. Sophisticated logic control circuits for very fast rise and decay times. Tough moulded plastic case, with tinted acrylic front. Size 84 x 27 x 45mm. **PRICE £8.50 + 50p P&P.**

**LOUDSPEAKERS**



**LARGE SELECTION OF SPECIALIST LOUDSPEAKERS AVAILABLE, INCLUDING CABINET FITTINGS, SPEAKER GRILLES, CROSS-OVERS AND HIGH POWER, HIGH FREQUENCY BULLETS AND HORNS, LARGE S.A.E. (30p STAMPED) FOR COMPLETE LIST.**

**McKENZIE:— INSTRUMENTS, P.A., DISCO, ETC.**

- ALL MCKENZIE UNITS 8 OHMS IMPEDENCE**
- 8" 100 WATT C8100GPM GEN. PURPOSE, LEAD GUITAR, EXCELLENT MID., DISCO. **PRICE £29.30 + £2.00 P&P**
  - RES. FREQ. 80Hz. FREQ. RESP. TO 14KHz. SENS. 99dB
  - 10" 100 WATT C10100GP GUITAR, VOICE, ORGAN, KEYBOARD, DISCO, EXCELLENT MID. **PRICE £35.58 + £2.50 P&P**
  - RES. FREQ. 70Hz. FREQ. RESP. TO 6KHz. SENS. 100dB
  - 10" 200 WATT C10200GP GUITAR, KEYBOARD, DISCO, EXCELLENT HIGH POWER MID. **PRICE £48.67 + £2.50 P&P**
  - RES. FREQ. 45Hz. FREQ. RESP. TO 7KHz. SENS. 103dB
  - 12" 100 WATT C12100GP HIGH POWER GEN. PURPOSE, LEAD GUITAR, DISCO. **PRICE £37.59 + £3.50 P&P**
  - RES. FREQ. 45Hz. FREQ. RESP. TO 7KHz. SENS. 98dB
  - 12" 200 WATT C12100TC TWIN CONE) HIGH POWER WIDE RESPONSE, P.A., VOICE, DISCO. **PRICE £38.58 + £3.50 P&P**
  - RES. FREQ. 45Hz. FREQ. RESP. TO 14KHz. SENS. 100dB
  - 12" 200 WATT C12200B HIGH POWER BASS, KEYBOARDS, DISCO, P.A. **PRICE £65.79 + £3.50 P&P**
  - RES. FREQ. 40Hz. FREQ. RESP. TO 7KHz. SENS. 100dB
  - 12" 300 WATT C12300GP HIGH POWER BASS LEAD GUITAR, KEYBOARDS, DISCO, ETC. **PRICE £87.51 + £3.50 P&P**
  - RES. FREQ. 45Hz. FREQ. RESP. TO 5KHz. SENS. 100dB
  - 15" 100 WATT C15100BS BASS GUITAR, LOW FREQUENCY, P.A., DISCO. **PRICE £55.05 + £4.00 P&P**
  - RES. FREQ. 40Hz. FREQ. RESP. TO 5KHz. SENS. 98dB
  - 15" 200 WATT C15200BS VERY HIGH POWER BASS. **PRICE £75.10 + £4.00 P&P**
  - RES. FREQ. 40Hz. FREQ. RESP. TO 4KHz. SENS. 99dB
  - 15" 250 WATT C15250BS VERY HIGH POWER BASS. **PRICE £82.54 + £4.50 P&P**
  - RES. FREQ. 40Hz. FREQ. RESP. TO 4KHz. SENS. 99dB
  - 15" 400 WATT C15400BS VERY HIGH POWER, LOW FREQUENCY BASS. **PRICE £96.47 + £4.50 P&P**
  - RES. FREQ. 40Hz. FREQ. RESP. TO 4KHz. SENS. 102dB
  - 18" 400 WATT C18404BS EXTREMELY HIGH POWER, LOW FREQUENCY BASS. **PRICE £172.06 + £5.00 P&P**
  - RES. FREQ. 27Hz. FREQ. RESP. TO 3KHz. SENS. 99dB

**EARBENDERS:— HI-FI, STUDIO, IN-CAR, ETC.**

- ALL EARBENDER UNITS 8 OHMS (EXCEPT EB50 & EB10-50 WHICH ARE DUAL IMPEDENCE TAPPED (4 & 8 OHM))**
- BASS, SINGLE CONE, HIGH COMPLIANCE, ROLLED FOAM SURROUND**
  - 8" 50 WATT EB8-50 DUAL IMPEDENCE, TAPPED 4 & 8 OHM BASS, HI-FI, IN-CAR. **PRICE £8.90 + £2.00 P&P**
  - RES. FREQ. 40Hz. FREQ. RESP. TO 7KHz. SENS. 97dB
  - 10" 50 WATT EB10-50 DUAL IMPEDENCE, TAPPED 4 & 8 OHM BASS, HI-FI, IN-CAR. **PRICE £12.00 + £2.50 P&P**
  - RES. FREQ. 40Hz. FREQ. RESP. TO 5KHz. SENS. 99dB
  - 10" 100 WATT EB10-100 BASS, HI-FI, STUDIO. **PRICE £27.76 + £3.50 P&P**
  - RES. FREQ. 35Hz. FREQ. RESP. TO 3KHz. SENS. 96dB
  - 12" 60 WATT EB12-60 BASS, HI-FI, STUDIO. **PRICE £21.00 + £3.00 P&P**
  - RES. FREQ. 28Hz. FREQ. RESP. TO 3KHz. SENS. 92dB
  - 12" 100 WATT EB12-100 BASS, STUDIO, HI-FI, EXCELLENT DISCO. **PRICE £38.75 + £3.50 P&P**
  - RES. FREQ. 26Hz. FREQ. RESP. TO 3KHz. SENS. 93dB
  - FULL RANGE TWIN CONE, HIGH COMPLIANCE, ROLLED SURROUND**
  - 5 1/2" 60 WATT EB5-60TC (TWIN CONE) HI-FI, MULTI-ARRAY DISCO ETC. **PRICE £9.99 + £1.50 P&P**
  - RES. FREQ. 63Hz. FREQ. RESP. TO 20KHz. SENS. 92dB
  - 6 1/2" 60 WATT EB6-60TC (TWIN CONE) HI-FI, MULTI-ARRAY DISCO ETC. **PRICE £10.99 + £1.50 P&P**
  - RES. FREQ. 38Hz. FREQ. RESP. TO 20KHz. SENS. 94dB
  - 8" 60 WATT EB8-60TC (TWIN CONE) HI-FI, MULTI-ARRAY DISCO ETC. **PRICE £12.99 + £1.50 P&P**
  - RES. FREQ. 40Hz. FREQ. RESP. TO 18KHz. SENS. 89dB
  - 10" 60 WATT EB10-60TC (TWIN CONE) HI-FI, MULTI-ARRAY DISCO ETC. **PRICE £16.49 + £2.00 P&P**
  - RES. FREQ. 35Hz. FREQ. RESP. TO 12KHz. SENS. 86dB

**TRANSMITTER HOBBY KITS**

**PROVEN TRANSMITTER DESIGNS INCLUDING GLASS FIBRE PRINTED CIRCUIT BOARD AND HIGH QUALITY COMPONENTS COMPLETE WITH CIRCUIT AND INSTRUCTIONS**



3 watt FM Transmitter

**3W FM TRANSMITTER 80-108MHz**, VARICAP CONTROLLED PROFESSIONAL PERFORMANCE, RANGE UP TO 3 MILES, SIZE 38 x 123mm, SUPPLY 12V (0.5 AMP). **PRICE £14.49 + £1.00 P&P**

**FM MICRO TRANSMITTER (BUG) 100-108MHz** VARICAP TUNED COMPLETE WITH VERY SENS FET MIC, RANGE 100-300m SIZE 56 x 46mm, SUPPLY 9V BATT. PRICE **£8.62 + £1.00 P&P**

\* PRICES INCLUDE V.A.T. \* PROMPT DELIVERIES \* FRIENDLY SERVICE \* LARGE S.A.E., 30p STAMPED FOR CURRENT LIST.

**OMP VARISPEED TURNTABLE CHASSIS**



- \* MANUAL ARM
- \* STEEL CHASSIS
- \* ELECTRONIC SPEED CONTROL 33 & 45
- \* VARI PITCH CONTROL
- \* HIGH TORQUE SERVO DRIVEN DC MOTOR
- \* TRANSIT SCREWS
- \* 12" DIE CAST PLATTER
- \* NEON STROBE
- \* CALIBRATED BAL WEIGHT
- \* REMOVABLE HEAD SHELL
- \* CARTRIDGE FIXINGS
- \* CUE LEVER
- \* POWER 220 240V 50/60Hz
- \* 390x305mm
- \* SUPPLIED WITH MOUNTING CUT-OUT TEMPLATE

**PRICE £59.99 + £3.50 P&P.**

**OPTIONAL MAGNETIC CARTRIDGES**

**STANTON AL500**  
PRICE £16.99 + 50p P&P

**GOLDRING G850**  
PRICE £6.99 + 50p P&P

**OMP MOS-FET POWER AMPLIFIERS, HIGH POWER, TWO CHANNEL 19 INCH RACK**

**THOUSANDS PURCHASED BY PROFESSIONAL USERS**



**NEW MXF SERIES OF POWER AMPLIFIERS**

THREE MODELS:— **MXF200 (100w + 100w)**  
**MXF400 (200w + 200w)** **MXF600 (300w + 300w)**

All power ratings R.M.S. into 4 ohms.

**FEATURES:** \* Independent power supplies with two Toroidal Transformers \* Twin L.E.D. Vu meters \* Rotary indexed level controls \* Illuminated on/off switch \* XLR connectors \* Standard 775mV inputs \* Open and short circuit proof \* Latest Mos-Fets for stress free power delivery into virtually any load \* High slew rate \* Very low distortion \* Aluminium cases \* MXF600 Fan Cooled with D.C. Loudspeaker and Thermal Protection.

**USED THE WORLD OVER IN CLUBS, PUBS, CINEMAS, DISCOS ETC.**

**SIZES:**— **MXF 200** W19" x H3 1/2" (2U) x D11"  
**MXF 400** W19" x H5 1/4" (3U) x D12"  
**MXF 600** W19" x H5 1/4" (3U) x D13"

**MXF200 £171.35**

**MXF400 £228.85**

**MXF600 £322.00**

**SECURICOR DELIVERY £12.00 EACH**

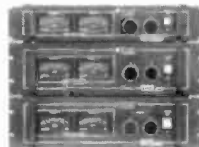

**OMP LINNET LOUDSPEAKERS**

THE VERY BEST IN QUALITY AND VALUE



MADE ESPECIALLY TO SUIT TODAY'S NEED FOR COMPACTNESS WITH HIGH OUTPUT SOUND LEVELS. FINISHED IN HARDWEARING BLACK VYNYDE WITH PROTECTIVE CORNERS, GRILLE AND CARRYING HANDLE INCORPORATES 12" DRIVER PLUS HIGH FREQ HORN FOR FULL FREQ RANGE 45Hz-20KHz BOTH MODELS 8 OHM. SIZE H18" x W15" x D12"

CHOICE OF TWO MODELS

**POWER RATINGS QUOTED IN WATTS RMS FOR EACH CABINET**

**OMP 12-100 (100W 100dB) PRICE £159.99 PER PAIR**

**OMP 12-200 (200W 102dB) PRICE £209.99 PER PAIR**

**SECURICOR DEL.— £12.00 PER PAIR**

**IN CAR STEREO BOOSTER AMPLIFIER**



**TWO SUPERB HIGH POWER CAR STEREO BOOSTER AMPLIFIERS**

150 WATTS (75+75) INTO 4 OHMS  
300 WATTS (150+150) INTO 4 OHMS

- HIGH & LOW INPUT IMPEDANCES
  - HIGH & LOW INPUT SENSITIVITIES
  - VARIABLE INPUT GAIN CONTROL
  - SHORT CIRCUIT OUTPUT PROTECTION
  - POWER REQUIREMENT 12V D.C.
- PRICES: 150 WATT £43.00**  
**300 WATT £95.00 + £3.00 P&P EACH**

**PIEZO ELECTRIC TWEETERS-MOTOROLA**

**PIEZO ELECTRIC TWEETERS — MOTOROLA**

Join the Piezo revolution. The low dynamic mass (no voice coil) of a Piezo tweeter produces an improved transient response with a lower distortion level than ordinary dynamic tweeters. As a crossover is not required these units can be added to existing speaker systems of up to 100 watts (more if 2 put in series). **FREE EXPLANATORY LEAFLETS SUPPLIED WITH EACH TWEETER.**

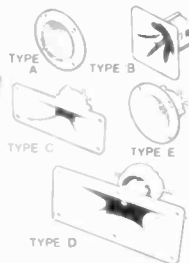

- TYPE 'A' (KSN2036A)** 3" round with protective wire mesh, ideal for bookshelf and medium sized Hi-Fi speakers. **Price £4.90 each + 50p P&P**
  - TYPE 'B' (KSN1005A)** 3 1/2" super horn. For general purpose speakers, disco and P.A. systems etc. **Price £5.99 each + 50p P&P**
  - TYPE 'C' (KSN6016A)** 2" x 5 1/2" wide dispersion horn. For quality Hi-Fi systems and quality discos etc. **Price £6.99 each + 50p P&P**
  - TYPE 'D' (KSN1025A)** 2 x 6" wide dispersion horn. Upper frequency response retained extending down to mid range (2KHz). Suitable for high quality Hi-Fi systems and quality discos. **Price £9.99 each + 50p P&P**
  - TYPE 'E' (KSN1038A)** 3 1/4" horn tweeter with attractive silver finish trim. Suitable for Hi-Fi monitor systems etc. **Price £5.99 each + 50p P&P**
- LEVEL CONTROL** Combines on a recessed mounting plate, level control and cabinet input jack socket. 85 x 85mm. **Price £3.99 + 50p P&P**

**STEREO DISCO MIXER**

**STEREO DISCO MIXER** with 2 x 5 band L & R graphic equalisers and twin 10 segment L.E.D. Vu Meters. **Many outstanding features** 5 Inputs with individual faders providing a useful combination of the following:—  
3 Turntables (Mag). 3 Mics. 4 Line including CD plus Mic with talk over switch Headphone monitor. Pan Pot L & R. Master Output controls. Output 775mV. Size 360x280x90mm. Supply 220-240v.  
**Price £134.99 — £4.00 P&P**

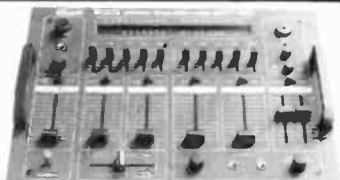

**B. K. ELECTRONICS** Dept EE  
UNIT 5, COMET WAY, SOUTHEND-ON-SEA, ESSEX, SS2 6TR  
TEL: 0702-527572 FAX: 0702-420243

POSTAL CHARGES PER ORDER £1.00 MINIMUM OFFICIAL ORDERS WELCOME FROM SCHOOLS, COLLEGES, GOVT. BODIES, ETC. PRICES INCLUSIVE OF V.A.T. SALES COUNTER. VISA ACCESS ACCEPTED BY POST, PHONE OR FAX





1992 BUYER'S GUIDE TO ELECTRONIC COMPONENTS

# Maplin

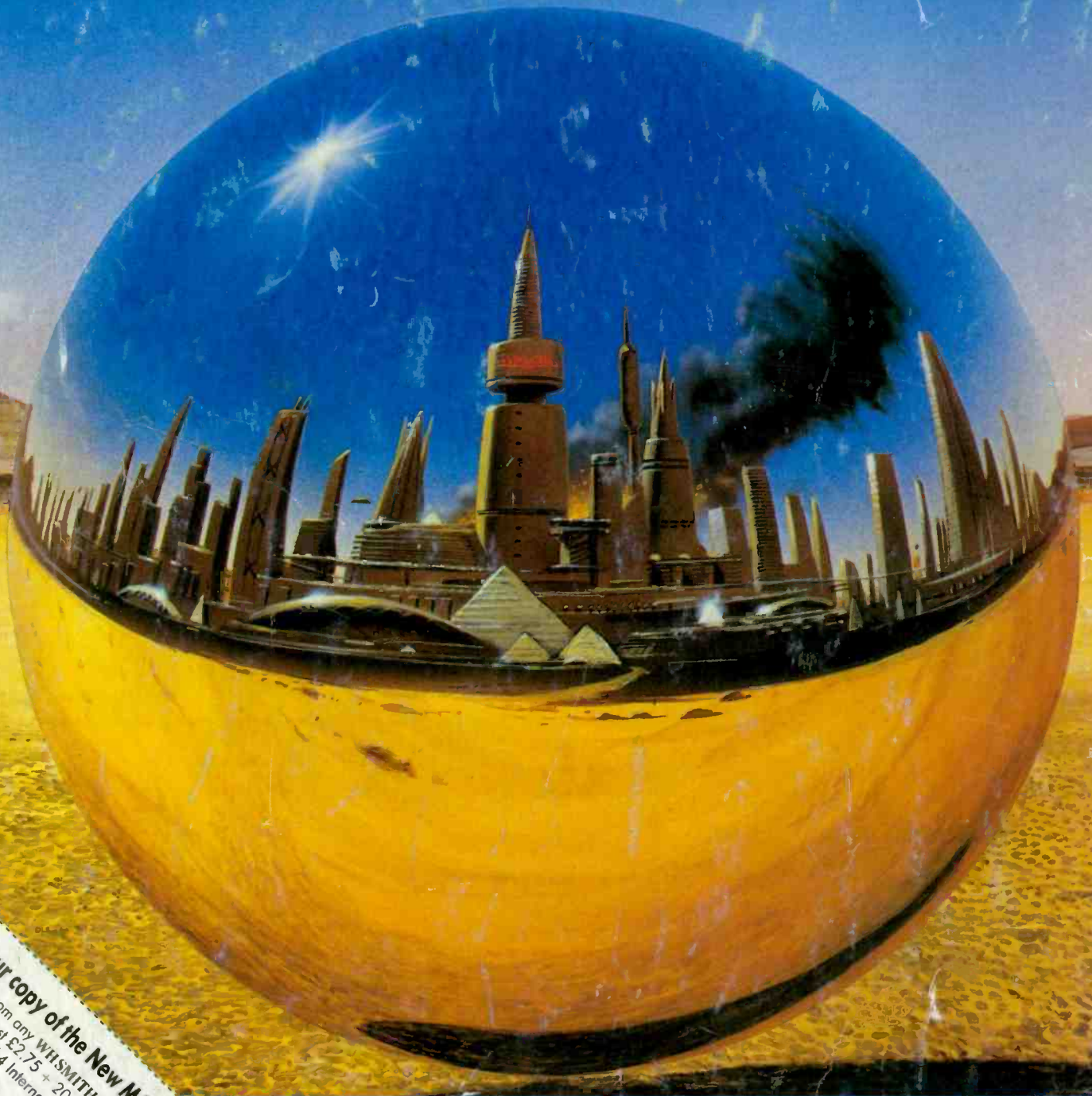

**Order your copy of the New MAPLIN Catalogue on sale NOW!**  
Pick up a copy from any WHSMITH for just £2.75 or post this coupon now to receive your copy for just £2.75 + 20p p&p. If you live outside the UK, send £4.85 or £4 International Reply Coupons. I enclose £2.95.

Name .....  
Address .....  
Post Code .....

Send to Maplin Electronics,  
P.O. Box 3, Rayleigh,  
Essex SS6 8LR.  
EE92

Over 600 product packed pages with  
more than 600 brand new products.  
On sale now, only £2.75

Available from all branches of WHSMITH and  
Maplin shops nationwide. Hundreds of new products  
at super low prices!