

EVERYDAY

AUGUST 1995

With **PRACTICAL**

ELECTRONICS

INCORPORATING ELECTRONICS MONTHLY

FULLY S.O.R. £2.25

STATIC

How to avoid the problems

PERSONAL PRACTICE AMPLIFIER

For budding rock stars

MICROCONTROLLED 3-DIGIT TIMER

Versatile up/down timer

INFRA-RED REMOTE CONTROL

Adds remote control to almost anything

SOLAR SEEKER

Motorised solar panel for battery charging

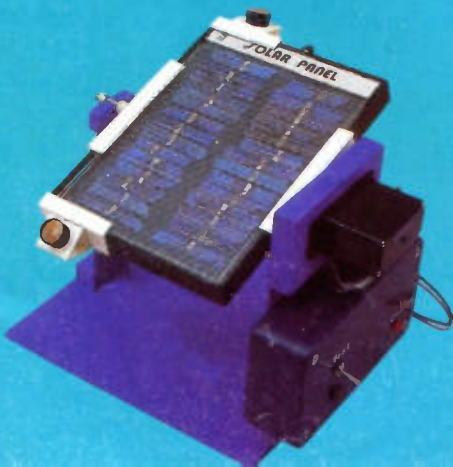

THE NO. 1 INDEPENDENT
MAGAZINE FOR
ELECTRONICS TECHNOLOGY
& COMPUTER PROJECTS



ENERGY BANK KIT 100 6"x6" 6v 100mA panels, 100 diodes, connection details etc. £69.95 ref EF112.

CCTV CAMERA MODULES 46X70X29mm, 30 grms, 12v 100mA, auto electronic shutter, 3.6mm F2 lens, CCIR, 512x492 pixels, video output is 1v p-p (75 ohm). Works directly into a scart or video input on a tv or video. IR sensitive. £79.95 ref EF137.

IR LAMP KIT Suitable for the above camera, enables the camera to be used in total darkness! £5.99 ref EF138.

PASTEL ACCOUNTS SOFTWARE, does everything for all sizes of businesses, includes wordprocessor, report writer, windowing, networkable up to 10 stations, multiple cash books etc. 200 page comprehensive manual. 90 days free technical support (0345-326009 try before you buy) Current retail price is £129, ours? just £29 ref EF134. SAVE £100!!!

MINI MICRO FANS 12V 1.5" sq just £3.99 each. Ref EF199.

CITOH PRINTERS 80 cpi, 9pin matrix, serial/parallel, NLQ/draft, 3 mth warranty, good condition. £49 ref EF133.

MICROSOFT TRACKBALL AND MOUSE Combined unit with 4 buttons and trackball, PS2 type connector. Complete with storage bracket. Our price just £11.99 ref EF201.

REUSEABLE HEAT PACKS. Ideal for fishermen, outdoor enthusiasts elderly or infirm, warming food, drinks etc, defrosting pipes etc.reusable up to 10 times, lasts for up to 8 hours per go, 2,000wh energy, gets up to 90 degC. Price is £12 ref EF129. rrp £37!

1.44MB 3.5" DISC DRIVES Returns from a top PC manufacturer so they may need attention, bargain price £8.50 ea ref EF203.

1.2MB 6.25" DISC DRIVES Again returns so may need attention, bargain price is £8.50 ref EF204. (1 of each 1.2+1.44 £14.99 ref EF205)

A4 DTP MONITORS Brand new, 300 DPI. Complete with diagram but no interface details. (so you will have to work it out!) Bargain at just £7.99 each!!! Ref EF185

OPD MONITORS 9" mono monitor, fully cased complete with rasterboard, switched mode psu etc. CGAT/TL Input (15way D), IEC mains. £15.99 ref DEC23. Price including kit to convert to composite monitor for CCTV use etc is £21.99 ref DEC24.

12V ZAMP LAPTOP psu's 110x55x40mm (includes standard IEC socket) and 2m lead with plug. 100-240v IP. £8.99 ref EF200.

PC CONTROLLED 4 CHANNEL TIMER Control (on/off times etc) up to 4 items (8A 240v each) with this kit. Complete with Software, relays, PCB etc. £25.99 Ref 95/26

COMPLETE PC 300 WATT UPS SYSTEM Top of the range UPS system providing protection for your computer system and valuable software against mains power fluctuations and cuts. New and boxed, UK made Provides up to 5 mins running time in the event of complete power failure to allow you to run your system down correctly. SALE PRICE just £118.00.

RACAL MODEM BONANZA! 1 Racal MPS123 1200/75 modem, telephone lead, mains lead, manual and comms software, the cheapest way onto the net! all this for just £13 ref DEC13.

HOW LOW ARE YOUR FLOPPIES? 3.5" (1.44) unbranded. We have sold 100,000+ so ok! Pack of 50 £24.99 ref DEC16

6mw LASER POINTER. Supplied in kit form, complete with power adjuster, 1-5mw. and beam divergence adjuster. Runs on 2 AAA batteries. Produces thin red beam ideal for levels, gun sights, experiments etc. Cheapest in the UK! just £39.95 ref DEC49

SHOP WOBBLERS! Small assemblies designed to take D size batteries and 'wobble' signs about in shops! £3.99 Ref SEP4P2.

RADIO PAGERS Brand new, UK made pocket pagers clearance price is just £4.99 each 100x40x15mm packed with bits! Ref SEP5.

BULL TENS UNIT Fully built and tested TENS (Transcutaneous Electrical Nerve Stimulation) unit, complete with electrodes and full instructions. TENS is used for the relief of pain etc. in up to 70% of sufferers. Drug free pain relief, safe and easy to use, can be used in conjunction with analgesics etc. £49 Ref TEN/1

COMPUTER RS232 TERMINALS. (LIBERTY) Excellent quality modern units, (like wyse 50, s) 2xRS232, 20 function keys. 50 thro to 38,400 baud, menu driven port, screen, cursor, and keyboard setup menus. (18 menus) £29 REF NOV4.

OMRON TEMPERATURE CONTROLLERS (E6C2). Brand new controllers, adjustable from 0 deg C to +100 deg C using graduated dial, 2% accuracy, thermocouple input, long life relay output. 3A 240v o/p contacts. Perfect for exactly controlling a temperature. Normal trade £50+, ours £15. Ref E5C2.

ELECTRIC MOTOR BONANZA! 110x60mm. Brand new precision, cap start (or spin to start), virtually silent and features a moving outer case that acts as a fly wheel. Because of their unusual design we think that 2 of these in a tube with some homemade fan blades could form the basis for a wind tunnel etc. Clearance price is just £4.99 FOR A PAIR!! (note these will have to be wired in series for 240v operation Ref NOV1).

MOTOR NO 2 BARGAIN 110x90mm. Similar to the above motor but more suitable for mounting vertically (ie turntable etc). Again you will have to wire 2 in series for 240v use. Bargain price is just £4.99 FOR A PAIR!! Ref NOV3.

OMRON ELECTRONIC INTERVAL TIMERS.
*****NEW LOW PRICES TO CLEAR!!*****

Minute adjustable timers, 4 pole c/o output 3A 240v.

HY1230S, 12vDC adjustable from 0-30 secs.	£4.99
HY1210M, 12vDC adjustable from 0-10 mins.	£4.99
HY1260M, 12vDC adjustable from 0-60 mins.	£4.99
HY2460M, 24vAC adjustable from 0-60 mins.	£2.99
HY241S, 24vAC adjustable from 0-1 secs.	£2.99
HY2460S, 24vAC adjustable from 0-60 secs.	£2.99
HY243H, 24vAC adjustable from 0-3 hours.	£2.99
HY2401S, 240v adjustable from 0-1 secs.	£4.99
HY2405S, 240v adjustable from 0-5 secs.	£4.99
HY24060m, 240v adjustable from 0-60 mins.	£6.99

PC PAL VGA TO TV CONVERTER Converts a colour TV into a basic VGA screen. Complete with built in psu, lead and s/ware. £49.95. Ideal for laptops or a cheap upgrade. We also can supply this in kit form for home assembly at £34.95 ref EF54.

DRINKING BIRD Remember these? hook onto wine glass (supplied) and they drink, stand up, drink, stand up ETC! £4 each Ref EF1

EMERGENCY LIGHTING UNIT Complete unit with 2 double bulb floodlights, built in charger and auto switch. Fully cased. 6v 8AH

lead acid req'd. (secondhand) £4 ref MAG4P11.

GUIDED MISSILE WIRE. 4,200 metre reel of ultra thin 4 core insulated cable. 28lbs breaking strain, less than 1mm thick! Ideal alarms, intercoms, fishing, dolls house's etc. £14.99 ref MAG15P5

ASTEC SWITCHED MODE PSU BM41012 Gives +5 @ 3.75A, +12 @ 1.5A, -12 @ 4A 230/110, cased, BM41012. £5.99 ref AUG6P3.

AUTO SUNCHARGER 155x300mm solar panel with diode and 3 metre lead fitted with a cigar plug. 12v 2watt. £9.99 ea ref AUG10P3.

FLOPPY DISCS DSDD Top quality 5.25" discs. These have been written to once and are unused. Pack of 20 is £4 ref AUG4P1.

ECLATRON FLASH TUBE As used in police car flashing lights etc, full spec supplied, 60-100 flashes a min. £9.99 ref APR10P5.

24v AC 96WATT Cased power supply. New. £13.99 ref APR14.

MILITARY SPECCEGEIGER COUNTERS Unused an straight from Her majesty's forces. £5 ref MAG 50P3.

OUTDOOR SOLAR PATH LIGHT Captures sunlight during the day and automatically switches on a built in lamp at dusk. Complete with sealed lead acid battery etc. £19.99 ref MAR20P1.

ALARM VERSION Of above unit comes with built in alarm and pir to deter intruders. Good value at just £24.99 ref MAR25P4.

CARETAKER VOLUMETRIC Alarm. will cover the whole of the ground floor against forced entry. Includes mains power supply and integral battery backup. Powerful internal sounder, will take external bell if req'd. Retail £150+, ours? £49.99 ref MAR50P1.

TELEPHONE CABLE White 6 core 100m reel complete with a pack of 100 clips. Ideal 'phone extns etc. £7.99 ref MAR8P3.

MICRODRIVE STRIPPERS Small cased tape drives ideal for stripping. Lots of useful goodies including a smart case, and lots of components. £2 each ref JUN2P3. Box of 10 just £9.99 ref EF207.

SOLAR POWER LAB SPECIAL You get TWO 6"x6" 6v 130mA solar cells, 4 LED's, wire, buzzer, switch plus 1 relay or motor. Superb value kit just £5.99 REF: MAG6P8

BUGGING TAPE RECORDER Small voice activated recorder, uses micro cassette complete with headphones. £28.99 ref MAR29P1.

ULTRAMINI BUGMIC 6mmx3.5mm made by AGK, 5-12v electret condenser. Cost £12 ea, Ours? just four for £9.99 REF MAG10P2.

RGB/CGA/EGA/TTL COLOUR MONITORS 12" in good condition. Back anodised metal case. £79 each REF JUN79

ANSWER PHONES Returns with 2 faults, we give you the bits for 1 fault, you have to find the other yourself. BT Response 200's £18 ea REF MAG18P1. PSU £5 ref MAG6P12

SWITCHED MODE PSU eq equip, 60w +5v @5A, -5v @5A, +12v @2A, -12v @5A 120/220v cased 245x88x55mm IEC input socket £6.99 REF MAG7P1

PLUG IN PSU 9V 200mA DC £2.99 each REF MAG3P9

PLUG IN ACORN PSU 19v AC 14w, £2.99 REF MAG3P10

POWER SUPPLY fully cased with mains and o/p leads 17v DC 900mA output. Bargain price £5.99 ref MAG6P9

ACORN ARCHMEDES PSU +5v @ 4.4A on/off sw uncased, selectable mains input. 145x100x45mm £7 REF MAG7P2

9v DC POWER SUPPLY standard plug in type 150mA 9v DC with lead and DC power plug, price for two is £2.99 ref AUG3P4.

AA NICAD PACK encapsulated pack of 8 AA nicad batteries (tagged) eq equip, 55x32x32mm. £3 a pack. REF MAG3P11

13.8V 1.9A psu cased with leads. Just £9.99 REF MAG10P3

PPC MODEM CARDS. These are high spec plug in cards made for the Amstrad laptop computers. 2400 baud dial up unit complete with leads. Clearance price is £5 REF: MAG5P1

INFRA RED REMOTE CONTROLLERS Originally made for hi spec satellite equipment but perfect for all sorts of remote control projects. Our clearance price is just £2 REF: MAG2

200 WATT INVERTER Converts 10-15v DC into either 110v or 240v AC. Fully cased 115x36x156mm, complete with heavy duty power lead, cigar plug, AC outlet socket. Auto overload shutdown, auto short circuit shut down, auto input over voltage shutdown, auto input under voltage shut down (with audible alarm), auto temp control, unit shuts down if overheated and sounds audible alarm. Fused reversed polarity protected, output frequency within 2%, voltage within 10%. A well built unit at a keen price. Just £64.99 ref AUG6S.

UNIVERSAL SPEED CONTROLLER KIT Designed by us for the C5 motor but ok for any 12v motor up to 30A. Complete with PCB etc. A heat sink may be required. £17.00 REF: MAG17

MAINS CABLE Precut black 2 core 2 metre lengths ideal for repairs, projects etc. 50 metres for £1.99 ref AUG2P7.

COMPUTER COMMUNICATIONS PACK Kit contains 100m of 6 core cable, 100 cable clips, 2 line drivers with RS232 interfaces and all connectors etc. Ideal low cost method of communicating between PC's over a long distance. Complete kit £8.99.

ELECTRIC MOTOR KIT Comprehensive educational kit includes all you need to build an electric motor. £9.99 ref MAR10P4.

VIEWDATA SYSTEMS made by Phillips, complete with internal 1200/75 modem, keyboard, psu etc RGB and composite outputs, menu driven, autodialler etc. £18 each Ref EF88.

BOOMERANG High tech, patented polypropylene, 34cm wing span. Get out and get some exercise for £4.99 ref EF83

AIR RIFLES .22 As used by the Chinese army for training purposes, sq there is a lot about! £39.95 Ref EF78. 500 pellets £4.50 ref EF80.

PLUG IN POWER SUPPLIES Plugs into 13A socket with output lead. three types available, 9vdc 150mA £2 ref EF58, 9vdc 200mA £2.50 ref EF59, 6.5vdc 500mA £3 ref EF61.

VIDEO SENDER UNIT. Transmits both audio and video signals from either a video camera, video recorder, TV or Computer etc to any standard TV set in a 100' range! (tune TV to a spare channel) 12v DC *SOME OF OUR PRODUCTS MAY BE UNLICENSEABLE IN THE UK

op. Price is £15 REF: MAG15 12v psu is £5 extra REF: MAG5P2

***FM CORDLESS MICROPHONE** Small hand held unit with a 500' range! 2 transmit power levels. Reqs PP3 9v battery. Tuneable to any FM receiver. Price is £15 REF: MAG15P1

LOW COST WALKIE TALKIES Pair of battery operated units with a range of about 200'. Ideal for garden use or as an educational toy. Price is £8 a pair. REF: MAG 8P1 2 x PP3 req'd.

***MINATURE RADIO TRANSCEIVERS** A pair of walkie talkies with a range up to 2km in open country. Units measure 22x5x2x155mm. Including cases and earpieces. 2xPP3 req'd. £30.00 pr. REF: MAG30

COMPOSITE VIDEO KIT. Converts composite video into separate H sync, V sync, and video. 12v DC. £8.00 REF: MAG8P2.

LQ3600 PRINTER ASSEMBLIES Made by Amstrad they are entire mechanical printer assemblies including printhead, stepper motors etc etc in fact everything bar the case and electronics, a good stunner! £5 REF: MAG5P3 or 2 for £8 REF: MAG8P3

LED PACK of 100 standard red 5m leds £5 REF: MAG5P4

UNIVERSAL PC POWER SUPPLY complete with flyleads, switch, fan etc. 200w at £20 REF: MAG20P3 (265x155x125mm).

GYROSCOPE About 3" high and an excellent educational toy for all ages! Price with instruction booklet £6 Ref EF15.

FUTURE PC POWER SUPPLIES These are 295x135x60mm, 4 drive connectors 1 mother board connector. 150watt, 12v fan, iec inlet and on/off switch. £12 Ref EF6.

VENUS FLY TRAP KIT Grow your own carnivorous plant with this simple kit £3 ref EF34.

PC POWER SUPPLIES (returns) These are 140x150x90mm. o/ps are +12, -12, +5 and -5v. Built in 12v fan. These are returns so they may well need repairing! £3.50 each ref EF42.

***FM TRANSMITTER KIT** housed in a standard working 13A adapter! the bug runs directly off the mains so lasts forever! why pay £700? or price is £15 REF: EF62 Transmits to any FM radio. (this is in kit form with full instructions.)

***FM BUG KIT** New design with PCB embedded coil for extra stability. Works to any FM radio. 9v battery req'd. £5 REF: MAG5P5

***FM BUG BUILT AND TESTED** superior design to kit. Supplied to detective agencies. 9v battery req'd. £14 REF: MAG14

TALKING COINBOX STRIPPER Originally made to retail at £79 each, these units are designed to convert an ordinary phone into a payphone. The units have the locks missing and sometimes broken hinges. However they can be adapted for their original use or used for something else?? Price is just £3 REF: MAG3P1

TOP QUALITY SPEAKERS Made for Hi Fi televisions these are 10 watt 4R Jap made 4" round with large shielded magnets. Good quality. £2 each REF: MAG2P4 or 4 for £6 REF: MAG6P2

TWEETERS 2" diameter good quality tweeter 140R (ok with the above speaker) 2 for £2 REF: MAG2P5 or 4 for £3 REF: MAG3P4

AT KEYBOARDS Made by Apricot these quality keyboards need just a small mod to run on any AT, they work perfectly but you will have to put up with 1 or 2 foreign keycaps! 3.30 ea REF: MAG6P3

DOS PACKS Microsoft version 3.3 or higher complete with all manuals or price just £5 REF: MAG5P8 Worth it just for the very comprehensive manual! 5.25" only.

GAS HOBS Brand new made by Optimus, basic three burner suitable for small flat etc bargain price just £29.95 ref EF73.

GAT AIR PISTOL PACK Complete with pistol, darts and pellets £12.95 Ref EF82 extra pellets (500) £4.50 ref EF80.

DOS PACK Microsoft version 6 with manual £29.95 ref EF209

WINDOWS 3.1 3.5" with manual £24.99 ref EF210.

NOVELL NETWARE LTE (network s/ware) £24.99 ref EF211.

PIR DETECTOR Made by famous UK alarm manufacturer these are hi spec, long range internal units. 12v operation. Slight marks on case and unboxed (although brand new) £8 REF: MAG8P5

MOBILE CARPHONE £5.99 Well almost complete in carphone excluding the box of electronics normally hidden under seat. Can be made to illuminate with 12v also has built in light sensor so display only illuminates when dark. Totally convincing! REF: MAG6P6

6"x12" AMORPHOUS SOLAR PANEL 12v 155x310mm 130mA. Bargain price just £5.99 ea REF: MAG6P12.

FIBRE OPTIC CABLE BUMPER PACK 10 metres for £4.99 ref MAG5P13 ideal for experimenters! 30m for £12.99 ref MAG13P1

HEATSINKS (finned) TO220, designed to mount vertically on a pcb 50x40x25mm you can have a pack of 4 for £1 ref JUNT1P11.

STROBE LIGHT KIT Adjustable from 1 hz night up to 60hz! (electronic assembly kit with full instructions) £16 ref EF28.

ROCK LIGHTS Unusual things these, two pieces of rock that glow when rubbed together! believed to cause rain! £3 a pair Ref EF29.

AMSTRAD GX4000 games machines, returns, untested, sold as seen. Just £2.99 ref EF186.

NEW HIGH POWER LASERS
15mW, Helium neon, 3 switchable wave lengths .63um, 1.15um, 3.39um
(2 of them are infrared) 500:1 polarizer built in so good for holography. Supplied complete with mains power supply 790x65mm. Use with EXTREME CAUTION AND QUALIFIED GUIDANCE.
NEW SALE PRICE TO CLEAR JUST £249-VAT

WE BUY SURPLUS STOCK FOR CASH
FREE CATALOGUE

1995 100 PAGE CATALOGUE NOW AVAILABLE, 45P STAMP OR FREE WITH ORDER.

PORTABLE RADIATION DETECTOR
WITH NEW COMPUTER INTERFACE £59

A Hand held personal Gamma and X Ray detector. This unit contains two Geiger Tubes, has a 4 digit LCD display with a Piezo speaker, giving an audio visual indication. The unit detects high energy electromagnetic quanta with an energy from 30K eV to over 1.2M eV and a measuring range of 5-9999 UR/h or 10-9990 Nr/h. ref NOV18

BULL ELECTRICAL
250 PORTLAND ROAD, HOVE, SUSSEX.
BN3 5QT. (ESTABLISHED 50 YEARS).

MAIL ORDER TERMS: CASH, PO OR CHEQUE
WITH ORDER PLUS £3 POST PLUS VAT.
PLEASE ALLOW 1-10 DAYS FOR DELIVERY PHONE ORDERS
WELCOME (ACCESS, VISA, SWITCH, AMERICAN EXPRESS)

TEL: 01273 203500
FAX 01273 323077

The No. 1 Independent Magazine for Electronics,
Technology and Computer Projects

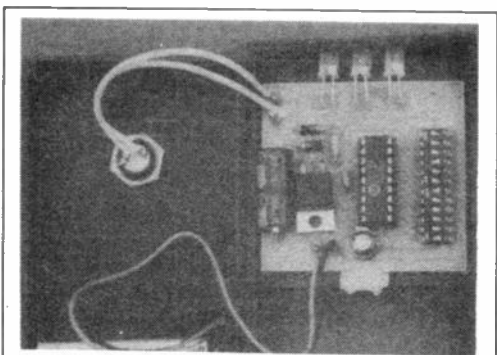
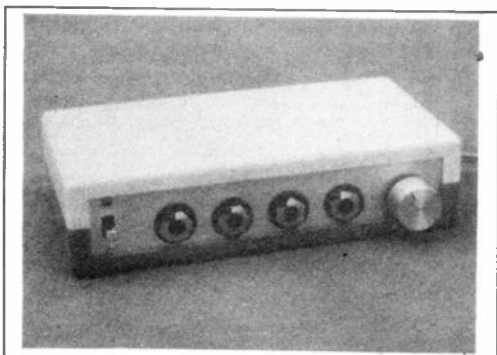
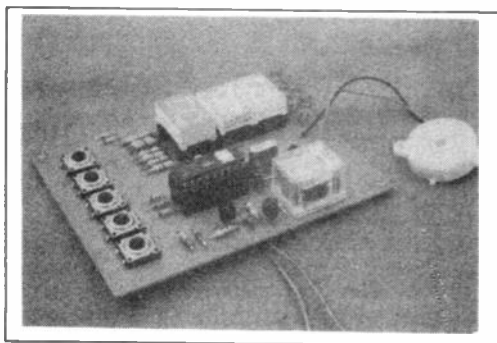
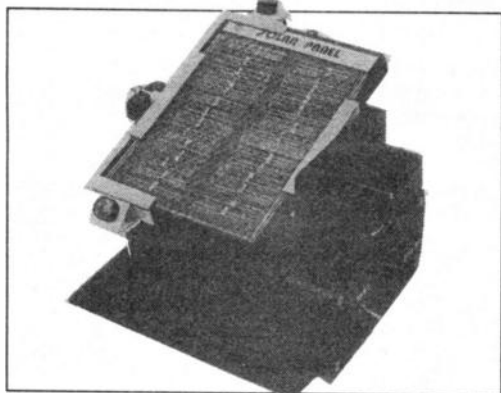

© Wimborne Publishing Ltd 1995. Copyright in all drawings, photographs and articles published in **EVERYDAY with PRACTICAL ELECTRONICS** is fully protected, and reproduction or imitations in whole or in part are expressly forbidden.

Our September '95 Issue will be published on Friday, 4th August 1995. See page 583 for details.

Projects

- SOLAR SEEKER** by Jim and Chris Wiles **594**
Economise – build a solar powered battery charger that tracks the sun
- PERSONAL PRACTICE AMPLIFIER** by Andy Flind **606**
On the road or in your pad, carry on practising without a carry-on!
- INFRA-RED REMOTE CONTROL UNIT** by Max Horsey **616**
Multipurpose coded controller. Ideal for last month's Curtain Winder
- VERSATILE MICROCONTROLLED 3-DIGIT TIMER** by Bart Trepak **629**
Dial-a-time with this PIC controlled timer – up (or down!) to ten hours
- RAMP GENERATOR - 2** by Niel Johnson BEng (Hons) AMIEE **644**
Sophisticated test equipment for the serious constructor's workshop

Series

- INTERFACE** by Robert Penfold **626**
A hardware interface for Morse decoding commercial software
- TECHNIQUES – ACTUALLY DOING IT** by Robert Penfold **636**
Computerised front panel finishing
- CIRCUIT SURGERY** by Alan Winstanley **640**
Precision rectifier, UJT oscillator, BCD switches, and on the Net!
- AMATEUR RADIO** by Tony Smith G4FAI **650**
NZ and the Morse test, amateur radio and the Net; RSGB news and dates

Features

- EDITORIAL** **593**
- INNOVATIONS** **602**
Everyday news from the world of electronics
- NEW TECHNOLOGY UPDATE** by Ian Poole **604**
R.F. designers may soon be aided by the new Silvar chip technology
- SHOPTALK** with David Barrington **609**
Component buying for EPE projects
- FOX REPORT** by Barry Fox **610**
Dormant EEPROMS may assist the introduction of photo-fit ID cards
- STATIC** by Ian Poole **612**
Understand and avoid the electronic problems of static electricity
- OHM SWEET HOME** by Max Fidling **614**
Fish-tank fiddlings don't impress a predatory Piddles!
- BACK ISSUES** **624**
Did you miss these?
- ELECTRONICS VIDEOS** **638**
Our range of educational videos
- DIRECT BOOK SERVICE** **652**
A wide range of technical books available by mail order
- PRINTED CIRCUIT BOARD SERVICE** **655**
PCBs for EPE projects
- ADVERTISERS INDEX** **660**

Readers Service ● Editorial and Advertisement Departments **593**

Surplus always wanted for cash!

THE ORIGINAL SURPLUS WONDERLAND!

THIS MONTH'S SELECTION FROM OUR VAST EVER CHANGING STOCKS

Surplus always wanted for cash!

LOW COST PC's - ALL EXPANDABLE - ALL PC COMPATIBLE

SPECIAL BUY AT 286

40Mb HD + 3Mb Ram

LIMITED QUANTITY only of these 12MHz HI GRADE 286 systems Made in the USA to an industrial specification, the system was designed for total reliability. The compact case houses the motherboard, PSU and EGA video card with single 5 1/4" 1.2 Mb floppy disk drive & integral 40Mb hard disk drive to the front. Real time clock with battery backup is provided as standard. Supplied in good used condition complete with enhanced keyboard, 640k + 2Mb RAM, DOS 4.01 and 90 DAY Full Guarantee. Ready to Run!
Order as HIGRADE 286 **ONLY £149.00** (E)
CALL FOR QTY DISCOUNTS

Optional Fitted extras: VGA graphics card	£29.00
1.4Mb 3 1/2" floppy disk drive (instead of 1.2 Mb)	£24.95
NE2000 Ethernet (thick, thin or twisted) network card	£49.00

FLOPPY DISK DRIVES 3 1/2" - 8"

5 1/4" from £22.95 - 3 1/2" from £24.95

Massive purchases of standard 5 1/4" and 3 1/2" drives enables us to present prime product at industry beating low prices! All units (unless stated) are BRAND NEW or removed from often brand new equipment and are fully tested, aligned and shipped to you with a 90 day guarantee and operate from standard voltages and are of standard size. All are IBM-PC compatible (if 3 1/2" supported on your PC).

3 1/2" Panasonic JU363/4 720K or equivalent	£24.95(B)
3 1/2" Mitsubishi MF355C-L. 1.4 Meg. Laptops only *	£36.95(B)
3 1/2" Mitsubishi MF355C-D. 1.4 Meg. Non laptop	£29.95(B)
5 1/4" Teac FD-55GFR 1.2 Meg	£29.95(B)
5 1/4" BRAND NEW Mitsubishi MF501B 360K	£22.95(B)
* Data cable included in price.	
Shugart 801/801 B' S5 refurbished & tested	£195.00(E)
Shugart 851 B' double sided refurbished & tested	£250.00(E)
Mitsubishi M2894-63 B' double sided NEW	£275.00(E)
Mitsubishi M2896-63-02U B' D5 slimline NEW	£285.00(E)
Dual 8" drives with 2 mbyte capacity housed in a smart case with built in power supply. Ideal as exterior drive!	£499.00(F)

HARD DISK DRIVES

End of line purchase scoop! Brand new NEC D2248 8" 85 Mbyte of hard disk storage! Full industry standard SMD Interfaces. Ultra hi speed data transfer and access time, replaces Fujitsu equivalent model. complete with manual. Only **£299.00(E)**

3 1/2" FUJIK FK-309-26 20mb MFM I/F RFE	£59.95(C)
3 1/2" CONNER CP3024 20 mb IDE I/F (or equiv.) RFE	£89.95(C)
3 1/2" CONNER CP3044 40mb IDE I/F (or equiv.) RFE	£89.00(C)
3 1/2" RODIME RQ3057S 45mb SCSI I/F (Mac & Acorn)	£99.00(C)
5 1/4" MINISCRIIBE 3425 20mb MFM I/F (or equiv.) RFE	£49.95(C)
5 1/4" SEAGATE ST-238R 30 mb RLL I/F Refurb	£69.95(C)
5 1/4" CDC 64205-51 40mb HH MFM I/F RFE tested	£195.00(E)
6" FUJITSU M2322K 160Mb SMD I/F RFE tested	£195.00(E)
Hard disc controllers for MFM, IDE, SCSI, RLL etc. from	£16.95

THE AMAZING TELEBOX

Converts your colour monitor into a QUALITY COLOUR TV!

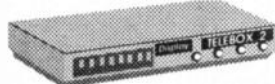

TV SOUND & VIDEO TUNER!

The TELEBOX consists of an attractive fully cased mains powered unit, containing all electronics ready to plug into a host of video monitors made by makers such as MICROVITEC, ATARI, SANYO, SONY, COMMODORE, PHILIPS, TATUNG, AMSTRAD etc. The composite video output will also plug directly into most video recorders, allowing reception of TV channels not normally receivable on most television receivers* (TELEBOX MB). Push button controls on the front panel allow reception of 8 fully tuneable 'off air' UHF colour television channels. TELEBOX MB covers virtually all television frequencies VHF and UHF including the HYPERBAND as used by most cable TV operators. A composite video output is located on the rear panel for direct connection to most makes of monitor or desktop video systems. For complete compatibility - even for monitors without sound - an integral 4 watt audio amplifier and low level Hi Fi audio output are provided as standard.

TELEBOX ST for composite video input type monitors	£34.95
TELEBOX STL as ST but with integral speaker	£37.50
TELEBOX MB Multiband VHF - UHF Cable - Hyperband tuner	£89.95
For overseas PAL versions state 5 or 6mhz sound specification.	
*For cable / hyperband reception Telebox MB should be connected to cable type service. Shipping code on all TELEBOX is (B)	

FANS & BLOWERS

MITSUBISHI MMF-D6D12DL 80 x 25 mm 12v DC	£4.95 10 / £42
MITSUBISHI MMF-09B12DH 92 x 25 mm 12v DC	£5.95 10 / £53
PANACHE 12-3.5 92 x 18 mm 12v DC	£7.95 10 / £89
EX-EQUIP 120 x 38mm AC fans - tested specify 110 or 240 v	£8.95
EX-EQUIP 60 x 38mm AC fans - tested specify 110 or 240 v	£5.95
VERO rack mount 1U x 19" fan tray specify 110 or 240v	£45.95 (E)
MMHOF B26 1900 rack mnt 3U x 19" Blower 110/240v NEW	£79.95
Shipping on all fans (A). Blowers (B). 50,000 Fans Ex Stock CALL	

IC's - TRANSISTORS - DIODES

OBSOLETE - SHORT SUPPLY - BULK

5,000,000 items EX STOCK

For MAJOR SAVINGS - SAE or CALL FOR LATEST LIST

PC SCOOP COMPLETE

COLOUR SYSTEM ONLY £99.00

A massive bulk purchase enables us to bring you a COMPLETE ready to run colour PC system at an unheard of price! The Display Electronics PC99 system comprises of fully compatible and expandable XT PC with 256k of RAM, 5 1/4" 360k floppy disk drive, 12" CGA colour monitor, standard 84 key keyboard, MS DOS and all connecting cables - just plug in and go! Ideal students, schools or anybody wishing to learn the world of PC on an ultra low budget. Don't miss this opportunity. Fully guaranteed for 90 Days. **Order as PC99COL £99.00 (E)**

Optional Fitted extras: 640k RAM	£29.00
2nd floppy drive, specify 5 1/4" 360k or 3 1/2" 720k	£29.95
Above prices for PC99 offer ONLY.	

VIDEO MONITOR SPECIALS

One of the highest specification monitors you will ever see - At this price - Don't miss it!!

Mitsubishi FA3415ETKL 14" SVGA Multitrac monitor with fine 0.28 dot pitch tube and guaranteed resolution of 1024 x 768. A variety of inputs allows connection to a host of computers including IBM PC's in CGA, EGA, VGA & SVGA modes, BBC, COMMODORE (including Amiga 1200), ARCHIMEDES and APPLE. Many features: Etched faceplate, text switching and LOW RADIATION HPRR specification. Full 90 day warranty. Supplied in EXCELLENT little used condition. **Only £139 (E)**
Order as MITS-SVGA
Tilt & Swivel Base £8.00 Leads for IBM PC £8.95 (A)
External Cables for other computers £ CALL

PHILIPS HCS35 (same style as CM8833) attractively styled 14" colour monitor with built in RGB and standard composite 15.825 Khz video inputs via SCART socket and separate phono jacks. Integral audio power amp and speaker for all audio visual uses. Will connect direct to Amiga and Atari BBC computers. Ideal for all monitoring / security applications with direct connection to most colour cameras. High quality with many features such as front concealed flap controls, VCR correction button etc. Good used condition - fully tested with a 90 day guarantee. **Only £99 (E)**
Dimensions: W14" x H12 3/4" x 15 1/4" D.

Special Offer save £16.95 - Order TELEBOX ST & HCS35 together - giving you a quality colour TV & AV system for **Only £122.50 (E)**

KME 10" high definition colour monitors. Nice tight 0.28" dot pitch for superb clarity and modern styling. Operates from any 15.625 khz sync RGB video source, with RGB analog and composite sync such as Atari, Commodore Amiga, Acorn Archimedes & BBC. Measures only 13 1/2" x 12" x 11". **Only £125 (E)**
Good used condition, 90 day guarantee.
KME 10" as above for PC EGA standard £145.00 (E)

PHILIPS HCS31 Ultra compact 9" colour video monitor with standard composite 15.625 khz video input via SCART socket. Ideal for all monitoring / security applications. High quality, ex-equipment fully tested with a 90 day guarantee (possible minor screen blem). In attractive square black plastic case measuring W10" x H10" x 1 1/2" D. Mains powered Limited Quantity - **Only £79.00 (D)**

20" 22" and 26" AV SPECIALS

Superbly made UK manufacture. PIL all solid state colour monitors, complete with composite video & optional sound inputs. Attractive teak style case. Perfect for Schools, Shops, Disco, Clubs, etc. In EXCELLENT little used condition with full 90 day guarantee.

20"....£135 22"....£155 26"....£185 (F)

DC POWER SUPPLIES

Virtually every type of power supply you can imagine. Over 10,000 Power Supplies Ex Stock Call for info / list.

SPECIAL INTEREST

Zeta 3220-05 A0 4 pin HPGL R5232 fast drum plotter	£1950
3M VDA - Video Distribution Amps. 1 in 32 out	£375
Trfo 0-18 vdc bench PSU. 30 amps. New	£470
Fujitsu M3041 600 LPM band printer	£1950
VG Electronics 1035 TELETEXT Decoding Margin Meter	£3750
Andrews LARGE 3.1 m Satellite Dish + mount (For Voyager)	£950
RED TOP IR Heat seeking missile (not armed!!)	POA
KNS EMC / Line interference tester NEW	£375
Thurby LA 160B logic analyser	£1200
INTEL SBC 486/133SE Multibus 486 system. 8Mb Ram	£1200
GEC 1.5kw 115v 60Hz power source	£950
Brush 2Kw 400 Hz 3 phase frequency converter	£850
Anton Pillar 75 kW 400 Hz 3 phase frequency converter	POA
Newton Derby 70 KW 400 Hz 3 phase frequency converter	POA
COMPONEDX T10000 Portable TELEX tester NEW	£250
Sekonic SD 150H 18 channel digital Hybrid chart recorder	£1995
HP 7580A A1 8 pin HPGL high speed drum plotter	£1850
Computer MCA1813APC 16mm auto iris lenses C' mount	£125
Seaward PAT 2000 dual voltage computerised PAT tester	£585
Densel MUD 0185AH 1KVA UPS system with batts NEW	£575

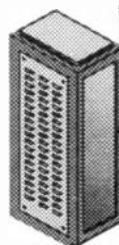

19" RACK CABINETS

Superb quality 6 foot 40U Virtually New, Ultra Smart Less than Half Price!

Top quality 19" rack cabinets made in UK by Optima Enclosures Ltd. Units feature designer, smoked acrylic lockable front door, full height lockable half louvered back door and removable side panels. Fully adjustable internal fixing struts, ready punched for any configuration of equipment mounting plus ready mounted integral 12 way 13 amp socket switched mains distribution strip make these racks some of the most versatile we have ever sold. Racks may be stacked side by side and therefore require only two side panels to stand singly or in bays. Overall dimensions are: 77 1/2" H x 32 1/2" D x 22" W. Order as:
OPT Rack 1 Complete with removable side panels. £335.00 (G)
OPT Rack 2 Rack, Less side panels £225.00 (G)

32U - High Quality - All steel cabinet

Made by Eurocraft Enclosures Ltd to the highest possible spec, rack features all steel construction with removable side, front and back doors. Front and back doors are hinged for easy access and all are lockable with five secure 5 lever barrel locks. The front door is constructed of double walled steel with a 'designer style' smoked acrylic front panel to enable status indicators to be seen through the panel, yet remain unobtrusive. Internally the rack features full slotted reinforced vertical fixing members to take the heaviest of 19" rack equipment. The two movable vertical fixing struts (extras available) are pre punched for standard 'cage nuts'. A mains distribution panel internally mounted to the bottom rear, provides 8 IEC 3 pin Euro sockets and 1 x 13 amp 3 pin switched utility socket. Overall ventilation is provided by fully louvered back door and double skinned top section with top and side louvers. The top panel may be removed for fitting of integral fans to the sub panel etc. Other features include: fitted castors and floor levers, pre-punched utility panel at lower rear for cable / connector access etc. Supplied in excellent, slightly used condition with keys. Colour Royal blue. External dimensions 64" H x 25" D x 23 1/2" W.

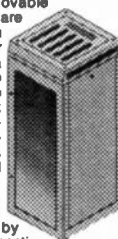

Sold at LESS than a third of makers price !!

A superb buy at only **£195.00 (G)**

Over 1000 racks in all sizes 19" 22" & 24" 3 to 44 U. Available from stock !! Call with your requirements.

TOUCH SCREEN SYSTEM

The ultimate in 'Touch Screen Technology' made by the experts - MicroTouch - but at a price below cost!! System consists of a fast translucent glass laminated panel measuring 29.5 x 23.5 cm connected to a PCB with on board sophisticated electronics. From the board comes a standard serial RS232 or TTL output. The output continuously gives simple serial data containing positional X & Y co-ordinates as to where a finger is touching the panel - as the finger moves, the data instantly changes. The X & Y information is given at an incredible matrix resolution of 1024 x 1024 positions over the screen size!!! So, no position, however small fails detection. A host of available translation software enables direct connection to a PC for a myriad of applications including: control panels, pointing devices, POS systems, controllers for the disabled or computer un-trained etc. Imagine using your finger in 'Windows' instead of a mouse!! (a driver is indeed available!) The applications for this amazing product are only limited by your imagination!! Supplied as a complete system including Controller, Power Supply and Data at an incredible price of only: **£145.00 (H)**
RFE. Full software Support Available - Fully Guaranteed.

LOW COST RAM & CPU'S

INTEL 'ABOVE' Memory Expansion Board. Full length PC-XT and PC-AT compatible card with 2 Mbytes of memory on board. Card is fully selectable for Expanded or Extended (286 processor and above) memory. Full data and driver disk supplied. In good used condition fully tested and guaranteed. Windows compatible. Order as: ABOVE CARD **£59.95 (A1)**
Half length 8 bit memory upgrade cards for PC AT XT expands memory either 256k or 512k in 64k steps. May also be used to fit in RAM above 640k DOS limit. Complete with data.
Order as: XT RAM UG. 256K. £5.95 or 512K £38.95 (A1)

SIMM OFFERS	
1 MB x 9 SIMM 8 chip 120ns only	£19.50 (A1)
1 MB x 9 SIMM 3 chip 80 ns	£26.00 (A1)
1 MB x 9 SIMM 3 chip 80 ns	£23.50 70ns
1 MB x 9 SIMM 3 chip 80 ns	£22.50 70ns
4 MB 70ns 72 pin SIMM module only	£125.00 (A1)
SPECIAL INTEREST 486-DX33 CPU	£79.90 (A1)

NO BREAK UNINTERRUPTIBLE PSU'S

EMERSON ACCUCARD UPS, brand new 8 Bit half length PC compatible card for all IBM XT/AT compatibles. Card provides DC power to all internal system components in the event of power supply failure. The Accusaver software provided uses only 8k of base RAM and automatically copies all system, expanded and video memory to the hard disk in the event of loss of power. When power is returned the machine is returned to the exact status when the power failed!! The unit features full self diagnostics on boot and is supplied brand new, with full, easy fitting instructions and manual. Normality **£189.00 NOW! £69.00 or 2 for £120 (H)**

Issue 13 of Display News now available - send large SAE - PACKED with bargains!



LONDON SHOP
Open Mon - Sat 9.00 - 5.30
215 Whitehorse Lane
South Norwood
on 88A Bus Route
N. Thornton Heath &
Selhurst Park SR Rail Stations

ALL MAIL & OFFICES
Open Mon-Fri 9.00-5.30
Dept EE. 32 Biggin Way
Upper Norwood
LONDON SE19 3XF

DISTEL © The Original
FREE On Line Database
Info on 1000's of items
V21, V22, V22 BIS
0181 679 1888

ALL ENQUIRIES
0181 679 4414
FAX 0181 679 1927

All prices for UK Mainland. UK customers add 17.5% VAT to TOTAL order amount. Minimum order £10. Bone Fide account orders accepted from Government, Schools, Universities and Local Authorities - minimum account order £50. Cheques over £100 are subject to 10 working days clearance. Carriage charges (A)-£3.00, (A1)-£4.00, (B)-£5.50, (C)-£8.50, (D)-£12.00, (E)-£15.00, (F)-£18.00, (G)-CALL. Allow approx 6 days for shipping - faster CALL. Scotland surcharge CALL. All goods supplied to our Standard Conditions of Sale and unless stated guaranteed for 90 days. All guarantees on a return to base basis. All rights reserved to change prices / specifications without prior notice. Orders subject to stock. Discounts for volume. Top CASH prices paid for surplus goods. All trademarks etc acknowledged. © Display Electronics 1995. E & O.E. 4/5

COMPREHENSIVE SECURITY SYSTEM

Give all-round protection to your garden shed, garden furniture, garage and home. A mains powered intruder alarm with battery back-up. Features a hard-to-bypass balanced loop sensor system which interfaces to alarm bells, sirens and P.I.R. detectors.

VANDATA

Make sure your caravan or trailer is still on tow with its multiple lighting network intact and functional. Monitors the fridge as well! A dash-mounted display gives you added peace of mind. Suitable for virtually any car and 'van combination.

SIMPLE THEREMIN

Just wave your hand in the air to make music. The Theremin saw a resurgence of interest following last year's Channel 4 documentary on the Russian Leon Theremin who invented the first successful electronic musical instrument back in the 1920s. Next month we present a simple battery powered version for everyone's enjoyment. The fascination of the Theremin is that it is played without physical contact.



LOW RANGE OHMMETER ADAPTOR

Ever tried measuring very low value resistances using a standard digital multimeter? This simple, inexpensive adaptor allows a DMM to measure resistance values of less than 1Ω with two decimal place indication. The unit has two ranges, 0 to 1Ω and 0 to 10Ω . It is easy to build and calibrate.

EVERYDAY

With **PRACTICAL**

ELECTRONICS

SEPTEMBER ISSUE ON SALE FRIDAY, 4th AUGUST

"moving from schematic to layout could not be easier"

Electronics World & Wireless World Jan 1995

**PRO+ now
with SPICE
file export
& SpiceAge
DDE link!**

Quickroute 3.0 for Windows 3.1 has been designed from the start to be as easy to use as possible, without sacrificing the power professional engineers need to get the job done. Quickroute is available with schematic capture, support for busses & power rails, 1-8 layer auto-routing, SPICE file export, and our new extended library pack.

- Quickroute 3.0 PRO+ can also connect to the Windows simulation package SpiceAge using Windows DDE. Contact POWERware for more details!

Quickroute 3.0

**Integrated Schematic and PCB
Design for Windows 3.1**

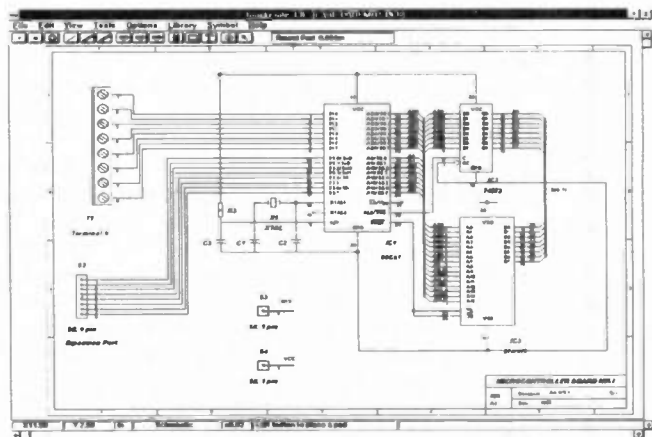
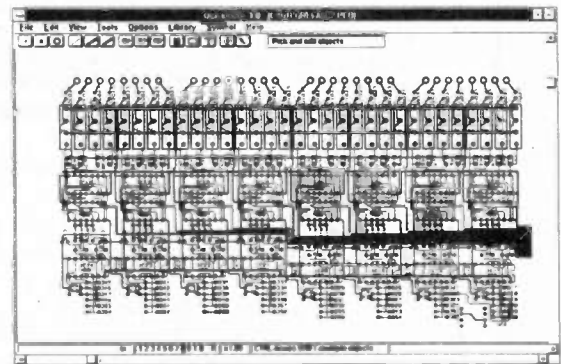

**Busses and Power rails handled easily
using Global Nets on PRO+**

DESIGNER £99

*Schematic & PCB Drawing *1/2 layer auto-router
*Supports Windows printers/plotters *Full set of
libraries *Clipboard support *Designer Special (manual
on disk) also available.

PRO £199

*Schematic & PCB Design *Schematic Capture
*Integrated Rats-Nest Generation *1-8 layer Auto-router
(faster than Designer) *Net-List Export *Supports
Windows printers/plotters *CAD-CAM outputs.

PRO+ £299

As the PRO but also includes *Advanced Schematic Capture
(Busses, Power rails, etc) *Larger Schematic & PCB Designs
*Gerber file IMPORT for File Exchange *Extended libraries
(CMOS, SMT, etc) *SPICE Export *SpiceAge DDE link.

*Prices exclude P+P and V.A.T. VISA/MasterCard
Accepted *Network versions available.

**POWERware, 14 Ley Lane, Marple
Bridge, Stockport, SK6 5DD, U.K.**

**Tel/Fax 0161 449 7101
email info@powrware.demon.co.uk**

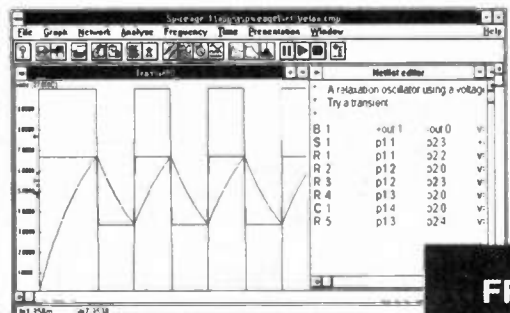

**DDE link to SpiceAge
Simulator with PRO+**

**FREE
Demo Pack
Available.**

ELECTRONICS SOFTWARE

If you are looking for a means of improving your knowledge of the basics of electronics then this software is for you.

ELECTRONICS PRINCIPLES 2.1

- ★ Insulators, Conductors, Resistance ★ D.C. Circuits
- ★ Capacitance and Inductance ★ A.C. Series Circuits
- ★ A.C. Parallel Circuits ★ Reactance and Impedance
- ★ A.C. and D.C. Power ★ Frequency and Tuned Circuits
- ★ Using Numbers ★ Complex Numbers, Phase Angles
- ★ P.N. Junction Diode ★ Bi-polar and MOSFET Transistors
- ★ Operational Amplifiers ★ Logic Gates ★ Digital Number Systems
- ★ Combinational Logic ★ Flip Flops ★ Counters and Shift Registers
- ★ Memory ★ Microcomputer operation

Now an extended range of electronics topics with an improved graphics presentation, available to electronics hobbyists, students, schools, colleges, and used for training within industry throughout the UK and overseas. A fully interactive electronics program where the user selects from over 250 analogue and digital topics. Circuit diagrams, wave forms, phase angles, voltages and currents or logic states are shown, drawn to scale, in full colour. Formulae are given demonstrating all the calculation steps, exactly as in a textbook, using your input values.

An 'on screen' electronics package including circuit theory to enable a learning through doing approach to encourage experimentation. For the young student, mature hobbyist or the engineer that just needs to keep up-to-date in an easy and enjoyable way.

Having reviewed a dozen, or more, educational software packages designed to "teach" electronics, I was more than a little sceptical when I first heard about Electronics Principles: there seemed to be little that could be done that has not been done elsewhere. When I started to use the package my views changed. Indeed, I was so impressed with it that I quickly came to the conclusion that readers should have an opportunity to try the package out for themselves! - MIKE TOOLEY B.A. Dean of Faculty of Technology, Brooklands Technical College.

Complete package **Still only £49.95**

ELECTRONICS PC TOOLBOX VERSION 2.0

An extended and improved version of the popular Toolbox software. Presents commonly used formulae in a way that makes calculations easier thus encouraging experimentation in circuit design.

Covers D.C. Calculations from Ohm's Law to Loading a Potential Divider; Further D.C. Calculations from Power Ratio Decibels to Kirchhoff's Laws; A.C. Calculations from Average Peak Current to Filters and Admittance; Capacitance Calculations from Values to RC Time Constants; Inductance Calculations from Values to Selectivity; Binary Calculations from Addition to 2's Complement; Numbers and Phase Angles from Addition to Polar to Rectangular; **Operational Amplifiers** from Inverting Op.Amp to Op.Amp Differentiator.

Only £19.95

These programs require a PC (or fully compatible system) running DOS or Windows with an 80286 or better processor and VGA (ideally colour) graphics. In addition you must have 4Mb of hard disk space, a high density (1.44Mb) floppy drive and at least 640K of RAM. We also recommend the use of a mouse. Site licences are available - please enquire.

Available from

EPT Educational Software, Pump House, Lockram Lane, Witham, Essex. UK. CM8 2BJ. Tel: 01376 514008.

Add £2 per order for UK post and packing. Make cheques payable to EPT Educational Software.

Visa and Mastercard orders accepted - please give card number, expiry date and cardholders address if different from the delivery address.

OVERSEAS ORDERS: Add £2.50 postage for countries in the E.E.C. Overseas readers, outside the E.E.C. countries add £3.50 for airmail postage.

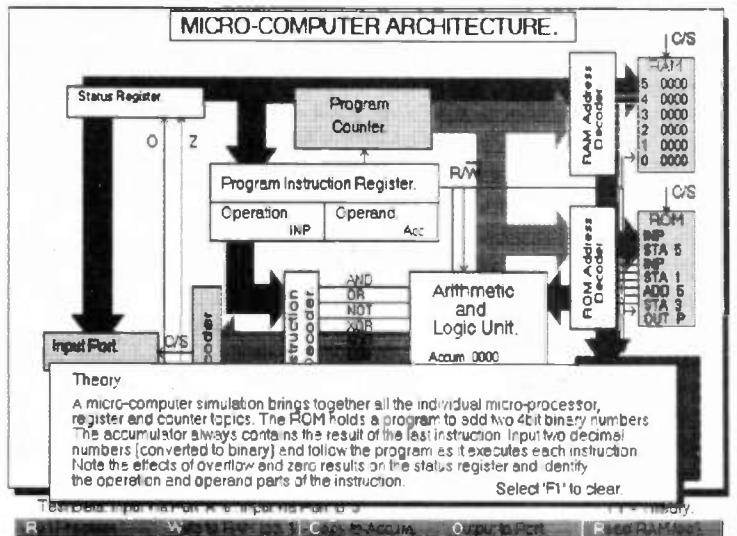

GCSE ELECTRONICS VERSION 2.0

Designed to complement the *EPE Teach-In* No. 7 publication, which contains a complete electronics course aimed at GCSE and A Level students, this software can also be used as a stand alone learning package for everyone interested in electronics. From simple d.c. current flow and Ohm's Law it covers the whole GCSE syllabus including a.c., semiconductors, op.amps, digital electronics, radio and fibre optic communications, digital numbering systems and goes on to look at microprocessor c.p.u.s, 6502 addressing modes and instruction sets. It even produces a program listing, which can be saved or retrieved from hard disk, when any of the instructions from the listed instruction set are input, thus allowing the user to monitor the registers for each of the addressing modes.

The original version is now widely used in schools and colleges throughout the UK.

An interactive, user friendly medium which assists learning in an enjoyable and interesting way.

Only £39.95

For more information or software upgrades call us on 01376 514008

GCSE MATHS now version 2.0

A series of programs covering all the major topics required by the school syllabus. Designed to be user friendly enabling you to study or revise in what we believe is an interesting and enjoyable way. There are nearly one hundred and fifty menu driven screens with interactive graphics, enabling a "learning through doing" approach to encourage experimentation. Now being used in many schools throughout the UK.

Only £49.95

SURVEILLANCE PROFESSIONAL QUALITY KITS

No. 1 for Kits

Whether your requirement for surveillance equipment is amateur, professional or you are just fascinated by this unique area of electronics SUMA DESIGNS has a kit to fit the bill. We have been designing electronic surveillance equipment for over 12 years and you can be sure that all our kits are very well tried, tested and proven and come complete with full instructions, circuit diagrams, assembly details and all high quality components including fibreglass PCB. Unless otherwise stated all transmitters are tuneable and can be received on an ordinary VHF FM radio.

Genuine SUMA kits available only direct from Suma Designs. Beware inferior imitations!

UTX Ultra-miniature Room Transmitter
Smallest room transmitter kit in the world! Incredible 10mm x 20mm including mic. 3-12V operation. 500m range.....£16.45

MTX Micro-miniature Room Transmitter
Best-selling micro-miniature Room Transmitter
Just 17mm x 17mm including mic. 3-12V operation. 1000m range.....£13.45

STX High-performance Room Transmitter
Hi performance transmitter with a buffered output stage for greater stability and range. Measures 22mm x 22mm including mic. 6-12V operation, 1500m range.....£15.45

VT500 High-power Room Transmitter
Powerful 250mW output providing excellent range and performance. Size 20mm x 40mm. 9-12V operation. 3000m range.....£16.45

VXT Voice Activated Transmitter
Triggers only when sounds are detected. Very low standby current. Variable sensitivity and delay with LED indicator. Size 20mm x 67mm. 9V operation. 1000m range...£19.45

HVX400 Mains Powered Room Transmitter
Connects directly to 240V AC supply for long-term monitoring. Size 30mm x 35mm. 500m range.....£19.45

SCRX Subcarrier Scrambled Room Transmitter
Scrambled output from this transmitter cannot be monitored without the SCDM decoder connected to the receiver. Size 20mm x 67mm. 9V operation. 1000m range.....£22.95

SCLX Subcarrier Telephone Transmitter
Connects to telephone line anywhere, requires no batteries. Output scrambled so requires SCDM connected to receiver. Size 32mm x 37mm. 1000m range.....£23.95

SCDM Subcarrier Decoder Unit for SCRXX
Connects to receiver earphone socket and provides decoded audio output to headphones. Size 32mm x 70mm. 9-12V operation.....£22.95

ATR2 Micro Size Telephone Recording Interface
Connects between telephone line (anywhere) and cassette recorder. Switches tape automatically as phone is used. All conversations recorded. Size 16mm x 32mm. Powered from line.....£13.45

UTLX Ultra-miniature Telephone Transmitter
Smallest telephone transmitter kit available. Incredible size of 10mm x 20mm! Connects to line (anywhere) and switches on and off with phone use. All conversations transmitted. Powered from line. 500m range.....£15.95

TLX700 Micro-miniature Telephone Transmitter
Best-selling telephone transmitter. Being 20mm x 20mm it is easier to assemble than UTLX. Connects to line (anywhere) and switches on and off with phone use. All conversations transmitted. Powered from line. 1000m range.....£13.45

STLX High-performance Telephone Transmitter
High performance transmitter with buffered output stage providing excellent stability and performance. Connects to line (anywhere) and switches on and off with phone use. All conversations transmitted. Powered from line. Size 22mm x 22mm. 1500m range.....£16.45

TKX900 Signalling/Tracking Transmitter
Transmits a continuous stream of audio pulses with variable tone and rate. Ideal for signalling or tracking purposes. High power output giving range up to 3000m. Size 25mm x 63mm. 9V operation.....£22.95

CD400 Pocket Bug Detector/Locator
LED and piezo bleeper pulse slowly, rate of pulse and pitch of tone increase as you approach signal. Gain control allows pinpointing of source. Size 45mm x 54mm. 9V operation.....£30.95

CD600 Professional Bug Detector/Locator
Multicolour readout of signal strength with variable rate bleeper and variable sensitivity used to detect and locate hidden transmitters. Switch to AUDIO CONFORM mode to distinguish between localised bug transmission and normal legitimate signals such as pagers, cellular, taxis etc. Size 70mm x 100mm. 9V operation.....£50.95

QTX180 Crystal Controlled Room Transmitter
Narrow band FM transmitter for the ultimate in privacy. Operates on 180 MHz and requires the use of a scanner receiver or our QRX180 kit (see catalogue). Size 20mm x 67mm. 9V operation. 1000m range.....£40.95

QLX180 Crystal Controlled Telephone Transmitter
As per QTX180 but connects to telephone line to monitor both sides of conversations. 20mm x 67mm. 9V operation. 1000m range.....£40.95

QSX180 Line Powered Crystal Controlled Phone Transmitter
As per QLX180 but draws power requirements from line. No batteries required. Size 32mm x 37mm. Range 500m.....£35.95

QRX180 Crystal Controlled FM Receiver
For monitoring any of the 'Q' range transmitters. High sensitivity unit. All RF section supplied as a pre-built and aligned module ready to connect on board so no difficulty setting up. Outpt to headphones. 60mm x 75mm. 9V operation.....£60.95

A build-up service is available on all our kits if required.

UK customers please send cheques, POs or registered cash. Please add £1.50 per order for P&P. Goods despatched ASAP allowing for cheque clearance. Overseas customers send sterling bank draft and add £5.00 per order for shipment. Credit card orders welcomed on 0827 714476.

OUR LATEST CATALOGUE CONTAINING MANY MORE NEW SURVEILLANCE KITS NOW AVAILABLE. SEND TWO FIRST CLASS STAMPS OR OVERSEAS SEND TWO IRCS.

★★★ Specials ★★★

DLTX/DLRX Radio Control Switch
Remote control anything around your home or garden, outside lights, alarms, paging system etc. System consists of a small VHF transmitter with digital encoder and receiver unit with decoder and relay output, momentary or alternate, 8-way di1 switches on both boards set your own unique security code. TX size 45mm x 45mm. RX size 35mm x 90mm. Both 9V operation. Range up to 200m.
Complete System (2 kits).....£50.95
Individual Transmitter DLTX.....£19.95
Individual Receiver DLRX.....£37.95

MBX-1 Hi-Fi Micro Broadcaster
Not technically a surveillance device but a great idea! Connects to the headphone output of your Hi-Fi, tape or CD and transmits Hi-Fi quality to a nearby radio. Listen to your favourite music anywhere around the house, garden, in the bath or in the garage and you don't have to put up with the DJ's choice and boring waffle. Size 27mm x 60mm. 9V operation. 250m range.....£20.95

**SUMA
DESIGNS**

**DEPT. EE
THE WORKSHOPS, 95 MAIN ROAD,
BAXTERLEY, NEAR ATHERSTONE,
WARWICKSHIRE CV9 2LE
VISITORS STRICTLY BY APPOINTMENT ONLY**



**Tel/Fax:
01827 714476**

SUPER SENSATIONAL SUMMER SALE

OUT NOW! RING, WRITE, FAX or call in for your **FREE** copy of our 64 page catalogue!

MICROPHONE



SALE PRICE
£14.95

Z5964 Audix HM230S/Tact UDM 100 professional dynamic mic with on/off switch and cardioid characteristics. 5m lead with XLR socket fitted mic end. Impressive spec! 600R impedance. Supplied with clip and adaptor, individually boxed. List price £44.06

HIGH VOLTAGE CAPACITORS



X3215 33µF 250V size 25x16 **5/£0.75**
X3191 100µF 160V size 40x25 **5/£0.75**
X3189 100µF 400V size 31x25 DP 3.89 **£1.50**
X3221 150µF 385V size 48x36 DP 3.88 **£1.50**
X3190 470µF 350V size 51x30 DP 6.00 **£2.25**

FANS



X6082 **X6084** **X6085** **X6086**

X6082 120x120x38mm 220V ac, various makes but all diecast frame and metal blades. **SALE £2.00**
X6083 As above but 115V ac **SALE £1.70**
X6084 Deeper than usual, this Papst fan is 120x120x55mm. 220V ac **SALE £2.35**
X6085 Same as X6046 except no 5V tap. **SALE £4.00**
X6086 170mm dia x 51mm deep, but with flattened sides 150mm across, this fan is made by Comair Rotron. Rated 24V DC 1A. **SALE £3.50**

AMSTRAD PRINTER MECHANISM

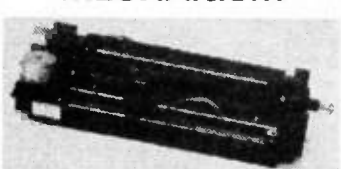

X9013 Brand spanking new mech. but not sure which model printer this was intended for. The Amstrad part no is Z70315 it's virtually complete, just the print head missing. Ideal for modellers to strip down - there's a wealth of mechanical bits and pieces + 2 24V, 24 position stepper motors and an opto slotted switch. **£6.95**

SALE PRICE
£3.00

Electronics Template

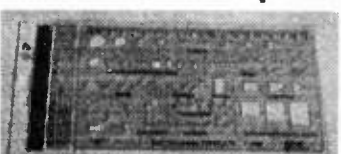

(Normally £1.99)
Order Code H80

SALE PRICE
£1.50

POWER SUPPLIES



SALE PRICE
£15.00

Z9157 One of the best power supplies we've seen for the money - this 397 watt switch mode beauty is one of the highest quality, made by Delta Electronics Inc. Removed from equipment, but in excellent condition (less than a year old!) the unit is totally enclosed in a steel case 340x152x152mm. It has an IEC mains inlet with suppressor fitted and on/off mains rocker switch, and all outputs are on leads with power connectors. Now for the spec:

Inputs: 100-120V @ 10A or 200-240V @ 6A. Outputs: +5V @ 40A; +12V @ 15A; -5V @ 1A; -12V @ 1A switchable on front panel. A 12Vdc 120x120mm fan is fitted at the rear of the case. Current distributor price of a unit of this ilk would be around £400.

ETHERPORT FOR MACINTOSH



X9012 Shiva EtherPort SE. This brand new boxed set of parts from Novell for networking Apple Macintosh computers is fantastic value. You get the Etherport SE Controller Board, the Etherport SE Access Board, the software on a 3.5" disk, an Installation Guide and a User's Guide. Wonderwhat the original cost was? Our normal price £14.95

SALE PRICE
£11.70

MICROPHONE

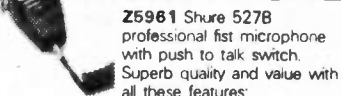

Z5961 Shure 527B professional fist microphone with push to talk switch. Superb quality and value with all these features:

- A. Dynamic
- B. Triple flex heavy duty cord
- C. Noise cancelling
- D. Low impedance

List Price is an incredible **£71.67!**
 Individually Boxed
 Our Price: **£29.95**

SALE PRICE
£19.95

EXCELLENT CASE OFFER



F860D Steel case 230x190x56mm with ally front panel. Comes in flat pack for self assembly. Cat price £10.99

SALE PRICE
£2.95

X5729 Set of 3 back to back connectors: 25W D socket - 25W D socket, 25W D socket - 25W D plug, 25W D socket - 36W Centronics plug. These are not 'straight through' connectors, but covers are easily removable to wire in any way desired. Price for all 3: **£3.95**

NICAD BATTERIES

Z4150 Back in stock! The popular ex-radio batteries containing 8xAA NiCads. Generally rejected because of physical damage - but there may be the occasional duff cell. Total capacity: 10V @ 500mA. Price **£1.60**

SWITCH MODE PSU's

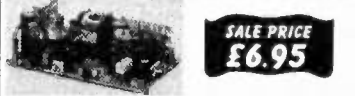

X6016 Brand new, boxed SMPSU by ASTEC. Mains in, -12V 0.2A +12V 2A and +5V 5A out. 44W max PCB 160x100mm. **£9.95**

SALE PRICE
£6.95

BACK IN STOCK



Z5789 We've been very lucky to secure a further few hundred of this extremely popular and useful gear set - and at the same price, too! There are 7 items:(a) Steel 56.6mm dia 3.7mm thick with boss 13.4mm dia and 7.7mm thick 6mm hole.(b) Two of these: steel, 31.5mm dia, 6mm thick with boss 13.4mm dia 9.4mm thick 6mm hole.(c) & (d) Steel rack 86mm long and pinion with 9mm hole(e) & (f) Plastic bevel gears giving right angle drive. The larger is 36.4mm dia with steel boss 9mm dia and 5mm hole, and the smaller is 18.5mm dia with 2mm hole. As can be seen from the pic, they can all be put together in a chain if required. Complete set.

SALE PRICE
£2.95

VERSATILE INSTRUMENT CASE



X6147 Versatile soft padded instrument case measuring 250x250x80mm, with expanding side pocket 175x80x90mm. Both have velcro fasteners. On one side are two apertures, one 15x15mm and the other 80x40mm covered by a leatherette flap. Strong carrying handle. Grey material with black edging. Stacks of uses - toolbag, electrical/electronic equipment, sandwiches/drinks, knitting, cassettes (holds 36), CDs (14), school books...

SALE PRICE
£2.95

99P CLOCK



All this for 99p!

Z3873 Super Offer! A complete clock in a 40x25mm module 9V operation with sleep B snooze, 24hr alarm, FM, color and alarm indicators. Sample last/slow setting modes. 6 display modes. 12/24hr selectable, display brightness control.

TRANSFORMERS



SALE PRICE
£2.35

Z6874 Great value on this 60 watt mains transformer, suitable for PCB mounting or bolted to a chassis. Two main windings: 12V 2A and 16V 2A. There are also two low current windings - 5V 50mA and 38V 50mA. Overall size 64x53x65mm. Only **£3.50** or a box of 20 for just **£35.00**

CAR VFD

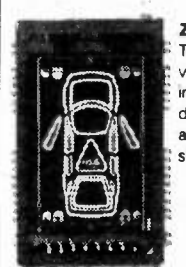

Z3100 Car VFD. This shows the plan view of a saloon and indicates whether doors are shut, lights are on etc. With data sheet. **£2.00**

SALE PRICE
£1.00

4 WAY TRAILING SOCKET WITH 2.7M LEAD & PLUG

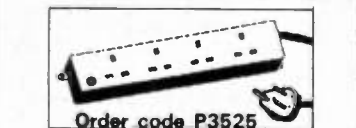

Order code **P3525**
Was **£10.70!**

SALE PRICE
£6.95

Words & Figures

by Lfetree
546 page manual, spread out menu, disks, boxed. Features include:

- 1-2-3 1A compatible Wks FILES
- 9999 rows by 256 columns.
- Supports 1-2-3 1A functions, macros
- Protected and hidden cells
- Horizontal or vertical split screen
- Move, copy, transpose ranges
- Sparse matrix data storage
- Supports LIM Expanded Memory
- Uses 8087, 80287 main compressor
- Word Processor:
 - Include 'live' spreadsheet data in document
 - Two-line headers and footers
 - Bold, underline shown on-screen
 - Global find and replace
 - Automatic reformat, word wrap
 - Import text from ASCII files
 - Supports over 200 printers.
- Auditor
 - Toggle from worksheet to audit display
 - Pinpoint circular references
 - Identify source of other errors.
- Data Management
 - Three key data sort
 - 7 database statistical function
 - Query using up to 32 search criteria, wild card
- Graphics
 - Line and XY graphs, scatter plots, pie and bar charts
 - Superset of 1-2-3 1A type fonts
 - High-resolution display (EGA, Hercules)
 - Output to printers and plotters
- Requirements: DOS 2.0 or higher 256k RAM; Printers: Text - over 200 including Epsons, BM, Tandy, HP Laser Jet, and many others. Graphics - Epson, HP LaserJet, Postscript printers and others. **Z5442** (6.25" version) **Z6443** (3.5" version) **£14.95** each

STOP PRESS ★ PRIZE ★ STOP PRESS

Prize Draw **DRAN** FREE Clock
 Win an £850 Hitachi Oscilloscope for just **£1** in our prize draw **SEE SUMMER CATALOGUE FOR DETAILS** Get a FREE clock module with every order over **£20**

Phone Nos: **SALES 01703 236363** Accounts **231003**
 Fax (All depts) **236307** FaxOnDemand **236315**

*To obtain latest lists, info etc just dial 01703 236315 from any fax and follow instructions. Single prices in this advert include VAT; Quantity prices don't include VAT. Min order (9.50 next day). Min credit card £12.

orders welcome from Education - min invoice charge £15, payment accepted by cheque, PO, cash, book tokens, Switch, Access, Visa. Connect Our stores (over 10,000 sq ft) have enormous stocks. We are open 8 - 5.30 Mon - Sat. Come and see us!

27D Park Road Southampton SO15 3UQ



MOTORS - BATTERY 1V-12V

3 Different Model Motors, £1, Order Ref: 35.
Spin to Start 3V DC Motors for model aircraft etc, 5 for £1, Order Ref: 134.
Cassette Motor 1.5V, powerful, speed increases with voltage, £1, Order Ref: 224.
Mini Cassette Motor 6V to 9V working, £1, Order Ref: 944.
High Efficiency Motor for solar cell working, £1, Order Ref: 643.
12V Motor ex BSR record player, £1, Order Ref: 687.
9V Cassette Motor, brushless, £1.50, Order Ref: 1.5P14.
1/2HP 12V D.C. Motor, Smiths, £6, Order Ref: 6P47.
1/4HP 12V D.C. Motor, Smiths, £8, Order Ref: 8P54.
1/8HP 12V D.C. Motor, Smiths, £10, Order Ref: 10P125.

MAINS MOTORS WITH GEARBOXES

5 r.p.m. 60W, £5, Order Ref: 5P54.
110 r.p.m. 60W, £5, Order Ref: 5P172.
150 r.p.m. 60W, £8, Order Ref: 8P57.
200 r.p.m. 60W, £8, Order Ref: 8P58.
1 Rev Per 24hrs 2W Motor, £1, Order Ref: 89.
1 Rev Per 4hrs 2W Motor, £1, Order Ref: 2P239.
1 Rev Per Hour 2W Extra Small Motor, 2 for £1, Order Ref: 500.
12 r.p.m. Motor, £2, Order Ref: 2P342.
20 r.p.m. Motor, £1, Order Ref: 1010.
1/4 r.p.m. 2W Motor, £2, Order Ref: 2P346.
4 r.p.m. 2W Motor, £2, Order Ref: 2P393.
15 r.p.m. 2W Motor, £2, Order Ref: 2P321.
200 r.p.m. 2W Motor, £1, Order Ref: 175.
250 r.p.m. 2W Motor, £1, Order Ref: 750.

MAINS MOTORS

3/4 Stack Motor with 1/4" spindle, £1, Order Ref: 85.
Stack Motor 1 1/2" with good length spindle from each side, £2, Order Ref: 2P55.
Stack Motor 1 1/4" with 4" long spindle, £2, Order Ref: 2P203.
Motor by Crompton 0-06HP but little soiled, £3, Order Ref: 3P4.
JAP Made Precision Motor balanced rotor reversible, 1500r.p.m., £2, Order Ref: 2P12.
EMI 2-speed and reversible, £4, Order Ref: 4P80.
Very Powerful Mains Motor with extra long (2 1/2") shafts extending out each side. Makes it ideal for a reversing arrangement for, as you know, shaded-pole motors are not reversible, £3, Order Ref: 3P157.

MOTORS - STEPPER

Mini Motor by Philips 12V-7.5 degree step, quite standard, data supplied, only £1, Order Ref: 910.
Medium Powered Jap made 1.5 degree step, £3, Order Ref: 3P182.
Very Powerful Motor by American Philips, 10V-14V 7.5 degree step, £10, Order Ref: 10P128.

MAINS TRANSFORMERS

5V 45A, £20, Order Ref: 20P16.
6V 1A, 2 for £1, Order Ref: 9.
8V 1A, £1, Order Ref: 212.
9V 1/2A, 2 for £1, Order Ref: 266.
9V 1A, £1, Order Ref: 236.
10V 1A, £1, Order Ref: 492.
12V 1/2A, 2 for £1, Order Ref: 10.
12V 1A, £1, Order Ref: 436.
12V 2A, £2, Order Ref: 2P337.
15V 1A, £1, Order Ref: 267.
17V 1A, £1, Order Ref: 492.
18V 1/2A, £1, Order Ref: 491.
20V 4A, £3, Order Ref: 3P106.
24V 1/2A, £1, Order Ref: 337.
28V 2 1/2A, £4, Order Ref: 4P24.
36V 3A, £3, Order Ref: 3P14.
40V 2A, £3, Order Ref: 3P107.
43V 3 1/2A, £4, Order Ref: 4P14.
50V 2A fully shrouded, £5, Order Ref: 5P210.
50V 15A, £20, Order Ref: 20P2.
90V 1A, £4, Order Ref: 4P39.
875V 100mA, £5, Order Ref: 5P166.
3kV 3mA, £7, Order Ref: 7P7.
4kV 2mA, £5, Order Ref: 5P139.
6V-0-6V 10VA, £1, Order Ref: 281.
9V-0-9V 5VA, £1, Order Ref: 661.
12V-0-12V 2V 3VA, £1, Order Ref: 636.
12V-0-12V 6VA, £1, Order Ref: 811.
12V-0-12V 40VA, £3.50, Order Ref: 3.5P7.
15V-0-15V 1VA, £1, Order Ref: 937.
15V-0-15V 15VA, £2, Order Ref: 2P68.
18V-0-18V 10VA, £1, Order Ref: 813.
20V-0-20V 10VA, £1, Order Ref: 812.
20V-0-20V 10VA, £2, Order Ref: 2P85.
20V-0-20V 20VA, £2, Order Ref: 2P138.
20V-0-20V 80VA, £4, Order Ref: 4P36.
36V-0-36V 20VA, £2, Order Ref: 2P156.
90V-0-90V 100VA, £4, Order Ref: 4P39.

SPECIAL TRANSFORMERS

15VA gives 1V, 7V, 8V, 9V or 10V, £1, Order Ref: 744.
8V + 8V 10VA, £15, Order Ref: 15P51.
38V-0-38V 15VA with regulator winding, £10, Order Ref: 10P36.
230V-115V auto transformer 100VA, £2, Order Ref: 2P6.
Ditto but 10VA, £1, Order Ref: 822.
Ditto but 250VA, £3, Order Ref: 3P142.

MISCELLANEOUS BARGAINS

ALMOST ALL OF THE BARGAINS OFFERED LAST MONTH ARE STILL AVAILABLE. IF IN DOUBT, GIVE US A RING.

0V-20V DC Panel Meter. This is a nice size 65mm sq. It is ideal if you are making a voltage variable instrument or battery charger. Price £3, Order Ref: 3P188.

Flashing Beacon. Ideal for putting on a van, a tractor or any vehicle that should always be seen. Uses a XENON tube and has an amber coloured dome. Separate fixing base is included so unit can be put away if desirable. Price £7.50, Order Ref: 7.5P13.

12V 2A Transformer. £2, Order Ref: 2P337.

Another 12V-0V-12V Transformer is a 50VA and is suitable for dropping through the chassis or as it is fitted with four pillars it can be mounted above the chassis. Also should you want a 12V 4A transformer then this one should be quite suitable, you use just one half of the secondary. Price £3.50, Order Ref: 3.5P7.

High Resolution Monitor. 9" by Philips, in metal frame for easy mounting. Brand new, offered at less than the price of the tube alone, £15, Order Ref: 15P1.

15W 8" 8 Ohm Speaker and 3" Tweeter. Amstrad, made for their high quality music centre, £4 per pair, Order Ref: 4P57.

Insulation Tester with Multimeter. Internally generates voltages which enables you to read insulation directly in megohms. The multimeter has four ranges, AC/DC volts, 3 ranges milliamps, 3 ranges resistance and 5 amp range. These instruments are ex-British Telecom but in very good condition, tested and guaranteed OK, probably cost at least £50, yours for only £7.50 with leads, carrying case £2 extra, Order Ref: 7.5P4.

We Have Some of the above testers but slightly faulty, not working on all ranges, should be repairable, we supply diagram, £3, Order Ref: 3P176.

250W Light Dimmer. Will fit in place of normal wall switch, only £2 each, Order Ref: 2P380. Note these are red, blue, green or yellow but will take emulsion to suit the colour of your room. Please state colour required.

LCD 3 1/2" Digit Panel Meter. This is a multi-range voltmeter/ammeter using the A-D converter chip 7106 to provide five ranges each of volts and amps. Supplied with full data sheet. Special snip price of £12, Order Ref: 12P19.

Multi Tester. 19 ranges, ex-British Telecom, reconditioned. These measure AC and DC volts, DC milliamps and have three resistance ranges made to BT specification and 20,000 ohm movement. Complete with test prods, £8.50, Order Ref: 8.5P3. Carrying case with handle £2 extra.

Speed Controller. Suitable for the C5 or other DV 12V motor. Complete kit £18, Order Ref: 18P8, already made, £29.50, Order Ref: 29.5P2.

Clock Module. 2" LCD display, requires 1.5V battery, goes back to zero when switched off so ideal for timing operations, £2, Order Ref: 2P307.

Mini Blow Heater. 1kW, ideal for under desk or airing cupboard, etc. Needs only a simple mounting frame, £5, Order Ref: 5P23.

Medicine Cupboard Alarm. Or it could be used to warn when any cupboard door is opened. The light shining on the unit makes the bell ring. Complete built and neatly cased, requires only a battery, £3, Order Ref: 3P155.

Don't Let it Overflow. Be it bath, sink cellar, sump or any other thing that could flood. This device will tell you when the water has risen to the pre-set level. Adjustable over quite a useful range. Neatly case for wall mounting, ready to work when battery fitted, £3, Order Ref: 3P156.

Quartz Clock Mechanisms. Complete with 2 sets of hands, modern or period, made up ready to work, £3, Order Ref: 3P111.

Amstrad Modem FM240. In as new condition but customer return, so you may need to fault find, £8, Order Ref: 6P34.

£1 BARGAIN PACKS

This is the £1 Bargain Packs List 2 - watch out for lists 3 and 4 next month.

3 x Battery Model Motors, tiny, medium and large. Order Ref: 35.
2 x Tuning Condensers for medium wave radios. Order Ref: 36.
Miniature 12V Relay with low current consuming coil, 2 x 3A changeover contacts. Order Ref: 51.
2 x Ferrite Slab Aerials with medium wave coils. Ideal for building small radio. Order Ref: 61.
2 x 25W 6 OHM Variable Resistors. Ideal for loud speaker volume control. Order Ref: 69.
2 x Wire Wound Variable Resistors in any of the following values, 18, 35, 50, 100 ohms, your choice. Order Ref: 71.
4 x 30A Porcelain Fuse Holders. Make your own fuse board. Order Ref: 82.
2 x 8 1/2" Meal Fan Blades for 1/2" shaft. Order Ref: 86/6 1/2.
Mains Motor to suit the 6 1/2" blades. Order Ref: 88.
1 x 4.5V 150mA DC Power Supply. Fully enclosed so quite safe. Order Ref: 104.
10 each red and black small size Crocodile Clips. Order Ref: 116.
15mm Twin Wire, screened. Order Ref: 122A.
100 Plastic Headed Cable Clips, nail in type, several sizes. Order Ref: 123.
4 x MES Batten Holders Order Ref: 126.
Complete Pocket Size MW Radio, believed OK but not tested. Order Ref: 133R.
4 x 2 Circuit Micro Switches (Licon). Order Ref: 157.
1 x 13A Switch Socket, quite standard but coloured. Order Ref: 164.
1 x 30A Panel Mounting Toggle Switch, double pole. Order Ref: 166.
2 x Neon Numicator Tubes. Order Ref: 170.
100 x 1/4 Rubber Grommets. Order Ref: 181.
6 x BC Lamp Holder Adaptors. Order Ref: 191.
6 x Superior Type Push Switches. Make your own keyboard. Order Ref: 201.
Mains Transformer 8V-0-8V 1/2A. Order Ref: 212.
2 x Sub Min Toggle Switches. Order Ref: 214.
High Power 3" Speaker (11W 8ohm). Order Ref: 246.
Medium Wave Permeability Tuner. Its almost a complete radio with circuit. Order Ref: 247.
6 x Screwdown Terminals with through panel insulators. Order Ref: 264.
LCD Clock Display. 1/2" figures. Order Ref: 329.
10 x Push On Long Shafted Knobs for 1/4" spindle. Order Ref: 339.
2 x ex-GPO Speaker Inserts, ref 4T. Order Ref: 352.
100 x Sub Min 1F Transformers. Just right if you want coil formers. Order Ref: 360.
1 x 24V 200mA PSU. Order Ref: 393.
1 x Heating Element, mains voltage 100W, brass encased. Order Ref: 8.
1 x Mains Interference Suppressor. Order Ref: 21.
3 x Rocker Switches, 13A mains voltage. Order Ref: 41.
1 x Mini Uni Selector with diagram for electronic jig-saw. Order Ref: 56.
2 x Appliance Thermostats, adjustable up to 15A. Order Ref: 65.
1 x Mains Motor with gearbox giving 1 rev per 24 hrs. Order Ref: 89.
10 x Round Pointer Knobs for flatted 1/4" spindles. Order Ref: 295.
1 x Ceramic Wave Change Switch, 12 pole, 3 way with 1/4" spindle. Order Ref: 303.
1 x Tublar Hand Mike, suits cassette recorders, etc. Order Ref: 305.
2 x Plastic Stethosets, take crystal or magentic inserts. Order Ref: 331.
20 x Pre-set Resistors, various types and values. Order Ref: 332.
6 x Car Type Rocker Switches, assorted. Order Ref: 333.
10 x Long Shafted Knobs for 1/4" flatted spindles. Order Ref: 339.
1 x Reversing Switch, 20A double pole or 40A single pole. Order Ref: 343.
4 x Skirted Control Knobs, engraved 0-10. Order Ref: 355.
3 x Luminous Rocker Switches. Order Ref: 373.
2 x 1000W Tublar Heating Elements with terminal ends. Order Ref: 376.
1 x Mains Transformer Operated Nicad Charger, cased with leads. Order Ref: 385.
2 x Clockwork Motors, run for one hour. Order Ref: 389.

Prices include VAT. Send cheque/postal order or ring and quote credit card number. Add £3 post and packing. Orders over £25 post free.

M & B ELECTRICAL SUPPLIES LTD
Pilgrim Works (Dept. E.E.)
Stairbridge Lane, Bolney,
Sussex RH17 5PA
Telephone: 01444 881965
(Also fax but phone first)
Callers to 12 Boundary Road,
Hove, Sussex.

HART

HART AUDIO KITS - YOUR VALUE FOR MONEY ROUTE TO ULTIMATE HI-FI

HART KITS give you the opportunity to build the very best engineered hifi equipment there is, designed by the leaders in their field, using the best components that are available.

Every HART KIT is not just a new equipment acquisition but a valuable investment in knowledge, giving you guided hands-on experience of modern electronic techniques.

In short HART is your 'friend in the trade' giving you, as a knowledgeable constructor, access to better equipment at lower prices than the man in the street.

You can buy the reprints and construction manual for any kit to see how easy it is to build your own equipment the HART way. The FULL cost can be credited against your subsequent kit purchase.

Our list will give you full details of all our Audio Kits, components and special offers.

INTRODUCING

The Hart "Chiara"

Single-Ended Class "A" Headphone Amplifier.

Most modern high fidelity amplifiers either do not have a headphone output facility, or this may not be up to the highest standard.

The new Hart "Chiara" has been introduced as an add-on unit to remedy this situation, and will provide two ultra high quality headphone outlets. This is the first unit in our 2000 Range of modules to be introduced through the year. Housed in the neat, black finished, Hart Minibox it features the wide frequency response, low-distortion and "musicality" that one associates with designs from the renowned John Linsley Hood.

Both outputs will drive any standard high quality headphones with an impedance greater than 30 ohms and the unit is ideal for use with the Sennheiser range. A signal link-through makes it easy to incorporate into your system and two extra outputs, one at output level and one adjusted by the Volume control are available on the back panel. The high level output also makes a very useful line driver where remote mounted power amplifiers are used. Power requirements are very simple and can be provided by either of our new "Andante" power supplies. Use the K3565 to drive the "Chiara" on its own, K3550 if driving other modules as well.

Volume and Balance controls are provided and as befits any unit with serious aspirations to quality these are the ultra high quality Alps "Blue Velvet" components.

Very easily built, even by beginners, since all components fit directly on the single printed circuit board and there is no conventional wiring whatsoever. The kit has very detailed instructions, and even comes with a roll of Hart audiograde silver solder. It can also be supplied factory assembled and tested.

Selling for less than the total cost of all the components, if they were bought separately, this unit represents incredible value for money and makes an attractive and harmonious addition to any hifi system.

K2100 The total cost of a complete set of all components to build this unit is £126.37. Our special discount price for all parts bought together as a kit is.....**£109.50**

K2100SA Series Audiophile, with extra selected components.....**£112.46**

HART TC1D Triple Purpose TEST CASSETTE

Now available again and even better than before! Our famous triple purpose test cassette will help you set up your recorder for peak performance after fitting a new record/play head. This quality precision Test Cassette is digitally mastered in real time to give you an accurate standard to set the head azimuth, Dolby/VU level and tape speed, all easily done without test equipment.

TC1D Triple Purpose Test Cassette.....**£9.99**

Send or phone for your copy of our FREE List of these and many other Kits & Components. Enquiries from Overseas customers are equally welcome, but PLEASE send 2 IRCs if you want a list sent surface post, or 5 for Airmail. Ordering is easy. Just write or telephone your requirements to sample the friendly and efficient HART service. Payment by cheque, cash or credit card. A telephoned order with your credit card number will get your order on its way to you THAT DAY.

Please add part cost of carriage and insurance as follows: -INLAND Orders up to £20 - £1.50,

Orders over £20 - £3.50. Express Courier, next working day £10.

OVERSEAS - Please see the ordering information with our lists.

NEW BOOK

"Audio Electronics"

And now, hot off the press, yet another classic from the pen of John Linsley Hood. Following the ongoing enormous success of his "Art of Linear Electronics" the latest offering is the all-new edition of "Audio Electronics", now entirely re-written by the master himself.

Underlying audio techniques and equipment is a world of electronics that determines the quality of sound. For anyone involved in designing, adapting or using digital or analogue audio equipment understanding electronics leads to far greater control over the reproduced sound.

The subjects covered include tape recording, tuners, power output stages, digital audio, test instruments and loudspeaker crossover systems. John's lifetime of experience and personal innovation in this field allow him to apply his gift of being so familiar with his subject that he can write clearly about it and make it both interesting and comprehensible to the reader.

Containing 240 pages and over 250 line illustrations this new book represents great value for money at only £18.99 plus £2.50 postage. Send or telephone for your personal copy now.

ALPS "Blue Velvet" Precision Audio Controls



To fulfil the need for ultra high quality controls we import a special range of precision audio pots in values to cover most quality amplifier applications. All in 2-gang stereo format, with 20mm long 6mm diam. steel shafts, except for the 50K Log which is 25mm x 6mm. Overall size of the manual pot is 27W x 24H x 27Deep, motorised versions are 72-4mm Deep from the mounting face. Mounting bush for both types is 8mm diameter.

Now you can throw out those noisy ill-matched carbon pots and replace with the real hi-fi components only used selectively in the very top flight of World class amplifiers. The improvement in track accuracy and matching really is incredible giving better tonal balance between channels and rock solid image stability.

The motorised versions use a 5V DC motor coupled to the normal control shaft with a friction clutch so that the control can be operated manually or electrically. The idea of having electrically operated pots may seem odd, archaic even, but it is in fact the only way that remote control can be applied to any serious Hi-Fi system without loss of quality. The values chosen are the most suitable available for a low loss passive volume and balance control system, allowing armchair control of these two functions.

Our prices represent such super value for pots of this quality due to large purchases for our own kits.

MANUAL POTENTIOMETERS

2-Gang 100K Lin.....**£15.67**

2-Gang 10K, 50K or 100K Log.....**£16.40**

2-Gang 10K Special Balance, zero crosstalk and zero centre loss.....**£17.48**

MOTORISED POTENTIOMETERS

2-Gang 20K Log Volume Control.....**£26.20**

2-Gang 10K RD Special Balance, zero crosstalk and less than 10% loss in centre position.....**£26.98**

REEL TO REEL HEADS

999R 2/4 R/P 100mH.....**£16.84**

We have a few erase heads to suit which can only be supplied when 2 R/P heads are purchased **£36.80**

TAPE RECORDER CARE PRODUCTS

DEM1 Mains Powered Tape Head

Demagnetizer, prevents noise on playback due to residual head magnetisation.....**£4.08**

DEM115 Electronic, Cassette Type, demagnetizer.....**£8.61**

LINSLEY HOOD 'SHUNT FEEDBACK' RIAA MOVING COIL & MOVING MAGNET PICKUP PRE AMPLIFIERS



The HART K1450 Magnetic pickup preamplifier kit features a totally discrete component implementation with a specially designed low input impedance front end and the superior sound of the Shunt Feedback circuitry. High quality components fitting to an advanced double-sided printed circuit board make this a product at the leading edge of technology that you will be proud to own. Nevertheless with our step by step instructions it is very easy and satisfying to assemble. The higher current consumption of this unit means that it is best powered by our new Andante Audio Power Supply, itself an advanced piece of technology in a matching case. This supplies the superbly smoothed and stabilised supply lines needed by any sensitive preamplifier and features a fully potted Hi-grade toroidal transformer along with a special limited shift earth system for hum free operation. The K1450 is suitable for all moving coil and moving magnet transducers this unit is especially recommended for, and will extract the very best from the modern generation of low output high quality moving coil transducers.

K1450 Kit, complete with all parts ready to assemble inside the fully finished 228mm x 134mm x 63mm case. Kit includes full, easy to follow, assembly instructions as well as the Hart Guide to PCB Construction, we even throw in enough Hart Audiograde Silver Solder to construct your kit!

.....**£111.58**

K1450SA Series Audiophile version with selected components.....**£133.94**

HIGH QUALITY REPLACEMENT CASSETTE HEADS



Do your tapes lack treble? A worn head could be the problem. For top performance cassette recorder heads should be replaced every 1,500 hours. Fitting one of our high quality replacement heads could restore performance to better than new! Standard Inductances and mountings make fitting easy on nearly all machines (Sony are special dimensions, we do not stock) and our TC1 Test Cassette helps you set the azimuth spot on. As we are the actual importers you get prime parts at lower prices, compare our prices with other suppliers and see! All our heads are suitable for use with any Dolby system and are normally available ex-stock. We also stock a wide range of special heads for home construction and industrial users.

HC80 NEW RANGE High Beta Permalloy Stereo head. Modern space saver design for easy fitting and lower cost. Suitable for chrome, metal and ferric tapes, truly a universal replacement head for everything from hi-fi decks to car players and at an incredible price too!.....**£11.70**

HRP373 Downstream monitor combi head.....**£62.59**

HQ551A 4-Track R/P.....**£8.75**

HQ551S Sony Mount 4-Tr. R/P.....**£14.90**

HQR560 Rotary Base 12.5mm R/P/E.....**£21.90**

HQR570 Rotary Base 15mm R/P/E.....**£22.59**

HQR580 Rotary Base 12.5mm R/P.....**£14.29**

HART Classical CD's.

Top quality, Full Digital (DDD), over 100 titles from only **£1.99!** Ring or send for your list!

TECHNICAL BOOKSHELF

We stock a good range of books of interest to the electronics and audio enthusiast, including many reprinted classics from the valve era. Some were in last months advertisement, but see our list for the full range.

New this month is the GEC Valve designs book at **£18.95**, and the VTL Book, a modern look at valve designs, **£17.95**.

QUALITY AUDIO KITS

24 hr. SALES LINE (01691) 652894

ALL PRICES INCLUDE UK/EC VAT

HART

HART ELECTRONIC KITS LTD
8 PENTLAND HILL
OSWESTRY, SHROPSHIRE
SY10 8AF



SHOP OPEN 9-5 MON-FRI. CLOSED SAT --- OFFICIAL ORDERS WELCOME

EPE MICROCONTROLLER P.I. TREASURE HUNTER

The latest MAGENTA DESIGN - highly stable & sensitive - with μ C control of all timing functions and advanced pulse separation techniques.

- New circuit design 1994
- High stability drift cancelling
- Easy to build & use
- No ground effect, works in seawater



- Detects gold, silver, ferrous & non-ferrous metals

- Efficient quartz controlled microcontroller pulse generation.
- Full kit with headphones & all hardware

KIT 847.....£63.95

DIGITAL LCD THERMOSTAT

A versatile thermostat using a thermistor probe and having an l.c.d. display. MIN/MAX memories, -10 to 110 degrees celsius, or can be set to read in Fahrenheit. Individually settable upper and lower switching temperatures allow close control, or alternatively allow a wide 'dead band' to be set which can result in substantial energy savings when used with domestic hot water systems. Ideal for greenhouse ventilation or heating control, aquaria, home brewing, etc. Mains powered, 10A SPCO relay output. Punched and printed case.

KIT 841.....£29.95

PORTABLE ULTRASONIC PEST SCARER

A powerful 23kHz ultrasound generator in a compact hand-held case. MOSFET output drives a special sealed transducer with intense pulses via a special tuned transformer. Sweeping frequency output is designed to give maximum output without any special setting up.

KIT 842.....£22.56

DIGITAL CAPACITANCE METER

A really professional looking project. Kit is supplied with a punched and printed front panel, case, p.c.b. and all components. Quartz controlled accuracy of 1%. Large clear 5 digit display and high speed operation. Ideal for beginners - as the μ F, nF and pF ranges give clear unambiguous read out of marked and unmarked capacitors from a few pF up to thousands of μ F.

KIT 493.....£39.95

ACOUSTIC PROBE

A very popular project which picks up vibrations by means of a contact probe and passes them on to a pair of headphones or an amplifier. Sounds from engines, watches, and speech travelling through walls can be amplified and heard clearly. Useful for mechanics, instrument engineers, and nosy parkers!

KIT 740.....£19.98

WINDICATOR

A novel wind speed indicator with LED read-out. Kit comes complete with sensor cups, and weatherproof sensing head. Mainspower unit £5.99 extra.

KIT 856.....£28.00

BAT DETECTOR

An excellent circuit which reduces ultrasound frequencies between 20 and 100 kHz to the normal (human) audible range. Operating rather like a radio receiver the circuit allows the listener to tune-in to the ultrasonic frequencies of interest. Listening to Bats is fascinating, and it is possible to identify various different types using this project. Other uses have been found in industry for vibration monitoring etc.

KIT 814.....£21.44

1000V & 500V INSULATION TESTER



Superb new design. Regulated output, efficient circuit. Dual-scale meter, compact case. Reads up to 200 Megohms. Kit includes wound coil, cut-out case, meter scale, PCB & ALL components.

KIT 848.....£32.95

MOSFET MkII VARIABLE BENCH POWER SUPPLY 0-25V 2.5A.

Based on our MkI design and preserving all the features, but now with switching pre-regulator for much higher efficiency. Panel meters indicate Volts and Amps. Fully variable down to zero. Toroidal mains transformer. Kit includes punched and printed case and all parts. As featured in April 1994 EPE. An essential piece of equipment.

KIT 845.....£64.95



ULTRASONIC PEST SCARER

Keep pets/pests away from newly sown areas, fruit, vegetable and flower beds, children's play areas, patios etc. This project produces intense pulses of ultrasound which deter visiting animals.

- KIT INCLUDES ALL COMPONENTS, PCB & CASE
- EFFICIENT 100V TRANSDUCER OUTPUT
- COMPLETELY INAUDIBLE TO HUMANS
- UP TO 4 METRES RANGE
- LOW CURRENT DRAIN

KIT Ref. 812.....£14.81



'COMSTEP' P.C. COMPUTER STEPPING MOTOR INTERFACE

An exciting project supplied with two 200 step motors, interface board, and easy to use P.C. software.

Allows independent control of both motors - speed, direction, number of steps, and half/full step mode. Connects to computer parallel port. Requires 12V 1A D.C. supply and printer lead.

KIT 846 (with 2 motors)£67.00 (Printer lead £5.00)

SPACEWRITER

An innovative and exciting project. Wave the wand through the air and your message appears. Programmable to hold any message up to 16 digits long. Comes pre-loaded with "MERRY XMAS". Kit includes PCB, all components & tube + instructions for message loading.

KIT 849.....£16.99



12V EPROM ERASER

A safe low cost eraser for up to 4 EPROMS at a time in less than 20 minutes. Operates from a 12V supply (400mA). Used extensively for mobile work - updating equipment in the field etc. Also in educational situations where mains supplies are not allowed. Safety interlock prevents contact with UV.

KIT 790.....£28.51

MOSFET 25V 2.5A POWER SUPPLY

High performance design has made this one of our classic kits. Two panel meters indicate Volts and Amps. Variable from 0-25 Volts and current limit control from 0-2.5A. Rugged power MOSFET output stage. Toroidal mains transformer.

KIT 769.....£56.82

INSULATION TESTER

A reliable and neat electronic tester which checks insulation resistance of wiring and appliances etc., at 500 Volts. The unit is battery powered, simple and safe to operate. Leakage resistance of up to 100 Megohms can be read easily. A very popular college project.

KIT 444.....£22.37

DIGITAL COMBINATION LOCK

Digital lock with 12 key keypad. Entering a four digit code operates a 250V 16A relay. A special anti-tamper circuit permits the relay board to be mounted remotely. Ideal car immobiliser, operates from 12V. Drilled case, brushed aluminium keypad.

KIT 840.....£19.86

E.E. TREASURE HUNTER P.I. METAL DETECTOR MKI

Magenta's highly developed & acclaimed design. Quartz crystal controlled circuit MOSFET coil drive. D.C. coupled amplification. Full kit includes PCB, handle, case & search coil.

- KIT INC. HEADPHONES
- EFFICIENT CMOS DESIGN
- POWERFUL COIL DRIVE



- DETECTS FERROUS AND NON-FERROUS METAL - GOLD, SILVER, COPPER ETC.
- 190mm SEARCH COIL
- NO 'GROUND EFFECT'

KIT 815.....£45.95

HAMEG HM303 30 MHz DUAL TRACE OSCILLOSCOPE & COMPONENT CHECKER

Western Europe's best selling oscilloscope - now improved. It now features 30MHz bandwidth, triggering to 100MHz and 2mV/div sensitivity.

Sharp bright display on 8 x 10cm screen with internal grid. Special component tester built in - allows capacitors, resistors, transistors, diode, and many other components to be checked at a glance.

As with its predecessor, the QUALITY OF THIS INSTRUMENT IS OUTSTANDING. It is supported with a two year warranty covering parts and labour. If you are buying an oscilloscope, this is the one. It costs a fraction more than some others, but it is far far superior. Supplied with test probes, mains lead, and manual.

£392.00 + £68.60 VAT Includes FREE Next-day delivery (Cheques must be cleared)

EDUCATIONAL BOOKS & PACKS

ADVENTURES WITH ELECTRONICS

The classic book by Tom Duncan used throughout schools. Very well illustrated, ideal first book for age 10 on. No soldering. Uses an S.DEC breadboard. Book & Components £28.95, Book only £7.25

FUN WITH ELECTRONICS

An Usborne book, wonderfully illustrated in colour. Component pack allows 6 projects to be built and kept. Soldering is necessary. Age 12 on, or younger with adult help. Book & Components £20.88, Book only £2.95

30 SOLDERLESS BREADBOARD PROJECTS

A more advanced book to follow the others. No soldering. Circuits cover a wide range of interests. Book & Components £30.69, Book only £2.95

DC MOTOR/GEARBOXES

Ideal for robots, buggies, and many other mechanical projects. Min. plastic gearbox with 1.5-4.5V DC motor. 6 ratios can be set up.

Small type MGS.....£4.77

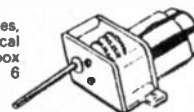

STEPPING MOTORS

For computer control via standard 4 pole unipolar drivers.

MD38 - miniature 48 steps per rev.....£9.15
MD35 1/4 - standard 48 steps per rev.....£12.99

PIC

DEVELOPMENT & TRAINING SYSTEM

PIC

YOUR KEY TO ANOTHER NEW AGE OF ELECTRONICS

PICs are being used more and more because they allow complicated jobs to be done with a single chip. All the work is done by programming. One PIC replaces a board full of ICs. Saving time, space, power, and **MONEY**.

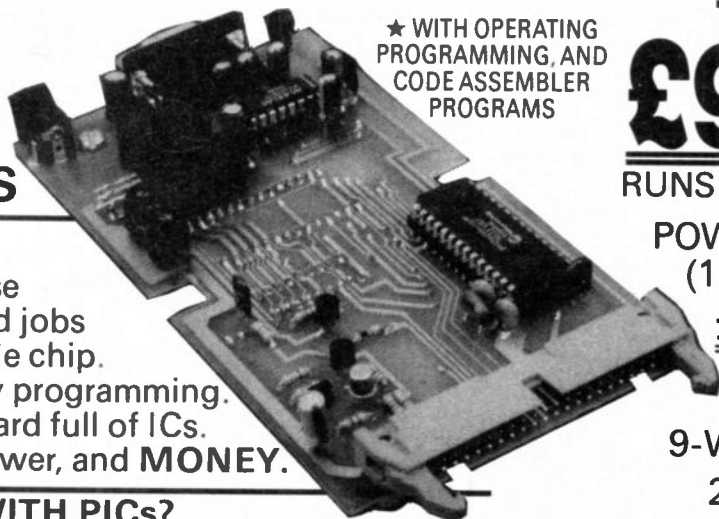

★ WITH OPERATING PROGRAMMING, AND CODE ASSEMBLER PROGRAMS

£99 INCLUDING VAT + £3.00 p&p
RUNS WITH ANY PC

POWER SUPPLY (12V at 200mA) **£8.99**

PC LEADS
9-WAY **£6.00**
25-WAY **£7.00**

HOW DO I START WITH PICs?

- STEP 1** – Buy the PIC-DATS Development & Training System
- STEP 2** – Follow May & June '95 EPE Series – showing how to program for practical applications
- STEP 3** – Start writing and testing your own programs

PIC PROJECT – LIGHT CONTROLLER DEVELOPMENT SYSTEM

A real-world application for a PIC microchip. This project can be made to do just what you choose by writing your own software. It can be programmed to work as a 4-Channel Light Chaser or a simple controller for domestic lighting. Zero volt crossing signal is provided and there is a 4x3 matrix keypad. (Less case).

Kit 855.....£35.95

Motors and Controllers

A range of kits and components for motion control and computer interfacing. Ideal for Design and Technical projects, and a whole range of up to the minute 'Home Automation' applications.

Comstep PC Computer Interface and Driver board

Drives two motors from PC parallel port. Supplied with comprehensive software. Needs 12Volt 1A supply.

With 2-200 Step Motors

Kit 846.....£67.00

PC Joystick Interface for Comstep

Software for operating Comstep from a standard PC Joystick. Allows two Axis control, with acceleration, speed, and X-Y position control. Stores co-ordinates.

Kit 852.....£28.95

DC Motor/Gearboxes

Our Popular and Versatile DC motor/Gearbox sets. Ideal for Models, Robots, Buggies etc. 1.5 to 4.5V Multi ratio gearbox gives wide range of speeds.

LARGE TYPE – MGL £6.95
SMALL – MGS – £4.77

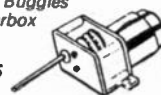

Power Booster for Comstep

Adds to Comstep and allows motors up to 4 Amps to be driven. Two boosters drive two motors from a single Comstep. Uses standard Comstep software.

With MD24 Motors

Kit 850.....£39.95

Stand-Alone Stepping motor Driver/Interface

A Stand alone interface giving full control in all modes. Pushbutton operation with adjustable acceleration and speed. Ideal for demo and setting up. Then connect to computer port for full control.

Kit 843.....£39.95

Stepping Motors

MD38...Mini 48 step...£8.65
MD35...Std 48 step...£12.98
MD200...200 step...£16.80
MD24...Large 200 step...£22.95



PC Communications Protocol for Comstep

An interface board adding four switched inputs to the Comstep + All the code to develop your applications. Files in C, BASIC, FORTRAN & ASSEMBLER + demo.

Kit 851.....£26.98

Versatile Stepping motor Interface

A Magenta design, gives Half and Full-Wave drive. Up to 1Amp and 24Volts. CMOS inputs – Drive from logic or computer port. Needs power supply.

Kit 816.....£9.82

More Information:

All listed items come with data and instructions. For more information, including reprints of the appropriate magazine articles, send an SAE + £1.00 per kit – or phone and use Mastercard/Visa etc.

Mini-Lab & Micro Lab Electronics Teach-In 7

As featured in EPE and now published as Teach-In 7. All parts are supplied by Magenta. Teach-In 7 is £3.95 from us or EPE Full Mini Lab Kit – £119.95 – Power supply extra – £22.55 Full Micro Lab Kit – £155.95 Built Micro Lab – £189.95

MAGENTA

Tel: 01283 565435 Fax: 01283 546932

All prices include VAT. Add £3.00 p&p.



Tel (0191) 251 4363
 Fax (0191) 252 2296
ESR
 ELECTRONIC COMPONENTS
 Station Road, Cullercoats,
 Tyne & Wear
 NE30 4PQ
 U.K.

AD9696KN £12.45	SSM2143P £4.99	1N5407 £0.14	2SB548 £0.30	BC328 £0.10	BD807 £0.80
ADE12020AN £4.54	TBA120S £0.90	1N5408 £0.15	2SD1730 £1.44	BC328-16 £0.10	BDX32 £0.70
ADM222AH £3.55	TBA800 £0.70	BA157 £0.10	AC126 £0.44	BC337 £0.10	BDX33C £0.49
ADM232AAN £3.55	TBA810S £0.68	BA158 £0.10	AC127 £0.50	BC337-25 £0.10	BDX34C £0.50
ADM485JN £2.57	TBA820M £0.59	BA159 £0.10	AC128 £0.40	BC338 £0.10	BDX53C £0.47
ADM690AN £4.89	TDA1024 £1.49	BA160 £0.10	AC129 £0.48	BC338-25 £0.10	BDX54C £0.50
ADM695AN £5.91	UD217B £1.83	BA161 £0.11	AC188 £0.48	BC348B £0.14	BF180 £0.31
ADM699AN £5.91	TDA2002 £1.04	BY133 £0.10	AC190 £0.10	BC357 £0.25	BF182 £0.31
AMP04FP £21.02	TDA2004 £3.11	OA47 £0.28	AD149 £1.67	BC393 £0.73	BF185 £0.31
BUF04GP £10.02	TDA2030 £1.18	OA90 £0.07	AD161 £0.92	BC414C £0.13	BF194 £0.19
CA74ICE £0.28	TDA2050V £3.98	OA91 £0.10	AD162 £0.92	BC441 £0.40	BF194B £0.31
CA747CE £0.39	TEA5115 £3.11	OA200 £0.10	BC107 £0.16	BC461 £0.40	BF195 £0.19
CA3046 £0.37	TLO62CP £0.35	OA202 £0.29	BC107B £0.15	BC463 £0.29	BF244 £0.35
CA3059 £1.16	TLO62CN £0.60	Zeners 2.7 to 33V £0.08	BC108 £0.14	BC478 £0.32	BF244B £0.35
CA3080E £0.72	TLO71CP £0.72	0.08 £0.32	BC108A £0.14	BC479 £0.32	BF257 £0.33
CA3130E £0.98	TLO72CP £0.68	0.10 £0.32	BC182 £0.16	BC490 £0.34	BF257 £0.33
CA340E £0.56	TLO74CN £0.58	0.10 £0.32	BC109 £0.17	BC516 £0.22	BF259 £0.33
CA3189E £1.22	TLO81 £0.33	W02 1.5A 200V £0.20	BC109C £0.17	BC517 £0.20	BF337 £0.36
CA3240E £1.12	TLO82CP £0.54	W04 1.5A 400V £0.22	BC114 £0.41	BC527 £0.20	BF355 £0.38
DG211CJ £1.49	TLO84CN £0.63	W06 1.5A 600V £0.22	BC115 £0.41	BC528 £0.20	BF423 £0.13
DG212CJ £1.55	TL94NC £1.49	W08 1.5A 600V £0.27	BC118 £0.41	BC537 £0.20	BF451 £0.19
DG411DJ £3.11	TL7705ACP £1.62	WR10 1.5A 1kV £0.24	BC132 £0.36	BC546B £0.08	BF459 £0.31
DG412DJ £4.19	TLC271 £0.54	BR32 3A 200V £0.36	BC134 £0.36	BC546C £0.08	BF469 £0.36
EL2020CN £4.99	TLC272 £0.88	BR34 3A 400V £0.40	BC136 £0.36	BC547B £0.09	BFX29 £0.29
EL2030CN £5.67	TM801FP £7.25	BR36 3A 600V £0.50	BC140 £0.25	BC548C £0.10	BFX84 £0.41
CL7106 £1.06	U267B £1.28	BR62 6A 200V £0.70	BC141 £0.27	BC549C £0.08	BFX85 £0.32
ICL7611DCPA £1.06	U276T £1.28	BR68 6A 800V £1.74	BC142 £0.31	BC550C £0.10	BFY50 £0.29
ICL7621 £1.70	UA2240CN £2.30	100A 400V £1.39	BC143 £0.34	BC556A £0.08	BFY52 £0.28
KCL8038 £5.25	ULN2003 £0.52	2502 25A 200V £1.68	BC149 £0.21	BC557B £0.08	BS107 £0.21
KCM7555 £0.43	ULN2004A £0.48	2506 25A 600V £1.75	BC154 £0.36	BC557C £0.08	BS170 £0.21
KCM7556 £0.98	ULN2608 £1.20	0.10 £0.20	BC157 £0.15	BC558C £0.08	BSW66 £1.35
LM165V £2.63	ULN2803 £0.60	0.10 £0.20	BC159 £0.12	BC559C £0.08	BUT126 £1.32
L272M £1.89	ZN490CE £1.89	TIC106D £0.40	BC160 £0.28	BC560A £0.09	BUT205 £1.24
L293E £4.32	ZN4142 £1.16	TIC116D £0.66	BC170 £0.16	BC560B £0.09	BUT208A £1.40
L297 £6.67	ZN4142 £1.16	TIC126D £0.77	BC170B £0.16	BC637 £0.21	BU1326A £1.24
L298 £6.99	ZN1034E £3.11	0.10 £0.20	BC171 £0.11	BC638 £0.21	BU500 £1.54
LF347N £0.86	2716 £4.46	TIC206D £0.65	BC171B £0.16	BC639 £0.21	BU508A £1.42
LF351N £0.43	2732 £4.84	TIC226D £0.73	BC172 £0.13	BC640 £0.21	BU508D £1.44
LF353N £0.42	2764-25 £4.20	BTAC8-600B £0.99	BC172B £0.13	BCY70 £0.21	BU526 £1.74
LF356 £0.84	2764-25 £4.20	TIC236D £0.96	BC177 £0.18	BCY71 £0.20	BU806 £1.06
LM301A £0.25	2764-25 £4.20	0.10 £0.20	BC178 £0.18	BCY72 £0.20	BUT11A £1.33
LM308N £0.42	27010 £5.74	0.10 £0.20	BC179 £0.17	BD124P £6.86	BUT11AF £1.35
LM311N-8 £0.28	27128-20 £4.08	0.10 £0.20	BC179A £0.17	BD136 £0.37	BUX84 £0.78
LM318 £1.28	27C128-20 £4.08	0.10 £0.20	BC182 £0.08	BD212 £0.21	IRF540 £1.60
LM319N-14 £0.28	27256-20 £4.08	0.10 £0.20	BC182A £0.11	BD137 £0.23	IRF740 £1.80
LM324 £0.30	27C256-20 £3.95	0.10 £0.20	BC182B £0.08	BD138 £0.22	MJ2501 £1.60
LM335Z £1.52	27C512 £3.95	0.10 £0.20	BC182L £0.08	BD139 £0.23	MJ3001 £1.80
LM339N £0.24	27C512 £3.95	0.10 £0.20	BC182LB £0.08	BD140 £0.25	MJ1015 £2.11
LM348N £0.31	4164-15 £1.78	2N2219A £0.25	BC183 £0.08	BD150C £0.82	MJ1016 £2.11
LM358N £0.27	6116-10 £1.53	2N2222A £0.18	BC183L £0.08	BD165 £0.42	MJE340 £0.40
LM377 £2.57	6264-10 £3.06	2N2646 £0.86	BC183LB £0.08	BD166 £0.35	MJE350 £0.48
LM380N-14 £1.12	41256-10 £2.80	2N2904 £0.25	BC184 £0.08	BD187 £0.39	MPSA05 £0.14
LM381N £2.70	62256-10 £3.35	2N2905A £0.25	BC184L £0.08	BD201 £0.37	MPSA13 £0.12
LM382 £0.30	51100-8 £6.88	2N2907 £0.20	BC185 £0.32	BD202 £0.40	MPSA13 £0.12
LM386 £1.79	51426-8 £6.88	2N2907A £0.20	BC204C £0.08	BD203 £0.40	MPSA42 £0.17
LM387 £1.60	AD Converters £1.60	2N2926 £0.16	BC206B £0.72	BD204 £0.40	MRF475 £2.28
LM392N £0.79	Data Acquisition £2.92	2N3053 £0.27	BC207B £0.74	BD222 £0.58	PIP32C £0.31
LM393N £0.28	AD420AN £2.92	2N3054 £0.90	BC208 £0.72	BD225 £0.42	PIP30C £0.31
LM709T £0.79	AD557JN £8.75	2N3055 £0.62	BC209A £0.72	BD232 £0.38	PIP31C £0.34
LM733 £0.64	AD574AJN £0.66	2N3439 £0.62	BC212 £0.08	BD237 £0.32	PIP32C £0.32
LM748CN-8 £0.31	AD767JN £2.44	2N3440 £0.50	BC212L £0.08	BD238 £0.32	PIP33C £0.72
LM579CP £3.38	AD775JN £2.44	3N3702 £0.09	BC212LB £0.08	BD240C £0.37	PIP4 £0.48
LM1458 £0.26	AD7226KN £2.65	3N3703 £0.10	BC213B £0.08	BD244A £0.53	PIP4C £0.38
LM1881 £3.22	AD7528JN £1.28	3N3704 £0.10	BC214 £0.08	BD244A £0.53	PIP4 £0.48
LM1917N £3.20	AD7545AKN £1.18	3N3705 £0.10	BC213LC £0.08	BD244C £0.53	PIP4 £0.48
LM1920N £0.72	AD7581JN £2.66	3N3706 £0.10	BC214 £0.08	BD245C £0.18	PIP50 £0.53
LM1990N £1.76	AD7828KN £2.66	3N3771 £1.44	BC214L £0.08	BD246 £1.18	PIP21 £0.35
LM3911 £2.56	AD7845JN £1.06	3N3772 £1.51	BC225 £0.15	BD246C £1.18	PIP22 £0.40
LM3914 £2.70	ICL7109CPL £7.75	3N3773 £1.79	BC237B £0.09	BD283 £0.61	PIP25 £0.46
LM3915 £2.70	LC5491P £3.51	3N3819 £0.39	BC238 £0.09	BD284 £0.61	PIP27 £0.40
LM13600 £1.82	ZN425E £5.94	3N3820 £0.66	BC238C £0.09	BD400 £0.79	PIP32 £0.46
LMC660CN £2.16	ZN426E £3.03	3N3820 £0.66	BC239C £0.10	BD441 £1.37	PIP37 £0.46
LMC6032IN £1.55	ZN428E £5.94	3N3905 £0.10	BC350A £0.15	BD442 £0.50	PIP42 £0.48
LMC6042IN £1.82	ZN439E £7.13	3N3906 £0.10	BC351 £0.13	BD534 £0.47	PIP47 £1.12
LP324N £0.74	ZN488E £7.02	3N5245 £0.80	BC252 £0.13	BD535 £0.50	PIP95 £0.63
LP339N £0.73	7805 £0.44	3N5296 £0.57	BC261B £0.24	BD536 £0.65	PIP3055 £0.63
MAX202CPE £2.97	7808 £0.50	5N3231 £0.57	BC262B £0.24	BD581 £0.62	VNI0KM £0.48
MAX208CNG £6.99	7812 £0.38	5N3403 £0.11	BC267B £0.30	BD597 £0.92	VN66AFD £1.50
MAX222CPE £5.06	7818 £0.38	2N6107 £0.60	BC307 £0.10	BD646 £0.52	ZTX300 £0.16
MAX232CPE £2.58	7815 £0.38	2N6491 £1.58	BC308 £0.10	BD648 £0.52	ZTX500 £0.16
MAX238CNG £6.88	7905 £0.31	7912 £0.38	BC319C £0.13	BD650 £0.53	SAMEDAY
MAX242CPE £3.55	7915 £0.38	7915 £0.38	BC327 £0.10	BD707 £0.42	DESPATCH
MAX635ACP £4.99	7924 £0.38	7924 £0.38	BC327-16 £0.10	BD708 £1.04	
MC1488 £0.46	78L05 £0.25	78L05 £0.25			
MC1489 £0.46	78L08 £0.23	78L12 £0.24			
MC3302 £0.56	78L12 £0.24	78L15 £0.24			
MC3340P £1.60	78L15 £0.24	78L24 £0.39			
MC4558P £0.36	78L24 £0.39	79L05 £0.28			
MV500DP £2.63	79L05 £0.28	79L08 £0.28			
MV601DP £2.97	79L12 £0.28	79L15 £0.28			
NE5511 £1.47	79L15 £0.28	79L24 £0.30			
NE555N £0.25	79L24 £0.30	AD5666AN £3.99			
NE556N £0.36	AD5666AN £3.99	L200CV £1.24			
NE565 £1.84	L200CV £1.24	L296 £1.13			
NE566N £0.90	L296 £1.13	L387A £3.20			
NE567N £0.39	L387A £3.20	LM2904CT £2.30			
NE571N £2.47	LM2904CT £2.30	LM317T £0.65			
NE592 £0.62	LM317T £0.65	LM334Z £1.35			
NE5532N £0.80	LM334Z £1.35	LM338K £5.52			
NE5534N £0.60	LM338K £5.52	LM323 £0.29			
OP07CN £1.42	LM323 £0.29	LP2950CT £2.97			
OP77GP £3.12	LP2950CT £2.97	MAX666CPA £3.76			
OP90GP £4.14	MAX666CPA £3.76	REP01CP £4.46			
OP97FP £4.02	REP01CP £4.46	REP02CP £4.14			
OP176GP £2.30	REP02CP £4.14	REP12Z £1.28			
OP177GP £2.49	REP12Z £1.28	REP195GP £5.50			
OP183GP £3.78	REP195GP £5.50	REF2Z £1.22			
OP200GP £6.81	REF2Z £1.22	REF50Z £1.22			
OP213FP £6.38	REF50Z £1.22	TL431CP £0.45			
OP275GP £2.84	TL431CP £0.45	ZN423 £1.52			
OP282GP £2.63	ZN423 £1.52	ZN458B £1.89			
OP283GP £5.81	ZN458B £1.89				
OP290GP £6.24					
OP295GP £5.54					
OP297GP £7.56					
OP400GP £13.56					
OP467GP £15.90					
OP495GP £10.44					
PM1012GP £6.38					
RC4136 £5.90					
SA1027 £4.52					
SC3524N £1.08					
SC3543 £6.88					
SL486 £2.63					
SL490 £2.63					
SSM2017P £3.38					
SSM2131P £4.87					
SSM2141P £5.94					
SSM2142P £6.08					

4000 Series	74HC Series	74LS Series	
4000 £0.17	74HC00 £0.16	74LS51 £0.72	
4001 £0.20	74HC02 £0.21	74LS73 £0.40	
4002 £0.17	74HC03 £0.21	74LS74 £0.25	
4006 £0.40	74HC04 £0.21	74LS75 £0.19	
4007 £0.18	74HC08 £0.21	74LS76 £0.25	
4008 £0.31	74HC10 £0.16	74LS83 £0.31	
4009 £0.19	74HC11 £0.20	74LS85 £0.35	
4010 £0.23	74HC14 £0.22	74LS90 £0.44	
4011 £0.21	74HC15 £0.16	74LS92 £0.35	
4012 £0.16	74HC27 £0.16	74LS99 £0.42	
4013 £0.24	74HC30 £0.22	74LS93 £0.42	
4014 £0.30	74HC32 £0.21	74LS107 £0.23	
4015 £0.31	74HC42 £0.25	74LS109 £0.24	
4016			

EVERYDAY With PRACTICAL ELECTRONICS

INCORPORATING ELECTRONICS MONTHLY

VOL. 24 No. 8

AUGUST '95

UP, UP AND AWAY

Unfortunately it may become a little more difficult to find your copy of EPE on the bookshelves in future months. This year we have been faced with massive paper price increases over which we have absolutely no control. The increases are being caused by a worldwide shortage of paper.

SALE OR RETURN

In order to minimise the effect of these increases we are taking steps to reduce all forms of wastage. The most effective step is to minimise the level of unsold copies. Virtually all U.K. magazines go out on a sale or return basis to newsagents. This ensures that we get plenty of copies on the shelves all over the country, but it also means that we have a number of unsold copies returned at the end of each month – these are pulped by the wholesalers and the waste is recycled. The cost of producing the magazine is now so high that if we do not increase the cover price or put up the advertising rates (both of which we are trying to avoid) then we must minimise our unsolds.

The result of this is bound to be reduced availability of the magazine even though we will try to avoid this as much as possible. The message is clear; either place an order with your newsagent for your issue to be delivered or "shop saved" for you (you can still refuse a shop saved issue if you wish because it will still be on sale or return) or take out a subscription and let us post your issue to you each month.

SUBSCRIPTIONS

A subscription has the added advantage of protecting you from cover price increases and, at just £24 (U.K. including postage) for 12 issues, now represents excellent value for money. Since the cover price will almost certainly have to go up with the October issue to meet inflationary demands perhaps now is the best ever time to consider this option. Our subscription issues are posted to arrive at U.K. readers' addresses before they appear on the bookstalls, so subscribers can also get the pick of any bargains or offers from advertisers. You will find a subscription order form on page 658.

Please make sure you don't miss your issue of EPE. You have been warned!

FUTURE

What affect will all this have on magazines in the future? It's easy to see that if paper goes on increasing in price more publications will turn to electronic methods of data storage. The CDROM magazine is with us now and no doubt the trend will continue – then you can print out your own pages, if you wish to, or just read the magazine off your PC screen. It won't have the same "feel" but I guess it will come.



SUBSCRIPTIONS

Annual Subscriptions for delivery direct to any address in the UK: £24. Overseas: £30 (£47.50 airmail). Cheques or bank drafts (in £ sterling only) payable to *Everyday with Practical Electronics* and sent to EPE Subscriptions Dept., Allen House, East

Borough, Wimborne, Dorset BH21 1PF. Tel: 01202 881749. Subscriptions start with the next available issue. We accept Access (MasterCard) or Visa.

BINDERS

Binders to hold one volume (12 issues) are now available from the above address. These are finished in blue p.v.c., printed with the magazine logo in gold on the spine. Price £5.95 plus £3.50 post and packing (for overseas readers the postage is £6.00 to everywhere except Australia and Papua New Guinea which cost £10.50). *Normally sent within seven days but please allow 28 days for delivery – more for overseas orders.*

Payment in £ sterling only please. Visa and Access (MasterCard) accepted, minimum credit card order £5. Send or phone your card number and card expiry date with your name, address etc.



Editorial Offices:
EVERYDAY with PRACTICAL ELECTRONICS EDITORIAL
ALLEN HOUSE, EAST BOROUGH, WIMBORNE
DORSET BH21 1PF
Phone: Wimborne (01202) 881749
Fax: (01202) 841692. DX: Wimborne 45314
Due to the cost we cannot reply to orders or queries by Fax.

See notes on Readers' Enquiries below – we regret lengthy technical enquiries cannot be answered over the telephone.

Advertisement Offices:
EVERYDAY with PRACTICAL ELECTRONICS
ADVERTISEMENTS
HOLLAND WOOD HOUSE, CHURCH LANE
GREAT HOLLAND, ESSEX CO13 0JS
Phone/Fax: (01255) 850596

Editor: MIKE KENWARD

Secretary: PAM BROWN

Deputy Editor: DAVID BARRINGTON

Technical Editor: JOHN BECKER

Business Manager: DAVID J. LEAVER

Subscriptions: MARILYN GOLDBERG

Editorial: Wimborne (01202) 881749

Advertisement Manager:

PETER J. MEW, Frinton (01255) 850596

Advertisement Copy Controller:

DEREK NEW, Wimborne (01202) 882299

READERS' ENQUIRIES

We are unable to offer any advice on the use, purchase, repair or modification of commercial equipment or the incorporation or modification of designs published in the magazine. We regret that we cannot provide data or answer queries on articles or projects that are more than five years old. Letters requiring a personal reply *must* be accompanied by a **stamped self-addressed envelope or a self-addressed envelope and international reply coupons. Due to the cost we cannot reply to queries by Fax.**

All reasonable precautions are taken to ensure that the advice and data given to readers is reliable. We cannot, however, guarantee it and we cannot accept legal responsibility for it.

COMPONENT SUPPLIES

We do not supply electronic components or kits for building the projects featured, these can be supplied by advertisers.

We advise readers to check that all parts are still available before commencing any project in a back-dated issue.

We regret that we cannot provide data or answer queries on projects that are more than five years old.

ADVERTISEMENTS

Although the proprietors and staff of EVERYDAY with PRACTICAL ELECTRONICS take reasonable precautions to protect the interests of readers by ensuring as far as practicable that advertisements are *bona fide*, the magazine and its Publishers cannot give any undertakings in respect of statements or claims made by advertisers, whether these advertisements are printed as part of the magazine, or in inserts.

The Publishers regret that under no circumstances will the magazine accept liability for non-receipt of goods ordered, or for late delivery, or for faults in manufacture. Legal remedies are available in respect of some of these circumstances, and readers who have complaints should first address them to the advertiser.

TRANSMITTERS/BUGS/TELEPHONE EQUIPMENT

We advise readers that certain items of radio transmitting and telephone equipment which may be advertised in our pages cannot be legally used in the UK. Readers should check the law before buying any transmitting or telephone equipment as a fine, confiscation of equipment and/or imprisonment can result from illegal use or ownership. The laws vary from country to country; overseas readers should check local laws.

SOLAR SEEKER



JIM and CHRIS WILES

A solar battery charger with a moving panel that tracks the sun.

CARE for the environment has become more and more important to everyone and quite a bit of commercial attention is now placed on the manner in which electricity can be produced from renewable sources. An example of this can be seen from the arrays of wind powered generators which are now obvious in the West Country.

To take an interest in renewable energy sources, though, it is not necessary to manufacture a large whizzing machine with forty-foot blades and place this in the garden. As in the early days of amateur radio, in some ways it is still possible for electronics enthusiasts to move technology forward. In a modest way, this Solar Seeker Battery Charger strives to do that. Its purpose is to get more energy from the available sunlight by tilting its solar panel to follow the sun.

SOLAR BATTERY CHARGERS

The simplest form of solar-powered battery charger circuit is shown in Fig. 1. In this circuit, the voltage generated at the terminals of the solar panel is used to charge the battery via current limiting resistor R1. The resistor prevents batteries from being recharged at too high a rate for too long. It can be omitted if the solar panel used has a low current rating. Diode D1 prevents the battery from discharging through the solar panel when sunlight is absent.

A graph of charging current plotted against time of day is shown in Fig. 2. It was plotted using measurements gathered in the West of England in July, using a

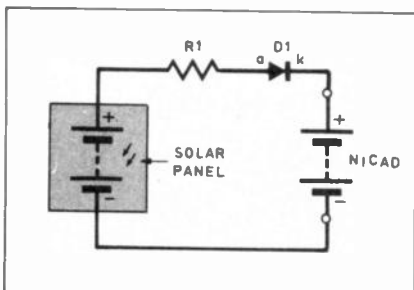

Fig. 1. Simple solar powered battery charger circuit.

10cm by 12cm solar panel. The curves assume that an 8.4V NiCad battery is being charged. Curve 1 shows the charging current from a panel laid flat on the ground. Curve 2 shows the charging current available if the panel is tilted and moved by hand to follow the sun.

From the graphs it can be seen that not only does the tilted panel have a higher prospective charging current for most of the day, but that it can provide the current for several hours longer than a static panel. Calculating the total charge which can be achieved in a day, it becomes apparent that a tilting panel can theoretically achieve as much as 100 per cent more energy capture than a static panel.

With a tilted solar panel the designers have found that it is also possible to achieve significant charging levels to within 20 minutes of sunset. They assume that the

same is true of sunrise, although they claim to remain firmly asleep for most of these!

Obviously, a solar panel which follows the sun generally has a greater available energy capture and therefore it seemed a good idea to try to automate its tracking movement. The problem that had to be overcome, though, was how to do this without consuming a lot of energy.

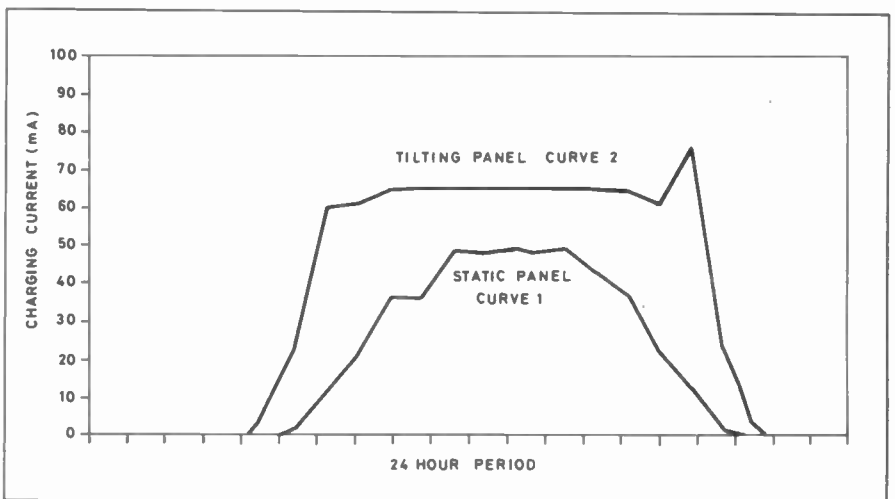
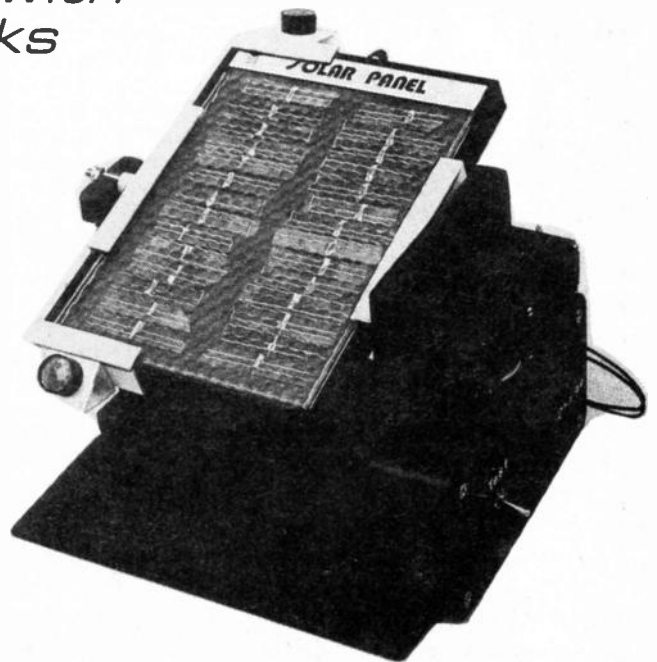

Fig. 2. Measured solar panel performance.

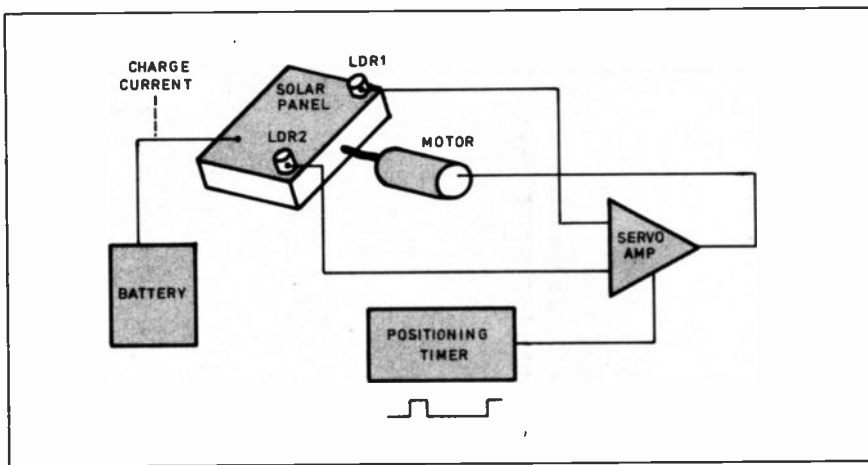

Fig. 3. Block diagram for the Solar Seeker.

SEEKING APPROACH

The system adopted is shown in Fig. 3. Its concept is simple. The solar panel is rotated about a horizontal axis by a small electric motor. Two light dependent resistors (l.d.r.s) are mounted on the solar panel. These sense the position of the sun with respect to the position of the panel and any difference is converted into a small drive voltage, which is amplified and drives the motor to correctly reposition the panel.

Output current from the solar panel charges a battery and this battery is also used to power the positioning circuit. As even small motors can draw quite large currents, the positioning circuit must be switched off for most of the time. If this is not done then the battery will probably never charge or even be totally flattened by the permanent load of the motor.

In the Solar Seeker, a low power timer is used to control the power supply to the motor and positioning need only occur for about five seconds in every 30 minutes.

The system shown is totally self-powered. In very bright sunlight it was found that the solar panel can power the positioning circuit almost on its own. In less bright conditions, the battery is used briefly to power the positioning process and then return to accepting charge.

In principle, the system can be used to charge a number of NiCad cells arranged in series as a battery. The only requirement is that the battery should provide a high enough voltage to adequately drive the motor via the positioning circuit. For the Solar Seeker as described, the battery is assumed to be a NiCad PP3, although guidance will be given on component changes to enable the circuit to charge AA or AAA cells arranged as a six-cell battery.

POSITIONING

The l.d.r.s are attached to the solar panel at an angle of approximately 45 degrees. This angle ensures that each sensor receives the same amount of sunlight only when the panel is pointed directly at the sun. When the panel is not directly pointed at the sun, each l.d.r. receives a different amount of light and this difference determines how much repositioning the panel requires.

The circuit used to achieve automatic positioning is shown in Fig. 4. The two l.d.r.s are labelled as R6 and R7. Facing straight into bright sunlight, the l.d.r.s have a resistance of about 50 ohms. When angled slightly away from the sun the

resistance rises slightly to 55 or 60 ohms. In the latter condition, a difference of about 30mV appears at the input to op.amp IC2a. The voltage difference is amplified by IC2a to produce a 2V drive to the motor M1. Preset potentiometer VR1 is used to offset any mismatch in the l.d.r.s and their mounting angles.

Power to drive the positioning motor is provided by IC2a, which is an L272 low-cost dual power op.amp. This is capable of operating at supply voltages down to 4V, has a 1A drive capability and a power rating of 1W. The suggested motor draws a maximum of about 50mA and at this current the low voltage supply rails ensure that the chip dissipates less than the maximum power rating. A heatsink is not required.

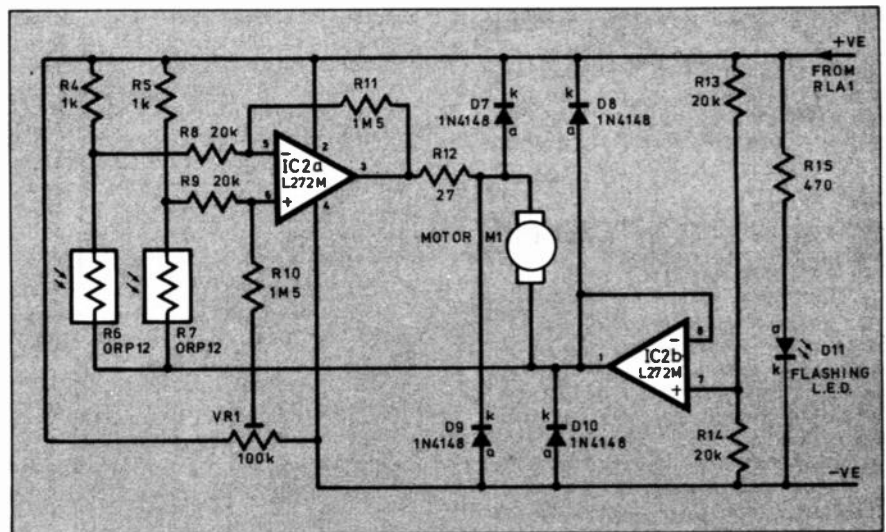

Fig. 4. Solar panel positioning circuit.

The gain of IC2a is set by the ratio of resistors R11/R8 and R10/R9 and is nominally 75. This gain value is suitable for use with the modified radio control (RC) servo motor used in the prototype, but it may need to be varied if a different motor is used.

In order to track the sun, the panel must move both forwards and backwards. Consequently, the drive voltage to the motor needs to be bidirectional, and so a low impedance centre power rail is required. This is achieved by using the second op.amp of the L272, IC2b.

Operating as a unity gain buffer, IC2b is biased via its non-inverting input, pin 7, by resistors R13 and R14 to produce an output on its pin 1 which is at half the

voltage of the main supply rail. Resistor R12 is included to limit the maximum current drawn by the motor and reduce battery drain.

IC2 needs to be protected from inductive spikes created by the motor. Diodes D7 to D10 ensure that such transients cannot appreciably exceed the supply rails. However, even when clamped by the diodes, these transients can, in some situations, produce radio frequency interference (RFI). This was tested for with the motor type used on the prototype and no RFI was detectable by a radio located a metre from the Solar Seeker.

It should be borne in mind, though, that RFI may become appreciable and require alleviating measures if the design is varied and larger panels needing bigger motors are used.

The flashing light emitting diode (i.e.d.), D11, operates when the positioning circuit is energised and the panel is being moved. Although this l.e.d. does not actually require a series resistor, R15 has been included to minimise current drain.

TIMER CIRCUIT

The timer circuit, which triggers the tilting system, has to remain dormant for 30 minutes, during which time it must consume as little current as possible. To achieve this, a CMOS 555 timer chip (IC1) has been used: it consumes only 100 microamps when in the "off" state.

The circuit is shown in Fig. 5 and is configured as a conventional astable. It is important that the timing capacitor, C1, is of the tantalum variety. Such capacitors have a very low current

leakage, which is essential in this circuit; the use of an electrolytic capacitor is not recommended.

The 20 megohm resistor, R1, results in a charging current to C1 of between 0.5 to 1.0 microamps. Although this is less than the nominal leakage currents for 100µ tantalum capacitors, and in theory the capacitor should not charge up fully, the designers tried a number of 100µ tantalum capacitors and found that the circuit worked with all of them.

The timer output, IC1 pin 3, has a high current-sink capability but acts as a poor source. Therefore the output from IC1 is arranged to switch on the supply to the positioning circuit when its output is in the "off" state (0V).

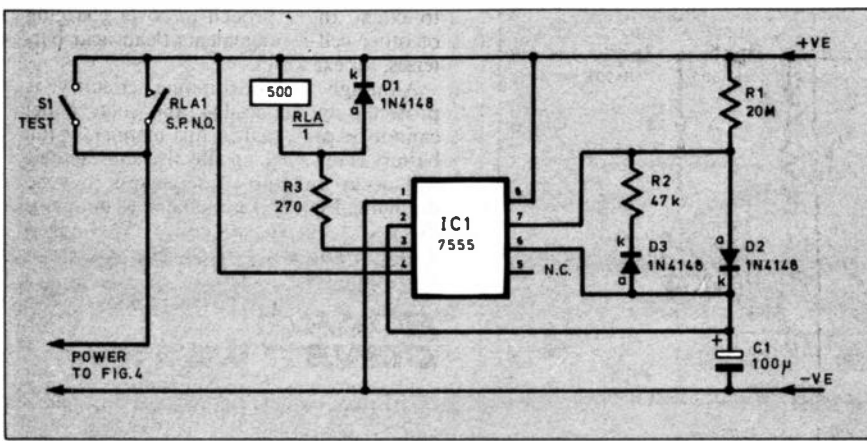

Fig. 5. Circuit diagram for the timer. It is important that C1 is a tantalum type. The relay is a reed type.

The circuit includes two diodes, D2 and D3, which are normally associated with low duty cycle operation (output off for a long time and on for a short time). However, it was found that although the duty cycle was the reverse of this, the circuit was erratic without the diodes. With them included, though, repeatability was within a few seconds in thirty minutes.

Switching of the supply voltage to the positioning circuit is achieved by reed relay RLA1. Switch S1 has been included to bypass the relay, to enable testing and internal positioning of the solar panel.

MOTORING

The choice of motor and transmission method caused the greatest amount of thought in this project. The difficulty lies in the transmission rather than the motor. This is because the object was to produce a speed of six r.p.m. from a 2V or 3V drive voltage whilst achieving low current drain.

To achieve this, an efficient motor with a compact gearbox is required. Small motors are readily available but compatible compact gear boxes are not the easiest things to find. Industrial grade servo motors would fit the bill, but are not cheap! After a lot of

head scratching, the simple approach was adopted: adapting a readily available radio control (RC) servo motor.

These motors already include a high reduction gearbox, but they are designed to be driven by a pulse code signal, rather than d.c. power. The solution is to open up the servo and connect wires directly to the internally mounted motor, discarding the small pulse decoding circuit board.

Via its gearbox, the modified motor is coupled to turn the solar panel, consuming an average of 10mA, with an instantaneous peak demand of about 50mA.

SOLAR PANEL

Solar panels are constructed from a number of silicon solar cells wired in series. Each cell will produce a little more than 0.4V in bright sunlight and the current available is proportional to the area of each cell. The ready-made panel used in this project has 28 cells connected to produce a nominal 12V at 30mA.

The measured characteristic of the solar panel is shown in Fig. 6. The highest voltage is produced when unloaded. As loading is increased, the voltage drops and eventually the panel's output current saturates at a level dependent upon the sunlight intensity. It can be seen from the graphs that the panel has a good output level, not just in summer, but also as winter approaches.

The saturated-current portion of the curves is suited to automatic NiCad constant current charging without additional circuitry. There are two problems, though. Firstly, sunlight intensity varies throughout the day and so a predictable constant current cannot be guaranteed, despite automatically tracking the sun's direction.

The second problem is that in bright sunlight, the charging rate may be higher than required for a nominal 16-hour charge. Care is then needed to ensure that current is discontinued when the battery is fully charged. The problem can be solved with a suitable charging circuit, but first it is necessary to know the acceptable charging range for the battery concerned.

BATTERIES

The panel positioning and timing circuitry can position and charge PP3 batteries, or, either six AAA or AA cells in an appropriate holder. The limit of operation is reached with only four cells, which barely tilt the panel.

The maximum charge currents for the six-cell combinations and the PP3 are shown in Table 1. All but the PP3 can be fast charged. As the suggested panel maximum current (about 70mA) exceeds the maximum charge rate for the PP3 and AAA, cells any charging circuit must act to limit the charge current appropriately. If fast charging is employed, it is also necessary to reduce the charge rate when the battery is fully charged.

For the larger AA cells and the suggested solar panel, it is almost possible to dispense with any control over the charging, simply remembering to disconnect after, say, 16 hours: this is because the maximum current from the panel is close to the standard charge rate. It should be noted that, on the brightest summer days, only the AA cell combination is capable of accepting all the incident solar energy.

In general terms, it is not a good idea to charge NiCad cells as a battery of several cells. For the PP3, this cannot be avoided as the connections between cells are internal. If several individual cells are to be

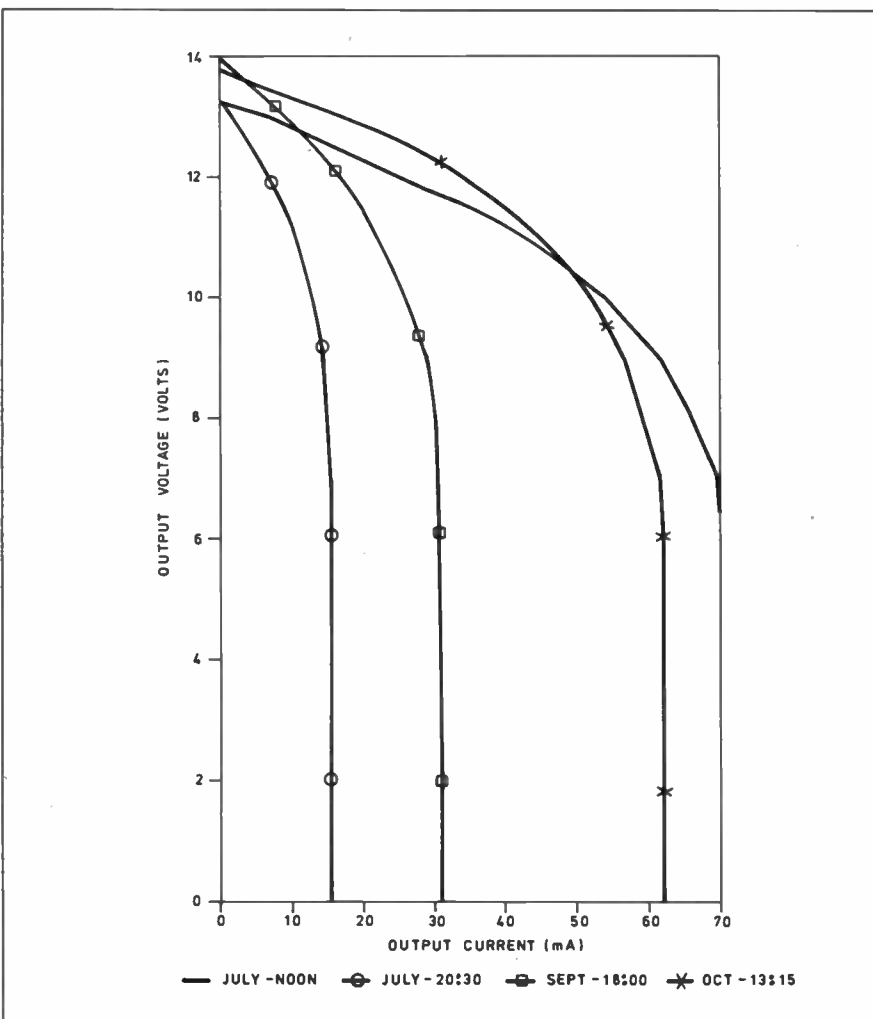

Fig. 6. Voltage and current characteristics of the solar panel measured on four occasions.

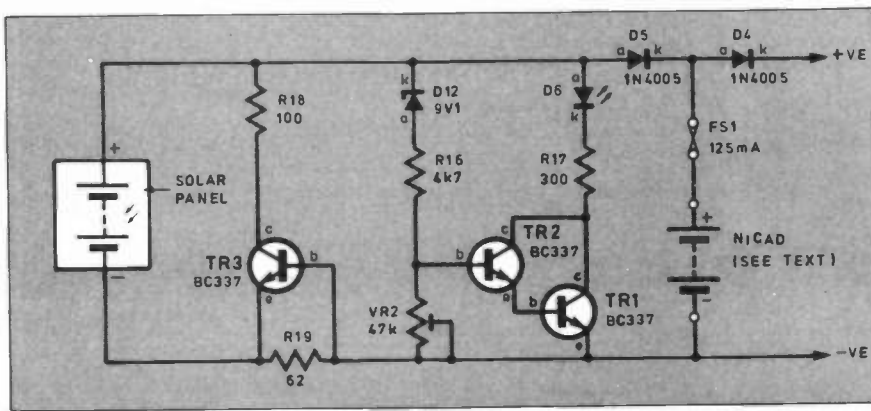

Fig. 7. Shunt regulator battery charging circuit.

charged in series as a battery, then it is good practice to individually discharge the cells, but to no less than 1V per cell.

CHARGING CIRCUIT

The charging circuit is shown in Fig. 7. As a basic design it can cope with charging either a PP3 or the six-cell combinations listed in Table 1. The component values shown in Fig. 7 are for charging a PP3.

Two purposes are served by the circuit: prevention of excessive charging currents and illumination of an l.e.d. as an approximate indication of charge completion. The current illuminating the l.e.d. reduces the available current to the battery and can be arranged to terminate fast charging.

Basically, the circuit consists of two shunt regulators. It has been designed on the principle that all energy should pass unimpeded to the battery unless it is unsafe to do so. Safe charging current is regulated by transistor TR3, and is set by the value of resistor R19.

As the current through R19 approaches the safe charging current (I_c) the voltage between the base (b) and emitter (e) of TR3 rises to 0.6V and the transistor starts to turn on. This shunts current away from the charging circuit and dissipates the surplus energy in R18. The value of R19 is calculated from: $R19 = 0.6 / I_c$.

The circuit around transistors TR1 and TR2 serves to warn the user and reduce the charge current as the NiCad voltage rises. The battery voltage is sensed by Zener diode D12, resistor R16 and preset VR2. The circuit values were chosen to minimise current drain.

Preset VR2 is adjusted so that resistor R17 and l.e.d. D6 shunt the required current when the battery reaches its full charge. This can be arranged to either terminate charging or to reduce charging so that the solar panel can continue safely charging the NiCad at its standard rate.

In this circuit, the current is dumped through the l.e.d., which glows at its brightest when the battery is fully charged. Note that the current to this part of the circuit is ultimately limited by TR3 and if all the available current is dumped through the l.e.d. then no current will pass to the battery.

Typical values for resistor R19 and Zener diode D12 to suit different batteries are given in Table 2. Two different modes of charging are illustrated by the values in this table. The PP3 is charged at its standard rate and the current flow virtually ceases as it becomes fully charged.

On the other hand, the six AAA cells are fast-charged at their maximum rate and then charging is reduced to the standard rate. The details in Fig. 7 and Tables 1 and 2 should enable experienced constructors

to extend the approach to cover charging of other cell arrangements (lead acid batteries, for example).

Although the positioning circuitry is protected by diode D4, the solar panel cannot be protected in this manner. If the battery is reversed, an effective short circuit will occur and the consequences may be dramatic. Fuse FS1 is included to minimise this risk. Its value may need to be changed if the motor differs from the RC servo recommended.

BOARD CONSTRUCTION

The complete circuit is constructed on a single piece of stripboard, whose assembly and track-cutting details are shown in Fig. 8. Assemble the components in any order most convenient. Sockets should be used for both i.c.s. Note that resistor R1 is made up of two resistors connected in series. Solder pins can be used to make wiring to off-board components easier. With the compact size of the unit the connections should be sleeved.

All stripboard tracks should be checked for solder bridges before the circuit is powered-up. In particular, the solder joints and tracks around the timer IC1 should be checked and cleaned to minimise track-to-track leakage currents. Make sure that capacitor C1 is correctly orientated. It is also essential to observe the normal handling precautions for CMOS devices, ensuring that you discharge static electricity from yourself before handling them.

The stripboard is housed in a small plastic box. The switch and l.e.d.s are mounted on the lid. For the triangular l.e.d. D6, a small hole was first drilled in the box and a triangular needle file then used to carefully cut the correct shape.

As the plastic box is fastened to the Solar Seeker stand with screws, make sure to use a strip of tape to insulate the screw heads, before finally positioning the circuit board.

MOTOR MODIFYING

To modify the RC servo motor, the motor is carefully opened up (usually by

TABLE 1: Battery charging information

Battery Type	Cell Qty.	Nominal Voltage (1)	Charge Capacity mA/hr	Charge Standard mA	Current Fast mA	Charge Efficiency (2) (3)
PP3	7	8.4V	110	11	11	72% -
AAA x 6	6	7.2V	180	18	45	60% 70%
AA x 6	6	7.2V	500	50	500	60% 90%

(1) Typical operating voltages lie in the range 1.24V to 1.27V per cell.
 (2) Energy stored / Energy supplied. At the standard charge rate
 (3) Indicative efficiency at the fast charge rate.

On charge, the maximum voltage per cell must not rise above 1.5V.
 The minimum voltage per cell on discharge must not fall below 1V.

TABLE 2. Essential factors for charging various batteries

Battery	R19 ohms	D12 value	D6 Max. mA	Charge Current mA	Residual Charge Current mA	Charge Time hrs
PP3	62	9V1	10	10	<1	14
AAA x 6	15	6V8	22	40	18	5
AA x 6	12	6V8	22	50	28	16

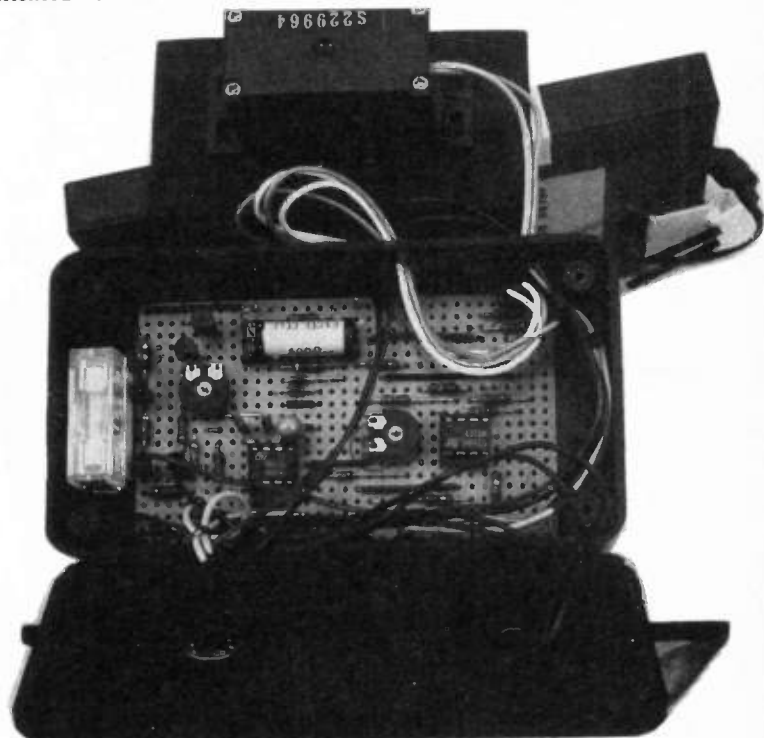

COMPONENTS

Resistors

- R1 10M (2 off - see text)
- R2 47k
- R3 270Ω
- R4, R5 1k 1% (2 off)
- R6, R7 ORP12 light dependent resistor (2 off*)
- R8, R9 20k 1% (2 off)
- R10, R11 1M5 1% (2 off)
- R12 27Ω 0.6W
- R13, R14 20k 1% (2 off)
- R15 470Ω
- R16 4k7
- R17 300Ω 0.6W (see text and Table 2)
- R18 100Ω 0.6W
- R19 62Ω 1% (see text and Table 2)

See
**SHOP
TALK**
Page

All 0.25W 5% carbon film or better, unless otherwise specified.
*The I.d.s. should both be purchased at the same time.

Potentiometers

- VR1 100k submin. preset horiz.
- VR2 47k submin. preset horiz.

Capacitor

- C1 100μ tantalum, 10V

Semiconductors

- D1 to D3, D7 to D10 1N4148 signal diode (7 off)
- D4, D5 1N4005 rectifier diode (2 off)
- D6 i.e.d., triangular
- D11 i.e.d., flashing
- D12 9V1 Zener diode 400mW (see text)
- TR1 to TR3 BC337 npn transistor (3 off)
- IC1 ICM7555IPA CMOS timer
- IC2 L272M dual power op.amp

Miscellaneous

- S1 s.p.s.t. min. toggle switch
 - FS1 125mA fuse and 20mm fuseholder
 - RLA1 Submin. s.p. reed relay, 500 ohm coil
- Solar panel, 98mm x 128mm, 12V/30mA output at 100mW/sq.cm illumination; RC servo motor with mounting hardware (see text); strip-board 0.1 inch grid, 33 strips x 20 holes; plastic case 115mm x 60mm x 30mm; test resistor, 47 ohms 5% 0.25W carbon film; plywood and beading for frame (see Fig. 9); nuts, bolts, screws etc; A4 slide binder; adhesive; 1mm solder pins; connecting wire; solder, etc.

Approx cost
guidance only

£30

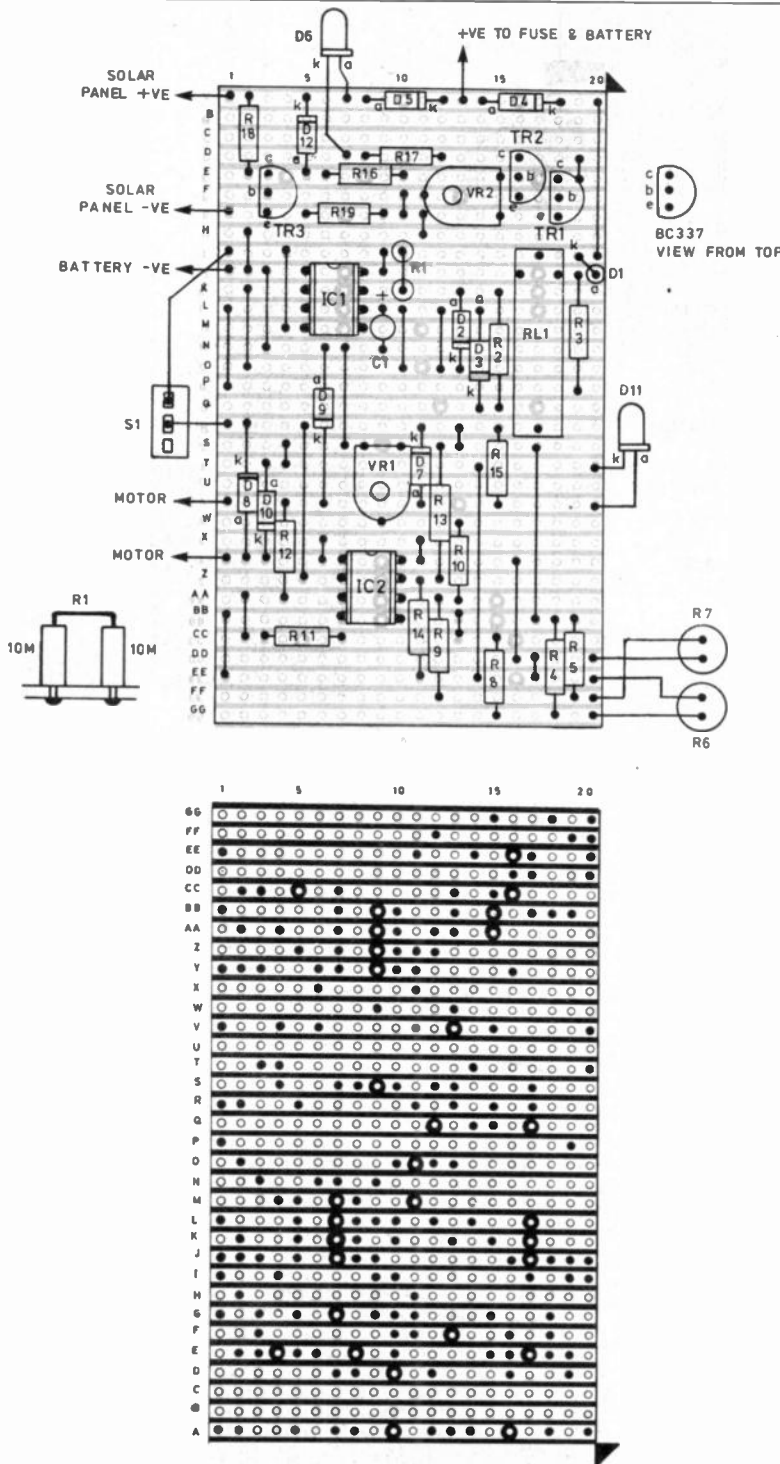
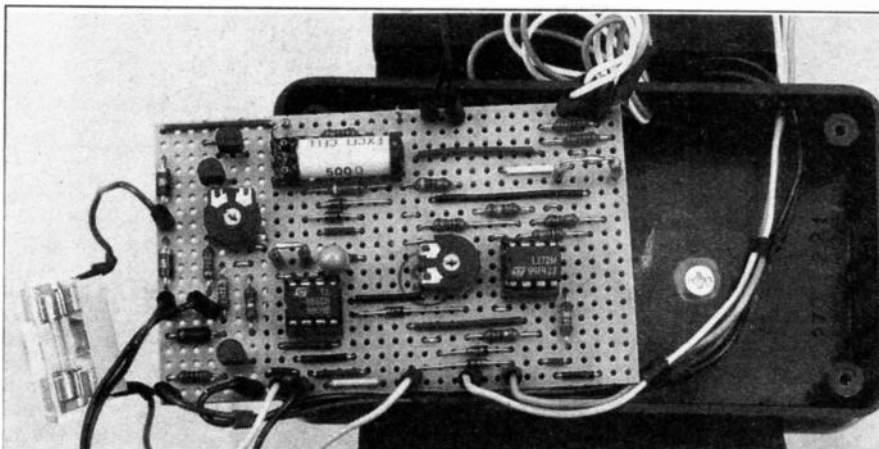

Fig. 8. Stripboard component layout, wiring and track cutting details for the Solar Seeker. The completed circuit board is shown below.



undoing four screws) and the internal circuit board exposed. It was found with the prototype that the gearbox was in a separate compartment from the circuit board, but that both compartments shared the same screws for fastening.

If the joints in the case are looked for, it should be possible to access the circuit board and motor connections without spilling all the cogs on the floor! The joint furthest from the front (drive shaft end) of the servo is the one to carefully prise first.

The motor's circuit board was disconnected from the internal potentiometer and motor and put aside for another project. It may be easiest to snip the connecting wires

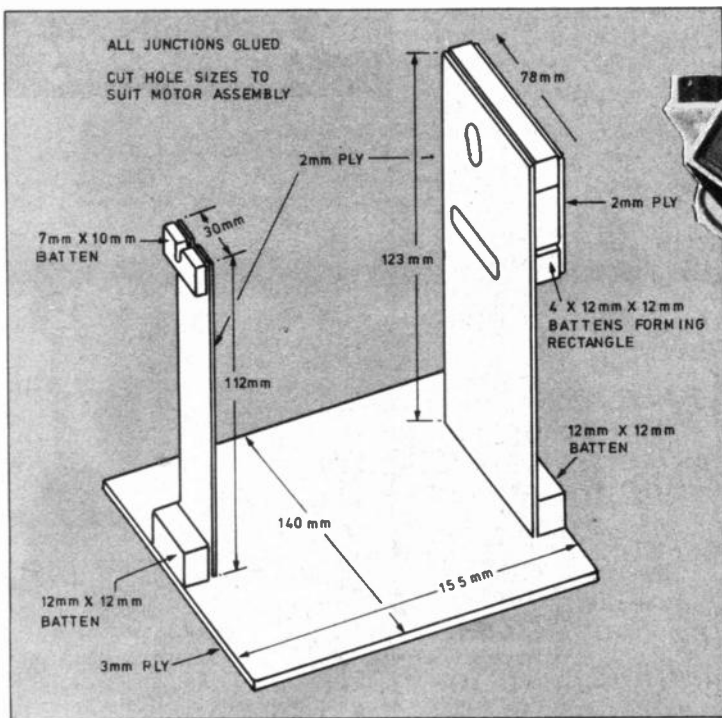
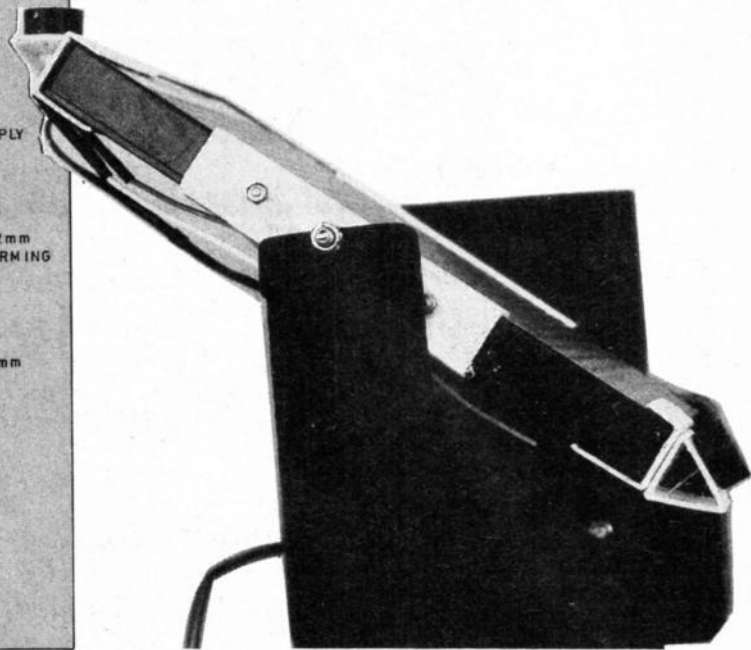

Fig. 9. Mounting frame for the solar panel assembly.



and use them as connection points. Two wires are soldered to the motor leads or terminals and brought out from the case.

Sometimes, an RC servo may have interference suppressing components connected to the motor terminals and case. These may be small capacitors or resistors; it should do no harm to leave them in place.

MECHANICS

Almost the entire hardware construction of the Solar Seeker frame can be made from modelling plywood and square beading. Details of the frame are shown in Fig. 9, Fig. 10 and the photographs.

Two nuts and bolts secure the plastic case to the frame. The wider upright has a small compartment fitted to which the

servo motor body is screwed. The solar panel fits between the two uprights and is supported by two "RC servo horns" (small plastic couplings available from RC model shops) which pass directly through holes in the uprights. One of the horns is push-fitted directly to the motor. The other has an M3 bolt passed through it and locked with a nut, to form an axle.

Both the l.d.r.s and the servo horns are mounted on the solar panel using a plastic "slide binder". This is a long clip, with an almost triangular section, which is normally used to hold together several sheets of A4 paper. It is cut into various lengths and used as shown in Fig. 10.

The panel is assembled with its various clips and trailing wires, and then mounted onto its stand. The servo motor is push-fitted on one side and the bolt is slid into a "U" shaped slot on the other (appropriate tubing can be obtained from model shops and cut up to form bearings if needed).

Cables from the solar panel and l.d.r.s pass through the slot in the wider upright and connect to the circuit case. A slot is used rather than a hole to allow for movement in the cables as the panel turns. After testing, the cables can be secured to the panel using small adhesive clips.

SETTING-UP

To set up the charger circuit, in place of the solar panel connect a 12V d.c. source (e.g. battery or power supply) to the board via a 47 ohm resistor. Rotate preset VR2 until l.e.d. D6 turns on. Now rotate VR2 to the opposite end of its track and the l.e.d. should turn off. Take a fully charged PP3 NiCad (or the combined AA or AAA cells as appropriate) and connect to the charger circuit via fuse FS1. The fuseholder is not mounted in the case but simply connected externally between the unit and the battery.

Using a multimeter, check the charge current going into the battery: it should be the required safe charging current (see Table 2) with the l.e.d. off. Leave the battery connected and charging for five minutes, and then adjust VR2 until the l.e.d. just glows at its brightest. For this setting to be most accurate the battery should have been charged at the same current used in the charge circuit. Ultimately, this setting can be checked using a battery which has already been charged using the Solar Seeker.

With the timer circuit, check that l.e.d. D11 flashes when S1 is closed. Open the switch and wait. D11 should now flash for five seconds every 30 minutes. The first

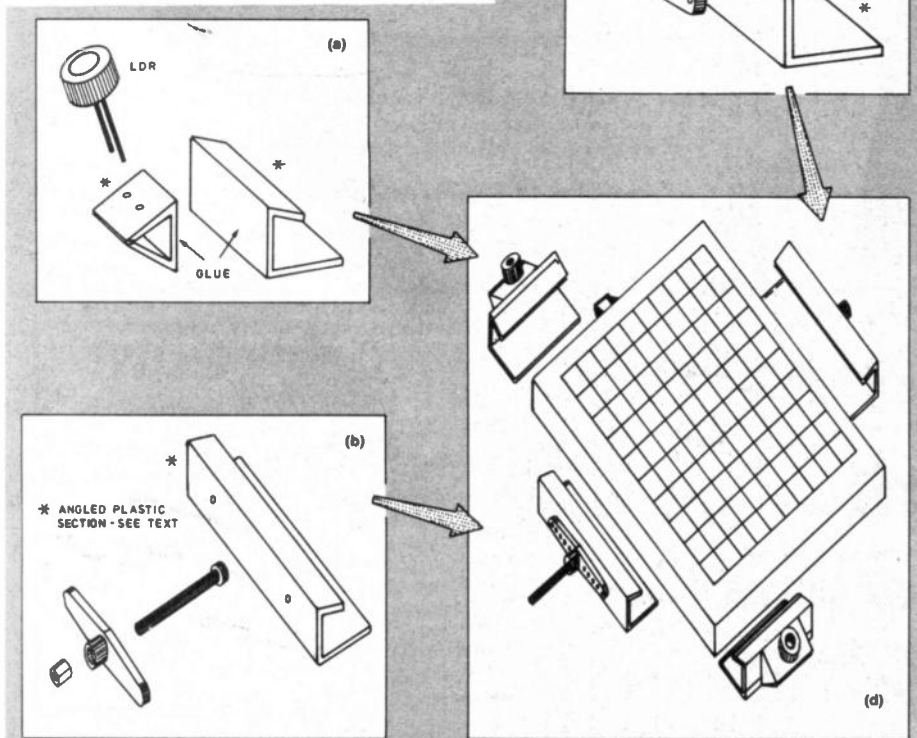

Fig. 10(a). L.D.R. assembly, (b) axel mounting, (c) servo coupling, (d) solar panel assembly.

timed period may be longer than 30 minutes, as the circuit initialises itself, but after that a very repeatable sequence should be apparent.

In the unlikely event that trouble is experienced with the timer, test the circuit with a 100k resistor connected across R1. This should allow D11 to flash every ten seconds. The most likely cause of failure with a high value for resistor R1 is leakage current between adjacent tracks. Re-clean between the tracks around IC1. If difficulties persist it may be necessary to reduce the value of R1. Alternatively, simply try replacing C1 in case its leakage current is greater than expected.

LIGHTLY TEST

When the solar panel, motor and electronics have been mounted on the frame, rotate the solar panel by hand to ensure that the motor allows movement over the full range. If the motor was at the extreme of its travel when the panel was fitted then remove it, rotate the panel, and refit to ensure proper movement. On test, it may be necessary to swap over the motor connections to obtain the correct drive sense. Connect up the battery and switch on S1.

A very bright light source, such as a desk light about 200mm away, is needed to check that the Solar Seeker tracks correctly. Normal room lights are not a good check. The problem with weak light sources is that they cause much higher resistance values in the l.d.r.s than sunlight, consequently the l.d.r.s do not appear as well matched under such conditions.

Ideally, make any adjustments to VR1 outside in sunlight. However, with the prototype it was found that no adjustment was really needed. It was found, though, that the panel was driven slightly faster in one direction than the other. This was not significant in terms of operation of the solar panel and adjustments of VR1 did not change this.

When finally testing in sunlight, diode D6 should be brightly lit with the battery disconnected and off with it connected. As the battery charges, D6 will gradually come on and grow brighter to give a general indication of charge completion. Switch S1 MUST be turned off during battery charging.

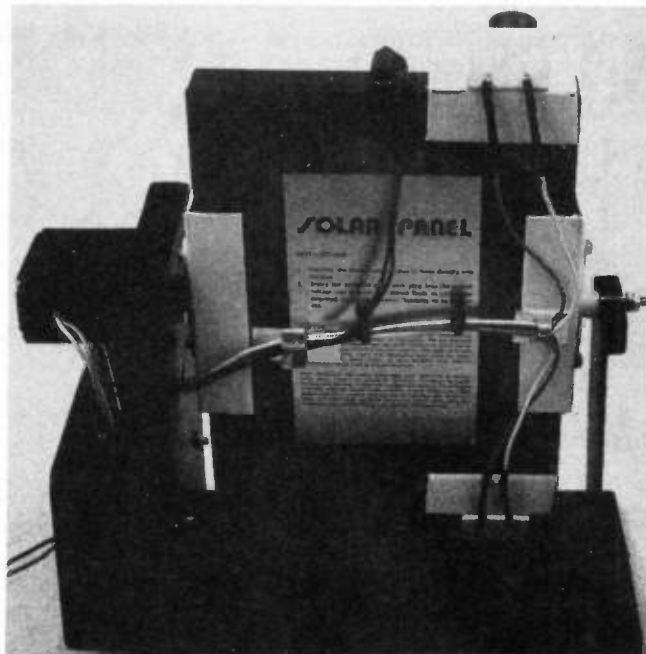

No recommendation is offered about water proofing or permanent exterior installation: the Solar Seeker as described is definitely a fair weather charger. It may be painted, of course, but bring it inside if it rains!

PERFORMANCE

Using the Solar Seeker, roughly constant charging levels were maintained for longer than had been expected. This can be seen from the shape of curve 2 in Fig. 2, which is surprisingly square. It was concluded that this was due to the fact that the panel voltage drops as the panel heats up.

Any assessment of efficiency is subject to considerations of the weather and time of year. In summer, the design is estimated to use less than one per cent of the energy given to its battery and will gather 20 per cent to 100 per cent more energy than a static panel using a similar charger circuit. The lowest energy gain relates to charging a PP3 and the higher to AA cells or any battery type that can safely accept all the available incident energy.

It is not claimed that the Solar Seeker is an optimum design and the project raises many possibilities and "what if?" questions:

- ★ Is it worth automatically cooling the solar panel?
- ★ Is it worth tilting the panel in two directions?
- ★ Is there a simpler way to tilt the panel?
- ★ What is the optimum charging approach?
- ★ Could camcorder batteries be charged while owners lounge on the beach?
- ★ Could the Solar Seeker benefit Third World countries?

Any of these questions could keep interested experimenters going for some time and many adaptations seem possible.

The Solar Seeker has a wide operating range, but it is unrealistic to expect it to be greatly used in a British mid-winter. Also, unfortunately, it cannot make the clouds go away! It is hoped, though, that you enjoy making the Solar Seeker and that the sun shines often enough for you to make good of use of it. □

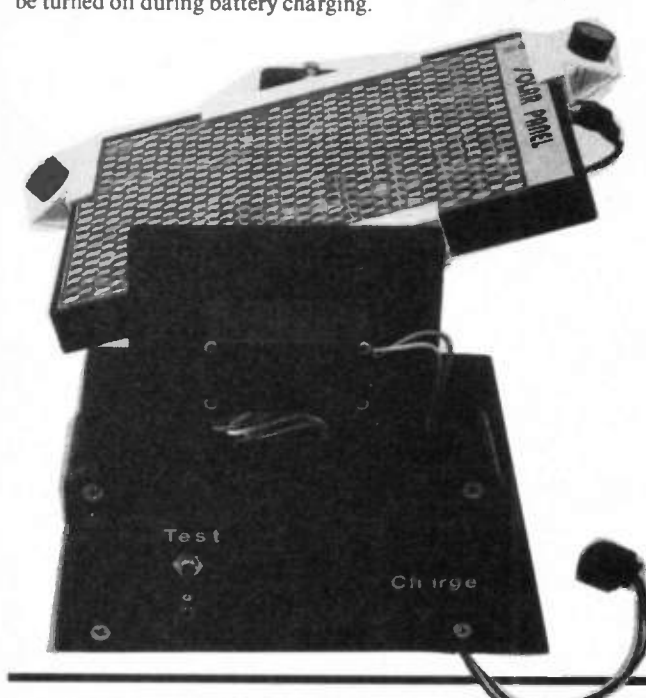

DON'T MISS AN ISSUE - ORDER YOUR COPY NOW!

EVERYDAY

With PRACTICAL

ELECTRONICS

INCORPORATING ELECTRONICS MONTHLY

NEWSAGENTS ORDER FORM

Please reserve/deliver a copy of *Everyday with Practical Electronics* for me each month.

Everyday with Practical Electronics is published on the first Friday of each month and distributed on Sale or Return by Seymour.

Make sure of your copy of EPE each month - cut out or photostat this form, fill it in and hand it to your newsagent.

Signed

Name and Address
(BLOCK CAPITALS PLEASE)

.....
.....
.....

MIXED-MODE SIMULATION. THE POWER OF VERSION 4.

New
Version 4

Analog, Digital & Mixed Circuits

Electronics Workbench® Version 4 is a fully integrated schematic capture, simulator and graphical waveform generator. It is simple to mix analog and digital parts in any combination.

Design and Verify Circuits... Fast!

Electronics Workbench's simple, direct interface helps you build circuits in a fraction of the time. Try 'what if' scenarios and fine tune your designs painlessly.

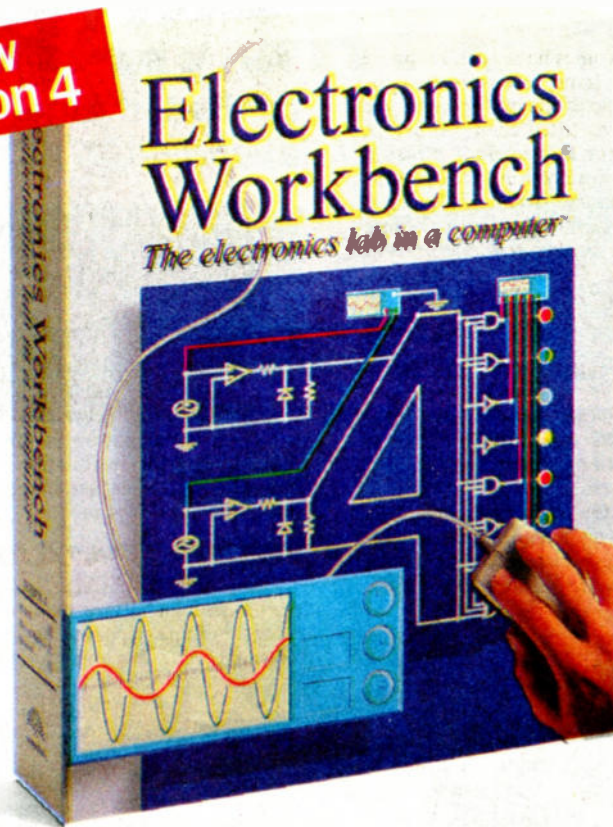

More Power

Simulate bigger and more complex circuits. Faster. On average, Electronics Workbench Version 4 is more than 5 times faster than Version 3.

More Parts

Multiple parts bins contain over twice the components of Version 3.

More Models

Over 350 real world analog and digital models are included free with Electronics Workbench. And, if you need more, an additional 2,000 models are available.

Incredibly Powerful. Incredibly Affordable.

If you need mixed-mode power at a price you can afford, take a look at this simulator and graphical waveform generator that mixes analog and digital with ease.

With over 20,000 users world-wide, Electronics Workbench has already been tried, tested and accepted as an invaluable tool to design and verify analog and digital circuits. With Version 4 true mixed-mode simulation is now a reality with incredible simplicity.

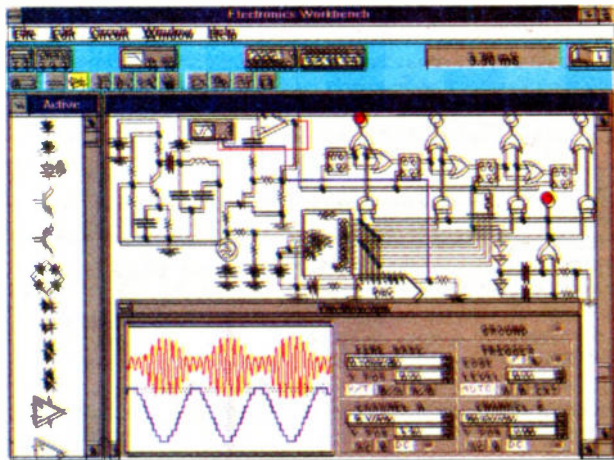

True mixed-mode simulation: Simultaneous AM transmission, digitization and pulse-code modulation of a signal.

Electronics Workbench™
The electronics lab in a computer™

Order Now! Just £199*
44-(0)1203-233-216

RM Robinson Marshall (Europe) Plc

Nadella Building, Progress Close,
Leofric Business Park,
Coventry, Warwickshire CV3 2TF
Fax: 44 (0)1203 233-210
E-mail: rme@cityscape.co.uk

Shipping charges UK £5.99. All prices are plus VAT.
All trade marks are the property of their respective owners.
Electronics Workbench is a trademark of Interactive Image Technologies Ltd., Toronto, Canada.
* 30 Day money-back guarantee.

Australia: 2-519-3933 • Brazil: 11-453-5588 • Cyprus: 2-62-1068 • Denmark: 33-25-0017 • Finland: 0-297-5033 • France: 14-908 9000 • Germany: 711-62-7740 • Greece: 1-524-9981
Hungary: 1-215-0082 • India: 11-544-1343 • Israel: 3-647-5613 • Italy: 11-437-5549 • Japan: 3-3382-3136 • Malaysia: 603-7778945 • Mexico: 5-396-3075 • Netherlands: 18-031-7666
New Zealand: 9-267-1756 • Norway: 22-16-70-45 • Portugal: 1-814-6609 • Singapore: 462-0006 • Slovenia: 61-317-830 • South Africa: 331-6-8309 • South Korea: 2-2-222-3431
Spain: 1-553 3234 • Sri Lanka: 1-86-5970 • Sweden: 8-740-5500 • Thailand: 66-2-398-6952 • United Kingdom: 203-23-3216



COOLING THE WARRIOR

British cooling system monitor installed in American destroyers

— by Hazel Cavendish

ANOTHER important contract has been won for Britain by the small Hampshire firm of Stewart Hughes, whose success in designing a method of detecting mechanical faults in helicopters by analysing vibration signals was reported in the December issue of *EPE*. Their brief to design a small control box to monitor the cooling system of an American Spruance class destroyer was executed with such originality and economy of space that they beat all the competition from United States firms to secure a £650,000 contract. The control box is no larger than an A4 ringbinder ledger.

Maintaining chilled water in new-age Navy ships fully sealed against a nuclear, biological and chemical warfare environment is vital for the functioning of a ship. "The total loss of cooling water would cause the anti-aircraft defence radar to shut down within 20 seconds," says Max Hadley, the Consultant Systems Design Engineer who planned the development of the Intelligent Sensor Interface sold to the US Navy.

What Max Hadley describes as "an experiment on a grand scale" was prompted by the US Navy's drive for economy. The US Defence department asked for tenders from a large number of companies for a demonstration system to be installed in a Spruance class destroyer. It was intended to cut down manpower by using sophisticated equipment to perform monitoring tasks previously done by sailors.

"The result has been a complete Star-Trek type of automated

maintenance," says Hadley, "In developing our unit, the Intelligent Sensor Interface, we took the opportunity of using some advanced technology. Unlike airborne systems, where one has to rely on proven components, we stuck our necks out and used the latest microchips.

"First we used the new Motorola MC68360 microprocessor, which incorporates both the processor and an Internet interface. The system is designed so that it obeys the TCP-IP networking protocol suite, and if hung on a network connected to the Internet it is possible to select any place in the world and learn the temperature there at that moment.

"While the Motorola processor handles the communication and network side of the work, the TMS320C30 digital signal processor deals with the signal analysis side of the software. A Motorola 56AD16 analogue to digital converter interfaces the sensors. Flash memory is used by both processors. It is only by using advanced chips like these that we are able to get the system down to a little box which screws conveniently to the bulkhead."

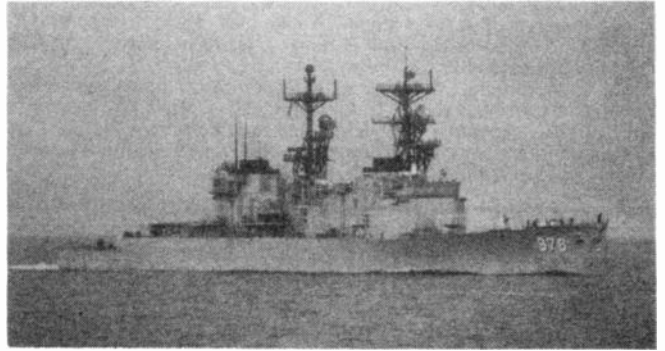

DD978 "Stump", Spruance class destroyer.
Photo courtesy of Jane's Information Group

Because Naval ships with their extensive radar installations prove appalling environments for electromagnetic systems, fibre-optic signal cables are used to provide insulation against troublesome interference. "The Falklands campaign taught us that radar blips can play merry hell with electronic systems unless they are proofed against it," says Hadley, who uses the fibre-optic Ethernet as the networking medium.

A second unit called the Diagnostic Processing Unit has also been developed by the company. This acts as an interface between the intelligent sensor and the ship's main network. With the ship's computerised monitoring system a fault can be traced immediately by asking the damage control computer what has gone wrong and where - "just like Star-Trek," says Hadley.

TELETEST

Those of our many readers who show an interest in the technical side of television (not just the goggling thereof) will welcome the introduction of Ozad's handheld TV test pattern generator, the Teletest.

Ozad express the belief that the Teletest is the TV engineer's "Ultimate Toolkit Accessory". Although it has been designed to meet the TV repair engineer's everyday use in the workshop or in the field, the Teletest should prove to be an invaluable test tool for keen electronics enthusiasts as well as AV technicians in companies, colleges and universities.

Teletest provides four essential PAL test patterns: colour bars, grey scale, cross-hatch and red purity. A 1kHz audio test tone is also generated. The r.f. video and audio signals are output from a 75 ohm-terminated co-axial socket. The instrument is pre-tuned to UHF channel 36, with the audio sub-carrier set to 6MHz for

the UK (a 5.5MHz version is available for other countries).

Powered by a 9V battery, Teletest can be connected to the r.f. and line input sockets of TVs and VCRs. An external mains PSU is included for continuous use. Teletest measures 155mm x 80mm x 40mm, weighs 265g and is made from a tough black ABS plastic. It costs £99, excluding VAT and post.

For further information contact Nick Rose at OZAN, 37 Haviland Road, Ferndown Industrial Estate, Poole, Dorset, BH21 7SA. Tel: 01202 877270.

SEVENOAKS C&G COURSES

Sevenoaks Adult Education Centre has advised us that they are again offering their successful Radio Amateurs City and Guilds 7650 courses. The next course is for the period 1995/96, full details of which, including cost, dates and times, can be obtained from the Centre, address Bradbourne Road, Sevenoaks, Kent, TN13 3QN. Tel: 01732 451618.



LE VOXBOX TO THE RESCUE

Jeremy Austin who, together with Guy Dance, designed the Voxbox project (EPE July 1994) has told us of a novel way in which the design is being used. Regular readers will remember that the Voxbox is a tapeless voice recorder capable of recording two messages each of ten seconds duration, or one message of twenty seconds' duration. It was originally produced at GPT's Poole factory for introducing youngsters to a career in hardware engineering.

Voxbox attracted the attention of Poole lifeboat crew member Nigel Burton. He approached Guy Dance with a request for a sea-going version. The RNLI could see the advantage of using a small, self-contained, ultra-simple and reliable voice recorder for capturing distress messages under arduous circumstances at sea.

For their requirement, the RNLI needed to be able to record longer messages, so Guy and the boys back at GPT put in extra circuits to stretch the record time out to two minutes. Seafaring Voxbox is also a tougher cousin of the published version, being water-proof and (almost) sailor proof.

Once completed, this new design lacked only a suitable name before handover could take place. "We decided to call it Le Voxbox," said Guy, "in honour of our French exchange student, David Passaretti, who constructed the final design for us".

Now Le Voxbox has received its sea-trials and Nigel's verdict is that it is a great success. "It isn't practical to keep rewinding a taperecorder," he said, "and when everyone's on deck we can be short-handed for monitoring the radio. Le Voxbox is really very handy, and much better than using pencil and paper!"



Left to right: Nigel Burton, David Passaretti and Guy Dance.

Meanwhile Guy, whose latest exploit with the Voxbox has been to demonstrate its versatility as an auto-dialling burglar alarm, is pondering what will be the next application for his ubiquitous design. "Now Le Voxbox has gone to sea," he said, "we wonder where next it will bob up to the surface?"

GRAPHICAL MULTIMETER

A graphics facility has been added to Fluke's new 860 series of digital multimeters. This offers users the means of viewing waveforms, graphs, in-situ component signatures, trend plotting and logic activity. The meter also provides, of course, all the functions you would expect on a DMM from a leading manufacturer.

Waveform display mode provides a clear picture of noise, distortion, intermittent failures and glitches, with either a fully automatic or manual set-up. The trend graph plots high resolution meter readings for up to 30 hours, in intervals from one second to 15 minutes.

Meter mode is more traditional, offering both digital and analogue information on a 4.5 digit display and analogue needle graph.

With prices starting at £675 for the 863 model the meters are, however, really only suitable for the serious constructor/designer. For more information contact the Professional Instrument Distributors Association, P.O. Box 35, Skipton, North Yorks, BD23 6PT. Tel: 01756 799737.

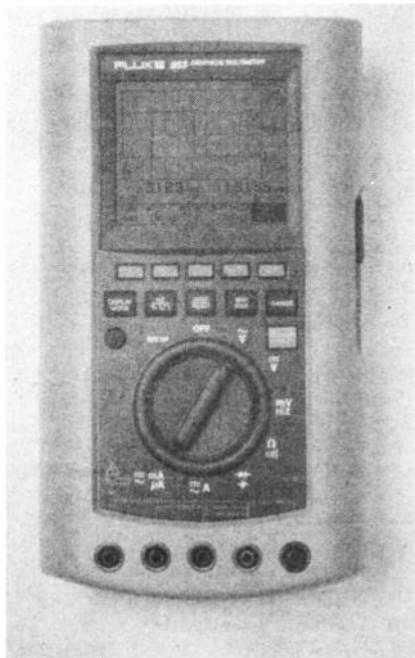

The Fluke 863 Graphical Multimeter.

PLD TRAINER

New software is one feature included in the latest PLD (Programmable Logic Device) trainer designed and manufactured by E & L Technologies.

Upgrading of this popular training tool has given integral development software based on a version of National Semiconductor's software. Compilation and simulation support is provided for a wide range of devices which include G16V8, G20V8, G22V10, G6001V, MAPL 128, MAPL 144, MAPL 244 and MAPL 268.

Reprogrammable Lattice device 22V10 is supplied with the trainer, and may be programmed from any JEDEC file produced for GAL22V10, regardless of software used to compile the equations.

This PLD trainer has all the features and functions necessary to program, test and use PLDs and is supplied with full supporting documentation. As an educational trainer it is a complete digital electronic system which allows all levels of students to become familiar with and understand the concept and use of PLDs. The price is £450.00, excluding VAT.

For further information contact E & L Technologies, Rackery Lane, Llay, Wrexham, Clwyd, LL12 0PB. Tel: 01978 853920.

SURFACE MOUNT ADAPTOR

An increasing problem for hobbyist electronics experimenters is that sometimes the ideal chip to use is only available as a surface mounting device (SMD). Whereas experimenters can readily plug various standard dual-in-line (DIL) chips in and out of sockets, the gull-wing configuration of many SMDs precludes their easy use in this way.

CorinTech, though, have introduced a product which should find obvious appeal with experienced hobbyists. Their new range of ceramic SO (small outline) to DIL converters allow a variety of SM i.c.s to be adapted to fit into standard sockets. From SO8 upwards, all standard package styles can now be reconfigured to the equivalent DIL format.

Mike Barton, CorinTech's General Manager, says that "these converters also

offer design engineers access to otherwise wasted space". Tracks may be routed and components located both around the SO i.c. and on the underside of the unit. Decoupling capacitors, pull-up/down resistors and protection diodes are easily accommodated and many neat technical solutions can be achieved, particularly in high frequency applications. For further information contact CorinTech Ltd., Ashford Mill, Station Road, Fordingbridge, Hants, SP6 1DG. Tel: 01425 655655.

NEW SCOPE

B.K. Electronics are now stocking the new Hameg HM303 oscilloscope. Succeeding the HM203, which sold over 170,000 worldwide, the HM303 bandwidth has been extended to 30MHz, the unit boasts a lighter weight of 5.6kg, and a switched mode power supply. Another

advantage of the scope is that it will work from a mains supply of between 90V and 240V a.c. without adjustment.

The HM303 is priced at £392 plus VAT, and includes two switched probes and a manual. Carriage is free of charge.

For more information contact B.K. Electronics, Unit 1, Comet Way, Southend-on-Sea, Essex, SS2 6TR. Tel: 01702 527572.

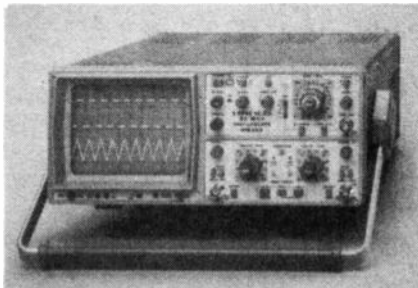

New Technology Update

Ian Poole looks at a new family of devices which, it is claimed, could be the answer to the r.f. designer's prayers.

WHILST the growth of the communications industry is good news for many, it also brings its own problems. The increase in demand for spectrum means that new services have to use higher frequencies. Already many cell phone services are operating at frequencies around 1800MHz. Some services are having to use very much higher frequencies.

Monolithic M.M.I.C.

To be able to use these frequencies a number of new radio frequency developments have come to the fore. One of these is the monolithic microwave integrated circuit or M.M.I.C.

These come in a variety of forms. There are amplifiers, mixers, dividers and a host of other circuits which have been developed. They are all true r.f. i.c.s, often containing elements like inductors and transmission lines.

Some are capable of operating at exceedingly high frequencies. Fifteen to twenty thousand megahertz (i.e. 15GHz-20GHz) is not unheard of.

There is a wide variety of these circuits which are available for use on a variety of frequencies. AvanteK, which is now owned by Hewlett Packard, developed a series of M.M.I.C.s for use on relatively low frequencies. This range of amplifiers has a variety of specifications, with gains of up to 20dB and frequencies up to 2GHz.

For many r.f. designers these are ideal building blocks to use in a variety of situations. They are very easy to use, requiring input and output capacitors and a series feed resistor to limit the supply current as shown in Fig. 1.

They are never known to "take off" and give spurious oscillations, and provided that a few fundamental r.f. design layout precautions are observed they give excellent performance. They are also very cheap, costing only a few pounds. As a result they are often the answer to an r.f. designer's prayers.

These circuits are comparatively simple, containing a transistor amplifier but no strip lines or inductors. They are fabricated from silicon.

The very much higher frequency circuits are often far more complicated, and sometimes consisting of a number of M.M.I.C.s placed onto the same substrate or carrier plate. When very high frequencies are required they are usually made from gallium arsenide.

Power Play

Often high power M.M.I.C.s are required, especially for applications in transmitters. Here a new substrate material is

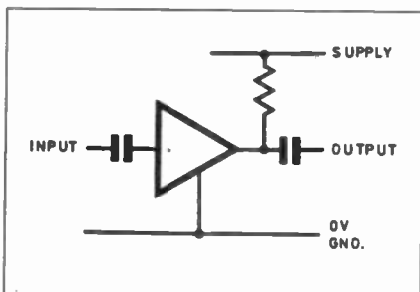

Fig. 1. Circuit diagram for an r.f. amplifier using an MSA series M.M.I.C.

helping to reduce costs and improve performance.

High power M.M.I.C.s experience problems with the efficient removal of the heat generated in the circuit. To overcome this, additional stages are usually required in the fabrication of the i.c. so that the correct heat removal techniques can be installed.

This adds a considerable amount of cost to the final item. However, by using a new material called Silvar, developed by their Metallurgical Materials Division, Texas Instruments claim they can reduce the cost of a power devices by as much as 50 per cent.

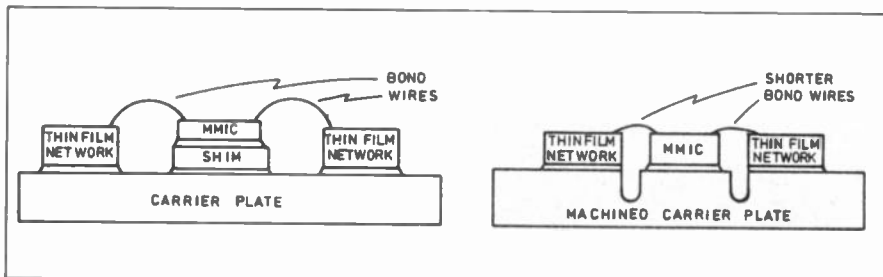

Fig. 2. Comparison of (left) existing M.M.I.C. method, and (right) new method using Silvar carrier plate.

In the production of specialised M.M.I.C.s and their assemblies there are three main areas which contribute to the costs. The first is the very specialised nature of the assembly, which means that automated manufacturing techniques cannot be used.

This calls for the use of very accurate assembly jigs which are very costly to produce. Highly skilled manual labour also has to be employed and this adds to the costs as well.

The final reason for the high production costs is that dimensional changes caused by temperature cycling which occur during manufacture can greatly reduce the yield. In order to ensure the production of any device remains viable, the number of rejects must be reduced to a minimum. In addition

to this a device having a low yield in manufacture is also less likely to have good long term reliability.

Silvar Lining

Texas Instruments decided that the production of these devices could be greatly improved if a new concept in production was adopted. In a standard assembly the semiconductor itself is placed on a shim and then onto the substrate. Solder joints then connect the gallium arsenide chip to its external circuits, which might typically be thin film networks.

With the introduction of Silvar, a much simplified process can be used, removing much of the assembly time. The Silvar itself can be very accurately machined and this enables much less complicated assembly jigs to be used.

Another advantage of Silvar is that wire lengths can be shortened because circuits in the chip can be placed closer together. This considerably improves performance allowing the full potential of the chips to be realised.

The new material also exhibits the right co-efficient of expansion. It matches the gallium arsenide very well. In fact after all

the processing stages it leaves the gallium arsenide chip in a state of slight compression. This has been proved to enhance the reliability of the chip.

The material is made from a combination of nickel iron alloys which are balanced to give the correct co-efficient of expansion. Some silver is also included to enable the high degree of thermal conductivity to be achieved.

Silvar is also very easy to machine, proving to be very much faster and hence cheaper than the existing materials which are used. Once the substrate is complete, the remaining stresses within the material are said to be very much lower than other materials. This is another factor which helps improve the reliability of the completed assemblies.

Is your PCB design package not quite as "professional" as you thought? Substantial trade-in discounts still available.

Board Capture

Schematic Capture Design Tool

- Direct netlist link to BoardMaker2
- Forward annotation with part values
- Full undo/redo facility (50 operations)
- Single-sheet, multi-paged and hierarchical designs
- Smooth scrolling
- Intelligent wires (automatic junctions)
- Dynamic connectivity information
- Automatic on-line annotation
- Integrated on-the-fly library editor
- Context sensitive editing
- Extensive component-based power control
- Back annotation from BoardMaker2

£395

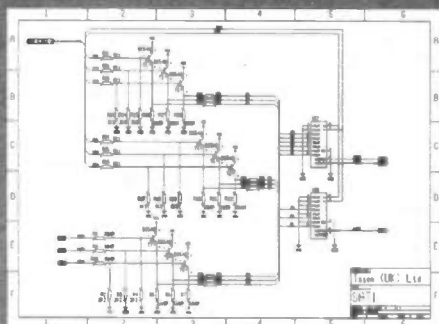

BoardMaker

BoardMaker1 - Entry level

- PCB and schematic drafting
- Easy and intuitive to use
- Surface mount and metric support
- 90, 45 and curved track corners
- Ground plane fill
- Copper highlight and clearance checking

£95

BoardMaker2 - Advanced level

- All the features of BoardMaker1
- Full netlist support- BoardCapture, OrCad, Schema, Tango, CadStar
- Full Design Rule Checking both mechanical and electrical
- Top down modification from the schematic
- Component renumber with back annotation
- Report generator- Database ASCII, BOM
- Thermal power plane support with full DRC

£395

Board Router

Gridless re-entrant autorouter

- Simultaneous multi-layer routing
- SMD and analogue support
- Full interrupt, resume, pan and zoom while routing

£200

Output drivers - Included as standard

- Printers - 9 & 24 pin Dot matrix, HPLaserjet and PostScript
- Penplotters - HP, Graphtec & Houston
- Photoplotters - All Gerber 3X00 and 4X00
- Excellon NC Drill and Annotated drill drawings (BM2)

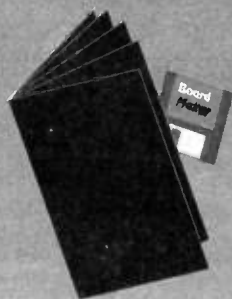
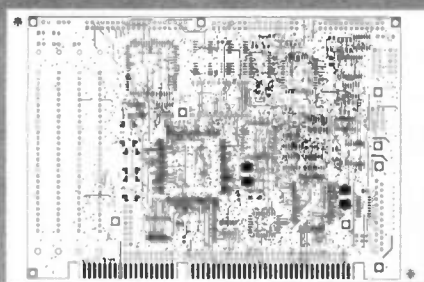

All trademarks acknowledged

For further information contact
 Tsien (UK) Limited
 Aylesby House
 Wenny Road, Chatteris
 Cambridge, PE16 6UT
 Tel 01354 695959
 Fax 01354 695957
 E-mail Sales@tsien.demon.co.uk

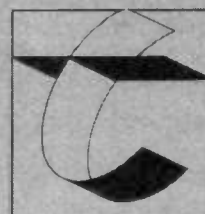

tsien

PERSONAL PRACTICE AMPLIFIER

ANDY FLIND

Headphone power keeps the family cordial while you strive for chords harmonial.

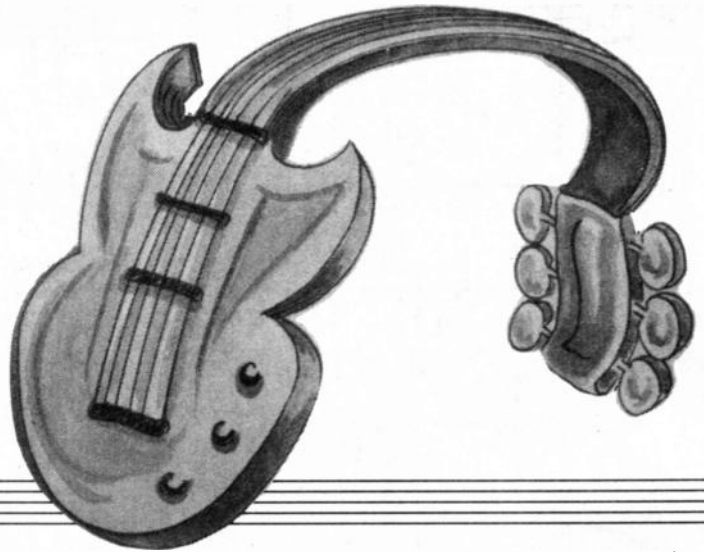

LIKE many of the author's projects, the idea for this one began with a request from a friend. A lead guitarist with a heavy metal and blues band, he spends a lot of his spare time practising and always likes his music loud.

His wife and neighbours, needless to say, are not always quite so keen. In addition, he spends a certain amount of time "on the road", and for this a personal amplifier that could be used whilst travelling or in hotel rooms was considered a most desirable accessory.

MIXED RESPONSE

These days, musicians (rich ones, anyway!) can purchase magic boxes full of microprocessor driven electronics that will generate just about any effect desired. Guitarist friend wished to combine the headphone output from one of these, a stereo source despite the guitar's output being mono, with the output from a Walkman playing taped music with which he wished to practise.

The initial request, therefore, was to produce a box containing a simple mixer for combining headphone level signals, and having an output capable of driving eight-ohm enclosed stereo headphones at fairly high volume. These are apparently preferred by musicians to the smaller 32-ohm types generally used with Walkman players as they provide greater volume and exclude external noise more efficiently.

Additionally, it was felt that a mono input accepting signals directly from the guitar should be provided. It was decided at the outset not to provide any tone or input level controls as all the signal sources to be used with the unit would have their own. Restricting the controls of the unit to a single volume control and an on-off switch would make it simple and compact.

OP.AMP MIXERS

For readers not familiar with op.amp mixer circuits, it is probably worth taking a few moments to explain their action. The basic circuit, which is configured as a simple op.amp inverter, is shown in Fig. 1.

Using negative feedback through resistor R3, the op.amp strives to maintain a voltage at its inverting (-) input identical to the one applied to its non-inverting (+) input, in this case zero volts or "ground".

If input currents flow through resistors R1 and R2 the op.amp will try to maintain this potential by adjusting its output voltage to sink the currents through R3. For this reason the inverting input of this circuit is sometimes referred to as a "virtual earth" point.

The advantage of this for mixing applications is that because the input and output feedback resistors always have a "ground" potential at one end, the input currents are always directly proportional to the input voltages. Consequently, the output voltage is always directly proportional to the (inverted) sum of the input voltages since this

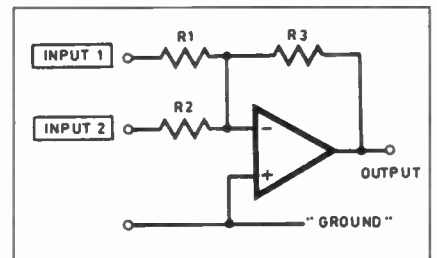

Fig. 1. Simplified op.amp mixer circuit.

is what has to be applied to resistor R3 in order to maintain the "ground" potential. This applies where the resistors all have the same value, of course, so preserving unity gain.

With suitable adjustment to the ratio of input and output resistor values the circuit can also provide gain or attenuation. Additionally, since the inputs are always connected effectively to a fixed potential, they do not interfere with each other, an advantage in some applications.

AMPLIFIER CIRCUIT

The full circuit for the Personal Practice Amplifier is shown in Fig. 2. Since it is a stereo circuit there are two mixers, one each for the left and right channels. The mixers are formed around IC1a and IC1b, the two op.amps within an LM358 device.

The four audio signals (two lefts and two rights) from the headphone sockets of the

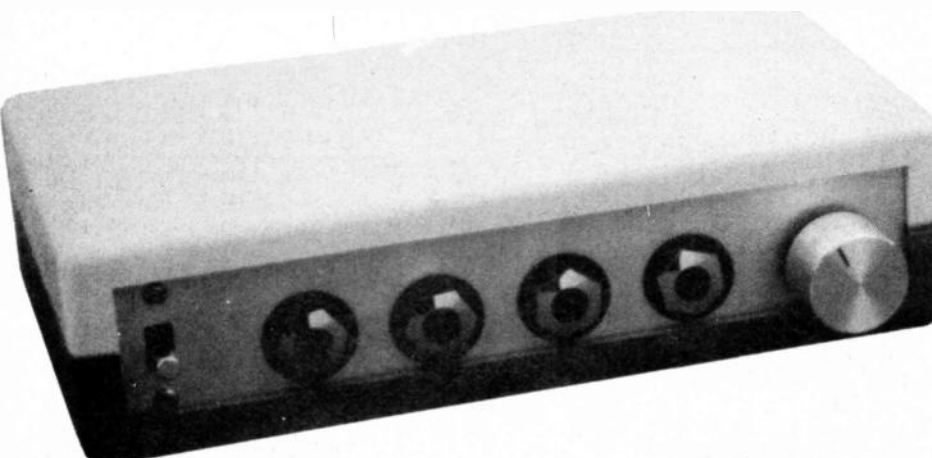

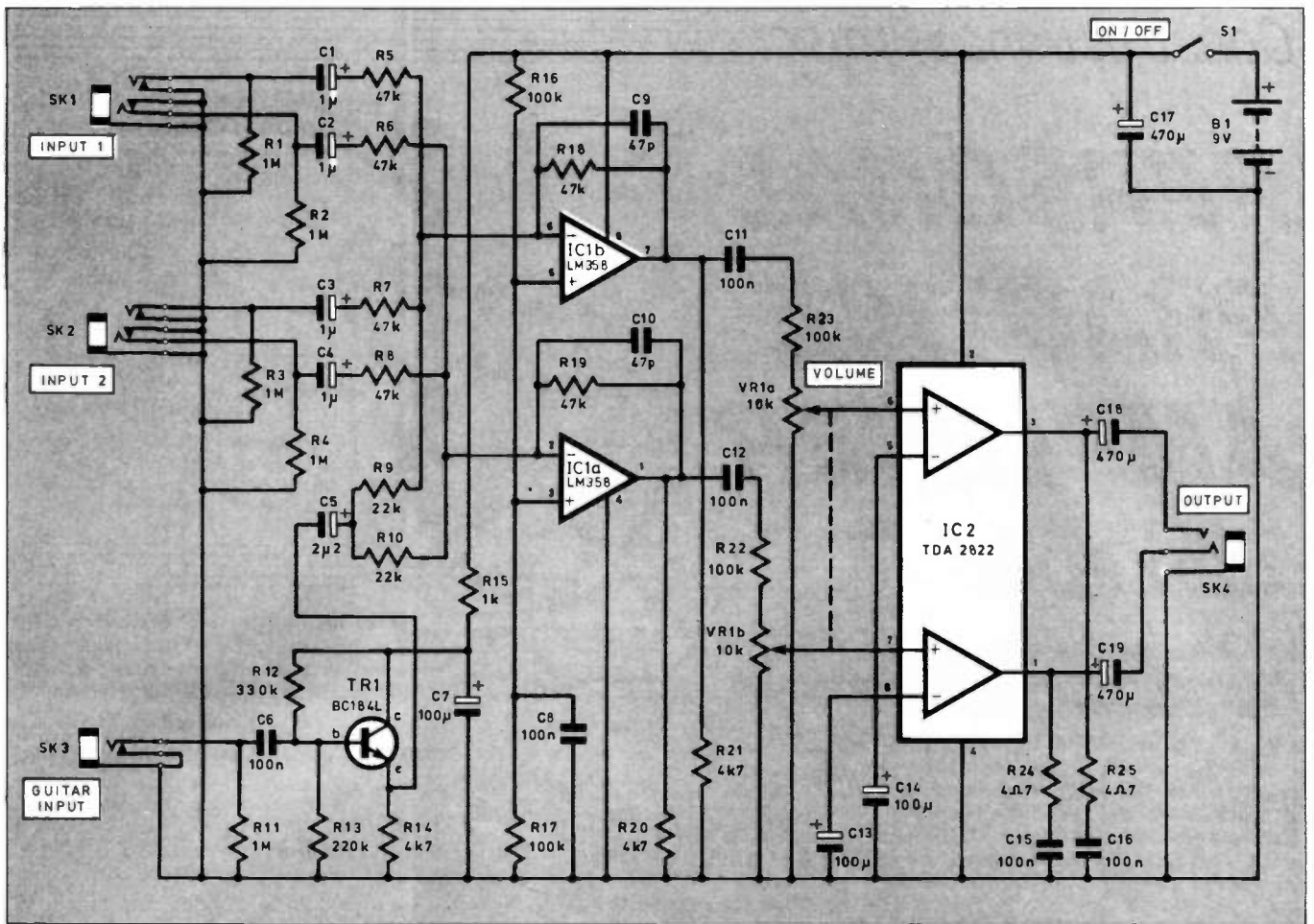

Fig. 2. Complete circuit diagram for the Personal Practice Amplifier.

two main music sources are a.c. coupled from stereo jack sockets SK1 and SK2 through capacitors C1 to C4 into resistors R5 to R8. The jack sockets are switched types, arranged so that unused inputs are connected to ground to eliminate any noise that might occur if they were left open-circuit.

High value resistors R1 to R4 are included to ensure that the input capacitors, and possibly the output capacitors of connected equipment, receive a "polarizing" voltage.

The signal from the guitar is input via mono jack socket SK3 and is buffered by transistor TR1 to provide an input impedance of around 120k, as required by the magnetic pickups of most electric guitars. This stage does not provide any voltage gain, the slightly higher gain required is achieved by the use of lower value input resistors R9 and R10 to the mixers. Both mixer stages are driven simultaneously by this input. The power supply to the transistor is decoupled by resistor R15 and capacitor C7 to ensure stability.

In the simple example of Fig. 1, it was assumed that the op.amp was supplied from a dual supply and the inputs worked at "earth" potential. In Fig. 2 it will be seen that there is only a single 9V supply, so the reference for the two mixers is set to half this by resistors R16 and R17, with a decoupling capacitor C8.

With two other minor additions, the mixers are virtually as described in Fig. 1. Since we are surrounded by assorted radio transmitters, from CB to portable telephones, it's always a good idea to define the upper frequency response of audio circuits. Capacitors C9 and C10 restrict the

upper limit to around 40kHz. The low frequency response of this circuit is around 20Hz, so bass players should find it just as useful as lead guitarists.

Next, the two op.amp outputs are slightly loaded by resistors R20 and R21 to negative supply, the reason for which may not at first be obvious. The LM358/324 op.amp family is not really intended for audio applications, and its Class B output stage can introduce unpleasant "cross-over" distortion.

However, as these op.amps are cheap and simple to use, they are often employed in audio applications such as graphic equalisers without apparent problems. This is because, where low-power signal process-

ing is required, the performance can be improved with a loading resistor, as in this circuit. The small d.c. current taken from the output ensures that only one of the two internal output transistors ever conducts, effectively converting it to Class A operation and eliminating the cross-over problem.

OUTPUT AMPLIFIER

From the mixers, the left and right signals pass through the volume controls VR1a and VR1b to the output amplifier. This is a TDA2822 stereo device, with two internal amplifiers each capable of delivering around 0.5W into an 8-ohm load. They have a fixed gain of around 40dB, and

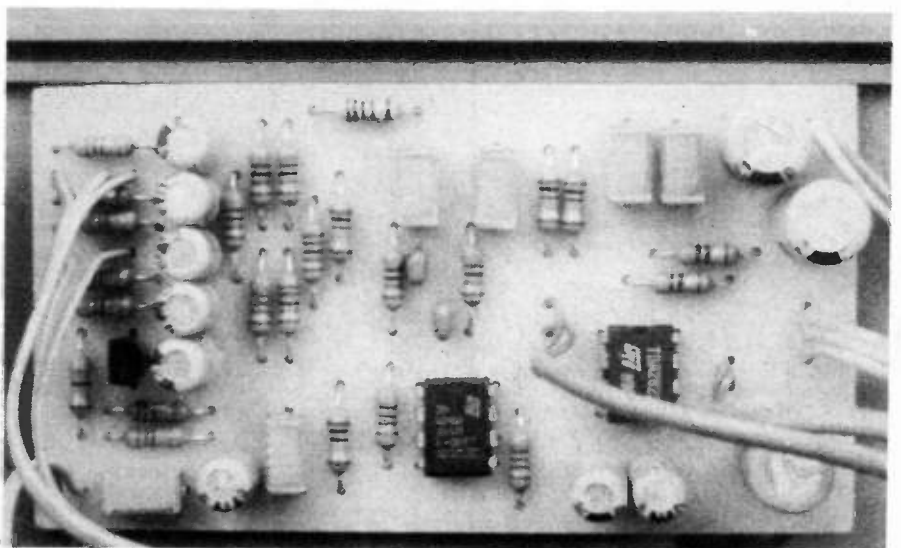

the input signals from the mixers are attenuated by resistors R22 and R23 to compensate for this.

Outputs are taken to the output jack socket SK4 through the coupling capacitors C18 and C19. "Zobel" networks R24/C15 and R25/C16, are provided in accordance with the manufacturers' recommendations for stability. (Zobel is renowned for his work on filter designs.)

Power for the circuit is supplied by a 9V d.c. source. As the quiescent drain is only about 12mA, and is not much more than this at most normal listening levels, a PP3 battery is suitable. This should be an alkaline type as these cope more effectively with occasional peaks of current demand. The circuit continues to operate quite happily down to below 6V, so PP3 battery life should be adequate. Where a great deal of use is foreseen, a pack of six AA batteries could be used instead.

CONSTRUCTION

The circuit is built on a single printed circuit board (p.c.b.) which is available from the *EPE PCB Service*, code 950. The layout

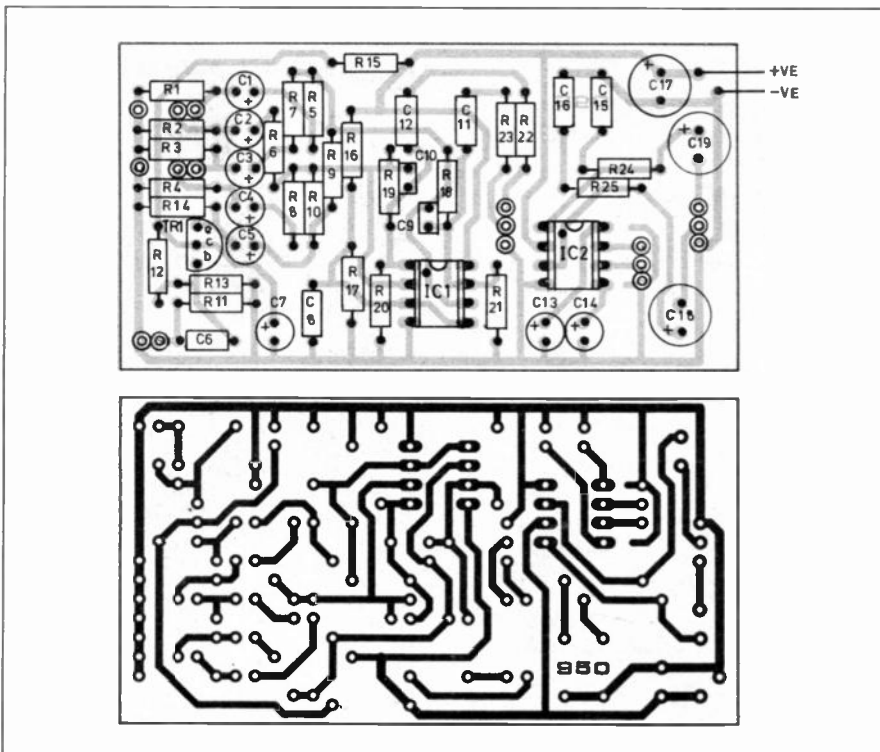

Fig. 3. Component layout and full size copper foil track master for the printed circuit board.

COMPONENTS

Resistors

R1 to R4, R11	1M (5 off)
R5 to R8, R18, R19	47k (6 off)
R9, R10	22k (2 off)
R12	330k
R13	220k
R14, R20, R21	4k7
R15	1k
R16, R17, R22, R23	100k (4 off)
R24, R25	4Ω7 (2 off)

See
**SHOP
TALK**
Page

Potentiometer

VR1	10k dual carbon rotary, log
-----	--------------------------------

Capacitors

C1 to C4	1μ radial elect. 63V (4 off)
C5	2μ2 radial elect. 63V
C6, C8, C11, C12, C15, C16	100n polyester (6 off)
C7, C13, C14	100μ radial elect. 10V (3 off)
C9, C10	47p ceramic (2 off)
C17 to C19	470μ radial elect. 16V (3 off)

Semiconductors

TR1	BC184L npn silicon transistor
IC1	LM358 dual op.amp
IC2	TDA2822 stereo power amplifier

Miscellaneous

SK1, SK2, SK4	stereo jack socket, switched (see text) (3 off)
SK3	mono jack socket, switched (see text)
S1	s.p.s.t. slide switch

Printed circuit board, available from the *EPE PCB Service*, code 950; plastic case 153mm x 84mm x 39.5mm; knob; battery connector (see text); 8-pin d.i.l. sockets (2 off); connecting wire; solder, etc.

Approx cost
guidance only

£21

positions for all components are shown in Fig. 3.

There should be no problems with constructing this circuit. The components could be simply fitted to the board, checked and powered up, but for the more cautious it can be built and tested in stages if preferred.

All the passive components – resistors and capacitors – can be fitted to the board first. Care should be taken to ensure that the electrolytics are fitted the right way round. Omit transistor TR1 and the two i.c.s for the moment, although their d.i.l. sockets may be soldered in. After thoroughly checking that your soldering of all the components is satisfactory, power can then be applied.

Apart from the charging surge and any minute leakage of capacitors C7 and C17, the current taken should be negligible.

Anything more than a couple of hundred microamps indicates a problem and should be investigated before proceeding.

Next, transistor TR1 can be fitted, again taking care with polarity. This will add just over half a milliamp to the current drain, and the potential at its emitter should be a little over 2V. Now insert IC1, which will take the total supply current to about 3.5mA. The potential at IC1's outputs, pins 1 and 7, should be half the supply, or about 4.5V.

If an oscilloscope is available, it is possible to monitor these outputs whilst injecting input signals to check operation of the mixer stages, but this is probably being over-cautious!

Before fitting IC2 it is necessary to connect volume control VR1a and VR1b and provide for monitoring the output,

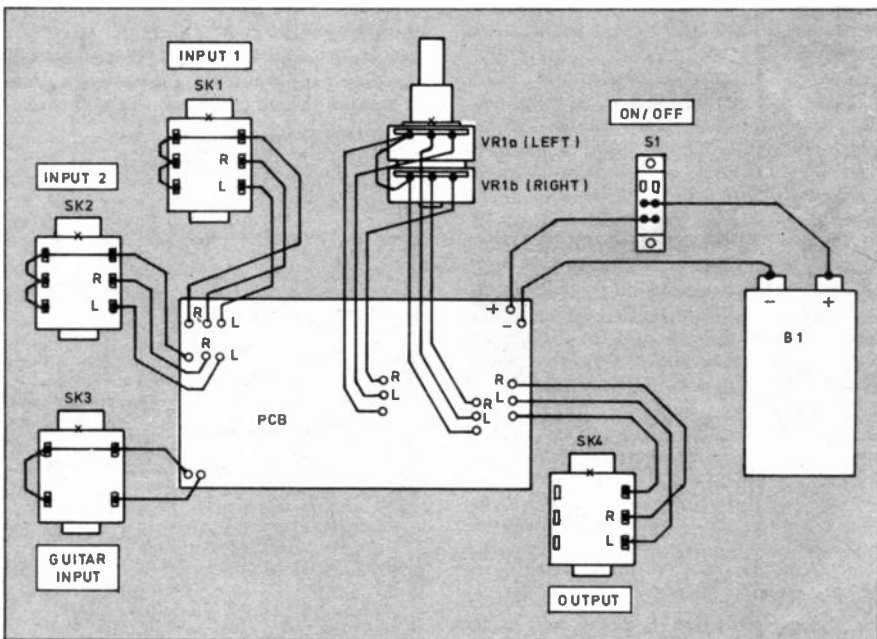

Fig. 4. Interwiring details for the Personal Practice Amplifier.

either with headphones or a 'scope. The fitting of IC2 will raise the total supply current to about twelve milliamps. The audio output should respond with loud hums when inputs are touched with a finger, the level depending upon the volume control setting.

CASE AND WIRING

Any type of case preferred by individual constructors can be used for this project, though the one suggested results in a very attractive, pocket-sized unit.

If a metal case is used, it should be connected to the negative supply rail, as should any metal panels in plastic cases. In the prototype this was achieved simply by soldering a short lead between the negative wiring on the nearest jack socket and one of the securing screws of switch S1.

The wiring connections shown in Fig. 4 are for the standard 0.25-inch switched jack sockets used by most musical equipment, though other types, such as 2.5mm or 3.5mm, can be used if preferred. Provided the input connection leads are fairly short, there is no need to use screened leads as the inputs are mostly of relatively low impedance and high signal level.

Volume control connections, however, should be made with screened lead, as these carry low level signal voltages at medium impedance and are therefore more sensitive to hum, etc. Connections to socket SK3 might need shielding if interference problems are experienced in use, though this was not the case with the prototype. Note the crossover of the signal connections to SK4, necessary to maintain correct "left" and right" signal paths.

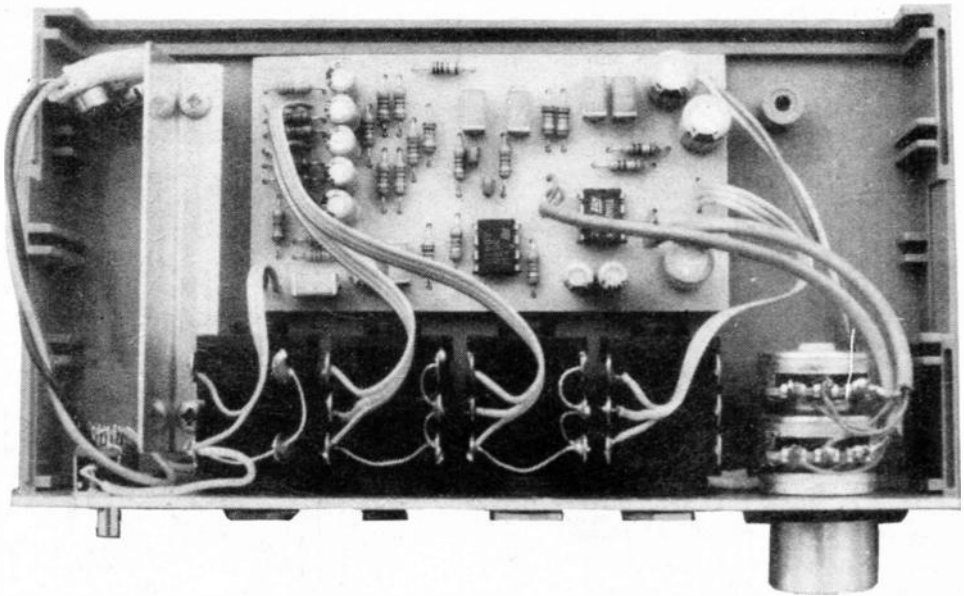

A switched socket may be fitted for an external mains driven power supply. If this is done, it may prove necessary to earth the negative side of the supply to prevent mains hum, and to ensure safety.

AMPLE USES

The output of this amplifier when driving headphones should certainly prove sufficient to satisfy the demands of most musicians. It may also find other uses beyond the application for which it was designed. If a large power supply is used, the outputs could supply a couple of

8-ohm loudspeakers, so it could be used as a mini PA or perhaps as a booster for a Walkman.

Another use would be as a general purpose workbench amplifier for experimenters. One note of caution: the volume should not be turned up so far as to drive the output into clipping, as under these conditions the output chip suddenly gets very thirsty, which translates as expensive in terms of batteries. It is unlikely, though, that many users would wish to use it at anywhere near this level for very long. □

SHOP TALK

with David Barrington

Versatile Microcontrolled 3-Digit Timer

The little pushbutton switches used in the *Versatile Microcontrolled 3-Digit Timer* project may prove difficult to purchase from your usual local source. These are variously listed as "miniature p.c.b. keyboard key-switches" or more commonly as "miniature tactile switches".

The horizontal version is used here and should be stocked by most component advertisers. However, in case of difficult similar switches are listed by **Maplin** as Tactile Switches, code KR92A and by **Electromail** (☎ 01536 204555) under Keyboard Switches, code 320-871.

The 0.5in. 7-segment displays should be available generally. Display XI *must* be the "high brightness" type. Also, to fit on the p.c.b. they must be the type with a "horizontal" pinout arrangement, i.e. pins run across the top and bottom of the device. Remember to specify a common anode and *two* common cathode devices when ordering.

Checking for supplies of the 3-2768MHz crystal, we were surprised how few component stockists carried a good selection of crystals. It is currently listed in the new **Circuit** catalogue, stock code 45-03000. We only found it listed by **Electromail** (657-527) by looking at the end of their semiconductor section; they do not carry a "crystal" listing in their main Index.

Most of our component advertisers will be able to supply a suitable 12V relay. However, before ordering check that it will fit on the p.c.b. or be prepared to mount it off-board and hard wire it to the p.c.b. The **Maplin** 3 Amp Min Relay (YX96E) should sit directly

on the p.c.b. *It is most important that whichever relay is used the CONTACTS are suitably rated for switching the attached appliance.*

A pre-programmed PIC16C54 microcontroller is available (*strictly mail order only*) from the author, price £9.50 including postage. All monies should be made payable to B. Trepak. Orders should be sent to **Mr. B. Trepak, 20 The Avenue, London, W13 8PH.** Overseas customers add £2 to order.

The Timer printed circuit board is available from the *EPE PCB Service*, code 933.

Solar Seeker

The choice of motor and transmission caused the authors the greatest number of headaches when selecting parts for the *Solar Seeker*. After a lot of head scratching a radio control (RC) servo motor was finally adopted here.

The motor in the prototype model is designated "Acoms IC AS-7 Servo." We understand from the designers that most model shops should be able to offer a suitable RC servo motor, with gearbox. They also pointed out that "RC motor with mounting hardware" is also referred to by some model makers as an "RC Servo horn" and is a small plastic coupling stocked by RC model shops.

They also took some time trying to assess the leakage current in tantalum capacitors and found that the **Maplin** sourced ones were better than some others tried - Maybe a statistical freak! Anyway, don't forget that capacitor C1 must be a tantalum type.

The reed relay is a sub-miniature type rated at 5V d.c. 10mA, with a 500 ohm

coil. A suitable type is listed by **Maplin** code JH12N. The dual power op.amp type L272M is also listed, code UJ36P.

Infra-Red Remote Control Unit

The only item that could cause any real concern when undertaking the *Infra-Red Remote Control Unit* is likely to be the UM3750 encoder/decoder i.c. used in both the Transmitter and Receiver circuits. If any problems do arise, it can be ordered from **Maplin**, code UK77J.

The red plastic lens, used over the Receiver photo diode, also came from the same source, code FA95D. The TBA2800 infra-red preamplifier i.c. is currently listed by **Maplin** (JU36P) and **Circuit** stock number 61-02800. Most of our component advertisers should be able to supply the TIL100 infra-red photo diode or its equivalent.

The only other part called up for the Transmitter that needs careful selection is the infra-red emitting diode. This must be a "high power" type, such as the TIL38.

The 6-way d.i.l. switch is now a stock line with most of our advertisers and should not be a problem locating. The Transmitter and Receiver printed circuit boards are available from the *EPE PCB Service*, codes 948 (Trans.) and 949 (Rec.) respectively.

Ramp Generator

Some of the items called up for the *Ramp Generator* need to be specially purchased if the constructor is to adhere to the published design. Information on these items was given in *Shop Talk* last month.

Personal Practice Amplifier

Not too much can go wrong when ordering parts for the *Personal Practice Amplifier* project. Remember to quote the suffix L when ordering the BC184L transistor and to ask for a stereo dual ganged "log" potentiometer.

The TDA2822 stereo power amplifier i.c. was purchased from **Maplin**, code UJ38R.

FOX

REPORT

by Barry Fox



ID Cards

The UK government will soon decide whether to introduce an electronic identity card scheme. The main options are to do nothing, make cards available on a voluntary basis, treat a driving licence with photo as an ID card, or make it compulsory for everyone to carry a government card which stores full personal details. Everyone will have their own views and anyone can send their comments to the Home Office before 30 September.

In a "special feature" (*EPE* July '95) I described how Smart Cards could be used to store a wide range of picture and text information, but at a relatively high cost. This is one argument against a compulsory scheme. But two recent developments have moved the goalposts.

US giant Motorola has joined with Matsushita of Japan and bought the Indala Corporation, a specialist electronics company in San Jose, to offer new memory technology which cuts the cost of memory storage. Kodak and IBM have developed a "hypercompression" system that stores photographs in such a small memory space that even a magnetic credit card can carry the owner's electronic picture.

Radio Honeycomb

Existing memory cards either have a built-in battery to hold data inside volatile RAM, or use high currents to write to non-volatile memory EEPROM (Electrically Erasable Programmable Read Only Memory). A new material, Y1 is a ferroelectric ceramics material similar to a high temperature superconductor and when formed into a honeycomb lattice of individual cells, the cells store bits of digital code as isolated spots of capacitive charge. The written charge pattern remains permanent until a fresh writing current is applied.

The Y1 theory was proposed five years ago by the University of Colorado, but Matsushita of Osaka developed and patented a way of making a cell matrix by a technique similar to that used to fabricate microchips from silicon wafers. Indala then worked out a way of burying the matrix inside a credit card or resin button, along with a miniature radio transponder and aerial made from 400 turns of very thin wire. The matrix uses the power of an interrogation signal to send back a response signal which is coded to carry whatever information is in the memory.

In 1993 Motorola bought Indala and also signed a joint venture deal with

Matsushita. Motorola and Indala design the Y1 cell structures which Matsushita fabricates in Osaka.

"It is very nearly the perfect memory material" says Rudyard Istvan, the Motorola President of Indala. "But if you do not use exactly the right recipe for the mix, the cake turns out flat".

Energy Levels

Structures of Y1 need less than 1V, and energy levels of only 20 picojoules to read and write to the cells. This compares with the 12 volts and 200 picojoules needed to write to EEPROM or Flash memory chips used in smart cards.

Whereas Y1 reads and writes at the near instantaneous speed of RAM, Flash and EEPROM takes one second to read each kilobit of data. Also Flash and EEPROM memories start to fail after they have been written to and erased a few hundred thousand times. Y1 survives a billion cycles.

For identity cards the reader emits a signal at 125kHz, from a distance of up to one metre. For car tolling, the reader transmits at 2.4GHz, and can reach over a range of 100 metres.

The only limiting factor is the minimum working size of the Y1 cells. These cannot be less than one micrometre across, and this limits the practical capacity of a Y1 memory chip to 256 kilobits or 32 kilobytes, or around 3000 words of text. Although small by today's PC standards this is more than enough for identity cards.

Istvan says Motorola can drive the cost of cards down to \$2 each, which is less than half the cost of a smart card with equivalent memory, and none of the practical limitations. Tag buttons will cost \$1. Readers can be made for \$75.

Image Bank

Says Istvan "We have already thought of using the system to store electronically compressed photographs. You could walk through passport control without taking the card out of your pocket. The only way to counterfeit cards would be to build a silicon wafer fabrication plant and modify it for Y1 processing".

Kodak's Image Verification System (IVS) works with a reader developed by IBM to display an image of the cardholder's face on a TV screen. The display terminal, says Kodak, can either be a cash register or an identity verification terminal.

"We are proposing IVS as an industry standard", said Carl Gustin, Vice-President

of Kodak's Digital and Applied Imaging Division.

A full colour image normally requires at least a megabyte of storage space, and fills a floppy disk. Existing compression technology can reduce this to a few tens of kilobytes, without too much quality loss. But this is still far too much data for a card with affordable memory capacity.

To be useful as an identification tool, the card must also store text which needs one byte for each character. The magnetic strip on an ordinary credit card has a storage of capacity of under 250 bytes.

By using IVS it squeezes the image down to an unprecedented 400 bits, or 50 bytes. This leaves plenty of space on even the cheapest one kilobyte smart card for personal and medical text. It is also small enough to store on a magnetic credit card.

On Track for Photo-fit Identity

Kodak suggests putting the picture in the third of the three magnetic tracks which are defined by the ISO card standard. According to this standard two tracks contain information about the holder and can only be read by a card reader.

The third track can be written to by a reader as well as read. This third track has a capacity of 107 bytes and is usually left half empty by the banks. So a standard credit card can store a 50 byte hypercompressed picture without limiting other functions.

Although Kodak will not explain how the technology works, the black and white pictures displayed by IBM's reader suggest that no attempt is made to store a true photographic image of the holder. Instead the 50 bytes convey flag signals which trigger the reader into searching through a pre-programmed memory of facial characteristics.

The reader then blends these together into a photo-fit image. Dithering, the addition of a little random noise, smooths the joins between the component parts of the image. Because so little information is needed, the same technique can be used to store pictures on bank cheques as a bar code string.

Although the images so far displayed are only in black and white, Kodak claims that colour recording of passport picture quality is also possible if the store capacity is increased to three or four kilobytes.

Pico Releases PC Potential

Pico's Virtual Instrumentation enable you to use your computer as a variety of useful test and measurement instruments or as an advanced data logger.

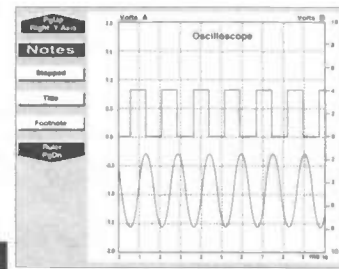

PicoScope
'Virtual instrument' software.

Hardware and software are supplied together as a package - no more worries about incompatibility or complex set-up procedures. Unlike traditional 'plug in' data acquisition cards, they simply plug into the PC's parallel or serial port, making them ideal for use with portable PC's.

Call for your Guide on 'Virtual Instrumentation'.

PicoLog
Advanced data logging software.

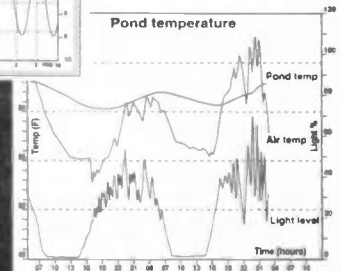

NEW from Pico TC-08 Thermocouple to PC Converter 8 channel Thermocouple Interface

- Connects to your serial port - no power supply required.
- Supplied with PicoLog datalogging software for advanced temperature processing, min/max detection and alarm.
- 8 Thermocouple inputs (B,E,J,K,N,R,S and T types)
- Resolution and accuracy dependant on thermocouple type. For type K the resolution is better than 0.1°C.

TC-08 £ 199

TC-08 + Calibration Certificate £ 224

complete with PicoLog, software drivers and connecting cable. A range of thermocouple probes is available.



SLA-16 & SLA-32 Logic Analysers Pocket sized 16/32 channel Logic Analysers

- Connects to PC serial port.
- Up to 50MHz sampling.
- Internal and external clock modes.
- 8K Trace Buffer.

SLA-16 £ 219
SLA-32 £ 349
with software, power supply and cables



ADC-100 Virtual Instrument Dual Channel 12 bit resolution

- Digital Storage Scope
- Spectrum Analyser
- Frequency Meter
- Chart Recorder
- Data Logger
- Voltmeter

The ADC-100 offers both a high sampling rate (100kHz) and a high resolution. It is ideal as a general purpose test instrument either in the lab or in the field. Flexible input ranges ($\pm 200\text{mV}$ to $\pm 20\text{V}$) allows the unit to connect directly to a wide variety of signals.

ADC-100 with PicoScope £199
with PicoScope & PicoLog £219

The ADC-10 gives your computer a single channel of analog input. Simply plug into the parallel port.

ADC-10 with PicoScope £49
PicoScope & PicoLog £59

ADC-10 1 Channel 8 bit

- Lowest cost in the Pico range
- Up to 22kHz sampling
- 0-5V input range



Carriage UK free, Overseas £9 Oscilloscope Probes (x1, x10) £10

PICO TECHNOLOGY



Pico Technology Ltd. Broadway House, 149-151 St Neots Rd, Hardwick, Cambridge. CB3 7QJ
Tel: (0)1954 - 211716 Fax: (0)1954 - 211880 E-mail: 100073.2365 @compuserve.com



Phone or FAX for sales, ordering information, data sheets, technical support. All prices exclusive of VAT

STATIC

IAN POOLE

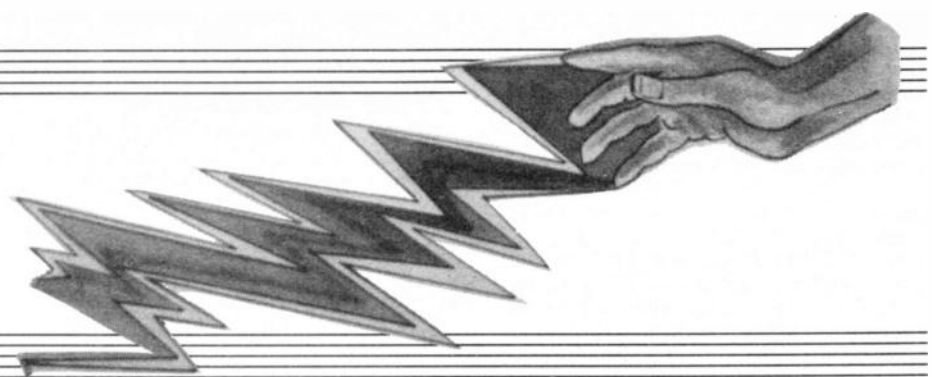

Understand the nature of static electricity and how to avoid its problems in electronics.

STATIC is a problem which is becoming increasingly important in electronics. In the very early days of valves, no one gave it a thought. When transistors arrived, it was still not a real problem. However, when MOSFETs arrived they started to fail for no apparent reason as people began to discover that static could have disastrous effects on semiconductors.

Nowadays, manufacturers of electronic equipment spend vast amounts of money investing in equipment to ensure that semiconductor devices are not exposed to static or as it is more correctly termed electro-static discharge (ESD). Indeed many manufacturers treat all semiconductors as static sensitive devices, not just the MOS devices which are most prone to damage.

WHAT IS STATIC?

Static is an everyday fact of life. It is simply the build up of a static electrical charge between two bodies. From time to time this build up is discharged. This can take place in a very short space of time, and there can be some surprisingly high levels of current and voltage.

Lightning is, of course, the most dramatic result of static discharge. Potentials of many thousands of millions of volts are reached and the currents can be as high as several tens of thousands of amps. This is all discharged in a matter of a few milliseconds. With these levels it is hardly surprising that it can cause serious amounts of damage when it occurs.

Even in the electronics workshop, in the office, or around the home very high levels of static can build up. It is not unusual for someone to build up a static charge of ten or even twenty kilovolts (kV) simply by moving around in the home.

The discharge of this type of static is much faster than that of lightning. It lasts a matter of a few tens of nanoseconds and the peak currents can be as high as several tens of amps. It is hardly surprising that occasionally one can feel a tingle as the discharge takes place!

Obviously the levels of voltage and current which are produced depend of a large variety of factors. Everything from the size of the person, to clothing being worn, the object against which the discharge is made, and of course the humidity of the air. These all have a pronounced effect so it is almost impossible to predict the exact size of the discharges which are possible.

HOW IT AFFECTS ELECTRONICS

Problems caused by ESD came to the fore with the arrival of metal oxide silicon (MOS) technology. When these devices were introduced many had input resistances well in excess of a thousand megohms.

Whilst this seemed the answer to many design engineers' dreams it also spelt disaster as these devices were only able to withstand voltages between the gate and drain of about 40 volts maximum. Even people walking nearby could damage them if they were carrying a large charge!

Responding to this problem, manufacturers integrated protection diodes into their devices. Even so they often put a shorting protection wire around the leads which was to be removed only when the devices were safely installed in their circuits. Once in their circuits they were relatively safe because there would be sufficient leakage paths around the device to prevent damage under normal circumstances.

Many investigations were made into the effects of ESD in view of the enormous possible costs to industry. It was soon discovered that even though many devices failed immediately after they had been subject to a static discharge, others would carry on working for a while, or they would have their performance reduced.

Many studies were undertaken by a variety of organisations. Obviously those involved in space research were very keen to ensure the maximum reliability of their equipment. NASA undertook some large investigations to determine the long term effects of static.



Typical anti-static plastic case and conductive foam. May be used with larger or more expensive i.c.s.

They analyzed the results of the electronic failures that had occurred during the Apollo programme. As a result they now attribute over 50 per cent of the failures to the effects of ESD, both in the short and long term.

Originally only MOS devices were treated as being static sensitive. Most electronic enthusiasts who have used the original 4000 series of CMOS chips will remember the extreme care which had to be used when handling them. Radio amateurs will also remember the problems when handling discrete MOSFETs which were very popular for v.h.f. preamplifiers.

These devices can be damaged by discharges of static voltages of between 100V and 200V. However, the devices which must take the prize for sensitivity to ESD must be gallium arsenide f.e.t.s. They can be destroyed by discharges as small as 5V.

Nowadays, virtually all semiconductor devices should be treated as static sensitive. A typical discrete bipolar transistor can withstand the sort of discharge which can just be felt by the human hand.

However, as the size of components within integrated circuits shrinks it is found

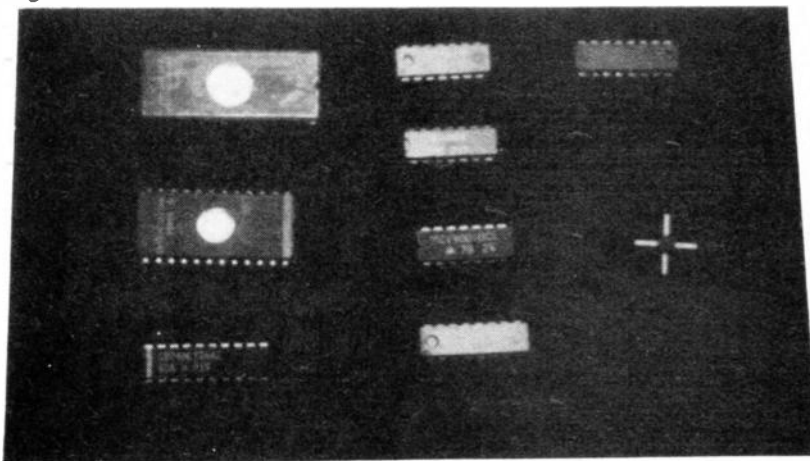

Anti-static conductive foam should be used for storing loose i.c.s. It is available in large sheets from many electronics stockists.

that bipolar i.c.s are becoming just as susceptible as their MOS counterparts.

In fact even some passive devices like capacitors and resistors can be damaged in some instances. With the ever decreasing size of components with the surface mount technology revolution, even those devices which were once thought safe from the effects of ESD are found not to be immune.

In the future, matters are likely to become even more critical. With feature sizes on i.c.s shrinking even further, as more is added to each chip, they will become even more susceptible. The addition of more components to each chip will mean that they become more expensive, making the results of static even more costly.

MODES OF FAILURE

In looking at how ESD affects semiconductor devices it is necessary to remember that it is not just the voltage that is important. The time taken for the discharge must also be taken into consideration. Often the discharge takes around 100ns or less.

The actual time depends on many factors, but it is found that discharges from sharp points, e.g. the end of a small screwdriver, or tweezers are much faster than from a relatively blunt object like a finger. There can be a factor of five or more difference! This means that if the same amount of energy is discharged the currents can vary by five or more, being higher when sharp instruments are involved.

It is quite possible that a person charged up to 20kV can give a peak current of 20A. When it is considered in these terms it is easy to see how the possibility of damage arises in i.c.s.

When compared with the size of some of the elements in the semiconductors these currents are colossal. In fact even relatively small discharges can produce significant amounts of heat.

Even though the discharges are very short lived, the architecture is so small that the heat cannot be dissipated in time, and elements can be melted or even vaporized. Often semiconductor junctions are the victims, and it is found that the time needed to destroy a junction is inversely proportional to the duration of the pulse.

When a semiconductor junction breaks down, the high voltages present cause it to reverse avalanche. This happens as the electrons are accelerated by the electric fields associated with the high potential difference across the junction.

As these electrons move faster they collide with other atoms releasing further electrons which in turn release more. With the high currents which are available from the ESD sufficient current can pass through the junction to cause it to overheat and melt. This will leave a low impedance short circuit across the junction rendering it useless.

Other failures can occur when a track joining areas of the device is vaporized leaving it open circuit.

Not all discharges result in immediate failures. The aspect of more concern is that the device can be left with a long term weakness which will fail later in its life, or it can result in an intermittent failure.

This occurs when insufficient damage is done by the discharge to completely destroy the track or junction. A track may have its width reduced, and as it may no longer have sufficient width to carry the required current it can fail when even small overloads are placed on it during normal operation.

COMBATTING THE PROBLEM

In view of the problems with ESD, it is obvious that even the home constructor must take precautions to avoid its effects.

Whilst it is not possible for the amateur enthusiast to take the same steps as commercial manufacturers there are a number which are quite easy to implement, and will avoid most of the problems.

When looking at how to combat ESD it is necessary to look at all stages of the life of the i.c.. This means that just as much care has to be taken when handling and storing the chip as it does when soldering the chip into the circuit board, and then handling the completed circuit board.

To help reduce the possibility of ESD damage a wide variety of products are available. Firstly, conductive foam should be used for storing loose i.c.s. The chips can be easily inserted into the foam, thereby ensuring that all the connections are shorted together.

However, before using the foam it is best to make sure that it is conductive. Although it is often black in colour, not all black foam is conductive. A simple test by applying the two probes of a multimeter switched to the resistance range will reveal whether it is conductive. If it is then the meter should read a value of a few hundred ohms at the most.

This foam is now available from many electronic stockists. Whilst it may appear a little on the expensive side to buy, a single sheet is more than sufficient. In fact it may be worth buying a sheet with one or more friends.

Anti-static i.c. tubes are also available. Often when buying a few chips, they may arrive in these tubes. If they do, then keep the tubes for use in the future.

For handling completed circuit boards special anti-static bags are available. Often it is not worth buying these bags at a stockist. However, many ready built boards now come in anti-static bags. Computer boards are a very good example and it is worth keeping these bags when the opportunity presents itself.



Anti-static bags are frequently used to store i.c.s, complete board assemblies and other static-prone components.

CONSTRUCTION

Precautions are also very important when fitting static sensitive devices into circuits. A number of steps can be taken here to ensure that the risks of damage are reduced.

First of all it is necessary to make sure that you are not charged up. This can be done by ensuring that you are earthed.

Special wrist straps are used by most electronics companies to ensure that people are not carrying any charge. The strap itself consists of an elasticated band containing conductive fibres. A lead with a resistance of one Megohm or more is then used to connect the strap to ground. This resistance is quite sufficient to ensure that any charge which is built up is safely routed to earth.

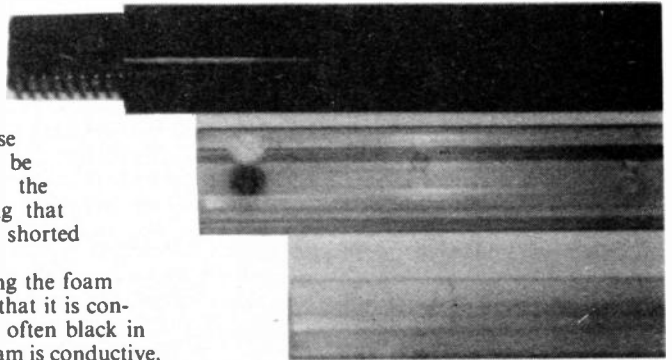

If your i.c.s arrive in anti-static tubes, keep the tubes for future use.

Static dissipative work benches can also be installed. New work stations being installed generally have these surfaces. They should obviously not be totally conductive otherwise they will short out any circuits placed on them. Again they have sufficient conductivity to remove any charge in a controlled fashion.

Another alternative is to use semi-conductive rubber mats. These are popular because they are quite cheap and are an ideal solution for the home experimenter. Some stockists sell all the parts for a complete anti-static work station for as little as about £25. Although this may appear to be a significant amount of money, it may prevent a project from damage and being consigned to the cupboard to gather dust because it does not work.

The anti-static mats and wrist straps are normally connected to earth, usually via a large value resistor. As mains earth is normally used, extreme care must be taken to ensure that the work station does not become live, even though the resistors will help to reduce the danger. Special yellow plugs with only an earth connection are available for this, and can help reduce the danger. Even so, **check that the system is totally safe before using it.**

Care should also be taken when using tools. Most items with metal handles are perfectly fine. However, many have insulated handles and if these have to be used they should be discharged before use and kept on the anti-static area.

The most important tool is the soldering iron. These days it is possible to buy irons with earthed bits. These should be used at all times. Not only are they better from a safety point of view, but they also do not build up static.

CIRCUIT DESIGN

Circuits should also be designed to minimise the effects of static. If not then even completed boards can be sensitive to the effects of static.

The major precaution is to provide a leakage path to earth for all lines which come onto a board or go off it. This is particularly important where logic families such as the ordinary 4000 series of chips or the more modern 74HC and 74HCT series of chips are concerned.

For these circuits it is usually just a matter of adding a pull-up or pull-down resistor of about 10 kilohms or 100 kilohms from the line to either supply rail. In this way any static build up can be prevented and any static which may be discharged onto the lines will have a leakage path to earth.

SUMMARY

Industry is spending millions of pounds in protecting against the effects of static. Home constructors and enthusiasts also need to be aware of the effects of static on electronic devices.

Even though it is not feasible to go to the same lengths as manufacturing companies, there are many precautions which should be taken which do not cost vast sums of money. By doing this it is quite possible to save many hours in fault finding devices which have failed as the result of static.

Providing that the simple basic ESD precautions are observed, readers should not be unduly worried about using static-prone components.

Table 1. Basic anti-static handling precautions.

Most of these rules are easy to apply and only require a little forethought. If in doubt, always treat a device as static-sensitive - it is better to be safe than sorry!

1. Static sensitive components are normally supplied in special packaging which is designed to safely dissipate static charges. Components should not be removed from this packaging until they are required to be put into service. The packaging should then be retained for future use.
2. Store components that are susceptible to static in their original packaging, using electrically conductive containers or conductive plastic foam.
3. Avoid contact with the pin connections of a device whenever it is "out of circuit".
4. Regularly discharge your body before handling components or circuits. You can very easily do this by simply touching a grounded point (such as the

metal case of an oscilloscope or power supply) with first one hand and then the other.

5. Ensure that you have a "grounded area" in which to work. A rubber "earth mat" makes an ideal area in which to keep your devices and circuits while you work on them.
6. Avoid the use of all static producing materials. In particular it is worth keeping polythene bags and other plastic materials well away from your work area.
7. Make use of a low-voltage soldering iron and ensure that the metal parts of the iron are properly earthed. It is also worth checking that all of your other mains operated equipment is properly grounded.
8. If you have a computer or TV receiver in your workshop it is important to keep the display well away from static sensitive circuitry. Very high static voltages (usually well in excess of 10kV) are present in the vicinity of a cathode ray tube.
9. Finally, if you regularly handle static sensitive devices, consider using an earthed wrist strap!

Table by courtesy of the *Electronics Service Manual*.

Ohm Sweet Ohm

Max Fidling

Fishy Goings-On

The domestic scene at Chez Fidling had very recently gained a new element of entertainment which appealed to Piddles, my feline friend, probably in more ways than one: I had bought a tropical aquarium. A small glass tank, now suitably replete with gurgling decorations (a tasteful plastic icon of a deep sea diver, to be precise), plastic seaweed, fluorescent lighting and a thermostat added to the general interest, whilst my home-made and freshly painted wrought iron fish-tank stand completed the scene. Of course, the fish themselves were just incidental, of much more interest was the wiring up and the general alchemy involved in successfully commissioning my new aquatic acquisition!

Justly proud of this latest project, I had switched it all on to let everything settle down for a week or so, before cycling over to the local pet shop to invest in some brightly-coloured guppies. These were successfully introduced and were swimming merrily away in the new tank. The puss entertained himself periodically by nudging the tank with his nose, in close proximity to my piscine pals inside. Needless to say, my attention soon turned to the electrical side of things and before long I had determined that I could "improve the performance" of the fish-tank with the addition of some electronic goodies. Preferably with lots of flashing light-emitting diodes, like all good projects have!

One major worry (such was the heavy burden of responsibility I carried as a newly-found fishkeeping expert) was to ensure that the fish-tank's pump was never accidentally switched off. The Boss would occasionally unplug it when doing the Hoovering, much to my chagrin. However,

the electrical outlet happened to be on the same circuit as my workshop's, so whenever I fused the wiring in the 'shop - which was pretty often - the fish-tank's pump also went a.w.o.l.; in the guppy scale of things, pretty catastrophic! Perhaps I could develop a gadget which would help avoid this perilous position . . . ?

Under pressure

I retreated to the workshop to ponder a plan. I have a large cardboard box full of ex-equipment paraphernalia, mainly taken from old washing-machines, dishwashers, fridges and the like. I lifted the box from the shelf and rummaged amongst the water pumps and motors within. Entwined in copious lengths of quarter-inch rubber tubing was a water level switch that I'd removed from a defunct washing machine. This was a round device, roughly four inches in diameter with a spout. To my delight I had discovered that if I blew down the spout, a "click" would ensue from its innards. Intrigued by this phenomenon I tested out the switch contacts and discovered that what I was holding was a pressure switch with a set of changeover contacts. A rare find indeed!

Wiring this up to an audible warning device and 9V battery, I had invented the world's first automatic, electronic, fish pump failure alarm! The sounder was a fiendishly piercing piezo siren, deafening and rather excessive for this application but it was all I could find in my biscuit tins full of bits. The gadget was soon spliced into the pump's air supply tubing using some black rubber hose taken from the old washer. Although the corroded pressure switch looked rather incongruous against all the new pump equipment, it was effective and cheap and was pressed into immediate service. Mission accomplished, I

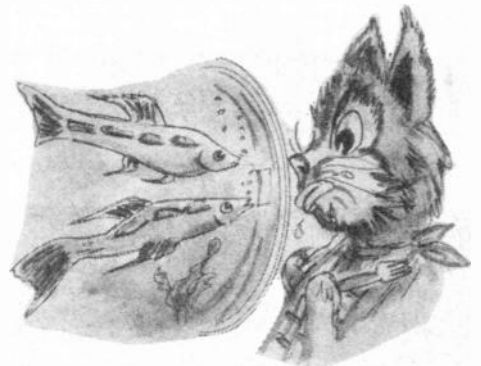

retired to the 'shop to carry on tinkering with my latest magazine project whilst Piddles sat transfixed with tail swishing, licking his lips and peering up at the tropical fish swimming inside.

In the workshop my latest constructional project was taking shape: a thermostat which I hoped to adapt for the fishtank. Bristling with thumbwheel switches, sockets and l.e.d.s (naturally), this looked impressive and having quickly wired the mains side up, I was ready for the switch-on and the first test. This I did with the usual flourish, full of confidence in my abilities.

At precisely this point, there was a dull thud and blue flash from the plug, and everything electrical went off. I had fused it all again! Approximately five seconds later, Piddles was seen rocketing out through the cat flap in the kitchen door as he disappeared round the corner. Yes indeed - the fish-tank pump had also stopped working, and the alarm had sounded, petrifying the pesky puss who scooted out the door! They say revenge is sweet. In my case revenge is rare, therefore sweeter still! Upon his return I proffered some bread and honey as compensation which Piddles scoffed greedily (as usual), whilst eyeing the fish tank warily.

SUPER VALUE KITS

SURVEILLANCE

High quality electronic surveillance kits that give excellent performance. Room Transmitters are supplied with sensitive electret microphone & battery holders/clips. All Transmitters can be received on an ordinary VHF FM radio.

MTX MINIATURE 3V TRANSMITTER
Easy to build & guaranteed to transmit 500 metres - over 1000m possible with higher voltage & better aerial
3-9V operation. Only 45x18mm. KIT 1007. £4.95

MTX MINIATURE 9V ROOM TRANSMITTER
Our best selling 'bug'. Super sensitive, high power - 1000m range (2 miles possible with 18V supply & better aerial). 9-18V operation. Just 45x19mm. KIT 1018. £5.95

HPTX HIGH POWER ROOM TRANSMITTER
High performance, 2 stage transmitter gives greater stability & high quality reception. 1000m range with 9V battery. 6-12V operation. On/Off switch on PCB. Size 70x15mm. KIT 1032. £6.95

VTX VOICE ACTIVATED ROOM TRANSMITTER
Activates only when sounds are detected. Low standby current conserves battery power. Adjustable sensitivity & turn-off delay. 8V operation. Size 63x38mm. Powerful 2 stage transmitter. 1000m range. KIT 1028. £8.95

MTTX MINIATURE TELEPHONE TRANSMITTER
Attaches anywhere to phone line. Transmits only when phone is used! Uses phone line as aerial & power source. 500m range. Only 45x15mm. KIT 1016. £4.95

TRT TELEPHONE RECORDING INTERFACE
Connects between phone line and cassette recorder. Automatically switches on tape when phone is used. Records all conversations. Powered from line. Size 48x32mm. KIT 1033. £6.25

TRVS TAPE RECORDER VOX SWITCH
Very sensitive, voice activated switch - automatically turns on cassette recorder when sounds are detected. Adjustable sensitivity and turn-off delay. Size 115x19mm. Including sensitive electret mic. KIT 1013. £7.95

MISCELLANEOUS

ULTRASONIC MOVEMENT DETECTOR Kit controlled oscillator, detector circuits & pair of edge mounted Ultrasonic transducers on single board just 75x40mm. Detection range from 4-7m with adjustable sensitivity. Red LED indicator. Outputs to drive external relay or circuits. 9V DC operation. KIT 1048. £14.95

LOGIC PROBE Use for fault finding & testing of digital circuits. Switch for either TTL or CMOS. This modern design using a PUT. Includes detection circuit for very fast pulses. Gives visual (3 LEDs) & audio (piezo buzzer) response. KIT 1024. £8.95

COMBINATION LOCK Fully working 9 key combination lock. Keypad & separate from main circuit. Lock resets if incorrect combination entered. 240V switching relay supplied. 9-12V operation. KIT 1029. £10.95

3 1/2 DIGIT PANEL METER Designed around a single IC containing both Analogue & Digital sections to provide a simple, versatile meter. Terminal strip input, power switch, selectable decimal point. Space for scaling & current shunt resistors. 9V battery powered. KIT 3034. £21.95

INTRODUCTION TO CLASS AB AMPS Build your own Class AB amplifier. Delivers several watts of power to the 8 ohm speaker supplied. Gives hands-on learning about cross-over distortion bootstrapping, complementary pairs, & push-pull. Detailed explanation given. KIT 1048. £10.95

ONE CHIP AM RADIO Complete AM radio on a PCB. Tuned radio frequency front-end, single chip RF amplifier & detector and two stages of amplification of the audio signal into the speaker provided. All components supplied. Coil pre-wound. Excellent for schools. KIT 1063. £10.95

TRAIN SOUND KIT Produces 4 selectable train sounds - Whistle blowing, Level Crossing Bell, Chugging & "Clickety-Click". 2.5-5V operation. Chip-on-Board PCB just 29x16mm. Two boards can be joined to produce a sequence of sounds. SG1. £4.95

AUDIO ♦ LASER ♦ TEST GEAR ♦ FIBRE-OPTIC ♦ SECURITY ♦ TIMERS ♦ GAMES

Our range of HIGH QUALITY project kits come complete with all components, top quality fibre glass PCB's & comprehensive instructions. Send 2 x 1st class stamps for our latest catalogue containing over 100 kits & publications. Mail order only. Please ADD £1.50 P. & P. per order & make cheques/P.O.'s payable to:

QUASAR ELECTRONICS

(Dept. EPE) Unit 14 Sunningdale BISHOP'S STORTFORD Hertfordshire CM23 2PA

HEWLETT PACKARD HP71B

As easy to use as a calculator but as powerful as a computer



BARCODE READER

Smart wand

Automatically recognises and decodes all major bar-code standards.

SPECIAL OFFER

Buy 2 kits for £59.00

- A powerful set of basic functions, statements, and operators - over 230 in all - many larger computers don't have a set of basic instructions this complete.
- Advanced statistics functions enabling computations on up to 15 independent variables.
- Recursive subprograms and user defined functions.
- An advanced internal file system for storing programs and data - The HP71 has continuous memory - when you turn the computer off it retains programs and data.
- A keyboard that can be easily customised for your specific application.
- HP-1L Interface pre-installed to create a system that can print, plot, store, retrieve and display information. Control or read instruments or speak to other computers, 5000 bytes/sec. Built in ROM includes 46 separate commands, Interface to HP-1L, HP-1B, RS232C, GPIO or series 80. Includes connection cables.

These are second users systems, ex NHS, are fully tested and working but have no programming (THAT IS UP TO YOU).

HP71B.....	£29.95
Bar-code Reader.....	£12.95
A.C. Power Supply.....	£4.95
(Works from batteries normally)	
Keyboard Overlay.....	£1.00
(Limited quantities)	
(Unknown Program) Memory Module.....	£3.00
Complete kit of HP71B, Bar-code Reader and power supply.....	£39.50
(Prices include VAT/Delivery within 7 days, £3.00 for UK)	
(Currently selling in US for over US\$500!)	

INTERCONNECTIONS LTD
Unit 51, InShops, Wellington Centre
Aldershot, Hants, GU11 5DB
Tel: (01252) 341900 Fax: (01293) 822786

Please rush me HP71B Powerful Calc/Computer @ £29.95
 Bar-code Reader @ £12.95
 Power Supply @ £4.95
 Keyboard overlay @ £1.00
 Memory module @ £3.00
 Complete kit of HP71B, Bar-code Reader and Power Supply @ £39.50

Total payment £..... + £3 delivery = £..... Tel.....

We accept Mastercard, Visa. Cheques or money orders - please post the above form to us, or Fax it, or Telephone with a verbal credit card order.

Please debit credit card
 No..... Exp.....
 Name.....
 Address.....
 Postcode.....

Electronic Designs Right First Time?

Schematic Design and Capture

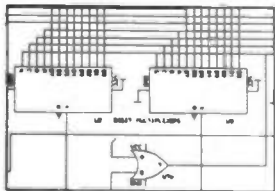

Create your schematics quickly and efficiently using EASY-PC Professional. Areas of the circuit can be highlighted on screen and simulated automatically using PULSAR, ANALYSER III and Z-MATCH our simulation and design programs.

Affordable Electronics CAD

EASY-PC: Entry level PCB and Sch. CAD.	\$195.00	£98.00
EASY-PC Professional: Schematic Capture and PCB CAD. Links directly to ANALYSER III, LAYAN and PULSAR.	\$375.00	£195.00
PULSAR: Digital Circuit Simulator ~ 1500 gate capacity.	\$195.00	£98.00
ANALYSER III: Linear Analogue Circuit Simulator ~ 130 node capability	\$195.00	£98.00
LAYAN: New Electro-magnetic layout Simulator. Include board parasitics in your Analogue simulations.	\$950.00	£495.00
Z-MATCH for Windows: Windows based Smith-Chart program for RF Engineers.	\$475.00	£245.00
FILTECH: Active and Passive Filter Design	\$275.00	£145.00
We operate a no penalty upgrade policy. Technical support is FREE FOR LIFE. Special prices for Education		
US\$ prices include Post and Packing	Sterling Prices exclude P&P and VAT.	

Digital and Analogue Simulation

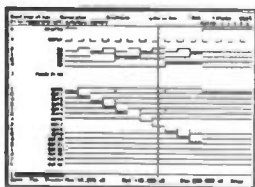

Modify the configuration and change component values until the required performance is achieved.

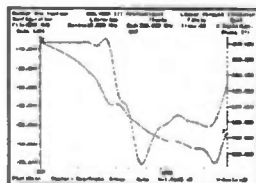

PCB Design

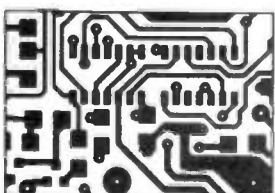

The design, complete with connectivity, can then be translated into the PCB. The connectivity and design rules can be checked automatically to ensure that the PCB matches the schematic. And with LAYAN the Parasitic effects of the PCB can be included in the Analogue Simulation



Number One Systems

Ref EVD, Harding Way, St. Ives, Huntingdon, Cambs. PE17 4WR, UK.

For Full Information Please Write, Phone or Fax.

Tel: +44 (0) 1480 461778

Fax: +44 (0) 1480 494042

INFRA-RED REMOTE CONTROL UNIT

MAX HORSEY P.C.B. Design by James Cohen

Produces a coded infra-red signal, suitable for use in alarm systems, door openers, light controllers etc. Designed particularly for last month's Automatic Curtain Winder project.

THIS article shows how an infra-red control system for on/off control of any other equipment can be designed, and is particularly tailored for the Automatic Curtain Winder project last month.

The essential design points are:

1. The system operates over a distance of several metres
2. The receiver can operate on the same 12V supply as the Curtain Winder
3. The receiver is not triggered by daylight, room lights, other remote control units etc.
4. The Transmitter is small and portable

WHERE DO WE START?

One of the problems associated with infra-red control projects is that when they fail to work (like most circuits when first tested!) it is hard to know whether it is the Transmitter or Receiver at fault. However, most people now own commercially built remote control units and although these will not operate the decoder section of the receiver, they are helpful in testing the sensor and amplifier stages if the full circuit fails to work. We will begin with the infra-red transmitter and encoder.

INFRA-RED TRANSMITTER

The principle by which the Transmitter operates is shown in the block diagram Fig. 1. The circuit is basically an encoder followed by a Darlington driver capable of delivering quite a large current to a set of three infra-red light emitting diodes (l.e.d.s).

Most people have at least one, and in many cases several remote control units, and coding/decoding is necessary in order to differentiate between them. Coding/decoding has the additional advantage that a circuit can be programmed to "look" for a particular signal even

though it may be much weaker than other infra-red sources such as daylight.

The UM3750 encoder/decoder i.c. is designed to send a particular code depending upon which of 12 input pins are connected to 0V or left open circuit. This provides a total of 4096 possible combinations. A further UM3750 in the Receiver can be set to the same combination and will provide an output when it receives the precise code which is transmitted.

Note that the system is designed for a single transmitted signal; for example, to

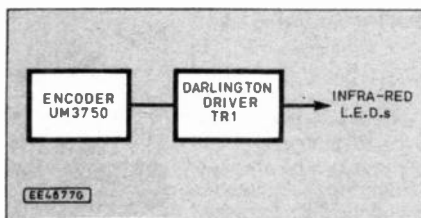

Fig. 1. Transmitter block diagram.

open a garage door, or close a pair of curtains. It could be adapted for a multi-channel system, such as the type used to control a video recorder, but there are other specialised i.c.s available for this purpose.

The UM3750 can be used with radio control, ultrasonic control or infra red, and Fig. 2 shows how the encoding is accomplished. The pushbutton switch S13 must be pressed to transmit the encoded signal. Note that the other switches (S1 to S12) shown in Fig. 2 can be toggle switches, p.c.b. mounting d.i.l. switches, or simply wire links, inserted or not inserted to make a particular code.

When experimenting, all the pins 1 to 12 can be left open circuit (i.e. not connected); the only reason for connecting some to 0V is to ensure that another remote control unit (with the same circuit) will not operate your device accidentally. The combination of resistor R1 and capacitor C1 sets the frequency of the signal.

Depending upon the control and transmission system employed, R1 and/or C1 may need to be changed in value. However, it is essential to make identical changes in the receiver decoder circuit.

TRANSMITTER CIRCUIT

The full transmitter circuit diagram is shown in Fig. 3, and consists of the encoder, plus a Darlington pair driver circuit, and a method of making the output into a short burst of power, to reduce battery consumption. The Darlington pair may be either a single *npn* Darlington transistor such as TIP121 or TIP122, or may be comprised of two separate *npn* transistors such as BC184L (or similar) followed by a power transistor such as TIP41A. The p.c.b. is designed for a single Darlington transistor.

Resistor R3, which limits the current through the infra-red l.e.d.s D2 to D4, is rather low in value and appears to allow a total of 1.8A to flow. Clearly neither the l.e.d.s nor the battery would be able to tolerate this current, so the circuit contains an additional 100 ohm resistor R4 which limits the total current to less than 100mA.

This would limit the possible operating range and so the smaller current is used to charge the 1000µF capacitor C4. When the pushswitch S3 is pressed a large

INFRA-RED REMOTE CONTROL - TRANSMITTER

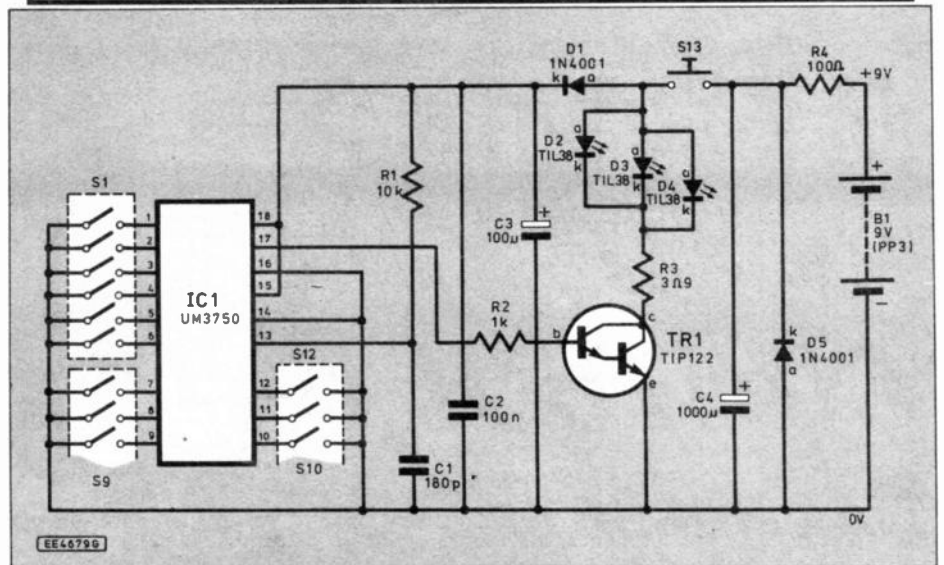

Fig. 3. Complete circuit diagram for the Infra-Red Remote Control Transmitter. Switches S1 to S12 are made up from two 6-way d.i.l. switches.

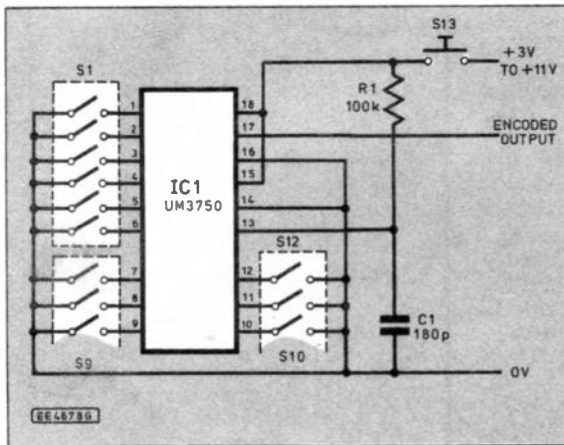

Fig. 2. Circuit diagram for the encoding stage of the transmitter. The code is set by selection of the switches S1 to S12.

current flows from the capacitor through the l.e.d.s for a short time. The pulse is too short to cause any damage, but provides the punch necessary to increase the range of the Remote Control System to several metres.

Diode D1, with the help of capacitor C3 maintains a 9V supply for the encoding circuit even whilst the voltage across C4 is collapsing. The diode D5 prevents disaster to the circuit if the supply is accidentally reversed. Such action will cause the battery to short circuit through the diode and resistor.

This is preferable to destroying the l.e.d.s, capacitor etc. A series diode could be used instead of the parallel diode shown, but its forward voltage drop may be unacceptable since every ounce of power is needed.

RECEIVER CIRCUIT

The block diagram for the Receiver is given in Fig. 4. The Receiver requires several modules; first a high power amplifier followed by a decoder, programmed to look for the encoded signal from the Transmitter. The decoder triggers

Everyday with Practical Electronics

COMPONENTS

TRANSMITTER

Resistors

R1	10k	R3	3Ω9
R2	1k	R4	100Ω

All 0.25W 5% carbon film

Capacitors

C1	180p disc ceramic
C2	100n disc ceramic
C3	100µ radial elect., 16V
C4	1000µ axial elect. 16V

Semiconductors

D1, D5	1N4001 50V 1A rec. diode (2 off)
D2 to D4	TIL38 high power infra-red emitting diode or similar (3 off)
TR1	TIP122 <i>n.p.n.</i> Darlington transistor
IC1	UM3750 encoder/decoder

Miscellaneous

S1 to S12	6-way d.i.l. switch (optional - see text) (2 off)
S13	miniature push-to-make switch
B1	9V battery (PP3), with clips

Printed circuit board available from the EPE PCB Service, code 948; handheld remote control plastic case, with battery compartment, size 103mm x 62mm x 23mm; 18-pin d.i.l. socket; multistrand connecting wire; solder terminal pins; solder etc.

Approx cost guidance only

£15

The completed Infra-Red Remote Control combined with last month's Curtain Winder project. The Receiver board is housed in the curtain control case.

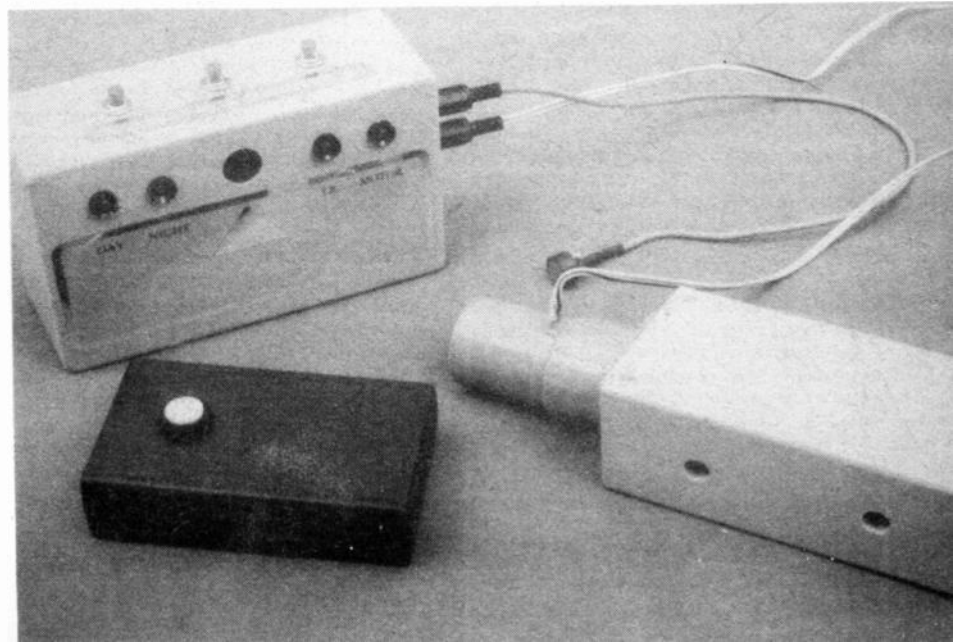

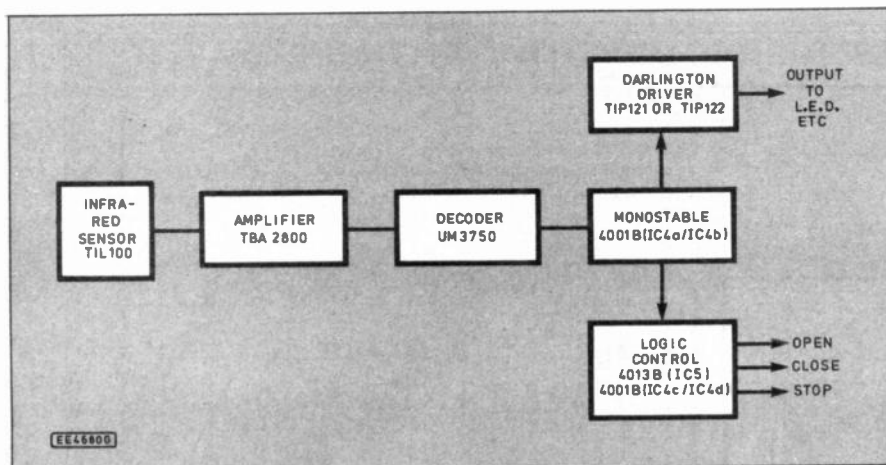

Fig. 4. Block diagram for the Infra-Red Receiver.

a monostable, which in turn lights an l.e.d. to provide the user with a visual indication that the message is being received.

The output from the monostable also triggers a logic circuit which translates the single messages into the required sequence of Open, Stop, Close, Stop to operate the Automatic Curtain Winder featured last month. Of course, the circuit may be used to operate any system; the l.e.d. signal switches on each time the Remote Control Transmitter button is pressed; the Stop signal switches on at every other press (i.e. on/off/on/off etc.) and the Open signal switches on at every fourth press (i.e. off/on/off/off/off/on/off etc.)

The TBA2800 amplifier i.c. was chosen to provide the necessary gain, together with an infra-red photo diode similar to a TIL100. The signal available from an infra-red photo diode is rather small, and may contain unwanted interference from other sources such as lights, daylight etc. The amplifier is therefore carefully designed to reject this interference yet still provide a large amount of signal gain. The TBA2800 achieves this by means of three stages of amplification and includes automatic gain control (a.g.c.) – a very complex circuit in a small, low-cost package.

The complete circuit diagram for the Receiver is shown in Fig. 5, and the internal circuitry of the TBA2800 (IC1) is illustrated, in block diagram form, inside the dashed lines. The only external components required are three capacitors, C2, C3 and C4. The i.c. does the rest! Note that resistor R1 together with decoupling capacitor C1 provides a very stable power supply for the i.c.

The pin numbers of IC1 are shown around the dashed lines. Two outputs are provided, a "normal" output from pin 7 and an "inverted" output from pin 8. The values of the capacitors have been chosen in relation to the signal being processed as discussed later. Some experimentation may be necessary if other signals are required.

IMPORTANT NOTE: IC1 must be used on a supply of 5V, not 9V or 12V. A 4.5V battery will do, or ideally a 5V regulated supply.

DECODER

The signal from the output of IC1 (pin 8) is delivered to pin 16 of IC2, the decoder. The decoder is very similar to the encoder in the Transmitter.

Providing the same combination of pins (1 to 12) are tied to 0V as in the encoder, when the correct code is received pin 17 goes low for a short time (about 0.1s). In

fact, IC2 waits until it has received four valid codes in quick succession to ensure against false triggering. Many repeats of the code will be transmitted when the Transmitter switch is pressed and so there is no apparent delay whilst the four valid codes are checked.

The output from IC2 is capable of sinking 2mA when low (active). Although this could be used via a transistor circuit to operate an l.e.d., the short time for which the output pulses low suggests the need for a latching circuit or a monostable. A monostable allows a short pulse to trigger a pulse of any duration as required.

POWER SUPPLY

We should at this stage pause and examine the power supply requirements. The amplifier IC1 requires 5V. IC2 will work on supplies of between 3V and 11V. A supply of 5V is therefore suitable for IC1 and IC2. However, the Curtain Winder module (last month) and hence the rest of the circuit requires 12V.

Regulator IC3 is, therefore, included in order to supply 5V for IC1 and IC2. Capacitors C6 and C7 provide decoupling, and diode D8 prevents damage to IC3 if the 12V supply is switched off and the voltage at the input side of IC3 becomes less than at its output due to the charge stored on capacitor C7.

TRANSISTOR INTERFACE

The output from pin 17 of IC2 is normally "high" (about 5V in this case). This is connected via resistor R3 to the base of transistor TR1.

The current flowing through R3 keeps TR1 switched on. Hence the voltage at the collector (c) of TR1 is low (about 0V) and since this is connected to pin 1 of IC4a, it also will be low.

When a valid code is received pin 17 of IC2 will go low, turning off TR1 and causing its collector voltage to switch to 12V, thanks to resistor R4. Note that TR1 both acts as an inverter, and an interface between the 5V circuit and the 12V circuit.

MONOSTABLE

Pins 1 to 6 of IC4 are associated with two NOR gates which act as a monostable. A positive pulse at IC4a pin 1 causes the output pin 3 to go low, and this change of voltage is "conducted" via capacitor C8, making pins 5 and 6 of IC4b also low. Hence the output pin 4 goes high.

There is now a voltage difference across resistor R5, and so current will flow, charging C8. After a time determined by the

values of R5 and C8, input pins 5 and 6 will be sufficiently positive to be counted as logic 1, and pin 4 switches back to low. The time for which pin 4 is high is not affected by the time for which pin 1 is high, therefore a very reliable pulse is obtained from pin 4 regardless of the pulse time at pin 1.

The output from IC4b pin 4 is fed, via resistor R6, to a Darlington pair TR2 (i.e. two transistors in one transistor package). When these switch on they illuminate l.e.d. D2, and could be used to turn on a relay etc. if required.

This may be all that is required, depending upon the application for which the remote control circuit is put. However, the circuit diagram Fig. 5. shows two T-type bistables (IC5) and a pair of logic gates (IC4c, IC4d) to provide the more complex control needed for the Curtain Winder described last month.

COMPONENTS

RECEIVER

Resistors

R1	100Ω
R2, R3	10k (2 off)
R4, R8,	
R9, R10,	
R11, R12	100k (6 off)
R5	680k
R6	4k7
R7	680

All 0.25W 5% carbon film

Capacitors

C1	22μ radial elect. 16V
C2	2μ2 radial elect. 16V
C3, C4	10n ceramic disc (2 off)
C5	180p disc ceramic plate
C6, C12	100n ceramic disc (2 off)
C7	100μ radial elect. 16V
C8	1μ radial elect. 16V
C9, C10,	
C11	220n ceramic disc (3 off)
C13	1000μ radial elect. 16V

Semiconductors

D1	TIL100 photo diode or similar
D2	5mm red l.e.d.
D3 to D7	1N4148 signal diode (5 off)
D8	1N4001 50V 1A rec. diode
TR1	BC184L npn transistor
TR2	TIP122 npn Darlington transistor
IC1	TBA 2800 infra-red preamplifier
IC2	UM3750 encoder/decoder
IC3	78L05 + 5V 100mA voltage regulator
IC4	4001B CMOS quad 2-input NOR gate
IC5	4013B CMOS dual D-type flip-flop

Miscellaneous

S1 to	
S12	6-way d.i.l. switch (2 off)
Printed circuit board available from the EPE PCB Service, code 949; plastic case, shared with Curtain Winder (last month); 14-pin d.i.l. socket (3 off); 18-pin d.i.l. socket; red plastic lens, approx. 37mm dia.; multistrand connecting wire; p.c.b. stand-off pillars (if required); solder terminal pins; solder etc.	

Approx cost guidance only

£18

INFRA-RED REMOTE CONTROL - RECEIVER

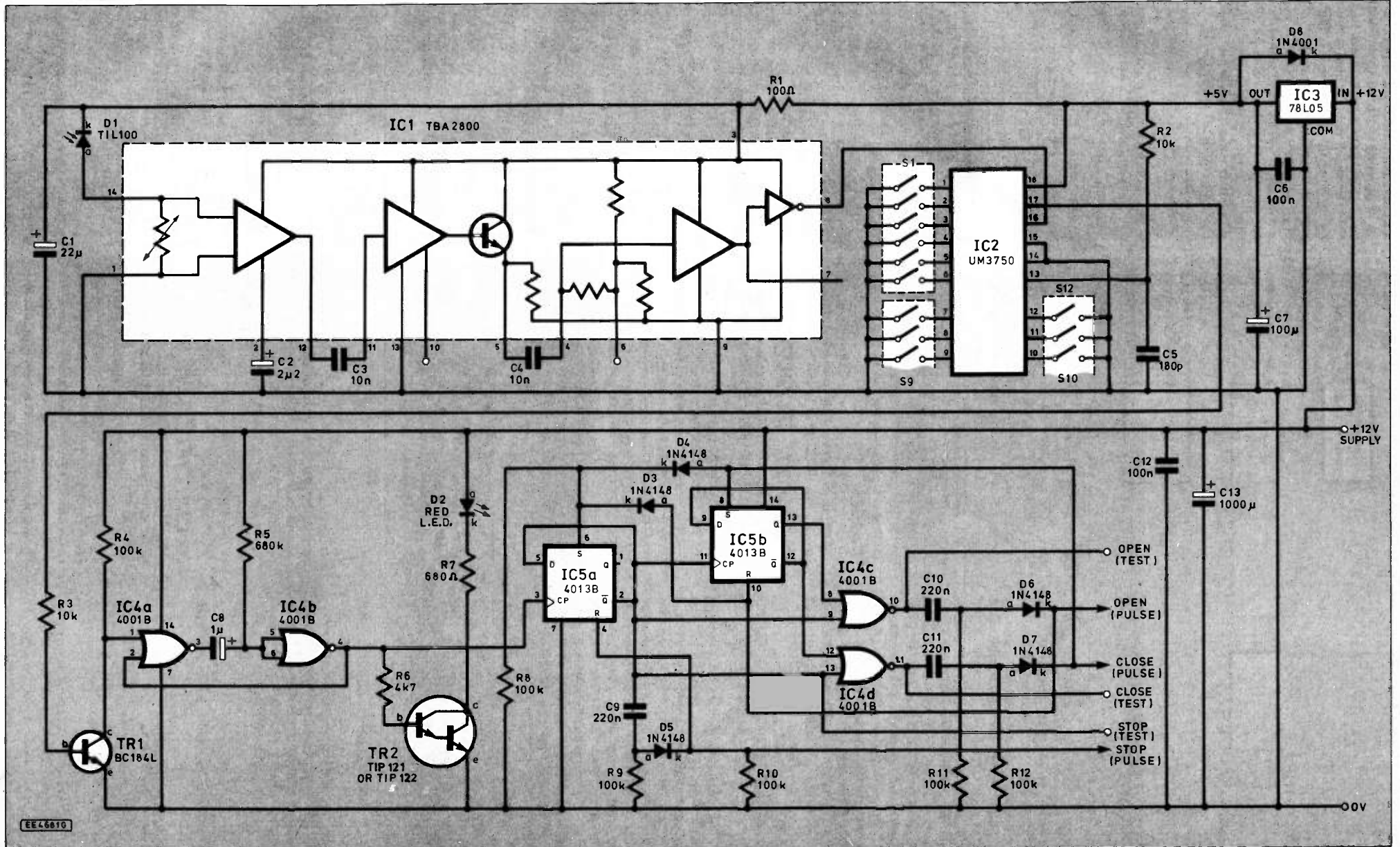

Fig. 5. Complete circuit diagram for the Infra-Red Receiver

LOGIC CONTROL SYSTEM

The Remote Control System in this circuit offers only one type of signal and hence a single output from IC2. It is possible to design a circuit like a TV Controller with a variety of functions but the single function system offers maximum security since the valid code is one of 4096. It is the job of the logic control system to translate this single command into three outputs suitable for driving a motor in the following sequence:

FORWARD/STOP/BACKWARD/STOP

If we substitute Open for Forward and Close for Backward the remote control system can be used to control the curtain winder described last month.

T-BISTABLE

The type of sequence required can be obtained using a type of bistable known as a "T-bistable". It works rather like a toggle action push switch – the type used on many TV sets.

Press it once and the TV switches on, press the switch again and the TV switches off. The T-bistable is an electronic version of this. In simple terms, the first electrical signal switches its output from 0V to positive, the second switches the output back to 0V.

How a T-bistable can be made with the aid of a CMOS 4013 i.c. is shown in Fig. 6. This i.c. actually contains two D-bistables. In brief, a D-bistable has a "data input" (D). Its normal output (known as Q) copies its data input at the instant its "clock input" (CP) is switched from 0V to positive.

A second output (known as "not Q and written \bar{Q} ") assumes the opposite state of Q. The bistable also contains "set" (S) and "reset" (R) inputs. Making Set positive for a moment causes Q to switch to positive; making Reset positive for a moment switches Q back to 0V. This is regardless of the other input pins.

How the \bar{Q} output can be connected to the "Data" input is shown in Fig. 6. This turns the D-bistable into a T-bistable. We will now describe more fully how the T-bistable works, and will begin by assuming that Q is "low" (0V), and therefore \bar{Q} is "high" (positive).

Imagine that we switch the clock input from low to high. Since the data input is high (remember \bar{Q} is high), this will be copied to Q making Q high and \bar{Q} low. Even though the clock may remain high the outputs will be stable in this new state since data is only copied to Q at the moment when the clock input changes from low to high.

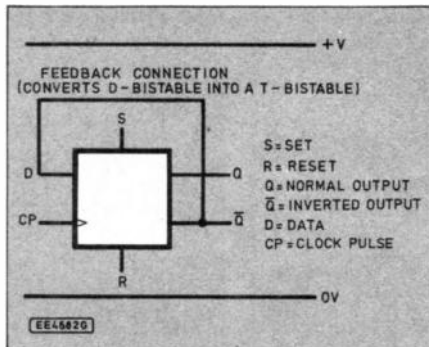

Fig. 6. Using a 4013 i.c. to produce a T-bistable.

Output \bar{Q} will now be low, making data low. If the clock input is made low, nothing happens. However, when the clock becomes high again, the data input is copied to Q making Q low, and therefore \bar{Q} high.

To sum up: First clock pulse causes Q to switch to high

Second clock pulse causes Q to switch to low

Third clock pulse causes Q to switch to high etc.

Notice that Q switches between low and high at half the rate of the clock pulse. For

this reason the circuit is sometimes called a *frequency divider*.

Practical Note

When using a D-bistable such as the CMOS 4013B, note that the positive supply is connected to pin 14, and the 0V supply to pin 7. All inputs must be connected to something i.e. not left "open circuit".

EMPLOYING THE T-BISTABLES

Returning to Fig. 5, IC5 is the CMOS 4013B i.c. This contains two D-bistables. We have made them behave as T-bistables by connecting \bar{Q} (pin 2 and pin 12) to Data input (i.e. pin 5 and pin 9). In the fully reset state pin 2 will be high, pin 13 low and pin 12 high.

The output from the monostable (pin 4 of IC4) is fed to clock input, pin 3 of IC5. Each time pin 3 (IC5) goes high, pin 1 (Q) changes state. Pin 2 also changes state, but is always at the opposite logic level to pin 1.

When the circuit is in its Reset state, pin 2 is positive. Hence pin 2 is used as the Stop command, and a glance at Fig. 5 reveals pin 2 is directly connected to the Stop Test output. Pins 1 and 2 of IC5 could therefore be used for on/off control since they both change state at each pulse from the monostable.

However, the curtain winder and similar circuits require a more complex command sequence i.e. Stop/Forward/Stop/Reverse etc. A second T-bistable, together with two logic gates achieve this.

The monostable required two NOR gates, leaving two spare gates in IC4. These two spare gates (IC4c, IC4d) are used to decode the outputs from pins 2, 12 and 13 of IC5.

The output from a NOR gate is "high" only when *both* inputs are "low". Hence, whenever Stop (pin 2 of IC5) is high, pins 9 and 13 of IC4c/d will be high and output pins 10 and 11 will be low. The other input pins 8 and 12 of IC4c/d are connected to output pins 13 and 12 of IC5. This ensures that when Stop is low only one or other NOR output is high, achieving the sequence, Stop/pin 10 of IC4 high/STOP/Pin 11 of IC4 high etc.

If pin 10 (IC4c) is high, Open is active. If pin 11 (IC4d) is high, Close is active. The outputs from pins 10 and 11 of IC4 are available on the p.c.b. and are labelled Open Test and Close Test. They are useful for testing the circuit since they assume a steady logic level which can be detected using a voltmeter. The Curtain Winder requires *pulses* rather than steady logic states; hence the need for the capacitors (C10, C11), diodes (D6, D7) and resistors (R11, R12).

INTERFACING TO THE CURTAIN WINDER

When adding the remote control Receiver to the Automatic Curtain Winder it is important not to interfere with the existing control of the Curtain Winder. It is also essential for the remote logic to respond to the commands issued by the separate manual switches in the winder logic, and the light sensing circuit.

The Open, Close and Stop commands were therefore reduced to short pulses which are fed directly to the appropriate switch inputs on the winder control p.c.b. Diodes D5, D6 and D7 are necessary to block any flow of current from the Curtain Winder logic circuit.

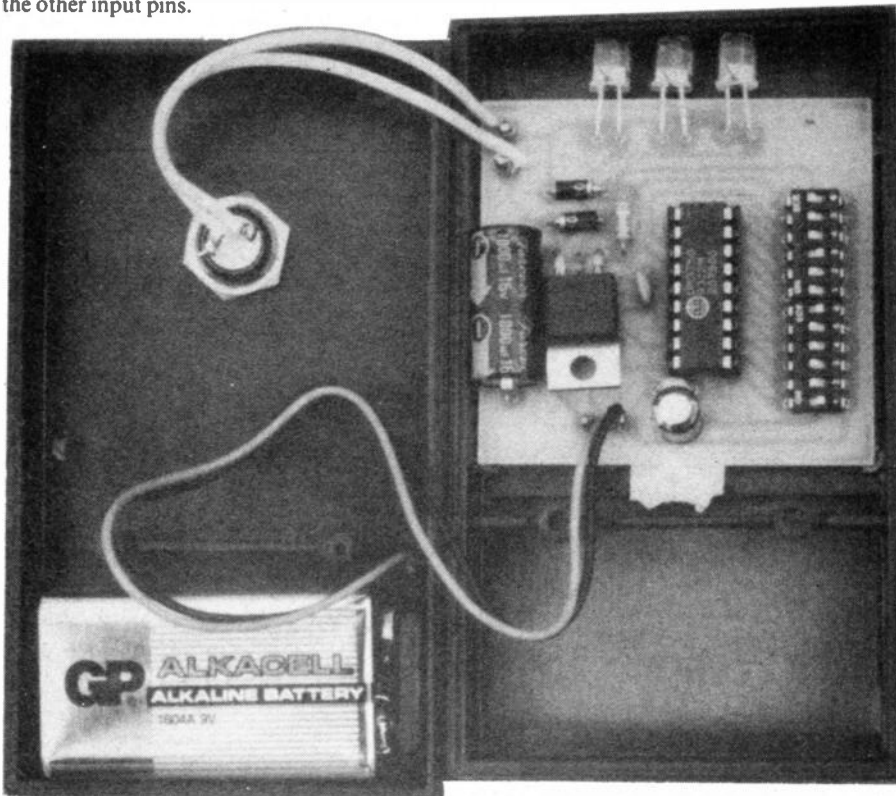

The completed Transmitter showing the positioning of the circuit board, battery and "trigger" switch.

INFRA-RED - TRANSMITTER

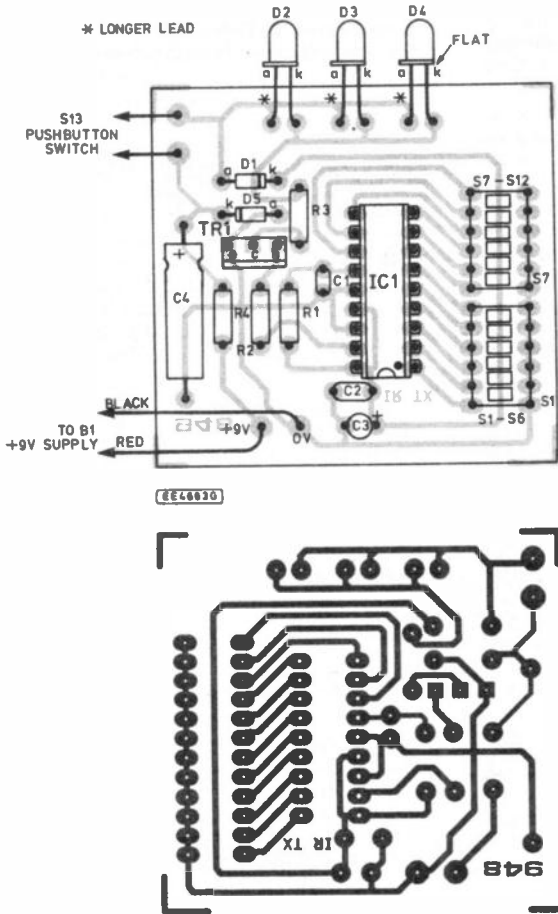

Fig. 7. Transmitter printed circuit board component layout and full size copper/foil master.

At first sight diodes D3, D4, and the feedback connections to the Set and Reset pins (6, 4, 8, 10 of IC5) are superfluous, since the feedback links will try to force the bistables into the states they already hold. However, the purpose of these links is to keep the remote control logic synchronised with commands issued at the Curtain Winder logic end.

For example, if darkness triggers the curtains to close, the fact that the curtains are closed must be relayed back to the remote control logic so that at the next press of the remote control button the curtains open.

This transfer of information works very well, enabling the curtains to be controlled by daylight, separate push button switches, the automatic current-sense stop circuit on the Curtain Winder p.c.b., and the Remote Control, all independently and in step. If curtain track stop switches are used to sense when the curtains are fully opened or fully closed there is no feedback to the remote control circuit and the system will not be fully synchronised. For this reason the automatic "current-sense" stop circuit included on the Curtain Winder p.c.b. is recommended if the remote control option is employed.

TRANSMITTER CONSTRUCTION

The printed circuit board (p.c.b.) component layout and underside copper foil master pattern for the Transmitter is given in Fig. 7. This board is available from the EPE PCB Service, code 948.

trim the edge of the p.c.b. before the components are mounted.

Following the layout shown in Fig. 7, begin work by soldering in the i.c. socket and smallest components, watching out for the polarities of diodes, transistor and electrolytic capacitors.

D.I.L. SWITCHES

Switches S1 to S12 were two sets of 6-way d.i.l. switches in the prototype. These are used to determine the code transmitted. If no other similar remote control systems are employed in the house the d.i.l. switches may be omitted.

Alternatively, one or more short wire links may be inserted for certain of the

switches S1 to S12 to create a particular fixed code. It is essential that the same code is used in the Receiver.

The infra-red l.e.d.s should be soldered in (the correct way round) so that they protrude over the side of the p.c.b. When the p.c.b. is fixed into the case the l.e.d.s will be in the correct position at the front of the Remote Control Unit.

Fit terminal pins as required, and connect the switch S3 and PP3 battery clip, or wires to the battery terminals. Finally insert the i.c. noting that its notch must be at the top.

Use a 5V or 9V 100mA regulated supply if possible, for testing. Do NOT use 12V since the i.c. is only rated to a maximum of 11V. If a regulated supply is not available insert a PP3 battery, taking care to fit it the correct way round.

TRANSMITTER TESTING

It is difficult to fully test the Transmitter until the Receiver is finished. If an early test is essential, an oscilloscope may be used to detect the signal on output pin 17 of IC1. If necessary, trace this signal to the collector (c) of the Darlington transistor TR1.

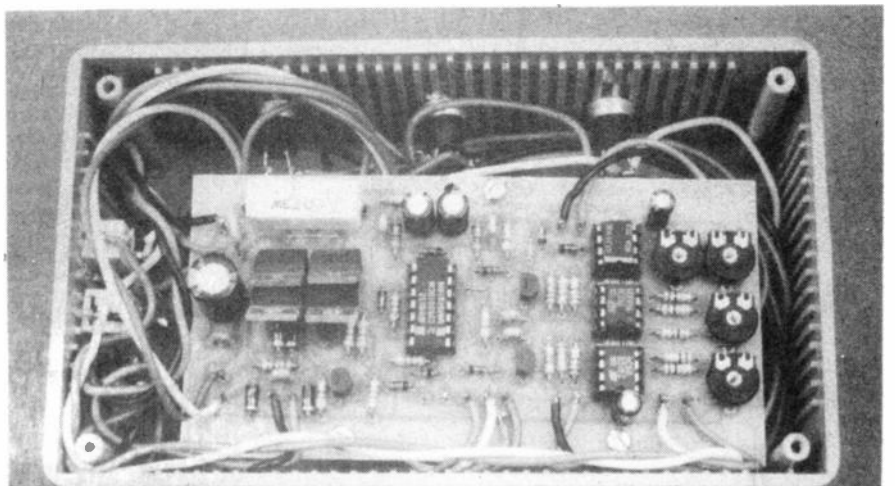
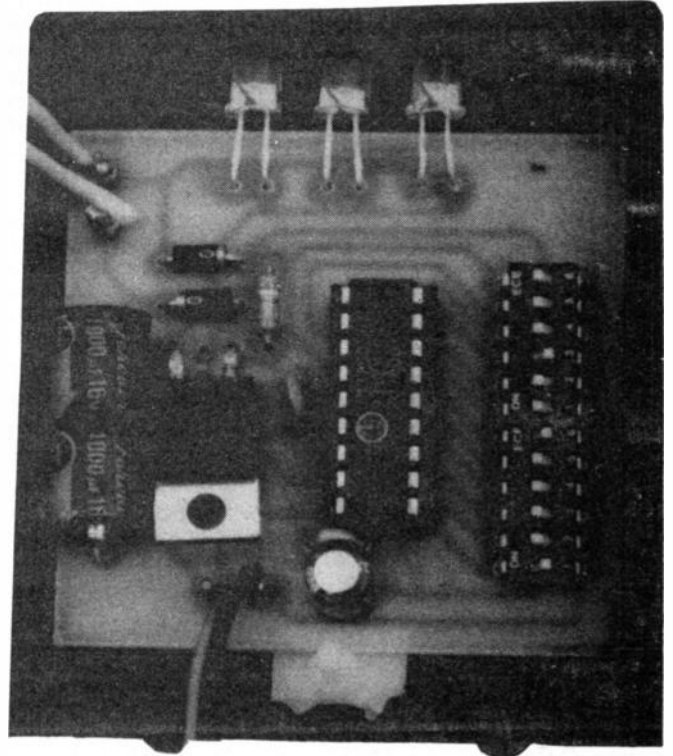

RECEIVER CONSTRUCTION

The topside printed circuit board (p.c.b.) component layout and full size underside copper foil master pattern for the Receiver is shown in Fig. 8. This board is also available from the *EPE PCB Service*, code 949.

Remember to check the options available before beginning construction. If you wish to use the circuit with the Automatic Curtain Winder then build the whole circuit.

If you only require a relay output, which switches on whenever a pulse is

received, then omit IC5 and associated components, but do not leave the input pins 8, 9, 12, 13 of IC4 open circuit; connect them to the 0V line. Alternatively, if you required a simple toggle action i.e. first pulse turns on, second turns off etc. then use the output from pin 2 of IC5 i.e. the STOP test output.

Begin construction of the Receiver board by soldering in the i.c. sockets, followed by the wire links and smallest components. Take care to fit the diodes the correct way round, and likewise the transistors, voltage regulator IC3 and electrolytic capacitors.

D.I.L. SWITCHES

Switches S1 to S12 are two sets of 6-way d.i.l. switches in the prototype. These are used to determine which code the Receiver is programmed to recognise. If no other similar remote control systems are employed in the house the d.i.l. switches may be omitted.

Alternatively, one or more short wire links may be inserted for certain of the switches S1 to S12 to create a particular fixed code. Clearly it is essential that the same code is used in the transmitter circuit.

TERMINAL PINS

The terminal pins on the p.c.b. are quite close together and the following tip on making connections to these pins may be helpful. First "tin" the pins i.e. place a small amount of solder on each one. Strip and tin the connecting wires so that only 2mm. of bare tinned wire shows.

The connecting wires may now be joined to the terminal pins without the need of further solder. Ignore the old advice about making a mechanically sound joint which does not rely on the strength of the solder - solder is more than adequate to secure a connecting wire.

Do *NOT* connect the infra-red sensor D1 at this stage. The red l.e.d. D2 should be connected directly to the appropriate terminal pins the correct way round, or temporarily via wires, for testing. Do not insert the i.c.s at this stage, other than IC3 which should have already been soldered in.

PRELIMINARY TESTING

It is well worth checking the voltages around the circuit *before* inserting the i.c.s and infra-red sensor D1 since a great deal of expensive damage can be avoided. Connect the circuit to a 12V power supply (a 12V 100mA regulated supply is ideal) and use a voltmeter to check the supply across pin 3 (positive) and pin 9 (negative) of IC1's socket.

The voltmeter should read 5V. If not, check the voltage regulator IC3 carefully. If all is well check that the supply across the IC2 socket is also 5V (pin 18 positive, pin 14 negative).

If all is well connect the infra-red sensor D1. In the prototype circuit the infra-red sensor was soldered directly to the terminal pins, leaving its wires as long as possible so that when flat against the p.c.b. the sensor protrudes over the edge.

Bend it up a little, for testing, and check again that it is connected the correct way round. Now insert the i.c.s checking that their notches are at the top.

TESTING THE SYSTEM

To check that the system is working, aim the Transmitter at the Receiver (the flat side of the sensor), holding the transmitter at a distance of about one metre. The Receiver should cause l.e.d. D2 to light for a brief time.

If there is no response check that the *code* on the Receiver matches the Transmitter i.e. the same pins are connected to 0V on the UM3750 encoder/decoder i.c.

The Receiver circuit is sensitive to reflections, and reliability can be improved by keeping the sensor away from a reflective surface e.g. by placing a back tube over the front of the sensor. At this stage a lens should not be necessary.

For reliable results the transmitter should be a metre or more from the receiver.

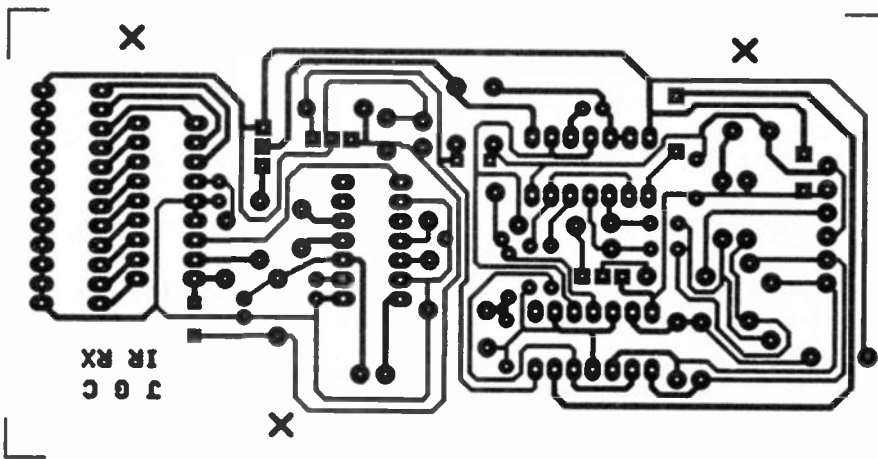
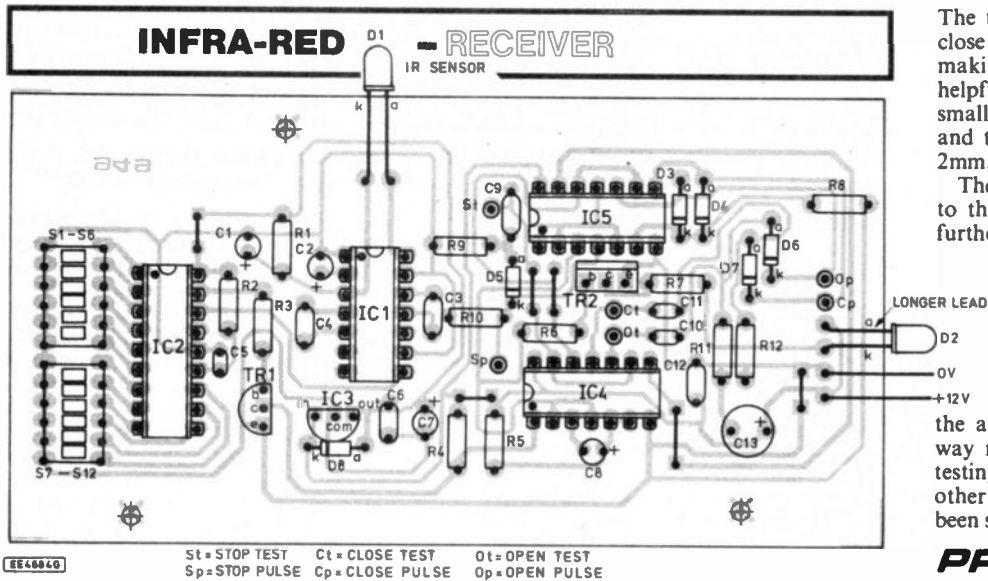
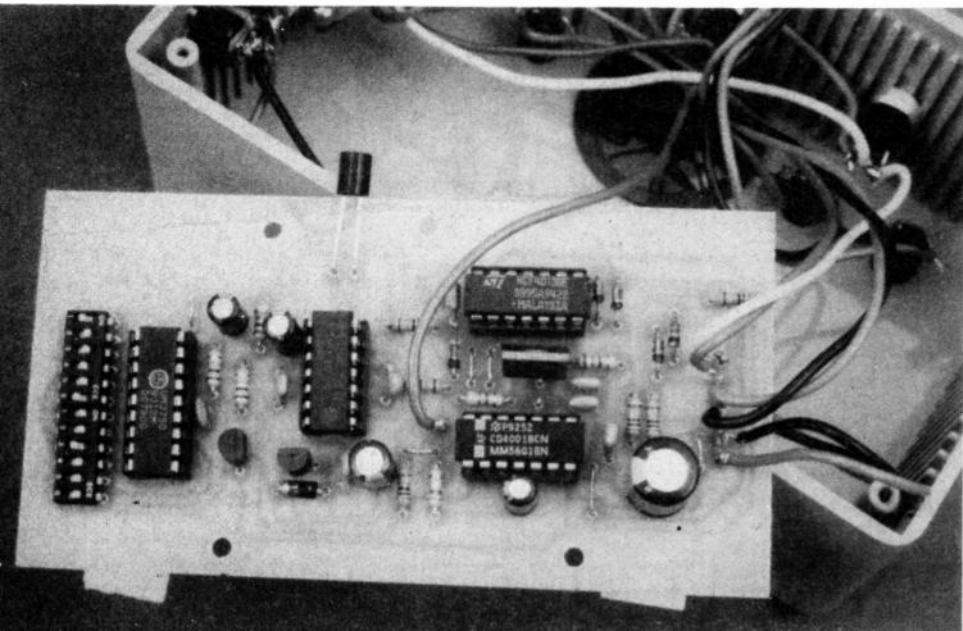

Fig. 8. Component layout and full size copper foil master for the Receiver p.c.b. The anode lead of D1 is the longer lead. The completed board, wired into last month's Curtain Winder case, is shown below.



FURTHER TESTS

If the red l.e.d. D2 continues to refuse to work it is important to establish whether the fault lies in the Transmitter or Receiver (or both!). Unfortunately, an oscilloscope is virtually essential at this stage.

Connect the oscilloscope ground to 0V in the Receiver. Connect the oscilloscope input to the side of the receiver sensor D1 which joins pin 14 of IC1. When the transmitter is triggered a signal should be apparent on the screen. If no signal is visible, try another remote control transmitter from a TV etc. If a signal now appears on the scope examine your Transmitter carefully.

Assuming that your own Transmitter is working, an amplified signal should be present on pins 12 and 5 of IC1 in the receiver. Finally, a much amplified signal should be present at the output pin 7, and an inverted version at output pin 8.

If no signal is apparent on pin 14 of IC1 (even when a TV or video recorder remote control unit is used), check the Receiver power supply (and IC3) and that the sensor D1 is connected the correct way round. If a signal is detected at pin 14, trace the signal through pins 12, 11, 5, 4 of IC1, and the output signal at pin 8. A dual-beam oscilloscope will allow a direct comparison between the signal at pin 17 of the i.c. in the Transmitter, and at pin 8 of IC1 in the Receiver.

A valid code received at pin 16 of IC2 in the Receiver should make the voltage at pin 17 (which is normally at about 5V) fall to 0V. This fall may be very brief and difficult to measure on a voltmeter.

The monostable should respond making pin 4 of IC4 switch from 0V to about 12V for about half a second. If necessary the monostable can be tested by shorting pin 3 to 0V for a moment. This should make pin 4 (IC4) switch to 12V, and trigger the Darlington TR2, causing, D2 to light for about half a second.

Once it is established that the output of the monostable (pin 4 IC4b) switches to 12V for a short time, check that pin 3 of IC5 copies this. Testing of the logic section of the circuit can be done by connecting a voltmeter (with its negative lead connected to 0V in the circuit) to the Open (test), Close (test) and Stop (test) points in turn.

The Open (pulse), Close (pulse) and STOP (Pulse) outputs designed to be connected to the Curtain Winder circuit can only be tested properly using an oscilloscope, since the voltage will pulse for a very brief time.

INTERFACING TO OTHER CIRCUITS

Clearly a remote control circuit is designed to connect to other equipment. A relay could be connected from positive to the collector (c) of the Darlington TR2, not forgetting to add a protective diode connected across the relay coil, with the diode's cathode (k) towards the positive supply.

A Darlington pair module could be connected to the STOP (Test) output to provide a "toggle" action i.e. ON/OFF/ON/OFF each time the Remote Control button is pressed.

CURTAIN WINDER

To link the Receiver to the Curtain Winder you should connect the Open (Pulse) output from the remote control receiver to the Open pushbutton switch input on the Curtain Winder p.c.b.. Do the

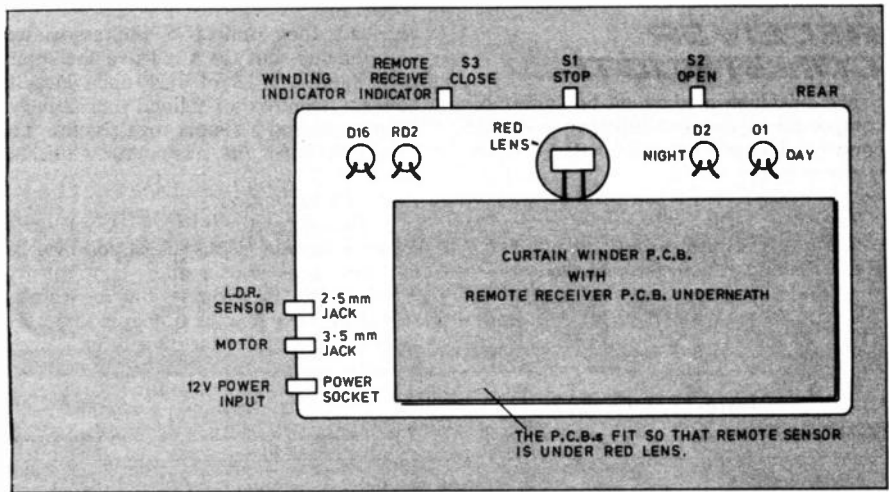

Fig. 9. If the receiver is incorporated into last month's Curtain Winder Unit it sits underneath the Winder p.c.b. so that the i.r. sensor aligns with the lens "window".

same with Close (pulse), and STOP (pulse) to their respective inputs on the Curtain Winder.

Normally both the Remote Control Receiver and Curtain Winder p.c.b.s will share the same 12V supply. If this is not the case it is important to connect 0V on one p.c.b. to 0V on the other.

HOUSING THE SYSTEM

The Transmitter p.c.b. should fit exactly into the remote control case as shown in the photographs. Begin by drilling holes for the infra-red diodes (D2 to D4), and pushswitch S13. The use of p.c.b. supports may be helpful, but they may make the p.c.b. foul the top of the case. In this instance the p.c.b. will be such a tight fit that additional support is unnecessary.

The Receiver p.c.b. is similar in size to the Curtain Winder p.c.b. and will fit very neatly into the specified case (64.5mm x 129.5mm x 42.5mm external dimensions). Fig. 9 shows how the Curtain Winder p.c.b. is mounted piggy-back fashion on the Remote Receiver p.c.b. Arrange them this way round so that the presets on the curtain winder are accessible.

The use of p.v.c. spacers and self-tapping screws can be used to clamp the boards together, the Receiver p.c.b. being mounted to the case using self-adhesive p.c.b. supports. Alternatively, single M2.5 nuts and bolts could be used with short and long spacers to fasten the pair of p.c.b.s in three or four places. Check exactly where they will be fitted, and then mark and prepare the case for drilling.

Holes will be needed for the three curtain control push switches, four l.e.d.s, a large hole for the infra-red sensor, and holes at the side for a power input socket, 2.5mm. jack socket for the LDR and 3.5mm. jack socket for the motor (see photographs).

Drilling should present no difficulty, but the infra-red sensor hole needs to be about 20mm in diameter assuming that a red plastic lens is used. This lens is flat on one side so that it can be glued with its flat surface against the inside of the case. It may be necessary to trim the top of the lens using a saw or cutters. Use of the lens should increase the operating distance of the system although the difference may be marginal; if in doubt, experiment for the best effect.

Fix the switches, l.e.d.s and sockets in position, and after gluing in the lens complete all the external connections using a variety of colour coded wires, noting the importance of connecting the l.e.d.s and power socket with the correct polarity.

If possible, connect the motor temporarily, so that its polarity can be reversed if necessary. It may be difficult to know before the first trial which way the motor will turn.

FINAL TESTING

Hopefully the Curtain Winder section of the project will already be functioning, and the mechanical part of the unit which was described last month. All that remains is to connect the motor, connect the LDR if required, and connect the 12V supply (a 12V 1A regulated mains adaptor is ideal).

The Remote Control Unit should cause its l.e.d. D2 to pulse when the message is received, and this in turn should wind or stop the curtains. □

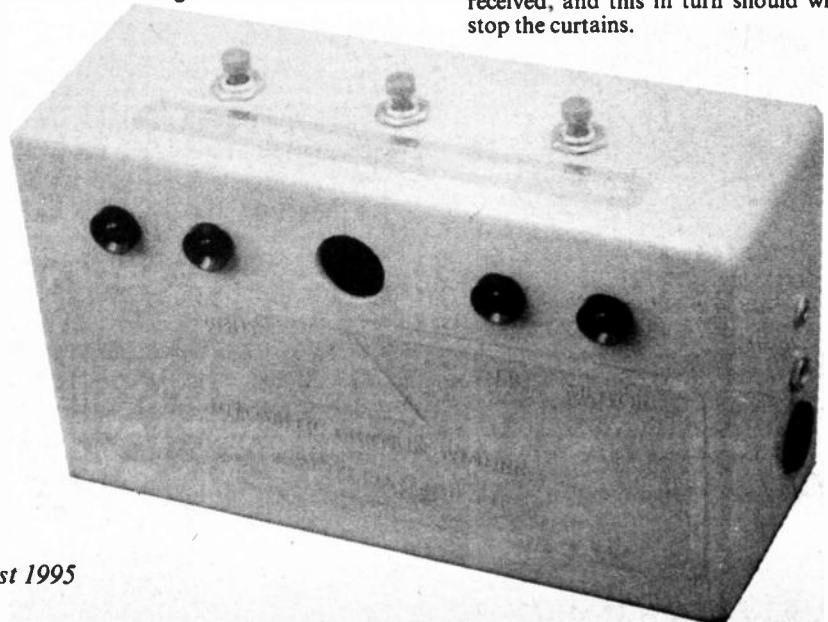

EVERYDAY With PRACTICAL ELECTRONICS

BACK ISSUES

We can supply back issues of *EPE* by post, most issues from the past five years are available. An index for each year is also available – see order form. Alternatively, indexes are published in the December issue for that year. Where we are unable to provide a back issue a photostat of any *one article* (or *one part* of a series) can be purchased for the same price.

DID YOU MISS THESE?

MARCH '94

PROJECTS ● Smart-Key Immobiliser ● Audio/R.F. Monitor ● CCD TV Camera, Part 1 ● Visual Doorbell ● Three-Phase Generator.
FEATURES ● Safety First, Part 4 ● Calculation Corner, Part 3 ● Free Wall Chart – Electronics Formulae 1.

APRIL '94 Photostats Only (see below)

PROJECTS ● MOSFET Variable Bench Power Supply ● *EPE* Soundac PC sound output board ● CCD TV Camera, Part 2/Frame Grab ● Impulse Clock Master Unit ● Telephone Ring Detector.
FEATURES ● Best of British, Part 1 ● Calculation Corner, Part 4 ● Electronics Workbench Review ● Free Wall Chart – Electronics Formulae 2.

MAY '94

PROJECTS ● Simple TENS Unit (transcutaneous pain relief) ● Capacitance/Inductance Meter ● L.E.D. Matrix Message Display, Part 1 ● Stereo Noise Gate ● Dual Stepping Motor Driver for PCs.
FEATURES ● Calculation Corner, Part 5 ● Best of British, Part 2.



JUNE '94

PROJECTS ● Microcontroller P.I. Treasure Hunter ● Digital Water Meter ● Microprocessor Smart Switch ● Advanced TENS Unit (transcutaneous pain relief) ● L.E.D. Matrix Message Display, Part 2.
FEATURES ● Best of British, Part 3 ● Calculation Corner, Part 6.

JULY '94

PROJECTS ● Voxbox Voice Recording Board ● Simple NiCad Charger ● Watering Wizard (automatic garden watering) ● Pocket Print Timer ● Stereo HiFi Controller, Part 1.
FEATURES ● Best of British, Part 4 ● Calculation Corner, Part 7.

AUG. '94

PROJECTS ● Experimental Noise Cancelling Unit ● Dancing Fountains, Part 1 ● Charged-Up (PC battery tip) ● 6802 Development Board ● TV Camera Update ● Stereo HiFi Controller, Part 2.
FEATURES ● Calculation Corner, Part 8 ● Best of British, Part 5 ● I'll Be Seeing You (multimedia communications)

SEPT. '94

PROJECTS ● Protector Plus Car Alarm ● Greenhouse Watering System ● Experimental Seismograph, Part 1 ● Three-Channel Lamp Controller ● Dancing Fountains, Part 2.
FEATURES ● Calculation Corner, Part 9 ● The Invisible Force (magnetic force).

OCT. '94

PROJECTS ● Digilogue Clock ● Visual/Audio Guitar Tuner ● Hobby Power Supply ● Audio Auxplexer ● Experimental Seismograph, Part 2.
FEATURES ● Electronics from the Ground Up, Part 1 with Free PC Software ● Calculation Corner, Part 10.

NOV. '94 Photostats Only (see below)

PROJECTS ● 1000V/500V Insulation Tester ● Video Modules, Part 1 (Simple Fader, Improved Fader, Video Enhancer) ● Active Guitar Tone Control ● Power Controller ● TV Off-er.
FEATURES ● Electronics from the Ground Up, Part 2 ● Consumer Electronics Show.



DEC. '94

PROJECTS ● Spacewriter Wand ● *EPE* Fruit Machine ● Universal Digital Code Lock ● Video Modules, Part 2 (Horizontal Wiper, Vertical Wiper, Audio Mixer) ● Rodent Repeller.
FEATURES ● Electronics from the Ground Up, Part 3 ● Embedded Controllers ● Index for Volume 23.

JAN. '95

PROJECTS ● Magnetic Field Detector ● Moving Display Metronome ● Model Railway Track Cleaner ● Beating the Christmas Lights ● *EPE* Fruit Machine, Part 2 ● Video Modules, Part 3 (Dynamic Noise Limiter, System Mains Power Supply).
FEATURES ● Electronics from the Ground Up, Part 4 ● Electromagnetic Compatibility ● Checking Transistors.

FEB. '95

PROJECTS ● 12V 35W PA Amplifier ● Foot-Operated Drill Controller ● The Ultimate Screen Saver ● MIDI Pedal Board ● Model Railway Signals.
FEATURES ● Electronics from the Ground Up, Part 5 ● Transformerless Power Supplies ● Quickroute 3.0 Review.



MARCH '95

PROJECTS ● Multi-Purpose Thermostat ● Name of the Game-1 Counterspell ● Sound Activated Switch ● Audio Amplifier ● Light Beam Communicator.
FEATURES ● Electronics from the Ground Up, Part 6 ● Understanding PIC Micro-controllers ● Visio Graphics Software Review. FREE Multi-Project PCB with this issue.

APRIL '95

PROJECTS ● National Lottery Predictor ● Auto-Battery Charger ● Light-Activated Switch ● Switch On/Off Timer ● Continuity Tester ● Name of the Game-2 Counterspin.
FEATURES ● Electronics from the Ground Up, Part 7 ● Circuit Surgery ● The Hard Cell (Mobile Telephones).

MAY '95

PROJECTS ● PIC-DATS-1 (PIC Development and Training System) ● R.F. Signal Generator – 1 ● MIDI Pedal ● Club Vote Totaliser ● Name of the Game-3, On Your Marks and Games Timer.
FEATURES ● Electronics from the Ground Up, Part 8 ● Las Vegas Show Report.

JUNE '95

PROJECTS ● PIC-DATS-2 (PIC controlled 4-Channel Light Chaser) ● *EPE* HiFi Valve Amplifier – 1 ● R.F. Signal Generator – 2 ● AA to PP3 Converter ● Name of the Game – 4, Star-Struck!, Six-Shot Light Zapper, Wander Wands.
FEATURES ● Electronics from the Ground Up, Part 9 ● Smart Cards.

JULY '95

PROJECTS ● Windicator ● Curtain Winder ● Ramp Generator ● High Voltage Capacitor Reformer ● *EPE* HiFi Valve Amplifier – 2
FEATURES ● Bridge Rectification Enhanced ● Ingenuity Unlimited.

BACK ISSUES ONLY £2.50 each inc. UK p&p. Overseas prices £3.10 each surface mail, £4.10 each airmail.

We can also supply the following issues from earlier years: 1989 (except March, June and Nov), 1990 (except March), 1991 (except Aug., Sept. and Nov.), 1992 (except April and Dec.), 1993 (except Jan., Feb. and March), 1994 (except April and Nov.). Please note we are not able to supply copies (or 'stats of articles) of *Practical Electronics* prior to the merger of the two magazines in November 1992.

Where we do not have an issue a photostat of any *one article* or *one part* of a series can be provided at the same price.

ORDER FORM – BACK ISSUES – PHOTOSTATS – INDEXES

- Send back issues dated
- Send photostats of (article title and issue date)
- Send copies of last five years indexes (£2.50 for five inc. p&p – Overseas £3.10 surface, £4.10 airmail)

Name

Address

I enclose cheque/P.O./bank draft to the value of £.....

Please charge my Visa/Mastercard £.....

Card No. Card Expiry Date

Note: Minimum order for credit cards £5. Please supply name and address of cardholder if different from that shown above.

SEND TO: Everyday with Practical Electronics, Allen House, East Borough, Wimborne, Dorset BH21 1PF.

Tel: 01202 881749. Fax: 01202 841692

Send a copy of this form, or order by letter if you do not wish to cut your issue.

M8/95

the new

CRICKLEWOOD Electronics

Very Interesting CATALOGUE

ASTRONOMICAL RANGE AT DOWN TO EARTH PRICES

- TRANSISTORS+ICs+SEMICONDUCTORS
- RESISTORS+CAPACITORS+INDUCTORS
- SURVEILLANCE+SECURITY+SECURITY
- PLUGS+SOCKETS+LEADS+CONNECTS
- TV & VIDEO SPARES (inc Video Heads)
- HIFI+DISCO+HIFI GADGETS+SPEAKERS
- AUDIOPHILE COMPONENTS (inc Capacitors)
- IN CAR AUDIO+SPEAKERS (inc Bass tubes)
- COMPUTER ACCESSORIES+BOARDS
- TOOLS+TEST EQUIPMENT+BENCHWARE

& much much much more (over 10,000 lines).

SEND TODAY FOR **THE VERY INTERESTING CATALOGUE**
Pay by PO, Cheque, Credit Card or tape Coins to Paper

Please send mecopies of the 1995 Cricklewood Catalogue.
I enclose £2.50 per copy (UK & Europe). £5.00 overseas

Name.....
Address.....

Please Charge my Credit Card.no.....
Expiry Date.....Tel no.....P.EE

Cricklewood Electronics Ltd, 40-42 Cricklewood Broadway
London NW2 3ET Tel 0181 450 0995 Fax 0181 208 1441

revised
edition

TRANSMITTERS

AT LAST. A comprehensive, easy to follow guide to building short range transmitters and surveillance devices. Packed with useful information and circuits.

★ Only £3.95 inc p&p.

(Some of the circuits included cannot be used legally in the UK)

RADIO KITS

All kits come with pre-drilled PCBs and high spec. components.

- MICRO FM TRANSMITTER (a).** 1km range, 80-100MHz preset inc. mic., very small (2 x 3cm) £6.95
- MICRO FM TRANSMITTER (b).** Variable mic. sens., tunable 90-110MHz. 1km range £7.95
- FM TRACKER.** Transmits an audio tone for direction finding, tracking etc. 80-110MHz £8.50
- ULTRA MINIATURE FM TRANSMITTER.** Runs off watch battery (inc), only 1x2cm, 200mtrs range, 80-100MHz £8.95
- FM RECEIVER (a).** Tiny high quality FM radio. Will drive headphones direct (not inc) £10.90
- FM RECEIVER (b).** As (a) but with 3 watt audio output and tuning LED £13.50
- CRYSTAL RADIO.** Includes tuner, earphone, ferrite aerial, etc. £7.50
- AM RADIO.** Single chip radio for headphones (not inc.) £8.90

AUDIO KITS

- AUDIO POWER AMPS** 15 WATT General purpose upgrade £8.95
- 800mS Digital Delay Kit on mute ideal for compact disc Only £24.95
- 150 WATT Rugged and powerful MOSFET design. PA/sound systems £22.95

PREAMPS ETC

- GENERAL PURPOSE PREAMP.** Variable gain 9-25V 40mV max in £4.00
- ULTRA LOW NOISE.** For high quality mixers, mics etc 9-25V £4.50
- ACTIVE TONE.** 12dB c/b bass and treble with variable gain £8.95
- 7 BAND EQ.** 150Hz-18kHz for EQ units and tone control, Includes on-board preamp and pots. Variable gain £12.95
- NOISE GATE.** Dynamic noise reduction system. Variable input and cut off level. Will accept instruments, tape decks etc £15.95
- MUSIC KITS.** Full range of on-board units for guitars and other instruments. Tone boosters, active circuits, delay lines, transducers. Send for list.

Prices include P&P. **Mail Order Only.** Make cheques and postal orders payable to:

JCG 
PO Box HP79, Woodhouse Street, Leeds LS6 3XN

PCB Designer

For Windows 3.1

Runs on any PC running Windows 3.1 in standard or enhanced mode with 2MB RAM
Will work with any Windows supported printer and monitor

Looking for the price?
It's just £49.00 all inclusive!
...no VAT...no postage...
...no additional charges for
overseas orders.
Dealers and distributors
wanted.

- ✓ Produce Single or Double sided PCBs.
- ✓ Print out to *any* Windows supported printer.
- ✓ Toolbar for rapid access to commonly used components.
- ✓ Helpful prompts on screen as you work.
- ✓ Pad, track & IC sizes fully customisable.
- ✓ No charges for technical support.
- ✓ Snap-to grid sizes 0.1", 0.05" 0.025" and unrestricted.
- ✓ SMT pads and other pad shapes.
- ✓ Prints at the resolution of your printer - much higher than the screen shot shown here.

Internet

A working demo is available via anonymous FTP from
[ftp.demon.co.uk](ftp://demon.co.uk/pub/ibmpc/windows/pcbdemo/pcbdemo.zip) as /pub/ibmpc/windows/pcbdemo/pcbdemo.zip
e-mail enquiries can be addressed to orders@niche.demon.co.uk

Niche Software (UK)

22 Tavistock Drive, Belmont, Hereford HR2 7XN

Phone (01432) 355 414



INTERFACE

Robert Penfold



THE decoding of amateur RTTY (radio teletype) and CW (Morse) signals has been covered in previous articles in *EPE*. The systems described previously relied heavily on hardware add-ons to do the decoding, with the computer having to do little more than print the received characters on the screen. In recent years a different approach has become quite popular, and this method relies on the software to provide virtually all the signal processing.

One probable reason for the increased popularity of this method is the availability of a shareware program for PCs called "Hamcomm 3.0". This program was written by W.F. Schroeder (DL5YEC), and although it is German in origin, it is supplied complete with an excellent on-disk English manual. It can be used for thirty days free of charge, after which a \$30 registration fee must be paid if you wish to continue using the program. As \$30 is currently equivalent to about £19, this represents very good value for what is quite a complex piece of specialised software.

Minimalist

While "Hamcomm" does not totally avoid the need for a hardware interface between the audio output of the receiver and the input port of the computer, it permits a minimalist approach. The manual includes the circuit diagram for a suggested interface, which is basically just an open loop operational amplifier which clips the audio output from the receiver and drives an input line of a serial port.

If preferred, the program can be used with a conventional tone decoder, but some of its facilities will then be lost. In particular, it will not provide any help with accurate tuning, and determining the shift of an RTTY signal. The program can handle transmission incidentally, and again needs only a very basic interface. However, I have not explored this aspect of the program, and it is not something we will consider further here.

The conventional approach to RTTY/CW decoding uses filters, level detectors, phase locked loops, etc. to recover the basic digital signal. In the case of RTTY, a UART (universal asynchronous receiver/transmitter) then provides the serial to parallel conversion. All the computer then has to do is convert the five bit Baudot codes to ASCII characters that are then displayed on the screen. Converting the dots and dashes of Morse code into ASCII characters is a bit more difficult, even if the hardware sorts out the dots from the dashes. It is still a relatively simple process though, with the hardware doing most of the processing.

A program such as "Hamcomm" avoids the need for a lot of expensive hardware, but it has to provide all the processing, including the tone decoding. An RTTY signal uses a conventional f.s.k. (frequency shift keying) system, where the two logic levels are represented by two audio tones. A tone spacing of 170Hz is normally used for amateur transmissions, but commercial stations mostly use a wider spacing of 425Hz or 850Hz. In order to determine the frequency of the input signal the computer measures the time between transitions on the input line. In this way the program can tell which frequency of an RTTY signal is being received, and whether or not the correct tone for a CW signal is present.

Rapid Demand

This type of program is fairly demanding on the computer, since it takes some rapid processing in order to accurately analyse the input signal and determine the frequencies present. Apart from the fact that this has to be undertaken in real-time, the computer must also carry out software routines to provide serial-to-parallel conversion, and to print the decoded characters on the screen. Again, this must be done in real-time.

Although "Hamcomm" uses efficient programming, it is necessary to use some form

of AT PC in order to guarantee it will run fast enough. Its more advanced features benefit from a faster computer, but I found that it ran reasonably well on a 33MHz 80386 based PC. In other respects it is not very demanding. The minimum requirements are 374K of free memory, MS-DOS 3.0 or higher, and any standard graphics adaptor if you wish to use the more advanced features of the program. The program will detect any standard video adaptor, and configure itself accordingly.

Interface

The manual provides the circuit for a basic interface, but I used my own design (Fig.1). A basic clipping amplifier will presumably work well enough if the short wave receiver has built-in filtering for RTTY and CW reception. With most receivers it is necessary to make do with the SSB (single sideband) mode, which will give a much wider bandwidth than is needed for CW and most RTTY reception. This often results in the computer being presented with a plethora of signals, making it difficult for the software to sort out the wanted signal from the general hubbub of signals.

The clipping amplifier is IC3, and it is preceded by two fourth order (24dB per octave) filters. The filter based on IC2a provides lowpass filtering with a cutoff frequency at a little over 1kHz. IC2b is used in a highpass filter which has a cutoff frequency at about 500Hz. This gives a reasonably flat passband about 500Hz wide, which is sufficient to accommodate CW signals, plus RTTY types having a tone shift of 170Hz or 425Hz. Switch S1 should be closed when receiving RTTY signals that have a tone shift of 850Hz. Switch S1 then bypasses the filter components and removes the filtering. IC1 simply acts as a buffer stage at the input of the circuit.

By the standards of short wave receivers the extra selectivity of the filter is not particularly great. Nevertheless, it seems to

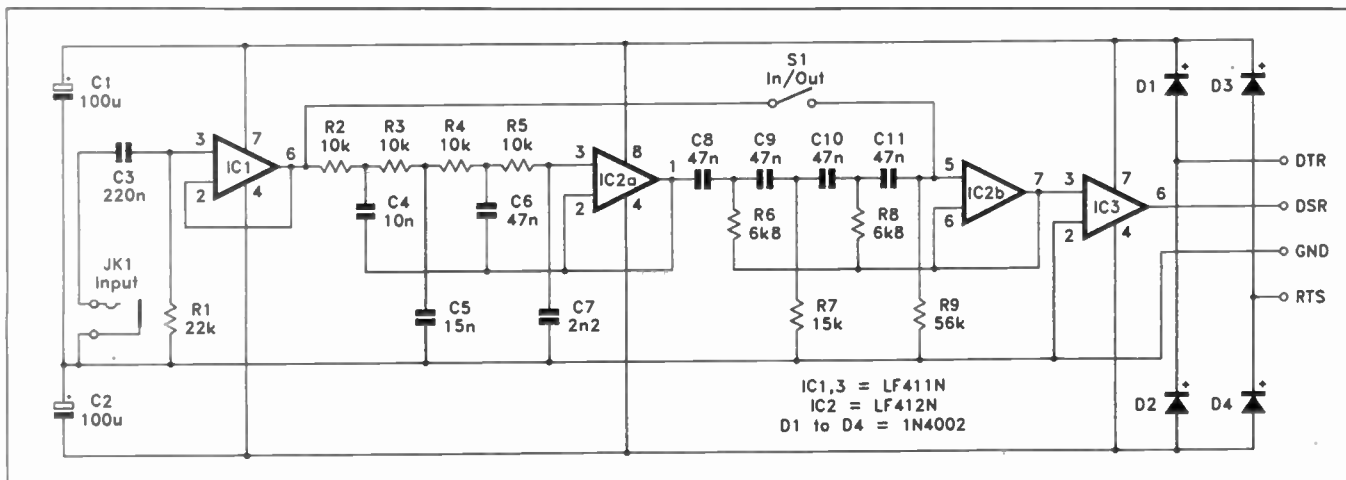

Fig. 1. Circuit diagram for the CW/RTTY interface.

make a worthwhile improvement in performance. The "Hamcomm" manual warns against using highly selective audio filtering. Apparently this can "tune" the background noise, making it difficult for the program to determine whether or not a tone is present.

Supply Problems

The circuit is powered from the otherwise unused DTR and RTS outputs of the serial port. Diodes D1 to D4 provide bridge rectification so that the interface receives a supply of the correct polarity regardless of the logic level on DTR and RTS lines. C1 and C2 are smoothing/decoupling capacitors. Due to the positive/negative signal voltages of an RS232C interface, the circuit is provided with dual balanced supplies. Only a very limited supply current is available, and low current operational amplifiers have therefore been used throughout the circuit. The total current consumption is slightly under one milliamp, plus any output current drawn from IC3. The serial port should be able to supply this without difficulty. I would not recommend the use of ordinary operational amplifiers such as the LF351N and LF353N.

The serial port can be a standard 25-pin type, or a 9-pin AT type. The connection details are shown in Fig. 2. In either case a female D-type connector is needed to make the connections to the computer. The input of the interface is fed from an audio output of the receiver via a screened cable fitted with the appropriate audio connectors. Where possible it is better to use the "tape" output of the receiver. This gives an output level which does not change when the volume control is adjusted, and it leaves the loudspeaker and headphone socket available for normal use.

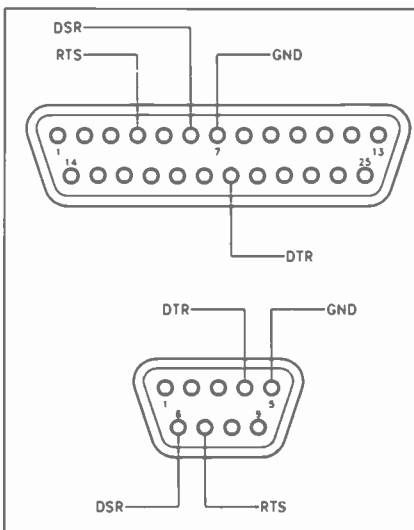
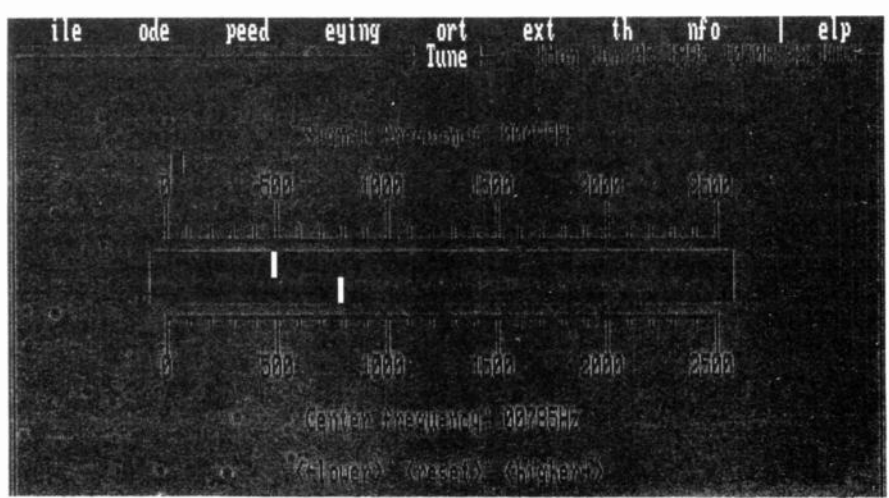

Fig. 2. Connections for 25-pin and 9-pin PC serial ports.

It is possible to use the output from a headphone socket, but this will probably cut off the receiver's built-in loudspeaker. It is then necessary to improvise some means of hearing the receiver's audio signal. A splitter cable represents an easy way of driving both the interface and a pair of headphones. Another possibility is to connect a crystal earphone to the interface between IC2 pin 7 and the earth rail. This enables the filtered audio signal to be monitored. There



Part of the "Hamcomm 3-0" tuning screen.

is insufficient drive available for any other type of earphone or headphones.

On Air

"Hamcomm" is very straightforward to install and use. The standard screen arrangement has a menu bar at the top, with the main screen split in two. The bottom section of the screen is used to print received data, and (where appropriate) the top section of the screen is used to show data that has been typed in for transmission. The program can be controlled via a mouse and pop-down menus, or via the keyboard.

I only used "Hamcomm" to decode amateur RTTY and CW signals, but it can also handle seven and eight bit ASCII, AMTOR, and SITOR A/B. The usual baud rates and f.s.k. shifts can be accommodated, and non-standard shifts can be set if necessary. Pressing the TAB key toggles the program between normal and reversed polarity, so it is still possible to decode an RTTY signal if the receiver is set to the wrong sideband mode.

For any system of this type to work well it is essential for the tuning to be accurate. Pressing function key nine switches the program to the tuning mode. This brings up a horizontal scale across the middle of the screen calibrated in Hertz. A marker shows the centre frequency of the decoder, but this can be moved to any desired frequency using the left and right cursor keys. Further markers indicate the frequencies of received input signals.

Tuning to a CW signal is just a matter of adjusting the receiver to line up its on-screen marker with the centre frequency marker. For an RTTY signal the two on-screen markers must be equally spaced either side of the centre frequency marker. Where necessary, the frequency shift of the signal can be measured quite accurately against the frequency scale. There are further facilities available which enable the input signal to be analyzed and displayed in various ways, but this basic tuning facility is all that is needed in normal use.

Results

A good filter or phase locked loop decoder can correctly decode RTTY signals that are barely audible amongst the background noise. This system seems to be rather less able at decoding signals under difficult conditions, but it is remarkably good when the minimal amount of inter-

face hardware is taken into account. A number of stations around 14.090MHz on the 20 metre band were received quite well, although there were the inevitable problems with noise and fading from time to time.

Results when used to decode amateur CW signals were less good. This was probably due in part to crowded band conditions, with the decoder often being fed with several signals on slightly different frequencies. There is another problem though, which is simply that human generated Morse code often has rather inaccurate and inconsistent timing, making it difficult for a computer to decode it. Some signals that were heavily infested with QRM were decoded quite accurately, while others that were largely free from interference were decoded with very poor accuracy. The rather cryptic nature of amateur Morse code signals does not help matters. The odd character wrong here and there can make complete nonsense of a message. However, it was usually possible to reliably decode the call-signs, plus some other information such as the location (QTH) of the station.

Big Noise

Unfortunately, computer systems are very good at generating r.f.i. (radio frequency interference) at frequencies right across the short wave bands. The problem seems to be more due to r.f.i. from the monitor than the computer itself. A modern low radiation monitor is likely to be less troublesome than an older type which is largely void of any electrical screening.

Using a short indoor aerial is unlikely to provide usable results. A long outdoor aerial will provide about the same amount of noise but other signals should be much stronger. The best type of aerial is an outdoor type mounted well away from the computer, with a screened or balanced feeder to connect it to the receiver. This should give strong signals with minimal pickup of noise from the computer system.

Any reasonably sophisticated communications receiver should give good results. Modern types having synthesised tuning are preferable to older types though, since good frequency stability is a decided asset for CW and RTTY reception. "Hamcomm 3-0" is available from The PDSL, Winscombe House, Beacon Road, Crowborough, Sussex, TN6 1UL (Tel. 01892 663298, Fax 01892 667 473).

Mixed metal/carbon film resistors 1/2W E12 series 10 ohms to 1 Megohm	2p
Carbon Film resistors 1/4W 5% E24 series 0.51 R to 10MΩ	1p
100 off per value - 75p, even hundreds per value totalling 1000	£6.00p
Metal Film resistors 1/4W 10R to 1 MΩ 5% E12 series - 1/2p, 1% E24 series	1/2p
Mixed metal/carbon film resistors 1/4W E24 series 1 R to 10MΩ	1p
1 watt mixed metal/Carbon Film 5% E12 series 4R7 to 10 Megohms	5p
Linear Carbon pre-sets 100mW and 1/4W 100R to 2M2 E6 series	7p
Miniature polyester capacitors 250V working for vertical mounting	
0.15, 0.22, 0.33, 0.47, 0.68-4p, 0.1 - 5p, 0.12, 0.15, 0.22 - 6p, 0.47 - 8p, 1.0 - 12p	
Mylar (polyester) capacitors 100V working E12 series vertical mounting	
1000p to 8200p - 3p, 0.1 to 0.68 - 4p, 0.1 - 5p, 0.12, 0.15, 0.22 - 6p, 0.47/50V - 8p	
Submin ceramic plate capacitors 100V wkg vertical mountings, E12 series	
2% 1.8pf to 47pf - 3p, 2% 56pf to 330pf - 4p, 10% 390p - 4700p	4p
Disc plate ceramics 50V E12 series 1P0 to 1000P, E6 Series 1500P to 47000P	2p
Polystyrene capacitors 63V working E12 series long axial wires	
10pf to 820pf - 5p, 1000pf to 10,000pf - 6p, 12,000pf	7p
741 Op Amp - 20p, 555 Timer - 20p, LM3900	80p
CMOS 4001 - 20p, 4011 - 22p, 4017 - 40p, 4069UB unbuffered	20p
DIL holders, 8-pin 9p; 14-, 16-, 18-pin 12p; 24-pin 18p; 28-pin 20p; 40-pin 25p.	
ALUMINIUM ELECTROLYTICS (Mfd/Volts)	
1/50, 2.2/50, 4.7/50, 10/25, 10/50	5p
22/16, 22/25, 22/50, 33/16, 47/16, 47/25, 47/50	6p
100/16, 100/25, 100/50	12p
220/16 8p; 220/25, 220/50 10p; 470/16, 470/25	11p
1000/25 25p; 1000/35, 2200/25 35p; 4700/25	70p
Subminiature, tantalum bead electrolytics (Mfd/Volts)	
0.1, 0.22, 0.47, 1.0, 2.2, 3.3 @ 35V - 4.7/16, 6.8/10, 10/6, 10p, 6.8/35, 12p, 4.7/25, 6.8/16, 10/6, 11p; 15/16, 22/6, 33/10, 15p, 10/25, 16p; 10/35, 22/16, 20p, 47/10, 20p; 47/16, 25p; 47/20, 30p; 47/35, 32p; 100/3, 18p; 100/6, 22/6, 20p.	
VOLTAGE REGULATORS	
1A + or - 5V, 8V, 12V, 15V, 18V & 24V - 55p, 100mA, 5.8, 12, 15, V +	30p
DIODES (piv/amps)	
75/25mA 1N4148 2p, 800/1A 1N4006 4p, 400/3A 1N5404 14p, 115/15mA OA91	8p
100/1A 1N4002 3p, 1000/1A 1N4007 5p, 60/1.5A S1M1 5p, 100/1A bridge	25p
400/1A 1N4004 4p, 1250/1A BY 127 10p, 30/150mA OA47 gold bonded	18p
Zener diodes E24 series 3V/3 to 33V 400mW - 6p, 1 watt	10p
Battery snaps for PP3 - 7p for PP9	12p
L.E.D.'s 3mm, 5mm, Red, Green, Yellow - 10p, Grommets 3mm - 2p, 5mm	2p
Red flashing L.E.D.'s require 9-12V supply only, 5mm	50p
Mains indicator neons with 220k resistor	10p
20mm fuses 100mA to 5A, O. blow 6p, A/surge 10p, Holders, chassis, mounting	6p
High speed pc drill 0.8, 1.0, 1.3, 1.5, 2.0mm - 40p, Machines 12V dc	£15.00
HELPING HANDS 6 ball joints and 2 croc clips to hold awkward jobs	£4.50
AA/HP7 Nicad rechargeable cells 90p each, Universal charger unit	£6.50
AA/HP7 zinc/carbon batteries in packs of 4	£1.10 per pack
Glass reed switches with single pole make contacts - 8p, Magnets	20p
0.1" Stripboard 2 1/2" x 1" 9 rows 25 holes - 25p, 3 1/2" x 2 1/2" 24 rows 37 holes	70p
Jack plugs 2.5 & 3.5mm - 14p; Sockets Panel Mtg. 2.5 & 3.5mm	10p
Ear pieces 2.5 & 3.5mm, dynamic - 20p; 3.5mm crystal	£1.50
Multi cored solder, 22G - 8p yard, 18G - 14p yard.	
TRANSISTORS	
BC107/8/9 - 12p, BC547/8/9 - 8p, BC557/8/9 - 8p, BC182, 182L, BC183, 183L, BC184, 184L, BC212, 212L - 10p.	
BC327, 337, 337L - 12p, BC727, 737 - 12p, BD135/6/7/8/9 - 25p, BCY70 - 18p, BFY50/51/52 - 20p.	
BFX88 - 15p, 2N3055 - 55p, TIP31, 32 - 30p, TIP41, 42 - 40p, BU208A - £1.50, BF195, 197 - 12p	
Ionisers with seven year guarantee, 240V AC, list price £16.95 or more	£12.50
Do not add VAT. Postage 30p (free over £5). Stamp for list.	

THE CR SUPPLY CO

127 Chesterfield Rd., Sheffield S8 0RN Tel: 01742 557771 Return posting

WE HAVE THE WIDEST CHOICE OF USED OSCILLOSCOPES IN THE COUNTRY

TEKTRONIX 7000 SERIES OSCILLOSCOPES Available from £200 - PLUS INS SOLD SEPARATELY

TEKTRONIX 2465 4 Channel 300MHz Delay Sweep Cursors	£1750
TEKTRONIX 485 Dual Trace 50MHz Delay Sweep	£750
TEKTRONIX 475 Dual Trace 200MHz Delay Sweep	£900
TEKTRONIX 465 Dual Trace 100MHz Delay Sweep	£600
TEKTRONIX SC504 Dual Trace 80MHz in TM503	£600
TEKTRONIX 2215 Dual Trace 60MHz Delay Sweep	£600
TEKTRONIX 455 Dual Trace 50MHz Delay Sweep	£600
PHILIPS PM5217 Dual Trace 50MHz Delay Sweep	£600
HITACHI V223 Dual Trace 50MHz Delay Sweep	£250
BECOMAN 9020 Dual Trace 20MHz Delay Sweep	£240
HAMEG 412 Dual Trace 20MHz Delay Sweep	£225
GOULD OS1100 Dual Trace 50MHz Delay Sweep	£240
GOULD OS1100S1 Dual Trace 20MHz	£200
GOULD OS300 Dual Trace 20MHz	£200
WATSU SS5702 Dual Trace 20MHz	£1200
HITACHI V66045 Dual Trace 100MHz Dig Storage; Cursors 40MS	£1100
PHILIPS PM5505 4 Trace 50MHz Digital Storage	£850
GOULD OS4000 Dual Trace 10MHz Digital Storage	£200
TEKTRONIX 464 Dual Trace 100MHz Analogue Storage	£350
H.P. 1741A Dual Trace 100MHz Analogue Storage	£400

THIS IS JUST A SAMPLE - MANY OTHERS AVAILABLE

KIRBY VISA - DUAL TRACE 35MHz ONLY £180

EATON/ALTECH 380K11 Synthesized Sig Gen 1MHz-2000MHz with PM3602 AM/FM Phase Mod	P.O.A.
H.P. B565A Synthesized AM/FM Sig Gen 100kHz-990kHz	£1900
MARCONI 2019 Synthesized AM/FM Sig Gen 80kHz-1040kHz	£1900
MARCONI 2018 Synthesized AM/FM Sig Gen 80kHz-520kHz	£700
H.P. B620C Sweep Osc. 5.9GHz-12.4GHz or 9GHz-12.4GHz	£350
H.P. B620C Sweep Oscillator Main Frame only	£200
RACAL 9081 Syn AM/FM Sig Gen 5kHz-520kHz	£600
FARNELL SSC520 Syn AM/FM Sig Gen 10kHz-520MHz	£450
MARCONI TF333 Automatic Distortion Meter	£200
MARCONI TF2331 Distortion Factor Meter 20Hz-20kHz 0.06%	£150
MARCONI TF938 Audio Power Meter Sinad	£250
MARCONI TF2163 Attenuator DC-1GHz	£150
H.P. 84956 Attenuator DC-18GHz, 0dB-11dB in 10dB Steps	£75
HATFIELD 2195 Attenuator 50Ohm	£1250
TEKTRONIX TR1502	£1250
R & S Video Noise Meter UPSF2 with UPSF2E2	£750
R & S Mobile Sump SAMP2 04MHz-1000MHz	£1250

WINDMILL & KEISER EQUIPMENT AVAILABLE PLEASE ENQUIRE

SPECTRUM ANALYSERS

FR 8750 Synthesized 1GHz	£4000
H.P. B565A 0.015GHz-22GHz	£4500
ANDO ACB281 with ACB211 1700MHz	£1500
POLARAD 641-1 10MHz-18GHz	£1000
H.P. 192 with B559B 100kHz-1500MHz	from £1500
H.P. 1411 with B555A & B552B 10MHz-18GHz	£1700
H.P. 1411 with B555B & B552B 500kHz-1250MHz	£1200
H.P. 1411 with B555B & B552A 1kHz-110MHz	£800
H.P. 1411 Main Frames Only Good Tubes	£225
MARCONI TF2370 30Hz-110MHz	£1000
TEKTRONIX 7112 Main Frame 10kHz-1800MHz	£1200
TEKTRONIX 715 with Main Frame 20MHz-5MHz	£1000

MARCONI 2440 Microwave Counter 20GHz	£1950
H.P. 5341A Frequency Counter 50MHz-1.5GHz LED	£300
RACAL 1998 Freq. Counter 1.5GHz 1000ns GPH & High Stab	£900
RACAL DANA 1991 Universal Counter/Timer 160MHz 9 digit	£800
MARCONI 2437 Universal Counter/Timer DC -100MHz 8 digit	£175 - PLUS INS
RACAL 9916 Frequency Counter 10Hz-520MHz	£175
RACAL 9908A Frequency Counter Timer 10Hz-200MHz	£250
BLACK STAR Meter 100 Frequency Counter 100MHz	£70
H.P. 5456A 6 1/2 digit DVM DC/True RMS AC/Res. HPB	£600
PHILIPS PM1534 Multi Funct DMM 3 1/2 digit CPB IEEE	£450
SOLARTRON 7065 6 1/2 digit Microprocessor Voltmeter AC/DC Ohms Auto	£400
SOLARTRON 7150 6 1/2 digit DMM with IEEE	£400
SOLARTRON 7045 4 1/2 digit Multi-Meter Volts/Amms/Ohms	£30
THANDAR 1504 4 1/2 digit True RMS Multimeter with Adaptor	£100
GOULD JSB Sine Square Oscillator 10Hz-100kHz	£150
FEEDBACK FG600 Sine/Sq/Tri 0.1Hz-100kHz	£60
JUPITER 500 Func. Gen. Sine/Sq/Triange/TTL	£175
THANDER 16201 Func. Gen. 0.0005Hz-5MHz	£175
Sine/Sq/Tri Ramp/Pulse/etc.	£70
THANDER TC102 Func. Gen. 0.02Hz-2MHz Sine/Sq/Tri/TTL	£850
PHILIPS PM5518 Colour TV Pattern Gen. Pal/Secam/NTSC	£500
UNICONS L41 M42 Audio Analyser	£350
UNICONS PM501 Audio Analyser	£350
RADFORD LDM4 Low Distortion Oscillator	£300
RADFORD LDM52 Low Distortion Measuring Set	£200
KEMO Dual Variable Filter VBF 3 0.1Hz-10kHz	£350
RACAL Instrumentation Recorder Type Store 4DN	£350
RACAL Instrumentation Recorder Type Store 7S	£350
H.P. 4261A LCR Meter with Test Fixture 16061A	£900
MARCONI TF2700 Universal Bridge, Battery Operated	from £150
WAYNE KERR BA2 Digital Component Meter LCR	£200
H.P. 16300 43 Channels	£750
H.P. 35000 43 Channels	£750
H.P. 6268 40V-0-30A	£500
FARNELL H501 10-0-30V 0-100A Metered	£800
THURLEY PL3200M 0-30V 0-2A Twice Digital	£225
FARNELL L350 0-30V 0-5A Metered	£100
FARNELL L350-2 0-30V 0-2A Twice	£160
FARNELL L350-2 0-30V 0-2A Metered	£90
FARNELL L350-1 0-30V 0-1A Twice	£130
FARNELL L350-1 0-30V 0-1A Metered	£85
FARNELL L350-0 150V 0-200mA Metered	£100
BRANDENBURG Model 472R +/- 2K Metered	£200

MANY OTHER POWER SUPPLIES AVAILABLE

NEW EQUIPMENT

HAMEG OSCILLOSCOPE HM1005 Triple Trace 100MHz Delay Timebase	£947
HAMEG OSCILLOSCOPE HM604 Dual Trace 60MHz Delay Sweep	£853
HAMEG OSCILLOSCOPE HM303 Dual Trace 50MHz Comp. Tester	£392
HAMEG OSCILLOSCOPE HM205-3 Dual Trace 20MHz Digital Storage	£893

All other models available - all oscilloscopes supplied with 7 probes

BLACK STAR EQUIPMENT (P)P all units £5

APOLLO 10 100MHz Counter Timer Ratio Period/Time Int. etc	£222
APOLLO 100 100MHz as above with more functions	£325
METEOR 100 FREQUENCY COUNTER 100MHz	£119
METEOR 600 FREQUENCY COUNTER 600MHz	£145
METEOR 1000 FREQUENCY COUNTER 1GHz	£188
JUPITER 500 FUNCTION GEN. 0.1Hz-500kHz Sine/Sq/Tri	£125
ORION COLOUR BAR GENERATOR Pal/TN Video	£243

All other Black Star equipment available

OSCILLOSCOPE PROBES Switched X1 X10 (PSP £3)

Used Equipment - Guaranteed. Manuals supplied if possible.

This is a VERY SMALL SAMPLE OF STOCK. See or telephone for details. Please check availability before ordering. CARRIAGE all units £16. VAT to be added to Total of Goods and Carriage.

STEWART OF READING

110 WYKEHAM ROAD, READING, BERKS RG6 1PL

Tel: 01734 268041 Fax: 01734 361696 Callers welcome 9am to 5.30pm MON-FRI (UNTIL 6pm THURS)

SEETRA CAE RANGER PCB DESIGN

WITH COOPER & CHYAN AUTOROUTER

RANGER3 - DOS £2500
- Windows\NT £2900

RANGER2 £150

- Hierarchical or flat schematic linked to artwork.
- Unlimited design size, 1 micron resolution
- Any shaped pad, definable outline library
- Pin, gate & outline swapping - auto back annotation
- Split power planes, switchable on - line DRC

COOPER & CHYAN SPECCTRA autorouter (SP2)

Inputs: OrCAD, Cadstar, PCAD, AutoCAD DXF

Outputs: Postscript, Windows bit map

R2 & R3 Outputs: 8/9 & 24 pin printers, HP Desk & Laser Jet, Cannon Bubble Jet, HP-GL, Gerber, NC Drill, AutoCAD DXF

- Upto 8 pages of schematic linked to artwork
- Gate & pin swapping - automatic back annotation
- Copper flood fill, Power planes, Track necking, Curved tracks, Clearance checking, Simultaneous multi-layer auto-router

RANGER2 UTILITIES £250

COOPER & CHYAN SPECCTRA auto-router (SP1)
 Gerber-in viewer, AutoCAD DXF in & out

UPGRADE YOUR PCB PACKAGE TO RANGER2 £60

TRADE IN YOUR EXISTING PACKAGE TODAY

Seetrex CAE, Hinton Daubnay House, Broadway Lane, Lovedean, Hants, PO8 0SG
 Call 01705 591037 or Fax 01705 599036 + VAT & P.P

All Trademarks Acknowledged

Everyday with Practical Electronics, August 1995

628

VERSATILE MICROCONTROLLED 3-DIGIT TIMER

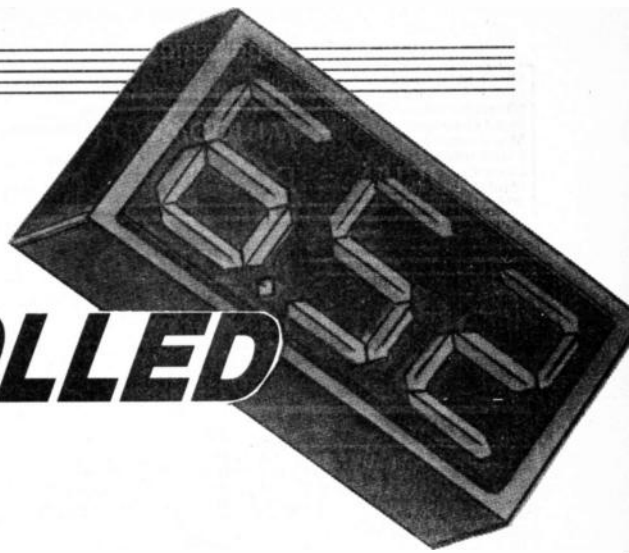

BART TREPAK

"Dial-a-time" with this Up/Down timer. From seconds up to 9 hours 59 mins. With relay switching output it will also control mains appliances. Ideal for darkroom process timing, games timing and elapsed time indicator.

WHEN it comes to generating a time delay of a few seconds or even minutes it is hard to beat the trusty old 555 timer for simplicity and accuracy. Even when longer time delays are required such as a few hours, the 555 followed by a binary divider or one of the similar chips such as the ZN1034 offer the same simplicity and get around the problem of using large capacitor values.

The situation is far more complicated however if a variable timer is required. There are not many uses for a fixed 60 second or 60 minute timer but a variable one with a range of one to 60 seconds or one to 60 minutes or even hours is far more useful.

Timing anything from a process in a darkroom to charging a battery are things which instantly spring to mind while a little more thought reveals more uses such as a games timer or to remind you to do something such as ring someone back in ten minutes.

GET SET

While in theory it is possible to make a timer for these applications using a 555 timer i.e., by making the timing resistor a variable and switching capacitors for different ranges, in practice the problem of calibrating the potentiometer would be difficult to say the least and with the resulting scale, setting a delay with any reasonable accuracy virtually impossible. With some of the devices which use an oscillator and a divider, it is possible to set the time delay by means of switches which are set in binary to give the required division ratio.

The accuracy is then dependent on the accuracy of the oscillator but setting the delay is still not that easy – what is 53 in binary for example. Anyone other than a computer programmer would probably need a bit of time to work it out while most people without a technical background would probably not know where to begin.

For this reason, commercial electronic timers are digital for accuracy and are made to be programmed in decimal to make them easy to set. These employ a

digital display on which the required delay is set and the timer then counts down to zero operating a buzzer when this is reached.

This, of course, is much more complex in actual circuitry than a 555 timer but is much easier to use. Most timers of this type are intended for use in the kitchen or similar situations so they use a small display and do no more than sound a buzzer to signal the completion of the timing period.

PLAY TIME

This project began life because of a need for a timer to put an end to the not so friendly arguments about when indoor games should have finished. The original requirement was for a timer which could be easily set to time for up to 20 minutes using the display, i.e. no binary, or BCD coded thumbwheel switches.

It also had to have a Start/Stop button so that the timing could be suspended for any reason and then restarted, and a buzzer which would sound at the end of the game. It was also felt more desirable (for some reason) to display the time elapsed rather

than the time remaining so the unit would have to count up rather than down.

While working on the design, it was soon realised that no dedicated i.c.s were available to perform this function and a microcontroller would have to be used, so various other features were considered to make the finished unit more versatile and useful in other applications. The specification was therefore "expanded" to a 3-digit timer which could count in minutes and seconds as well as in hours and minutes, count up or down and provide an output for switching off a mains appliance at the end of the period.

The additional cost in providing these features is negligible, requiring as it does only a few extra lines of program code and a relay. It also resulted in a timer with many more applications than the one with the original specification.

FOUR INTO TWO WILL GO

The first step in any microcontroller design, after deciding what the device is to do and what functions are going to be required (i.e. the number of switches, displays etc.) is to assign the available input/output lines to the peripheral devices.

The PIC16C54 microcontroller chosen for this design (because of its low cost) has two I/O ports: port A which is four bits

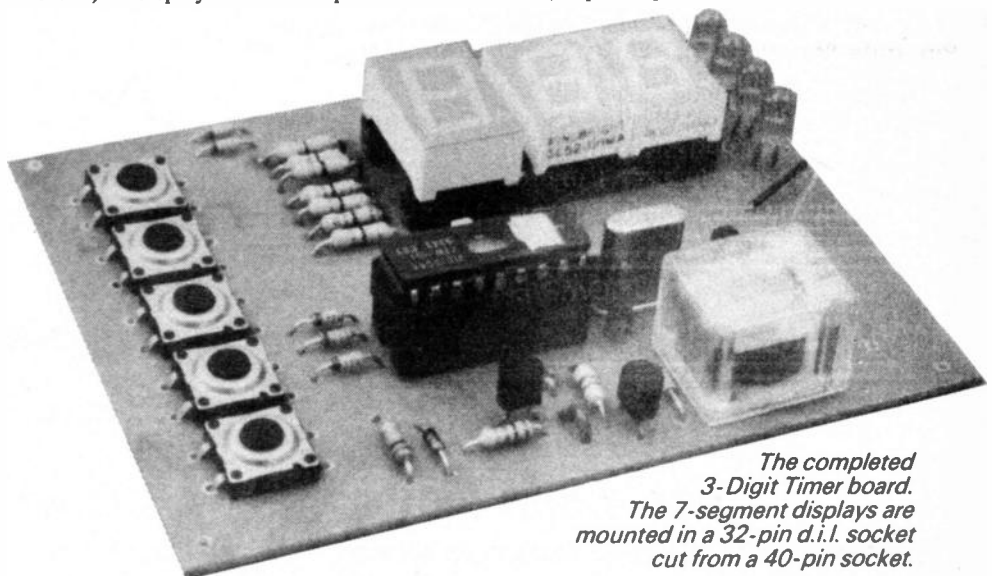

The completed 3-Digit Timer board. The 7-segment displays are mounted in a 32-pin d.i.l. socket cut from a 40-pin socket.

wide and port B which is eight bits, giving a total of 12 lines which can be made to function as inputs or outputs under program control. The pinout line-up and function is indicated in Fig. 1. Two of the lines of port A were chosen to drive the output relay and the buzzer (A0 and A1 respectively) and seven lines (port B lines B0 to B6) were required to drive the 7-segment i.e.d. display (see Fig. 6.).

Since only five function switches are required, five of the seven segment lines could double as drivers for the switches taking each switch contact high in turn and sensing the logic level on the input (port B line B7) which will be high if the switch is pressed. This line has to be dedicated to this function because if one of the segment lines were used for the input line, pressing a switch would short two of the segment lines together causing spurious segments to light or even damage the microcontroller i.c.

DRIVER

As with all multiplexed displays, the segment drives for all the i.e.d. Digit Displays are common and each display must be driven in turn by a separate digit drive line when the correct segment lines for that digit have been energised. In this design there are effectively four digits; the three 7-segment i.e.d. displays and the indicator i.e.d.s which show which mode (hours/mins or mins/secs and up or down counting) has been selected.

This would normally require four lines but we have only two (A2 and A3) left out of the twelve. Fortunately, the PIC I/O lines enable us to drive two digits with one line.

This is accomplished by using a common Anode and common Cathode display connected in inverse parallel and driving the digit line high and segment lines low to energise the common anode i.e.d. and digit line low and segment lines high to light the common cathode unit. When both units have to be off when the other digits are being driven or the switches are being interrogated, the digit line is put into its high impedance (input) mode, preventing either unit from lighting. Although you will not require sun-glasses to view the resulting display, assuming reasonably efficient i.e.d.s are used, the brightness should be sufficient for most indoor applications. The use of a red filter will also enhance the brightness.

The problem with driving i.e.d. 7-segment displays in this way, is the low reverse voltage rating of the diodes used in the display. This can lead to a segment passing sufficient current when it is reverse biased to light a segment in an adjacent digit.

No damage can result from this because the current is so low and if the segment in the next digit is meant to be on anyway, there will be no noticeable problem. If the segment is meant to be off however, it may be energised at a low level giving a "ghosting" effect.

One way of solving this problem would be to insert a silicon diode, which has a much higher reverse voltage rating, in series with each i.e.d. but this would result in having to fit 25 extra diodes to the circuit which would not be a very elegant solution. Since the reverse voltage rating of i.e.d.s is about 3-5V, driving them from a supply voltage of less than this would circumvent the problem. This is also the minimum microcontroller supply voltage and so to give a larger margin, a diode has been inserted into each digit drive line (four diodes) and the supply voltage increased to 4V.

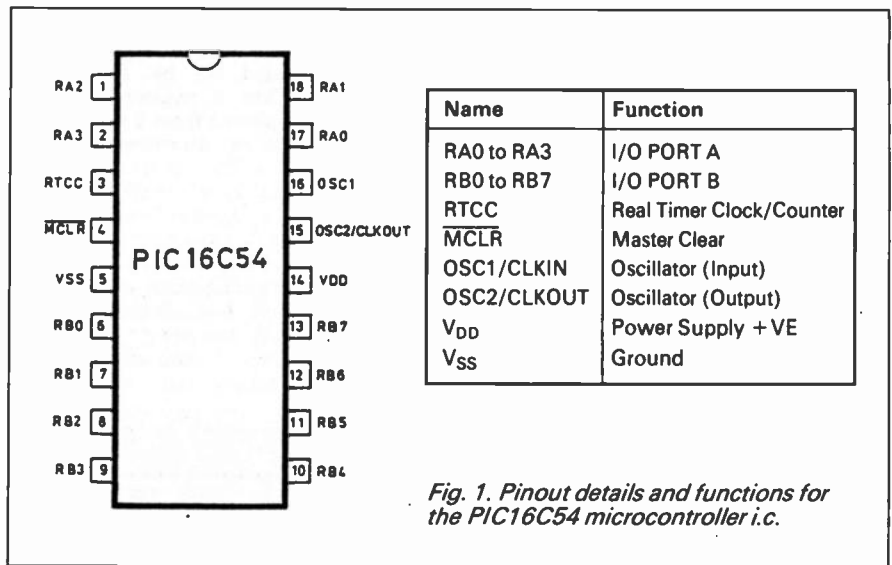

Fig. 1. Pinout details and functions for the PIC16C54 microcontroller i.c.

TIMEBASE

The most important thing about a timer is that it keeps time and so the next thing to consider is how this is to be done. The PIC (in common with many other microprocessors) contains a counter/timer (RTCC or Real Time Clock/Counter as it is called in the data sheet) which can be incremented by the internal instruction clock which is simply the crystal oscillator frequency divided by four by an internal divider.

The RTCC is an 8-bit counter which can count to a maximum of FF hex (255 decimal) and when it receives the next pulse, will "roll over" to 00 (zero) and start again. By selecting a suitable crystal frequency and loading the RTCC with a suitable value, the zero state would be reached every say 20ms which could then be further counted to provide us with seconds, minutes etc.

Many micros are designed to generate an interrupt signal automatically when the internal counter/timer reaches the zero state allowing the processor to continue executing the main program until this occurs. Unfortunately, the PIC16C54 is not one of them. The only way to see if the RTCC register has reached zero is to read it each time it is incremented.

This would, of course, mean that the microcontroller would have a full time job just reading the RTCC register because it is incremented at the same rate as the instructions are executed which would leave no time to do anything else. For this reason, the PIC has a prescaler which can be used to divide the instruction clock by up to 256 if required allowing the RTCC register to be incremented at an even slower rate.

If we divide the instruction clock by say 100 and load the RTCC with a value of 246 decimal so that it will reach 256 (or zero) after 10 input pulses, then the PIC will be able to execute $10 \times 100 = 1000$ instructions between each zero state of the RTCC. Thus following an RTCC zero, we can go off and run a program up to 1000 instructions long before returning to check the RTCC again, confident in the knowledge that the zero state will not have been reached by the time we return.

Ideally we want to choose a crystal which will give a nice round figure for the timebase when it is divided by the prescaler and RTCC such as 10ms, 20ms or 50ms and not 19.531ms or some other odd number. While this could be used, we would have to keep adjusting the count

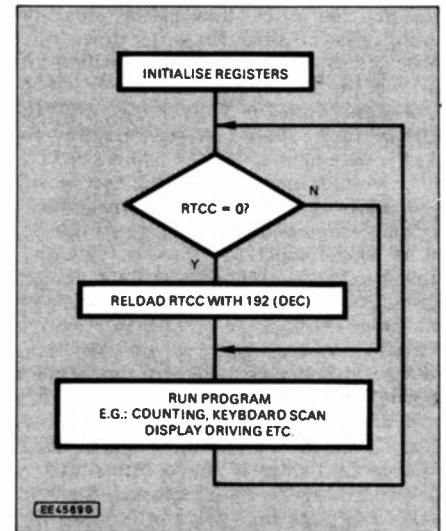

Fig. 2. Basic flowchart.

every second or minute otherwise our timer could be out by quite a few minutes after a long timing run.

The other consideration is that in between the times that the RTCC counter reaches zero, among other things the i.e.d. display must be updated. This must be done sufficiently often to make the display appear constant and not show an annoying flicker. As well as this, there must also be sufficient time between the RTCC "zeros" to enable all the other instructions to be executed.

To obtain a flicker free display, the i.e.d.s will have to be updated at least every 20ms and a 3-2768MHz crystal can be divided to give this figure quite easily. The PIC divides the crystal frequency by four to obtain the instruction clock (and also the frequency at which the prescaler will count) which gives us a frequency of 8192kHz or a time of 1.2µs per instruction.

In 20ms therefore, we can execute over 16,000 instructions which is more than enough to execute the whole program many times over. In fact the final program "wastes" most of these carrying out a delay loop so that the pulse width of the i.e.d. drives is longer to obtain a brighter display!

If we set the prescaler to divide by 256, the RTCC will be incremented at a frequency of 3200Hz and by loading the RTCC with 192 decimal, zero will be reached after $256 - 192 = 64$ increments, giving a period of $64/3200 = 0.02$ s or 20ms.

DESIGNING THE FLOWCHART

We now know roughly how the program will work so we could draw the flowchart shown in Fig 2. This shows the Timing section of the program with the rest of the routine called Program for the time being. This will finally include the display driving routines, keyboard reading etc.

Before this program can be executed however, we must first set up the microcontroller so that when the circuit is first switched on, it will be in a certain condition with the displays set to zero for example, not counting and in the count down mode. These conditions along with such routine things as defining which ports will be inputs and which outputs, the division ratio of the prescaler etc. can be set up in that part of the program marked Initialise which will be executed once when the circuit is first powered up.

Designing a flowchart is simply a process of drawing more and more detailed charts showing the logical flow of the program until it is possible to write down the instructions as defined in the instruction set of the microcomputer being used. The more familiar the programmer is with the instruction set and the more experienced he is in programming, the earlier this step can be performed and the fewer the number of flowcharts which need to be drawn.

Many programmers can, especially in more simple programs, dispense with the flowchart altogether. This is not to be recommended because, if nothing else, even a simple flowchart can give an overview of the way that a program works which can save many hours work in the future should a program need to be modified.

In Fig. 2 the RTCC counter will overflow every 20ms but the l.e.d. display will need to be updated every second or every minute depending on the mode selected and the l.e.d. indicating that the unit is counting (which flashes every second) will need to be switched on and off every half second. The RTCC "overflows" will therefore need to be counted to determine when the l.e.d. needs to be turned on and off and the resulting half-seconds counted to determine when a second or minute has elapsed.

EXPANSION

An expanded flowchart which now includes a Half-Second counter, which counts to 25 (decimal), is shown in Fig. 3. If the circuit is not in the Run mode (i.e. not timing) then the program branches at the third decision box, switches off the relay and goes on to scan the keyboard and display before returning to test the RTCC again until the next overflow is detected, but causing the l.e.d. to remain on permanently.

If the circuit is in the Run mode, then the relay is switched on and the l.e.d. is complemented (i.e. switched on if it is off and off if it is on) and another counter, (the Timebase counter) is decremented each time the Half-Second counter reaches zero.

The Timebase counter is loaded with the number contained in a Timebase register which is loaded with a value of 2 or 120 (decimal) depending on whether the hours/minutes or minutes/seconds mode has been selected. The timebase counter will therefore reach zero after two half-seconds (i.e. each second) or 120 half-seconds (i.e. 60 seconds or each minute) and this is used to increment or decrement the display.

Note that the read/write (or RAM)

memory in the PIC microcontroller is organised as a set of 8-bit registers which can be operated on by the various instructions. Thus a register may have individual bits altered from 0 to 1 or may be incremented or decremented like a counter. In this article, the term "counter" is used to denote a register used for counting while a "register" simply holds a numerical value or remembers the state of an output but both are in fact identical.

Although the timing chain looks complicated, it does in fact contain very few instructions (each box being typically one or at most two instructions in PIC assembler language) and so it is ex-

ecuted very quickly. Even the boxes marked "Increment/Decrement Displays" and "Keyboard Scan" contain relatively few instructions and execute quickly.

Rather than have the processor running the RTCC test routine all the time with short breaks to execute the rest of the program, a delay routine has been incorporated into the subroutine. Marked "display", this ensures that the digits are driven for as long as possible during the 20ms interval between RTCC zeros to give a brighter display while still leaving enough time to execute the rest of the program.

A delay routine simply sets up a dummy

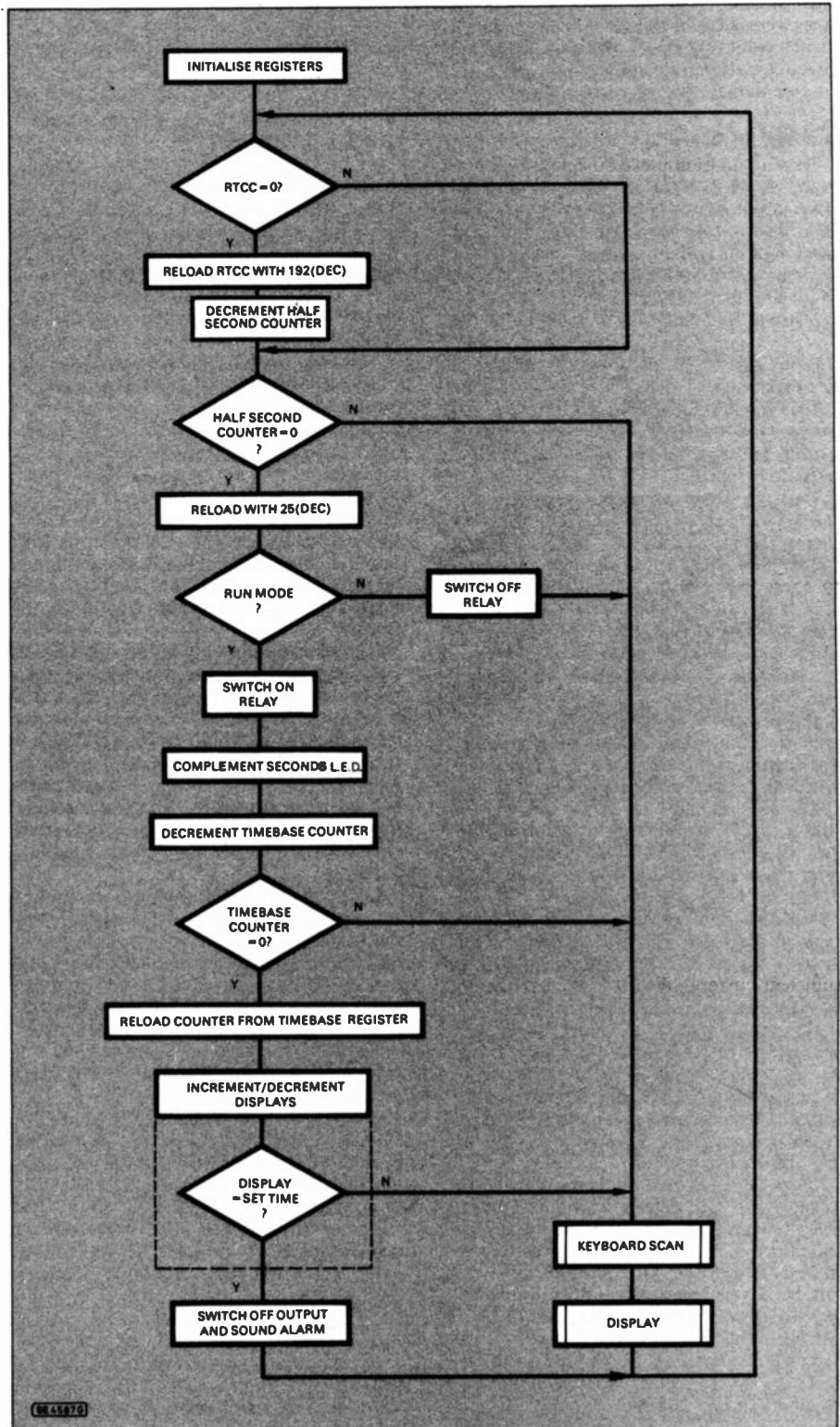

Fig. 3. Expanded flowchart for the timer, including a half-second counter.

counter which does nothing but counts down to zero and uses up time. The larger the number which is loaded into the counter at the beginning of the routine, the longer the time taken to reach zero and therefore the longer the delay.

JUST ROUTINE

The next step in the design is to expand further the boxes marked Initialise, Increment/Decrement Displays, Keyboard Scan and Display. Rather than describing all of these in detail only the first two will be dealt with and only the functions of the other subroutines mentioned.

The Initialise routine is shown in Fig. 4 and, as mentioned earlier, is only executed once shortly after the unit is first powered up. It consists mainly of instructions loading values into the various registers and counters. One trick which is used to save on switches and make for a less complicated front panel is to read the status of a switch during this time and if it is pressed, to use this to change the function of the circuit.

Since this timer is to count up or down, this could be set up at switch-on as it is unlikely that the user will want to change this during a timing operation. The program therefore reads the Start/Stop switch and if this is pressed when the unit is switched on, the circuit is placed into the

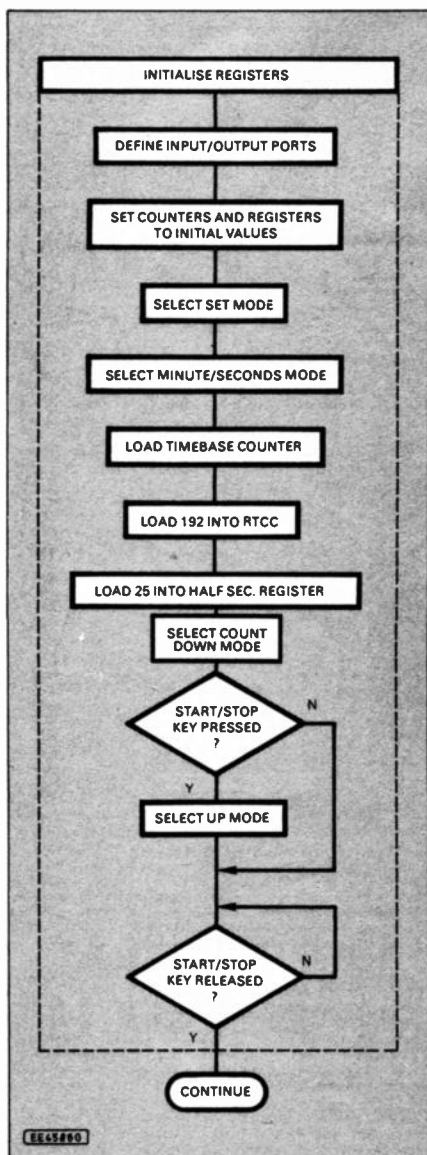

Fig. 4. Initialise routine flowchart.

UP mode and an l.e.d. lit to indicate this.

For DOWN mode the circuit should be switched on without depressing the switch. So that the main program is not entered and the switch read as Start/Stop as it would be in the Keyboard Scan routine, the program is made to wait until the key is released before continuing.

The Increment/Decrement Display routine is shown in Fig. 5. This routine has two outputs or exits: Continue Timing - which goes on to Keyboard Scan and Display, and Timing Completed - which ends the timing cycle and goes on to switch off the relay, sound the alarm and set up the unit for another timing run. Depending on whether the UP or DOWN mode has been selected, either the right hand or left hand side of the flowchart will be followed.

The time is counted on two counters called Tens/Units and Hundreds. These are simply memory locations or registers in the PIC which consist of eight bits with the Tens being the top four bits and Units the bottom four bits of one register and the Hundreds the bottom four of another. The Tens/Units are therefore stored as two BCD (binary coded decimal) numbers in one register and the Hundreds stored as a single BCD number in another.

In the DOWN mode, the counters are loaded with the values stored in a similar set of registers (which are incremented by means of the Set Units, Set Tens and Set Hours/Minutes switches) when the Run switch is pressed. Each time this routine is executed, the Tens/Units counter is decremented and when it reaches zero, it "overflows" to FF (hex) (255 decimal). The Hundreds counter is then checked and if this is already zero then the timing is over but if it is not, the Hundreds counter is decremented and the Tens/Units counter loaded with 59 to continue counting down from there.

If the Tens/Units counter does not equal FF(hex) after it has been decremented, then the lower four bits are checked to see if they have not "overflowed" past zero giving a value of 0F(hex) (= 15 decimal). If it has then six is subtracted from the Tens/Units register (which has the effect of decrementing the upper four bits (Tens) and setting the lower four bits (Units) to nine thus ensuring that the count down proceeds correctly.

In the UP mode, the counters are reset to zero when the Run switch is pressed at the beginning of the timing cycle and each time the routine is executed, the Tens/Units counter is incremented. In this case the Units counter will "overflow" to 0A(hex) which is ten in decimal so that six must be added to the counter to increment the top four bits (Tens) and reset the lower four (Units) to zero.

Once this has been done, the counter is checked to see that it has not been incremented to 60 and if it has, the Tens/Units counter is reset to 00 and the Hundreds incremented. The counters are then compared to the Set registers and depending on this, the program proceeds to the Timing Complete or Continue Timing section.

ONE STEP AT A TIME

In a similar way the other parts of the program are built up until they can be written down using the instructions supported by the PIC. The two other major routines which are required are Keyboard Scan and Display which are both written

as subroutines. These are simply programs which the main program "calls" as they are required.

The Keyboard Scan routine scans the switches S1 to S5 and determines which, if any have been pressed. After a short delay, the keys are read again and if the key is still pressed, its function such as Start/Stop or Set Minutes is carried out. This is done to prevent noise on the switch lines or switch bounce from being interpreted by the program as multiple key operations.

The Display routine deals with driving the display l.e.d.s, switching the various output lines as appropriate and also decoding the "counters" to provide a seven segment output on port B. A third subroutine which generates a delay is also called from within this routine. To make these subroutines "self contained", the various I/O lines which may be used as inputs in one and outputs in the other are redefined when the routines are called in the same way as in the initialise routine.

INSTRUCTIONS

Assuming that the flowchart has been designed carefully the process of converting it to PIC instructions is quite easy as it simply involves looking up the instructions in the data sheet. These can then be converted to a machine code listing consisting of lists of 1s and 0s or Hex characters (0 to F) and programmed into the EPROM.

Because this is very boring to do and very error prone, programs (called Assembler programs) are available which do this and run on an ordinary PC. The program, written using the instruction mnemonics listed in the data sheet, together with labels to mark places to which the program has to jump and comments which help the programmer to understand what is being done, is typed into the computer using a standard word processor package and then the Assembler program is run which converts this into a format suitable for loading into the device EPROM.

Suitable PIC programmers and assemblers are now becoming available at prices which are within reach of at least the more serious hobbyist (around £100). These only require connection to one or other of the ports on an IBM PC or compatible so that devices can be programmed without having to purchase expensive programs. In addition, simulator programs are also available for use on PCs which allow the user to single step or run a program up to pre-defined break points and observe how the various registers which are displayed on the screen change as each instruction is executed.

These enable quite complex programs to be developed and debugged without resorting to the purchase or hire of a development system costing thousands of pounds. This, however, is still a high price to pay if all you want is to build a timer, so a ready programmed chip for this project is also available (See *Shoptalk*).

CIRCUIT DETAILS

Now that we have looked at programming the PIC microcontroller, we shall now put it to work with a design for a Versatile Microcontrolled 3-Digit Timer. The full circuit diagram of the Timer is shown in Fig. 6. Note that the relay contacts must be rated to handle any appliance being controlled.

Transistor TR2 together with Zener diode D11 supplies +4V to the microcontroller IC1. The crystal X4 is a

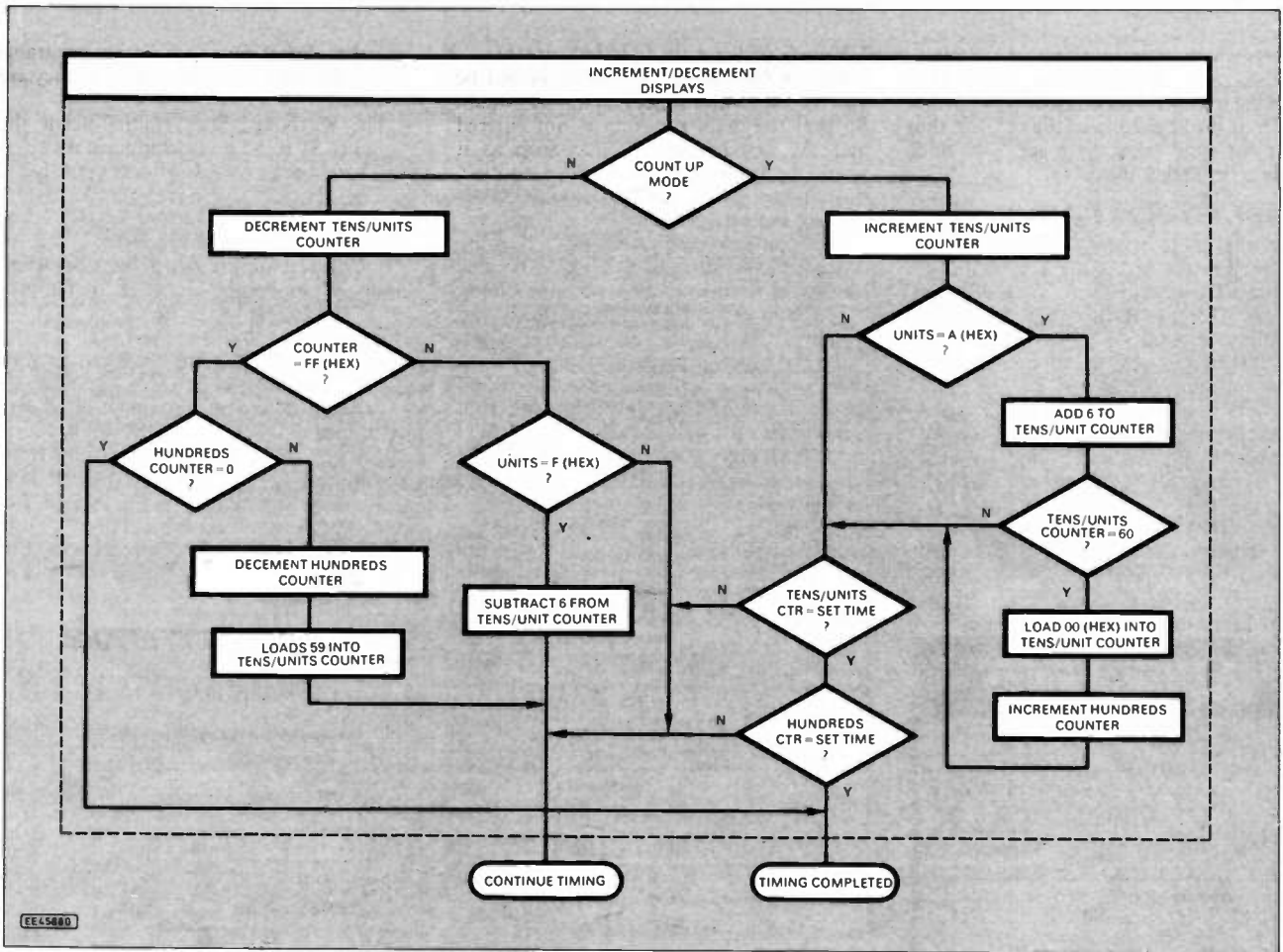

Fig. 5. Timer Up/Down count flowchart. Depending on Up or Down mode selected, the right or left hand side will be followed.

3-2768MHz type which together with capacitors C1 and C2 form the on-chip oscillator.

Time setting and other control functions are accomplished by pushbutton switches S1 to S5 and the diodes D1 to D5 are included to prevent the segment driver lines being shorted if two buttons are depressed simultaneously. The i.e.d. 7-segment displays are driven via the current limiting resistors R3 to R9, with X2 and X3 being common cathode displays while X1 and i.e.d.s D12 to D15 being connected in the common anode configuration.

The relay RLA and buzzer WD1 are switched at the appropriate times by transistors TR1 and TR3 driven from IC1 port A0 and A1 (pin 17, 18) respectively. If a relay with an operating voltage of other than 12V is used, then the circuit should be operated at the relay voltage but this should be in the range of 6V to 15V.

Any d.c. supply of the type available in the "mains plug boxes" used for powering small appliances with a suitable output voltage may be used or alternatively one can be made using a small mains transformer with a 9V-0V-9V secondary winding as shown in Fig. 7.

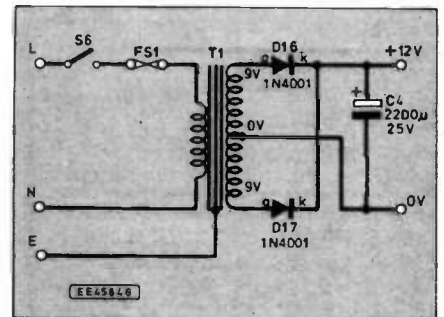

Fig. 7. Suggested mains power supply circuit.

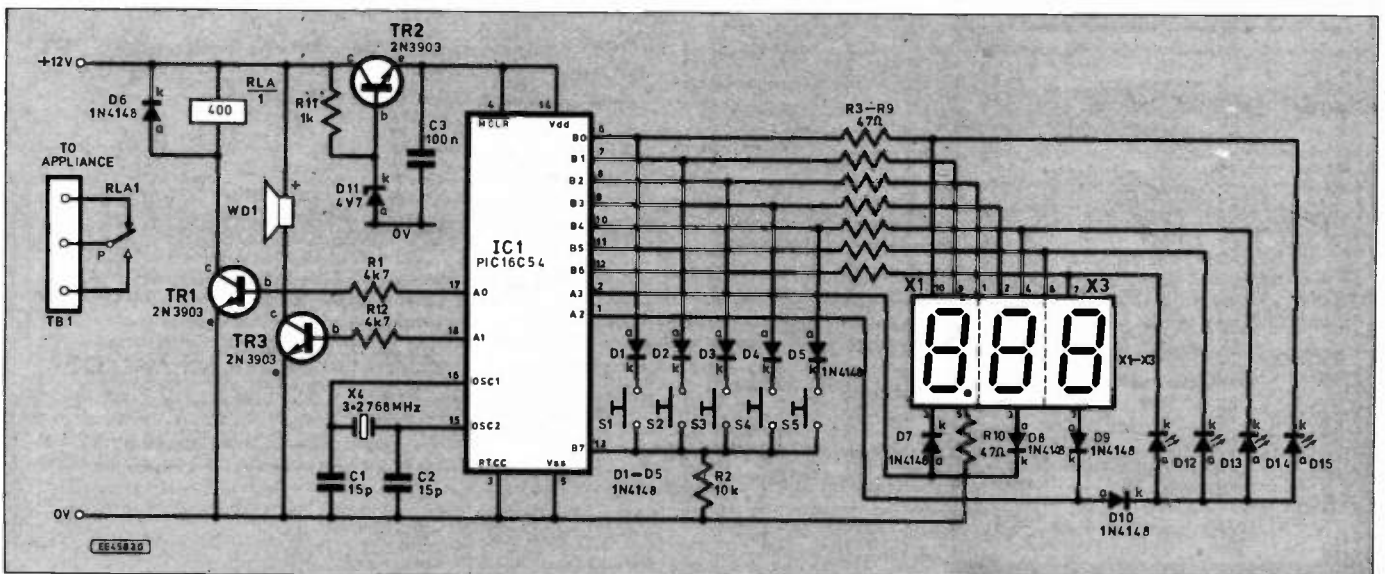

Fig. 6. Complete circuit diagram for the Versatile Microcontrolled 3-Digit Timer. Note that the display pins 1, 2, 4, 6, 7, 9 and 10 are paralleled to the identical pin on each display (X1 to X3).

CONSTRUCTION

Construction should not present any problems if the circuit is assembled on the recommended printed circuit board (p.c.b.). This board is available from the *EPE PCB Service*, code 933. The top-side p.c.b. component layout and full size underside copper foil master pattern are shown in Fig. 8.

Begin construction by inserting the low profile components such as resistors and diodes first, paying particular attention to the orientation of the latter. When these are in place, the taller components including the relay, buzzer and terminal block can be mounted. The buzzer is a 12V piezo type with an oscillator circuit built in and care should be taken to ensure that it is wired into the circuit the correct way around. The microcontroller IC1 should not be inserted at this stage but only the 18-pin socket should be mounted on the p.c.b.

COMPONENTS

Resistors

R1, R12 4k7 (2 off)
R2 10k
R3 to R10 47Ω (8 off)
R11 1k
All 0.25W 5% carbon film

See
**SHOP
TALK**
Page

Capacitors

C1, C2 15p ceramic (2 off)
C3 100n polyester

Semiconductors

D1 to D10 1N4148 signal diode (10 off)
D11 4V7 Zener diode
D12 to D15 5mm red l.e.d. (4 off)
TR1 to TR3 2N3903 npn transistor (3 off)
IC1 PIC16C54 pre-programmed microcontroller (see *Shoptalk*)
X1 0.5in. red 7-segment high brightness l.e.d. display, common anode
X2, X3 0.5in. red 7-segment l.e.d. display, common cathode (2 off)

Miscellaneous

S1 to S5 s.p.s.t. push-to-make, p.c.b. mounting switches (5 off)
X4 3.2768MHz crystal
RLA 12V 400Ω relay, with 3A changeover contacts or better
WD1 Piezoelectric buzzer, with internal oscillator

Printed circuit board available from the *EPE PCB Service*, code 933; 18-pin d.i.l. socket; 40-pin d.i.l. socket; 3-way p.c.b. mounting screw terminal block; red filter for displays; multistrand connecting wire; solder etc.

OPTIONAL COMPONENTS (P.S.U.)

T1 Miniature mains transformer, with 9V-0V-9V secondary winding
C4 2,200μ electrolytic capacitor, 25V
D16, D17 1N4001 rectifier diode (2 off)

Approx cost
guidance only

£28

VERSATILE MICROCONTROLLED 3-DIGIT TIMER

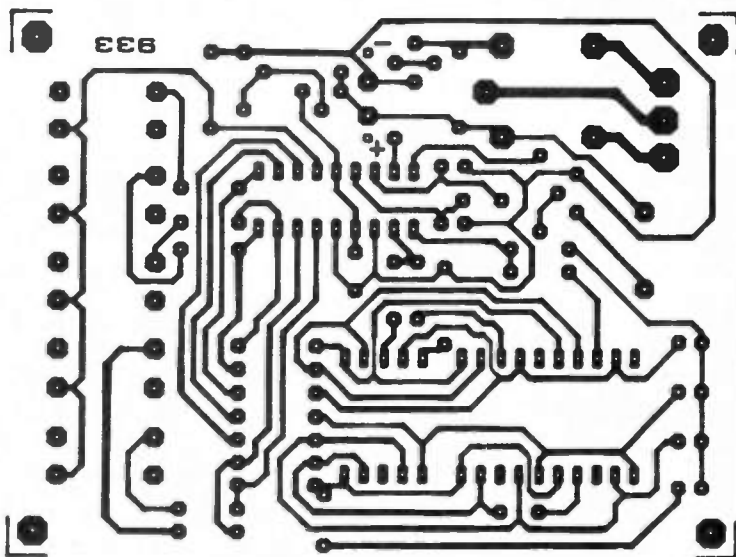
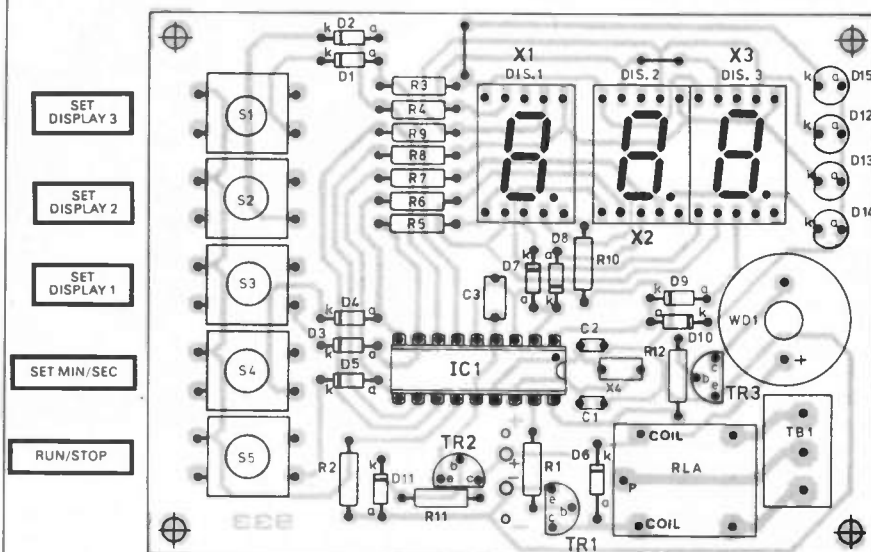
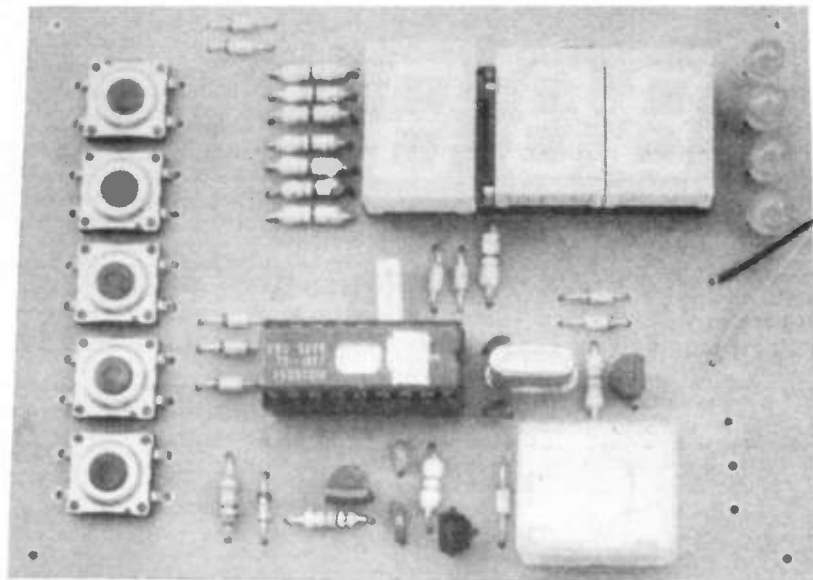

Fig. 8. Printed circuit board component layout and full size copper foil master pattern.



Layout of components on the completed p.c.b.

Techniques

ACTUALLY DOING IT!

by Robert Penfold

One or two *Actually Doing It* articles in the dim and distant past were devoted to the subject of making high quality front panel overlays using a simple photographic process. This method was not particularly cheap, but it could produce some high quality and extremely durable results.

The articles concerned certainly provoked a fair amount of reader interest. Many constructors are clearly prepared to put some time and money into making their projects look as professional as possible.

Unfortunately, the photographic materials for making front panel overlays seem to have become unobtainable. Certainly, nothing of this type seems to appear or be listed in any of the current electronic component and equipment catalogues. Computer generated panel overlays are the probable reason for the demise of the photographic methods of panel making.

RIGHT PROGRAM

There are special programs now available for producing front panel designs, and various gadgets that can convert these into high quality panel overlays. There are also dedicated units for producing panel overlays and (or) labels electronically. Unfortunately, the cost of this sort of thing is well beyond the limits of most electronics hobbyists.

As mentioned at the end of the previous *Actually Doing It*, there is a cheaper alternative for those who have access to a reasonably powerful computer and a decent printer. This is a fairly involved topic, and it is one that will be considered in more detail in this month's article.

There are numerous programs that can be used to produce simple labels. Producing complete panel designs, which must be accurately printed to scale, is another matter, and requires suitable graphics software.

Specialised graphics software, such as charting and printed circuit design programs, are not likely to be much

good for this sort of thing. So-called "paint" type drawing programs are less than ideal, since they work at relatively low resolutions, and there can be difficulties in printing out accurately to scale.

The two types of software that are most suitable are CAD (computer aided design) and illustration programs. The differences between the two has tended to narrow over the years, but CAD programs are primarily intended for technical drawings, such as house plans, circuit diagrams, etc.

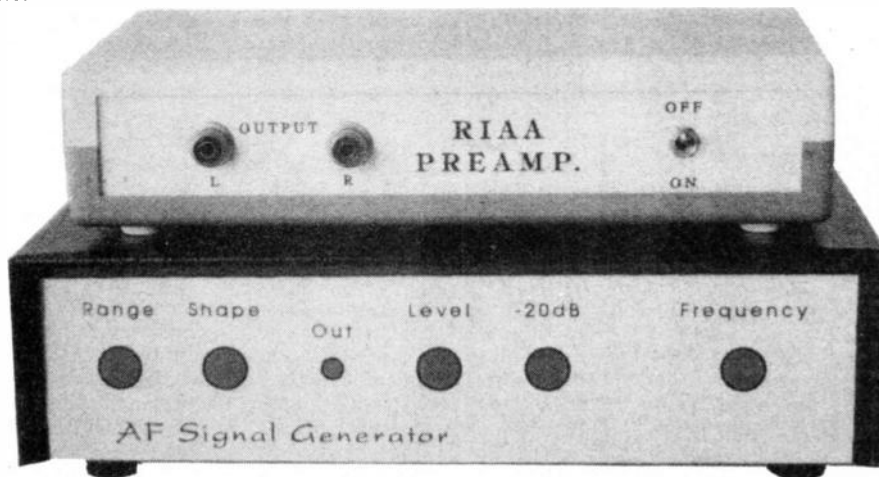

Two units labelled using a CAD drawing package.

Illustration programs are intended for general illustration work, and are in some ways less rigid than CAD programs. For example, they usually allow individual letters in words of text to be moved and manipulated in various ways, and they have sophisticated freehand drawing capabilities.

Some CAD programs can only produce relatively crude text, which is clearly a major limitation in the current context. If a CAD program will produce text of usable quality, and you only require relatively simple and straightforward panel designs, then it should provide a very quick and easy way of producing them. In general though, an illustration program is the better choice for this application.

Although programs of this kind were once extremely expensive, cut-throat competition has resulted in some sophisticated illustration software being offered at quite low prices. Programs such as "Corel Draw 3!" and "Designworks" for the PCs are reasonably cheap, and there are some

very low cost alternatives available from the usual PD/shareware sources.

Unfortunately, illustration programs mostly require a fairly powerful computer. Any reasonably modern PC, Macintosh, etc. should be able to run programs of this type, but with older PCs, and eight-bit computers it could be difficult to find suitable software.

LAYOUT

While it is possible to simply sit down at the computer and draw up a front panel layout, this approach is not recommended. It is all too easy to draw up a very plausible looking layout that turns out to be completely impractical when you actually start fitting things in place.

The safer approach is to work out a panel layout by placing control knobs onto the front panel of the case and working out a layout that is both attractive and practical. The fixing nuts of toggle switches, jack sockets, etc. can be used to represent these components, and help you to visualise the finished product. Small pieces of "Bostik Blu-Tak" can be used to hold things in place, plus it will also give you the freedom to alter the layout.

Remember that there are two sides to every panel. Just because everything fits nicely and is quite workable from the front side, it does not mean that there will be sufficient space for everything on the reverse side. Measure the components carefully to make sure that your layout has reserved enough space for them.

Also, bear in mind that most cases have internal obstructions. For example, built-in

mounting pillars for circuit boards, and the screws, etc. that hold the two halves of the case together. Some obstructions, such as unwanted mounting pillars, can be removed. Others are essential parts of the case, and you have to work around them.

Drawing to scale with an illustration or CAD program should be very straightforward. There is usually provision for a grid of on-screen dots to provide accurate reference points, plus a co-ordinate display showing the current cursor position.

Some programs have rulers marked across the top of the screen and up one side. These normally have moving markers which respond to changes in the position of the cursor. The cursor can be made to "snap" precisely to grid points, so that accurate drawings are assured.

Start by drawing a rectangle to represent the perimeter of the front panel. The position of each control and socket must be carefully measured on the "dummy" layout, and transferred to

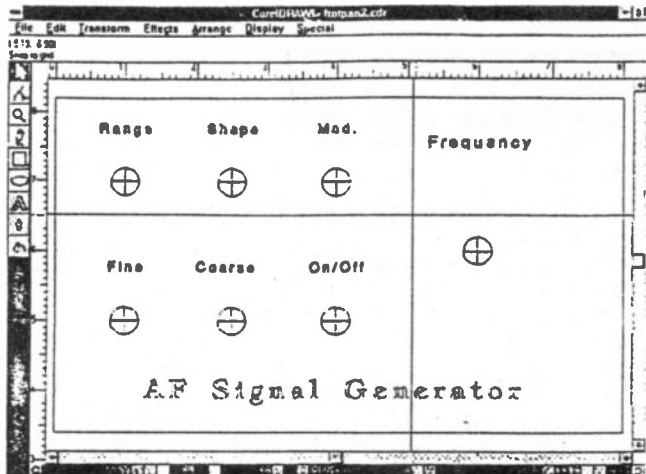

Screen dump from "Corel Draw 2!" The user interface is a standard Windows type. Note the on-screen rulers.

the drawing as accurately as possible. Lines, circles, etc. can be drawn, and it is quite easy to draw up a template that can be taped in place on the panel, and used as a guide when drilling the holes.

Most programs have layers, or some other method of letting you print out only the required elements of the drawing. In most cases the drilling template and the actual panel overlay can therefore be incorporated into a single drawing. This method ensures that there are no embarrassing discrepancies between the two!

RIGHT TYPE

Illustration software is usually supplied with a reasonable range of fonts (lettering styles), with many more available as optional extras. These days a virtually unlimited range of lettering sizes can be selected. For normal labels it is probably best not to get carried away, and to select a fairly simple font ("Swiss", "Times", "Helvetica", etc.).

Many programs allow the spacing between letters to be varied. The default spacing is usually very small, which does not give the most readable labels. Increasing the spacing slightly usually gives more comprehensible results.

Obviously some of more zany fonts might be applicable to projects of the "fun" variety, such as electronic games. Also, it is common practice to use a less formal font for name labels ("Signal Generator", "Stereo Preamp", etc.). This is a matter of using a little common sense.

When adding panel labels by hand it can be difficult to get them accurately centred above their controls and sockets. There is no problem of this type with computer produced panels, since the program should have a facility to automatically centre each piece of text above a given point.

Virtually all illustration programs provide proportional spacing, and in many cases kerning as well. Kerning is simply where pairs of letters such as "AW" and "PA", which have complementary shapes, are moved slightly closer together. Otherwise they tend to be perceived as being too far apart.

It may be possible for the user to manually adjust the position of

each letter. This is probably not worth the effort with the smaller legends, but it might be worthwhile with large labels. It is when using large letters that your perception of perfect kerning is most likely to be at odds with the program designer's opinions on the subject.

With illustration programs (and some CAD types) there are various "fill options" that can be used on

any part of the panel. It is therefore possible to have grey rather than black letters, or to have a pale grey background instead of a white background. In practice this type of thing is unlikely to produce particularly good results unless you have access to a very high resolution printer.

Using various colour fills is a very different matter. If you have access to a colour printer it is likely to be well worthwhile experimenting with a few colour schemes. Once again though, try not to get carried away, and try to choose colour schemes that are appropriate to each project.

ICONS

It is increasingly common for ready-made equipment to have controls, etc. marked with icons instead of normal labels. For instance, a volume control could be marked with a simple wedge shaped icon rather than being labelled "Volume".

This method is a useful one where panel space is limited, and it is difficult to accommodate normal labels. It does not require a great deal of artistic talent in order to draw up a few simple icons.

HARD COPY

With most printers it is only possible to produce the hard copy on some form of paper. Coloured paper is available for most printers, and can help to produce some attractive panels.

It is advisable to use a fairly heavy paper, because the lighter types are practically translucent, and do not usually provide very attractive results. Also, they tend to go slightly blotchy when glued in place. Coloured ribbons/ink cartridges are available for some printers, enabling the labels to be printed in something other than a "Ford" choice of colours.

The problem with a paper overlay is that with use it soon becomes dirty and discoloured. A covering of self-adhesive transparent plastic film is virtually essential.

With larger panels it can be difficult to get a wrinkle and blister free covering. Experience has taught, that it is best to remove the backing from the plastic film, and then lay it in place, starting at one corner and gradually working across to the opposite corner.

If necessary, with some films it is possible to peel the material back slightly and try again without damaging the overlay. Fortunately, if it should all go wrong it does not cost much to print out a new overlay and try again.

Laser printers are not restricted to use with paper, and they can be used with a variety of plastic films, including some self-adhesive types. These can be used to produce some very professional looking panels, but they tend to be very expensive.

Matters are made worse by the fact that these films are often only sold in packs of about 100 or 200 sheets. Some suppliers offer sample packs for little or nothing, and these provide an opportunity to experiment a little at low cost.

Modern graphics software is much easier to use than the equivalent software of a few years ago. It still takes some hours of effort to really get to grips with a good illustration or CAD package, but it should be well worth the effort.

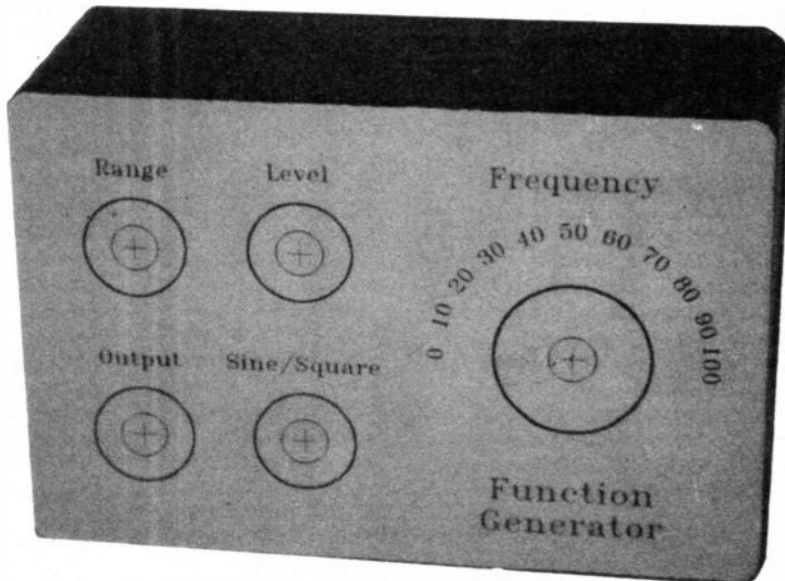

It is useful to use a CAD package which can rotate legends around controls.

VIDEOS ON ELECTRONICS

A range of videos designed to provide instruction on electronics theory. Each video gives a sound introduction and grounding in a specialised area of the subject. The tapes make learning both easier and more enjoyable than pure textbook or magazine study. They should prove particularly useful in schools, colleges, training departments and electronics clubs as well as to general hobbyists and those following distance learning courses etc.

VT201 to VT206 is a basic electronics course and is designed to be used as a complete series, if required.

VT201 54 minutes. Part One; D.C. Circuits. This video is an absolute must for the beginner. Series circuits, parallel circuits, Ohms law, how to use the digital multimeter and much more.
Order Code VT201

VT202 62 minutes. Part Two; A.C. Circuits. This is your next step in understanding the basics of electronics. You will learn about how coils, transformers, capacitors, etc are used in common circuits.
Order Code VT202

VT203 57 minutes. Part Three; Semiconductors. Gives you an exciting look into the world of semiconductors. With basic semiconductor theory. Plus 15 different semiconductor devices explained.
Order Code VT203

VT204 56 minutes. Part Four; Power Supplies. Guides you step-by-step through different sections of a power supply.
Order Code VT204

VT205 57 minutes. Part Five; Amplifiers. Shows you how amplifiers work as you have never seen them before. Class A, class B, class C, op.amps. etc.
Order Code VT205

VT206 54 minutes. Part Six; Oscillators. Oscillators are found in both linear and digital circuits. Gives a good basic background in oscillator circuits.
Order Code VT206

By the time you have completed VT206 you have completed the basic electronics course and should have a good understanding of the operation of basic circuit elements.

Now for the digital series of six videos. This series is designed to provide a good grounding in computer technology.

VT301 54 minutes. Digital One; Gates begins with the basics as you learn about seven of the most common gates which are used in almost every digital circuit, plus Binary notation.
Order Code VT301

VT302 55 minutes. Digital Two; Flip Flops will further enhance your knowledge of digital basics. You will learn about Octal and Hexadecimal notation groups, flip-flops, counters, etc.
Order Code VT302

VT303 54 minutes. Digital Three; Registers and Displays is your next step in obtaining a solid understanding of the basic circuits found in today's digital designs. Gets into multiplexers, registers, display devices, etc.
Order Code VT303

VT304 59 minutes. Digital Four; DAC and ADC shows you how the computer is able to communicate with the real world. You will learn about digital-to-analogue and analogue-to-digital converter circuits.
Order Code VT304

VT305 56 minutes. Digital Five; Memory Devices introduces you to the technology used in many of today's memory devices. You will learn all about ROM devices and then proceed into PROM, EPROM, EEPROM, SRAM, DRAM, and MBM devices.
Order Code VT305

VT306 56 minutes. Digital Six; The CPU gives you a thorough understanding in the basics of the central processing unit and the input/output circuits used to make the system work.
Order Code VT306

By now you should have a good understanding of computer technology and what makes computers work. This series is also invaluable to the computer technician to understand the basics and thus aid troubleshooting.

VT401 61 minutes. A.M. Radio Theory. The most complete video ever produced on a.m. radio. Begins with the basics of a.m. transmission and proceeds to the five major stages of a.m. reception. Learn how the signal is detected, converted and reproduced. Also covers the Motorola C-QUAM a.m. stereo system.
Order Code VT401

VT402 58 minutes. F.M. Radio Part 1. F.M. basics including the functional blocks of a receiver. Plus r.f. amplifier, mixer oscillator, i.f. amplifier, limiter and f.m. decoder stages of a typical f.m. receiver.
Order Code VT402

VT403 58 minutes. F.M. Radio Part 2. A continuation of f.m. technology from Part 1. Begins with the detector stage output, proceeds to the 19kHz amplifier, frequency doubler, stereo demultiplexer and audio amplifier stages. Also covers RDS digital data encoding and decoding.
Order Code VT403

VT501 58 minutes. Fibre Optics. From the fundamentals of fibre optic technology through cable manufacture to connectors, transmitters and receivers.
Order Code VT501

VCR MAINTENANCE

VT102 84 minutes: Introduction to VCR Repair. Warning, not for the beginner. Through the use of block diagrams this video will take you through the various circuits found in the NTSC VHS system. You will follow the signal from the input to the audio/video heads then from the heads back to the output.
Order Code VT102

VT103 35 minutes: A step-by-step easy to follow procedure for professionally cleaning the tape path and replacing many of the belts in most VHS VCR's. The viewer will also become familiar with the various parts found in the tape path.
Order Code VT103

Each video uses a mixture of animated current flow in circuits plus text, plus cartoon instruction etc., and a very full commentary to get the points across. The tapes are imported by us and originate from VCR Educational Products Co, an American supplier.
(All videos are to the UK PAL standard on VHS tapes)

ORDERING: Add £1.50 p&p per order for UK orders. **OVERSEAS ORDERS:** Add £3 postage for countries in the EEC. Overseas orders outside the EEC countries add £3 per tape airmail postage (or £6 per order surface mail postage).

All payments in £ sterling only (send cheque or money order drawn on a UK bank).

Visa and Mastercard orders accepted - please give card number, card expiry date and cardholder's address if different from the delivery address.

Orders are normally sent within seven days but please allow a maximum of 28 days - longer for overseas orders.

Send your order to: Direct Book Service, 33 Gravel Hill, Merley, Wimborne, Dorset BH21 1RW (Mail Order Only)

Direct Book Service is a division of
Wimborne Publishing Ltd.,
Tel: 01202 881749. Fax: 01202 841692

£29.95
each inc. VAT



Don't despair . . . Repair!

The all new Electronics Service Manual shows you how to troubleshoot and repair electronic equipment successfully. It is suitable for the beginner and more experienced enthusiast, trainee or repairman.

You can become a repair expert

- Understand electricity and electronics.
- Confidently use test equipment to pinpoint problems.
- Become skilled at understanding flow charts, circuit diagrams and manufacturers data.
- Successfully identify components and understand their function.
- Learn how to skillfully remove and replace components.

One source for all your repair needs

The Electronics Service Manual will get you started, or help develop your skills, in repairing and servicing electronic equipment. Over 850 pages, loose leaf A4 format in a durable, sturdy ring binder all for just £39.95 plus £5.50 post and packing.

Continue to broaden your repair expertise

You'll receive regular Supplements (about five a year) with new technical notes and information to enable you to service and repair an increasingly wide range of equipment. Each Supplement contains around 160 pages all for only £23.50 plus £2.50 p&p. You can of course return any Supplement (within ten days) or cancel the Supplements at any time.

GUARANTEE

Our 30 day money back guarantee gives you complete peace of mind. If you are not entirely happy with the Manual, for whatever reason, simply return it to us in good condition within 30 days and we will make a full refund of your payment – no small print and no questions asked.

(Overseas buyers do have to pay the postage charge)

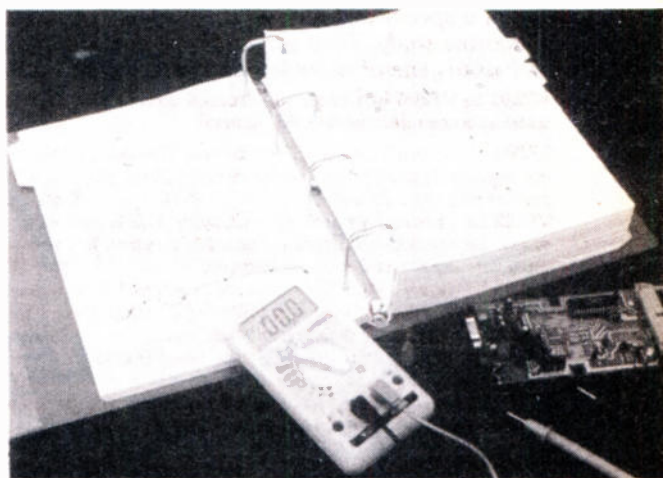

THE ELECTRONICS SERVICE MANUAL

Covers:

- Safety
- Underpinning Knowledge
- Practical Skills
- Test Equipment
- Technical Notes
- Reference Data
- Full Index

Easy to use format, professionally edited by Mike Tooley BA to be easily understandable by the beginner yet valuable to the more experienced enthusiast, trainee or repairman.

Wimborne Publishing Ltd., Dept. E8,
Allen House, East Borough, Wimborne,
Dorset BH21 1PF.
Tel: 01202 881749. Fax: 01202 841692.

PLEASE send me the ELECTRONICS SERVICE MANUAL

I enclose payment of **£45.45**. I shall also receive the appropriate Supplements several times a year. These are billed separately and can be returned (within 10 days) or discontinued at any time. Should I decide not to keep the Manual I will return it to you within 30 days for a full refund.

FULL NAME
(PLEASE PRINT)

ADDRESS.....

POSTCODE

SIGNATURE.....

I enclose cheque/PO payable to Wimborne Publishing Ltd.

Please charge my Visa/Mastercard (Access)

Card No. Card Exp. Date

ORDER FORM

Simply complete and return the order form with your payment to the following address:

Wimborne Publishing Ltd, Dept. E8,
Allen House, East Borough, Wimborne,
Dorset BH21 1PF

OVERSEAS ORDERS: All overseas orders must be prepaid and are supplied under a money-back guarantee of satisfaction. If you are not entirely happy with the Manual return it within a month for a refund of the purchase price (you do have to pay the overseas postage). SEND £39.95 PLUS THE POSTAGE SHOWN BELOW:

EIRE	AIR MAIL ONLY £11
EUROPE (E.E.C. Countries)	AIR MAIL ONLY £20
EUROPE (non E.E.C.)	SURFACE MAIL £20, AIR MAIL £26
U.S.A. & CANADA	SURFACE MAIL £25, AIR MAIL £32
FAR EAST & AUSTRALIA	SURFACE MAIL £31, AIR MAIL £33
REST OF WORLD	SURFACE MAIL £25, AIR MAIL £44

Note surface mail can take over 10 weeks to some parts of the world. Each manual weighs around 4kg when packed.

All payments must be made in £s Sterling payable to Wimborne Publishing Ltd. We accept Mastercard (Access) and Visa credit cards.

CIRCUIT SURGERY

ALAN WINSTANLEY

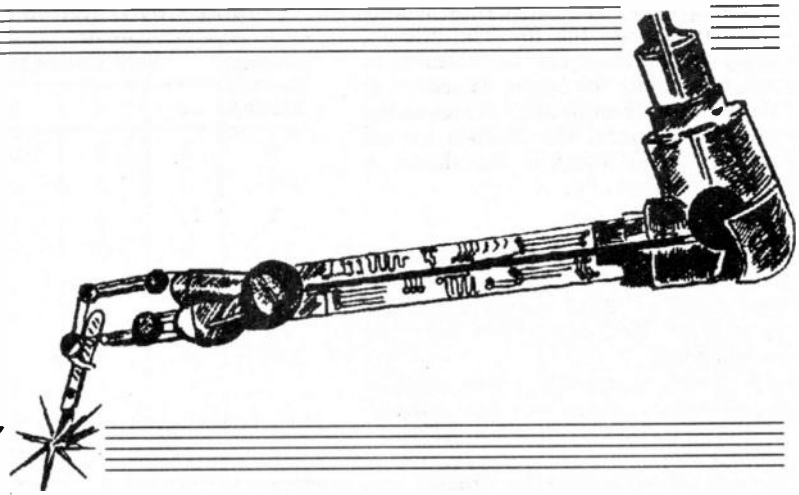

Our regular column handling readers' questions and problems looks at a precision rectifier with no forward voltage drop, also a peek at BCD codes plus a single transistor pulse generator. Last but not least, some queries answered by our Internet feed!

As always, a wide variety of questions and queries come our way hoping for a helping hand, so here's a selection which we hope will be of general interest to readers. Let's start with a question from *Mr. K.E. Langford* from Sidmouth in Devon, who asks:

Active Precision Diode

I recently encountered a problem which I've not seen discussed in EPE, perhaps you could help. What's the best circuit (for amateur hobbyists) to make a precision rectifier which eliminates the normal diode drop?

In my simple *Windicator* constructional project (last month) for example, I used a germanium diode to rectify the motor voltage output. This suffers from a 0.2V drop which consequently clips the signal at low wind speeds/motor voltages, though I thought it would not be a problem in that simple project. An application such as this could perhaps use a "precision rectifier" circuit, one which has the unidirectional behaviour of an ordinary diode but without an undesirable voltage drop, so none of the signal will be lost. (Silicon diodes drop 0.6V or so when conducting.)

A standard active rectifier which is based around an op.amp IC1 is shown in Fig. 1. Essentially it's a non-inverting amplifier circuit with a diode in the feedback path. This forms a half-wave

rectifier which will clip any negative-going transitions at the input. During positive input transitions, the op.amp "follows" the input signal and the cathode of D1 is fed back to the inverting input of the op.amp, providing negative feedback, which sees a lower voltage returned than that at the +VE input. Consequently, IC1 compensates for the diode drop by swinging higher to lose the difference in voltages arising between the two inputs.

For negative transitions, the diode clips the signal. The result is a very accurate rectifier which has no forward voltage drop, and which behaves almost like an ideal half-wave rectifier. Its accuracy will be maintained even at low millivolt levels. For best performance, choose an op.amp with a good "slew rate" (SR) – the parameter which describes how quickly the op.amp can actually respond by swinging its output voltage.

Measured in volts per microsecond (V/ μ s), if you have specific requirements then you will select an op.amp with a high SR figure. For example: the bipolar 741C has an SR of (only) 0.5V/ μ s – slow! – whilst at the other extreme a device such as the AD845K can change at up to 100V/ μ s – pretty fast! Clearly the speed of response of the op.amp determines how quickly it can follow the input signal, but in many hobbyist

applications I doubt if the SR value would be too critical. I've also drawn in a second op.amp IC2 which acts as an optional buffer for the rectified signal, preventing any excess loading of the precision rectifier output.

UJT Oscillator

My thanks to *Tony Dacro* of Morpeth for reviving memories of the once very common "unijunction transistor" oscillator. Tony posed the following question:

I'm assembling a trigger circuit for operating a silicon controlled rectifier. The trigger needs to operate at up to 20,000 times per second. Could you suggest a simple circuit based around the 2N2646 I'm interested in using?

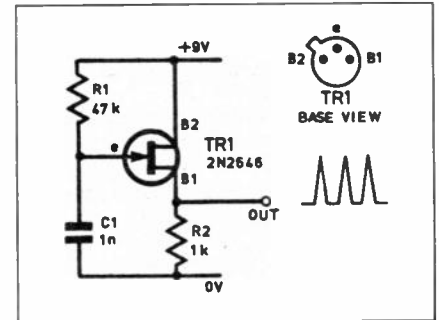

Fig. 2. Unijunction transistor oscillator.

Ah, yes ... the 2N2646! The unijunction transistor (UJT) has largely fallen into disuse, it would seem, though it was very popular in our project pages in the mid-late 1970s. It's possible to build a simple one-transistor circuit which generates a sawtooth-type waveform which could be used for firing triacs and thyristors, or could operate at audio frequencies as a simple audio oscillator.

A circuit, with values chosen to run at roughly 20kHz, is shown in Fig. 2. TR1 is a UJT and it conducts between emitter (e) and B1 when the RC network of R1/C1 has charged to a critical trigger voltage. The capacitor discharges through the B1 resistor resulting in a spike output, and the process repeats.

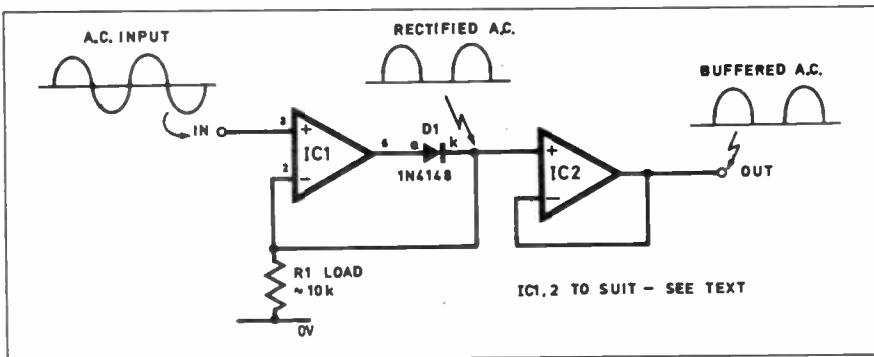

Fig. 1. Precision rectifier based around two op.amps.

The frequency can be altered by making R1 variable, say 10k to 100k; alternatively the capacitor can be increased in value to reduce the output frequency. It should operate easily with values in the low microfarads. The 2N2646 has an unusual pinout which is also shown in the circuit schematic.

BCD Switches

All is not what it appears, at least not if you buy a rotary switch which actually has a "BCD output". *Richard Beesley* of Tonbridge, Kent asks for some advice.

I recently acquired a switch which is a ten-position thumbwheel type (though instead of a thumbwheel it has two push-buttons to advance or retard the switch setting). It has a common terminal and four others. As a beginner in electronics, I'd appreciate it if you could unscramble the switch for me - in particular, can I use it to produce ten outputs?

It sounds like you have a switch which has a "BCD" output. Binary Coded Decimal (BCD) is a simple method of expressing a decimal digit using a four-bit code. BCD switches rely on the pattern of the copper tracks within the switch's printed circuit board mechanism to generate four binary digits - "ons" and "offs" if you like - which are the binary equivalents of the numbers 1 to 10 shown on the switch button. This is sometimes required for interfacing in certain logic applications. It works as shown in Table 1.

If you apply a Logic 1 to the "common" input and dial in a decimal number on the switch, a binary coded decimal number will be outputted at the four output terminals. For example, the table shows how the decimal number 7 is represented by the BCD code 0111 (which is decimal 0 + 4 + 2 + 1) which appears at the four output pins.

Although you have a BCD-version of the switch, Richard, you could convert the BCD code to decimal using a TTL decoder chip. The 74LS42 is a 1-to-10 BCD decoder/driver. Simply input the BCD code generated by the thumbwheel into pins 12 to 15 and out pops the decimal equivalent to emulate a one-pole 10-way switch. Fig. 3 shows the pin-outs of the 74LS42.

I could not see this chip advertised in the Maplin catalogue but Electromail and several others do list it. The similar 74LS45 is a high current version with open collector outputs. These can be pulled up with resistors up to +30V d.c.;

Table 1. BCD switch logic.

Decimal Switch Setting	BCD Switch Output			
	8	4	2	1
0	0	0	0	0
1	0	0	0	1
2	0	0	1	0
3	0	0	1	1
4	0	1	0	0
5	0	1	0	1
6	0	1	1	0
7	0	1	1	1
8	1	0	0	0
9	1	0	0	1

the output pins can sink up to 80mA when low. Alternatively you could perhaps have acquired a one-pole ten-way switch instead, Richard!

NiCad Discharging - More!

My column in Circuit Surgery, February 1995 included a simple design for a nickel-cadmium (NiCad) discharger. This prompted a few comments from *Chris Flynn* of Beverley, North Humberside.

I was a little concerned about the circuit given for a NiCad Discharger. One of the requirements for a sound design is that it does not take the voltage of the battery pack down to a level which risks one of the cells running down to zero volts, or worse, eventually reversing its own polarity!

A safe rule of thumb is to cut off discharge down to "Nominal Voltage - 1V". For example, a 6V pack would be taken down to 5V, an 8.4V pack down to 7.4V, and so on. This is manageable up to 10 cell (=12V) battery packs. Also, whilst writing, I appreciated the return of Ingenuity Unlimited - always the first thing I used to read in PE!

Thanks for writing, Chris, and point taken. In fact the basic design I published was only intended as a blow-out-proof load for a NiCad, having current limit and reverse voltage features, together with a token measure of automatic cut-off in that the LM317 regulator will in any case cease conduction when its input voltage falls below roughly 3V d.c. or so. It made no reference to the actual time spent discharging, of course.

I have actually performed quite some research on this topic, since I found conflicting "rules of thumb" at the time and no definite word from anyone in particular. There were lively discussions on this topic on the Internet recently, especially in the mostly American sci.electronics newsgroup. The consensus of opinion seems to be that there is no

such thing as "memory effect" in NiCad rechargeable cells. In particular, there is a need to distinguish between a cell's capacity and its terminal voltage. It is said to be beneficial to discharge NiCads down to 25 per cent of their capacity every once in a while. My information additionally is that it's a good idea to discharge down to only 10 per cent of stated capacity occasionally, or instead use a light load only to discharge to a terminal voltage of 1V per cell.

The chemistry behind this is complex. The idea is to prevent larger cadmium crystals from forming within the cell. Smaller "trickle" discharges help to form a small uniform microcrystalline structure which optimises the discharge performance of the cell. Larger crystals are more difficult to dissolve during the discharge process, eventually causing a build-up of internal resistance. This causes voltage depression, which commonly goes under the misnomer of "memory effect".

Trawling the Internet in tireless search of interesting stuff, I did come across an on-line document available by ftp (file transfer protocol) to anyone who's got an Internet connection. This document is a twelve page summary of various news items taken from the electronics newsgroups and is extremely interesting to read, with contributions from Hewlett Packard engineers and quotes from General Electric.

At the time of writing, the document is available by anonymous FTP from <ftp.armory.com/pub/user/rstevew/nicad.faq.zip> - note that the two dots in the filename may confuse DOS-based software (rather than UNIX), so it may be easier to get the file ftp'd on your behalf and emailed to you by an ftp server such as that at Imperial College. Then you can set about PKunzipping it when it's delivered!

For those readers not on the Internet who would like to review it, please send a large A4 size SAE (38p stamps UK only, or 2 IRCs) plus 60p to cover the copying - to Circuit Surgery and I'll send be happy to send you a reprint of the articles. Ask for the document "Circuit Surgery NiCad Text" - it's ten pages long and worth reading!

Micro Lab News!!

Our Internet feed is very lively and apart from enabling overseas readers to contact us - whether about subscription rates, back issues or anything else - it also enables me to join in lively discussions in the sci.electronics newsgroup. In fact, it's too addictive! Plus, *EPE* does its bit, flag-waving and posting general information and comments such as book reviews to which the broadly American newsgroups seem extremely receptive. *Dave Howey* in Cape Town, South Africa (but soon emigrating to the U.K., he tells me) asked by email:

Hi Alan, what happened to the "Robo Spot" project which is mentioned at the end of your Teach-In No. 7 book? I'm very interested in robotics and am waiting in keen anticipation of this project <grin>. David.Howey@chameleon.alt.za

Quite a number of readers who followed our highly popular *Teach-In '93*

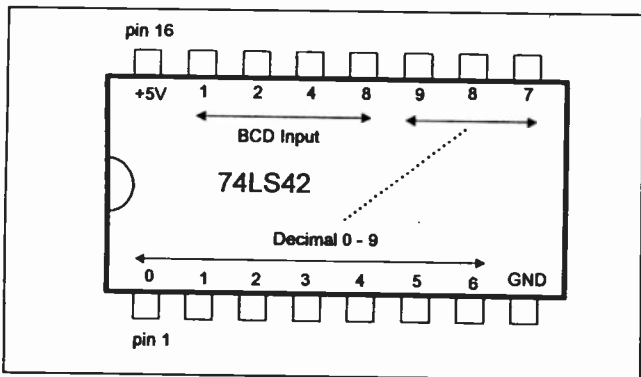

Fig. 3. Pinouts for the 74LS42 BCD decoder/driver chip.

Series successfully - re-published in book form as *Teach-In No. 7*, available directly from our Direct Book Service (see their pages for ordering information) - have asked about the progress of the *Micro Lab* "add-ons" which we mentioned both at the end of the series and also in the book. In particular, we had in mind at the time of design a potential idea for an electronic "buggy" which could interface to the *Micro Lab*, a project we code-named "Robo Spot" in a flurry of enthusiasm!

Regrettably it has not proven possible to complete the design for this particular add-on accessory, for the following reason. Whilst the *Mini Lab* design (also in *Teach-In No. 7*) was aimed at a very wide audience, and to date has sold well over a thousand units (and rising), the *Micro Lab* was of necessity a much more complex design which restricted its appeal to the more advanced section of the *Teach-In* readership, and in practice the number of the more specialised *Micro Labs* which were purchased could never reflect the enormous popularity of *Mini Lab* sales. Therefore, it was simply not viable for the *Teach-In* team to input such a great deal more design work into a buggy when only a few dozen units may ultimately be purchased.

Nonetheless the excellent *Micro Lab* microprocessor trainer/applications unit does indeed have quite a following, and

since we do want to encourage further use of the design, *Micro Lab* designers Keith Dye and Geoff MacDonald tell me confidently that they do intend to complete two additional aspects of the *Micro Lab*. So, stop press, *Micro Lab* fans will be pleased to hear that work is in hand with the following peripherals:

Micro Lab Parallel Port - to enable program listings to be dumped to an external printer through a new parallel port. This will require a revised version EPROM, which will also include several new commands - notably HEXDUMP and DISASSEMBLE, the latter enabling the user to print program listings in "plain English" (disassembled language) rather than unfriendly hexadecimal code. It's planned to include an Epsom printer emulator which many types of dot matrix printer (and laser printers even) should be happy with.

Micro Lab-PC Serial Link - this will consist of a small piggy-back p.c.b. which sits on the *Micro Lab* board, to provide a 9-pin D-type serial link which can connect with the serial connection of an IBM-compatible PC or a terminal emulator. The most notable feature is that it will enable users to read or write *Micro Lab* programs on their own PC, and save any program listings on hard disk! This will necessitate both an exchange EPROM and a revised (swap-out) PLA chip.

Work is at an advanced stage but the final specifications are subject to confirmation. So there you have it - still plenty more to look forward to if you've invested in this highly versatile design! Naturally, *Circuit Surgery* will keep you posted of any further news. (Note that both *Mini Lab* and *Micro Lab* kits continue to be available from Magenta Electronics Ltd., see their advertisement elsewhere in this issue.)

In Circuit Surgery next time: what those "IP" ratings for enclosures actually mean, i.e.d. flashing circuits, disposal of etchant fluid - how? - and more from our Internet feed! *Circuit Surgery* is your column, which relies heavily on your input. If you have any topical questions, follow-ups or comments, or any subject which you think will interest your fellow readers which you would like me to investigate, then please write to:

Alan Winstanley, *Circuit Surgery*, Wimborne Publishing Ltd., Allen House, East Borough, Wimborne, Dorset, BH21 1PF, United Kingdom. Or email to alan@epemag.demon.co.uk. As always, your scribe endeavours to respond to every query but cannot guarantee to do so unless we intend to use it in this feature.

Next month: *Ingenuity Unlimited*, another round up of readers' own circuits. See you soon!

VARIABLE VOLTAGE TRANSFORMERS

INPUT 220V/240V AC 50/60
OUTPUT 0V-280V

	Price	P&P
0-5KVA 2.5 amp max	£31.90	£6.00
	(£44.53 inc VAT)	
1KVA 5 amp max	£41.15	£7.00
	(£56.58 inc VAT)	
2KVA 10 amp max	£59.40	£8.50
	(£79.78 inc VAT)	
3KVA 15 amp max	£78.85	£8.50
	(£102.40 inc VAT)	
5KVA 25 amp max	£139.15	
	(Plus Carriage)	

Buy direct from the Importers. Keenest prices in the country
COMPREHENSIVE RANGE OF TRANSFORMERS-LT-ISOLATION & AUTO
110V-240V Auto transfer either cased with American socket and mains lead or open frame type. Available for immediate delivery.

WIDE RANGE OF XENON FLUORESCENT TUBES

Write/Phone your enquiries

ULTRA VIOLET BLACK LIGHT FLUORESCENT TUBES

4ft 40 watt £14.00 (callers only)	(£16.45 inc VAT)
2ft 20 watt £9.00 (callers only)	(£10.58 inc VAT)
12in 8 watt £4.80 + 75p p&p	(£5.52 inc VAT)
9in 6 watt £3.98 + 50p p&p	(£4.48 inc VAT)
6in 4 watt £3.98 + 50p p&p	(£4.48 inc VAT)

230V AC BALLAST KIT

For either 6in, 9in or 12in tubes £8.05 + £1.40 p&p (£9.45 inc VAT)

The above Tubes are suitable for Forged Bank Note detection, security marking etc.
Other Wavelengths of U.V. TUBE available please telephone your enquiries.

400 WATT UV LAMP

Only £38.00 + £4.00 p&p (£49.35 inc VAT)

160 WATT SELF-BALLASTED BLACK LIGHT MERCURY BULB

Available with E.S. fitting.
Price inc VAT & p&p £26.55



12V D.C. BILGE PUMP

500 GPH 15ft head 3 amp £19.98

1750 GPH 15ft head 9 amp £34.55

Also now available

24V D.C. 1750 GPH 15ft head

5 amp £36.55

All designed to be used submerged.

PRICES INCLUDE P&P & VAT

SUPER HY-LIGHT STROBE KIT

Designed for Disco, Theatrical use etc.

Approx 16 joules. Adjustable speed £50.00 + £3.00 p&p (£53.28 inc VAT)

Case and reflector £24.00 + £3.00 p&p (£31.73 inc VAT)

S&E for further details including Hy-Light and Industrial Strobe Kits.

5 KVA ISOLATION TRANSFORMER

As New Et. Equipment, fully shrouded, Line Noise Suppression, Ultra Isolation Transformer with terminal covers and knock-out cable entries. Primary 120V/240V. Secondary 120V/240V, 50/60Hz, 0-005pF Capacitance. Size L 37cm x W 19cm x H 16cm, Weight 42 kilos. Price £120 + VAT. Ex-warehouse. Carriage on request.

24V DC SIEMENS CONTACTOR

Type 3TH8022-08 2 x NO and 2 x NC 230V AC 10A. Contacts. Screw or Din Rail fixing. Size H 120 x W 45 x D 75mm. Brand New Price £7.83 incl. P&P and VAT.

240V AC WESTOOL SOLENIIDS

TT2 Mod. 1 Rat. 1 Max. stroke 3/8 in. Base mounting 1/2 in. stroke 5/8 pull approx. TT8 Mod. 1 Rat. 1 Max. stroke 1 in. Base mounting 1/2 in. stroke 1 1/2 pull approx. SERIES 400 Mod. 1 Rat. 2 Max. stroke 1/2 in. Front mounting 1/2 in. stroke 1 1/2 pull approx. Price incl. p&p & VAT. TTS £5.88. TT8 £8.81. SERIES 400 £7.64.

AXIAL COOLING FAN

230V AC 120mm square x 38mm 3 blade 10 watt Low Noise fan. Price £7.29 incl. P&P and VAT.

Other voltages and sizes available from stock. Please telephone your enquiries.

240V AC CENTRIFUGAL BLOWER

New Manuf. Surplus Skeleton Blower suitable for mounting inside an enclosure to cool equipment. Overall size 130 x 110 x 85mm. Outlet 80 x 35mm Impeller 60mm dia. x 60mm long. Price £14.10 inc p&p & VAT.

SEWING MACHINE MOTOR

Brand new 220V/240V AC/DC SEW-TRIC 2 lead Brush Motor. Size L 100mm x H. 70mm x W. 55mm. Spindle 1/4 in. dia. x 1 in. long. Price £14.10 inc p&p & VAT.

GEARED MOTORS

71 RPM 20lb/inch torque reversible 115V AC in-pull including capacitor and transformer for 240V AC operation. Price inc VAT and p&p £27.73.

SOLID STATE EHT UNIT

Input 230V/240V AC, Output approx 15KV. Producing 10mm spark. Built-in 10 sec timer. Easily modified for 20 sec, 30 sec to continuous. Designed for boiler ignition. Dozens of uses in the field of physics and electronics, e.g. supplying neon or argon tubes etc. Price less case £8.50 + £2.40 p&p (£12.81 inc VAT) NMS.

EPROM ERASURE KIT

Build your own EPROM ERASURE for a fraction of the price of a made-up unit. Kit of parts less case includes 12in 8 watt 2537 Argon Tube Ballast unit, pair of bi-pin leads, neon indicator, on/off switch, safety microswitch and circuit £15.00 + £2.00 p&p (£19.98 inc VAT)

WASHING MACHINE WATER PUMP

Brand new 240V AC fan cooled. Can be used for a variety of purposes. Inlet 1 1/2 in., outlet 1 in. dia. Price includes p&p & VAT. £11.20 each or 2 for £20.50 includes.

HIGH QUALITY LOW COST C.C.T.V. CAMERA

LOW LIGHT LEVEL 0.03 LUX @ F1.4
AUTO ELECTRONIC SHUTTER.
COMPOSITE VIDEO OUT VIA BNC PLUG.
SMALL DISCRETE SIZE.
CAN BE USED WITH PC DIGITISER.

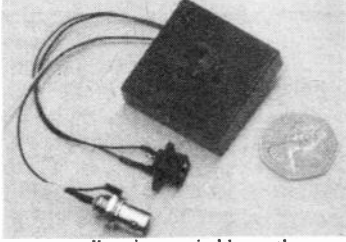

This super quality CCD camera can be connected into your existing TV or video using the AV channel and can be used for discrete surveillance or observing your property externally using a suitable weatherproof housing. Can accommodate lighting levels ranging from daylight to street lighting using its built in electronic shutter. Excellent when using with an infra red source. Built in wide angle fixed focus lens the camera has a resolution of 380 TVL. Can be housed inside an empty floodlight case, (extra).

Special offer price of only: **£79.95 Plus VAT (P&P £3.50)**

For full range of CCTV products send SAE to:
Direct CCTV Ltd., Dept. PE27., Unit 6, Carrick Court, Forrest Grove Business Park, Middlesbrough, TS2 1QE.

N. R. BARDWELL LTD (EPE)

200 Signal diodes 1N4148.....	£1.00	25 3mm red l.e.d.s.....	£1.00
75 Rectifier Diodes 1N4001.....	£1.00	25 Astd. high brightness l.e.d.s.....	£1.00
50 Rectifier Diodes 1N4007.....	£1.00	50 Astd. l.e.d.s (Diode package).....	£1.00
25 Rectifier Diodes 1N5401.....	£1.00	12 Astd. 7-segment displays.....	£1.00
8 NE555 Timer I.C.s.....	£1.00	2 ORP12 light dependant resistors.....	£1.00
50 Astd. Zener Diodes.....	£1.00	30 Astd. IF transformers.....	£1.00
30 BC212L Transistors.....	£1.00	48 Astd. coil formers.....	£1.00
30 BC213L Transistors.....	£1.00	100 Astd. RF chokes (inductors).....	£1.00
20 BC327 Transistors.....	£1.00	30 Astd. connectors edge,d.i.l., sil etc £1.00	
30 BC328 Transistors.....	£1.00	30 Astd. d.i.l. sockets up to 40-pin.....	£1.00
30 BC329 Transistors.....	£1.00	200 Astd. disc ceramic capacitors.....	£1.00
30 BC478 Transistors.....	£1.00	80 Astd. capacitors 1nF to 1µF.....	£1.00
30 BC546 Transistors.....	£1.00	80 Astd electrolytic capacitors.....	£1.00
30 BC547 Transistors.....	£1.00	10 4P3W MBB min. rotary switches.....	£1.00
30 BC548 Transistors.....	£1.00	20 Min. SP/CO slide switches.....	£1.00
30 BC550 Transistors.....	£1.00	20 1" glass reed switches.....	£1.00
25 BC557 Transistors.....	£1.00	200 4N7 mini axial capacitors.....	£1.00
30 BC558 Transistors.....	£1.00	24 24-pin d.i.l. wire wrap i.c. skts.....	£1.00
30 BC559 Transistors.....	£1.00	1 12V motorised volume control 50k.....	£1.00
25 BC640 Transistors.....	£1.00	50 Grommets 6.3mm id. 9.5mm od.....	£1.00
30 MPSA42 Transistors.....	£1.00	100 cfl 1/2 W 5% resistors any one value, E24, range 1R to 10M.....	£0.45
30 MPSA92 Transistors.....	£1.00		
20 2N3702 Transistors.....	£1.00		
20 2N3904 Transistors.....	£1.00		
10 78M08 8V 500mA Pos Regulators.....	£1.00		
10 79M08 8V 500mA Neg Regulators.....	£1.00		
25 5mm red l.e.d.s.....	£1.00		

Prices include VAT, postage £1.25. Stamp for Lists
288 Abbeydale Road, Sheffield S7 1FL
Phone (0114) 2552886 Fax (0114) 2500689

OMNI ELECTRONICS

174 Dalkeith Road, Edinburgh EH16 5DX ★ 0131 667 2611

The supplier to use if you're looking for:-



★ A WIDE RANGE OF
COMPONENTS AIMED
AT THE
HOBBYIST

★ COMPETITIVE
VAT INCLUSIVE
PRICES ★

★ MAIL ORDER - generally by
RETURN OF POST ★

★ FRIENDLY SERVICE ★

1995/6 CATALOGUE NOW IN STOCK!
COST: £2.00. Includes vouchers to offset
against future purchases.

OPEN: Monday-Thursday 9.15 - 6.00.

Friday 9.15-5.00

Saturday 9.30-5.00

VISA

SUMMER 1995 CATALOGUE

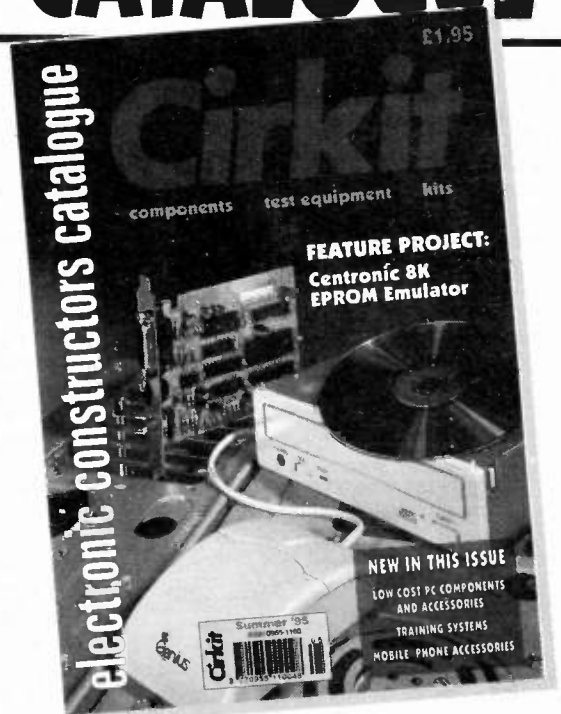

The Summer '95 edition has 280 pages packed with over 4000 products and now with news and features including a full construction project.

▶ The computer section is greatly increased with new ranges of equipment and accessories for PCs including:

Mother boards, CPUs and SIMMs
CD ROM drives and hard drives
Sound cards, I/O cards, disc drive
cards and video cards
Mice, trackerballs and joysticks
Power supplies and cases

£1.95
+ 30p p&p

▶ Feature project for an EPROM emulator

▶ New 20MHz 'scope from Leader, training systems from Flight and an extended range of mobile phone batteries and accessories from Uniross

▶ Latest addition from Velleman kits including a video digitiser card

▶ 280 pages, 26 sections, over 4000 products from some of the worlds finest manufactures and suppliers

▶ Available at most large newsagents, from 13th April, or directly from Cirkit

▶ Send for your copy today!

Cirkit



Cirkit Distribution Ltd

Park Lane · Broxbourne · Hertfordshire · EN10 7NQ
Telephone: 01992 448899 · Fax: 01992 471314

15 Amstrad Games.....	£5.00*	50 off mixed terminal blocks.....	£2.50*
15 Spectrum Games.....	£5.00*	25 off buzzers & sounders.....	£3.50
£1 PACKS			
50 BC547A; 20 BS107; 20 BSS92;		25 off mixed relays.....	£4.95*
10 2N2907A; 20 2N5086;		50 off mixed switches.....	£7.50*
50 2N5551; 3 BD145; 10 BD237;		250 off i.c. sockets.....	£3.95*
10 BD239A; 5 BFW43; 10 BFX30;		1000 off Ceramic caps.....	£7.50*
3 BSX59; 10 VN2010-L; 20 ZTX304;		5 off 3V Lithium memory	
20 ZTX311; 20 ZTX510; 20 ZTX551;		back-up batteries.....	£2.00*
5 5V d.i.l. relays; 10 21-10MHz		100 off 2200µF 25V caps.....	£6.00*
crystals; 10 811MHz filters; 50 6-way		31b mixed component pack.....	£4.95
i.c. skts.; 50 14-way d.i.p. hors;		Jumbo component pack.....	£10
20 TO18 heatsinks; 20 TO5 heatsinks;		Crystal oscillators 10/12MHz. .£1 ea	
200 TO5 mounting pads; 200 TO18		5V DPCO D.I.L. relay.....	60p ea*
mountings pads; 2 100Ω LOPT Tx;		5V SPCO S.I.L. reed relay.....	40p ea*
5 12-way terminal blocks; 10 silver		12V Piezoelectric Sounders.....	50p ea
control knobs; 10 95V V.D.R.; 3 12V		DIL Switches 3/4/6 and	
counters; 25 3-5mm jack plugs;		12-way.....	35p ea*
10 PCB MT microswitch; 10 6-way		3-5mm jack plugs.....	10 for £1*
d.i.l. switch; 10-1 pole 3-way rotary		100 off Zener diodes, mixed.....	£2*
switch; 25 slide switches; 5 3A 250V		21-piece mini screwdriver set.....	£3.95*
power toggle switch; 50 4-7µF 25V		Universal test lead kit.....	£3.95*
caps; 15 2200µF 25V caps;		10 crocodile clip leads.....	£3.50*
10 0.047µF suppression caps;		20 off mixed R.F. Filters,	
25 neons; 10 1µF 250V polyesters.		Crystals, etc.....	£4.95*
5¼" to 3½" floppy converter		100m P.V.C. sleeving.....	£4.50*
leads.....	£1.50 ea*	VALVES	
STC p.s.u. 240V Input; 5V 6A		QQV0310, £10*; QQV0320A, £10*;	
Output, (converts to 12V 3A,		QQV0640A, £20*; ECC 82, £3*;	
details supplied).....	£5.95	ECH 81, £2*; PCL 805, £3*;	
Temperature probes, with		ORP 11, £3; ORP 40, £3; CV 4004,	
data.....	£3.95*	4005, 4006, 4007, 4014, 4020,	
Universal Timer (10 min. delay and		4024, 4043, 4055, 4064, 5042,	
20 min. cut-off functions).....	£3.95*	5080, ALL £5 each*	
12V 400mW Zeners,.....	100 off £1*	QUANTITY DISCOUNTS	
3AMP mains filters.....	£1.00 ea*	AVAILABLE PLEASE RING.	
40 Character x 1-line dot		We also buy all forms of electronic	
matrix display.....	£4.95 ea*	components, p.s.u.'s, disk drives etc.	
Car Dashboard Display (shows		Lists to below address.	
lights, indicators, doors,		ALL PRICES INCLUDE V.A.T.	
on picture of car).....	£4.95*	PLEASE ADD £2.00 p&p EXCEPT	
4-digit clock display.....	£2.50*	ITEMS MARKED * WHICH ARE 50P.	
4-digit l.c.d. with 7211 driver.....	£3.50*	SAE FOR BULK BUYING LIST	
17-digit v.f. display.....	£2.95*	PAYMENT WITH ORDER TO:	
Giant 2-digit v.f. display.....	£2.95*	Dept EE, COMELEC,	
12V stepper motors, 48 steps		14 Constable Road,	
per rev., 7.3° step angle.....	£3.95*	St. Ives, Huntingdon,	
250 off mixed electrolytic		Cams PE17 6EQ,	
caps.....	£4.95*	Tel/Fax: 01480 300819	
250 off polyester caps.....	£4.95*		
1000 off mixed resistors ¼W.....	£4.95*		
100 off phono plugs.....	£2.95*		

RAMP GENERATOR

NEIL JOHNSON BEng(Hons) AMIEE **Part 2**

A professional quality ramp generator aimed at the intermediate to advanced constructor.

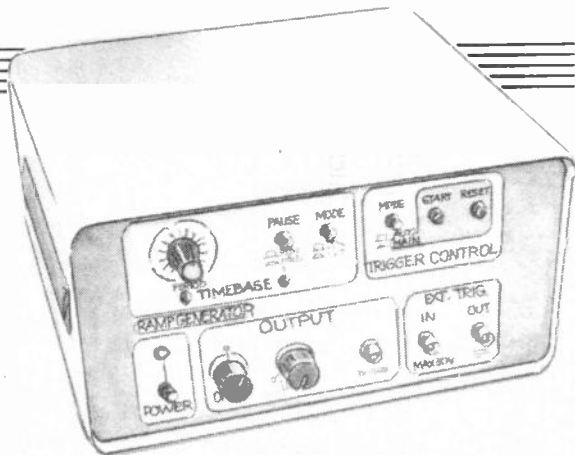

LAST month it was explained how the Ramp Generator project evolved from a need to expand and improve the author's range of test equipment with a versatile unit which could be used for a wide range of tasks. Detailed descriptions of how the circuit worked were then given.

This month we conclude by describing the construction and testing of the unit.

LOGIC BOARD ASSEMBLY

Details of the component layout on the double-sided Logic board are shown in Fig. 7. From hereon, this side of the p.c.b. is referred to as Side B. Side A, not surprisingly, is the reverse side!

Start construction with the small passive components – resistors R1 to R17 and capacitors C1 to C25. Continue by inserting terminal pins for l.e.d.s D1 and D2, and the two transistors TR1 and TR2. Next, fit the d.i.l. sockets.

Of the remaining items, connector PL1 can be fitted next. Rotary switch S1 needs to be fitted into its mounting bracket, then the whole assembly soldered to the board, including the bracket tags.

Before mounting, switches S3 and S4 need to be made momentary action. This is accomplished by carefully removing the small leaf spring and latching pin from each of them. Then fit the array of switches, S2 to S6, into their mounting bracket, and fold over the fixing tabs. Carefully fit the button caps to the switches and solder the complete assembly to the logic board.

The two l.e.d.s, D1 and D2, are mounted on the front panel, connected to the logic board via flying leads – a length of twisted-pair can be used for this. Ideally the leads need to be about 15cm to 20cm long, covering them with insulation sleeving.

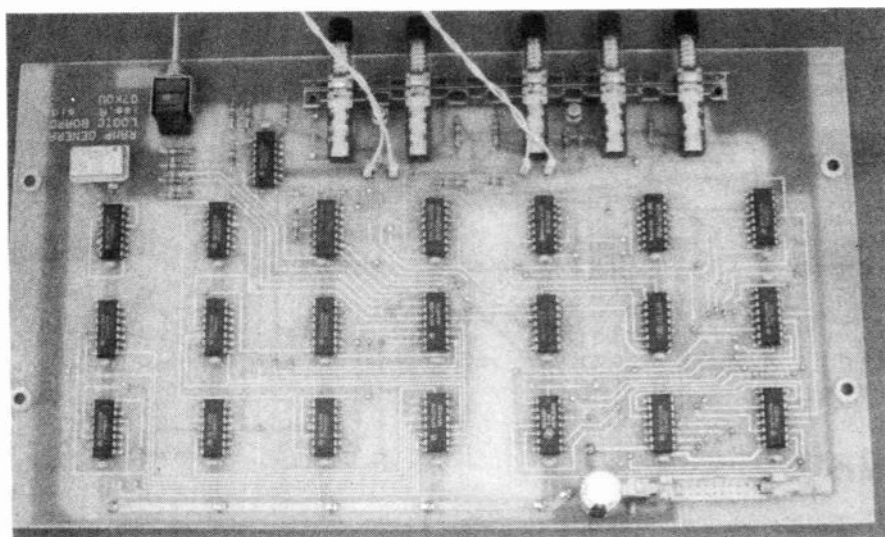

The assembled Ramp Generator Logic Board. Note that the switches are mounted integrally with the common brackets.

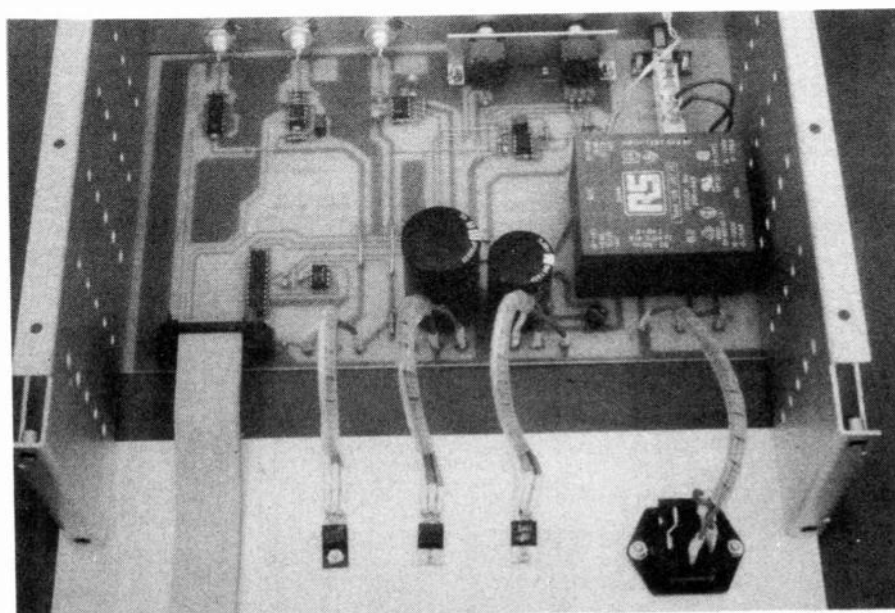

The assembled Analogue board, complete with the power supply components, mounted inside the case. Note how the voltage regulators and the mains input socket are connected to the rear panel.

ANALOGUE BOARD ASSEMBLY

Details of the component layout for the Analogue board, which is single-sided, are shown in Fig. 8.

Start off assembly by soldering in the wire links. Those shown in heavy lines should be made of fairly chunky

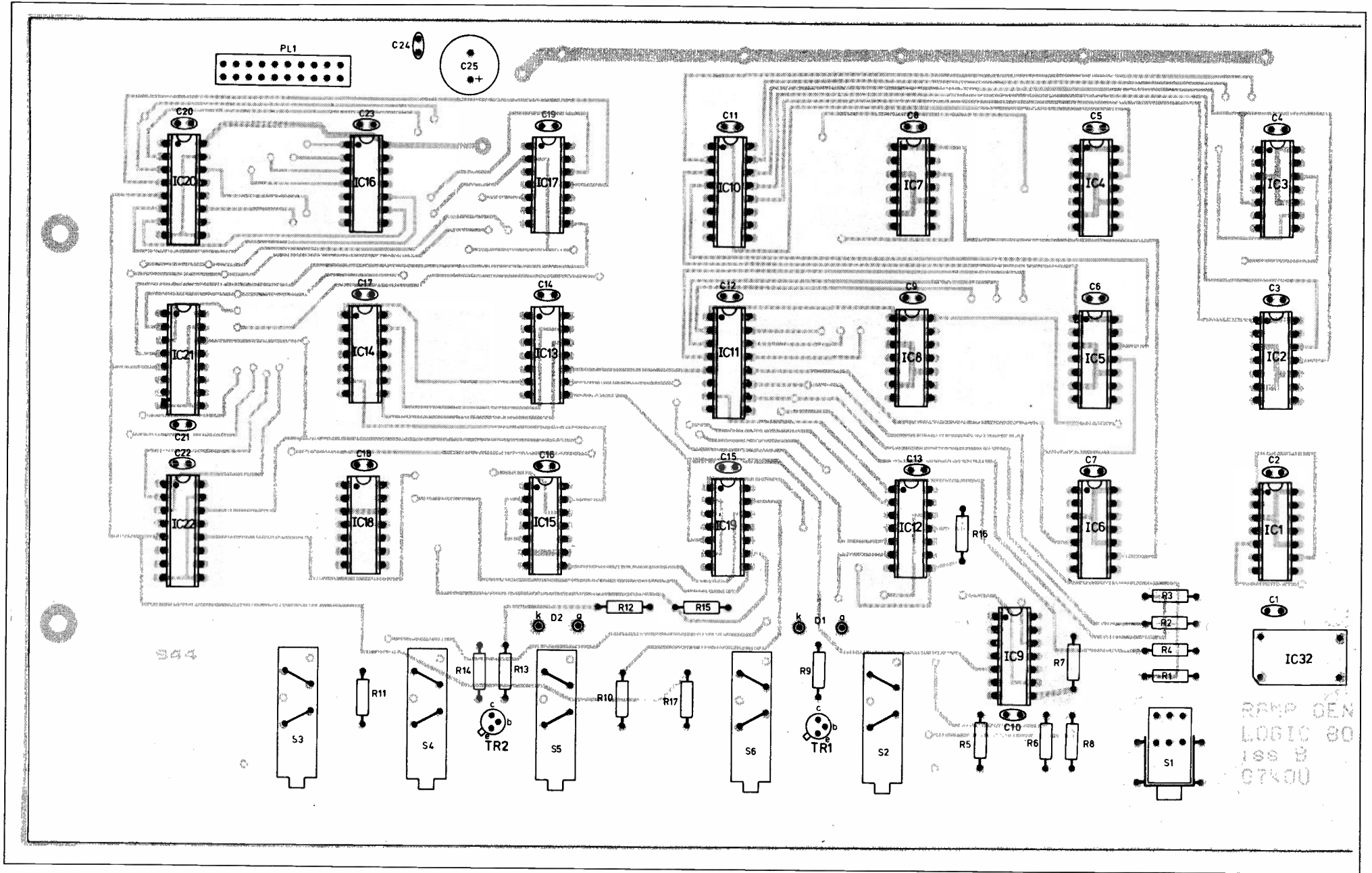

Fig. 7. Component layout details for the Logic board of the Ramp Generator. Only the upper side tracking is shown. The horizontal extremes of the board are not shown – they are vacant of components but include the mounting holes.

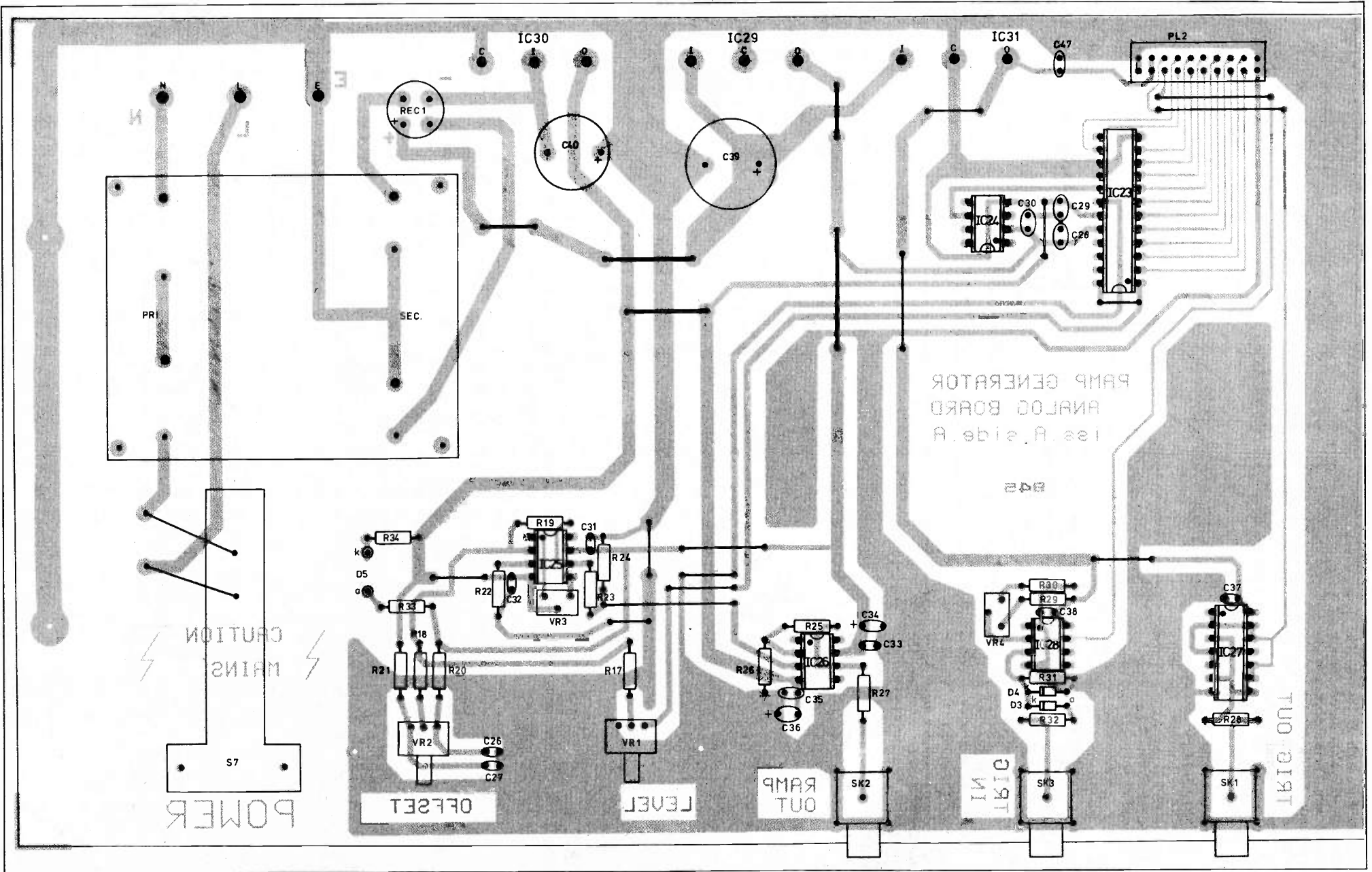

Fig. 8. Component layout details for the Analogue board of the Ramp Generator. This board is single-sided. The horizontal extremes of the board are not shown – they are vacant of components but include the mounting holes.

tinned copper wire, such as 18s.w.g. The remainder can be 22s.w.g. or 24s.w.g. tinned copper wire. There are nineteen wire links to be made. Follow on with terminal pins for all off-board connections, including those for i.e.d. D5 and the short links to switch S7.

All passive components in order of size – resistors, capacitors, tantalum capacitors, presets, electrolytic capacitors – are soldered to the board, taking care to correctly fit the polarised capacitors. The larger items, connector PL2, transformer T1 and switch S7, are fitted next. Transformer T1 has an asymmetric pin layout so it should be impossible to fit it the wrong way round.

Switch S7 is fitted into its mounting bracket, which is then bolted to the board. Use insulated wire links to connect the switch to the board.

With the semiconductors, start with diodes D3 and D4, and then the bridge rectifier REC1, making sure you get them the right way round! Follow with the three voltage regulators, IC29 to IC31, which are connected to the board via flexible wire leads. These should be made of 16/0.2 or 19/0.2 stranded wire about 15cm long. The 100n decoupling capacitors C41 to C46 are soldered directly to the regulator leads on the back of the board (Side A).

Next fit d.i.l. sockets for the integrated circuits. Finally, fit the mains connector SK4 to the board with flying leads. These should be made of stranded wire, capable of carrying about 3A, about 15cm long with both soldered ends covered in heat-shrink tubing. Connect i.e.d. D5 to the board in the same way as D1 and D2.

The last stage of construction of the analogue board is to mount the two potentiometers VR1 and VR2. A metal bracket supports them on the board, thus avoiding fixing them directly to the front panel. The bracket details are shown in Fig. 9. Fix the potentiometers to the bracket before bolting the assembly to the board.

CASE IT!

Assuming that the recommended case is being used, the front panel has four mounting studs welded to it. Drill out the required 15 holes in the front panel, as shown in Fig. 10, and five holes in the rear panel, as shown in Fig. 11, ensuring that they align with board-mounted components where necessary. Make sure the holes are cleanly finished and free from any burrs.

Clean both front and rear panels with white spirit or methylated spirits before applying lettering and protective varnish. The front panel legends of the prototype were made by photocopying the design

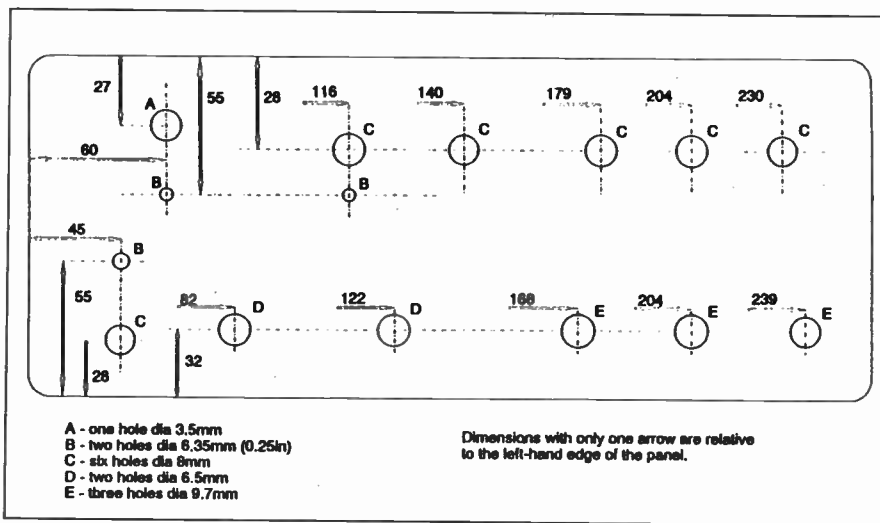

Fig. 10. Front panel drilling details.

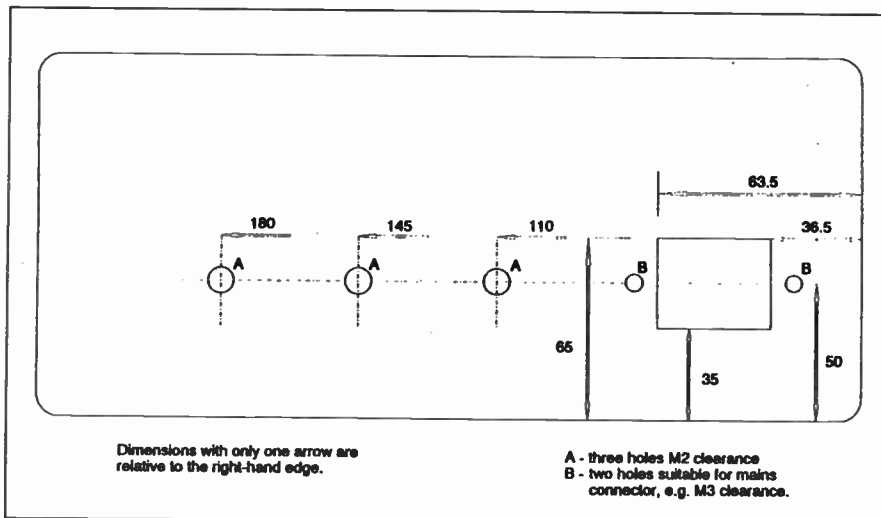

Fig. 11. Rear panel drilling details.

(seen in the photos and available as previously commented in Part One) onto adhesive-backed paper. This was then covered with sticky-backed plastic before the individual sections were cut out and stuck on to the panel.

Next fit the remaining panel hardware: i.e.d. clips and BNC sockets SK1 to SK3. Bolt the front and rear panels to the two side panels, using the nuts and bolts supplied, to make a sturdy frame onto which the boards are to be attached.

Starting with the Analogue board, bolt this to the underside of the frame, components facing upwards, carefully sliding

the shafts of the two potentiometers and power switch through their holes in the front panel. Then attach the mains connector and voltage regulators to the rear panel using M3 and M2 screws respectively. Do not forget the mica washers and silicone heatsink grease for the regulators.

Complete the Analogue board by pushing i.e.d. D5 into its front panel clip and connecting the BNC sockets (SK1 to SK3) to the board with short lengths of tinned copper wire.

Before fitting the Logic board, a cable link is required between connectors PL1 and PL2. This should be made from about 15cm of 20-way IDC ribbon cable and two 20-way IDC connectors.

Connect the cable link into PL1 on the Logic board, then flip the board over so that the component side is facing downwards and the switches are facing the front. Rest the board on the top of the frame while you fit the i.e.d.s D1 and D2 into their clips. Slide the board forward so that the switches protrude through their front panel holes, finally bolting the board firmly to the frame.

Now for the last fiddly bit. Turn the unit over and carefully push the other end of the cable link into connector PL2 until it clicks into place. Finally, attach the three knobs to the shafts of panel potentiometers VR1, VR2, and switch S1.

Before fitting the bottom half of the case, screw on its tilting feet. Then carefully fit

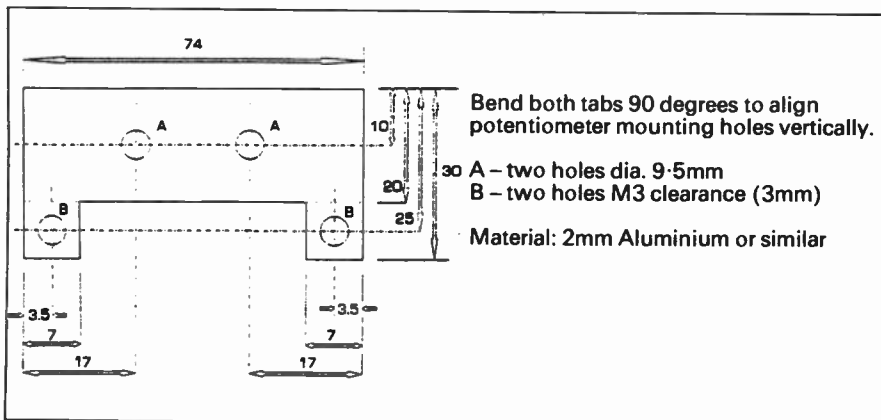
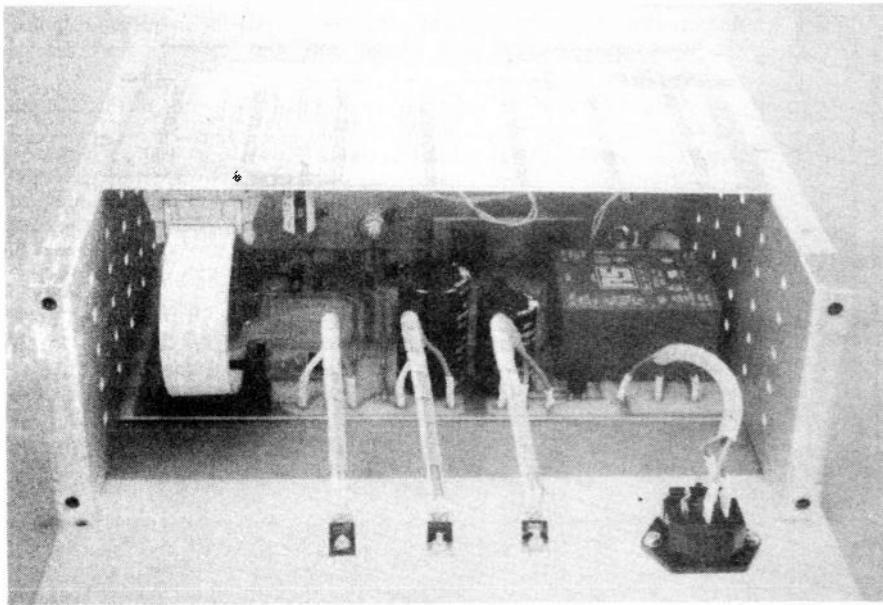

Fig. 9. Details of the mounting bracket for potentiometers VR1 and VR2.



The Logic board is mounted on top of the case frame, upside down.

the central frame into the shell before fitting the top shell. The two halves are attached to the frame with the dark-brown coloured side bars. Fit these into place and secure them with the matching screws – a penny makes an ideal screwdriver for these large headed screws.

TESTING... TESTING...

DO NOT PLUG THE UNIT INTO THE MAINS YET.

To perform the following tests you will need an Ohmmeter, reading up to several hundred kilohms, and an Oscilloscope. Begin by checking the mains power inlet.

There should be a very low resistance (a few milliohms) between the Earth pin and the case, with about 120 ohms between the Live and Neutral pins with the Power switch in the ON position. There should be a virtual open circuit between Live or Neutral and Earth – check this with the ohmmeter on its highest resistance range, or better still with a Mega-ohmmeter which tests at about 500 volts.

The following tests will involve operating the Ramp Generator with part of the cover removed. Because of the presence of mains voltages, **PRECAUTIONS SHOULD BE TAKEN:**

- Do not make adjustments with the unit connected to the mains. Disconnect it **BEFORE** you make any adjustments, then reconnect and test.
- When the mains is on, keep one hand in your pocket – if you should be careless, at least you will not provide the mains current with a path across your chest.
- Place the Ramp Generator on a wooden or plastic surface, clean off any solder splashes, swarf, strands of wire or any other conducting material.

To make adjustments to the two presets VR3 and VR4, the front panel must be removed.

Connect a mains lead to the mains input connector and an oscilloscope to the Ramp Output connector SK2. Set the Ramp Generator Period switch S1 to 100ms, Pause switch S2 off, Auto triggering switch S5 on, Offset potentiometer VR2 set midway for zero offset, and Output Level control VR1 set for about 2V.

Turn on the power. The power i.e.d. D5 and Sweeping i.e.d. D2 should come on and a ramp waveform be visible on the scope screen (the scope's timebase and input controls may need adjusting).

If all is well, check the operation of the Period, Pause and Ramp Mode controls (S1, S2, S6). Then check that the Level and Offset controls work correctly. If fitted, the Offset Null preset VR3 can be trimmed so that the middle point of the Offset Null control VR2 relates to an offset of zero.

The last section to check is the Trigger Control. Set the Trigger Mode (S5) to Manual and check that the output goes to zero (plus any offset). Operating the Start button (S4) should produce a single ramp. On slower period settings the Reset button (S3) should instantly stop the ramp and reset the unit. Also check that the Sweeping i.e.d. D2 remains on during the ramp sweep time and turns off at the end.

The final adjustment is the External Trigger Input Threshold, VR4. This can be set with the aid of a variable power supply and an additional push-to-make switch. Set the supply to the threshold level you want, say 2V, and use the pushswitch to provide a pulse of this voltage to the External Trigger

Input SK3. Then adjust VR4 until the Ramp Generator just triggers on the voltage pulse.

When you have completed the testing stage replace the front panel and any other panels you have removed. You are now the proud owner of a superb piece of bench test equipment with many applications. Now then, how about some...

APPLICATIONS

Apart from looking nice with lots of buttons to press and knobs to twiddle, the Ramp Generator has a wide range of uses.

The first use to which the prototype was put was to check the timebase of the author's Oscilloscope. The period of the ramp waveform, being crystal-controlled, is accurate to within $\pm 0.01\%$; most analogue scopes use an R-C timing circuit accurate to a couple of per cent.

To check the accuracy of the scope timebase select a convenient period, say 1ms, and set the scope timebase to ten times this value, in this case 10ms. If the scope is roughly in calibration, a complete ramp waveform should be seen, from start to finish, covering the complete 10cm horizontal graticule. If not, get out the scope's service manual!

If your main interest is electronic music you could use the Ramp Generator to control an oscillator, filter or amplifier. This would create single or multiple sweeps of pitch, cut-off or amplitude with a great degree of control.

If you have an X-Y plotter lying around, the Ramp Generator could provide it with a precision timebase. In fact, an X-Y plotter, or oscilloscope in X-Y mode, combined with the Ramp Generator can form the basis of a wide range of test equipment. A few suggestions are listed here, plus example block diagrams shown in Fig. 12.

Curve Tracer

The simple Curve Tracer circuit in Fig. 12a can plot a V_{ce} versus I_c curve for an npn transistor for a particular base current I_b .

Frequency Response Analyser

The Frequency Response Analyser circuit shown in Fig. 12b will produce a plot of gain or attenuation for a network over a particular range of frequencies; ideal for filter designers. Or the network could be replaced by a loudspeaker and



Full size photocopies of the front panel legends are available free from the Editorial office.

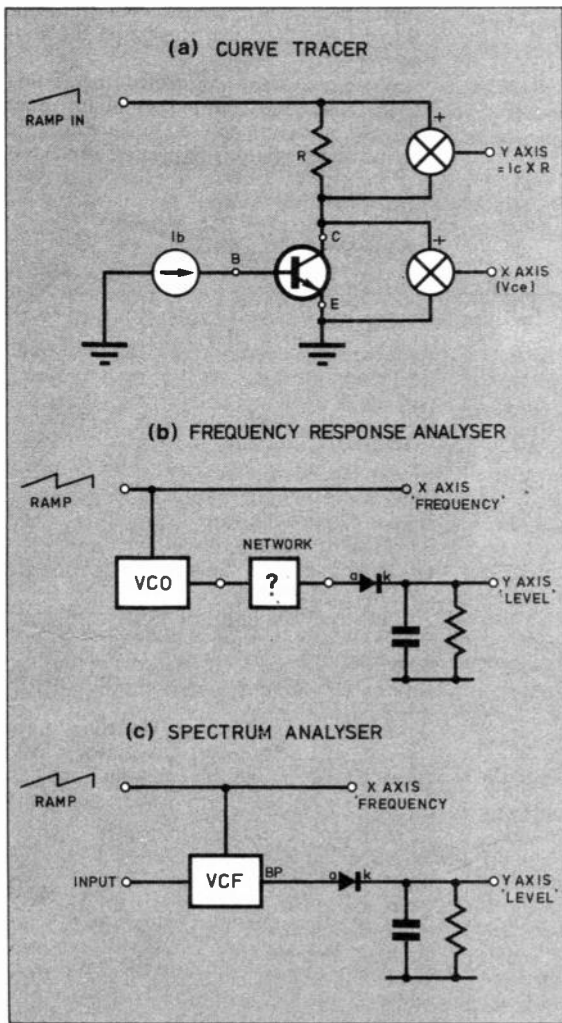

Fig. 12. Ramp Generator application examples.

microphone/amplifier pointing at each other to plot the frequency response of a loudspeaker system.

Spectrum Analyser

How would you like a Spectrum Analyser? As suggested in Fig. 12c, all that is needed is a voltage controlled filter (VCF – e.g. SSM2044) with a bandpass output, and a detector diode. This would work well at audio frequencies, or for an RF Spectrum Analyser you would need an RF VCO (voltage controlled oscillator), mixer, low-pass filter and detector diode (if you are not sure of what the circuit would look like you probably wouldn't understand how it would work – it's beyond the scope of this article to explain it!).

ON THE UP

The Ramp Generator is an accurate and versatile piece of equipment with a wide range of uses. Experienced constructors will recognise that there are many other uses beyond those outlined here. It is hoped that this project will generate much interest amongst other readers, to design and build a wide variety of accessories – probably even come up with ideas the author has never thought of. Perhaps even to publish their designs in *EPE*. Enjoy it! □



RING BINDERS FOR EPE

This ring binder uses a special system to allow the issues to be easily removed and reinserted without any damage. A nylon strip slips over each issue and this passes over the four rings in the binder, thus holding the magazine in place (see photo).

The binders are finished in hard wearing royal blue p.v.c. with the magazine logo in gold on the spine. They will keep your issues neat and tidy but allow you to remove them for use easily.

The price is £5.95 plus £3.50 post and packing. If you order more than one binder add £1 postage for each binder after the initial £3.50 postage charge, (for overseas readers the postage is £6.00 each to everywhere except Australia and Papua New Guinea which costs £10.50 each).

Send your payment in £'s sterling cheque or PO (Overseas readers send £ sterling bank draft, or cheque drawn on a UK bank or pay by credit card), to Everyday with Practical Electronics, Allen House, East Borough, Wimborne, Dorset BH21 1PF. Tel: 01202 881749. Fax: 01202 841692 (We cannot reply to overseas queries or confirm orders by fax due to the high costs).

We also accept credit card payments. Mastercard (Access) or Visa (minimum credit card order £5). Send your card number and card expiry date plus cardholders address (if different to the delivery address).



REPORTING

AMATEUR RADIO

Tony Smith G4FAI

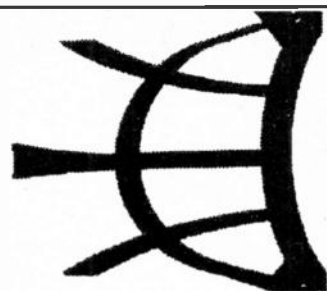

NZ PROPOSES NO-CODE

The International Amateur Radio Union recently came down firmly on the side of keeping the amateur Morse test for the foreseeable future, but there is now a new development in this ongoing controversial debate.

In New Zealand, an organisation called ORACLE (Organisation Requesting Alternatives by Code-Less Examinations) has bypassed New Zealand's national radio society, NZART, and has approached their licensing authority (the Ministry of Commerce) direct to suggest that the NZ government propose the abolition of the amateur Morse test at the next World Radio Conference (*WRC-95*), in Geneva in October.

Last September, NZART received an assurance from the Minister of Commerce, that New Zealand would not actively make proposals to change the international regulations "until such time as there is evidence of significant opinion here in New Zealand, and/or overseas" to support such change.

In March NZART received a further letter announcing that the government had now decided to propose to *WRC-95* the deletion of Radio Regulation 2735 which requires a Morse test for amateur radio h.f. operation.

WHO WILL SUPPORT IT?

At present, the various IARU member-societies around the world are discussing with their own government delegations to *WRC-95* the implications for amateur radio of the various items on the WRC agenda.

In theory, they will now close ranks and oppose a proposal that not only goes against their present internationally agreed policy, but undermines their status as collective representatives of the radio amateur fraternity to their licensing authorities.

The question is, will they? Or will some break ranks and support the New Zealand government's proposal? The last time something like this happened was at the 1979 World Administrative Radio Conference when several different countries put forward proposals to amend RR 2735.

At that time a Morse qualification was required for operating on frequencies below 144MHz. Sweden suggested the figure be reduced to 28MHz and Papua New Guinea suggested 30MHz.

The United States government delegation put forward a proposal that if approved would have resulted in the abolition of the Morse test requirement altogether. This proposal was made independently by the US administration in the face of strong opposition from the American Radio Relay League, which had a mandate from its membership to keep the test.

The US proposal was favoured by two administrations and opposed by at least fifteen others. Finally, it was withdrawn, the proposal from Papua New Guinea was adopted, and it is that which forms the present-day Radio Regulation relating to Morse code.

AMATEUR RADIO AND THE INTERNET

There are many facilities for radio amateurs on the Internet. This isn't the place to explain how to access them, or to include long lists of "addresses", but suffice to say there are collections of radio data, directories, organisations, news bulletins, callbooks, specialist groups, and individual radio clubs worldwide to be found by simply pressing a few buttons and making inexpensive (often local) telephone calls.

With new Internet facilities being developed all the time, I'm wondering if all those people said to be waiting to come into amateur radio, "if only the Morse test could be abolished", will continue to find the prospect of combining their interests with our hobby so attractive?

ORACLE (above), says that the number of computer enthusiasts under the age of 25 exceeds the total number of radio amateurs of all ages by many times (and this is no doubt true), and that future recruitment into amateur radio is more likely to be linked to computing interests than anything else. But will it?

The Internet can already provide communication facilities in many ways better than amateur radio. There is no compulsory technical examination, no Morse test to pass, and no need to set up an expensive radio station and antenna over and above the cost of a computer. There are no problems through causing radio interference to the neighbours, and there are no regulations restricting what you can talk about with other parties.

There is even software available now which provides real-time two-way voice or videophone function. One system, Internet Phone, developed in Israel, provides two-way simplex contacts, in effect just like amateur radio.

This includes a chat mode where you list your name under a particular topic. Then anyone with the same interest (and software) can click on your name for a one-to-one conversation (QSO!).

RADIO IS THE COMMON INTEREST

Why bother with amateur radio at all when such superior facilities are now available elsewhere? Well, there is one other factor which I omitted to mention. Radio itself.

Amateurs are interested in more than just a communications link, the radio function itself is an important part of the hobby. They talk about many

non-technical matters, but they always get back to their "rigs", their antennas, their ancillary equipment, discussing their performance or their problems.

They talk about propagation, low power achievements, DXing, and many other radio related matters. Furthermore, they enjoy the challenge offered by the vagaries of radio propagation, and the uncertainties of what will happen each time they go on the air.

That's why I suggest computer enthusiasts would find the Internet more satisfying. There are plenty of radio amateurs who enjoy using their computers on the air, but who are also interested in the radio side of things, and I don't mean them. But if amateur radio is simply to be a substitute for the telephone line, that surely can't be the way forward for a hobby that still claims to be scientifically and experimentally orientated?

As can be seen from ORACLE's remarks, most of the fuss about the amateur Morse test is related to the computer boom. Could it be that the communications explosion via the Internet will take the pressure off and we can all settle down again, enjoying our own separate interests within amateur radio, and still be linked by our mutual interest in the medium itself?

NEWS FROM THE RSGB

The Radio Society of Great Britain has published a new book aimed primarily at Novice licensees. *Practical Transmitters for Novices* contains a selection of easy-to-build transmitter designs suitable for the UK Novice bands. It includes designs for 160m double-sideband speech (DSB), 80m CW (Morse), and 6m FM speech transmitters.

This is one of a number of books specially written for Novices which are available from RSGB Sales (Telephone 01707 659015 for further details). All RSGB books are available to non-members but cost a little more than to members.

If you want to see these and other RSGB publications before buying, the RSGB will have book and information stands at the following events in the next two months.

August: 6th, RSGB National Mobile Rally, Woburn Abbey; 19/20th, RSGB Stafford Amateur Radio and Computer Show; 27th, Torbay Amateur Radio Society Annual Mobile Rally.

September: 3rd, Telford Rally; 10th, Southend and District ARS Radio and Computer Rally. Phone the RSGB (number as above) for details of venues, etc.

The RSGB's National Convention will be at the Stafford Show, and will include a lecture programme covering packet radio, repeaters, the Novice licence, contesting, and learning Morse.

LEARN ALL ABOUT ELECTRONICS

The essential reference work

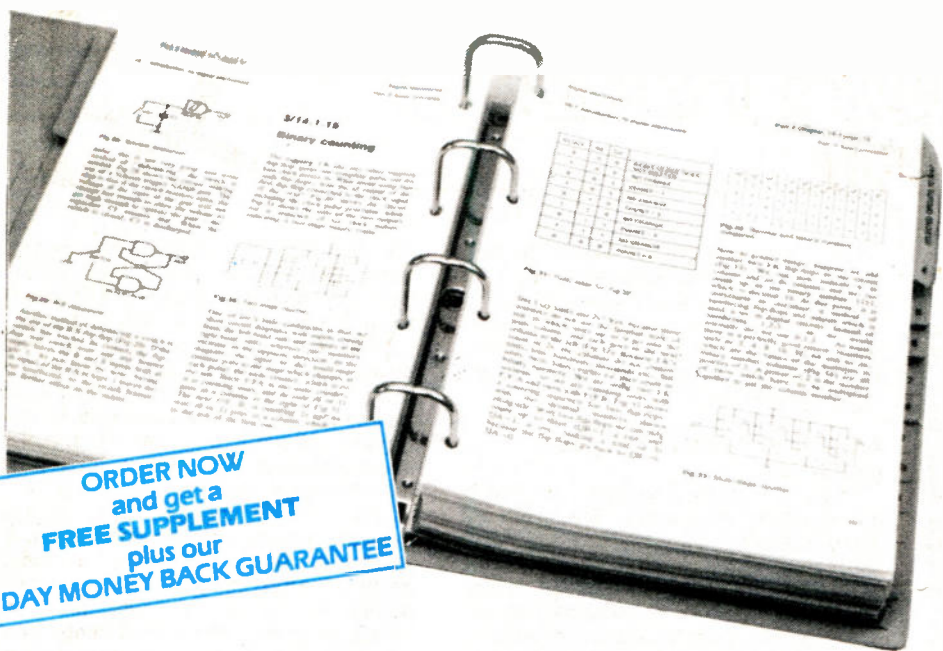

ORDER NOW
and get a
FREE SUPPLEMENT
plus our
30 DAY MONEY BACK GUARANTEE

- Easy-to-use format
- Clear and simple layout
- Comprehensive subject range
- Regular Supplements
- Sturdy ring-binder
- Projects to build
- Components checklists
- Extensive data tables
- Detailed supply information
- Ready-to-transfer PCBs
- Detailed assembly instructions
- Professionally written

The revised edition of **The Modern Electronics Base Manual** contains practical, easy-to-follow information on the following subjects:

BASIC PRINCIPLES: Symbols, components and their characteristics, active and passive component circuits, power supplies, acoustics and electroacoustics, the workshop, principles of metrology, measuring instruments, digital electronics, analogue electronics, physics for electronics.

CIRCUITS TO BUILD: From basic principles to circuit-building, The Modern Electronics Manual and its Supplements describe how to assemble radios, loudspeakers, amplifiers, car projects, computer interfaces, measuring instruments, workshop equipment, security systems, etc.

ESSENTIAL DATA: Extensive tables on diodes, transistors, thyristors and triacs, digital and linear i.c.s, microprocessors.

The Manual also has an extensive **Glossary**, and covers **Safety, Specialist Vocabulary with Abbreviations and Suppliers**. The most comprehensive reference work ever produced at a price you can afford, the revised edition of **THE MODERN ELECTRONICS MANUAL** provides you with all the essential information you need.

OVER 1,000 A4 loose leaf pages in a sturdy ring binder all for just **£39.95** plus **£6.00** post and packing. Regular Supplements continuously extend the Manual with new material, each Supplement contains approximately 160 pages of information. These are sent about five times a year and cost **£23.50** plus **£2.50** p&p. You can of course return any Supplement (within 10 days) or cancel the Supplements at any time.

**Wimborne Publishing Ltd., Dept. E8,
Allen House, East Borough,
Wimborne,
Dorset BH21 1PF
Tel: 01202 881749 Fax: 01202 841692**

GUARANTEE

Our 30 day money back guarantee gives you complete peace of mind. If you are not entirely happy with the Manual, for whatever reason, simply return it to us in good condition within 30 days and we will make a full refund of your payment – no small print and no questions asked.

(Overseas buyers do have to pay the postage charge)

PLEASE send me **THE MODERN ELECTRONICS MANUAL** plus a **FREE SUPPLEMENT**.

I enclose payment of **£45.95**. I shall also receive the appropriate supplements several times a year. These are billed separately and can be discontinued at any time. Should I decide not to keep the Manual I will return it to you within 30 days for a full refund.

ORDER FORM

Simply complete and return the order form with your payment to the following address:

**Wimborne Publishing Ltd, Dept. E8,
Allen House, East Borough, Wimborne,
Dorset BH21 1PF**

FULL NAME
(PLEASE PRINT)

ADDRESS.....

..... POSTCODE

SIGNATURE.....

I enclose cheque/PO payable to Wimborne Publishing Ltd.

Please charge my Visa/Mastercard/Access

Card No. Card Ex. Date

OVERSEAS ORDERS: All overseas orders must be prepaid and are supplied under a money-back guarantee of satisfaction. If you are not entirely happy with the Manual return it within a month for a refund of the purchase price (you do have to pay the overseas postage). SEND **£39.95 PLUS THE POSTAGE SHOWN BELOW:**

EIRE	AIR MAIL ONLY £11
EUROPE (E.E.C. Countries)	AIR MAIL ONLY £20
EUROPE (non E.E.C.)	SURFACE MAIL £20, AIR MAIL £26
U.S.A. & CANADA	SURFACE MAIL £25, AIR MAIL £32
FAR EAST & AUSTRALIA	SURFACE MAIL £31, AIR MAIL £33
REST OF WORLD	SURFACE MAIL £25, AIR MAIL £44

Note surface mail can take over 10 weeks to some parts of the world. Each manual weighs about 4kg including the free supplement when packed.

All payments must be made in £'s Sterling payable to Wimborne Publishing Ltd. We accept Mastercard (Access) and Visa credit cards.

Direct Book Service

The books listed have been selected by *Everyday with Practical Electronics* editorial staff as being of special interest to everyone involved in electronics and computing. They are supplied by mail order direct to your door. Full ordering details are given on the last book page. For another selection of books see next month's issue.

Everyday with Practical Electronics Books

ELECTRONIC PROJECTS - BOOK 1

Published by *Everyday Electronics* in association with Magenta Electronics. Contains twenty of the best projects from previous issues of EE each backed with a kit of components. The projects are: Seashell Sea Synthesiser, EE Treasure Hunter, Mini Strobe, Digital Capacitance Meter, Three Channel Sound to Light, BBC 16K Sideways Ram, Simple Short Wave Radio, Insulation Tester, Stepper Motor Interface, Eprom Eraser, 200MHz Digital Frequency Meter, Infra Red Alarm, EE Equaliser Ioniser, Bat Detector, Acoustic Probe, Mains Tester and Fuse Finder, Light Rider - (Lapel Badge, Disco Lights, Chaser Light), Musical Doorbell, Function Generator, Tilt Alarm, 10W Audio Amplifier, EE Buccaneer Induction Balance Metal Detector, BBC Midi Interface, Variable Bench Power Supply, Pet Scarer, Audio Signal Generator. 128 pages (A4 size) **Order code EPT1** £2.45

ELECTRONICS TEACH-IN 88/89 - INTRODUCING MICROPROCESSORS

Mike Tooley BA (published by *Everyday Electronics*) A complete course that can lead successful readers to the award of a City and Guilds Certificate in Introductory Microprocessors (726/303). The book contains everything you need to know including full details on registering for assessment, etc. Starting with basic terminology, integrated circuits, logic families and numbering systems the text builds in stages, with revision and assessments built in, up to programming, languages, flow charts, etc. The course is ideal for the newcomer to the subject. 80 pages (A4 size) **Order code TI-88-89** £2.45

ELECTRONICS TEACH-IN No. 6

DESIGN YOUR OWN CIRCUITS (Published by *Everyday with Practical Electronics*) Mike Tooley BA This book is designed for the beginner and experienced reader alike, and aims to dispel some of the mystique associated with the design of electronic circuits. It shows how even the relative newcomer to electronics can, with the right approach, design and realise quite complex circuits. Fourteen individual p.c.b. modules are described which, with various detailed modifications, should allow anyone to design and construct a very wide range of different projects. Nine "hands-on" complete DIY projects have also been included so readers can follow the thinking behind design, assembly, construction, testing and evaluation, together with suggested "mods" to meet individual needs. The practical projects have each been designed to stand on their own as complete items of equipment. P.C.B.s for all the modules and projects are available by mail order.

The subjects covered in each chapter of the book are: Introduction and Power Supplies; Small Signal Amplifiers; Power Amplifiers; Oscillators; Logic Circuits; Timers; Radio; Power Control; Optoelectronics. The nine complete constructional projects are: Versatile Bench Power Supply; Simple Intercom; Bench Amplifier/Signal Tracer; Waveform Generator; Electronic Die; Pulse Generator; Radio Receiver; Disco Lights Controller; Optical Communications Link. 136 pages (A4 size) **Order code T16** £3.45

TEACH-IN No. 7 plus FREE Software ANALOGUE AND DIGITAL ELECTRONIC COURSE

(Published by *Everyday with Practical Electronics*) Alan Winstanley and Keith Dye B. Eng(Tech)AMIEE The highly acclaimed *Teach-In* series, which included the construction and use of the *Mini Lab* and *Micro Lab* test and development units, has been put together in book form. Additionally EPT Educational Software have developed a GCSE Electronics software program to compliment the course and a FREE DISC covering the first two parts of the course is included with the book. An interesting and thorough tutorial series aimed specifically at the novice or complete beginner in electronics. The series is designed to support those undertaking either GCSE Electronics or GCE Advanced Levels, and starts with fundamental principles. If you are taking electronics or technology at school or college, this book is for you. If you just want to learn the basics of electronics then this is for you. If you are teaching electronics or technology you must make sure you see it. *Teach-In No. 7* will be invaluable if you are considering a career in electronics or even if you are already training in one. The *Mini Lab* and software enable the construction and testing of both demonstration and development circuits. These learning aids bring electronics to life in an enjoyable and interesting way: you will both see and hear the electron in action! The *Micro Lab* microprocessor add-on system will appeal to higher level students and those developing microprocessor projects. 152 pages (A4 size) **Order code T17** £3.95



Computers and Computing

HOW TO CHOOSE A SMALL BUSINESS COMPUTER SYSTEM

D. Weale This book is for anyone intending to buy an IBM compatible computer system, whether it is their first system or a replacement. There are sections on hardware, application and systems programs and how to actually make your choice as well as sections on the law, ergonomics and a glossary of common terms. The text contains many useful tips and some warnings (which could save much effort and expense). 114 pages **Order code BP323** £4.95

MAKING MS-DOS WORK FOR YOU (covers version 6.2)

N. Kantanis & P. R. M. Oliver This book was written with the busy person in mind and, as such, it has an underlying structure based on "what you need to know first, appears first". Nonetheless, the book has also been designed to be circular, which means that you don't have to start at the beginning and go to the end. The book explains: How to write customised batch files which allow you to display what you want on your screen, and in the form and order you want it, instead of being forced to use the DOS prompt on a blank screen. How to design and set up a fast interactive and professional looking menu system, so that you or anyone else can run utility applications or commercial software packages easily. How the ANSI.SYS display and keyboard commands can be used to position the cursor on any part of the screen, change the intensity of the displayed characters or change their colour. How the Edit screen editor or the Edlin line editor can be used to enter ESCAPE (ANSI.SYS) commands into simple ASCII files to allow control of both your screen display and your printer. How to control the operation of the two main types of printers in use today, Epson compatible dot matrix and HP compatible laser printers. How to use several routines, such as moving and finding files, protecting files from accidental erasure,

a simplified backup process, a screen saver, and a disc cataloguing system. The Debug program and how it can be used to create, see and change the contents of any file, including those of programs written in assembler code. This includes how to find your way around the names and tasks of the CPU registers and the meeting of some simple assembler mnemonics. 182 pages **Order code BP319** £4.95

MULTIMEDIA ON THE PC

Ian R. Sinclair In this book, you'll find out what a CD ROM is, how it works, and why it is such a perfect add-on for a PC, allowing you to buy programmes, text, graphics and sound on a CD. It also describes the installation of a CD ROM drive and a sound card, pointing out the common problems that arise, and then shows how to use them to create a complete multimedia presentation that contains text, photos, a soundtrack with your own voice recorded as a commentary, even animation and edited video footage. 184 pages **Order code PC112** £11.95

A CONCISE INTRODUCTION TO MS-DOS

N. Kantanis This guide is written with the non-expert, busy person in mind and, as such, it has an underlying structure based on "what you need to know first, appears first". Nonetheless, the guide is also designed to be circular, which means that you don't have to start at the beginning and go to the end. The more experienced user can start from any section. The guide covers versions 3.0, 3.1 and 3.2 of both PC-DOS and MS-DOS as implemented by IBM and other manufacturers of "compatible" microcomputers. 64 pages **Order code BP232** £2.95

UNDERSTANDING PC SPECIFICATIONS

R. A. Penfold If you require a microcomputer for business applications, or a high quality home computer, an IBM PC or compatible is often the obvious choice. They are competitively priced, and are backed up by an enormous range of applications programs, hardware add-ons, etc. The main difficulty for the uninitiated is deciding on the specification that will best suit his or her needs. PCs range from simple systems of limited capabilities up to complex systems that can happily run applications that would have been considered beyond the abilities of a microcomputer not so long ago. It would be very easy to choose a PC system that is inadequate to run your applications efficiently, or one which goes beyond your needs and consequently represents poor value for money.

This book explains PC specifications in detail, and the subjects covered include the following: Differences between types of PC (XT, AT, 80386, etc); Maths co-processors; Input devices (keyboards, mice, and digitisers); Memory, including both expanded (EMS) and extended RAM; RAM disks and disk caches; Floppy disk drive formats and compatibility; Hard disk drives (including interleave factors and access times); Display adaptors, including all standard PC types (CGA, Hercules, Super VGA, etc); Contains everything you need to know if you can't tell your EMS from your EGA! 104 pages **Order code BP282** £4.95

AN INTRODUCTION TO 6800 ASSEMBLY LANGUAGE

R. A. & J. W. Penfold Obtain a vast increase in running speed by writing programs for 6800 based micros such as the Commodore, Amiga, Atari ST range or Apple Macintosh range etc., in assembly language. It is not as difficult as one might think and this book covers the fundamentals. 112 pages **Order code BP184** £2.95

Testing and Test Gear

HOW TO USE OSCILLOSCOPES AND OTHER TEST EQUIPMENT

R. A. Penfold
This book explains the basic function of an oscilloscope, gives a detailed explanation of all the standard controls, and provides advice on buying. A separate chapter deals with using an oscilloscope for fault finding on linear and logic circuits, plenty of example waveforms help to illustrate the control functions and the effects of various fault conditions. The function and use of various other pieces of test equipment are also covered, including signal generators, logic probes, logic pulsers, and crystal calibrators.
104 pages

Order code BP267 £3.50

Audio and Music

AN INTRODUCTION TO LOUDSPEAKERS AND ENCLOSURE DESIGN

V. Capel
This book explores the various features, good points and snags of speaker designs. It examines the whys and wherefores so that the reader can understand the principles involved and so make an informed choice of design, or even design loudspeaker enclosures for him or herself. Crossover units are also explained, the various types, how they work, the distortions they produce and how to avoid them. Finally there is a step-by-step description of the construction of the *Kapellmeister* loudspeaker enclosure.
148 pages

Order code BP256 £2.95

ACOUSTIC FEEDBACK - HOW TO AVOID IT

V. Capel
Feedback is the bane of all public address systems. While feedback cannot be completely eliminated, many things can be done to reduce it to a level at which it is no longer a problem.

Much of the trouble is often the hall itself, not the equipment, but there is a simple and practical way of greatly improving acoustics. Some microphones are prone to feedback while others are not. Certain loudspeaker systems are much better than others, and the way the units are positioned can produce or reduce feedback. All these matters are fully explored as well as electronic aids such as equalizers, frequency-shifters and notch filters.

The special requirements of live group concerts are considered, and also the related problem of instability that is sometimes encountered with large set-ups. We even take a look at some unsuccessful attempts to cure feedback so as to save readers wasted time and effort duplicating them.

Also included is the circuit and layout of an inexpensive but highly successful twin-notch filter, and how to operate it.
92 pages

Order code BP310 £3.95

PREAMPLIFIER AND FILTER CIRCUITS

R. A. Penfold
This book provides circuits and background information for a range of preamplifiers, plus tone controls, filters, mixers, etc. The use of modern low noise operational amplifiers and a specialist high performance audio preamplifier i.c. results in circuits that have excellent performance, but which are still quite simple. All the circuits featured can be built at quite low cost (just a few pounds in most cases).

The preamplifier circuits featured include: Microphone preamplifiers (low impedance, high impedance, and crystal). Magnetic cartridge pick-up preamplifiers with R.I.A.A. equalisation. Crystal/ceramic pick-up preamplifier. Guitar pick-up preamplifier. Tape head preamplifier (for use with compact cassette systems).

Other circuits include: Audio limiter to prevent overloading of power amplifiers. Passive tone controls. Active tone controls. PA filters (highpass and lowpass). Scratch and rumble filters. Loudness filter. Audio mixers. Volume and balance controls.
92 pages

Order code BP309 £3.95

COMPUTERS AND MUSIC - AN INTRODUCTION

R. A. Penfold
Computers are playing an increasingly important part in the world of music, and the days when computerised music was strictly for the fanatical few are long gone.

If you are more used to the black and white keys of a synth keyboard than the QWERTY keyboard of a computer, you may be understandably confused by the jargon and terminology bandied about by computer buffs. But fear not, setting up and using a computer-based music making system is not as difficult as you might think.

This book will help you learn the basics of computing, running applications programs, wiring up a MIDI system and using the system to good effect, in fact just about everything you need to know about hardware and the programs, with no previous knowledge of computing needed or assumed. This book will help you to choose the right components for a system to suit your personal needs, and equip you to exploit that system fully.
174 pages

Order code PC107 £8.95

ELECTRONIC PROJECTS FOR GUITAR

R. A. Penfold
This book contains a collection of guitar effects and some general purpose effects units, many of which are suitable for beginners to project building. An introductory chapter gives guidance on construction.

Each project has an introduction, an explanation of how it works, a circuit diagram, complete instructions on strip-board layout and assembly, as well as notes on setting up and using the units. Contents include: Guitar tuner; Guitar preamplifier; Guitar headphone amplifier; Soft distortion unit; Compressor; Envelope wa-wa; Phaser; Dual tracking effects unit; Noise gate/expander; Treble booster; Dynamic treble booster; Envelope modifier; Tremolo unit; DI box.
110 pages

Order code PC110 £8.95

HIGH POWER AUDIO AMPLIFIER CONSTRUCTION

R. A. Penfold
Practical constructional details of how to build a number of audio power amplifiers ranging from about 50 to 300/400 watts r.m.s. Includes MOSFET and bipolar transistor designs.
96 pages

Order code BP277 £3.95

Theory and Reference

ELECTRONIC HOBBYISTS HANDBOOK

R. A. Penfold
Provides an inexpensive single source of easily located information that the amateur electronics enthusiast is likely to need for the day-to-day pursuance of this fascinating hobby. Covers common component colour codes. Details the characteristics and pinouts of many popular semiconductor devices, including various types of logic i.c.s, operational amplifiers, transistors, FETs, unijunctions, diodes, rectifiers, SCRs, diacs, triacs, regulators and SMDs, etc. Illustrates many useful types of circuits, such as timers and oscillators, audio amplifiers and filters, as well as including a separate section on power supplies. Also contains a multitude of other useful data.
88 pages

Order code BP233 £4.95

FROM ATOMS TO AMPERES

F. A. Wilson
Explains in crystal clear terms the absolute fundamentals behind electricity and electronics. Really helps you to discover and understand the subject, perhaps for the first time ever.

Have you ever: Wondered about the true link between electricity and magnetism? Felt you could never understand the work of Einstein, Newton, Boltzmann, Planck and other early scientists? Just accepted that an electron is like a little black ball? Got mixed up with e.m.f. and p.d.? Thought the idea of holes in semiconductors is a bit much?

Then help is at hand with this inexpensive book, in as simple a way as possible and without too much complex mathematics and formulae.
244 pages

Temporarily out of print

ELECTRONICS - A "MADE SIMPLE" BOOK

G. H. Olsen
Electronic devices surround us on all sides and their numbers are increasing without mercy. Ours is the problem therefore in keeping up with this relentless expansion. Unfortunately we cannot know it all and most of us do not wish to afford the cost of large reference books which explain many concepts in fair detail. Here is an answer, an inexpensive reference guide which explains briefly (but we hope, well) many of the underlying electronics features of practical devices, most of which, to a certain extent, control our lives.

This book is in effect more than just a dictionary of practical electronics terms, it goes a stage further in also getting down to fundamentals. Accordingly the number of terms

PRACTICAL MIDI HANDBOOK

R. A. Penfold
The Musical Instrument Digital Interface (MIDI) is surrounded by a great deal of misunderstanding, and many of the user manuals that accompany MIDI equipment are quite incomprehensible to the reader.

The Practical MIDI Handbook is aimed primarily at musicians, enthusiasts and technicians who want to exploit the vast capabilities of MIDI, but who have no previous knowledge of electronics or computing. The majority of the book is devoted to an explanation of what MIDI can do and how to exploit it to the full, with practical advice on connecting up a MIDI system and getting it to work, as well as deciphering the technical information in those manuals.
128 pages

Order code PC101 £6.95

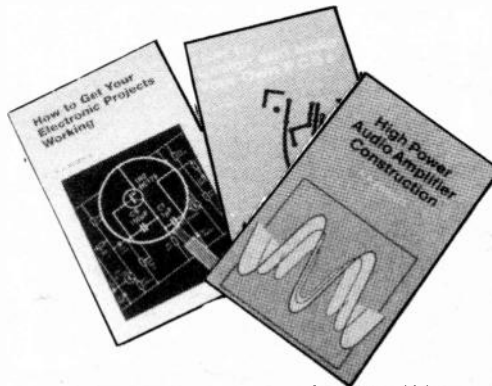

may be limited but the explanations of the many which are included are designed to leave the reader more competent and satisfied - and this is without the use of complicated mathematics which often on first reading can be confusing.

For those who also wish to get right down to the root of the matter, there is a second volume entitled *A Reference Guide to Basic Electronics Terms* (BP286), each of the books referring to its companion as necessary.

A reference guide for practically everybody concerned with electronics.
432 pages

Order code BP287 £5.95

ELECTRONIC MODULES AND SYSTEMS FOR BEGINNERS

Owen Bishop
This book describes over 60 modular electronic circuits, how they work, how to build them, and how to use them. The modules may be wired together to make hundreds of different electronic systems, both analogue and digital. To show the reader how to begin building systems from modules, a selection of over 25 electronic systems are described in detail, covering such widely differing applications as timing, home security, measurement, audio (including a simple radio receiver), games and remote control.
200 pages

Order code BP266 £3.95

Project Building

HOW TO GET YOUR ELECTRONIC PROJECTS WORKING

R. A. Penfold
We have all built projects only to find that they did not work correctly, or at all, when first switched on. The aim of this book is to help the reader overcome just these problems by indicating how and where to start looking for many of the common faults that can occur when building up projects.
96 pages

Temporarily out of print

HOW TO DESIGN AND MAKE YOUR OWN P.C.B.S

R. A. Penfold
Deals with the simple methods of copying printed circuit board designs from magazines and books and covers all aspects of simple p.c.b. construction including photographic methods and designing your own p.c.b.s.
80 pages

Order code BP121 £2.50

A BEGINNER'S GUIDE TO MODERN ELECTRONIC COMPONENTS

R. A. Penfold
The purpose of this book is to provide practical information to help the reader sort out the bewildering array of components currently on offer. An advanced knowledge of the theory of electronics is not needed, and this book is not intended to be a course in electronic theory. The main aim

is to explain the differences between components of the same basic type (e.g. carbon, carbon film, metal film, and wire-wound resistors) so that the right component for a given application can be selected. A wide range of components are included, with the emphasis firmly on those components that are used a great deal in projects for the home constructor.
166 pages

Order code BP285 £3.95

ELECTRONICS SIMPLIFIED - CRYSTAL SET CONSTRUCTION

F. A. Wilson, C.G.I.A., C.Eng., F.I.E.E., F.I.E.R.E., F.B.I.M.
Especially written for those who wish to participate in the intricacies of electronics more through practical construction than by theoretical study. It is designed for all ages upwards from the day one can read intelligently and handle simple tools.
80 pages

Order code BP92 £1.75

DESIGN YOUR OWN CIRCUITS

See the first page of books - ELECTRONICS TEACH-IN No. 6 - for full details.

ELECTRONICS PROJECT BOOK

Published by *Everyday Electronics* in association with *Magenta Electronics*. See the first page of books for full details.

Circuits and Design

PRACTICAL ELECTRONIC FILTERS

Owen Bishop

This book deals with the subject in a non-mathematical way. It reviews the main types of filter, explaining in simple terms how each type works and how it is used.

The book also presents a dozen filter-based projects with applications in and around the home or in the constructor's workshop. These include a number of audio projects such as a rhythm sequencer and a multi-voiced electronic organ.

Concluding the book is a practical step-by-step guide to designing simple filters for a wide range of purposes, with circuit diagrams and worked examples.

88 pages **Order code BP299** £4.95

ELECTRONIC ALARM CIRCUITS MANUAL

R. M. Marston

One hundred and forty useful alarm circuits, of a variety of types, are shown in this volume. The operating principle of each one is explained in concise but comprehensive terms, and brief construction notes are given where necessary.

Aimed at the practical design engineer, technician and experimenter, as well as the electronics student and amateur.

124 pages **Order code NE11** £13.95

DIGITAL GATES AND FLIP-FLOPS

Ian R. Sinclair

This book, intended for enthusiasts, students and technicians, seeks to establish a firm foundation in digital electronics by treating the topics of gates and flip-flops thoroughly and from the beginning.

Topics such as Boolean algebra and Karnaugh mapping are explained, demonstrated and used extensively, and more attention is paid to the subject of synchronous counters than to the simple but less important ripple counters.

No background other than a basic knowledge of electronics is assumed, and the more theoretical topics are explained from the beginning, as also are many working practices. The book concludes with an explanation of microprocessor techniques as applied to digital logic.

200 pages **Order code PC106** £8.95

ELECTRONIC CIRCUITS FOR THE COMPUTER CONTROL OF ROBOTS

Robert Penfold

Robots and robotics offer one of the most interesting areas for the electronics hobbyist to experiment in. Today the mechanical side of robots is not too difficult, as there are

robotics kit and a wide range of mechanical components available. The microcontroller is not too much of a problem either, since the software need not be terribly complex and many inexpensive home computers are well suited to the task.

The main stumbling block for most would-be robot builders is the electronics to interface the computer to the motors, and the sensors which provide feedback from the robot to the computer. The purpose of this book is to explain and provide some relatively simple electronic circuits which bridge this gap.

92 pages **Order code BPT79** £2.95

ELECTRONIC POWER SUPPLY HANDBOOK

Ian R. Sinclair

This book covers the often neglected topic of electronic power supplies. All types of supplies that are used for electronic purposes are covered in detail, starting with cells and batteries and extending by way of rectified supplies and linear stabilisers to modern switch-mode systems, i.c. switch-mode regulators, DC-DC converters and inverters.

The devices, their operating principles and typical circuits are all dealt with in detail. The action of rectifiers and the reservoir capacitor is emphasised, and the subject of stabilisation is covered. The book includes some useful formulae for assessing the likely hum level of a conventional rectifier reservoir supply.

136 pages **Order code PC108** £7.95

50 SIMPLE LED CIRCUITS

R. N. Soar

Contains 50 interesting and useful circuits and applications, covering many different branches of electronics, using one of the most inexpensive and freely available components - the light-emitting diode (LED). Also includes circuits for the 707 common anode display.

64 pages **Order code BP42** £1.95

BOOK 2 50 more l.e.d. circuits.

50 pages **Order code BP87** £1.95

CIRCUIT SOURCE BOOK 1

A. Penfold

Written to help you create and experiment with your own electronic designs by combining and using the various standard "building block" circuits provided. Where applicable, advice on how to alter the circuit parameters is given.

The circuits covered in this book are mainly concerned with analogue signal processing and include: Audio

amplifiers (op.amp and bipolar transistors); audio power amplifiers; d.c. amplifiers; highpass, lowpass, bandpass and notch filters; tone controls; voltage controlled amplifiers and filters; triggers and voltage comparators; gates and electronic switching; bargraphs; mixers; phase shifters, current mirrors, hold circuits, etc.

Over 150 circuits are provided, which it is hoped will be useful to all those involved in circuit design and application, be they professionals, students or hobbyists.

182 pages **Order code BP321** £4.95

CIRCUIT SOURCE BOOK 2

R. A. Penfold

This book will help you to create and experiment with your own electronic designs by combining and using the various standard "building blocks" circuits provided. Where applicable, advice on how to alter the circuit parameters is provided.

The circuits covered are mainly concerned with signal generation, power supplies, and digital electronics.

The topics covered in this book include: 555 oscillators; sinewave oscillators; function generators; CMOS oscillators; voltage controlled oscillators; radio frequency oscillators; 555 monostables; CMOS monostables; TTL monostables; precision long timers; power supply and regulator circuits; negative supply generators and voltage boosters; digital dividers; decoders, etc; counters and display drivers; D/A and A/D converters; opto-isolators, flip/flops, noise generators, tone decoders, etc.

Over 170 circuits are provided, which it is hoped will be useful to all those involved in circuit design and application, be they professionals, students or hobbyists.

192 pages **Order code BP322** £4.95

HOW TO USE OP. AMPS

E. A. Parr

This book has been written as a designer's guide covering many operational amplifiers, serving both as a source book of circuits and a reference book for design calculations. The approach has been made as non-mathematical as possible.

160 pages **Order code BP88** £2.95

A BEGINNER'S GUIDE TO TTL DIGITAL ICs

R. A. Penfold

This book first covers the basics of simple logic circuits in general, and then progresses to specific TTL logic integrated circuits. The devices covered include gates, oscillators, timers, flip/flops, dividers, and decoder circuits. Some practical circuits are used to illustrate the use of TTL devices in the "real world".

142 pages **Order code BP332** £4.95

Radio, TV, Satellite

PROJECTS FOR RADIO AMATEURS AND S.W.L.S.

R. A. Penfold

This book describes a number of electronic circuits, most of which are quite simple, which can be used to enhance the performance of most short wave radio systems.

The circuits covered include:- An aerial tuning unit; A simple active aerial; An add-on b.f.o. for portable sets; A wavetrapp to combat signals on spurious responses; An audio notch filter; A parametric equaliser; C.W. and S.S.B. audio filters; Simple noise limiters; A speech processor; A volume expander.

Other useful circuits include a crystal oscillator, and RTTY/C.W. tone decoder, and a RTTY serial to parallel converter. A full range of interesting and useful circuits for short wave enthusiasts.

92 pages **Order code BP304** £3.95

AN INTRODUCTION TO AMATEUR RADIO

I. D. Poole

Amateur radio is a unique and fascinating hobby which has attracted thousands of people since it began at the turn of the century.

This book gives the newcomer a comprehensive and easy to understand guide through the subject so that the reader can gain the most from the hobby. It then remains an essential reference volume to be used time and again. Topics covered include the basic aspects of the hobby, such as operating procedures, jargon and setting up a station. Technical topics covered include propagation, receivers, transmitters and aerials etc.

150 pages **Order code BP257** £3.50

AERIAL PROJECTS

R. A. Penfold

The subject of aerials is vast but in this book the author has considered practical aerial designs, including active, loop and ferrite aerials which give good performances and are relatively simple and inexpensive to build. The complex theory and mathematics of aerial design have been avoided.

Also included are constructional details of a number of aerial accessories including a pre-selector, attenuator, filters and a tuning unit.

96 pages **Order code BPT05** £2.50

SIMPLE SHORT WAVE RECEIVER CONSTRUCTION

R. A. Penfold

Short wave radio is a fascinating hobby, but one that seems to be regarded by many as an expensive pastime these days. In fact it is possible to pursue this hobby for a minimal monetary outlay if you are prepared to undertake a bit of d.i.y., and the receivers described in this book can all be built at low cost. All the sets are easy to construct, full wiring diagrams etc. are provided, and they are suitable for complete beginners. The receivers only require simple aerials, and do not need any complex alignment or other difficult setting up procedures.

The topics covered in this book include: The broadcast bands and their characteristics; The amateur bands and their

characteristics; The propagation of radio signals; Simple aerials; Making an earth connection; Short wave crystal set; Simple t.r.f. receivers; Single sideband reception; Direct conversion receiver.

Contains everything you need to know in order to get started in this absorbing hobby.

88 pages **Order code BP275** £3.95

AN INTRODUCTION TO AMATEUR COMMUNICATIONS SATELLITES

A. Pickford

Communications and broadcast satellites are normally inaccessible to individuals unless they are actively involved in their technicalities by working for organisations such as British Telecom, the various space agencies or military bodies. Even those who possess a satellite television receiver system do not participate in the technical aspects of these highly technological systems.

There are a large number of amateur communications satellites in orbit around the world, traversing the globe continuously and they can be tracked and their signals received with relatively inexpensive equipment. This equipment can be connected to a home computer such as the BBC Micro or IBM compatible PCs, for the decoding of received signals.

This book describes several currently available systems, their connection to an appropriate computer and how they can be operated with suitable software.

102 pages **Order code BP290** £3.95

INTERNATIONAL RADIO STATIONS GUIDE

P. Shore

Provides the casual listener, amateur radio DXer and the professional radio monitor with an essential reference work designed to guide him or her around the ever more complex radio bands. This new edition has been completely revised and rewritten and incorporates much more information which is divided into the following sections:

Listening to Short Wave Radio; Choosing a Short Wave Radio Receiver; How to Use the IRSG; Abbreviations; County Codes; Worldwide Short Wave Radio Stations; European, Middle Eastern and African Long Wave Radio Stations; European, Near and Middle Eastern and African Medium Wave Radio Stations; Canadian Medium Wave Radio Stations; USA Medium Wave Radio Stations; Broadcasts in English; Programmes for DXers and Short Wave Listeners; UK FM Radio Stations; Time Differences From GMT; Wavelength/Frequency Conversion.

226 pages **Order code BP255** £5.95

DIRECT BOOK SERVICE ORDERING DETAILS

Please state the title and order code clearly, print your name and address and add the required postage to the total order.

Add £1.50 to your total order for postage and packing (overseas readers add £3 for countries in the EEC, or add £6 for all countries outside the EEC, surface mail postage) and send a PO, cheque, international money order (£ sterling only) made payable to **Direct Book Service** or credit card details (including card expiry date), Visa or Mastercard (Access) - minimum credit card order is £5 - quoting your name and address, the order code and quantities required to **DIRECT BOOK SERVICE, 33 GRAVEL HILL, MERLEY, WIMBORNE, DORSET BH21 1RW (mail order only).**

Although books are normally sent within seven days of receipt of your order, please allow a maximum of 28 days for delivery. Overseas readers allow extra time for surface mail post.

Please check price and availability (see latest issue of *Everyday with Practical Electronics*) before ordering from old lists.

For a further selection of books see next month's issue.

DIRECT BOOK SERVICE IS A DIVISION OF WIMBORNE PUBLISHING LTD.

BABANI BOOKS

We now supply *all* the books published by Bernard Babani (Publishing) Ltd. We have always supplied a selected list of Babani books and you will find many of them described on the previous pages or in next month's issue of *Everyday with Practical Electronics* (all books with a BP prefix to the order code are Babani books). Many readers have asked us to also supply various other Babani books, which have a reputation for value for money.

Our customers tell us they appreciate our speedy service and low postage charge and they would like to be able to purchase all the books from us and thus keep the postage charge to an absolute minimum (**£1.50 for UK p&p no matter how many books you buy**). We are pleased to be able to respond; we are now able to meet all your requirements for Babani books.

Code	Title	Price	Code	Title	Price	Code	Title	Price
BP37	50 Projects using Relays, SCRs and TRIACS	£2.95	BP250	Programming in FORTRAN 77	£4.95	BP313	A Concise Introduction to Sage	£3.95
BP39	50 (FET) Field Effect Transistor Projects	£2.95	BP251	Computer Hobbyists Handbook	£5.95	BP314	A Concise Introduction to Quattro Pro 3.0	£4.95
BP44	IC 555 Projects	£2.95	BP258	Learning to Program in C (revised edition)	£4.95	BP315	An Introduction to the Electromagnetic Wave	£4.95
BP48	Electronic Projects for Beginners	£1.95	BP259	A Concise Introduction to UNIX	£2.95	BP317	Practical Electronic Timing	£4.95
BP49	Popular Electronic Projects	£2.50	BP260	A Concise Introduction to OS/2	£2.95	BP320	Electronic Projects for Your PC	£3.95
BP56	Electronic Security Devices	£2.95	BP261	A Concise Introduction to Lotus 1-2-3 (revised edition)	£3.95	BP322	Circuits Source Book 2	£4.95
BP74	Electronic Music Projects	£2.95	BP262	A Concise Introduction to WordPerfect (revised edition)	£3.95	BP324	The Art of Soldering	£3.95
BP76	Power Supply Projects	£2.50	BP264	A Concise Advanced User's Guide to MS-DOS (revised edition - covers version 6.2)	£4.95	BP326	A Concise Users Guide to Windows 3.1	£4.95
BP78	Practical Computer Experiments	£1.75	BP269	An Introduction to Desktop Publishing	£5.95	BP327	An Introduction to Satellite Communications	£5.95
BP84	Digital IC Projects	£1.95	BP273	Practical Electronic Sensors	£4.95	BP328	DOS One Step at a Time (covers Version 6.2)	£3.95
BP90	Audio Projects	£2.50	BP274	A Concise Introduction to SuperCalc5	£4.95	BP329	Sage Explained	£5.95
BP95	Model Railway Projects	£2.95	BP276	Short Wave Superhet Receiver Construction	£2.95	BP330	Electronic Music Learning Projects	£4.95
BP115	The Pre-computer Book	£1.95	BP280	Getting the Most From Your PC's Hard Disk	£3.95	BP331	A Concise User's Guide to Lotus 1-2-3 Release 2.4	£4.95
BP125	25 Simple Amateur Band Aerials	£1.95	BP283	A Concise Introduction to SmartWare II	£4.95	BP333	A Beginners Guide to MIDI	£4.95
BP126	BASIC & PASCAL in Parallel	£1.50	BP284	Programming in QuickBASIC	£4.95	BP334	Magic Electronics Projects	£4.95
BP132	25 Simple SW Broadcast Band Aerials	£1.95	BP291	A Concise Introduction to Ventura	£3.95	BP336	A Concise Users Guide to Lotus1-2-3 Release 3.4	£5.95
BP136	25 Simple Indoor and Window Aerials	£1.75	BP292	Public Address Loudspeaker Systems	£3.95	BP337	A Concise Users Guide to Lotus1-2-3 for Windows	£5.95
BP144	Further Practical Electronics Calculations & Formulae	£4.95	BP293	An Introduction to Radio Wave Propagation	£3.95	BP338	A Concise Introduction to Word for Windows	£5.95
BP145	25 Simple Tropical and MW Band Aerials	£2.95	BP294	A Concise Introduction to Microsoft Works (revised edition)	£4.95	BP339	A Concise Introduction to WordPerfect 5.2 for Windows	£5.95
BP147	An Introduction to 6502 Machine Code	£2.95	BP298	A Concise Introduction to the Mac System & Finder	£3.95	BP343	A Concise Introduction to Microsoft Works for Windows	£5.95
BP148	Computer Terminology Explained	£1.95	BP301	Antennas for VHF and UHF	£4.95	BP345	Getting Started in Practical Electronics	£4.95
BP171	Easy Add-on Projects for Amstrad CPC 464, 664, 612B and MSX Computers	£2.95	BP303	Understanding PC Software	£4.95	BP349	Practical Opto-Electronic Projects	£4.95
BP176	A TV-DXers Handbook (revised edition)	£7.95	BP305	Learning CAD with AutoSketch for Windows	£5.95	BP350	Electronic Board Games	£4.95
BP182	MIDI Projects	£2.95	BP306	A Concise Introduction to Ami Pro 3	£4.95	BP353	WordPerfect 6.0 for Windows Explained	£5.95
BP190	More Advanced Electronic Security Projects	£2.95	BP307	A Concise Introduction to QuarkXPress	£4.95	BP354	Word 6 for Windows Explained	£5.95
BP192	More Advanced Power Supply Projects	£2.95	BP308	A Concise Introduction to Word 5.1 on the Macintosh	£5.95	BP360	A Practical Introduction to Sage Sterling + 2 for Windows	£4.95
BP193	LOGO for Beginners	£2.95	BP311	An Introduction to Scanners and Scanning	£4.95	BP363	Practical Electronic Music Projects	£4.95
BP196	BASIC & LOGO in Parallel	£2.95	BP312	An Introduction to Microwaves	£3.95	BP368	Practical Electronic Musical Effects Units	£4.95
BP198	An Introduction to Antenna Theory	£2.95						
BP230	A Concise Introduction to GEM	£2.95						
BP243	BBC BASIC86 on the Amstrad PCs and IBM Compatibles - Book 1: Language	£3.95						
BP244	BBC BASIC86 on the Amstrad PCs and IBM Compatibles - Book 2: Graphics and Disk Files	£3.95						
BP245	Digital Audio Projects	£2.95						
BP246	Musical Applications of the Atari ST's	£5.95						
BP247	More Advanced MIDI Projects	£3.95						
BP249	More Advanced Test Equipment Construction	£3.50						

IF NO PRICE IS SHOWN THE BOOK IS OUT OF PRINT (O.O.P.)
SEE PREVIOUS PAGE FOR FULL ORDERING DETAILS

PCB SERVICE

Printed circuit boards for certain EPE constructional projects are available from the PCB Service, see list. These are fabricated in glass fibre, and are fully drilled and roller tinned. All prices include VAT and postage and packing. Add £1 per board for airmail outside of Europe. Remittances should be sent to The PCB Service, *Everyday with Practical Electronics*, Allen House, East Borough, Wimborne, Dorset BH21 1PF. Cheques should be crossed and made payable to *Everyday with Practical Electronics* (Payment in £ sterling only).

NOTE: While 95% of our boards are held in stock and are dispatched within seven days of receipt of order, please allow a maximum of 28 days for delivery - overseas readers allow extra if ordered by surface mail.

Back numbers or photostats of articles are available if required - see the *Back Issues* page for details.

Please check price and availability in the latest issue.

Boards can only be supplied on a payment with order basis.

Special KNOCK DOWN SALE of PCB's.

We have a few p.c.b.s left from past projects these are being offered at the knock down price of **£1.00 each** - no matter what size they are (some of these boards are worth over £10.00 each) while stocks last. This price includes VAT and UK post - overseas orders please add 50p postage (or £1 per board for airmail postage).

Tea Tune Thermostat 609; Suntan Timer 610; Time Switch 614; Doorbell Delay 616; Midi Pedal 639; Midi Merge 640; Audio Lead Tester 641; Music on Hold 646; Power Supply 25V 700mA 656; Stereo Noise Generator 681; Amstrad Speech Synthesiser 689; Hand Tally, main board 699 and display board 700; Ghost Waker 703; Amstrad PCW Sound Generator 715; Automatic Light Control - PSU board 747 and logic board 748; Modular Disco Lights - Simple Chaser 745 - Masterlink 752 - Pattern Generator 760 - Dimmer Interface 765 - VU Sound Module 767 - Superchaser 771 - Supersweep 772; UV Exposure Unit 768; Bicycle Alarm 773; Klockerbox 775; Auto Nightlight 779; Mind Machine - Programmer Board 780; Transistor Checker 781; Micro-Sense Alarm 783; Telesound 784; Programmable Timer, 785; Auto Garage Light 786; Versatile BBC Computer Interface, 787; Economy Seven Timer, 788.

Any of the above for just £1 each inc. VAT and p&p.

Back numbers or photostats of articles are available see the *Back Issues* page for details.

£1.00 EACH inc. VAT and p&p

PROJECT TITLE	Order Code	Cost
Sonic Continuity Tester	789	£4.79
Telephone Ringer	790	£5.46
Experimental Weighing Scale	792	£5.17
12V Drill Charger/PSU (both boards)	793	£5.31
Digital Servo Interface	791	£4.73
Tie Pulsar	794	£5.19
CCD Reverb Unit	795	£6.39
Switch-Mode Power Supply	796	£7.01
UV Exposure Timer	797	£5.33
Cricketer Game	798	£6.77
Quick Prom	799	£5.61
Gas Alarm	800	£5.47
Dual Metronome	801	£6.74
Ultrasonic Tape Measure	802	£6.06
Quicktest	803	£4.82
Traffic Lights System	806	£5.04
Mini Lab	MINI LAB	£14.95
EPE Altimeter (Altimeter)	807	£6.30
Personal Stereo Amplifier	808	£6.47
Universal Infra-Red Remote Control	811T/811R	£6.56
Combination Switch	812	£5.68
Christmas Lights Colour Spectrum	813	£5.97
TV/UHF Aerial Amp (double-sided)	814	£7.23
Continuously Variable Balanced Power Supply	815	£5.65
Emergency Lighting Unit	816	£6.77
Car Electric Window Enhancer	821	£5.00
Simplify Atari STFM Interface	822	£5.55
Personal Stereo Amp. Add-On	823	£3.90
Electronic Fire	820	£4.84
Mind Machine MkII - Signal Generator	824	£5.57
Ventilation Fan Timer	825	£4.70
Universal Data Logger	826	£5.88
Mind Machine MkII - Magic Lights	827	£6.58
Superhet Radio Control Receiver	828	£5.93
Guitar Preamp and Distortion Unit	829	£5.46
Linear Clock - Timing Board	830	£8.00
Display Board	831	£7.00
Universal Alarm Module	9070	£3.00

PROJECT TITLE	Order Code	Cost
Electronic Snooker Scoreboard	832	£9.17
Mind Machine MkII		
- Computer Interface	833	£6.39
Xenon Strobe	834	£5.84
Electronic Gong	835	£7.50
Micro Lab - p.c.b., EPROM, PAL and booklet	MICRO	£35.00
Bike Odometer (pair of boards)	836/7	£7.00
Amstrad PCW A to D Converter (double-sided)	838	£9.85
Experimental Electronic Pipe Descaler	839	£5.50
Sound Activated Camera Trigger	840	£5.34
L.E.D. Sandglass		
Main and Display boards	841/2	£7.30
Kettle Alert	843	£5.19
Linear Power Supply (double-sided)	844	£9.77
Multi-Purpose Audio System		
Six Channel Stereo Mixer	845	£11.98
Multi-Purpose Audio System		
Microphone Pre-Amp module	846	£4.88
RIAA Pre-Amp module	847	£5.11
20 Metre Receiver	848	£6.63
Multi-Purpose Audio System		
Tone Control and 1W Stereo Amplifier	849	£6.09
Tone Control	850	£5.12
1W Stereo Amplifier	851	£4.88
Three-Way Christmas Tree Lights Flasher	853	£5.65
Auto Alarm	854	£5.49
250W/600W Battery to Mains Inverter	855	£13.92
Multi-Purpose Audio System		
10W + 10W Stereo Power Amplifier		
Amplifier	852a	£5.65
Power Supply	852b	£5.49
Pond Heater Thermostat	856	£5.77
Timer/NiCad Capacity Checker	857	£6.30
Multi-Purpose Audio System		
Balanced Microphone Preamplifier	858	£5.30
Balanced Microphone Power Supply	859	£5.14
Whistle Controlled Light Switch	860	£5.19
Battery to Mains Inverter - U.P.S. charger board	862	£7.38
Three Phase Generator	861	£5.95
Visual Doorbell	863	£5.80
CCD TV Camera - Control Board		
(double-sided, plated-through-hole)	865	£15.00
Telephone Ring Detector	864	£4.72
CCD TV Camera		
Combined Video, Test & Ext Plug Boards	866a/e	£11.00
Frame Grab Control	867	£15.00
(double-sided plated-through-hole)		
EPE Sound DAC PC Sound Board	868	£4.77
MOSFET Variable Bench Power Supply	869	£5.80
L.E.D. Matrix Message Display Unit		
Display Board	870	£18.00
CPU Board	871	£7.20
Stereo Noise Gate	873	£6.14
Simple TENS Unit	875	£5.84
Capacitance/Inductance Meter	876	£6.44
Advanced TENS Unit	877	£6.56
Digital Water Meter - Scaler	878	£11.19
Counter/Display	879	pair
L.E.D. Matrix Message Display Unit		
Keypad	872	£5.19
PC Interface	880	£5.82
Microprocessor Smartswitch	881	£5.61
Microcontroller P.I. Treasure Hunter	882	£6.60
Print Timer	874	£5.82
Watering Wizard	883	£6.60
Simple NiCad Charger	884	£4.98
Voxbox	885	£6.90
Stereo HiFi Controller - 1 Power Supply	886	£5.66
Stereo HiFi Controller - 2		
Main Board	887	£7.39
Expansion/Display Boards (pair)	888	£9.80
Dancing Fountains - 1		
Pre.amp	889	£5.28
Pump Controller	890	£5.41
Filter	891	£5.23
6802 Microprocessor Development Board	894	£9.15
Dancing Fountains - 2		
PC-Compatible Interface (double-sided)	892	£10.90
Automatic Greenhouse Watering System	895	£5.33
Seismograph - 1 Sensor/Filter	896	£6.23
Clock/Mixer	897	£5.87
3-Channel Lamp Controller	899	£8.17
Seismograph - 2		
PC-Compatible Interface (double-sided)	898	£10.72
Visual/Audio Guitar Tuner	900	£7.55
Digilogue Clock	901	£12.50
Hobby Power Supply	902	£5.00
Audio Auxplexer		
Control Board	903	£7.72
Receiver	904	£6.24

PROJECT TITLE	Order Code	Cost
Power Controller	905	£4.99
1000V/500V Insulation Tester	906	£5.78
Active Guitar Tone Control	907	£4.50
TV Off-er (pair)	908/909	£7.25
Video Modules - 1		
Simple Fader	910	£5.12
Improved Fader	911	£6.37
Video Enhancer	912	£5.15
Rodent Repeller	913	£6.26
EPE Fruit Machine	914	£8.14
Video Modules - 2		
Horizontal Wiper	916	£6.23
Vertical Wiper	917	£6.35
4-Channel Audio Mixer	918	£6.20
Spacewriter Wand	921	£4.00
Universal Digital Code Lock	922	£6.25
Video Modules -		
3 Dynamic Noise Limiter	919	£5.92
System Mains Power Supply	920	£4.98
Magnetic Field Detector	923	£5.77
Model Railway Track Cleaner	924	£5.11
Moving Display Metronome	925	£6.24
The Ultimate Screen Saver	927	£5.66
Foot-Operated Drill Controller	928	£5.73
Model Railway Signals	929	£5.96
12V 35W PA Amplifier	930	£12.25
Multi-Purpose Thermostat	931	£6.30
Multi-Project PCB	932	£3.00
Sound-Activated Switch		
Audio Amplifier		
Light Beam Communicator (2 boards required)		
Multi-Project PCB		
Light-Activated Switch	932	£3.00
Switch On/Off Timer		
Continuity Tester		
Auto Battery Charger	934	£5.36
National Lottery Predictor	935	£5.34
R.F. Signal Generator		
R.F./Mod.	936	£6.48
Coil & Power Supply (pair)	937a/b	£6.10
MIDI Pedal	938	£7.78
Club Vote Totaliser	939	£6.05
PIC-DATS Development System		
(double-sided p.t.h.)	940	£9.90
EPE HiFi Valve Amplifier -		
Phase splitter	941	£6.71
PIC-DATS 4 -channel Light Chaser	942	£7.90
HV Capacitor Reformer	943	£5.60
Ramp Generator		
Logic Board (double-sided p.t.h.) & Analogue		
board (pair)	944/5	£32.00
Automatic Curtain Winder	946	£6.75
Windicator	947	£4.10
Microcontrolled 3-Digit Timer	933	£6.61
IR Remote Control - Transmitter	948	£5.76
- Receiver	949	£6.14
Personal Practice Amplifier	950	£6.09

EPE PRINTED CIRCUIT BOARD SERVICE

Order Code Project Quantity Price

Name.....

Address.....

I enclose payment of £..... (cheque/PO in £ sterling only) to:



Everyday with
Practical Electronics



Access (MasterCard) or Visa No.
Minimum order for credit cards £5

--	--	--	--	--	--	--	--	--	--

Signature..... Card Exp. Date.....

Please supply name and address of cardholder if different from the address shown



A mini FM transmitter, very high gain preamp, supplied complete with FET electret microphone. Designed to cover 88-108 Mhz but it is easy to change it to cover 63-130Mhz. Works with a common 9v (PP3) battery. 0.2W RF. £8.22 Kit no 1001.



Electronic siren kit with an impressive 5 watt power output. Ideal for car/bike alarms etc. 6-12vdc, max current 1A, tone frequency 1.2kHz. £7.05 Kit no 1003.



3-30v Power supply, variable, stabilized power supply for laboratory use. Short circuit protected, suitable for professional or amateur applications. 24v 3A transformer is also needed to complete the kit. £16.45 Kit 1007.



Powerful 1 watt FM transmitter supplied complete with piezoelectric microphone. 8-30vdc. At 25-30v you will get nearly 2 watts. £14.10 Kit no 1009.



FM/AM Scanner, well not quite you have to turn the knob yourself but you will hear things on this radio (even TV) that you would not hear on an ordinary radio! Receiver covers 50-160Mhz both AM and FM. Built in 5 watt amplifier. £17.62 Kit no 1013.



Mosquito repeller, modern way to keep midges at bay! Runs for about a month on a 1.5v battery. £8.22 Kit no 1015.



3 channel wireless sound to light system, mains operated, separate sensitivity adjustment for each channel, 1,200 watt power handling. Microphone included. £16.45 Kit no 1014.



Motorbike/cycle trembler alarm, adjustable sensitivity, preset alarm time, auto reset. Could be connected to bikes horn etc. £14.10 Kit no 1011



0-5 minute timer, adjustable from 0 to 5 mins, will switch up to 2A mains. Perfect for alarms, photographic laboratories etc. 12vdc. £8.22 Kit no 1020.



4 watt FM transmitter, small but powerful transmitter, 3 RF stages, microphone and an audio preamp include in kit. £23.50 Kit no 1028.



25 watt FM transmitter 4 RF stages, preamp required (our kit 1068 is suitable). Due to the complexity of the transmitter it is supplied in built up form only. £92.82 Kit no 1031.



Strobe light, adjustable frequency from 1- to 60 Hz (a lot faster than conventional strobes) mains operated. £18.80 Kit no 1037.



Ultrasonic radar ideal as a movement detector with a range of about 10 metres, automates your cat flap! 12v operation so ideal for cars, caravans etc. £16.45 Kit 1049.

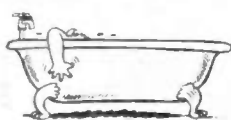

Liquid level detector useful for detecting fluid levels in tanks, fishponds, baths or as a rain or leak alarm. Will switch 2A mains. £5.87 Kit no 1081.



Combination lock 9 key, easily programmable, will switch 2A mains. Complete with keypad. 9v operation. £11.75 Kit 1114.



Phone bug detector, this device will warn you if somebody is eavesdropping on your phone line. £7.05 Kit no 1130.



Robot voice, interesting circuit that distorts your voice! adjustable, answer the phone with a different voice! 12vdc £10.57 Kit no 1131.

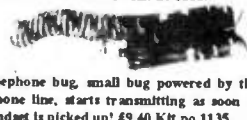

Telephone bug, small bug powered by the telephone line, starts transmitting as soon as the handset is picked up! £9.40 Kit no 1135.



function generator, produces sinusoidal, saw tooth and square waves adjustable from 20hz-20khz, separate level controls for each shape. Will produce all 3 together. 24vac £17.62 Kit no 1008.



3 Channel light chaser, 800 watts per channel, speed and direction controls supplied with 12 leds and mains triacs, so you can use mains light bulbs if you want. 9-15vdc £19.97 Kit no 1026.



12v fluorescent. A useful kit that will enable you to light 4' fluorescent tubes from your car battery! (you will also need a 9v 2A transformer, not supplied) £9.40 Kit no 1069.



VOX switch, sound activated switch ideal for turning tape recorders on and off when sounds are heard. Makes the tape last a lot longer! adjustable sensitivity, built in delay. £9.40 Kit 1073.



Incar sound to light, Put some atmosphere in your car with this mini 3 channel sound to light. Each channel has 6 leds. £11.75 Kit no 1086.

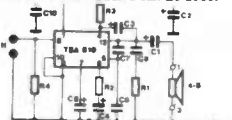

7 watt HI FI power amplifier useful, powerful, ideal for intercomms, audio systems, car use etc. 12-18vdc 500mA. £8.22 Kit No 1025.



Phone call relay, useful device that operates a relay when ever the 'phone rings, could be used to operate more bells or signalling lights etc. Will switch mains at 2A. £11.75 Kit no 1122.



Lead acid charger, two automatic charging rates, visual indication of battery state, ideal for alarm systems, emergency lighting etc. 100mA 12vdc. £14.10 Kit no 1095.



Car alarm system, works on voltage drop and/or vibration, entry and exit delays plus adjustable alarm duration. Good for cars, caravans etc. £14.10 Kit no 1019.

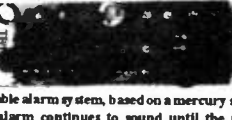

Portable alarm system, based on a mercury switch. The alarm continues to sound until the unit is disabled by the owner. Buzzer included. £12.92 Kit no 1150.



Preamp mixer, 3 input mono mixer, separate bass and treble controls plus independent level controls. 18vdc, input sens 150mv. 100mA. £17.62 Kit no 1052.



Mini metal detector, suitable for locating pipes in walls etc, range 15-20 cm, complete with case. 9v operation. £9.40 Kit no 1022.



800 watt single channel sound to light kit, mains operated, add rhythm to your party for only £9.40 Kit no 1006.



Sound effects generator, produce sounds ranging from bird chirps to sirens, complete with speaker, add sound effects to your projects for just £10.57 Kit no 1045.



Guitar preamp with tone controls, small enough to fit inside any guitar, based on TL082 IC, 9-12vdc, 50mA. £9.40 Kit no 1091.



15 watt FM transmitter, 4 stage high power, preamp required. 12-18vdc. Can use either ground plane, open dipole, or Yagi. Supplied in built form only at £81.07 Kit 1021.



Telephone amplifier, Very sensitive amplifier which uses a 'phone pickup coil (supplied) will let you follow a conversation without holding the phone. £12.92 Kit no 1059.

TOP 10 BEST SELLING KITS CORNER

1. Variable speed control kit for 12v DC motors up to 30A! (you may need a heat sink for 30A) £19.97.
2. Composite video kit, converts composite signals into separate Hsync, Vsync and video £9.40.
3. Geiger counter kit, contains everything you need to build a working counter £22.32.
4. Solar energy kit, contains a solar panel, motor, buzzer and cable for experiments £5.87.
5. Electronic acupuncture kit, may help with migraine, poor circulation, backache etc. £8.22.
6. Electrifying apparatus kit, produces a weak adjustable high tension of 80-300v from a 9v battery, ideal for catching worms etc! £9.40.
7. Adapter bug kit, contains everything you need to build a professional bug built inside a standard 13A mains adapter! the bug is mains powered so it operates all the time the adapter is plugged in. Price is £16.45 for the complete kit including adapter. Hand tools and glue required.
8. Nicad charger kit automatic charger for cells from 1.2v to 15v, 7 settings 50600mA, transformer required 18-20v 600mA. £9.40.
- 9&10. Inverter kits, produce 240vac from a 12vdc supply, two versions are available a 15w one at £14.10, and an 80w version at £23.50.

EXPRESS COMPONENTS

how to order.....
Remember to add £1.50 p&p.
By phone with a credit card.
By post with either a cheque, postal order or credit card details.
By fax with credit card details.
EXPRESS COMPONENTS, PO BOX 517 HOVE SUSSEX BN3 5QZ. DEPT EE
TEL 01273 771156
FAX 01273 206875
Overseas orders please add £3.50 post and packing.

EVERYDAY CLASSIFIED
 With **PRACTICAL**
ELECTRONICS

Everyday with Practical Electronics reaches nearly twice as many UK readers as any other independent monthly hobby electronics magazine, our audited sales figures prove it. We have been the leading independent monthly magazine in this market for the last ten years

If you want your advertisements to be seen by the largest readership at the most economical price our classified and semi-display pages offer the best value. The prepaid rate for semi-display space is £8 (+ VAT) per single column centimetre (minimum 2.5cm). The prepaid rate for classified adverts is 30p (+ VAT) per word (minimum 12 words).

All cheques, postal orders, etc., to be made payable to Everyday with Practical Electronics. **VAT must be added.** Advertisements, together with remittance, should be sent to Everyday with Practical Electronics Advertisements, Holland Wood House, Church Lane, Great Holland, Essex CO13 0JS. Phone/Fax (01255) 850596.

For rates and information on display and classified advertising please contact our Advertisement Manager, Peter Mew as above.

RCS VARIABLE VOLTAGE D.C. BENCH POWER SUPPLY
 1 to 24 volts up to ½ amp 1 to 20 volts up to 1 amp. 1 to 16 volts up to 1½ amps d.c. Fully stabilised. Twin panel meters for instant voltage and current readings. Overload protection.
 Fully variable.
 Operates from 240V a.c.
 Compact unit.
 Size 9 x 5½ x 3in.
NEW MODEL. Up to 38volts d.c. at 6 amps 10 amps peak. Fully variable. Twin panel meters. Size 14½ x 11 x 4½in. £45 inc VAT. Carr £6.



£45 inc. VAT
 + Post and insurance £4

RADIO COMPONENT SPECIALISTS
 337 WHITEHORSE ROAD, CROYDON SURREY, U.K. Tel: 0181-684 1665

Lots of transformers, high volt caps, valves, speakers, in stock. Phone or send your wants list for quote.

BTEC ELECTRONICS TECHNICIAN FULL-TIME TRAINING
 THOSE ELIGIBLE CAN APPLY FOR E.T. GRANT SUPPORT AN EQUAL OPPORTUNITIES PROGRAMME
 O.N.C., O.N.D. and H.N.C.
 Next course commences
Monday 18th September 1995
 FULL PROSPECTUS FROM

LONDON ELECTRONICS COLLEGE (Dept EPE) 20 PENYWERN ROAD EARLS COURT, LONDON SW5 9SU TEL: 0171-373 8721

Miscellaneous contd.

MIDI LIGHTING MODULE, eight 500w channels, 64 levels, 127 presets, assembled and tested. Requires 20V AC supply and case. Cheques for £59, made payable to Technology Direct, 27 Hartland Grove, Priestfield, Middlesbrough, Cleveland TS3 0HL.

LASER POINTERS 5mW 670nm (RED). German quality, £69.50 post paid. Also complete He-Ne Laser systems from £85.00. Telephone 01925 575848 for details. Cheques or PO to, English Scientific, 12 Orford Avenue, Warrington, Cheshire, WA2 7QL.

PLASTIC INJECTION MOULDING at prices you can afford. Very low cost (sometimes free) Tooling. Small quantities speciality. 01685 (Aberdare) 874763.

PIC CHIP PROGRAMMER. Low cost solution, uses PC printer port, full constructional details, £20. I. Bailey, 15 Mount Road, Fleetwood FY7 6EZ.

TEACH YOURSELF P.L.C. Toshiba EX20 Programmable controller, complete with LCD programmer and user guide. £45. Tel: 0115 9894416.

HF AM/SSB/CW WORLDWIDE RECEIVER. Build your own using High Quality chip. Easy to construct and inexpensive. For details send s.a.s.e. to D. Levi, Dunjop Brae, Bridge of Dee, Castle Douglas DG7 2AE.

100 WATT RACK AMPLIFIERS. £20.00, + regulated, ± 50 volt, power supply, + mains lead, + directions. K.I.A., 1 Regent Road, Ilkely, Modules, 60 watt, £6.00.

COMPLETE GUIDE to building a P.C. details send S.S.A.E. D. Bryan, MAYEP, 19 Acie Gdns., Bulwell, Nottingham NG6 8NY.

DIRT CHEAP unusual PC gadgets. Amazing pack, Circuits, Information, Software. Digitising, Satellite, Infra-red Transmitter, PICs, Eproms, Cellular, Diagnostics, Cabling, Interfaces, Much more! £15. 01633 276135.

This 3cm space in
 Everyday with
 Practical Electronics
 will ONLY cost you
£24 + VAT

THE BRITISH AMATEUR ELECTRONICS CLUB
 exists to help electronics enthusiasts by personal contact and through a quarterly Newsletter.
 For membership details, write to the Secretary:
Mr. J. F. Davies, 70 Ash Road, Cuddington, Northwich, Cheshire CW8 2PB.
 Space donated by Everyday with Practical Electronics

Miscellaneous

PROTOTYPE PRINTED CIRCUIT BOARDS one offs and quantities, for details send s.a.e. to B. M. Ansbro, 38 Poynings Drive, Hove, Sussex BN3 8GR, or phone Brighton 883871.

G.C.S.E. ELECTRONICS KITS, at pocket money prices. S.A.E. for FREE catalogue. SIR-KIT Electronics, 70 Oxford Road, Clacton, CO15 3TE.

PLDs AND EPROMS copied or programmed. We supply logic devices/convert discrete logic to PLDs. Also PCBs designed. Send for details to PO Box 1561 Bath (01225 444467).

VALVE ENTHUSIASTS: Capacitors and other parts in stock. For free advice/lists please ring, Geoff Davies (Radio), Tel: 01788 574774.

CAPACITORS WANTED, axial, 350V and above, polyester, polypropylene and electrolytic. Geoff Davies (Radio), Tel: 01788 574774.

EVERYDAY

With **PRACTICAL**
ELECTRONICS

SUBSCRIPTION ORDER FORM

Annual subscription rates
 (1995/6):
 UK £24.00.
 Overseas £30
 (surface mail),
 £47.50 (airmail).

To:
 Everyday with Practical
 Electronics,
 Allen House, East Borough,
 Wimborne, Dorset BH21 1PF

Tel: 01202 881749
 Fax: 01202 841692

Name

Address

.....

.....

.....

I enclose payment of £.....

(cheque/PO in £ sterling only, payable to Everyday with Practical Electronics). Alternatively send Access or Visa number and card expiry date.

Signature

Please supply name and address of card-holder if different from the subscription address shown above. **Subscriptions can only start with the next available issue.** For back numbers see the Editorial page.

M8/95

MAKE YOUR INTERESTS PAY!

Over the past 100 years more than 10 million students throughout the world have found it worth their while! An ICS home-study course can help you get a better job, make more money and have more fun out of life! ICS has over 100 years experience in home-study courses, and is the largest correspondence school in the world. You learn at your own pace, when and where you want under the guidance of expert 'personal tutors'. Find out how we can help YOU. Post or phone today for **FREE INFORMATION** on the course of your choice. (Tick one box only!)

GCSE/A' LEVEL over 20 examination subjects to choose from. Ask for details.

Electronics <input type="checkbox"/>	TV, Video & Hi-Fi Servicing <input type="checkbox"/>
C & G Basic Electronic Engineering <input type="checkbox"/>	Refrigeration & Air Conditioning <input type="checkbox"/>
Electrical Engineering <input type="checkbox"/>	PC Repair <input type="checkbox"/>
Electrical Contracting/Installation <input type="checkbox"/>	Computer Programming <input type="checkbox"/>

Mr/Mrs/Miss/Ms

Address

ICS International Correspondence Schools, Dept. ECS 85, 312/314 High Street, Sutton, Surrey SM1 1PR. Tel: 0141-221 7373 (24 hours). Fax: 0141-221 8151.

SERVICE MANUALS & Technical Books

Available for most equipment, any make, age or model.

Return the coupon for your **FREE** catalogue

MAURITRON TECHNICAL SERVICES (EPE)

8 Cherry Tree Road, Chinnor, Oxon, OX9 4QY.

Tel:- 01844-351694. Fax:- 01844 352554.

Please forward your latest catalogue for which I enclose 2 x 1st Class Stamps. or £3.50 for the complete Service Manuals Index on PC Disc plus catalogue.

NAME _____

ADDRESS _____

POSTCODE _____

Photocopy this coupon if you do not wish to cut the magazine

Cooke International

SUPPLIER OF QUALITY USED TEST INSTRUMENTS

ANALYSERS, BRIDGES, CALIBRATORS, VOLTMETERS, GENERATORS, OSCILLOSCOPES, POWER METERS, ETC. ALWAYS AVAILABLE

ORIGINAL SERVICE MANUALS FOR SALE
COPY SERVICE ALSO AVAILABLE

EXPORT, TRADE AND U.K. ENQUIRIES WELCOME
SEND LARGES A.E. (50p POSTAGE) FOR LISTS OF EQUIPMENT & MANUALS
ALL PRICES EXCLUDE VAT AND CARRIAGE
DISCOUNT FOR BULK ORDERS SHIPMENT ARRANGED

OPEN MONDAY TO FRIDAY 9AM-5PM
Unit Four, Fordingsbridge Site, Main Road, Barnham, Bognor Regis,
West Sussex, PO22 0EB
Tel (+ 44) 01243 545111/2 Fax (+ 44) 01243 542457
EQUIPMENT & ACCESSORIES PURCHASED

SHERWOOD ELECTRONICS

Special packs £1 each -

choose 1 x £1 pack FREE with 10 purchased

SP1	15 x 5mm Red Leds	SP41	20 x Mixed transistors
SP2	15 x 5mm Green Leds	SP42	200 x Mixed 0.25W C.F. resistors
SP3	12 x 5mm Yellow Leds	SP43	2 x LM1458
SP4	10 x 5mm Amber Leds	SP47	5 x Min. push button switches
SP6	15 x 3mm Red Leds	SP49	5 x 5 metres stranded wire
SP7	12 x 3mm Green Leds	SP102	20 x 8 pin DIL sockets
SP10	100 x 1N4148 diodes	SP103	15 x 14 pin DIL sockets
SP11	30 x 1N4001 diodes	SP104	15 x 16 pin DIL sockets
SP12	30 x 1N4002 diodes	SP105	5 x 74LS00
SP18	20 x BC182 transistors	SP109	15 x BC557 transistors
SP19	20 x BC183 transistors	SP112	5 x Cmos 4093
SP20	20 x BC184 transistors	SP115	3 x 10mm Red Leds
SP21	20 x BC212 transistors	SP116	3 x 10mm Green Leds
SP22	20 x BC214 transistors	SP118	2 x Cmos 4047
SP23	20 x BC549 transistors	SP125	10 x 1000/16V radial elect caps
SP28	5 x Cmos 4011	SP128	100 x Cable ties (small)
SP36	25 x 10/25V radial elect caps	SP130	100 x Mixed 0.5W C.F. resistors
SP37	15 x 100/35V radial elect caps	SP133	20 x 1N4004 diodes
SP39	10 x 470/16V radial elect caps	SP147	5 x Stripboard 9 strips/25 holes
SP40	15 x BC237 transistors	SP156	3 x Stripboard 14 strips/27 holes

RESISTOR PACKS - 0.25W C.Film

RP3	5 each value - total 365	£2.60
RP7	10 each value - total 730	£3.95
RP10	1000 popular values	£5.30

Catalogue £1 inc. P&P or **FREE** with first order. P&P £1.25 per order. **NO VAT.**

Orders to: Sherwood Electronics,
7 Williamson St, Mansfield, Notts. NG19 6TD.

NEWMARKET TRANSFORMERS LTD.

Unit 15, Craven Way Industrial Est., Newmarket, Suffolk. CB8 0AP
Telephone: (01638) 662989 Facsimile: (01683) 660799

TOROIDAL TRANSFORMER MANUFACTURERS
220/240V ANY Two Secondaries

VA	Price	Dimensions
30	£11.30	70 x 35mm
50	£12.40	80 x 45mm
80	£13.90	90 x 35mm
120	£14.80	90 x 45mm
160	£18.95	110 x 45mm
225	£21.75	110 x 50mm
300	£23.80	110 x 60mm
500	£29.85	140 x 60mm
625	£34.70	140 x 70mm
800	£39.80	125 x 65mm
1000	£45.70	160 x 70mm

Prices include VAT & Carriage
For further information and quantity discounts, contact Michael Dorman
Phone: 01638 662989 Fax: 01638 660799

INFOTECH & STREE

76 Church St, Larkhall, Lanarks, ML9 1HE
Phone (01698) 883334/888343 or Fax (01698) 884825

Remember: Not only do we have every sheet ever produced, but we also have

The World's Largest Collection of SERVICE MANUALS & CIRCUITS

We are now successfully running a *Library Service* which allows you to borrow any manual you want for as long as you want, and when you need another manual, just return the one you have, plus a £4.95 exchange fee and tell us what you want next.

Borrow any Service Manual for £4.95 regardless of its size or normal cost

The cost of this service is a yearly subscription fee of only £59.95. Join now & get a free 'Data Ref Guide'.

BTEC Certified



TUTOR Supported

NATIONAL COLLEGE OF TECHNOLOGY

DISTANCE LEARNING COURSES

The National College of Technology offer a range of packaged learning short courses for study at home or in an industrial training environment which carry modular BTEC awards leading to a higher BTEC certificate. Study can commence at any time and at any level enabling you to create a study routine to fit around existing commitments. Courses on offer include:

Analogue Electronics
Digital Electronics
Fibre/Optoelectronics
Mechanics & Mechanisms
Programmable Logic Controllers
Electronic Testing & Fault Diagnosis

Tutor support and BTEC certification are available as options with no travelling or college attendance required. These very popular courses which are ideal for vocational training contain workbooks, audio cassette lecturettes, PCB's, instruments, tools, components and leads as necessary to support the theoretical and practical training. Whether you are a newcomer to electronics or have some experience and simply need an update or certification, there is probably a distance learning course ready for you. Write or telephone for details to:

National College of Technology
NCT Ltd., PO Box 11
Wendover, Bucks
Tel: (01296) 624270

REMOTE CONTROLS
 Amnuz. Toshiba, Ferguson, Philips, FITT, Sony from £5.
 Genuine Philips RC5911 remote operates most TV/Videos. £12.
 Pinch Rollers from £2.99
 Video Fip - 8 Mains Lead. Telefonken type. £1.
 R.F. Video leads. 50p. SCART to SCART leads. £1.75.
 SCART to SCART leads, all pins connected. £2.17.
 Aerial R.F. cable. RG82, 30p per mtr.
 Aerial R.F. male plugs. 30p each.
 TV on/off switches, from £1.95, most types.
 Halogen Lamp. 240V 500W, for outdoor floodlamps. £1.25.
 Miniature Tool Kit, comprises: side-cutters, knife, screwdrivers. £7.00.
 Varta, p.c.b. mounting rechargeable batteries, oval type Ni-Cad. Suitable for CMOS and NMOS systems. 2.4V 100mAh. 99p.
 Indoor amplified antenna, wide band, UHF/VHF. £11.95 plus £3. p&p

INTEGRATED CIRCUITS
 SAA3010P £3.40, TDA3651SI £1.10, TDA3654 £1.89,
 TDA3651A £2.85, TDA3562A £2.85, TDA2600 £6.73,
 TDA2578 £3.43, TDA2579 £2.86, TDA2030 £2.28,
 TDA3653 £3.43, TDA3651 £2.29, TDA3562 £3.44,
 TDA3564 £4.59, TDA4500 £3.43, TDA8180 £6.48,
 TDA8190 £3.43, TDA8361, £19.99, TDA2595, £2.86,
 TDA4601, £1.76, STK4793, £9.00, STR 58041, £10.00.
DIODES: Type RH1, £2.00
TRANSISTORS: BU208A £1.20, BU508AF £1.75,
 BU11AF 50p, BC327 10p, BC337 10p, BC338 10p,
 BC548 10p, BC549 10p.
MINI DRILL: circuit board drill, 12V 1A, £8.20.
 Calculator/watch batteries. Philips silver oxide. SR4E RW44 D386, pack of 10 £1.
L.O.P.T. TRANSFORMERS - WIDE RANGE AVAILABLE. PHILIPS, FERGUSON etc.

SATELLITE TV
 Satellite Finder Kit, Meter etc. £29.99, plus £2 p&p
 Arnstad Streamline, voltage switching, LNB. £28.00, £2 p&p
 Enhanced LNB 12GHz, £30 plus £2 p&p.
 Latest type quick fit Satellite dishes. Black Mesh 63cm. £35.00 plus £5 p&p.
SPECIAL OFFER: satellite owners upgrade to Astra 1D with our ADX frequency extender. £25.00. Can be used with standard or enhanced LNB.
 Satellite cable, high quality copper screen. 30p mtr., 100 mtr. roll £27 plus £5 p&p. F. Connectors. 40p each
 NOKIA LNB FSS 1.3. £16.00. Scart to 'D' leads £1.50.

VIDEO
 Head Cleaners. £2.95.
 Arnstad Universal remote controls. £6.00.
 Periswitch SCART switching box, automatically switches between VCR, Satellite and TV. Expensive unit! Originally priced at £99.95. OUR PRICE £9.99. These units require an additional 12V d.c. adaptor at £4.99 and 3 SCART leads at £6. Technical details on request. £4 p&p.

AUDIO
 Connectors: Phone to phone couplers. 40p each;
 Phone plugs, red or black. 50p each; Phone sockets, red or black. 50p each;
 Philips Audio Cassette Head Cleaning Splicing Kit, £1.
 High quality loudspeaker cable. 50p per mtr.
 Servicing Sprays £3.00 most types.
 Speaker terminal outlets. 50p each.

This is just a small sample of components available, please phone with your requirements. Please add £1.00 p&p, except where stated otherwise. **NO VAT charged.**

COMPAC ELECTRONICS
 31, WYVERN ROAD, DAGENHAM,
 ESSEX RM10 1JG. Tel: 0181 984 0631

Millions of quality components at lowest ever prices!
 Plus Tools, Watches, Fancy Goods, Toys.
 Mail order UK only.
 All inclusive prices - **NO VAT** to add on.
 Send 43p stamped self addressed label or envelope for catalogue/clearance list.
 At least 2,100 offers to amaze you.
Brian J Reed
6 Queensmead Avenue, East Ewell
Epsom, Surrey KT17 3EQ
Tel: 0181-393 9055

KITS
TIMER KIT. Controls 4 outputs at preset times over a 7 day cycle. LED display. Easily programmed via keyboard. **£65.95**
ELECTRONIC LOCK KIT. Over 38,000 possible combinations. Alarm sounds after 3-9 failed guesses and locks out keyboard for preset time. **£25.50**
SUPER SENSITIVE FM MICROBUG. Runs off a 9V battery, fits in a match box, listen in on any FM radio. **£10.25**
STROBE KIT. Can be triggered by external voltage e.g. loudspeaker or as a slave flash for photographic purposes. **£21.85**
 Plus many many more. Including all TK Kits.
 For full details send your SAE now.

COMPONENTS
 We have a full range of electronic components at competitive prices. Send an SAE for price list.
NEW BOOK! Beginner's Guide To the Internet. 88pp £5 Inc.

GATS ELECTRONICS
 149 The Vale, Acton W3 7HR
 Tel: 0181 932 0144
 Fax: 0181 932 0145

High quality stepping motor kits (all including stepping motors) 'Comstep' independent control of 2 stepping motors by PC (Via the Parallel Port) with 2 motors and software. **Kit £87.00, ready built £99.00**
 Software support and manual. **£27.00**
 Power interface 4A klt £36.00, power interface 8A klt. **£46.00**
 Stepper kit 4 (manual control) includes 200 step stepping motor and control circuit. **£23.00**
 We are now stocking a range of stepping motors and kits to drive them - please ask for the stepping motor data sheet for full information.

Inverter toroidal transformers 225VA 10.5-0-10.5V primary 0.260-285V secondary. **£9.95**
 LEDs 3mm or 5mm red or green 7p each, yellow 11p each.
 Cable Ties 1p each, £5.95 per 1000. **£49.50 per 10,000.**

High quality photo resist copper clad epoxy glass boards

Dimensions	single-sided	double-sided
3x4 inches	£1.90	£1.23
4x8 inches	£2.75	£2.98
6x12 inches	£6.20	-
12x12 inches	£12.25	-

RECHARGEABLE BATTERIES

AA (HP7) 500mAh	£0.99
AA 700mAh	£1.75
C 2AH with solder tags	£3.80
D 4AH with solder tags	£4.95
1/2AA with solder tags	£1.55
AAA (HP16) 180mAh	£1.75
AA 500mAh with solder tags	£1.55
C (HP11) 1.8AH	£2.20
D (HP2) 1.2AH	£2.80
PP3 8.4V 1100mAh	£4.95
Sub C with solder tags	£2.50
1/3 AA with tags (Philips CTV)	£1.95

Standard Charger, charges 4 AA cells in 5 hours or 4Cs or 4Ds in 12 to 14 hours plus 1xPP3 (1, 2, 3 or 4 cells may be charged at a time). **£5.95**
 High power charger, as above but charges the Cs and Ds in 5 hours, AAs, Cs and Ds must be charged in twos or fours. **£10.95**
 Nickel Metal Hydride AA cells, high capacity with no memory. If charged at 100mA and discharged at 250mA or less 1200mAh capacity (lower capacity for high discharge rates). **£3.75**

SPECIAL OFFERS - PLEASE CHECK FOR AVAILABILITY

Stick of 4, 4.2mm x 16mm NiCad batteries, 171mm x 16mm dia., with red and black leads, 4-8V. **£6.95**
 Computer grade capacitors with screw terminals, 58000uF 60V. **£4.95**
 115V AC, 80V DC Motor, 4mm x 22mm shaft, 50mm dia., x 60mm long body (excluding shaft), it has a replaceable thermal fuse and brushes. **£4.95 each, £3.95 100+**
 7-segment common anode i.e.d. display, 12mm. 45p
 LM337K TO3 case variable regulator. **£1.95 100+**, **£1.44 each**
 GaAs F.E.T. low leakage current 58873 £12.95 each, **£9.95 10+**, **£7.95 100+**
 BS250 p-channel MOSFET. **45p**
 BC559 transistor. **£3.95 per 100**
 74LS05 Hex inverter. **£10.00 per 100**
 Used 8748 Microcontroller. **£3.50**
 SL962 UHF Limiting amplifier, LC 16 surface mounting package with data sheet. **£1.95**

JPG ELECTRONICS
 276-278 Chatsworth Road
 Chesterfield S40 2BH
 Access/Visa Orders:
 Tel: (01246) 211202 Fax: (01246) 550959
 Callers welcome

ADVERTISERS INDEX

N. R. BARDWELL	642
B.K. ELECTRONICS	Cover (iii)
BRIAN J. REED	660
BULL ELECTRICAL	Cover (ii)
CHATWIN GUITARS (JCG)	625
CIRKIT DISTRIBUTION	643
COMPAC ELECTRONICS	660
COMPELEC	643
COOKE INTERNATIONAL	659
CRICKLEWOOD ELECTRONICS	625
CR SUPPLY COMPANY	628
DIRECT CCTV	642
DISPLAY ELECTRONICS	582
EPT EDUCATIONAL SOFTWARE	585
ESR ELECTRONIC COMPONENTS	592
EXPRESS COMPONENTS	657
GATS ELECTRONICS	660
GREENWELD ELECTRONICS	587
HART ELECTRONIC KITS	589
ICS	659
INFOTECH & STREE	659
INTERCONNECTIONS	615
JPG ELECTRONICS	660
MAGENTA ELECTRONICS	590/591
MAPLIN ELECTRONICS	Cover (iv)
MAURITRON	659
M&B ELECTRICAL SUPPLIES	588
NCT	659
NEWMARKET TRANSFORMERS	659
NICHE SOFTWARE	625
NUMBER ONE SYSTEMS	615
OMNI ELECTRONICS	643
PICO TECHNOLOGY	611
POWERWARE	584
QUASAR ELECTRONICS	615
ROBINSON MARSHALL	601
SEETRAX CAE	628
SERVICE TRADING	642
SHERWOOD ELECTRONICS	659
STEWART OF READING	628
SUMA DESIGNS	586
TSIEN	605

ADVERTISEMENT MANAGER:
 PETER J. MEW
ADVERTISEMENT OFFICES:
 EVERYDAY with PRACTICAL ELECTRONICS, ADVERTISEMENTS, HOLLAND WOOD HOUSE, CHURCH LANE, GREAT HOLLAND, ESSEX CO13 0JS.
 Phone/Fax: (01255) 850596
 For Editorial address and phone numbers see page 593.

OMP MOS-FET POWER AMPLIFIERS
HIGH POWER, TWO CHANNEL 19 INCH RACK

THOUSANDS PURCHASED BY PROFESSIONAL USERS



THE RENOWNED MXF SERIES OF POWER AMPLIFIERS
FOUR MODELS:- MXF200 (100W + 100W) MXF400 (200W + 200W)
MXF600 (300W + 300W) MXF900 (450W + 450W)
ALL POWER RATINGS R.M.S. INTO 4 OHMS, BOTH CHANNELS DRIVEN

FEATURES: ★ Independent power supplies with two toroidal transformers ★ Twin L.E.D. Vu meters ★ Level controls ★ Illuminated on/off switch ★ XLR connectors ★ Standard 775mV inputs ★ Open and short circuit proof ★ Latest Mos-Fets for stress free power delivery into virtually any load ★ High slew rate ★ Very low distortion ★ Aluminium cases ★ MXF600 & MXF900 fan cooled with D.C. loudspeaker and thermal protection.

USED THE WORLD OVER IN CLUBS, PUBS, CINEMAS, DISCOS ETC.

SIZES:- MXF200 W19" xH3 1/2" (2U)xD11"
MXF400 W19" xH5 1/4" (3U)xD12"
MXF600 W19" xH5 1/4" (3U)xD13"
MXF900 W19" xH5 1/4" (3U)xD14 1/2"

PRICES:- MXF200 £175.00 MXF400 £233.85
MXF600 £329.00 MXF900 £449.15
SPECIALIST CARRIER DEL. £12.50 EACH



OMP X03 STEREO 3-WAY ACTIVE CROSS-OVER



Advanced 3-Way Stereo Active Cross-Over, housed in a 19" x 1U case. Each channel has three level controls: bass, mid & top. The removable front fascia allows access to the programmable DIL switches to adjust the cross-over frequency. Bass-Mid 250/500/800Hz, Mid-Top 1.8/3/5KHz, all at 24dB per octave. Bass invert switches on each bass channel. Nominal 775mV input/output. Fully compatible with OMP rack amplifier and modules.

Price £117.44 + £5.00 P&P

STEREO DISCO MIXER SDJ3400SE

★ ECHO & SOUND EFFECTS★

STEREO DISCO MIXER with 2 x 7 band L & R graphic equalisers with bar graph LED Vu meters. **MANY OUTSTANDING FEATURES:-** including Echo with repeat & speed control, DJ Mic with talk-over switch, 6 Channels with individual faders plus cross fade, Cue Headphone Monitor, 8 Sound Effects. Useful combination of the following inputs:- 3 turntables (mag), 3 mics, 5 Line for CD, Tape, Video etc.



Price £144.99 + £5.00 P&P

SIZE: 482 x 240 x 120mm

PIEZO ELECTRIC TWEETERS - MOTOROLA

Join the Piezo revolution! The low dynamic mass (no voice coil) of a Piezo tweeter produces an improved transient response with a lower distortion level than ordinary dynamic tweeters. As a crossover is not required these units can be added to existing speaker systems of up to 100 watts (more if two are put in series). **FREE EXPLANATORY LEAFLETS ARE SUPPLIED WITH EACH TWEETER.**

- TYPE 'A' (KSN1036A)** 3" round with protective wire mesh. Ideal for bookshelf and medium sized Hi-Fi speakers. Price £4.90 + 50p P&P.
- TYPE 'B' (KSN1005A)** 3 1/2" super horn for general purpose speakers, disco and P.A. systems etc. Price £5.99 + 50p P&P.
- TYPE 'C' (KSN1016A)** 2' x 5" wide dispersion horn for quality Hi-Fi systems and quality discos etc. Price £6.99 + 50p P&P.
- TYPE 'D' (KSN1025A)** 2' x 6" wide dispersion horn. Upper frequency response retained extending down to mid-range (2KHz). Suitable for high quality Hi-Fi systems and quality discos. Price £9.99 + 50p P&P.
- TYPE 'E' (KSN1038A)** 3 3/4" horn tweeter with attractive silver finish trim. Suitable for Hi-Fi monitor systems etc. Price £5.99 + 50p P&P.
- LEVEL CONTROL** Combines, on a recessed mounting plate, level control and cabinet input jack socket. 85x85mm. Price £4.10 + 50p P&P.

IBI FLIGHT CASED LOUDSPEAKERS

A new range of quality loudspeakers, designed to take advantage of the latest speaker technology and enclosure designs. Both models utilize studio quality 12" cast aluminium loudspeakers with factory fitted grilles, wide dispersion constant directivity horns, extruded aluminium corner protection and steel ball corners, complemented with heavy duty black covering. The enclosures are fitted as standard with top hats for optional loudspeaker stands.



POWER RATINGS QUOTED IN WATTS RMS FOR EACH CABINET
FREQUENCY RESPONSE FULL RANGE 45Hz - 20KHz

ibi FC 12-100WATTS (100dB) PRICE £159.00 PER PAIR
ibi FC 12-200WATTS (100dB) PRICE £175.00 PER PAIR

SPECIALIST CARRIER DEL. £12.50 PER PAIR

OPTIONAL STANDS PRICE PER PAIR £49.00
Delivery £6.00 per pair

IN-CAR STEREO BOOSTER AMP



PRICES: 150W £49.99 250W £99.99
400W £109.95 P&P £2.00 EACH

THREE SUPERB HIGH POWER CAR STEREO BOOSTER AMPLIFIERS

150 WATTS (75 + 75) Stereo, 150W Bridged Mono
250 WATTS (125 + 125) Stereo, 250W Bridged Mono
400 WATTS (200 + 200) Stereo, 400W Bridged Mono
ALL POWERS INTO 4 OHMS

Features:
★ Stereo, bridged mono ★ Choice of high & low level inputs ★ L & R level controls ★ Remote on-off ★ Speaker & thermal protection.

OMP MOS-FET POWER AMPLIFIER MODULES

SUPPLIED READY BUILT AND TESTED.

These modules now enjoy a world-wide reputation for quality, reliability and performance at a realistic price. Four models are available to suit the needs of the professional and hobby market i.e. Industry, Leisure, Instrumental and Hi-Fi etc. When comparing prices, NOTE that all models include toroidal power supply, integral heat sink, glass fibre P.C.B. and drive circuits to power a compatible Vu meter. All models are open and short circuit proof.

THOUSANDS OF MODULES PURCHASED BY PROFESSIONAL USERS



OMP/MF 100 Mos-Fet Output power 110 watts R.M.S. into 4 ohms, frequency response 1Hz - 100KHz -3dB, Damping Factor >300, Slew Rate 45V/uS, T.H.D. typical 0.002%, Input Sensitivity 500mV, S.N.R. -110 dB. Size 300 x 123 x 60mm.
PRICE £40.85 + £3.50 P&P



OMP/MF 200 Mos-Fet Output power 200 watts R.M.S. into 4 ohms, frequency response 1Hz - 100KHz -3dB, Damping Factor >300, Slew Rate 50V/uS, T.H.D. typical 0.001%, Input Sensitivity 500mV, S.N.R. -110 dB. Size 300 x 151 x 100mm.
PRICE £64.35 + £4.00 P&P



OMP/MF 300 Mos-Fet Output power 300 watts R.M.S. into 4 ohms, frequency response 1Hz - 100KHz -3dB, Damping Factor >300, Slew Rate 60V/uS, T.H.D. typical 0.001%, Input Sensitivity 500mV, S.N.R. -110 dB. Size 330 x 175 x 100mm.
PRICE £81.75 + £5.00 P&P



OMP/MF 450 Mos-Fet Output power 450 watts R.M.S. into 4 ohms, frequency response 1Hz - 100KHz -3dB, Damping Factor >300, Slew Rate 75V/uS, T.H.D. typical 0.001%, Input Sensitivity 500mV, S.N.R. -110 dB, Fan Cooled, D.C. Loudspeaker Protection, 2 Second Anti-Thump Delay. Size 385 x 210 x 105mm.
PRICE £132.85 + £5.00 P&P



OMP/MF 1000 Mos-Fet Output power 1000 watts R.M.S. into 2 ohms, 725 watts R.M.S. into 4 ohms, frequency response 1Hz - 100KHz -3dB, Damping Factor >300, Slew Rate 75V/uS, T.H.D. typical 0.002%, Input Sensitivity 500mV, S.N.R. -110 dB, Fan Cooled, D.C. Loudspeaker Protection, 2 Second Anti-Thump Delay. Size 422 x 300 x 125mm.
PRICE £259.00 + £12.00 P&P

NOTE: MOS-FET MODULES ARE AVAILABLE IN TWO VERSIONS: STANDARD - INPUT SENS 500mV, BAND WIDTH 100KHz, PEC (PROFESSIONAL EQUIPMENT COMPATIBLE) - INPUT SENS 775mV, BAND WIDTH 50KHz. ORDER STANDARD OR PEC.

LOUDSPEAKERS

LARGE SELECTION OF SPECIALIST LOUDSPEAKERS AVAILABLE, INCLUDING CABINET FITTINGS, SPEAKER GRILLES, CROSS-OVERS AND HIGH POWER, HIGH FREQUENCY BULLETS AND HORNS, LARGE (A4) S.A.E. (60p STAMPED) FOR COMPLETE LIST.

McKenzie and Fane Loudspeakers are also available.

EMINENCE:- INSTRUMENTS, P.A., DISCO, ETC

- ALL EMINENCE UNITS 8 OHMS IMPEDANCE**
- 8" 100 WATT R.M.S. ME8-100 GEN. PURPOSE, LEAD GUITAR, EXCELLENT MID, DISCO. RES. FREQ. 72Hz, FREQ. RESP. TO 4KHz, SENS 97dB. PRICE £32.71 + £2.00 P&P
 - 10" 100 WATT R.M.S. ME10-100 GUITAR, VOCAL, KEYBOARD, DISCO, EXCELLENT MID. RES. FREQ. 71Hz, FREQ. RESP. TO 7KHz, SENS 97dB. PRICE £33.74 + £2.50 P&P
 - 10" 200 WATT R.M.S. ME10-200 GUITAR, KEYB'D, DISCO, VOCAL, EXCELLENT HIGH POWER MID. RES. FREQ. 65Hz, FREQ. RESP. TO 3.5KHz, SENS 99dB. PRICE £43.47 + £2.50 P&P
 - 12" 100 WATT R.M.S. ME12-100LE GEN. PURPOSE, LEAD GUITAR, DISCO, STAGE MONITOR. RES. FREQ. 49Hz, FREQ. RESP. TO 6KHz, SENS 100dB. PRICE £35.64 + £3.50 P&P
 - 12" 100 WATT R.M.S. ME12-100LT (TWIN CONE) WIDE RESPONSE, P.A., VOCAL, STAGE MONITOR. RES. FREQ. 42Hz, FREQ. RESP. TO 10KHz, SENS 98dB. PRICE £36.67 + £3.50 P&P
 - 12" 200 WATT R.M.S. ME12-200 GEN. PURPOSE, GUITAR, DISCO, VOCAL, EXCELLENT MID. RES. FREQ. 58Hz, FREQ. RESP. TO 6KHz, SENS 98dB. PRICE £46.71 + £3.50 P&P
 - 12" 300 WATT R.M.S. ME12-300GP HIGH POWER BASS, LEAD GUITAR, KEYBOARD, DISCO ETC. RES. FREQ. 47Hz, FREQ. RESP. TO 5KHz, SENS 103dB. PRICE £70.19 + £3.50 P&P
 - 15" 200 WATT R.M.S. ME15-200 GEN. PURPOSE BASS, INCLUDING BASS GUITAR. RES. FREQ. 46Hz, FREQ. RESP. TO 5KHz, SENS 99dB. PRICE £50.72 + £4.00 P&P
 - 15" 300 WATT R.M.S. ME15-300 HIGH POWER BASS, INCLUDING BASS GUITAR. RES. FREQ. 39Hz, FREQ. RESP. TO 3KHz, SENS 103dB. PRICE £73.34 + £4.00 P&P

EARBENDERS:- HI-FI, STUDIO, IN-CAR, ETC

- ALL EARBENDER UNITS 8 OHMS** (Except EB8-50 & EB10-50 which are dual Impedance tapped @ 4 & 8 ohm)
- BASS, SINGLE CONE, HIGH COMPLIANCE, ROLLED SURROUND**
 - 8" 50watt EB8-50 DUAL IMPEDENCE, TAPPED 4/8 OHM BASS, HI-FI, IN-CAR. RES. FREQ. 40Hz, FREQ. RESP. TO 7KHz SENS 97dB. PRICE £8.90 + £2.00 P&P
 - 10" 50WATT EB10-50 DUAL IMPEDENCE, TAPPED 4/8 OHM BASS, HI-FI, IN-CAR. RES. FREQ. 40Hz, FREQ. RESP. TO 5KHz, SENS. 99dB. PRICE £13.65 + £2.50 P&P
 - 10" 100WATT EB10-100 BASS, HI-FI, STUDIO. RES. FREQ. 35Hz, FREQ. RESP. TO 3KHz, SENS 96dB. PRICE £30.39 + £3.50 P&P
 - 12" 100WATT EB12-100 BASS, STUDIO, HI-FI, EXCELLENT DISCO. RES. FREQ. 26Hz, FREQ. RESP. TO 3 KHz, SENS 93dB. PRICE £42.12 + £3.50 P&P
 - FULL RANGE TWIN CONE, HIGH COMPLIANCE, ROLLED SURROUND**
 - 5 1/4" 60WATT EB5-60TC (TWIN CONE) HI-FI, MULTI-ARRAY DISCO ETC. RES. FREQ. 63Hz, FREQ. RESP. TO 20KHz, SENS 92dB. PRICE £9.99 + £1.50 P&P
 - 6 1/2" 60WATT EB6-60TC (TWIN CONE) HI-FI, MULTI-ARRAY DISCO ETC. RES. FREQ. 38Hz, FREQ. RESP. TO 20KHz, SENS 94dB. PRICE £10.99 + 1.50 P&P
 - 8" 60WATT EB8-60TC (TWIN CONE) HI-FI, MULTI-ARRAY DISCO ETC. RES. FREQ. 40Hz, FREQ. RESP. TO 18KHz, SENS 89dB. PRICE £12.99 + £1.50 P&P
 - 10" 60WATT EB10-60TC (TWIN CONE) HI-FI, MULTI ARRAY DISCO ETC. RES. FREQ. 35Hz, FREQ. RESP. TO 12KHz, SENS 98dB. PRICE £16.49 + £2.00 P&P

TRANSMITTER HOBBY KITS

PROVEN TRANSMITTER DESIGNS INCLUDING GLASS FIBRE PRINTED CIRCUIT BOARD AND HIGH QUALITY COMPONENTS COMPLETE WITH CIRCUIT AND INSTRUCTIONS

3W TRANSMITTER 80-108MHz, VARICAP CONTROLLED PROFESSIONAL PERFORMANCE, RANGE UP TO 3 MILES, SIZE 38 x 123mm. SUPPLY 12V @ 0.5AMP. PRICE £14.85 - £1.00 P&P

FM MICRO TRANSMITTER 100-108MHz, VARICAP TUNED, COMPLETE WITH VERY SENS FET MIC, RANGE 100-300m, SIZE 56 x 46mm. SUPPLY 9V BATTERY. PRICE £8.80 - £1.00 P&P



PHOTO: 3W FM TRANSMITTER

NEW

FULL COLOUR GUIDE TO ELECTRONIC PRODUCTS

Sept 1994–Aug 1995

Maplin



BS 5750
Part 2 1987

Level B:
Quality Assurance
RS12750

Order your copy of the New MAPLIN Catalogue on sale NOW!
Pick up a copy from any branch of WHSMITH, branches of John Menzies in Scotland ONLY, Eason & Son in N. Ireland ONLY and Maplin stores nationwide for just £3.45 inc. p&p. If you live outside the U.K. send £7.30 or 18 IRCs to receive your copy for just £3.95 inc. p&p. (including Republic of Ireland): £6.50 or 16 IRCs for surface mail for Airmail in Europe, or £12.30 or 30 IRCs for Airmail outside Europe. I enclose £3.95/£7.30/£6.50/£12.30 (delete as applicable).

Name
Address
Post Code

Send to Maplin Electronics,
P.O. Box 3, Rayleigh,
Essex, England
SS6 8LR

Over 800 colour packed pages
with hundreds of Brand New
Products at Super Low Prices.

**OUT OF THIS WORLD
ON SALE NOW
ONLY
£3.45**

Available from all branches of WHSMITH, John Menzies in Scotland ONLY, Eason & Son in N. Ireland ONLY, and Maplin stores nationwide. The Maplin Electronics 1995 Catalogue **OUT OF THIS WORLD**