

**EVERYDAY**

DECEMBER 1990

# **ELECTRONICS**

INCORPORATING ELECTRONICS MONTHLY

£1.50

## **New Teach-In Series** **DESIGN YOUR OWN CIRCUITS**

**EIGHT CHANNEL MICROCOMPUTER  
CONTROLLED LIGHT SEQUENCER**

**VERSATILE BENCH POWER SUPPLY**

**FREE INSIDE!**  
**MAGENTA ELECTRONICS**  
**1991 CATALOGUE**

**PLUS INDEX FOR 1990**

ISSN 0262-3617



9 770262 361010

**The No.1 Magazine for Electronic & Computer Projects**



### ONE POUND PACKS

All packs are £1 each. Note the figure on the extreme left of the pack ref number and the next figure is the quantity of items in the pack, finally a short description.

- BD2 5 13A spurs provide a fused outlet to a ring main where devices such as a clock must not be switched off.
- BD9 2 6V 1A mains transformers upright mounting with fixing clamps.
- BD13 12 30 watt reed switches, it's surprising what you can make with these—burglar alarms, secret switches, relay, etc., etc.
- BD22 2 25 watt loudspeaker two unit crossovers.
- BD30 2 Nicad constant current chargers adapt to charge almost any nicad battery.
- BD32 2 Humidity switches, as the air becomes damper the membrane stretches and operates a microswitch.
- BD42 5 13A rocker switch three tags so on/off, or change over with centre off.
- BD45 1 24hr time switch, ex-Electricity Board, automatically adjust for lengthening and shortening day, original cost £40 each.
- BD49 5 Neon valves, with series resistor, these make good night lights.
- BD56 1 Mini uniselector, one use is for an electric jigsaw puzzle, we give circuit diagram for this. One pulse into motor, moves switch through one pole.
- BD67 1 Suck or blow operated pressure switch, or it can be operated by any low pressure variation such as water level in water tanks.
- BD103A 1 6V 750mA power supply, nicely cased with mains input and 6V output leads.
- BD120 2 Stripper boards, each contains a 400V 2A bridge rectifier and 14 other diodes and rectifiers as well as dozens of capacitors, etc.
- BD132 2 Plastic boxes approx 3in cube with square hole through top so ideal for interrupted beam switch.
- BD134 10 Motors for model aeroplanes, spin to start so needs no switch.
- BD137 1 6 1/2 inch 4 ohm speaker 10W rating.
- BD139 6 Microphone inserts—magnetic 400 ohm also act as speakers.
- BD148 4 Reed relay kits, you get 16 reed switches and 4 coils sets with notes on making c/o relays and other gadgets.
- BD149 6 Safety cover for 13A sockets—prevent those inquisitive little fingers getting nasty shocks.
- BD180 6 Neon indicators in panel mounting holders with lens.
- BD193 6 5 amp 3 pin flush mounting sockets make a low cost disco panel.
- BD199 1 Mains solenoid, very powerful, has tin pull or could push if modified.
- BD201 8 Keyboard switches—made for computers but have many other applications.
- BD211 1 Electric clock, mains operated, put this in a box and you need never be late.
- BD221 5 12V alarms, make a noise about as loud as a car horn. Slightly soiled but OK.
- BD252 1 Panostat, controls output of boiling ring from simmer up boil.
- BD259 50 Leads with push-on 1/4in tags—a must for hook ups—mains connections etc.
- BD263 2 Oblong push switches for bell or chimes, these can mains up to 5 amps so could be foot switch if fitted into patress.
- BD268 1 Mini 1 watt amp for record player. Will also change speed of record player motor.
- BD305 1 Tubular dynamic mic with optional table rest.
- BD653 2 Miniature driver transformers. Ref. LT44. 20k to 1k centretapped.
- BD548 2 3.5V relays each with 2 pairs changeover contacts.
- BD667 2 4.7 μf non-polarised block capacitors, pcb mounting.

There are over 1,000 items in our Catalogue. If you want a complete copy please request this when ordering.

**METAL PROJECT BOX** Ideal for battery charger, power supply etc. Sprayed grey size 8" x 4" x 4 1/2". Louvred for ventilation. Price £3.00. Ref. 3P75

**FLOPPY DISCS** 5 1/4" pack of 10 £5.00 Ref 168 3 1/2" pack of 15 £10.00 Ref 10P88

**PERSONAL STEREO** Again customer returns but complete and with stereo head phones. A bargain at only £3.00 each. Our ref 3P83

**MICROWAVE CONTROL PANEL** Mains operated, with touch switches. This unit has a 4 digit display with a built in clock and 2 relay outputs—one for power and one for pulsed power level. Could be used for all sorts of timer control applications. Only £6.00. Our ref 6P18.

**EQUIPMENT WALL MOUNT** Multi adjustable metal bracket ideal for speakers, lights, etc 2 for £5.00. Our ref 5P152

**NEW MAINS MOTORS** 25 watt 3000 rpm made by Framco. Approx 6" x 3" x 4". Priced at only £4.00 each. Our ref 4P54.

**SHADED POLE MOTORS** Approx 3" square. Available in 24V and 240V AC. Both with threaded output shaft and 2 fixing bolts. Price is £2.00 each. 24V Ref 2P65, 240V Ref 2P66.

**SUB-MIN TOGGLE SWITCH** Body size 8mm x 4mm x 7mm SBDT with chrome dolly fixing nuts 3 for £1. Order ref BD649

**COPPER CLAD PANEL** for making PCB. Size approx 12in long x 8 1/2in wide. Double-sided on fibreglass middle which is quite thick (about 1 1/16in) so this would support quite heavy components and could even form a chassis to hold a mains transformer, etc. Price £1 each. Our ref BD683.

### POWERFUL IONISER

Generates approx. 10 times more IONS than the ETI and similar circuits. Will refresh your home, office, workroom etc. Makes you feel better and work harder—a complete mains operated kit, case included. £18. Our ref 18P2

**2KV 500 WATT MAINS TRANSFORMERS.** Suitable for high voltage experiments or as a spare for a microwave oven etc £10.00 Ref 10P93

**REAL POWER AMPLIFIER** for your car, it has 150 watts output. Frequency response 20hz to 20Khz and signal to noise ratio better than 60dB. Has built in short circuit protection and adjustable input level to suit your existing car stereo, so needs no pre-amp. Works into speakers ref. 3P7 described below. A real bargain at only £57.00. Order ref: 57P1

**REAL POWER CAR SPEAKERS.** Stereo pair output 100W each 40hm impedance and consisting of 6 1/2" woofer, 2" mid range and 1" tweeter. Ideal to work with the amplifier described above. Price per pair £30.00. Order ref: 30P7.

**VIDEO TAPES** These are three hour tapes of superior quality, made under licence from the famous JVC Company. Offered at only £3 each. Our ref 3P63. Or 5 for £11. Our ref 11P3. Or for the really big user 10 for £20. Our ref 20P20.



**ELECTRONIC SPACESHIP.** Sound and impact controlled, responds to claps and shouts and reverses when it hits anything. Kit with really detailed instructions. Ideal present for budding young electrician. A youngster should be able to assemble but you may have to help with the soldering of the components on the pcb. Complete kit £10. Our ref. 10P81

**COMPUTER KEYBOARDS** Brand new, uncased. £3.00 each. ref 3P89.

**12" HIGH RESOLUTION MONITOR.** Amber screen, beautifully cased for free standing, needs only 12V 1.5 amp supply TTL input separate syncs. Brand new in makers cartons. Price £22.00. Order ref: 22P2

### SINCLAIR C5 WHEELS

Including inner tubes and tyres 13" and 16" diameter spoked poly carbonate wheels. Finished in black. Only £6.00 each. 13" Ref 6P10, 16" Ref 6P11

**COMPOSITE VIDEO KITS** These convert composite video into separate H sync, V sync and video. Price £8.00. Our ref 8P39.

**LINEAR POWER SUPPLY** Brand new -5v 3A +/-12v 1A. Complete with circuit diagram. Short circuit protected. Our price £12.00 Ref 12P21

**3 1/2in FLOPPY DRIVES** We still have two models in stock: Single sided, 80 track by Chicon. This is in the manufacturers metal case with leads and IDC connectors. Price £40, reference 40P1. Also a double sided, 80 track, by NEC. This is uncased. Price £60.00, reference 60P2. Both are brand new.

**10 MEMORY PUSHBUTTON TELEPHONES** These are customer returns and "sold as seen". They are complete and may need slight attention. Price £6.00. Ref. 6P16 or 2 for £10.00. Ref. 10P77. BT approved.

**INDUCTIVE PROXIMITY SWITCHES** These will detect ferrous or nonferrous metals at approx. 10mm and are 10-36V operation. Ideal for alarms position sensors, etc. RS price is £64.00 each! Ours £12.00. Ref. 12P19.

**BOSCHERT SWITCHED MODE POWER SUPPLIES** -5V at 15A -12V at 3A, -12V at 2A -24V at 2A, 220V or 110V input. Brand new and guaranteed. Retail price is £180! Ours £20. Ref. 20P30

**TV SOUND DECODER.** Nicely cased, mains powered with 8 channels. Will drive a small speaker directly or could be fed into Hi Fi system etc. £12.00 each Ref 12P22

**PC POWER SUPPLIES** Brand new with built in fan and power switch on the back -5 -5 -12 -12V 150 watt made by AZTEC £25.00 each Ref. 25P18

**VERY POWERFUL 12 VOLT MOTORS.** 1/2 Horsepower. Made to drive the Sinclair C5 electric car but adaptable to power a go-kart, a mower, a rail car, model railway, etc. Brand new. Price £20. Our ref 20P22.

**AS ABOVE** with gearbox. £40. Ref 40P8

### PHILIPS LASER

This is helium-neon and has a power rating of 2mW. Completely safe as long as you do not look directly into the beam when eye damage could result. Brand new, full spec. £35. Our ref. 35P1. Mains operated power supply for this tube gives 8kv striking and 1.25kv at 5mA running. Complete kit with case £15.

**PANEL METERS** 270 deg movement. New. £3.00 each. Our ref 3P87

**SURFACE MOUNT KIT** Makes a super high gain snoothing amplifier on a PCB less than an inch square! £7.00. Our ref 7P15.

**CB CONVERTERS** Converts a car radio into an AM CB receiver. £4.00. Our ref 4P48.

**GEIGER COUNTER KIT** Includes PCB, tube, loudspeaker, and all components to build a 9v battery operated geiger counter. Only £39. Our ref 39P1.

**12V TO 220V INVERTER KIT** This kit will convert 12v DC to 220v AC. It will supply up to 130 watts by using a larger transformer. As supplied it will handle about 15 watts. Price is £12. Our ref 12P17.

**5 1/4" 360K DISC DRIVES.** Brand new HALF HEIGHT disc drives made by Mitsubishi. Limited quantity available at £35.00. Ref. 35P5

**HIGH RESOLUTION MONITOR** 9in black and white, used Philips tube M24360W. Made up in a lacquered frame and has open sides. Made for use with OPD computer but suitable for most others. Brand new. £20. Our ref 20P26.

**12 VOLT BRUSHLESS FAN.** Japanese made. The popular square shape (4 1/2in x 4 1/2in x 1 3/4in). The electronically run fans not only consume very little current but also they do not cause interference as the brush type motors do. Ideal for cooling computers, etc., or for a caravan. £8 each. Our ref 8P26

**MINI MONO AMP** on p.c.b. size 4" x 2" (app.) Fitted Volume control. The amplifier has three transistors and we estimate the output to be 2W rms. More technical data will be included with the amp. Brand new, perfect condition, offered at the very low price of £1.15 each, or 13 for £12.00.

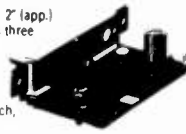

## BULL ELECTRICAL

Dept. EE 250 PORTLAND ROAD, HOVE, BRIGHTON, SUSSEX BN3 5QT.

**MAIL ORDER TERMS:** Cash, PO or cheque with order. Monthly account orders accepted from schools and public companies. Please add £2.50 postage to orders. Minimum order: £5. Phone (0273) 203500. Fax No. (0273) 23077

### POPULAR ITEMS — MANY NEW THIS MONTH

**MAINS FANS** Snail type construction. Approx. 5" x 4" mounted on a metal plate for easy fixing. New. £5.00 each. Our ref 5P166

**MICROWAVE TURNABLE MOTOR** Complete with weight sensing electronics that would have varied the cooking time. Ideal for window displays, etc. Only £5.00. Our ref 5P165.

**PC STYLE CASES 18" X 18" X 6"** Complete with fan and grill illuminated power switch and IEC filtered power input. Priced at only £15.00. Ref 15P38

**VERO EASIWIPE PROTOTYPING SYSTEM.** Ideal for designing projects on etc. Complete with tools, wire and reusable board. Our price £6.00. Ref 6P33

**MAINS AXIAL FANS.** Brand new 5 1/2" diameter powerful silent fans with shaped pole motors. Yours for £3.00. Ref 3P112

**AA CELLS** Probably the most popular of the rechargeable NICAD types 4 for £4.00. Our ref. 4P44

**20 WATT 4 OHM SPEAKER** With built in tweeter. Really well made unit which has the power and the quality for hi-fi. 6 1/2" dia. Price £5.00. Our ref. 5P155 or 10 for £40.00. Ref. 40P7.

**MINI RADIO MODULE** Only 2in square with ferrite aerial and solid dia. tuner with own knob. It is superb and operates from a PP3 battery and would drive a crystal headphone. Price £1.00. Our ref. BD716

**BULGIN MAINS PLUG AND SOCKET** The old and faithful 3 pin with screw terminals. The plug is panel mounted and the socket is cable mounted. 2 pairs for £1.00 or 4 plugs or 4 sockets for £1.00. Our ref. BD715, BD715P, or BD715S

**MICROPHONE** Low cost hand held dynamic microphone with on/off switch in handle. Lead terminates in 1.35mm and 1.25mm plug. Only £1.00. Ref. BD711

**MOSFETS FOR POWER AMPLIFIERS AND HIGH CURRENT DEVICES** 140V 100 watt pair made by Hitachi. Ref 2S199 and its complement 2SK343. Only £4.00 a pair. Our ref 4P51

**TIME AND TEMPERATURE LCD MODULE A** 12 hour clock a Celsius and Fahrenheit thermometer a too hot alarm and a too cold alarm. Approx 50 x 20mm with 12.7mm digits. Requires 1AA battery and a few switches. Comes with full data and diagram. Price £9.00. Our ref. 9P5.

**REMOTE TEMPERATURE PROBE FOR ABOVE.** £3.00. Our ref. 3P60

**PAPST** fan 80 x 80mm 230V. Our ref 9P7. Price £9

**PAPST** fan 120 x 120mm 230V. Our ref 6P6. Price £6

**600 WATT AIR OR LIQUID MAINS HEATER** Small coil heater made for heating air or liquids. Will not corrode, lasts for years. Coil size 3" x 2" mounted on a metal plate for easy fixing. 4" dia. Price £3.00. Ref. 3P78 or 4 for £10.00. Our ref. 10P76

**EX-EQUIPMENT POWER SUPPLIES** Various makes and specs. ideal bench supply. Only £8.00. Our ref. 8P36

**ACORN DATA RECORDER** Made for the Electron or BBC computer but suitable for others. Includes mains adaptor, leads and book. £12.00. Ref. 12P15

### SOLDER

22 SWG 60/40 resin cored solder, 1/2KG reel, top quality £4.00 Ref 4P70

**NEW PIR SENSORS** Infra red movement sensors will switch up to 1000V mains. UK made. 12 months manufacturers warranty. 15-20mm range with a 0-10mm timer, adjustable wall bracket. Our ref 25P16. Price £25

**GEARBOX KITS** Ideal for models, etc. Contains 18 gears (2 of each size), 4 x 50mm axles and a powerful adjustable speed motor. 9-12V operation. All the gears, etc. are 2mm push fit. £3.00 for the complete kit. Ref. 3P93.

**MINI HI-FI SPEAKERS** Made for televisions, etc. Two sizes available. 70mm x 57mm 3W 8 ohm, 2 for £3.00. Ref. 3P99. 127mm x 57mm 5W 8 ohm, 2 for £3.00. Ref. 3P100.

**TELEPHONE EXTENSION LEAD** 5m phone extension lead with plug on one end, socket on the other. White. Price £3.00. Our ref. 3P70 or 10 leads for only £19.00. Ref. 19P2.

**LCD DISPLAY** 4 1/2" digit supplied with connection data £3.00. Ref. 3P77 or 5 for £10. Ref. 10P78.

**CROSS OVER NETWORK** 8 Ohm 3 way for tweeter midrange and woofer nicely cased with connections marked. Only £2.00. Our ref. 2P255 or 10 for £15.00. Ref. 15P32

**BASE STATION MICROPHONE** Top quality uni-directional electret condenser mic 600r impedance sensitivity 16-18kHz - 68db built in chime complete with mic stand bracket. £15.00. Ref. 15P28.

**MICROPHONE STAND** Very heavy chromed mic stand, magnetic base 4" high £3.00 if ordered with above mic. Our ref. 3P80

**SOLAR POWERED NICAD CHARGER** 4 Nicad AA battery charger. Charges 4 batteries in 8 hours. Price £6.00. Our ref. 6P3

**YUASHA SEALED LEAD ACID BATTERIES.** 6V 10AH only £9.00 each or 2 for £15.00. Ref. 15P37

**STC SWITCHED MODE POWER SUPPLY.** 220V or 110V operation giving 5V at 2A - 24V at 0.25A - 12V at 0.15A and - 90V at 0.4A £12.00 each. Ref. 12P27

**SOLDERING IRON STAND** Price £3.00. Our ref. 3P66

**INCAR GRAPHIC EQUALIZER/BOOSTER** Slimline 7 band with built in 30 watts per channel amplifier. 12V operation, twin 5 LED power indicators, 20-21kHz with front and rear fader plus headphone output! Brand new and guaranteed. Only £25.00. Ref. 25P14.

**MODEMS** Dial up brand new units. Made by GEC. No data available, but good value at £18.00. Ref 18P6

**CAR IONIZER KIT** Improve the air in your car, clears smoke and helps prevent fatigue. Case req. Price £12.00. Our ref. 12P8.

**NEW FM BUG KIT** New design with PCB embedded coil 9v operation. Priced at £5.00. Our ref. 5P158

**NEW PANEL METERS** 50uA movement with three different scales that are brought into view with a lever. Price only £3.00. Ref. 3P81

**ELECTRONIC SPEED CONTROL KIT** Suitable for controlling our powerful 12v motors. Price £17.00. Ref. 17P3 (heatsink required)

**ELECTRONIC TICKET MACHINES.** These units contain a magnetic card reader, two matrix printers, motors, sensors and loads of electronic components etc. Very good value at £12.00. Ref 12P28 (12 x 7 x 7")

**JOYSTICKS** Brand new, can be adapted for most machines by changing the connector. Complete with 2 fire buttons and suction feet 2 for £5.00. Ref 5P174

**FIVE POUND MYSTERY PACKS.** We have decided to reintroduce our mystery packs once again. After a gap of 4 years we have amassed quite a lot of stock! For £5.00 you will receive a selection of goods containing at least £12.00 worth of goods at our normal low prices. Ref 5P175

**1990 CATALOGUE NOW AVAILABLE PLEASE SEND 6" X 9" SAE FOR FREE COPY**

# EVERYDAY ELECTRONICS

INCORPORATING ELECTRONICS MONTHLY

ABC

MEMBER OF THE ASSOCIATION OF PUBLISHERS

VOL. 19 No. 12 DECEMBER 1990

The No 1 Magazine for Electronic & Computer Projects

ISBN 0262 3617

PROJECTS... THEORY... NEWS...  
COMMENT... POPULAR FEATURES...

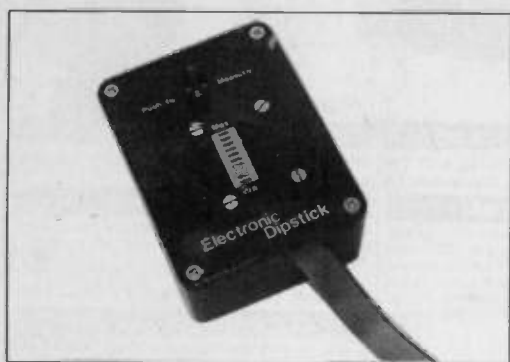
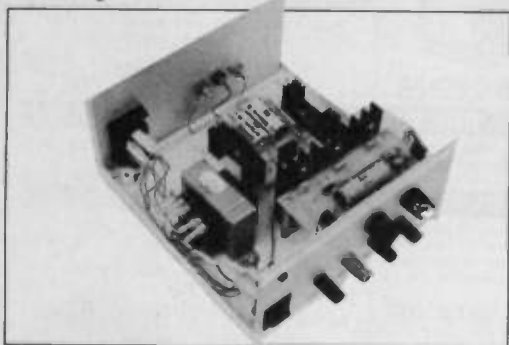
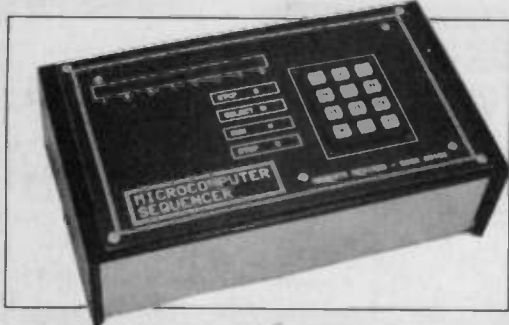
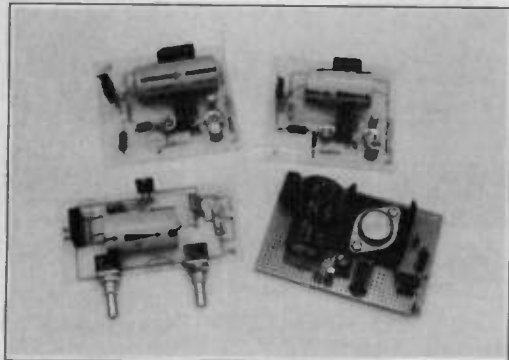

© Wimborne Publishing Ltd 1990. Copyright in all drawings, photographs and articles published in EVERYDAY ELECTRONICS is fully protected, and reproduction or imitations in whole or in part are expressly forbidden.

Our January '91 Issue will be published on Friday, 7 December 1990. See page 813 for details.

## Projects

- 8-CHANNEL MICROCONTROLLER LIGHT SEQUENCER** by Mark Stuart 772  
Versatile lighting unit with over 100 different programs
- ELECTRONIC DIPSTICK** by Chris Bowes 780  
A Pocket Money Project for remote liquid level sensing
- COLOUR-CHANGING CHRISTMAS LIGHTS** by Mark Daniels 802  
A colourful alternative to the usual festive decorations
- VERSATILE BENCH POWER SUPPLY** by Mike Tooley 808  
Companion project to our Teach-In '91 series
- 12V LAMP/VACUUM CLEANER CHARGER** by T. R. de Vaux Balbirnie 814  
Keep portable lamps and cleaners charged from a car or caravan supply

## Series

- AMATEUR RADIO** by Tony Smith G4FAI 785  
What does amateur radio offer me? Using the bureau, Call sign confusion
- TEACH-IN '91 - DESIGN YOUR OWN CIRCUITS - PART 1** by Mike Tooley 786  
The start of our Design series looks at the forthcoming course and at power supplies
- ROBOT ROUNDUP** by Nigel Clark 807  
News from the world of robotics
- DOWN TO EARTH** by George Hylton 819  
Simple Voltage Changing.
- INTERFACE** by Robert Penfold 822  
New regular article dealing with all aspects of interfacing popular micros

## Features

- FOR YOUR ENTERTAINMENT** by Barry Fox 800  
Getting taped, Screen speaker, Mindlink, Cycling computer
- EE REFERENCE LIBRARY** 801  
A special selection of comprehensive reference manuals
- SHOP TALK** with David Barrington 823  
Component buying for projects
- DIRECT BOOK SERVICE** 824  
EE selected technical books by mail order
- PRINTED CIRCUIT BOARD SERVICE** 829  
P.C.B.s for EE projects
- INDEX FOR 1990 - VOLUME 19** 831  
Comprehensive cross reference index for all EE articles published in 1990
- ADVERTISER'S INDEX** 840

## FREE WITH THIS ISSUE

Magenta Electronics Ltd 1990-1991 catalogue, between pages 800 and 801

Readers Services • Editorial and Advertisement Departments 771

# MARCO TRADING

**ELECTRONIC COMPONENTS & EQUIPMENT**



MAIL ORDERS • WHOLESALE  
RETAIL

SEND ORDERS TO - DEPT 12  
**MARCO TRADING**  
THE MALTINGS, HIGH STREET, WEM  
SHROPSHIRE SY4 5EN  
Tel: (0939) 32763 Telex: 35565  
Fax: (0939) 33800  
ELECTRICAL & ELECTRONIC  
COMPONENT SUPPLIERS  
**24HR ANSAPHONE**

**LATEST 1991  
132 Page  
CATALOGUE  
ONLY  
£1.50**

VISIT

OUR OTHER BRANCHES

**SUPERTRONICS**  
Tel: 021 666 6504  
65 MURST STREET  
BIRMINGHAM B5 4TE

**WALTONS**  
Tel: 0902 22039  
55A WORCESTER ST  
WOLVERHAMPTON  
WV2 4LL

**POST PACKING £1.75  
ALL PRICES INCLUDE 15% VAT**

**LOOK OUT FOR NEW SPECIAL  
OFFER EVERY MONTH WITH  
EVERYDAY ELECTRONICS**

## ANTEX IRONS

C-15W IRON	£8.37
CS-17W IRON	£8.48
XS-25W IRON	£8.59
XS-KIT 25W	£11.98
CS-KIT 17W	£11.87
C-KIT 15W	£11.98

ALL BITS FOR IRONS - £1.62  
ELEMENTS £4.10 STANDS £3.24

## NI-CAD RECHARGEABLE BATTERIES

PRICE	EACH
1+	10-
AAA £1.50	£1.30
AA 95p	85p
C £1.95	£1.80
D £2.00	£1.85
PP3 £3.90	£3.75

## VIDEO HEAD TESTER

A video head tester for determining whether a video head is in good condition by detecting the wear state and displaying it on a meter. Complete with carrying case and leads.  
**SPECIAL PRICE £39.50**



## MARCO KITS

Ceramic 50V (125)	£3.99
Electrolytics Red (100)	£8.50
Fuse 20mm Q.B. (80)	£4.75
Fuse 20mm A.S. (80)	£8.50
Pre-set Pots. Horiz. (120)	£7.75
Pre-set Pots. Vert. (120)	£7.75

## RESISTOR KITS

0.25W Popular (1000)	£6.99
0.25W 5 off (305)	£3.75
0.25W 10 off (610)	£5.10
0.5W Popular (1000)	£10.75
0.5W 5 off (365)	£5.40
0.5W 10 off (730)	£8.75
1W 5 off (365)	£15.25
2W 5 off (365)	£25.00
Zener Diodes 5 off (55)	£3.99

## NI-CAD CHARGER

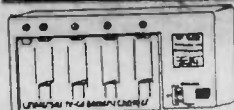

Charges AA, AAA, C, D & PP3  
Ni-Cads  
240V AC  
**£4.99**

## SOLAR PRODUCTS

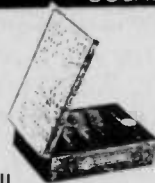

**Solar Cell**  
0.5V 700mA. Complete in plastic frame, connect in series for higher voltage.  
**Price: £3.99**



**Battery charger**  
Charges up to 4 x AA Ni-cads in 10-14 hours (2-3 hours per battery).  
**Price: £8.50**



**Solar Turntable**  
Ideal for shop window, house plants etc. Simply place in sunlight. Will turn up to 30lb load.  
**Price: £13.50**

## Educational Kit

A must for beginners. Contains instruction book, DC motor, solar panel, wire clips, spinner disc, etc.  
**Price £6.99**



## 21-PIECE TOOL SET

21 pc precision tool set in plastic moulded clear case with sliding lid. Set contains: 6 x flat blade screwdrivers, 0.9-3.5mm; 2 x cross head screwdrivers No0 & No 1; 3 hex key wrenches 1.5, 2.0, 2.5mm; 5 nut drivers, 3.0, 3.5, 4.0, 4.5, 5.0mm; 5 spanners, 4.0, 4.5, 5.0, 5.5, 6mm and a tommy bar. TOOL/21PC  
**£6.50**



# December Special Offer

## DIGITAL MULTIMETER



### 10MΩ MULTIMETER

- ★ 19 ranges
- ★ 3½ digit 12mm LCD display
- ★ Signal injector function
- ★ Diode test
- ★ Fuse protection
- ★ Automatic polarity and zero
- ★ Test leads with 4mm plugs

**Fantastic Offer**

AC volts.....	0-200m-2-20-200-1000Vdc ± 1.2%
DC volts.....	0-200µ-2m-20m-200m-2A dc ± 0.8%
DC current.....	0-200µ-2m-20m-200m-2A dc ± 1.0%
Resistance.....	0-200-2k-20k-200k-2MΩ ± 0.8%
Signal injector.....	50Hz square wave 5V peak to peak 126 x 70 x 24mm

Dims.  
Battery and instruction manual included

**ONLY £15.99**  
NORMALLY  
**£39.50**

Y122AJ (MX190)

## 12V TWIN FLUORESCENT LAMP 12" DOUBLE TUBES

**ONLY £5.99**

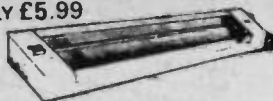

DIMENSIONS: 368 X 67 X 43MM

## FM TRANSMITTER

Very High Quality "MINI-BUG" - Ideal for baby alarms, car reception on any FM radio. Frequency 105-109MHz. FM power PP3 9V battery (not included). Dimensions 4.25" x 2.25" x 0.75" Code SO.004

**£9.99**

## YDK CASSETTES

AD 90, used once. Bulk erased, good as new, fully guaranteed.

**£7.50 for 10  
£60.00 for 100**

## HOME ALARM PACKAGE

- Includes:
- ★ Optima Alarm Control Panel
  - ★ External Red Bell Box
  - ★ 2 x 1 Internal Passive I.R.
  - ★ 2 x Door Contacts
  - ★ Siren for bell box
  - ★ 100 mtrs. cable and clips
  - ★ Full fitting instructions
- BACK-UP LEAD ACID BATTERY**  
12V 1.9Ah  
**£14.00**  
LEAD ACID CHARGER  
**£19.99**

## CLOSED CIRCUIT TELEVISION SYSTEM

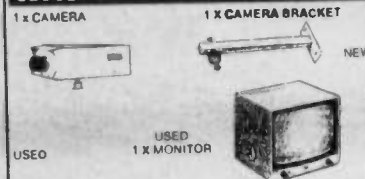

Complete price **£175 PLUS £10 CARR**



**QUARTZ HALOGEN SPOT LIGHT**  
**£5.75**

## EPROM SPECIAL

27C256-25 (BRAND NEW)  
**£3 ea 10 - £2.50 ea**

## VELLEMAN KITS

Send large S.A.E. now for our 1991 Full Colour Kit Catalogue

## SOLDER 18 & 22 SWG -500gm REEL

18swg	1+	10+
22 swg	£4.95	£4.70
	£4.99	£4.75

Remember: Our prices INCLUDE VAT!

## HEATSHRINK PACK

Approx 10 lengths odd assorted sizes from 1.6mm to 12.7mm. Lengths 12"

**PRICE £1.00 ea**

## BRS TURNTABLE

These need no introduction, brand new, complete with cartridge and stylus. Also, complete with turntable belt. 12V 0.06A motor fitted. Simply construct your own plinth. Absolute bargain.  
**ONLY £9.99**  
ORDER CODE/SO/BSR

## ILLUMINATED MAGNIFIER

Very handy, illuminated magnifier with mains lens X2 and pull out lens X8 magnification. Main lens can be illuminated for map or book reading. Uses 2 x AA batteries (Yes, supplied). Overall length, extended 6" (150mm)  
**PRICE: 7.50. HURRY LIMITED QTY**



## 12V/240V UHF/VHF/FM AERIAL

Ideal for either home or caravan, boat, picnic, etc. Turn aerial for best reception and if required, switch on built-in amplifier.  
Gain..... 20dbVHF, 30db UHF  
Gain Control..... 0-30db  
**HURRY, HURRY, LIMITED QUANTITY**

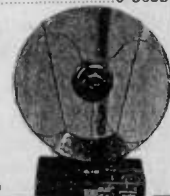

**PRICE: £29.95**

## LOGIC ANALYZER

Hewlett Packard HP1631D Complete with Disc Drive (HP9122D), Printer (HP2225A). Various probes, etc. Approx. 4 years old. List price over £14,000!  
**OUR PRICE £1,500**

## L100 CONSOLE LAMP

For disco consoles, Hi-Fi equipment, CB rigs, etc. where extra illumination is essential, 12V lamp in enclosed head with switch. Flexible chrome gooseneck on mounting plate with screw holes. Flying leads for connection to external 12Vdc supply. Length 300mm. Lamp 12V dc 5W tubular filament. L100  
**£2.95**



## STROBE LIGHT

Strobe light with circular reflector housed in veneered wooden cabinet. Various speed control.  
Power..... 240V ac 50Hz  
Dimensions..... 150 x 150 x 120mm  
Order code: AUD/STROBE  
**Price £27.50**

## MICROPHONE MIXER

4-channel mono microphone mixer. Inputs via 4.35mm mono sockets with individual volume controls. Output via 6.35mm mono socket with master volume control. ON/OFF switch and LED ON indicator. Tough steel case. Powered by 9V battery. Complete with 1.5m patch lead.  
Input impedance..... 600 ohms  
Output Impedance..... 1.2Kohms  
Output level..... 90mV (for 5mV input)  
Power..... 9V d.c. (PP3) battery  
Dimensions..... 148 x 86 x 46mm  
ORDER CODE MIC/MIXER  
**£19.50**

**184 PAGES  
PACKED WITH  
COMPONENTS,  
KITS, TEST  
EQUIPMENT  
AND BOOKS...**

**BATTERIES**

Ni-cad, Dry Cell, Ni-cad Chargers, Eliminators, Holders, Connections

**BOOKS**

General, Textbook and Basics, Radio and TV, Data/Reference, Projects/DIY, Measurement/Servicing, Linear Electronics, Audio, Digital Electronics, Computers

**CABLE AND WIRE**

Equipment Wire, Mains Cable, RF Cable, Audio Cables, Ribbon Cable, Enamelled Copper Wire, Accessories

**CAPACITORS**

Electrolytic, Ceramic, Foil, Variable, Trimmers

**COMPONENT PACKS  
COMPUTERS**

Amstrad 464/6128 Peripherals, Software, Computer Leads, Cable Adapters/Testers, Data Switches, PC Cards, Microcomputing Kits/Modules, Accessories

**CONNECTORS**

Audio, Servo, DC, RF, RF Adapters, IEC Mains, 13A Mains, Low Current, Terminal Blocks, PCB Ribbon, IDC Edge, 0.1" Pitch Edge, IC Sockets, Waterproof Sockets

**COUNTERS AND TIMERS**

LCD Modules Stopwatch

**CRYSTALS**

Crystals, Ceramic Resonators

**FILTERS**

Ceramic, Pilot Tone/and Bldie, LC Video Block, Helical, Crystal, Ceramic, RF Interference

**HARDWARE**

Equipment Cases, Aluminium Boxes, Plastic Boxes, Mounting Accessories, Knobs, Breadboards, Fuses, Fuseholders, Heatsinks, DC Fans

**INDUCTORS**

Toko Coils, Fixed Inductors, Axial RF Chokes, Surface Mount Inductors, Moulded VHF Coils, Ferrite Materials, Dust Iron Toroids

**KITS AND MODULES**

FM Tuner Sets, FM IF Amplifiers, Digital Frequency Meters, TV and Video Systems, Aerial Amplifiers, AM Systems, HF Amplifiers, Signal Processors, 6m Systems, VHF Systems, Satellite Systems, UHF Systems, Audio Amplifiers, Audio Accessories, Cassette Systems, Home and Hobby, Radio Control Systems, RF Test Equipment,

**"YOU NEVER  
KNEW THERE  
WAS SO  
MUCH IN IT"**

Signal Generators and Detectors, Time and Frequency Standards, Logic Probes, Digital Meters, Power Supplies, LCD Modules

**METERS**

Moving Coil

**PCBs & EQUIPMENT**

Prototyping Systems, Artwork Materials

**RELAYS**

Coaxial, PCB

**RESISTORS**

Carbon Film, Presets, Rotary Pots, Slide Pots, Multiturn Pots, Precision Pots

**RIGS AND RECEIVERS**

2m Systems, High Power HF ATUs, Accessories, Scanning Receivers

**SEMICONDUCTORS**

4000 Series CMOS Devices, 74HC Series, 74LS Series TTL, Linear ICs,

Prescalers ICs, Microprocessors

Memories, Transistors, Diodes

Regulators and Power Control ICs,

Schottky Diode Balanced Mixers,

LEDs, Mounted LEDs, Infra Red LEDs,

7 Segment LED Displays, Neon and

Signal Lamps

**SPEAKERS/SOUNDERS**

Piezo Buzzers, Headphones,

Loudspeakers, Microphones

**SWITCHES**

Key, DIL, Push Button, Contact,

Code, Rotary

**TEST EQUIPMENT**

Oscilloscopes, Frequency Meters, Signal

Generators, AF and RF Generators,

Analogue Multimeters, Digital

Multimeters, Multimeter Accessories,

RF Power Measurement, Digital

Thermometers, Logic Probe and Pulsers,

DC Power Supplies, LCR Meters,

Oscilloscope Probes, Test Leads,

Calculators

**TOOLS**

Soldering Irons, Soldering accessories,

Drills and accessories, Screwdrivers,

General Tools, Static Protection,

Service Aids

**TRANSFORMERS**

PCB Mounting, Chassis Mounting

**● AVAILABLE FROM LARGER**

**NEWSAGENTS OR DIRECT FROM CIRKIT**

**● £10 WORTH OF DISCOUNT VOUCHERS**

**● LOW COST MULTIMETERS**

**● MANY NEW PRODUCTS**

**Cirkit**

**Cirkit Distribution Ltd**

Park Lane, Broxbourne, Herts EN10 7NQ  
(0992) 444111



**THE NEW WINTER  
90/91 CATALOGUE  
OUT NOW**

**FREE!**

**25W SOLDERING IRON  
WORTH £5.98**

**WHEN YOU SUBSCRIBE  
TO THIS AND THE NEXT TWO  
ISSUES - FOR ONLY £5.00.**

**SIMPLY FILL IN THE  
COUPON AND KEEP  
UP TO DATE!**

**Please supply:**

- Winter '90/91 Catalogue @ £1.60
- Winter '90/91 Catalogue and subscription to the next two issues @ £5.00

I enclose Cheque/Postal Order for \_\_\_\_\_

Please debit my Access/Visa card for \_\_\_\_\_

NAME: \_\_\_\_\_

ADDRESS: \_\_\_\_\_

POST CODE \_\_\_\_\_

ACCESS OR VISA

EXPIRY DATE: \_\_\_\_\_

SIGNATURE: \_\_\_\_\_

DATE: \_\_\_\_\_

# Special CHRISTMAS OFFERS

Specialist from SEMICONDUCTORS

## MATCHBOX AMPLIFIERS

Amazingly powerful amplifier modules – small enough to fit in a matchbox!

50W amplifier  
20W amplifier

~~£11.27~~ ~~£8.95~~  
~~£7.59~~ ~~£5.95~~



## BIO-FEEDBACK MONITOR

Measures your stress level. Take life easy!

~~£19.32~~ ~~£12.65~~



## FREE

with every order received by December 10th

100 mixed high grade components

OR

Mini bio-feedback kit

Please tick box for the gift you would like. Orders over £35 get both!

## TACHO/DWELL METER

Essential for the motoring enthusiast

~~£18.86~~ ~~£14.85~~



## CREDIT CARD CASINO

with five extra games FREE!

The tiny pocket gambling machine

~~£6.78~~ ~~£5.25~~

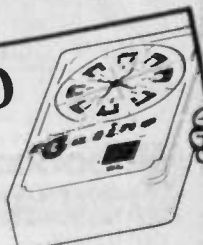

## MAINS CONTROLLER

For the expert. Control mains powered equipment from your logic circuits

~~£7.13~~ ~~£5.95~~



## BURGLAR BUSTER

Protect your home and valuables

~~£14.72~~ ~~£10.95~~



## IONISER

Get healthy without pills, drugs or jogging!

Black ioniser

~~£14.49~~ ~~£10.95~~

White ioniser

~~£14.72~~ ~~£11.25~~

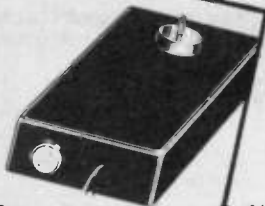

Please tick the boxes for the kits you would like and return the entire list to us. All prices include VAT, but please don't forget to add £1.20 for postage and packing. No orders accepted at these prices after 20th December 1990.

Please debit my ACCESS card no. .... I enclose cheque for £.....

Name .....

Address .....

Welcome to the 1990 Christmas list! Whether you intend to make somebody an original Christmas present or to treat yourself to a project for the holidays, there's just so much to choose from. To be sure of getting your products for Christmas, please allow enough time for postal delays in both directions and for our staff (who are very busy at this time of year, bless 'em) to pack your order. If you have an ACCESS card, you can speed things up by phoning in your order on 0600 3715, and we'll post your projects the very same day.

## SOUND FX COMPUTER ▷

This super project will make the most outrageously realistic sounds you've ever heard! How about a motor rally complete with revving engines and gear changes? Or a ship hooting its mournful way through the fog? Or a fly so realistic it'll have you running for the swat! Sirens, helicopters, steam trains, aliens—you name it, it's in there. In one mode you can even play it like a synthesizer!

The computer is ready built and programmed, and has its own audio amplifier built in. All you need to do is to connect up the speaker (supplied), wire together the 13 programming switches (supplied) and you're ready for action! What a Christmas present!

~~£14.72~~

£10.95

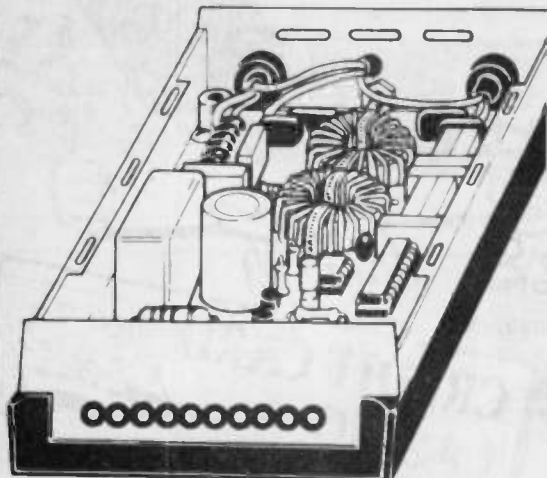
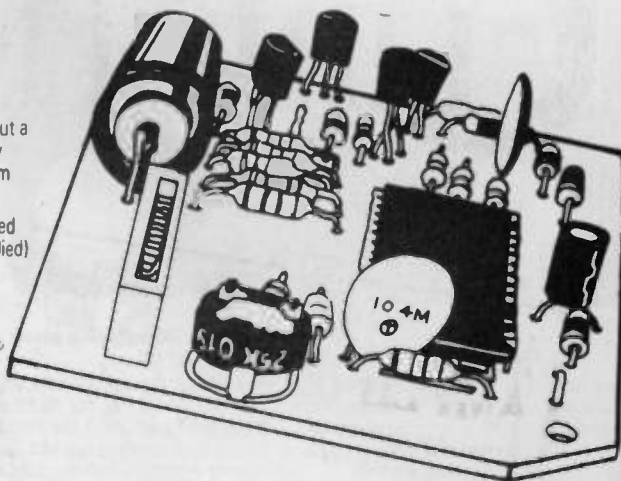

## ◁ POWER CONDITIONER

You don't have to be a hi-fi nut to notice the huge improvement in sound quality when you run your music system from a clean mains supply. How do you describe the difference? It's as if all this time your favourite artists have been playing and singing inside a wardrobe . . . and someone has just opened the door and let them out. You could spend 20 times as much on special cables, plugs, mats and stuff without achieving a tenth of the difference. But don't take my word for it. Try it for yourself.

The sophisticated circuitry of the Power Conditioner begins with a bank of six VDRs to eliminate impulsive spikes. Then comes a massive filter with thirteen capacitors and two current-balanced inductors to smooth away every trace of noise and interference. A ten LED logarithmic display flicks up and down as each spike is eliminated, and gives a second by second account of the interference removed. Maximum load 1.5kW.

~~£34.27~~

£26.65



## MAINS CONDITIONER ▷

If the budget won't stretch to the full Power Conditioner, its smaller brother the Mains Conditioner will give you a taste for the clear sounds. Just the thing for computer supplies too – it catches the spikes before they can do any harm.

~~£6.21~~

£5.65



Rugged plastic case £2.07

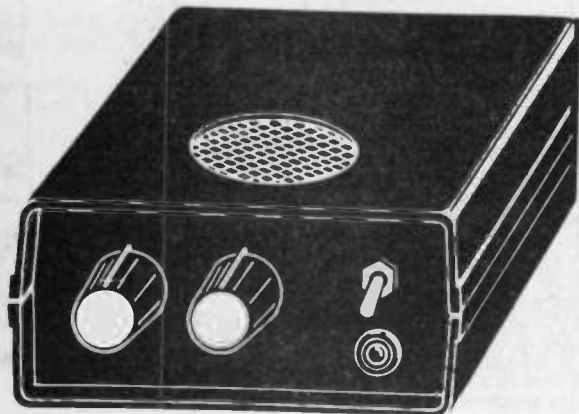
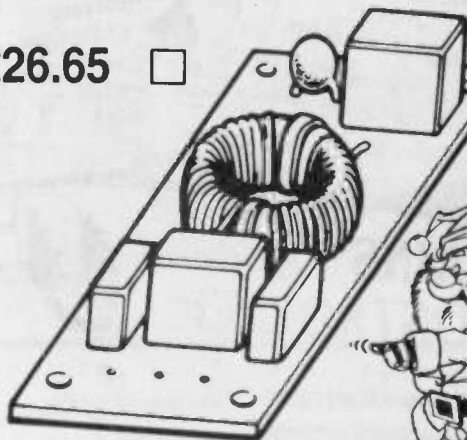

## ◁ THE DREAM MACHINE

What a project this is! The hypnotic powers of pink noise are not to be underestimated.

Legend has it that a New York dentist used to pull patients' teeth with only the gentle whoosh of pink sound to soothe them. No anaesthetic! Not something I'd care to try myself, but having experienced the effects of the Dream Machine I can well believe it.

The main function of the project is to give a truly refreshing sleep. One that leaves you feeling alert and ready for anything, not half dead until the third cup of coffee. For babies and young children it's just the thing. They drift into sleep quickly and are far less likely to wake in the middle of the night.

As for me, I enjoy experimenting with lucid dreams – ones where I'm completely in control of the action. The night time can be more exciting than the day!

~~£22.77~~

£16.95



## SILVER SOLUTION

We stock this for plating the electrodes on our Brainwave Monitor, but it's such fascinating stuff I just had to add it to the Christmas list. Just run a little onto any metal surface – coins, ornaments, PCB tracks – and a silver coating appears. This is real silver, bonded just as thoroughly to the metal as if it has been silver plated. Amazing stuff! Have a bottle for yourself and a few to give away as presents.

Silver solution £4.37



Three bottles of Silver Solution £11.95



We deliver from stock - The fastest way to order is a fax !

### ULTRASONIC CAR ALARM



**Complete kit including case**  
44.3678KL ..... £ 30.40

This system is specially designed to protect your car and its contents against potential thieves. Low current consumption and high noise immunity are just two of its distinguishing features.

In addition the system has a voltage sensing device i.e. the alarm is also triggered if appliances are switched on by an unauthorised person (e.g. the interior lighting when the door is opened).

### PC Radio (Elektor Electronics February 1990)

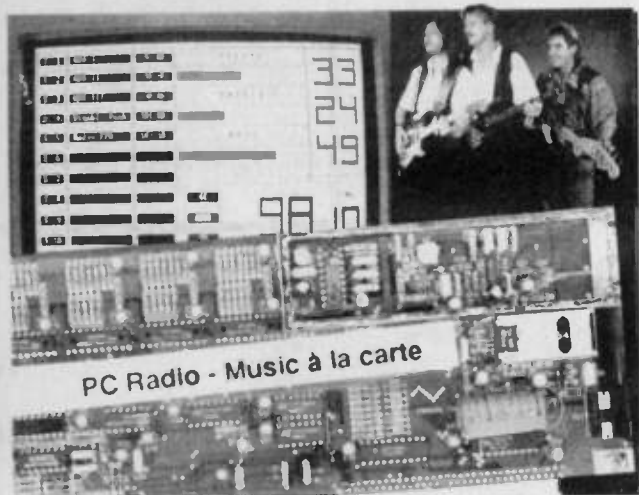

### DIGITAL PROFESSIONAL ECHO 1000

(Elektor Electronics June 89)

This low cost echo unit is certain to impress music lovers - amateur and professional - everywhere. Excellent specification and top performance make the EU 1000 a winner and despite meeting professional requirements the unit will not make too big a hole in your pocket. Working on the delta modulation prin-

ciple on a digital base, delay times up to one second are possible at full bandwidth and large signal to noise ratio.

**Complete kit**  
44.2558KL ..... £ 99.50

**Ready assembled module**  
44.255F ..... £ 134.50

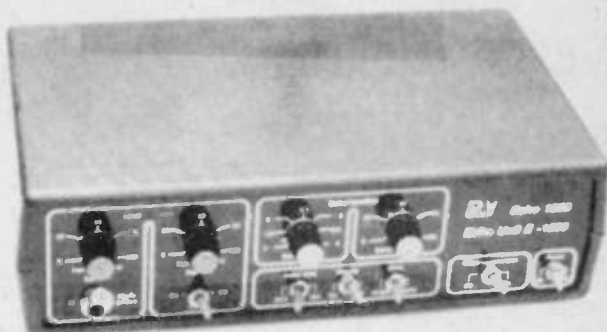

#### Specification

**Input sensitivity:**  
Input 1 : 2 mV  
Input 2 : 200 mV

**Delay Time:**  
variable from 60 ms to 1 s

**Bandwidth :**  
100 Hz to 12 kHz

**Additional features:**  
- inputs mixable  
- single and multiple echo  
- adjustable delay level  
- switchable vibrator  
- switch-controlled noise suppression

This FM radio consists of an insertion card for IBM PC-XTs, ATs and compatibles and is available as a kit or a ready-built and aligned unit. The radio has an on-board AF power amplifier for driving a loudspeaker or a headphone set, and is powered by the computer. A menu-driven program is supplied to control the radio settings.

**Complete kit**  
44.5448KL ..... £ 82.75

**Ready assembled module**  
44.544F ..... £ 137.30

### VM 1000 Video-Modulator (Elektor Electronics March 90)



Many inexpensive or older TV sets lack a SCART or other composite video input, and can only be connected to a video recorder or other equipment via an RF modulator. The modulator operates at a UHF TV channel between 30 and 40. Use is made of a single-chip RF modulator that couples low cost to excellent sound and picture quality.

**Complete kit**  
44.5468KL ..... £ 36.90

#### Ordering and payment:

- all prices excluding V.A.T. (french customers add 18.6%T.V.A.)
- send Euro-cheque, Bank Draft or Visa card number with order. Please add £ 3.00 for p & p (up to 2 kg total weight)
- postage charged at cost at higher weight Air/Surface -
- we deliver worldwide except USA and Canada
- dealer inquiries welcome

### RFK 7000 RGB-CVBS Converter

(Elektor Electronics October 89)

Nearly all computers supply as an output signal for colour monitors RGB signals. With the help of the RFK 7000 it is possible to record this signals with a videorecorder or to give them onto a colour TV (This is only possible, if the

computer delivers a vertical sync. of 50 Hz and a horizontal sync. of 15.625 Hz).

The voltage supply is gained from a 12V/300mA-DC voltage mains adaptor.

**Complete kit**  
44.5258KL ..... £ 66.50

**Ready assembled module**  
44.525F ..... £ 119.50

### FRK 7000 CVBS-RGB Converter

With the help of the FRK 7000 e.g. it is possible to use a cheap colour monitor with RGB input on a video recorder. The voltage supply is gained from a 12V/300mA-DC voltage mains adaptor.

**Complete kit**  
44.5098KL ..... £ 66.50

**Ready assembled module**  
44.509F ..... £ 119.50

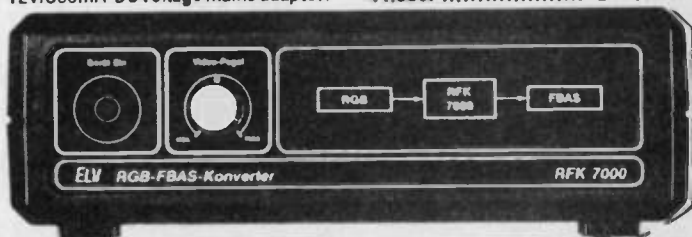



We deliver from stock - The fastest way to order is a fax !

## LPS 8000 / LC 7000 Low Cost Show Laser

(Electronics The Maplin Magazine Dec 88 + Feb-Mar 90)

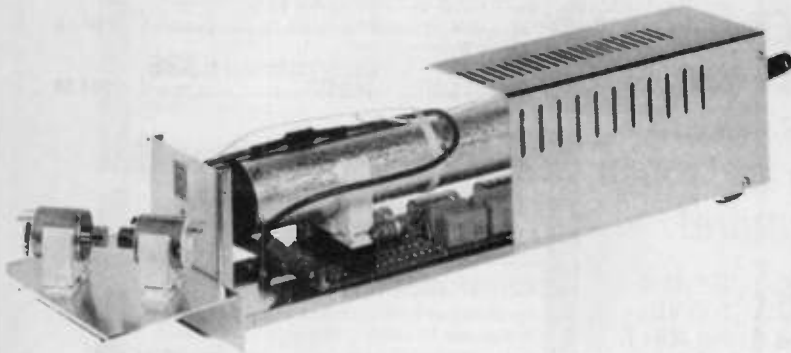

An almost infinite number of circular patterns can be projected onto a wall or ceiling with this super laser show equipment.

The complete project includes a laser tube and accompanying power supply, housed in a metal case, and a laser controller, LC 7000. The laser controller drives the accompanying deflection unit, fixed onto the laser power supply case, which produces the numerous configurations.

Naturally the laser tube, together with the power supply, can produce beams without the laser controller and the controller can be used with other, similar lasers.

LPS 8000 Laser Power Supply, complete kit  
Version 240 Volts AC  
44.428BK220 ..... £ 86.90  
Version 220 Volts AC  
44.428BK240 ..... £ 86.90

LC 7000 Laser Controller, complete kit  
Version 12 Volts DC  
44.427BK ..... £ 60.80

H-N Laser Tube 2 mW  
44.428LR ..... £ 60.80

LPS 8000 Laser Power Supply, ready assembled module  
Version 240 Volts AC  
44.428F240 ..... £ 156.50  
Version 220 Volts AC  
44.428F220 ..... £ 156.50

LC 7000 Laser Controller, ready assembled module  
Version 12 Volts DC  
44.427F ..... £ 104.30

Laser Motor-Mirror Set, complete kit  
44.506M ..... £ 22.95

## VIDEO RECORDING AMPLIFIER

(Elektor Electronics April 89)

Losses can easily occur when copying video tapes resulting in a distinct reduction in quality. By using this video recording amplifier, with no less than four (!) outputs, the modulation range is enlarged and the contrast range of the copy increases.

Two level controllers for edge definition (contour) and amplification (contrast range) allow individual and precise adaptation.

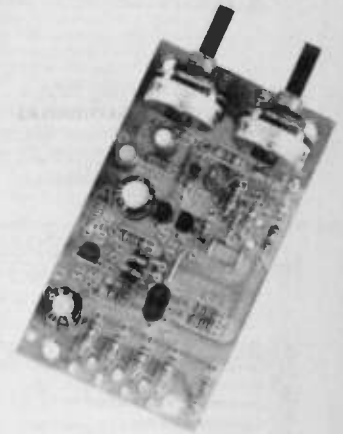

Complete Kit  
(including Box, PCB and all parts)  
44.324BK ..... £ 14.75

## IBM PC Service Card

(Elektor Electronics May 1990)

This card was developed for assistance in the field of service, development and test. The card is used as a bus-extension to reach the measurement points very easy. It is also possible to change cards without having a "hanging computer".

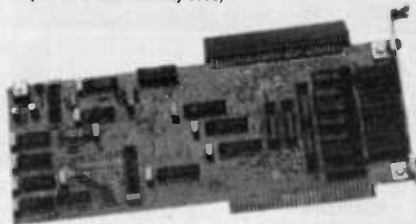

Complete kit  
44.517BK ..... £ 77.95

Ready assembled module  
44.517F ..... £ 137.95

## TA 1000 Telephone Answering Unit

(Elektor Electronics January 1990)

This automatic telephone answering unit uses a 256-kbit voice recording circuit to store and replay your spoken message of up to 15 seconds. Noteworthy features are that it is available as a complete kit, provides a battery back-up facility and does not require alignment. No provision is made, however, to record incoming calls.

Complete kit  
44.433BK ..... £ 45.65

Ready assembled module  
44.433F ..... £ 87.25

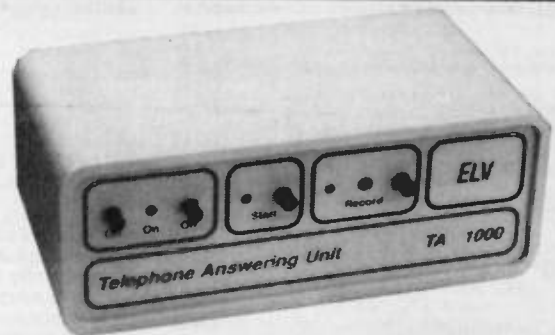

## IC TESTER for IBM-PC-XT/AT

(Electronics The Maplin Magazine Jun-Jul 89)

Elektor Electronics December 89)

With the ELV IC tester logic function tests can be carried out on nearly all CMOS and TTL standard components, accommodated in DIL packages up to 20 pin. The tester is designed as an insertion card for IBM-PC-XT/AT and compatibles. A small ZIF test socket PCB is connected via a flat band cable. Over 500 standard components can be tested using the accompanying comprehensive test software.

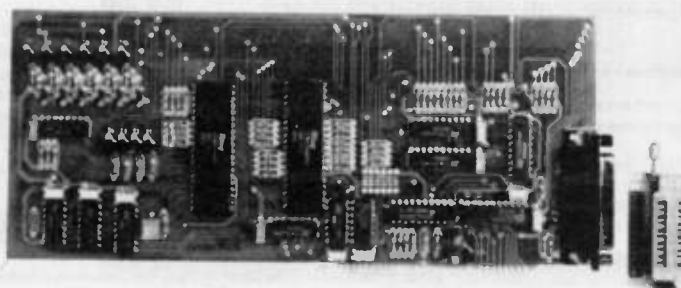

Complete Kit including Textool socket, connectors, sockets, Flat band cable, PCB, Software  
44.474BK ..... £ 60.85

Ready Assembled Module  
4.474F ..... £ 113.00

Software, single  
44.474SW ..... £ 17.85

# MAGENTA ELECTRONICS LTD



MAIL ORDER AND SHOP  
EE95 135 Hunter St  
Burton-on-Trent  
Staffs, DE14 2ST  
Tel: 0283 65435  
Fax: 0283 46932

All prices include VAT  
Shop open 9-5 Mon-Fri;  
9-2 Saturday  
Official orders welcome

Add £2  
p&p to  
all orders

## MICROCONTROLLER LIGHT SEQUENCER

EE DEC '90 KIT REF 838

A superb kit with pre-drilled painted and silk screen printed case for a really professional finish. This kit uses a microcontroller I.C. to generate 8-channel light sequences. Sequences are selected by keypad from over 100 stored in memory. Space for 10 user programmed sequences up to 16 steps long also available.  
1000 watts per channel, zero volt switching, inductive load capability. Opto-isolated for total safety. Many other features. Complete kit includes case, PCBs, all components and hardware.  
As published in EE Dec '90

£55.95

## D.C. MOTOR GEARBOXES

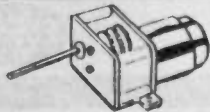

Ideal for Robots and Buggies. A miniature plastic reduction gearbox coupled with a 1.5-4.5 Volt mini motor. Variable gearbox reduction ratios are obtained by fitting from 1 to 6 gearwheels (supplied). Two types available:

**SMALL UNIT TYPE MGS £3.99**

Speed range 3-2200 rpm. Size 37x43x25mm

**LARGE UNIT TYPE MGL £4.55**

Speed range 2-1150 rpm. Size 57x43x29mm

Supplying Electronics  
for Education,  
Robotics, Music,  
Computing and much,  
much more!

NEW CATALOGUE FREE  
WITH THIS MAGAZINE.  
EXTRA COPIES AVAILABLE  
PRICE £1.00 INC. P&P

## STEPPING MOTORS

A range of top quality stepping motors suitable for driving a wide range of mechanisms under computer control using simple interfacing techniques.

**ID35 PERMANENT MAGNET MOTOR — 48 steps per rev. £16.50**

**MD200 HYBRID MOTOR — 200 steps per rev. £16.80**

**MD35 ¼ PERMANENT MAGNET MOTOR — 48 steps per rev. £12.70**

**MD38 PERMANENT MAGNET MOTOR — 48 steps per rev. £8.95**

## HAMEG HM 203-7 OSCILLOSCOPE

New model just arrived. High quality reliable instrument made in W. Germany. Outstanding performance. Full two year parts and labour warranty.  
20MHz - 2 channels 1mV sensitivity  
Easy to operate and high performance

£338

+ £50.70 VAT  
Next Day Delivery £5.00

## EDUCATIONAL BOOKS & BOOK PROJECTS

### ADVENTURES WITH ELECTRONICS

The classic Easy to Follow book suitable for all ages. Ideal for beginners. No soldering, uses an S-DEC breadboard. Gives clear instructions with lots of pictures. 16 projects — including three radios, siren, metronome, organ, intercom, timer, etc. Helps you learn about electronic components and how circuits work. Component pack includes an S-DEC breadboard and all the components for the series.

**ADVENTURES WITH ELECTRONICS £5.25**  
**COMPONENT PACK (less book) £22.35**

### FUN WITH ELECTRONICS

From the USBORNE Pocket Scientist series — An enjoyable introduction to electronics. Full of very clear full colour pictures accompanied by easy to follow text. Ideal for all beginners — children and adults. Only basic tools are needed. 64 full colour pages cover all aspects — soldering — fault finding — components (identification & how they work). Also full details of how to build 6 projects — burglar alarm, radio, game, etc. Requires soldering — 4 pages clearly show you how.

The components supplied in our pack allows all the projects to be built and kept. The book is available separately.

**FUN WITH ELECTRONICS Book £2.95**  
**COMPONENT PACK (less book) £17.55**

### 30 SOLDERLESS BREADBOARD PROJECTS

A book of projects by R. A. Penfold covering a wide range of interests. All projects are built on a Verobloc breadboard. Full layout drawings and component identification diagrams enable the projects to be built by beginners. Each circuit can be dismantled and rebuilt several times using the same components. The component pack allows all projects in the book to be built one at a time.  
Projects covered include amplifiers, light actuated switches, timers, metronome, touch switch, sound activated switch, moisture detector, M.W. Radio, Fuzz unit, etc.

**30 SOLDERLESS BREADBOARD PROJECTS Book 1 £2.95**  
**COMPONENT PACK £27.15**

### ENJOYING ELECTRONICS

A more advanced book which introduces some arithmetic and calculations to electronic circuits. 48 chapters covering elements of electronics such as current, transistor switches, flip-flops, oscillators, charge, pulses, etc. An excellent follow-up to Teach-in or any other of our series. Extremely well explained by Owen Bishop who has written many excellent beginners' articles in numerous electronics magazines.

**ENJOYING ELECTRONICS Book £3.60**  
**COMPONENT PACK £14.31**

Note — A simple multimeter is needed to fully follow this book. The M102 BZ is ideal. **£13.98**

### A FIRST ELECTRONICS COURSE

A copiously illustrated book that explains the principles of electronics by relating them to everyday objects. At the end of each chapter a set of questions and word puzzles allow progress to be checked in an entertaining way. An S-DEC breadboard is used for this series — soldering is not required.

**A FIRST ELECTRONIC COURSE BOOK £4.50**  
**PACK £22.35**

## EVERYDAY ELECTRONICS KIT PROJECTS

ALL KITS HERE HAVE BEEN FEATURED IN EE. IF YOU DO NOT HAVE THE MAGAZINE WITH THE ORIGINAL ARTICLE, YOU WILL NEED TO ORDER THE REPRINT FOR 80p EXTRA. REPRINTS ALSO AVAILABLE SEPARATELY. KITS INCLUDE CASES, PCB'S, HARDWARE AND ALL COMPONENTS (UNLESS STATED OTHERWISE) CASES ARE NOT DRILLED. LABELS ARE NOT SUPPLIED

Ref	Price	Ref	Price
835 SUPERHET BROADCAST RECEIVER Mar 90	£16.79	542 PERSONAL RADIO June 86	£12.89
With drilled panels and dial		528 PA AMPLIFIER May 86	£29.95
Without above	£13.64	523 STEREO REVERB Apr 86	£29.57
834 QUICK CAP TESTER Feb 90	£10.17	513 BBC MIDI INTERFACE Mar 86	£31.25
833 EE 4 CHANNEL LIGHT CHASER Jan 90	£31.45	512 MAINS TESTER & FUSE FINDER Mar 86	£9.86
815 EE TREASURE HUNTER Aug 89	Full Kit £41.95	497 MUSICAL DOOR BELL Jan 86	£20.95
814 BAT DETECTOR June 89	£20.98	493 DIGITAL CAPACITANCE METER Dec 85	£46.46
812 ULTRASONIC PET SCARER May 89	£14.49	481 SOLDERING IRON CONTROLLER Oct 85	£6.12
800 SPECTRUM EPROM PROGRAMMER Dec 88	£29.95	464 STEPPER MOTOR INTERFACE FOR THE BBC	
796 SEASHELL SYNTHESISER Nov 88	£27.94	COMPUTER less case Aug 85	£9.40
790 EPROM ERASER Oct 88	£27.90	1D35 STEPPER MOTOR EXTRA	£8.95
769 VARIABLE 25V-2A BENCH POWER SUPPLY		OPTIONAL POWER SUPPLY PARTS	£5.74
Feb 88	£55.61	461 CONTINUITY TESTER July 85	£6.93
763 AUDIO SIGNAL GENERATOR Dec 87	£15.66	455 ELECTRONIC DOORBELL June 85	£8.45
739 ACCENTED BEAT METRONOME Nov 87	£23.43	453 GRAPHIC EQUALISER June 85	£29.98
740 ACOUSTIC PROBE Nov 87 (less bolt & probe)	£19.58	444 INSULATION TESTER Apr 85	£21.89
744 VIDEO CONTROLLER Oct 87	£32.58	392 BBC MICRO AUDIO STORAGE SCOPE	
734 AUTOMATIC PORCH LIGHT Oct 87	£19.20	INTERFACE Nov 84	£39.95
728 PERSONAL STEREO AMP Sep 87	£15.99	387 MAINS CABLE DETECTOR Oct 84	£6.18
730 BURST-FIRE MAINS CONTROLLER Sep 87	£15.17	386 DRILL SPEED CONTROLLER Oct 84	£9.70
724 SUPER SOUND ADAPTOR Aug 87	£42.93	362 VARICAP AM RADIO May 84	£14.70
718 3-BAND 1.6-30MHz RADIO Aug 87	£29.66	337 BIOLOGICAL AMPLIFIER Jan 84	£27.00
719 BUCCANEER I.B. METAL DETECTOR July 87		263 BUZZ OFF Mar 83	£6.35
Inc coils, and case, less handle and hardware	£29.58	242 INTERCOM no case July 82	£6.36
722 FERMOSTAT July 87	£13.58	240 EGG TIMER June 82	£7.68
715 MINI DISCO LIGHTS June 87	£14.08	108 IN SITU TRANSISTOR TESTER June 78	£10.53
707 EQUALIZER (IONISER) May 87	£17.37	106 WIERD SOUND EFFECTS GEN Mar 78	£8.75
700 ACTIVE I/R BURGLAR ALARM Mar 87	£39.87	101 ELECTRONIC DICE Mar 77	£7.00
581 VIDEO GUARD Feb 87	£9.39		
584 SPECTRUM SPEECH SYNTH (no case) Feb 87	£23.39		
578 SPECTRUM I/O PORT less case Feb 87	£10.55		
569 CAR ALARM Dec 86	£13.94		
563 200MHz DIG. FREQUENCY METER Nov 86	£69.95		
561 LIGHT RIDER LAPEL BADGE Oct 86	£11.40		
560 LIGHT RIDER DISCO VERSION	£21.93		
559 LIGHT RIDER 16 LED VERSION	£15.25		
556 INFRA-RED BEAM ALARM Sep 86	£31.70		
544 TILT ALARM July 86	£8.75		

### TEACH-IN PROJECT 1

591 REGULATOR UNIT & SAFE POWER SUPPLY	£29.95
592 UNIVERSAL LCR BRIDGE	£28.89
593 DIODE/TRANSISTOR TESTER	£21.22
594 AUDIO SIGNAL TRACER	£18.73
595 AUDIO SIGNAL GENERATOR	£29.31
596 R.F. SIGNAL GENERATOR	£27.37
597 FET VOLTMETER	£24.02
598 DIGITAL PULSE GENERATOR	£18.65

## INSULATION TESTER

EE APRIL 85



A reliable electronic tester which checks insulation resistance of wiring appliances etc., at 500 volts. The unit is battery powered simple and safe to operate. Leakage resistance of up to 100 Megohms can be read easily. One of our own designs and extremely popular.

£21.89

KIT REF 444

## PET SCARER

EE MAY 89

Produces high power ultrasound pulses. L.E.D. flashes to indicate power output and level. Battery powered (9V-12V or via Mains Adaptor).

KIT REF 812

Mains Adaptor £1.98

£14.49



## DIGITAL CAPACITANCE METER

EE DEC 85

Simple and accurate (1%) measurement of capacitors from a few pF up to 1,000  $\mu$ F. Clear 5-digit LED display indicates exact value. Three ranges - pF, nF, and  $\mu$ F. Just connect the capacitor, press the button and read the value.

KIT REF 493

£46.46



## 3 BAND SHORT WAVE RADIO

EE AUG 87

Covers 1.6-30 MHz in 3 bands using modern miniature coils. Audio output is via a built-in loudspeaker. Advanced design gives excellent stability, sensitivity and selectivity. Simple to build.

KIT REF 718

£29.66

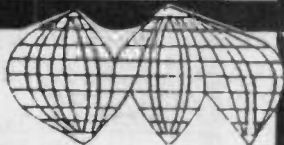

## DIGITAL FREQUENCY 200 MHz METER

EE NOV 86

An 8 digit meter reading from AF up to 200 MHz in two ranges. Large 0.5" Red LED display. Ideal for AF and RF measurements. Amateur and C.B. frequencies.

KIT REF 563

£69.95

## MOSFET VARIABLE BENCH 25V 2.5A POWER SUPPLY

EE FEB 88

A superb design giving 0.25V and 0-2.5A. Twin panel meters indicate Voltage and Current. Voltage is variable from zero to 25V. A Toroidal transformer MOSFET power output device, and Quad op-amp IC design give excellent performance.

KIT REF 769

£55.61

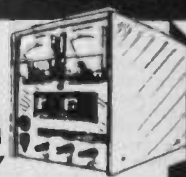

## MINI STROBE

EE MAY '86

A hand held stroboscope which uses 6 "ultra bright" LEDs as the light source. Designed to demonstrate the principles of stroboscope examination, the unit is also suitable for measuring the speed of moving shafts etc. The flash rate control covers 170-20,000 RPM in two ranges.

KIT REF 529

£15.50

## ACOUSTIC PROBE

EE NOV '87

A very popular project which picks up vibrations by means of a contact probe and passes them on to a pair of headphones or an amplifier. Sounds from engines, watches and speech travelling through walls can be amplified and heard clearly. Useful for mechanics, instrument engineers and nosey parkers!

KIT REF 740

£19.58



## 4 CHANNEL LIGHT CHASER

EE Jan '90

A 1000W per channel chaser with zero volt switching, hard drive, inductive load capability, mic sound sensor and sophisticated 'beat' detector. Chase steps to music or auto when quiet. Variable speed and mic. sens. LED mimic on front panel. Switchable for 3 or 4 channels. P552 output. Ideal for rope lights, pin spots, disco and display lighting.

KIT REF 833

£31.45

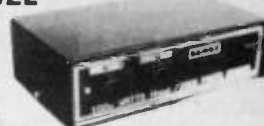

## EE EQUALISER

EE MAY '87

A mains powered ioniser with an output of negative ions that give a refreshing feeling to the surrounding atmosphere. Negligible current consumption and all-insulated construction ensure that the unit is safe and economical in use. Easy to build on a simple PCB.

KIT REF 707

£17.37



## MUSICAL DOORBELL

EE JAN '86

This project uses a special I.C. pre-programmed with 25 tunes and 3 chimes. A Magenta design, the circuit is battery powered and only draws current whilst producing sounds. Two rotary switches select the tune required. Provision is made for three bell pushes, each of which sounds a different tune, so that three points of entry can be identified.

KIT REF 497

£20.95

## EPROM ERASER

EE OCT '88

Safe low-cost unit capable of erasing up to four EPROM's simultaneously in less than twenty minutes. Operates from a 12V supply. Safety interlock. Convenient and simple to build and use.

KIT REF 790

£27.90



## LIGHT RIDERS

EE OCT '86

Three projects under one title - all simulations of the Knight Rider lights from the TV series. The three are a lapel badge using six LEDs, a larger LED unit with 16 LEDs and a mains version capable of driving six main lamps totalling over 500 watts.

KIT REF 559 CHASER LIGHT

£15.25

KIT REF 560 DISCO LIGHTS

£21.93

KIT REF 561 LAPEL BADGE

£11.40

## EE TREASURE HUNTER

EE AUG '89

A sensitive pulse induction Metal Detector. Picks up coins and rings etc., up to 20cms deep. Low "ground effect". Can be used with search-head underwater. Easy to use and build, kit includes search-head, handle, case, PCB and all parts as shown.

KIT REF 815

Headphones

£41.95

£1.99



## SUPERHET BROADCAST RECEIVER

EE MAR '90

At last, an easy to build SUPERHET A.M. radio kit. Covers Long and medium Wave bands. built in loudspeaker with 1 watt output. Excellent sensitivity and selectivity provided by ceramic I.F. filter. Simple alignment and tuning without special equipment. Kit available less case, or with pre-cut and drilled transparent plastic panels and dial for a striking see-through effect.

KIT REF 835

£16.79

# TK FOR KITS

## GUARD DOG KIT



One of the best burglar deterrents is a guard dog and this kit provides the barking without the bite! Can be connected to a doorbell, pressure mat or any other intruder detector and produces random threatening barks. Includes mains supply and horn speaker.

**XK125 £21.95**

## DISCO LIGHTING KITS

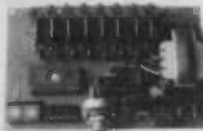

**OL8000K** 8-way sequencer kit with built-in opto-isolated sound to light input. Only requires a box and control knob to complete .... **£39.95**  
**OL1000K** 4-way chaser features bi-directional sequence and dimming 1kW per channel .... **£23.95**  
 DLA/1 (for DZ1000K)  
 Optional op-to input allowing audio beat/light response..... **95p**  
**DL3000K** 3-channel sound to light kit, zero voltage switching, automatic level control and built-in mic. 1kW per channel ..... **£19.55**  
**XK139** Uni-directional chaser. Zero switching and built-in audio input..... **£12.95**

## POWER STROBE KIT

Produces an intense light pulse at a variable frequency of 1 to 15Hz.



Includes high quality PCB, components, connectors, 5Ws strobe tube and assembly instructions. Supply: 240V ac. Size: 80x50x45.  
**XK124 STROBOSCOPE KIT. £17.25**

## PROGRAMMABLE ELECTRONIC LOCK KIT

Keys could be a thing of the past with this new high security lock. Secure doors to sheds, garages, even your home or prevent the unauthorised use of computers, burglar alarms or cars. One 4-digit sequence will operate the lock while incorrect entries will sound an alarm. The number of incorrect entries allowed

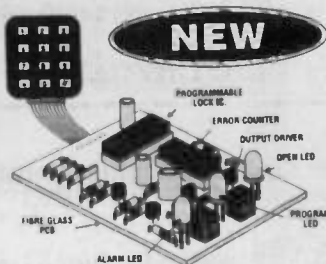

before the alarm is triggered is selected by you. Further entries will be ignored for a time also set by you. Only the correct sequence will open the lock and switch off the alarm. The sequence may easily be changed by entering a special number and code on the supplied keyboard. Kit includes; keyboard, alarm buzzer, high quality PCB and all electronic components. Supply 5-15V DC. Will drive our Latch Mechanism (701 150 @ £18.98) or relay directly.

**XK131 £19.95**

## SIMPLE KITS FOR BEGINNERS

Especially aimed at the beginner. Have fun with your project even after you have built it and also learn a little from building it. These kits include high quality solder resist printed circuit boards, all electronic components (including speaker where used) and full construction instructions with circuit description.



**SK1 DOOR CHIME** plays a tune when activated by a pushbutton **£4.50**

**SK2 WHISTLE SWITCH** switches a relay on and off in response to whistle command **£4.50**

**SK3 SOUND GENERATOR** produces FOUR different sounds, including police/ambulance/fire-engine siren and machine gun **£4.50**

**XK118 TEN EXCITING PROJECTS FOR BEGINNERS** this kit contains a solderless breadboard, components and a booklet with instructions to enable the absolute novice to build ten fascinating projects including a light operated switch, intercom, burglar alarm and electronic lock. Each project includes a circuit diagram, description of operation and an easy to follow layout diagram. A section component identification and function is included, enabling the beginner to build the circuits with confidence .... **£17.25**

## SUPER-SENSITIVE MICROBUZ

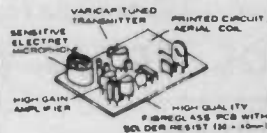

Only 45x25x15mm, including built-in mic. 88-100MHz (standard FM radio). Range approx. 300m depending on terrain. Powered by 9V PP3 (7mA). Ideal for surveillance, baby alarm etc. **XK128 £6.35**

## REMOTE CONTROL DIMMER KIT

Imagine controlling the brightness of your lights or switching them on or off from the comfort of your armchair. This kit contains all the components from front panel to the last screw to enable you to do just that and fit the shallowest wall boxes. Max power 300W (not fluorescents).

**XK132.....£19.95**

## IR TRANSMITTER KIT

Designed for use with the XK132 and comes complete with a pre-drilled box. A PP3 9 volt battery is required.

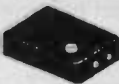

**MK 6.....£4.95**  
**XK136 TDUCH DIMMER KIT.....£12.95**

## VERSATILE REMOTE CONTROL SYSTEM

These kits can switch up to 16 pieces of equipment on and off or control 16 functions depending on the keyboard selected for the MK18 transmitter. MK12 receiver has 16 logic outputs and operates from 12 to 24V d.c. or 240V a.c. via the transformer supplied. The MK18 requires a 9V battery and keyboard. Great for controlling lights, TVs, garage doors etc.

**MK12 IR Receiver.....£19.55**  
**MK18 Transmitter.....£8.95**  
**MK 9 4-way Keyboard.....£2.75**  
**MK10 16-way Keyboard.....£7.95**  
**601 133 Box for transmitter.....£2.95**

## ELECTRONIC WEIGHING SCALE

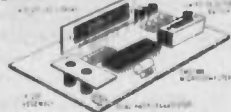

Kit contains a single chip microprocessor, PCB, displays and all electronics to produce a digital LED readout of weight in Kgs or Sts/Lbs. A PCB link selects the scale-bathroom/two types of kitchen scales. A low cost digital ruler could also be made.

**ES1 £8.25**

## VOICE RECORD/PLAYBACK KIT

This simple to construct and even simpler to operate kit will record and playback short messages or tunes. It has many uses - seatbelt or light reminder in the car, welcome messages to visitors at home or at work, warning messages in factories and public places. In fact anywhere where a spoken message is announced and which needs to be changed from time to time. Also suitable for toys - why not convert your daughter's £8 doll to an £80 taking doll!

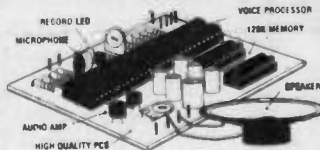

Size ..... 76 x 60 x 15mm  
 Message time ..... 1-5 secs normal speed, 2-10 secs slow speed  
**XK129 £25.95**

## PROPORTIONAL TEMPERATURE CONTROLLER KIT

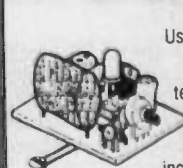

Uses 'burst fire' technique to maintain temperature to within 0.5°C. Ideal for photography, incubators, wine making, etc.

Maximum load 3kW (240V AC). Temperature range up to 60°C.  
 Size 50x40x25mm. **XK140.....£8.95**

# TK ELECTRONICS

## TK ELECTRONICS

13 Boston Road  
 London W7 3SJ  
 Tel: 081-579 9794  
 Fax: 081-566 1916

**ORDERING INFORMATION** All prices INCLUDE VAT. Free P & P on orders over £60 (UK only), otherwise add £1.15. Overseas Customers divide total order by 1.15 then add P & P: Europe £3.50, elsewhere £10.00. Send cheque/PO/Visa/Access No. with order. Giro No. 529314002. Local Authority and educational institutions orders welcome. Shop Open: Tuesday-Thursday 10 am - 5 pm. Saturday 10 am - 4 pm.



**ORDERS: 081-567 8910 24 HOURS**

# EVERYDAY ELECTRONICS

INCORPORATING ELECTRONICS MONTHLY

The No.1 Magazine for Electronic & Computer Projects  
**VOL. 19 No. 12**      **December '90**

## DEDICATED

I think I'm right in saying that the Light Sequencer in this issue is the first project we have published that uses a "dedicated" chip. In fact this statement is perhaps a little misleading because the chip is an 8-bit CMOS microcontroller with 8K bytes of EPROM and 256 bytes of RAM on board. The EPROM has been specially programmed for this unit and thus the "dedicated chip" is produced.

The advent of such a cheap microprocessor chip (less than £15 for one off) which can be programmed in small quantities in this way does open up the possibilities for various dedicated controllers that are now within the hobbyists price range. Previously the cost of development and production of low volume dedicated chips was prohibitive and the obvious answer was to use a microprocessor with a separate EPROM which could then be cheaply "blown" with appropriate software. The new device is essentially the same animal all on one chip, together with some RAM for user programming. There is even the option of battery back up to protect any user programs when the unit is not turned on.

The controller has, in this case, been pre-programmed with over 100 different lighting sequences that can be run individually or set to step one after the other, each being shown a few times before the next one is selected. This unit thus provides an incredibly versatile lighting unit which is compact, inexpensive and easy to use.

## NOW READ THIS!

For those of you who read your magazine what follows might be a bit of a surprise, for the rest – well they won't read it anyway! Time and again people phone us for general information, phone numbers, addresses or prices of items that are clearly shown in the magazine. If you want information on the books we supply check the *Direct Book Service* pages; on p.c.b.s, see that page; for back numbers, subscriptions, binders and technical queries it's all on this page. If it's a query on component buying for one of our projects then the answer may be in *Shop Talk*. But of course you know all that, because you read the mag – how do we get at the others?

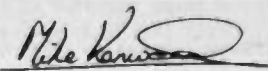

## SUBSCRIPTIONS

Annual subscriptions for delivery direct to any address in the UK £17.00. Overseas: £21.00 (£39 airmail). Cheques or bank drafts (in £ sterling only) payable to Everyday Electronics and sent to EE Subscriptions Dept., 6 Church Street, Wimborne, Dorset BH21 1JH. Subscriptions can only start

with the next available issue. For back numbers see below.

## BACK ISSUES

Certain back issues of EVERYDAY ELECTRONICS are available price £1.70 (£2.20 overseas surface mail) – £ sterling only please – inclusive of postage and packing per copy. Enquiries with remittance, made payable to Everyday Electronics, should be sent to Post Sales Department, Everyday Electronics, 6 Church Street, Wimborne, Dorset BH21 1JH. In the event of non-availability one article can be photostatted for the same price. *Normally sent within seven days but please allow 28 days for delivery.* We have sold out of Sept., Oct. & Dec. 85, April, May, Oct. & Dec. 86, Jan., April, May & Nov. 87, Jan., March, April, June & Oct. 88, & March 90.

## BINDERS

Binders to hold one volume (12 issues) are available from the above address for £4.95 (£6.95 to European countries and £9.00 to other countries, surface mail) inclusive of post and packing. *Normally sent within seven days but please allow 28 days for delivery.* Payment in £ sterling only please.



## Editorial Offices:

EVERYDAY ELECTRONICS EDITORIAL,  
6 CHURCH STREET, WIMBORNE,  
DORSET BH21 1JH

Phone: Wimborne (0202) 881749

Fax: (0202) 841692. DX: Wimborne 45314.

See notes on Readers' Enquiries below – we regret that lengthy technical enquiries cannot be answered over the telephone.

## Advertisement Offices:

EVERYDAY ELECTRONICS ADVERTISEMENTS,  
HOLLAND WOOD HOUSE, CHURCH LANE,  
GREAT HOLLAND, ESSEX CO13 0JS.  
Phone (0255) 850596

Editor: MIKE KENWARD

Secretary: PAMELA BROWN

Deputy Editor: DAVID BARRINGTON

Business Manager: DAVID J. LEAVER

Editorial: WIMBORNE (0202) 881749

Advertisement Manager:  
PETER J. MEW, Frinton (0255) 850596

Classified Advertisements:  
Wimborne (0202) 881749

## READERS' ENQUIRIES

We are unable to offer any advice on the use, purchase, repair or modification of commercial equipment or the incorporation or modification of designs published in the magazine. We regret that we cannot provide data or answer queries on articles or projects that are more than five years old. Letters requiring a personal reply must be accompanied by a stamped self-addressed envelope or a self addressed envelope and international reply coupons.

All reasonable precautions are taken to ensure that the advice and data given to readers is reliable. We cannot however guarantee it and we cannot accept legal responsibility for it.

## COMPONENT SUPPLIES

We do not supply electronic components or kits for building the projects featured, these can be supplied by advertisers.

We advise readers to check that all parts are still available before commencing any project in a back-dated issue.

We regret that we cannot provide data or answer queries on projects that are more than five years old.

## ADVERTISEMENTS

Although the proprietors and staff of EVERYDAY ELECTRONICS take reasonable precautions to protect the interests of readers by ensuring as far as practicable that advertisements are *bona fide*, the magazine and its Publishers cannot give any undertakings in respect of statements or claims made by advertisers, whether these advertisements are printed as part of the magazine, or are in the form of inserts.

The Publishers regret that under no circumstances will the magazine accept liability for non-receipt of goods ordered, or for late delivery, or for faults in manufacture. Legal remedies are available in respect of some of these circumstances, and readers who have complaints should first address them to the advertiser.

## TRANSMITTER/BUGS/TELEPHONE EQUIPMENT

We would like to advise readers that certain items of radio transmitting and telephone equipment which may be advertised in our pages cannot be legally used in the U.K. Readers should check the law before using any transmitting or telephone equipment as a fine, confiscation of equipment and/or imprisonment can result from illegal use. The laws vary from country to country; overseas readers should check local laws.

# 8 CHANNEL MICROCONTROLLER LIGHT SEQUENCER

MARK STUART

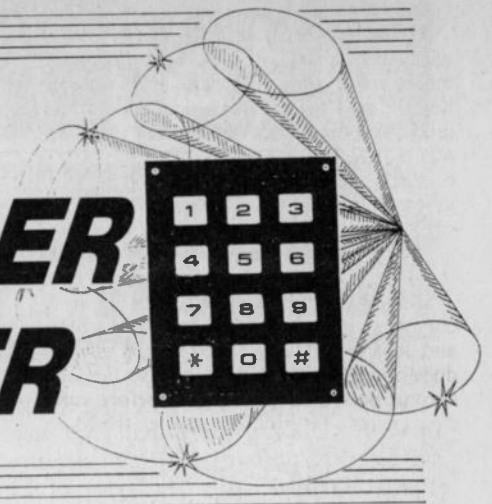

*Complete fingertip control for lighting effects for Discos and Stage shows are made possible by the use of a pre-programmed microcontroller chip.*

**T**HIS sequencer was designed to open up a new range of lighting effects for Discos, Stage Effects, and Commercial Displays at a reasonable price. It will no doubt find many other uses because of its versatility and low cost.

The circuit is based upon a pre-programmed microcontroller i.c. which drives eight triac mains switches via opto-isolators, and provides a full front panel mimic display along with four other indicators which display the current operating mode. The i.c. is controlled by a twelve key keypad, providing the following functions:

#### SELECT MODE:

##### Select lamp ON

- 1) Select pre-programmed sequence from memory by entering keypad code. Select from over 100 sequences, including standard 3 and 4 channel chases and a vast range of others including random and Light Rider eight lamp end-to-end sequences.

#### RUN MODE:

##### Run lamp ON

- 2) Runs the selected sequence, or continuous selection if none selected. Increase Speed / Decrease speed; continuously and smoothly varies sequence speed whilst running using UP/DOWN keys.

#### STOP MODE:

##### Stop lamp ON

- 3) Stop sequence at any position and individually control each lamp by use of its number button. Alternate toggle action: Press once for ON, once for OFF and so on. Useful for setting up colour effects.

#### STEP MODE:

##### Stop lamp ON and Step lamp ON

- 4) Automatically steps through the selected sequence one step at a time each time the STEP key is pressed. An external switch or contact pad may be connected to allow manual stepping to music beat.

#### FULL SEQUENCE MODE:

##### Run lamp ON

- 5) After switch on this mode is entered automatically. The controller runs through its entire sequence memory, running each sequence a number of times and then stepping on. At the end it returns to the first sequence and repeats.

#### PROGRAM MODE 1:

##### Stop lamp ON and Select lamp ON

- 6) Up to ten sequences each 16 steps long may be entered step by step and stored in memory. These are held in memory by on chip battery backed RAM. Any number of lamps may be on or off in each step.

#### PROGRAM MODE 2:

##### Stop lamp ON and Select lamp ON

- 7) A single sequence up to 160 steps long may be entered step by step and stored in memory. As with Mode 1, Battery Backed RAM is used. This program is particularly useful for stage effects and display lighting. The sequence may be stepped manually or run automatically, and will repeat continuously.

Note that Program Modes 1 and 2 cannot be used at the same time as they use the same memory space.

#### SAFETY

The 8-Channel Microcontroller Light Sequencer is compact and uses two standard 8 way sockets for lamp connections. All channels are individually fused. Sequence patterns are provided which allow existing three- and four-channel lamp set ups and rope lights to be connected, and give much better effects than standard chasers. The two 8 way sockets can be used simultaneously with different sequences programmed for each, provided that they are run at the same speed.

Opto-isolators are used to maintain all of the control board electronics at safe low voltages completely isolated from the mains. All lamps are switched at the mains Zero Crossing point to minimise interference and stress to the lamps and triacs.

The triacs are connected to the "Live" side of the mains for added safety, so that when they are off there is no mains live connection to any of the lamps. A double pole mains isolating switch is also used for additional safety.

#### CIRCUIT DESCRIPTION

The circuit diagram for the 8-Channel Microcontroller Light Sequencer is really straightforward but looks complicated because many parts are repeated eight times.

The power section and the control section are built on separate printed circuit boards and have been drawn as separate circuits. Either one may be used without the other in conjunction with other equipment. In particular the Power Board is fully isolated and can be driven from a computer I/O port or other low power circuits to control a range of mains powered equipment.

The Control Board could be operated from 12V d.c. and be fitted with power Darlington transistors to drive 12V lamps for use in car displays.

It is also practical to drive more than one power board from a single control board so that power boards can be built into the lamp units and connected using thin signal cables to a central controller.

#### POWER SECTION

The complete power section circuit diagram is shown in Fig. 1. Triacs CSR1 to CSR8 switch the mains Live via the bank of eight fuses to the output sockets. Triac CSR8 has a resistor R31 between its gate terminal and its common or MT1 terminal. This resistor holds the gate at the same voltage as MT1 and so the triac is held in the off state. It is inappropriate here to go into full detail about the operation of triacs, but a simple explanation will help the rest of the circuit to be understood better.

Normally a triac is in the OFF state and current cannot flow between its MT1 and MT2 terminals ( MT stands for Main Terminal ). A small current passed between the gate terminal and MT1 (the Gate Current) turns on the triac so that current can flow in either direction between the two Main Terminals.

If the gate current is now removed the triac will remain turned ON provided some current is still passing between the Main Terminals. With an a.c. supply the current is reduced to zero each time the voltage reverses between half cycles (this happens 100 times per second for 50Hz mains).

A triac turned on with a short pulse of gate current just after the beginning of a mains half cycle will therefore remain conductive until the mains voltage and current fall to zero at the end of the half cycle. To maintain a triac in what is effectively a permanently ON state only a small pulse of gate current is required after the beginning of each mains half cycle.

This is true with resistive loads such as lamps and heaters where the current rises as soon as voltage is applied, but with more complicated loads such as transformers and fluorescent lamp chokes, the current does not rise immediately, and so the gate current pulse comes and goes before sufficient current has built up between the Main Terminals to maintain the triac in the ON state. (There is a minimum current called the Hold Current which is required between the Main Terminals to maintain conduction, typically it is equal to the minimum gate current required to start conduction.)

## PULSE TRIGGERING

To deal with these more complicated loads the ideal method is Hard Triggering, where gate current is applied continuously.

This has only one drawback which is that it increases the current demand from the gate control circuit.

In this circuit it is particularly difficult to provide hard triggering because there could

The completed unit showing the keypad and channel mimic i.e.d.s.

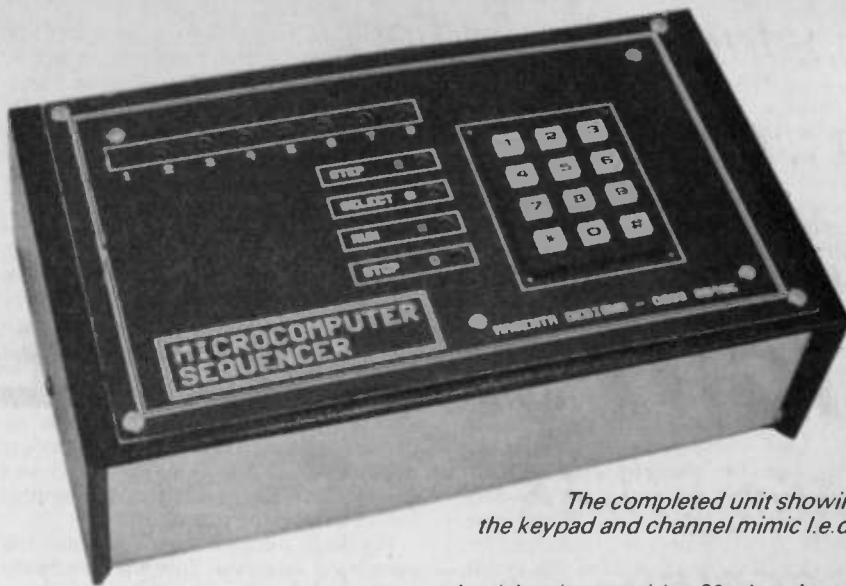

be eight triacs requiring 20mA each at the same time. This current is not available from the 20V tapping on the transformer being used and so an alternative method is used to combine low current operation and yet provide triggering over all of the mains cycle.

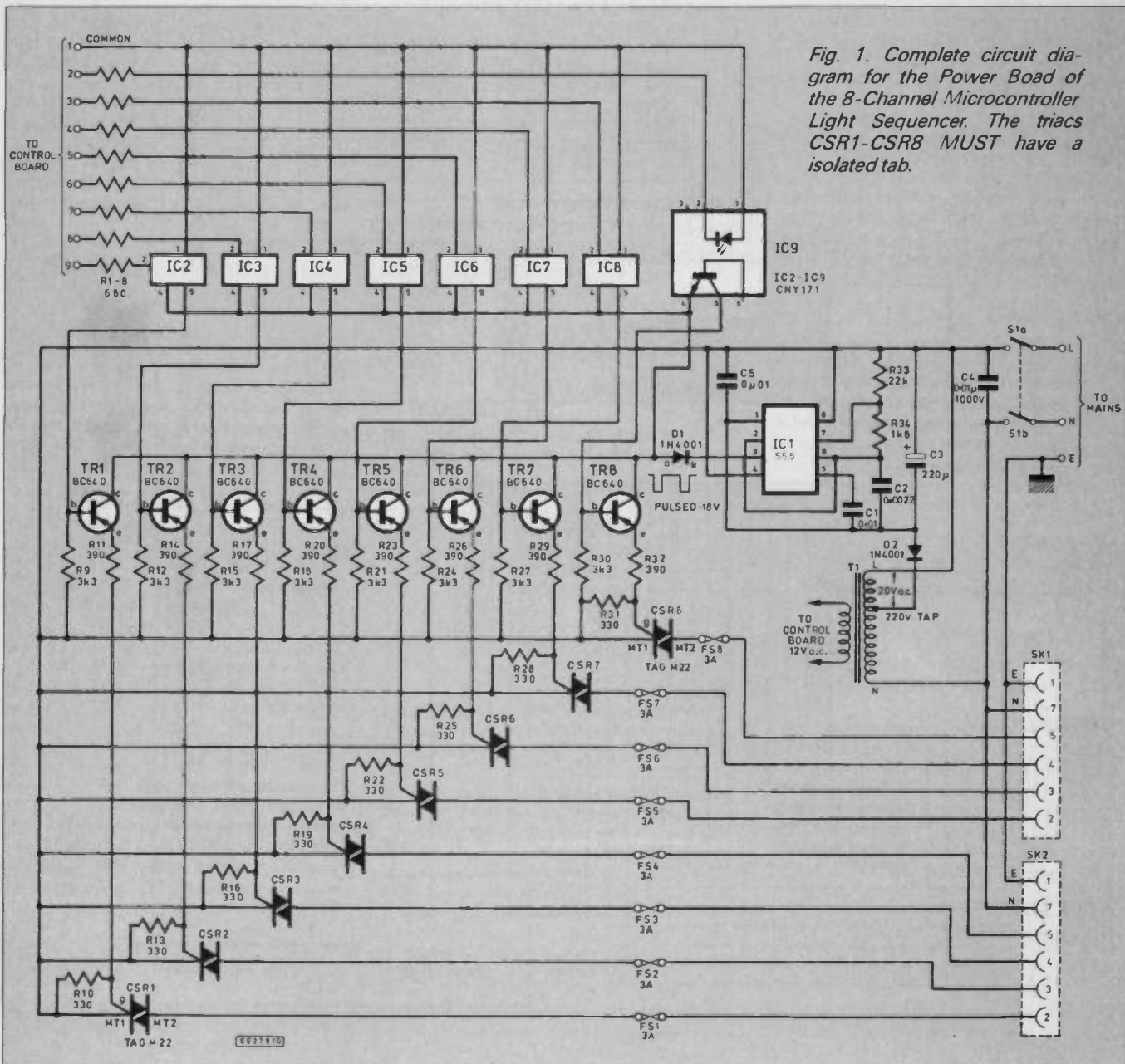

Fig. 1. Complete circuit diagram for the Power Board of the 8-Channel Microcontroller Light Sequencer. The triacs CSR1-CSR8 MUST have a isolated tab.

Instead of applying gate current continuously it is applied in pulses throughout the mains cycle. The mark-space ratio of the pulses is 1 to 10 so that the average current flowing is one tenth of the peak.

The result is that 20mA gate pulses are available for only 2mA of supply current. The pulse rate is over 10kHz so that there are over 100 pulses per half cycle, a rate which is practically indistinguishable by the triac from continuous current.

### TRIGGER CIRCUIT

Trigger pulses are produced by a standard 555 timer (IC1) operating in the astable mode. The circuit is powered from a 20 volt tapping (see Fig. 1) on the mains transformer primary after rectification by diode D2 and smoothing by capacitor C3.

The timing components are resistors R33, R34, and capacitor C2. Capacitors C1 and C5 provide essential decoupling for stable operation. The output of this circuit is a series of 18 volt negative pulses which are passed via diode D1 to the trigger circuits of the eight triacs.

Triacs are not too worried about the direction of the gate current and turn on happily with "positive" or "negative" drive. Negative drive has been chosen because the 555 timer is easier to use producing negative pulses and a simple circuit results. Also there is a slight increase in gate sensitivity when negative pulses are used.

Gate current to the triacs is supplied via transistors TR1 - TR8 which act as emitter followers, amplifying the small current available from the phototransistor inside the opto-isolators IC2 - IC9. The emitter resistors R32 etc. limit the maximum peak gate current to 20mA.

Resistor R30 is the load resistor for IC9 and determines the current which is required from the phototransistor to produce full gate drive. The value of 3k3 chosen requires 3mA to produce the 10V required for full drive at the base of TR8.

The I.e.d. side of the opto-isolator is completely insulated from the phototransistor and so provides complete mains isolation. Current in the I.e.d. illuminates the phototransistor and turns it on.

The CTR or Current Transfer Ratio of the opto-isolator indicates the ratio of phototransistor current to I.e.d. current. Average units give between 80 per cent and 20 per cent and so the design should allow for 20 per cent.

If 3mA is required from the phototransistor then with 20 per cent CTR the I.e.d. current should be  $3 \times 100/20$  or 15mA. This sets the value of the series limiting resistors R1 to R8. In practice most opto-isolators will be well above this level of sensitivity and so ample current has been provided.

Sockets SK1 and SK2 provide two standard output connectors and are wired to match most commercial chasers. This allows existing three- and four-channel lamp units to be connected without re-wiring.

The secondary winding on the transformer is of course completely insulated from the mains and so provides an isolated supply for the control board. Capacitor C4 is a mains rated component that helps to reduce mains spikes and prevent them from triggering the triacs and upsetting the control board microcontroller.

Fig. 2. Complete circuit diagram for the control section of the 8-Channel Microcontroller Lights Sequencer.

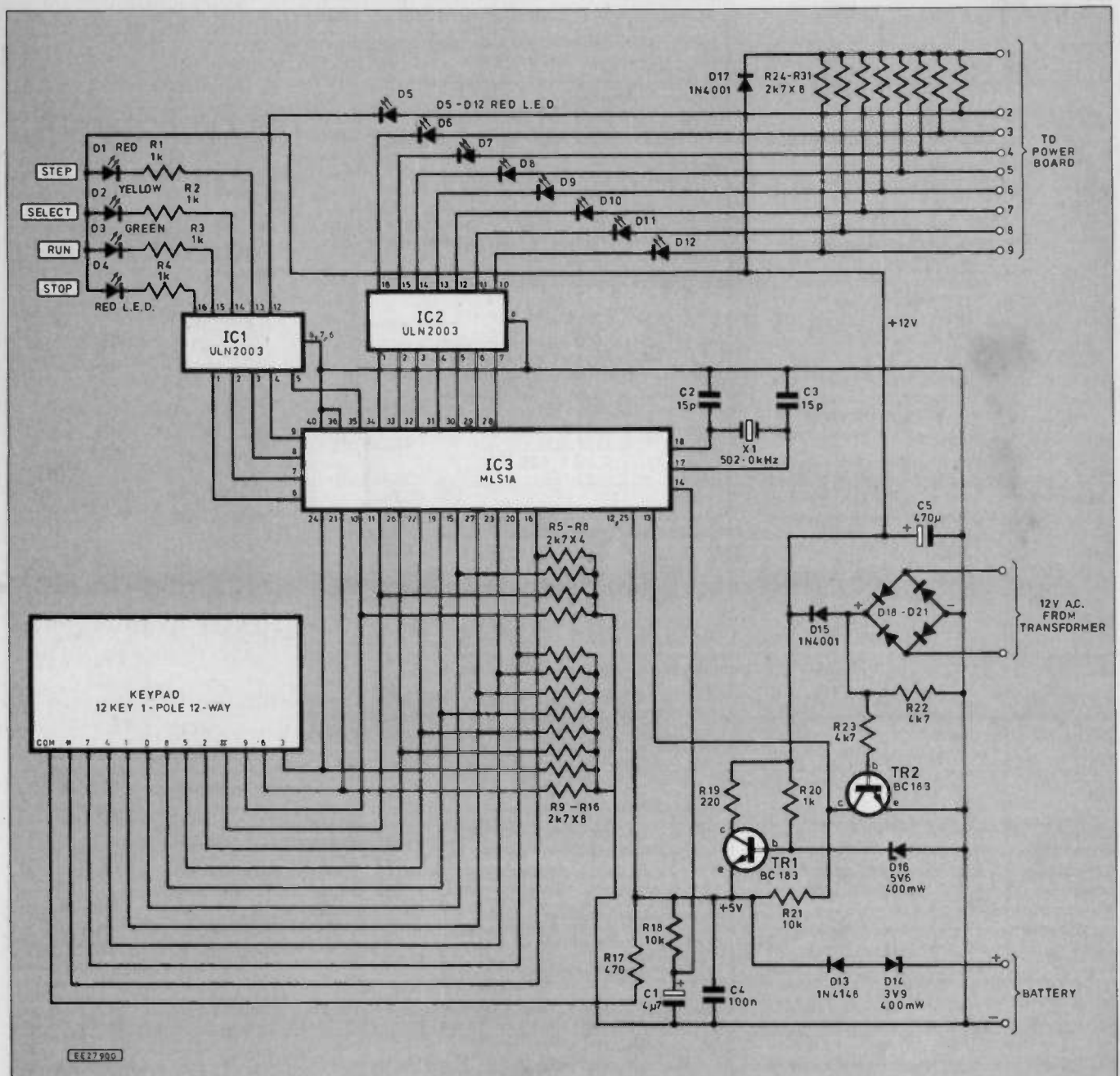



## CONTROL SECTION

The complete circuit diagram for the control section is shown in Fig. 2.

The Control Board uses a special pre-programmed Microcontroller i.c. which reads the keypad, drives the indicators and opto-isolators and works out the timing to ensure zero volt switching takes place correctly. It also contains a large array of sequences programmed into its ROM area and has an area of RAM that can be programmed with special sequences by the user.

As IC3 does most of the work the rest of the circuitry is simplified greatly and consists of a power supply, output buffers, a mains zero cross detector, and assorted pull-up and pull-down resistors. An optional battery backup connection is available to retain user programmed sequences.

## INPUTS

The keypad is a one-pole 12-way type that connects straight into IC3. Resistor networks containing R5 to R8 and R9 to R16 pull the inputs down to zero without any keys pressed.

Pressing a key pulls the corresponding input high via resistor R17 which connects to the 5V rail. More than one key can be operated at a time in some modes in which case several inputs are pulled up together.

## OUTPUTS

Outputs from IC3 are buffered by the Darlington drivers, IC1 and IC2. These contain seven separate stages each and so one section of IC1 and all of IC2 are required for the eight sequence outputs. Four other sections of IC1 are used to drive the four function indicator l.e.d.s (D1 to D4) via resistors R1 to R4.

All of the outputs from IC1 and IC2 are open collectors which turn on when the input voltage is 5V and off when it is zero. They have a current capability of 500mA each which is enough to drive several power boards.

The outputs to the power board are driven via the mimic l.e.d.s D5 to D12. These are in series with the opto-isolator l.e.d.s which are fed from the 12V positive supply rail via diode D17. Resistor network R24 to R31 contains eight resistors which allow a small current to flow in the l.e.d.s when the power board is not connected. This allows the control board to be tested fully on its own with just a 12V a.c. supply.

## CLOCK

A 502kHz ceramic resonator X1 connected between pins 17 and 18 of IC3 provides the clock signal from which the microcontroller derives all of its internal timing functions. Capacitors C2 and C3 provide the necessary loading and phase shift to ensure oscillation.

## POWER SUPPLY

The 12V a.c. from the transformer secondary is rectified by the d.i.l. bridge rectifier containing D18 to D21. Before smoothing, the full wave rectified output is fed to transistor TR2 base via resistor R23. As long as the input exceeds 0.6V TR2 is turned on and holds the voltage at pin 13 of IC3 at zero.

When the voltage falls below 0.6V, which it does around the mains zero crossing points, TR2 is turned off and the voltage on its collector and on pin 13 of IC3 is

## COMPONENTS

### CONTROL BOARD

#### Resistors

R1-R4, R20	1k (5 off)
R5-R8	2k7 s.i.l. 4-way resistor pack
R9-R16	2k7 s.i.l. 8-way resistor pack
R17	470
R18, R21	10k (2 off)
R19	220
R22, R23	4k7 (2 off)
R24-R31	2k7 s.i.l. 8-way resistor pack

All 0.25W 5% carbon except where indicated.

#### Capacitors

C1	4µ7 min radial elec. 6V
C2, C3	15p ceramic (2 off)
C4	100n ceramic, 50V
C5	470µ min. axial elec. 16V

#### Semiconductors

D1, D4, D5-D12	5mm red l.e.d. (10 off)
D2	5mm yellow l.e.d.
D3	5mm green l.e.d.
D13	1N4148 signal diode
D14	3V9 400mW Zener diode
D15, D17	1N4001 1A 50V rec. diode (2 off)
D16	5V6 400mW Zener diode
D18-D21	d.i.l. bridge rec.
TR1, TR2	BC183 npn silicon transistor (2 off) (NOT BC183L)
IC1, IC2	ULN2003 Darlington driver (2 off)
IC3	MLS1A programmed sequencer (Magenta)
X1	502.0kHz ceramic resonator

#### Miscellaneous

Keypad, 12 key 1-pole 12-way; printed circuit board available from the *EE PCB Service*, code EE708; 9-way 90° 0.1in. pitch pin header; 16-pin i.c. socket (2 off); 40-pin d.i.l. socket; single sided p.c.b. screening panel, 185mm x 106mm; mounting pillars and long screws (4 off); nuts (8 off); solder tag (2 off); washer; solder, etc.

### POWER BOARD

#### Resistors

R1-R8	680 (8 off)
R9, R12, R15, R18, R21, R24, R27, R30	3k3 (8 off)
R10, R13, R16, R19, R22, R25, R28, R31	330 (8 off)
R11, R14, R17, R20, R23, R26, R29, R32	390 (8 off)
R33	22k
R34	1k8

All 0.25W, 5% min. carbon film

#### Capacitor

C1, C5	0µ01 ceramic, 50V
C2	0µ0022 Mylar, 50V
C3	220µ radial elec. 25V
C4	0µ01 ceramic, 1000V

#### Semiconductors

D1-D2	1N4001 1A 50V rec. diode (2 off)
TR1-TR8	BC640 npn transistor (8 off)
CSR1-CSR8	TAG M22 isolated tab triac (Magenta) (8 off)
IC1	NE555 timer i.c.
IC2-IC9	CNY171 opto-isolators (8 off)

#### Miscellaneous

T1	3VA Mains transformer, with 220V primary tapping: 12V secondary (wire-ended connections)
S1	DPDT 13A mains rocker switch
SK1, SK2	8-pin chassis socket - P552 (2 off)
FS1-FS8	3A 20mm quick-blow fuse (8 off), with 0.4in. pitch fuse clip (16 off) - see text.

Printed circuit board available from *EE PCB Service*, code EE709; metal case, 230mm x 133mm x 63mm; 8-pin i.c. socket; 10A 250V mains cable; mains cable entry clamp; "star" or 3-way solder tag; self-tapping screws (4 off); insulating sleeving; solder, etc.

Approx cost  
guidance only

**£56**

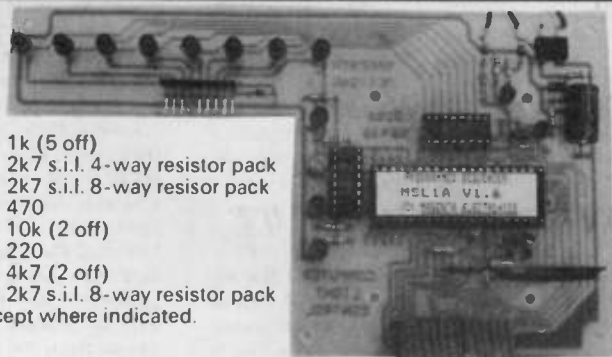

See  
SHOP  
TALK  
Page

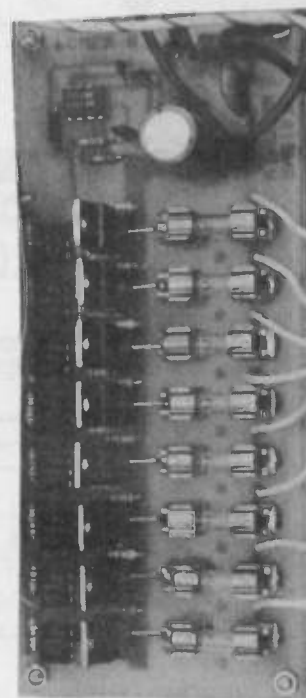

pulled up to 5V via resistor R21. This pulse which occurs every cycle is used by IC3 to determine when the mains cycle is crossing zero and is used to synchronise the sequence so that steps only occur at this time.

The rectified 12V is passed via diode D15 to smoothing capacitor C5. From here a simple regulated supply of 5V is provided via a standard emitter follower regulator consisting of Zener regulator diode D16, transistor TR1 and resistors R19, R20. This is a simple short-circuit proof regulator that protects IC3. C4 is a decoupling capacitor which keeps voltage spikes off the supply line.

Diodes D13 and D14 allow a 9V battery to power IC3 for intervals between use so that it can store the user entered programs. Just leave out the battery if this feature is not needed.

## RESET

Two remaining components provide the vital function of resetting IC3 at switch on. This is necessary so that it knows where to begin.

As power is applied IC3 pin 14 is temporarily held at zero volts by capacitor C1 holding the microcontroller in the starting

condition. As C1 charges via resistor R18 pin 14 rises to 5V and operation begins.

This action is not required when battery backup is used and the circuit re-starts automatically.

## CONSTRUCTION

Before doing any electronic construction the case should be prepared. As there is a fair amount of drilling it is recommended that those without the necessary tools or skills might like to buy the kit version, which is supplied with a drilled case and fascia panel.

Those who enjoy "metal bashing" may buy the version with a blank case or may chose to make their own housing. A paper drilling template is available free from Magenta.

Alternatively it is quite effective to use the bare printed circuit boards as an aid to marking out to ensure that the mounting holes and l.e.d. drillings are made correctly. The power board should be fitted with its front edge 4mm from the front panel of the case to allow the heatsink (if used) to fit correctly.

The keypad position is not critical but should be approximately as shown. The

sockets, switch and cable entry clamp on the rear panel must be mounted as low as possible to ensure there is enough room for the control board in the top of the case.

The best method of cutting out the larger holes is to use an Abraframe saw which can cut in all directions. First drill a pilot hole and then thread the blade and re-fit it to the saw frame. If the case has been marked out well it is fairly easy to make good holes in this way. A smooth file finishes the job.

A rectangular piece of copper clad board is needed to act as a screen and an "earthed" safety barrier mounted on the rear of the control board. This board must be cut to 102mm x 180mm and drilled using the control board as a template so that it fits with its *unclad* side facing the track side of the control board.

The rear panel holds the ON/OFF switch, mains cable entry clamp, output sockets, and most important of all, a star earthing tag. This should be fitted using a single screw fitted with shakeproof washers and two nuts. *It is NOT acceptable to use a component mounting point for earthing purposes.*

When all of these components have been mounted the mains connections should be

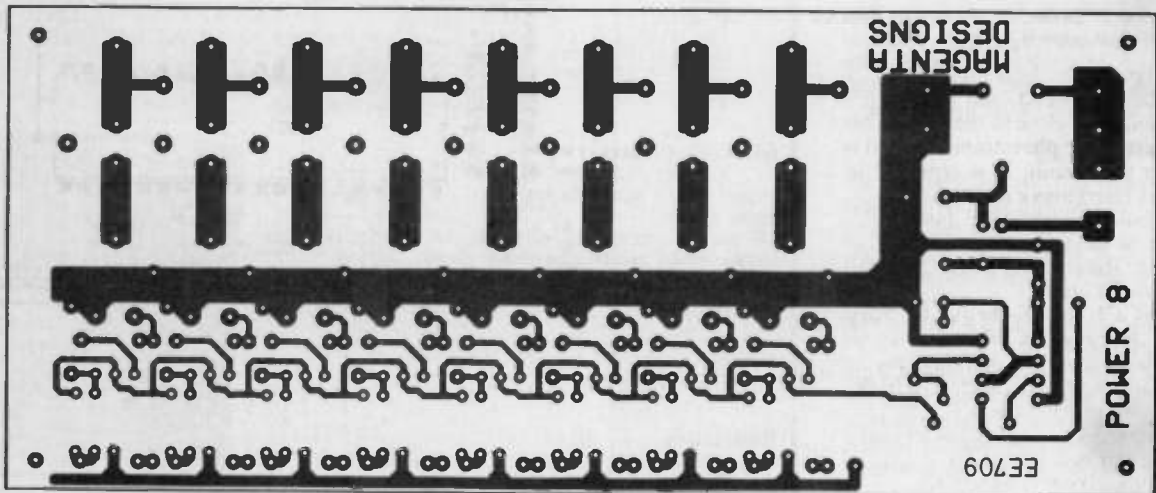
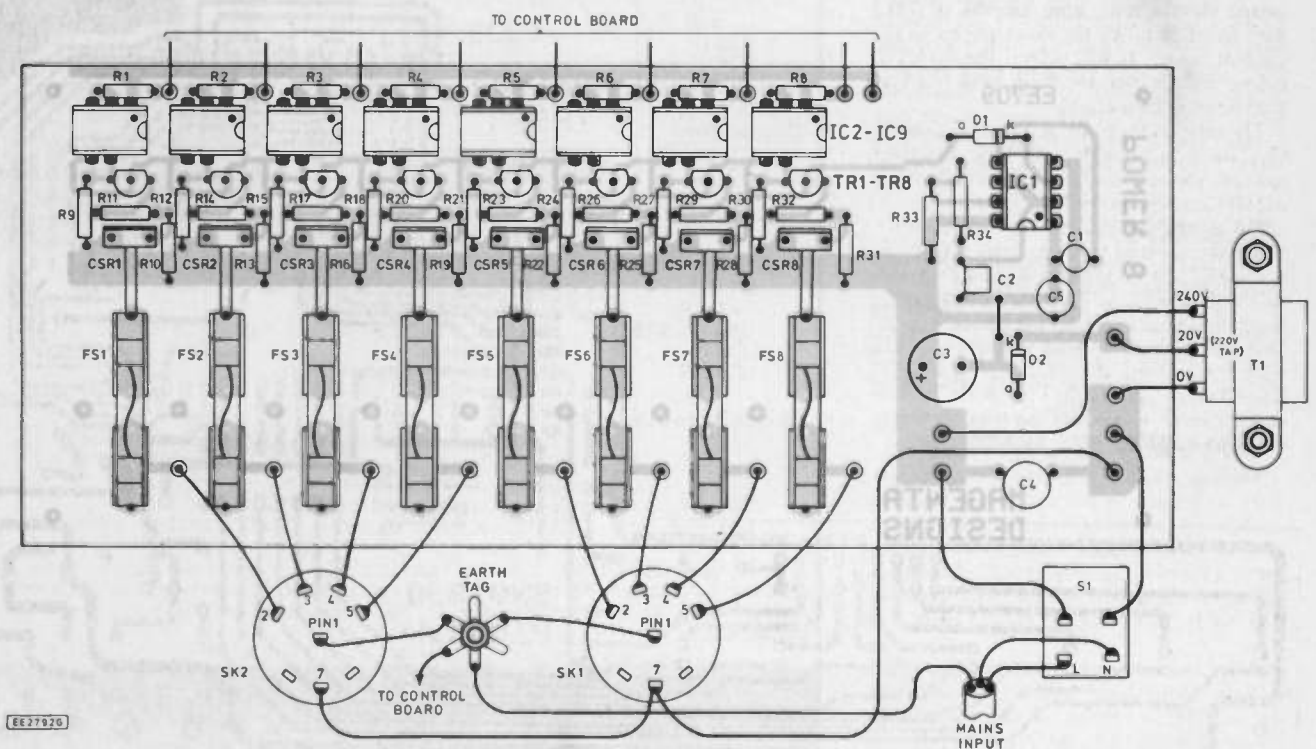

Fig. 3. Printed circuit board component layout and full size copper foil master for the Power Board



made between them following the wiring diagram Fig. 3. All mains connections should be covered with insulating sleeving.

## POWER BOARD

The component layout and full size copper foil master pattern of the Power Board is shown in Fig. 3. Fit all of the resistors first. Care is required because they are closely spaced to keep board area to a minimum. It is best to fit R11, R14, etc first.

Next fit the opto isolators, IC2 to IC9, *directly* to the board. Sockets should not be used as they reduce the clearance between

The centre leads of the triacs must be bent 3mm from the plastic case towards the non metal side. The other two leads should then be inserted into the board down to the shoulder on the pins and soldered in.

Straighten the triacs up on the board and then solder the centre leads to the point where the fuseholder tag passes into the board. It is important that the correct isolated tab triacs are used. Each one **MUST** be checked before insertion by an ohmmeter between the centre lead and the tab to ensure that there is NO connection.

The remaining connections between the mains input and the transformer should be

left until later, because the board can be tested at low voltage before making these final connections.

## CONTROL BOARD

The construction of the Control Board requires care because the l.e.d.s must be aligned with the front panel drillings. It is best to do this first without the clutter of other components. The Control Board component layout and full size printed circuit copper foil master pattern is shown in Fig. 4.

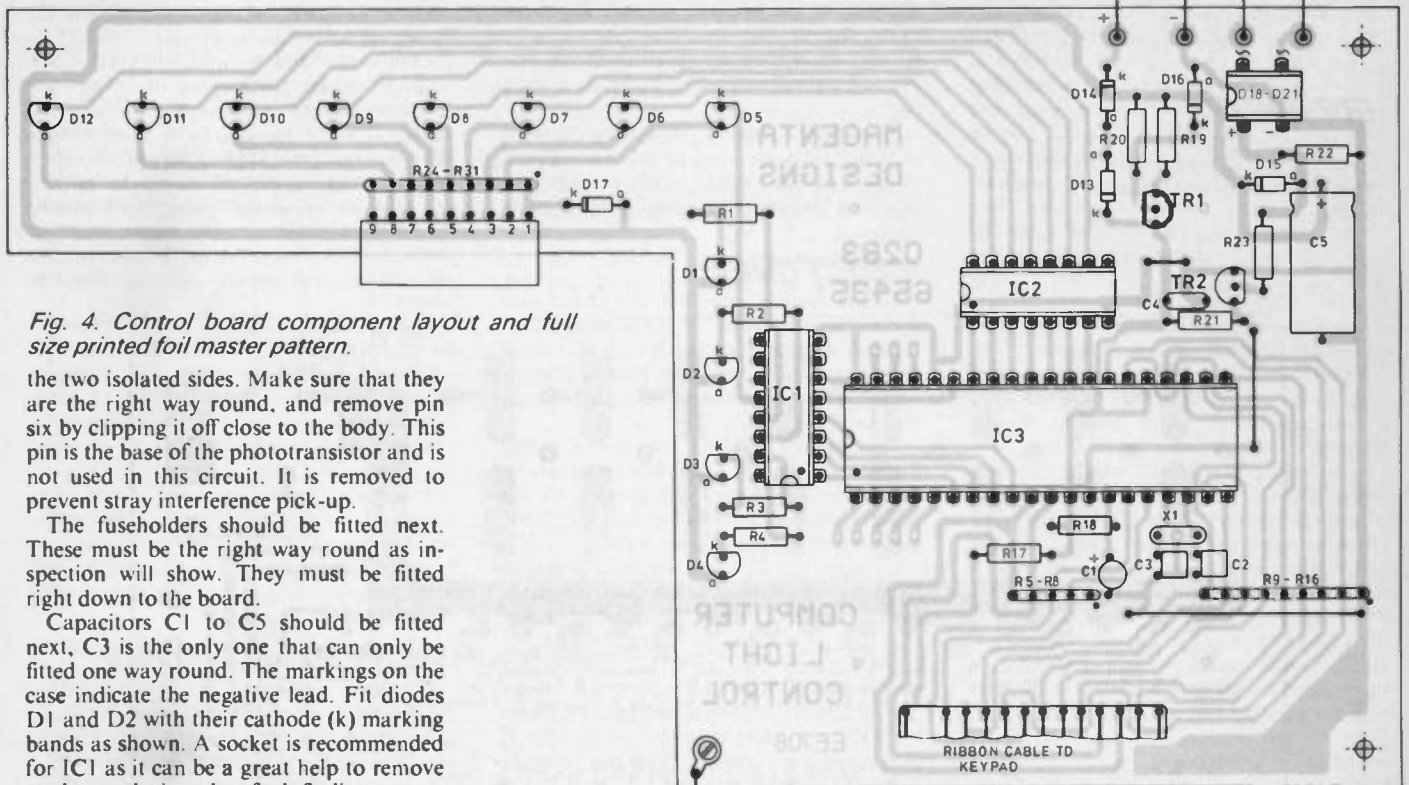

Fig. 4. Control board component layout and full size printed foil master pattern.

the two isolated sides. Make sure that they are the right way round, and remove pin six by clipping it off close to the body. This pin is the base of the phototransistor and is not used in this circuit. It is removed to prevent stray interference pick-up.

The fuseholders should be fitted next. These must be the right way round as inspection will show. They must be fitted right down to the board.

Capacitors C1 to C5 should be fitted next, C3 is the only one that can only be fitted one way round. The markings on the case indicate the negative lead. Fit diodes D1 and D2 with their cathode (k) marking bands as shown. A socket is recommended for IC1 as it can be a great help to remove or change the i.c. when fault finding.

Eight lengths of 16/0.2 wire should be fitted to the board to make the connections to the output sockets. The other side of the board should have nine lengths of 7/0.2 wire fitted to make the connections to the control board. It will help if the standard colour code is used for these, with black as the common connection.

The transistors must be fitted as close to the board as possible with their flat sides towards the opto-isolators. Check that they are all the correct type before fitting.

Fitting the triacs is slightly unusual because the centre leads are bent across the surface of the board and soldered directly to the fuseholders. This method makes a huge simplification in board layout, and allows the main live input voltage to use a wide track along the middle of the board linking all of the triac MT1 terminals. Note that the metal tab side of the triacs is facing the opto-isolators.

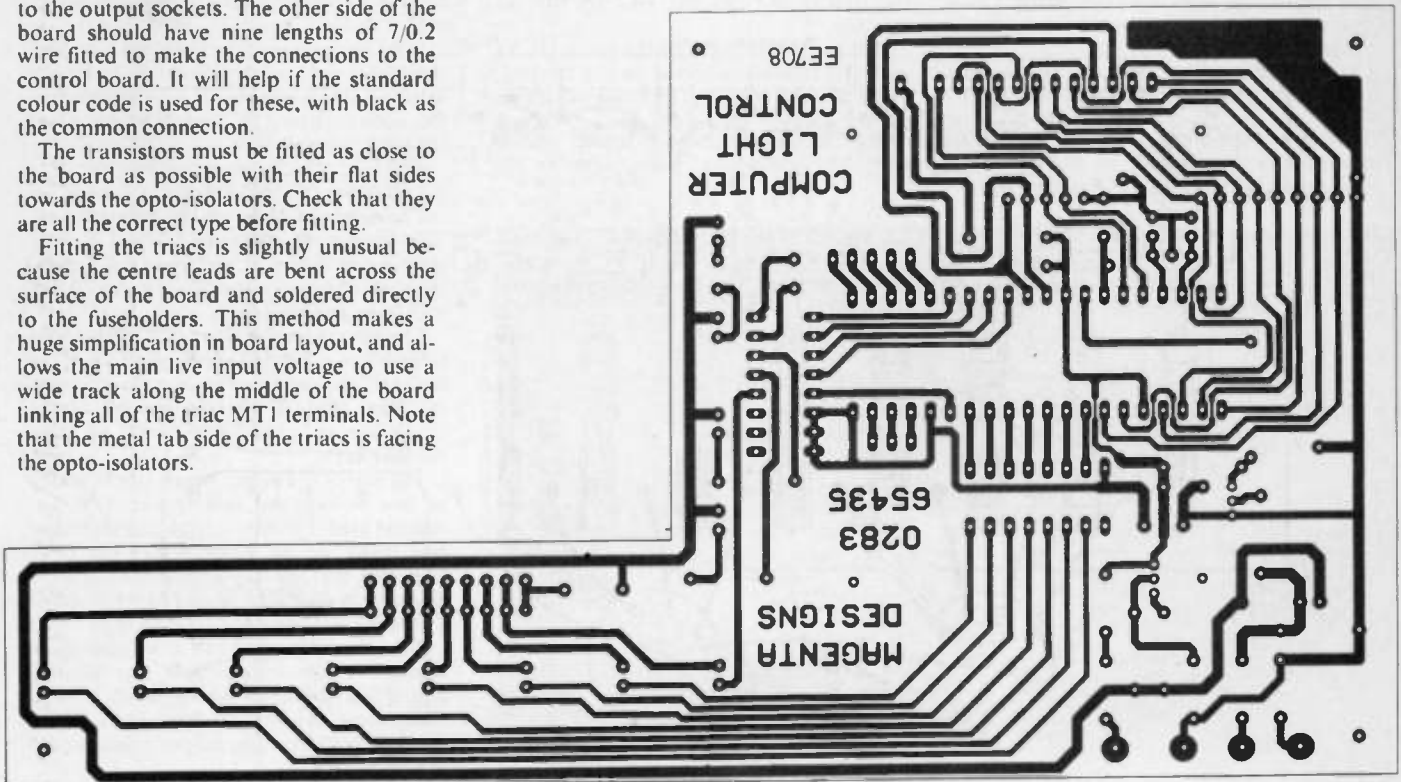

Insert the l.e.d.s into the board but do not solder them. With the l.e.d.s in position fit the board to the front panel using long screws and 12mm spacers. In this position the l.e.d.s can be fitted one by one into their front panel holes so that their lenses fit evenly, and then soldered in place.

When this is done, remove the front panel and fit all of the resistors and capacitors, the wire links and the resistor networks. Note that the resistor networks have a dot marking the common end which must match the dot in Fig 4. Curious things will happen if they are the wrong way round. Capacitors C1 and C5 must be fitted correctly as they are polarised.

All three i.c.s should be fitted in sockets. IC1 and IC2 are power types which can be damaged by short circuits, and IC3 is CMOS. There are no particular handling difficulties with any of the i.c.s, but make sure they are the right way round, and fit them only after testing the power circuits.

The bridge rectifier should be soldered directly into the board in the direction shown. Transistors TR1 and TR2 are the same type and must be fitted with their flat sides as shown. Diodes D14, D15, D16, and D17 need careful identification using a magnifier and must be inserted with their cathode (k) marking bands as shown.

There are three wire links, the two longer ones should be made from insulated wire, or tinned wire fitted with sleeving. Wiring between the keypad and the board requires 13 equal lengths of 7/0.2 wire or a short length of 0.1in. pitch ribbon cable. A length of approximately 50mm allows plenty of room to move the keypad away from the board when testing and is short enough to be tidy in the final assembly.

Standard ribbon can be used but it is flimsy and awkward to handle. Those constructors who prefer to use a different case can extend the keypad leads up to 300mm without problems as long as they are kept clear of mains carrying wires and other sources of interference.

Finally the 0.1in. pitch connector should be fitted next to R24 - R31. A standard straight connector is used with its pins bent over just above the moulded insulator. This is best done before inserting the connector into the board.

Two wires carrying 12V from the mains transformer need to be extended with 7/0.2

wire and the joins insulated with sleeving. These connections are made directly to the control board next to the bridge rectifier.

The nine leads from the power board must be routed as shown in the photographs and clipped inside the front of the case alongside the 12V power leads using a self-adhesive cable retainer. Cut the nine leads to equal lengths, strip 4mm of insulation from the ends and crimp on the female connectors for the 0.1in. pitch connector. A pair of pointed pliers will produce an adequate crimp which can be further secured by soldering for extra reliability.

The finished crimp tags are fitted into the rear of the housing so that the small barbs engage with the slots. They can be withdrawn if they are fitted in the wrong order by pressing in the barbs to release them.

A 10-way connector shell must be used as 9-way ones are hard to get. The unused position can be used as a polarising key by blocking the hole with a small piece of plastic.

## TESTING

Before further assembly the power and control boards should be tested separately.

Begin with the Control Board. IC3 must be left out and the back up battery disconnected. The lead to the power board should also be unplugged.

Temporarily connect the mains transformer primary 0V and 240V terminals to the mains via sleeved connections to the power switch. Carefully insulate the "20V tap" and tie it out of harms way.

Connect the 12V a.c. secondary output from the transformer to the control board. Switch on and check that all lamps are out, that the voltage across capacitor C5 is approximately 16V and that the voltage across diode D16 is 5.6V.

Check that the emitter voltage of transistor TR1 is 5V and that pins 14 and 25 of IC3's socket are both at 5V. If pin 14 reads below 4.5V check R18 and C1. Next check that the voltage on pin 13 reads slightly above zero and rises to 5V when the base and emitter of transistor TR2 are shorted together.

Measure the voltages on the pins of IC3's socket that are connected to the keypad. These should read 0V and rise to above

4V when the corresponding key is pressed. Check that only the correct key changes each pin's voltage. This seems tedious but ensures that everything will go smoothly when IC3 is finally inserted.

The output circuits can now be checked by touching a one kilohm (1k) or similar value resistor between the 5V supply and each output pin in turn. This should result in the corresponding l.e.d.s lighting one by one. Failure of any l.e.d. to light could indicate a fault in IC1 or IC2, or more likely, a reversed or damaged l.e.d.

The l.e.d.s D5 to D12 will be dimmer than the others until the power board is connected, note also that incorrectly fitted resistor networks will produce very odd results. If D5 to D12 all fail to light then the odds are that diode D17 is at fault.

So far so good, now it is time to switch off, carefully insert IC3 and switch on again. If all is well an eight lamp chase sequence should greet the eye! If not, make sure that capacitors C2, C3, and X1 are all correctly fitted and that there are no short circuits or dry joints around them. Check also that the 5V supply is still correct and that pin 13 reads slightly above 0V.

The power to IC3 is current limited by resistor R19 and R20 so it should withstand reversed insertion. Don't forget to look for obvious things such as i.c. pins folding under and missing the socket, unsoldered joints and solder bridges account for 9 out of 10 faults, so check carefully. If the sequence runs correctly, check the action of the control keys and the number keys as explained later in the section headed "Operation". All i.c.s are tested after programming before despatch so any faults are likely to lie elsewhere.

## POWER BOARD

Provided the mains connections have NOT yet been made to the Power Board, it is a useful test to connect the 9-way cable to the working Control Board and switch on. The immediate effect should be an increase in brightness of the Mimic l.e.d.s because they now have a current path through the opto-isolator l.e.d.s instead of just resistors R24 - R31.

If no increase occurs check the lead, and that the correct value resistors R1 to R8 are fitted on the power board. Check also that the opto-isolators (IC2 to IC9) are fitted the right way round.

Any l.e.d. that is dimmer or brighter than its neighbours should direct attention to the associated section on the power board. This section of the power board is very simple, consisting of just one l.e.d. (inside the opto-isolator) and a resistor. Any faults should be unlikely.

The circuit on the other side of the opto isolators can not have any effect on these tests. It is easier to carry out these tests if the Stop mode is selected and all of the l.e.d.s are switched individually by their number keys.

The rest of the power board can be tested at low voltage by linking the 12V a.c. supply used by the control board to the two points on the board where the 240V live, and the 20V tap connections will be made later. **DO NOT MAKE ANY MAINS CONNECTIONS TO THE BOARD.**

The transformer 12V secondary is capable of powering both the control board and the power board during testing. Once these connections have been made, check that the voltage across capacitor C3 is around 16V.

*Complete sequencer with top panel removed to reveal the power board, mains transformer and wiring to the output sockets The "screening" panel shields the control panel mounted in the top cover.*

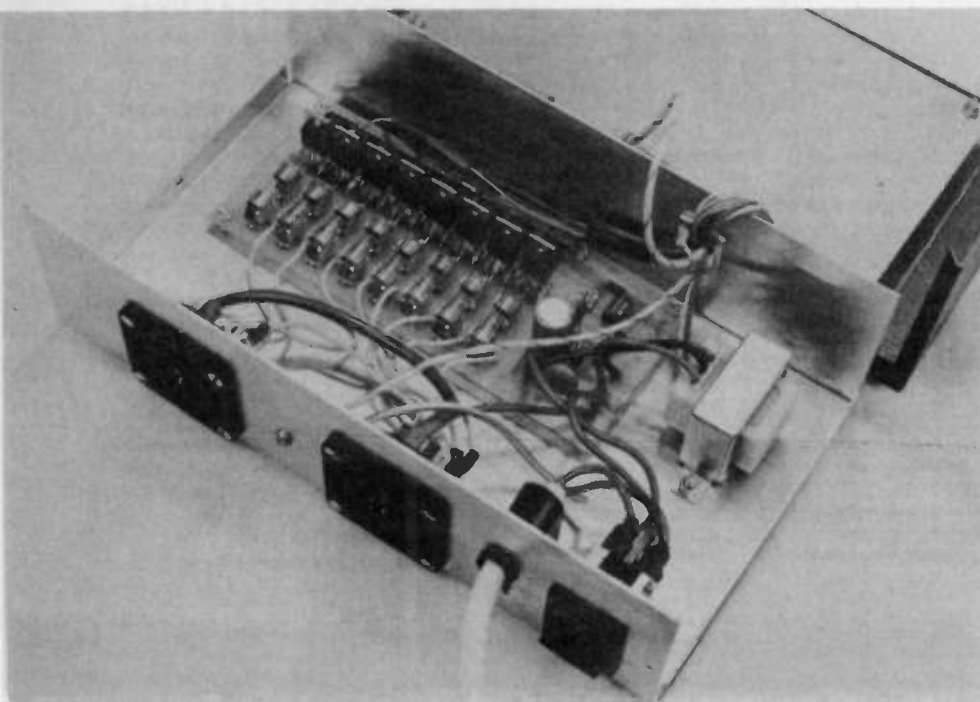

The operation of IC1 on the power board can be checked by measuring between pins 3 and 4. Pin 3 should be negative by between 1V and 2V. This is the average reading of the pulsed waveform and will depend upon the meter used, a digital voltmeter could give readings which are way out as it reads the pulses and gaps alternately.

Next temporarily link the anode of diode D1 to the anode of D2 on the power board. This will bypass the pulses and apply 16V continuously to the triac gate trigger circuits. Connect the positive meter terminal to the MT1 terminal of any of the triacs and use the negative test meter probe to measure the voltage in the following tests.

With the control board connected and set in the Stop mode, set all of the l.e.d.s off. Check the voltage at the collectors of TR1 to TR8. This should be close to 15V. Next check the base and emitter voltages which should all be zero. Any irregularities here should direct attention to the corresponding transistors triacs and resistors.

Turn on one channel and check that the base voltage rises to 14V and the emitter to 13V. Check each channel in turn and investigate any differences.

The final test is to check that the triacs are turning on correctly. This can be done at low voltage by connecting a small 12V one or two watt bulb between the cathode of diode D2 and each fuseholder (the end nearer to the triacs). The bulb should turn on and off as expected on each channel.

## FINAL ASSEMBLY

Having completed the tests, the transformer should be disconnected from both boards and the power board wiring should be completed. Ensure that the transformer connections to the Power Board are made exactly as shown, a reversed connection here will do some damage by applying near mains voltage to D2 and associated circuits (most of the components on the board).

The Control Board can now be mounted on the front panel by four long screws and 0.5in. pillars. The keypad fits snugly over the board and can be held in position either by sticking it to the front panel or by using the four screw holes.

The glue method is neater and provided something like Bostik is used it allows the keypad to be removed if necessary. Check that the connections to the keypad do not contact the inside of the case, use a small strip of tape if necessary to make sure.

One of the control panel mounting screws should be fitted with a solder tag between the pillar and the inside of the front panel. Scrape away some paint to ensure that this tag will make a good Earth contact. When the four panel fixing nuts are fitted the battery clip and 12V a.c. connections should be made to the board.

Clip the 9-way lead to the front panel of the case and plug it into the control board. The leads should allow just enough movement to take off the case top and and lie it face down in front of the case bottom with all connections still made. Finally push the screening panel, plain side down onto the screws holding the control board.

The four nuts should allow sufficient space to accommodate the soldered joints on the rear of the board. If necessary clip any joints that stand too high or use extra nuts.

The Battery should be fitted between this panel and the front panel, using a sticky pad to hold it to the inside of the front. Position the battery so that the clip can be attached and will not fall among the mains connections if it comes loose.

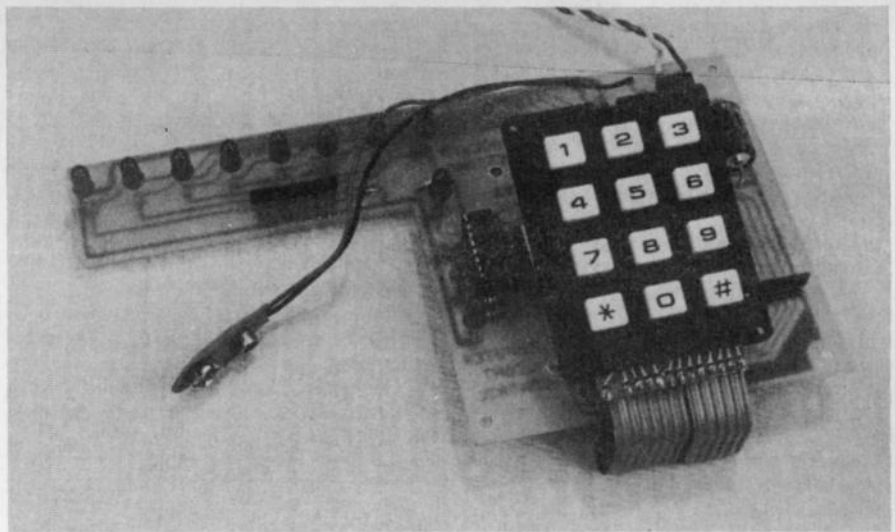

The finished control board with the keypad wired in circuit with ribbon cable. The mimic l.e.d.s can be seen in the top left corner.

A second solder tag must be fitted between the copper side of the screening panel and the final fixing nut. This tag and the one next to the front panel must be linked to the Earthing tag on the case rear panel using green or green/yellow 16/0.2 wire. This lead must be threaded through the solder tag holes and wrapped around to make a good mechanical joint before soldering. Leave enough wire free to enable the case to be opened easily.

## HEATSINK

The use of isolated tab triacs allows any type of heatsink to be connected to the triacs without insulation difficulties. In some applications a heatsink will not be required at all, and the circuit can certainly be run for test purposes in this state.

To get the best power output and efficiency requires a piece of 16s.w.g. folded to link the case to the triac tabs, or a piece of solid bar 25mm x 8mm x 100mm drilled to take self-tapping screws through the tabs and to be attached to the case at the other side by similar means. The option chosen is left to the constructor.

## POWER

The specified triacs are rated at 8A 250V each. Since all triacs could be on together this gives a maximum rating of 64A! The limit of the mains supply and the surges generated by large tungsten filament lamps gives a very comfortable limit of something under 2A or 500W per channel.

With care, and sensible programming the situation where more than four lamps are on together can be eliminated. This allows 4A or 1000W per channel capability.

Whatever the chosen level of operation, reliability will be very much enhanced by good heatsinking. The aluminium bar method being the best.

The fuses should be as low as possible consistent with the load used. You should find 3A quick blow 20mm types cover most applications, but as with all fuses they cannot be guaranteed to protect the triacs under all conditions.

## OPERATION

Running the 8-Channel Microcontroller Light Sequencer is easy, and largely self explanatory. After switch on the RUN mode is entered automatically. The Run lamp lights and the entire range of pre-programmed sequences are run automatically.

To select a particular sequence press the STOP key and the SELECT key. Enter a 3 digit number to select the required sequence followed by the RUN key. If you enter the wrong number, enter the correct three digits before pressing the RUN key. The sequencer acts only on the last three and will run that sequence continuously until another is entered.

To alter the speed of the sequence, press the 9 key for increase or the Hash key for decrease while the sequence is running. Holding the keys for longer produces a greater change.

The sequence can be stopped at any time by pressing the STOP key and can be stepped on manually in this mode by using the 9 key after pressing the STEP key. Lamps can be turned on and off manually whilst in the STOP and STEP mode without interfering with the selected sequence. Returning to RUN mode restores the sequence where it left off.

## PROGRAMMING

To program sequences press STOP then STEP and then SELECT followed by a number from 0 to 9. Selecting 0 enters the PROGRAM MODE 2 which allows sequences up to 160 steps long to be entered and run.

Programs are entered one step at a time by setting up the lamps for each step and pressing the STEP key until the required number of steps have been programmed. Steps are entered into memory one byte at a time and are retained indefinitely until re-programmed. Leave the program mode by pressing RUN.

Entering a number from 1 to 9 after STOP, STEP, SELECT enters PROGRAM MODE 1 and allows one of nine sets of 15 step long areas of memory to be programmed. These will run and repeat in the same way as the pre programmed sequences.

The length of the sequence is automatically set when the RUN key is pressed to exit the programming of each sequence. It can be different for each one and be anything from one to 15 steps long.

All 15 memory locations are reserved even if the sequence is short, so that the maximum number of user entered programs is nine. It is unlikely that more will be needed because the pre programmed sequences cover most requirements. A full list of the programs is supplied with the i.c., or can be obtained separately. □

# ELECTRONIC DIPSTICK

**CHRIS BOWES**



*A novel circuit for measuring the depth of aqueous liquids, indicated by a bargraph display. Ideal for remote sensing.*

**A**FTER a short break, we return to the pocket money projects with an Electronic Dipstick which will enable you to measure the depth of any aqueous liquid in a container. The depth of the liquid is indicated by means of 10 l.e.d.s arranged on a bar display.

This project has a number of potential uses, since the length of the sensor wire is not particularly critical. It may therefore be used for remote sensing of the level of liquid in, for example, the washer bottle of a car.

## HOW IT WORKS

This, relatively simple circuit relies on the fact that a high gain transistor, such as the BC109 used in this circuit, provides such a large current gain that, when it is used to control a low current device such as a l.e.d., only a very minute current is required to flow through its base/emitter connection to make a current flow through the emitter/collector circuit. The circuit also relies on the fact that all aqueous liquids allow a very minute current to flow through them, in this case this is sufficient to allow the transistor to "switch" the l.e.d. on.

## CIRCUIT DESCRIPTION

The full circuit diagram for the Electronic Dipstick is shown in Fig. 1. At first sight the circuit may appear slightly complex but if you look at it carefully you will notice that it basically consists of one very simple circuit, consisting of one resistor and one transistor and a l.e.d. (with its associated dropping resistor) repeated 10 times. Since the action of each of the driver circuits is identical, it is only necessary to consider the action of l.e.d. D10; the first l.e.d. to be operated.

When the sensor cable is dipped into the liquid sufficiently deeply for the liquid to complete the circuit between the positive power supply rail and the connection to resistor R10 then the movement of the charge carriers in the liquid is enough to cause a very small current to flow between these two points. This can not occur until switch S1 is depressed, connecting the battery to the two power supply rails.

The minute current which flows from the positive power supply rail through the sensor cable also flows, via resistor R10, to the base of transistor TR10. R10 is a 47 ohm

resistor which is incorporated into the circuit to prevent an excessive current flowing through TR10 should a good conductor, such as a metallic object, accidentally short out the connections in the sensor cable.

If resistor R10 were not included in the circuit a direct short between the positive power supply and the base of TR10 would cause the base/emitter voltage of the transistor to exceed the safe limit of approximately 0.7 volts. The action of the transistor would then be to reduce the voltage by dissipating the excess energy as heat. This would cause destruction of the transistor.

The small current which passes through the liquid flows through the base/emitter junction of the transistor TR10 and, in so doing, allows a much larger current to flow through the collector/emitter circuit of the transistor. This in turn allows current to flow through the l.e.d. (D10), causing it to glow. Resistor R20 is included in the collector circuit to reduce the current flowing through the l.e.d. to a safe limit and allow the diode to glow without it being destroyed.

## CONSTRUCTION

This project has been designed to be built on two stripboards, main circuit board and display board. It is advisable for the two boards to be constructed separately from each other and for the display board to be tested independently before being connected to the main board.

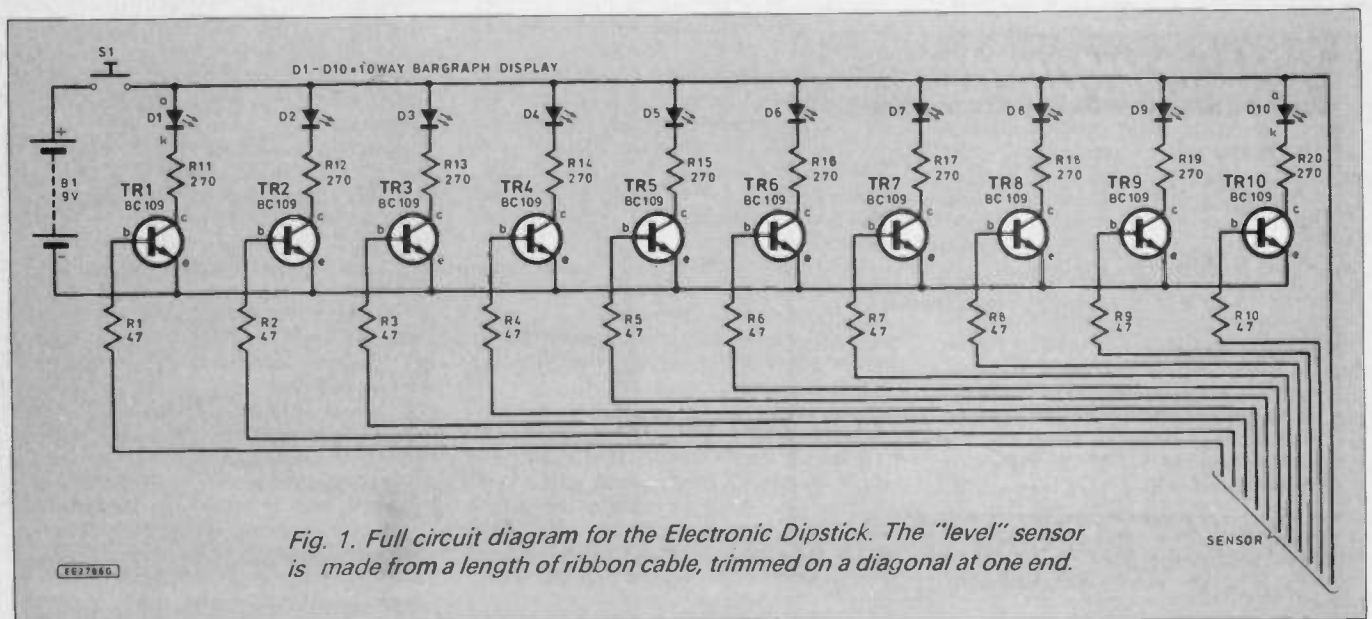

## MAIN BOARD

The main circuit requires a piece of strip-board which is 7 strips by 40 holes. The component layout and details of breaks required in the underside copper strips are shown in Fig.2. It is very important that care should be taken to ensure the copper tracks are completely broken, with not even the merest silver of copper left to bridge across the broken track.

Although the operation of the circuit will not be affected in any way by the order in which the components are assembled onto the strip-board you will probably find it easiest to insert the smallest components first, in this case resistors R1 to R10. Care should be taken to ensure that the solder used for these connections is not allowed to bridge between adjacent tracks.

Once the resistors have been soldered into place then the transistors (TR1 to TR10) should be inserted into the correct spaces as shown in Fig.2. It is very important to ensure that the transistors are inserted the correct way round, with the little metal tabs on the transistor case pointing in the direction indicated.

## SENSOR CABLE

Once the board mounted components have been assembled on the board and

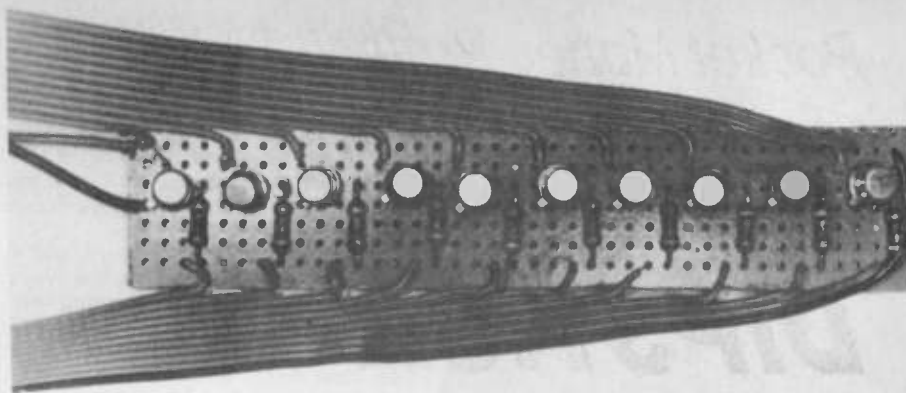

The completed main driver circuit board.

soldered into place, the next stage of the process is to attach the sensor cable to the strip-board. The sensor cable should be made from a piece of 11-core ribbon cable.

This size of cable is not a standard conformation and it will be necessary to obtain a larger size of cable and remove the excess cores. Once a suitable length of cable has been prepared one of the cores should be identified as the common positive connection.

Before the sensor cable is connected to

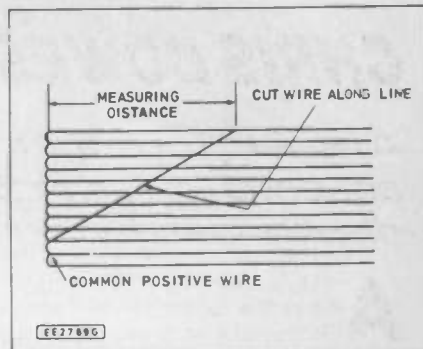

Fig. 3. Preparing one end of the sensor cable.

the main board it should be prepared as shown in Fig.3. The distance through which the range of the liquid sensing should operate is measured and marked off on the opposite side of the ribbon cable to the common positive wire.

The ribbon cable should now be placed flat on a suitable cutting board and a steel ruler placed on the cable so that it marks the angle between the first sensor wire and the point marked on the opposite side of the cable. A sharp knife should be used to

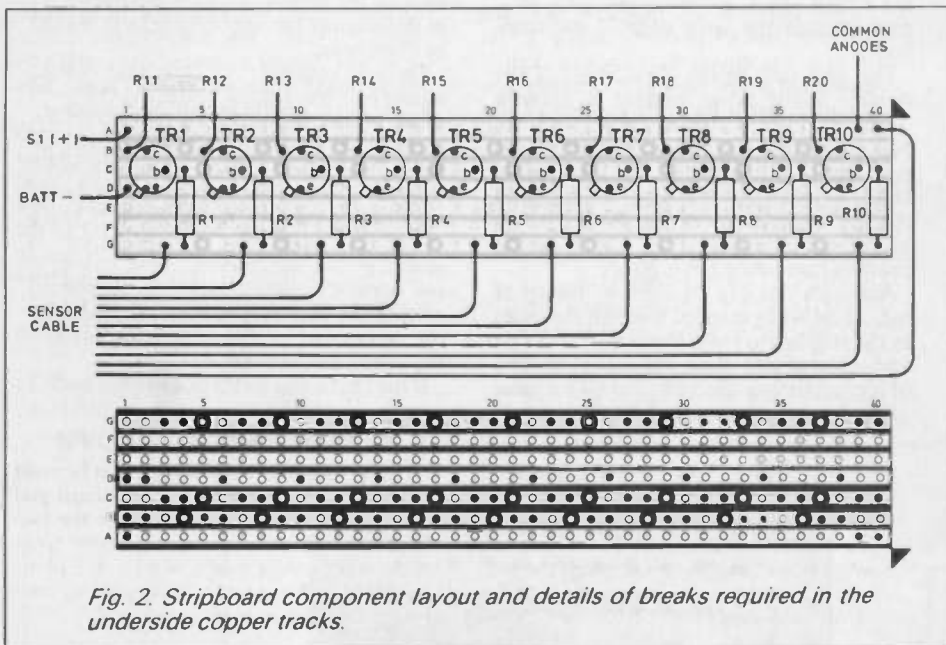

Fig. 2. Stripboard component layout and details of breaks required in the underside copper tracks.

## COMPONENTS

### Resistors

R1-R10 47 (10 off)  
R11-R20 270 (10 off)  
All 0.25W 5% carbon

See  
**SHOP  
TALK**  
Page

### Semiconductors

D1-D10 10-way I.e.d. display array  
TR1-TR10 BC109 (or any npn signal transistor)

### Miscellaneous

S1 S.P.S.T. push-to-make switch  
B1 PP9 battery and connector  
Stripboard, size 7 strips x 40 holes (1 off), 16 strips x 14 holes (1 off); 11-core ribbon cable (see text); plastic case, size 115mm x 75mm x 45mm; 4 x long bolts and 12 nuts.

Approx cost  
guidance only

**£10**





cut the ribbon cable so that the end of the wire is cut at an angle as shown in Fig.3. It is not necessary to strip the wires at this end of the cable, since the wire bared by the cutting action will be sufficient to enable a current to flow.

The other end of the sensor cable should then be prepared by cutting, stripping and solder "tinning" the ends of the wires in the ribbon cable to connect at the points shown in Fig.2. The battery connections can also be made at this time with the negative connection of the battery connector lead soldered to the point shown as Batt - in Fig.2.

The positive wire of the battery connector should be connected to one of the terminals on switch S1 and a suitable piece of flexible insulated wire should be connected between the second terminal of S1 and the point marked plus (+) on Fig.2. Once these connections have been made the stripboard should be put to one side while the display stripboard is completed.

## DISPLAY BOARD

The display for this project is a 10-segment bar l.e.d. array. The board needed to hold this display, and its associated series resistors, is made from a piece of stripboard which is 16 strips by 14 holes in size. The component layout and details of breaks required in the underside copper tracks as shown in Fig.4.

In order to mount the display board on the lid of the case which houses this project it is necessary to drill four mounting holes, in the positions shown in Fig.4. Once the stripboard has been cut the correct size then these should be drilled using a 4mm. drill bit. Once the stripboard has been prepared the resistors (R11 to R20) should be soldered in the appropriate places.

Although the 10 - segment bar l.e.d. display used in this project can be directly mounted onto the stripboard, fault finding will be made easier if this unit is mounted in a carrier in the same way as is used for integrated circuits. The easiest way to make a carrier of the type suitable for mounting the display is to obtain a 25 - way, single-in-line socket strip and cut it to give two 10-way strips. These are then inserted into the appropriate holes in the stripboard and soldered in the normal way. Care should be taken to ensure that both of the socket strips are mounted with their pins towards the same edge of the stripboard.

The next task in the completion of the display board is to connect a suitable length of 11-core ribbon cable, with the ends previously stripped and tinned to the positions shown in Fig.4. The final wiring task is to make sure that all of the common positive connections of the display (those on the opposite side of the display to the resistors) are connected together.

Although this can be done by means of individual wires inserted through the holes in the stripboard from the component side and soldered into place, the easiest method of accomplishing this task is to take a piece of single strand bare wire and solder it di-

rectly across the display carrier pins, which are on the side of the display which is opposite to the resistors, directly on the track side of the stripboard.

The ends of the ribbon cable used to connect the display board to the main driver board can now be stripped, tinned and soldered into place in the positions shown in Fig.4. The other ends of the cable should be cut to the correct lengths, stripped and tinned ready for termination on the main driver board. It is however advisable to delay connection of the display board to the main board until after the display board has been tested.

## TESTING - DISPLAY BOARD

Fault finding on the completed project should commence with the Display Board since a fully working display board will enable testing of the main circuit board to be carried out with greater ease.

The Display Board is very simple to test, since all that is necessary to do this is to connect the end of the ribbon cable wire connected the common positive connections of the display, to the positive terminal of a 9V battery and then touch the end of each of the other wires in turn to the negative terminal of the battery. When each of the individual wires are connected in this manner the appropriate l.e.d. should be illuminated.

There is actually very little that can go wrong with the display board and the likely cause of any fault which might occur can be easily diagnosed by considering the pattern of which l.e.d.s do not illuminate when tested in this manner. If none of the l.e.d.s are illuminated then the most likely cause of the fault, assuming that the battery is sound, is that the common positive wire is not correctly connected to the stripboard or that the display has been inserted onto the stripboard or the connecting sockets the wrong way around.

If the l.e.d.s illuminate in sequence up to a certain point and then cease to function

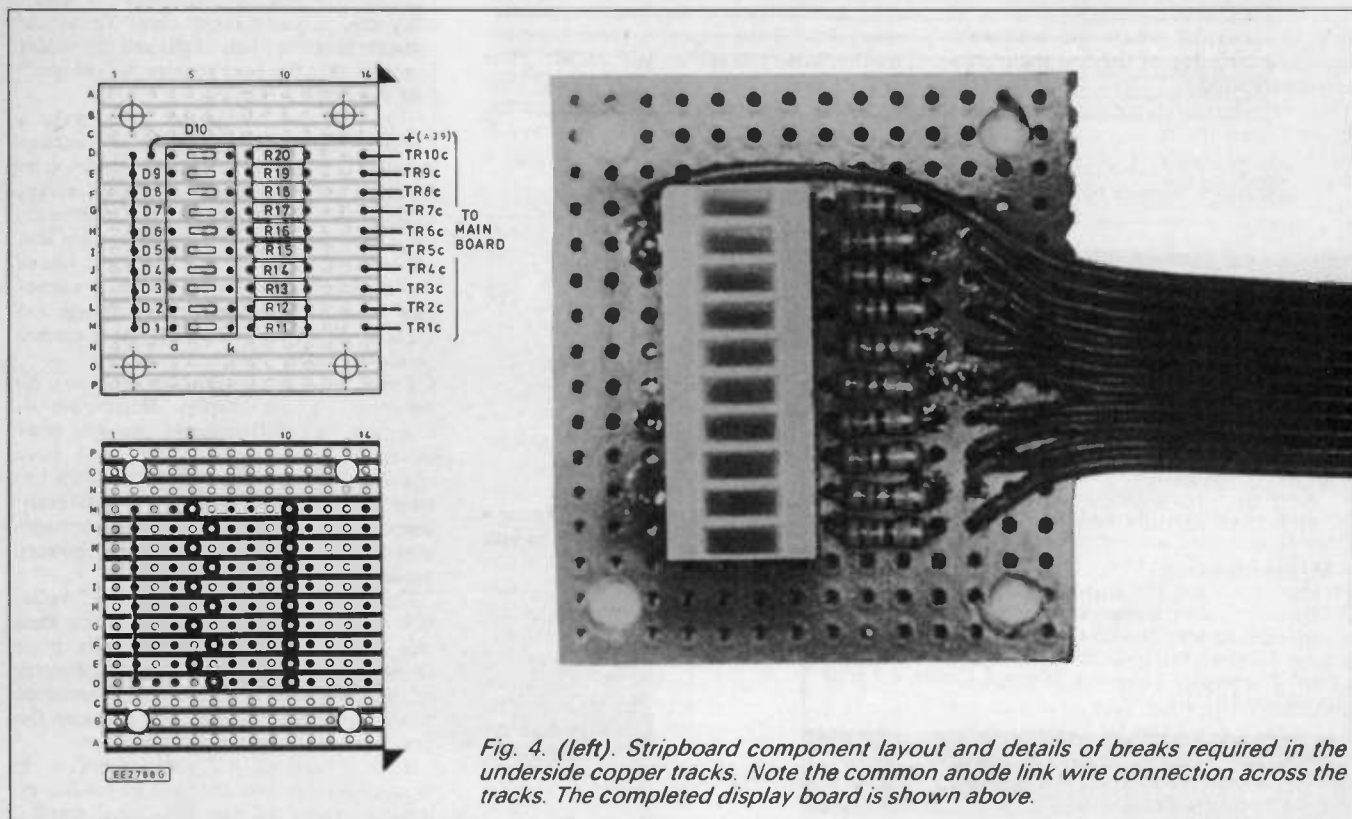

Fig. 4. (left). Stripboard component layout and details of breaks required in the underside copper tracks. Note the common anode link wire connection across the tracks. The completed display board is shown above.



after a specific point then the most likely cause is that the wire connecting the common anodes of the display has become open circuit at some point. In this case the cause of the problem will be found to be between the first l.e.d. which does not light and the last l.e.d. which does. The connection between these points should therefore be carefully checked to ensure that there are no breaks in the connecting wire.

If certain of the l.e.d.s illuminate but the others do not do so in a random pattern, then it will be necessary to check the connections throughout the circuit through each of the l.e.d.s which do not illuminate. Testing and fault finding should be done in a logical manner, starting with a resistance check along the wire in the ribbon cable associated with that particular l.e.d.

If this test proves that there is a complete circuit along the connecting cable then the next stage is to check the resistance between the point of termination on the cable on the stripboard and the nearest end of the appropriate series resistor. This is followed by a check on the actual resistance of the series resistor (which should be within + or - 20% of the stated value).

The next stage is to check the connection between the end of the series resistor and the cathode (k) of the l.e.d. in the bar display. If a break in continuity is discovered between any of these points, then the track associated with the connections and the associated soldered joints should be checked as should the soldering of the joint at the anode(a) of the l.e.d. which does not illuminate.

The integrity of the l.e.d. can also be checked by using the resistance setting of a multimeter. A sound l.e.d. should give a high resistance reading when the probes are connected with the polarity of the probes one way round and low resistance when the polarity of the test probes is reversed. (The precise polarity giving each of these two readings will depend upon the way in which the resistance measuring circuitry of the test meter has been constructed.)

Once a fully working display has been obtained then the ribbon cable from the display board should be connected to the Main Board in the positions shown in Fig.2. It is then possible to test the complete project.

Once a fully working display has been obtained then the ribbon cable from the display board should be connected to the Main Board in the positions shown in Fig.2. It is then possible to test the complete project.

## FINAL TESTING

The easiest method of testing the completed project is to lower the end of the sensor cable into a glass of water, whilst operating switch S1. As each of the cores of the sensor wire are submerged in the water then each of the l.e.d.s in the display should progressively illuminate.

As the number of illuminated l.e.d.s increases it is possible that there may be some fluctuation in the brightness of the display but this is not significant. It is, however, important to check that each l.e.d. is turned on in turn, that no two l.e.d.s come on at the same time and that, when the sensor cable is completely immersed in the water, all of the l.e.d.s are illuminated.

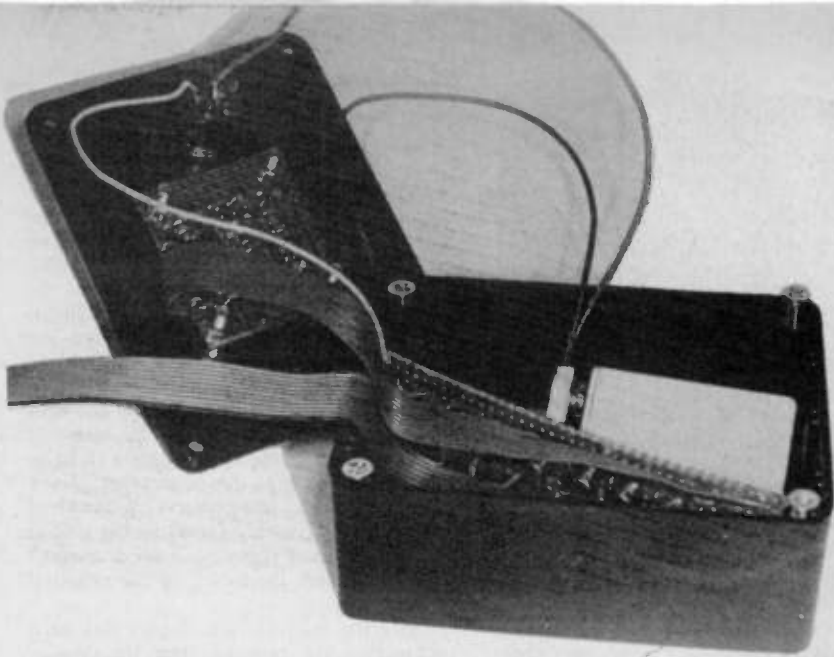

The completed unit showing the display board mounted on the lid and the driver board positioned diagonally to allow room for the battery.

## LIGHTING UP

The most likely fault to be encountered in this project is that one or more of the l.e.d.s does not illuminate as required. As all of the transistor driver circuits are identical then the same fault finding technique can be used for each of the l.e.d.s.

Before investigating the individual driver circuits in detail it is advisable to look at the pattern of which l.e.d.s light up and which do not, to see if any pattern emerges. If, when the sensor cable is inserted into the water, the first few l.e.d.s do not light up but the circuit then appears to be working after the cable has been immersed up to a certain level then, assuming that the display has tested out correctly, the most likely cause is that there is a break in the connections somewhere along the common negative track of the stripboard.

This can be most easily checked by connecting the multimeter, set to read 9V d.c. potential difference, so that the positive meter lead is connected to the connection to the battery positive wire at S1. The negative lead of the test meter should then be connected to each of the emitters of the transistors (TR1 to TR10) in turn and a note made of whether the battery voltage is measurable or not at each emitter.

If at any point the battery voltage ceases to be measured then a careful investigation should be made at the point at which the voltage was last measured and the first point at which the voltage was missing. The likely cause of any problems of this nature will be a break in the track or a "dry" soldered joint.

## TEST DRIVE

Testing of each individual circuit will be made easier if switch S1 is shorted out by temporarily soldering both of the connecting tags together since this saves the necessity of having to operate S1 every time you wish to make a test.

The next stage of fault finding in this circuit is to make a temporary short circuit between the emitter and collector of the transistor associated with any non working l.e.d. using a piece of wire. If this causes the l.e.d. associated with the transistor to be illuminated then this indicates that the fault lies on the main circuit board and not on the display board.

If this test fails to cause the l.e.d. to il-

luminate then the complete circuit between collector of the transistor and the common positive connection to the anode of the display l.e.d. should be carefully investigated, using the resistance setting of the multimeter. If all is well in the circuit through the l.e.d. and its series resistor to the battery positive connection and the negative connection to the emitter is also correct then it will be necessary to check the continuity of the circuit from the sensor cable, through the associated resistor to the base of the transistor.

Connect a test meter, set to the resistance range, to the cut end of the sensor cable associated with the non working circuit and check through the circuit from there to the base of the transistor. It should be possible to measure a very low resistance (typically 47 ohms) between these two points. Taking the meter probe from the base to the emitter should give a similar reading. If a resistance significantly higher than this is measurable then this would indicate that the likely faults are dry solder joints or that the base resistor is "off spec" and should be replaced.

The final check required is to make a temporary connection between any battery positive connection (such as the wires connected to S1) and the end of the associated base resistor furthest away from the transistor. It is very important to make sure that the connection is made to the correct side of the dropping resistor since a direct connection between the positive battery voltage and the base of the transistor will cause certain destruction of it.

The effect of this on the display should be observed. If the display diode does illuminate, this will indicate that the fault lies in the sensor cable. If the l.e.d. does not light up then the voltage between the base and the emitter of the associated transistor should be measured, with the connection between the resistor and the battery positive still in place.

This should be approximately 0.7 volts. If 0 volts is measurable at this point then this would indicate the possibility of a short circuit between the base and emitter of the transistor. The most likely cause of this is a blobbed solder joint between the base and the emitter of the transistor.

If a voltage of 0.7 volts or more is measurable between the base or emitter of the transistor and the associated display



diode is not illuminated, but the display diode illuminates when a temporary short circuit is made between the collector and the emitter of the transistor then the most likely cause is that the transistor is defective. It should therefore be replaced with another transistor and the circuit checked to ensure that it operates correctly.

The only other form of fault that you are likely to encounter in this project is where two or more l.e.d.s come on at the same time. There is really only one cause of this fault which is that there is an incomplete tract break between two adjacent circuits.

### CASE

The circuit, once completed and tested, should ideally be mounted in a case. The first stage is to allocate a position for the 10-bar l.e.d. display and switch S1. When

doing this care must be taken to ensure that the body of the switch and the display board will not foul the main stripboard when it is inserted into the case with the lid in position.

Once the position of S1 and the display have been allocated then these positions should be carefully marked onto the lid of the case. The hole for S1 can be drilled using an appropriate sized drill bit but the hole for the display is slightly more difficult to construct, because it will require the cutting of a rectangular hole in the case lid.

The easiest way to accomplish this is to carefully draw the required shape and drill a series of small holes around the inside of the marked rectangle, sufficiently close to each other so that the connecting plastic may be cut away using cutters. When all of the pieces of plastic connecting the drilled holes have been removed, a file is used to carefully finish the hole to the required shape.

Once the hole for the display has been shaped in the case lid then the display board should be offered into position and the location of the four mounting holes, previously drilled in the display board should be marked on the under side of the case. These holes should then be drilled through the case front using a 4mm drill bit. If desired, these may be counter sunk from the front of the case, to enable countersunk bolts to be used for retaining the display board.

The final cutting operation involving the case is to carefully cut out a slot, in both the case body and in the lip of the lid, through which the sensor cable can protrude when the case lid is secured in place.

The case can now be lettered, using rub down lettering which is secured in place by

several layers of clear varnish, sufficient time being allowed between each coat for the previous application to thoroughly dry. Once the preparation of the case is completed then the case mounted components can then be installed in to the positions already prepared for them.

Although the mounting of the switch S1 is simple enough the method of mounting the display needs a little explanation. The display board is supported away from the case lid by means of four long bolts which are mounted in the holes already drilled in to the case lid for them. In order to achieve a satisfactory support for the board, whilst at the same time standing it away from the case lid itself, it is necessary for each bolt to be fitted with three nuts. One of these nuts is used to clamp the bolt firmly to the face of the case lid whilst the other two are used to position and clamp in place the display board.

The main driver board and battery should now be positioned in the case. Because of the fact that the main driver board is rather long it may be necessary to mount it inside the case in a diagonal position.

When positioning the battery and the driver board care should be taken to ensure that when the case lid is fitted neither S1 nor the display board will foul the battery of the main driver board.

### IN USE

When using the Electronic Dipstick to measure the depth of liquid in a container, all that has to be done is to insert the sensor cable into the container of liquid until the end of the cable reaches the bottom and press switch S1. The depth of the liquid in the container is immediately indicated on the l.e.d. display.

Remember  
The Cricklewood  
Service is Fast  
and Efficient

# CRICKLEWOOD ELECTRONICS

## BIGGER AND BETTER 90'S DECADE COMPONENTS CATALOGUE

- ONE OF THE LARGEST RANGES OF COMPONENTS IN THE UK
- FAST AND EFFICIENT SAME DAY PERSONAL SERVICE
- VERY COMPETITIVE PRICES; QUANTITY DISCOUNTS AVAILABLE
- DISCOUNT VOUCHERS INCLUDED
- NO MINIMUM ORDER

WITH OVER 13,000 STOCK LINES, CRICKLEWOOD ARE ABLE TO SUPPLY MOST OF THE COMPONENTS NEEDED FOR E.E. PROJECTS  
PHONE US FOR YOUR SPECIAL NEEDS.

FILL IN THE COUPON AND POST IT WITH YOUR CHEQUE, PO ETC FOR £1.50 TO RECEIVE YOUR CRICKLEWOOD ELECTRONICS CATALOGUE AND VOUCHERS WHICH YOU CAN USE AGAINST YOUR NEXT PURCHASE

**Cricklewood Electronics Ltd**  
40 CRICKLEWOOD BROADWAY, LONDON, NW2 3ET  
Tel: 081-450 0995/452 0161  
Fax: 081-208 1441 Telex: 914977



TELEPHONE ORDERS OUR SPECIALITY

### CRICKLEWOOD ELECTRONICS COMPONENTS CATALOGUE

PLEASE SEND.....COPIES OF  
THE CRICKLEWOOD ELECTRONICS  
CATALOGUE AT £1.50

NAME .....

ADDRESS .....

.....

.....

.....

Remittance enclosed £..... E

# REPORTING AMATEUR RADIO

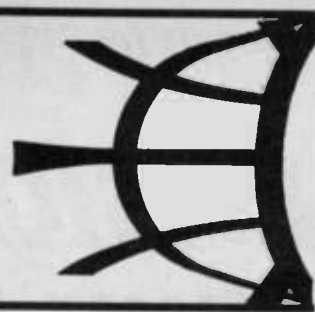

**Tony Smith G4FAI**

## WHAT DOES AMATEUR RADIO OFFER ME?

The revised edition of the DTI's booklet *"How to become a Radio Amateur"* contains an introductory question and answer section beginning with the question "What Does Amateur Radio Offer Me?" This is difficult to answer in a few words because there are so many things that can be said about such a wide-ranging hobby. The booklet makes a good attempt, however, and is worth repeating here:

"Amateur radio is unique in the freedom it allows you to develop and experiment with radio communication equipment. It can even enable you to communicate around the world.

"Radio amateurs may make contact with people in any country. Even language differences need not be a barrier by using Morse code and "Q" codes (these are three-letter codes which have the same meaning throughout the amateur radio world).

"Radio amateurs are often at the forefront of radio technology and increasingly they are able to use their home computers to combine computer technology and radio. By becoming a radio amateur you can prepare yourself for a world which is increasingly technology based. For example, you can experiment with antennas, television, RTTY (radio teletype), data (including computer controlled communications such as packet radio), satellite communications and, of course, short or long range voice or Morse code transmissions.

## FRIENDSHIPS

"The hobby frequently leads to participants making lasting friendships both in the United Kingdom and worldwide. In this way it has proved to be a great asset to those who are housebound, or who find mobility a problem, because of the opportunity it provides to make friends.

"Many other amateurs are able to offer their services to the first aid organisations and even the police at public events during disaster relief operations at home and abroad. For most amateurs, however, it is just the sheer excitement of that chance contact with an individual hundreds or even thousands of miles away that is so absorbing."

There's even more to it than that, of course, and the publication goes on to give the bare bones of it all in terms of the rules and regulations. In the meantime, keep reading this column as I put the meat on the bones, illustrating what amateur radio is in practical terms and what it means to the individuals involved in it. There is no short answer to that original question!

The booklet is available free of charge from *Radio Amateur Licensing Unit, Post Office Counters Ltd, Chetwynd House, Chesterfield S49 1PF.*

## FURTHER READING

For those interested in taking the radio amateurs' examination, the DTI recommends a short "further reading" list. This includes *"How to Improve Television and Radio Reception"*; available from Post Offices; *"The Radio Amateurs' Examination Manual"* (RSGB); *"A Guide to Amateur Radio"* (RSGB); *"Amateur Radio Operating Manual"* (RSGB); and a number of DTI Information sheets which expand on some of the information contained in the booklet.

These are: No. 1, Radio Amateur Licensing; No. 2, Amateur Service Allocation in the 50MHz (6 metre) and 70MHz (4 metre) Band; No. 3, Morse; No. 4, Amateur Radio Call Signs; No. 5, Amateur Radio Clubs and Societies; No. 6, Radio Amateurs' Examination; No. 7, New Amateur Radio Licence; No. 8, Radio Investigation Service District Offices; No. 9, CEPT Amateurs (UK Licensees); and No. 10, CEPT Amateurs (Visiting Licensees). These sheets can be obtained, free of charge, from *Radiocommunications Agency, Information and Library Service, Waterloo Bridge House, Waterloo Road, London SE1 8UA.*

## USING THE BUREAU

The most used service of the Radio Society of Great Britain is its QSL Bureau, whereby members send and receive QSL cards worldwide at minimal cost, and non-members can receive cards from members on the same basis. The Society recently re-organised the bureau, which is now sited at RSGB headquarters.

Cards for distribution are sent by individual amateurs, in quantity, to Posters Bar. Here they are sorted and despatched in bulk to overseas bureaux, usually operated by member-societies of the International Amateur Radio Union, or to UK sub-bureaux organised by call-sign series.

Members and licensed non-members can send stamped addressed envelopes to the appropriate sub-bureau and these are returned filled with cards when the weight of cards "waiting" reaches the maximum covered by the pre-paid postage. Cards for amateurs who have not lodged envelopes are kept for three months and then destroyed. The full facilities of the bureau are available to both transmitting and receiving members of the society, although reception reports relating to short-wave broadcasting stations cannot be accepted.

Although the bureau represents the cheapest way of exchanging QSL cards, it is not the fastest. By the time a card gets through the different stages of its journey, and its reply returns by the same route, some six to nine months can elapse. Some amateurs take a long time to send out cards and I sometimes receive QSLs for contacts I had four or five years ago!

The moral of all this is that those who desperately want a particular card should consider sending their own direct to the other station, enclosing an s.a.e., or two international reply coupons, to cover the cost of return postage. This won't guarantee a reply but it improves the chance of getting one quite considerably.

## CALL-SIGN CONFUSION

For years, the UK call-sign system has been fairly easy to follow. The letter *G* signifies a British station and a second letter indicates a region other than England, thus *GW* - Wales; *GM* - Scotland; *GI* - Northern Ireland; *GU* - Guernsey; *GJ* - Jersey; and *GD* - Isle of Man.

A special series of call-signs using the prefix *GB* has been allocated to "special event" demonstration stations, which have been permitted to put unlicensed operators (eg, members of the public) "on-the-air", under supervision, to send simple greetings to other stations in the UK, the USA, Canada, the Falklands, and Pitcairn Island.

New regulations now permit licensed club stations to use the greetings message facility without the need for a special GB call-sign, but they have to modify their existing call to indicate when they are using the facility. A club station normally located in England, with a *G* prefix, would therefore become *GX*; Wales (normally *GW*) *GC*; Scotland (*GM*) *GS*; Northern Ireland (*GI*) *GN*; Guernsey (*GU*) *GP*; Jersey (*GJ*) *GH*; and Isle of Man (*GD*) *GT*; reverting to its regular call-sign when returning to normal amateur operation.

Even more confusing are the DTI's proposals for a new series of calls when either the remaining class *B* (*G7s*) to be followed by *G5s*) or class *A* (*G0*) series run out. It is then proposed to abandon all further *G*-allocations and start a new series of calls beginning with the letter *M*.

A second letter will indicate the class of licence. Possibly *MA-MJ* prefixes will denote class *A*, and *MK-MZ* class *B*, although *MB* could be reserved for special event stations and *MC* for clubs. A number would indicate the region where the station is located; England - 2; Scotland - 3; Wales - 4; Northern Ireland - 5; Isle of Man - 6; Jersey - 7; Guernsey - 8. For example, *MA2AAA* would be a class *A* station in England, but if it moved to Wales it would become *MA4AAA*.

To add to the confusion, call-signs for the new Novice licences will probably start with the figure 2, with the series running from *2A1AAA* to *2Z9ZZZ*. The second symbol (letter) would again indicate the licence class (Novice *A* or Novice *B*), and the third symbol would again be a number, indicating the region where the station is located.

# DESIGN YOUR OWN CIRCUITS

Getting started

MIKE TOOLEY BA

PART 1

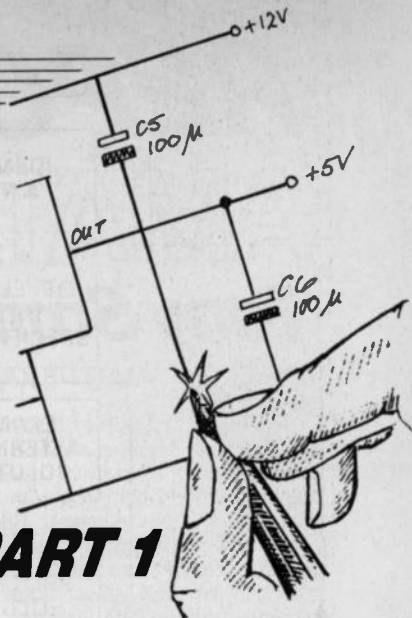

*This ten part series which is designed for the beginner and experienced reader alike, aims to dispell some of the mystique associated with the design of electronic circuits. It shows how even the relative newcomer to electronics can, with the right approach, design and realise quite complex circuits.*

*In this first part we introduce the series, describe the tools and test equipment you will require to follow the series, outline some basic concepts and get to grips with practical aspects of the design of electronic power supplies. Our companion project deals with the construction of a Versatile Bench Power Supply.*

## Introduction

Welcome to *Design Your Own Circuits*, a new and exciting series which has been designed especially for *Everyday Electronics* readers. The series deals with a topic which we feel almost every reader will wish to get to grips with and differs in a number of important respects from any of the previous "educational" features in this magazine. The series will lead you gently through all of the stages in designing a wide range of electronic circuits "from scratch". There is no "magic" in this; just logical thinking coupled with a basic understanding of electronic circuits and components!

In order to provide readers with an opportunity to develop their skills further, each part will incorporate a **design problem** together with a complete **practical project**. The problems have been included so that readers can test their knowledge and understanding as they progress through the series and, although "model answers" will be provided they should not be regarded as the ultimate solution. Readers should not therefore be discouraged if they find that their own answers differ markedly from

those presented. In addition to the design problems, the text for each part will be interspersed with questions so that readers can rather more frequently check their understanding.

Practical projects have been included so that readers can follow the complete process of design, assembly, construction, testing and evaluation. Each project will be accompanied by a number of suggested modifications and improvements so that each one can be "customised" to suit the needs of individual readers. The practical projects have been designed to stand on their own as complete items of equipment in their own right and thus should appeal to those readers who may not necessarily be following the series.

Our overall aim in this series has been that of attempting to foster an intuitive approach to design. Such an approach does not rely on the mastery of complex mathematical formulae rather it is based upon an understanding of the behaviour of common electronic components and the application of a few basic principles. To this end, the approach will be somewhat unorthodox in that theory will only be

introduced where it is directly relevant to a particular topic. By this means, we shall be able to get to grips with some fairly complex circuits at an early stage.

## Readers

At this stage, you may perhaps be forgiven for wondering just what it is that we have assumed about you! Essentially, you should be able to:

1. Identify common electronic components and recognise their symbols.
2. Understand commonly used component markings and colour codes.
3. Use a multi-range meter to make voltage, current, and resistance measurements.
4. Know the basic electrical units and the symbols used to represent them.
5. Make use of multiples and sub-multiples and recognise the prefixes used to denote them.
6. Understand basic electrical concepts such as e.m.f., potential difference, and current flow.
7. Read and understand *simple* circuit diagrams (if you can cope with the majority of circuits published in *E.E.* then you will have little difficulty with any of those which will appear within this series).
8. Use a soldering iron and a range of small electronic tools.

If you are doubtful about topics 1 to 7, then it would be well worth investing in a copy of the *Everyday Electronics Data Book* (available at £8.95 from the *Everyday Electronics Direct Book Service*). This book contains all of the preliminary information that is required to follow the series and also contains numerous examples, hints and tips for the budding electronic circuit designer.

## Tools and test equipment

In order to follow the series (and to build the modules and projects which we describe) you will need very little in the way of tools and test equipment. Most of the items will already be available but if this is not the case most of *E.E.*'s regular advertisers should be able to help. The following list should give readers some idea of what is required:

- ★ a soldering iron (15W to 20W) with a supply of multicore solder
- ★ a multi-range meter (preferably digital) with test leads
- ★ a set of small electronic tools including

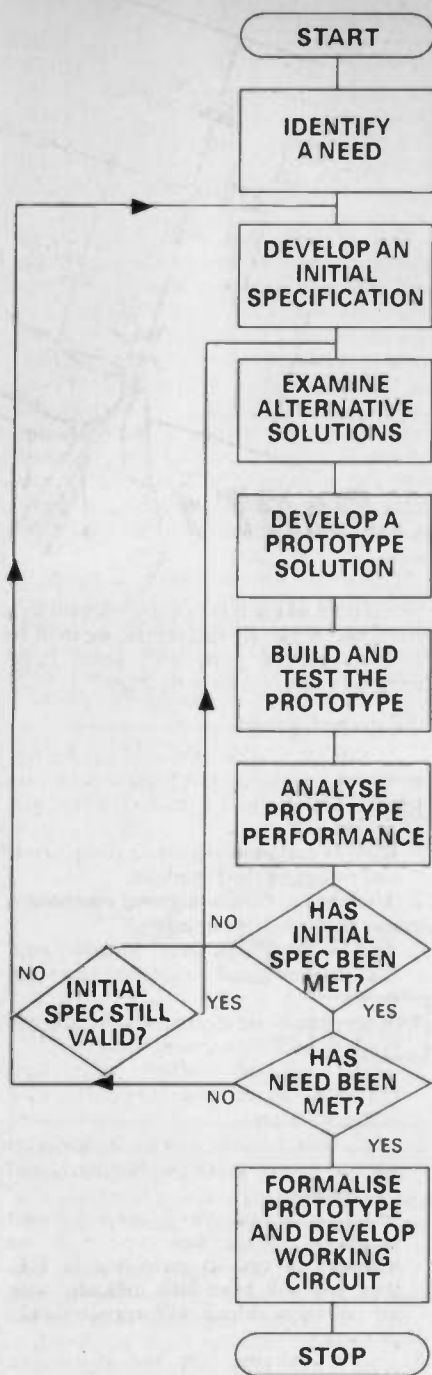

Fig. 1.1. Basic steps in the design process

side cutters, pliers and screwdrivers, a small drill (either a hand-drill or mini-electric drill), a set of drill bits (1mm to 10mm), and a trimming knife

★ a desoldering pump

The following additional items will be found useful in conjunction with our companion projects:

- ★ a small hacksaw
- ★ a set of small hand files
- ★ a tension file
- ★ a steel rule, scribe and centre-punch

### Series summary

Each part of the series deals with a different topic area. In Part One, we start with a general introduction to the principles of circuit design before moving on to deal with the design of power supplies for use in a variety of electronic equipment. Our design problem features a simple oscilloscope voltage calibrator whilst our accom-

panying practical project involves the construction of a versatile bench power supply.

Parts Two and Three deal with amplifiers (transistor and operational amplifiers are introduced in Part Two whilst Part Three is largely devoted to consumer integrated circuits and power amplifiers). A number of important concepts are developed in these two parts including gain, phase-shift, feedback, noise and distortion. The design problems and projects include a microphone pre-amplifier, a guitar amplifier, an intercom system, and a bench amplifier/signal tracer.

Oscillator design is covered in Part Four. We shall be dealing with sinusoidal (both a.f. and r.f.) and square wave oscillator circuits and our project features a signal generator with sine, square and triangular wave outputs.

Part Five introduces the world of digital electronics and describes the use of logic gates, monostable and bistable circuits, counters and shift registers. Our design problem is based on an intruder alarm.

Integrated circuit timers are featured in Part Six and the complementary project features a versatile pulse generator. Radio is introduced in Part Seven whilst Part Eight deals with power control. Projects include an r.f. signal generator (with internal and external modulation) and a disco lights controller.

Part Nine is devoted to optoelectronics and features the use of photo-emitters and photo-detectors. Our design problem is based on an automatic porch light whilst the accompanying project shows readers how to design and construct an optical communications link. Finally, Part Ten (entitled *What Next?*) aims to round-off the series with feedback from readers as well as providing some "food for thought" for further work.

### The design process

The process of design, whether it be in electronics or in any other field, is, of necessity a logical undertaking in which there is nonetheless plenty of scope for flair and imagination. As with many other pursuits, the sequence of events is crucial. Fig. 1.1 shows the basic steps within the design process. The first stage (and arguably the most important) is that of identifying a need. Without this, the rest of the process is meaningless. Indeed, if a need cannot be identified at an early stage, there is little point in progressing further.

The need for an electronic circuit may arise from a variety of sources; from a purely personal requirement to widespread commercial demand. Examples in the former category could include a requirement to produce a baby alarm consequent on the arrival of a brand new member of the family. Here, the designer is likely to be the "end-user".

In the commercial category, however, the end-user is not the designer and appropriate market research will be an essential pre-requisite when carrying out an analysis of needs. In addition, many commercial products are "test marketed" before large-scale production starts. This test marketing is instrumental in not only determining the size of the potential market but also yielding some very useful information about the end-user.

A commercial decision concerning the viability of a product will not usually be taken until both market research and test marketing has taken place. Financial backing may be dependent upon both of these

elements as well as the viability of the overall "business plan" produced by an organisation.

### Modular approach

A modular approach to circuit design offers a number of advantages, not the least of which is that it readily permit the assembly of quite complex equipment from a number of more easily assembled and tested sub-circuits. A further significant advantage (and one which is often forgotten at the early stages) is that a modular approach readily permits the replacement and upgrading of parts of the equipment as needs dictate.

A module may comprise as few as half a dozen active devices or perhaps as many as fifty or more. Each module should have a defined function and will probably be associated with one (or more) blocks within the functional block schematic of the equipment. The interface from one module to other modules within the equipment should be clearly defined in terms of the signals and voltage levels present. As far as possible, these should be standardised so that modules can be made fully interchangeable.

Throughout this series we have attempted to standardise on the range of connectors, signals and supply voltages so that, not only are the individual circuit modules compatible with one another but also those which provide similar functions are interchangeable.

A number of the circuits described in our series will be presented as "modules". A printed circuit layout (together with a component layout diagram and detailed component list) will be provided for each and, whilst each is a complete working circuit in its own right, modules may be interconnected to realise a number of more complex functional circuits. Our modules can thus be thought of as constituting the basic "building blocks" of a large number of practical electronic circuits.

Hence, for example, it would be possible to put together a complete audio amplifier system using standard modules taken from several parts of the series. The power supply module (a dual regulated supply providing  $\pm 15V$  rails at 1A) could be taken from Part One, a pre-amplifier/ tone control module taken from Part Two, and a 10W high-quality output stage taken from Part Three.

A cumulative index of modules (together with brief specifications) will accompany each part of the series. This index will provide readers with a means of matching their requirements with circuits which have previously appeared in the series and which are thus available "off the shelf".

### Specifications

At the outset, it is vital to form an initial specification for a circuit. This is an essential pre-requisite in any design project. Indeed, to start without any fixed idea of what is actually required is foolhardy to say the least!

The initial specification should be regarded as a target. In practice, it may not be possible to realise this initial specification for a whole host of reasons hence the initial specification should not be so fanciful that it is impossible to achieve.

Getting the initial specification right is an art in itself; if the specification is made too exacting it may be impossible to achieve, if made too undemanding there may be little incentive to improve on known technology.

Where a requirement is particularly novel, a little "brainstorming" can be useful when forming a specification. Try to think laterally and avoid falling into the trap of merely adapting an existing solution; a balance between lateral and traditional thinking is essential. Indeed, to go too far along either road at the expense of the other can be detrimental to the development of one's skills as a designer.

### Lateral thinking

At this point, it is probably worth spending a little time to explain just what we mean by the term "lateral thinking". Lateral thinking involves dismissing (at least initially) traditional methods of solving a problem. As far as possible, one should abandon the "tried and tested" approach and think "around" the problem in a radical manner.

As an example, consider a requirement for a highly accurate 1MHz reference clock signal for use in an item of test equipment. Using the traditional approach, we might consider using the output of a highly stable crystal oscillator. In order to achieve the requisite stability, we would probably have to place the crystal and associated oscillator circuitry in a carefully temperature controlled environment (a "crystal oven"). Furthermore, the quartz crystal itself would have to be a very high quality and accurate component. Using this approach, we could hope to produce an arrangement which offers a frequency accuracy of around  $\pm 20$  parts-per-million.

Lateral thinking may, however, result in a totally different (and cost-effective) approach to this problem. Rather than adopt a circuit which is based on a locally generated signal, the "lateral thinker" may decide to make use of a broadcast standard frequency signal. This signal would be used as a "reference" to which a locally generated signal can be "locked". The "off-air" signal is simply received, amplified and squared before it is applied as the reference signal within a phase-locked loop

(PLL). As a bonus, the frequency accuracy of such an arrangement is several orders of magnitude greater than that which can be obtained by the conventional "oven-crystal" approach and the long-term stability is also greatly improved.

The traditional approach to the problem is illustrated in Fig. 1.2a whilst Fig. 1.2b shows the arrangement which results from lateral thinking. The arrangement of Fig. 1.2b is more complex than that in Fig. 1.2a however very considerable savings are achieved since individual component tolerances can be very much less stringent and there would be no need for a closely temperature controlled environment.

A representative breakdown in cost for the two approaches is as follows:

<b>Traditional:</b>	
Crystal (close tolerance)	£8.00
Oscillator circuitry	£3.00
Buffer/amplifier	£3.00
Voltage regulator circuit	£2.00
Temperature controller	£8.00
Thermally sealed enclosure	£5.00
PCB etc	£5.00
Approx. total component cost:	<b>£34.00</b>

<b>Lateral approach:</b>	
Ferrite antenna	£2.00
RF filter	£10.00
RF amplifier/squarer	£2.00
Divider stage	£2.00
PLL oscillator	£3.00
PCB etc	£5.00
Approx. total component cost:	<b>£24.00</b>

This example has been designed to highlight the differences in approach and, whereas it shows clearly the cost-effectiveness and advantages of the solution achieved by lateral thinking, there are some disadvantages (notably the fact that an "off-air" signal may not always be available!). This again highlights the importance of starting out with a meaningful specification; we should have specified that the equipment will operate in any normal environment (including a basement) – clearly this may not always be the case!

In practice, we may wish to adopt a compromise approach which benefits from the advantages of both techniques. In such an event, we could capitalise on the very significant improvement in accuracy and long-term stability offered by an "off-air"

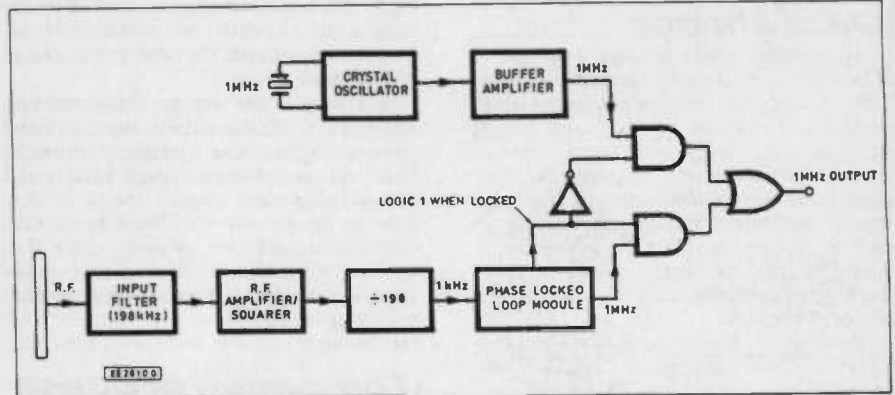

Fig. 1.3 A combined solution

reference (typically 1 part in  $10^{10}$  for a Droitwich locked standard) whilst being able to revert to the inherent reliability of a locally generated signal whenever the off-air standard is unavailable.

The final solution might run along the lines shown in Fig. 1.3. By combining the "tried and tested" approach with the innovative approach we have produced a solution which offers very significant advantages over either method used alone.

### Data

Most electronics enthusiasts are avid collectors of data. Anyone involved within the design of electronic circuits will find that access to a bank of data is essential in order to make effective use of the huge variety of electronic components currently available. Magazine articles and application notes (published by component manufacturers) are an excellent source of ideas and are likely to contain numerous tested circuits. Would-be designers should not feel guilty about "borrowing" ideas from other people as one can learn a lot from others' ideas and there is absolutely no point in "re-inventing the wheel"!

Sources of data available to the electronics enthusiast include manufacturers' data sheets and data books, suppliers' catalogues, magazine articles, application notes, textbooks and technical reports. At the outset it is worth organising a data library into related topics using a filing cabinet or just simply a collection of cardboard boxes fitted with dividers.

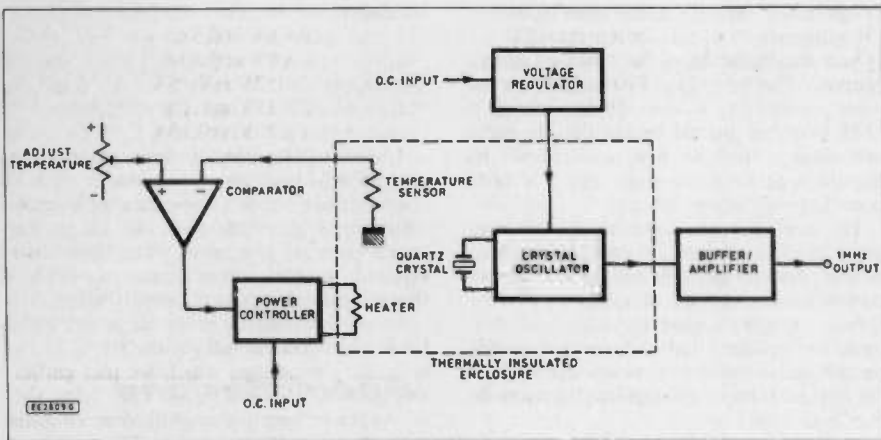
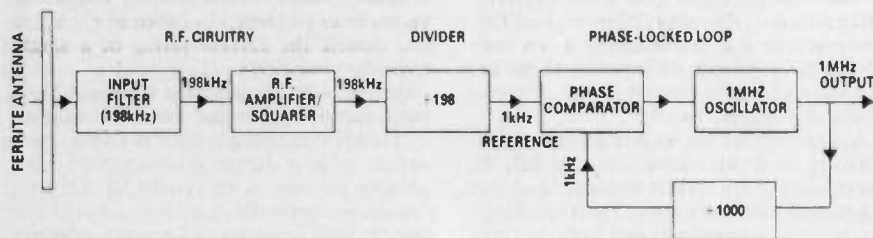

Fig. 1.2a Traditional approach to providing the highly stable 1MHz signal

Fig. 1.2b "Lateral thinking" approach based on a PLL and off-air standard



Textbooks and data books can be stored in a conventional bookshelf along with magazines (preferably in binders) and the larger catalogues.

Sources of data which can be particularly recommended include:

**The Maplin Buyer's Guide to Electronic Components.** This excellent publication is more than just a catalogue since it contains a vast amount of information on just about every common type of electronic component. Several thousand semiconductors are listed and the section of the catalogue devoted to integrated circuits contains pin-connecting information and numerous application circuits.

**Everyday Electronics.** This monthly magazine never fails to provide a wide variety of electronic projects and educational features which are suited both to the beginner and the more experienced enthusiast.

**The Modern Amateur Electronics Manual.** This enormous reference work aims to provide a practical reference to modern electronic technology. It is a loose-leaf publication (in several volumes) with regular updating supplements which are published approximately bi-monthly.

## Data sheets

All manufacturers provide data sheets (often free) and data books (usually available at moderate cost) which cover their products. These can be invaluable to the designer since they provide a great deal of useful information and, in particular, give some indication of the maximum and minimum operational parameters for a particular device. The designer is thus made aware of the limits within which he must work when designing a circuit based on the device in question.

Many data sheets (and data books) contain typical application circuits. Some manufacturers also provide detailed application notes which are written by their own applications design staff. These can make very useful reading since they give a considerable insight into the thought process of other designers and can sometimes point the way to some really novel applications.

As an example of using data sheets (and since this first part of our series is devoted to power supplies) it is worth taking a look at the first four pages of the National Semiconductor data sheet for the LM723 voltage regulator shown in Fig. 1.4.

The format of this data sheet is typical of that used by nearly every semiconductor manufacturer and comprises a general description of the device, internal schematic (circuit diagram) and pin connections for the device, absolute maximum ratings, electrical characteristics, derating curves, typical performance characteristics, and typical applications circuits.

Readers should spend a little time reading through the data sheet but should not be too worried if very little of it makes sense initially! Much of the data will be of relatively little significance in most applications and it is certainly not essential to understand everything on the data sheet to put the LM723 to good use.

**Question 1:** Use the National Semiconductor data sheets for the LM723 to determine the following:

- maximum continuous input voltage
- maximum operating temperature for an LM723C
- positive input connection for the dual-in-line version

- minimum input voltage
- minimum output voltage
- typical load regulation
- typical short-circuit current (at 25°C)
- typical short-circuit current (at 125°C)
- maximum power dissipation at 50°C for an LM723C in a TO5 package

## Power Supplies

Having now set the scene (and hopefully whetted readers' appetites for what is to come!) we now get to grips with the first topic within our practical circuit design series: **Power Supplies**. Since every circuit that is not operated directly from a battery will require a power supply, this seems a very logical place to start!

The power supply is the hidden hero of every electronic circuit; we happily assume that it is there and doing its job. Rarely do we give it the attention that it really deserves.

In general a power supply should:

- provide the rated voltage of the circuit which it is to supply (within acceptable tolerance limits)
- provide current up to the rated maximum for the circuit which it is to supply (without the supply voltage falling outside the specified working range)
- maintain the rated output voltage (and current capability) over a range of conditions (e.g. ambient temperature, a.c. mains voltage variations, load circuit demand, etc)
- cope with short-circuit component failures which may arise within the circuit which it is to supply (and which may otherwise damage the power supply)
- have adjustable voltage and current limit (as required)

A typical power supply specification may run along the following lines:

Output voltage:	12V $\pm$ 5%
Maximum output/	
load current:	1A
Hum and noise:	less than 10mV
Regulation:	better than 2%
Output impedance:	less than 0.1 ohm
Input voltage:	220 to 240V a.c.
	50Hz

Most of this should be reasonably self-explanatory. First we need to achieve an output voltage which is nominally 12V (but an output in the range 11.4V to 12.6V would be acceptable). The output voltage needs to be maintained within this range for load currents of up to 1A (note that the output voltage can be expected to fall as the load current increases).

There is residual hum (i.e. an a.c. signal component at mains or twice mains frequency) and noise (a random unwanted a.c. component) present on the output of every power supply. In practice this can be reduced to negligible proportions by regulation, smoothing and decoupling. We simply have to ensure that, in this case, the total amount of hum and noise superimposed on the d.c. output does not exceed 10mV r.m.s.

Regulation is a measure of how good the power supply is at maintaining its output voltage in the light of input voltage or load current variations. A regulation of 2% means simply that the output voltage should be maintained within 2% over the given range of a.c. input voltages (220V to 240V) and load current (zero to 1A). In practice (and since we may suffer from variations in line voltage and load current

at the same time) we may wish to quote two figures for regulation: one for line and one for load.

**Question 2:** What is the maximum permissible change in output voltage from the power supply if the mains voltage falls from 240V to 220V? (Hint: we would expect the output to change by no more than 2%)

## Transformers

Arguably the most important (but often most neglected) component in any power supply is the transformer. This component is used to provide both isolation from the a.c. mains supply (ensuring that the equipment which is being powered is not connected directly to either of the supply lines, line and neutral) and a means of stepping down (or stepping up) the mains supply voltage to a value which is within the range acceptable to the rectifying and stabilising stages which follow.

Transformers must be adequately rated for the service which they are required to perform. Not only does this mean the selection of the correct primary and secondary voltages but also consideration of the current which is drawn from the secondary. Transformer manufacturers often quote a "VA" rating for their components. This is simply the total secondary load, which can be determined by adding together the products of voltage, V, and current, A, in each secondary winding present.

If this is beginning to sound a little complex, consider the case of a mains transformer with two identical secondary windings each rated at 6V 0.5A. Its nominal VA rating would then be 6VA.

**Question 3:** A transformer has two secondary windings each rated at 12V 2.5A. Determine its VA rating.

Fortunately, most transformer manufacturers provide components which, within a particular VA rating, have identical size but different values of secondary voltage and current. Hence, a popular 6VA rated transformer for printed circuit board mounting is available with the following secondary windings:

2 $\times$ 6V at 0.5A
2 $\times$ 9V at 0.33A
2 $\times$ 12V at 0.25A
2 $\times$ 15V at 0.2A
2 $\times$ 20V at 0.15A

The range of secondary voltages and the provision of two separate secondary windings provides the designer with considerable scope. In addition, since the primary will generally also have two separate windings (each rated at 120V), this will provide even greater flexibility.

Fig. 1.5 shows the range of possibilities for the 6VA transformer with two 6V 0.5A secondary windings, which we met earlier as shown in Fig. 1.5. In Fig. 1.5a, the primary windings are connected in series to operate on a 240V a.c. supply whilst the two secondary windings (also connected in series) are wired to produce an a.c. output of 12V at 0.5A. The transformer in Fig. 1.5b is again connected for 240V a.c. operation however the parallel connected secondaries produce an output of 6V at 1A (i.e. double the current rating of a single secondary winding).

In Fig. 1.5c the primary windings have been parallel connected for 120V (rather than 240V) operation. The two secondary windings have been series connected to provide an output of 12V at 0.5A. Finally, the transformer in Fig. 1.5d has both primary and secondary windings connected



# Voltage Regulators

## LM723/LM723C voltage regulator

### general description

The LM723/LM723C is a voltage regulator designed primarily for series regulator applications. By itself, it will supply output currents up to 150 mA; but external transistors can be added to provide any desired load current. The circuit features extremely low standby current drain, and provision is made for either linear or foldback current limiting. Important characteristics are:

- 150 mA output current without external pass transistor
- Output currents in excess of 10A possible by adding external transistors

- Input voltage 40V max
- Output voltage adjustable from 2V to 37V
- Can be used as either a linear or a switching regulator.

The LM723/LM723C is also useful in a wide range of other applications such as a shunt regulator, a current regulator or a temperature controller.

The LM723C is identical to the LM723 except that the LM723C has its performance guaranteed over a 0°C to 70°C temperature range, instead of -55°C to +125°C.

### schematic and connection diagrams \*

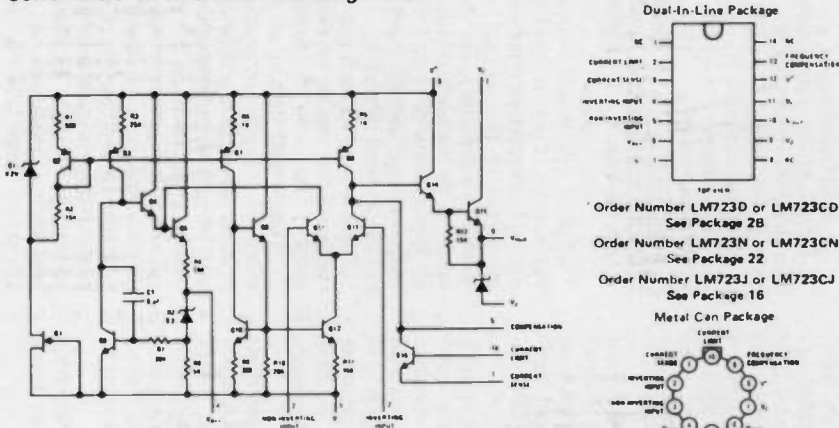

- Order Number LM723D or LM723CD See Package 2B
- Order Number LM723N or LM723CN See Package 22
- Order Number LM723J or LM723CJ See Package 16
- Metal Can Package
- Order Number LM723H or LM723CH See Package 12

### equivalent circuit \*

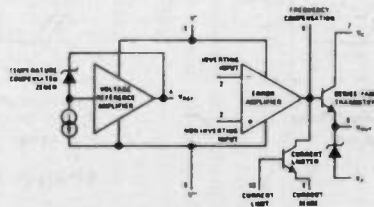

\* Pin numbers refer to metal can package.

### absolute maximum ratings

Pulse Voltage from $V^+$ to $V^-$ (50 ms)	50V
Continuous Voltage from $V^+$ to $V^-$	40V
Input Output Voltage Differential	40V
Maximum Amplifier Input Voltage (Either Input)	7.5V
Maximum Amplifier Input Voltage (Differential)	5V
Current from $V_Z$	25 mA
Current from $V_{REF}$	15 mA
Internal Power Dissipation Metal Can (Note 1)	800 mW
Cavity DIP (Note 1)	900 mW
Molded DIP (Note 1)	660 mW
Operating Temperature Range LM723	-55°C to +125°C
LM723C	0°C to +70°C
Storage Temperature Range Metal Can	-65°C to +150°C
DIP	-55°C to +125°C
Lead Temperature (Soldering, 10 sec)	300°C

### electrical characteristics (Note 2)

PARAMETER	CONDITIONS	LM723			LM723C			UNITS	
		MIN	TYP	MAX	MIN	TYP	MAX		
Line Regulation	$V_{IN} = 12V$ to $V_{IN} = 15V$ $-55^\circ C \leq T_A \leq +125^\circ C$ $0^\circ C \leq T_A \leq +70^\circ C$ $V_{IN} = 12V$ to $V_{IN} = 40V$		.01	0.1		.01	0.1	% $V_{OUT}$	
				0.3			0.3	% $V_{OUT}$	
				0.2	0.2		0.1	0.5	% $V_{OUT}$
									% $V_{OUT}$
Load Regulation	$I_L = 1$ mA to $I_L = 50$ mA $-55^\circ C \leq T_A \leq +125^\circ C$ $0^\circ C \leq T_A \leq +70^\circ C$		.03	0.15		.03	0.2	% $V_{OUT}$	
				0.6			0.6	% $V_{OUT}$	
Ripple Rejection	$f = 50$ Hz to $10$ kHz, $C_{REF} = 0$ $f = 50$ Hz to $10$ kHz, $C_{REF} = 5 \mu F$		74			74		dB	
			86			86		dB	
Average Temperature Coefficient of Output Voltage	$-55^\circ C \leq T_A \leq +125^\circ C$ $0^\circ C \leq T_A \leq +70^\circ C$		.002	.015				%/°C	
						.003	.015	%/°C	
Short Circuit Current Limit	$R_{SC} = 10\Omega$ , $V_{OUT} = 0$		65			65		mA	
Reference Voltage		6.95	7.15	7.35	6.80	7.15	7.50	V	
Output Noise Voltage	$BW = 100$ Hz to $10$ kHz, $C_{REF} = 0$ $BW = 100$ Hz to $10$ kHz, $C_{REF} = 5 \mu F$		20			20		$\mu V_{rms}$	
			2.5			2.5		$\mu V_{rms}$	
Long Term Stability			0.1			0.1		%/1000 hrs	
Standby Current Drain	$I_L = 0$ , $V_{IN} = 30V$		1.3	3.5		1.3	4.0	mA	
Input Voltage Range		9.5		40	9.5		40	V	
Output Voltage Range		2.0		37	2.0		37	V	
Input-Output Voltage Differential		3.0		38	3.0		38	V	

- Note 1: See derating curves for maximum power rating above 25°C.
- Note 2: Unless otherwise specified,  $T_A = 25^\circ C$ ,  $V_{IN} = V^+ = V_C = 12V$ ,  $V^- = 0$ ,  $V_{OUT} = 5V$ ,  $I_L = 1$  mA,  $R_{SC} = 0$ ,  $C_1 = 100$  pF,  $C_{REF} = 0$  and divider impedance as seen by error amplifier  $\leq 10$  k $\Omega$  connected as shown in Figure 1. Line and load regulation specifications are given for the condition of constant chip temperature. Temperature drifts must be taken into account separately for high dissipation conditions.
- Note 3:  $L_1$  is 40 turns of No. 20 enameled copper wire wound on Ferroxcube P36/22-387 pot core or equivalent with 0.009 in. air gap.
- Note 4: Figures in parentheses may be used if R1/R2 divider is placed on opposite input of error amp.
- Note 5: Replace R1/R2 in figures with divider shown in Figure 13.
- Note 6:  $V^+$  must be connected to a +3V or greater supply.
- Note 7: For metal can applications where  $V_Z$  is required, an external 6.2 volt zener diode should be connected in series with  $V_{OUT}$ .

Fig. 1.4 National Semiconductor LM723 data sheet



maximum power ratings

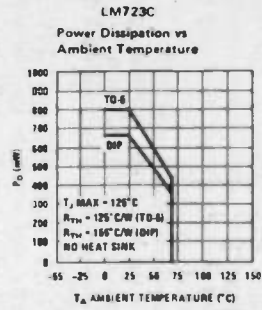
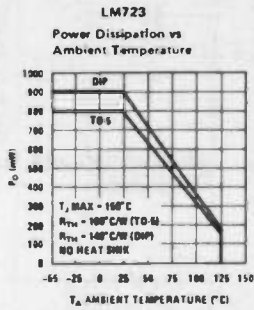

typical performance characteristics

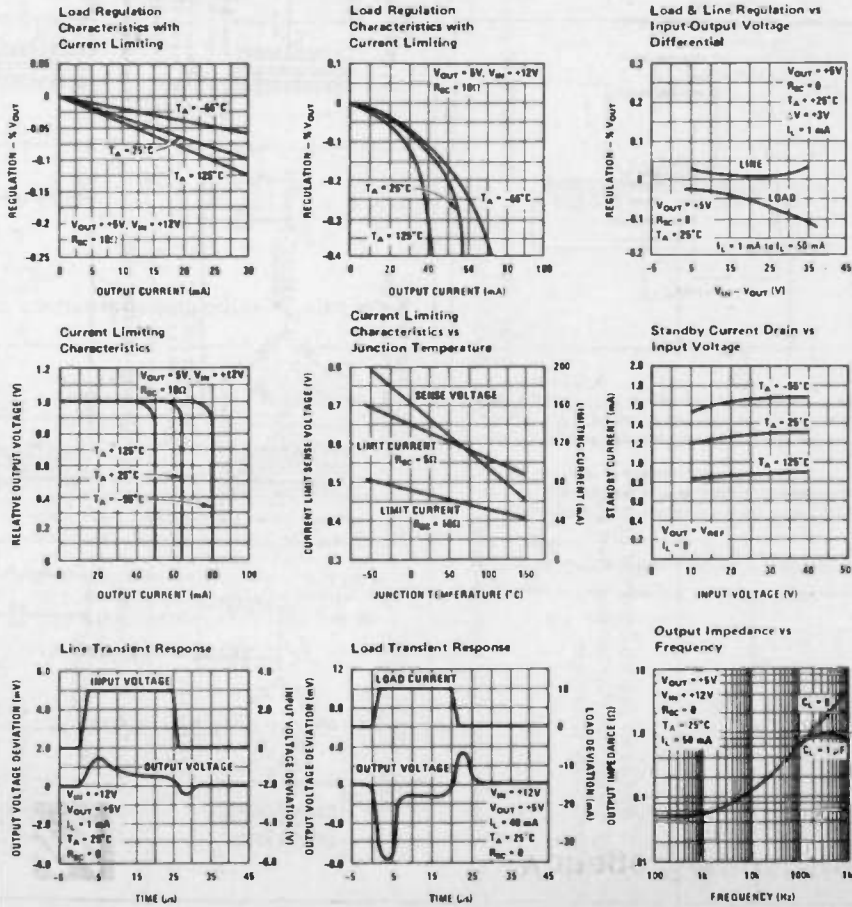

TABLE I RESISTOR VALUES (kΩ) FOR STANDARD OUTPUT VOLTAGE

POSITIVE OUTPUT VOLTAGE	APPLICABLE FIGURES	FIXED OUTPUT ±5%		OUTPUT ADJUSTABLE ±10% (Note 5)		NEGATIVE OUTPUT VOLTAGE	APPLICABLE FIGURES	FIXED OUTPUT ±5%		% OUTPUT ADJUSTABLE ±10%			
		R1	R2	R1	P1			R2	R1	P1	R2		
+3.0	(Note 4) 1, 5, 6, 9, 12 (4)	4.12	3.01	1.8	0.5	1.2	+100	7	3.57	102	2.2	10	91
+3.6	1, 5, 6, 9, 12 (4)	3.57	3.65	1.5	0.5	1.5	+250	7	3.57	255	2.2	10	240
+5.0	1, 5, 6, 9, 12 (4)	2.15	4.99	75	0.5	2.2	-6 (Note 6)	3, (10)	3.57	2.43	1.2	0.5	75
+6.0	1, 5, 6, 9, 12 (4)	1.15	6.04	0.5	0.5	2.7	-9	3, 10	3.48	5.36	1.2	0.5	2.0
+9.0	2, 4, 15, 6, 12, 9)	1.87	7.15	.75	1.0	2.7	-12	3, 10	3.57	8.45	1.2	0.5	3.3
+12	2, 4, (5, 6, 9, 12)	4.87	7.15	2.0	1.0	3.0	-15	3, 10	3.85	11.5	1.2	0.5	4.3
+15	2, 4, (5, 6, 9, 12)	7.07	7.15	3.3	1.0	3.0	-28	3, 10	3.57	24.3	1.2	0.5	10
+28	2, 4, (5, 6, 9, 12)	21.0	7.15	5.6	1.0	2.0	-45	8	3.57	41.2	2.2	10	33
+45	7	3.57	48.7	2.2	10	39	-100	8	3.57	97.6	2.2	10	91
+75	7	3.57	78.7	2.2	10	68	-250	8	3.57	249	2.2	10	240

TABLE II FORMULAE FOR INTERMEDIATE OUTPUT VOLTAGES

<p>Outputs from +2 to +7 volts [Figures 1, 5, 6, 9, 12, (4)]</p> $V_{OUT} = [V_{REF} \times \frac{R2}{R1 + R2}]$	<p>Outputs from +4 to +250 volts [Figure 7]</p> $V_{OUT} = [ \frac{V_{REF}}{2} \times \frac{R2 - R1}{R1} ], R3 = R4$	<p>Current Limiting</p> $I_{LIMIT} = \frac{V_{SENSE}}{R_{SC}}$
<p>Outputs from +7 to +37 volts [Figures 2, 4, (5, 6, 9, 12)]</p> $V_{OUT} = [V_{REF} \times \frac{R1 + R2}{R2}]$	<p>Outputs from -6 to -250 volts [Figures 3, 8, 10]</p> $V_{OUT} = [ \frac{V_{REF}}{2} \times \frac{R1 + R2}{R1} ], R3 = R4$	<p>Foldback Current Limiting</p> $I_{KNEE} = [ \frac{V_{OUT} R3}{R_{SC} R4} + \frac{V_{SENSE} (R3 + R4)}{R_{SC} R4} ]$ $I_{SHORTCY} = [ \frac{V_{SENSE}}{R_{SC}} \times \frac{R3 + R4}{R4} ]$

typical applications

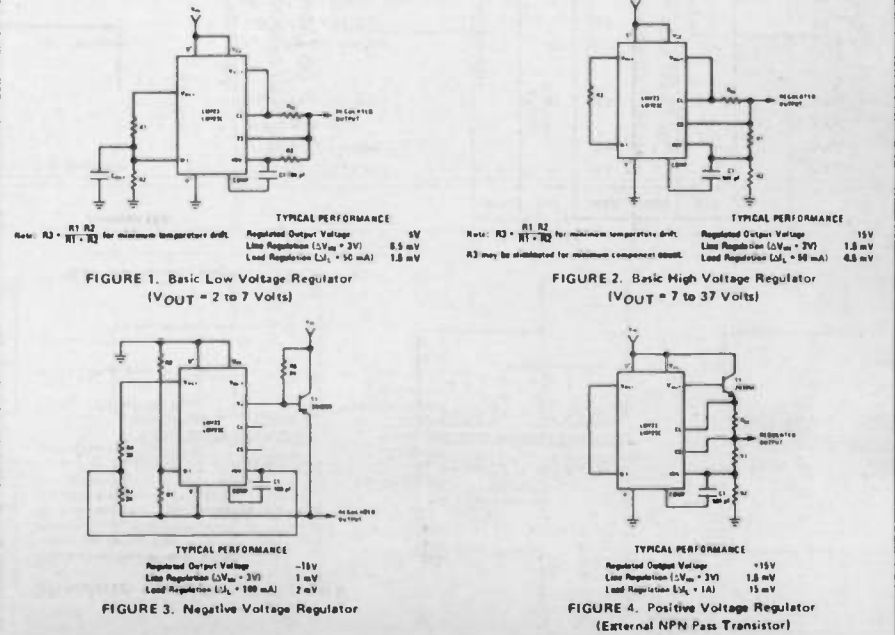

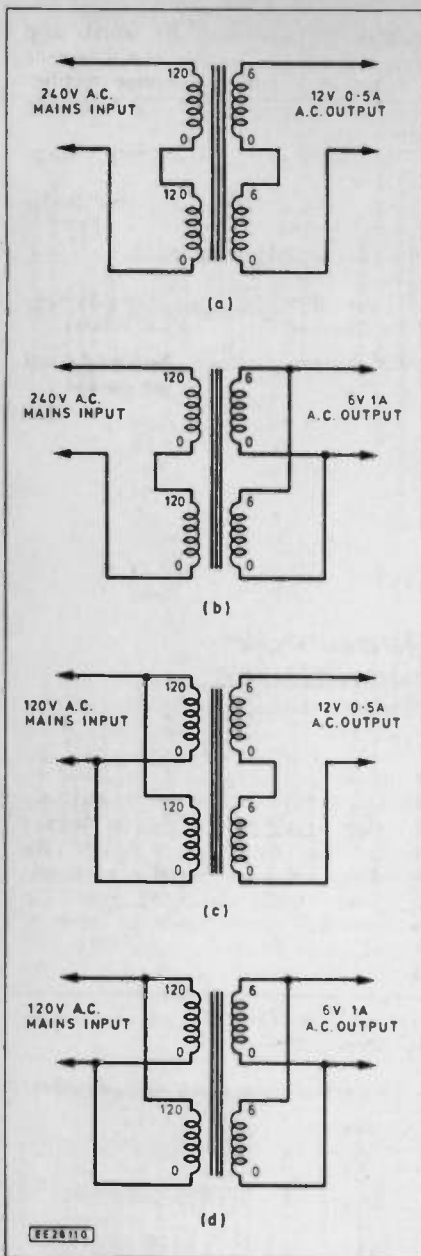
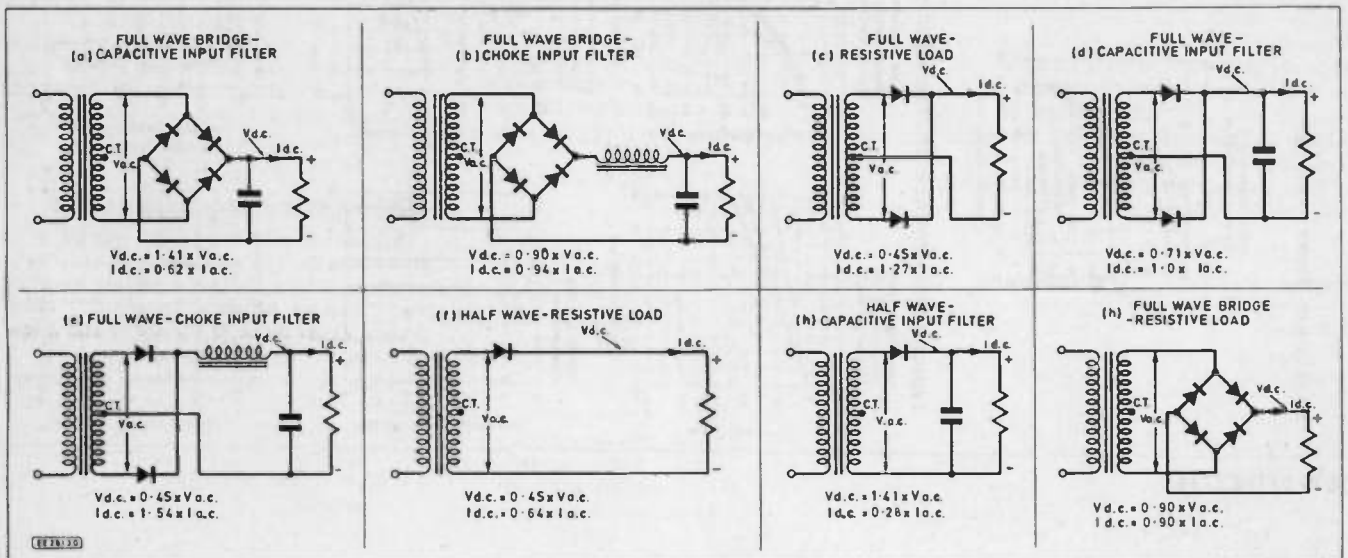

Fig. 1.5 Range of possibilities for connecting a 6VA transformer with two 6V 0.5A secondary windings

Fig. 1.7 Various rectifier arrangements



in parallel providing a unit which will provide 6V at 1A from an a.c. mains input of 120V.

In either case, it is important to ensure that the transformer windings are connected in the correct phase. This simply means that, in the case of a series connection the "finish" of one winding must be connected to the "start" of the other whilst, in the case of the parallel connection, the two "starts" must be connected together and the two "ends" connected together. Fig. 1.6a and 1.6b show the correct connections for series and parallel operation (respectively) whilst Fig. 1.6c and 1.6d show incorrect connections.

### Non-resistive loads

Thus far, we have assumed that the transformer has been operating with a purely resistive load. Unfortunately, most rectifier arrangements impose a load on a transformer which is not equivalent to a pure resistance. Often the load will be capacitive although in some cases it may also be inductive. These reactive loads can result in the need to derate a transformer's a.c. current rating in order to prevent overloading. Recommended derating factors for various types of rectifier circuit have been included in Fig. 1.7.

### Regulation

An important (though often misunderstood) characteristic of a transformer is its ability to maintain the rated output voltage at full-load. This regulation is usually quoted as a percentage and is determined from the following formula:

$$\text{Regulation} = \frac{V_{OL} - V_{FL}}{V_{OL}} \times 100\%$$

Where  $V_{OL}$  and  $V_{FL}$  are the off-load and full-load output voltages respectively.

Typical transformers have regulation which varies from 5% (usually for larger transformers) to around 20% (for smaller components). The implication of this is quite important and is one reason why a voltage regulator is often required after the rectifier stage. Consider the following example for two different transformers, each providing a single secondary winding rated at 12V 1A:

#### Component A (regulation 20%)

Since the component provides an off-load output of nominally 12V (i.e.  $V_{OL} = 12V$ ), its full-load output ( $V_{FL}$ ) will have dropped by 20%, thus:

$$V_{FL} = 12V - (12V \times 0.2) = 12V - 2.4V = 9.4V$$

Clearly, this would be quite unacceptable in a number of applications!

### Component B (regulation 5%)

Since the component provides an off-load output of nominally 12V (i.e.  $V_{OL} = 12V$ ), its full-load output ( $V_{FL}$ ) will have dropped by 5%, thus:

$V_{FL} = 12V - (12V \times 0.05) = 12V - 0.6V = 11.4V$   
Unfortunately, the old maxim "you get what you pay for" applies here since the cost of a transformer is very much related to the quality of the component and consequently is also related to the regulation which can be achieved. In practice, this means simply that, when purchasing a transformer, there is a trade-off between cost and performance!

## Rectifiers

Rectifiers are another breed of component which, like transformers, are largely taken for granted. Here again, the choice of the "right" component can be crucial to the operation of a power supply.

Wire ended diodes are commonly available with maximum forward current ( $I_{FM}$ ) ratings of up to around 6A and maximum repetitive reverse voltage ( $V_{RRM}$ ) ratings of up to 1,250V. Stud-mounting diodes (designed for bolting to a heatsink) are available with forward current ratings ranging typically from 16A to 75A.

The following types of wire ended diode are commonly available:

Type	Encapsulation	Mounting	$I_{FM}$ (typ)	Range of $V_{RRM}$
1N4000 series	Min. plastic	p.c.b.	1A	50V to 1000V
1N5400 series	Plastic	p.c.b.	3A	100V to 1000V
MR750 series	Plastic	p.c.b.	6A	200V to 800V
P600 series	Plastic	p.c.b.	6A	50V to 600V
BY126	Plastic	p.c.b.	1.5A	650V
BY127	Plastic	p.c.b.	1.5A	1250V
BYX10	Plastic	p.c.b.	0.35A	1600V

Most d.c. power supply circuits will make use of full-wave (bridge or bi-phase) rectification rather than half-wave. Hence the choice will involve either selecting two (or four) individual components or using an encapsulated bridge rectifier (comprising four individual bridge connected diodes). Fig. 1.7 shows a number of possible arrangements. Of these, the full-wave bridge with capacitive input is the most common, followed by the full-wave bi-phase circuit with capacitive input.

Rectifiers should be adequately rated in terms of both the maximum inverse voltage which they must withstand but also in terms of the maximum forward current which they must carry. In addition, components which are to be used in conjunction with capacitive input filters must generally be derated to around 80% of the quoted maximum forward current. As an example, a bridge rectifier rated at 1.6A used with a capacitive input filter should be derated to 1A maximum.

The following types of bridge rectifier are commonly available:

Type	Encapsulation	Mounting	$I_{FM}$ (typ)	Range of $V_{RRM}$
DF series	4-pin d.i.l.	p.c.b.	0.9A	200V to 800V
Vm series	4-pin d.i.l.	p.c.b.	0.9A	200V to 800V
WO series	Cylindrical	p.c.b.	1A	50V to 800V
BY164	In-line	p.c.b.	1.5A	60V
SKB2 series	In-line	p.c.b.	1.6A	200V to 800V
KBPC series	Square	p.c.b.	2A/6A	200V to 800V
KBU4 series	In-line	p.c.b.	4A	200V to 800V
SKB25 series	Epoxy-potted	Heatsink	6A to 35A	200V to 1200V

Components which are expected to carry currents in excess of 2A, or so, will generally require fitting with a heatsink in order to reduce dissipation to an acceptably low value. A heatsink of 5°C/W will generally suffice for current up to about 5A forward current whilst a component rated at 2.1°C/W (or less) will be required for operation at 10A, or so. As with most semiconductor devices, rectifiers should be linearly derated at high temperatures (typically beyond 50°C) to zero at around 150°C.

The maximum inverse voltage (PIV or  $V_{RRM}$ ) should be at least twice the peak value of the input voltage (purely resistive loads) or 2.8 times the input voltage (for a capacitive input filter). In practice, and to allow a margin for safety, it is wise to employ a component which is rated at at least four times the quoted r.m.s. secondary voltage of the transformer. Hence, a rectifier for use in conjunction with a transformer which has a 12V secondary should be rated at 48V, or more. In practice, a 50V or 200V component would be suitable.

## Worst case conditions

As shown in Fig. 1.7, the output voltage developed across the capacitor of a capacitor input filter circuit will be approx-

imately 1.4 times the transformer secondary voltage. On-load, this voltage will fall due in part to the regulation offered by the transformer and in part due to the forward voltage drop of the diodes within the bridge rectifier. In order to ensure that operation is within specification, it is important to be aware of the "worst case" condition" which occurs at full-load.

It is worth dwelling on this point a little! Let us suppose that we are making use of a transformer with a secondary voltage of 12V at 1A which offers a regulation of 10%. At full-load, the a.c. voltage provided by the secondary will fall by 10% to 10.8V and the corresponding peak output voltage developed across the reservoir capacitor will be 1.4 times this value minus the forward voltage drop associated with two silicon diodes within the bridge rectifier (note that there are two diodes in the current path at any one time). Hence the worst case output voltage will be given by:

$$V_O \text{ (worst case)} = 1.4 \times 10.8V - 2 \times 0.7V = 15.12V - 1.4V = 13.7V$$

**Question 2:** Determine the worst case voltage developed across the reservoir capacitor in a full-wave bridge rectifier circuit which operates with the following parameters:

Transformer off-load secondary voltage ( $V_{OL}$ ) = 9V  
Diode forward voltage drop (per diode) ( $V_F$ ) = 0.7V  
Transformer regulation = 15%

Typical values of no-load output voltage for the circuit of Fig. 1.7a are as follows:

R.M.S. secondary voltage	No-load d.c. output voltage
4.5V	6.3V
6V	8.5V
9V	12.7V
12V	16.9V
15V	21.2V
18V	25.4V
20V	28.2V
24V	33.9V

## Reservoir capacitors

The value of reservoir capacitor used in the circuits shown in Fig. 1.7 will be governed by the load current and the amount of ripple that can be tolerated. In addition, maximum reservoir capacitance values are sometimes specified by rectifier manufacturers. As a "rule of thumb", the capacitance value (expressed in  $\mu$ ) should be between 2,000 and 5,000 times the maximum load current (expressed in A). If a regulator is fitted (and provided that sufficient headroom voltage is available) the value of capacitance may be closer to the lower limit. Hence the following values are recommended:

Nominal load current	Reservoir capacitance
125mA	220 $\mu$ to 470 $\mu$
250mA	470 $\mu$ to 1000 $\mu$
500mA	1000 $\mu$ to 2200 $\mu$
1A	2200 $\mu$ to 4700 $\mu$
2A	4700 $\mu$ to 10000 $\mu$
4A	10000 $\mu$ or greater

It is important to ensure that the component selected is adequately rated in terms of maximum working voltage. To provide a margin of safety, the reservoir capacitor should be rated at about twice the r.m.s. secondary voltage of the transformer. Hence, a component for use in a full-wave bridge rectifier circuit using a capacitive input filter Fig. 1.7a in which the transformer is rated at 12V a.c. output should be rated at a minimum of 24V d.c. working (even though, in normal operation, the off-load d.c. output voltage will only reach about 16V). In practice, reservoir capacitors are available in ranges of different working voltages (usually 16V, 25V, 35V, 50V, 63V and 100V).

## Simple regulators

Regulation of the output voltage of a power supply is important in nearly every application and, in some simple applications, can be achieved by nothing more than a Zener diode, a transistor and a few additional components.

Zener diodes are available in various families (according to their general characteristics, encapsulation and power ratings) with reverse breakdown (Zener) voltages in the E12 and E24 series (ranging from 2.7V to around 68V).

The following data applies to the most common families of Zener diode:

Zener family	Power rating	Encapsulation	Voltage range
BZY88 series	500mW	Min. glass	2.7V to 15V
BZX85 series	1.3W	Min. glass	5.1V to 62V
BZX61 series	1.3W	Min. glass	7.5V to 72V
BZX55 series	500mW	Min. glass	2.4V to 91V
BZY93 series	20W	Stud mounting	9.1V to 75V
BZY97 series	1.5W	Plastic	9.1V to 37V
1N5333 series	5W	Plastic	3.3V to 24V.

Where accuracy of the Zener voltage is an important consideration, it is important to note that the temperature coefficient of the Zener voltage of a Zener diode tends to vary with the Zener voltage rating. The temperature coefficient for a 2.7V component will usually be of the order of  $-2\text{mV/deg.C}$  whilst a 6.8V component will exhibit a temperature coefficient of around  $+2\text{mV/deg.C}$ . The optimum voltage (at which the temperature coefficient approaches zero) is around 4.7V. Hence this voltage may be preferred for certain applications (particularly where the Zener voltage is used as a "reference" voltage).

### Shunt regulators

The simple shunt Zener voltage regulator shown in Fig. 1.8 is only suitable for applications in which the load current is less than about 50mA. A regulation of about 10% can be achieved with this type of circuit which will exhibit an impedance of typically 15 ohm, or less.

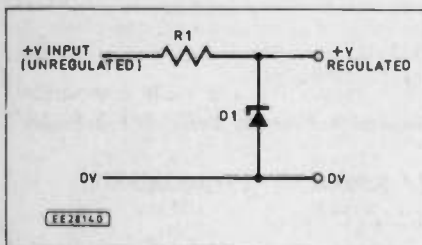

Fig. 1.8 Simple Zener diode shunt regulator

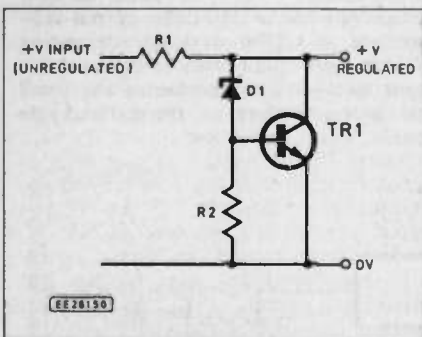

Fig. 1.9 "Amplified Zener" shunt regulator

The performance of a Zener regulator can be considerably improved by adding a shunt connected transistor, as shown in Fig. 1.9. This "amplified Zener" arrangement is suitable for applications in which the load current is very much greater than the maximum rated current of the Zener (found by dividing its maximum permissible power dissipation by its nominal Zener voltage). The compound arrangement of Zener and transistor behaves like a superior Zener diode having a much higher power rating.

The circuit shown in Fig. 1.9 has an output impedance of less than 1 ohm but note that, by virtue of the base-emitter voltage drop of the transistor, the output voltage will be approximately 0.8V greater than the nominal Zener voltage.

Unfortunately, high current shunt regulators have several obvious disadvantages not the least of which is associated with the power dissipation in the series dropping resistor. This must be adequately rated (a wirewound resistor will usually be required) and mounted so that convection cooling is possible. Another problem is that maximum dissipation in the shunt transistor occurs under no-load conditions. It, too, will probably require heatsinking!

Despite this, shunt regulators do offer one advantage over their series connected counterparts; they are inherently safe since a collector-emitter short circuit failure within the transistor will make the output fall to zero. A similar fault condition in a series regulated power supply will result in the full unregulated d.c. voltage being applied to the load. In some cases this can prove to be extremely embarrassing (not to mention expensive!) since it can result in wholesale destruction of any voltage sensitive devices present in the load which may have their maximum ratings exceeded whenever the series transistor fails!

### Series regulators

The basic arrangement of a series regulator is shown in Fig. 1.10. The transistor is effectively connected as an emitter follower and thus the output voltage will be approximately 0.8V less than the nominal Zener voltage. Dissipation in the series element rises as the load current increases. Under worst-case conditions (i.e. under full-load and with the minimum expected value of the a.c. mains supply), the input voltage should be at least 2V greater than the desired output.

In order to minimise dissipation in the transistor (and thus minimise heatsink ratings) the d.c. input should not, however, be very much greater than this value. A recommended range for the input would be between 2V and 7V greater than the desired output voltage. Thus, for a nominal 12V output, the rectifier output should be within the range 14V (minimum) to 19V (maximum).

### Integrated circuit voltage regulators

Integrated circuit voltage regulators are now so widely available in popular ranges of voltage and current output that discrete component regulator circuits are nowadays hardly ever necessary. In addition, integrated circuit regulators offer a number of significant advantages over simple circuits which employ discrete components

including such useful features as foldback current limiting and thermal shut-down.

The 78 (positive output) and 79 (negative output) regulators are available in a range of voltages (e.g. 5V, 9V, 12V, 15V, 18V and 24V). Current ratings for different variants range from 100mA (L series) to 5A (H series). The most commonly available range are designed to operate at load currents of up to 1A.

Basic positive and negative regulated power supplies are shown in Fig. 1.11. The two 100n capacitors (C1 and C2) are included to ensure unconditional high frequency stability and they should be mounted as close to the regulator terminals as possible. C3 is placed in parallel with the output simply to provide additional decoupling. In practice, any value between 22 $\mu$  and 100 $\mu$  should prove adequate.

When using 78 series regulators, it is important to note that the worst-case unregulated d.c. input voltage should normally be at least 3V greater than the nominal regulated output voltage. The penalty for not observing this precaution will be poor regulation and an unacceptable level of residual mains hum present at the output. Furthermore, the worst-case unregulated d.c. input voltage should not be allowed to exceed the nominal regulated output voltage by more than about 15V otherwise regulator dissipation will be excessive. Failure to avoid this precaution can result in premature thermal shut-down. Typical characteristics of 100mA, 1A and 2A plastic fixed voltage regulators are shown opposite:

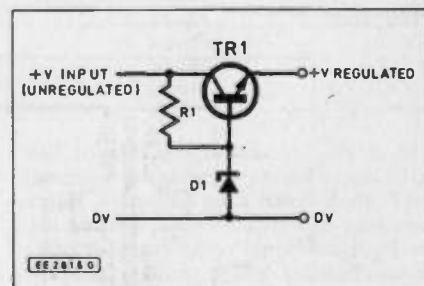

Fig. 1.10 Basic series regulator

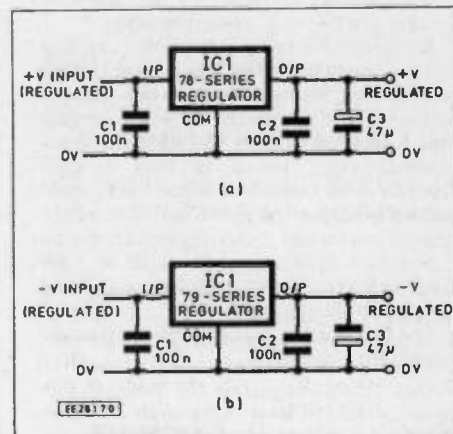

Fig. 1.11 Integrated circuit regulator arrangements, (a) positive output, (b) negative output

### Dual output power supplies

When dual regulated outputs are required, a bridge rectifier can be used in

### 100mA series

Type	Positive output Negative output	78L05 79L05	78L12 79L12	78L15 79L15	78L24 79L24
Input voltage range	(V)	7-30	14.5-35	17.5-35	27-35
Load regulation	(%)	0.2	0.2	0.3	0.4
Line regulation	(%)	1	1	1.5	1.5
Ripple rejection	(dB)	60	55	52	49
Output resistance	(mΩ)	200	400	500	850
Output noise voltage [10Hz TO 100kHz]	(μV)	40	70	90	200
Short-circuit current	(mA)	75	35	25	20

### 1A series

Type	Positive output Negative output	7805 7905	7812 7912	7815 7915	7824 7924
Input voltage range	(V)	7-25	14.5-30	17.5-30	27-38
Load regulation	(%)	0.2	0.4	0.5	0.6
Line regulation	(%)	0.2	0.2	0.3	0.3
Ripple rejection	(dB)	71	61	60	56
Output resistance	(mΩ)	30	75	95	150
Output noise voltage [10Hz to 100kHz]	(μV)	40	80	90	170
Short-circuit current	(mA)	750	350	230	150

### 2A series

Type	Positive output Negative output	78S05 79S05	78S12 79S12	78S15 79S15	78S24 79S24
Input voltage range	(V)	8-35	15-35	18-35	27-40
Load regulation	(mV)	100	160	180	250
Line regulation	(mV)	100	240	300	480
Ripple rejection	(dB)	60	53	52	48
Output resistance	(m)	17	18	19	28
Output noise voltage [10Hz to 100kHz]	(μV)	40	75	90	170
Short-circuit current	(mA)	500	500	500	500

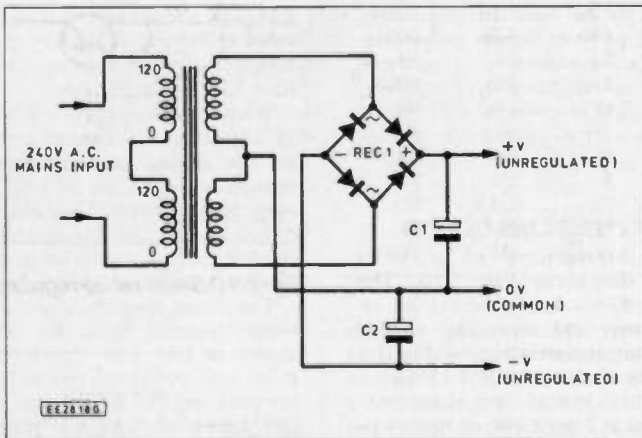
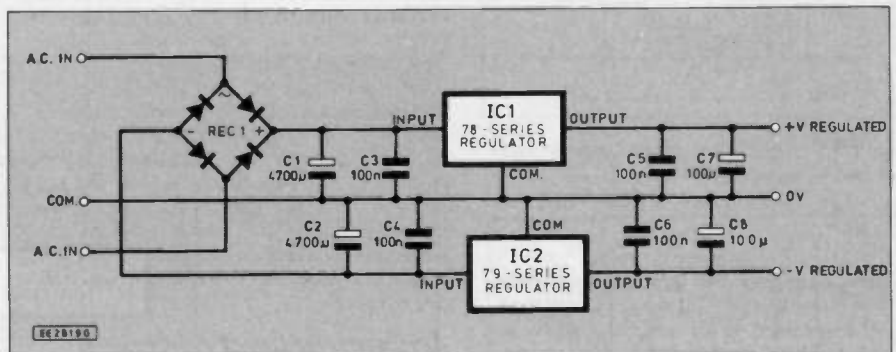

Fig. 1.12 Dual output rectifier circuit

Fig. 1.13 Circuit diagram of the dual output power supply module

conjunction with a transformer having two identical secondaries, as shown in Fig. 1.12. With this arrangement it is important to note that the maximum reverse repetitive voltage rating ( $V_{RRM}$ ) for the diodes in this circuit should at least be equal to 2.8 times the r.m.s. voltage produced by each individual secondary winding.

The unregulated positive and negative outputs produced by the circuit of Fig. 1.12 can be regulated by means of two fixed voltage regulators of opposite polarity. Fig. 1.13 shows the complete circuit of a dual output power supply module based on standard 78 and 79 series regulators. The necessary component changes for different output voltages are given in the table below the circuit.



Output	IC1	IC2	Transformer secondaries (each rated at 2.2A minimum)	Transformer power rating (minimum)
±5V	7805	7905	2 × 4.5V or 1 × 9V	20VA
±12V	7812	7912	2 × 6V or 1 × 12V	27VA
±15V	7815	7915	2 × 9V or 1 × 18V	40VA

## COMPONENTS

### Dual-Output Power Supply Module

See  
**SHOP  
TALK**  
Page

#### Capacitors

C1, C2 4700μ axial elect. 25V (2 off)  
C3 to C6 100n miniature dipped case polyester (4 off)  
C7, C8 100μ axial elect. 25V (2 off)

#### Semiconductors

REC1 200V min. 2.6A in-line type (e.g. KBU4D)  
IC1 7805, 7812 or 7815 (see table)  
IC2 7905, 7912 or 7915 (see table)

#### Miscellaneous

T1 20VA mains transformer with two secondary windings (see table)  
Heatsink, 4°C/W (see text); p.c.b., available from the *EE PCB Service*, order code 712; Terminals, 0.042" terminal pins (6 off)

Approx cost  
guidance only

**£8**

The copper foil and p.c.b. component layouts for the dual output power supply module are shown in Fig. 1.14

### Variable power supplies

Where a variable regulated output voltage is required it is expedient to make use of a variable i.c. voltage regulator such as the LM317 or LM338. These versatile devices provide an adjustable output voltage range of 1.2V to over 30V (depending upon the upper limit of the unregulated d.c. input voltage) and incorporate the usual internal current limiting, thermal and safe operating area protection.

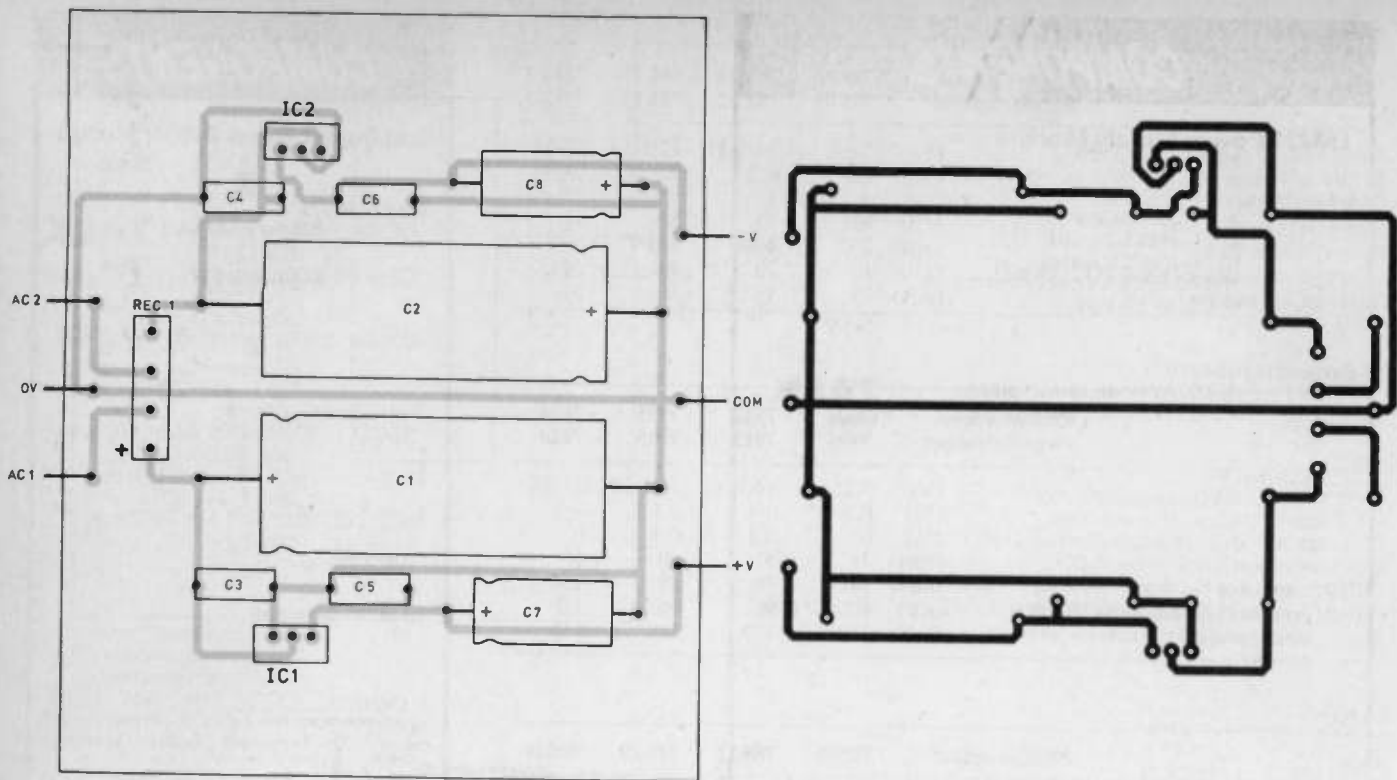

EE26200

The characteristics of the LM317/LM338 family are listed below:

Fig. 1.14 P.C.B. copper foil and component layout for the dual output power supply module

Type	LM317L	LM317M	LM317T	LM317K	LM338K
Maximum load current	100mA	500mA	1.5A	1.5A	5A
Output voltage range	(V) 1.2-37	1.2-37	1.2-37	1.2-37	1.2-32
Input voltage range	(V) 4-40	4-40	4-40	4-40	4-35
Load regulation	(%) 0.1	0.1	0.3	0.1	0.1
Line regulation	(%/V) 0.01	0.01	0.02	0.01	0.005
Ripple rejection	(dB) 65	65	65	65	60
Output impedance	(m) 10	10	10	10	3
Adjustment pin current	( $\mu$ A) 50	50	50	50	45
Thermal resistance [junction case]	(deg.C/W) 160	12	4	2.3	1
Maximum junction temperature	(deg.C) 125	125	125	125	125
Maximum dissipation	(W) 0.625	7.5	15	20	50
Package	TO92	TO202	TO220	TO3	TO3

of up to 1.5A. Fig. 1.17 shows the circuit of a 5A power supply which has an adjustment voltage range of 9.5V to 13.8V (the LM338K should be mounted on a heatsink rated at 1 deg.C/W, or better). This power supply makes an ideal bench replacement for a 12V lead-acid battery!

Where it is necessary to provide a means of adjusting the output current as well as the output voltage provided by a monolithic regulator, an LM723 regulator may be preferred. This device was described earlier and has established a long track record as a reliable and predictable "industry standard" device.

The circuit diagram of a complete power supply module based on an LM723 is shown in Fig. 1.17. Almost any suitably rated high power *npn* silicon transistor can be used as the series pass device, TR1 (for which an adequate heatsink, e.g. 2 deg.C/W, will be required). Adjustment of the output voltage and current limit is

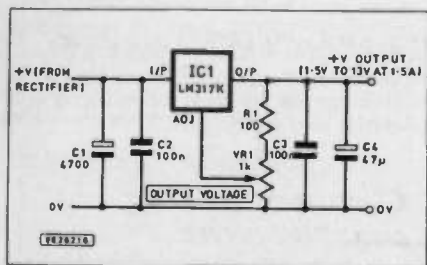

Fig. 1.15 Variable regulated power supply based on an LM317K

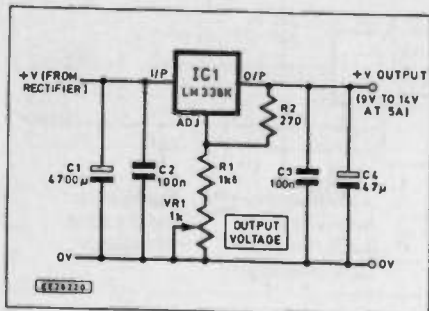

Fig. 1.16 Variable regulated power supply based on an LM338K

Representative circuits using variable voltage regulators are shown in Fig. 1.15 and 1.16. The circuit of Fig. 1.15 uses an LM317K (which should be mounted on a heatsink rated at 2 deg.C/W, or better) and provides an output voltage which is fully variable from 1.5V to 13V at load currents

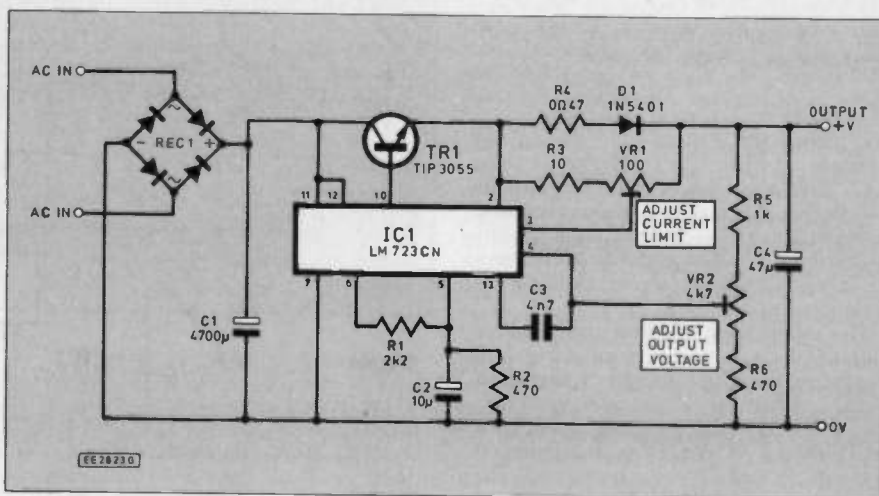

Fig. 1.17 Circuit diagram of the LM723 variable power supply module

# COMPONENTS

## LM723 Power Supply Module

### Resistors

R1	2k2 0.25W 5% carbon
R2, R6	470 0.25W 5% carbon
R3	10 0.25W 5% carbon
R4	0Ω247 2.5W 5% vitreous coated
R5	1k 0.25W 5% carbon

### Potentiometers

VR1	100 0.5W horiz. cermet preset
VR2	4k7 0.5W horiz. cermet preset

### Capacitors

C1	4700μ axial elect. 25V
C2	10μ radial elect. 16V
C3	4n7 miniature plate ceramic
C4	47μ radial elect. 50V

NB: Capacitor maximum working voltages are shown for a nominal 12V a.c. input. Values of working voltage should be updated appropriately for higher voltage operation (see text).

### Semiconductors

REC1	200V 4A in-line type (e.g. KBU4D)
IC1	LM723CN
TR1	TIP3055
D1	1N5401

### Miscellaneous

T1 50VA (min.) mains transformer with suitable rated secondary windings (see text)  
Heatsink, see text; terminals 0.042" terminal pins (4 off); p.c.b., available from the *EE PCB Service*, order code EE713.

Approx cost  
guidance only

See  
**SHOP  
TALK**  
Page

**£15**

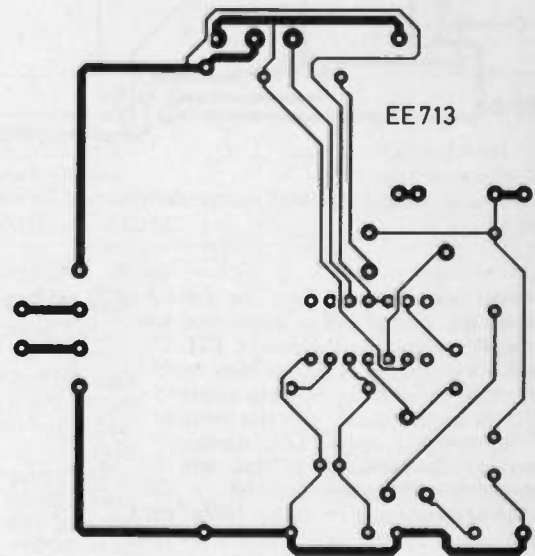
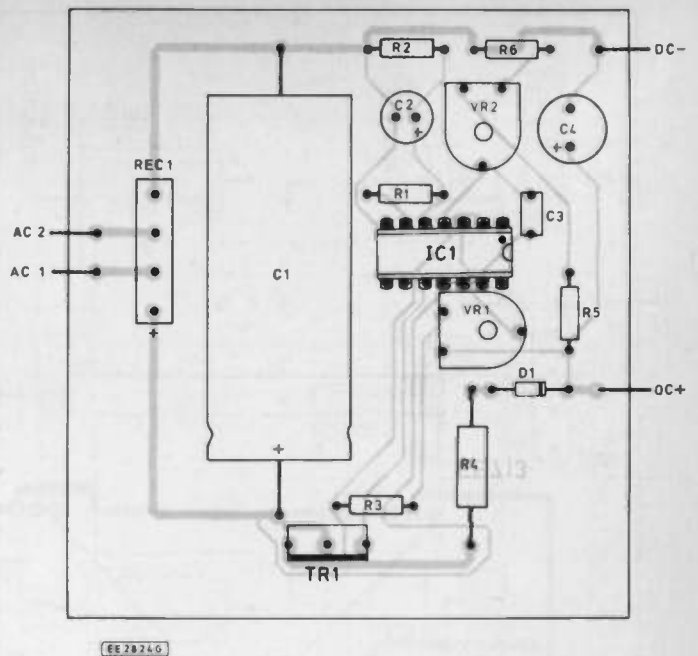

Fig. 1.18 P.C.B. copper foil and component layout for the LM723 power supply module

achieved by means of VR2 and VR1 and the circuit is capable of supplying outputs of up to 5A at voltages of up to 35V. The range of output voltage adjustment may be reduced (or increased) by appropriate changes to the potential divider formed by R5, R6 and VR2. The LM723 data sheet shown in Fig. 1.4 gives the necessary information.

The copper foil and p.c.b. component layouts for the dual output power supply module are shown in Fig. 1.18. Note that the power transistor, TR1, may be mounted on or off the p.c.b. according to the amount of heatsinking required. If a TO3 device is used (e.g. 2N3055) this can be wired to the p.c.b. by means of short lengths of insulated stranded wire (which MUST be capable of carrying the maximum rated output current).

In some cases, an L200 regulator may be preferred to the LM723. The L200 provides an adjustable output voltage range of 2.8V to 36V together with an adjustable output current range with a 2A upper limit. The device is housed in a 5-pin plastic package. Load regulation is typically 1.5% and the device incorporates safe operating area protection as well as input overvoltage protection (up to 60V, 10ms) and short-circuit protection.

The circuit of Fig. 1.19 shows how the L200 can be used in a simple power supply which produces an output which can be varied from approximately 2.7V to 35V at

2A maximum. It should be noted that, regulator dissipation will be large when operating near the maximum rated current (2A) with low output voltages. An adequate heatsink (2 deg.C/W, or better) is therefore essential in order to prevent premature thermal limiting of the output current.

The copper foil and p.c.b. component

layouts for the L200 power supply module are shown in Fig. 1.20

## Crowbar protection

Short circuit failure within the series pass element of a regulator can have

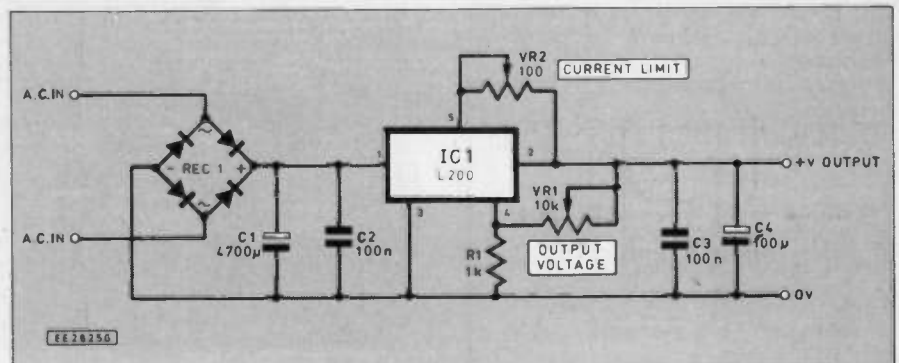

Fig. 1.19 Circuit diagram of the L200 variable power supply module

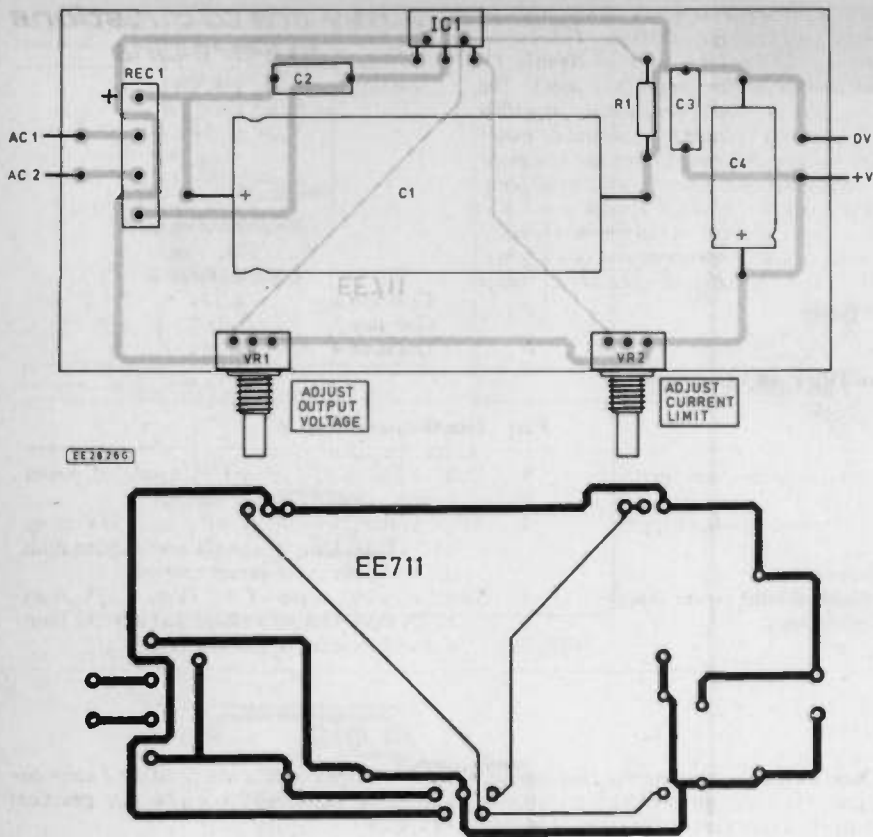

Fig. 1.20 P.C.B. copper foil and component layout for the L200 power supply module

catastrophic consequences since the full unregulated d.c. voltage will be transferred directly to the output. In the case of TTL circuits, for example, a regulator may be fed with an unregulated d.c. input in excess of 10V. If the output should ever rise much above 7V, however, most TTL devices connected to the nominal 5V rail will self-destruct virtually instantaneously!

The dire consequences of such a failure can be avoided by the incorporation of a "crow-bar" over-voltage protection circuit of the type shown in Fig. 1.21. This circuit places a virtual short-circuit across the supply whenever the rail voltage exceeds approximately 6.1V. The circuit can be readily adapted for operation with other voltages using the formula:

$$\text{Crow-bar voltage, } V = V_Z + V_{GT}$$

where  $V_Z$  is the Zener voltage and  $V_{GT}$  is the thyristor gate trigger voltage (for the BT152,  $V_{GT} = 1V$  approx.).

It is important to note that once triggered, the thyristor remains in the conducting state until the supply is disconnected or a mains fuse ruptures. The action of the circuit may appear to be somewhat crude but it does make a useful "last-ditch" protection!

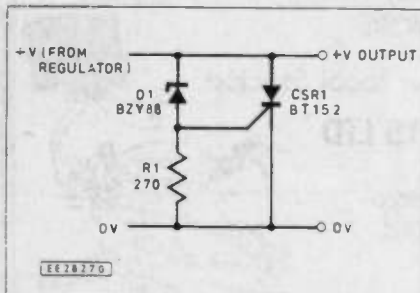

Fig. 1.21 Basic crow-bar over-voltage protection circuit

### Current Limit

Most general purpose commercial power supplies are fitted with a current limit (usually variable) which allows the user to adjust the threshold of output current at which the output voltage rapidly falls to zero.

The current limit control is normally adjusted to the maximum current value associated with the circuit which is connected to the power supply. In the event of a fault arising (such as a short-circuit capacitor across the supply rail or short-circuit out-

Approx cost guidance only

**£13**

put transistor), the current trip will operate and protect both the equipment and power supply from the results of an excessive supply current.

Operation of a current trip is usually virtually instantaneous (i.e. within a few microseconds) rather than the milliseconds associated with conventional fuses.

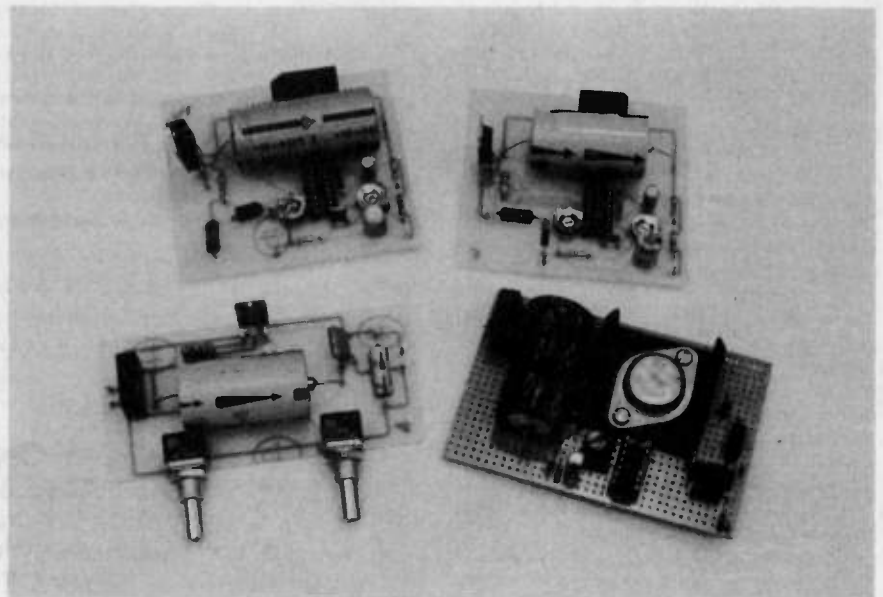

Three prototypes for the 723 power supply modules plus the L200 module.

## COMPONENTS

### L200 Power Supply Module

See  
**SHOP  
TALK**  
Page

#### Resistors

R1 1k 0.25W  
5% carbon

#### Potentiometers

VR1 10k 1W p.c.b. mounting lin.  
VR2 100 1W p.c.b. mounting lin.

#### Capacitors

C1 4700µ axial elect. 25V  
C2, C3 100n miniature dipped case  
polyester (2 off)  
C4 100µ axial elect. 25V

NB: Capacitor maximum working voltages are shown for a nominal 12V a.c. input. Values of working voltage should be updated appropriately for higher voltage operation (see text).

#### Semiconductors

REC1 200V 2.5A (min.) in-line  
bridge rectifier  
IC1 L200 regulator

#### Miscellaneous

T1 30VA (min.) mains transformer  
with suitable rated secondary  
windings (see text)  
Heatsink, see text; terminals 0.042"  
terminal pins (4 off); p.c.b., available  
from the *EE PCB Service*, order code  
EE 711.



Failure to set a current trip at a sufficiently high current can sometimes cause rather strange effects including a form of low-frequency instability (in which the equipment is rapidly switched on and off by the current trip repeatedly operating and releasing).

Most bench power supplies are fitted with voltage and current meters which may be either of digital or analogue type. Some instruments use a single analogue meter movement (or digital display) which can be switched to read either voltage or current. In such a case, it is important to ensure that the meter is switched to display voltage (not current) before using the power supply and to check that the required voltage is set before connecting the equipment on test. Failure to observe such a simple precaution can sometimes result in the destruction of components (just imagine the effect of connecting a 30V supply to a piece of equipment designed for operation on 3V!).

### Design Problem

This month's exercise, in common with all of our design problems, is designed for readers who would welcome the opportunity of tackling a little "homework" and, whilst the exercise can be accomplished purely "on paper", some of you may wish to go further by building and testing your solutions. This month's problem arises from the need for a means of calibrating an oscilloscope:

*An oscilloscope is to be fitted with an accurate d.c. voltage calibrator. This circuit is to provide fixed d.c. levels of 100mV, 1V and 10V at a front-panel test point. The voltage levels should be accurate to within  $\pm 2\%$  and the voltage level should be maintained within this range when the test point is "loaded" by a standard oscilloscope input (equivalent to 1Mohm). Design a suitable circuit arrangement based on a standard voltage regulator operating from an internal +18V rail. Specify all component values required.*

## Answers to questions in Part One

Question 1	(a) 40V (b) +70°C (c) pin-12 (d) 9.5V (e) 2.0V (f) 0.03% of $V_{OUT}$ (g) 65mA (h) 50mA (i) 600mW
Question 2	0.24V
Question 3	60VA
Question 4	6.25V

### Cumulative index to modules

Title	Part	Function/specification
Dual output power supply	1	Dual $\pm 5V$ , $\pm 12V$ or $\pm 15V$ regulated power supply rated at 1A max. output
723 variable power supply	1	Single variable output of +2V to +37V at up to 5A max. Output voltage and current limit are set by means of preset controls.
L200 variable power supply	1	Single variable output of +2.7V to +35V at up to 2A max. Output voltage and current limit are set by means of variable controls.

**Next month:** In next month's instalment we deal with transistor and operational amplifier circuits. Our design problem involves a microphone pre-amplifier whilst our practical project involves the construction of an intercom system.



**HILLS COMPONENTS**  
established since 1973

can offer the trade a selection of nearly 4,000 product lines covering the following ranges

- Aerials & Accessories
- Batteries & Accessories
- Cables & Accessories
- Computer Accessories
- Connectors (all types)
- Electronic kits/Modules
- Filters/Fuses
- Hardware/Fixings
- Headphones/Intercoms
- Connecting leads (all types)
- Microphones
- Multimeters
- Passive Components
- P.C. Boards
- Relays
- Speakers
- Switches
- Service Aids
- Soldering Equipment
- Telephones & Accessories
- Transformers

**TRADE ENQUIRIES ONLY**

Please phone or write quoting your company name & address for a copy of our 1990 catalogue

**TRADE ONLY**



## ELECTRONIC KITS & MODULES

FOR HOBBYISTS ELECTRONICS ENTHUSIASTS  
EDUCATIONAL ESTABLISHMENTS ETC.

Build your own:  
Geiger-Meuller Indicator, Metal Detector,  
Stereo Amplifier, Digital Combination Lock, or  
any of the many other kits available for numerous applications

Each kit comes in component form with easy to follow instructions for assembly

**OVER 100 KITS TO CHOOSE FROM**

Some of the popular kits include

- \* Antenna Amplifiers
- \* Lie Detectors
- \* Alarm Systems & Monitors
- \* Infra-Red Light Barriers
- \* Sirens - Kojak-Warship-FBI-Ships-Spoce
- \* Micro-Wave Indicators
- \* Radios & Receivers
- \* Electronic Barking Dog
- \* Lighting Consoles
- \* Amplifiers (up to 200w)
- \* Car Aerial Amplifiers

**PLUS MANY MANY MORE**

Call us now for details of your local Stockist

**HILLS COMPONENTS LTD**  
Units 5 & 6  
Melinite Industrial Estate  
Brixton Road, Watford  
Herts WD2 5SL  
0923 52000





# FOR YOUR ENTERTAINMENT

by Barry Fox



## Getting Taped

The tape companies continually complain that it is virtually impossible to sell high grade domestic video tape in Britain. People just go for the cheapest price tag. And there is nothing to stop manufacturers putting a "high grade" label onto the lowest grade tape, because there are no agreed technical specifications which define the grades.

The packaging and publicity material is confusing because it usually only talks about performance (e.g. the ratio of wanted signal to unwanted random noise on luminance picture detail and chrominance colour wash) being several dB better than the company's own reference tape. A fat lot of help that is!

Catch a tape maker in an honest mood, and he may just admit that for time-shifting there is really no point in spending extra money on high grade tape if good standard grade is available. This is because there is very little visible benefit when the video signal-to-noise ratio is raised above 40dB. It's a threshold, below which the pictures on screen start to look fuzzy, but above which the couple of extra dB gained from using better tape can only be seen by experts with a trained eye.

The benefit of a signal-to-noise ratio above 40dB becomes apparent when the tape is dubbed through several generations, for instance for editing camcorder movies. That's when it really does pay to pay for high grade tape, which can push s/n ratios out to 44 or even 46 dB.

It's also one of the real advantages of S-VHS, where the luminance performance is improved by the higher carrier frequency for S-VHS, and the colour performance is improved because S-VHS tape is by specification of higher quality and coercivity than standard VHS tape.

It's odd that the tape industry has never got its act together on the need to educate the public over the real benefits of high grade tape. Education is the key, and they just haven't educated us. Could this be because a lot of people selling tape don't understand the first thing about the technology?

## Screen Speaker

A couple of neat ideas popped up in patent applications recently. West German company E W D Electronic-Werke is filling patents around the world on a way of improving the sound of a TV set without increasing its size.

E W D proposes that the screen and loudspeaker be combined. This is done by making the loudspeaker from a transparent film of piezopolymer, which overlays the screen.

All piezoelectric materials flex and move when an electric current passes

through them. When the current is a fluctuating audio signal, the material vibrates at audio frequencies.

The result should be good sound, because the loudspeaker diaphragm is as large as the TV screen. But there is no addition to the size of the TV set cabinet. An added benefit is that the sound appears to be coming direct from the mouths of actors depicted on the screen.

## Mindlink

In 1984, at the Chicago Consumer Electronics Show, Atari demonstrated "Mindlink" a headband that was claimed to control a computer video game "by power of your mind alone". The demonstrator said it sensed electrical signals from the brain. Concentrate hard, they told everyone who tried it.

I reckoned that the headband just sensed any slight change in pressure e.g. from a furled brow. I quickly took mine off during a demonstration and (before being jumped on by the Atari people) found it had three pressure sensors that worked just as well if you pressed them with your finger. Predictably, Mindlink soon disappeared without trace.

Now, computer firm Wang of Lowell, Massachusetts is patenting a headband that controls the cursor on the screen of a desktop computer, without the need to move a mouse or keyboard cursor keys. This leaves the user's hands free to do other work or control other functions of the keyboard. It also makes it easier for handicapped workers to operate a computer. The same system could be used to play video games. But there is no non-sense talk of sensing brainwaves.

Wang's patent application shows a

## Cycling Computer

Here's a mental challenge, and a neat way of shutting up people who say "computers will soon be able to do even the most complicated things."

Devise a hardware-software system that rides a bicycle through traffic—something that humans do every day, without thinking, or while thinking about something completely different.

The pedalling drive is the easy part, once you have found batteries that can deliver the power needed and recharge on a plate of cornflakes and slice of toast!

Now build a level sensor system with feedback loop which continually adjusts the balance of the load on the two wheel support to stop the whole thing falling over. The adjustments will have to be very fast, and cope with all speeds from stationary to downhill cruising, as well as uphill wobbling, uneven roads and camber on corners.

band which clips over the top of the user's head, like a pair of personal stereo headphones. The band supports a spherical container, like a tennis ball. The sphere is half filled with liquid in the lower half of the sphere and gas, such as air, in the upper half.

When the user's head is upright, the boundary is horizontal. When the user's head tilts, the boundary changes its angle with respect to the sphere.

The change in boundary angle is sensed by a cluster of light emitting diodes mounted inside the top of the sphere and beaming pencils of light down through the liquid boundary onto photodetector diodes mounted inside the lower part of the sphere, and submerged in the liquid.

When a light pencil is perpendicular to the liquid boundary, it passes through to the diodes unhindered. When the pencil strikes the boundary at an angle, at least some of the light is refracted, so the photo diode senses a drop in light.

There are four pairs of transmitter and receptor diodes, each 90 degrees apart, and each angled at 45 degrees to the fluid boundary. Comparison of the electrical outputs from the four sensors gives an accurate indication of both the direction of rotation of the sphere and the magnitude of rotation. This in turn gives an electrical representation of the position of the computer user's head.

It is a simple step to convert the output signals from the orientation sensors into digital code, which is formatted to simulate the cursor control signals put out by a keyboard or mouse. In this way the user is able to aim a cursor at any part of a TV or computer screen, simply by head movement.

Don't forget the need for three dimensional vision to detect distances, with side vision to avoid any pedestrians that step off the pavement and peripheral vision to get advance warning of any vehicles coming up close from behind. And you will need sound sensing too, in stereo to pinpoint the direction of cars and horns.

Both the sound and vision systems will of course have to work in the main feedback control loop, judging the speed and relative speed of several objects at the same time, to avoid collisions. Predictive software, based on a memory bank of past experience will be needed to replicate a cyclist's sixth sense feeling that the pedestrian or car ahead may do something wholly unpredictable.

Finally, all this work must be done as background processing, to leave the computer's "mind" clear to think nice thoughts and enjoy the scenery.



# KITS & COMPONENTS CATALOGUE 1990-1991

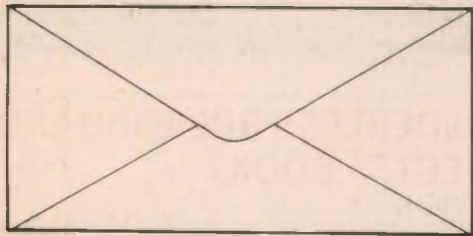

**MAIL ORDER  
SINCE 1975**



**SHOP OPEN  
9-5 MON-FRI  
9-2 SAT**

**135 HUNTER STREET  
BURTON-ON-TRENT  
STAFFS DE14 2ST**

**PHONE 0283 65435**

**FAX 0283 46932**

# BOOKS AND COMPONENT SETS

Complete Sets of Components to accompany these popular Entertaining and Educational books. Ideal Presents for Beginners of All Ages. Used extensively in Schools and Training Centres

## FUN WITH ELECTRONICS

From the Usborne Pocket Scientist series.

A colourful and exceptionally well illustrated book. 64 pages covering component identification, soldering and fault finding, and the construction of 6 projects. A Burglar Alarm, Radio, Games, etc. Only basic tools are needed. Soldering is necessary - four pages clearly show you how. The component pack allows all projects to be built and kept.

**Book only:** 502-100 £2.95  
**Component Pack only:** 502-120 £17.55

## INTRODUCTION TO ELECTRONICS

By Pam Beasant

An Usborne book full of the usual high quality colour illustrations. There are lots of circuits to build which cover a range of analogue and digital applications of electronics. The circuits are built on standard matrix board into which pins are inserted. Components and wires are then connected between these pins and soldered. Components can be re-used by desoldering them. Ideal for absolute beginners who are keen to solder and learn the practical aspects of circuit construction.

**Book only:** 502-102 £3.95  
**Component Pack only:** 502-122 £11.70

## ADVENTURES WITH ELECTRONICS

By Tom Duncan

Three types of radio, a parking light, flashing lamp, electronic organ, metronome, wailing siren electronic timer, computer counter and fire alarm are built when following this book. An S DEC breadboard is used so that soldering is not required and all components can be re-used. A batteries are required for this, and all of the other books in this section, these are not included in the pack but should be readily available locally.

**Book only:** 502-107 £5.25  
**Component Pack only:** 502-127 £22.35

## ADVENTURES WITH DIGITAL ELECTRONICS

By Tom Duncan

The most advanced of the Adventures With series, this book follows on from Microelectronics and introduces Shift Registers, Memories, Arithmetic Logic etc. Two breadboards are employed for some of the circuits in this book.

**Book only:** 502-106 £5.25  
**Component Pack only:** 502-126 £44.56

## A FIRST ELECTRONICS COURSE

By R B Arnold

A copiously illustrated book that explains the principles of electronics by relating them to everyday objects. At the end of each chapter a set of questions and word puzzles allow progress to be checked in an entertaining way. The experiments in this book are performed on an S-DEC plug-in breadboard (in comp. pack) and soldering is not required. All of the components can be used over and over again. This book goes well with Adventures With Electronics which uses the same breadboard.

**Book only:** 502-101 £4.50  
**Component Pack only:** 502-121 £22.35

## ENJOYING ELECTRONICS

By Owen Bishop

This well illustrated book was designed for older secondary school pupils. It pursues a greater understanding of electronic circuits by means of self assessment questions included in the text. Basic calculations of Voltage and Current are introduced and a large number of practical experiments are carried out on a 0.1 inch pitch solderless breadboard (our K120). All components can be re-used. Pack includes Breadboard, Photocell, Thermistor, Transistors, Capacitors LEDs etc.

**Book only:** 502-103 £3.60  
**Component Pack only:** 502-123 £14.31

## ADVENTURES WITH MICROELECTRONICS

By Tom Duncan

A companion book to Adventures With Electronics. Explains and uses Integrated Circuits including the 556 dual timer, the LM380 audio amplifier, and various CMOS devices. Uses a Bimboard breadboard and so soldering is not required.

**Book only:** 502-104 £5.25  
**Component Pack only:** 502-124 £36.52

## 30 SOLDERLESS BREADBOARD PROJECTS - BOOK 1

By R A Penfold.

A book of projects all built on a solderless breadboard. Altogether there are 30 projects which can be built and dismantled over and over again. A fully detailed component layout diagram and circuit explanation are provided for each project.

**Book only:** 502-105 £2.95  
**Component Pack only:** 502-125 £27.15

## INDEX

68000 Board.....	26	Diodes.....	39	Multimeters.....	20-21	Solder.....	37
Amplifier ICs.....	38	Disco - see Music		Music Kits.....	17-19	Soldering Irons.....	37
Analogue Multimeters.....	21	Drill Stand.....	37	Novelty Kits.....	7-8	Speakers.....	36
Battery Clips.....	36	Drive Belts.....	23	Optical Fibres.....	22	Stepping Motors.....	25
Battery Holders.....	36	Earpieces.....	36	Optocouplers.....	39	Stripboard.....	37
Belts.....	23	Etch Resist Pen.....	37	Order Form.....	27	Switches.....	32-33
Books.....	28	Etching Kit.....	37	Oscilloscopes.....	40	Terminal Blocks.....	35-36
Boxes.....	34	Ferrite Rod.....	31	Panel Meters.....	36	Test Gear Kits.....	8-10
Bridge Rectifiers.....	39	Fibre Optics.....	22	Photographic Kits.....	13	Test Leads.....	36
Bulbholder.....	39	Footswitches.....	32	Phototransistors.....	39	Thermal Fuses.....	32
Bulbs.....	39	Fuses.....	32	Piezo Sirens.....	36	Thermistors.....	29
Buzzers.....	36	Game Kits.....	4	Pliers.....	37	Thyristors.....	39
Cable & Wire.....	33-34	Gearbox.....	24	Plugs.....	35	Tools.....	37
Capacitors.....	29-31	Gears.....	23	Potentiometers.....	29	Transformers.....	31
Car Kits.....	12	Helping-Hands.....	37	Power Supplies.....	32	Transistors.....	38
Cases.....	34	Hobby Kits.....	5-7	Presets.....	29	Triacs.....	40
CMOS ICs.....	38	Household Kits.....	16-17	Printed Circuit Board.....	37	Trimmers.....	29
Coils.....	31	IC Sockets.....	38	Pulleys.....	23	Tuning Capacitors.....	31
Component Sets.....	28	ICs.....	38	Racks.....	23	Ultrasonic Transducers.....	36
Components.....	29-36	IDC Connectors.....	35	Radio Kits.....	13	Variabale Capacitors.....	31
Computing Kits.....	14-16	Kits.....	3-19	Rectifiers.....	39	Vice.....	37
Connectors.....	35	LEDs.....	39	Relays.....	32	Voltage Regulators.....	39
Croc Clips.....	36	Light Guides.....	22	Resistors.....	29	Wire Strippers.....	37
Cutters.....	37	Logic.....	38	Rocker Switches.....	32	Zener Diodes.....	39
DEE Connectors.....	35	Loudspeakers.....	36	Security Kits.....	11-12		
Desolder Braid.....	37	Microcontroller.....	24	Seven Seg. Displays.....	39		
Desolder Pump.....	37	Microphones.....	36	Shafts.....	23		
Digital Multimeters.....	20	Microswitches.....	33	Sleeving.....	34		
DIL Switches.....	33	Mini Drill.....	37	Slide Switches.....	33		
DIN Plugs.....	35	Motors.....	23-25	Sockets.....	35		

# KIT INDEX

Pg	Ref.	TITLE	PRICE	Pg	Ref.	TITLE	PRICE
8	197	0-12V POWER SUPPLY E.E. SEPT 81	£27.46	8	559	LIGHT RIDER - CHASER LIGHT E.E. OCT 86	£15.25
18	562	10 WATT AUDIO AMPLIFIER E.E. OCT 86	£39.95	8	560	LIGHT RIDER - DISCO LIGHT E.E. OCT 86	£21.93
5	242	2 WAY INTERCOM E.E. JULY 82	£6.36	8	561	LIGHT RIDER - LAPEL BADGE E.E. OCT 86	£11.40
10	563	200MHZ DIGITAL FREQUENCY METER E.E. NOV 86	£69.95	12	777	LOW FUEL ALERT E.E. APR 88	£7.19
13	718	3 BAND 1.6-30MHZ RADIO E.E. AUG 87	£29.66	5	387	MAINS CABLE DETECTOR E.E. OCT 84	£16.18
19	739	ACCENTED METRONOME E.E. NOV 87	£23.43	7	499	MAINS DELAY SWITCH E.E. JAN 86	£22.11
6	740	ACOUSTIC PROBE E.E. NOV 87	£19.58	9	512	MAINS TESTER & FUSE FINDER E.E. MARCH 86	£9.86
11	700	ACTIVE INFRA RED ALARM E.E. MAR 87	£39.87	19	715	MINI DISCO LIGHT E.E. JUNE 87	£14.08
15	799	AMIGA MIDI INTERFACE ST/Amiga Format iss. 5	£21.19	5	529	MINI STROBE E.E. MAY 86	£15.50
15	789	AMSTRAD PIO E.E. SEPT 88	£22.45	16	278	MOISTURE DETECTOR E.E. MAY 83	£7.70
14	459	AMSTRAD USER PORT E.E. JULY 85	£19.76	19	721	MONOMIX E.E. JULY 87	£23.49
15	818	ATARI ST DISK TRACK INDICATOR ST Format Iss. ?	£26.99	16	497	MUSICAL DOORBELL E.E. JAN 86	£20.95
17	105	AUDIBLE VISUAL METRONOME E.E. JAN 78	£9.28	5	350	NI-CAD BATTERY CHARGER E.E. MAR 84	£13.88
10	710	AUDIO LOGIC TRACER E.E. MAY 87	£10.34	19	729	NOISE GATE E.E. SEPT 87	£25.99
10	763	AUDIO SIGNAL GENERATOR E.E. DEC 87	£15.66	7	333	NOVEL EGG TIMER E.E. DEC 83	£14.43
12	569	AUTOMATIC CAR ALARM E.E. DEC 86	£13.94	7	270	NOVELTY EGG TIMER E.E. APR 83	£7.73
17	734	AUTOMATIC/MANUAL PORCH LIGHT E.E. OCT 87	£19.20	18	528	P.A. AMPLIFIER E.E. MAY 86	£29.95
7	814	BAT DETECTOR E.E. JUNE 89	£20.98	7	815	P.I. TREASURE HUNTER E.E. AUGUST 89	£41.95
10	553	BATTERY TESTER E.E. AUG 86	£8.04	11	551	PASSIVE INFRA RED DETECTOR P.E. JULY 86	£39.95
14	568	BBC 16K SIDEWAYS RAM E.E. DEC 86	£21.99	13	542	PERSONAL RADIO E.E. JUNE 86	£12.89
14	392	BBC MICRO AUD. STORAGE SCOPE INT. E.E. NOV 84	£39.95	19	728	PERSONAL STEREO AMP E.E. SEPT 87	£15.99
18	513	BBC MIDI INTERFACE E.E. MARCH 86	£31.25	13	209	PHOTO FLASH SLAVE E.E. OCT 81	£5.36
11	230	BIKE ALARM H.E. APRIL 82	£19.72	13	171	PHOTOGRAPHIC TIMER H.E. MAR 81	£5.40
14	337	BIOLOGICAL AMPLIFIER E.E. JAN 84	£27.00	7	226	POCKET TIMER E.E. MAR 82	£5.79
5	719	BUCCANEER I.B. METAL DETECTOR E.E. JULY 87	£29.58	10	769	POWER SUPPLY (MOSFET) E.E. JAN 88	£55.61
17	705	BULB LIFE EXTENDER E.E. APR 87	£5.86	11	262	PUSH BIKE ALARM E.E. FEB 83	£16.52
6	730	BURST FIRE MAINS CONTROLLER E.E. SEPT 87	£15.17	10	834	QUICK CAPACITANCE TESTER E.E. FEB 90	£10.17
4	263	BUZZ OFF E.E. MAR 83	£6.35	4	571	RANDOM NUMBER GENERATOR E.E. DEC 86	£17.58
16	236	CABLE TRACKER H.E. MAY 82	£15.25	8	103	RAPID DIODE CHECK E.E. JAN 78	£4.44
13	225	CAMERA OR FLASHGUN TRIGGER E.E. MAR 82	£19.24	7	243	REFLEX TESTER E.E. JULY 82	£10.95
12	114	CAR ALARM H.E. FEB 79	£19.89	18	473	RIAA PRE-AMP INPUT SELECTOR E.E. JULY 85	£18.72
12	771	CAR LAMP CHECKING SYSTEM E.E. FEB 88	£7.83	10	716	SCOPE STORE P.E. JULY 87	£49.95
11	474	CARAVAN ALARM E.E. JULY 85	£12.10	18	558	SCRATCH BLANKER E.E. SEPT 86	£62.43
12	735	CARAVAN FRIDGE ALERT E.E. OCT 87	£6.08	6	796	SEASHELL SEA SYNTHESIZER E.E. NOV 88	£27.94
18	332	CHILDREN'S DISCO LIGHTS E.E. DEC 83	£11.72	9	344	SIGNAL TRACER E.E. FEB 84	£20.99
4	199	CMOS DIE E.E. SEPT 81	£12.40	8	229	SIGNAL TRACER H.E. APR 82	£5.99
14	360	COMM. 64 A TO D CONVERTER E&CM MAY 84	£21.92	13	219	SIMPLE INFRA RED REM CONTROL E.E. NOV 81	£26.34
9	334	CONTINUITY TESTER E.E. DEC 83	£13.98	11	364	SIMPLE LOOP BURGLAR ALARM E.E. MAY 84	£19.19
9	461	CONTINUITY TESTER E.E. JULY 85	£6.93	5	181	SOIL MOISTURE INDICATOR E.E. MAY 81	£6.33
8	330	CONTINUITY TESTER H.E. DEC 83	£7.81	5	148	SOIL MOISTURE MONITOR E.E. NOV 80	£8.99
10	704	CURRENT TRACER E.E. APR 87	£22.98	5	481	SOLDERING IRON POWER CONTROL E.E. OCT 85	£6.12
13	118	DARKROOM TIMER E.E. JULY 79	£4.50	19	519	SOUND ACTIVATED SWITCH P.E. APRIL 86	£48.44
9	493	DIGITAL CAPACITANCE METER E.E. DEC 85	£46.46	13	383	SOUND OPERATED FLASH E.E. SEPT 84	£8.20
12	782	DOOR SENTINEL E.E. MAY 88	£14.32	17	111	SOUND TO LIGHT UNIT E.E. SEPT 78	£12.27
16	417	DOORCHIME E.E. DEC 84	£20.98	15	800	SPECTRUM EPROM PROGRAMMER E.E. DEC 88	£29.95
4	260	DOUBLE DICE E.E. JAN 83	£16.67	15	578	SPECTRUM I/O PORT (LESS CASE) E.E. FEB 87	£10.55
19	801	DOWNBEAT METRONOME E.E. DEC 88	£19.65	15	584	SPECTRUM SPEECH SYNTH (LESS CASE) E.E. FEB 87	£23.39
5	386	DRILL SPEED CONTROLLER E.E. OCT 84	£9.70	14	370	SPEECH SYNTHESIZER E.E. JUNE 84	£40.98
6	764	DUAL MAINS LIGHT FLASHER E.E. DEC 87	£23.46	14	322	SPEECH SYNTH FOR THE BBC MICRO E.E. NOV 83	£30.98
18	355	DUAL MIC PRE-AMPS&CM APR 84	£18.61	5	131	SPEED CONTROL FOR R/C H.E. APR 80	£26.99
16	240	EGG TIMER E.E. JUNE 82	£7.68	17	124	SPRING LINE REVERB UNIT E.E. JAN 80	£38.33
7	117	ELECTRONIC CANARY E.E. JUNE 79	£8.99	18	361	SPRING REVERB UNIT H.E. MAY 84	£28.89
4	101	ELECTRONIC DICE E.E. MAR 77	£7.00	15	813	ST/Amiga SOUND SAMPLER ST Amiga Format	£23.10
16	186	ELECTRONIC DOOR BUZZER H.E. JULY 81	£9.14	15	464	STEPPER MOTOR INTEFFACE FOR THE BBC COMPUTER E.E. JULY 85	£9.40
7	455	ELECTRONIC DOORBELL E.E. JUNE 85	£8.45	15	579	STEPPING MOTOR BOOSTER (FOR 578) E.E. FEB 87	£6.09
7	548	ELECTRONIC SCARECROW E.E. JULY 86	£9.92	16	816	STEPPING MOTOR DRIVER P.E. AUG 89	£8.34
19	775	ENVELOPE SHAPER E.E. MAR 88	£16.76	19	779	STEREO NOISE GATE E.E. APR 88	£29.99
15	790	EPROM ERASER E.E. OCT 88	£27.90	18	523	STEREO REVERB E.E. APRIL 86	£29.57
17	707	EQUALISER IONISER E.E. MAY 87	£17.37	14	301	STORAGE 'SCOPE INTERFACE - BBC E.E. AUG 83	£21.63
15	703	EXPERIMENT. SPEECH RECOGNITION E.E. APR 87	£23.46	13	808	SUPER FILTER E.E. MARCH 90	£4.99
13	746	EXPERIMENTER'S CRYSTAL SET E.E. NOV 81	£9.28	19	724	SUPER SOUND ADAPTOR E.E. AUG 87	£42.93
5	722	FERMESTAT E.E. JULY 87	£13.58	13	835	SUPERHET BROADCAST RECEIVER E.E. MARCH 90	£16.79
19	833	FOUR CHANNEL LIGHT CHASER E.E. JAN 90	£31.45	16	203	TELEPHONE BELL REPEATER H.E. OCT 81	£21.35
17	555	FREEZER FAILURE ALARM E.E. SEPT 86	£17.34	17	150	THREE CHANNEL SOUND TO LIGHT E.E. NOV 80	£33.36
16	475	FRIDGE ALARM E.E. JULY 85	£8.99	11	544	TILT ALARM E.E. JULY 86	£8.75
12	708	FRIDGE ALARM E.E. MAY 87	£10.98	8	115	TRANSISTOR TESTER E.E. APR 79	£7.58
9	503	FUNCTION GENERATOR E.E. FEB 86	£27.77	8	147	TRANSISTOR TESTER E.E. NOV 80	£17.98
8	112	FUSE CHECKER E.E. OCT 78	£3.57	8	153	TRANSISTOR TESTER H.E. NOV 80	£10.22
9	358	FUSE/DIODE CHECKER E.E. APR 84	£4.86	10	745	TRANSTEST E.E. OCT 87	£10.85
18	211	FUZZBOX E.E. OCT 81	£11.24	18	295	TRI BOOST GUITAR TONE CONTROL E.E. JULY 83	£11.76
4	770	GAMES TIMER E.E. FEB 88	£15.99	8	283	TTL LOGIC PROBE H.E. JUNE 83	£12.38
4	432	GAMES TIMER E.E. JAN 85	£10.19	7	120	TWINKLING STAR E.E. DEC 79	£9.05
18	453	GRAPHIC EQUALISER E.E. MAY 85	£29.98	11	791	ULTRASONIC BREAK- GLASS ALARM E.E. SEPT 88	£19.58
17	174	GUITAR FUZZ BOX H.E. MAR 81	£16.88	6	812	ULTRASONIC PEST SCARER E.E. MAY 89	£14.49
17	180	GUITAR HEADPHONE AMPLIFIER E.E. MAY 81	£6.47	17	714	ULTRASONIC TAPE MEASURE E.E. MAR 87	£30.78
18	381	GUITAR HEADPHONE AMPLIFIER E.E. SEPT 84	£8.94	11	122	UNIBOARD BURGLAR ALARM E.E. DEC 79	£9.37
17	140	GUITAR PHASER H.E. SEPT 80	£21.54	14	293	USER PORT CONTROL BOARD E.E. JULY 83	£28.95
17	149	GUITAR PRACTICE AMPLIFIER E.E. NOV 80	£25.66	14	292	USER PORT I/O BOARD E.E. JULY 83	£14.78
17	575	HANDS-OFF INTERCOM E.E. JAN 87	£11.73	8	191	VARIABLE BENCH POWER SUPPLY H.E. JULY 81	£41.08
12	783	HEADLIGHT REMINDER E.E. JUNE 88	£8.94	13	362	VARICAP AM RADIO E.E. MAY 84	£14.70
4	207	HEADS & TAIL GAME E.E. OCT 81	£3.89	9	524	VERSATILE P.S.U. E.E. APRIL 86	£27.60
16	315	HOME INTERCOM E.E. OCT 83	£20.27	10	580	VERSATILE PULSE GENERATOR E.E. FEB 87	£35.21
12	210	ICE ALARM E.E. OCT 82	£11.98	6	744	VIDEO CONTROLLER E.E. OCT 87	£32.58
8	108	IN SITU TRANSISTOR TESTER E.E. JUNE 78	£10.53	6	712	VIDEO ENCHANCER P.E. DEC 86	£36.14
11	556	INFRA RED BEAM ALARM E.E. SEPT 86	£31.70	6	713	VIDEO FADER P.E. JAN 87	£15.59
13	340	INFRA RED CAMERA CONTROL H.E. FEB 84	£24.06	11	581	VIDEO GUARD E.E. FEB 87	£9.39
9	444	INSULATION TESTER E.E. APRIL 85	£21.89	6	784	VIDEO WIPER E.E. JULY 88	£37.56
14	246	INTERFACE BOARD H.E. SEPT 82	£17.56	12	543	WATCHDOG E.E. JUNE 86	£9.22
5	514	INTERVAL TIMER E.E. MAR 86	£21.11	7	106	WEIRD SOUND EFFECTS GENERATOR E.E. MAR 78	£8.75
11	750	INTRUDER CONFUSER H.E. JAN 82	£5.33	12	173	WINDSCREEN WIPER CONTROL H.E. MAR 81	£12.66
10	785	ISOLINK E.E. JULY 89	£27.41				
7	776	LIE DETECTOR E.E. MAR 88	£13.20				

## PROJECT KITS FROM MAGENTA

### KITS FROM MAGENTA

Carefully selected sets of components to enable you to construct the projects that have appeared in many hobby magazines.

### HARDWARE

Kits include all the electronics and hardware needed - we have even included appropriate screws, nuts, I.C. sockets etc. Transformers, knobs, fuseholders and fuses are also included of course, as are cases for most kits. In some projects the cases originally specified are either too expensive or no longer obtainable in which case we supply suitable alternatives. Our price list indicates which projects are supplied less case.

### PRINTED CIRCUIT BOARDS

Projects using stripboard are supplied with a suitable standard piece. The majority of our kits use printed circuit boards. These are supplied ready made - that is etched, drilled, and roller tinned.

### COMPONENT ALTERNATIVES

Where possible we supply the exact components specified in the original design. This is not always possible and so alternatives of equivalent rating are used. All substitutes have been tested in the projects by our engineers.

### ARTICLE REPRINTS

All of our kits are from articles published in various magazines. If you do not have the issue of the magazine that contains the project - you will need to order the instructions / reprint as an extra.

To obtain more details of a project, order the reprint on its own - you don't have to buy the kit.

### KIT REPAIRS

Please make sure that you are happy with your ability to construct the projects. We cannot offer any general repair service because engineers' time is too expensive. Certain projects of our own design can be repaired for a minimum charge of £10.00. Send back the project with payment and we will proceed with the repair. We reserve the right to decline repairs where extensive work is needed and may charge extra for expensive components found to have been damaged.

### COMPONENT QUALITY

Components found to be faulty on receipt from us will be replaced free of charge. We supply only good quality components, never sub-standard or reject parts.

## GAME KITS

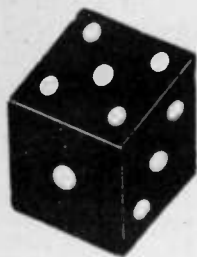

### 101 ELECTRONIC DICE E.E. MAR 77

A row of 6 LEDs one of which stays alight at random after pressing and releasing a push button switch. powered by a PP3 battery, built on stripboard. Easy to build and ideal for beginners. Our first project kit!

### 199 CMOS DIE E.E. SEPT 81

This electronic die has for its display a set of LEDs arranged in the standard die pattern. The circuit is activated by a small 'throw' push button & the score remains displayed for approximately 10 seconds before the circuit switches itself off. PP3 battery provides power.

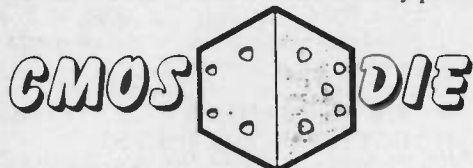

### 207 HEADS & TAIL GAMES E.E. OCT 81

This is a very simple project suitable for beginners. two LEDs are fitted in a balanced circuit. When the circuit is switched on only one of them can light - which one lights is determined at random by the noise in the circuit, hence the lamps can be used to simulate the tossing of a coin.

### 260 DOUBLE DICE E.E. JAN 83

A double version of the electronic dice. The display is by means of two sets of LEDs arranged in the shape of a standard dice. A single push button spins both dice together. The numbers are displayed continuously until the power is switched off. Operates from a 9V battery.



### 263 BUZZ OFF E.E. MAR 83

An improved version of the traditional steady hand game. The player must guide a loop along a bent wire obstacle course. a buzzer is used instead of a bell & an electronic circuit ensures that the buzzer will sound for half a second even if only momentary contact is made.

### 432 GAMES TIMER E.E. JAN 85

A simple timer giving four pre-set switched ranges for timing moves during games etc. Component values can be selected to give times between 5 mins and 30 mins. Battery powered.

### 571 RANDOM NUMBER GENERATOR E.E. DEC 86

A two digit random number generator which can be switched to select numbers between 1 and 90 (for bingo) and 1 and 55 (for standard pools coupons). Built on stripboard, and powered from 4 x AA cells. numbers occur completely at random, and so may repeat.



### 770 GAMES TIMER E.E. FEB 88

An adjustable timer which gives delays variable from 0 - 40 seconds, with an alarm which bleeps for a short period as the end of the time approaches, and then sounds a continuous tone. Battery powered, built on PCB.

## HOBBY KITS

**131 SPEED CONTROL FOR R/C H.E. APR 80**

Controls speed & direction for electric motors up to 15 amps. uses a single channel of a proportional radio control system. Can be used to replace servo/rheostat control assemblies. Gives excellent control right down to crawl speeds. Includes a heavy duty relay.

**148 SOIL MOISTURE MONITOR E.E. NOV 80**

A simple project which provides a reliable wet/dry indication using red & green LEDs. Supplied with probes.

**181 SOIL MOISTURE INDICATOR E.E. MAY 81**

LED gives 3 indications: flashes - soil dry, glows - soil moist, off - soil wet. Based on a '555' IC. Complete with probes.

**242 2 WAY INTERCOM E.E. JULY 82**

A simple two way intercom constructed using screw terminal blocks. soldering is not required so the project is ideal as an introductory educational exercise. Using a PP3 battery good performance over 100 metres is achieved.

**350 NI-CAD BATTERY CHARGER E.E. MAR 84**

A constant current regulator circuit which is designed to be added to a standard car battery charger or similar 12V supply. A small meter indicates the charge current which is set by a control potentiometer. The circuit will charge PP3, HP7, HP11 & HP2 size cells. Up to 12 cells of the same type may be connected & charged in one go.

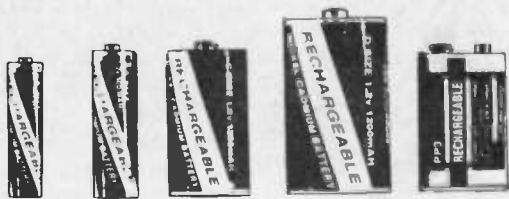
**386 DRILL SPEED CONTROLLER E.E. OCT 84**

This power controller allows the speed of standard pistol drills to be varied over a wide range. The circuit incorporates back emf sensing which ensures that full torque is obtainable even at very low speeds. Also suitable for controlling universal AC motors in many other applications.

**387 MAINS CABLE DETECTOR E.E. OCT 84**

A compact unit which helps find concealed mains cables when drilling walls etc. The hand held detector produces a loud buzz when it is held near to live AC mains cables. Built on veroboard. Battery powered.

**481 SOLDERING IRON POWER CONTROLLER E.E. OCT 85**

A very neat and compact unit that provides variable heat control for soldering irons or other lower power (up to 150 watts) loads. Control of soldering iron temperature extends bit life and makes soldering much easier because it reduces the formation of scale and oxides. A tremendous help for beginners and a must for serious constructors.

**514 INTERVAL TIMER E.E. MAR 86**

A versatile timer that gives an audible warning after a pre-set period between 30 sec and 15 mins. A twelve position switch allows selection of the required delay. The warning tone can be switched to sound just before or just after the time has elapsed. Battery powered.

**529 MINI STROBE E.E. MAY 86**

A hand held stroboscope which uses six 'ultra bright' LEDs as the light source. Designed to demonstrate the principles of stroboscopic examination, the unit is also suitable for measuring the speed of moving shafts etc. The flash rate control covers 170 - 20,000 rpm in two ranges. An external sync socket allows the strobe to be synchronised to an accurate frequency source or, via a suitable pick up, to the machine being viewed.

**722 FERRESTAT E.E. JULY 87**

For brewers, gardeners, and other users requiring controlled low temperature heating. This circuit uses a thermistor to provide control of mains heating elements (up to 5 amps) for controlling the temperature of a small cupboard for heating a brewing container, incubator, or small greenhouse. A sensitive circuit ensures accurate control via a mains triac. Also can be used with soil heaters and other systems requiring accurate temperature control. Built on a PCB. Mains powered.

**719 BUCCANEER I.B. METAL DETECTOR E.E. JULY 87**

This metal locator uses the sensitive and versatile I.B. (induction balance) technique. It is an easy to build detector with good sensitivity which rejects iron and foil to a good extent. The output is via a small loudspeaker (or headphones can be plugged in). Kit includes all electronic components, PCB, case, wire for search coils etc., but excludes the search head and handle. These were made from a plastic plate and tubing in the prototype but other materials can be used. A quality design, using interesting circuit techniques.

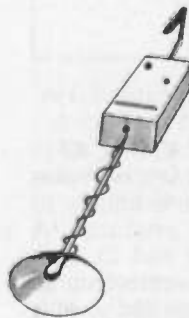

## 730 BURST FIRE MAINS CONTROLLER E.E. SEPT 87

A project for reducing the power of the heating elements in soldering irons or similar appliances (up to 500W). The system works by switching the load on and off near to mains zero crossing points, resulting in silent interference free switching. A potentiometer alters the on/off ratio to provide a wide range of control from zero to full power. The circuit is built on pcb and mains powered.

## 713 VIDEO FADER P.E. JAN 87

A simple fader that allows a complete video signal to be processed when editing video recordings etc. The signal can be faded right down to zero with no loss of synchronisation as the circuit maintains these at a high level even when the video signal is faded away. A compact mains powered unit.

## 744 VIDEO CONTROLLER E.E. OCT 87

For use with home video recording equipment, this project gives separate facilities to control sound and vision via two adjacent slider controls. It also allows a microphone signal to be mixed with the audio signal so that, for example, a commentary can be added to an existing video track. As well as a stereo output an independent mono output is also provided, and a pan control allows the microphone channel to be positioned anywhere across the sound stage. The circuit is battery powered, and built on a PCB.



## 740 ACOUSTIC PROBE E.E. NOV 87

A very popular project which picks up vibrations by means of a contact probe and passes them on to a pair of headphones or an amplifier. The probe (which must be constructed following the details in the article) is held in contact with the object to be examined. Sounds from engines, watches, and speech travelling through walls can be amplified and heard clearly. A very useful piece of equipment for mechanics, instrument engineers, and nosey parkers. Battery powered, PCB constructed.



## 764 DUAL MAINS LIGHT FLASHER E.E. DEC 87

A circuit which independently flashes two sets of mains lights, the flash rate of each can be set individually so that complex changing patterns can be produced. A switch is provided to override the flashing and fix both channels at full output. The circuit can control up to 100W per channel. Two pairs of special plugs and sockets are provided for the outputs, and the circuit is built in a fully insulated plastic case. Ideal for Christmas lights, shop displays etc.



## 712 VIDEO ENHANCER P.E. DEC 86

A combined audio and video processor that allows picture sharpness to be enhanced, or softened according to taste. The audio signal is also processed by a dynamic noise reduction circuit, reducing background noise substantially by means of a voltage controlled filter which is automatically adjusted according to the incoming signal level. Ideal for improving poor video recordings and enhancing good ones. The circuit is mains powered, and operates on composite video signals. It is not suitable for UHF modulated signals or RGB.

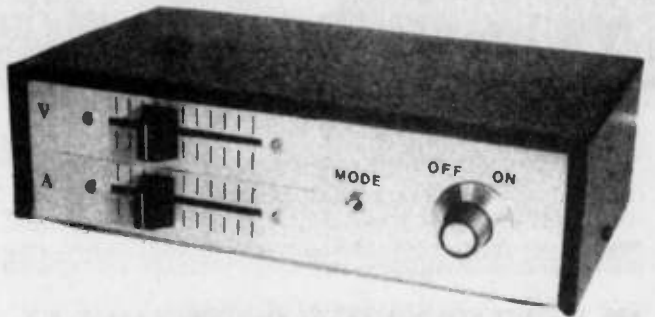

## 784 VIDEO WIPER E.E. JULY 88

Adds a professional touch to Video recordings by enabling the screen to be wiped from top to bottom progressively down (or up) at the end of one scene and up (or down) at the beginning of the next. This is a mains powered unit which also has a passive audio fader built in to allow simultaneous fading with the video signal. Works on standard PAL composite video at 75 ohms impedance and produces jitter free results.

## 796 SEASHELL SEA SYNTHESIZER E.E. NOV 88

A battery powered unit that plugs into a stereo system and produces the relaxing rushing sounds of waves on the beach. The circuit contains digital noise generators and low frequency modulating oscillators to produce a true stereo output. Soothing sounds for the tired businessman/woman and the restless infant.

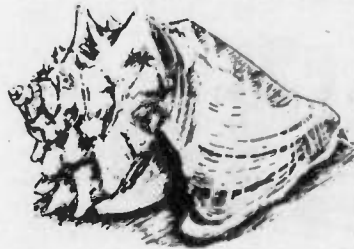

## 812 ULTRASONIC PEST SCARER E.E. MAY 89

Keep pets/pests away from newly sown areas with this advanced efficient Magenta design. Quartz controlled frequency and High Voltage transducer drive give intense pulses of Ultrasound unpleasant to cats and dogs. The unit can be battery powered or powered from a small 9V AC transformer (optional extra). We have developed this project since publication and now supply the MkII version which operates at a different frequency.





**814 BAT DETECTOR E.E. JUNE 89**

This is an excellent circuit which reduces Ultrasonic frequencies between 20kHz and 100kHz to the audio range. Operating rather like a Radio Receiver the circuit allows the user to Tune-in to the Ultrasonic frequencies of interest. Listening to Bats is a fascinating hobby, and it is possible using this instrument to identify the different types of bat and get some insight into their Ultrasonic RADAR system. The circuit has found other uses as well in industry and laboratories.



**815 P.I. TREASURE HUNTER E.E. AUGUST 89**

A highly developed and acclaimed Magenta designed easy to build P.I. metal detector with excellent performance and reliability. This kit features a complete hardware package as well as all the electronic components. An advanced Quartz Crystal controlled design with High Voltage MOSFET search head drive and High Slew-Rate DC Coupled amplification. Total absence of Ground Effect enable this detector to work with the search head totally immersed in sea water. Detects a 10p coin at 20cms and larger objects much deeper. The 190mm diameter search coil is easy to wind and gives good area coverage. The advanced design minimises setting up procedures and makes the detector simple to use. Audible output is provided to a pair of stereo headphones.



**NOVELTY KITS**

**106 WEIRD SOUND EFFECTS GENERATOR E.E. MAR 78**

Three tuneable oscillators coupled together. Create your own science fiction 'music' by playing this unit through an amplifier or tape recorder.



**117 ELECTRONIC CANARY E.E. JUNE 79**

The pleasing twittering sound produced by this simple circuit makes it a novel replacement for the doorbell.

**120 TWINKLING STAR E.E. DEC 79**

An effective decoration suitable for the Christmas tree, a window or wall etc. Consists of 6 lamps which are positioned on a hardboard star shape - using 2 '555' timer ics the circuit is arranged so that the centre light is always on & the others flash in such a way that the star appears to be 'twinkling'. Requires a 9V 300-400mA power supply. The kit is supplied with a plug in power supply - which can of course be used on its own after Christmas.



**226 POCKET TIMER E.E. MAR 82**

A simple circuit which lights an LED after an internally pre-set time delay. Components supplied allow up to 3 hours to be achieved. Suitable for use as a parking meter timer etc.

**243 REFLEX TESTER E.E. JULY 82**

For use by two players. Tests how quickly a button is pressed in response to an LED lighting. After pressing a 'start' button a time delay passes before the 'go' light comes on, after which both players press their response buttons. LEDs indicate which person pressed first.



**270 NOVELTY EGG TIMER E.E. APR 83**

A timer continuously variable from 0 - 8 mins. At the end of the time period a pleasant warbling alarm sounds & two LEDs flash. This kit comes without a case because the original was built to look like an egg - hence the 'novelty' title.

**333 NOVEL EGG TIMER E.E. DEC 83**

An electronic circuit which makes a good imitation of a cackling chicken when the egg is cooked. The time is variable by means of an internal preset control. 9V battery powered.

**455 ELECTRONIC DOORBELL E.E. JUNE 85**

A circuit which produces an electronic imitation of a standard doorbell. The circuit is battery powered and uses a piezo ceramic audio transducer to produce the sound.



**ELECTRONIC DOORBELL**

A doorbell with the ringing sound of a conventional electromechanical device, but taking advantage of the reliability and compactness of electronic technology.

**499 MAINS DELAY SWITCH E.E. JAN 86**

A turn-off time delay circuit giving 8 or 20 mins of power after the start button has been pressed. Designed for use with porch lights or similar circuits where power can be wasted by leaving things switched on accidentally. The circuit is designed to be built into a double surface mounting switch box.

**548 ELECTRONIC SCARECROW E.E. JULY 86**

This circuit provides a 25 seconds burst of 200Hz square waves every 60 seconds. It is designed to be placed in the garden to disturb birds and animals that destroy crops. The circuit requires a source of 6-9V AC which can be supplied from a plug in adaptor or a transformer mounted in the house, garage or shed.

**776 LIE DETECTOR E.E. MAR 88**

A simple project that causes a line of LEDs to light progressively in response to skin resistance. Fun to use in games and at parties.

# LIGHT RIDER



## DISCO LIGHTS...LAPEL BADGE...CHASER LIGHT

Three projects that will certainly test the creative eye of the experimenter. You could even create your own version of "Kit" of TV Knight Rider fame.

### LIGHT RIDER E.E. OCT 86

Three projects under one title - all simulations of the Knight Rider lights from the TV series. The three are a lapel badge using 6 LEDs, a larger unit with 16 LEDs and a mains version capable of driving six mains lamps totalling over 500 Watts.

### 560 LIGHT RIDER - DISCO LIGHT E.E. OCT 86

An adaptation of the lapel badge circuit to drive 6 banks of mains lamps. Each bank of lamps can be rated up to 500 watts to give a large bright display. A variable speed control allows the effect to be changed over a wide range. The circuit is housed in a plastic box for complete safety and built on a single PCB.

### 561 LIGHT RIDER - LAPEL BADGE E.E. OCT 86

A very effective compact lightweight unit that gives a continuous moving light with realistic fade out and overlap between lights. The circuit uses high efficiency miniature LEDs to give a bright display with long life. The display is clearly visible in daylight and very bright at night.

### 559 LIGHT RIDER - CHASER LIGHT E.E. OCT 86

A 16 LED version of the effect which can be built into model robots, or cars to add interest and appeal. The circuit is built on a single printed circuit board and powered from a 9V PP3 battery.

## TEST GEAR KITS

### 103 RAPID DIODE CHECK E.E. JAN 78

This very simple device is capable of checking a silicon or germanium diode for polarity in half the time required using a multimeter. In addition to ascertaining whether a diode is in working order, this device also identifies the cathode lead by LED indicators.

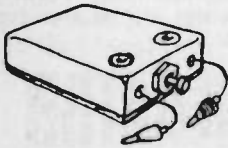

### 108 IN SITU TRANSISTOR TESTER E.E. JUNE 78

Can be used to check a transistor while it is in or out of a circuit. Provides a general guide to transistor condition. Can also be used for quick checks on diodes & rectifiers. Indication by LED.

### 112 FUSE CHECKER E.E. OCT 78

A handy device for checking all types of household fuses. With test button & LED indication of blown - not blown fuses.

### 115 TRANSISTOR TESTER E.E. APR 79

A simple & cheap tester which is, within its limits, accurate. Measures gain. Output is via the crystal earpiece provided.

TRANSISTOR  
TESTER

### 147 TRANSISTOR TESTER E.E. NOV 80

This battery powered tester allows PNP & NPN transistors to be checked. Also measures current gain (HFE) & leakage. HFE range 5-650 at 2 mA collector current.

### 153 TRANSISTOR TESTER H.E. NOV 80

Test NPN or PNP transistor quickly & easily with this simple to build project for beginners. Calibrated to give a visual readout of the transistor's gain. Includes a set of test leads.

### 191 VARIABLE BENCH POWER SUPPLY H.E. JULY 81

An extremely useful power supply unit which provides from 0 to 14 volts at 1 Amp. The voltage is set by means of a calibrated control & a panel meter accurately indicates the output current. Regulation is provided by an excellent I.C. regulator which has full internal protection against overheating & short circuits. The circuit is housed in an attractive PVC coated metal case & is fitted with 4mm screw terminals suitable for connecting either plugs or loose wires.

### 197 0-12V POWER SUPPLY E.E. SEPT 81

A versatile supply providing an output adjustable from 0-12V at up to 400mA by means of a calibrated potentiometer. The circuit is fully regulated & incorporates three step adjustment of current limiting to prevent damage to circuits being tested. A rotary switch selects 40, 100, or 400mA maximum current. If the set current is reached the current limiting circuit comes into action & an audible alarm sounds. This is very useful feature & eliminates the need for an expensive current meter.

### 229 SIGNAL TRACER H.E. APR 82

A high impedance probe suitable for tracing signals in radio & audio circuitry. The circuit uses an FET input stage which drives a high gain transistor output stage. The output stage is biased so that A.M. radio signals will be demodulated to produce an audible output. The output is suitable for connection to a crystal earpiece.

### 283 TTL LOGIC PROBE H.E. JUNE 83

A very simple logic probe which gives indication of logic '1' or '0' on a two colour LED indicator. Two presets allows the logic high & low thresholds to be set independently. If a high speed pulse waveform is present both led colours will light together & an orange/yellow colour is seen.

### 330 CONTINUITY TESTER H.E. DEC 83

A compact tester which gives audible indication of low resistances & short circuits. In addition two LED indicators are provided which allow the tester to distinguish between short circuits & 'false' current paths through semiconductor junctions etc.

**334 CONTINUITY TESTER E.E. DEC 83**

A continuity tester which responds to low resistance with one tone & high resistance with another tone. The current in the probes is very low so the tester will not damage sensitive circuits. Power is provided by a 9V battery.

**344 SIGNAL TRACER E.E. FEB 84**

This circuit is built in two sections. One section generates an 800Hz signal for injection into the circuit under test. The other section consists of a high impedance probe connected to a high gain amplifier circuit. The amplifier output can drive either a crystal earpiece or high impedance headphones. Suitable for 'trouble shooting' in audio circuitry.

**358 FUSE/DIODE CHECKER E.E. APR 84**

A simple circuit which gives LED indication of the state of fuses and diodes. Two LEDs indicate conduction in opposite polarities, thus a blown fuse or open circuit give no light, a good fuse or short circuit lights both lamps, & a good diode will light one or other of the lamps depending on which way it is connected.



**444 INSULATION TESTER E.E. APRIL 85**

A reliable electronic tester which checks insulation resistance of wiring appliances etc at 500 volts. The unit is battery powered simple and safe to operate. Leakage resistance of up to 100 megohms can be read easily. One of our own designs, and extremely popular.

**461 CONTINUITY TESTER E.E. JULY 85**

This tester produces an audible and visual output when the probes are bridged by any resistance less than 7k ohms or so. The circuit will also check transistor and diode junctions without danger of damaging them. A pair of metal pads on the case of the tester allow fuses and small components to be checked simply without the need for test leads.



**524 VERSATILE P.S.U. E.E. APRIL 86**

This power supply can provide 1.2 to 15 volts DC output at up to 1.2 amps. The circuit uses a solid state voltage regulator which is practically indestructible. A feature of the supply is a constant current mode in which the supply can be set to deliver one of six pre-set currents which have been selected for charging the range of NICAD batteries from a PP3 right up to D cells.

**493 DIGITAL CAPACITANCE METER E.E. DEC 85**

A superb easy to use instrument with five digit direct read-out of capacitance values from 1pf to 1000uf. The circuit has been designed for quick accurate use, even by absolute beginners. calibration is not required as the unit uses a quartz crystal and close tolerance resistors. A special time-out circuit blanks the display after 30 seconds to ensure maximum battery life.



**503 FUNCTION GENERATOR E.E. FEB 86**

A circuit which provides sine, triangle and square waves from 10hz to 100khz in 4 ranges. The unit is suitable for testing audio circuits, digital logic circuits and computer peripherals such as a to d convertors. The sine and triangle wave output level is variable in 3 ranges covering 0-10mv, 100mv and 1 volt rms. The square wave output is fixed at 10 volts peak to peak from an open collector transistor stage. The circuit features a constant 600 ohms output impedance at all settings and is therefore excellent for testing op-amp circuits when gain often depends on the source impedance. The circuit can be battery powered but an optional mains power unit is also available.

**FUNCTION GENERATOR**

Produces sine, square and triangular waveforms over the range 0.01Hz to 1MHz at up to 1V output, thus forming a very useful piece of test equipment. The article includes a simple battery eliminator for those that require mains operation.

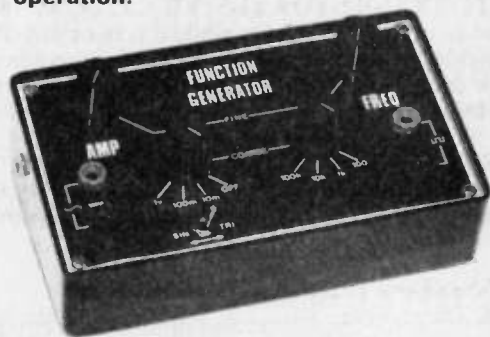

**512 MAINS TESTER & FUSE FINDER E.E. MARCH 86**

A handy unit which sounds an audible warning when the mains supply is disconnected and gives visual indication on three neon lamps of the connections to mains sockets. Designed for checking the correct connections of mains wiring and for tracing which socket in the house connects to which fuse in the fusebox. the circuits can detect fault conditions as follows: No live, No neutral, No earth, I/N reversal, I/E reversal.

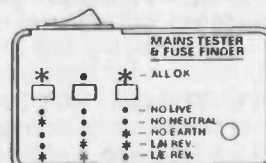

## 553 BATTERY TESTER E.E. AUG 86

A tester that applies the correct load to batteries to give meaningful voltage readings. This tester achieves this by means of a push button switch which connects an appropriate load resistor across the battery and gives a voltage reading on a built in panel meter. The meter is specially scaled so that it reads 1-1.5v and 6-10 volts. This gives a very precise reading of voltage which enables the battery condition to be assessed easily.

## 563 200MHZ DIGITAL FREQUENCY METER E.E. NOV 86

An easy to construct project which measures frequencies from a few Hz to 200mhz. The circuit has an 8 digit led display, and is powered from a 9V plug-in mains adaptor (supplied with the kit). 10Mhz quartz crystal master oscillator ensures high accuracy without any need for calibration. An ideal instrument for CB, and amateur (HF and VHF) use. Also ideal of calibrating audio oscillators, radio tuners I.F. amplifiers etc.

## 580 VERSATILE PULSE GENERATOR E.E. FEB 87

Another digital trouble shooting project. This unit provides pulses from 1.4 sec to 14u sec in 5 ranges. Pulse width is adjustable from 0.7 to 7u sec and amplitude from 0v to 8v peak. Rise and fall times are 0.5u sec on all ranges. A mains powered project housed in verobox. Built on stripboard.

## 704 CURRENT TRACER E.E. APR 87

Another of the digital trouble shooting projects. This one detects the voltage drop in short lengths of PCB track and so allows the current to be estimated without actually breaking the circuit. This is a very effective way of tracing faults, especially short circuits, as it allows the current to be followed progressively from the source to the leak. Built on stripboard, battery powered and housed in a verobox.

## 710 AUDIO LOGIC TRACER E.E. MAY 87

A simple logic tracer that takes pulses from a digital circuit under test and produces an audible output via a small audio transducer. A very useful simple method of fault finding in logic circuits, which can yield a lot of information very quickly, especially when testing known systems.

## 745 TRANSTEST E.E. OCT 87

An in circuit tester for transistors and diodes. This circuit works by applying an alternating voltage between two probes which are placed on the diode and transistor under test. Two leds indicate the current flowing in each direction through the circuit indicate the polarity of any diode or transistor junction between them. Neither LED lights for an open circuit, both LEDs light for a short circuit, and either one of the LED lights to indicate a good semi. junction. A simple well designed project.

## 834 QUICK CAPACITANCE TESTER E.E. FEB 90

A low cost hand held audio/visual unit which can identify short, open, and working capacitors quickly and with a minimum of fuss. Also gives indication of leakage current. Especially useful for electrolytics and for diode and transistor junctions. An ideal kit for beginners. Built on a single circuit board which has large copper areas used as test pads. Only the very minimum of wiring is needed. Output is provided by 2 LEDs and a piezo transducer. The capacitance value is determined by the pitch of the tone and which test pads are being used. Ideal for Bargain Pack sifting.

## 716 SCOPE STORE P.E. JULY 87

A solid state digital store which enables intermittent and one shot waveforms to be captured and studied on a standard oscilloscope. Sample rate of up to 100,000 per second is obtainable, allowing good accuracy with audio waveforms. For slower waveforms sample rate can be lowered as required. The unit uses a 2k x 8 RAM chip, giving a 2048 x 256 display which shows no sign of stepping at all on the average oscilloscope. Input sensitivity and trigger controls are provided. Manual and automatic triggering may be used, and the input signal may be A.C. or D.C. coupled. A very effective and interesting piece of equipment.



## 763 AUDIO SIGNAL GENERATOR E.E. DEC 87

A compact reliable and effective source of audio sine waves for checking speakers, amplifiers, peizo sounders etc. This circuit is a Magenta design and provides frequencies from 33hz to 33khz in 3 ranges. Simple to assemble and use, it provides three outputs. The first is up to 1/2 watt into 8 ohms, the second variable from 0 to 6V, the third 0 - 60mV. Operates from a PP3 battery, built on PCB.

## 769 POWER SUPPLY (MOSFET) E.E. JAN 88

The best power supply project published for some time. This Magenta design gives 0-25V at 0-2.5 Amps output so is capable of powering almost anything. Two panel meters indicate voltage and current. The output is fully protected from short circuits. As well as the usual voltage control, The circuit also has fully adjustable current limit control which allows the supply to work in constant current mode. This is ideal for charging batteries - especially NICADs. A power MOSFET is used as the output device, and this gives the unit exceptional ruggedness and reliability. Printed circuit board construction. Uses a toroidal power transformer.



## 785 ISOLINK E.E. JULY 89

An opto-isolated circuit that allows small signals to be passed between its input and output whilst being fully isolated from one another. Ideal for use in BIOLOGICAL experiments where the input signal from electrodes fixed to a person can be connected to a mains powered oscilloscope and other test gear without any danger. Frequency response is DC to 30kHz with very low distortion due to a special opto-isolated feedback loop technique. The circuit has many other uses including the testing of electronic circuits which have sections connected to mains voltages - such as lamp dimmers, motor drives, switch mode power supplies and television receivers.

## SECURITY KITS

**556 INFRA RED BEAM ALARM E.E. SEPT 86**

A broken beam intruder detector module with a range of over 10 metres which is designed for connection into an existing closed loop alarm system. The transmitter and receiver are fitted in to separate boxes and each powered from 4 - HP7 type cells. When the beam is not broken a relay in the receiver circuit is permanently energised. Breaking the beam or failure of either of the batteries will cause the relay to release.

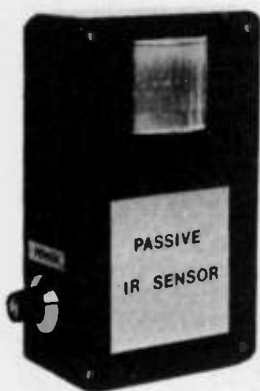
**551 PASSIVE INFRA RED DETECTOR P.E. JULY 86**

A mains powered module with a relay output that switches in response to the movement of body heat. A pyro-electric sensor is used coupled with a special fresnel lens capable of covering a room up to 4m x 7m. The circuit is designed to switch on a light when the room is entered. An additional photocell is incorporated so that the circuit does not turn on the light during daylight hours. Easily adapted to operate a burglar alarm or warning buzzer.

**581 VIDEO GUARD E.E. FEB 87**

This novel project provides good anti-theft protection for VHS type video recorders. A small printed circuit board is built into an empty cassette and inserted into the machine. A tilt switch on the board will be activated if the video recorder is picked up or moved, sounding a loud alarm. The circuit is automatically switched off when it is inserted into the recorder, and switched on when it is removed. A simple but very effective anti-theft device. Very long battery life is assured by the low circuit quiescent current.

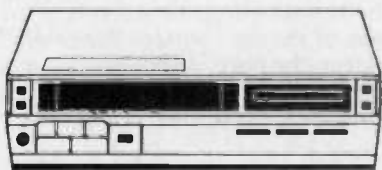
**700 ACTIVE INFRA RED ALARM E.E. MAR 87**

An infra red alarm that emits a pulsed beam of radiation and detects the amount of it received by a sensor which can either be placed alongside the emitter (reflective mode), or facing it (beam mode). The circuit is suitable for mounting indoors or outdoors and is powered from a mains transformer in a separate indoor unit. When triggered the alarm closes a relay for a time that can be pre-set from a few seconds up to an hour. The relay contacts can be used to operate an outdoor light, or can be connected to a siren, or other alarm system. Two pairs of change over contacts are available. A special type of synchronous detector ensures that interference effects from mains lighting etc. are ignored.

**791 ULTRASONIC BREAKING GLASS ALARM E.E. SEPT 88**

This self contained battery powered alarm picks up the high frequency 'sounds' produced when glass breaks. A 40kHz ultrasonic detector is used followed by a filter which rejects any audio frequencies which might cause false alarms. The alarm is set by a key operated switch and produces a whooping sound from a built in speaker when triggered. Pick up range is in excess of 3 metres.

**122 UNIBOARD BURGLAR ALARM E.E. DEC 79**

A simple but effective circuit which accepts inputs from normally open & normally closed types of contact loops. Battery powered - very low current drain. Test button facility. Includes a buzzer.

**750 INTRUDER CONFUSER H.E. JAN 82**

This device is intended to confuse a would be intruder by appearing to be part of a sophisticated alarm system. It steadily flashes an LED day & night. When placed at one side of a window for example, it attracts the attention of the would be intruder who is led to believe that an infra red beam is protecting the property - so he goes elsewhere. The circuit is powered by a single cell that will give at least 7 months continuous use.

**230 BIKE ALARM H.E. APRIL 82**

Protect your bike or other moveable property (camera bag, toolbox etc) with this movement sensitive alarm. The alarm is set by removing a jack plug which contains your own secret resistor. Any movement will trigger the alarm which will continue to sound for 20 seconds. Further movement will retrigger the alarm for a further 20 seconds & so on. The alarm can be instantly silenced by insertion of the special jack plug. The circuit is designed to take very low current & give very long battery life.

**262 PUSH BIKE ALARM E.E. FEB 83**

An alarm which detects movement by means of a mercury switch. The alarm sounds for approximately 1 minute after it has been triggered, after which it resets. A keyswitch is fitted to turn the alarm on & off. A PP3 battery provides the power.

**364 SIMPLE LOOP BURGLAR ALARM E.E. MAY 84**

An alarm system designed for use with a loop of wire which is woven around goods to be protected. The unit includes its own alarm speaker & key operated switch for setting.

**474 CARAVAN ALARM E.E. JULY 85**

A 'loop wire' type alarm for protecting caravan contents and also items outside the caravan through which a loop wire can be passed. The alarm required 12v car battery and an external car horn or other 12V warning device. A 30 second time-out prevents the alarm sounding continuously causing a nuisance and discharging the battery.



Portable, easy to operate, with a two minute alarm time out. This simple alarm was designed initially to attach to the handle of the inside of a hotel room, but the list of applications is almost endless.

**544 TILT ALARM E.E. JULY 86**

This simple tilt alarm was designed to be portable and easy to operate. It can be used in any situation where an attempted theft involves tilting something e.g. a hotel door handle, toolbox lid, camera case, suitcase etc. The alarm is compact and draws very little current on standby so that it can be left unattended for long periods. An automatic time out circuit stops the alarm from sounding and re-arms the circuit after two mins. The circuit uses a printed circuit board and is powered by a PP3. The alarm sound is a loud high-pitched warble which is very penetrating.

## 114 CAR ALARM H.E. FEB 79

Easy to build - quick to fit - complex in circuit operation. The circuit detects a voltage drop anywhere in the vehicle's electrical system. Not prone to false alarms. Connect it to any point which is normally live at all times. Alarm is automatically turned off after 45 seconds & reset. Most thieves are deterred by knowing an alarm is fitted - so project includes a flashing LED. A reliable effective and popular alarm.

## 782 DOOR SENTINEL E.E. MAY 88

A low cost security project which allows doors and windows to be monitored using magnetic reed switches in a normally closed loop. The loud alarm tone sounds for two minutes after the circuit has been triggered and then resets. A flashing LED announces that the alarm is in operation and so deters theft. The alarm is set and reset by means of a magnet operating a concealed reed switch.

## CAR KITS

### 735 CARAVAN FRIDGE ALERT E.E. OCT 87

A very good gadget that senses the state of a caravan fridge supply (a fridge of the absorption type). It prevents gas and electricity being connected at the same time (to dual-fuel fridges) and also ensures that current is being drawn by the fridge from the car battery system, sounding an alarm if power fails for some reason. A simple, well thought out project.

### 173 WINDSCREEN WIPER CONTROL H.E. MAR 81

An easy to build project for the car owner - helps to stop those smeary screens at a flick of a switch. In addition to giving single intermittent wipes this gives several alternative time delays between wipes. Suitable for 12 volt positive or negative earth cars. The wipers are controlled by a pair of normally open relay contacts which are wired across the ordinary wiper switch - so continuous operation of the wipers can be obtained in the normal way.

### 210 ICE ALARM E.E. OCT 82

Detects icy road conditions by means of a thermistor mounted under the front of the car. A flashing warning LED indicates the potential hazard to the driver.



### 543 WATCHDOG E.E. JUNE 86

A car lights warning circuit which provides an audible indication when the car ignition is turned off whilst the headlights or sidelights are on. An override switch allows the sidelights to be left on when parking.

### 569 AUTOMATIC CAR ALARM E.E. DEC 86

A fully automatic alarm with entry and exit delays and a buzzer which sounds during the entry delay. The alarm is armed and disarmed by means of the ignition switch which must be turned within 12 seconds of entry. Sensing is by means of the car courtesy light switches. In the event of an alarm, the horn is sounded for a pre-settable period between 1 and 5 minutes, a very well thought out alarm with a number of other useful features.

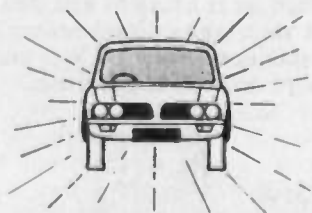

### 708 FRIDGE ALARM E.E. MAY 87

A low temperature alarm that monitors fridge temperature with a thermistor and sounds a tone if the internal temperature rises above a certain fixed level. Useful for checking caravan fridges etc. A small self contained unit, that consumes practically no power when in the quiescent state.

### 777 LOW FUEL ALERT E.E. APR 88

Using the existing petrol gauge sensor, this circuit provides an audible warning of low fuel. Suitable for most negative earth cars. Constructed on stripboard, housed in a small plastic case.

### 771 CAR LAMP CHECKING SYSTEM E.E. FEB 88

A circuit which checks the current flowing in car brake lights and side/tail lights and indicates a fault in any of them. Panel mounted warning lights give indication. A neat little circuit, built on stripboard. Suitable for negative earth vehicles only and not suitable for caravan/trailers.

### 783 HEADLIGHT REMINDER E.E. JUNE 88

Simple easy to build unit which sounds a buzzer and flashes an LED if one of the front car doors is opened whilst the headlamps are on. Once fitted it can be forgotten and will constantly guard against flat batteries.

### 114 CAR ALARM H.E. FEB 79

Easy to build - quick to fit - complex in circuit operation. The circuit detects a voltage drop anywhere in the vehicle's electrical system. Not prone to false alarms. connect it to any point which is normally live at all times. Alarm is automatically turned off after 45 seconds & reset. Most thieves are deterred by knowing an alarm is fitted - so project includes a flashing led for mounting in a prominent place. A reliable effective and popular alarm.

## PHOTOGRAPHIC KITS

**225 CAMERA OR FLASHGUN TRIGGER E.E. MAR 82**

This trigger unit enables action photographs to be taken by producing a trigger pulse whenever an infra red beam is broken. Two range settings give up to 2 metres range at maximum setting & 1 metre at minimum with reduced battery drain. The output should trigger any normal electronic flashgun & also most modern SLR cameras fitted with electronic shutter controls or autowind facilities.

**340 INFRA RED CAMERA CONTROL H.E. FEB 84**

Designed for use with cameras that have electric remote shutter release and/or autowinder. Provides remote triggering at up to six metres range provided there is a transparent path between the hand held transmitter & the receiver. An indicator on the receiver allows the unit to be set up without connecting a camera.

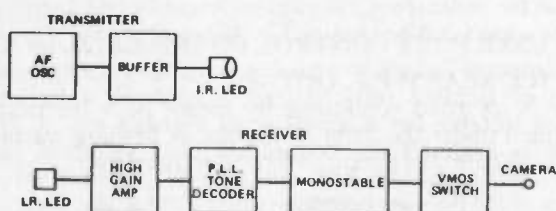
**383 SOUND OPERATED FLASH E.E. SEPT 84**

This unit will trigger most standard flashguns in response to sound, enabling many interesting frozen action shots to be taken. The sound is picked up by a crystal microphone.

**118 DARKROOM TIMER E.E. JULY 79**

A simple battery powered unit with an LED which flashes once per second. Flashes are counted by the operator to give the desired exposure time. Ideal for short printing jobs. Max. accuracy 1/60th of a second.

**171 PHOTOGRAPHIC TIMER H.E. MAR 81**

Simple to build. The unit has an LED indicator which flashes at one second intervals. Useful in the darkroom etc.

**209 PHOTO FLASH SLAVE E.E. OCT 81**

Designed to trigger one flash gun in response to the flash from another. The circuit uses a phototransistor to detect the flash. This drives a thyristor which triggers the second flash unit via a diode bridge. Power is derived directly from the slave flashgun.

**219 SIMPLE INFRA RED REMOTE CONTROL E.E. NOV 81**

A range of about 9 metres is achieved with this remote control circuit. The system is a simple on/off switching type where a pair of relay contacts at the receiver close while a push button switch at the transmitter is pressed. Transmitter & receiver are battery powered. Suitable for the remote control of slide projectors or similar. Alternatively the unit could be mains powered & operate a broken beam alarm.

## RADIO KITS

**718 3 BAND 1.6-30MHZ RADIO E.E. AUG 87**

A three band TRF receiver using modern miniature plug-in coils covering 1.6 - 30mhz in 3 bands. The circuit uses a special i.c. containing 5 matched high frequency transistors to obtain exceptionally smooth control of regeneration (or reaction) and produce a highly sensitive circuit which can be tuned easily by beginners and experienced short wave listeners. The audio output is approx 1/2 watt via a built-in loudspeaker. Another Magenta design, this is one of our 'top kits' and is exceptionally good project to build and use.

**808 SUPER FILTER E.E. MARCH 90**

A universal filter designed to remove high frequency signals from the power and low frequency connections of HI-FI, CB, Amateur radio and Vehicle Radio/Audio systems. Based on a special filter block which provides 12 feedthrough PI filters.

**746 EXPERIMENTAL CRYSTAL SET E.E. NOV 81**

A simple crystal set capable of driving a crystal earpiece or high impedance headphones. Wire is provided for four home made coils to cover MW & SW bands.

**542 PERSONAL RADIO E.E. JUNE 86**

A simple compact medium wave radio designed to be used with 'personal stereo' headphones of 30-64 ohms impedance. The circuit is built on a printed circuit board and powered by a PP3 battery. Controls are provided for volume, and tuning. As the circuit is a trf design it does not require alignment and should work satisfactorily from switch on.

**362 VARICAP AM RADIO E.E. MAY 84**

A compact medium wave TRF radio tuned by varicap diodes. The circuit is battery powered & provides an output suitable for driving high impedance headphones or a crystal earpiece.

**835 SUPERHET BROADCAST RECEIVER E.E. March 90**

An up to the minute low cost design using high tech I.C.s. One I.C. is the front end with R.F. amplifier, I.F. amplifier and detector, the other is an audio power amplifier driving a loudspeaker. The circuit uses a ceramic I.F. filter for excellent selectivity and simple alignment. Covers Long and Medium Wavebands. Built in a clear plastic case made from two panels with a simple wooden frame. The drilled panels and a transparent (plain) tuning dial are included.

## COMPUTING KITS

**337 BIOLOGICAL AMPLIFIER E.E. JAN 84**

This carefully designed circuit enables the electrical signals produced by muscular, brain, & plant activity to be coupled to a microcomputer. A balanced differential input stage followed by an opto-isolated output stage ensures excellent performance & safety in use. The output is suitable for connection to a range of computer A to D convertors.

Block diagram of the Biological Amplifier.

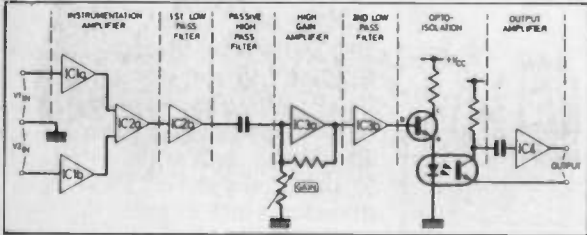
**370 SPEECH SYNTHESISER E.E. JUNE 84**

Suitable for all computers which have or are fitted with an 8 bit output port. This circuit uses the SPO256/AL2 IC to generate allophones which can be strung together to produce an unlimited range of speech. The circuit requires a 12V DC supply which may be available from some computers. An audio amplifier & loudspeaker are included. Pitch & volume are variable by means of two potentiometers.

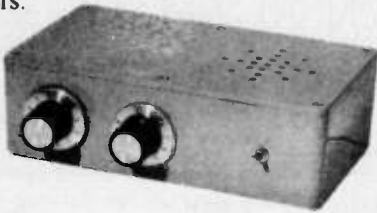
**392 BBC MICRO AUDIO STORAGE SCOPE INTERFACE E.E. NOV 84**

A fast analogue to digital converter which is connected to the computer user port. A sampling rate 200,000 per second enables audio frequency waveforms to be captured and displayed on the computer monitor. There are four controls, a switched coarse gain control, a fine gain control, sampling speed and D.C. shift control. Maximum sensitivity is 25mV for a full screen waveform.

**459 AMSTRAD USER PORT E.E. JULY 85**

This add on unit provides all the input/output facilities of the BBC B and VIC 20 Computers for the Amstrad CPC464. The use of a 6522 VIA chip allows most BBC and VIC add-ons to be interfaced to the Amstrad with a little ingenuity. The unit connects to the 25 way double sided expansion slot and is powered from the computer.

**568 BBC 16K SIDEWAYS RAM E.E. DEC 86**

A versatile add-on providing 16K static 'sideways' RAM for the BBC computer. Built on a small PCB which plugs into one of the ROM slots of the computer. A 'write protect' switch allows the RAM to be used as 'ROM' if required. A software tape containing a number of utilities is included with the kit to accompany the board (or other sideways RAM boards). Easy to install and use, a Magenta designed project which is extremely popular.

**246 INTERFACE BOARD H.E. SEPT 82**

Suitable for both Sinclair ZX81 & SPECTRUM computers. This is an easy to build unit with gives two independent ports. One is an 8 bit input port, the other is an 8 bit output port. The entire circuitry is built on a single printed circuit board which plugs directly onto the computer user port. The connections to the port are made to four miniature PCB mounted plugs (sockets are provided). Extremely simple programming can be used. PEEK/POKE on the ZX81, & IN/OUT on the Spectrum.

**292 USER PORT I/O BOARD E.E. JULY 83**

Designed to investigate the facilities offered by a computer user port. This board has 8 buffered LED displays & 8 switches so that each bit of an 8 bit port can be 'written to' or 'read'. Suitable for any computer with a 8 bit port & 5V output.

**293 USER PORT CONTROL BOARD E.E. JULY 83**

A computer interface board providing 4 independent pairs of isolated relay contact outputs & 4 buffered inputs suitable for connection to switches etc. A fifth input is available for connection to a standard edge sensitive handshake line. Suitable for connection to many of the popular computers that have a user port.

**301 STORAGE 'SCOPE INTERFACE FOR BBC MICRO' E.E. AUG 83**

This circuit connects to the analogue input socket of the BBC computer. It is designed to convert the amplitude of an audio signal into a varying DC signal which can be analysed & displayed by use of appropriate software. Suitable for displaying ADSR envelope functions & frequency response curves when used with a suitable audio signal generator. Software is available from E.E. on cassette to operate in conjunction with this project, however it is not essential.

**322 SPEECH SYNTHESISER FOR THE BBC MICRO E.E. NOV 83**

This system uses the GI SPO256 Allophone chip to produce an unlimited range of speech. The circuit connects straight to the user port & produces an audio output suitable for connection to a hi-fi system or small amplifier. Simple programs are given in the article to allow the composition of any speech output by combining the allophones.

**360 COMMODORE 64 A TO D CONVERTER E&CM MAY 84**

A two channel A to D converter capable of operating at up to 50,000 conversions per second. Suitable for other computers which have an 8 bit user port with two handshake lines such as the VIC20, PET, & BBC Model B. Simple setting up & programming are a feature of this straightforward design which uses the Plessey ZN448/449 chip.



**800 SPECTRUM EPROM PROGRAMMER E.E. DEC 88**

A single board programmer for the Spectrum computer which allows the most common 2764 and 27128 EPROMS to be programmed. Software is available to accompany this project (directly from the author). The kit includes components for 21V and 12.5V programming, and a ZIF socket for the EPROM. The circuit board mounts directly onto the computer expansion slot, and so is supplied without a case.

**790 EPROM ERASER E.E. OCT 88**

A safe low cost unit that uses a 12V supply to drive a special ultra-violet tube which will erase all EPROMS in 10 to 30 minutes. Efficient High Frequency inverter circuit gives instant starting and extended lamp life. The use of a 12V supply makes the unit especially safe for Educational applications, and a reed switch and magnet provide an interlock to ensure that the tube cannot be viewed whilst turned on. Erases up to four EPROMS at a time. Requires 12V at 0.5A minimum.

**789 AMSTRAD PCW PIO E.E. SEPT 88**

An easy to build and effective interface which provides two programmable 8 Bit I/O ports for the Amstrad PCW 8256/512 computers. Supports both memory mapped and I/O operation so allowing a wide range of programming options. Ideal for use with Mallard BASIC the circuit uses a Z80PIO chip on a PCB fitted with a ribbon cable connector terminated at each end with IDC connectors.

**799 AMIGA MIDI INTERFACE****ST/Amiga Format iss. 5**

Provides a MIDI interface with In, Thru, and three Out sockets for the Amiga A500, A1000, and A2000 computers. It connects to the serial port and takes its power from the computer. Suitable for use with any programs that use the serial port method of MIDI interfacing. Easy to construct with minimal wiring.

**813 ST/Amiga SOUND SAMPLER****ST/Amiga Format**

A high speed sound sampler circuit providing fully digitised output for the parallel ports of the ATARI ST and Commodore AMIGA computers. A 5 way DIN connector is provided for the audio input which can be from a Music centre, Tuner, or any other sound source with suitable levels of output. Microphone input is possible but will need some pre-amplification. Originally available in Built or Kit form, but now only supplied as a kit with drilled and printed front panel and plastic case. A very popular and effective project. The circuit can be battery powered but a regulated plug-in power supply is recommended and available as an extra.

**818 ATARI ST DISK TRACK INDICATOR ST Format**

A compact unit with two digit display indicating which side and track of a disc drive is currently being accessed. Kit is supplied complete with case and special 14 way connector.

**464 STEPPER MOTOR INTEFFACE FOR THE BBC COMPUTER E.E. JULY 85**

This interface enables 4 phase unipolar stepping motors to be driven from four output lines of any computer user port. The circuit is especially suitable for the ID35/MD35-1/4 motor and our MD200 which are commonly used in buggies and robot arms. The interface is supplied complete with ribbon cable and connector for the BBC user port and a full listing is given in the article to accelerate, run, and decelerate the motor. A 12 volt power supply is required. Screw terminals on the board allow easy connections for the power supply and motor leads. A very popular Magenta design.

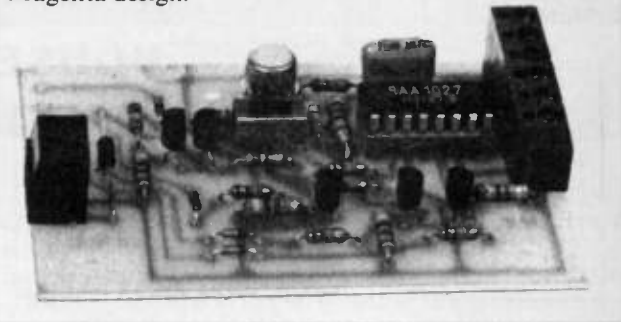
**578 SPECTRUM I/O PORT****E.E. FEB 87**

A compact and versatile I/O port for the ZX Spectrum computer. 8 input and 8 output lines are provided simultaneously via a 2 way IDC header. A simple project to construct using a double-sided PCB. The port is I/O mapped and requires only a single IN and OUT instruction to read, or write. The port can be housed in a plastic case, but this is not necessary and is not supplied with the kit. Use with 579 for driving stepping motors and other high current loads.

**579 STEPPING MOTOR BOOSTER (FOR ABOVE)****E.E. FEB 87**

Use this circuit with our 578 or other computer port to provide high current output for driving a four phase unipolar stepping motor (our ID35 or MD200 types are suitable). A program which provides suitable full and half step drive routines (using 578) is supplied in the article. To keep this circuit as simple as possible it uses screw type terminal blocks for construction.

**584 SPECTRUM SPEECH SYNTH E.E. FEB 87**

This synthesiser uses the SPO256 AL2 PIO IC. Speech output of up to 1 watt is provided by an LM380 audio amplifier on the board which drives a small speaker. As only 8 lines of the PIO chip are used for speech, a further 8 spare I/O lines are available for other purposes. The circuit is built on a single sided printed circuit board. Supplied without a case.

**703 EXPERIMENTAL SPEECH RECOGNITION****E.E. APR 87**

This very interesting circuit splits incoming sounds into four frequency bands and produces four analogue outputs corresponding to the level of each band. A BBC computer program listing is printed in the article to enable words to be learned, recognised and printed, by comparison with a range of stored samples. The unit connects to the computer analogue port.

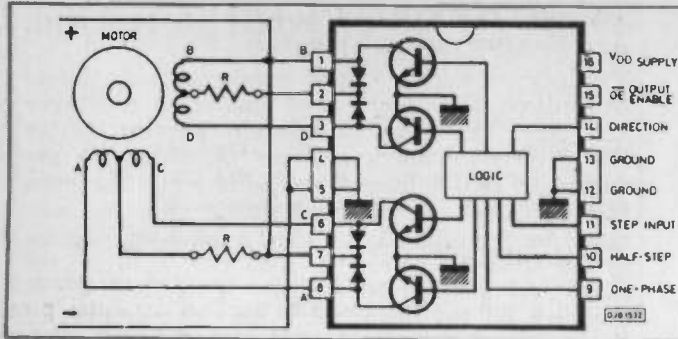

**816 STEPPING MOTOR DRIVER P.E. AUG 89**  
 A refined and adaptable design using the M5804 I.C. to give HALF STEP and FULL STEP drive to any four phase unipolar stepping motor requiring up to 35V and up to 1.25A per phase. All of the Magenta motors are suitable but the MD35 1/4 and MD200 are particularly recommended. A special offer price is provided for purchasers of the interface and MD35 1/4 motors. The interface can be driven directly from any 5V logic system and so is compatible with the BBC computer I/O ports and those of practically all other computers and logic teaching systems.

## HOUSEHOLD KITS

**240 EGG TIMER E.E. JUNE 82**  
 A pre-set device operated by a touch switch. An LED lights at the start of the time period & stays alight until a buzzer sounds at the end of the set time. The time period can be internally adjusted by means of a pre-set control.

**278 MOISTURE DETECTOR E.E. MAY 83**  
 Suitable for use as an overflow warning device, rain detector & many other water sensing jobs. The circuit detects water by sensing the leakage current across a piece of stripboard & sounds a warning alarm.

**315 HOME INTERCOM E.E. OCT 83**  
 A battery powered two station intercom capable of operating over 200 metres. The circuit uses an IC audio amplifier. Calling is possible from either station without the need to keep the unit switched on. Very long battery life.

**497 MUSICAL DOORBELL E.E. JAN 86**  
 This project uses a special I.C. pre-programmed with twenty five tunes and three chimes. A Magenta design, the circuit is battery powered and only draws current whilst producing sounds. Two rotary switches select the tune required. Provision is made for three bell pushes, each of which sound a different tune, so that three points of entry can be identified. A popular project, easy to build and reliable.

**417 DOOECHIME E.E. DEC 84**  
 This battery powered doorbell circuit produces an excellent electronic imitation of a chime. Two oscillators are combined via a ring modulator and given a decaying amplitude envelope by a VCA circuit. A 500mW audio amplifier I.C. driving a miniature 8 ohm speaker provides the audio output.

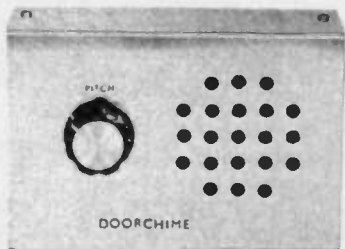

**475 FRIDGE ALARM E.E. JULY 85**  
 A simple device which ensures that the fridge or freezer door is closed correctly after use. A photocell is used to detect light from the internal fridge light and from light leaking around the door. If light is detected for more than 1.5 mins an audible alarm sounds.

**203 TELEPHONE BELL REPEATER H.E. OCT 81**  
 This project picks up the sound from a ringing telephone or doorbell & transmits it along a wire to a remote unit. The remote unit contains an oscillator which drives a loudspeaker, producing a loud beep each time the phone rings. Also in the remote unit is a relay which closes in sympathy with the beep. This can be connected either to a large mains powered alarm bell or to one or more lamps. The lamps flash whenever the phone or doorbell rings & so could attract attention in a noisy area, or be used as a 'doorbell' by a deaf person.

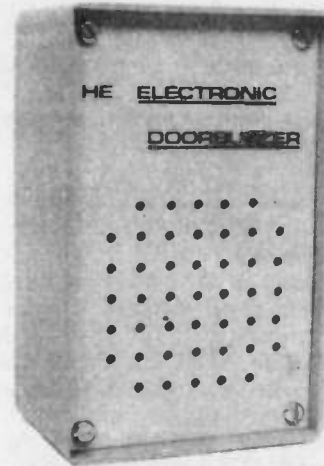

**186 ELECTRONIC DOOR BUZZER H.E. JULY 81**  
 A warbling tone oscillator coupled to a miniature loudspeaker which produces a much pleasanter sound than a conventional mechanical buzzer. The circuit uses a '555' timer IC modulated by a unijunction transistor oscillator. Battery drain is very low, a PP3 should last 6 months or more.

**236 CABLE TRACKER H.E. MAY 82**  
 Suitable for detecting wiring & piping concealed beneath floors or walls etc. This is sensitive & stable circuit which gives an audible beep whenever metal is approached. The pick up head uses a high 'Q' tuned coil fitted on a ferrite rod. Essential in any serious DIY toolbox.



**707 EQUALISER IONISER E.E. MAY 87**

A mains powered ioniser with an output of negative ions that give a refreshing feeling to the surrounding atmosphere. Negligible current consumption, and all-insulated construction ensure that the unit is safe and economical in use. easy to build on a simple PCB.

**714 ULTRASONIC TAPE MEASURE E.E. MAR 87**

An ultrasonic ranging device with digital output which is capable of measuring distances of up to 5 metres. A three digit LED display indicates the range in centimeters. This project is supplied without a case. Battery powered, built on a printed circuit board.

**555 FREEZER FAILURE ALARM E.E. SEPT 86**

A temperature sensing device with a probe for fitting inside a domestic freezer. If the temperature rises above a pre-settable level an audible warning sounds. Although designed for freezers the circuit has numerous other applications. Its function can be reversed easily so that it sounds the alarm on falling temperature. The circuit is mains powered and housed in a plastic case.

**575 HANDS-OFF INTERCOM E.E. JAN 87**

A two-way intercom which allows simultaneous speech in both directions. Much easier to use than the usual 'press to talk-release to listen' systems. Full privacy is assured by an on-off switch at each end, which allows the intercom to accept only incoming calls. Battery powered, built on stripboard.

**705 BULB LIFE EXTENDER E.E. APR 87**

A 'soft start' circuit which produces greatly increased mains bulb life by gently increasing the applied voltage and by running it very slightly under its maximum rating. Ideal for use with modern spotlight fittings and special coloured lamps when can be very expensive to replace. Built on a small PCB. Supplied less case.

**734 AUTOMATIC/MANUAL PORCH LIGHT E.E. OCT 87**

A mains powered circuit that switches on and off porch lights at dusk and dawn. A manual override is provided, and the output is via a relay with 1A mains rated contacts. The project is built on stripboard.

## MUSIC KITS

**150 THREE CHANNEL SOUND TO LIGHT E.E. NOV 80**

500 watts per channel. Independent control for bass, middle & treble. Bridge circuit used to give full wave control. Full mains interference suppression is incorporated. Outputs via PL552 socket & PL551 plug - both supplied. A master control allows all 3 channels to be adjusted simultaneously for different input levels. Input is taken from across the speaker terminals.

**174 GUITAR FUZZ BOX H.E. MAR 81**

Produce delightful distortion from your electric guitar in a novel way. A simple to build project with foot pedal control. This unit produces a very smooth sound. Circuit is housed in a 'foot pedal case' complete with a pedal to operate an internal switch. Features more controlled distortion & less background noise than most other designs.

**180 GUITAR HEADPHONE AMPLIFIER E.E. MAY 81**

For personal use with stereo headphones. Ideal for those who want to practice without disturbing others. This unit is small & battery operated & so is completely portable. It can drive a pair of ordinary stereo headphones to more than adequate volume for practice purposes.

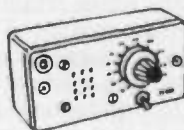
**105 AUDIBLE VISUAL METRONOME E.E. JAN 78**

An aid for music practice that produces an audible timing reference together with a light flashing in step. Beat range is 40 to 210 beats per minute.

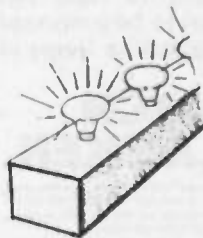
**111 SOUND TO LIGHT UNIT E.E. SEPT 78**

A simple safe and effective one channel sound to light converter. Modulates a light according to the amplitude of the music. Total output 800 watts e.g. 16 x 50 watt bulbs.

**124 SPRING LINE REVERB UNIT E.E. JAN 80**

Reverberation is the fading echo effect heard in churches, large halls etc, without it music can sound 'flat'. Use for recording or with instruments such as electric guitar, electronic organ etc. Incorporates a master volume control, & mixer for the reverb & straight-through signals. Very effective project.

**140 GUITAR PHASER H.E. SEPT 80**

Simple to construct. Compares well with far more expensive commercial units. Built in compact diecast box. Overcomes the problem of noise by using bi-fet op amp technology these give low noise & low power consumption. This phaser uses the Texas TL064 IC. An override footswitch is provided, also a switched jack socket for automatic on/off.

**149 GUITAR PRACTICE AMPLIFIER E.E. NOV 80**

A self contained mains powered unit delivering a comfortable 5 watts into 8 or 15 ohm speakers. Speaker not included. A separate output socket is provided for headphones listening at reduced power level.

## 453 GRAPHIC EQUALISER E.E. MAY 85

A mono graphic equaliser with six frequency bands centred at 50Hz, 150Hz, 500Hz, 1.5Hz, 5KHz and 15KHz. This unit gives very good control of the frequency spectrum of P.A. systems etc and is particularly effective with electric guitars and other instruments.

## 513 BBC MIDI INTERFACE E.E. MARCH 86

A standard Musical Instrument, Digital Interface which will link a BBC Mirco to a keyboard or synthesiser. A compact reliable circuit built on a single printed circuit board which connects to the 1 MHz bus output of the computer. DIN sockets are used for the instrument connections, one input and two outputs are provided. The circuit is powered from the computer.



## 523 STEREO REVERB E.E. APRIL 86

This reverb effects unit uses a spring line to add 'richness' to music. It is designed to be inserted between a pre-amplifier and power amplifier (most commercial HI-FI systems have suitable sockets). It can be used as a Stereo simulator, Headphone enhancer, or Quadraphonic synthesiser and also as a musical effects unit.

## 528 P.A. AMPLIFIER E.E. MAY 86

A portable amplifier designed to be powered from a 12V car battery. It will deliver 20 watts rms into 4 ohms, or 10 watts into 8 ohms from a microphone or line input. The circuit uses a low noise IC input stage and incorporates a variable cut off frequency low pass filter on the mic channel. The output stage is protected from short circuits, over voltage, and overheating.

## 558 SCRATCH BLANKER E.E. SEPT 86

A sophisticated stereo signal conditioner that removes the clicks produced by scratched records whilst retaining the full 20Hz - 20Khz bandwidth of the system. Two CCD delay lines are used so that the scratch signal can be detected and removed before the signal has reached the output. Special techniques are used to differentiate between clicks and high frequency music so that even small clicks are removed without losing sections of music. The circuit is mains powered and is designed to be connected between the pre-amplifier and power amplifier stages of stereo equipment.



## SCRATCH BLANKER

Far more sophisticated than a scratch filter this unit cuts out the noise spikes and replaces them with smooth audio—invaluable for anyone with a well used collection of conventional records.

## 562 10 WATT AUDIO AMPLIFIER E.E. OCT 86

Designed to be extremely versatile and useful, this amplifier provides 10 watts rms sine wave output power (20 watts peak) and will accept a wide variety of inputs. There are two 'flat' inputs, one for dynamic and electret microphones, guitar pick-ups and other low signal sources. The other input accepts signals at standard 'line' levels between 100mV and one volt. A third, completely independent input is provided with full disc RIAA equalisation for use with moving magnet pick up cartridges. The input can also be mixed to blend announcements with music etc.



## 211 FUZZBOX E.E. OCT 81

A compact unit producing the familiar diode clipped fuzz effect. Fitted with a footswitch to remove the effect when not required. The unit is switched on by inserting the guitar lead. Housed in a robust diecast case.

## 295 TRI BOOST GUITAR TONE CONTROLLER E.E. JULY 83

This project provides switchable gain boost to either low, medium, or high audio frequencies selected by a single rotary switch. A separate filter switch enables a dip in frequency response to be inserted between the area of real base & middle frequencies. This has a very good clarifying effect & reduces the 'boominess' which can often spoil the overall sound. A footswitch allows the effect to be switched in or bypassed.

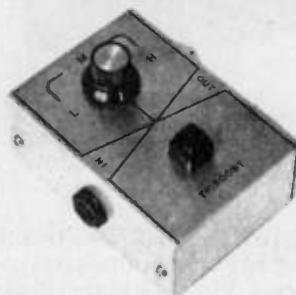

## 332 CHILDREN'S DISCO LIGHTS E.E. DEC 83

A safe simple sound to light circuit which flashes a row of coloured lights in response to music. The sound is picked up by a microphone eliminating the need for any external connections. Battery powered for complete safety.

## 355 DUAL MIC PRE-AMP ES&CM APR 84

An excellent low noise wide dynamic circuit providing two independent channels with pre-settable gain from 10 to 50dB steps. The circuit uses the NE5532 IC to achieve a high level of performance without becoming overcomplicated. Ideal for matching low output pick ups & microphones into line level mixer inputs & effect units. The input may be adjusted to match 50K or 600 ohm sources by means of a single resistor change.

## 381 GUITAR HEADPHONE AMPLIFIER E.E. SPET 84

A simple battery powered unit which will drive low or high impedance headphones directly from a guitar pick-up. Output power is 0.5 watts into 4 ohms.



## 361 SPRING REVERB UNIT H.E. MAY 84

A reverberation unit incorporating a standard spring line delay module. Bass & Treble controls operate on the reverberated signal to produce a range of effects & compensate for the losses in the spring line. A master volume control allows the effect to be added in varying proportions to a P.A. system.

## 473 RIAA PRE-AMP INPUT SELECTOR E.E. JULY 85

A low noise stereo pre-amplifier to match a magnetic cartridge to the auxiliary inputs of an amplifier. A three position selector switch is incorporated which allows two other signal sources to be selected in place of the cartridge.

**775 ENVELOPE SHAPER E.E. MAR 88**

A sound effects unit for keyboard and guitar use. The circuit is sound triggered, and produces an output of slow attack, sustain, and short delay. A footswitch allows the unit to be put in and out of circuit. Battery powered, housed in a strong discast case and built on a PCB

**779 STEREO NOISE GATE E.E. APR 88**

A very high quality noise gate device with special 'zero volt' switching arrangements that eliminate clicks as the circuits turns on and off. A variable threshold control allows optimum performance in circuits with differing levels of background noise. Suitable for use with many sound sources, such as musical instruments, keyboards, 78 records (silencing hiss between tracks or at the start and end), PA systems etc. A very effective unit built on a single PCB. Easy to construct and use.

**801 DOWNBEAT METRONOME E.E. DEC 88**

A Quality Metronome design with Accented Beats, Variable speed, Audio output, and LED output for silent operation when recording. Battery powered and constructed on a single printed circuit board.



**813 ST/Amiga SOUND SAMPLER ST/Amiga Format**

A high speed sound sampler circuit providing fully digitised output for the parallel ports of the ATARI ST and Commodore AMIGA computers. A 5 way DIN connector is provided for the audio input which can be from a Music centre, Tuner, or any other sound source with suitable levels of output. Microphone input is possible but will need some pre-amplification. Originally available in Built or Kit form, but now only supplied as a kit with drilled and printed front panel and plastic case. A very popular and effective project. The circuit can be battery powered but a regulated plug-in power supply is recommended and available as an extra.



**833 FOUR CHANNEL LIGHT CHASER E.E. JAN 90**

1000 watts per channel Hard Fired chaser with full inductive load capability. Zero Volt switching ensures low interference levels, and high reliability. Built in microphone and special Beat Seeker circuitry give superior Beat Synchronised chase performance. 3 / 4 channel selector switch, Mic sensitivity control, Free running chase speed control, and full front panel LED mimic complete this comprehensive Magenta designed project. Fitted with standard 8 pin connector. Will drive Rope Lights, Pin Spots and Tungsten-Halogen lamps with or without transformers.

**519 SOUND ACTIVATED SWITCH P.E. APRIL 86**

A superb system for switching on a tape recorder or radio transmitter in response to speech without losing the first syllables. This is achieved by a bucket brigade delay line which delays the speech by sufficient time for the switch to have operated. The delay is adjustable from a few milliseconds to around one tenth of a second. Input sensitivity is at microphone level, two outputs provide microphone level and line level. A relay provides the switching output. A 9 volt or 12 volt battery is required.

**721 MONOMIX E.E. JULY 87**

A four channel mono mixer designed for the video enthusiast. One input channel is at microphone level. The other three are a line (500mV) levels. Outputs from the circuit are also at line level for driving amplifiers, video recorders etc. There are no tone controls, A compact battery powered unit, built on a PCB.

**715 MINI DISCO LIGHT E.E. JUNE 87**

A single channel sound to light unit which picks up sound using a small loudspeaker as a microphone. A 5A triac coupled via an opto-isolator provides the output. A combination of lamps totaling up to 250W can be driven. The circuit is built on a printed circuit board and housed in a plastic box.

**728 PERSONAL STEREO AMP E.E. SEPT 87**

A low cost stereo amplifier delivering 2 Watts per channel from a personal stereo player output. The circuit is battery powered and drives two miniature loudspeaker.

**729 NOISE GATE E.E. SEPT 87**

For reducing the background noise of a guitar effects system. This noise gate switches on only when the input level exceeds a certain threshold. Below that it mutes the input signal and noise, so that silence prevails. A fast switch on time (2m sec) ensures that no signal is lost, and a slow decay time allows slow decaying signals to die away before they are muted. Mains powered, the circuit is built on a PCB, and mounted in a metal case.

**724 SUPER SOUND ADAPTOR E.E. AUG 87**

A mono audio signal fed into this unit is processed and converted to a pseudo stereo effect by means of a clever new I.C. which introduces frequency selective phase shifts in the mid audio band, but leaves high and low frequencies unchanged. The result is a very good enhanced mono effect which broadens the sound stage very effectively. Two audio amplifiers (1 Watt) are built in, so the circuit can be used on its own by being connected to the audio line of a T.V. set or video recorder. The unit is mains powered.

**739 ACCENTED METRONOME E.E. NOV 87**

A well designed circuit that provides an accented beat selectable from every other beat to 1 beat in 10. A 10 LED bargraph display moves along one step each beat and returns to zero on each accented beat. The beat rate is variable from 30 to 300 beats per minute. Built on PCB, battery powered, and housed in a neat case.

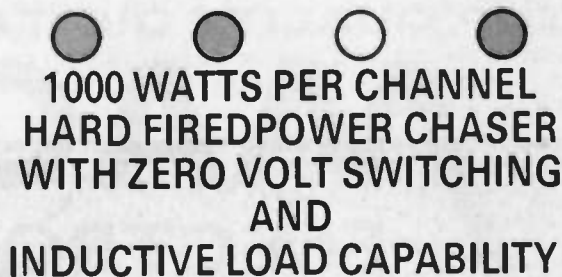

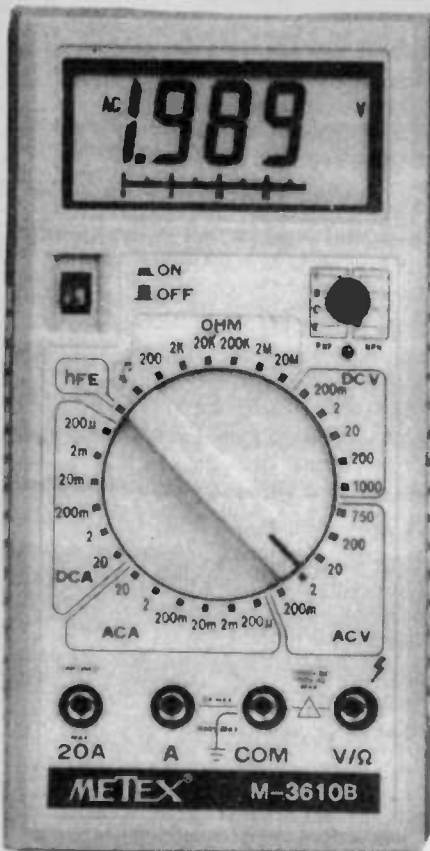

**M3610B £59.95**

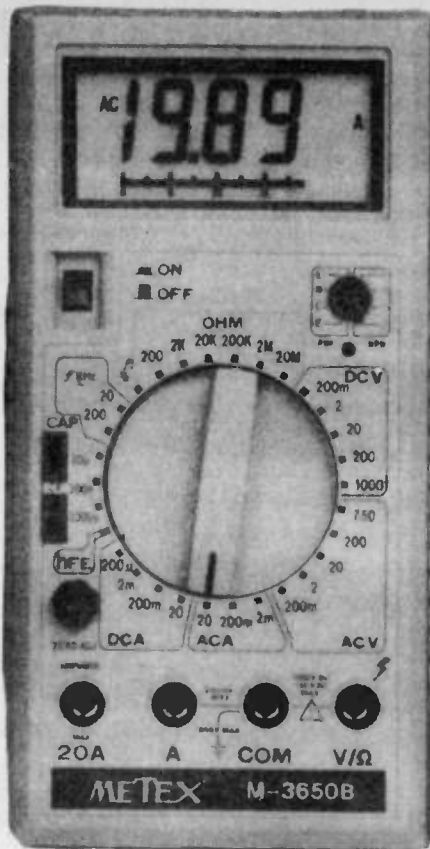

**M3650B £73.95**

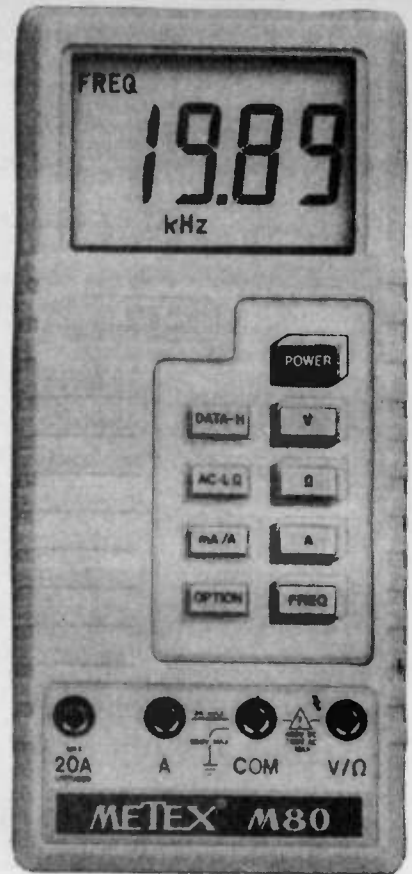

**M80 £60.95**

40 point analog bargraph display



- ★ 3½ digit 17mm LCD display
- ★ 30 ranges including 20A ac/dc
- ★ Transistor and diode test
- ★ Continuity test with LED indicator and buzzer
- ★ Built and tested to IEC348

Fully shrouded test leads, battery, instruction manual and carrying case included.

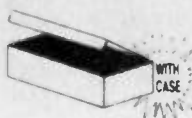

AC volts	0-200m-2-20-200-750Vac ±0.8%
DC volts	0-200m-2-20-200-1000Vdc ±0.3%
AC current	0-200µ-2m-20m-200m-2A-20Aac ±1.0%
DC current	0-200µ-2m-20m-200m-2A-20Adc ±0.5%
Resistance	0-200-2k-20k-200k-2M-20MΩ ±0.5%
Transistor hFE	0-1000 NPN/PNP
Dims	176 x 90 x 36mm

**ALSO — M3610**  
same but without bargraph **£46.95**

40 point analog bargraph display



- ★ 3½ digit 17mm LCD display
- ★ 30 ranges including 20A ac/dc
- ★ Frequency counter
- ★ Capacitance test with zero adjust
- ★ Continuity test with LED indicator and buzzer
- ★ Transistor and diode test
- ★ Built and tested to IEC348

Fully shrouded test leads, battery, instruction manual and carrying case included.



AC volts	0-200m-2-20-200-750Vac ±0.8%
DC volts	0-200m-2-20-200-1000Vdc ±0.3%
AC current	0-2m-200m-20Aac ±1.8%
DC current	0-200µ-2m-200m-20Adc ±0.5%
Resistance	0-200-2k-20k-200k-2M-20MΩ ±0.5%
Capacitance	0-20p-200n-20µF ±2.0%
Frequency	0-20k-200kHz ±2.0%
Transistor hFE	0-1000 NPN/PNP
Dims	176 x 90 x 36mm

**ALSO — M3650**  
same but without bargraph **£61.95**

- ★ Autoranging volts, ohms, amps and frequency count
- ★ Large 21mm 3½ digit display
- ★ 20 Amp ac/dc ranges
- ★ Data hold function
- ★ Ruggedised, weatherproof case
- ★ Diode and continuity test
- ★ Auto polarity and zero
- ★ Built and tested to IEC 348

Fully shrouded test leads, battery, carrying case and instruction manual included.



AC volts	0-400-700Vac ±1.8%
DC volts	0-400m-4-40-400Vdc ±0.5%
AC current	0-4m-40m-400m-2-20Aac ±1.8%
DC current	0-4m-40m-400m-2-20Adc ±1.2%
Resistance	0-4k-40k-400k-4MΩ ±1.2%
Frequency	0-4k-20kHz ±2.0%
Dims	182 x 85 x 34mm



**TOP QUALITY DIGITAL MULTIMETERS FROM:**

**MAGENTA ELECTRONICS LTD**

# ANALOGUE MULTIMETERS

## ETU2070 20k ohm/Volt

### ETU2070 MULTIMETER

A reliable and versatile meter suitable for use in hobby, educational and maintenance fields. Featuring a 3-colour mirrored scale, battery test facility, and a built in continuity buzzer. The movement is protected by diodes and a fuse. 19 ranges including 10A dc. Test leads fitted with 4mm plugs. Supplied with batteries and instructions.



AC Volts.....10-50-250-1000Vac  
 DC Volts.....0.25-2.5-10-50-250-1000Vdc  
 DC Current.....50μ-5m-50m-500m-10A dc  
 Resistance.....10k-100k-10MΩ  
 Continuity Buzzer.....Battery Test 1.5V and 9V

**ORDER CODE 420-101 £16.98**

## HC215 2k ohm / Volt

### HC215 MULTIMETER

A handy miniature multimeter with 12 ranges selected by a rotary switch. Test leads supplied with 2mm plugs, battery, and instruction book. Mirrored scale. Suitable for basic testing, fault finding and experimenting. A straightforward meter giving voltage, current and resistance ranges. Diode protected movement  
 Size 90 x 60 x 30mm



AC Volts.....0-10-50-250-500Vac  
 DC Volts.....0-10-50-250-500Vdc  
 DC Current.....0-500μ-50m-250mA  
 Resistance.....0-1MΩ

**ORDER CODE 420-102 £8.98**

## HC201 20k ohm/Volt

### HC201 MULTIMETER

A quality meter with a very clear mirrored scale. Featuring 12A AC and DC ranges. Fuse and Diode protection, 4mm shrouded test leads, and 19 ranges. Supplied with batteries and instructions.  
 Size 148 x 100 x 42mm



AC Volts.....12-30-60-300-600Vac  
 DC Volts.....3-12-60-300-600Vdc  
 DC Current.....60μ-1.2m-12m-120m-12A  
 Resistance.....1k-10k-1M-10MΩ  
 AC Current 12A

**ORDER CODE 420-104 £18.95**

## HC2020S 20k ohm/Volt

### HC2020S MULTIMETER

A superior meter with large open mirrored scale and 20 ranges. Featuring a Plug-in Transistor and Diode tester, and polarity reversing switch. Test leads fitted with shrouded 4mm plugs. Fuse and diode protection. Batteries and instructions supplied.  
 Size 150 x 102 x 45mm



AC Volts.....0-10-50-250-1000Vac  
 DC Volts.....0-0.1-2.5-10-50-250-1000Vdc  
 DC Current.....0-50μ-2.5m-25m-250mA-10A  
 Resistance.....0-2k-20k-2M-20MΩ  
 Transistor and Diode Tester

**ORDER CODE 420-105 £22.95**

# OPTICAL FIBRES

## INTRODUCTION

Plastic optical fibres that conduct visible and near infra-red light along their length. Made from high purity polymers on advanced equipment. These fibres are flexible, tough, and can be handled and bent repeatedly. They can be cut with a scalpel or razor blade and their ends can be prepared quickly and easily for maximum light transmission. Compared with Glass polymer fibres are cheaper, more flexible and lighter.



## TECHNICAL

Polymer optical fibres consist of a core of high purity polymethylmethacrylate surrounded by an optical cladding of fluoropolymer with a lower refractive index. This junction of different refractive indices produces total internal reflection at the perimeter of the fibre, preventing light from escaping and giving efficient transmission along its length. Excellent performance through the whole visible spectrum and near infra-red is achieved, allowing great potential for colour and decorative displays and short range communications use. Typical attenuation is 1.5 dB (30%) per metre.

## APPLICATIONS

A wide range of applications already exists for optical fibres, and more are being found constantly. In industry they are used in sensing devices, display panels, instrumentation, simulator panels, and automotive lamp monitoring and dial illumination.

Commercial applications such as eye catching colourful signs and point of sale displays. Animated advertising signs are made simpler and more effective by using optical fibres.

## HOBBY AND EDUCATIONAL USES

Ideal for model railway signals and lighting, doll's house lighting, and decorative lamps. More technical hobby applications include data and voice communications links, optically isolated sensing and control, and image scanners.

## LIGHT SOURCES AND SENSORS

Specially made LEDs and PHOTOTRANSISTOR

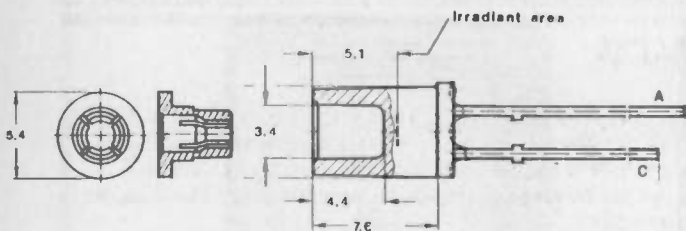

Red Green and Yellow visible emitters and High Efficiency Infra-Red emitter. Collets for 1, 1.5, and 2mm allow direct fitting of fibres right down to the chip. Phototransistor responds to visible and IR.

TYPE	ORDER CODE	PRICE
RED LED	422-130	48p
GREEN LED	422-131	48p
YELLOW LED	422-132	48p
I.R. LED	422-133	£1.39
PHOTOTRANS.	422-134	£1.89
COLLETS 1mm	422-139	10p
1.5mm	422-139	10p
2mm	422-140	10p

## STOCK RANGE

### ROUND

- 0.5mm dia.
- 0.75mm dia.
- 1.0mm dia.
- 1.5mm dia.
- 2.0mm dia.
- ▬ 2.0 x 0.3mm ribbon
- ◌ 1.3 x 0.9mm oval
- 1.0mm with black cladding

All sizes are supplied in continuous lengths up to 100m.

A mixed trial pack is also available containing 1m each of the unclad fibres and 2m of the 1.0mm black clad type (9 metres in all) Order code 422-120 Price £1.99

TYPE	ORDER CODE	PRICE		
		1m	10m	100m
0.5mm	422-100	7p	60p	£4.99
0.75mm	422-101	12p	£1.00	£7.99
1.0mm	422-102	16p	£1.40	£10.99
1.5mm	422-103	27p	£2.40	£17.99
2.0mm	422-104	36p	£3.30	£24.00
2.0 x 0.3mm	422-105	24p	£2.00	£16.00
1.3 x 0.9mm	422-106	28p	£2.40	£18.99
1.0mm clad	422-108	60p	£4.99	£38.98
<b>MIXED PACK</b>		<b>422-120</b>	<b>£1.99</b>	

## PREPARATION



When cut the end of the fibre can be rough, and not ideal for gathering light. It must be smoothed or even polished for better performance. The simplest way is to rub the tip of the fibre over very fine wet-and-dry abrasive paper using water as a lubricant. This should produce the result shown in (B). It is also possible to produce a smooth end by pressing the fibre end onto a heated smooth surface to produce the effect shown in (C).

On the thinner fibres it is possible to obtain a good finish simply by cutting with a sharp, warm, razor blade.

## LIGHT SOURCES

Any source of illumination can be used by these fibres. The best sources are the specially made devices which clamp the fibre end in a small ferrule close to an LED source, (or a photo-diode or phototransistor detector). We now stock a range of such devices which give excellent performance at reasonably low cost.

Alternative less efficient but still very effective methods rely on the fact that **holding one end of the fibre near to any light source will cause the other end to light up!**

Filament bulbs with coloured filters, LEDs (visible and infra-red types), lasers, sparks, flames, and flash tubes all have their uses. The output from the fibres can then be used either for direct vision or to illuminate a range of photo-sensing devices such as ORP12 photoconductive cells OP500 phototransistors, and BPW41 PIN photodiodes.



## D.C. MOTOR/GEARBOX ASSEMBLIES

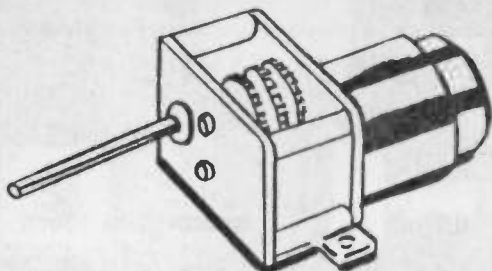

Ideal for robots and buggies. A miniature plastic reduction gearbox coupled with a 1.5 - 4.5 Volt mini motor. Variable gearbox reduction ratios are obtained by fitting from 1 to 6 gearwheels (supplied) as required. Two types are available, the smaller size has a higher revving motor, the large unit a lower revving but higher torque motor. The output shaft is 75mm long and 3mm diameter. On full reduction there is plenty of torque to drive a small buggy using 75mm diameter wheels.

### Small Unit type MGS

Speed range 3 - 2200 rpm. Size 37 x 43 x 25mm

**ORDER CODE 424-100 £3.99**

### Large unit type MGL

Speed range 2 - 1150 rpm. Size 57 x 43 - 29mm

**ORDER CODE 424-101 £4.55**

The table below shows the output shaft speeds obtained for various supply voltages and gear ratios for the two types of motor.

NUMBER OF GEARS FITTED	1.5Volts		3.0Volts		4.5Volts	
	MGS	MGL	MGS	MGL	MGS	MGL
6	3	2	5	4	6	6
5	10	5	18	10	24	14
4	32	16	58	32	74	45
3	96	44	180	88	230	125
2	290	150	540	300	700	410
1	900	400	1700	800	2200	1150

## MINI MOTORS

Low cost permanent magnet D.C. motors. Ideal for robotics, buggies, models, and toys. These motors are reversible by changing the polarity of the supply.

### MM1



### MM2



Both of these motors run at approximately 10,000 rpm on a three volt supply with a current of 1A and 10gcm torque. Current consumption is around 200mA when running lightly loaded and rises above 1A when stalled. The spindles are 2mm diameter and 8mm long.

TYPE	ORDER CODE	PRICE
MM1	424-110	29p
MM2	424-111	48p

## GEARS AND PULLEYS

A range of low cost pulleys and gears that enable many types of drive to be built.

### NYLON GEARS

Type G1. A range of gears with brass bushes and steel grub screws. Bush hole size is  $\frac{3}{32}$  and can be drilled out easily to 3mm.

TYPE	ORDER CODE	PRICE
Diameter $\frac{3}{8}$ inches	10	424-130
$\frac{9}{16}$	20	424-131
$\frac{13}{16}$	30	424-132
1	40	424-133
1- $\frac{1}{4}$	50	424-134
1- $\frac{1}{2}$	60	424-135

### NYLON PULLEYS

A range of pulleys with brass bushes and steel grub screws. Bush hole size is  $\frac{3}{32}$  and can be drilled out easily to 3mm.



TYPE	ORDER CODE	PRICE
Diameter $\frac{3}{8}$ inches	424-140	38p
$\frac{1}{2}$	424-141	38p
$\frac{3}{4}$	424-142	46p
1	424-143	48p

Also available, without brass bushes to be a tight push fit on a 2mm shaft in the following sizes only:

Gear -  $\frac{3}{8}$  dia 10 teeth. Pulleys -  $\frac{5}{16}$  dia and  $\frac{3}{8}$  dia.

TYPE	ORDER CODE	PRICE
Gear- $\frac{3}{8}$ 10t	424-138	16p
Pulley- $\frac{5}{16}$	424-146	14p
Pulley- $\frac{3}{8}$	424-147	14p

## SHAFTING

Lengths of  $\frac{3}{32}$  dia steel shafting to suit the above pulleys and gears. Supplied in 12 lengths.

**ORDER CODE 424-150 38p/length**

## RACKS

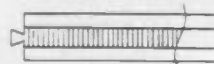

Nylon racks which match the abovegears in pitch. Each rack is a strip 4 long x  $\frac{3}{8}$  wide with a central toothed section  $\frac{1}{4}$  wide 50 teeth long. Racks can be fastened together to give continuous long runs using moulded in dovetails.

**ORDER CODE 424-154 53p each**

## RUBBER DRIVE BELTS

Ideal for models and as replacements in cassette recorders etc. Square section belts with limited stretch. Sizes given are the diameters of the belts when lying in a circle.

19mm, 30mm, 35mm, 46mm, 57mm, 66mm, 70mm, 75.5mm, 83mm, 90mm.

**ORDER CODE 425-19mm etc 55p each**

100mm, 110mm

**ORDER CODE 425-100mm etc 65p each**

## VARIABLE RATIO EPICYCLIC GEARBOX AND MOTOR

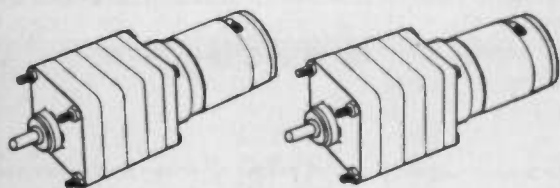

A high quality unit with a high torque 5 pole motor. Four epicyclic gear modules are stacked onto the shaft as required to produce different gearing. These modules have different ratios: 3 : 1, 4 : 1, 5 : 1, and 6 : 1, and can be assembled onto the motor shaft in any number and combination to give a wide range of reduction ratios between 3 : 1, and 360 : 1.

The motor operating voltage range is from 5V to 15V and this gives an additional method of speed control which combined with different gear ratios gives available speeds from 15 rpm to 4,800 rpm.

An extremely reliable and robust unit.

Motor size: 29mm dia x 38mm long  
 Gearbox size: 32mm square x 62mm long (inc. shaft)  
 Shaft size: 4mm dia x 10mm long  
 Each gearbox section is 8mm thick

Possible reduction ratios are: 3, 4, 5, 6, 12, 15, 18, 20, 24, 30, 60, 72, 90, 120, and 360 to 1

**ORDER CODE 424-200 £12.98**

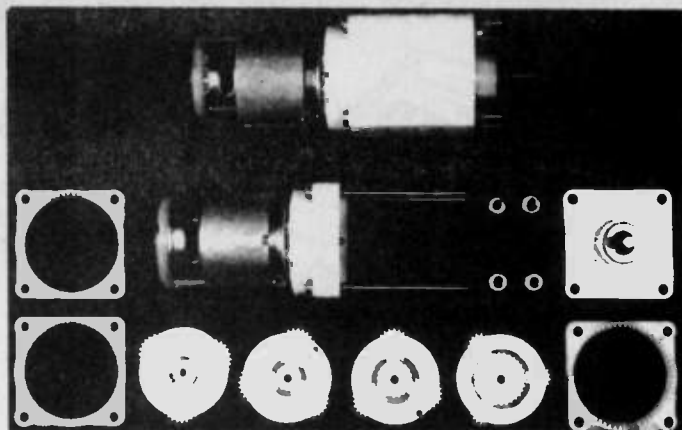

Output rpm at different voltages and gear ratios

Ratio	6V rpm	9V rpm	12V rpm	15V rpm
3 : 1	1400	2250	3000	4000
6 : 1	700	1100	1500	2000
18 : 1	2390	370	520	660
30 : 1	140	220	300	390
90 : 1	46	75	100	130
360 : 1	11	18	26	33

### EXTRA GEARBOX KIT

An additional 4 module gearbox pack that can be added on to the above units to give even higher reduction ratios. Each pack contains one each of the four reduction gearbox stages with ratios of 3 : 1, 4 : 1, 5 : 1, and 6 : 1 and four extra long screws. The maximum ratio now possible is extended to 129,000 : 1 which gives possible output speeds of well below 1 rpm (0.03 rpm with all sections fitted).

**ORDER CODE 424-201 £5.90**

## PICOTUTOR ASSEMBLY LANGUAGE TRAINER

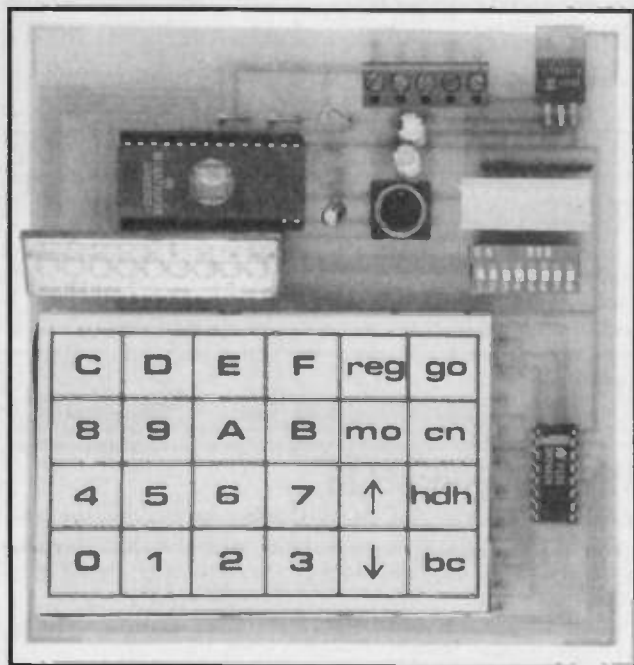

*Machine code programs run hundreds of times faster than their BASIC equivalents and take up much less memory space, but they are difficult to write. Assembly language simplifies machine code programming and can be learned and understood by following the exercises in the manual which accompanies this single board stand-alone trainer. This simple low cost microcontroller can also be connected to the outside world via switches and relays and is suitable for developing and running simple control applications.*

The Picotutor is a single board computer built around one of the many 'single chip' control oriented microcontroller ICs. It is accompanied by an educational series that covers all aspects of its operation and aims to familiarise the user with the operation and programming of microprocessors at assembly language level.

The kit includes a hexadecimal keypad, a nine digit seven segment display, an octal di/d switchbank, and an eight segment bargraph display, all of which are interfaced directly to the IC.

The board requires 5V at 300mA and has a built in voltage regulator to allow operation from supplies between 8 and 15V.

An optional analogue interface board can be connected to provide 8 Bit D/A and A/D functions.

Throughout the manual care has been taken to discuss other microprocessors as well as the Motorola 68705 series so that a broader range of techniques are presented.

The monitor programme which is supplied programmed into the IC contains many subroutines that can be called from the user's own programs. This allows complicated programs to be run without having to enter long sections of standard code.

	ORDER CODE	PRICE
Micro-controller KIT	501-625	£44.95
Analogue Interface KIT	501-626	£10.47

# STEPPING MOTORS

Three stepping motors suitable for driving a wide range of mechanisms under computer control using simple interfacing techniques. They are electrically similar and may be driven from any interface designed for Four Phase Unipolar operation.

The simplest drive circuit need only consist of four medium power darlington transistors which can be driven directly from most computer output I/O ports.

The motors differ mechanically and so it is on this basis that the most suitable type should be selected.

The MD200 motor is the best motor because it offers higher torque and faster stepping rates, and above all has 200 steps per revolution against 48 steps for the other two. The MD35-1/4 motor is very similar to the ID35 motor but has a more convenient spindle diameter of 1/4 with a flat. The MD38 is for applications where space is limited and has lower power than the other two.

## MD35-1/4

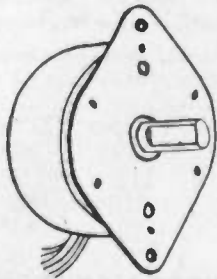

### MD35-1/4 Permanent Magnet motor - 48 steps per rev

Diameter.....	55mm	Torque.....	65mNm
Depth.....	25mm	Max step rate.....	180/sec
Fixing Centres.....	68mm	Inductance per phase.....	520mH
Shaft Dia.....	0.25 with flat	Current per phase.....	330mA
Resistance per phase.....	36Ω	Rotor inertia.....	40gcm <sup>2</sup>
Step angle.....	7.5°		

#### Connections

Winding 1 start.....	red	Winding 2 start.....	blue
Winding 1 centre.....	white	Winding 2 centre.....	white
Winding 1 finish.....	brown	Winding 3 finish.....	yellow

## MD38

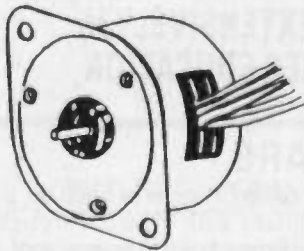

### MD38 Permanent Magnet motor - 48 steps per rev

Diameter.....	42mm	Torque.....	50mNm
Depth.....	22mm	Max step rate.....	320/sec
Fixing Centres.....	50mm	Inductance per phase.....	790mH
Shaft Dia.....	3mm	Current per phase.....	240mA
Resistance per phase.....	50Ω	Rotor inertia.....	13gcm <sup>2</sup>
Step angle.....	7.5°		

#### Connections

Winding 1 start.....	black	Winding 2 start.....	orange
Winding 1 centre.....	red	Winding 2 centre.....	red
Winding 1 finish.....	brown	Winding 3 finish.....	yellow

## MD200

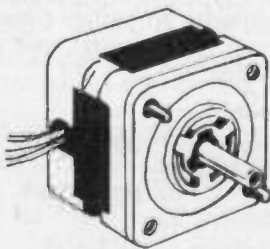

### MD200 Hybrid motor 200 steps per rev

Width and height.....	42mm	Torque.....	90mNm
Depth.....	34mm	Max step rate.....	630/sec
Fixing Centres (diagonal).....	44mm	Inductance per phase.....	32mH
Shaft Dia.....	5mm	Current per phase.....	320mA
Resistance per phase.....	34Ω	Rotor inertia.....	19gcm <sup>2</sup>
Step angle.....	1.8°		

#### Connections

Winding 1 start.....	red	Winding 2 start.....	blue
Winding 1 centre.....	black	Winding 2 centre.....	white
Winding 1 finish.....	yellow	Winding 3 finish.....	orange

## STEPPING MOTOR DRIVING INTERFACES

Magenta offer two interfaces that connect between a computer output port and any of the above motors. Both interfaces require a separate motor supply which is normally 12V.

Our kit 464 is a simple interface for a single motor which is supplied with a program for the BBC model B user port. This interface has been used extensively in schools and provides bi-directional operation in Full Step mode.

Kit 816 is a more sophisticated (and yet easier to build) interface that provides Half Step and Full Step operation along with a third method called One Phase or Wave Drive. This interface has the ability to handle up to 35V at 1.5A per phase and so can be used with the above motors and series resistors to give enhanced performance by allowing much higher stepping rates with maintained torque

TYPE	ORDER CODE	PRICE
<b>48 step:</b>		
MD35-1/4	424-210	£12.70
MD38	424-214	£9.95
<b>200 step:</b>		
MD200	424-218	£16.80

# THE MAGENTA 68000 BOARD

FULL 16 BIT  
DATA BUS

SUPPLIED IN KIT FORM OR  
ASSEMBLED AND TESTED  
BASIC SYSTEM KIT £110.00

DUAL  
SERIAL  
PORT

FOR ENGINEERS, STUDENTS  
AND ENTHUSIASTS

LARGE I/O  
EXPANSION AVAILABLE

USED EXTENSIVELY IN  
FURTHER EDUCATION

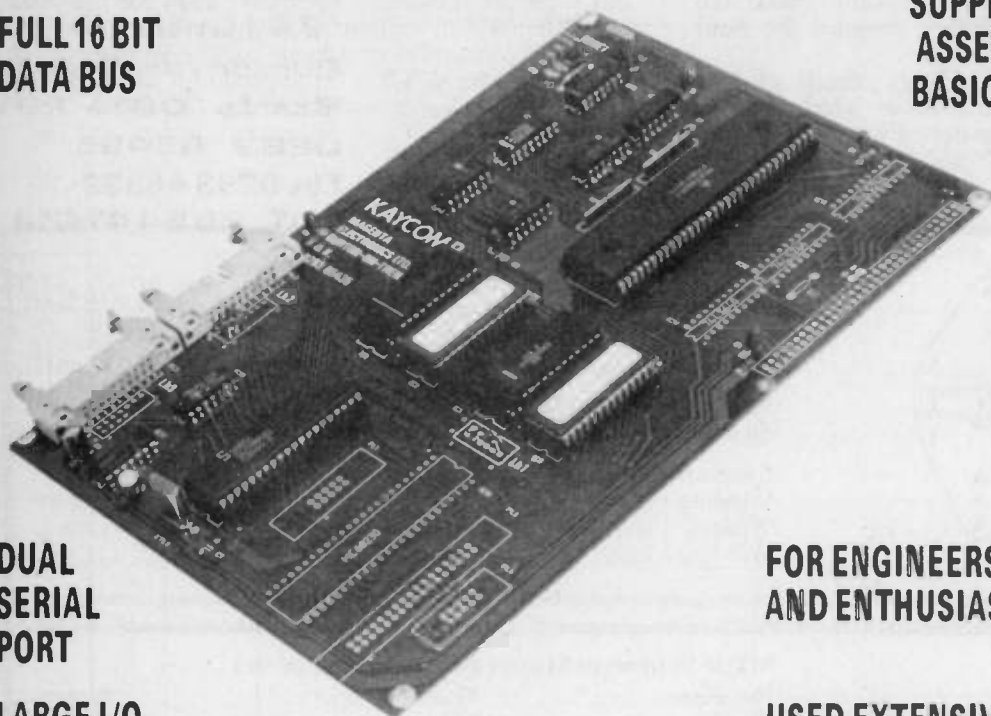

## MAGENTA 68000

The Magenta 68000 computer board is a low cost design/evaluation tool for educational and training applications. As it is such a low cost system it can be provided on a one-per-student basis.

### PROGRAMS

Programs are developed with an on-board monitor program and an optional line-by-line assembler/disassembler contained in EPROMS. The system is used with a host computer configured as a terminal, usually a BBC model B or a PC. Full details are given of the lead connections, and a short BBC program listing is given. There are many such programs for PCs the most common one being PROCOM.

### CROSS-ASSEMBLERS

The board is an ideal target system for use with cross-assembler programs. A particularly low cost approach to this is to use our 68000 cross-assembler program which runs on the BBC computer.

#### Minimum system with Monitor EPROMS

	ORDER CODE	PRICE
KIT	501-600	£110.00
BUILT	501-650	£138.00

#### With Monitor and Assembler EPROMs

KIT	501-601	£134.00
BUILT	501-651	£164.00

#### Add-ons

PIO/Timer	501-603	£11.88
G64 Interface	501-604	£5.99
16k RAM	501-605	£8.96
64k RAM	501-606	£16.88
Switch mode PSU	501-609	£18.95

## HARDWARE

The Magenta 68000 system is built on a top quality double sided board with Plated Through Holes and Solder Mask. Printed with component layout and identification. The system includes a DUART IC which provides serial communications with the host computer and a printer if required. Full RS232 levels are provided. 5V and 12V (pos and neg) supplies are required. Our supply type 501-609 provides this and has ample spare capacity for other connected systems. 8Mhz processor clock crystal, and a separate 3.6864Mhz are included.

### DATA PACKS

Operating Manual	501-612	£3.00
Monitor Source Listing and 68000 Data	501-610	£7.20
68681 and 68020 Data	501-611	£4.20

## 68020

A new option which allows the system to be upgraded to 68020 operation by plugging a daughter board into the 68000 socket. The board is a sophisticated 5 layer one using two PAL devices for the additional logic and resulting in a very compact design which can also accommodate the arithmetic co-processor 68881. The board is supplied with two 27256 EPROMS containing an enhanced operating system.

Price of the add on board does not include the 68020, or 68881 ICs but does include sockets for both and all other components so that the system is ready to go once the chips are inserted

ORDER CODE	501-616	£97.00
------------	---------	--------



# BABANI BOOKS

The full range of these excellent and popular low cost books. Order using the BP number.

BP128	20 PROGRAMS FOR THE ZX SPECTRUM & 16K ZX81	£1.95	BP266	ELECTRONIC MODULES & SYSTEMS FOR BEGINNERS	£3.95
BP125	25 SIMPLE AMATEUR BAND AERIALS	£1.95	BP74	ELECTRONIC MUSIC PROJECTS	£2.50
BP136	25 SIMPLE INDOOR & WINDOW AERIALS	£1.75	BP48	ELECTRONIC PROJECTS FOR BEGINNERS	£1.95
BP132	25 SIMPLE SW BROADCAST BAND AERIALS	£1.95	BP94	ELECTRONIC PROJECTS FOR CARS & BOATS	£1.95
BP145	25 SIMPLE TROPICAL & MW BAND AERIALS	£1.75	BP104	ELECTRONIC SCIENCE PROJECTS	£2.95
BP107	30 SOLDERLESS BREADBOARD PROJECTS BOOK 1	£2.95	BP56	ELECTRONIC SECURITY DEVICES	£2.50
BP113	30 SOLDERLESS BREADBOARD PROJECTS BOOK 2	£2.25	BP185	ELECTRONIC SYNTHESISER CONSTRUCTION	£2.95
BP39	50 (FET) FIELD EFFECT TRANSISTOR PROJECTS	£2.95	BP92	ELECTRONICS SIMPLIFIED-CRYSTAL SET CONSTRUCTION	£1.75
BP58	50 CIRCUITS USING 7400 SERIES ICs	£2.50	BP228	ESSENTIAL THEORY FOR THE ELECTRONICS HOBBYIST	£2.50
BP36	50 CIRCUITS USING GERMANIUM, SILICON & ZENER DIODES	£1.50	BP278	EXPERIMENTAL ANTENNA TOPICS	£3.50
BP37	50 PROJECTS USING RELAYS, SCRS & TRIACS	£2.95	BP254	FROM ATOMS TO AMPERES	£3.50
BP87	50 SIMPLE LED CIRCUITS BOOK 2	£1.95	BP144	FURTHER PRACTICAL ELECTRONICS CALCULATIONS & FORMULAE	£4.95
BP42	50 SIMPLE LED CIRCUITS	£1.95	BP188	GETTING STARTED WITH BASIC & LOGO ON AMSTRAD PCWS	£5.95
BP264	A CONCISE ADVANCED USERS GUIDE TO MS-DOS	£2.95	BP239	GETTING THE MOST FROM YOUR MULTIMETER	£2.95
BP263	A CONCISE INTRODUCTION TO DBASE	£3.95	BP181	GETTING THE MOST FROM YOUR PRINTER	£2.95
BP230	A CONCISE INTRODUCTION TO GEM	£2.95	BP205	HI-FI LOUDSPEAKER ENCLOSURES	£2.95
BP232	A CONCISE INTRODUCTION TO MS-DOS	£2.95	BP277	HIGH POWER AUDIO AMPLIFIER CONSTRUCTION	£3.95
BP260	A CONCISE INTRODUCTION TO OS-2	£2.95	BP121	HOW TO DESIGN & MAKE YOUR OWN PCBs	£2.50
BP270	A CONCISE INTRODUCTION TO SYMPHONY	£3.95	BP127	HOW TO DESIGN ELECTRONIC PROJECTS	£2.25
BP149	A CONCISE INTRODUCTION TO THE LANGUAGE OF BBC BASIC	£1.95	BP110	HOW TO GET YOUR ELECTRONIC PROJECTS WORKING	£2.50
BP262	A CONCISE INTRODUCTION TO WORDPERFECT	£2.95	BP101	HOW TO IDENTIFY UNMARKED ICs	£0.95
BP274	A CONCISE INTRODUCTION TO SUPERCALCS	£3.95	BP88	HOW TO USE OP-AMPS	£2.95
BP261	A CONCISE INTRODUCTION TO LOTUS1-2-3	£2.95	BP267	HOW TO USE OSCILLOSCOPES & OTHER TEST EQUIPMENT	£3.50
BP72	A MICROPROCESSOR PRIMER	£1.75	BP159	HOW TO WRITE AMSTRAD CPC464 GAMES PROGRAM	£2.50
BP187	A PRACTICAL REF. GUIDE TO WORD PROCESSING AMSTRAD 8256,8512	£5.95	BP175	HOW TO WRITE WORD GAME PROGRAMS AMSTRAD CPC 464,664,6128	£2.95
BP225	A PRACTICAL INTRODUCTION TO DIGITAL ICs	£2.50	BP157	HOW TO WRITE ZX SPECTRUM & SPECTRUM GAMES PROGRAMS	£2.50
BP176	A TV-DXERS HANDBOOK	£5.95	BP44	IC 555 PROJECTS	£2.95
BP112	A Z-80 WORKSHOP MANUAL	£3.95	BP97	IC PROJECTS FOR BEGINNERS	£1.95
BP276	ADVANCED SHORTWAVE RECEIVER CONSTRUCTION	£3.95	BP272	INTERFACING PCs & COMPATIBLES	£3.95
BP105	AERIAL PROJECTS	£2.50	BP108	INTERNATIONAL DIODE EQUIVALENTS GUIDE	£2.95
BP63	ALTERNATING CURRENT THEORY BOOK 2	£3.50	BP255	INTERNATIONAL RADIO STATIONS GUIDE	£4.95
BP199	AN INTRO TO BASIC 2 ON THE AMSTRAD PCS	£5.95	BP85	INTERNATIONAL TRANSISTOR EQUIVALENTS GUIDE	£3.50
BP177	AN INTRO TO COMPUTER COMMUNICATIONS	£2.95	BP161	INTO THE QL ARCHIVE	£2.50
BP133	AN INTRO TO PROGRAMMING THE DRAGON 32	£1.95	BP259	LEARNING INTRODUCTION TO UNIX	£2.95
BP129	AN INTRO TO PROGRAMMING THE ORIC 1	£1.95	BP141	LINEAR IC EQUIVALENTS & PIN CONNECTIONS	£5.95
BP147	AN INTRODUCTION TO 6502 MACHINE CODE	£2.95	BP193	LOGO FOR BEGINNERS	£2.95
BP184	AN INTRODUCTION TO 68000 ASSEMBLY LANGUAGE	£2.95	BP29	MAJOR SOLID STATE AUDIO HI-FI CONSTRUCTION PROJECTS	£0.85
BP257	AN INTRODUCTION TO AMATEUR RADIO	£3.50	BP130	MICRO INTERFACING CIRCUITS BOOK 1	£2.25
BP198	AN INTRODUCTION TO ANTENNA THEORY	£2.95	BP121	MICRO INTERFACING CIRCUITS BOOK 2	£2.25
BP86	AN INTRODUCTION TO BASIC PROGRAMMING TECHNIQUES	£1.95	BP77	MICROPROCESSING SYSTEMS & CIRCUITS BOOK 4	£3.95
BP268	AN INTRODUCTION TO COMPUTER GRAPHICS IBM & COMPATIBLES	£4.95	BP184	MIDI PROJECTS	£2.95
BP170	AN INTRODUCTION TO COMPUTER PERIPHERALS	£2.50	BP99	MINI-MATRIX BOARD PROJECTS	£2.50
BP269	AN INTRODUCTION TO DESK TOP PUBLISHING	£5.95	BP246	MUSICAL APPLICATIONS FOR THE ATARISTS	£5.95
BP256	AN INTRODUCTION TO LOUDSPEAKERS & ENCLOSURE DESIGN	£2.95	BP95	MODEL RAILWAY PROJECTS	£2.95
BP154	AN INTRODUCTION TO MSX BASIC	£2.50	BP106	MODERN OP-AMP PROJECTS	£1.95
BP142	AN INTRODUCTION TO PROGRAMMING THE ACORN ELECTRON	£1.95	BP194	MODERN OPTO DEVICE PROJECTS	£2.95
BP153	AN INTRODUCTION TO PROGRAMMING THE AMSTRAD CPC464 & 664	£2.50	BP249	MORE ADVANCED TEST EQUIPMENT CONSTRUCTION	£3.50
BP139	AN INTRODUCTION TO PROGRAMMING THE BBC MODEL B MICRO	£1.95	BP174	MORE ADVANCED ELECTRONIC MUSIC PROJECTS	£2.95
BP158	AN INTRODUCTION TO PROGRAMMING THE COMMODORE 16 & PLUS 4	£2.50	BP190	MORE ADVANCED ELECTRONIC SECURITY PROJECTS	£2.95
BP156	AN INTRODUCTION TO QL MACHINE CODE	£2.50	BP247	MORE ADVANCED MIDI PROJECTS	£2.95
BP91	AN INTRODUCTION TO RADIO DXING	£1.95	BP192	MORE ADVANCED POWER SUPPLY PROJECTS	£2.95
BP195	AN INTRODUCTION TO SATELLITE TELEVISION	£5.95	BP265	MORE ADVANCED USES OF THE MULTIMETER	£2.95
BP197	AN INTRODUCTION TO THE AMSTRAD PCS	£5.95	BP80	POPULAR ELECTRONIC CIRCUITS BOOK 1	£2.95
BP152	AN INTRODUCTION TO Z80 MACHINE CODE	£2.75	BP98	POPULAR ELECTRONIC CIRCUITS BOOK 2	£2.95
BP143	AN INTRODUCTION TO PROGRAMMING THE ATARI 600-800XL	£4.95	BP49	POPULAR ELECTRONIC PROJECTS	£2.50
BP111	AUDIO (ELEMENTS OF ELECTRONICS BOOKS 6)	£3.95	BP235	POWER SELECTOR GUIDE	£4.95
BP122	AUDIO AMPLIFIER CONSTRUCTION	£2.95	BP76	POWER SUPPLY PROJECTS	£2.50
BP120	AUDIO AMPLIFIER FAULT-FINDING CHART	£0.95	BP78	PRACTICAL COMPUTER EXPERIMENTS	£1.75
BP214	AUDIO ENTHUSIASTS HANDBOOK	£0.85	BP118	PRACTICAL ELEC. BUILDING BLOCKS BOOK 2	£1.95
BP90	AUDIO PROJECTS	£2.50	BP117	PRACTICAL ELEC. BUILDING BLOCKS BOOK 1	£1.95
BP138	BASIC & FORTH IN PARALLEL	£1.95	BP53	PRACTICAL ELECTRONICS CALCULATIONS & FORMULAE	£3.95
BP137	BASIC & FORTRAN IN PARALLEL	£1.95	BP208	PRACTICAL STEREO & QUADROPHONY HANDBOOK	£0.75
BP196	BASIC & LOGO IN PARALLAL	£2.95	BP250	PROGRAMMING IN FORTRAN 77	£4.95
BP126	BASIC & PASCAL IN PARALLEL	£1.50	BP45	PROJECTS IN OPTO-ELECTRONICS	£1.95
BP244	BBC BASIC86 ON AMSTD PCS & IBM COMP BK2 GRAPHICS&DSK FILES	£3.95	BP7	RADIO & ELECTRONIC COLOUR CODES DATA CHART	£0.95
BP243	BBC BASIC86 ON THE AMSTRAD PCS & IBM COMP BOOK 1 LANGUAGE	£3.95	BP240	REMOTE CONTROL HANDBOOK	£3.95
BP227	BEGIN GUIDE TO BUILDING ELECTRONIC PROJECTS	£1.95	BP28	RESISTOR SELECTION HANDBOOK	£0.60
BP220	BUILD YOUR OWN SOLID STATE HI-FI & AUDIO ACCESSORIES	£0.85	BP135	SECRETS OF THE COMMODORE 64	£1.95
BP27	CHART OF RADIO. ELECTRONIC SEMICONDUCTOR & LOGIC SYMBOLS	£0.95	BP64	SEMICONDUCTOR TECHNOLOGY BOOK 3	£3.50
BP68	CHOOSING & USING YOUR HI-FI	£1.65	BP191	SIMPLE APPLIC OF THE AMSTRAD CPCs FOR WRITERS	£2.95
BP160	COIL DESIGN & CONSTRUCTION MANUAL	£2.50	BP275	SIMPLE SHORTWAVE RECEIVER CONSTRUCTION	£3.95
BP89	COMMUNICATION BOOK 5	£2.95	BP219	SOLID STATE NOVELTY PROJECTS	£0.85
BP251	COMPUTER HOBBYISTS HANDBOOK	£5.95	BP248	TEST EQUIPMENT CONSTRUCTION	£2.95
BP173	COMPUTER MUSIC PROJECTS	£2.95	BP114	THE ART OF PROGRAMMING THE 16K ZX81	£2.50
BP148	COMPUTER TERMINOLOGY EXPLAINED	£1.95	BP109	THE ART OF PROGRAMMING THE 1K ZX81	£2.50
BP162	COUNTING ON QL ABACUS	£2.50	BP119	THE ART OF PROGRAMMING THE ZX SPECTRUM	£2.50
BP245	DIGITAL AUDIO PROJECTS	£2.95	BP146	THE PRE-BASIC BOOK	£2.95
BP140	DIGITAL IC EQUIVALENTS & PIN CONNECTIONS	£5.95	BP115	THE PRE-COMPUTER BOOK	£1.95
BP84	DIGITAL IC PROJECTS	£1.95	BP62	THE SIMPLE ELECTRONIC CIRCUIT & COMPONENTS BOOK 1	£3.50
BP171	EASY ADD-ON PROJECTS FOR AMSTRAD CPC464,664,6128 & MSX	£2.95	BP70	TRANSISTOR RADIO FAULT-FINDING CHART	£0.95
BP124	EASY ADD-ON PROJECTS FOR SPECTRUM ZX81 & ACE	£2.95	BP234	TRANSISTOR SELECTOR GUIDE	£4.95
BP180	ELECTRONIC CIRCUITS FOR COMPUTER CONTROL MODEL RAILWAYS	£2.95	BP272	UPGRADING & REPAIRING PCs & COMPATIBLES	£3.95
BP179	ELECTRONIC CIRCUITS FOR COMPUTER CONTROL OF ROBOTS	£2.95	BP273	USING ELECTRONIC SENSORS	£3.95
BP69	ELECTRONIC GAMES	£1.75	BP189	USING YOUR AMSTRAD CPC DISC DRIVES	£2.95
BP233	ELECTRONIC HOBBYISTS HANDBOOK	£4.95			

## RESISTORS

Carbon Film 5% 0.25 Watt

E12 series: 1, 1.2, 1.5, 1.8, 2.2, 2.7, 3.3, 3.9, 4.7, 5.6, 6.8, 8.2, 10 etc. and all decades from 1ohm to 10Meg.

**ORDER CODE 100-1R, 100-1k8, 100-470k etc.**  
all values 2p each or 12p for 10 of 1 value.



Carbon Film 5% 2 Watt

E12 series (as 0.25 W) range 1R to 1Meg

**ORDER CODE 101-1R, 101-1k, 101-33k etc.**  
all values 12p each or 50p for 5 of 1 value.



Metal Film 1% 0.6 Watt

E 24 series: 1, 1.1, 1.2, 1.3, 1.5, 1.6, 1.8, 2.0, 2.2, 2.4, 2.7, 3.0, 3.3, 3.6, 3.9, 4.3, 4.7, 5.1, 5.6, 6.2, 6.8, 7.5, 8.2, 9.1, 10. and all decades from 4R7 to 1Meg.

**ORDER CODE 102-4.7R, 102-16k etc.**  
all values 4p each or 30p for 10 of 1 value



Wirewound 5% 2.5 Watt resin coated

E12 series from 0.1 ohm to 1k

**ORDER CODE 103-0.1R, 103 33R etc.**  
all values 28p each or £1.10 for 5 of 1 value

## RESISTOR NETWORKS

SINGLE IN LINE (SIL)

Networks containing 7 or 8 resistors of the same value with a single common connection at one end. Values: 100R, 220R, 470R, 1k, 2k2, 4k7, 10k, 22k, 47k.

**ORDER CODE 7 Way 104-100R etc. 20p each**  
**8 Way 105-100R etc. 22p each**



## OPEN PRESETS

Miniature Horizontal and Vertical Open Type  
0.1 Watt

100R, 220R, 470R, 1k, 2k2, 4k7, 10k, 22k, 47k, 100k, 220k, 470k, 1M, 2M2.

**ORDER CODE Vertical 106-100R etc. 14p**  
**Horizontal 107-100R etc. 14p**



## MULTITURN PRESETS

Standard 3/4 inch type with  
end adjustment

100R, 200R, 500R, 1k, 2k, 5k, 10k, 20k, 50k, 100k, 200k, 500k, and 1M

**ORDER CODE 116-100R etc. 89p each**



10mm Square, top adjustment  
Range of values as type 116



**ORDER CODE 118-100R etc. £1.20 each**

## POTENTIOMETERS

Midget Carbon, Single

Standard size pots with 3/8  
mounting bushes and 1/4 spindles

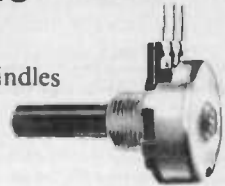

LINEAR and LOG Values:

4k7, 10k, 22k, 47k, 100k, 220k, 470k, 1M, 2M2.

Reverse log (antilog) 470R and 470k only

**ORDER CODE LIN 108-4K7 etc. 56p each**  
**LOG 109-4k7 etc. 58p each**  
**REVERSE LOG 110-470R etc. 98p each**

Switched - DPST 2A Mains switch.

values LIN and LOG

4k7, 10k, 22k, 47k, 100k, 220k, 470k, 1M

**ORDER CODE**

**LIN 111-4K7 etc. £1.20 each**

**LOG 112-4k7 etc. £1.22 each**

Dual Ganged (Stereo)

LIN and LOG values (both sections the same)

10k, 47k, 100k, 470k.

**ORDER CODE**

**LIN 113-10k etc. £1.56 each**

**LOG 114-10k etc. £1.58 each**

## THERMISTORS

Disc type - Negative TC

5mm diameter disc thermistors for temperature sensing  
and measurement. Resistance given at 25 and 100 deg.C

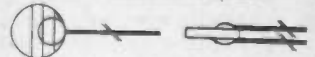

R 25	R 100	ORDER CODE	PRICE
300R	40R	115-010	all 59p each
1k	80R	115-012	
4k7	380R	115-014	
15k	1k2	115-016	
33k	2k8	115-018	
100k	9k0	115-021	

Rod type TH3 - Negative TC

Used for sensing and circuit  
surge protection.

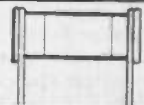

**ORDER CODE 115-030 £1.95 each**

Glass Vacuum Sealed - R53  
For amplitude stabilisation in  
oscillators

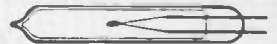

**ORDER CODE 115-033 £7.49 each**

## CAPACITORS

CERAMIC PLATE Sub Min. 50V

2.5 mm pitch, long leads.

2.2pF, 3.3, 4.7, 5.6, 6.8, 8.2, 10, 15, 22 TC NP0;  
33, 47, 56, 68 TC N150; 82, 100 TC N750.

**ORDER CODE 136-2.2p etc 8p each**

150, 180, 220, 270, 390, 470, 560, 680, 1000 (1nF), 2200  
(2n2), 3300 (3n3), 4700 (4n7); High K dielectric.

**ORDER CODE 138-470p etc. 8p each**

CERAMIC DISC 50V

Coupling and decoupling capacitors

High K dielectric. 5mm lead pitch.

10nF, 22nF, 33nF, 47nF, 100nF.



**ORDER CODE 140-10n etc. 8p each**  
**140-100n only 10p each**

# COMPONENTS

## CAPACITORS

### CERAMIC DISC HIGH VOLTAGE

High voltage discs for mains suppression, Voltage multipliers, and contact protection.

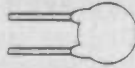

1nF 1000V	141-131	18p
4n7 500V	141-132	20p
10nF 1000v	141-136	22pp

### POLYSTYRENE

Highly stable 63V 5%. N150 TC  
10, 15, 22, 33, 47, 68, 100, 150, 220,  
330, 470, 680,



<b>ORDER CODE</b>	<b>142-10p etc</b>	<b>16p each</b>
-------------------	--------------------	-----------------

1nF, 1n5, 2n2, 3n3, 4n7

<b>ORDER CODE</b>	<b>142-1n etc</b>	<b>16p each</b>
-------------------	-------------------	-----------------

5n6, 6n8, 8n2, 10n

<b>ORDER CODE</b>	<b>142-5n6 etc</b>	<b>28p each</b>
-------------------	--------------------	-----------------

### MYLAR

General purpose 100V 10% low cost  
Polyester film. Resin Coated

VALUE	ORDER CODE	PRICE
.001uF	148-101	7p each
.0022uF	148-102	8p each
.0047uF	148-104	8p each
.01uF	148-110	9p each
.015uF	148-115	12p each
.022uF	148-122	13p each
.033uF	148-133	15p each
.047uF	148-147	15p each
0.1uF	148-200	16p each

### MINIATURE LAYER, PETP

High quality block foil construction  
10% tolerance. Compact construction

VALUE	ORDER CODE	PRICE
.01uF 400V	153-101	14p each
.022uF 250V	153-102	14p each
.047uF 250V	153-104	16p each
0.1u F 100V	153-110	16p each
0.22uF 100V	153-120	22p each
0.33u F 100V	153-130	26p each
0.47uF 100V	153-140	34p each
0.68uF 100V	153-160	42p each
1uF 100V	153-200	36p each
2.2uF 100V	153-220	68p each

### C368 POLYESTER 250V DC (C280)

Standard resin dipped capacitors  
20% tolerance.

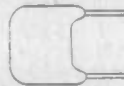

VALUE	ORDER CODE	PRICE
.01uF	164-101	9p each
.15uF	164-102	9p each
.022uF	164-103	9p each
.033uF	164-104	9p each
.047uF	164-105	9p each
.068uF	164-106	10p each
0.1u F	164-110	12p each
0.15uF	164-115	14p each
0.22uF	164-120	18p each
0.33u F	164-130	22p each
0.47uF	164-140	28p each
0.68uF	164-160	38p each
1uF	164-200	44p each
1.5uF	164-215	59p each
2.2uF	164-220	86p each

## SUPPRESSION CAPACITORS

Class X2 for direct connection  
across the mains. Radial leads



VALUE	ORDER CODE	PRICE
.022uF	185-102	28p each
.047uF	185-104	32p each
0.1u F	185-110	36p each
0.22uF	185-120	64p each
0.33u F	185-130	78p each
0.47uF	185-140	95p each

## TANTALUM BEAD

Low leakage and series inductance  
for decoupling and timing circuits



VALUE	ORDER CODE	PRICE
0.1uF 35V	170-101	14p
0.22uF 35V	170-102	14p
0.33uF 35V	170-103	14p
0.47uF 35V	170-104	14p
1uF 35v	170-110	14p
1.5uF 35V	170-115	16p
2.2uF 35V	170-122	20p
3.3uF 35V	170-133	26p
4.7uF 35V	170-147	29p
6.8uF 35V	170-168	30p
10uF 16V	170-210	28p
10uF 35V	170-211	38p
15uF 16V	170-215	39p
22uF 16V	170-222	40p
22uF 25V	170-223	60p
33uF 16V	170-230	80p
47uF 10V	170-240	70p
47uF 16V	170-241	82p
100uF 3V	170-300	80p
100uF 10V	170-301	£1.80

## AXIAL ELECTROLYTIC CAPACITORS

Miniature axial lead  
capacitors.  
Polarity indicated by  
negative signs on sleeve.

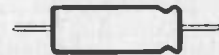

VALUE	ORDER CODE	PRICE
1uF 63V	180-110	10p
2.2uF 63V	180-112	10p
3.3uF 63V	180-113	10p
4.7uF 40V	180-114	10p
10uF 25v	180-120	14p
10uF 63V	180-121	18p
22uF 16V	180-122	14p
22uF 25V	180-222	16p
22uF 63V	180-322	17p
33uF 40V	180-123	16p
47uF 16V	180-124	14p
47uF 25V	180-224	16p
47uF 40V	180-324	16p
47uF 63V	180-424	18p
100uF 16V	180-130	16p
100uF 25V	180-230	18p
100uF 40V	180-330	20p
100uF 63V	180-430	28p
220uF 16V	180-132	20p
220uF 40V	180-232	30p
330uF 10V	180-133	20p
470uF 16V	180-134	28p
470uF 25V	180-234	38p
470uF 40V	180-334	42p
470uF 63V	180-434	54p
1000uF 10V	180-140	38p
1000uF 25V	180-240	50p
1000uF 40V	180-340	65p
1000uF 63V	180-440	80p
2200uF 25V	180-142	78p
2200uF 40V	180-242	84p
2200uF 63V	180-342	90p
4700uF 25V	180-144	£1.22



**CAPACITORS**

**RADIAL ELECTROLYTICS**

Miniature radial lead capacitors plastic sleeved, polarity indicated by negative signs on one side



VALUE		ORDER CODE	PRICE
1uF	63V	181-110	8p
2.2uF	63V	181-112	8p
3.3uF	63V	181-113	8p
4.7uF	40V	181-114	8p
10uF	25v	181-120	8p
10uF	63V	181-121	9p
22uF	16V	181-122	8p
22uF	25V	181-222	8p
22uF	63V	181-322	12p
33uF	40V	181-123	14p
47uF	16V	181-124	10p
47uF	25V	181-224	12p
47uF	40V	181-324	16p
47uF	63V	181-424	18p
100uF	16V	181-130	12p
100uF	25V	181-230	14p
100uF	40V	181-330	16p
100uF	63V	181-430	22p
220uF	16V	181-132	16p
220uF	25V	181-232	22p
330uF	10V	181-133	12p
470uF	16V	181-134	18p
470uF	25V	181-234	24p
470uF	40V	181-334	36p
470uF	63V	181-434	44p
1000uF	10V	181-140	26p
1000uF	25V	181-240	29p
1000uF	40V	181-340	34p
1000uF	63V	181-440	60p
2200uF	25V	181-142	72p
2200uF	40V	181-242	80p
2200uF	63V	181-342	86p
4700uF	25V	181-144	£1.14

**COMPRESSION TRIMMERS**

100-470pF Rectangular trimmers

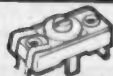

ORDER CODE	188-100	72p each
------------	---------	----------

**MINIATURE ROTARY FILM TRIMMERS**

General purpose compact trimmers for crystal and RFtrimming.



VALUE	ORDER CODE	PRICE
2 -10pF	188-120	36p
2 -22pF	188-121	44p
5.5 - 65pF	188-122	52p

**JACKSON C804 TUNING CAPACITORS**

Top quality tuning capacitors for short wave construction. 1/4 shaft

VALUE	ORDER CODE	PRICE
10pF	188-130	£5.20
22pF	188-131	£4.89
50pF	188-132	£5.28

**MINIATURE TUNING CAPACITORS**

Solid dielectric type with 2 - 330pF sections (AM) and 2 - 30pF sections (FM) plus 4 trimmers

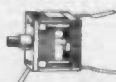

ORDER CODE	188-151	£1.24 each
------------	---------	------------

**COILS & TRANSFORMERS**

**FERRITE ROD**

3/8 Dia 5 1/2 long rods suitable for MW and LW

ORDER CODE	201-100	69p each
------------	---------	----------

**COILS & TRANSFORMERS**

**FERRITE ROD AERIAL**

Our 3/8 Ferrite rod fitted with LW and MW coils. Both coils are wound on paxolin tubes fitted with 4 solder tags and have separate coupling windings.

ORDER CODE	201-102	£1.44 each
------------	---------	------------

**LW COIL AND MW COIL**

Long wave and Medium wave coils available separately, fit any 3/8 rod



TYPE	ORDER CODE	PRICE
M.W. coil	201-105	69p each
L.W. coil	201-108	72p each

**MAINS TRANSFORMERS**

A range of British made transformers with twin primary windings for 120 / 240v operation. Twin secondary windings allow series operation for double voltage or parallel for double current. When series connected the centre link can be used to make 6-0-6V outputs etc.

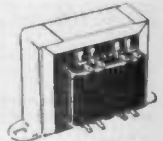

**6 VA Output (3 VA) per winding.**

W 45 D 40 H 37mm Regulation 25% Mtg Ctrs 53mm

OUTPUT	ORDER CODE	PRICE
2 x 4.5V 0.6A	204-100	£3.98 each
2 x 6V 0.5A	204-102	
2 x 9V 0.33A	204-105	
2 x 12V 0.25A	204-108	
2 x 15V 0.2A	204-109	
2 x 20V 0.15A	204-112	

**12 VA Output (6 VA) per winding.**

W 59 D 50 H 50mm Regulation 10% Mtg Ctrs 70mm

OUTPUT	ORDER CODE	PRICE
2 x 4.5V 1.3A	204-200	£5.20 each
2 x 6V 1A	204-202	
2 x 9V 0.6A	204-205	
2 x 12V 0.5A	204-208	
2 x 15V 0.4A	204-209	
2 x 20V 0.3A	204-212	

**20 VA Output (12 VA) per winding.**

W 68 D 54 H 58mm Regulation 7% Mtg Ctrs 85mm

OUTPUT	ORDER CODE	PRICE
2 x 4.5V 2.2A	204-300	£5.98 each
2 x 6V 1.6A	204-302	
2 x 9V 1.1A	204-305	
2 x 12V 0.8A	204-308	
2 x 15V 0.6A	204-309	
2 x 20V 0.5A	204-312	

**50 VA Output (25 VA) per winding.**

W 79 D62 H 65mm Regulation 10% Mtg Ctrs 92mm

OUTPUT	ORDER CODE	PRICE
2 x 4.5V 5.5A	204-400	£8.24 each
2 x 6V 4.1A	204-402	
2 x 9V 2.7A	204-405	
2 x 12V 2A	204-408	
2 x 15V 1.6A	204-409	
2 x 20V 1.2A	204-412	

**MAINS ISOLATING 12VA**

240V - 240V 50mA ideal for testing low powered Mains equipment safely.

ORDER CODE	204-224	£3.98 each
------------	---------	------------

# COMPONENTS

## PLUG-IN POWER SUPPLIES

### LOW VOLTAGE MULTI-OUTPUT SUPPLIES

Three types available, all have switchable output voltages of 3, 4.5, 6, 7.5, 9, and 12V

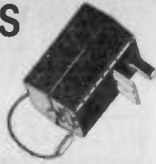

OUTPUT	ORDER CODE	PRICE
300mA unregulated	204-500	£3.85
300mA regulated	204-501	£7.98
500mA regulated	204-502	£11.95

## FUSES AND FUSEHOLDERS

### QUICK BLOW and ANTI-SURGE

20 x 5mm glass.

250, 315, 500mA, 1, 1.25, 1.6, 2, 2.5, 3.15, 5, 6.3A

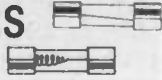

TYPE	ORDER CODE	PRICE
QUICK BLOW	220-250mA etc.	14p
ANTI-SURGE	221-250mA etc.	20p

### QUICK BLOW and ANTI-SURGE

1-1/4 x 1/4 glass.

250, 500mA, 1A, 1.25A, 2A, 5A, 10A

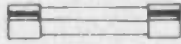

TYPE	ORDER CODE	PRICE
QUICK BLOW	224-250mA etc.	20p
ANTI-SURGE	225-250mA etc.	30p

### AXIAL THERMAL FUSES

Metal body 250V 15A thermal fuses

72, 98, 121, 141, 169, 184, and 228 deg. C

ORDER CODE	226-72deg. etc.	82p each
------------	-----------------	----------

### FUSEHOLDERS

Panel mounting fuseholders for 20mm fuses. Finger release. 6A rated.



ORDER CODE	230-100	48p each
------------	---------	----------

### OPEN CHASSIS FUSEHOLDER 20mm

Solder tag connections, one hole fixing.



ORDER CODE	230-102	18p each
------------	---------	----------

### IN-LINE 1-1/4 FUSEHOLDER

For car radio and audio leads.



ORDER CODE	230-112	22p each
------------	---------	----------

## RELAYS

### MINIATURE CRADLE RELAYS

Plug-in or solder directly. Standard 2 pole changeover relays. Contacts rated 250V AC 1A. Coil: 12V type, 185 ohms 5V type 200 ohms.

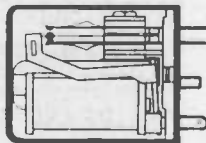

TYPE	ORDER CODE	PRICE
12V 185 ohm	240-100	£3.98
5V 200 ohm	240-104	£3.64

### UPRIGHT PCB MOUNTING

#### 10 AMP RELAYS.

SPDT 250V AC, 24V DC 10A rating

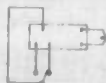

TYPE	ORDER CODE	PRICE
12V 280 ohm	240-106	£2.42
6V 70 ohm	240-108	£2.42

### UPRIGHT PCB MOUNTING

#### 16 AMP RELAYS

SPDT 250V AC, 16A rating

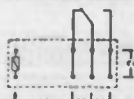

TYPE	ORDER CODE	PRICE
12V 280 ohm	240-112	£2.94
24V1100 ohm	240-115	£2.94

### UPRIGHT PCB MOUNTING

#### 10A RELAYS

DPDT 250V AC 10A contacts  
12V 280 ohm coil

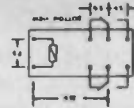

ORDER CODE	240-118	£3.34 each
------------	---------	------------

### ECONOMY PCB MOUNTING

#### 10A RELAYS

Enclosed low cost sensitive relays

SPDT 10A 110V AC, 24V DC contacts



TYPE	ORDER CODE	PRICE
6V 100 ohm	240-122	£1.40
12V 4200 ohm	240-123	£1.42
24V 1800 ohm	240-124	£1.68

## SWITCHES

### MINIATURE TOGGLE SWITCHES

2A 250V AC 1/4 fixing hole. Standard, Centre-Off, and Biased (spring return to centre)

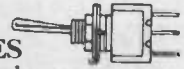

TYPE	ORDER CODE	PRICE
SPST	244-100	79p
SPDT	244-102	89p
DPDT	244-104	95p
DPDT Centre OFF	244-106	£1.05
DPDT Bias one way	244-108	£1.24
DPDT Bias two ways	244-110	£1.30

### STANDARD TOGGLE SWITCHES

2A 250V AC 12mm fixing hole.

SPST and DPDT Types.

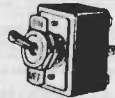

TYPE	ORDER CODE	PRICE
SPST	242-100	57p
DPDT	244-102	77p

### MINIATURE PUSH SWITCHES

Low voltage 1A switches. Push to Make (red top) Push to Break (black top)



TYPE	ORDER CODE	PRICE
Push to Make	246-100	19p
Push to Break	246-102	23p

### PUSH ON / PUSH OFF

Single pole 1A screw terminals alternate action



ORDER CODE	248-100	34p each
------------	---------	----------

### FOOTSWITCHES

Large chrome plunger, heavy duty SPDT and DPDT types. Low voltage.



TYPE	ORDER CODE	PRICE
SPDT	248-112	£2.60
DPDT	248-114	£2.95

### ROCKER SWITCHES

10A AC mains rated black rocker switches. 1/4 spade contacts.

30 x 11mm SP, 30 x 22mm DP.



TYPE	ORDER CODE	PRICE
SPST	248-121	90p
SPDT	248-122	96p
DPST	248-124	£1.08
DPDT	248-127	£1.16

### MINIATURE ROCKER SWITCHES

10A SPST and SPDT rocker switches Black body fits 19.3 x 13mm hole.



TYPE	ORDER CODE	PRICE
SPST	248-130	62p
SPDT	248-131	78p

## SWITCHES

**MINIATURE KEYPAD SWITCH**  
PCB mounting push to make.  
Positive feel, excellent quality



<b>ORDER CODE</b>	<b>248-140</b>	<b>28p each</b>
-------------------	----------------	-----------------

**PCB MOUNTING PUSH TO MAKE SWITCH.**

A high quality upright push to make switch  
8mm x 6mm rectangular button

<b>ORDER CODE</b>	<b>248-142</b>	<b>29p each</b>
-------------------	----------------	-----------------

**DIL SWITCHES**

Switches with standard IC pin layout  
4 way SPST (8 pin) 4 way DPDT (16 pin)  
8 way SPST (16 pin)



TYPE	ORDER CODE	PRICE
<b>4P SPST</b>	<b>248-200</b>	<b>79p</b>
<b>4P SPDT</b>	<b>248-202</b>	<b>£1.99</b>
<b>8P SPST</b>	<b>248-204</b>	<b>96p</b>

**ROTARY HEXADECIMAL DIL SWITCH**

BCD coded 16 position rotary switch in 8mm square 5 pin package. 0 to F, screwdriver slot.

<b>ORDER CODE</b>	<b>248-218</b>	<b>£1.48 each</b>
-------------------	----------------	-------------------

**SLIDE SWITCH - SUB MIN PCB**

SPST 12 x 5 x 5mm

<b>ORDER CODE</b>	<b>248-224</b>	<b>11p each</b>
-------------------	----------------	-----------------

**MINIATURE SLIDE SWITCH**

DPDT Panel mounting type 15 x 8 x 7



<b>ORDER CODE</b>	<b>248-226</b>	<b>18p each</b>
-------------------	----------------	-----------------

**CENTRE OFF SLIDE SWITCH**

DPDT 22 x 13 x 8mm 2 - M3 fixings

<b>ORDER CODE</b>	<b>248-228</b>	<b>28p each</b>
-------------------	----------------	-----------------

**1 POLE 3 WAY SLIDE SWITCH**

PCB mounting with side acting slider  
Gold plated contacts 25 x 7 x 7mm

<b>ORDER CODE</b>	<b>248-230</b>	<b>34p each</b>
-------------------	----------------	-----------------

**MULTIPOLE ROTARY SWITCHES**

24V 1A or 240V 150mA. 1/4 spindle  
Plastic body, solder tag connections. Adjustable end stop. 3/8 fixing bush.



TYPE	ORDER CODE	PRICE
<b>1Pole 12 Way</b>	<b>248-240</b>	<b>96p each</b>
<b>2Pole 6 Way</b>	<b>248-241</b>	
<b>3Pole 4 Way</b>	<b>248-242</b>	
<b>4Pole 3 Way</b>	<b>248-243</b>	

**MAINS ROTARY ON/OFF SWITCH**

2A mains DPST 1/4 spindle

<b>ORDER CODE</b>	<b>248-246</b>	<b>94p each</b>
-------------------	----------------	-----------------

**MERCURY TILT SWITCHES**

Glass tilt switches 1A rating  
For burglar alarms and sensors. 20mm long x 8mm dia.



<b>ORDER CODE</b>	<b>248-320</b>	<b>65p each</b>
-------------------	----------------	-----------------

**REED SWITCH**

Glass reed switch. 25mm long



<b>ORDER CODE</b>	<b>248-306</b>	<b>19p each</b>
-------------------	----------------	-----------------

**MAGNET 3 X 3 X 20MM** For reed switches

<b>ORDER CODE</b>	<b>248-310</b>	<b>49p each</b>
-------------------	----------------	-----------------

## MICROSWITCHES

Standard size (V3) SPDT 250V 10A  
Button, 25mm Lever, and 25mm Lever with Roller.

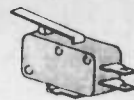

TYPE	ORDER CODE	PRICE
<b>Button</b>	<b>248-250</b>	<b>94p</b>
<b>Lever</b>	<b>248-251</b>	<b>£1.08</b>
<b>Roller</b>	<b>248-252</b>	<b>£1.16</b>

**MINIATURE MICROSWITCHES**

Miniature (V4) microswitches 5A 250V rating. SPDT 20 x 10 x 6mm  
Button, 15mm Lever and 15mm Lever with Roller

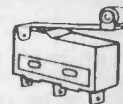

TYPE	ORDER CODE	PRICE
<b>Button</b>	<b>248-265</b>	<b>64p</b>
<b>Lever</b>	<b>248-266</b>	<b>80p</b>
<b>Roller</b>	<b>248-267</b>	<b>£1.04</b>

**LOCKSWITCH**

British made switch with high security lock. 10A 12V, 4A250V DPDT. Key removable in both positions. 19mm panel hole



<b>ORDER CODE</b>	<b>248-300</b>	<b>£4.80 each</b>
-------------------	----------------	-------------------

**LOCKSWITCH**

British made switch with high security lock. 1A 12V, 1 pole 3 way. Key removable in all positions. 19mm panel hole

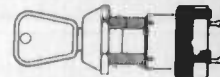

<b>ORDER CODE</b>	<b>248-303</b>	<b>£4.68 each</b>
-------------------	----------------	-------------------

## CABLE & WIRE

**RIBBON CABLE**

0.05 pitch standard cable for IDC connectors. Plain grey and rainbow colour coded types. 10, 20, and 40 way. Easily split to narrower sizes.

TYPE	ORDER CODE	PRICE
<b>10 Way Grey</b>	<b>250-010</b>	<b>33p/m</b>
<b>20 Way</b>	<b>250-012</b>	<b>65p/m</b>
<b>40 Way</b>	<b>250-014</b>	<b>£1.32/m</b>
<b>10 Way Rainbow</b>	<b>250-020</b>	<b>64p/m</b>
<b>20 Way</b>	<b>250-022</b>	<b>£1.20/m</b>
<b>40 Way</b>	<b>250-024</b>	<b>£1.99/m</b>

**SINGLE SCREENED CABLE**

PVC insulated grey 3mm dia.  
10 - 0.12mm core, Lapped screen



<b>ORDER CODE</b>	<b>250-032</b>	<b>18p/m</b>
-------------------	----------------	--------------

**4 CORE INDIVIDUALLY SCREENED**

4 x 7 - 0.1mm cores with individual screens  
5mm dia. Ideal for HIFI leads etc.

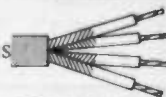

<b>ORDER CODE</b>	<b>250-036</b>	<b>35p/m</b>
-------------------	----------------	--------------

**TWIN SCREENED FIG 8**

Two screened cables bonded side by side  
Black. For headphone leads etc.



<b>ORDER CODE</b>	<b>250-040</b>	<b>25p/m</b>
-------------------	----------------	--------------

**MICROPHONE CABLE**

Twin twisted mic cable screened overall  
Tough black outer 6mm dia. For trailing mic and instrument leads. Balanced or unbalanced.



<b>ORDER CODE</b>	<b>250-040</b>	<b>60p/m</b>
-------------------	----------------	--------------

**MULTICORE SCREENED CABLE**

15 Core 7 - 0.16mm 7.5mm dia. Braid screen.

<b>ORDER CODE</b>	<b>250-050</b>	<b>68p/m</b>
-------------------	----------------	--------------

# COMPONENTS

## CABLE & WIRE

### MULTICORE CABLE

Unscreened 7-0.12mm cores  
13 way 6mm dia.



<b>ORDER CODE</b>	<b>250-046</b>	<b>34p/m</b>
-------------------	----------------	--------------

### MAINS CABLE

3 Core white PVC outer.



TYPE	ORDER CODE	PRICE
2.5A	250-061	26p/m
3A	250-062	39p/m
6A	250-063	52p/m
10A	250-064	58p/m
13A	250-065	68p/m

### SPEAKER CABLE

Twin fig. 8 marked one side for polarity.



TYPE	ORDER CODE	PRICE
7/0.2 1Amp	250-080	10p/m
13/0.2 2Amp	250-081	15p/m
16/0.2 4Amp	250-082	24p/m
32/0.2 9Amp	250-083	40p/m

### CONNECTING WIRE

1/0.6mm solid core wire 1A. Colours: Red, Black, Green, Yellow, Blue, White, Brown, Grey, Pink, Orange, Violet. supplied in multiples of 10m of a colour.



<b>ORDER CODE</b>	<b>250-088/Colour</b>	<b>69p/10m</b>
-------------------	-----------------------	----------------

7/0.2 stranded core 1A. Colours as 1/0.6

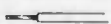

<b>ORDER CODE</b>	<b>250-092/Colour</b>	<b>59p/10m</b>
-------------------	-----------------------	----------------

16/0.2 stranded core 4A.

Colours: Red, Black, Green, Blue, Yellow.

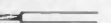

<b>ORDER CODE</b>	<b>250-096/Colour</b>	<b>95p/10m</b>
-------------------	-----------------------	----------------

32/0.2 stranded core 9A.

Colours: Red, Black, Green.

<b>ORDER CODE</b>	<b>250-098/Colour</b>	<b>£1.30/10m</b>
-------------------	-----------------------	------------------

### INSULATING SLEEVING

High temperature PVC. 5m lengths.

Colours: Red, Black, Green, Blue, Brown.

TYPE	ORDER CODE	PRICE
1mm Bore	250-110/Colour	55p/5m
1.5mm	250-111/Colour	75p/5m
2mm	250-112/Colour	90p/5m
3mm	250-113/Colour	£1.05/5m
4mm	250-114/Colour	£1.15/5m

## CASES

Top quality ABS Cases (Bimboxes)

Black cases with PCB guides around all sides. Metal threaded inserts for lid screws. Cut and drill very well. Polished finish.

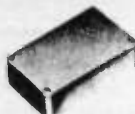

W x L x H	ORDER CODE	PRICE
100 x 50 x 25	252-100	£1.98
112 x 62 x 31	252-101	£2.28
120 x 65 x 40	252-102	£2.56
150 x 80 x 50	252-103	£3.24
190 x 110 x 60	252-104	£4.85

### POLYSTYRENE CASE

Low cost good quality case, no PCB guides 112 x 62 x 31.

<b>ORDER CODE</b>	<b>252-108</b>	<b>£1.35 each</b>
-------------------	----------------	-------------------

## CASES

ABS cases

Black cases with PCB guides.

Brass threaded inserts for lid screws.

Cut and drill very well. Polished finish.

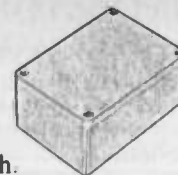

W x L x H	ORDER CODE	PRICE
80 x 62 x 40	252-112	£1.85
102 x 78 x 40	252-113	£2.05
120 x 100 x 45	252-114	£2.20
212 x 126 x 82	252-115	£2.80
220 x 150 x 64	252-116	£3.60

### FOLDED ALUMINIUM BOXES

Two piece boxes made from aluminium sheet covered with plastic protection film

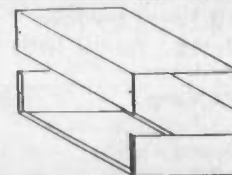

W x L x H	ORDER CODE	PRICE
133 x 70 x 38	252-137	£1.95
102 x 70 x 38	252-139	£1.90
100 x 133 x 38	252-140	£2.26
100 x 64 x 50	252-141	£1.90
75 x 50 x 25	252-142	£1.28
152 x 102 x 50	252-143	£2.75
203 x 152 x 76	252-145	£4.98

### ALUMINIUM / STEEL CASES

Two part cases with textured PVC coated steel tops and plastic protected aluminium bases.

Tops are black except 252-158 which is blue.

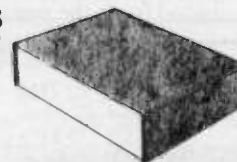

W x L x H	ORDER CODE	PRICE
152 x 102 x 38	252-150	£3.95
229 x 127 x 64	252-152	£5.95
280 x 191 x 89	252-154	£7.95
152 x 178 x 182	252-158	£7.95

### ABS CASES WITH METAL LIDS

Black ABS bases with PCB guides.

Grey plastic coated aluminium recessed panels.

Very neat appearance.

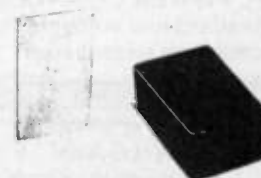

W x L x H	ORDER CODE	PRICE
85 x 56 x 29	252-173	£2.25
111 x 76 x 42	252-174	£2.75
161 x 96 x 53	252-175	£3.45

### SLOPING TOP CASES

Similar to 252-173 but with sloping top

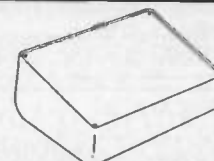

W x L x H	ORDER CODE	PRICE
161 x 96 x 39 (57)	252-185	£2.85
215 x 130 x 47 (73)	252-186	£4.48

### SLOPING TOP CASES

A different type of sloping top case with a metal wrap over panel that is top front and rear. and a flat section on top. Black ABS lower half.



W x L x H	ORDER CODE	PRICE
105 x 143 x 32 (56)	252-190	£3.45
170 x 143 x 32 (56)	252-191	£4.25
170 x 214 x 32 (82)	252-292	£6.45

# COMPONENTS

## CONNECTORS

### MINIATURE JACK PLUGS AND SOCKETS



Mono and stereo connectors for audio applications. Switched sockets have a single pole break contact on the tip connection

TYPE	ORDER CODE	PRICE
<b>Plastic plugs</b>		
2.5mm	254-100	18p
3.5mm	254-101	20p
3.5mm stereo	254-106	30p
<b>Metal plugs</b>		
2.5mm	254-108	18p
3.5mm	254-122	29p
3.5mm stereo	254-126	35p
<b>Sockets - Panel mtg</b>		
2.5mm	254-130	19p
3.5mm	254-132	16p
3.5mm stereo	254-134	38p
<b>Sockets - Line</b>		
2.5mm	254-137	30p
3.5mm	254-139	28p
3.5mm stereo	254-142	44p

## CONNECTORS

### 1/4 JACK PLUGS AND SOCKETS

Mono and stereo plugs and a variety of switched socket options. Sockets have black nylon fixing nuts and are insulated from the panel



TYPE	ORDER CODE	PRICE
<b>1/4 Plugs</b>		
Plastic mono	254-150	33p
Plastic stereo	254-151	48p
Metal mono	254-156	59p
Metal stereo	254-158	79p
<b>1/4 Sockets</b>		
Mono Bk-Bk	254-160	27p
Mono Mk-Bk	254-162	29p
Stereo Bk-Bk-Bk	254-164	88p

### DC POWER CONNECTORS

Standard low voltage as used in computers, stereos etc.



TYPE	ORDER CODE	PRICE
1.3mm plug	254-170	38p
2.1mm plug	254-173	30p
2.3mm plug	254-176	32p
2.1mm panel skt	254-179	36p
2.5mm panel skt	254-179	36p

### PHONO PLUGS AND SOCKETS

Plastic and metal plugs and sockets and paxolin type chassis socket.



TYPE	ORDER CODE	PRICE
Plastic plug	254-180	20p
Metal plug	254-181	30p
Plastic line socket	254-186	24p
Metal chassis skt.	254-189	32p
Paxolin chassis skt.	254-191	15p

### CO-AX CONNECTORS

Plugs and sockets for TV aerials chassis socket is insulated type. Coupler is Back to Back Sockets.



TYPE	ORDER CODE	PRICE
Metal plug	254-240	30p
Line socket	254-244	44p
Chassis socket	254-245	24p
Coupler (Female)	254-247	20p

## DIN PLUGS AND SOCKETS

Standard round plastic plugs and metal panel sockets - 2 hole fixing.



DIN PLUGS	ORDER CODE	PRICE
2 pin speaker	254-200	12p
3 pin	254-201	18p
4 pin	254-202	26p
5 pin 180 deg	254-203	20p
5 pin 240 deg	254-204	20p
5 pin domino	254-205	38p
6 pin	254-206	40p
7 pin	254-207	42p
8 pin	254-208	50p
13 pin	254-213	£1.99
14 pin	254-214	£2.10

DIN SOCKETS	ORDER CODE	PRICE
2 pin speaker	254-220	10p
3 pin	254-221	22p
4 pin	254-222	28p
5 pin 180 deg	254-223	22p
5 pin 240 deg	254-224	22p
5 pin domino	254-225	34p
6 pin	254-226	24p
7 pin	254-227	26p
8 pin	254-228	52p
13 pin line socket	254-223	£2.44
14 pin line socket	254-224	£2.45

### MINIATURE D TYPE CONNECTORS

Standard D connectors, 2 row. Sockets, Plugs and Plastic Hoods. Also 15 pin 3 row type.



TYPE	ORDER CODE	PRICE
9 pin plug	254-250	55p
15 pin plug	254-251	66p
23 pin plug	254-253	£1.15
25 pin plug	254-252	78p
9 pin socket	254-255	59p
15 pin socket	254-256	72p
23 pin socket	254-259	£1.17
25 pin socket	254-257	90p
9 pin cover	254-260	48p
15 pin cover	254-261	55p
25 pin cover	254-262	58p
Note use 9 way cover with 3 row 15 pin types		
15 pin 3 row Plug	254-265	£1.36
15 pin 3 row Skt	254-266	£1.44

### IDC CONNECTORS

20, 26, 34, and 40 way sockets to fit onto ribbon cable. Straight and right angled PCB plugs.



TYPE	ORDER CODE	PRICE
20 pin plug Str.	254-280	95p
26 pin plug ..	254-281	£1.04
34 pin plug ..	254-283	£1.15
40 pin plug ..	254-285	£1.80
20 pin plug 90deg	254-300	58p
26 pin plug ..	254-301	£1.09
34 pin plug ..	254-303	£1.26
40 pin plug ..	254-304	£1.65
20 pin socket	254-290	50p
26 pin socket	254-291	54p
34 pin socket	254-293	58p
40 pin socket	254-295	£1.16

### TERMINAL BLOCKS

2A, 5A, and 15A strips of 12. Cut down to size easily.



TYPE	ORDER CODE	PRICE
2A	254-320	00p
5A	254-321	00p
15A	254-322	00p

# COMPONENTS

## TERMINAL BLOCKS PCB TYPE

Interlocking blocks on 5mm pin spacing

TYPE	ORDER CODE	PRICE
2 way	254-360	32p
3 way	254-361	40p
6 way	254-362	62p

## CROCODILE CLIPS

Small insulated clips,



TYPE	ORDER CODE	PRICE
Red	254-370	10p
Black	254-371	10p

## CROCODILE CLIP TEST LEADS

10 Leads, 5 colours fitted with small matching insulated clips.



ORDER CODE	254-376	£1.98 each
------------	---------	------------

## TEST LEADS WITH PROBES



Moulded probes on good quality leads, with different types of plugs. 2mm pins, 4mm plain, & 4mm shrouded

TYPE	ORDER CODE	PRICE
2mm	254-380	£1.10
4mm	254-381	£1.44
4mm shrouded	254-382	£4.95

## BATTERY CLIPS

Standard press stud type



TYPE	ORDER CODE	PRICE
PP3 (small twin)	254-390	10p
PP9 (larger)	254-381	14p

## BATTERY HOLDERS

A range of types with PP3 type press studs, or solder tags.

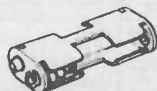

TYPE	ORDER CODE	PRICE
1 x AA	254-390	15p
2 x AA	254-391	19p
4 x AA long type	254-392	21p
4 x AA Square	254-393	24p
6 x AA	254-394	29p
8 x AA	254-395	33p
4 x C 2 wide x 2	254-396	36p
4 x D 4 wide x 1	254-397	63p

## PANEL METERS

### MOVING COIL TYPE

Size 45H x 51W x 34D  
Cut out 38mm dia.



TYPE	ORDER CODE	PRICE
100uA	255-100	£5.98 each
1mA	255-110	
1A	255-120	
5A	255-125	
25V	255-130	
100-0-100uA	255-105	

## SPEAKERS, MICs, & BUZZERS

Electret, Dynamic and Crystal Mic Inserts

TYPE	ORDER CODE	PRICE
Electret 9mm dia	261-130	65p
Crystal 25mm dia	261-132	70p
Dynamic 22mm dia	261-133	72p

## TELEPHONE PICK-UP COIL

For recording phone calls

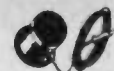

ORDER CODE	261-135	85p each
------------	---------	----------

## ULTRASONIC TRANSDUCERS

40 and 32kHz piezo-ceramic

TYPE	ORDER CODE	PRICE
32 kHz Trans.	261-140	£2.99
32 kHz Rec	261-141	£2.99
40 kHz Trans	261-146	£2.49
40 kHz Rec	261-149	£2.49

## MINIATURE LOUDSPEAKERS

Standard miniature speakers for all applications. 100 - 250mW



TYPE	ORDER CODE	PRICE
8 ohm 1.1/2	260-100	79p
8 ohm 2	260-101	81p
8 ohm 2 1/4	260-102	82p
8 ohm 2 1/2	260-103	84p
64 ohm 2 1/2	260-120	93p
80 ohm 2 1/2	260-122	95p

## PILLOW SPEAKER

8 ohm with lead and 3.5mm plug

ORDER CODE	260-136	£1.40 each
------------	---------	------------

## EARPIECES

Crystal (high impedance)  
Magnetic 8 ohms



TYPE	ORDER CODE	PRICE
Magnetic	260-130	22p
Crystal	260-141	72p

## PIEZO TRANSDUCER PB2720

Plastic housed piezo element used as speaker or pick-up. 2.6kHz resonance

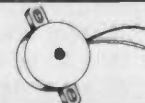

ORDER CODE	261-120	90p each
------------	---------	----------

## BUZZERS

Miniature Electronic buzzers with low current drain 22 x 16 x 15mm



TYPE	ORDER CODE	PRICE
6V	261-101	82p
9V	261-102	84p
12V	261-103	86p

## PIEZO BUZZER 3 - 28V

High pitch output 30mm dia  
12mA at 12V



ORDER CODE	261-104	98p each
------------	---------	----------

## HIGH OUTPUT PIEZO BUZZER

100 dB High pitch output  
VERY piercing. 20mA at 12V.

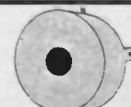

ORDER CODE	261-105	£1.24 each
------------	---------	------------

## PCB MOUNTING PIEZO BUZZER

3 - 24V 23mm dia 5mA



ORDER CODE	261-108	92p each
------------	---------	----------

## PIEZO SIREN - HIGH OUTPUT

12V 150mA. Whooping type sound. Very loud. For Burglar alarms.

ORDER CODE	261-110	£7.99 each
------------	---------	------------

**SOLDERING**

**ANTEX IRONS**

British made irons of the highest quality with iron clad bits for long life.

Model XS 25Watts. Model C 17 Watts lightweight.

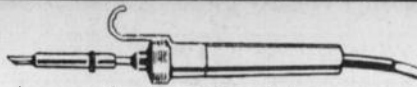

MODEL	ORDER CODE	PRICE
XS 240v	290-100	£8.59
XS 110V	290-101	£8.75
XS 24V	290-102	£9.13
XS 12V	290-103	£9.13
Model C 240V	290-120	£8.37

**Spare Bits for Model XS**

TYPE	ORDER CODE	PRICE
Small No. 50 <sup>3</sup> / <sub>32</sub>	290-110	£1.62
Med No. 51 <sup>1</sup> / <sub>8</sub>	290-111	£1.62
Large No. 52 <sup>3</sup> / <sub>16</sub>	290-112	£1.62

**Spare Bits for Model C**

TYPE	ORDER CODE	PRICE
106 1mm	290-130	£1.73
820 2.3mm	290-131	£1.62
821 3mm	290-132	£1.62
822 4.7mm	290-134	£1.62
302 2.3mm cranked	290-135	£1.62
10 0.5mm cone	290-137	£1.62

**ANTEX HEAT SINK TWEEZERS**

For protecting delicate components

<b>ORDER CODE</b>	<b>290-145</b>	<b>48p/pair</b>
-------------------	----------------	-----------------

**ANTEX ST4 STAND**

Suits models XS, C, and many other irons. With Cleaning sponge



<b>ORDER CODE</b>	<b>290-148</b>	<b>£3.24</b>
-------------------	----------------	--------------

**DESOLDER BRAID**

Extremely effective solder removal



<b>ORDER CODE</b>	<b>290-150</b>	<b>99p/ reel</b>
-------------------	----------------	------------------

**DESOLDER PUMP**

Spring return suction tool with PTFE nozzle

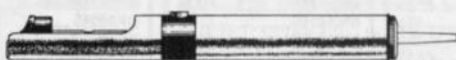

<b>ORDER CODE</b>	<b>290-152</b>	<b>£3.98 each</b>
-------------------	----------------	-------------------

**SOLDER**

Flux cored solder 60 tin 40 lead for all electronic assembly 18 swg - standard 22 swg - fine.



TYPE	ORDER CODE	PRICE
100g reel 22swg	290-260	£2.25
500g reel 18 swg	290-164	£6.99
3 yd dispenser 18 swg	290-170	75p
size 10 multicore reel 22 swg	290-172	£4.99
size 12 multicore reel 18 swg	290-174	£4.99

**MINI VICE**

Suction base plastic vice with metal jaws 85 x 65 x 60mm Lever action base.



<b>ORDER CODE</b>	<b>290-180</b>	<b>£1.48</b>
-------------------	----------------	--------------

**HELPING HANDS**

Top quality model with Glass magnifier Heavy metal base and two spring loaded clips.



<b>ORDER CODE</b>	<b>290-182</b>	<b>£5.99</b>
-------------------	----------------	--------------

**TOOLS**

**WIRE STRIPPERS AND CUTTERS**

BIB adjustable strippers with spring return and pvc coated handles.



<b>ORDER CODE</b>	<b>290-300</b>	<b>£2.99 each</b>
-------------------	----------------	-------------------

**MINI SHEARS**

The ideal tool for cropping component leads through PCBs etc Spring loaded PVC coated handles.



<b>ORDER CODE</b>	<b>290-301</b>	<b>£2.85 each</b>
-------------------	----------------	-------------------

**LOW COST PLIERS AND CUTTERS**

PVC insulated handles. Pliers have spring return and serrated jaws. 5" long overall.

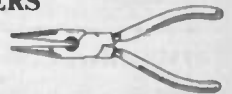

TYPE	ORDER CODE	PRICE
Pliers	290-302	£1.98
Cutters	290-303	£1.96

**TOOL SET & SCREWDRIVER SETS**

Popular sets of small tools Screwdriver set has 6 jewellers screwdrivers. Tool sets have 5 spanners 5 nut spinners, 5 allen keys and 4 screwdrivers.



TYPE	ORDER CODE	PRICE
Screwdrivers	290-304	£1.48
Tool set	290-305	£4.49

**SPOT FACE CUTTER**

For cutting stripboard tracks



<b>ORDER CODE</b>	<b>290-320</b>	<b>£2.20</b>
-------------------	----------------	--------------

**COMO MINI DRILL**

398D Drill with 3 collets. 9 - 18V DC

**COMO DRILL STAND**

594D New design stand for Vertical and Horizontal use.

TYPE	ORDER CODE	PRICE
398D Drill	290-330	£11.95
594D Stand	290-332	£14.95

**STRIPBOARD**

0.1 INCH PITCH BOARD



Strips x Holes	ORDER CODE	PRICE
9S x 24H - Pack of 5	290-500	94p/ pack
36S x 50H	290-503	£1.95 each
36S x 170H	290-505	£5.98 each

**PRINTED CIRCUIT BOARD**

Copper clad laminate for making PCBs. Single & double sided Glass Fibre based, and single sided paper based. Supplied in 150 x 200 mm panels <sup>1</sup>/<sub>16</sub> thick.

TYPE	ORDER CODE	PRICE
SS Paper	290-520	£1.30
SS Glass fibre	290-521	£1.85
DS Glassfibre	290-524	£1.98

**FERRIC CHLORIDE CRYSTALS**

For etching copper clad board. Makes 1 litre of solution

<b>ORDER CODE</b>	<b>290-530</b>	<b>£1.95 pack</b>
-------------------	----------------	-------------------

**ETCH RESIST PEN**

For drawing tracks onto board before etching.



<b>ORDER CODE</b>	<b>290-534</b>	<b>48p</b>
-------------------	----------------	------------

**ETCHING KIT**

Contains everything to make PCBs including Crystals, Drill bits, Pen, Board, Tray, Transfers, Cleaner, and Instructions

<b>ORDER CODE</b>	<b>290-538</b>	<b>£6.49</b>
-------------------	----------------	--------------

## Transistors

2N2926	11p
2N2955	£1.12
2N3053	32p
2N3055	79p
2N3702	11p
2N3704	11p
2N3819	52p
2N3820	78p
2N3904	11p
2N3906	11p
2N5457	58p
2N5484	63p
3SK51	£1.18
40673	£1.18
AC128	59p
AC141	48p
AC142	49p
AC176	57p
AD161	66p
AD162	66p
BC107	14p
BC108	14p
BC109	14p
BC109C	15p
BC171	12p
BC177	18p
BC178	18p
BC179	18p
BC182	11p
BC182L	11p
BC183	11p
BC183L	11p
BC184	11p
BC184L	11p
BC212	11p
BC212L	11p
BC213	11p
BC213L	11p
BC214	11p
BC214L	11p
BC440	51p
BC441	56p
BC460	50p
BC461	55p
BC547	12p
BC548	12p
BC549	12p
BC640	38p

BC650	58p
BD131	48p
BD132	49p
BF244B	65p
BFX88	32p
BFY50	35p
BFY51	29p
BFY52	38p
BRY39	78p
BSX20	48p
HPWR6501	£6.78
IRF740	£3.98
IRF840	£4.20
MJE340	62p
MPF102	69p
MPF105	68p
MPSA13	36p
MPSA65	48p
TIP121	64p
TIP122	66p
TIP126	68p
TIP127	96p
TIP141	£2.48
TIP146	£2.56
TIP2955	69p
TIP3055	69p
TIP31A	50p
TIP31C	52p
TIP32A	50p
TIP32C	52p
TIP33A	94p
TIP33C	99p
TIP34A	92p
TIP34C	98p
TIP41C	£1.90
TIP42C	£1.97
TIS88A	68p
TPSA13	35p
VN10KM	69p
VN66AF	£1.62
VN67AF	£1.60
ZTX300	19p
ZTX450	30p
ZTX451	38p
ZTX500	19p
ZTX550	51p
ZTX650	64p

## CMOS Logic ICs

4000	24p
4001	22p
4001A	39p
4007	39p
4008	98p
40103	£2.46
40106	69p
4011	24p
40114	£3.80
4012	24p
4013	26p
4014	96p
4015	69p
4016	42p
4017	58p
40174	96p
4018	66p
4020	72p
4022	76p
4023	28p
4024	68p
4025	32p

4026	£1.40
4027	48p
4028	82p
4029	98p
4030	56p
4033	£1.68
4035	99p
4040	59p
4041	48p
4042	76p
4043	69p
4046	84p
4047	72p
4049	38p
4050	49p
4051	94p
4053	92p
4060	98p
4066	62p
4068	39p
4069	39p
4069UB	49p

4070	39p
4071	38p
4076	76p
4081	40p
4082	38p
4093	66p
4098	84p
4502	68p
4510	89p
4511	99p
4514	£1.18
4516	99p
4518	99p
4520	99p
4528	96p
4534	£7.13
4553	£4.96
4583	£2.99
4584	34p
4585	96p

## Linear & Digital ICs

2114	48p
2240	£2.48
27128	£2.42
27128	£4.48
4116	80p
4164	£1.20
555	36p
556	84p
6116	£1.63
6116	£1.64
6264	£1.98
6264	£1.98
723	58p
8038C	£6.46
AD595AQ	£11.65
AD7581JN	£23.63
ADC0844CCN	£13.60
AY3-1350	£4.95
AY3-8912	£5.98
CA3080E	88p
CA3085AE	£1.24
CA3086	88p
CA3130E	96p
CA3140E	69p
CA3240E	£1.67
COP420 SYNTH	£11.98
DAC0800LCN	£3.80
ICL7611	£1.55
ICL7660CPA	£1.98
ICL8069DCSQ	£3.96
ICM7106	£13.61
ICM7216D	£27.95
ICM7217J	£8.40
ICM7555	89p
ICM7556	£1.66
L200CV	£1.80
LA4422	£1.89
LF347N	£2.92
LF351N	69p
LF353N	89p
LF355N	£2.17
LF356N	£2.39
LM13600	£1.98
LM13700	£1.98
LM1830	£2.98
LM2917N8	£4.98
LM301A	78p
LM311N	78p
LM317K	£1.99
LM317T	76p
LM318H	£5.38
LM324	88p

LM334Z	£1.89
LM335Z	£3.50
LM339	82p
LM348N	£1.48
LM358N	£1.02
LM35DZ	£4.96
LM377N	£5.76
LM380N	£1.48
LM381N	£2.38
LM382N	£3.99
LM383T	£4.80
LM384N	£4.99
LM386N	£1.48
LM387N	£2.84
LM389N	£2.95
LM3900	98p
LM3909	£1.67
LM3911	£3.75
LM3914	£4.54
LM3915	£4.55
LM393N	84p
LM394	£8.98
LM567N	£1.98
LM747	98p
LM748CN	74p
LM833	£2.23
M5804	£4.98
MC1301P	60p
MC1455L	£6.86
MC1458N	67p
MC1488	48p
MC1489	48p
MC3302	£1.68
MC3340	£2.99
MC3360P	£2.10
MC3403	£1.48
MC6800P8	£15.95
MC6802P	£3.96
MC6810P	£1.80
MC6821P	£1.98
MC68230P8	£6.99
MC6850P	£2.08
MC68681	£9.60
MC68705P3	£19.98
MF10CN	£5.98
NE5532N	£1.74
NE566	£2.40
NE567	£1.48
NE570N	£4.47
NE571N	£2.36
NE5534N	98p
OM335	£9.92

OM361	£12.66
OPI2252	£1.54
R6522	£6.69
SAA1027	£3.48
SL1640	£6.99
SL560DP	£2.56
SL6270	£3.87
SN76018	£1.20
SN76131	98p
SP8629DP	£2.36
SPO256AL2	£2.98
SSM2040	£1.80
TBA820M	£1.20
TDA2002	£3.50
TDA2006	£3.83
TDA2030	£1.99
TDA7052	£1.48
TDS2004	£4.69
TEA5570	£2.20
TL061	93p
TL064	£1.97
TL430	£1.40
TL497	£3.17
TLO71	49p
TLO72	81p
TLO81	49p
TLO82	76p
TLO83	£1.73
TMS1000-MPO121	£6.48
TMS1000-MPO27	£6.58
TOL84	£1.48
U237B	£1.99
U267B	£2.50
UGN3501	£5.48
ULN2003N	86p
ULN2004	97p
ULN2803N	£1.04
UPD43256-16	£6.80
UPD8255	£2.95
XR2206	£5.98
Z80API0	£1.60
ZN1034E	£2.97
ZN1040	£5.88
ZN414	£1.20
ZN419-409CE	£2.21
ZN423	£1.76
ZN424P	£1.44
ZN425E8	£6.99
ZN428E8	£8.28
ZN448E	£7.20
ZN449E	£4.85

## 74 Series TTL Logic ICs

7400	38p
7401	38p
7402	28p
7403	28p
7404	36p
7406	64p
7407	62p
7408	35p
7410	28p
74107	63p
74121	78p
74123	73p
74128	94p
7413	82p
74132	79p
7414	85p
74141	£1.90
74150	£1.44
74154	£1.61
7416	48p
74192	98p
74193	£1.24
7420	44p
7427	38p

7430	36p
7432	44p
7440	36p
7441	£1.42
7445	£1.36
7447	£1.48
7451	36p
7454	67p
7470	56p
7472	48p
7473	39p
7474	38p
7475	77p
7476	72p
7480	£1.42
7482	£1.76
7483	72p
7486	61p
7490	86p
7492	72p
7493	71p
7495	82p
7496	76p

## 74LS Series TTL Logic ICs

LS00	27p
LS02	27p
LS03	27p
LS04	33p
LS05	27p
LS08	27p
LS09	27p
LS123	44p
LS125	48p
LS132	52p
LS138	36p
LS139	44p
LS14	40p
LS161	56p
LS175	38p
LS193	64p
LS20	27p
LS240	86p
LS244	68p

LS245	82p
LS27	27p
LS273	69p
LS30	27p
LS32	30p
LS367	64p
LS373	83p
LS374	58p
LS377	85p
LS42	43p
LS47	£1.67
LS640	£1.38
LS73	28p
LS74	38p
LS75	40p
LS76	36p
LS85	50p
LS86	36p
LS90	44p

## IC Sockets

### IC SOCKETS

low profile standard sockets.

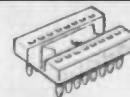

TYPE	ORDER CODE	PRICE
6 pin	254-406	6p each
8 pin	254-407	8p each
14 pin	254-409	10p each
16 pin	254-411	12p each
18 pin	254-414	14p each
20 pin	254-416	18p each
24 pin	254-418	22p each
28 pin	254-421	24p each
40 pin	254-424	32p each
64 pin	254-426	98p each



## Diodes and Rectifiers

### DIODES

<b>1 AMP RATING:</b>	
1N4001 ..50V .....	6p
1N4002 ..100V .....	6p
1N4003 ..200V .....	6p
1N4005 ..600V .....	7p
1N4007 ..1000V .....	8p
<b>3 AMP RATING:</b>	
1N5401 ..100V .....	18p
1N5402 ..200V .....	18p
1N5404 ..400V .....	19p
1N5408 ..1000V .....	22p
<b>6 AMP RATING:</b>	
MR751 ..50V .....	94p

<b>SIGNAL DIODES</b>	
1N4148 .....	5p
1N914 .....	5p
<b>LOW LEAKAGE</b>	
BAS45 .....	48p
<b>GERMANIUM</b>	
OA47 .....	18p
OA90/91 .....	19p
<b>TV TYPES</b>	
BY127 ..1250V ..1.5A .....	28p
BY407A .....	48p
BY206G .....	44p
<b>VARICAP AM</b>	
KV1236 ..9V ..300pF .....	£1.87

### BRIDGE RECTIFIERS

<b>1.5AMP RATING 9mm ROUND TYPE</b>	
W005 ..50V .....	36p
W04 ..400V .....	40p

<b>4 AMP RATING 23mm IN-LINE TYPE</b>	
KBL-02 ..200V .....	£1.22
KBL-08 ..800V .....	£1.36

<b>3AMP RATING 15mm SQUARE TYPE</b>	
C30-200 ..200V .....	68p
C30-800 ..800V .....	92p

<b>25 AMP RATING 29mm SQUARE TYPE WITH SPADE TAGS, METAL CLAD</b>	
C250-050 ..50V .....	£2.17
C250-600 ..600V .....	£2.48

<b>6 AMP RATING 16MM SQUARE TYPE</b>	
C80-200 ..200V .....	£1.10
C80-800 ..800V .....	£1.24

### ZENER DIODES

400mW and 1.3W ZENER DIODES in the following range of voltages: 2.4, 2.7, 3.0, 3.3, 3.6, 3.9, 4.3, 4.7, 5.1, 5.6, 6.2, 6.8, 7.5, 8.2, 9.1, 10, 11, 12, 13, 15, 18, 20, 22, 24, 27, 30, and 33V.

400mW Range BZY79 - etc 12p      1.3W Range BZX85 - etc. 18p  
REMEMBER TO STATE VOLTAGE WHEN ORDERING

### VOLTAGE REGULATORS

<b>100mA TO92 PLASTIC POSITIVE O/P</b>	
78L05 ..5V .....	44p
78L12 ..12V .....	44p
78L15 ..15V .....	44p

<b>1A TO220 PACKAGE NEGATIVE O/P</b>	
7905 ..5V .....	69p
7912 ..12V .....	69p
7915 ..15V .....	69p
7924 ..24V .....	74p

<b>100mA TO92 PLASTIC NEGATIVE O/P</b>	
79L05 ..5V .....	52p
79L12 ..12V .....	52p
79L15 ..15V .....	52p

<b>ADJUSTABLE REGULATORS</b>	
Positive	
LM317L .. 1.2-37V 100mA TO92 .....	86p
LM317T .. 1.2-37V 1.5A TO220 .....	97p
LM317K .. 1.2-37V 1.5A TO3 .....	£2.79
L200CV .. 2.8-36V 2AT0220 5pin .....	£2.36
Negative	
LM337T .. -1.2-37V 1.5A TO220 .....	£1.49

<b>1A TO220 PACKAGE POSITIVE O/P</b>	
7805 ..5V .....	59p
7812 ..12V .....	59p
7815 ..15V .....	59p
7824 ..24V .....	64p

### THYRISTORS & TRIACS

<b>DIAC</b>	
BR100 .....	48p

<b>TRIACS - NON-ISOLATED TABS</b>	
TAGM9/K9 ..400V 5.5A TO220 .....	94p
TIC226D .... 400V 8A TO220 .....	£1.23

<b>THYRISTORS (SCRs)</b>	
TICV106D ..400V 1A TO92 .....	48p
C106D ..400V 3A TO126 .....	56p
TIC106D ..400V 4A TO220 .....	68p
TIC116D ..400V 8A TO220 .....	£1.14
TIC126M ..600V 12A TO220 .....	£1.26
2N4443 ..400V 5A TO220 .....	98p

<b>TRIAC - ISOLATED TAB</b>	
TAGM22 ..8A 400V TO220 .....	£1.36

### OPTOELECTRONICS

<b>PHOTOTRANSISTORS</b>	
BPX25 ..TO18 .....	£3.98
TIL81 ..TO18 .....	£2.76
XC500C ..3mm .....	62p
OP500 ..3mm .....	69p
TIL78 ..3mm .....	79p

<b>OPTOCOUPERS</b>	
4N25 ..Transistor O/P .....	48p
CNY17-1 .....	56p
CNY17-3 ..High Efficiency .....	94p
ISD74 ..Dual .....	£1.08
ISQ74 ..Quad .....	£1.68
OPI2252 ..Dual .....	£1.25
MOC3020 ..TRIAC 400V 100mA .....	98p

<b>PHOTODIODES</b>	
MIR10L ..Infra Red .....	£2.13
BPW41 ..Infra Red .....	68p

<b>SENSORS</b>	
H21L1 ..Reflective .....	£4.95
H21A1 ..Slotted .....	£1.75
TIL139 ..Reflective .....	£3.20

<b>INFRA RED EMITTERS</b>		
TIL38 ..5mm Infra Red .....	79p	
TIL32 ..3mm Infra Red .....	48p	
CQW13R ..Lensed, with Chrome Mount .....		£2.94

<b>PASSIVE IR SENSOR FOR BURGLAR ALARMS</b>	
SR02 .....	£9.60

<b>PHOTOCONDUCTORS</b>	
ORP12 .....	99p

## OPTO ELECTRONICS & INDICATORS

### LEDs



TYPE	ORDER CODE	PRICE
<b>Standard Diffused</b>		
3mm Red 2mcd	295-100	12p
3mm Green 2mcd	295-101	12p
3mm Yellow 4mcd	295-102	12p
5mm Red 4mcd	295-104	13p
5mm Green 4mcd	295-105	14p
5mm Yellow 4mcd	295-106	15p

<b>Super Bright Diffused</b>		
3mm Red 80mcd	295-107	28p
3mm Green 80mcd	295-108	30p
3mm Yellow 80mcd	295-109	30p
5mm Red 100mcd	295-114	28p
5mm Green 100mcd	295-115	30p
5mm Yellow 100mcd	295-116	30p

<b>Ultra Bright Water Clear</b>		
5mm Red 250mcd	295-124	36p
5mm Green 250mcd	295-125	36p
5mm Yellow 250mcd	295-126	36p

### LOW CURRENT LEDs

Optimised for 2mA. Drive directly from ICs

TYPE	ORDER CODE	PRICE
3mm Red diffused	295-130	39p
Sub min - side leads	295-134	34p

### LED BAR ARRAY - 10 WAY

10 rectangular red LEDs in DIL 20 pin.



<b>ORDER CODE</b>	<b>295-143</b>	<b>£1.24</b>
-------------------	----------------	--------------

### SEVEN SEGMENT DISPLAYS - RED

Standard 0.3 and 0.5 displays

Common Anode and Common Cathode.



TYPE	ORDER CODE	PRICE
0.3 Common Anode	295-146	£1.44
0.3 Common Cathode	295-147	£1.40
0.5 Common Anode	295-149	98p
0.5 Common Cathode	295-150	95p

### MES FILAMENT BULBS

Standard screw in bulbs.



TYPE	ORDER CODE	PRICE
200mA 3.5V	295-165	
60mA 6V	295-167	
150mA 6V	295-169	all 18p each
150mA 12V	295-170	

### MES BATTEN HOLDERS

Screw terminal type.



<b>ORDER CODE</b>	<b>295-190</b>	<b>35p</b>
-------------------	----------------	------------

### BREADBOARDS

A range of solderless breadboards into which standard component leads are plugged to build circuits. Especially useful for educational experiments and testing new components and circuit ideas. The S-DEC has 70 contacts on 0.3 x 0.6in pitch. The Eurobreadboard has 550 contacts on 0.1in pitch. K10 has 390 contacts on 0.1in pitch, and K12 has 840 0.1in pitch contacts. The K120 is a K12 with added power terminals.

TYPE	ORDER CODE	PRICE
S-DEC	254-610	£4.95
EUROBREADBOARD	254-612	£6.99
BIMBOARD1	254-614	£8.32
K-BLOCK-K10	254-617	£2.88
K-BLOCK-K12	254-618	£4.48
K-BLOCK-K120	254-624	£8.44

## Specification

### Vertical Deflection

**Operating modes:** Channel I or Ch. II separate, Channel I and II; alternate or chopped. (Chopper frequency approx 0.4MHz)  
**Sum or difference** of Ch. I and Ch. II. (channel II invertible).  
**X-Y Mode:** via Channel I and Channel II.  
**Frequency range:** 2 × DC to 20MHz (−3dB).  
**Risetime:** approx. 17.5ns. **Overshoot:** ≤ 1%.  
**Deflection coefficients:** 10 calibrated steps from 5mV/div. to 5V/div. in 1-2-5 sequence.  
**Accuracy in calibrated position:** ± 3%  
**Variable 2.5:1 to max. 12.5V/div.**  
**Y-magnification × 5 (calibrated) to 1mV/div. ± 5% (frequency range DC to 3.5MHz, −3dB).**  
**Input impedance:** 1MΩ || 25pF.  
**Input coupling:** DC-AC-GD (Ground)  
**Input voltage:** max. 400V (DC + peak AC)  
**Y-output from Ch. I or Ch. II optional.**

### Trigger System

With **automatic:** 10Hz-40MHz, ≥0.5div. normal with level control from **DC-40 MHz**.  
**Slope:** positive or negative.  
**ALT. triggering,** LED indication for trigger action.  
**Sources:** Ch. I, Ch. II, line, external.  
**Coupling:** **AC** (≥10Hz - 15MHz), **DC** (0 - 15MHz), **LF** (0 - ≤1 kHz), **HF** (≥1.5 kHz - 40MHz).  
**Threshold external** ≥0.3V.  
**Active TV-Sync-Separator** for line and frame.

### Horizontal Deflection

**Time coefficients:** 18 calibrated steps from 0.2 μs/div. to 0.1 s/div. in 1-2-5 sequence, accuracy in calibrated position: ± 3%.  
**variable 2.5:1 to max. 0.25s/div., with X-Magnifier x 10 (± 5%) to ≈ 20 ns /div.**  
**Hold-Off time:** variable to approx. 10:1.  
**Bandwidth X-Amplifier:** DC-3MHz (−3dB).  
**Input X-Amplifier via Channel II,** sensitivity see Ch. II specification.  
**X-Y phase shift:** <3° below 220kHz.  
**Z input optional**

### Component Tester

**Test voltage:** approx. 8.5V<sub>rms</sub> (open circuit).  
**Test current:** approx. 24mA<sub>rms</sub> (shorted).  
**Test frequency:** 50 - 60 Hz (line frequency).  
**Test connection:** 2 banana jacks 4 mm Ø.  
**One test lead is grounded (Safety Earth).**

### General Information

**Cathode-ray tube:** D14-364 P43/123, or ER 151-GH/, rectangular screen, intern. graticule, **8 x 10cm**.  
**Acceleration voltage:** 2000V.  
**Trace rotation:** adjustable on front panel.  
**Calibrator:** square-wave generator ≈ 1 kHz for probe compensation. Output: 0.2V and 2V ± 1%.  
**Line voltage:** 110, 125, 220, 240V ~ ± 10%.  
**Power consumption:** ≈ 37 Watt, 50/60/400Hz.  
**Max. ambient temperature:** −10°C...+40°C.  
**Protective system:** Safety Class I (IEC 348).  
**Weight:** approx. 7.5kg. **Colour:** techno-brown.  
**Cabinet:** W 285, H 145, D 380mm.  
**Lockable tilt handle.**  
 Subject to change without notice.

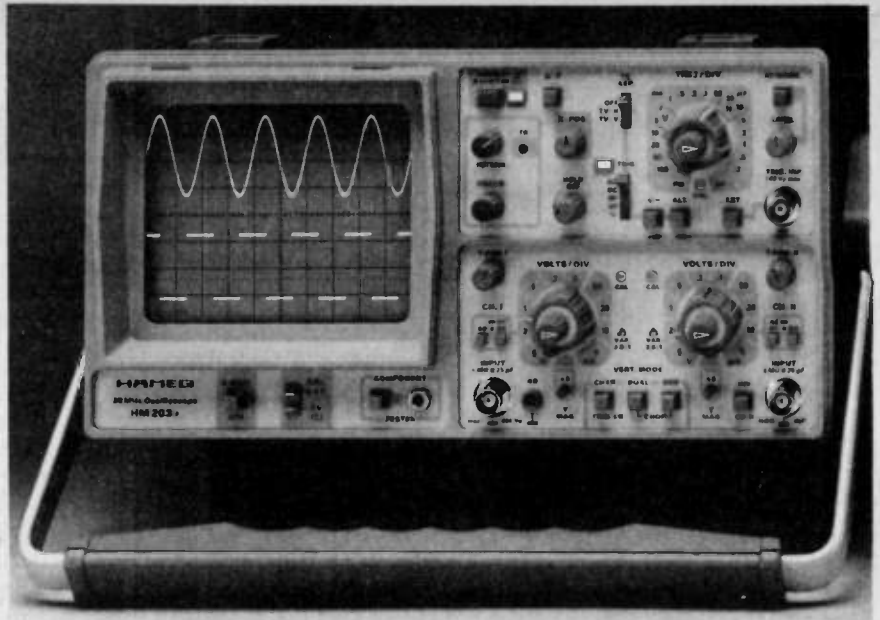

## 20 MHz Standard Oscilloscope

**2 Channels, max. 1 mV/div. sensitivity; Component Tester**

**Timebase: 0.1 s/div. to 20 ns/div.; Variable Holdoff; Alternate Triggering; Triggering: DC-40 MHz; TV Sync Separator; Trigger LED**

The **HM 203-7** is Western Europe's best selling oscilloscope because it responds thoroughly to customer demands for **reliability, superior performance, and ease of operation.**

The outstanding transient response of the **HM 203-7**, particularly when displaying square wave signals, is one of the pre-eminent features of this quality instrument. The integrity of the signals reproduced by this oscilloscope reflect a dedication to engineering excellence normally only found in expensive laboratory instruments. As an aid to ensure the correct polarities when displaying the sum, difference, or video signals, an "invert" control is provided on channel II. Technically advanced triggering circuits enable the user to attain clear, stable displays from **DC to over 40 MHz**, with input levels as **low as 0.5 divisions**. The **Holdoff** control enables even complex asynchronous waveforms to be solidly displayed. Trigger action is indicated by an **LED**, which illuminates whenever the trigger threshold point is crossed. And for the display of video signals, the **HM 203-7** has a low distortion **active TV sync separator**, which allows for automatic synchronizing with line and frame frequencies. "**Alternate triggering**" mode enables the display of two asynchronous signals simultaneously.

The CRT's 8x10 cm internal graticule enhances parallax-free viewing over a wide field. In addition, the **CRT** is fully shielded with **mu-metal** to prevent display distortion in the presence of magnetic fields.

As a practical, built-in feature, the **component tester** enables the operator to quickly identify faulty semiconductors and a large variety of individual components, both in circuit and out.

Designed for use in production, service, design, and educational applications. The **HM 203-7** is versatile and yet simple to use. A high quality reliable instrument made in West Germany. Outstanding 'build quality' gives this instrument an excellent 'feel' and make it a delight to use.

**£338.00 + £50.70 VAT** £5.00 NEXT DAY DELIVERY  
 2 YEARS PARTS + LABOUR WARRANTY  
**EDUCATIONAL USERS PLEASE CONTACT US FOR SPECIAL PRICES**

Accessories supplied: Two 10:1 probes, Line cord, Operators manual

# MAGENTA ELECTRONICS LTD

MAIL ORDER AND SHOP:  
 135 Hunter Street,  
 Burton-on-Trent,  
 Staffs. DE14 2ST  
 Tel: 0283 65435  
 Fax: 0283 46932



# EE REFERENCE LIBRARY

We have specially selected the four books shown here as very high quality reference books. They are all fairly expensive *but* they are all extremely comprehensive; between them they contain over 8,000 pages of information.

We are not suggesting that many people would require all four books, any one of them would be very useful and interesting. Each of them would make an excellent Christmas present. These reference books would be invaluable to any company, electronics club, group of students or anyone involved in teaching electronics etc.



**McGRAW-HILL CONCISE  
ENCYCLOPEDIA OF SCIENCE  
& TECHNOLOGY  
(2ND EDITION)**

This single volume is the most authoritative, all inclusive work of its kind, with information on science, engineering and technology.

Hard cover, 2,200 pages,  
1,700 illustrations. £95



**McGRAW-HILL ENCYCLOPEDIA OF  
ELECTRONICS AND COMPUTERS  
(2ND EDITION)**

Updated and revised to cover the developments in an extremely fast-growing field, this encyclopedia contains 520 alphabetically arranged articles; 120 of them completely revised for this edition and 45 that are brand new.

Hard cover, 1,250 pages,  
1,250 illustrations. £75



**McGRAW-HILL DICTIONARY  
OF SCIENTIFIC AND TECHNICAL  
TERMS (4TH EDITION)**

This completely up-to-date fourth edition of this standard international reference will meet your needs for understanding the language of all areas of science and engineering.

Hard cover, 2,200 pages,  
2,900 illustrations. £85



**ELECTRONIC ENGINEERS'  
HANDBOOK by Donald G. Frik  
and Donald Christiansen  
(3RD EDITION)**

One of the excellent range of McGraw-Hill Handbooks this definitive work covers all aspects of today's electronic engineering. This third edition has been completely revised, updated and expanded.

Hard cover, 2,642 pages. £79.95

Send your order together with a cheque (make cheques payable to Everyday Electronics), P.O. or your credit card number (Visa or Access) and card expiry date to EE Reference Library, 33 Gravel Hill, Merley, Wimborne, Dorset BH21 1RW.

**BOOKS FROM THE EE REFERENCE LIBRARY ARE SUPPLIED, BY MAIL ORDER ONLY, POST FREE, TO ALL UK ADDRESSES – overseas readers please add £5 per book for surface mail post. Please allow up to 28 days for delivery.**

# COLOUR CHANGING CHRISTMAS LIGHTS

MARK DANIELS



*A low cost project to add some colour to the festive season*

THE ILLUMINATION of Christmas trees has not seen any significant changes for many years. Originally they were lit with candles and more recently with coloured lamps which are sometimes made to flash. But imagine if the lamps themselves were to actually change colour as you watched them. From red to green to yellow and back again.

Obviously this cannot be achieved using ordinary Christmas lights, and in this design the effect is obtained by using bi-colour l.e.d.'s, with an electronic control unit and power supply. The resulting display is very effective and the timing may be adjusted to give numerous different patterns.

## BI-COLOUR L.E.D.

As already mentioned this project uses bi-colour l.e.d.s to produce the three colours, red, green and yellow (depending on the l.e.d.s used the yellow may appear as orange). The Bi-colour l.e.d.'s used are packaged in a colourless translucent plastic encapsulation.

The two l.e.d. chips, one red, one green are connected across the two package leadout pins in inverse parallel. Thus when current is passed through the device one or other of the l.e.d.'s will illuminate. This will give either red or green depending on the direction of current flow.

To obtain the yellow would require both the red and green chips being lit at the same time. This is not really possible since the two l.e.d.'s require current flow in completely opposite directions!

However, if we were to switch the two chips on and off sufficiently quickly they will appear to be on simultaneously and the eye will perceive this as a constant yellow. Fig. 1a shows the switching waveform that may be used to achieve the three required colours.

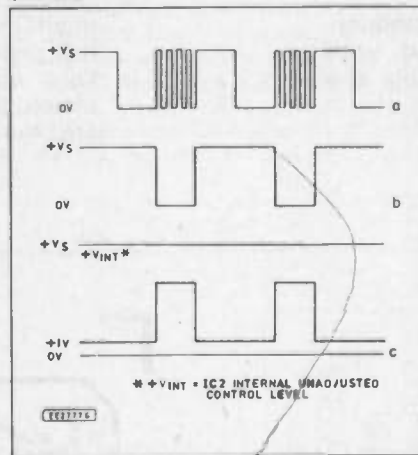

Fig. 1. Switching waveform to achieve the three colours.

## CIRCUIT DESCRIPTION

The complete circuit diagram for the Colour Changing Christmas Lights is shown in Fig. 2. Transformer T1 steps the mains voltage down to 15V-0V-15V a.c. This is rectified by diodes D1 and D2 to give a pulsating d.c. which is smoothed by capacitor C1. The smoothed d.c. is then fed into a voltage regulator circuit consisting of resistor R1 and D3, a 13V Zener diode, which provides a constant voltage for the two CMOS i.c.s. IC1 and IC2.

In this application the CMOS multi-vibrator IC1 is used in its astable mode to give a low frequency square wave output at pin 11, of the form shown in Fig. 1b. It can be seen from the diagram that the high time is approximately twice as long as the low time. This is made possible by using two different timing resistors for the two half cycles. Diodes D4 and D5 direct capacitor C2 charge and discharge currents through two separate resistors of different values in order to achieve this.

The output of IC1 at pin 11 is fed to transistor TR1 base, via resistor R4, and appears inverted at its collector which is connected to the bottom end of a potential divider, made up of VR1 and R5. The adjustable output of potentiometer VR1 provides the control voltage, shown in Fig. 1c, for pin 9 of IC2, a voltage controlled oscillator (VCO).

When VR1 is correctly adjusted the voltage at its wiper will swing between around

Fig. 2. Complete circuit diagram for the Colour Changing Christmas Lights. Fuse S1 is insulated in the mains plug.

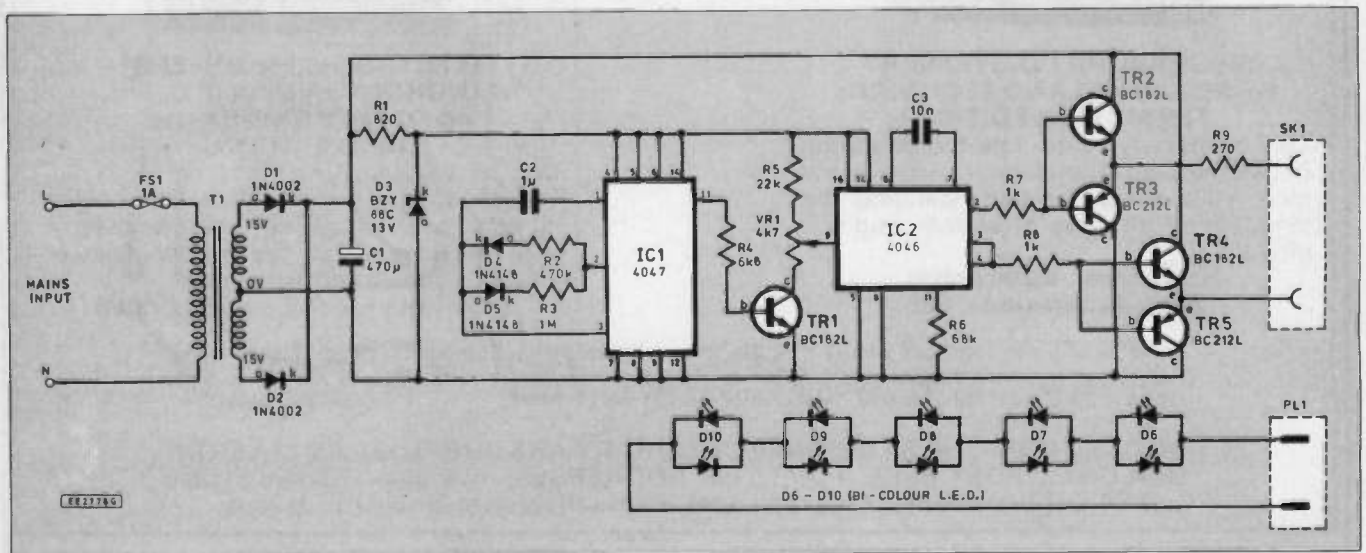

one volt with TR1 conducting and a voltage set by the on chip potential divider when TR1 is turned off. The control voltage at pin 9 determines the output frequency of IC2 which changes from about 1Hz with the external control voltage of around one volt to 2kHz when set by the internal potential divider. Resistor R6 and capacitor C3 set the frequency range of the VCO.

The two out of phase outputs of the VCO at pin 2 and pins 3 and 4 are amplified by a pair of simple pull-push amplifier stages having unity voltage gain but a large current gain, so that several chains of series connected bi-colour l.e.d.'s may be driven. The push-pull amplifier configuration consisting of transistors TR2 to TR5 allows the bi-directional flow of current necessary to achieve the tri-colour states of l.e.d.s D6 to D10.

## CONSTRUCTION

Most of the components are mounted on a single-sided glass-fibre printed circuit board (p.c.b.), the foil pattern and component overlay for which is shown in Fig. 3. This board is available from the *EE PCB Service*, code EE707.

It is recommended that the resistors and i.c. sockets be fitted first followed by capacitors.

It is suggested that screw terminal blocks be used for the mains connections to the board for reasons of safety (terminal blocks were also used for the l.e.d. outputs on the prototype) and these may be fitted next. Otherwise solder suitable lengths of flexible leads to the board. The three potentiometer connecting leads may be soldered directly into the board or solder pins can be used if preferred. The transformer T1 is fitted last as it makes the board heavy and awkward to work on.

Mount the p.c.b. securely in the bottom part of the case (see Fig. 4), so that it can-

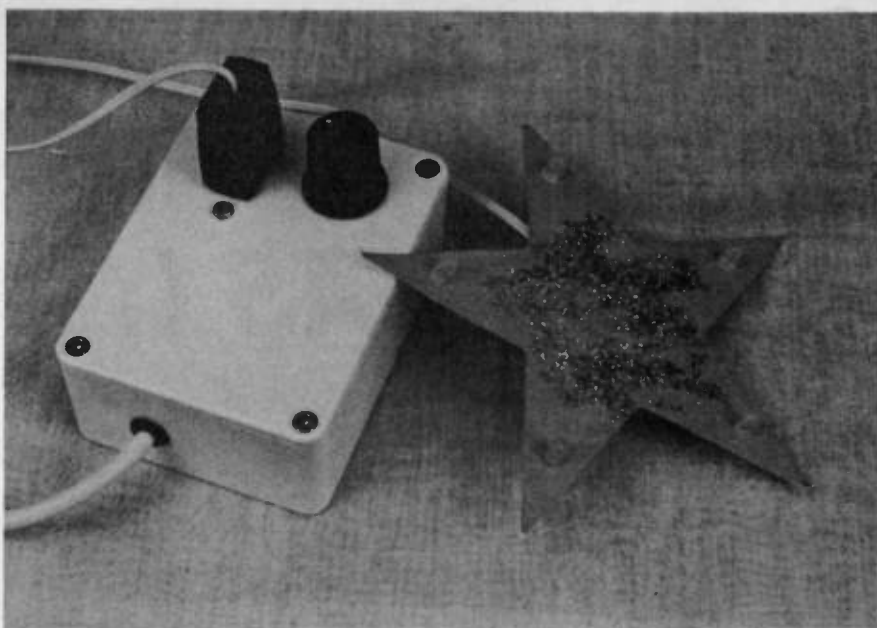

The completed unit showing another suggestion for displaying the bi-colour l.e.d.s.

not move around. Make suitable holes in the lid of the box to accept VR1, SK1 and a grommet for the mains input lead. Ensure that all lid mounted components will clear the p.c.b. when the box is assembled.

Pass a length of two core mains cable through the grommet and connect to terminal block TB1. Fasten a cable tie around the mains lead inside the box to prevent its being pulled out. Wire SK1 and resistor R9 to TB2 using thin insulated leads, the polarity is unimportant since the socket is non-polarised. The last connection to be made is between VR1 and the p.c.b. and must be correctly made otherwise the unit may fail to work at all or the control will work in reverse.

IC1 and IC2 may now be fitted in their

respective sockets ensuring that they are the correct way round. Note IC2 is upside down compared to IC1. The pins may need some adjustment before they will go into the sockets. Remember these i.c.s are CMOS types and that it is possible for them to be damaged by static electricity, so avoid touching the pins with your fingers until after they have been inserted into their sockets!

Before fitting the lid tie or fasten all loose leads in place and ensure that nothing will foul when the lid is on. A plastic knob should be fitted to VR1 and a 13A plug fitted with a 1A or 3A fuse connected to the mains lead.

The strings of lights may be made up as follows: Trim the leads on five bi-colour

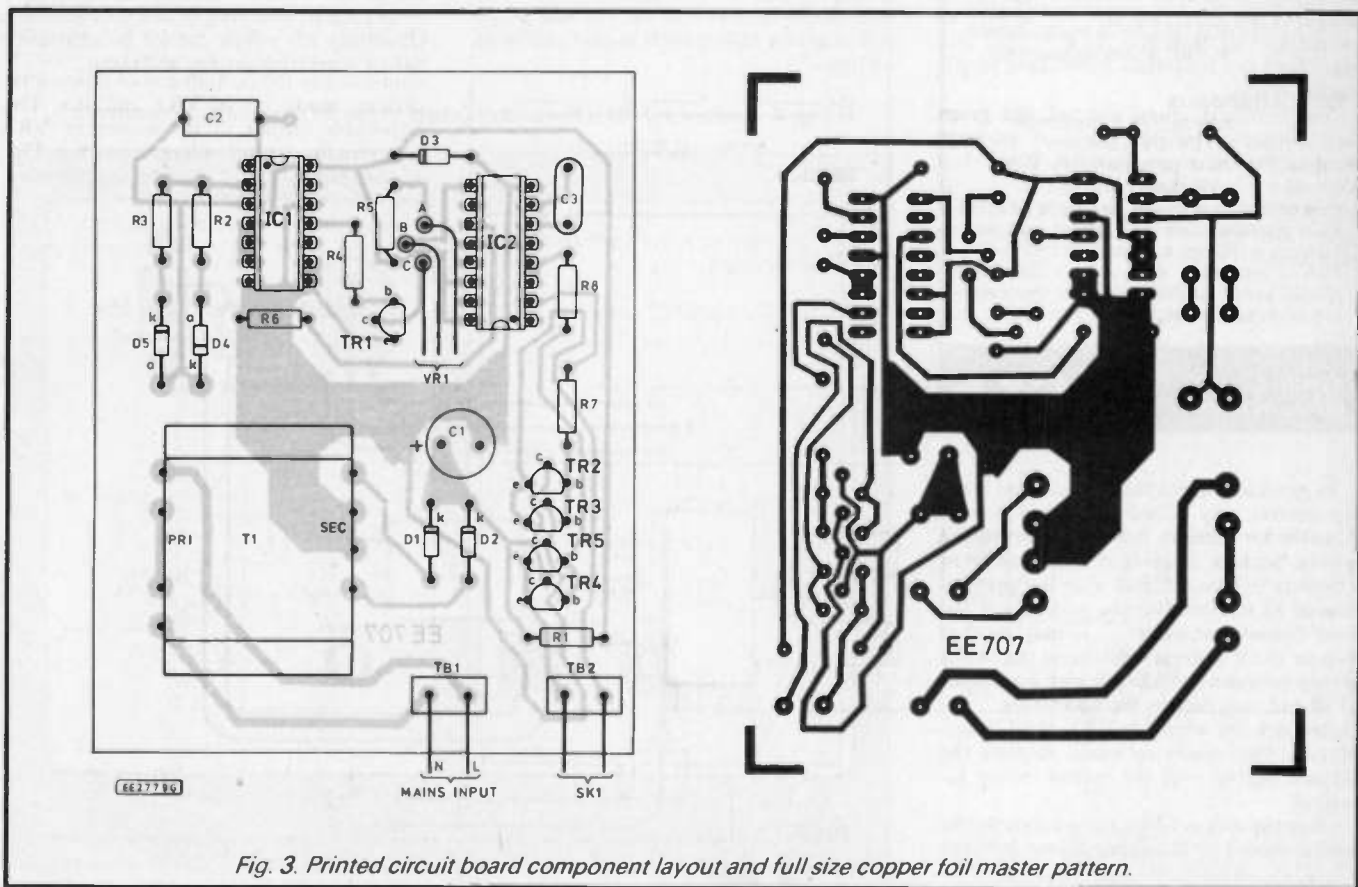

Fig. 3. Printed circuit board component layout and full size copper foil master pattern.

i.e.d.'s to about 3mm and connect them up in series, observing the polarity of each one, as shown in Fig. 5 using thin single core flex. Insulate the connections on each i.e.d. using Araldite or hot adhesive from a glue gun. Connect the two free ends to PL1 and plug into the main unit.

## TESTING

Commence testing by setting VR1 fully anti-clockwise. Plug into the mains and watch the i.e.d.s which should be changing colour about once a second. If nothing happens *unplug* from the mains and check that all internal wiring is correct.

## COMPONENTS

### Resistors

R1	820
R2	470k
R3	1M
R4	6k8
R5	22k
R6	68k
R7, R8	1k (2 off)
R9	270

All 0.25W 5% carbon

### Potentiometer

VR1	4k7 rotary, lin. (plastic spindle)
-----	---------------------------------------

### Capacitors

C1	470µ radial elec.
C2	1µ polyester layer
C3	10n polyester

### Semiconductors

D1, D2	1N4002 1A 100V rec. (2 off)
D3	BZY88C 13V Zener
D4, D5	1N4148 signal diode (2 off)
D6-D10	bi-colour 2-pin i.e.d. (5 off)
TR1, TR2,	
TR4	BC182L npn silicon (3 off)
TR3, TR5	BC212L pnp silicon (2 off)
IC1	4047B CMOS multivibrator
IC2	4046B phase locked loop

### Miscellaneous

T1	Mains 3VA transformer; 15V-0V-15V sec.
SK1/PI1	Non-polarised min. 2-pin plug and socket

Printed circuit board, available from *EE PCB Service*, code 707; plastic case, size 100mm x 76mm x 41mm; mains cable; 13A 3-pin plug, with 1A or 3A fuse; plastic knob; rubber grommet; connecting wire, solder etc.

Approx cost  
guidance only

**£15**

In particular check that the i.c.s are fitted the correct way round (it should not be possible for them to have been put in the wrong sockets since they have different numbers of pins). Check also the orientation of all semiconductors, particularly the four output transistors as it may be that two or more of these have been put in the wrong positions which will give no output at all and may destroy the transistors.

Recheck the wiring to VR1. If all is correct the unit ought to work. Replace the lid and secure with the screws before re-testing.

Once the unit is functioning correctly the i.e.d.s should be changing colour between

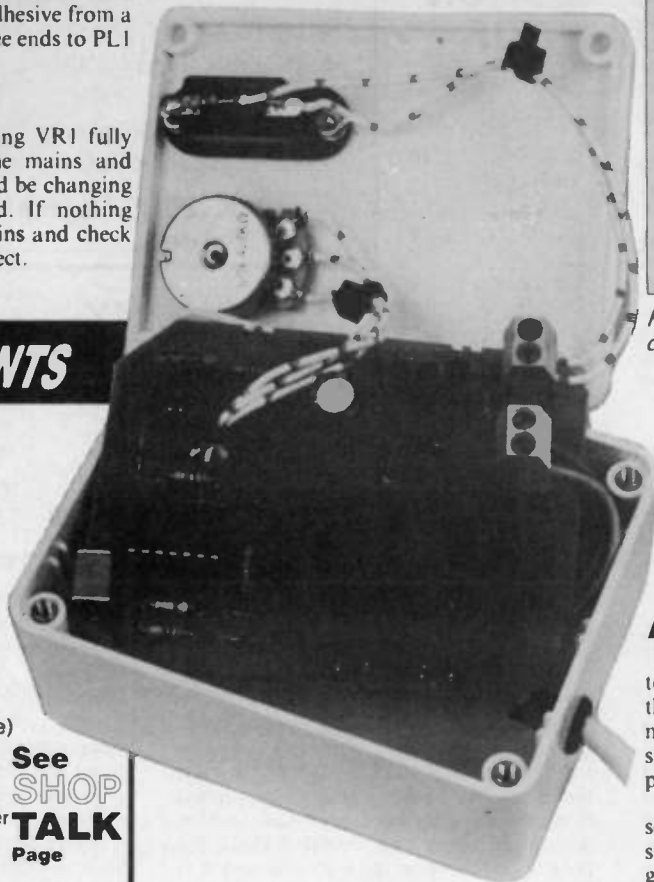

See  
**SHOP  
TALK**  
Page

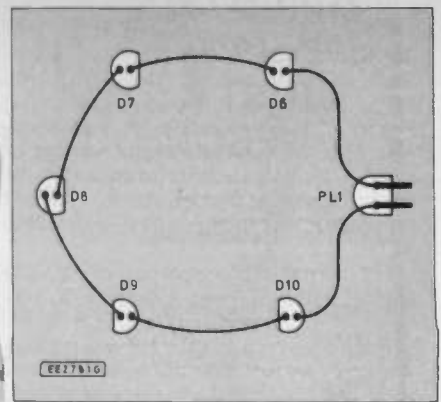

Fig. 5. Wiring up the i.e.d.s to form a display chain.

*Due to mains voltage being present on the circuit board, extreme care should be exercised when carrying out work on the unit. In all cases the mains plug must be removed first.*

## MORE LIGHTS

Duplicating R9, SK1, PL1 and i.e.d.s D6 to D10 is all that is necessary to add up to three or four more strings of lights. Any more than this will require uprating transistors TR2 to TR5 and ultimately a larger power supply will be required.

The value of resistor R9 may need some small adjustment with any number of strings connected and should be selected to give a current of 20mA or so through each i.e.d.

A variation on this circuit would be to use ordinary red and green i.e.d.s in place of the bi-colour ones. Simply connect up two strings of i.e.d.s (one of red, the other green) in the manner shown for the bi-colour set. Connect the two strings in inverse parallel and plug in to the controller. Obviously the yellow cannot be obtained, but an interesting display will result. □

yellow and either red or green. To obtain the missing colour turn VR1 slowly clockwise and the third colour should appear.

Turning VR1 further clockwise will increase the flashing rate of the red and green, leaving the yellow unaffected. Further clockwise still and the red and green will alternate fast enough to give yellow at all times.

Fig. 4. Interwiring from the circuit board to the lid mounted components.

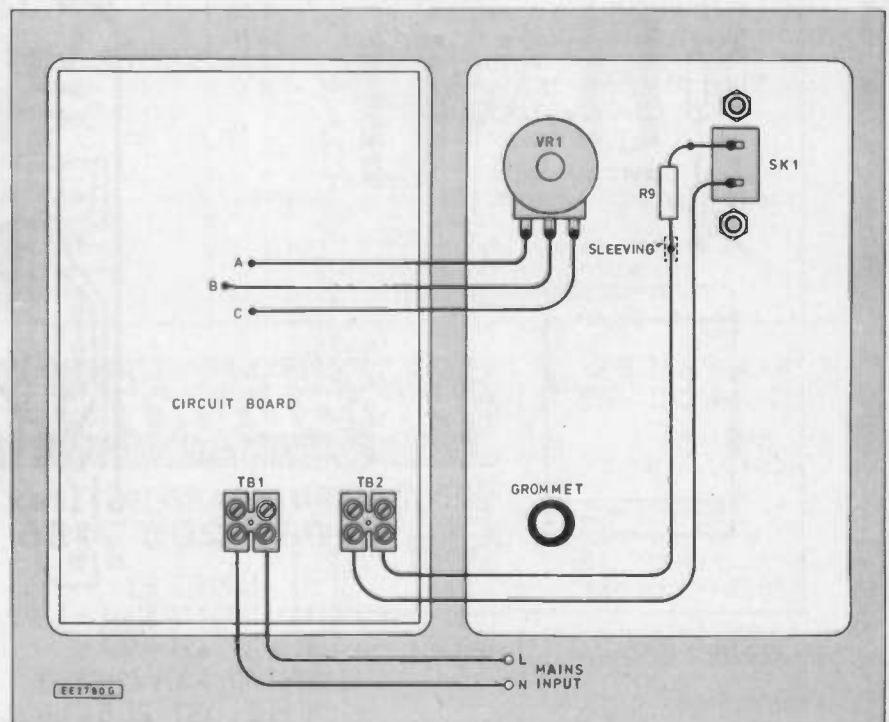

**JUST A SMALL SELECTION  
FROM OUR RANGE OF  
OVER 120 KITS**

Kit No	Description	Price £ (ea)
1001	0.2 WATT FM TRANSMITTER.....	4.16
1004	LIGHT SWITCH.....	5.83
1006	800 WATT MUSIC-TO-LIGHT.....	4.99
1009	1 WATT FM TRANSMITTER.....	5.42
1011	MOTORBIKE ALARM.....	8.33
1013	AM-FM-VHF RECEIVER.....	13.33
1014	3x700 WATT WIRELESS MUSIC-TO-LIGHT.....	10.82
1018	GUITAR TREMELO.....	7.08
1020	0-5 MINUTE TIMER.....	5.42
1022	METAL DETECTOR.....	4.16
1026	RUNNING LIGHTS.....	8.33
1028	4 WATT FM TRANSMITTER.....	14.16
1029	4 SOUNDS ELECTRONIC SIREN.....	4.99
1030	LIGHT DIMMER.....	4.59
1034	CAR BATTERY CHECKER.....	2.92
1036	TRANSISTOR TESTER.....	3.75
1037	DISCO STROBE LIGHT.....	11.25
1038	AM-FM AERIAL AMPLIFIER.....	2.92
1044	GRAPHIC EQUALIZER.....	12.91
1045	SOUND EFFECT GENERATOR.....	6.66
1047	SOUND SWITCH.....	9.58
1049	ULTRASONIC RADAR.....	14.98
1055	FM RECEIVER USING TDA7000.....	12.49
1059	TELEPHONE AMPLIFIER.....	8.33
1065	INVERTER 12V D.C. TO 220V A.C.....	20.82
1069	12V D.C. FLUORESCENT TUBE UNIT.....	5.42
1073	VOX.....	6.24
1074	DRILL SPEED CONTROLLER.....	4.99
1075	ELECTRONIC DICE WITH L.E.D.'s.....	6.66
1084	TV LINE AMPLIFIER.....	3.34
1091	GUITAR PRE-AMPLIFIER.....	7.50
1098	DIGITAL THERMOMETER WITH L.C.D. DISPLAY.....	20.82
1111	LOGIC PROBE.....	3.75
1114	ELECTRONIC LOCK.....	7.50
1117	TV PATTERN GENERATOR.....	9.17
1119	TELEPHONE LINE RECORDING.....	4.16
1122	TELEPHONE CALL RELAY.....	6.66
1124	ELECTRONIC BELL.....	4.99
1125	ELECTRONIC LOCK.....	6.66
1129	NEGATIVE ION GENERATOR.....	14.16
1130	TELEPHONE "BUG" DETECTOR.....	3.34
1133	STEREO SOUND-TO-LIGHT.....	9.52
1203	MINI FM TRANSMITTER WITH MIC. (SUPPLIED READY ASSEMBLED).....	4.16

*All kits contain a Silk-Screened high quality p.c.b., components, solder, wire and FULL instruction sheet.*

*Plastic boxes with silk screened front panels are available for some of the kits. Full details are given in our catalogue.*

**DIGITAL LCD METER**

Major features include:

- ★ Up to 20A AC and DC
- ★ DC volts up to 1000V
- ★ AC volts up to 700V
- ★ HFE and Diode Testing
- ★ 3½ digit LCD display
- ★ 30 position rotary switch
- ★ Push button ON/OFF switch
- ★ Complete with leads, battery

**M-3800 Digital Multimeter**  
**Price .....£32.20**

**ECONOMY  
MULTIMETER**

- ★ Up to 10A DC
- ★ Diode Testing
- ★ DC 200V/AC 500V
- ★ Leads and Battery

**EC-METER £14.38**

**LOGIC  
PROBE**

- ★ Use on TTL or CMOS
- ★ Detect pulses of 25nS
- ★ LED Indicators
- ★ 2 Tone sounder

**LO-PROBE £9.14**

Economy Side Cutters.....	£2.13	Heavy Duty Long Nose Pliers.....	£2.60
Economy Top Cutters.....	£2.13	Heavy Duty Bent Nose Pliers.....	£2.60
Economy Pliers.....	£2.13	Butane Gas Pencil Torch.....	£5.00
Light Duty Cutters.....	£1.61	Crimping Tool.....	£1.84
Automatic Wire Striper.....	£3.34		
Mains Soldering Iron 17W.....	£6.84	Insulated Crimp Terminals: (Pack of 20)	
De-Soldering Pump.....	£2.88	Ring Red.....	£0.62
De-Soldering Braid.....	£0.58	Blue.....	£0.68
6 Piece Screwdriver Set.....	£5.69	Spade Red.....	£0.62
7 Piece Screwdriver Set.....	£6.33	Blue.....	£0.68
8 Piece Screwdriver Set.....	£7.76	Push-on Male Red.....	£0.62
PVC Tape (Assorted Pack of 5).....	£1.04	Blue.....	£0.68
Large Snap-Off Blade Knife.....	£0.58	Push-on Female Red.....	£0.62
Small Snap-Off Blade Knife.....	0.40	Blue.....	£0.68
Pack Large & Small Knife.....	£0.83	Butt Connector Red.....	£0.62
Tweezer Set (Set of 4).....	£3.80	Blue.....	£0.68
Heavy Duty Side Cutters.....	£2.60		

**★★ JUST ARRIVED ★★**

Twin 360K 5.25" Floppy Disc Drive complete with Power Supply. Enclosed in a professional white case complete with mains lead. Connections are via a 37 Pin "D" Socket. Full connection details supplied.  
**TWIN FDD + PSU.....£68.95**

For comprehensive details of all our tools, test equipment and electronic components please see our catalogue. Please follow the information given below.

**★ ALL PRICES INCLUDE VAT ★**

**UK Orders:**  
Add £2.00 carriage

**Europe & Eire:**  
Deduct 15% VAT  
(divide price by 1.15)  
Add £5.00 carriage.

**Outside Europe**  
Deduct 15% VAT  
(divide price by 1.15)  
Add £10.00 carriage.

**Hobbykit Ltd.**



**CREDIT CARD HOTLINE**

**☎081-205 7485**



**UNIT 19  
CAPITOL INDUSTRIAL PARK  
CAPITOL WAY  
LONDON NW9 0EQ  
FAX NO: 081-205 0603**

For a comprehensive Kit Catalogue plus our new Tools, Test Equipment and Component Catalogue please send an A4 envelope stamped:

**UK:**  
£0.45  
**Europe & Eire:**  
£1.00  
**Outside Europe:**  
£2.75

## DIGITAL SPEEDOMETER

Exciting FULL feature kit, intended for bicycles but adapts to virtually any wheeled transport (10" to 32" diameter). POWERFUL custom micro crunches numbers with precision accuracy. Memorises 9 journeys up to 99.9 miles/Km. Great fun to assemble and use. Available as Budget (BK) or Complete Kit (CK) to suit all pockets. PP3 battery needed, fits inside case of CK kit.

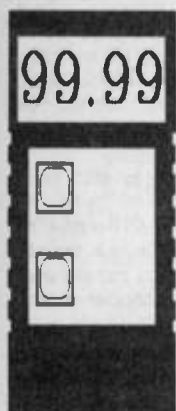

### BIG 4 DIGIT 7 SEG LCD

easy to view on the move, shows SPEED, TOP SPEED, AVERAGE SPEED, DISTANCE GONE, DISTANCE TO GO, and TIME TO DESTINATION...at the touch of a button. Alpha prompts tell you whats on display..eg SPD, DTG etc.

**VERSATILE** just switch on & go or select a favourite journey. Great for training, getting to work on time or plain outdoors fun!

**PROGRAMMABLE.** Journey number, trip distance, and units for display (Km or miles) are easily

entered by 2 buttons.... friendly alpha prompts and messages guide you through. Data is stored in state of the art EEPROM for up to 10 years with NO POWER!

No special tools needed, just a pencil tip soldering iron.

Wheel sensor is miniature NON CONTACT solid state Hall effect device...requires 1 TINY magnet to be fitted on to wheel. CK kit shown includes smart ABS case 120\*60\*25 plus switches plus all of BK kit. Sorry we dont sell brackets to fix case to bike etc.

BK includes pcb, micro, LCD, Hall sensor with cycle fork bracket. Order CK-SPD £51.85, BK-SPD £38.95.

## CENTRONICS BUFFER POD

COMPUTERS are *FAST* PRINTERS are *SLOW*  
Your parallel Centronics printer or plotter WASTES time & money by tying up your computer. How often have you had to wait frustrated, wanting to carry on, whilst the printer/plotter GRINDS your time away?

Fit Buffer Pod and be back on the computer SECONDS after starting a print or plot. Schools, colleges, universities, programmers, business users and hobbyists will all benefit from greater productivity and timesaving.

Available as an easy to build kit or assembled and tested. INTELLIGENT & FAST. 64K unit loads a massive 40 pages of A4 text in 40 seconds or less. REPRINT button for 1 to 255 copies. Installs in 5 seconds(!)...NO NEW CABLE needed. Powered from pin 18 of printer OR optional user supplied external lo-volt AC supply.

Complete kit includes COMPACT stylish ABS case 145\*90\*41 plus switches plus all of BK kit. Budget kit has top grade PTH pcb, Centronics socket, Centronics plug on 12" ribbon header (assembled), programmed micro, CMOS RAM(s) etc.

No room for a picture.....full page advert in next issue!

Assembled, tested, cased AT-64K £82.31

Complete Kits CK-64K £69.70, CK-32K £63.70.

Budget Kits BK-64K £56.00 BK32K £49.90

ALL ITEMS offered include detailed cct & instructions.

\*ALL\* prices INCLUDE VAT. Overseas divide by 1.15. UKp&p £2 per item. Eire, Europe £4, elsewhere £10 STRICTLY MAIL ORDER ONLY. An sae will ensure fast response to enquiries. Dedicated phone/fax line coming. Terms HMG,LEA orders accepted else cwo, cheque/PO payable to D.RICHARDSON.

## D.RICHARDSON SYSTEMS

120BATHROAD, ATWORTH, MELKSHAM WILTSHIRE. SN12 8HN



## The UK Distributor for Standard Toroidal Transformers

- 106 types available from stock
- Sizes from 15VA to 625VA
- Dual 120v primaries allowing 110/120v or 220/240v operation

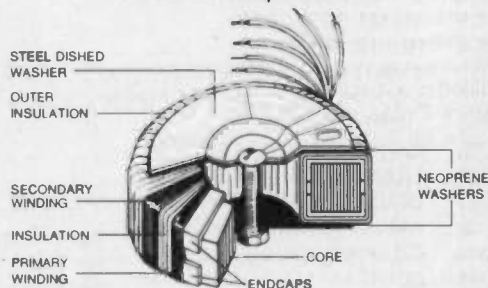

TYPE	SERIES NO.	SEC VOLTS	RMS CURRENT	TYPE	SERIES NO.	SEC VOLTS	RMS CURRENT
15VA £10.45	03010	6+6	1.25	160VA £18.80	53011	9+9	8.89
	03011	9+9	0.83		53012	12+12	6.66
	03012	12+12	0.63		53013	15+15	5.33
	03013	15+15	0.50		53014	18+18	4.44
	03014	18+18	0.42		53015	22+22	3.63
	03015	22+22	0.34		53016	25+25	3.20
	03016	25+25	0.30		53017	30+30	2.66
30VA £11.95	03017	30+30	0.25		53018	35+35	2.28
	13010	6+6	2.50		53026	40+40	2.00
	13011	9+9	1.66		53028	110	1.45
	13012	12+12	1.25		53029	220	0.72
	13013	15+15	1.00		53030	240	0.66
	13014	18+18	0.83		225VA £20.60	63012	12+12
	13015	22+22	0.68	63013		15+15	7.50
13016	25+25	0.60	63014	18+18		6.25	
13017	30+30	0.50	63015	22+22		5.11	
50VA £13.55	23010	6+6	4.16	63016		25+25	4.50
	23011	9+9	2.77	63017		30+30	3.75
	23012	12+12	2.08	63018		35+35	3.21
	23013	15+15	1.66	63026		40+40	2.81
	23014	18+18	1.38	63025		45+45	2.50
	23015	22+22	1.13	63033		50+50	2.25
	23016	25+25	1.00	63028		110	2.04
80VA £15.10	23017	30+30	0.83	63029		220	1.02
	23028	110	0.45	63030		240	0.93
	23029	220	0.22	300VA £22.45	73013	15+15	10.0
	23030	240	0.20		73014	18+18	8.33
	33010	6+6	6.66		73015	22+22	6.82
	33011	9+9	4.44		73016	25+25	6.00
	33012	12+12	3.33		73017	30+30	5.00
33013	15+15	2.66	73018		35+35	4.28	
33014	18+18	2.22	73026		40+40	3.75	
33015	22+22	1.81	73025		45+45	3.33	
33016	25+25	1.60	73033		50+50	3.00	
33017	30+30	1.33	73028		110	2.72	
33028	110	0.72	73029		220	1.36	
33029	220	0.36	73030		240	1.25	
33030	240	0.33	500VA £28.95		83016	25+25	10.0
120VA £16.10	43010	6+6		10.0	83017	30+30	8.33
	43011	9+9		6.66	83018	35+35	7.14
	43012	12+12		5.00	83026	40+40	6.25
	43013	15+15		4.00	83025	45+45	5.55
	43014	18+18		3.33	83033	50+50	5.00
	43015	22+22		2.72	83042	55+55	4.54
	43016	25+25		2.40	83028	110	4.54
43017	30+30	2.00		83029	220	2.27	
43018	35+35	1.71		83030	240	2.08	
43028	110	1.09		625VA £31.95	93017	30+30	10.41
43029	220	0.54			93018	35+35	8.92
43030	240	0.50			93026	40+40	7.81
			93025		45+45	6.94	
			93033		50+50	6.25	
			93042		55+55	5.68	
			93028		110	5.68	
			93029		220	2.84	
			93030		240	2.60	



Prices include VAT and carriage

Quantity prices available on request  
Write or phone for free Data Pack

## Jaytee Electronic Services

143 Reculver Road, Beltinge, Herne Bay, Kent CT6 6PL  
Telephone: (0227) 375254 Fax: 0227 365104



# ROBOT ROUNDUP

Nigel Clark

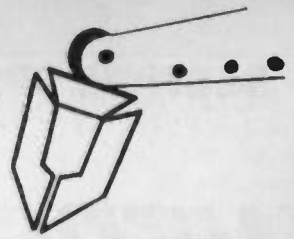

## TWENTY YEARS AWAY

There will be no market for domestic robots for at least 20 to 25 years. There is nothing unusual in that being the view expressed by someone close to the industry. There has always been a body of opinion less optimistic, or more realistic – depending on your view – in its reading of developments in domestic robots.

However when it is expressed by the head of the company which has been given the task of taking the Department of Trade and Industry's domestic robot initiative through its next phases it has more than a good chance of becoming a self-fulfilling prophecy.

Dr Patrick Finlay, head of Fulmar Systems, backs up his view by saying that any devices which could be built today would be so expensive that only the very rich would be able to afford them.

"That will remain the case until the costs come down and the processing power increases."

However, he is not totally negative on the issue. He still thinks that there is work which can be done at the moment to help advance the day when domestic robots will become viable.

## DISABLED AID

Fulmar's own suggestion is a mobile robot with an arm which could be an aid for the disabled. One critical element of the device would be that it should operate in any home environment, not requiring the house to be adapted to the needs of the robot.

This idea is now being evaluated by the DTI and Fulmar hopes to get the go-ahead soon to enable the project definition to be completed by Easter next year. The next phase would be the preparation of a demonstration prototype by the end of 1992.

Fulmar's work is taking up where Richard Pawson's Personal Robots Ltd left off when it went into liquidation towards the end of last year. In its final report on the feasibility phase of the DTI initiative it suggested four areas for further study:

- Low-cost single task device for jobs such as lawn mowing, vacuum cleaning, cooking and home security.
- Multi-function domestic robot aimed at the luxury home market.
- Domestic service industry robot.
- Healthcare robot for the handicapped.

If the Fulmar idea gets the OK from the DTI the work of preparing the prototype will be split among the members of the domestic robot initiative. As only 50 per cent of the cost of this stage will be met by the DTI the balance will have to be met from outside sources. It is expected that the initiative members doing the prototype work will fund it themselves. The final stage of producing a commercial product will get no government support at all.

## VALIANT FOR CDT

Valiant Technology is determined to make its Roamer mobile an important

part of teaching Design in the National Curriculum's Craft, Design and Technology section. For most of this year, since the company decided to design a package around Roamer, Dave Catlin has been working on the project.

"It's turned into a monster," he said, adding that he hoped to have the work finished in the near future. "It's all I'm doing at the moment."

The concept was to show how the design process works, giving it a practical basis by explaining it in relation to customising Roamer, their Smartie-shaped mobile. When he began to get into the subject Catlin quickly realised that a basic idea of creating something to satisfy a need soon expands into defining a solution, creating a design, building and testing. And into those steps are inserted varying constraints such as the technology and materials available and the need to be aware that what might seem old technology could be the most relevant if adapted; for instance power from windmills is now making a comeback.

Catlin commented that, "there are certain logical steps in all this and we are hoping that this package will provide a framework to show how those steps combine to create the final product."

In the meantime Valiant has produced two new packs to enable further customising of Roamer. The light pack contains eight l.e.d.s with four different colours, two lamps and a flasher unit. An activity booklet gives some ideas of models which can be made.

The most obvious is some form of vehicle with headlights, rear lights and indicators which use the flasher unit. This unit is needed because if the flashes are programmed into Roamer they would cause the robot to stop. Another idea is to turn Roamer into a jukebox with the lights programmed to go on and off in time with the notes being played.

The sensor pack contains two touch switches, sound and light sensors and a

push button switch, increasing the design possibilities immensely. With careful programming the mobile could be made to appear as if it had a personality, reacting to changes in sound and light. Catlin even suggested it would be possible to create a form of sheepdog reacting to whistles.

Valiant's control console is also now available. Not to be confused with the control box which is added to Roamer to increase its use, the console is a stand-alone controller. It has eight inputs and eight outputs plus two stepper-motor drives and a counter unit.

It is an upgrade of the controller on the Roamer with a number of added facilities, one of the most interesting of which is the counter. Catlin gave as an example of its capabilities a mobile which would wait until something like a light flashing on and off had occurred a set number of times before reacting.

## TURTLE TRAILS

The Jessop turtle, also known as the Edinburgh turtle, the upturned mixing bowl, has had its capabilities expanded for the first time in many years with the introduction of Turtle Trails. They have been developed by MEU Cymru and are made up of printed floor mats and keyboard overlays.

The mats contain routes for the turtles to follow and the overlays for the Concept keyboard enable the children to guide the turtle. As well as the turtle and the keyboard Logotron Logo and a Multiplexer are needed. The pack, which costs about £20, also contains instructions and templates for making other routes. Teachers' instructions and a video help provide ideas.

Jessop's turtle was one of the first on the market in this country having been developed by the Artificial Intelligence Department at Edinburgh University. It has sold steadily over the years, finding a new interest with the introduction of the National Curriculum. Costing a little more than £200 there are versions for the BBC series, Nimbus, IBM PC, Commodore C64 and Spectrum. It is driven by two stepper motors, has a retractable pen holder and uses each manufacturer's version of Logo.

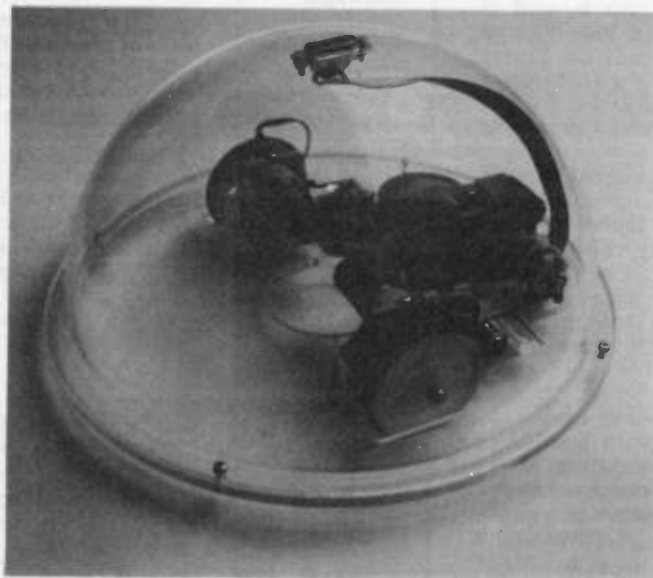

*The Jessop turtle is claimed to have been one of the first "mobiles" on the UK market and the new expanded version carries a price tag of just over £200.*

# VERSATILE BENCH POWER SUPPLY

**MIKE TOOLEY BA**

*The first constructional project to accompany our Design Your Own Circuits, series takes the form of a Versatile Bench Power supply. This unit provides one variable output (3V to 15V) together with two fixed outputs (one of 5V and the other of 12V, both rated at 1A maximum continuous current). As with all of the practical constructional projects in this series, a number of modifications are suggested so that the more intrepid constructor can customise the unit to his or her own particular requirements.*

**A** RELIABLE bench power supply can be an extremely valuable addition to the range of test equipment available in any electronic workshop. Not only does our versatile bench power supply fulfil a general need but it can also be used to provide the various voltage rails required by the projects described in the Design series. In addition, one of the fixed voltage dual-output modules described in the text can be easily added to further extend the facilities available.

The vast majority of electronic circuits and modules operate from one or more low voltage d.c. supply rails. Indeed, the voltages and currents used by most electronic circuits are usually quite small (often less than 12V and below 1A) and none of the circuits described in our Design series require anything unusual in this respect.

## OUTPUTS

Our versatile bench power supply has been designed to satisfy the need for a reliable low-voltage, low-current supply which has accurate fixed as well as variable outputs. The variable output can supply currents well in excess of 1A (its maximum continuous rating) and it has a variable current limit. This useful facility can be

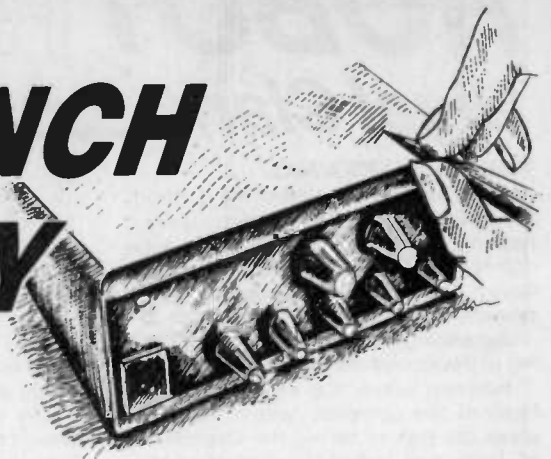

instrumental in helping to avoid damage to circuits under test when excessive currents flow due to inadvertent misconnection or failure of individual components.

All three of the power supply outputs are protected against inadvertent short circuit connection though such a condition should not be allowed to persist for more than 60 seconds, or so.

## SAFETY

It is worth stating at the outset that this project is ideal for construction by a relative beginner. The circuit is straightforward and uses relatively few components. The components themselves are quite rugged (both electrically and mechanically) and therefore do not require special handling. There is, however, one important proviso: this project derives its power directly from the domestic a.c. mains supply and thus special precautions are necessary since the mains supply (of nominally 240V at 50Hz) can be lethal if handled incorrectly. It is, therefore, vitally important that constructors observe the following precautions when building this project:

1. Ensure that the equipment is switched off and the a.c. mains supply lead removed whenever the equipment is

## Specifications

### Variable output:

Voltage:	Variable from +3V to +15V
Current:	1A maximum continuous
Current limit:	Variable from 5mA to 2A max.
Regulation:	0.15% (typical)
Output resistance:	0.1 ohm (typical)
Hum and noise:	Less than 500 $\mu$ V

### Fixed outputs:

Voltage:	+5V and +12V
Current:	1A maximum continuous (total)
Current limit:	Fixed at 1A (either output)
Regulation:	0.2% (typical)
Output resistance:	0.05 ohm (typical)
Hum and noise:	Less than 250 $\mu$ V

### Mains input:

Voltage:	220V to 240V (see note)
Current:	200mA (typical)
Power:	50VA (maximum)

Note: The mains transformer may also be wired for 110/120V a.c. operation by parallel connecting the two primary windings. In this case the input current will typically be 400 mA.

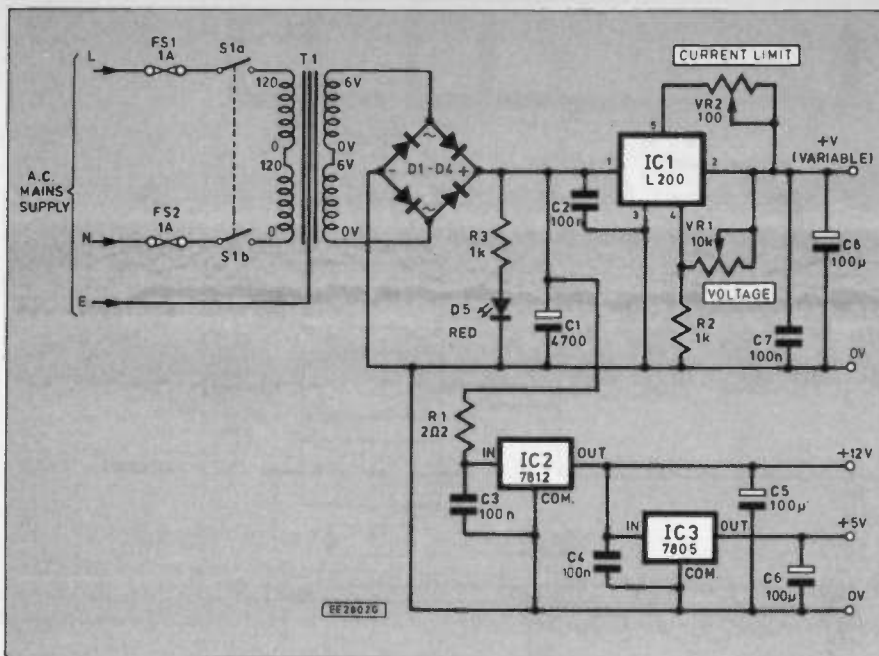

Fig. 1. Complete circuit diagram of the versatile bench power supply.

being worked on and whenever the case is in a dismantled state.

2. Ensure that only correctly rated fuses are fitted to the equipment (as specified in the components list). A standard 3A mains fuse should be fitted to the mains plug.

3. Only use the type of IEC mains lead and connector (which incorporates an earth) specified in the components list. This lead should be disconnected (and the unit switched off) whenever it is necessary to remove power from the equipment during testing and/or fault finding.

4. Do not attempt to apply mains voltage to the equipment until all of the wiring and assembly has been completed and the wiring has been carefully checked.

## CIRCUIT DESCRIPTION

The complete circuit of the versatile bench power supply is shown in Fig. 1. The circuit is based on an L200 variable voltage regulator (IC1) and two fixed voltage regulators (IC2 and IC3) which respectively provide the fixed +12V and +5V outputs.

A conventional bridge rectifier/reservoir capacitor arrangement is used to provide a source of raw d.c. (approximately 17V off-load falling to 15V on-load) for the regulators. A low-value series resistor is incorporated in the d.c. feed to the two fixed voltage regulators in order to limit the current on full load. All three of the voltage regulators incorporate internal over-current and thermal protection.

## CONSTRUCTION

The vast majority of the components for the versatile bench power supply are assembled on a single-sided printed circuit board measuring approximately 60 × 130mm. The copper foil layout of the printed circuit board and the corresponding component side layout are shown in Fig. 2.

Components should be assembled on the printed circuit board in the follow-

ing sequence: p.c.b. headers, resistors, capacitors, variable resistors, bridge rectifier, integrated circuit regulators. As with all of our projects, it is important to ensure that all of the components are correctly located. Furthermore, in the case of the polarised components (such as electrolytic capacitors, bridge rectifier, and integrated circuits) it is absolutely essential to ensure that each component is correctly orientated.

When construction of the printed circuit board has been completed (and before the heatsink is attached) it is well worth carrying out a careful visual check of both the upper and lower sides of the board. The upper (component) side of the printed circuit board should be examined to ensure that the components have been correctly located whilst the lower (copper track) side of the board should be checked to ensure that there are no dry joints or solder bridges between adjacent tracks. This precaution will only take a few minutes to carry out but can be instrumental in preventing much heartache at a later stage!

When assembly of the printed circuit

board has been completed, the board should be mounted on the front panel by means of the two threaded shafts fitted to the variable resistors. The rear of the printed circuit board is supported above the base of the case by means of two plastic or aluminium alloy mounting pillars. These must be cut to the required length (approximately 49 mm in the prototype unit) and attached by means of self-tapping No. 6 fixing screws.

## HEATSINK

In order to avoid premature thermal shut-down (which would severely limit the current output capability), the three regulators require a heatsink of 3.5 degrees C per Watt (or better). This can be achieved by means of a commonly available black finished finned heatsink measuring approximately 75 × 108 × 14 mm. In order to promote effective heat dissipation, the heatsink should be fitted with its fins aligned vertically and, as far as possible, in a region in which free airflow exists.

Having obtained a suitable component, the heatsink should then be aligned with the rear of the printed circuit board so that its lower edge rests on the base of the ABS case with the heat-radiating fins aligned in the vertical plane. The heatsink should be marked and carefully drilled to match the mounting holes provided in the metal tabs of the regulators, each of which should be bolted to the heatsink using an M3 nut, bolt and shakeproof washer (insulating washers and bushes are not required since the conductive mounting tabs of all three regulators are connected directly to common 0V). The bottom of the heatsink may then be attached to the base of the case by means of a small L-shaped aluminium bracket. This is also retained by means of two M3 nuts, bolts and shakeproof washers.

In order to improve thermal conductivity between the integrated circuits and the heat sink, a small film of heat sink compound should be smeared onto the rear surface of each device prior to mounting. This film can be instrumental in improving thermal conductivity between the integrated circuits and the heat sink. It is important to note that effective heat dissipation is essential in order to prevent premature thermal shut-down of the regulators. Furthermore maximum load currents can only be achieved if there is effective heat transfer from the regulators to the heat sink.

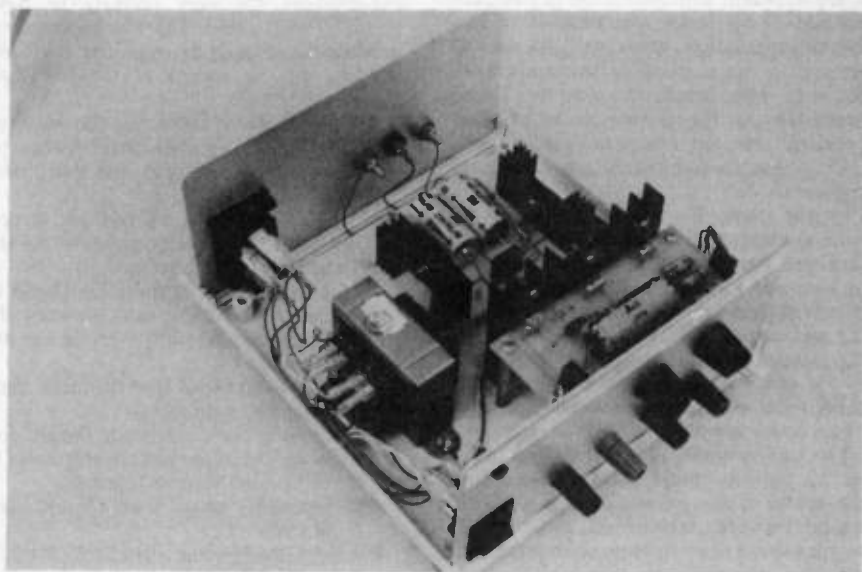

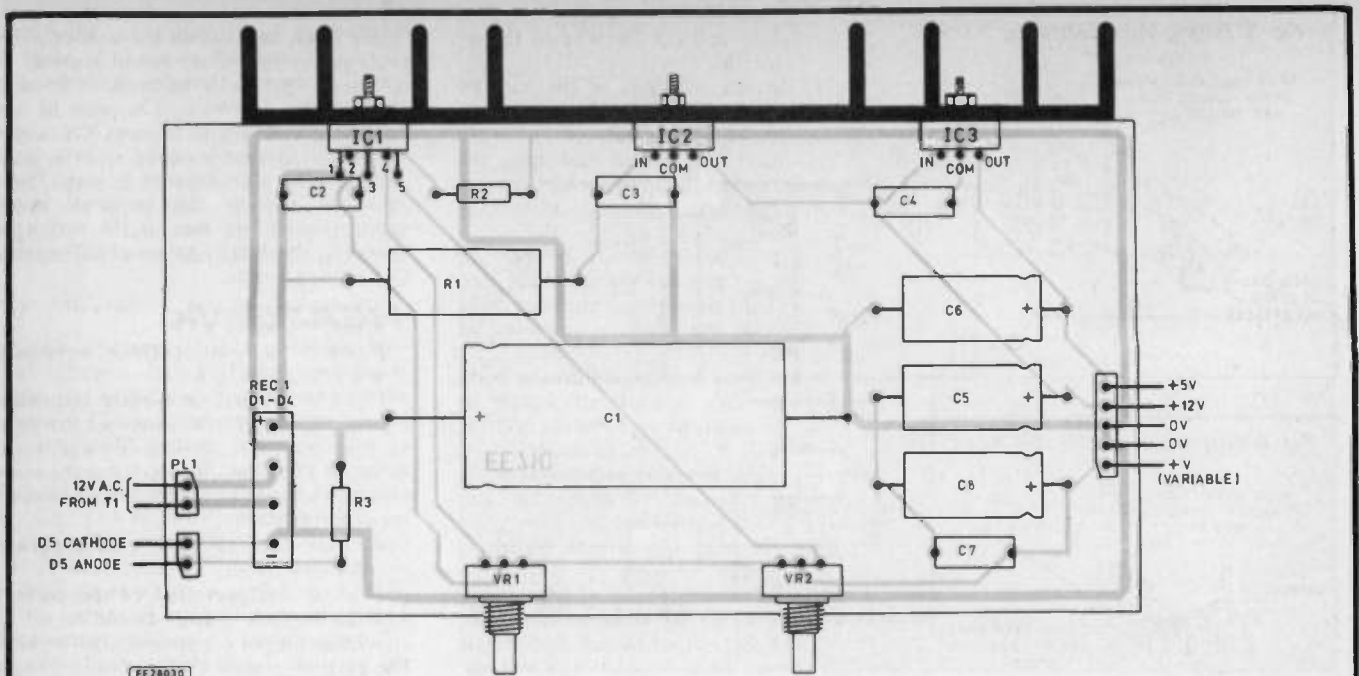
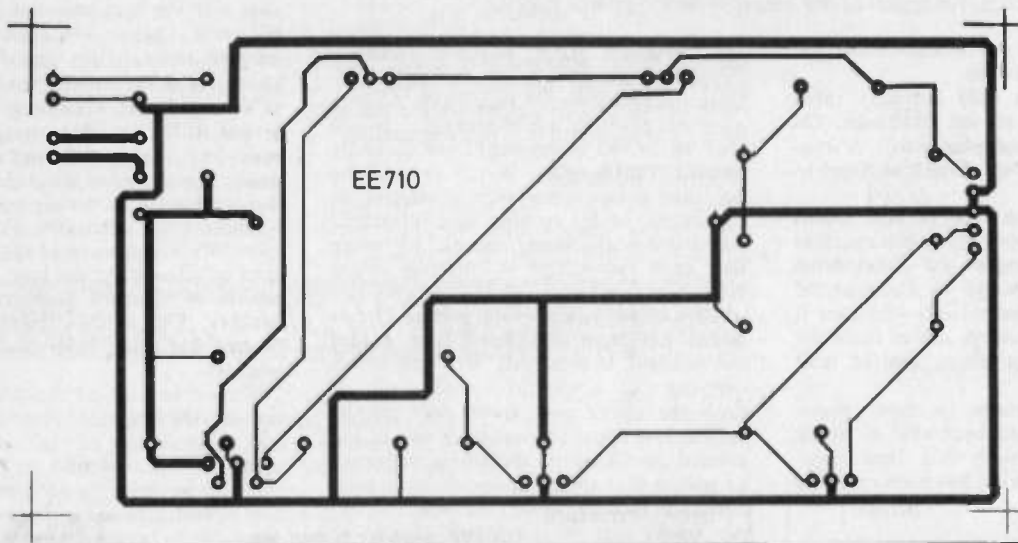

Fig. 2. Copper foil and component layout for the power supply printed circuit board.



## CASE

The Versatile Bench Power Supply may be housed in any suitable ABS or metal enclosure which measures approximately 220 × 230 × 105mm or greater. Ventilation is unimportant provided there is sufficient volume of air inside the unit. If in any doubt, ventilation holes can be cut at strategic points in the underside and rear of the unit. This precaution was not found necessary on the prototype which was "soaked" for ten hours at rated output (12V 1A) in an ambient temperature of 30 degrees C.

In any event, the case should be fitted with aluminium front and rear panels to facilitate mounting of the controls, connectors and indicator. The front and rear panels should be marked out before drilling and cutting takes place. There is nothing particularly critical about the layout of the unit and constructors may wish to experiment with the location of the front panel controls and sockets.

The two controls and five output sockets all require round holes to be cut in the metal front panel. This is a fairly straightforward exercise (it is, however, worth using a centre punch so that the drill bit does not wander!) however the rear

mounted IEC mains power connector and front-panel mounted mains switch require rectangular mounting holes and are thus not quite so easy to deal with! In production applications, the required holes are normally cut using a rectangular punch but constructors are very unlikely to have access to such a tool. There is, however, no need to panic since the required apertures may be cut by means of the following simple procedure:

(a) Accurately mark out the required apertures on the aluminium front and rear panels using a ruler and sharp pencil.

(b) Carefully drill 6.5 mm (or larger) diameter holes at each corner (within the area of material to be removed).

(c) Cut, using a tension file (fitted in a hacksaw or coping saw) between the four holes and carefully remove the unwanted metal.

(d) Use a flat file to trim the metal back to the marked outline.

For reference, the dimensions (height followed by width) of the rectangular holes in the prototype unit were as follows:

IEC chassis plug and fuseholder: 48.5 × 34.5mm

Rocker-action mains switch: 27.5 × 22.5mm

In any event, constructors are advised to check the dimensions of the components actually used prior to marking out the front and rear panels.

## CONNECTORS

The IEC mains connector specified for use in this project is fitted with integral 20mm fuseholders. In the event that such a component is unavailable, a standard IEC chassis mounting plug can be used in conjunction with two separately mounted 20mm fuseholders.

All mains connections (i.e. those associated with the IEC mains connector, fuseholders, and mains switch) are made with the aid of shrouded snap-on receptacles. This method of wiring is inherently safe (since all joints are fully insulated) and furthermore it avoids the need for soldering directly to the individual components.

Two sizes of receptacle are required; 250 (0.25 inch) for the IEC chassis connector and rocker-action mains switch and 110 (0.11 inch) for the fuseholders and transformer connections. The receptacles are assembled as follows:

(a) Select the appropriate wire colour (see below) and cut the wire to the required length.

(b) Prepare the ends of the wire by

Fig. 3. Fitting the receptacles.

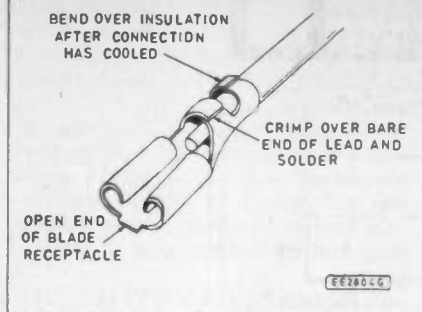
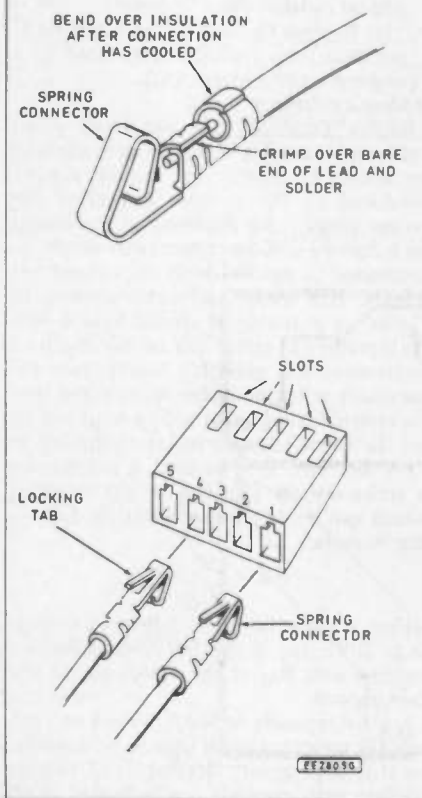

Fig. 4. Fitting the header contacts



stripping back the insulation by 3mm (110 receptacles) or 5mm (250 receptacles), twist and tin the ends.

(c) Fit receptacle covers (of appropriate sizes) to the wires (the larger open end should face towards the tinned end to which the receptacle will be fitted).

(d) Insert the tinned ends into the receptacles. Bend the receptacle to grip the tinned wire and insulation (as shown in Fig. 3).

(e) Apply heat from a soldering iron bit and run a small amount of solder into the receptacle from the open end.

(f) Slide the receptacle cover over the receptacle until it is completely insulated.

The wire used for the mains wiring should be 7/0.2mm or 16/0.2mm stranded equipment wire which conforms to BS 4808. The following colour coding is recommended:

Brown: Mains - line. Blue: Mains - neutral. Green: Mains - earth. Pink: All low-voltage a.c. wiring

Connections to the printed circuit board are made using two 5-way printed circuit board headers.

(a) Select the appropriate wire colour

(see below) and cut the wire to the required length.

(b) Prepare the ends of the wire by stripping back the insulation 2.5mm from the end. Tin the end.

(c) Insert the tinned end into the sprung contact. Bend the header contact to grip the tinned end and insulation (as shown in Fig. 4).

(d) Apply heat from a soldering iron and run a small amount of solder into contact from the spring-loaded end (take care to use the absolute minimum of solder!).

(e) Snap the receptacle into the body of the printed circuit board header (it should be gently pushed into the body of the header until it locks into place).

The wire used to make connections to the l.e.d. power indicator and 4mm screw terminals should be 1/0.6mm conforming to BS 4808. The following colour coding is recommended:

LED cathode: Black. LED anode connection: Violet. 0V/common terminals: Black. Variable output (+ve): Red. Fixed +5V output: Blue. Fixed +12V output: Yellow.

The internal wiring of the versatile bench power supply is shown in Fig. 5. It is important to carefully check the wiring of the unit before attempting to connect the power supply to the mains. Particular emphasis should be placed on the mains wiring and mains transformer connections.

## TESTING

Insert two 20mm 1A quick-blow fuses into the IEC chassis plug assembly, connect an IEC mains lead (fitted with a 3A

mains fuse), and switch the unit on. The l.e.d. power indicator should become illuminated. Set both controls (VR1 and VR2) to the fully clockwise position (i.e. maximum voltage and current). Connect a voltmeter (preferably digital type) to each output in turn (the negative meter lead can be connected to either of the black 0V terminals) and measure the voltages produced. These should be within the following range:

Maximum variable output (red terminal): +15V to +17V

Fixed +5V output (blue terminal): +4.75V to +5.25V

Fixed +12V output (yellow terminal): +11.5V to +12.5V

Now set the voltage control (VR1) to minimum and again measure the voltage produced at the variable output (red terminal). This should be in the range:

Minimum variable output (red terminal): +2.4V to +3.2V.

To check the operation of the current trip, the variable output should be set to provide an output of approximately +12V. The current control (VR2) should remain set at the maximum (fully clockwise) position. Now connect a 560ohm 1/2W carbon resistor to the variable output (i.e. between the red and black terminals). Slowly back-off the current control until the output voltage starts to fall rapidly to a low value. If all is well, current limiting should occur at a position which is roughly half-way between the maximum and minimum settings. The output voltage should fall to a very low value as the setting of VR2 current control is further reduced.

If any of the output voltages are not

## COMPONENTS

### Resistors

R1	22Ω 2.5W vitreous coated wirewound
R2	1k 0.5W 5% carbon
R3	1k 0.25W 5% carbon

### Potentiometers

VR1	10k 1W panel/p.c.b. mtg. lin.
VR2	100 1W panel/p.c.b. mtg. lin.

### Capacitors

C1	4700μ axial elect. 25V
C2, C3, C4, C7	100n miniature dipped case polyester (4 off)
C5, C6, C8	100μ axial elect. 25V (3 off)

### Semiconductors

BR1	200V 1.6A in-line bridge rectifier (e.g. SKB2/02L5A)
IC1	L200
IC2	7812
IC3	7805
D1	Red LED (with mounting bezel)

### Miscellaneous

T1	20VA mains transformer with two secondary windings, each rated at 6V 1.6A
PL1, PL3	2-way straight p.c.b. header (0.1in pitch) (2 off)
PL2	5-way straight p.c.b. header (0.1in pitch)
SK1, SK2	5-way socket housing (0.1in pitch) (2 off)
FS1, FS2	20mm 1A quick-blow fuses (2 off)
S1	DPST snap-fit rocker-action mains switch
Heatsink, 3.5deg. C/W finned black heatsink approx. 75 x 108 x 14mm (see text); Enclosure, ABS enclosure (220 x 230 x 105 mm) with aluminium front and rear panels; knobs, Styled grub screw fixing knobs with pointers (2 off); terminals, insulated 4mm terminals (1 red, 2 black, 1 blue, 1 yellow); receptacles, (7 off) 110 (0.11in) receptacles (10 off) 250 (0.25in) receptacle covers (7 off) 110 (0.11in) receptacle covers (10 off); mains plug, double fused snap-in IEC chassis plug; printed circuit board (see text) available from the <i>EE PCB Service</i> , order code EE710; pillars plastic or aluminium alloy (see text) with self-tapping No. 6 fixing screws (4 off)	

See  
SHOP  
TALK  
Page

Approx cost  
guidance only

£30 plus case

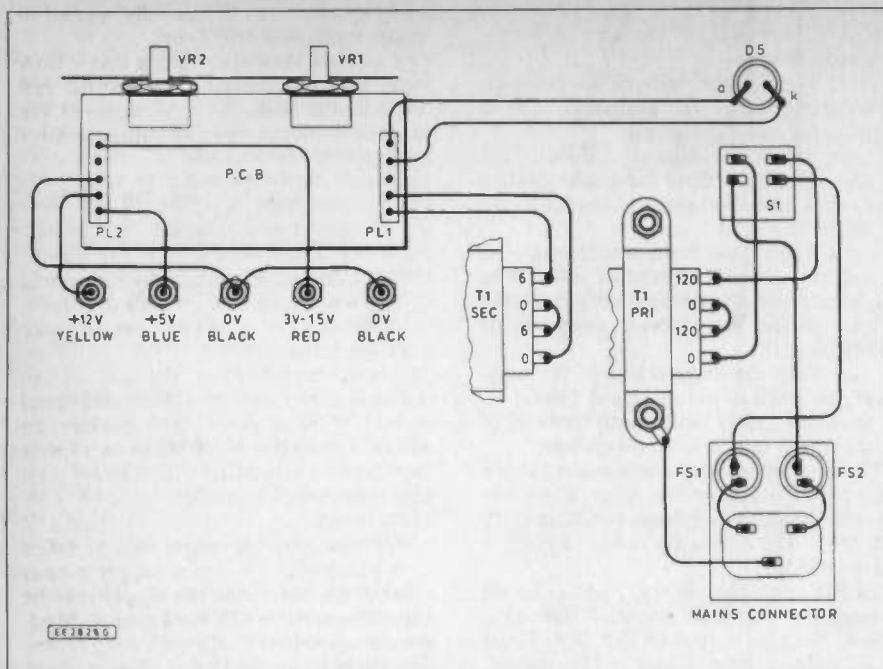

Fig. 5. Internal wiring of the versatile bench power supply.

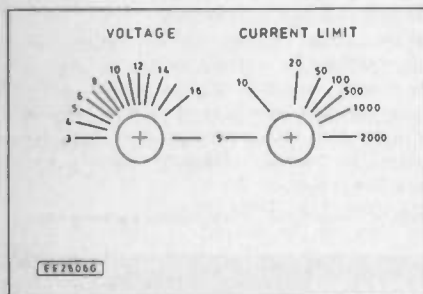

Fig. 6. Front panel calibration marks.

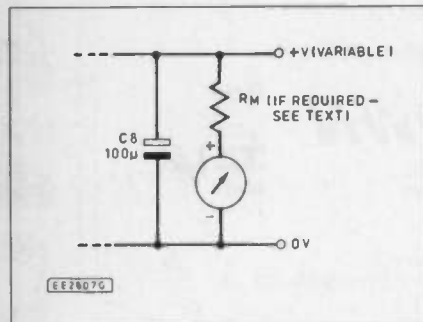

Fig. 7. Connecting a voltmeter to the variable output

within the ranges specified or if the variable output current limit fails to operate as described, it is best to switch off and disconnect the mains power before carefully checking the printed circuit board and internal wiring.

## MODIFICATIONS

A number of useful modifications may be made to the basic power supply design. The suggestions made here are provided as "food for thought" and should make a starting point for further development. Constructors are invited to report their own modifications to be incorporated in the Readers' Feedback which will appear in the final part of our Design series.

### Additional fixed dual-voltage outputs

The ability to provide dual-voltage outputs (i.e. outputs of identical voltage but of opposite polarity) can be an extremely useful additional facility when dealing with

variable output voltage of +15V can be considered something of a limitation. Indeed, under full-load, the output voltage may fall to somewhat less than this value. In order to increase the maximum output voltage to around 22V, the following modifications are required:

- Replace the mains transformer, T1, with a suitable rated (30VA, or greater) component with two secondary windings, each rated at 9V 1.6A (or greater).
- Replace C1 (4700µ 25V) by a 4700µ axial lead electrolytic rated at 35V (or greater).
- Replace C8 (100µ 25V) by a 100µ axial lead electrolytic rated at 35V (or greater).
- Replace R1 (2.2ohm 2.5W) by a 4.7ohm vitreous coated wirewound component rated at 6W
- Replace the heatsink (3.5 degrees C per Watt) by a similar unit rated at 3 degrees C per Watt (or less).

### Adding a voltmeter

Rather than rely on the front panel calibration marks, a meter can usefully be added to display the output voltage produced by the variable output of the power supply. An analogue meter (based on a moving coil movement) can simply be connected in parallel with the output terminals. If a meter calibrated directly in "volts" is available, it should have a full-scale reading of either 20V or 25V. Such an instrument will generally incorporate the necessary series multiplier resistor and thus no external component will be required. If, on the other hand, a meter calibrated in "µA" or "mA" is to be used, it will require a series resistor (see Fig. 7) the value of which can be determined from the following formula:

$$R = \frac{V}{I_{FS}} - R_M$$

where V is the full-scale deflection voltage (e.g. 20V),  $I_{FS}$  is the full-scale deflection current and  $R_M$  is the resistance of the moving coil.

$I_{FS}$  will typically be 50µA, 100µA or 1mA and the meter scale will have to be modified so that appropriate increments of voltage (rather than current) are indicated. This is not a particularly arduous task since most meter scales are removable and rub-

equipment which requires split power supply rails (such as ±5V, ±9V or ±12V). This facility can easily be added to the versatile bench power supply and, in order to support the necessary modification, sufficient space has been left to accommodate a fixed dual-voltage module at the rear of the unit.

The outputs provided by this module can easily be made available via 4 mm screw-terminals fitted to the rear panel whilst the required low-voltage a.c. input (2 × 6V) can be derived from the existing mains transformer (the centre-tap link is taken to the 0V connection on the dual-voltage module). It is important to note that, since the fixed and variable power supply modules are not electrically isolated when a common low-voltage a.c. supply is used, the 0V connections should remain separate (i.e. there should be no direct connection between the two modules).

### Increased output voltage capability

In some circumstances, the maximum

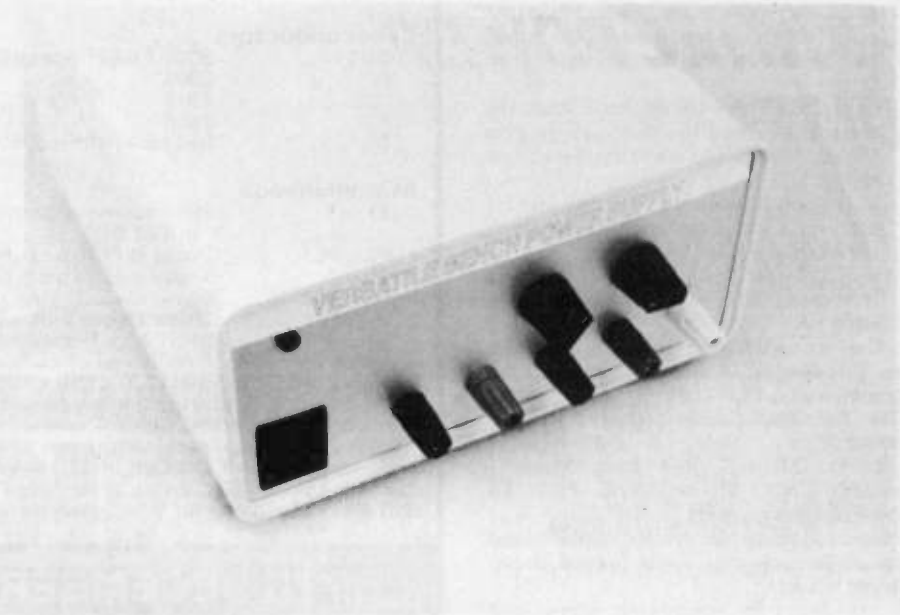

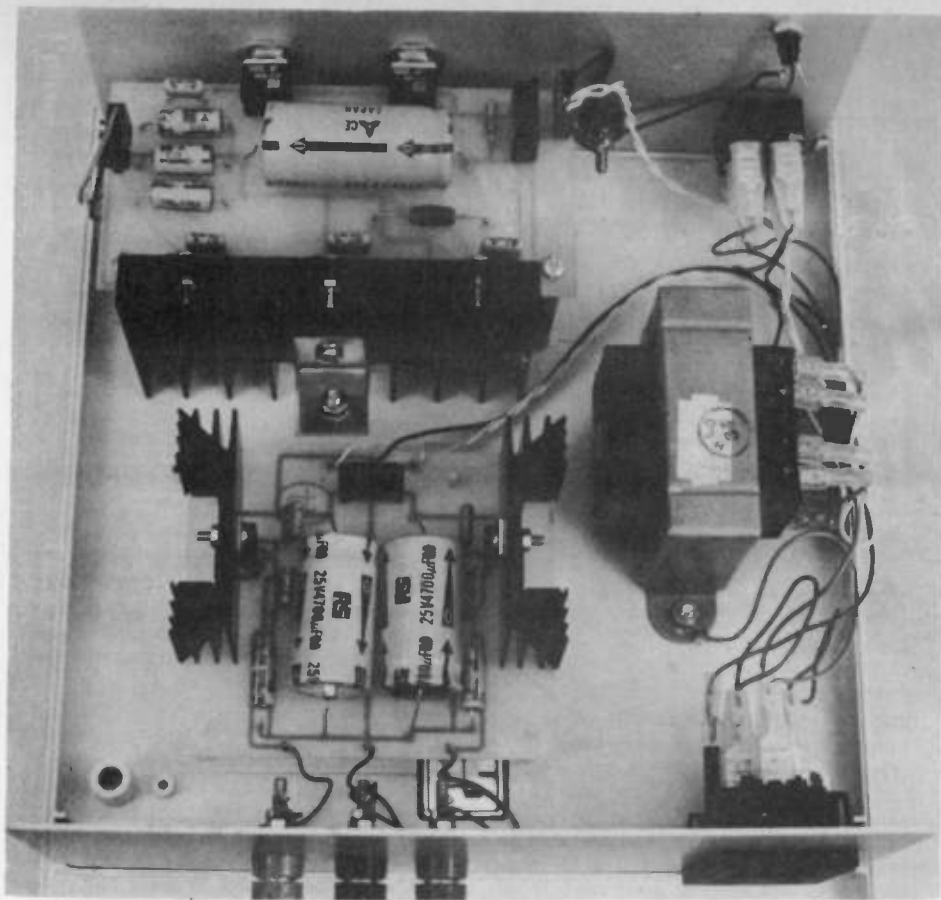

An additional  $\pm$  fixed output board can easily be added as shown above.

down transfers can be carefully applied to produce a professional finish.

As an example and assuming that a 1mA meter movement having an internal coil resistance of 200ohm is to be employed, the required value of series multiplier resistor will be:

$$R = \frac{20V}{1mA} - 200 \text{ ohms}$$

$$\text{thus } R = 20k - 0.2k = 19.8k$$

This value can be realised by connecting an 18k resistor in series with a 1k8 resistor. Both resistors should be close tolerance  $\pm 5\%$  (or better) types.

As an alternative to the use of an analogue meter and at a little additional expense, a digital panel meter module can be used. These are available in two forms with either l.e.d. and l.c.d. displays and require a separate supply voltage of +5V (l.e.d.) or typically +7.5V to 15V (l.c.d.).

In the first case, the supply may be taken from the fixed +5V power supply output whilst in the latter case the supply may be derived from the +12V fixed output. Modules are usually provided with comprehensive connecting instructions. It is perhaps worth stating that the l.e.d. types offer very much improved readability under poor lighting conditions and thus can readily justify the slightly higher cost.

Front panel mounting of either an analogue meter movement or a digital panel meter module should prove to be reasonably straightforward and an area of no more than about 60 x 46mm (analogue meter) or 72 x 36mm (digital meter module) will be required.

## PCW SOUND GENERATOR

Unspired by your PCW'S "beeping"? This unit gives the PCW three channel stereo sound. The frequency and volume of each channel is software programmable, noise can be added into any or all channels and there is an envelope generator.

## TEACH-IN '91 DESIGN YOUR OWN CIRCUITS

The next instalment deals with transistor and operational amplifier circuits. The design problem involves a microphone preamplifier and the Teach-In '91 Project is an INTERCOM SYSTEM.

## SPATIAL POWER DISPLAY

An attractive and novel way of monitoring the output from a stereo system. This unit will provide four separate visual displays representing the output from each of the four speakers in a car hi-fi system. It can also be used with other audio equipment. If you like flashing lights, knobs, whistles and all the gadgets then this is for you!



# EVERYDAY ELECTRONICS

JANUARY ISSUE ON SALE 7TH DECEMBER 1990



# 12V LAMP/VACUUM CLEANER CHARGER

T. R. de VAUX-BALBIRNIE

*A lamp or vacuum cleaner charger for the family on the move*

**S**MALL rechargeable lamps and vacuum cleaners of the Black & Decker "Dustbuster" type are very popular. These contain nickel-cadmium batteries which are kept charged from the mains using a small plug-in unit. Such lamps and vacuum cleaners are useful for general jobs inside the car, caravan or boat. However, on trips away from home where no mains supply is available, they are of limited use. This is because the operating time between one charge is quite short.

## OPERATION

The present circuit temporarily replaces the existing mains unit and enables charging to be effected from a 12V d.c. source (car battery). The appliance may then be kept charged from the car system or from a caravan or boat supply. The lamp or vacuum cleaner may then be used just as it is at home.

The unit may be used to charge lamps, vacuum cleaners or other appliances operating from up to 8 cells (nominally 9.6V). It may also be used as a "straight" general purpose nickel-cadmium battery charger. No modification is made to the lamp or vacuum cleaner itself - apart from

fitting an additional socket - so mains charging may be resumed at any time.

The 12V Lamp/Vacuum Charger is very straightforward to construct but note that a milliammeter (or multi-tester) will be needed at the setting-up stage. This can probably be borrowed if one is not owned - an inexpensive one will be quiet good enough for the purpose since high accuracy is not required. Since the metal case is connected to the negative supply, the device is suitable for negative-earth systems only.

The charger has a three-position switch providing "off", "trickle" and "boost" charging. The "boost" setting will bring totally discharged batteries back to full charge in approximately 16 hours. No harm will result if the switch is left in this position continuously but this practice is thought to reduce the life of the batteries somewhat and wastes power.

The "trickle" setting will normally be used for continuous charging. The load of 10mA approximately here imposes negligible drain on the charging battery. The circuit is fitted with a fuse which will guard against circuit failure accompanied by gross overcharging.

Nickel-cadmium batteries (Ni-Cads) require constant current charging. The cir-

cuit must therefore be designed to provide a steady output current despite quite wide variations in the operating voltages. Thus, as the terminal voltage of the nickel-cadmium cells rises or when the input voltage changes, correct charging will be maintained.

## CIRCUIT DESCRIPTION

The circuit for the 12V Lamp or Vacuum Charger is shown in Fig. 1. S1 is a 4-pole 3-position slide switch but only two poles are used in this application - poles A and B. It would be possible to use a two-pole rotary switch instead. Alternatively, two two-position slide switches - one to select charging mode and the other for on-off switching could be used. In this circuit, pole B is responsible for on-off switching while pole A provides circuit changes for trickle/continuous settings.

With S1 in position 1 (OFF), the supply positive feed is disconnected from the rest of the circuit. In position 2 (TRICKLE) and 3 (BOOST), pole B connects the supply. Current now flows through diodes D1 and D2 connected in series and through resistor, R1. Since a forward biased silicon diode develops 0.7V approximately between its ends, there will be 1.4V appearing between the base of transistor TR1 and the positive supply line.

Note that TR1 is a *pnp* transistor rather than the more usual *nnp* type. The emitter of TR1 has resistor, R3, and either resistor, R2, or the network consisting of fixed resistor R4 connected in parallel with preset, VR1, connected to the positive supply line according to whether S1 is in position 2 (TRICKLE) or 3 (BOOST).

With TR1 carrying base current via R1, the transistor is biased on and approximately 0.7V will appear between base and emitter. There will therefore be approximately 1.4V - 0.7V = 0.7V appearing between TR1 emitter and the positive supply line. By selecting suitable values for R2, R3, R4 and VR1 the current flowing may be controlled.

The emitter current is the sum of the collector current and base current but since the base current is small, the collector and emitter currents are virtually the same. The nickel-cadmium battery pack, B1, is connected in the collector circuit through plug and socket, PL1/SK1, so its charging current is practically the same as the emitter current. Diode, D3, prevents current possibly draining from the nickel-cadmium cells into the rest of the circuit if S1 is switched off.

Fig. 1. Complete circuit diagram for the 12V Lamp/Vacuum Cleaner Charger.

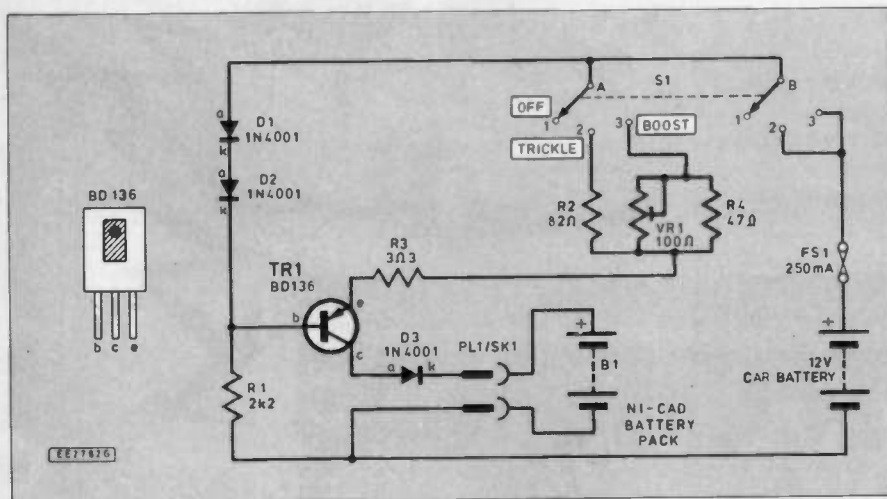



## CHARGING CURRENT

Suppose a charging current of 120mA is required (a typical value) with the circuit on BOOST. Using Ohm's Law for the emitter resistance:  $R = V/I = 0.7/0.12 = 6$  ohms approximately. Since R3 is fixed at 3Ω, VR1 will need to be adjusted to 3 ohms approximately. The meter referred to earlier will be needed to get this figure right since the predicted value may vary by a small margin from the theoretical one. The value of resistor, R2, sets the trickle current to 8mA approximately and no adjustment is allowed for here since its value is not critical.

The predicted current will flow through B1 so long as its total nominal voltage over that of the supply is developed between TR1 collector and emitter. For example, suppose the battery pack is rated at nominal 4.8V (four cells) and the supply is 12V. 0.7V appears across the emitter resistor as explained previously. A further 0.7V is developed across D3 and 4.8V across the battery pack itself. The total excess voltage is therefore  $12 - (0.7 + 0.7 + 4.8) = 5.8V$ . This will appear between TR1 collector and emitter and will vary during the course of charging to maintain a stable operating current. This will take account of the terminal voltage of B1 rising as the cells charge and variations in the supply voltage.

Transistor TR1 will dissipate power as the product of the voltage between collector and emitter and the current flowing. This will appear as heat. Even if the output terminals were short-circuited, the current as calculated would still flow but now the maximum excess voltage (nominally 10.6V) would appear between collector and emitter. More heat would therefore be

## COMPONENTS

### Resistors

R1	2k2
R2	82
R3	3Ω3
R4	47
All 0.25W 5% carbon.	

See  
**SHOP  
TALK**  
Page

### Potentiometer

VR1	100 sub-miniature horiz. preset.
-----	----------------------------------

### Semiconductors

TR1	BD136 <i>npn</i> silicon
D1 to D3	1N4001 silicon (3 off)

### Miscellaneous

S1	4-pole 3 position slide switch - (see text)
FS1	20mm-chassis fuseholder and 250mA quick-blow fuse to suit.

Stripboard 0.1 in. matrix, size 13 strips x 11 holes; aluminium box size 76 x 51 x 25mm; T0126 mounting kit; rubber grommets (2 off); adhesive fixing pads; 2.1mm power in plug and socket to suit; two-core stranded wire; "rainbow" ribbon cable; self-adhesive plastic feet (4 off).

Approx cost  
guidance only

**£7**

produced. TR1 is of a type normally used for audio amplifier applications - in some ways the present circuit behaves like an amplifier with the transistor operating somewhere between cut-off and saturation.

## PRE-CONSTRUCTION CHECK

Before commencing construction of the main unit, the appliance must be partly dismantled to fit the power-in socket. It is also necessary to determine the number and type of cells inside. This is usually a simple matter of removing a few self-tapping screws which hold the two halves of the case together. Any number of cells up to eight is satisfactory four being common.

While inspecting the cells, take note of their size (height and diameter) and whether any additional circuitry exists inside the case. If there is additional circuitry, apart from the lamp motor and on-off switch, it will be as well to abandon the project. However, it may be possible to use the "break" contacts on the power-in socket to isolate it when the plug is inserted. A typical arrangement is shown in Fig. 2.

Look for a free space for the power-in socket (perhaps in the handle as in the prototype - see photograph), drill a hole and mount it. Note that the single hole mounting type gives a neater appearance than the two-hole fixing variety. Check that the internal batteries are connected direct to the mains charger connector and connect the new socket direct to these using light-duty twin stranded wire. Alternatively, make the connections direct to the solder tags on the batteries themselves.

Take note which connection is the positive one so that the new charger will be connected with the correct polarity later. This is essential as damage will be caused if it is connected to the nickel-cadmium cells in the wrong sense. When this work has been checked, the unit may be re-assembled.

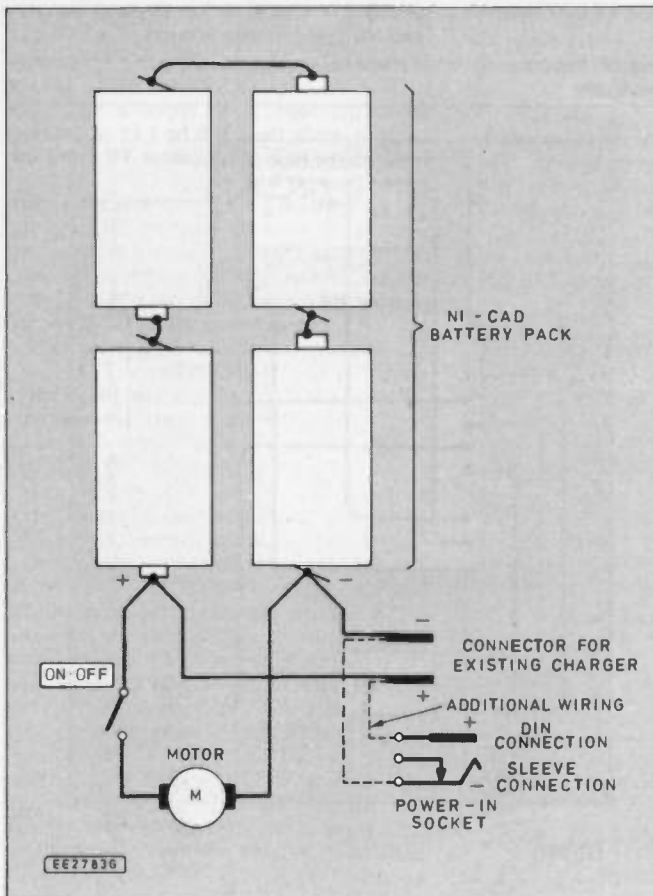
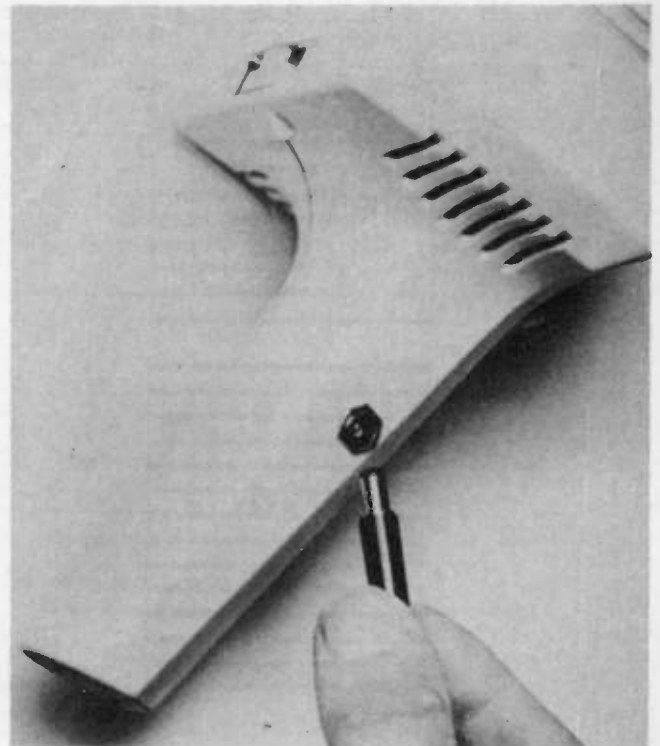

Fig. 2 (left). Adding a power-in socket to the existing low voltage vacuum cleaner.

(below). The power-in socket installed in the handle of the appliance.



## CONSTRUCTION

The circuit is built chiefly on a piece of 0.1 in. matrix stripboard, size 13 strips x 11 holes (see Fig. 3). Begin by cutting this to size, drilling the single mounting hole and make the track breaks and inter-strip link. After a careful check for errors, the soldered on-board components should be added. Take care over the polarity of the three diodes. Solder 8 cm pieces of light-duty stranded connecting to wire copper strips *A, C, D, E, F, G, I* and *L* as indicated. Using different coloured wires e.g. "rainbow" ribbon cable here will help in avoiding wiring errors.

**Note:** Since the case is used as a heatsink for transistor TR1, an aluminium box must be used.

Drill holes in the box for input and output leads also for S1, FS1, TR1, circuit panel and solder tag mounting. Fit rubber grommets in the input/output lead holes. Mount S1 - some packing will be needed between the body and case so that the plastic slider does not protrude too far on the outside.

Mount all remaining components but do not attach the circuit panel yet. Complete the internal wiring (see Fig. 4) noting that TR1 must be attached using a mounting kit. This will isolate it from the metalwork electrically yet allow the free flow of heat. Note that S1 wiring refers to the particular type of switch used in the prototype unit. This may need to be modified to suit the particular switch or switches being used.

Input and output leads consist of pieces of light-duty twin stranded wire. Figure-of-8 loudspeaker wire is ideal since one wire is striped and this may be used to denote the positive one. Put strain relief clamps on the input and output leads inside the case to prevent them from pulling free in service. Note the connection between the wire leading from strip *F* on the circuit panel and the positive output lead. This joint must be properly sleeved to prevent short-circuits.

Fig. 3. Stripboard component layout and details of breaks in the underside tracks (not to scale).

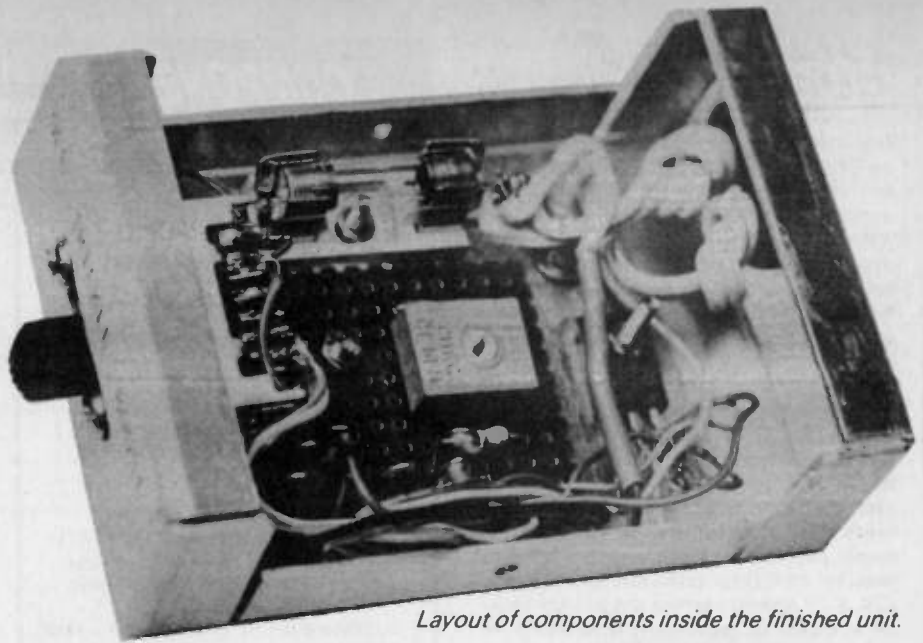
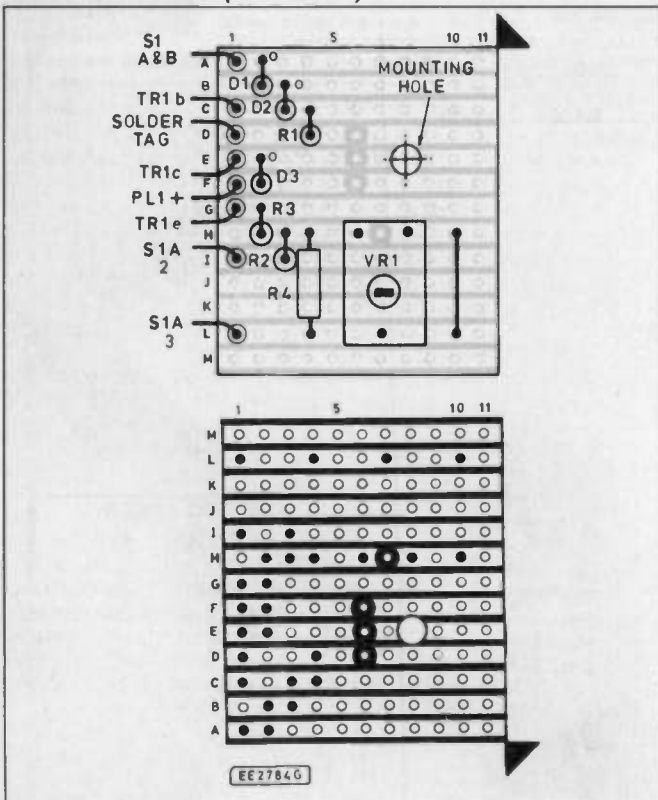

Layout of components inside the finished unit.

Place three or more adhesive fixing pads on the copper strip side of the circuit panel. These will keep all connections well clear of the metalwork when it is in position. Attach the panel securely using an 8BA fixing through the hole drilled for the purpose. Insert the fuse into its holder. Note that all components are mounted on the base section of the box with nothing on the lid. Fit the base of the case with self-adhesive plastic feet. Switch S1 "off" and leave VR1 adjusted fully anticlockwise.

## TESTING

Make a basic test by connecting the output wires direct to the milliammeter observing the polarity. If a multimeter is being used for this purpose, it should be set to a d.c. current range of not less than 250mA full-scale deflection. Connect the input wires to the supply, again, observing the polarity. For this test, a 9V PP9 battery in good condition will do.

Switch S1 to "TRICKLE". A current in the region of 10mA should be indicated. Now switch to "BOOST". The meter should read about 10 to 20mA which may be increased by rotating VR1 clockwise. Do not exceed 200mA - although it may be impossible to reach this figure anyway. Set the current to the correct value.

If "C" size cells are used (27mm high x 49mm diameter) then 150 to 200mA would be correct. Sometimes specialist sizes are used - the Dustbuster uses so-called "RR" cells 42mm high x 23mm diameter) and here 100 to 120mA would be appropriate. Where "AA" cells are used (50mm high x 14mm diameter) then 30-40mA is suitable.

Solder the output wires to the power-in plug. Fit the input wire with a plug appropriate to the existing installation. The switch may now be labelled, the case assembled - checking for trapped wires - and the unit put into service. □

Fig. 4. Interwiring from the circuit board to all off-board components.

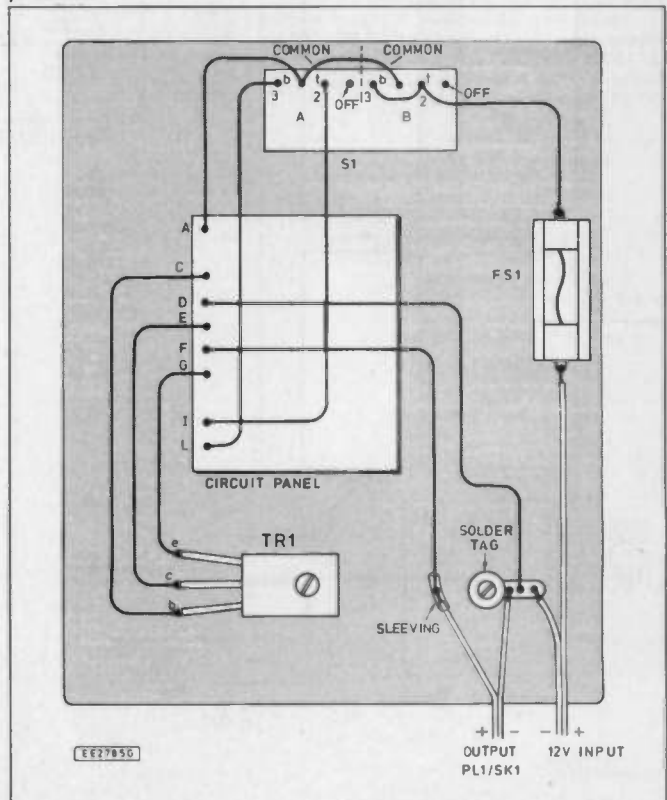

### RTVC HAVE DONE IT AGAIN!

We have secured all stocks of nearly new factory refurbished units with manufacturer approved, at unrepeatable prices. We also offer a 6 month guarantee with all units (this only applies to products marked ★ on this page.)



Alba digital auto reverse push button AM/FM / LW car stereo with separate bass/treble control APSS on tape. 25 watts per channel output, with line output for car components use.

★£79.40 + £2.30 pp



Sparkomatic Phoenix Digital auto reverse AM/FM/LW car stereo, with tape volume and balance control. 9 watts output per channel

★£52.40 + £2.80 pp



Sparkomatic Auto reverse AM/FM car stereo with tone, volume and balance control

★£44.20 + £2.80 pp

### IN-CAR STEREO BOOSTERS

In-Car Stereo Hi-power booster amplifiers 400W output. 200W x 2 inputs for low power car stereos and phono inputs short circuit protection



£110.95 + £2 pp

150W output 75 x 2 inputs as above

£46.00

+ £2.00 pp

### IN CAR WOOFERS

6 1/2" 40W Nominal, 60W Max, 4 ohm Goodmans woofer. £9.95 + £1.90 pp  
 8" 60W Nom. 90W Max, 4-5 ohm Richard Allen woofer £33.80 + £3.50 pp  
 10" 100W Nom. 150W Max 4-5 ohm Richard Allen woofer £41.50 + £3.50 pp  
 10" 150W nom, 300W max 4-5 ohm Eminence sub woofer £43.50 + £3.50 pp  
 12" 100W Nom. 250W Max, 4-5 ohm Richard Allen woofer £43.50 + £4 pp  
 12" 150W nom 300W max 4-5 ohm Eminence sub woofer £45.00 + £4 pp  
 15" 200W Nom. 400W Max, 4-5 ohm Richard Allen woofer £60.00 + £5 pp

### TWEETERS AND MID RANGE FOR IN-CAR USE

4 1/2" 100W 4-5 ohm sealed back mid-range. Goodman £5.50 + £1.50 pp  
 2 1/2" 65W 4-5 ohm Ferro fluid cooled dome tweeter with housing. Audax £5.00 + £1.20 pp  
 3 1/2" 100W 8 ohm Ferro fluid cooled dome tweeter for 4-8 ohm use £6.90 + £0.80 pp

### IN CAR 3-WAY 200W STEREO CROSSOVER NETWORK

Electronically divides the sound output from car stereos into bass, mid and treble speakers crossover points 800Hz and 5KHz (6dB per oct) 4-5 ohm imp. Size 200 x 135 x 55mm £19.50 + £1.80 pp

### 30 + 30 WATT GRAPHIC EQUALISER BOOSTER AMPLIFIER



Improve the sound and output of your low power car stereo unit with this 60 watt graphic equaliser booster. It has 10 slider controls so can accurately select the tonal quality of the music and a fader control to adjust the front to back volume; LED power display and stereo headphone jack

£24.20 + £1.80 pp

As illustrated above with 7 slider controls £19.90 + £1.80 pp

### ACOUSTIC REAR PARCEL SHELF

To get the best sound from your car woofers, replace your rear hatchback parcel shelf with one of these 14mm thick fibreboard units, tailor made for your car, supplied with grille cloth and fixings. When ordering please state make, model, and year of Reg. £39.80 + £6 pp

### AUSTIN ROVER SHELF MOUNTING

15 watt pod speaker. Moulded in black plastic housing for vertical or horizontal use, contains 4 1/2" Goodmans drive unit with a good size magnet £6.95 pair + £2 pp

### HIFI WOOFERS

10" round 100 watt Goodmans Hifi woofer 2" coil, paper cone, foam rubber surround 4 1/2" magnet, frame size 10 1/2" imp 8Ω £17.50 + £2.80 pp  
 8" round 100 watt Audax Hifi woofer, 1" coil with fitted phaseplug, Hi-teck TPX polimar core with rubber surround 4 1/2" magnet, die cast chassis, size 9 1/2" 8Ω imp £34.90 + £4 pp  
 8" square 80 watt Audax Hifi woofer, 1 1/2" coil, polypropylene cone, rubber surround, 3 1/2" magnet, chassis size 8 1/2" square 8Ω imp £19.70 + £2.50 pp  
 8" round 70 watt Peerless Hifi woofer 1" coil, treated paper cone, foam rubber surround, 3 1/2" magnet, 8Ω imp £12.50 + £2.50 pp  
 5 1/2" 45 watt Audax Hifi woofer 1" coil, Bextrene treated cone, rubber surround, 4" magnet, 8Ω imp £9.80 + £3 pp  
 5 1/2" 35 watt Goodmans Hifi woofer, 1" coil, treated paper cone, rubber surround, 3 1/2" magnet, 8Ω imp £7.20 + £2.50 pp  
 4 1/2" square 35 watt Audax Hifi woofer, 1in coil, paper cone, rolled surround, 2 1/2" magnet, 8Ω imp £7.50 + £2.50 pp

### HIFI TWEETER AND MID RANGE

4 1/2" square 100 watt Goodmans sealed back mid range, 1" coil, treated paper cone, 2 1/2" magnet, 8Ω imp £5.50 + £2.50 pp  
 4" square 75 watt Audax sealed back mid range 3/4" coil treated paper cone, Ferrofluid cooled coil, chassis size 3 1/2" 8Ω imp £7.95 + £1 pp  
 4" round 130 watt Peerless 1" metal dome Hifi tweeter, 1" coil, 2 1/2" magnet, rec. crossover freq 3KHz £15.90 + £1.60 pp  
 4 1/2" x 2 1/2" 75 watt 3/4" direct drive dome tweeter, Ferrofluid cooled 3/4" voice coil rec crossover, freq 4.5KHz as above but with 3 1/2" face plate £6.90 + £1.30 pp

### MOTOROLA PIZO CERAMIC TWEETERS

Convert electrical energy into sound without the use of voice coils and magnet assemblies. No moving mass - hence excellent transient response and low distortion with high efficiency levels as they cannot reproduce bass sounds. No crossovers are required  
 3 1/2" square, 50 watt Pizo super horn tweeter £5.95 + 75 pp  
 3 1/2" round, 50 watt Pizo horn tweeter £5.75 + 75 pp  
 2" x 6" wide dispersion 400 watt Pizo horn tweeter £11.95 + £1 pp

### MULTIBAND RADIO

VHF 54-176MHz + AM CB BANDS 1-80  
 Listen to: AIR TRAFFIC CONTROL, AIRCRAFT, RADAR, PUBLIC UTILITIES, RADIO AMATEURS AND MANY MANY MORE SQUELCH CONTROL "RUBBER DUCK AERIAL"  
 £17.95 POSTAGE £2.85

### ROSS PUSH BUTTON RADIO

Mains and battery operated. High quality VHF/FM, Medium and Long Wave reception 6 push button selected preset stations. Fully retractable telescopic aerial Headphone/earphone jack socket. Size 230H x 150W x 65D Ref. RE-5500 Brand new. Listed price over £30.00 £14.95 + £2.80 pp

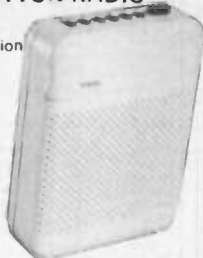

### 4.5" ROSS MONO TV WITH AM/FM RADIO

4.5" Ross mono Television with AM/FM Radio for battery or mains use, supplied with mains adaptor/charger, 12v car plug with lead, earphone, stand and extension aerial socket. battery component holds 8 x UM2 batt. Alkaline or NiCads (batts not included). Control volume, tone and tuning for radio and television. £49.95 + £4.10 pp



### RADIO AND TV COMPONENTS ACTON LTD

21 HIGH STREET, ACTON, LONDON W3 6NG  
 MAIL ORDER TERMS: POSTAL ORDERS and/or CHEQUES with orders  
 Net monthly accounts to Schools, Colleges and P.L.C only  
 ACCESS-VISA. Phone orders between 9.30-12pm please. Overseas readers write for quote on delivery  
 Phone 071 723 8432 or 081 992 8430  
 Callers 323 Edgware Road, London W2. Closed Sun  
 21 High St. Acton, London W3. closed Sun, Mon, Tues & Wed.

### 2 CHANNEL HAND HELD WALKI TALKIES

Ideal for sports or any outdoor activities. Built-in squelch and volume control, range 1.5Km maximum; 27MHz 2 channel crystal controlled superhet circuit with built-in condenser mic and speaker. Size 172 x 60 x 33mm £39.90 + 1.50pp



### VIDEO SENDER

With this handy unit you can transmit the output of your home video, video camera or satellite equipment over-the-air to a receiving television within a range of 100ft. Simply connect the video and audio output of your equipment into this unit and a 10-13.8V dc power supply extra £3.75 size 122 x 70 x 21mm £18.95 + 1.55 pp

### VHF RADIO TRANSMITTERS

100mW mini bug. Built on a neat little fibre glass pcb with condenser mic. Fully tunable over the 7M band. 9V DC £5.75 + £0.90 pp  
 2 Watt transmitter kit, supplied with fibre glass pcb, all components, diagrams, ready for you to build. 12-24V DC. £7.50 + £0.70 pp  
 25 Watt Transmitter kit. Fully tuneable over the FM band. Kit comprises double sided pcb diagrams and all components, including heat sink. Supply voltage 12-18V DC. Transmitters listed on this page are not licensable in the UK.

### 30 + 30 WATT AMPLIFIER KIT



An easy to build amplifier with a good specification. All the components are mounted on the single PCB which is already punched and back-printed.

- 30W x 2 (DIN 4 ohm)
- CD/Aux, tape I, tape II, tuner and phono inputs.
- Separate treble and bass.
- Headphone jack.
- Size (H.W.D.) 74 x 400 x 195mm.
- Kit enclosed: case, PCB, all components, scale and knobs £36.80 + £3.50 pp.
- (Featured project in *Everyday Electronics*, April 1989 issue). Reprint Free with kit.

### QUICK START BELT-DRIVE VARI SPEED DISC TURNTABLE

- ★ Quick start, ideal for scratching
- ★ Pitch control
- ★ Target lamp
- ★ Counter weighted tubular tone arm with plug-in head shell
- ★ 2-speed full manual control
- ★ Remote start stop
- ★ 7.5Kg £112.90 + £7 pp



### AMPHONIC 125 + 125 POWER AMPLIFIER



125 watt per channel stereo power amplifier with independent volume controls, professional 19" rack mount and silent running cooling fan for extra reliability. Output power.....125W RMS max. per channel Output impedance.....4 to 16 ohms (max power into 4 ohms)  
 Sensitivity.....450V at 22K ohms  
 Protection.....Electronic short-circuit and fuses  
 Power.....220-240V a.c. 50Hz  
 Chassis dim.....435 x 125 x 280mm  
 £142 + £7.00 pp

### GEMINI 2200 DISCO MIXER



This versatile little mixer has a high reputation with DJ's. Its simplicity and quality sound reproduction makes it ideal for bedroom or high power gigs. Features: Fader control • 2 phono inputs • 1 monitor headphone circuit with high power output • Talk switch • VU meters. Specification: 5n ratio mic less than 1mv (745dB). Phono: 0.4mV less than (755dB) • Talkover -12dB • Power AC220-240 at 3 watts • Size 10 1/2" x 8 1/2" x 2 1/2" • Weight 4 1/2 lbs £89.95 + £5 pp

TRANSISTORS		MPS9015		2N 3705		78L08		MC-3302		74LS28		COMPUTER IC'S			
AAV32	9p	BF869	22p	MPSA05	15p	2N 3706	9p	78L12	28p	MC-3401	70p	74LS30	14p	2114	200p
AC107	40p	BF870	22p	MPSA06	15p	2N 3707	9p	78L15	28p	MC-3403	60p	74LS31	15p	2532	300p
AC125	26p	BD241A	40p	BF871	23p	2N 3708	9p	78L18	28p	MC-3423	75p	74LS32	15p	2532	300p
AC126	25p	BD243A	50p	BF960	38p	MPSA20	15p	78L24	28p	NE-531	115p	74LS33	15p	2716	200p
AC127	21p	BD244	50p	BF961	35p	MPSA42	15p	79L05	40p	NE-544	170p	74LS38	15p	2732	280p
AC128	21p	BD245	50p	BF962	40p	MPSA43	15p	79L08	40p	NE-555	20p	74LS40	15p	2732A	300p
AC128K	26p	BD246A	50p	BF963	38p	MPSA65	25p	79L12	40p	NE-556	40p	74LS42	25p	2764	240p
AC141K	30p	BD265	45p	BF964	40p	MPSA66	25p	79L15	40p	NE-565	110p	74LS48	48p	2764	550p
AC142K	30p	BD267	45p	BF965	40p	MPSA70	15p	78BKC	100p	NE-567	130p	74LS48	48p	27128	310p
AC176	22p	BD269	45p	BF966	40p	MPSA71	15p	7824K	100p	NE-570	360p	74LS54	13p	27256	25
AC176K	28p	BD278	50p	BF967	40p	MPSA92	20p	LM317T	220p	NE-571	290p	74LS54	13p	41256.15	400p
AC187	28p	BD311	100p	BF968	40p	MPSA93	20p	LM317T	220p	NE-572	85p	74LS55	15p	4116	75p
AC187K	28p	BD312	100p	BF969	40p	MR856	36p	LM323K	420p	NE-553P2	140p	74LS57	24p	4164-15	150p
AC188	21p	BD314	100p	BF970	40p	OC28	250p	LM723	40p	NE-553P2	140p	74LS74	18p	6116	150p
AC188K	21p	BD315	100p	BF971	40p	OC29	250p	LM723	40p	NE-553P2	140p	74LS75	24p	6264-12	300p
AC198	48p	BD316	150p	BF972	40p	OC35	250p	78BKC	570p	NE-553P2	140p	74LS76	24p	6502	300p
AC198K	48p	BD317	150p	BF973	40p	OC36	250p	78H05KC	800p	NE-553P2	140p	74LS78	24p	6502A	400p
AD149	60p	BD318	150p	BF974	40p	OC45	250p	78H12KC	700p	NE-553P2	140p	74LS83	37p	6502C	930p
AF124	50p	BD319	150p	BF975	40p	OC71	30p	78G1UC	190p	NE-553P2	140p	74LS85	37p	6503	570p
AF125	50p	BD331	40p	BF976	40p	OC72	30p	79G1UC	215p	NE-553P2	140p	74LS86	25p	6520	170p
AF126	50p	BD332	40p	BF977	40p	OC72	30p	79G1UC	215p	NE-553P2	140p	74LS87	25p	6522	330p
AF127	50p	BD361	60p	BF978	40p	OC72	30p	79G1UC	215p	NE-553P2	140p	74LS90	26p	6522	330p
AF139	30p	BD362	60p	BF979	40p	OC72	30p	79G1UC	215p	NE-553P2	140p	74LS91	26p	6522	330p
AF239	30p	BD370	30p	BF980	40p	OC72	30p	79G1UC	215p	NE-553P2	140p	74LS92	26p	6522	330p
AF379	45p	BD371	30p	BF981	40p	OC72	30p	79G1UC	215p	NE-553P2	140p	74LS93	26p	6522	330p
BA145	10p	BD410	50p	BF982	40p	OC72	30p	79G1UC	215p	NE-553P2	140p	74LS94	26p	6522	330p
BA148	10p	BD433	28p	BF983	40p	OC72	30p	79G1UC	215p	NE-553P2	140p	74LS95	26p	6522	330p
BA154	6p	BD434	31p	BF984	40p	OC72	30p	79G1UC	215p	NE-553P2	140p	74LS96	26p	6522	330p
BA157	12p	BD435	31p	BF985	40p	OC72	30p	79G1UC	215p	NE-553P2	140p	74LS97	26p	6522	330p
BB105B	18p	BD436	30p	BF986	40p	OC72	30p	79G1UC	215p	NE-553P2	140p	74LS98	26p	6522	330p
BB205B	24p	BD437	30p	BF987	40p	OC72	30p	79G1UC	215p	NE-553P2	140p	74LS99	26p	6522	330p
BC107	8p	BD438	38p	BF988	40p	OC72	30p	79G1UC	215p	NE-553P2	140p	74LS100	26p	6522	330p
BC108	8p	BD439	38p	BF989	40p	OC72	30p	79G1UC	215p	NE-553P2	140p	74LS101	26p	6522	330p
BC109C	10p	BD440	40p	BF990	40p	OC72	30p	79G1UC	215p	NE-553P2	140p	74LS102	26p	6522	330p
BC115	10p	BD442	40p	BF991	40p	OC72	30p	79G1UC	215p	NE-553P2	140p	74LS103	26p	6522	330p
BC118	11p	BD520	60p	BF992	40p	OC72	30p	79G1UC	215p	NE-553P2	140p	74LS104	26p	6522	330p
BC140	20p	BD533	50p	BF993	40p	OC72	30p	79G1UC	215p	NE-553P2	140p	74LS105	26p	6522	330p
BC141	20p	BD534	38p	BF994	40p	OC72	30p	79G1UC	215p	NE-553P2	140p	74LS106	26p	6522	330p
BC142	20p	BD535	38p	BF995	40p	OC72	30p	79G1UC	215p	NE-553P2	140p	74LS107	26p	6522	330p
BC143	20p	BD536	38p	BF996	40p	OC72	30p	79G1UC	215p	NE-553P2	140p	74LS108	26p	6522	330p
BC147	8p	BD537	38p	BF997	40p	OC72	30p	79G1UC	215p	NE-553P2	140p	74LS109	26p	6522	330p
BC148	8p	BD538	38p	BF998	40p	OC72	30p	79G1UC	215p	NE-553P2	140p	74LS110	26p	6522	330p
BC149	8p	BD643	50p	BF999	40p	OC72	30p	79G1UC	215p	NE-553P2	140p	74LS111	26p	6522	330p
BC157	8p	BD645	50p	BF1000	40p	OC72	30p	79G1UC	215p	NE-553P2	140p	74LS112	26p	6522	330p
BC159	8p	BD647	50p	BF1001	40p	OC72	30p	79G1UC	215p	NE-553P2	140p	74LS113	26p	6522	330p
BC163	8p	BD649	50p	BF1002	40p	OC72	30p	79G1UC	215p	NE-553P2	140p	74LS114	26p	6522	330p
BC171	10p	BD651	50p	BF1003	40p	OC72	30p	79G1UC	215p	NE-553P2	140p	74LS115	26p	6522	330p
BC172	10p	BD675	40p	BF1004	40p	OC72	30p	79G1UC	215p	NE-553P2	140p	74LS116	26p	6522	330p
BC177	14p	BD676	40p	BF1005	40p	OC72	30p	79G1UC	215p	NE-553P2	140p	74LS117	26p	6522	330p
BC178	14p	BD677	38p	BF1006	40p	OC72	30p	79G1UC	215p	NE-553P2	140p	74LS118	26p	6522	330p
BC179	14p	BD678	40p	BF1007	40p	OC72	30p	79G1UC	215p	NE-553P2	140p	74LS119	26p	6522	330p
BC182	7p	BD680	40p	BF1008	40p	OC72	30p	79G1UC	215p	NE-553P2	140p	74LS120	26p	6522	330p
BC183	7p	BD681	45p	BF1009	40p	OC72	30p	79G1UC	215p	NE-553P2	140p	74LS121	26p	6522	330p
BC183L	7p	BD682	45p	BF1010	40p	OC72	30p	79G1UC	215p	NE-553P2	140p	74LS122	26p	6522	330p
BC184	7p	BD705	50p	BF1011	40p	OC72	30p	79G1UC	215p	NE-553P2	140p	74LS123	26p	6522	330p
BC184L	7p	BD707	50p	BF1012	40p	OC72	30p	79G1UC	215p	NE-553P2	140p	74LS124	26p	6522	330p
BC212	7p	BD709	50p	BF1013	40p	OC72	30p	79G1UC	215p	NE-553P2	140p	74LS125	26p	6522	330p
BC212L	7p	BD711	50p	BF1014	40p	OC72	30p	79G1UC	215p	NE-553P2	140p	74LS126	26p	6522	330p
BC213	7p	BD736	50p	BF1015	40p	OC72	30p	79G1UC	215p	NE-553P2	140p	74LS127	26p	6522	330p
BC213L	7p	BD826	50p	BF1016	40p	OC72	30p	79G1UC	215p	NE-553P2	140p	74LS128	26p	6522	330p
BC214	7p	BD828	50p	BF1017	40p	OC72	30p	79G1UC	215p	NE-553P2	140p	74LS129	26p	6522	330p
BC214L	7p	BD875	50p	BF1018	40p	OC72	30p	79G1UC	215p	NE-553P2	140p	74LS130	26p	6522	330p
BC237	7p	BD897	50p	BF1019	40p	OC72	30p	79G1UC	215p	NE-553P2	140p	74LS131	26p	6522	330p
BC238	7p	BD899	50p	BF1020	40p	OC72	30p	79G1UC	215p	NE-553P2	140p	74LS132	26p	6522	330p
BC239	7p	BD901	50p	BF1021	40p	OC72	30p	79G1UC	215p	NE-553P2	140p	74LS133	26p	6522	330p
BC300	20p	BD977	50p	BF1022	40p	OC72	30p	79G1UC	215p	NE-553P2	140p	74LS134	26p	6522	330p
BC301	20p	BDX32	100p	BF1023	40p	OC72	30p	79G1UC	215p	NE-553P2	140p	74LS135	26p	6522	330p
BC302	20p	BDX33	60p	BF1024	40p	OC72	30p	79G1UC	215p	NE-553P2	140p	74LS136	26p	6522	330p
BC303	20p	BDX53	60p	BF1025	40p	OC72	30p	79G1UC	215p	NE-553P2	140p	74LS137	26p	6522	330p
BC304	25p	BUX65	80p	BF1026	40p	OC72	30p	79G1UC	215p	NE-553P2	140p	74LS138	26p	6522	330p
BC305	10p	BDW43	55p	BF1027	40p	OC72	30p	79G1UC	215p	NE-553P2	140p	74LS139	26p	6522	330p
BC327	7p	BDW24	55p	BF1028	40p	OC72	30p	79G1UC	215p	NE-553P2	140p	74LS140	26p	6522	330p
BC328	7p	BDW93	50p	BF1029	40p	OC72	30p	79G1UC	215p	NE-553P2	140p	74LS141	26p	6522	330p
BC337	7p	BDW94	50p	BF1030	40p	OC72	30p	79G1UC	215p	NE-553P2	140p	74LS142	26p	6522	330p
BC338	7p	BDY20	100p	BF1031	40p	OC72	30p	79G1UC	215p	NE-553P2	140p	74LS143	26p	6522	330p
BC441	28p	BDY92	100p	BF1032	40p	OC72	30p	79G1UC	215p	NE-553P2	140p	74LS144	26p	6522	330p
BC446	8p	BF137	25p	BF1033	40p	OC72	30p	79G1UC	215p	NE-553P2	140p	74LS145	26p	6522	33



## SIMPLE VOLTAGE CHANGING

WHILE on holiday we bought a car accessory called a Seven-Output DC/DC converter. It plugged into the cigar lighter socket (i.e. to the 12V car battery). A switch enabled it to be set up for outputs of 1.5V, 3V, 4.5V, 6V, 7.5V, 9V and 12V d.c.

The outputs were taken to a cable terminated in one of those hydra-headed jacks capable of being plugged into almost any d.c. power socket on a radio, tape recorder, etc.. The stated output was 500mA max. Handy; but how did it work?

## PERFORMANCE

The circuit diagram is given in Fig. 1 (omitting a l.e.d. and a polarity-reversal switch, irrelevant here). The performance, when powered by a 12.2V d.c. supply is given in Fig. 2.

The mode of operation is simple enough. The chain of resistors R1 to R7 forms a voltage divider (see Fig 1). The voltage-selecting switch S1 picks off one of the preset voltages and applies it to the base of TR1 (a small silicon power transistor, type unknown).

The transistor is connected as an emitter-follower and passes on a voltage to the output. With an ideal "follower" this would be the same as the selected input. In practice it is lower by about 0.7V, the base-emitter voltage ( $V_{BE}$ ) of TR1.

Because of this base-emitter drop it is necessary to apply voltages to the base about 0.7V higher than the nominal output voltages. If the input voltage were exactly 12V, if the resistances were exactly as shown, and if the transistor drew no base current then the divider voltages would have the values shown in brackets.

These are all above the nominal outputs but not by equal amounts. However, it must be remembered that the actual terminal voltage of a charged 12V car battery is a variable quality. For a fully charged car battery it is typically 12.6V but may rise to 14V or even more when the battery is on charge.

On the other hand, in cars with sealed batteries, where it would be dangerous to reach high voltages, automatic controls may restrict the voltages to somewhere close to the nominal 12V. And, should the battery get exceptionally run down, the voltage may be less than 12V.

Clearly, the designer must compromise by choosing a plausible battery voltage to give the best compromise on voltage accuracy. To get an output of 1.5V it is necessary to apply about 2.2V to TR1, which is why resistor R7 is higher than the other resistances. From 1.5V, the outputs rise in steps of 1.5V so the flow through the divider chain ought to provide increments of 1.5V.

## BASE CURRENT LOADING

From the measured performance with the 12.2V input I used, the output voltages up to 9V are close to their nominal values when the output current is 400mA. The 12V output setting is less, but on this range the circuit doesn't really work, because the base and collector are connected together and the transistor behaves as a diode.

The designer has to allow for the effect of base current. This increases the voltage drop in all resistors above the tap point, and so pulls the output down a little.

How much? The base current depends on the current gain of the transistor. To make the circuit operate consistently the current gain should be precisely known. In practice, of course, it is variable.

A good compromise is to bleed as much current as is reasonable through the divider and to use a high gain transistor. This way the effect of base current is minimised and, provided the divider passes several times the maximum base current the effect of variations is small.

Fig. 1. Car Voltage Converter circuit diagram.

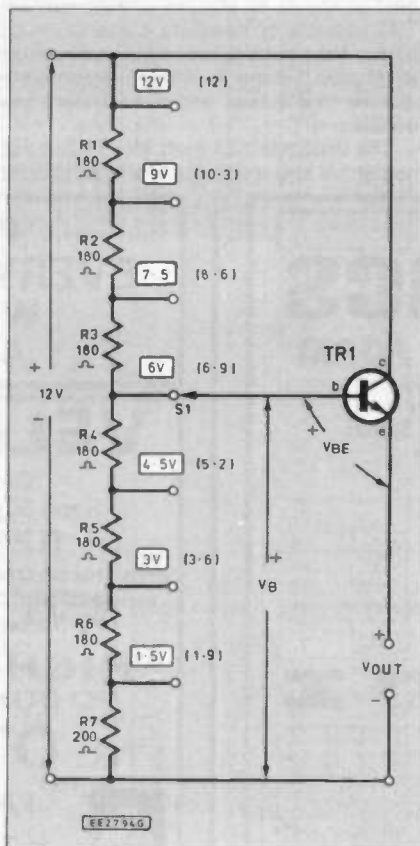

## VOLTAGE VARIATIONS

The performance curves (Fig.2) show, however, that variations are not negligible. On the 6V range, for example, the output is about 7V at low loads, falling to about 5.7V at maximum load. These voltages must suffer further variations as the car battery charges up or runs down.

With the car battery at 14V the voltage settings will all go about 15 per cent higher. At 11V, all go about 10 per cent lower. Thus, there seems to be some risk that equipment powered by such a converter may sometimes receive uncomfortably high voltages, and sometimes voltages too low for corrected operation.

It all depends on how tolerant the equipment is. Fortunately, much battery powered equipment is quite tolerant.

Can we do better? Of course we can, if extra complexity and expense are permissible. Instead of a simple emitter follower a proper variable voltage stabiliser could be used. But can we do better at minimal extra cost and complexity?

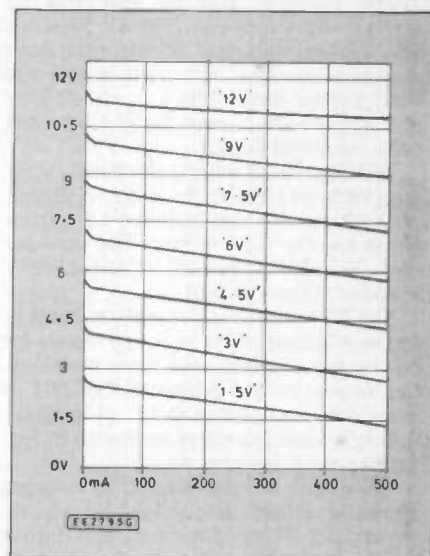

Fig. 2. Car converter circuit outputs.

## DARLINGTON OUTPUT

The effect of base current variations can be made negligible by using a compound emitter follower such as the Darlington stage (TR1, TR2) in Fig. 3. Here the effective current gain is the product of the gains of TR1 and TR2. This can easily be several thousand.

The base current of TR1 is very small and imposes little loading on the divider chain. However, it is still necessary for a few milliamps to flow through the divider. Some economy in standby drain can be obtained by using this current to light an indicator l.e.d. D1. A red l.e.d. runs at about 1.6V and the addition of a resistor can bring this up to a suitable voltage to drive the 1.5V output.

Since there are two  $V_{BE}$  drops between input and output of the Darlington "pair" the output is about 1.4V less than the input, which must be about 2.9V for 1.5V output. Each resistance above the "1.5V" tap must add 1.5V, until the "9V" tap, which requires 10.4V. Resistor R1 must drop 1.6V if the input is exactly 12V. (The "12V" output has been abandoned in Fig. 3).

Although the effect of base current loading is eliminated, the output voltage

of the Darlington circuit still drops as the current drawn is increased. For my test circuit the outputs at 500mA were down by about 0.5V on the low-load value.

The reason is that  $V_{BE}$  varies with the base current. If the Darlington has a current gain of 1000 then TR1's current must be 0.5mA at maximum output current, falling to virtually zero for small currents. Transistor TR2's base current varies from nearly zero at low output current to perhaps 10mA-20mA at maximum.

These are wide variations and the  $V_{BE}$  drops are bound to change. The effect is quite serious at low output voltages, where a 0.5V change is large in percentage terms.

The effect can be reduced by connecting resistances R8 and R9 (shown dotted). These allow small collector currents to flow even when there is no load, so the base currents don't change from zero to maximum but from a certain amount to maximum.

### TRIPLE FOLLOWER

The situation can be improved by using a triple follower (Fig 4). This has very high current gain, so the input base current is very low. Also there is only one base-emitter drop (TR1's - about 0.6V at the low base current drawn) between base input and output.

With my 12.2V supply the output voltages were all close to the required values, after resistor R7 was trimmed by resistor R8 to set the 1.5V output. The voltages for 1.5V to 9V output fell by about 0.25V at about 400mA output.

The 12V output is not really subject to follower action and is included merely for convenience; resistor R9 limits base current to prevent the destruction of TR1 in the event of an output short. (The omission of a corresponding resistance in Fig. 1 looks like a designer error.)

The circuit can be adapted to voltages above or a little below 12V by adjusting resistor R1 to obtain a correct output on the 9V setting. The other resistances are then the same, with the proviso that resistor R7 may need trimming to obtain a correct 1.5V (One could use a 2.2 kilohm preset potentiometer in place of resistors R7 and R8).

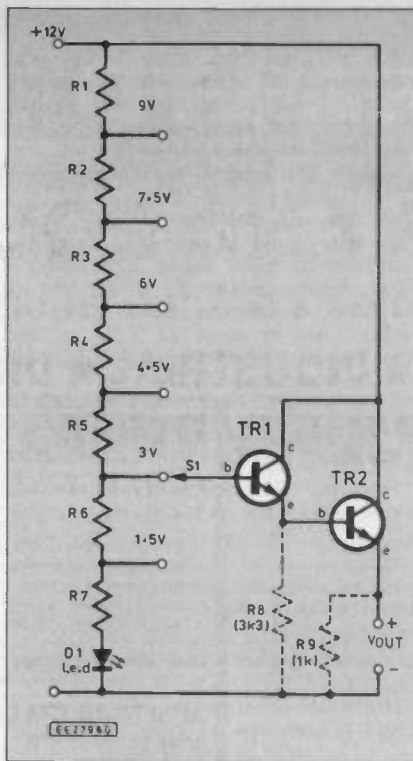

Fig. 3. Using a Darlington transistor output stage.

### DISSIPATION

The problems of "energy" or "heat" dissipation in the circuit of Fig. 4 is greatest at low output voltages because the transistors then have to absorb most of the battery voltage. Assuming 12.6V input and 1.5V output there is 11V across TR3. At 500mA output it must dissipate nearly 5.5W and a heatsink is essential.

Under shorted-output conditions the dissipation can be very high and the best policy is to choose a transistor for TR3 capable of handling currents much higher than needed and to include a fuse as shown. There is then a reasonable chance that a fuse will blow before the transistors.

The dissipation in transistor TR2 is not negligible and a small power type should

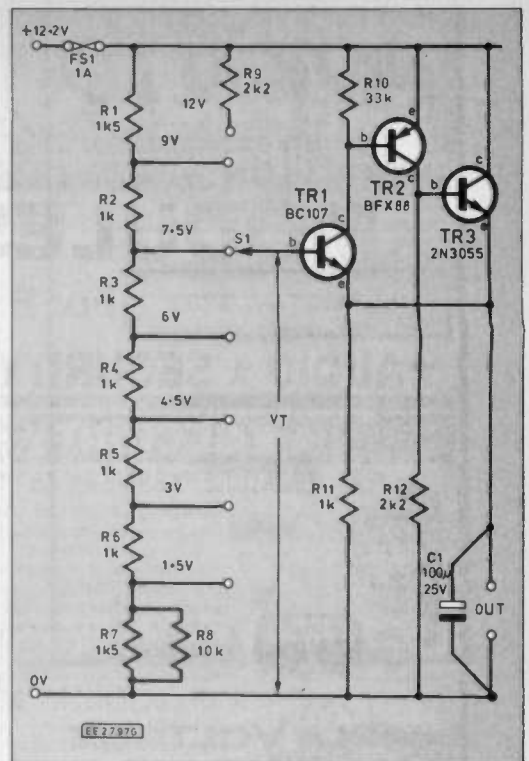

Fig. 4. Triple Follower. Only TR1's base-emitter drop comes between the tap voltage  $V_T$  and the output. Capacitor C1 is included to reduce the risk of instability.

be used. Dissipation in TR1 is low except under fault conditions.

You may well feel that, in view of the complexity of a triple follower, it would be cheaper and better to buy a variable i.c. stabiliser. These are now relatively cheap and can provide short-circuit protection and stabilisation against input voltage variations.

All a follower can do is provide constant voltage when the load varies, which stabilisers do too. If you have suitable transistors in the spares box, however, it might be attractive.

Triple followers are used in the output stages of some audio amplifiers. The advantage there is that they make little current demands on the driver stage.

**EVERYDAY ELECTRONICS**

**SUBSCRIPTION ORDER FORM**

Annual subscription rates (1991): UK £17.  
Overseas £21 (surface mail) £39 (air mail)  
To: Everyday Electronics, 6 Church Street  
Wimborne, Dorset BH21 1JH

Name.....

Address.....

I enclose payment of £..... (cheque/PO in  
£ sterling only payable to Everyday Electronics)  
Access or Visa No.

Signature..... Card Ex. Date.....  
Please supply name and address of card-holder if different from the subscription address  
shown above. Subscriptions can only start with the next available issue.  
For back numbers see the Editorial page.

PLEASE MENTION  
**EVERYDAY ELECTRONICS**  
WHEN REPLYING TO  
ADVERTISEMENTS

**VELLEMAN KITS**

Over 100 Project Kits in stock  
Send 50p for 1990 Catalogue + Price List

**RETAILERS WANTED**

Why not be one of our many retailers who carry our top  
range of high quality kits (Discounts to be arranged)  
Send Details and Letterhead to:

**HIGH-Q-ELECTRONICS**  
PO BOX 1481 LONDON NW7 4RF

TEL: **0707 263562**

FAX: **081-209 1231**

SCHOOLS AND COLLEGES WELCOME



# AUTONA LTD

UK's leading module manufacturer since 1972

51B POPPY ROAD  
PRINCES RISBOROUGH  
BUCKS HP17 9DB

TEL: (084 44) 6326 FAX: (084 44) 7102

Add VAT +£1.50 on all orders. Export add 10%

Callers by  
appointment  
only



## MODULES AND EQUIPMENT

FULLY BUILT AND TESTED

For Projects & Applications in:

ALL UNITS SUPPLIED WITH  
COMPREHENSIVE INSTRUCTIONS

### ★AUDIO★ SECURITY★ INDUSTRIAL★ DIGITAL VOLTMETERS

#### ★★ SECURITY ★★



##### MINIATURE PASSIVE INFRA-RED SENSOR-RP33

Switchable Dual range, detects intruders up to 6 or 12 metres. This advanced sensor operates by detecting the body heat of an intruder moving within the detection field. Slow ambient changes such as radiators, etc. are ignored. Easily installed in a room or hallway. Providing reliable operation from a 12V supply, it is ideal for use with the CA 1382 or equivalent high quality control unit. Supplied with full instructions. Size 80 x 60 x 40mm. Quantity discounts start at 3 units

Now only  
**£19.95**  
VAT



##### DIGITAL ULTRASONIC DETECTOR-US 5063

Crystal controlled movement detection module operating at 50kHz with an effective range up to 20ft. Suitable for operation in household or vehicle security systems. 12V operation and built-in timing makes it suitable for a wide range of applications.

**£14.93**  
VAT

Easily Installed

##### ADVANCED CONTROL UNIT-CA 1382



*Automatic Loop Test & Switch On ★ Automatic Siren Re-Set ★ Audible Entry/Exit Warning Buzzer ★ Two Separate Loop Inputs + 24-hr Circuits ★ Easily Installed, Full Instructions Supplied.*

This advanced control panel provides effective and reliable control for all security installations, yet its operation is sheer simplicity for all members of the family, and is supplied with two keys. Housed in a steel case with an attractive moulded front panel, it compares with units costing twice the price

Only  
**£44.95**  
VAT

##### LOW-COST CONTROL UNIT-CA 1250



This tried and tested control unit provides the finest value for money in control systems, with many thousands protecting houses all over the country. A suitable steel enclosure is available separately.

*The unit offers the following features: Built-in electronic siren, drives two loudspeakers incorporating exit & entry delays ★ Anti-tamper and panic facility ★ Screw connector for ease of installation, etc. etc.*

Only  
**£21.35**  
VAT

FULL RANGE OF SECURITY ACCESSORIES STOCKED PROVIDING EVERYTHING YOU NEED TO PROTECT YOUR HOME

#### DIGITAL VOLTMETER MODULES

##### DVM 456 HIGH PERFORMANCE 3½ DIGIT PANEL METER

Sensitivity 0-± 1.999V  
Accuracy Within 0.1 ± 1 digit  
Input Impedance 100M ohm  
Supply Voltage 8V-12V  
Dimensions 95.5 x 55 x 11mm

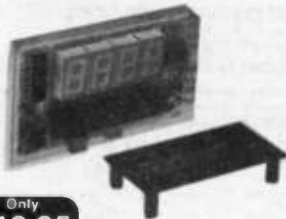

Only  
**£19.95**  
VAT

This exciting new module provides a large, bright digital read-out with an accuracy within 0.1%. It incorporates a built-in regulator which allows it to be used from an unregulated supply of between 8V-12V. Full over-load protection is included and the unit is supplied with a mounting bezel and filter, together with full application instructions showing how to extend its range and measure resistance, current and temperature.

##### DVM 356 VERSATILE 3-DIGIT PANEL METER

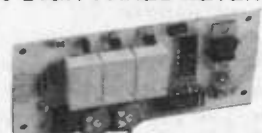

**DT10 TEMPERATURE MEASUREMENT MODULE**  
A simple, though effective module which when constructed provides a linear output of 10mV/°C over the temperature range -10 to +100°C.  
**£3.95 + VAT**

**PS209 DUAL POWER SUPPLY**  
Fully built mains power supply providing two 9V outputs of up to 250mA each. Suitable for use with either DVM modules and other equipment.  
**£6.65 + VAT**

The DVM 356 is a low-cost module offering 3-digit performance with an FSD of +999mV and -99mV. Supplied with a comprehensive Data Sheet. No bezel available

**£17.83**  
VAT

#### ★★ AUDIO ★★

##### AL 12580-125W POWER AMPLIFIER

A rugged, high powered module that is ideal for use in discos & P.A. Systems where powers of up to 125W, 4 ohms are required. The heavy duty output transistors ensure stable and reliable performance. It is currently supplied to a large number of equipment manufacturers where reliability and performance are the main considerations, whilst for others its low price is the major factor. Operating from a supply voltage of 40-80V into loads from 4-16 ohms.

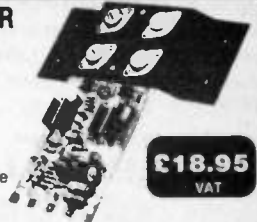

**£18.95**  
VAT

##### AL 5070-ULTRA LOW DISTORTION 50W AMPLIFIER

Provides sound reproduction of the highest quality with distortion levels below 0.02%, this module offers superlative performance in all types of audio equipment. Full over-load protection is incorporated ensuring reliability of the highest order. Supplied with its own heat sink, it operates from a 40V-65V supply rail into loads of 8-16 ohms.

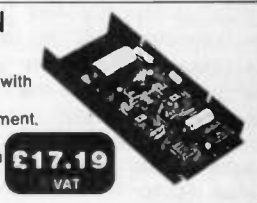

**£17.19**  
VAT

##### AL 2550-COMPACT LOW-COST 25W AMPLIFIER

One of our most popular audio modules with tens of thousands installed. Ideal for domestic applications where low distortion and compact size are the prime requirements. Used with supply rails of 20V-50V into loads of 8-15 ohms.



**£6.55**  
VAT

##### AL 1030-RUGGED 10W AMPLIFIER

This low cost unit provides a powerful 10W output making it ideal for all medium power applications requiring quality reproduction with rugged performance. Representing excellent value for money it operates from a supply of 18V-30V into loads of 8-16 ohms.



**£4.77**  
VAT

##### MM 100-BUDGET 3-INPUT MIXER

With a host of features including 3 individual level controls, a master volume and separate bass and treble control, it provides for inputs for microphone, magnetic pick-up and tape, or second pick-up (selectable), and yet costs considerably less than competitive units. This module is ideal for discos and public address units and operates from 45V-70V.

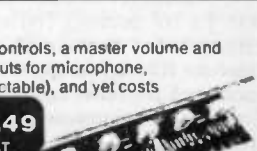

**£17.49**  
VAT

##### MG 100G

As MM 100 with two guitar +1 microphone input intended for guitar amplifier applications.



**£17.49**  
VAT

#### ★★ INDUSTRIAL ★★

##### 50FT INFRA-RED BEAM-IR1470

The IR1470 consists of a separate transmitter and receiver providing a beam of up to 50ft which, when interrupted, operates a relay in the receiver which in turn may be used to control external equipment. The system requires only 65mA from a 12V supply. Size: (each unit) 82 x 52 x 57mm

**£25.61**  
VAT

##### TIMER SWITCH & POWER SUPPLY-DP3570

The DP3570 consists of an adjustable timer switch and 12V stabilised power supply designed to provide switching of loads up to 4A at 240V A.C. for a preset time between 10 secs and 6 mins, the timed period being initiated by the normally open or normally closed inputs.



**£13.95**  
VAT

##### GENERAL PURPOSE ULTRASONIC MOVEMENT DETECTOR US4012

This module uses ultrasonic techniques to detect movement at distances up to 5 metres with an operating range of 60°. Supply voltage 10-14V (12mA). Size: 147 x 52.5 x 15mm.



**£11.72**  
VAT

##### STABILISED SUPPLY & SWITCHING UNIT-PS1265

The PS1265 provides stabilised 12V output for current levels up to 700mA. Additionally it incorporates a high impedance input for switching loads up to 1kW at 240V without timing

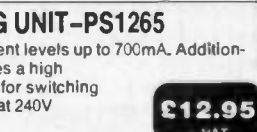

**£12.95**  
VAT

ATTRACTIVE DISCOUNTS  
AVAILABLE FOR QUANTITY USERS

# INTERFACE

**Robert Penfold**



**I**NTERFACE is a new series which, as explained more fully in last month's issue of *Everyday Electronics*, will cover interfacing to any microcomputer that is currently quite popular. Other technical topics may also be covered, such as programs that are of particular interest to *Everyday Electronics* readers. Here we are talking about programs such as printed circuit design, circuit simulation, etc., not the latest in "zap" everything in sight games!

## Expansion

I think it is fair to say that most of the modern microcomputers have less scope for home-made add-ons than do most of the computers from a few years ago. With computers such as the VIC-20, Commodore 64, and BBC model B there are user ports which can very easily be used to control motors, i.e.s, etc., or to read digital signals.

There is nothing similar on most of the computers currently on offer. In some cases there is a printer port that can be used in a similar way to a user port, but in most systems this port will be occupied by the printer.

Another problem is that most modern computers do not have anything that is strictly comparable to the expansion ports of the popular 8 bit computers. The expansion ports of the ZX81, Spectrum, BBC computers, etc. have their peculiarities, but still offer a fairly simple route to massive expansion. In fact the maximum possible expansion is so great with these computers that there is little likelihood of ever occupying more than a few percent of the available addresses. Producing DIY add-ons for these ports is reasonably straightforward.

Expansion ports on more recent computers tend to be large, inaccessible, and relatively difficult to use. In some cases there seems to be no proper expansion port at all. It is probably possible to add your own peripheral devices to any current computer, but in some cases this task will be less than straightforward. In some cases the degree of expansion possible may be rather limited by the standards of the past.

## Slot Machines

I should imagine that the IBM PCs and the various "compatibles" from Amstrad etc. are the most popular computers so far produced. The success of these computers is largely based on their widespread acceptance in the business world. I produce the text and drawings for *Everyday Electronics* articles on a PC AT compatible, and on reaching the EE offices they are processed using more IBM compatibles. Although the "PCs" (as IBMs and compatibles are

popularly known) are the standard business computers, in recent years they have also sold well as home computers.

In some respects they are perhaps something less than ideal for home use. The graphics capabilities of the early models were either limited or non-existent, but with the much improved EGA and VGA graphics boards now being commonplace, the displays of most modern PCs are really excellent. The same is not true of the sound generator, which remains rather weak even by 8 bit computer standards. The PCs are quite powerful computers, and are backed-up by masses of software of just about every conceivable type. These days, this includes much software of interest to home users.

## PC Add Ons

For the add-on enthusiast the PCs offer excellent potential. All PCs and true compatibles have about eight expansion slots within the main system unit. Unlike most other microcomputers, expansion boards fit within the computer, rather than externally on the rear of the unit. If the board must connect to the outside world, this is achieved via connectors mounted on the rear of the board which can be accessed via cutouts in the rear of the computer's case.

The number of expansion slots varies somewhat from one type and make of PC to another, but any modern PC that is a true compatible should have around six to eight slots. Some of these are occupied by essential pieces of hardware, such as the display adaptor, disk controller, and serial/parallel ports. Typically there would still be something like three or four spare expansion slots, leaving plenty of scope for specialised add-ons.

The easy approach to interfacing to a PC is to fit it with a few specialised interface cards, such as analogue to digital and digital to analogue converter boards, and parallel interface boards. Temperature sensors, relay drivers, etc. are then easily connected up to these boards and used with the computer. This method has definite attractions, but suitable interface boards are relatively difficult to obtain, and can be quite expensive.

It is much cheaper to build your own interface boards, including on the board some or all of the additional circuitry for your particular applications if desired. Interfacing to a PC, from the electronics point of view, is more simple than you might expect. Quite simple address and control line decoding will usually suffice, and in this respect interfacing to the PCs is more straightforward than interfacing to the buses of many eight bit computers.

There is an awkward aspect to PC inter-

facing in that a double-sided printed circuit board is needed to fit into the expansion slot, and it must be made quite accurately if everything is to fit into place and operate properly.

With eight bit computers it is quite common to have add-ons connected to the computer via a suitable connector and a length of ribbon cable. Due to the higher clock speeds involved with PCs, and the minimal latitude in the timing of most signals, this method is not a very practical one. It can be used, but only if the ribbon cable is kept very short indeed. This is a feasible method for testing prototype circuits, but is not a very practical one for the final units.

## 8 Bit Bus

There are several types of PC expansion bus. The latest IBM machines and a few compatibles use the MCA (micro channel architecture) type, which is a very modern high speed bus. A few compatibles use the EISA (Extended Industry Standard Architecture) type, which is a form of 32 bit bus. This is based on what I suppose would have to be considered the standard PC bus, which is the ISA (Industry Standard Architecture) type. It is actually the 16 bit version of the ISA bus, with some extra connections to take the extra data lines etc.

The original PC bus is an eight bit type, and it is the one still used on the 8088 and 8086 based PCs (the XT type). The ATs and compatibles (including most 80386 based PCs) have a 16 bit bus, but this is the original 8 bit variety with an extra connector to carry the eight extra data lines plus some extra control lines. This method means that there is good compatibility between the XT and AT machines, with most 8 bit cards operating perfectly well in either type of computer.

Of course, a 16 bit card cannot operate properly in a machine that only has 8 bit expansion slots, although some 16 bit cards can be switched to 8 bit operation or will automatically switch to this mode if necessary.

As far as most user add-ons are concerned, they only need the basic 8 bit bus. Unless you have some form of AT compatible, you are obviously restricted to 8 bit expansion cards anyway. For the time being we will only consider the basic 8 bit bus. Fig.1 shows the normal method of pin numbering for the 8 bit expansion slot, which is a 2 x 31 way 0.1 inch pitch edge connector. This is a list of all the lines present on an 8 bit expansion slot:-

Many of these lines are familiar microprocessor types.

The eight data lines (D0 to D7) and the



Terminal		Terminal	
No.	Function	No.	Function
A1	I/O CH CK	B14	-IOR
A2	D7	B15	-DACK3
A3	D6	B16	DRQ3
A4	D5	B17	-DACK1
A5	D4	B18	DRQ1
A6	D3	B19	-DACK0
A7	D2	B20	CLK
A8	D1	B21	IRQ7
A9	D0	B22	IRQ6
A10	I/O CH RDY	B23	IRQ5
A11	AEN	B24	IRQ4
A12	A19	B25	IRQ3
A13	A18	B26	-DACK2
A14	A17	B27	TC
A15	A16	B28	ALE
A16	A15	B29	+5V
A17	A14	B30	OSC
A18	A13	B31	GND
A19	A12		
A20	A11		
A21	A10		
A22	A9		
A23	A8		
A24	A7		
A25	A6		
A26	A5		
A27	A4		
A28	A3		
A29	A2		
A30	A1		
A31	A0		
B1	GND		
B2	RESET		
B3	+5V		
B4	IRQ2		
B5	-5V		
B6	DRQ2		
B7	-12V		
B8	Reserved		
B9	+12V		
B10	GND		
B11	-MEMW		
B12	-MEMR		
B13	-IOW		

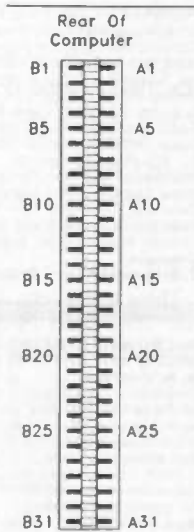

Fig. 1. The numbering used for the IBM 8-bit bus. The connector is a 2 x 31-way 0.1 inch pitch edge type.

twenty address lines (A0 to A19) should require no further explanation. Neither should the ground and various supply rail connections. One point worth making is that not all the address lines are used for input/output devices. Normally the lower 16 address lines are used, giving a massive 64K address space. In the PCs only the ten least significant address lines are used though, giving the reduced (but still substantial) address space of 1K.

### Read/Write

The 8088 series of microprocessors have the same origins as the Z80, and some of the control lines are similar to Z80 types. In particular, the 8088 series have separate input/output and memory maps, with two sets of read/write lines for the two types of access.

The read/write lines for memory accesses are -MEMR and -MEMW, while -IOR and -IOW perform the same functions when input/output devices are accessed. These are all negative active lines (as denoted by the "-" signs). User add-ons would normally go into the input/output map. Therefore, -IOR and -IOW are important lines which will normally need to be decoded by user add-ons.

AEN (address enable) is another important line for user add-ons. This indicates whether DMA (direct memory access) or processor bus cycles are taking place. Add-ons should only be activated during processor cycles, when AEN is low.

The lines mentioned so far are the only ones that are essential to most PC interfacing, but we will briefly consider the other lines. ALE is a timing output which can be used as an aid to synchronising events to processor bus cycles.

Inputs DRQ1 to DRQ4, outputs -DACK0 to -DACK3, and TC (the terminal count output) are concerned with direct memory access. IRQ0 to IRQ7 are active high interrupt request lines, but note that IRQ0 and IRQ1 are not available on the expansion bus. These are used by the system for the time of day clock and the keyboard. Some of the interrupt lines that are accessible are likely to be used by standard expansion cards such as the serial and parallel ports, mouse interface card, etc.

### Clock

Two clock signals are available on the bus. These are CLK and OSC. The former is the system clock, which has a 2 to 1 duty cycle and is at 4.77MHz on the original PCs and some compatibles. On ATs and XT's used in the "turbo" mode this clock will be at a higher frequency. The OSC signal is a 14.318MHz signal which is apparently intended mainly for use with the CGA graphics card.

RESET is an output which is active low, and which provides a pulse at switch-on that can be used to reset circuits on expansion cards. I/O CH RDY is an input which is normally high, but which can be taken low by a slow peripheral circuit in order to insert additional wait states. Most user add-ons are fast enough to avoid the need for inserted wait states.

I/O CH CK is a normally high input which can be pulled low if a parity error is detected (and a non-maskable interrupt is then generated). This can be used with input/output or memory circuits, but is mainly used with the latter.

Next month we will consider suitable spots for user add-ons in the input/output map, and address decoder circuits.



with David Barrington

#### 12V Lamp/Vacuum Cleaner Charger

We cannot foresee any purchasing difficulties for the components required to build the 12V Lamp/Vacuum Cleaner Charger.

Some readers may experience problems locating a local source for the 4-pole 3-position slide switch. As only two poles are used, it may prove easier to buy and use two, two-position slide switches as indicated in the article.

#### Versatile Bench Power Supply

Most of the components required for the Versatile Bench Power Supply, the first of the Teach-In '91 back-up projects for the Design Your Own Circuit series should be available generally. We understand that some of our advertisers are making up kits for this series and a look through the advertisement pages should produce a local source.

#### 8-Channel Microcontroller Light Sequencer

The MLS1A programmed i.c. used in

the 8-Channel Microcontroller Light Sequencer is a special item and only available from Magenta Electronics. The chip, pre-programmed and ready to run, costs £14.95 plus post and packing.

A full kit of parts (less only the battery and solder) including the printed circuit boards, programmed i.c., heatsink block, punched and labelled case is available from Magenta for the sum of £55.95 including VAT plus £2 postage and packing. All parts are available separately.

For case drilling templates and i.c. programmed light sequences send a large stamped addressed envelope to Magenta Electronics, Dept EE, 135 Hunter Street, Burton on Trent, Staffs, DE14 2ST. (☎ 0283 65435).

The two printed circuit boards for this project are obtainable from the EE PCB Service, codes EE708 and EE709.

#### Colo.. Changing Christmas Lights

The bi-colour l.e.d.s used in the Colour Changing Christmas Lights project now seem to be recognised as

standard stock lines by most component advertisers and should not cause any sourcing problems. The rest of the components should also be readily available.

The small printed circuit board for this project is available from the EE PCB Service, code EE707.

As there is mains voltage on the p.c.b. and, due to the nature of this project which likely to attract the attention of the younger members of the family, extreme care should be taken when working on this unit.

It would certainly be advisable to use nylon nut and bolts to secure the board and "display lights" sockets in the case. You could also consider sealing the case lid, covering the fixing screws, with insulating tape.

#### Electronic Dipstick

We do not expect any component buying problems to be encountered by constructors of the Electronic Dipstick, this month's Pocket Money Project. Most of our advertisers stock the 10-way l.e.d. display. You could, if you wish, use the individual stackable types if the single package type is hard to come by.

The rest of the components are standard "off-the-shelf" items. It might prove cheaper to buy a single large piece of stripboard and cut this to size for the two small boards.

# DIRECT BOOK SERVICE

The books listed have been selected as being of special interest to everyone involved in electronics and computing. They are supplied by mail order direct to your door. Full details are given on the last book page.

For another selection of books see next month's issue.

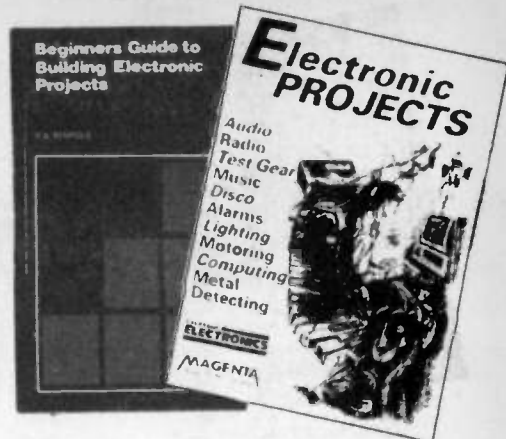

## MORE BOOKS NEXT MONTH — MORE BOOKS NEXT MONTH

### PROJECT CONSTRUCTION

#### HOW TO GET YOUR ELECTRONIC PROJECTS WORKING

R. A. Penfold

We have all built projects only to find that they did not work correctly, or at all, when first switched on. The aim of this book is to help the reader overcome just these problems by indicating how and where to start looking for many of the common faults that can occur when building up projects.

96 pages Order code BP110 £2.50

#### HOW TO DESIGN AND MAKE YOUR OWN P.C.B.s

R. A. Penfold

Deals with the simple methods of copying printed circuit board designs from magazines and books and covers all aspects of simple p.c.b. construction including photographic methods and designing your own p.c.b.s.

80 pages Order code BP121 £2.50

#### BEGINNER'S GUIDE TO BUILDING ELECTRONIC PROJECTS

R. A. Penfold

Shows the complete beginner how to tackle the practical side of electronics, so that he or she can confidently build the electronic projects that are regularly featured in magazines and books. Also includes examples in the form of simple projects.

112 pages Order code No. 227 £1.95

#### ELECTRONIC SCIENCE PROJECTS

O. Bishop

These projects range in complexity from a simple colour temperature meter to an infra-red laser. There are novelties such as an electronic clock regulated by a resonating spring, and an oscilloscope with solid-state display. There are scientific measuring instruments such as a pH meter and an electro-cardiometer. All projects have a strong scientific flavour. The way they work, and how to build and use them are fully explained.

144 pages Order code BP104 £2.95

#### ELECTRONIC PROJECTS — BOOK 1

Published by *Everyday Electronics* in association with *Magenta Electronics*.

Contains twenty of the best projects from previous issues of *EE* each backed with a kit of components. The projects are: Seashell Sea Synthesiser, *EE* Treasure Hunter, Mini Strobe, Digital Capacitance Meter, Three Channel Sound to Light, BBC 16K Sideways Ram, Simple Short Wave Radio, Insulation Tester, Stepper Motor interface, Eprom Eraser, 200MHz Digital Frequency Meter, Infra Red Alarm, *EE* Equaliser Ioniser, Bat Detector, Acoustic Probe, Mainstester and Fuse Finder, Light Rider - (Lapel Badge, Disco Lights, Chaser Light), Musical Doorbell, Function Generator, Tilt Alarm, 10W Audio Amplifier, *EE* Buccaneer Induction Balance Metal Detector, BBC Midi Interface, Variable Bench P.c.wer Supply, Pet Scarer, Audio Signal Generator.

128 pages (A4 size) Order code EP1 £2.45

### CIRCUITS & DESIGN

#### PRACTICAL ELECTRONIC BUILDING BLOCKS—BOOK 1 PRACTICAL ELECTRONIC BUILDING BLOCKS—BOOK 2

R. A. Penfold

These books are designed to aid electronic enthusiasts who like to experiment with circuits and produce their own projects, rather than simply following published project designs.

**BOOK 1** contains: Oscillators—sinewave, triangular, squarewave, sawtooth, and pulse waveform generators operating at audio frequencies. Timers—simple monostable circuits using i.c.s, the 555 and 7555 devices, etc. Miscellaneous—noise generators, rectifiers, comparators and triggers, etc.

**BOOK 2** contains: Amplifiers—low level discrete and op-amp circuits, voltage and buffer amplifiers including d.c. types. Also low-noise audio and voltage controlled amplifiers. Filters—high pass, low-pass, 6, 12, and 24dB per octave types. Miscellaneous—i.c. power amplifiers, mixers, voltage and current regulators, etc.

**BOOK 1** 128 pages Order code BP117 £1.95  
**BOOK 2** 112 pages Order code BP118 £1.95

#### ELECTRONIC ALARM CIRCUITS MANUAL

R. M. Marston

One hundred and forty useful alarm circuits, of a variety of types, are shown in this volume. The operating principle of each one is explained in concise but comprehensive terms, and brief construction notes are given where necessary.

Aimed at the practical design engineer, technician and experimenter, as well as the electronics student and amateur.

124 pages Order code NE11 £10.95

#### DESIGNING DC POWER SUPPLIES

G. C. Loveday C.Eng MIERE

Covers all aspects of the design of regulated power units, using discretes, i.c. regulators and switched units. It also covers protection circuits and reference supplies. Many design examples and exercises all with fully worked solutions are given.

131 pages Order code BM2 £6.95

#### ELECTRONIC POWER SUPPLY HANDBOOK

Ian R. Sinclair

This book covers the often neglected topic of electronic power supplies. All types of supplies that are used for electronics purposes are covered in detail, starting with cells and batteries and extending by way of rectified supplies and linear stabilisers to modern switch-mode systems, IC switch-mode regulators, DC-DC converters and inverters.

The devices, their operating principles and typical circuits are all dealt with in detail. The action of rectifiers and the reservoir capacitor is emphasised, and the subject of stabilisation is covered. The book includes some useful formulae for assessing the likely hum level of a conventional rectifier reservoir supply.

136 pages Order code PC108 £7.95

#### MODERN OPTO DEVICE PROJECTS

R.A. Penfold

In recent years, the range of opto devices available to the home constructor has expanded and changed radically. These devices now represent one of the more interesting areas of modern electronics for the hobbyist to experiment in, and many of these devices have useful practical applications as well. This book provides a number of practical designs which utilize a range of modern opto-electric devices, including such things as fibre optics, ultra bright l.e.d.s and passive IR detectors etc.

While many of these designs are not in the "dead simple" category, they should be within the capabilities of anyone with a reasonable amount of experience in electronics construction and some of the more simple designs are suitable for beginners.

104 pages Order code BP194 £2.95

#### DIGITAL LOGIC GATES AND FLIP-FLOPS

Ian R. Sinclair

This book, intended for enthusiasts, students and technicians, seeks to establish a firm foundation in digital electronics by treating the topics of gates and flip-flops thoroughly and from the beginning. This is not a constructor's book in the sense of presenting circuits to build and use, it is for the user who wants to design and troubleshoot digital circuitry with considerably more understanding of principles.

Topics such as Boolean algebra and Karnaugh mapping are explained, demonstrated and used extensively, and more attention is paid to the subject of synchronous counters than to the simple but less important ripple counters.

No background other than a basic knowledge of electronics is assumed, and the more theoretical topics are explained from the beginning, as also are many working practices. The book concludes with an explanation of microprocessor techniques as applied to digital logic.

200 pages Order code PC106 £8.95

#### HOW TO USE OP-AMPS

E. A. Parr

This book has been written as a designer's guide covering many operational amplifiers, serving both as a source book of circuits and a reference book for design calculations. The approach has been made as non-mathematical as possible.

160 pages Order code BP88 £2.95

#### MICRO INTERFACING CIRCUITS—BOOK 1 MICRO INTERFACING CIRCUITS—BOOK 2

R. A. Penfold

Both books include practical circuits together with details of the circuit operation and useful background information. Any special constructional points are covered but p.c.b. layouts and other detailed constructional information are not included.

Book 1 is mainly concerned with getting signals in and out of the computer; Book 2 deals primarily with circuits for practical applications.

**Book 1** 112 pages Order code BP130 £2.25  
**Book 2** 112 pages Order code BP131 £2.75

#### SENSORS AND TRANSDUCERS

Keith Brindley

There are a considerable number of transducers. Look through any electronic components catalogue and you'll find a wide variety of types, and each type has many variations. It's not easy to choose a transducer correctly for a particular function. In many specifications, terms and procedures are referred to which might deter you from using one that is, in fact, the best for the job. Yet, opting to use a transducer merely because it is easier to interface into the measuring system is not the answer. A greater knowledge of all types of transducers capable of doing the task is the ideal, and only then can a totally satisfactory decision be made to use one in particular.

176 pages Order code NE17 £12.95

#### ELECTRONIC CIRCUITS FOR THE COMPUTER CONTROL OF ROBOTS

Robert Penfold

Robots and robotics offer one of the most interesting areas for the electronics hobbyist to experiment in. Today the mechanical side of robots is not too difficult, as there are robotics kits and a wide range of mechanical components available. The micro controller is not too much of a problem either, since the software need not be terribly complex and many inexpensive home computers are well suited to the task.

The main stumbling block for most would-be robot builders is the electronics to interface the computer to the motors, and the sensors which provide feedback from the robot to the computer. The purpose of this book is to explain and provide some relatively simple electronic circuits which bridge this gap.

92 pages Order code BP179 £2.95

#### 50 SIMPLE LED CIRCUITS

R. N. Soar

Contains 50 interesting and useful circuits and applications, covering many different branches of electronics, using one of the most inexpensive and freely available components—the light-emitting diode (LED). Also includes circuits for the 707 common anode display.

64 pages Order Code BP42 £1.95  
**BOOK 2** 50 more l.e.d. circuits Order code BP87 £1.95

#### ELECTRONICS SIMPLIFIED —CRYSTAL SET CONSTRUCTION

F. A. Wilson, C.G.I.A., C.Eng., F.I.E.E., F.I.E.R.E., F.B.I.M.

Especially written for those who wish to participate in the intricacies of electronics more through practical construction than by theoretical study. It is designed for all ages upwards from the day one can read intelligently and handle simple tools.

80 pages Order Code BP92 £1.75

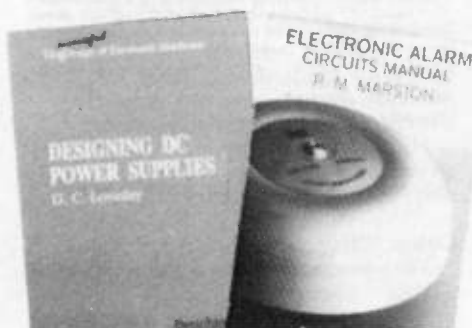



**ELECTRONICS TEACH-IN No. 4 INTRODUCING DIGITAL ELECTRONICS** (published by *Everyday Electronics*)  
**Michael J. Cockcroft**

Although this book is primarily a City & Guilds Introductory level course (726/301), approximately 80% of the information forms a very basic introduction to electronics in general, it therefore provides an excellent introductory text for beginners and a course and reference book for GCSE students.

Full details on registering for C&G assessment, details of assessment centres, components required and information on the course in general are given.

The City & Guilds Introduction to module 726/301 reads: "A candidate who satisfactorily completes this module will have a competence to identify basic components and digital integrated circuits and connect them together to form simple working circuits and logic units." This provides an excellent introduction to the book

112 pages (A4 size) Order code T14 £2.95

**ELECTRONICS TEACH-IN 88/89—INTRODUCING MICROPROCESSORS**  
**Mike Tooley BA** (published by *Everyday Electronics*)

A complete course that can lead successful readers to the award of a City & Guilds Certificate in Introductory Microprocessors (726/303). The book contains everything you need to know including full details on registering for assessment, etc.

80 pages (A4 size) Order code TI-88/89 £2.45

**FROM ATOMS TO AMPERES**

**F. A. Wilson**

Explains in crystal clear terms the absolute fundamentals behind electricity and electronics. Really helps you to discover and understand the subject, perhaps for the first time ever.

Have you ever: Wondered about the true link between electricity and magnetism? Felt you could never understand the work of Einstein, Newton, Boltzmann, Planck and other early scientists? Just accepted that an electron is like a little black ball? Got mixed up with e.m.f. and p.d.? Thought the idea of holes in semiconductors is a bit much?

Then help is at hand with this inexpensive book. In as simple a way as possible and without too much complex mathematics and formulae.

244 pages Order code BP254 £3.50



**ELECTRONICS TEACH-IN No. 3—EXPLORING ELECTRONICS** (published by *Everyday Electronics*)  
**Owen Bishop**

Another EE value for money publication aimed at students of electronics. The course is designed to explain the workings of electronic components and circuits by involving the reader in experimenting with them. The book does not contain masses of theory or formulae but straightforward explanations and circuits to build and experiment with.

Exploring Electronics contains more than 25 useful projects, assumes no previous knowledge of electronics and is split into 28 easily digestible sections.

88 pages (A4 size) Order code T13 £2.45

**NEWNES ELECTRONICS POCKET BOOK**

**E. A. Parr**

Newnes Electronics Pocket Book has been in print for over twenty years and has covered the development of electronics from valve to semiconductor technology and from transistors to LSI integrated circuits and microprocessors. To keep up to date with the rapidly changing world of electronics, continuous revision has been necessary. This new Fifth Edition takes account of recent changes and includes material suggested by readers of previous editions. New descriptions of op.amp. applications and the design of digital circuits have been added, along with a totally new chapter on computing, plus other revisions throughout.

315 pages (hard cover) Order Code NE02 £9.95

**BEGINNERS GUIDE TO MICROPROCESSORS**

**E. A. Parr**

An excellent grounding in microprocessors, this book is broadly relevant to the whole of our Introducing Microprocessors course. It is easy to read and well illustrated.

224 pages Temporarily out of print

**ELECTRONICS—A "MADE SIMPLE" BOOK**

**G. H. Olsen**

This book provides excellent background reading for our *Introducing Digital Electronics* series and will be of interest to everyone studying electronics. The subject is simply explained and well illustrated and the book assumes only a very basic knowledge of electricity.

330 pages Order code NE10 £4.95

**EVERYDAY ELECTRONICS DATA BOOK**

**Mike Tooley BA**

(published by EE in association with PC Publishing)

This book is an invaluable source of information of everyday relevance in the world of electronics. It contains not only sections which deal with the essential theory of electronic circuits, but it also deals with a wide range of practical electronic applications.

It is ideal for the hobbyist, student, technician and engineer. The information is presented in the form of a basic electronic recipe book with numerous examples showing how theory can be put into practice using a range of commonly available "industry standard" components and devices.

A must for everyone involved in electronics!  
 256 pages Order code DATA £8.95

**ELECTRONIC HOBBYISTS HANDBOOK**

**R. A. Penfold**

Provides an inexpensive single source of easily located information that the amateur electronics enthusiast is likely to need for the day-to-day pursuit of this fascinating hobby. Covers common component colour codes. Details the characteristics and pinouts of many popular semiconductor devices, including various types of logic ICs, operational amplifiers, transistors, FETs, unijunctions, diodes, rectifiers, SCRs, diacs, triacs, regulators and SMDs, etc. Illustrates many useful types of circuits, such as timers and oscillators, audio amplifiers and filters, as well as including a separate section on power supplies. Also contains a multitude of other useful data.

88 pages Order code BP233 £4.95

**ESSENTIAL THEORY FOR THE ELECTRONICS HOBBYIST**

**G. T. Rubaroe, T. Eng (C.E.I.), Assoc. I.E.R.E.**

The object of this book is to supply the hobbyist with a background knowledge tailored to meet his or her specific requirements and the author has brought together the relevant material and presented it in a readable manner with minimum recourse to mathematics.

128 pages Order Code 228 £2.50

**PRACTICAL DIGITAL ELECTRONICS HANDBOOK**

**Mike Tooley** (Published in association with *Everyday Electronics*)

The vast majority of modern electronic systems rely heavily on the application of digital electronics, and the *Practical Digital Electronics Handbook* aims to provide readers with a practically based introduction to this subject. The book will prove invaluable to anyone involved with the design, manufacture or servicing of digital circuitry, as well as to those wishing to update their knowledge of modern digital devices and techniques. Contents: Introduction to integrated circuits; basic logic gates; monostable and bistable devices; timers; microprocessors; memories; input and output devices; interfaces; microprocessor buses; Appendix 1: Data. Appendix 2: Digital test gear projects; tools and test equipment; regulated bench power supply; logic probe; logic pulser; versatile pulse generator; digital IC tester; current tracer; audio logic tracer; RS-232C breakout box; versatile digital counter/frequency meter. Appendix 3: The oscilloscope. Appendix 4: Suggested reading. Appendix 5: Further study.

208 pages Order code PC100 £8.95

COMPUTING

**NEWNES COMPUTER ENGINEER'S POCKETBOOK** (Second Edition)

**Michael Tooley**

An invaluable compendium of facts, figures, circuits and data, indispensable to the designer, student, service engineer and all those interested in computer and microcomputer systems. It will appeal equally to the hardware or software specialist and to the new band of "software engineers". This first edition covers a vast range of subjects at a practical level, with the necessary explanatory text. The data is presented in a succinct and rapidly accessible form so that the book can become part of an everyday toolkit.

205 pages (hard cover) Order code NE01 £9.95

**AN INTRODUCTION TO Z80 MACHINE CODE**

**R. A. & J. W. Penfold**

Takes the reader through the basics of microprocessors and machine code programming with no previous knowledge of these being assumed. The Z80 is used in many popular home computers and simple programming examples are given for Z80-based machines including the Sinclair ZX-81 and Spectrum, Memotech and the Amstrad CPC 464. Also applicable to the Amstrad CPC 664 and 6128.

144 pages Order code BP152 £2.75

**A Z80 WORKSHOP MANUAL**

**E. A. Parr, B.Sc., C.Eng., M.I.E.E.**

This book is intended for people who wish to progress beyond the stage of BASIC programming to topics such as machine code and assembly language programming, or need hardware details of a Z80 based computer.

192 pages Order Code BP112 £3.50

**COMPUTERS AND MUSIC—AN INTRODUCTION**

**R. A. Penfold**

Computers are playing an increasingly important part in the world of music, and the days when computerised music was strictly for the fanatical few are long gone. Computer-based music systems in the past have tended to be either horrendously expensive, very crude, or both. These days, prices are much more modest and the potential of the equipment is much greater. Consequently a lot of musicians are being tempted into the unfamiliar territory of computer music systems.

If you are more used to the black and white keys of a synth keyboard than the QWERTY keyboard of a computer, you may be understandably confused by the jargon and terminology bandied about by computer buffs. But fear not, setting up and using a computer-based music making system is not as difficult as you might think.

This book will help you learn the basics of computing, running applications programs, wiring up a MIDI system and using the system to good effect, in fact just about everything you need to know about hardware and the programs, with no previous knowledge of computing needed or assumed. This book will help you to choose the right components for a system to suit your personal needs, and equip you to exploit that system fully.

174 pages Order code PC107 £7.95

**GETTING THE MOST FROM YOUR PRINTER**

**J. W. Penfold**

Details how to use all the features provided on most dot-matrix printers from programs and popular word processor packages like Wordwise, Visawrite and Quill, etc. Shows exactly what must be typed in to achieve a given effect.

96 pages Order Code BP181 £2.95

**A CONCISE INTRODUCTION TO MS-DOS**

**N. Kantaris**

This guide is written with the non-expert, busy person in mind and, as such, it has an underlying structure based on "what you need to know first, appears first". Nonetheless, the guide is also designed to be circular, which means that you don't have to start at the beginning and go to the end. The more experienced user can start from any section.

The guide covers versions 3.0, 3.1 and 3.2 of both PC-DOS and MS-DOS as implemented by IBM and other manufacturers of "compatible" microcomputers, including the AMSTRAD PCs. It covers both floppy disc-based systems and hard disc-based systems.

64 pages Order code BP232 £2.95

**AN INTRODUCTION TO 68000 ASSEMBLY LANGUAGE**

**R. A. & J. W. Penfold**

Obtain a vast increase in running speed by writing programs for 68000 based micros such as the Commodore Amiga, Atari ST range or Apple Macintosh range etc., in assembly language. It is not as difficult as one might think and this book covers the fundamentals.

112 pages Order code BP184 £2.95

**THE ART OF PROGRAMMING THE ZX SPECTRUM**

**M. James, B.Sc., M.B.C.S.**

It is one thing to have learnt how to use all the Spectrum's commands and functions, but a very different one to be able to combine them into programs that do exactly what you want them to. This is just what this book is all about—teaching you the art of effective programming with your Spectrum.

144 pages Order code BP119 £2.50

**BEGINNER'S GUIDE TO HI-FI**

Ian Sinclair  
The *Beginner's Guide to Hi-Fi* will appeal to the audio enthusiast, whether newly won over by advances in technology or well established and wondering whether to update equipment. The book deals with the sound from its sources in the studio to its ultimate end in your ears, and shows what sound is, how it is recorded and how it is reproduced.

Every aspect of Hi-Fi, from pickup cartridges to loudspeakers, has been covered, and the emphasis has been on explaining design aims. Cassette systems have been given considerable prominence, including the more modern Dolby C and dbx noise reduction systems. The CD record has been covered in detail so that you can find out just why this system of sound reproduction is so superior.  
194 pages **Temporarily out of print.**

**DATA & COMPONENT IDENTIFICATION**

**HOW TO IDENTIFY UNMARKED ICs**

K. M. Recort  
Shows the reader how, with just a test-meter, to go about recording the particular signature of an unmarked i.c. which should enable the i.c. to then be identified with reference to manufacturers' or other data. An i.c. signature is a specially plotted chart produced by measuring the resistances between all terminal pairs of an i.c.  
Chart **Order code BP101 £0.95**

**INTERNATIONAL DIODE EQUIVALENTS GUIDE**

A. Michaels  
Designed to help the user in finding possible substitutes for a large selection of the many different types of diodes that are available. Besides simple rectifier diodes, also included are Zener diodes, i.e. d.s. diacs, triacs, thyristors, OCIs, photo and display diodes.  
144 pages **Temporarily out of print**

**LINEAR IC EQUIVALENTS AND PIN CONNECTIONS**

A. Michaels  
Shows equivalents and pin connections of a popular selection of European, American and Japanese linear i.c.s. Also includes details of functions, manufacturer and country of origin.  
320 pages **Temporarily out of print**

**RADIO AND ELECTRONIC COLOUR CODES AND OATA CHART**

B. B. Babani  
Although this chart was first published in 1971 it provides basic information on many colour codes in use throughout the world, for most radio and electronic components. Includes resistors, capacitors, transformers, field coils, fuses, battery leads, speakers, etc. It is particularly useful for finding the values of old components.  
Chart **Order code BP7 £0.95**

**RADIO, TV, SATELLITE**

**AN INTRODUCTION TO AMATEUR RADIO**

I.D. Poole  
Amateur radio is a unique and fascinating hobby which has attracted thousands of people since it began at the turn of the century.

This book gives the newcomer a comprehensive and easy to understand guide through the subject so that the reader can gain the most from the hobby. It then remains an essential reference volume to be used time and again. Topics covered include the basic aspects of the hobby, such as operating procedures, jargon and setting up a station. Technical topics covered include propagation, receivers, transmitters and aerials etc.  
150 pages **Order code BP257 £3.50**

**INTERNATIONAL RADIO STATIONS GUIDE**

P. Shore  
Provides the casual listener, amateur radio DXer and the professional radio monitor with an essential reference work designed to guide him or her around the ever more complex radio bands. This new edition has been completely revised and rewritten and incorporates much more information which is divided into the following sections:  
Listening to Short Wave Radio; ITU Country Codes; World-wide Short Wave Radio Stations; European, Middle East and North African Long Wave Radio Stations; European, Near East and North African Medium Wave Radio Stations; Canadian Medium Wave Radio Stations; USA Medium Wave Radio Stations; Broadcasts in English; Programmes for DXers and Short Wave Listeners; UK FM Radio Stations; Time differences from GMT; Abbreviations; Wavelength/Frequency Conversion.  
320 pages **Order code BP255 £4.95**

**AERIAL PROJECTS**

R. A. Penfold  
The subject of aerials is vast but in this book the author has considered practical aerial designs, including active, loop and ferrite aerials which give good performances and are relatively simple and inexpensive to build. The complex theory and mathematics of aerial design have been avoided.  
Also included are constructional details of a number of aerial accessories including a pre-selector, attenuator, filters and tuning unit.  
96 pages **Order code BP105 £2.50**

**AN INTRODUCTION TO LOUSPEAKERS AND ENCLOSURE DESIGN**

V. Capel  
This book explores the various features, good points and snags of speaker designs. It examines the whys and wherefores so that the reader can understand the principles involved and so make an informed choice of design, or even design loudspeaker enclosures for him or herself. Crossover units are also explained, the various types, how they work, the distortions they produce and how to avoid them. Finally there is a step-by-step description of the construction of the *Kapellmeister* loudspeaker enclosure.  
148 pages **Order Code BP256 £2.95**

**MUSICAL APPLICATIONS OF THE ATARI ST's**

R. A. Penfold  
The Atari ST's are now firmly established as the computers to use for electronic music applications. The range and sophistication of these applications are much greater than most people may realise, but there are still a lot of misconceptions about just what can and cannot be achieved. This book will help you sort out the fact from the fallacy and to get the most musically from the ST's.  
A wide selection of topics are covered, including the internal sound chip; MIDI; applications programs such as sequencing and score writing, etc; simple but useful add-on projects and MIDI programming.  
90 pages **Order code BP246 £5.95**

**TESTING & TEST GEAR**

**TRANSISTOR RADIO FAULT-FINDING CHART**

C. E. Miller  
Used properly, should enable the reader to trace most common faults reasonably quickly. Across the top of the chart will be found four rectangles containing brief description of these faults, viz—sound weak but undistorted, set dead, sound low or distorted and background noises. One then selects the most appropriate of these and following the arrows, carries out the suggested checks in sequence until the fault is cleared.  
Chart **Order code BP70 £0.95**

**HOW TO USE OSCILLOSCOPES AND OTHER TEST EQUIPMENT**

R. A. Penfold  
This book explains the basic function of an oscilloscope, gives a detailed explanation of all the standard controls, and provides advice on buying. A separate chapter deals with using an oscilloscope for fault finding on linear and logic circuits. Plenty of example waveforms help to illustrate the control functions and the effects of various fault conditions. The function and use of various other pieces of test equipment are also covered, including signal generators, logic probes, logic pulsers, and crystal calibrators.  
104 pages **Order code BP267 £3.50**

**AN INTRODUCTION TO SATELLITE TELEVISION**

F.A. Wilson  
As a definitive introduction to the subject this book is presented on two levels. For the absolute beginner or anyone thinking about purchasing or hiring a satellite TV system, the story is told as simply as such a complex one can be in the main text.

For the professional engineer, electronics enthusiast, student or others with technical backgrounds, there are numerous appendices backing up the main text with additional technical and scientific detail formulae, calculations, tables etc.

There is also plenty for the DIY enthusiast with practical advice on choosing and installing the most problematic part of the system—the dish antenna.  
104 pages **Order Code BP195 £5.95**

**COMMUNICATION**

F. A. Wilson, C.G.I.A., C.Eng., F.I.E.E., F.I.E.R.E., F.B.I.M.  
A look at the electronic fundamentals over the whole of the communication scene. This book aims to teach the important elements of each branch of the subject in a style as interesting and practical as possible. While not getting involved in the more complicated theory and mathematics, most of the modern transmission system techniques are examined including line, microwave, submarine, satellite and digital multiplex systems, radio and telegraphy. To assist in understanding these more thoroughly, chapters on signal processing, the electromagnetic wave, networks and transmissions assessment are included, finally a short chapter on optical transmission.  
256 pages **Order Code BP89 £2.95**

**AN INTRODUCTION TO VHF/UHF FOR RADIO AMATEURS**

I. D. Poole  
This book covers the essentials required to gain the most from using the VHF and UHF bands. As such it will be of use to both the newcomer and more experienced operator alike.  
Topics included in this book include propagation, descriptions of the bands with outlines of the bandplans and channels, aerials, receivers, transmitters and a special chapter on scanners. In addition to this repeater and mobile operation are included as well as DXing and data modes together with a section on packet radio.  
102 pages **Order Code BP281 £3.50**

**PRACTICAL MIDI HANDBOOK**

R.A. Penfold  
The Musical Instrument Digital Interface (MIDI) is surrounded by a great deal of misunderstanding, and many of the user manuals that accompany MIDI equipment are quite incomprehensible to the reader.  
The *Practical MIDI Handbook* is aimed primarily at musicians, enthusiasts and technicians who want to exploit the vast capabilities of MIDI, but who have no previous knowledge of electronics or computing. The majority of the book is devoted to an explanation of what MIDI can do and how to exploit it to the full, with practical advice on connecting up a MIDI system and getting it to work, as well as deciphering the technical information in those equipment manuals.  
128 pages **Order code PC101 £5.95**

**COMPUTERS AND MUSIC**

— see computer section

**DIRECT BOOK SERVICE**

(A Division of Wimborne Publishing Ltd.)

**TO ORDER**

Please state the title and order code clearly, print your name and address and add the required postage to the total order.

Add 75p to your total order for postage and packing (overseas readers add £1.50 for countries in Europe, or add £2.00 for all countries outside Europe, surface mail postage) and send a PO, cheque or international money order (£ sterling only) made payable to *Direct Book Service* quoting your name and address, the order code and quantities required to *DIRECT BOOK SERVICE*, 33 GRAVEL HILL, MERLEY, WIMBORNE, DORSET, BH21 1RW (mail order only).

See next month's issue for another three page selection of books.

Although books are normally sent within seven days of receipt of your order, please allow a maximum of 28 days for delivery. Overseas readers allow extra time for surface mail post. *Please check price and availability (see latest issue of Everyday Electronics) before ordering from old lists.*

**Note — our postage charge is the same for one book or one hundred books!**

**MORE BOOKS NEXT MONTH**

10% OFF

# MULTITEST THE NEW MULTISOURCE

10% OFF



- ★ Scopes 20–100MHz Plus DSO's
- ★ DMM's Handheld & Bench
- ★ Function Generators 0.01Hz–10MHz
- ★ Frequency Counters/Timers 0.01Hz–1GHz
- ★ Over 30 models to choose from

Free Catalogue

## MULTITEST Limited

**SPECIAL INTRODUCTORY OFFER 10% OFF LIST PRICE TO 31-1-91**  
(Just send a copy of this advert to qualify)

P.O. Box 4, St. Neots, Huntingdon, Cambs. PE19 4QX U.K.  
Telephone: (0480) 403617 Facsimile: (0480) 403618

## EASY-PC, SCHEMATIC and PCB CAD

### NEW VERSION! LASER PRINTER SUPPORT!

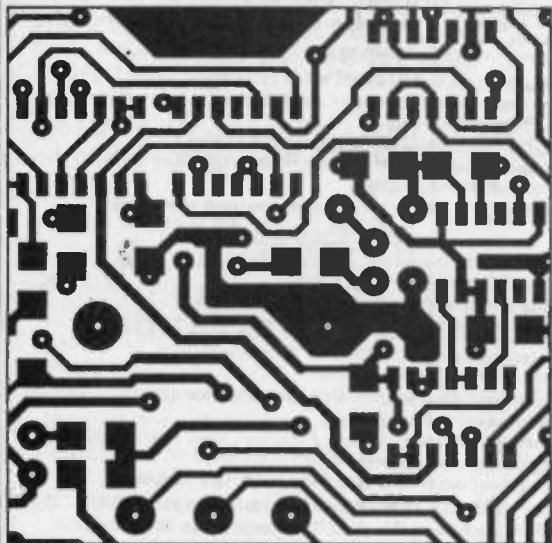

- Runs on:- PC/XT/AT/386/486 CGA EGA VGA.
- Design:- Single sided, Double sided and Multilayer boards.
- Provides Surface Mount support.
- Standard output includes Dot Matrix printer, Laser Printer Pen Plotter, Photo-plotter and N.C. Drill.

Still Only  
**£98.00!**

**BRITISH DESIGN AWARD 1989**

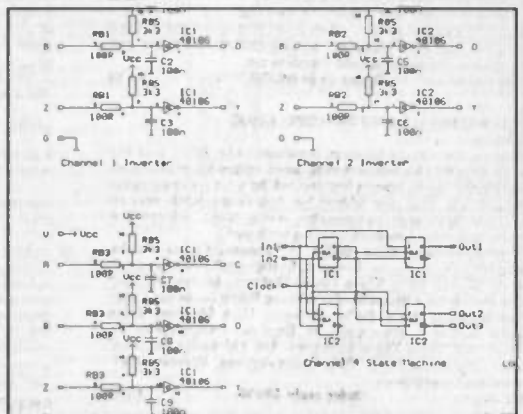

**Fast Professional Quality Output at an Affordable Price**

Write, Phone or Fax for full details:-

**Number One Systems Ltd.**



See us at **Desktop CAD** Stand 4

REF:EVD, HARDING WAY, SOMERSHAM ROAD, ST.IVES, HUNTINGDON, CAMBS, PE17 4WR, ENGLAND.  
Telephone: 0480 61778 (6 lines) Fax: 0480 494042 ACCESS, AMEX, MASTERCARD, VISA Welcome.

# GEM TECH

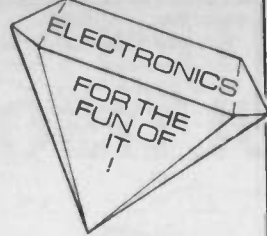

**DIY KIT MODULES**  
All with pcbs and step by step instructions

SCOPE TRACE DOUBLER.....	£12.50
DIGITAL SIGNAL GEN.....	£16.95
AUDIO SIGNAL GEN.....	£17.50
ROBOT VOX MODULE.....	£19.50
MULTIPLE SIRENS.....	£16.95
TIME SWITCH.....	£10.95
ENTRY ALARM CONTROLLER.....	£15.95
FROST ALARM.....	£10.80
CAR ALARM.....	£19.95
GEIGER COUNTER.....	£58.30
3-CHAN. SOUND-TO-LIGHT CONTROL.....	£37.95
3-CHANNEL LIGHT SEQUENCER.....	£32.95

**ALL PRICES INCLUDE V.A.T P&P ONLY £1.00 PER ITEM**

**MORE KITS IN FREE CATALOGUE**  
PLUS TOOLS, BOOKS, PCB MAKING EQUIPMENT, TEST GEAR AND MORE DETAILS

## SPECIAL TOOL KIT OFFER

One each of: mains soldering iron, soldering iron stand, solder pack, solda-mop, side cutters, snipe nose pliers, neon screwdriver, modelling screwdrivers set of 6, wire stripper

LIST PRICE £20.97  
SPECIAL OFFER  
**ONLY £17.80**

## GEM-TECH

DEPT EE12, UNIT J,  
8 FINUCANE DRIVE,  
ORPINGTON, KENT, BR5 4ED  
24 HOUR ANSAFONE  
TEL: 0689 37821

# TRANSFORMERS EX STOCK

**MAINS ISOLATORS**  
Pri 120V x2 or 220/240V or 415/440V. Sec 440 or 240V or 110V Centre Tapped

20 VA	£8.33	2.51
60	13.60	2.70
100	15.87	P 2.92
200	22.49	& 3.52
250	29.20	P 3.62
500	41.91	4.24
1000	76.01	5.33
1500	98.04	6.54
2000	117.96	7.64
3000	165.41	O/A
6000 VA	353.43	O/A

**24/12V or 12-0-12V**

<b>2x12V Secs</b>				
24V	12V	£	P&P	
0.15	0.3	3.44	1.87	
0.25	0.5	3.64	1.90	
0.5	1	4.36	1.98	
1	2	6.08	2.09	
2	A	4	7.01	2.20
3	M	6	12.08	2.36
4	P	8	12.87	2.42
6	S	12	15.62	2.64
8		16	18.59	3.08
10		20	25.02	3.52
15		30	31.10	3.63
20		40	44.40	4.12
30		60	63.75	4.89
41		83	73.41	6.32

**AUTOS**  
105, 115, 200, 220, 230, 240V

<b>for step-up or down</b>		
80 VA	£ 6.91	1.92
150	10.03	2.09
250	12.25	2.31
500	19.05	P 3.08
1000	34.93	& 3.68
1500	40.40	P 4.18
2000	60.41	5.11
3000	102.72	6.32
4000	133.35	O/A
5000	155.28	O/A
7500	239.70	O/A
10KVA	283.23	O/A

**30/15V or 15-0-15V**  
2x15V Tapped Secs. Volts available: 3, 4, 5, 6, 8, 9, 10, 15, 18, 20, 27, 30V or 15-0-15V

30V	15V	£	P&P	
0.5	1	4.55	1.81	
1	2	6.19	1.98	
2	A	4	10.01	2.20
3	M	6	11.60	2.42
4	P	8	13.84	2.53
5	S	10	17.72	2.74
6		12	19.41	2.92
8		16	25.94	3.02
10		20	29.94	3.24
12		24	33.42	3.35
15		30	37.43	4.01
20		40	51.10	6.54

**50/25V or 25-0-25V**

2x25V Tapped Secs to give 7, 8, 10, 13, 17, 20, 25, 33, 40, 50V or 20-0-20V or 25-0-25V

50V	25V	£	P&P	
0.5	1	5.91	2.09	
1	2	7.19	2.21	
2	A	4	12.81	2.75
3	M	6	14.82	2.92
4	P	8	20.30	3.24
6	S	12	25.81	3.41
8		16	36.52	4.12
10		20	43.34	4.41
12		24	51.87	5.22

**CASED AUTOS**

240V Cable Input 3-pin 115V USA Socket Outlet

20 VA	£ 9.85	2.03
80	13.38	2.14
150	17.34	2.53
250	21.13	P 3.57
500	34.66	& 3.90
1000	48.65	P 4.90
2000	86.70	6.16
3000VA	124.46	O/A

REVERSE Cased Autos 110V Cable I/P 240V 13A Skt O/P 250VA £35.66 £3.57 p&p

**AVO's & MEGGERS**  
Full range available

Please add 15% V.A.T. to all items after P&P

**60/30V or 30-0-30V**  
2x30V Tapped Secs  
Volts available: 16, 18, 36, 40, 60V or 24-0-24 or 30-0-30V

60V	30V	£	P&P	
0.5	1	6.72	2.09	
1	2	10.25	2.21	
2	A	4	13.17	2.53
3	M	6	19.05	2.64
4	P	8	21.72	2.75
5	S	10	27.46	3.19
6		12	31.32	3.41
8		16	44.04	3.93
10		20	51.28	4.40
12		24	59.09	5.22

96/48V or 48-0-48V  
2x0-36-48V Secs to give 60, 72, 84, 96V, or 36-0-36V or 48-0-48V

**96V 48/36V**

0.5	1	£7.16	1.76	
1	2	12.80	2.31	
2	A	4	21.05	2.91
3	M	6	25.49	3.02
4	P	8	32.54	3.32
5	S	10	46.21	4.18
6		12	57.87	4.40
8		16	63.12	5.28

**TOOL TRANSFORMERS**

240V to 110Vet O/P  
2KVA £71+£5.33 P&P

**CONSTANT VOLTAGE TRANSFORMERS**

For Spike-free Stable Mains

**INVERTERS**

12/24V DC to 240V AC Square or Sine Wave

**TRANSFORMERS WOUND TO SPEC**

Batches 3VA to 15KVA TOROIDALS 30VA to 4KVA

Also Valve Mains & Output Transformers

**EDUCATIONAL METERS**

0-30V DC or 0-10A DC £4 each + 70p P&P

Send SAE for Lists

PO BOX 70, ILFORD ESSEX, IG5 0AP

**BARRIE ELECTRONICS LTD**  
TELEPHONE: 081-551 8454

## VARIABLE VOLTAGE TRANSFORMERS

**INPUT 220/240V AC 50/60 OUTPUT 0-260V**

0.5KVA 2.5 amp max	£29.00	£3.75	(£37.55 inc VAT)
1KVA 5 amp max	£37.40	£4.25	(£47.90 inc VAT)
2KVA 10 amp max	£54.00	£5.48	(£68.40 inc VAT)
3KVA 15 amp max	£71.50	£8.24	(£89.40 inc VAT)
5KVA 25 amp max	£126.50		(Carriage on request)

**VOLTAGE CHANGING TRANSFORMER**  
1250 Watt auto. Tapped 0-90V, 100, 110, 115, 120, twice to obtain voltages between 90 and 240V. Fitted in heavy duty louvered metal case. Fused input. Price incl VAT & p&p £39.50.

**COMPREHENSIVE RANGE OF TRANSFORMERS-LT-ISOLATION & AUTO 110-240V** Auto transfer auto-cased with American socket and mains lead or open frame type. Available for immediate delivery.

**ULTRA VIOLET BLACK LIGHT FLUORESCENT TUBES**  
4ft 40 watt £10.44 (£12.00 inc VAT) Caller only  
2ft 20 watt £7.44 + £1.25 p&p (£9.99 inc VAT)  
13in 10 watt £5.80 + 75p p&p (£6.53 inc VAT)  
12in 8 watt £4.80 + 75p p&p (£5.38 inc VAT)  
9in 6 watt £3.96 + 50p p&p (£4.32 inc VAT)  
6in 4 watt £3.96 + 50p p&p (£4.32 inc VAT)

**230V AC BALLAST KIT** for either: 6in, 9in or 12in tubes £5.50 + 55p p&p (£6.96 inc VAT)  
For 13in tubes £6.00 + 75p p&p (£7.25 inc VAT)

**400 WATT UV LAMP**  
Only £34.00 + £2.50 p&p (£41.98 inc VAT)  
**175 WATT SELF BALLASTED BLACK LIGHT MERCURY BULBS** Available with BC or ES fitting. Price incl VAT & p&p £19.84.

**12 VOLT BILGE PUMPS**  
Buy direct from the Importers  
500 GPH 15ft head 3 amp £18.00 inc.  
1750 GPH 15ft head 9 amp £20.18 + £2.60 p&p (£26.20 inc VAT)

**EPROM ERASURE KIT**  
Build your own EPROM ERASURE for a fraction of the price of a made-up unit kit of parts less case. Includes 12in 8 watt 2357 Angstrom Tube Ballast unit pair of bi-pin leads neon indicator on/off switch safety microswitch and circuit £14.00 + £2.00 p&p (£18.40 inc VAT)

**SUPER MY-LIGHT STROBE KIT**  
Designed for Disco, Theatrical uses etc. Approx 16 joules. Adjustable speed £48.00 + £2.00 p&p (£52.50 inc VAT)  
Case and reflector £22.00 + £2.00 p&p (£27.60 inc VAT)  
SAE for further details including My-Light and Industrial Strobe Kits.

## WIDE RANGE OF XENON FLASH TUBES

Write/Phone your enquiries  
EXTENSIVE RANGE OF DIFFERENT TYPES OF GEARED MOTORS AVAILABLE FROM STOCK

**WASHING MACHINE WATER PUMP**  
Brand new 240V AC fan cooled can be used for a variety of purposes. Inlets 1 1/2 in. Outlet 1 inch. Price including p&p and VAT — £10.95 or 2 for £20 including p&p and VAT.

## 12V DC 20 RPM REVERSIBLE MOTOR

Swiss precision built. Ideal for robotics. Size: length inc. shaft 90mm. Diameter front fixing 38mm square. Currently advertised by well known supplier at £27.00 plus p&p & VAT. Our Price £14.95 inc. p&p & VAT

**GIANT BLOWER EXTRACTOR UNIT**  
Twin output centrifugal blower: 1 HP 240V AC motor, output approx. 3800 cfm. Size: Length 100cm; Height 27cm. Depth 26cm; Flating plate 106x33cm. Price £175 + VAT. Ex warehouse.

**TORIN CENTRIFUGAL BLOWER**  
230V ac, 2.800 RPM, 0.9amp, 130mm diameter impeller outlet 63 x 37mm overall size 195 x 160 x 150mm long. Price £175.00 + £2.50 p&p (£23 inc VAT)

**SHADED POLE GEAR MOTORS**  
In the following sizes:  
9 RPM 12 RPM 80 RPM 160 RPM 110V AC or 240V AC with capacitors (supplied). Price incl VAT & p&p £12.65

**GEARED MOTORS**  
71 RPM 20lb inch torque reversible 115V AC input including capacitor and transformer for 240V AC operation. Price incl VAT & p&p £23.00.

**SOLID STATE EHT UNIT**  
Input 230/240V AC. Output approx 15KV. Producing 10mm spark. Built-in 10 sec timer. Easily modified for 20 sec. 30 sec to continuous. Designed for boiler ignition. Dozens of uses in the field of physics and electronics, eg supplying neon or argon tubes etc. Price less case £8.50 + £1.00 p&p (£10.93 inc VAT) NMS

**HEAVY DUTY MOTOR**  
Crouzet 115V/230V A.C. heavy duty 1RPM motor. Anticlockwise type 820/15. Size 68mm diameter x 55mm long. Shaft 6mm diameter x 20mm long. Price inc. VAT & p&p £18.40.

**RHEOSTAT**  
50W 2ohm 5amp ceramic power rheostat. Price inc. VAT & p&p £10.35

**MICROSWITCH**  
Pye 15amp changeover lever microswitch, type S171. Brand new. Price 5 for £8.90 inc. VAT & p&p.  
NMS = NEW MANUF SURPLUS  
R&T = RECONDITIONED AND TESTED

## SERVICE TRADING CO

57 BRIDGMAN ROAD, CHISWICK, LONDON W4 5BB

081-995 1560

ACCOUNT CUSTOMERS MIN. ORDER £10

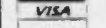

Showroom open Monday/Friday



Ample Parking Space

# BRIAN PRICE BOHM ORGAN STUDIOS

66 Ashchurch Drive, Wollaton, Nottingham NG8 2RA  
Telephone/Fax: 0602-284766

33 years of experience in high quality Organ and Keyboard design behind every BOHM product.

## The LATEST from BOHM 900/910 Series Organs

- ★ 400 sounds in NEW BOHM H.D.S. System
- ★ 256 Sampled Rhythms and Accompaniments
- ★ 22 Track Sequencer
- ★ Touch-Sensitive keyboards 49 Notes
- ★ All features fully Programmable by user, Soundcard or Optional Floppy Disc.
- ★ Available in choice of cabinets and Veneers.

## 520 Expander

- ★ Full Organ features. Stereo Voicing
- ★ Sound Sampled Rhythms
- ★ Fully Programmable from Soundcard

## STATION ONE EXPANDER

- ★ All features of 900 Series Organs
- ★ Plus 48 track sequencer
- ★ Unlimited Programming facilities for Sounds, Rhythms and Accompaniments
- ★ Storage on soundcard, Floppy Disc, Hard Disc or very large Internal memory
- ★ Supplied with 400 Sounds and 120 Rhythms.

We are also the UK suppliers for the BOHM IC E510. Available with full Technical Information.

## Supplied in kit form or built by: THE BOHM SPECIALISTS

Part Exchanges welcome. Please write or phone for NEW English brochures and price list. — Callers by appointment please.

Contact your local agent:

South Wales:  
Vernon Pursall  
66 Colcol Road  
Barry  
South Glamorgan  
Tel: 0446-733277

Scotland:  
Keyboard Services  
9 Kingswood Road  
Kingswell  
Aberdeen  
Tel: 0224-744585

North West:  
Nick Stammers  
Westling, Tenfields  
Hetton Le Hole  
Tyne and Wear  
Tel: 091-526 3589

# PCB SERVICE

Printed circuit boards for certain constructional projects are available from the PCB Service, see list. These are fabricated in glass fibre, and are fully drilled and roller tinned. All prices include VAT and postage and packing. Add £1 per board for overseas airmail. Remittances should be sent to The PCB Service, *Everyday Electronics*, 6 Church Street, Wimborne, Dorset BH21 1JH. Cheques should be crossed and made payable to *Everyday Electronics* (Payment in £ sterling only).

Boards for some older projects - not listed here - can often be obtained from Magenta Electronics, 135 Hunter St., Burton-on-Trent, Staffs DE14 2ST. Tel: 0283 65435 or Lake Electronics, 7 Middleton Close, Nuthall, Nottingham NG16 1BX. Tel: 0602 382509.

NOTE: While 90% of our boards are now held in stock and are dispatched within seven days of receipt of order, please allow a maximum of 28 days for delivery - overseas readers allow extra if ordered by surface mail. Please check price and availability in the latest issue before ordering. We can only supply boards listed in the latest issue. Boards can only be supplied on a payment with order basis.

PROJECT TITLE	Order Code	Cost
Noise Gate <b>SEP'87</b>	577	£4.41
BBC Sideways RAM/ROM <b>NOV'87</b>	585	£4.10
Pipe & Cable Locator <b>APR'88</b>	598	£3.00
Multi-Channel Remote Light Dim		
Transmitter	599	£3.00
Receiver	600	£3.07
Door Sentinel	605	£3.00
Multi-Chan Remote Light Dim		
Relay/Decoder	601	£4.86
Dimmer Board	602	£3.07
Power Supply	603	£3.00
Video Wiper	612	£6.75
Isolink	613	£4.21
Tea Tune	609	£3.00
Time Switch	614	£4.84
Suntan Timer	610	£3.07
Car Alarm	615	£3.12
Breaking Glass Alarm <b>SEP'88</b>	617	£4.27
EPROM Eraser <b>OCT'88</b>	620	£4.07
Doorbell Delay	616	£3.56
Infra-Red Object Counter Trans	£9.28	£4.61
Receiver	as a	£3.23
Display	set	£3.05
Seashell Sea Synthesiser	625	£4.84
Downbeat Metronome <b>DEC'88</b>	629	£4.84
EPROM Programmer ( <i>On Spec</i> )	630	£8.29
Phasor	631	£5.64
Monkey/Hunter Game <b>JAN'89</b>	634	£3.36
Continuity Tester <b>FEB'89</b>	619	£2.67
Mini PSU	636	£3.23
Sound-to-Light Interface <b>MAR'89</b>	637	£6.24
Midi Pedal	639	£7.00
Midi Merge	640	£3.00
Audio Lead Tester	641	£5.77
Light Sentinel <b>APR'89</b>		
Main Control Board	632	£9.20
Remote Interface (4 boards)	633	£4.59
Electron User Port	638	£6.64
4-Channel Auto-Fade Interface	642	£6.80
Pet Scarer <b>MAY'89</b>	644	£3.00
Electron A/D Interface	645	£4.84
Spectrum EPROM Programmer <b>JUN'89</b>	628	£7.87
Bat Detector	647	£4.95
Programmable Pocket Timer <b>JUL'89</b>	648	£3.82
Electronic Spirit Level <b>AUG'89</b>	649	£3.85
Distance Recorder	651	£5.23
Treasure Hunter	652	£3.73
Xenon Beacon <b>SEP'89</b>	650	£4.13
Probe Pocket Treasure Finder	653	£4.12
Power Supplies - Fixed Voltage	654	£4.08
Variable Voltage	655	£4.48
Music on Hold <b>OCT'89</b>	646	£3.85
Power Supplies - 25V 700mA	656	£4.35
30V 1A	657	£4.55
EE Seismograph - Control	658	£4.08
Detector	659	£4.22
Lego/Logo & Spectrum	660	£6.49

PROJECT TITLE	Order Code	Cost
Wash Pro <b>NOV'89</b>	643	£3.83
Biofeedback Monitor - Front End	661	£4.52
Processor	662	£4.56
Power Supplies - 1.5V-25V 2A	663	£4.78
Logo/Logo & Spectrum Interface	664	£5.60
EEG Electrode Impedance Meter <b>DEC'89</b>	665	£3.98
Biofeedback Signal Generator <b>JAN'90</b>	666	£4.08
Four-Channel Light Chaser	667	£6.70
Quick Cap Tester <b>FEB'90</b>	668	£3.92
Weather Station		
Anemometer - Freq./Volt Board	670	£3.94
Optional Display	669	£3.73
Wind Direction	673/674	£4.22
System Power Supply	675	£3.59
Prophet In-Car Ioniser	676	£3.18
EE Weather Station <b>MAR'90</b>		
Display Driver	672 & 678	£4.22
Display and Sensor	671	£4.47
Fermostat Mk2	677	£4.28
Superhet Broadcast Receiver-Tuner/Amp	679/680	£4.22
Stereo Noise Generator <b>APR'90</b>	681	£4.24
Digital Experimenter's Unit - Pulse Generator	682	£4.46
Power Supply	683	£3.66
684		£4.28
Enlarger Timer		
EE Weather Station		
Rainfall/Sunlight Display	685	£4.27
Rainfall Sen and Sunlight Sen	686/687	£4.16
Amstrad Speech Synthesiser <b>MAY'90</b>	689	£4.68
Quizmaster	690	£4.74
80 Metre Direct Conversion Radio <b>JUN'90</b>	691	£4.95
Mains Appliance Remote Control		
Infra-Red Transmitter	692/693	£4.75
Mains Appliance Remote Control <b>JUL'90</b>		
Encoder Board A	694	£6.61
Encoder Board B	695	£4.78
The Tester	696	£4.15
Mains Appliance Remote Control <b>AUG'90</b>		
Mains ON/OFF Decoder	697	£4.55
(5 or more 697's ordered <i>together</i> £3.25 each)		
Simple Metronome	698	£3.94
Hand Tally <b>SEP'90</b>		
Main Board (double-sided)		
Display	699, 700	£10.95
Alarm Bell Time-Out	701	£4.10
Mains Appliance Remote Control		
Temperature Controller (p.c.b. only)	702	£5.20
Ghost Walker <b>OCT'90</b>	703	£4.32
Frequency Meter	704	£5.25
Freq. Meter/Tachometer <b>NOV'90</b>	705	£3.98
EE Musketeer (TV/Video/Audio) 706		£5.78
Colour Changing Christmas Lights <b>DEC'90</b>	707	£4.39
Microcontroller Light Sequencer	708/709	£10.90
Versatile Bench Power Supply Unit	710	£4.24
Teach-In '91, Part 1 - Design Your Own Circuits		
L200 Module	711	£3.93
Dual Output Module	712	£4.13
LM723 Module	713	£4.21

Please note it is important to give project title as well as order code.

## EE PRINTED CIRCUIT BOARD SERVICE

Please send me the following p.c.b.s.

Order Code    Project    Quantity    Price

.....  
 .....  
 .....

I enclose cheque/PO for £.....

Name.....

Address.....

Please allow 28 days for delivery (see note above)

BLOCK CAPITALS PLEASE

# AGE & G ELECTRONICS

ELECTRONIC COMPONENTS MAIL ORDER COMPANY.

1990 COMPONENTS CATALOGUE IS AVAILABLE NOW.

**FREE** entry to win an ultraviolet exposure Unit Value £200.

Have you sent for your copy yet?

Electronic Components at the right prices.

- FAST SERVICE
- LOW PRICES
- LARGE DISCOUNTS

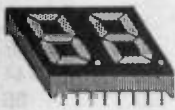

Competition ends 31 Dec 1990.

0.5" ORANGE DUAL LED DISPLAY

Value £ 2.00 absolutely free !!!

Simply complete and return the order form below and we will send your free gift.

PLEASE SEND A COPY OF THE A & G ELECTRONICS CATALOGUE AT £1.00 ( REFUNDABLE WITH MY FIRST ORDER ) AND MY FREE GIFT TO:

NAME .....  
ADDRESS .....

I HAVE ENCLOSED £ .... Tick box to enter the competition.

**A & G ELECTRONICS LTD.**  
Free Post ,100 Park Avenue ,  
London E 6 2BR. (No Stamp Required)  
TEL : 081-552 2386 Fax : 081 - 519 3419.

# HENRY'S ELECTRONICS DISTRIBUTORS

FOR TRADE, INDUSTRY, EXPORT, EDUCATION AND ALL HOBBYISTS

LARGE RANGE OF ELECTRONIC COMPONENTS IN STOCK!!!

AUDIO, TV, VIDEO, TELEPHONE & COMPUTER ACCESSORIES

Two Car Parks Nearby

A COMPLETE RANGE OF CATALOGUES, COVERING THE VAST HENRY'S STOCK

TEST INSTRUMENTS (SAE 38p) Includes 'Scopes, Counters, PSU's, Dmms, Generators, TV/Video, Clamps, Insulation, Temperature, Logic plus much more (UK's largest in stock range).

SECURITY (SAE 28p) Home, Office, Shop, Store etc. Alarms and Alarm Systems, CCTV, Doorphones, PIR Indoor/Outdoor, TV/Video, and Telephone Accessories, Intercomms.

COMPONENTS (SAE 32p) Tools, Service Aids, Components, Computer Accessories, Semiconductors etc.

COLOUR CATALOGUE (SAE £2.00) Huge Range of Audio, Test, In Car, PA, Disco Equipment plus Leads, Plugs etc.

PUBLIC ADDRESS (SAE 32p) Disco, PA, Speakers etc

COMMUNICATIONS (SAE 28p) CB Radio, Scanners etc

TRADE/INDUSTRY/EDUCATION Write or fax for your FREE (UK only) CATALOGUES with Trade prices (Export Send £5)

RETAIL MAIL ORDER Send SAE min. Size A4 with Stamp as Indicated (UK). Complete set with colour catalogue send PO/Chq (no SAE) £3.00. Export £5.00

**HENRY'S**  
AUDIO ELECTRONICS

404 EDGWARE ROAD  
LONDON W2 1ED

Instruments/PA/Audio 071-724 3564  
Security/Communications/CCTV 071-724 0323  
Components 071-723 1008  
Trade/Education/Export 071-258 1831  
Account facilities available Fax: 071-724 0322

OPEN 6 DAYS A WEEK FOR CALLERS AND TELEPHONE ORDERS



ALL CATALOGUES CONTAIN PURCHASE VOUCHERS WORTH

**£90**

FOR RETAIL MAIL ORDER ONLY



NATIONAL COLLEGE OF TECHNOLOGY

## PACKAGED SHORT COURSES

The National College of Technology (NCT Ltd) offers a range of packaged short courses in analogue electronics, digital electronics, fibres & optoelectronics and programmable logic controllers for study at home or at work. The advantages are that you may,

- commence at any time
- work at your own pace
- have a tutor (optional)

and there is no travelling involved. BTEC certificates are available subject to the conditions of the award. These highly popular packed courses contain workbooks, a cassette tape, circuit board and components necessary to provide both theoretical and practical training.

Whether you are a newcomer to electronics or have some experience and simply need updating, there is probably a packaged short course ready for you. Write or telephone for details, quoting Everyday Electronics, to:

**NCT Ltd, P.O. Box 11**  
**High Street, Wendover**  
**Buckinghamshire HP22 6XA**  
or telephone (0296) 613067 Ext. 202.

## LITESOLD FUME CAPTOR AT ONLY £54.65 - IT'S LIKE A BREATH OF FRESH AIR!



**PRICE £54.65**  
including 3 spare filters, p&p and VAT.  
Spare filters available separately.

A compact free standing filter unit that gets rid of the nasties. The 120mm axial fan and an activated-carbon filter helps remove almost 100% of fumes, smoke, dust and filters out the noxious constituents within an area of 300mm of the work in hand.

Used in industry to remove soldering fumes, under current safety regulations, also effective with paints, solvents, adhesives and similar fume-producing substances.

Quite simply: it gives you filtered air to breathe, at a price that won't take your breath away!

Technical Specification - Overall size: 220 x 155 x 85mm.  
Airflow: 2.64 cu. ft/min. Noise Level: 46 DBA at 1m. 220/240V Electrical Supply.

**LITESOLD**



Ring for Access/Visa sales

Light Soldering Developments, 97-99 Gloucester Road, Croydon CR0 2DN. Tel: 081 689 0574. Fax: 081 689 0090



# EVERYDAY ELECTRONICS

INCORPORATING ELECTRONICS MONTHLY

ABC

JANUARY 1990 TO  
DECEMBER 1990

Pages	Issue	Pages	Issue
1-76	January	425-496	July
77-148	February	497-560	August
149-220	March	561-624	September
221-292	April	625-696	October
293-360	May	697-760	November
361-424	June	761-840	December

The No 1 Magazine for Electronic & Computer Projects

## VOLUME 19 INDEX

### CONSTRUCTIONAL PROJECTS

AIR IONISER, PROPHET IN-CAR	88	GRAND NATIONAL GAME <i>by Ivan Patrick Gore</i>	436
ALARM BELL TIMEOUT <i>by G. Jackson</i>	574	HALLOWEN GHOST WAKER	642
ALARM, FALSE	126	HUMIDITY SENSOR	202
ALARM, POSSESSION LOOP	18	IN-CAR IONISER, PROPHET	88
ALARM, PRESSURE PAD	534	INFRA-RED CONTROLLER	708
ALERT, FRIDGE	670	IN-LINE DIMMER <i>by T. R. de Vaux-Balbirnie</i>	744
ALERT, FROST	257	IONISER, PROPHET IN-CAR	88
ALERT, TELEPHONE	378	LAMP/VACUUM CLEANER CHARGER, 12V	814
AMATEUR BAND RADIO	391	LIGHT CHASER, FOUR-CHANNEL	12
AMPLIFIER, MINI BRIDGE	404	LIGHT CONTROLLER, 8-CHANNEL	772
AMSTRAD CPC SPEECH SYNTHESISER <i>by Robert Penfold</i>	304	LIGHT DIMMER, IN-LINE	744
ANEMOMETER	107	LIGHT LEVEL INDICATOR	444
AUTO MEMO <i>by Owen Bishop</i>	342	LIGHT MONITOR, CYCLE REAR	716
AZIMUTH ADJUSTMENT AID <i>by T. R. de Vaux-Balbirnie</i>	322	LIGHT SEQUENCER	772
BAROMETER, ELECTRONIC	310	LIGHTS, COLOUR CHANGING CHRISTMAS	802
BIOFEEDBACK SIGNAL GENERATOR <i>by Andy Flind</i>	58	LINEAR SCALE OHMMETER <i>by T. R. de Vaux-Balbirnie</i>	192
BUGGY, LINE TRACKER	659	LINE TRACKER, MOBILE	659
CAMPING GAS RESERVE INDICATOR	508	LOOP ALARM, POSSESSION	18
CANDLE, CHRISTMAS	44	MANS APPLIANCE REMOTE CONTROL SYSTEM <i>by Chris Walker</i>	372, 457, 526, 545, 596
CAPACITOR TESTER, QUICK	94	MEMO, AUTO	342
CAR AIR IONISER, PROPHET	88	METAL MATE <i>by T. R. de Vaux-Balbirnie</i>	570
CAR ENGINE EFFICIENCY METER	232	METER, ENGINE EFFICIENCY	232
CAR HEATER THERMOSTAT <i>by T. R. de Vaux-Balbirnie</i>	680	METER, ENLARGER TIMER/EXPOSURE	262
CAR TOWING SOCKET TESTER	466	METER, FREQUENCY	636
CHRISTMAS CANDLE <i>by Chris Walker</i>	44	METRONOME, SIMPLE	512
COLOUR CHANGING CHRISTMAS LIGHTS <i>by Mark Daniels</i>	802	MIDI HI FI CONTROLLER, INFRA-RED	708
COUNTER, HANDHELD OBJECT	606	MINI BRIDGE AMPLIFIER <i>by Robert Penfold</i>	404
CRYSTAL SET RADIO <i>by Robert Penfold</i> (Amateur Radio Supp) May '90		MOBILE LINE TRACKER <i>by Chris Walker</i>	659
CYCLE REAR LIGHT MONITOR <i>by T. R. de Vaux-Balbirnie</i>	716	MUSICAL CANDLE	44
DARKROOM WHISTLE BOX TIMER	734	M.W./L.W. SUPERHET BROADCAST RECEIVER	160
DICE, ELECTRONIC	186	NOISE GENERATOR, STEREO	248
DIGITAL EXPERIMENTER'S UNIT <i>by Robert Penfold</i>	236	OHMMETER, LINEAR SCALE	192
DIMMER, IN-LINE	744	PHONEY PHONE <i>by Owen N. Bishop</i>	546
DIPSTICK, ELECTRONIC	780	PIPE AND WIRE DETECTOR	570
DISTORTION UNIT, VALVE	582	POCKET MONEY PROJECTS	18, 40, 132, 186, 257, 780
EE MUSKETEER <i>by Chris Walker</i>	708	ELECTRONIC DICE	186
EE WEATHER STATION <i>by Mike Feather</i>	107, 202, 274	ELECTRONIC DIPSTICK	780
ELECTRONIC BAROMETER <i>by Owen Bishop</i>	310	FROST ALERT	257
ELECTRONIC DICE <i>by Chris Bowes</i>	186	GAME TIMER	40
ELECTRONIC DIPSTICK	780	POSSESSION LOOP ALARM	18
ELECTRONIC HAND TALLY <i>by Chris Bowes</i>	606	TUNE GENERATOR	132
ENGINE EFFICIENCY METER <i>by Steve Garrison</i>	232	POSSESSION LOOP ALARM <i>by Chris Bowes</i>	18
ENLARGER TIMER/EXPOSURE METER <i>by Chris Brown</i>	262	POWER SUPPLY	236
EXPOSURE METER	262	POWER SUPPLY, VERSATILE BENCH	808
FALSE ALARM <i>by T. R. de Vaux-Balbirnie</i>	126	PRESSURE PAD ALARM <i>by T. R. de Vaux-Balbirnie</i>	534
FERMOSTAT Mk2 <i>by Andy Flind</i>	166	PROGRAMMABLE LIGHT SEQUENCER	772
FOUR-CHANNEL LIGHT CHASER <i>by Mark Stuart</i>	12	PROPHET IN-CAR IONISER <i>by Andrew Armstrong</i>	88
FREQUENCY METER/TACHOMETER <i>by Steve Knight</i>	636, 728	PULSE GENERATOR	236
FRIDGE ALERT <i>by T. R. de Vaux-Balbirnie</i>	670	QUICK CAP TESTER <i>by Mark Raven</i>	94
FROST ALERT <i>by Chris Bowes</i>	257	QUIZMASTER <i>by Adrian Galea</i>	328
GAME, GRAND NATIONAL	436	RADIO, CRYSTAL SET	(May '90) Supplement-2
GAME TIMER <i>by Chris Bowes</i>	40	RADIO, M.W./L.W. SUPERHET	160
GAS RESERVE INDICATOR <i>by T. R. de Vaux-Balbirnie</i>	508	RADIO, S.W.	(May '90) Supplement-7
GENERATOR, STEREO NOISE	248	RADIO, 80 METRE DIRECT CONVERSION	391
GENERATOR, TUNE	132	RAINFALL GAUGE	274
GHOST WAKER <i>by Max Horsey</i>	642	REGULATOR, MICROPOWER STABILISED VOLTAGE	398
		REMOTE CONTROL EMULATOR	708

REMOTE CONTROL SYSTEM, MAINS APPLICANCE	372, 457, 526, 545, 596	TUNE GENERATOR <i>by Chris Bowes</i>	132
SEQUENCER, MICROPROCESSOR CONTROLLED LIGHT	772	TV CONTROLLER, HANDHELD INFRA-RED	708
SIGNAL GENERATOR, BIOFEEDBACK	58	VACUUM CLEANER CHARGER, 12V LAMP/	814
SIMPLE METRONOME <i>by Andy Flind</i>	512	VALVE DISTORTION UNIT <i>by Jonathan P. Oliver</i>	582, 665
SOUND WARBLER	546	VERSATILE BENCH POWER SUPPLY <i>by Mike Tooley</i>	808
STABILISED VOLTAGE REGULATOR	398	VIDEO CHECK <i>by T. R. de Vaux-Balbirnie</i>	444
STEREO NOISE GENERATOR <i>by Andy Flind</i>	512	VIDEO CONTROLLER, INFRA-RED	708
SUNLIGHT RECORDER	274	VOLTAGE REGULATOR	398
SUPERHET BROADCAST RECEIVER <i>by Mark Stuart</i>	160	WAKER, GHOST	642
S. W. RADIO <i>by Robert Penfold</i>	Supplement-7 (May '90)	WEATHER STATION, EE	107, 202, 274
TACHOMETER/FREQUENCY METER	636, 728	WEIGH MACHINE, GAS CYLINDER	508
TAPE RECORDER AZIMUTH ADJUSTMENT AID	322	WHISTLE BOX TIMER <i>by G. M. Worthington</i>	734
TELEPHONE ALERT <i>by T. R. de Vaux-Balbirnie</i>	378	WIND DIRECTION INDICATOR	107
TEMPERATURE SENSOR	202	WIND SPEED INDICATOR	107
TESTER, QUICK CAPACITOR	94	WINE BREWING THERMOSTAT	166
THERMOMETER, WINE BREWING	166	WIRE AND PIPE DETECTOR	570
THERMOSTAT, CAR HEATER	680	5° FRIDGE ALERT	670
THE TESTER <i>by George Hylton</i>	480	8-CHANNEL LIGHT CONTROLLER <i>by Mark Stuart</i>	772
TIMER, GAME	40	10Hz-100kHz FREQUENCY METER	636, 728
TIMER, WHISTLE BOX	734	12V LAMP/VACUUM CLEANER CHARGER	
TOW-TEST <i>by Peter Rawnsley</i>	466	<i>by T. R. de Vaux-Balbirnie</i>	814
T.R.F. RECEIVER <i>by Robert Penfold</i>	(Amateur Radio Supp) May '90	80 METRE DIRECT CONVERSION RECEIVER	
		<i>by Robert Penfold</i>	391
		1000W PER-CHANNEL LIGHT SEQUENCER	772

## SPECIAL SERIES

ACTUALLY DOING IT		1-Nimbus and its BBC-type Parallel Card	578
<i>by Robert Penfold</i>	55, 140, 198, 254, 346, 532, 666, 732	2-Analogue to Digital Converter	674
AMATEUR RADIO <i>by Tony Smith G4FAI</i>	24, 142, 184, 252, 348, 390, 479, 542, 614, 668, 747, 785	MICRO IN CONTROL <i>by John Hughes</i>	
BBC MICRO <i>by R. A. Penfold</i>	51, 98, 200, 266, 350, 382, 484, 524, 604, 664, 720	34, 120, 172, 242, 316, 400, 470, 538, 586, 652, 723	
CHOOSING AND USING TEST EQUIPMENT		2-The Transistor and Light Dependent Resistor	34
<i>by Robert Penfold</i>	384, 448, 518	3-Relays and Logic	120
1-Multimeter	384	4-Combinational Logic	172
2-Oscilloscope Specifications Explained	448	5-Sequential Logic and Pulse Circuits	242
3-Power Supplies, Logic Probes, Frequency Meters and Millivoltmeter	518	6-Counting Circuits and Control Logic	316
DESIGN YOUR OWN CIRCUITS (TEACH-IN '91)		7-Designing a Model Lift	400
<i>by Mike Tooley</i>		8-Lift Logic and Meet The Microprocessor	470
1-Introduction	786	9-6502 Microprocessor	538
INTERFACE <i>by Robert Penfold</i>	822	10-More on the 6502	586
INTERFACING THE RML NIMBUS		11-Software Development	652
<i>by Andrew Channerley</i>	578, 674	12-Software and Look-up Tables	723
		ON SPEC <i>by Mike Tooley</i>	
		62, 114, 208, 282, 334, 408, 476, 516, 610, 647	
		ROBOT ROUND UP <i>by Nigel Clark</i>	
		32, 100, 196, 260, 326, 414, 465, 551, 595, 684, 748, 807	

## GENERAL FEATURES

DIODE DATA <i>by Mike Tooley</i>	268	GETTING YOUR PROJECTS WORKING	
DOWN TO EARTH <i>by George Hylton</i>	210, 256, 340, 412, 486, 544, 750, 819	<i>by Robert Penfold</i>	178
ELECTRONICS AND CAD <i>by Robert Penfold</i>	738	MATSUSHITA ELECTRIC <i>by Barry Fox</i>	26
EDITORIAL	11, 87, 159, 231, 303, 371, 435, 507, 569, 635, 707, 771	NEWS	63, 116
FIBRES AND OPTOELECTRONICS <i>by Mike Tooley</i>	686	PLEASE TAKE NOTE	56, 545, 665
FIRST STEPS IN PROJECT BUILDING		Mains Appliance Remote Control System	545
<i>by Robert Penfold</i>	102	Two Tone Siren	56
FOR YOUR ENTERTAINMENT <i>by Barry Fox</i>	22, 130, 170, 246, 320, 410, 443, 522, 576, 650, 736, 800	Valve Distortion Unit	665
		POWER SUPPLIES FOR PROJECTS <i>by Vivian Capel</i>	336
		SHOPTALK <i>by David Barrington</i>	
		64, 131, 209, 251, 319, 409, 468, 545, 612, 665, 746, 823	

## SPECIAL OFFERS AND SERVICES

AMATEUR RADIO SUPPLEMENT (12 pages)	between 326/327	COMPONENTS CATALOGUE	
Crystal Set <i>by Robert Penfold</i>	Supp 2	(132-page Marco '91)	banded with OCT '90
DIY Aerials <i>by George Hylton</i>	Supp 4	COMPONENTS CATALOGUE	
Shortwave Reception <i>by Robert Penfold</i>	Supp 1	(40-page Magenta '90/'91)	between 800/801
T. R. F. Receiver <i>by Robert Penfold</i>	Supp 7	EE REFERENCE LIBRARY (Books)	722/801
BOOK SERVICE	66, 136, 212, 284, 352, 416, 488, 552, 616, 688, 752, 824	MARKET PLACE	21, 118, 169, 333, 453, 475, 550
COMPONENTS CATALOGUE		MULTIMETER, AUTORANGING DIGITAL	
(32-page Greenweld Spring Catalogue)	between 256/257	(Greenweld Special Offer)	119
COMPONENTS CATALOGUE		OSCILLOSCOPE (Crotech Special Offer)	57
(132-page Greenweld '91)	banded with Nov '90	PASSIVE INFRA-RED INTRUDER DETECTOR	
COMPONENTS CATALOGUE		(Riscomp Special Offer)	469, 523
(32-page Marco Spring '90)	between 184/185	PRINTED CIRCUIT BOARD SERVICE	
		70, 144, 216, 288, 356, 420, 492, 556, 620, 692, 756, 829	

# HIGHGRADE Christmas COMPETITION

We've gone completely loopy this year: we're giving away up to £1000! Yes, the winner of our Christmas Competition will receive a voucher for *ten times* the value of the order that accompanies the entry, up to a maximum of £1000! The voucher can be exchanged for any components offered by Highgrade in 1991 — you choose what to buy with it. If that's not enough for you, every single competition entry entitles you to a gift, whether you get the answers right or not! Are you ready? Here we go.

In the Highgrade lab we've been experimenting with a special recognition circuit. To test it out, the system is connected to a printer: we speak into the microphone and it prints what it thinks we said. Sad to say, there are still a few bugs in the system. For instance, when I said into the microphone 'Can you recognise speech?' the printer came back with—Can you wreck a nice beach?! Here are some of the mistakes it made when read it a list of television programs. What should it have printed?

- |                        |                  |       |
|------------------------|------------------|-------|
| 1) Colliders Cope      | should have been | _____ |
| 2) Casual Tea          | should have been | _____ |
| 3) Cora Nation's Treat | should have been | _____ |
| 4) Stale Ucky          | should have been | _____ |
| 5) Start Wreck         | should have been | _____ |
| 6) Woe Gun             | should have been | _____ |

Right now we're working on a nudie vice for hoe moaners — sorry, I must remember to turn off the speech circuit. A new device for home

**Win up to  
£1,000 worth  
of components!**



**EVERY ENTRY  
WINS A PRIZE!**

owners is what I meant to say, of course. Anyway, now you've filled in your answers you can choose any one of the gifts below!

- 1) Special blade for cutting grooves and notches
- 2) Mini biofeedback monitor kit
- 3) Secret circuits file—things the authorities would rather you didn't know!

The competition winner will be chosen by draw from all completely correct entries received by the closing date: December 20th 1990. I'd like to say that some famous celebrity will make the draw, but in reality fair play will be supervised by our not very famous solicitor. The winner will be notified early in January 1991. If you have any queries about the competition, please tel: 0600 3715.

## SUPER Christmas COMPONENT BARGAINS

- |   |  |
|---|--|
| BF167 Transistors: pack of 100 for £2.80! <input type="checkbox"/>  | Thermal fuses: open at 70°C: a pack of 5 is yours for £1.00! <input type="checkbox"/>                      |
| 0.68µF Polyester capacitors: bag of 200 for £3.80! <input type="checkbox"/>                               | Scarab switching regulator: 5V @ 6A: a £60 regulator for £2.20! <input type="checkbox"/>                   |
| DIL switches, 4-pole, pack of 10 for £1.40! <input type="checkbox"/>                                      | 7-way Molex plugs, pack of 100 for £2.60! <input type="checkbox"/>   |
| Horizontal cermet trimmers, 250K, pack of 25 for £1.60! <input type="checkbox"/>                          | Multi-contact lever switch: 2 sets of 4pc/o contacts: loopy price of 2 for £1.00! <input type="checkbox"/> |
| 10-way Molex straight plug, pack of 100 for £2.80! <input type="checkbox"/>                               | Ceramic caps, 120pF, pack of 100 for only £1.20! <input type="checkbox"/>                                  |
| J201 FETs: pack of 100 for £3.80! <input type="checkbox"/>  | Motorola NPN transistors: pack of 100 for...wait for it...£1.80! <input type="checkbox"/>                  |
| DIN speaker sockets: bargain pack of 10 for 80p! <input type="checkbox"/>                                 | Vertical cermet trimmers, 250k, pack of 25 for £1.60! <input type="checkbox"/>                             |
| 3A Rectifiers: you'll never see an offer like this again: 25 for £1.80! <input type="checkbox"/>          | SAB0600 three tone chime IC, with data and circuits, yours for £1.00! <input type="checkbox"/>             |
| Green rectangular LEDs: not perfect, but all working: goofy offer 200 for £2.80! <input type="checkbox"/> | 6A 200V Rectifiers: what a bargain! 25 for £2.80! <input type="checkbox"/>                                 |
| 4n7 Polyester capacitors: wicked! 200 pack for £2.60! <input type="checkbox"/>                            | 78L08 Voltage regulators, 8V @ 100mA: 10 for £1.60! <input type="checkbox"/>                               |
| 8F394 transistors: extra special Christmas offer: 100 for £2.60! <input type="checkbox"/>                 | ST72A FETs: another splendid bargain: pack of 100 for £3.80! <input type="checkbox"/>                      |
| Push switches: you won't believe this: 100 for £3.80 (less than 4p ea!) <input type="checkbox"/>          | Miniature carbon trimmers, 47k, with finger adjust: pack of 100 for £2.60! <input type="checkbox"/>        |
| Canned coils: mean looking components: 25 for £2.20! <input type="checkbox"/>                             | SIL resistor networks: 8 commoned 3k3 Rs per IC: pack of 25 for only £1.60! <input type="checkbox"/>       |
| 22n (0.022µF) Polyester capacitors: bag of 200 for just £3.20! <input type="checkbox"/>                   | Ceramic resonator (use as crystal), 4MHz, pack of 3 for £1.00! <input type="checkbox"/>                    |
| DIL resistor networks: 15 commoned 10K resistors each IC: 25 for £1.60! <input type="checkbox"/>          | BT137 mains (600V) triac, will switch up to 8A. Yummy offer: 3 for £1.20! <input type="checkbox"/>         |
| Full feature clock module: extra special offers: £2.80! <input type="checkbox"/>                          | Extra special offer: 6 quad comparator ICs, with data, £1.20! <input type="checkbox"/>                     |
| TEA5570 AM and FM radio IC, with data and circuits: £2.20! <input type="checkbox"/>                       | Miniature STC 12V relays, 2pc/o, pack of 2 for £1! <input type="checkbox"/>                                |
| 47n (0.047µF) Polyester caps: another monster bargain: 200 for £3.20! <input type="checkbox"/>            | Ceramics, 5p6 sub-miniature, pack of 100 for £1.40! <input type="checkbox"/>                               |
| 3-way Molex plugs, pack of 100 for £2.20! <input type="checkbox"/>  | 1µF Polyester caps: bag of 100 for £3.20! <input type="checkbox"/>   |
| Ceramic filter 455kHz (use with radio IC) 2 for £1.00! <input type="checkbox"/>                           | CMCO25 Power transistors: pack of 10 for £1.20! <input type="checkbox"/>                                   |
| Ceramic filter 10.7MHz (use with radio IC) 2 for £1.00! <input type="checkbox"/>                          | BF173 transistors: treat yourself to a pack of 100 for £2.80! <input type="checkbox"/>                     |
| 8C307 Transistors: pack of 100 for £3.20! <input type="checkbox"/>  | Seven segment LED displays: 0.5" 1 1/2 digit CC: pack of 10 for £2.80! <input type="checkbox"/>            |
| Horizontal cermet trimmers, 100R, pack of 25 for £1.60! <input type="checkbox"/>                          | Multi-turn cermets: 1/4" 20-turn 2k2: pack of 25 for £2.80! <input type="checkbox"/>                       |
| Believe this: 39p 2.5% tolerance top grade polystyrene caps: 100 for £1.20! <input type="checkbox"/>      | Cable clips: tidy up those wires! Pack of 200 for 80p! <input type="checkbox"/>                            |
| Trimmer capacitors: delightful components: silly price of 25 for £1.80! <input type="checkbox"/>          | Hi-Fi signal switches: 2pc/o contacts: pack of 10 for £1.80! <input type="checkbox"/>                      |
| D-sockets: 25-way R/A: pack of 5 for £1.80! <input type="checkbox"/>                                      | Push-switch buttons: black with silver trim: 50 for £1.00! <input type="checkbox"/>                        |
| D-plugs: 25-way R/A: pack of 5 for £1.80! <input type="checkbox"/>  | LM342 voltage regulators: 18V @ 250mA: 10 for £1.80! <input type="checkbox"/>                              |
| Intelligent 2-digit numeric display, with data: suicidal offer: £1.80! <input type="checkbox"/>           | 47n Disc ceramic caps, for decoupling: pack of 50 for £1.00! <input type="checkbox"/>                      |
| 68n (0.068µF) Film capacitors: the baddest caps around: 100 for £1.60! <input type="checkbox"/>           | Microprocessor IC, 8085, yours at the ridiculous price of £1.20! <input type="checkbox"/>                  |
| 8CY56 Transistors: you'll love these: pack of 100 for £2.40! <input type="checkbox"/>                     | Circuit and programming data for 8085: £2.00! <input type="checkbox"/>                                     |
| Presets: miniature carbon, enclosed, 22k, a super bargain: 100 for £2.80! <input type="checkbox"/>        | Amp connectors, 4-way, pack of 100 for £1.20! <input type="checkbox"/>                                     |
| COP321 Microcomputer ICs: how do they do it?: 2 for 80p! <input type="checkbox"/>                         |  |
| COP321 circuit and programming data £2.20! <input type="checkbox"/>                                       |  |
| 8F410 FETs: super FETs at an amazing price: 100 for £3.60! <input type="checkbox"/>                       |  |
| Standard red LEDs: light up your Christmas tree! New and perfect. 100 for £2.80! <input type="checkbox"/> |  |



Please tick the boxes for any components you would like, and send the entire page (with your competition entry!) to: Highgrade Components Ltd., 8 Woburn Road, Eastville, Bristol, BS5 6TT.

Name

Address

I enclose cheque/postal order for  £

Please charge my Access/Visa card no.

Expiry date

Components total £

Postage (£2.80 UK) £

Sub total £

VAT (UK only)\* £

TOTAL £

Signed

# EVERYDAY ELECTRONICS

CLASSIFIED

Reach effectively and economically today's enthusiasts anxious to know of your products and services through our semi-display and classified pages. The prepaid rate for semi-display spaces is £8.00 (plus VAT) per single column centimetre (minimum 2.5 cm). The prepaid rate for classified advertisements is 30 pence (plus VAT) per word (minimum 12 words).

All cheques, postal orders, etc., to be made payable to Everyday Electronics. VAT must be added. Advertisements, together with remittance, should be sent to the Classified Advertisement Dept., Everyday Electronics, 6 Church Street, Wimborne, Dorset BH21 1JH. Tel: (0202) 881749.

**RCS VARIABLE VOLTAGE D.C. BENCH POWER SUPPLY**  
1 to 24 volts up to 1/2 amp. 1 to 20 volts up to 1 amp. 1 to 16 volts up to 1 1/2 amps d.c. Fully stabilised. Twin panel meters for instant voltage and current readings. Overload protection.  
Fully variable.  
Operates from 240V a.c.  
Compact Unit  
Size 9 x 5 1/2 x 3 in.  
**NEW MODEL:** Up to 38volts d.c. at 6 amps. 10 amps peak. Fully variable. Twin panel meters. Size 14 1/2 x 11 x 4 1/2 in. £69 inc VAT. Carr £6.



**£42 inc. VAT**  
+ Post £2

**RADIO COMPONENT SPECIALISTS**  
337 WHITEHORSE ROAD, CROYDON  
SURREY, U.K. Tel: 081-684 1665

List, Large SAE. Delivery 7 days. Callers welcome. Closed Wednesday

**SERVICE MANUALS**

Available for most Video Recorders, Colour & Mono Televisions, Cameras, Test Equipment, Amateur Radio, Vintage Valve Wireless, Any Audio, Music Systems, Computers, Kitchen Appliances, etc.

Equipment from the 1930's to the present and beyond.

Over 100,000 models stocked, originals & photostats.

FREE Catalogue Repair & Data Guides with all orders.

**MAURITRON TECHNICAL SERVICES (EE)**  
8 Cherry Tree Road, Chinnor, Oxfordshire OX9 4QY.  
Tel: (0844) 51694. Fax: (0844) 52554

**TECHNICAL INFO SERVICES (EE)**  
76 Church St., Larkhall, Lanarkshire ML9 1HE  
Phone 0636 884525 Mon-Fri 9.5.  
any other time 0636 883334. FOR FAST QUOTES

WORLD'S LARGEST COLLECTION SERVICE MANUALS. Most unobtainable elsewhere. Prices range from only £4.50 - large size any quotation, no obligation to buy.

WORLD'S SOLE Suppliers of TV & Video Repair manuals, etc. from TV TECHNIC, also such publishers as Henemann, Newsday, TV Technic, Thorn etc. Every published service sheet in stock, supplied full size, not bits & pieces. CTV's or any combination £3.50 plus LSAE, any other single item £2.50 plus LSAE. Complete Circuit Sets for most Videorecorders only £7 set (no serv. this made).

LSAE for QUOTATIONS plus GIANT CATALOGUE NEWSLETTERS BARGAINS FREE SAE as available.

Comprehensive TV Repair Manual £9.50. Complete Radio Service and Repair Course £9.50. Complete Repair & Service Manuals: Mono TV £12.50. CTV £17.00. Video £19.50. Complete Repair Data with circuit: Mono TV £9.50. CTV £23.50. Video £10.50.

£3.00 plus LSAE BRINGS THE ONLY COMPREHENSIVE SERVICE SHEETS & MANUALS, CATALOGUES plus FREE CHASSIS GUIDE and £4.00 OF VOUCHERS

**N. R. BARDWELL LTD**

10 - 40 3w MBB Rotary Switches.....	£1.00
200 - Signal Diodes 1N4148.....	£1.00
100 - Rectifier Diodes 1N4001.....	£1.00
100 - Zener Diodes 6V8 400mW.....	£1.00
30 - Assorted diode sockets up to 40 pin.....	£1.00
Header etc.....	£1.00
30 - Transistors BC478.....	£1.00
25 - Assorted High Brightness Leds.....	£1.00
20 - Miniature SP/CO Slide Switches.....	£1.00
20 - Magnetic ear pins plus lead and plug.....	£1.00
75 - Electrolytics 4.7uF 63V.....	£1.00
1 - Pellet effect Heat Pump.....	£1.95
1 - 10 watt Stereo Amplifier, 4 Controls plus data.....	£2.95

Prices include VAT, postage 85p. All items new. Many more lines in stock. Lists free. Shop open Mon-Sat 9.30-5.30  
288 Abbeydale Road, Sheffield S7 1FL.  
Tel (0742) 552886. Fax (0742) 500689

FM Transmitter Kits also a Telephone Bug Detector Kit  
Ready built FM transmitter £6.50 including P&P  
These are commercial kits.  
We also stock a selection of Scanning receivers so Telephone for latest stock or ask for a free catalogue

**HOTLINE ELECTRONICS**  
97 LEIGH RD, ATHERTON, GT MANCHESTER  
Tel: (0942) 891140  
Mail Order Only

**ELECTRONIC COMPONENTS**  
EVERYTHING FOR YOUR NEXT PROJECT

THE BIGGEST DISPLAY IN THE SOUTH IS AT

**FRASER ELECTRONICS**  
42 ELM GROVE \* SOUTHSEA \* HANTS  
Telephone 0705-815584

**Manufacturers Original Spares**

Available for many makes of TV, Video & Audio Equipment. Also Sinclair, Amstrad, Commodore & Atari Computers. Write (encl. S.A.E. please) or phone for a Price & Availability on your requirements.

SINCLAIR & AMSTRAD		COMMODORE & ATARI	
MAB8049 (QL)	£6.96	6510 CPU	£9.87
TEA2000	£4.04	6522 VIA	£4.56
TMS4523-3 or -4	£3.44	6526 CIA	£10.96
ULA2G007	£16.37	6561 VIC	£10.74
ULA6C001E	£15.99	8501 CPU	£10.61
ULA7C001 (+2)	£16.99	8565VIC	£23.48
ZTX313 OR 650	£0.42	8580 R5	£13.98
UM1233 Modulator	£4.75	8701 Clk Gen	£7.56
28wy Edge Conn	£3.49	906 114 PL A	£5.73
Spec 48K Membrane	£4.50	901225 ROM	£6.37
+ & 128K Membrane	£7.90	901226 ROM	£9.21
CPC464 Serv Man	£8.49	C16 User Guide	£5.37
CPC664 Serv Man	£13.49	SN75188 or -89	£0.88
PEGA1A (84pin)	£42.72	PC900 (ST)	£3.07

For Catalogue/Lists please send 44p stamps/cheque/2xIRC's etc. MAIL ORDER ONLY. Please add 95p (UK) P&P to above orders

Tel 0452 26883  
MARAPET (EEM) 1 Hornbeam Mews, Gloucester GL2 0UE

**NEW VHF MICROTRANSMITTER KIT**  
Tunable 80-135MHz. 500 metre range, sensitive electret microphone, high quality PCB.  
SPECIAL OFFER complete kit ONLY £5.95  
Assembled and ready to use £9.95 post free.  
Access/Visa orders telephone 021 411 1821  
S.A.E. for details of this and other kits. Cheques/P.O.s payable to:

**QUANTEK ELECTRONICS LTD**  
Kits Dept. (EE), 45a Station Road Northfield, Birmingham B31 3TE

**DOES YOUR ELECTRONIC EQUIPMENT LOOK NON-PROFESSIONAL? DO YOU LACK A QUALITY FINISH?**

Achieve that professional look by using printed front panels, sub-frames, outer cases, etc. from a company that has its own metalwork division and offers a wide range of metal work at affordable prices

**Telephone 0268 793381**  
or  
**Fax 0268 565759**

**PARTRIDGE ELECTRONICS**  
A. C. PARTRIDGE LTD  
UNIT D, 318 HIGH ROAD BENFLEET, ESSEX SS7 5HB

**Kits**

**G.C.S.E. ELECTRONIC KITS.** Ten different. £10.50 (+ 70p p&p) or SAE for details. SirKit Electronics, 70 Oxford Rd, Clacton CO15 3TE.

**T.M. ELECTRONIC kits** transmitters, receivers plus many more. Sae plus 50p (A4) New 1990 Catalogue. Under New Management, 39 Mayeswood Road, Grove Park, London E12 9RR.

**Miscellaneous**

**HUNDREDS** of unusual items cheap! Send 90p (coins/stamps) for interesting samples and list. Grimsby Electronics, Lambert Road, Grimsby.

**TRANSMITTER** circuit diagrams, VHF, UHF, crystal. Twenty for £5.25. K. Parti, 10 Chivers Road, London E4 9TD.

**FREE** tape demo plus Christmas catalogue plus 40 astd. components. Mail add. plus £1.50 p&p to 8 Cunliffe Road, Ilkley.

**£12.00!!** Racks. 60 Watt!! Completely mains operated plus i.e.d. control and sockets!! K.I.A., 8 Cunliffe Road, Ilkley.

**TRANSMITTER** circuit diagrams, F.M., C.B., medium, shortwave, uncomplicated instructions. All eighteen circuits £4.25. Cherques to D. Davies, 33 Gwaelodygarth, Methyry Tydfil CF47 8YU

High quality **EXTENDER CARDS** are available as circuit board only, in kit form or fully assembled from **ORETECH SYSTEMS**.

	Board only	Kit form	Fully Assembled
EUROCARD 64W Rows a,b	£10	£16	£20
EUROCARD 64W Rows a,c	£10	£17	£21
PC XT 31 Way	£9	£13	£20
PC AT 18/31 Way	£9	£14	£21

Add 50p postage + 15% VAT to above prices

CONTACT  
**ORETECH SYSTEMS**  
0493 442350

**CATALOGUE £1.00 + 25p P&P**

Resistor pack. 85 different E12 values + zero ohm link total content 1,000 resistors..... £8.95

LEDs 3mm or 5mm red or green..... 6p each. Yellow 11p each

Cables..... 1p each. £5.95 per 1,000. £49.50 per 10,000

Stepping motor 4 phase 12V 7.5 step 50 ohms..... £8.95

SAA1027 stepping motor driver chip..... £3.95

FM Transmitter kit, good quality sound..... £8.60

High quality photo resist copper clay epoxy glass boards

Dimensions	single sided	double sided
3 x 4 inches	£0.95	£1.07
4 x 8 inches	£2.40	£2.68
6 x 12 inches	£5.37	---
12 x 12 inches	£10.66	---

**Special offers:** Computer grade capacitors with screw terminals 3800uf 20V £2.50, 8700uf 10V £1.95, 6800uf 15V £2.95, 1000uf 16V £1.50. 7 segment common anode led display 12mm £0.45. LM2931AT5 0 low drop out 5V regulator TO220 package £0.95. BS250 P channel mosfet £0.45. BC559 transistor £3.95 per 100. 74LS05 hex inverter £10.00 per 100, used 8748 Microcontroller £3.50. Stereo LM/MW/FM Tuner/preamp assy with volume/tone controls and tuning scale. Brand new in makers carton £6.95. faulty £3.50. circuit etc for above £0.50. Hour counter used 7 digit 240V AC 50Hz £1.45. LCD Display 16 digit 7x5 dots dot matrix £2.50. QWERTY keyboard 58 key, good quality switches, new £5.00. QWERTY keyboard with serial output, no data £5.00. Wide range of CMOS, TTL, 74HC, 74F Linear Transistors kits, capacitors, tools, etc. always in stock. Please add 95p towards P&P. VAT included.

**DEPT EE, JPG ELECTRONICS**  
276-278 Chatsworth Road, Chesterfield S40 2BH  
Access/Visa Orders (0246) 211202. Callers welcome.

USE THIS SPACE

**SELL YOUR PRODUCTS**

IT ONLY COSTS **£28** + VAT  
(see above for details)

## MAKE YOUR INTERESTS PAY!

Over the past 100 years more than 9 million students throughout the world have found it worth their while! An ICS home-study course can help you get a better job, make more money and have more fun out of life! ICS has over 90 years experience in home-study courses and is the largest correspondence school in the world. You learn at your own pace, when and where you want under the guidance of expert 'personal' tutors. Find out how we can help YOU. Post or phone today for your **FREE INFORMATION PACK** on the course of your choice. (Tick one box only!)

Electronics	<input type="checkbox"/>	TV, Video & Hi-Fi Servicing	<input type="checkbox"/>
Basic Electronic Engineering (City & Guilds)	<input type="checkbox"/>	Refrigeration & Air Conditioning	<input type="checkbox"/>
Electrical Engineering	<input type="checkbox"/>	Car Mechanics	<input type="checkbox"/>
Electrical Contracting/Installation	<input type="checkbox"/>	Computer Programming	<input type="checkbox"/>
GCSE/GCE/SCSE over 40 examination subjects to choose from			

Name \_\_\_\_\_ Address \_\_\_\_\_

**ICS** International Correspondence Schools Dept. ECS CO 312/314 High Street, Sutton, Surrey SM1 1PR  
Telephone: 081-643 9568 or 041-221 2926 (24 hours)

## SPIERS ELECTRONICS

Service Repairs

Design-Build Free Estimates

We have a large range of electronic components for sale at very competitive prices. Our second-hand corner often has some exceptional bargains, i.e. "Smart Modem" card for PC's, 1200 baud £85. Terminals at £15 each.

We stock spares for the Dragon computer including power supplies at £15, SAM chips at £10.25 and MPU's at £2.50.

S.A.E. for full details..... WATCH THIS SPACE!!!

20 Eaton Way, Great Totham, Maldon, Essex CM9 8EE.

Contact Nic. Spiers

Tel: 0621 892512

## SHERWOOD ELECTRONIC COMPONENTS

45 Rutland Street, Mansfield, Notts NG18 4AP

### SPECIAL PACKS - ALL AT £1 EACH

SP1	12 x 5mm Red Leds	SP31	4 x Cmos 4071
SP2	12 x 5mm Green Leds	SP32	4 x Cmos 4077
SP3	12 x 5mm Yellow Leds	SP33	4 x Cmos 4081
SP4	10 x 5mm Amber Leds	SP34	2 x Cmos 4510
SP5	30 x 5mm 1 part Led clips	SP35	2 x Cmos 4511
SP6	12 x 3mm Red Leds	SP36	20 x 10uF/25V Rad. Elect. Caps.
SP7	12 x 3mm Green Leds	SP37	15 x 100uF/35V Rad. Elect. Caps.
SP8	10 x 3mm Yellow Leds	SP38	20 x 47uF/25V Rad. Elect. Caps.
SP9	36 x 3mm 1 part Led clips	SP39	12 x 470uF/16V Rad. Elect. Caps.
SP10	75 x 1N4148 signal diodes	SP40	15 x BC237 transistors
SP11	25 x 1N4001 rectifier diodes	SP41	20 x mixed transistors
SP12	25 x 1N4002 rectifier diodes	SP42	2 x LM1458
SP13	25 x Radial Elect. caps (1-1000uF)	SP43	12 x 5mm Leds - 4 ea. Red, Grn., Yel.
SP18	15 x BC182 transistors	SP44	15 x 400mW Zener diodes
SP19	15 x BC183 transistors	SP45	5 x min. push button switches
SP20	15 x BC184 transistors	SP47	15 x 8 pin DIL sockets
SP21	15 x BC212 transistors	SP103	12 x 14 pin DIL sockets
SP22	15 x BC214 transistors	SP104	12 x 16 pin DIL sockets
SP23	15 x BC549 transistors	SP105	5 x 74LS00 ICs
SP24	5 x Cmos 4001	SP106	5 x 74LS02 ICs
SP25	5 x 555 timer	SP107	15 x mixed presets - Hor. + Vert.
SP26	5 x 471 Op-amp	SP108	15 x BC382 transistors
SP27	5 x Cmos 4002	SP109	15 x BC557 transistors
SP28	5 x Cmos 4011	SP110	5 x Cmos 4093
SP29	5 x Cmos 4013	SP111	15 x BC556 transistors
SP30	5 x Cmos 4025		

1 pack of your choice FREE when you buy any 10 of the above £1 packs

### ADDITIONAL PACKS

SP50	25 x 5mm Red Leds	£2.00
SP51	25 x 5mm Green Leds	£2.00
SP53	30 x DIL sockets - 8, 14, 16 pin	£2.00
SP55	10 x 741 Op-amps	£1.90
SP57	200 x 1N4148 diodes	£2.50
SP 60	10 x Cmos 4011	£1.80
SP64	4 x 7812 1A V. regulators	£1.20

### RESISTOR PACKS

0.25W C. Film resistors 10R - 10M	
5 each value - total 365	£2.75
10 each value total 730	£4.50
1000 popular values	£6.00
Individual resistors	2p each
10 + one value	1p each
100 one value	75p

### CMOS

4000	22p	4070	27p
4001	22p	4071	27p
4006	60p	4072	27p
4011	22p	4073	27p
4013	35p	4075	27p
4017	52p	4077	30p
4025	22p	4081	27p
4027	48p	4093	27p
4030	45p	4510	65p
4040	70p	4511	65p
4047	65p	4518	65p
4049	42p	4520	65p
4060	80p	4528	70p
4066	42p	4538	95p

### LINEAR

555	22p
555 Cmos	75p
556	75p
747	70p
CA3080	85p
CA3140E	45p
CA3240E	125p
LM317T	80p
LM339	55p
LM380	125p
LM723	60p
LM1458	55p
TL071	60p
TL072	80p

### TRANSISTORS

BC182	13p
BC183	13p
BC184	13p
BC212	13p
BC213	13p
BC214	13p
BC239	15p
BC327	15p
BC337	16p
BC549	15p
BC557	16p
BFY50	47p
TIP31A	45p
TIP32A	46p

Cheques or P.O. to NO VAT  
**SHERWOOD ELECTRONIC COMPONENTS**  
Please add £1 P&P to orders under £20.00

1991 Catalogue now available - price £1.  
Contains £1.50 worth of vouchers redeemable against orders. Many new lines in stock

# SURVEILLANCE PROFESSIONAL QUALITY KITS EQUIPMENT

Whether your requirement for surveillance equipment is amateur, professional or you are just fascinated by this unique area of electronics SUMA DESIGNS has a kit to fit the bill. We have been designing electronic surveillance equipment for over 12 years and you can be sure that all of our kits are very well tried, tested and proven and come complete with full instructions, circuit diagrams, assembly details and all high quality components including fibreglass PCB. Unless otherwise stated all transmitters are tuneable and can be received on an ordinary VHF FM radio.

**UTX Ultra-miniature room transmitter.** Smallest room transmitter kit in the world! Incredible 10mm x 20mm including mic, 3-12V operation, 500m range. £15.95

**MTX Micro-miniature room transmitter.** Best selling micro-miniature room transmitter. Just 17mm x 17mm including mic, 3-12V operation, 1000m range. £12.95

**STX High-performance room transmitter.** High performance transmitter with a buffered output stage for greater stability and range. Measures 22mm x 22mm including mic. 6-12V operation, 1500m range. £14.95

**VT500 High-power room transmitter.** Powerful 250mW output providing excellent range and performance. Size 20mm x 40mm, 9-12V operation. Range 3000m. £15.95

**VXT Voice activated room transmitter.** Triggers only when sounds are detected. Very low standby current, variable sensitivity and delay with i.e.d. indicator. Size 20mm x 67mm, 9V operation, 1000m range. £18.95

**QTX180 Crystal controlled room transmitter.** Narrow band FM transmitter for the ultimate in privacy. Operates on 180MHz and requires the use of a scanner receiver or our QRX180 kit (see catalogue). Size 20mm x 67mm, 9V operation, 1000m range. £39.95

**SCRX Subcarrier scrambled room transmitter.** Scrambled output from this transmitter cannot be monitored without the SCDM decoder connected to receiver. Size 20mm x 67mm, 9V operation, 1000m range. £21.95

**SCDM Subcarrier decoder unit for SCRX.** Connects to receiver earphone socket and provides decoded audio output to headphones. Size 32mm x 70mm, 9-12V operation. £21.95

**HVX400 Mains powered room transmitter.** Connects directly to 240V a.c. supply for long term monitoring. Size 30mm x 35mm, 500m range. £18.95

**ATR2 Micro size telephone recording interface.** Connects between telephone line (anywhere) and cassette recorder. Switches tape automatically as phone is used. All conversations recorded. Size 16mm x 32mm. Powered from line. £12.95

**UTLX Ultra-miniature telephone transmitter.** Smallest telephone transmitter kit available. Incredible size of 10mm x 20mm. Connects to line (anywhere) and switches on and off with phone use. All conversations transmitted. Powered from line, 500m range. £14.95

**TLX700 Micro-miniature telephone transmitter.** Best selling telephone transmitter. Being 20mm x 20mm it is easier to assemble than UTLX. Connects to line (anywhere) and switches on and off with phone use. All conversations transmitted. Powered from line, 1000m range. £12.95

**STLX High-performance telephone transmitter.** High power telephone transmitter with buffered output stage providing excellent stability and performance. Connects to line (anywhere) and switches automatically with phone use. All conversations transmitted. Powered from line. Size 22mm x 22mm, 1500m range. £15.95

**TKX900 Signalling/tracking transmitter.** Transmits a continuous stream of audio pulses with variable tone and rate. Ideal for signalling or tracking purposes. High power output gives range up to 3000m. Size 25mm x 63mm, 9V operation. £21.95

**CD600 Professional bug detector/locator.** Multicolour bargraph readout of signal strength with variable rate bleeper and variable sensitivity used to detect and locate hidden transmitters. Switch to AUDIO CONFIRM mode to distinguish between localised bug transmission and normal legitimate signals such as pagers, cellular, taxis etc. Size 70mm x 100mm, 9V operation. £49.95

### ★★★ SPECIAL ★★★

**DLTX/DLRX Radio control switch.** Remote control anything around your home or garden, outside lights, alarms, paging system etc. System consists of a small VHF transmitter with digital encoder and receiver unit with decoder and relay output, momentary or alternate. 8-way d.i.f. switches on both boards set your unique security code. TX size 45mm x 45mm, RX size 35mm x 90mm. Both 9V operation. Range up to 200m. Complete system (2 kits) £49.95  
Individual transmitter DLTX £18.95  
Individual receiver DLRX £36.95

A build-up service is available on all of our kits if required. UK customers please send cheques, PO's or registered cash. Please add £1.50 per order for P&P. Goods despatched ASAP allowing for cheque clearance. Overseas customers send sterling bank draft and add £5.00 per order for shipment. Credit card orders welcome on 0827 714476.

OUR LATEST CATALOGUE CONTAINING MANY MORE NEW SURVEILLANCE KITS NOW AVAILABLE. SEND TWO FIRST CLASS STAMPS OR OVERSEAS SEND TWO IRC's.

**SUMA DESIGNS**  
THE WORKSHOPS  
95 MAIN ROAD  
BAXTERLEY, Nr ATHERSTONE  
WARWICKSHIRE CV9 2LE

0827  
714476

# TUTORKIT MICROELECTRONICS TUTOR

## OP AMP TUTOR OT1

A versatile teaching aid for Operational Amplifier fundamentals. Includes socketed 741, Mode Control Switch, Two Potentiometers and close tolerance components. Will solve simple Differential Equations and generate waveforms etc.

Op Amp Tutor OT1 (kit) **£30.00** plus vat

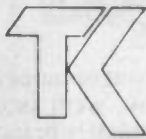

TUTORKIT PRODUCTS  
(Div. of Limrose Electronics Ltd.),  
Llay Industrial Estate, Wrexham,  
Clwyd, LL12 0TU, UK  
Tel: 0978 85 5555  
Fax: 0978 85 5556

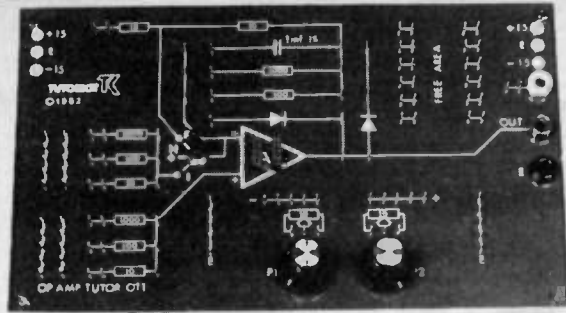

## C.E.S.N.W. FOR ELECTRONIC COMPONENTS

TEST EQUIPMENT REPAIRS  
IBM PC ACCESSORIES  
AT DISCOUNT PRICES

Let us source that difficult to find component  
for your kit or project

Send for details of all our services.

Appt. 2, No 8 Meirion Gardens  
Colwyn Bay, Clwyd  
North Wales LL29 7PR

Tel: 0492 533083 Fax: 0492 534716

# OMNI ELECTRONICS

174 Dalkeith Road, Edinburgh EH16 5DX · 031 667 2611

A COMPREHENSIVE RANGE WITH  
SERVICE SECOND TO NONE

OUR MUCH EXPANDED, BETTER  
ILLUSTRATED CATALOGUE  
WILL COST £1.50 – TO  
INCLUDE VOUCHERS  
TO USE AGAINST  
FUTURE PURCHASES.  
TO RECEIVE A COPY  
AS SOON AS THEY  
ARE READY, PLEASE  
SEND YOUR REMITTANCE  
WITH THE VOUCHER BELOW.

New  
1990/91  
Catalogue  
available  
now

Please send me a copy of the 1990/91 OMNI catalogue as soon as it is ready.  
Payment of £1.50 enclosed.

NAME: .....

ADDRESS: .....

TELEPHONE: .....

Open: Monday-Friday 9.00-6.00  
Saturday 9.00-5.00

VISA

## MAIL ORDER £1 BARGAIN PACKS BUY 20 GET 1 FREE

(Please state  
pack(s)  
required)

No.	Qty. per pack	Description
BP015B	1	30W dome tweeter. Size 90x66mil JAPAN made
BP017	3	3300µF 16V d.c. electrolytic high quality computer grade UK made
BP019	20	20 ceramic trimmers
BP020	4	Tuning capacitors, 2 gang dielectric a.m. type
BP021	10	3 position, 8 tag slide switch 3 amp rated 125V a.c. made in USA
BP022	5	Push-button switches, push on push off, 2 pole changeover. PC mount JAPAN made
BP023	6	2 pole 2 way rotary switch
BP024	2	2 Right angle, PCB mounting rotary switch, 4 pole, 3 way rotary switch UK made by LORLIN
BP025	4	3 pole, 3 way miniature rotary switch with one extra position off (open frame YAXLEY type)
BP026	4	4 pole, 2 way rotary switch UK made by LORLIN
BP027	30	Mixed control knobs
BP029	6	Stereo rotary potentiometers
BP030	2	10k wire wound double precision potentiometers UK made
BP031	6	Single 100k multiturn pots, ideal for varicap tuners UK made by PHILIPS
BP032	4	UHF varicap tuner heads, unboxed and untested UK made by PHILIPS
BP033	2	FM stereo decoder modules with diagram UK made by PHILIPS
BP033A	4	6" x 3" High grade Ferrite rod. UK made
BP034	3	AM IF modules with diagram PHILIPS UK MADE
BP034A	2	AM-FM tuner head modules. UK made by Mullard
BP034B	1	Hi-Fi stereo pre-amp module inputs for CD, tuner, tape, magnetic cartridge with diagram. UK made by MULLARD
BP035	6	All metal co-axial aerial plugs
BP036	6	Fuse holders, panel mounting 20mm type
BP038	20	5 pin din, 180° chassis socket
BP039	6	Double phono sockets, Paxolin mounted
BP041	3	2.8m lengths of 3 core 5 amp mains flex
BP042	2	Large VU meters JAPAN made
BP043	30	4V miniature bulbs, wire ended, new untested
BP044	2	Sonotone stereo crystal cartridge with 78 and LP styli JAPAN made
BP045A	2	Mono Cassette Record and play heads
BP046A	2	606 Mains transformers, PCB mounting, Size 42x33x35
BP047A	1	25V DC 150mA mains adaptor in black plastic case with flying input and output leads new units made for famous sound mixer manufacturer. Size 80x55x47
BP049	10	OC44 transistors. Remove paint from top and it becomes a photo-electric cell (ORP 12). UK made by MULLARD
BP050	30	Low signal transistors n.p.n., p.n.p. types
BP051	6	14 watt output transistors. 3 complimentary pairs in TO66 case. (Ideal replacement for AD161 and 162s)
BP052A	1	Tape deck pre-amp IC with record/replay switching No LM1818 with diagram
BP053	5	5 watt audio ICs. No TBA800 (ATEZ)
BP054	10	Motor speed control ICs, as used with most cassette and record player motors
BP055	1	Digital DVM meter I.C. made by PLESSEY as used by THANDAR with diagram
BP056	4	7 segment 0.3 LED display (red)
BP057	8	Bridge rectifiers, 1 amp, 24V
BP058	200	Assorted carbon resistors
BP059	1	Power supply PCB with 30V 4V/A transformer. MC7818CT IC & bridge rectifier. Size 4" x 2" x 1"
BP061	5	6.35mm Mono jack plugs
BP063	5	6.35mm stereo switched jack sockets
BP064	12	Coax chassis mount sockets
BP065	1	3mtr Euro-mains lead with chassis socket

**28.0.28V 4 AMP MAINS TRANSFORMERS** With a 5.5V at 0.5A mains input 110-240. Size 90 x 105 x 75 fitted with a copper screening band, made for famous HIFI Co. £6.50 each. Postage £2.80. It's weight is 2.7Kg. Brand new and unused condition.

**KOSS MINI SPEAKERS** Use instead of headphones on your personal stereo, just plug in instead of headphones. Koss sound cells can be mounted on top of your personal stereo with the holder supplied or simply detach for shelf mounting. This quality unit was made to sell for over seventeen pounds by the KOSS professional headphone company of the U.S.A. Due to a massive scoop purchase we can offer these units for £4.30 each or buy in multiples of ten and you get one free. Postage £1.50.

**KOSS STEREO HEADPHONES** High quality light weight stereo headphones fitted 3.5mm jack with adaptor to 6.4mm jack. Ideal use Hifi or personal stereos made to sell for nine pounds. Our price for this unit £4.25. Postage 60p.  
**Hi-Fi stereo cassette deck transport mechanism**, complete with 3 digit rev counter and tape heads, 12V d.c. operation. Unused manufacturers surplus JAPAN made. £6.20 + £1.50 P&P 2 for £10 + £2.50 P&P

## RADIO AND TV COMPONENTS ACTON LTD 21 HIGH STREET, ACTON, LONDON W3 6NG

MAIL ORDER TERMS. POSTAL ORDERS and or CHEQUES with orders. Orders under £20 add £3 service charge  
Nett monthly accounts to Schools, Colleges and P.L.C. only. ACCESS VISA. Phone orders between 9.30-12pm  
please. Overseas readers write for quote on delivery  
Phone 071 723 8432 or 081 992 8430  
Callers 323 Edgware Road, London W2. Closed Sun  
21 High St. Acton, London W3, closed Sun, Mon, Tues & Wed

**SPECIAL  
OFFER  
SAVE  
£1000**

- BT approved. ● Link up with Prestel, Telecom Gold, Mailbox. ● Contact bulletin boards and information services. ● Communicate with any computer anywhere. ● Send previously prepared messages. ● Receive messages—forget answer machines, use electronic mail! ● Use (via Telecom Gold) as an alternative to Fax and Telex. ● Built-in call charge calculator, text editing, message storage. ● Standard Centronics printer port for hard copy. ● RS232 capability for use as a modem for other computers. ● IBM keyboard emulator available. ● Modem can be configured, via Vistel's keyboard, for word length, start and stop bits, odd, even or no parity, V21 or V23 protocols, and so on. In other words, it will talk to anything! The ideal hacker's tool?

**Intended Price**

**£1280**

**FROM US ONLY**

**£198**

**+ VAT**

*While Stocks Last*

**Tel: 0600 3715  
to reserve**

The Vistel was designed by TCS to be the ultimate in desk top communications for the new age of information technology. Many more people will be working from home, so it will send and receive messages and data, give access to the computer, receive (via Telecom Gold) telex and fax messages, and keep you generally in touch with what's going on.

Instant access to information will be increasingly important too. There already exist massive databases and information stores, if only you could tap into them. The Vistel will do just that.

The firm that made these beautiful machines ran out of money before they could start selling them and, sad to say, went into liquidation. We now have all the completed Vistels: absolutely brand new, boxed, with full 100 page operating manual. Made to sell at £1280, we ask only £198 + VAT from anyone quick enough to order before they're all gone.

### GETTING STARTED

Installing your Vistel couldn't be easier—you just unplug your telephone, pop the Vistel's connector into the socket, plug your telephone into the back of the Vistel, push the Vistel's mains plug into the nearest outlet, and you're up and running.

Your Vistel will get you into all kinds of data bases, bulletin boards, mail services, news and information services, and goodness knows what else. Most of the services are yours for a small subscription charge, and some are free!

While you're waiting for the postman to deliver your Vistel, why not ask BT to send details of their Prestel and Telecom Gold services? Call them up on 0800 200700—it's a free number, so you won't even be charged for the call. The bump they send out includes info on Games City, Mailbox, music, current affairs, stock market and sports services, and lots more.

The bulletin boards and special interest groups are usually run by enthusiasts for free. Very professional some of them are, too. Try this: set the Vistel's modem to V23, 8-bit, no parity, one stop bit. Now dial 0772 735122. Once you hear the ringing tone, press the 'Khd Modem' switch, which allows the Vistel to work as an interactive terminal. After a few minutes the log-on message will appear on the Vistel's screen, and you're in!

You've just contacted the Hobbit's Armpit bulletin board. While you're there you can call up the newsletter, find a brief history of the world, how the Egyptians learned to make bread without straw—all very silly, but what the hell? It's free! . or download bits of software, or whatever else may be on offer at the time you phone through.

Here are some more numbers you can try:

**PRESTEL DEMO** Obviously they're trying to get you to subscribe to the full service, so they let you poke around a little to see what's on offer. A good opportunity for hackers, maybe...

Tel: 01 South or 021 Midlands or 061 North or 041 Scotland followed by 618 1111. To log on, use ID 44444444 ten 4s and password 4444. Modem setting: 7 bits, even parity, one stop bit.

**PACKET BBS** A free service run by the RSGB. Dial: 01 547 1479. Hit CR for response. Modem setting: 8 bits, no parity, 1 stop bit.

**INDEX 3 A** Swedish bulletin board for the adventurous, and for those with no worries about running up outrageous telephone bills. Dial: 010 46 42138 476.

**HAWK'S CASTLE** An interesting bulletin board which often has numbers for yet more bulletin boards. Who knows where you might end up? Dial 0344 411621.

**MORE INFO** Comes with your Vistel.

**Don't miss this—the world of databases and computer communications can be YOURS!**

**Pick up the phone now and your Vistel will be on its way to you today.**

 **ACCESS**  
or  
 **VISA orders:**  
**TEL. 0600 3715**

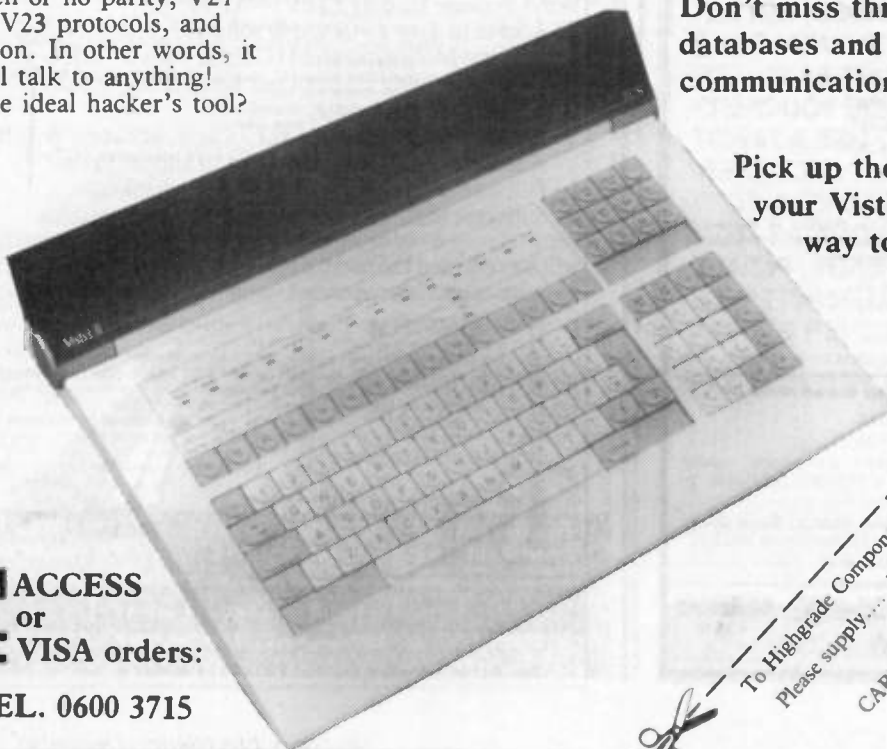

To Highgrade Components Ltd, Unit 8, 8 Woburn Road, Eastville, Bristol BS5 6TT  
Please supply..... Vistel Telecommunication Computers @ £227.70 inclusive £.....  
CARRIAGE: FREE TO ANY UK ADDRESS. Europe & Eire add £22  
I authorise you to debit my ACCESS or VISA card number £.....  
I enclose cheque/postal order for £.....  
Expiry date: .....  
Name: .....  
Address: .....  
Signed: .....

## NATIONAL COMPONENT CLUB

### CHRISTMAS TREE!

An unrivalled kit comprising all the parts to build a superb "Picture PCB" of a Christmas tree, which, when connected to a power supply (or battery) of 12-14vdc, will flash alternately from red to green and back again at an adjustable rate. The other components on the PCB have been arranged to appear as parcels at the bottom of the tree, and resistors hang from the branches! Power consumption is around 100ma, so you could leave it in the rear window of your car and impress the neighbours! Or stick it on top of the real Christmas tree. With a total of 63 LED's, this is a real eyecatcher! Size 100 x110mm.

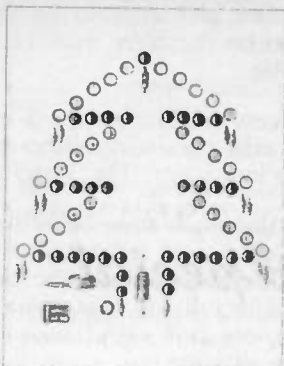

**COMPLETE KIT £12.50**

### STAR CHASER!

A superb 24 LED chaser display. The kit contains everything you need, including the PCB and easy to follow instructions to build the "Starchaser" which gives the impression of a circle of light spreading outwards from the centre. The kit is available with red or green LED's, both at the same price. A PP3 battery or 9v power supply is required. Size 100mm x 70mm.

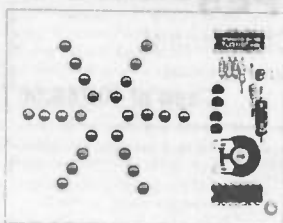

**COMPLETE KIT £7.50**

P.O. or cheque to NATIONAL COMPONENT CLUB, DEPT. EE, HIGHER ANSFORD, CASTLE CARY, SOMERSET BA7 7JG. Please add £1 P & P but do not add VAT.



**FREE CLUB MEMBERSHIP**



## B.C.E. ELECTRONICS



### 4000 CMOS

4000	23p	4024	41p	4052	41p	4099	67p	4532	53p
4001	23p	4025	23p	4053	41p	40106	37p	4534	354p
4002	23p	4027	36p	4060	48p	4502	67p	4536	239p
4007	23p	4028	41p	4066	34p	4058	142p	4538	44p
4008	48p	4029	44p	4068	23p	4510	53p	4539	62p
4011	23p	4033	126p	4069	23p	4511	53p	4541	53p
4012	23p	4035	28p	4070	23p	4512	53p	4543	80p
4013	28p	4038	106p	4071	23p	4514	115p	4553	221p
4014	42p	4040	55p	4072	23p	4515	115p	4554	354p
4015	41p	4042	40p	4073	23p	4516	62p	4556	60p
4016	28p	4043	54p	4075	23p	4518	41p	4560	195p
4017	44p	4044	54p	4076	50p	4520	44p	4561	221p
4018	41p	4046	50p	4077	23p	4522	80p	4566	283p
4020	48p	4047	41p	4078	28p	4526	64p	4582	203p
4021	48p	4049	32p	4081	23p	4527	71p	4584	37p
4022	49p	4050	32p	4093	28p	4528	67p	4585	53p
4023	23p	4051	41p	4094	50p				

### LINEAR

CA3046	71p	LM3352	124p	MC3302	133p	TL072	57p
CA3080	85p	LM339	39p	MC3340	203p	TL074	74p
CA3130	142p	LM348	48p	NE555	28p	TL081	48p
CA3140	67p	LM358	39p	NE556	53p	TL082	62p
CA3240E	159p	LM380	142p	NE565	159p	TL084	74p
ICM7555	71p	LM381N	300p	NE566	159p	UA709C	62p
ICM7556	124p	LM382	248p	NE567	53p	UA741	28p
LF347	88p	LM386	124p	NE5532	97p	UA747	78p
LF351	48p	LM387	192p	NE5534	80p	UA748	45p
LF353	62p	LM393	39p	SAA1027	327p	ULN2003	71p
LF355	248p	LM710	80p	SL560C	268p	ULN2004	71p
LF356	103p	LM723	44p	SP8629	265p	ULN2803	115p
LM301A	36p	LM1458	39p	TBA120S	95p	XR2206CP	540p
LM308	88p	LM2917	300p	TBA810	103p	ZN414	142p
LM311	39p	LM3900	106p	TBA820M	71p	ZN416E	221p
LM317T	80p	LM3909	168p	TDA2030H	177p	ZN424E	124p
LM324	39p	LM3914	336p	TDA7000	220p	ZN427E	991p
LM334Z	115p	LM3915	336p	TL071	50p	ZN1034E	295p

FULL RANGE OF CMOS, TTL & LINEAR I.C.S. LARGE RANGE OF TRANSISTORS, RESISTORS, CAPACITORS, BOXES, PLUGS, SOCKETS, SWITCHES, P.C.B. MATERIALS, SERVICE AIDS, TOOLS AND LOTS MORE FOR THE ELECTRONICS ENTHUSIAST.

Send 20p stamp for lists. All prices include VAT. Please add 60p p&p Mon., Tues., Wed., Fri., Sat. 10.00-6.00. CLOSED THURSDAYS



**(0543) 277572**



Unit 3, Chasewood Park Business Centre  
Hednesford Road, Heath Hayes  
Cannock, Staffs WS12 5HL

## MICRO-PRESSURE CAR ALARM

This new type of alarm is triggered by a unique pressure sensing system. As any vehicle door is opened, air is drawn out, causing a minute drop in air pressure. A sensor detects this sudden pressure change and sets off the alarm.

This new sensing system and a sophisticated arrangement of electronic filters and timers provide features to match more expensive ultra-sonic systems.

- ★ 1 Micro-Pressure intruder detection.
- ★ 2 Operates on all doors and tailgate.
- ★ 3 No door switches needed.
- ★ 4 Automatically armed 1 minute after leaving vehicle.
- ★ 5 10 second entry delay with audible warning.
- ★ 6 Sounds horn intermittently for 1 minute.
- ★ 7 Easy fitting - only 3 wires to connect - no holes to drill.
- ★ 8 Compact design can be hidden below dashboard.
- ★ 9 All solid state Power MOSFET output - no relays.

MICRO-PRESSURE ALARM KIT £15.75  
ASSEMBLED READY TO FIT £21.75

### VOLT DROP CAR ALARM

This alternative alarm uses the popular voltage drop method of triggering. Based on the timers of the micro-pressure alarm it offers features 4 to 9 above but relies on the existing door switch operation for triggering.

VOLT DROP ALARM KIT £14.55  
ASSEMBLED READY TO FIT £20.55

### TOTAL ENERGY DISCHARGE IGNITION

Our unbeatable Extended CDI system retains the contacts for easy fitting. The contacts operate at low current whilst the 12v supply is converted to 370v for a super power spark with improved starting, performance and economy.

TOTAL ENERGY DISCHARGE IGNITION KIT £20.95  
ASSEMBLED READY TO FIT £26.25

All Electronize kits include clear, easy to follow instructions, quality components, PCB and case. Everything needed is included, right down to solder and heatsink compound.

All prices now include post, packing and VAT on U.K. orders. Same prices apply for all European countries. For delivery outside Europe please add £3.

Telephone orders accepted with VISA or ACCESS payment.

Order direct (quote ref. C0C) or send for more details from:-

**ELECTRONIZE DESIGN** tel. 021 308 5877

2 Hillside Road, Four Oaks, Sutton Coldfield, B74 4DQ

## Page Make-up for £185 plus VAT

**I**F YOU are looking for a superb, page make-up system complete with over 200 typefaces, that really works and won't cost you an arm and a leg, Typefit is the system for you.

Why? Because for only £185 + VAT you get:

- Access to over £90k hard/software, and over 200 genuine Monotype and ITC fonts from 1 - 1000 pt.
- Disc processing through our typesetting bureau from £2.50 for an A4 page.
- Page make-up, on screen.  Clear, accurate WYSIWYG.
- A system that's easy to learn and simple to use.
- Full on-screen help, and telephone back-up.
- Software that runs on IBM PCs and compatibles.

Send us your discs or modem your files and your typesetting will be returned the same day.

EVERYDAY  
ELECTRONICS  
is produced  
entirely on  
Typefit

# Typefit

Interested? Please 'phone  
Terry or Paul for further  
information or a  
demonstration  
disc. Please  
state disc  
size and  
density.



THE TYPESETTING BUREAU LTD

6 Church Street, Wimborne, Dorset BH21 1JH. Tel: (0202) 882299.  
Fax: 841692. Modem: 882270. DX: 45314 Wimborne. Datalink: TYPBUR



### POWER SUPPLY ELECTROLYTICS

These high value, high ripple current cans are made by BHC/LCR and are of excellent quality and value.

Code	Value	Voltage	Ripple	Std	Mfr price
Z4343	2200µF	40V	27A	45 x 26	£2.12
Z4344	4700µF	63V	4.4A	56 x 36	£3.77
Z4345	10,000µF	40V	4.9A	56 x 41	£3.89
Z4346	15,000µF	25V	5.5A	56 x 41	£3.96

Prices:

Z4343	60p	25+	£0.52	100+	£0.345
Z4344	£2.00	25+	£1.84	100+	£1.49
Z4345	£2.50	25+	£2.07	100+	£1.72
Z4346	£2.50	25+	£2.07	100+	£1.72

**AUDIO AMPS AT GIVEAWAY PRICES**  
Z914 Audio amp panel 95 x 65mm with TBA820 chip, gives 1W output with 9V supply. Switch and vol control. Just connect battery and speaker. Full details supplied.

**Price £1.50**

Z915 Stereo version of above 115 x 65mm, featuring 2 x TBA820M and dual volume control.

**Price £3.50**

**BRIDGE RECTIFIER OFFER**  
25A 200V by IR.  
Only £1.50

**FREE!**

WITH ALL ORDERS OVER £25

**EASIWIRE** WORTH £15!!

ONLY TO EE READERS ORDERING BEFORE DEC 31st (While stocks last - 1 per customer)  
To obtain your FREE EASIWIRE, cut out and attach this starburst to your order (no photocopies)

## 1991 CATALOGUE

### YOU GET A GREAT DEAL MORE WHEN YOU DEAL WITH GREENWELD!!

The 1991 Greenweld Catalogue is out NOW!

- ★ MANY SUBSTANTIAL REDUCTIONS
- ★ QUANTITY PRICING FOR BULK BUYERS
- ★ 132 PAGES OF VALUE-PACKED GOODS
- ★ NEXT SIX UPDATES PLUS LISTS INCLUDED IN PRICE
- ★ EASY TO USE ORDER FORM
- ★ 1ST CLASS REPLY PAID ENVELOPE
- ★ OUR FAMOUS BARGAIN LIST

Price to include Catalogue, current bargain list and next six lists. All supplied with reply paid envelope £2.50 (UK & BFPO) £5.00 Overseas.

## Christmas Special

Our 8-page Christmas Special is out now and contains some stunning Bargains!! Massive price reductions on headphones, speakers, mixers, microphones, meters, power supplies, etc. Make someone happy on Christmas Day - Get them a Gift from Greenweld!! Ring, write, fax or call in for your free copy NOW!

## VIDEO TAPES

Stock up now for Christmas!

Top quality 3 hr VHS tapes by Videolab

£2.50 each      Box of 10 £20.70      Case of 40 £69.00

**GREENWELD**  
ELECTRONIC COMPONENTS

All prices include VAT, P&P £2.00 per order. Min. Credit Card £5. No CWO min. Official Order from Education welcome & min invoice charge £10.00.  
Payment is accepted by cheque, postal order, cash, inc. foreign currency bank notes/book tokens/Access/Visa/Connect.  
Our stores have enormous stocks of components and our trade counter is open from 9-5.30 from Mon-Sat. Come and see us!

Tel: (0703) 236363

Fax: (0703) 236307

27D PARK ROAD, SOUTHAMPTON, SO1 3TB

### SWITCH MODE POWER SUPPLIES

Over the years, we've had many different switch mode power supplies, but this latest unit is without doubt one of the finest we've ever seen!

Made by Astec, it is a totally enclosed steel cased unit measuring 175 x 136 x 65mm, which has incorporated in it a switched and fused IEC mains inlet.

Inside, the PCB is 160 x 80mm, with output pins fitted on one end. A connector to these pins is provided the outputs to the exterior of the case is extended.

Specification:  
Model Number: **BM41012**  
Input: 115/230V, 50/60Hz  
Outputs: +5V 3.75A  
+12V 1.5A  
-12V 0.4A

Total Wattage: 65W

Price: **£14.95**

We've also discovered a small quantity of an Astec model offered previously. Regrettably we've had to increase the price, but they still represent outstanding value for money. Enclosed in a steel case 203 x 112 x 60mm is a PCB 197 x 106mm. Input/Outputs are via pins on the PCB

Specification:  
Model Number: **AC9231**  
Input: 115/230V, 50/60Hz  
Outputs: +12V 2.5A  
+5V 6A

12V 0.5A (+ or -)  
5V 0.5A (+ or -)  
50W

Total Wattage: 50W

Price: **£17.95**

We still have good supplies of yet another Astec model. This one is partially cased, the overall size being 160 x 104 x 45mm. The PCB measures 160 x 100mm. Input & Outputs on flying leads, all colour coded. There is also an additional IEC socket to extend mains to another unit.

Specification:  
Model Number: **AA12531**  
Input: 115/230V, 50/60Hz  
Outputs: +5V 5A  
+12V 0.15A

50W

Total Wattage: 50W

Price: **£6.95**

Also still available: An Astec 'bare board' model. The PCB is standard Eurocard size, 160 x 100mm. Inputs & Outputs are on right angled PCB pins. This is a very compact model offering excellent value for money.

Specification:  
Model Number: **ACB151-01**  
Input: 115/230V, 50/60Hz  
Outputs: +5V 2.5A  
+12V 2A

-12V 0.1A  
40W

Total Wattage: 40W

Price: **£12.95**

## HART AUDIO KITS - YOUR VALUE FOR MONEY ROUTE TO ULTIMATE HI-FI

HART KITS give you the opportunity to build the very best engineered hi-fi equipment there is, designed by the leaders in their field, using the best components that are available. With a HART KIT you not only get more performance for your money but also added free bonus of your own hands-on experience of modern electronic assembly. The HART combination of innovative circuit techniques, sound engineering design and professional grade components is your recipe for success in the quest for affordable ultimate audio fidelity.

Telephone or write for your FREE LISTS giving full details of all our KITS, components and special offers. Featured this month is the:

### AUDIO DESIGN 80 WATT POWER AMPLIFIER



This fantastic John Linsley Hood designed amplifier is the flagship of our range, and the ideal powerhouse for your ultimate hi-fi system. This kit is your way to get EK performance for a few tenths of the cost!

Featured on the front cover of 'Electronics Today International' this complete stereo power amplifier offers World Class performance allied to the famous HART quality and ease of construction. John Linsley Hood's comments on seeing a complete unit were enthusiastic: -

"The external view is that of a thoroughly professional piece of audio gear, neat, elegant and functional. This impression is greatly reinforced by the internal appearance, which is redolent of quality, both in components and in layout."

Each power amplifier channel has its own advanced double sided PCB and no less than four power mosfets, directly mounted on the board for consistent predictable performance. The sophisticated power supply features no less than six separate voltage rails, all fully stabilised, and the complete unit, using a toroidal transformer, is contained within a heavy gauge aluminium chassis/heatsink

fitted with IEC mains input and output sockets. To make assembly very easy all the wiring is even pre-terminated, ready for instant use.

The standard amplifier comes with the option of a stereo LED power meter and a versatile passive front end giving switched inputs, and ALPS precision, low-noise volume and balance controls. All inputs are taken to gold plated Phono sockets and outputs to heavy duty 30 amp binding posts. These are also available gold plated as an optional extra.

Another new option is the relay switched front end stage which even gives a tape input and output facility. This means that for use with tuners, tape and CD players, or indeed any other 'flat' inputs the power amplifier may be used on its own, without the need for any external signal handling stages. For your special system requirements our 'Slave' and 'monobloc' versions without the passive input stage and power meter are also available.

All amplifiers fit within our standard 420 x 260 x 75mm case to match our 400 Series Tuner range. The case and front plate are finished in textured matt black with white lettering and all parts are precision jig-punched for accuracy.

K1100 STANDARD Amplifier kit

Total cost of all parts is £503.56

SPECIAL DISCOUNT PRICE ONLY ..... £428.02

If Bargraph Power Meter not required. Deduct ..... £32.81

If Relay Input System required. Add ..... £39.43

K1100G Option with Gold plated speaker terminals. Add ..... £4.40

K1100S SLAVE Amplifier Kit

Total cost of all parts is £382.85

SPECIAL DISCOUNT PRICE ONLY ..... £325.42

K1100M MONOBLOC Amplifier kit (total cost of all parts is £297.65)

SPECIAL DISCOUNT PRICE ONLY ..... £253.00

All HART kits are designed to the very highest standards for easy home construction, and can be built by anyone with reasonable manual ability. If you are still not convinced how easy it is to build it yourself with a HART kit you can order the Instruction Manual to read for yourself and we will refund the cost when you buy your kit!

1100CM Construction Manual. 20+ pages of step by step assembly instructions, circuit diagrams and full parts identification list. £5.50

RLH11 Reprints of the latest 1989 articles £1.80

Our FREE LIST has further details of this kit as well as our range of super quality tuners, ALPS precision pots and tape recorder circuits. Send for your copy.

### HIGH QUALITY REPLACEMENT CASSETTE HEADS



Do your tapes lack treble? A worn head could be the problem. Fitting one of our replacement heads could restore performance to better than new! Standard inductances and mountings make fitting easy on nearly all machines and our TC1 Test Cassette helps you set the azimuth spot on. As we are the actual importers you get prime parts at lower prices, compare our prices with other suppliers and see! All our heads are suitable for use with any Dolby system and are normally available ex. stock. We also stock a wide range of special heads for home construction and industrial users.

HS16 Sendust Alloy Stereo Head, high quality head with excellent frequency response and hyperbolic face for good tape contact..... £17.86

HC40 NEW RANGE High Beta Permalloy Stereo Head. Modern space saver design gives excellent high-frequency response with easy fitting and lower cost. Suitable for chrome, metal and ferric tapes, truly a universal replacement head, with ample quality for hi-fi decks and cheap enough for car players!..... £6.65

HX100 Special Offer Stereo permalloy Head..... £2.86

HRP373 Downstream Monitor Stereo Combination Head..... £44.39

HQ551 4-Track Record & Play Permalloy Head for auto-reverse car players or quadraphonic recording..... £16.79

See our list for our complete range of Cassette and Reel-to-reel heads

### TAPE RECORDER CARE PRODUCTS

HART TC1 TEST CASSETTE. Our famous triple purpose test cassette. Sets tape azimuth, VU level and tape speed..... £5.36

DEM1 Mains Powered Tape Head Demagnetizer, prevents noise on playback due to residual head magnetisation..... £4.08

DEM115 Electronic, Cassette Type, demagnetizer..... £8.61

Our new Autumn/Winter '90 price list is FREE. Send for your copy now. Overseas customers welcome, please send 2 IRCs to cover surface post or 13 for Airmail.

We now accept inland and overseas order by post or telephone on all Access, Master and Visa Credit Cards.

Please add part cost of carriage and insurance as follows:

INLAND: Orders up to £20 - £1; Orders over £20 - £2.50.

Next day - £9. OVERSEAS: Please see the ordering information with our lists.

QUALITY AUDIO KITS

24hr SALES LINE  
(0691) 652894

ALL PRICES INCLUDE VAT

**HART**  
HART ELECTRONIC KITS LTD  
15 HANMILL  
OSWESTRY, SHROPSHIRE  
SY10 9AF

Carbon Film resistors 1/4W 5% E24 series 0.51 R to 10MΩ	1p
100 off per value - 75p, even hundreds per value totalling 1000	£6.00p
Metal Film resistors 1/4W 10R to 1MΩ 5% E12 series - 2p, 1% E24 series	3p
Mixed metal/carbon film resistors 1/4W E24 series 1R0 to 10MΩ	11p
1 watt mixed metal/carbon film resistors 5% E12 series 4R7 to 10 Megohms	5p
Linear Carbon pre-sets 100mW and 1/4W 100R to 4M7 E6 series	7p
Miniature polyester capacitors 250V working for vertical mounting	
0.15, 0.22, 0.33, 0.47, 0.68-4p 0.1-5p 0.12, 0.15, 0.22-6p 0.47-8p 0.68-8p 1.0-12p	
Mylar (polyester) capacitors 100V working E12 series vertical mounting	
1000p to 8200p - 3p, 0.1 to 0.68-4p 0.1-5p 0.12, 0.15, 0.22-6p 0.47/50V-8p	
Submin ceramic plate capacitors 100V wkg vertical mountings E12 series	
2% 1.8pf tp 47pf-3p, 2% 56 pf to 330pf - 4p, 10% 390p - 4700p	4p
Disc/plate ceramics 50V E12 series 1P0 to 1000P, E6 Series 150CP to 47000P	2p
Polystyrene capacitors 63V working E12 series long axial wires	
10pf to 820pf - 3p, 1000pf to 10,000pf - 4p, 12,000pf	5p
741 Op Amp - 20p, 555 Timer	22p
cmos 4001 - 20p, 4011 - 22p, 4017	40p
ALUMINIUM ELECTROLYTICS (Mfds/Volts)	
1/50, 2.2/50, 4.7/50, 10/25, 10/50	
22/16, 22/25, 22/50, 47/16, 47/25, 47/50	5p
100/16, 100/25, 100/50, 100/100, 100/100	6p
220/16, 220/25, 220/50, 10p, 470/16, 470/25	14p
1000/25, 25p, 1000/35, 2200/25, 35p, 4700/25	11p
70p	70p
Submin, tantalum bead electrolytics (Mfds/Volts)	
0.1/35, 0.22/35, 0.47/35, 1.0/35, 3.3/16, 4.7/16	
2.2/35, 4.7/25, 4.7/35, 6.8/16, 15p, 10/16, 22/6	14p
33/10, 47/6, 22/16, 30p, 47/10, 35p, 47/16, 60p, 47/35	20p
80p	80p
VOLTAGE REGULATORS	
1A + or - 5V, 8V, 12V, 15V, 18V & 24V - 55P, 100mA, 5.8, 12, 15, V +	30p
DIODES (piv/amps)	
75/25mA 1N4148 2p, 800/1A 1N4006 4p, 400/3A 1N5404 14p, 115/15mA OA91	8p
100/1A 1N4002 3p, 1000/1A 1N4007 5p, 60/1.5A 1N5401 5p, 100/1A bridge	25p
400/1A 1N4004 4p, 1250/1A BY127 10p, 30/15A OA47	10p
Zener diodes E24 series 3V3 to 33V 400mW - 8p, 1 watt	12p
Battery snaps for PP3 - 6p for PP9	12p
L.E.D.'s 3mm, & 5mm, Red, Green, Yellow - 10p, Grommets 3mm - 2p, 5mm	2p
Red flashing L.E.D.'s require 5V supply only	50p
Mains indicator neons with 220k resistor	10p
20mm fuses 100mA to 5A, Q blow 5p, A/surge 8p, Holders, chassis, mounting	5p
High speed pc drill 0.8, 1.0, 1.3, 1.5, 2.0mm - 30p, Machines 12V dc	£7.00
HELPING HANDS 6 ball joints and 2 croc clips to hold awkward jobs	£3.50p
AA/HP7 Nicad rechargeable cells 80p each, Universal charger unit	£6.50p
Glass reed switches with single pole make contacts - 8p, Magnets	12p
0.1" Stripboard 2 1/2" x 1" 9 rows 25 holes - 20p, 3" x 2 1/2" 24 rows 37 holes	12p
Jack plugs 2.5 & 3.5m	6p
Sockets Panel Mtg 2.5 & 3.5m	10p
TRANSISTORS	
BC107/8/9-12p, BC547/8/9-8p, BC557/8/9-8p, BC182, 182L, BC183, 183L, BC184, 184L, BC212, 212L-10p	
BC327, 337, 337L-12p, BC727, 737-12p, BD135/6/7/8/9-25p, BCY70-15p, BFY50/51/52-20p	
BFX88-15p, 2N3055-50p, TIP31, 32-30p, TIP41, 42-40p, BU208A-£1.20, BF195, 197-12p	
All prices are inclusive of VAT, Postage 30p (free over £5). Lists Free.	

## THE CR SUPPLY CO

127 Chesterfield Rd., Sheffield S8 0RN  
Tel: 0742 557771 Return posting

## ADVERTISERS INDEX

A&G ELECTRONICS	830
AUTONA	821
BARRIE ELECTRONICS	828
B.C. ELECTRONICS	838
BK ELECTRONICS	Cover (iii)
BRIAN PRICE	828
BULL ELECTRICAL	Cover (ii)
CAMBRIDGE COMP SCIENCE	840
CES	836
CIRKIT DISTRIBUTION	763
CRICKLEWOOD ELECTRONICS	784
CR SUPPLY COMPANY	840
DCP MICRODEVELOPMENTS	840
ECLIPSE	840
ELECTRONIZE DESIGN	838
ELV FRANCE	766/767
GEM-TECH	828
GRANDATA	818
GREENWELD ELECTRONICS	839
HART ELECTRONIC KITS	839
HENRY'S AUDIO ELECTRONICS	830
HIGHGRADE COMPTS	833/837
HIGH-O-ELECTRONICS	820
HILLS COMPONENTS	799
HOBBYKIT	805
ICS	835
JAYTEE ELECTRONIC SERV'S	806
LITESOLD	830
LONDON ELECTRONICS COLLEGE	840
MAGENTA ELECTRONICS	768/769
MAPLIN ELECTRONICS	Cover (iv)
MARCO TRADING	762
MULTITEST	827
NATIONAL COLLEGE OF TECH	830
NATIONAL COMPONENT CLUB	838
NUMBER ONE SYSTEMS	827
OMNI ELECTRONICS	836
PARTRIDGE ELECTRONICS	834
RADIO & TV COMPONENTS	817/836
RICHARDSON SYSTEMS	806
SERVICE TRADING CO	828
SHERWOOD ELEC. COMP SPECIALIST	835
SEMICONDUCTORS	764/765
SPIERS ELECTRONICS	835
SUMA DESIGNS	835
THE TYPESETTING BUREAU	838
TK ELECTRONICS	770
TUTORKIT PRODUCTS	836

## BTEC ELECTRONICS TECHNICIAN FULL-TIME TRAINING

**2 YEAR BTEC National Diploma (OND) ELECTRONIC & COMMUNICATIONS ENGINEERING**  
(Electronics, Computing, Television, Video, Testing & Fault Diagnosis)

**1 YEAR BTEC National Certificate (ONC) ELECTRONIC ENGINEERING**  
1—INFORMATION TECHNOLOGY  
(Electronics, Satellite TV, Networks, Telecomms)

2—ELECTRONIC EQUIPMENT SERVICING  
(Electronics, Television, Video Cassette Recorders, CCTV, Testing and Fault Diagnosis)

3—SOFTWARE ENGINEERING  
(Electronics, Assembler, BASIC, Pascal, CAD/CAM)

4—COMPUTING TECHNOLOGY  
(Electronics, Computing Software/Hardware, Microelectronics)

**10 MONTHS BTEC Higher National Certificate (HNC) COMPUTING TECHNOLOGY & ROBOTICS**  
(Microprocessor Based Systems, Control, Robotics)

*These courses include a high percentage of college based practical work to enhance future employment prospects. No additional fees for overseas students. Shortened courses of from 3 to 6 months can be arranged for applicants with previous electronics knowledge.*

THOSE ELIGIBLE CAN APPLY FOR E.T. GRANT SUPPORT AN EQUAL OPPORTUNITIES PROGRAMME

**O.N.C. and O.N.D. Next Course Commences Monday 7th January 1991**  
FULL PROSPECTUS FROM

**LONDON ELECTRONICS COLLEGE**  
(Dept. EE) 20 PENYERN ROAD  
EARLS COURT, LONDON SW5 9SU  
TEL 071-373 8721

## CAMBRIDGE COMPUTER SCIENCE LIMITED

* 10MB Byte Winchester, used 3 months Wty	£42.00 each
* 5.25" Disk Drives, 80 Tk, DSDD	£34.00 each
* 5.25" Disk Drives, 80 Tk, DSDD, used, no Wty (Sold on a strictly 'as is' basis)	£15.00 each
* 5.25" Disks, DSDD, 48Tpi boxes of 10	£3.00 box
* 40W PSU 5V 3.75A, 12V 1.5A - 12V 0.4A, cased with on/off switch	£10.00 each
* Bare switch mode PSU 5V 2.5A, 12V 2A, -12V 0.1A	£7.00 each
* 8086 CPU chips	£2.00 each
* 280A CPU, CTC, PIO	£1.20 each, DMA £2.00
* 74LS TTL, pick and mix, buy 10 or more for	£4.50 all 4
Types available: 00 02 04 08 11 12 13 15 15 20 21 26 27 30 32 33 38 42 74 85 96 107 109 122 132 136 139 145 151 153 157 158 162 163 164 165 174 191 193 253 257 298 353 365 670	£0.12 each
* 2764 EPROMS (EX-equipment)	£1.00 each
* 27128 EPROMS (EX-equipment)	£1.20 each
* 27128 EPROMS	or £3.00/5 or £3.00/8
* 27C256-25 EPROMS	£2.50 each
* 256K Byte DRAM Modules, removed from equipment	£6.00 each
* 6116 2K Byte SRAM	£1.10 each
* 6264 8K Byte SRAM	£3.80 each
* 65256 32K Byte RAMS	-15 £3.00 each - 12 £3.80 each
* 8K Byte NV RAM chips	£7.00 each
* 20-pin dll low profile IC sockets	£3.00 each
* 40-pin dll low profile IC sockets	£0.50/10
* DEC LSI11/23 CPU cards used but working	£1.00/100
* CPU cards (New or used) 280 CPU, 3 EPROMS & 60+ mostly 74LS ICs	£4.00/100
* LCD graphics module 240 by 64 pixel with drive rchips	£50.00 each
* Circuit tester, finds faults in TTL & CMOS logic circuits, inc. leads.	£2.00 each
* Keyboard, 100 keys on board LCD & micro I/F	£13.00 each
* Keyboard, 100 keys on board LCD & micro I/F	£8.00 each

Prices include postage. Add 50p (plus VAT) to orders below £5.00. All items new unless stated. Add 15% VAT to all prices. Send an SAE for our latest list or for more info.

Dept EE, 374 Milton Road, Cambridge CB4 1SU  
Tel: 0223 424602 or 0831 430496 (Please note mail order only)

## COMPUTER CONTROL

- Multi-channel A to D •
- Power relay outputs •
- Stepping Motor Control •
- Switch/Sensor Inputs •
- D to A conversion •

### PUT YOUR MICRO IN CONTROL!

- BBC/Master • Spectrum (all models) •
- IBM PC/XT/AT • Apple IIe/IIIGS •
- Amstrad CPC range • Archimedes •
- Commodore 64/128 • Scorpion •

Our range of inexpensive Interpack Interfaces can connect and interchange with all of these computers using the unique Interpack personality card system. Ideal for robotics, models, test and measurement, alarm systems, automation etc. Interfacing introductory packs from under £50. For a free detailed information pack and special offer brochure please write, FAX or telephone:

DCP Microdevelopments Ltd,  
2 Station Close,  
Lingwood,  
Norwich, NR13 4AX.  
Technical (0480) 830997  
FAX (0480) 830534

**DCP**  
microdevelopments

## Eclipse

### ELECTRONIC COMPONENTS

Importers and Distributors of Electronic Components and Computer Products

166 CROSS STREET, SALE  
CHESHIRE M33 1AQ

Tel: 061  
9690619

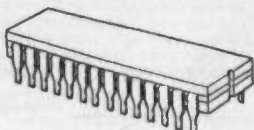

Fax: 061  
9051499

**COMPONENTS FOR ENTHUSIASTS AND INDUSTRY**

# OMP POWER AMPLIFIER MODULES-TURNTABLES-DIMMERS-LOUDSPEAKERS-19 INCH STEREO RACK AMPLIFIERS

## OMP POWER AMPLIFIER MODULES

Supplied ready built and tested.

**OMP POWER AMPLIFIER MODULES** Now enjoy a world-wide reputation for quality, reliability and performance at a realistic price. Four models available to suit the needs of the professional and hobby market, i.e. Industry, Leisure, Instrumental and Hi-Fi etc. When comparing prices, NOTE all models include Toroidal power supply, Integral heat sink, Glass fibre P.C.B. and Drive circuits to power compatible Vu meter. Open and short circuit proof.

**THOUSANDS OF MODULES PURCHASED BY PROFESSIONAL USERS**



**OMP100 Mk 11 Bi-Polar** Output power 110 watts R.M.S. into 4 ohms, Frequency Response 15Hz - 30KHz - 3dB, T.H.D. 0.01%, S.N.R. -118dB, Sens for Max. output 500mV at 10K, Size 355 x 115x65mm. **PRICE £33.99 + £3.00 P&P.**

### NEW SERIES II MOS-FET MODULES



**OMP MF 100 Mos-Fet** Output power 110 watts R.M.S. into 4 ohms, Frequency Response 1Hz - 100KHz - 3dB, Damping Factor, >300, Slew Rate 45V/uS, T.H.D. Typical 0.002%, Input Sensitivity 500mV, S.N.R. -125dB. Size 300 x 123 x 60mm. **PRICE £39.99 + £3.00 P&P.**



**OMP MF 200 Mos-Fet** Output power 200 watts R.M.S. into 4 ohms, Frequency Response 1Hz - 100KHz - 3dB, Damping Factor >300, Slew Rate 50V/uS, T.H.D. Typical 0.001%, Input Sensitivity 500mV, S.N.R. -130dB. Size 300 x 155 x 100mm. **PRICE £62.99 + £3.50 P&P.**



**OMP MF 300 Mos-Fet** Output power 300 watts R.M.S. into 4 ohms, Frequency Response 1Hz - 100KHz - 3dB, Damping Factor >300, Slew Rate 60V/uS, T.H.D. Typical 0.0008%, Input Sensitivity 500mV, S.N.R. -130dB. Size 330 x 175 x 100mm. **PRICE £79.99 + £4.50 P&P.**

NOTE:— MOS-FET MODULES ARE AVAILABLE IN TWO VERSIONS. STANDARD — INPUT SENS. 500mV BAND WIDTH 100KHz. PEC (PROFESSIONAL EQUIPMENT COMPATIBLE) — INPUT SENS. 775mV BAND WIDTH 50KHz. ORDER STANDARD OR PEC.



**Vu METER** Compatible with our four amplifiers detailed above. A very accurate visual display employing 11 L.E.D. diodes (7 green, 4 red) plus an additional on/off indicator. Sophisticated logic control circuits for very fast rise and decay times. Tough moulded plastic case, with tinted acrylic front. Size 84 x 27 x 45mm. **PRICE £8.50 + 50p P&P.**

## LOUDSPEAKERS



**LARGE SELECTION OF SPECIALIST LOUDSPEAKERS AVAILABLE, INCLUDING CABINET FITTINGS, SPEAKER GRILLES, CROSS-OVERS AND HIGH POWER, HIGH FREQUENCY BULLETS AND HORNS, LARGE S.A.E. (30p STAMPED) FOR COMPLETE LIST.**

### McKENZIE:— INSTRUMENTS, P.A., DISCO, ETC.

**ALL MCKENZIE UNITS 8 OHMS IMPEDENCE**

- |  |                           |
|--|---------------------------|
| 8" 100 WATT C8100GPM GEN. PURPOSE, LEAD GUITAR, EXCELLENT MID, DISCO. RES. FREQ. 80Hz FREQ. RESP. TO 14KHz SENS. 99dB          | PRICE £29.30 + £2.00 P&P  |
| 10" 100 WATT C10100GP GUITAR, VOICE, ORGAN, KEYBOARD, DISCO, EXCELLENT MID RES. FREQ. 70Hz FREQ. RESP. TO 6KHz SENS. 100dB     | PRICE £35.58 + £2.50 P&P  |
| 10" 200 WATT C10200GP GUITAR, KEYBOARD, DISCO, EXCELLENT HIGH POWER MID RES. FREQ. 45Hz FREQ. RESP. TO 7KHz SENS. 103dB        | PRICE £48.67 + £2.50 P&P  |
| 12" 100 WATT C12100GP HIGH POWER GEN. PURPOSE, LEAD GUITAR, DISCO RES. FREQ. 45Hz FREQ. RESP. TO 7KHz SENS. 98dB               | PRICE £37.59 + £3.50 P&P  |
| 12" 100 WATT C12100TC TWIN CONE) HIGH POWER WIDE RESPONSE, P.A., VOICE, DISCO RES. FREQ. 45Hz FREQ. RESP. TO 14KHz SENS. 100dB | PRICE £38.58 + £3.50 P&P  |
| 12" 200 WATT C12200B HIGH POWER BASS, KEYBOARDS, DISCO, P.A. RES. FREQ. 40Hz FREQ. RESP. TO 7KHz SENS. 100dB                   | PRICE £65.79 + £3.50 P&P  |
| 12" 300 WATT C12300GP HIGH POWER BASS LEAD GUITAR, KEYBOARDS, DISCO, ETC. RES. FREQ. 45Hz FREQ. RESP. TO 5KHz SENS. 100dB      | PRICE £87.51 + £3.50 P&P  |
| 15" 100 WATT C15100BS BASS GUITAR, LOW FREQUENCY, P.A., DISCO RES. FREQ. 40Hz FREQ. RESP. TO 5KHz SENS. 99dB                   | PRICE £55.05 + £4.00 P&P  |
| 15" 200 WATT C15200BS VERY HIGH POWER BASS RES. FREQ. 40Hz FREQ. RESP. TO 4KHz SENS. 99dB                                      | PRICE £75.10 + £4.00 P&P  |
| 15" 250 WATT C15250BS VERY HIGH POWER BASS RES. FREQ. 40Hz FREQ. RESP. TO 4KHz SENS. 99dB                                      | PRICE £82.54 + £4.50 P&P  |
| 15" 400 WATT C15400BS VERY HIGH POWER, LOW FREQUENCY BASS RES. FREQ. 40Hz FREQ. RESP. TO 4KHz SENS. 102dB                      | PRICE £96.47 + £4.50 P&P  |
| 18" 400 WATT C18400BS EXTREMELY HIGH POWER, LOW FREQUENCY BASS RES. FREQ. 27Hz FREQ. RESP. TO 3KHz SENS. 99dB                  | PRICE £172.06 + £5.00 P&P |

### EARBENDERS:— HI-FI, STUDIO, IN-CAR, ETC.

- ALL EARBENDER UNITS 8 OHMS** (Except EB8-50 & EB10-50 which are dual impedance tapped at 4 & 8 ohm)
- BASS, SINGLE CONE, HIGH COMPLIANCE, ROLLED FOAM SURROUND**
- |   |                          |
|---|--------------------------|
| 8" 50 WATT EB8-50 DUAL IMPEDENCE, TAPPED 4/8 OHM BASS, HI-FI, IN-CAR RES. FREQ. 40Hz FREQ. RESP. TO 7KHz SENS. 97dB   | PRICE £8.90 + £2.00 P&P  |
| 10" 50 WATT EB10-50 DUAL IMPEDENCE, TAPPED 4/8 OHM BASS, HI-FI, IN-CAR RES. FREQ. 40Hz FREQ. RESP. TO 5KHz SENS. 99dB | PRICE £12.00 + £2.50 P&P |
| 10" 100 WATT EB10-100 BASS, HI-FI, STUDIO RES. FREQ. 35Hz FREQ. RESP. TO 3KHz SENS. 96dB                              | PRICE £27.76 + £3.50 P&P |
| 12" 60 WATT EB12-60 BASS, HI-FI, STUDIO RES. FREQ. 28Hz FREQ. RESP. TO 3KHz SENS. 92dB                                | PRICE £21.00 + £3.00 P&P |
| 12" 100 WATT EB12-100 BASS, STUDIO, HI-FI, EXCELLENT DISCO RES. FREQ. 26Hz FREQ. RESP. TO 3KHz SENS. 93dB             | PRICE £38.75 + £3.50 P&P |
- FULL RANGE TWIN CONE, HIGH COMPLIANCE, ROLLED SURROUND**
- |  |                          |
|--|--------------------------|
| 5 1/2" 60 WATT EB5-60TC (TWIN CONE) HI-FI, MULTI-ARRAY DISCO ETC RES. FREQ. 63Hz FREQ. RESP. TO 20KHz SENS. 92dB | PRICE £9.99 + £1.50 P&P  |
| 6 1/2" 60 WATT EB6-60TC (TWIN CONE) HI-FI, MULTI-ARRAY DISCO ETC RES. FREQ. 30Hz FREQ. RESP. TO 20KHz SENS. 94dB | PRICE £10.99 + £1.50 P&P |
| 8" 60 WATT EB8-60TC (TWIN CONE) HI-FI, MULTI-ARRAY DISCO ETC RES. FREQ. 40Hz FREQ. RESP. TO 18KHz SENS. 89dB     | PRICE £12.99 + £1.50 P&P |
| 10" 60 WATT EB10-60TC (TWIN CONE) HI-FI, MULTI-ARRAY DISCO ETC RES. FREQ. 35Hz FREQ. RESP. TO 12KHz SENS. 86dB   | PRICE £16.49 + £2.00 P&P |

## TRANSMITTER HOBBY KITS

**PROVEN TRANSMITTER DESIGNS INCLUDING GLASS FIBRE PRINTED CIRCUIT BOARD AND HIGH QUALITY COMPONENTS COMPLETE WITH CIRCUIT AND INSTRUCTIONS**

- 3W FM TRANSMITTER** 80-108MHz VARICAP CONTROLLED PROFESSIONAL PER. FORMANCE RANGE UP TO 3 MILES. SIZE 38 x 123mm. SUPPLY 12V @ 0.5AMP. **PRICE £14.49 + £1.00 P&P**
- FM MICRO TRANSMITTER (BUG)** 100-108MHz VARICAP TUNED COMPLETE WITH VERY SENS FET MIC. RANGE 100-300m. SIZE 56 x 46mm. SUPPLY 9V BATT. **PRICE £8.62 + £1.00 P&P**

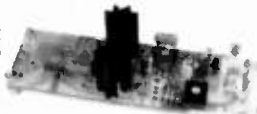

3 watt FM Transmitter



POSTAL CHARGES PER ORDER £1.00 MINIMUM. OFFICIAL ORDERS WELCOME FROM SCHOOLS, COLLEGES, GOVT. BODIES, ETC. PRICES INCLUSIVE OF V.A.T. SALES COUNTER. VISA ACCESS ACCEPTED BY POST, PHONE OR FAX.



\* PRICES INCLUDE V.A.T. \* PROMPT DELIVERIES \* FRIENDLY SERVICE \* LARGE S.A.E., 30p STAMPED FOR CURRENT LIST.

## OMP VARISPEED TURNABLE CHASSIS



★ MANUAL ARM ★ STEEL CHASSIS ★ ELECTRONIC SPEED CONTROL 33 & 45 ★ WARI PITCH CONTROL ★ HIGH TORQUE SERVO DRIVEN DC MOTOR ★ TRANSIT SCREWS ★ 12" DIE CAST PLATTER ★ NEON STROBE ★ CALIBRATED BAL WEIGHT ★ REMOVABLE HEAD SHELL ★ CARTRIDGE FIXINGS ★ CUE LEVER ★ POWER 220 240V 50 60Hz ★ 390 x 305mm ★ SUPPLIED WITH MOUNTING CUT-OUT TEMPLATE

**PRICE £59.99 + £3.50 P&P.**

### OPTIONAL MAGNETIC CARTRIDGES

**STANTON AL500**  
PRICE £16.99 + 50p P&P

**GOLDRING G850**  
PRICE £6.99 + 50p P&P

## OMP MOS-FET POWER AMPLIFIERS, HIGH POWER, TWO CHANNEL 19 INCH RACK

**THOUSANDS PURCHASED BY PROFESSIONAL USERS**



### NEW MXF SERIES OF POWER AMPLIFIERS

THREE MODELS:— MXF200 (100w + 100w)  
MXF400 (200w + 200w) MXF600 (300w + 300w)

All power ratings R.M.S. into 4 ohms.

**FEATURES:** ★ Independent power supplies with two Toroidal Transformers ★ Twin L.E.D. Vu meters ★ Rotary indexed level controls ★ Illuminated on/off switch ★ XLR connectors ★ Standard 775mV inputs ★ Open and short circuit proof ★ Latest Mos-Fets for stress free power delivery into virtually any load ★ High slew rate ★ Very low distortion ★ Aluminum cases ★ MXF600 Fan Cooled with D.C. Loudspeaker and Thermal Protection.

**USED THE WORLD OVER IN CLUBS, PUBS, CINEMAS, DISCOS ETC.**

SIZES:— MXF 200 W19" x H3 1/2" (2U) x D11"  
MXF 400 W19" x H5 1/4" (3U) x D12"  
MXF 600 W19" x H5 1/4" (3U) x D13"

**PRICES: MXF200 £171.35**

**MXF400 £228.85**

**MXF600 £322.00**

SECURICOR DELIVERY £12.00 EACH

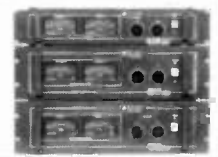

## OMP LINNET LOUDSPEAKERS

THE VERY BEST IN QUALITY AND VALUE



MADE ESPECIALLY TO SUIT TODAY'S NEED FOR COMPACTNESS WITH HIGH OUTPUT SOUND LEVELS. FINISHED IN HARDWEARING BLACK VINYLIDE WITH PROTECTIVE CORNERS GRILLE AND CARRYING HANDLE INCORPORATES 12 DRIVER PLUS HIGH FREQ HORN FOR FULL FREQ RANGE 45Hz-20KHz BOTH MODELS 8 OHM. SIZE H18" x W15" x D12"

CHOICE OF TWO MODELS

POWER RATINGS QUOTED IN WATTS RMS FOR EACH CABINET

OMP 12-100 (100W 100dB) PRICE £159.99 PER PAIR

OMP 12-200 (200W 102dB) PRICE £209.99 PER PAIR

SECURICOR DEL. — £12.00 PER PAIR

## IN CAR STEREO BOOSTER AMPLIFIER

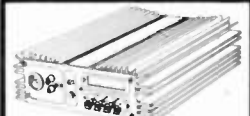

**TWO SUPERB HIGH POWER CAR STEREO BOOSTER AMPLIFIERS**

150 WATTS (75+75) INTO 4 OHMS  
300 WATTS (150+150) INTO 4 OHMS  
FEATURES:  
• HIGH & LOW INPUT IMPEDANCES  
• HIGH & LOW INPUT SENSITIVITIES  
• VARIABLE INPUT GAIN CONTROL  
• SHORT CIRCUIT OUTPUT PROTECTION  
• POWER REQUIREMENT 12V D.C.  
PRICES: 150 WATT £43.00  
300 WATT £95.00 + £3.00 P&P EACH

## PIEZO ELECTRIC TWEETERS—MOTOROLA

Join the Piezo revolution! The low dynamic mass (no voice coil) of a Piezo tweeter produces an improved transient response with a lower distortion level than ordinary dynamic tweeters. As a crossover is not required these units can be added to existing speaker systems of up to 100 watts (more if 2 put in series) **FREE EXPLANATORY LEAFLETS SUPPLIED WITH EACH TWEETER.**

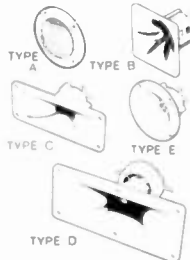

**TYPE 'A'** (KSN2036A) 3" round with protective wire mesh. Ideal for bookshelf and medium sized Hi-Fi speakers. **Price £4.90 each + 50p P&P**

**TYPE 'B'** (KSN1005A) 3 1/2" super horn. For general purpose speakers, disco and P.A. systems etc. **Price £5.99 each + 50p P&P**

**TYPE 'C'** (KSN6016A) 2" x 5" wide dispersion horn. For quality Hi-Fi systems and quality discos etc. **Price £6.99 each + 50p P&P**

**TYPE 'D'** (KSN1025A) 2" x 6" wide dispersion horn. Upper frequency response retained extending down to mid range (2KHz). Suitable for high quality Hi-Fi systems and quality discos. **Price £9.99 each + 50p P&P**

**TYPE 'E'** (KSN1038A) 3 1/2" horn tweeter with attractive silver finish trim. Suitable for Hi-Fi monitor systems etc. **Price £5.99 each + 50p P&P**

**LEVEL CONTROL** Combines on a recessed mounting plate, level control and cabinet input jack socket 85 x 85mm. **Price £3.99 + 50p P&P**

## STEREO DISCO MIXER

**STEREO DISCO MIXER** with 2 x 5 band L & R graphic equalisers and twin 10 segment L.E.D. Vu Meters. Many outstanding features 5 Inputs with individual faders providing a useful combination of the following:—  
3 Turntables (Mag), 3 Mics, 4 Line including CD plus Mic with talk over switch Headphone Monitor Pan Pot L & R Master Output controls. Output 775mV. Size 360 x 280 x 90mm. Supply 220-240V.

**Price £134.99 — £4.00 P&P**

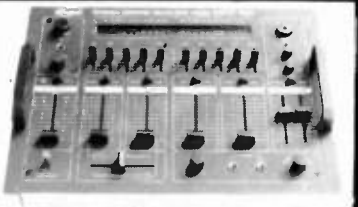

**B. K. ELECTRONICS** Dept EE

UNIT 5, COMET WAY, SOUTHEND-ON-SEA, ESSEX. SS2 6TR  
TEL: 0702-527572 FAX: 0702-420243

1991 BUYER'S GUIDE TO ELECTRONIC COMPONENTS

# Maplin

FEATURING:  
AN ELECTRONICS  
CAST OF  
THOUSANDS!

POWER-PACKED  
WITH OVER  
600 PAGES!!

STARRING  
HUNDREDS OF  
NEW PRODUCTS  
AT SUPER  
LOW PRICES!

**SHOWING NOW!**  
at your local  
WHSMITH



ROD BROWN '90

PERFORMANCES DAILY  
At your local branch  
of WHSMITH  
**ONLY £2.45**

**Order you copy of the New MAPLIN Catalogue on sale NOW**  
Pick up a copy from any WHSMITH for just £2.45 or post this coupon now to receive your  
copy for just £2.45 + 50p p&p. If you live outside the UK, send £4.85 or  
20 International Reply Coupons. I enclose £2.95.

Name \_\_\_\_\_  
Address \_\_\_\_\_  
Post Code \_\_\_\_\_  
Send to Maplin Electronics,  
P.O. Box 3, Royleigh,  
Essex SS6 8LR.  
EE91