

**EVERYDAY**

**AUGUST 1989**

# **ELECTRONICS**

**INCORPORATING ELECTRONICS MONTHLY**

**£1.40**

---

**TREASURE  
LOCATOR**

---

**DISTANCE  
RECORDER**

---

**ELECTRONIC  
LEVEL**

---

**ROBOTICS • AMATEUR RADIO • BOOKS •  
THEORY • DESIGN**

**The Magazine for Electronic & Computer Projects**



### No. 1 LIST BAKERS DOZEN PACKS

All packs are £1 each, if you order 12 then you are entitled to another free. Please state which one you want. Note the figure on the extreme left of the pack ref number and the next figure is the quantity of items in the pack, finally a short description.

- BD2 5 13A spurs provide a fused outlet to a ring main where devices such as a clock must not be switched off.
- BD7 4 In flex switches with neon on/off lights, saves leaving things switched on.
- BD9 2 6V 1A mains transformers upright mounting with fixing dampers.
- BD11 1 6 1/2in speaker cabinet ideal for extensions, takes our speaker. Ref BD137.
- BD13 12 30 watt reed switches, it's surprising what you can make with these—burglar alarms, secret switches, relay, etc., etc.
- BD22 2 25 watt loudspeaker two unit crossovers.
- BD29 1 B.O.A.C. stereo unit is wonderful breakdown value.
- BD30 2 Nicad constant current chargers adapt to charge almost any nicad battery.
- BD32 2 Humidity switches, as the air becomes damper the membrane stretches and operates a microswitch.
- BD42 5 13A rocker switch three tags so on/off, or change over with centre off.
- BD45 1 24hr time switch, ex-Electricity Board, automatically adjust for lengthening and shortening day. original cost £40 each.
- BD49 10 Neon valves, with series resistor, these make good night lights.
- BD56 1 Mini uniselector, one use is for an electric jigsaw puzzle, we give circuit diagram for this. One pulse into motor, moves switch through one pole.
- BD59 2 Flat solenoids—you could make your multi-tester read AC amps with this.
- BD67 1 Suck or blow operated pressure switch, or it can be operated by any low pressure variation such as water level in water tanks.
- BD91 1 Mains operated motors with gearbox. Final speed 16rpm, 2 watt rated.
- BD103A 1 6V 750mA power supply, nicely cased with mains input and 6V output leads.
- BD120 2 Stripper boards, each contains a 400V 2A bridge rectifier and 14 other diodes and rectifiers as well as dozens of condensers, etc.
- BD122 10m Twin screened flex with white pvc cover.
- BD128 10 Very fine drills for pcb boards etc. Normal cost about 80p each.
- BD132 2 Plastic boxes approx 3in cube with square hole through top so ideal for interrupted beam switch.
- BD134 10 Motors for model aeroplanes, spin to start so needs no switch.
- BD139 6 Microphone inserts—magnetic 400 ohm also act as speakers.
- BD148 4 Reed relay kits, you get 16 reed switches and 4 coil sets with notes on making c/o relays and other gadgets.
- BD149 6 Safety cover for 13A sockets—prevent those inquisitive little fingers getting nasty shocks.
- BD180 6 Neon indicators in panel mounting holders with lens.
- BD193 6 5 amp 3 pin flush mounting sockets make a low cost disco panel.
- BD196 1 in flex simmerstat—keeps your soldering iron etc. always at the ready.
- BD199 1 Mains solenoid, very powerful, has 1in pull or could push if modified.
- BD201 8 Keyboard switches—made for computers but have many other applications.
- BD210 4 Transistors type 2N3055, probably the most useful power transistor.
- BD211 1 Electric clock, mains operated, put this in a box and you need never be late.
- BD221 5 12V alarms, make a noise about as loud as a car horn. Slightly soiled but OK.
- BD242 2 6in x 4in speakers, 4 ohm made from Radiomobile so very good quality.
- BD252 1 Panostat, controls output of boiling ring from simmer up boil.
- BD259 50 Leads with push-on 1/4in tags—a must for hook-ups—mains connections etc.
- BD263 2 Oblong push switches for bell or chimes, these can mains up to 5 amps so could be foot switch if fitted into patress.
- BD268 1 Mini 1 watt amp for record player. Will also change speed of record player motor.
- BD283 3 Mild steel boxes approx 3in x 3in x 1in deep—standard electrical.
- BD293 50 Mixed silicon diodes.
- BD305 1 Tubular dynamic mic with optional table rest.

**CAMERAS.** Three cameras, all by famous makers, Kodak etc. One disc, one 35mm and one instamatic. All in first class condition, believed to be in perfect working order, but sold as untested. You can have the three for £10 including VAT, which must be a bargain—if only for the lenses, flash gear, etc. Our ref 10P58.

**675 VOLT MAINS TRANSFORMER** PCB mounting, 20VA. A very well made (British) transformer. Ideal for laser power supply, etc. Price £4. Our ref 4P38.

**EXTRA SPECIAL CROC CLIPS** Medium size, just right for most hook-ups. Normally sell for around 10p to 15p each. These are insulated and have a length of spring rod connected to them but this is very easy to snip off if you do not need it. 20 for £1. Our ref BD117A.

**COPPER CLAD PANEL** for making PCB. Size approx 12in long x 8 1/2in wide. Double-sided on fibreglass middle which is quite thick (about 1/16in) so this would support quite heavy components and could even form a chassis to hold a mains transformer, etc. Price £1 each. Our ref BD683.

### POWERFUL IONISER

Generates approx. 10 times more IONS than the ETI and similar circuits. Will refresh your home, office, workroom etc. Makes you feel better and work harder—a complete mains operated kit, case included. £12.50+£2 P&P. Our ref 12P5.1.

**MODERN TELEPHONES.** Two-piece push-button desk or wall mounting telephone. Fitted with standard BT flat plug for immediate use. Standard model £8. Our ref 8P31. Or similar but with 10 memory feature £10. Our ref 10P68. If not collecting add £2 for special packing.

**BUSH RADIO MIDI SPEAKERS** Stereo pair. BASS reflex system, using a full range 4in driver of 40ohms impedance. Mounted in very nicely made black fronted walnut finish cabinets. Cabinet size approx 8 1/2in wide, 14in high and 3 1/2in deep. Fitted with a good length of speaker flex and terminating with a normal audio plug. Price £5 the pair plus £1 post. Our ref 5P141.



assemble but you may have to help with the soldering of the components on the pcb. Complete kit £8. Our ref 8P30.

### ELECTRONIC SPACESHIP.

Sound and impact controlled, responds to claps and shouts and reverses when it hits anything. Kit with really detailed instructions. Ideal present for budding young electrician. A youngster should be able to assemble but you may have to help with the soldering of the components on the pcb. Complete kit £8. Our ref 8P30.

**DATA RECORDER FOR COMPUTERS** For playing games or for listening to music cassettes. It has a built-in condenser microphone and loudspeaker (muted if you use the extension socket). Has the following controls: pause, stop/eject, fast forward, rewind, play and record. Also has built-in tape counter, extension headphone and microphone socket and volume control. Built-in power supply enables it to run from the mains but provision also for battery operation. In 'as new' condition, but customer returns so may have fault. Price only £10 and if you order 4 you get a fifth one free. Our ref 10P65.

**3 1/2in FLOPPY DISC DRIVE—DOUBLE SIDED, DOUBLE DENSITY, 80 TRACK** Shugart compatible. Has 34 way IDC connector and will interface with almost any computer. Made by the famous Japanese NEC Company. Price £59.50 plus £3 insured post.



**ATARI 65XE COMPUTER** AT 64K this is most powerful and suitable for home and business. Complete with PSU, TV lead, owner's manual and six games. Can be yours for only £45 plus £3 insured delivery.

**65XE COMPENDIUM** Contains: 65XE Computer, its data recorder XCI2 and its joystick, with ten games for £62.50 plus £4 insured delivery.

**AGAIN AVAILABLE: ASTEC PSU.** Magnetically switched mode, so very compact. Outputs +12V 2.5A, +5V 6A, ±5V 5A, ±12V 5A. Size: 7 1/4in long x 4 3/4in wide x 2 3/4in high. Cased ready for use. Brand new. Normal price £30—, our price only £10. Our ref 10P34.

**VERY POWERFUL 12 VOLT MOTORS.** 1/3rd Horsepower. Made to drive the Sinclair C5 electric car but adaptable to power a go-kart, a mower, a rail car, model railway, etc. Brand new. Price £15 plus £2 postage. Our ref 15P8.

### PHILIPS LASER

This is helium-neon and has a power rating of 2mW. Completely safe so long as you do not look directly into the beam when eye damage could result. Brand new, full spec, £30 plus £3 insured delivery. Mains operated power supply for this tube gives 8kv striking and 1.25kv at 5mA running. Complete kit with case £15. Battery operated P.S.U. now available at £15.

**BATTERY DRIVEN LASER POWER SUPPLY** This is available in three versions. First: is a cased unit which holds the power supply and is fed from a separate 12 volt battery and drives the laser through extension leads. Kit complete with ABS case. Price £15. Our ref 15P22. Second: is a metal cased unit which holds the power supply and the laser but is driven from an external 12 volt battery. This unit, in kit form, costs £18. Our ref 18P2. A conversion kit from 15P22 to 18P2 is £6. Our ref 6P14. Third: is a metal cased unit which holds the laser, its power supply and 2x6 volt rechargeable batteries which feed it, also the mains driven unit to recharge the batteries. Complete kit is £24. Our ref 24P2.

**MONO RADIO CASSETTE RECORDER** AM/FM with all the normal controls. In 'as new' condition but customer returns or shop rejects, so may need attention. Price £10. Order 5 of these and get a sixth one free. Our ref 10P66.

**PRETTY CASSETTE PLAYER** in handy carrying pouch with silk type shoulder cord. Ideal present for a young girl. New, tested and in perfect order. Just needs headphones and batteries. Price £4. Our ref 4P35.

**HIGH RESOLUTION MONITOR.** 9in black and white, used Philips tube M24306W. Made up in a lacquered frame and has open sides. Made for use with OPD computer but suitable for most others. Brand new. £16 plus £5 post. Our ref 16P1.

**12 VOLT BRUSHLESS FAN.** Japanese made. The popular square shape (4 1/2in x 4 1/2in x 1 3/4in). The electronically run fans not only consume very little current but also they do not cause interference as the brush type motors do. Ideal for cooling computers, etc., or for a caravan. £8 each. Our ref 8P26.

### FDD BARGAIN

3 1/2in made by Chicon of Japan. Single sided, 80 track. Shugart compatible interface, interchangeable with most other 3 1/2in and 5 1/4in drives. Completely cased with 4 pin power lead and 34 pin computer lead £40 plus £3 insured delivery. Our ref 40P1.

**MINI MONO AMP** on p.c.b. size 4" x 2" (app.) Fitted Volume control and a hole for a tone control should you require it. The amplifier has three transistors and we estimate the output to be 3W rms. More technical data will be included with the amp. Brand new, perfect condition, offered at the very low price of £1.15 each, or 13 for £12.00.



### J & N BULL ELECTRICAL

Dept. E.E., 250 PORTLAND ROAD, HOVE, BRIGHTON, SUSSEX BN3 5QT

**MAIL ORDER TERMS:** Cash, PO or cheque with order. Orders under £20 add £1.50 service charge. Monthly account orders accepted from schools and public companies. Access and Bcard orders accepted. —minimum £5. Phone (0273) 734648 or 203500.

### POPULAR ITEMS

Some of the many items described in our current list which you will receive if you request it

**BATTERY OPERATED TRAVEL MECHANISM.** On a plastic panel measuring approx 9in x 3 1/2in. Is driven by a reversible 12V battery motor, fitted with pulley and belt which rotates a threaded rod and causes a platform to travel backwards and forwards through a distance of approx 5in. Price £5. Our ref 5P140.

**MAINS OPERATED WATER VALVE** with hose connection for inlet and outlet suitable for low pressure. Auto plant watering, etc. Only £1 each. Our ref BD370.

**20VOLT 4AMP MAINS TRANSFORMER.** Upright mounting with fixing feet. Price £3. Our ref 3P59.

**12VOLT SOLENOID.** Has good 1/2in pull or could be made to push if fitted with a rod. Approx. 1 1/2in long by 1in square. Price £1. Our ref BD232A.

**16OHM PM SPEAKERS.** Approx 7in x 4in. 5 watts. Offered at a very low price so you can use two in parallel to give you 10 watts at 8 ohms. £1 for the two. Our ref BD684.

**EHT TRANSFORMER** 4kv 2mA Ex-unused equipment. £5. Our ref 5P139.

**FOIL CAPACITORS** Axial ended. 33uf 1000v. 4 for £1. Our ref BD672. Many other sizes in stock, send for May newsletter

**4 CORE TINSEL COPPER LEAD** As fitted to telephones, terminating with flat BT plug. 2 for £1. Our ref BD639

**EHT TRANSFORMER** 8kv 3mA. £10. Our ref 10P56

**DOUBLE MICRODRIVES.** We are pleased to advise you that the Double Microdrives which we were offering at about this time last year as being suitable for the 'QL', 'OPD' and several other computers are again available, same price as before namely £5. Our ref 5P13.

**VERY USEFUL MAGNETS.** Flat, about 1in long, 1/2in wide and 1/4in thick. Very powerful. 6 for £1. Our ref BD247(a).

**ACORN COMPUTER DATA RECORDER REF ALF03** Made for the Electron or BBC computers but suitable for most others. Complete with mains adaptor, leads and handbook £10. Our ref 10P44. Plus £2 special packing.

**FREE POWER!** Can be yours if you use our solar cells—sturdily made modules with new system bubble magnifiers to concentrate the light and so eliminate the need for actual sunshine—they work just as well in bright light. Voltage input is 45—you join in series to get desired voltage—and in parallel for more amps. Module A gives 100mA, Price £1. Our ref BD631. Module C gives 400mA, Price £2. Our ref 2P199. Module D gives 700mA. Price £6. Our ref 6P3

**SOLAR POWERED NI-CAD CHARGER** 4 Ni-Cad batteries AA (HP7) charged in eight hours or two in only 4 hours. It is a complete, boxed ready to use unit. Price £6. Our ref 6P3.

**METAL PROJECT BOX** Ideal size for battery charger, power supply, etc.; sprayed grey, size 8in x 4 1/4in x 4in high, ends are louvered for ventilation other sides are flat and undrilled. Price £2. Order ref 2P191.

**4-CORE FLEX CABLE.** Cores separately insulated and grey PVC covered overall. Each copper core size 7/0.2mm. Ideal for long telephone runs or similar applications even at mains voltage. 20 metres £2. Our ref 2P196 or 100 metres coil £8. Order ref 8P19.

**6-CORE FLEX CABLE.** Description same as the 4-core above. Price 15 metres for £2. Our ref 2P197 or 100 metres £9. Our ref 9P1.

**13A PLUGS** Pins sleeved for extra safety, parcel of 5 for £2. Order ref 2P186.

**13A ADAPTERS** Takes 2 13A plugs, packet of 3 for £2. Order ref 2P187.

**20V-0-20V Mains transformers** 2 1/2 amp (100 watt) loading, tapped primary. 200-245 upright mountings £4. Order ref 4P24.

**BURGLAR ALARM BELL—6"** good OK for outside use if protected from rain. 12V battery operated. Price £8. Ref. 8P2.

**CAPACITOR BARGAIN**—axial ended, 4700uF at 25V. Jap made, normally 50p each, you get 4 for £1. Our ref 6P13.

**SINGLE SCREENED FLEX** 7.02 copper conductors, pvc insulated then with copper screen, finally outer insulation. In fact quite normal screened flex. 10m for £1. Our ref BD668.

**M.E.S. BULB HOLDERS** Circular base batten type fitting. 4 for £1. Our ref BD127a.

**SPRING LOADED TEST PRODS**—Heavy duty, made by the famous Bulgain company. very good quality. Price 4 for £1. Ref. BD597.

**3-CORE FLEX BARGAIN No. 1**—Core size 5mm so ideal for long extension leads carrying up to 5 amps or short leads up to 10 amps. 15mm for £2. ref. 2P189.

**3-CORE FLEX BARGAIN No. 2**—Core size 1.25mm so suitable for long extension leads carrying up to 13 amps, or short leads up to 25A. 10m for £2. Ref. 2P190.

**ALPHA-NUMERIC KEYBOARD**—This keyboard has 73 keys giving trouble free life and no contact bounce. The keys are arranged in two groups, the main area is a QWERTY array and on the right is a 15 key number pad, board size is approx. 13" x 4"—brand new but offered at only a fraction of its cost, namely £3, plus £1 post. Ref. 3P27.

**WIRE BARGAIN**—500 metres 0.7mm solid copper tinned and p.v.c. covered. Only £3 plus £1 post. Ref. 3P31—that's well under 1p per metre, and this wire is ideal for push on connections.

**1/8th HORSEPOWER 12 VOLT MOTOR** Made by Smiths, the body length of this is approximately 3in, the diameter 3in and the spindle 5/16th of an inch diameter. It has a centre flange for fixing or can be fixed from the end by means of 2 nuts. A very powerful little motor which revs at 3,000rpm. We have a large quantity of them so if you have any projects in mind then you could rely on supplies for at least two years. Price £6. Our ref 6P1. discount for quantities of 10 or more.

**3 VOLT MOTOR** Very low current so should be very suitable for working with solar cells. £1 each. Our ref BD681.

**MINI SPEAKERS** to use instead of headphones with your personal stereo—simply plug in to earphone socket. Excellent sound quality, only £4 per pair. Our ref 4P34.

**INNER EAR STEREO HEADPHONES** Ideal for lady listeners as they will not mess up your hair! Come complete in a neat carrying case. Price £3. Our ref 3P56.

**STEREO HEADPHONE AMPLIFIER** Very sensitive. A magnetic cartridge or tape head will drive it. Has volume control and socket for stereo headphones. 3V battery operated. £1 each. Our ref BD680.

**FET CAPACITOR MICROPHONE** EAGLE CI.200 Output equivalent to a high class dynamic microphone while retaining the characteristics of a capacitor microphone. Price £1. Our ref BD646.

**SUB-MIN TOGGLE SWITCH** Body size 8mm x 4mm x 7mm SBDT with chrome dolly fixing nuts. 4 for £1. Our ref BD649.

**SUB-MIN PUSH SWITCH DPDT.** Single hole fixing by hexagonal nut. 3 for £1. Our ref BD650.

**DISPLAY 16 CHARACTER 2 LINE** As used in telephone answering and similar machines. Screen size 85mm x 36mm x 9.3mm. Alpha-numeric, dot matrix module with integral CMOS micro processor. LCD display. Made by the EPSON Company, reference 16027AR. Price £10. Our ref 10P50.

ISSN 0262-3617

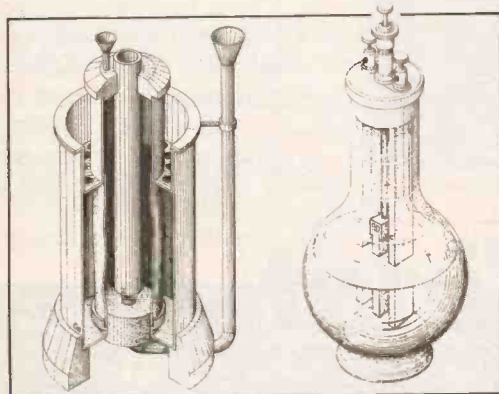
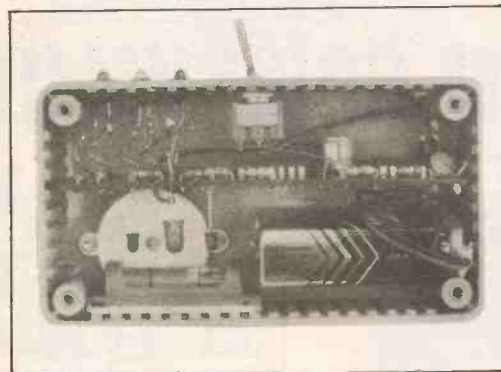
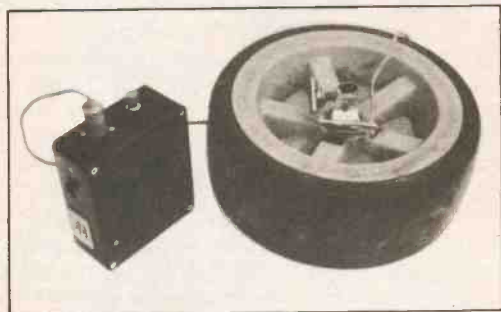
PROJECTS ... THEORY ... NEWS ...  
COMMENT ... POPULAR FEATURES ...

© Wimborne Publishing Ltd 1989. Copyright in all drawings, photographs and articles published in EVERYDAY ELECTRONICS is fully protected, and reproduction or imitations in whole or in part are expressly forbidden.

Our September '89 Issue will be published on Friday, 4 August 1989. See page 483 for details. EveryDay Electronics, August 1989

## Projects

- EE TREASURE HUNTER** by Mark Stuart **488**  
For a relatively small outlay you could uncover a "Treasure-Trove".
- DISTANCE RECORDER** by P. Lewis **496**  
Improve your awareness of distances. Ideal practice aid for the golfer.
- TWO LED FLASHER** by Chris Bowes **508**  
The classic Multivibrator in action — A "pocket money" project.
- ELECTRONIC SPIRIT LEVEL** by Peter Cartwright **524**  
An audio/visual aid for the DIY enthusiast.
- PULSATING ALARM** by Chris Bowes **530**  
A very simple and inexpensive unit that produces a series of pulsating sounds.

## Series

- STABILIZED POWER SUPPLIES** by Steve Knight **502**  
Part Two: Zener diodes and voltage regulators.
- ON SPEC** By Mike Tooley **506**  
Readers' Sinclair Spectrum page.
- AMATEUR RADIO** by Tony Smith G4FA1 **515**  
New DXCC Country; Scouts and Amateur Radio.
- INTRODUCING DIGITAL ELECTRONICS** by Mike Cockcroft **516**  
Part Eleven: Combinational Logic.
- BBC MICRO** by R. A. Penfold and J. W. Penfold **528**  
Regular spot for BEEB fanatics.
- ROBOT ROUNDUP** by Nigel Clark **537**  
Investigating the world of robotics.
- ACTUALLY DOING IT** by Robert Penfold **538**  
Heatsinks.

## Features

- EDITORIAL** **487**
- IMAGE OF LIFE** by Graham Hough **493**  
A short history of the evolution of the battery — 1800 to 1900.
- FOR YOUR ENTERTAINMENT** by Barry Fox **501**  
Program for Chaos; Expensive Toy; Pocket Computer.
- SHOPTALK** by David Barrington **507**  
Product news and component buying.
- MARKET PLACE** **510**  
Free readers' buy and sell spot
- DIRECT BOOK SERVICE** **534**  
Special service to EE readers
- PRINTED CIRCUIT BOARD SERVICE** **540**
- ADVERTISERS INDEX** **544**

Readers' Services • Editorial and Advertisement Departments

487

481

# TRANSFORMERS FROM JAYTEE

## The UK Distributor for Standard Toroidal Transformers

- \* 106 types available from stock
- \* Sizes from 15VA to 625VA
- \* Dual 120v primaries allowing 110/120v or 220/240v operation

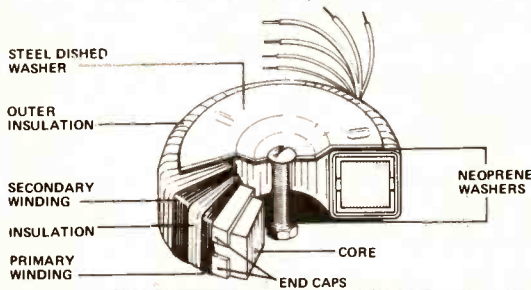

TYPE	SERIES NO.	SEC VOLTS	RMS CURRENT	TYPE	SERIES NO.	SEC VOLTS	RMS CURRENT
15VA £9.30	03010	6+6	1.25	160VA £16.85	53011	9+9	8.89
	03011	9+9	0.83		53012	12+12	6.66
	03012	12+12	0.63		53013	15+15	5.33
	03013	15+15	0.50		53014	18+18	4.44
	03014	18+18	0.42		53015	22+22	3.63
	03015	22+22	0.34		53016	25+25	3.20
	03016	25+25	0.30		53017	30+30	2.66
30VA £10.60	13010	6+6	2.50	53018	35+35	2.28	
	13011	9+9	1.66	53019	40+40	2.00	
	13012	12+12	1.25	53020	110	1.45	
	13013	15+15	1.00	53021	220	0.72	
	13014	18+18	0.83	53022	240	0.66	
	13015	22+22	0.68	225VA £18.40	63012	12+12	9.38
	13016	25+25	0.60		63013	15+15	7.50
13017	30+30	0.50	63014		18+18	6.25	
50VA £12.20	23010	6+6	4.16	63015	22+22	5.11	
	23011	9+9	2.77	63016	25+25	4.50	
	23012	12+12	2.08	63017	30+30	3.75	
	23013	15+15	1.66	63018	35+35	3.21	
	23014	18+18	1.38	63026	40+40	2.81	
	23015	22+22	1.13	63025	45+45	2.50	
	23016	25+25	1.00	63033	50+50	2.25	
	23017	30+30	0.83	63028	110	2.04	
	23028	110	0.45	63029	220	1.02	
	23029	220	0.22	63030	240	0.93	
80VA £13.50	33010	6+6	6.66	300VA £20.10	73013	15+15	10.0
	33011	9+9	4.44		73014	18+18	8.33
	33012	12+12	3.33		73015	22+22	6.82
	33013	15+15	2.66		73016	25+25	6.00
	33014	18+18	2.22		73017	30+30	5.00
	33015	22+22	1.81		73018	35+35	4.28
	33016	25+25	1.60		73026	40+40	3.75
	33017	30+30	1.33	73025	45+45	3.33	
	33028	110	0.72	73033	50+50	3.00	
	33029	220	0.36	73028	110	2.72	
120VA £14.35	43010	6+6	10.0	73029	220	1.36	
	43011	9+9	6.66	73030	240	1.25	
	43012	12+12	5.00	500VA £26.55	83016	25+25	10.0
	43013	15+15	4.00		83017	30+30	8.33
	43014	18+18	3.33		83018	35+35	7.14
	43015	22+22	2.72		83026	40+40	6.25
	43016	25+25	2.40		83025	45+45	5.55
	43017	30+30	2.00	83033	50+50	5.00	
	43018	35+35	1.71	83042	55+55	4.54	
	43028	110	1.09	83028	110	4.54	
43029	220	0.54	83029	220	2.27		
43030	240	0.50	83030	240	2.08		
				625VA £29.30	93017	30+30	10.41
					93018	35+35	8.92
					93026	40+40	7.81
					93025	45+45	6.94
					93033	50+50	6.25
					93042	55+55	5.68
				93028	110	5.68	
				93029	220	2.84	
				93030	240	2.60	



Prices include VAT and carriage

Quantity prices available on request  
Write or phone for free Data Pack

### Jaytee Electronic Services

143 Reculver Road, Beltinge, Herne Bay, Kent CT6 6PL  
Telephone: (0227) 375254 Fax: 0227 365104

# Cirkit NEWS

JULY 1989

## NEW CAT OUT NOW!

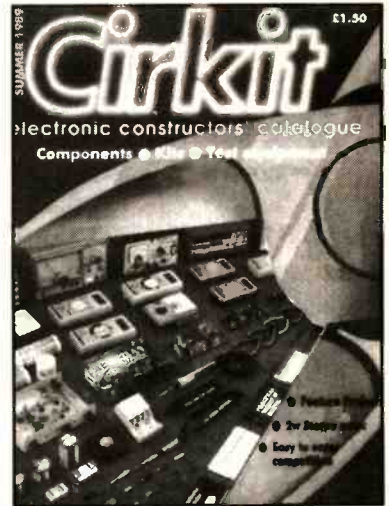

Over 3,000 product lines feature in the Summer 1989 edition of the Cirkit Constructors' Catalogue.

available from most larger newsagents or direct from the company priced at £1.50. The latest books, an RF frequency meter, two new PSU designs and a 3.5MHz converter are among the innovative new kits this issue, while our construction project - a 2 Watt stereo amplifier - is bound to prove an absorbing activity for dedicated constructors. In the test equipment section there's a whole new range of multimeters, a bench DVM and a triple output PSU.

For eagle-eyed readers who enjoy a challenge of a different sort, there is the opportunity of winning an audio signal generator worth more than £180.00 in the latest fiendish competition. All prices now include VAT for quicker, easier ordering; and Cirkit's same-day despatch of all orders, combined with value-for-money discount vouchers, makes the line-up even more attractive.

## D-MM GOOD VALUE!

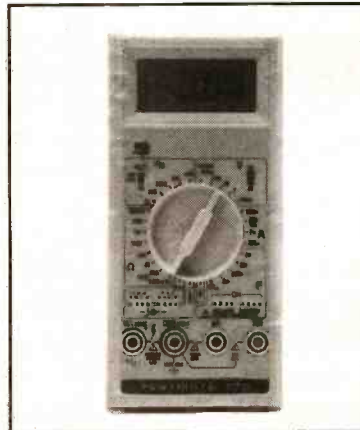

Cirkit's six new digital multimeters are packed with sophisticated extra facilities: capacitance measurement, frequency measurement up to 20MHz, temperature reading, transistor test and logic test in addition to the usual volts, current (DC and AC) and resistance measurement - and all unbeatable value with prices ranging from £20.00 to £55.00!

# Cirkit

### Cirkit Distribution Ltd

Park Lane Broxbourne Herts EN10 7NQ  
Telephone (0992) 444111 Fax (0992) 669021

Also at

53 Burrfields Road Portsmouth Hants PO3 5EB  
Telephone (0705) 669021 Fax (0705) 695485

# **WIN** a fabulous Radio Control 4-Wheel Drive Model Car and Controller **FREE ENTRY** **COMPETITION**

There are **FIVE** Maplin cars and controllers to be won. The first prize comes with a set of rechargeable batteries and a charger. There will be eight consolation prizes of **EE** subscriptions and binders.

Total value of prizes over **£500**



## **XENON BEACON**

This high intensity portable beacon was originally used for locating amateur radio stations on hilltops, alternative uses include mountain and sea rescue and to warn motorists of accidents or breakdown.

The 1.5Hz flash can be seen at up to two miles under favourable conditions.

## **PROBE POCKET TREASURE FINDER**

An indispensable accessory for the keen metal detecting enthusiast. This compact unit can pin point any small object which has been located by a conventional metal detector, saving much time and effort. Single handed, automatic operation ensures a quick, efficient "find".

## **THE MAGIC LAMP**

No, the title's not as misnomer. It describes the derivative of the domestic light bulb that started the entire field of electronics at the turn of the century; the thermionic valve. Far from being obsolete, valves are still extensively used in high power applications, particularly in professional audio power amplifiers and radio and TV broadcast transmitters. We take a look at the development of valves.

# **EVERYDAY ELECTRONICS**

**SEPTEMBER ISSUE ON SALE AUGUST 4 1989**

**EVERYDAY ELECTRONICS**

# SURVEILLANCE PROFESSIONAL QUALITY KITS

A range of high quality kits as supplied to leading UK security companies, all in-house designed and produced, not to be confused with cheap imports. All kits come fully documented with concise assembly and setting-up details, fibreglass PCB and all components. All transmitters are fully tuneable and can be monitored on a normal VHF radio or tuned higher for greater security. All units available ready built if required.

- MTX. Micro-miniature audio transmitter. 17mm x 17mm. 9V operation. 1000m range ..... **£10.95**
- VT500. Hi-power audio transmitter. 250mW output. 20mm x 40mm 9-12V operation. 2-3000m range ..... **£12.95**
- VOX75. Voice activated transmitter. Variable sensitivity. 30mm x 40mm. 9V operation. 1000m range ..... **£15.95**
- CTX900. Sub-carrier scrambled audio transmitter. Cannot be monitored without decoder fitted to radio. 30mm x 40mm. 9V operation. 1000m range ..... **£18.95**
- DSX900. Sub-carrier decoder unit for monitoring CTX900. Connects to radio earphone socket. Provides output for headphones. 35mm x 50mm. 9-12V operation ..... **£17.95**
- HVX400. Mains powered audio transmitter. Connects directly to 240V AC supply. 30mm x 35mm. 500m range ..... **£15.95**
- XT89. Crystal controlled audio transmitter. High performance. 100mW output. Supplied with xtal for 108MHz. Others available to 116MHz. 85mm x 28mm. 9V operation. 2-3000m range ..... **£29.95**
- TKX900. Tracker/Beeper transmitter. Transmits continuous stream of audio pulses. Variable tone and rate. Powerful 200mW output. 63mm x 25mm. 9V operation. 2-3000m range ..... **£18.95**
- ATR2. Micro size telephone recording interface. Connects between telephone line (anywhere) and cassette recorder. Tape switches automatically with use of phone. All conversations recorded. Powered from line 10mm x 35mm ..... **£10.95**
- TLX700. Micro miniature telephone transmitter. Connects to line (anywhere) switches on and off with phone use. All conversations transmitted. 20mm x 20mm. Powered from line 1000m range ..... **£10.95**
- XML900. RF bug detector. Variable sensitivity. Triggers LED and beeper when in presence of RF field. Detects MTX 15-20 feet. 55mm x 55mm. 9V operation ..... **£21.95**
- XL7000. Professional bug detector/locator. Variable sensitivity. Twin mode ten segment LED readout of signal strength with variable rate beeper. Second mode AUDIO CONFIRM distinguishes between localised bug transmission and normal legitimate signal such as pagers, cellular etc. 70mm x 100mm. 9V operation ..... **£49.95**

UK customers please send cheques, PO's or registered cash. Please add £1.50 per order for P&P. Goods despatched ASAP allowing for cheque clearance. Overseas customers send sterling bank draft or Eurocheque and add £5.00 per order for shipment. Credit card orders accepted on 0827 714476. Full catalogue available on receipt of 28p stamp. Trade enquiries welcome.



The Workshops, 95 Main Rd  
Baxterley, Nr. Atherstone  
Warks CV9 2LE



0827 714476

## Z80A MICROCONTROLLER

A low cost single board micro-system providing all the requirements needed for many applications in industrial, experimental and educational fields

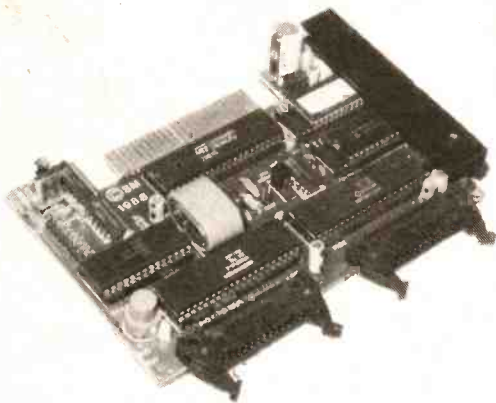

Just some of its extensive features include:

- \* Z80A CPU operating at 4MHz
- \* EPROM socket—jumper link selectable as 2, 4, 8, 16 or 32K accepts 2716/2732/2764/27128/27256 EPROMS
- \* RAM socket—jumper link selectable as 2, 8, 32K accepts 6116/6264/62256 CMOS static RAMS—battery back up included
- \* INPUT/OUTPUT—2 Z80A PIOs providing 32 programmable I/O lines
- \* HARDWARE COUNTER/TIMER—a Z80A CTC providing four independent counter/timer circuits
- \* Expansion boards available—DtoA, 8 channel AtoD, RS232 serial I/O etc
- \* Full documentation and user notes

**Z80A Single Board Controller fitted with 2K x 8 CMOS static RAM  
ONLY £94.95 + VAT—BUILT AND TESTED!!**

Specialising in microprocessor data logging and control applications, we provide a complete service covering any or all of the stages from initial hardware and software design through manufacture to final installation. Phone/send for full details—OEM, trade and overseas enquiries welcome

**SM ENGINEERING**  
Telephone 0323-766262

'St Georges' Lion Hill, Stone Cross  
Pevensey, East Sussex BN24 5ED

## VOICE RECORD/PLAYBACK KIT

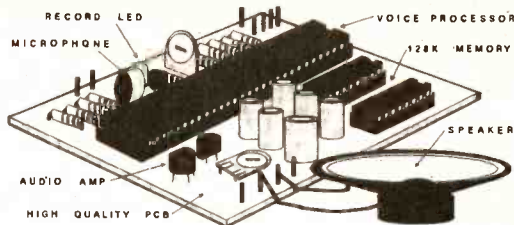

This simple to construct and even simpler to operate kit will record and playback short messages or tunes. It has many uses—seatbelt or lights reminder in the car, welcome messages to visitors at home or at work, warning messages in factories and public places, in fact anywhere where a spoken message is announced and which needs to be changed from time to time. Also suitable for toys—why not convert your daughter's £8 doll to an £80 talking doll!!

Size: ..... 78 x 60 x 15 mm  
Message time: ..... 1-5 secs normal speed, 2-10 secs slow speed

**XX129 ..... £22.50**

## ELECTRONIC WEIGHING SCALES

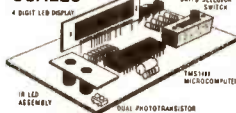

Kit contains a single chip micro-processor, PCB, displays and all electronics to produce a digital LED readout of weight in Kgs or Sls/lbs. A PCB link selects the scale—bathroom/ two types of kitchen scales. A low cost digital ruler could also be made.

ES1 ..... **£6.50**

## SUPER-SENSITIVE MICROBUG

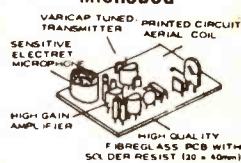

Only 45 x 25 x 15mm, including built-in mic. 88-100MHz (standard FM radio). Range approx. 300m depending on terrain. Powered by 9V PP3 (7mA). Ideal for surveillance, baby alarm etc. .... **£5.50**

## TK ELECTRONICS, 13 Boston Rd, London W7 3SJ.

ORDERING INFORMATION All prices exclude VAT. Free p&p on orders over £50 (UK only), otherwise add £1+Vat. Overseas (a.p.) Europe £3.50 elsewhere £10. Send cheque/PO/Barclaycard/Access No. with order. Giro No. 529314002. Local authority and export orders welcome. Goods by return subject to availability.

**ORDERS: 01-5678910 - 24 HOURS**

## TWO GREAT HOBBIES

ONLY  
**£124.50**  
INC VAT



## ... IN ONE GREAT KIT!

The K5000 Metal Detector Kit combines the challenge of DIY Electronics assembly with the reward and excitement of discovering Britain's buried past.

THE KIT—simplified assembly techniques require little technical knowledge and no complex electronic test equipment. All stages of assembly covered in a detailed 36 page manual.

THE DETECTOR—features Analytical Discrimination & Ground Exclusion, backed by the proven pedigree of C-Scope, Europe's leading detector manufacturer.

A comprehensive instruction book is available @ £5 (deductable from order).

Ask at your local Hobby/Electronics shop or contact C-Scope for a copy of a published Field Test Report.

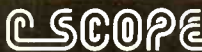

C-Scope International Ltd., Dept. EE86  
Wotton Road, Ashford, Kent TN23 2LN.  
Telephone: 0233 629181.

# MAKING ELECTRONICS C.A.D. AFFORDABLE

- \* HAVE YOU BEEN PUTTING OFF BUYING PCB CAD SOFTWARE?
- \* ARE YOU STILL USING TAPES AND A LIGHT BOX?
- \* HAVE YOU ACCESS TO AN IBM PC/XT/AT OR CLONE INCL. AMSTRAD 1640 & 1512?
- \* WOULD YOU LIKE TO BE ABLE TO PRODUCE PCB LAYOUTS UP TO 17" SQUARE?
- \* WITH UP TO 8 TRACK LAYERS AND 2 SILK SCREEN LAYERS?
- \* PLUS DRILL TEMPLATE AND SOLDER RESIST?
- \* WITH UP TO 8 DIFFERENT TRACK WIDTHS ANYWHERE IN THE RANGE .002 to .531"?
- \* WITH UP TO 16 DIFFERENT PAD SIZES FROM THE SAME RANGE?
- \* WITH PAD SHAPES INCLUDING ROUND, OVAL, SQUARE, WITH OR WITHOUT HOLE, AND EDGE CONNECTOR FINGERS?
- \* WITH UP TO 1500 IC's PER BOARD, FROM UP TO 100 DIFFERENT OUTLINES?
- \* WITH AUTO REPEAT ON TRACKS OR OTHER FEATURES—IDEAL FOR MEMORY PLANES?
- \* THAT CAN BE USED FOR SURFACE MOUNT COMPONENTS?
- \* WITH THE ABILITY TO LOCATE COMPONENTS AND PADS OR GRID OR TO .002" RESOLUTION?
- \* WITH AN OPTIONAL AUTO-VIA FACILITY FOR MULTILAYER BOARDS?
- \* WITH THE ABILITY TO CREATE AND SAVE YOUR OWN SYMBOLS?
- \* THAT IS AS GOOD AT CIRCUIT DIAGRAMS AS IT IS AT PCB'S?
- \* THAT CAN BE USED WITH EITHER CURSOR KEYS OR MOUSE?
- \* WHERE YOU CAN LEARN HOW TO USE IT IN AROUND HALF AN HOUR?
- \* WHICH WITH EASY PLOT AND EASY-GERB CAN OUTPUT TO PEN-PLOTTER OR PHOTO-PLOTTER (VIA BUREAUX)

PRICES: **£95+ VAT (TINY-PC) £275+VAT (EASY-PC)**  
WRITE OR TELEPHONE FOR FULL INFORMATION

**BRITISH  
DESIGN  
AWARD  
1989**

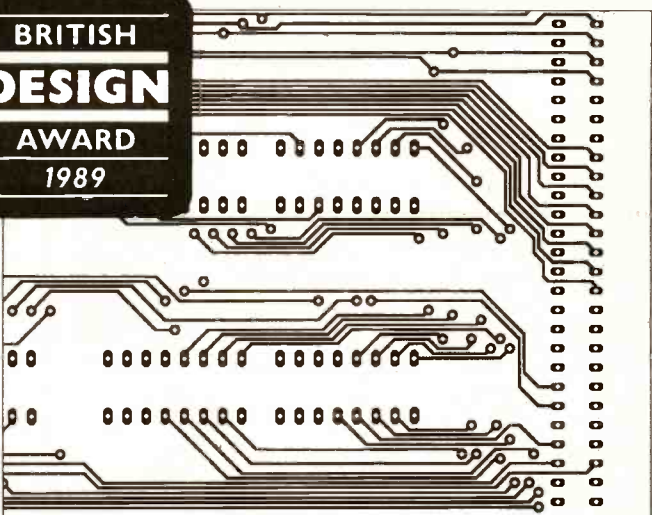

Excellent quality from dot matrix printer

**EASY-PC, TINY-PC, EASY-PC, TINY-PC, EASY-PC, TINY-PC, EASY-PC**

## Number One Systems Ltd **I**

Ref. EVD. HARDING WAY, SOMERSHAM ROAD  
ST IVES, HUNTINGDON, CAMBS PE17 4WR

Telephone: 0480 61778 (4 lines)



**HART AUDIO  
KITS—YOUR  
VALUE FOR MONEY  
ROUTE TO ULTIMATE HI-FI**



Yes, you too can afford the very best in real Hi-fi equipment by building a HART kit. With a HART kit you can avoid the hilarious prices and magical claims of the 'oxygen free grain oriented copper' brigade and the flashy exterior and mundane interior of the mass market products. With every HART kit you get the benefit of circuit design by world leaders in their field, men of the calibre of John Linsley Hood for instance who has been in the forefront of audio design for many years. This circuit expertise is harnessed to realise its full potential by HART engineering standards which have been famous in the kit field since 1961. The HART approach is simply to give you the best value in Hi-fi by combining the best circuit concepts with the latest and best components within a unit carefully designed to bring out your hidden skills as an equipment builder.

Units in the HART audio range are carefully designed to form matched stacks of identically sized cases, in many cases even the control pitches are also lined up from unit to unit for a cohesive look to your customised ensemble.

Flagship of our range, and the ideal powerhouse for your ultimate system is the new AUDIO DESIGN 80 WATT POWER AMPLIFIER, described in the May issue of 'Electronics Today International'. This complete stereo power amplifier has so many features that you really need our list to browse through them all. Glossing over its technical merits, which its pedigree guarantees anyway, it is a power amp with the extra versatility of a built-in passive input stage giving three switched inputs, volume and balance controls. Tape or CD players may, therefore, be directly connected along with a standard pre-amp output, indeed your system may not need a preamp at all with the well balanced output of competent CD players.

Send for our new FREE Spring '89 List. It has full information on this new amplifier as well as details of improvements to other kits in our range.

Our 300 SERIES amplifiers for instance now feature optional Phono input sockets and double size LCR power supply capacitors. The 400 SERIES John Linsley Hood Audiophile Tuner range now incorporates the very latest updated stereo decoder circuit which can also be retro-fitted to existing tuners with our 'Tuner Enhancement Package'.

Also listed are many exciting new products for the serious audiophile such as our Gold plated phono and XLR plugs and sockets and ultimate quality connection leads for CD audio or digital signals.

### VFL600 VERTICAL FRONT LOADING CASSETTE MECHANISM



High quality, reasonably priced front loading cassette deck, fitted with good quality stereo R/P and erase heads. The mechanism has a 3-digit counter, chrome operating keys, mechanical auto stop and a removable decorative cassette door with central window and key functions marked below. Cassette door/carrier has a hydraulically damped 'soft eject' feature. Motor is internally governed and only needs a 12V DC supply with an average current of 80mA. A change-over switch is fitted to energise the motor when required and provide a make contact in the stop position for replay mute. Overall size is 160mm wide including counter, 100mm high and 85mm deep including motor and keys. A robust and thoroughly useful deck for many purposes.

VFL600 Vertical Front Loading Cassette Deck ..... **£27.95**

### SOLENOID CONTROLLED FRONT LOAD CASSETTE DECK TN3600



High quality (0.08%W&F) successor to our very popular SF925F. A very useful high quality cassette mechanism for domestic or industrial use. Offers all standard facilities plus cue and revue modes all under remote, logic or software control. The power and control requirements are very simple with 12V solenoids and 12V Motor with built in speed control. Deck is supplied as standard fitted with a very nice 10kHz R/P head and a 1.5mH erase head.

TN3600 Deck with stereo head ..... **£48.53**  
INF340 Full manufacturers data ..... **£2.90**

### HIGH QUALITY REPLACEMENT CASSETTE HEADS



Do your tapes lack treble? A worn head could be the problem. Fitting one of our replacement heads could restore performance to better than new! Standard inductances and mountings make fitting easy on nearly all machines and our TC1 Test Cassette helps you set the azimuth spot on. As we are the actual importers you get prime parts at lower prices, compare our prices with other suppliers and see! All our heads are suitable for use with any Dolby system and are normally available ex stock. We also stock a wide range of special heads for home construction and industrial users.

HS16 Sendust Alloy Stereo Head. High quality head with excellent frequency response and hyperbolic face for good tape to head contact ..... **£17.86**

HC40 NEW RANGE High Beta Permalloy Stereo head. Modern space saver design for easy fitting and lower cost. Suitable for chrome metal and ferric tapes, truly a universal replacement head for hi-fi decks to car players and at an incredible price too! ..... **£6.65**

HX100 Special Offer Stereo Permalloy Head ..... **£2.86**

HRP373 Downstream Monitor Stereo Combination Head ..... **£44.39**

HQ551 4-Track Record & Play Permalloy Head for auto-reverse car players or quadrasonic recording ..... **£16.79**

H524 Standard Erase Head ..... **£2.59**

SM166 2/2 AC Erase Head, Standard Mount ..... **£12.60**

HS9510 2/4 Stereo DC Erase Head ..... **£8.70**

HQ751E 4/4 AC Erase Head, tracks compatible with HQ551 ..... **£57.06**

We can supply card reader heads for OEMs at very keen prices.

### REEL TO REEL HEADS

999R 2/4 Record/Play 110mH. Suits Stuart tape Circuits ..... **£13.34**

998E 2/4 Erase Head 1mH. Universal Mount. Suits Stuart ..... **£11.96**

### TAPE RECORDER CARE PRODUCTS

HART TC1 TEST CASSETTE Our famous triple purpose test cassette. Sets tape azimuth, VU level and tape speed ..... **£5.36**

DEM1 Mains Powered Tape Head Demagnetizer, prevents noise on playback due to residual head magnetisation ..... **£4.08**

DEM115 Electronic, Cassette Type, demagnetizer ..... **£8.61**

Our new SPRING '89 List is FREE. Send for your copy now. Overseas customers welcome, please send 2 IRCs to cover surface post, or 5 for Airmail.  
Please add part cost of carriage and insurance as follows:-

INLAND  
Orders up to £10—£1  
Orders £10 to £49—£1.50  
Orders over £50—£2.50  
Express Courier—£9

OVERSEAS  
Please see  
the ordering  
information  
with our lists.

**QUALITY AUDIO KITS**

**24hr SALES LINE  
(0691) 652894**

**ALL PRICES INCLUDE VAT**



# MAGENTA ELECTRONICS Ltd.

## A SELECTION OF OUR BEST PROJECT KITS

As usual these kits come complete with printed circuit boards, cases, all components, nuts, screws, wire etc. All have been tested by our engineers (many of them are our own designs) to ensure that you get excellent results.

### INSULATION TESTER

An electronic High Voltage tester for mains appliances and wiring. An inverter circuit produces 500 volts from a PP3 battery and applies it to the circuit under test. Reads insulation up to 100 Megohms. Completely safe in use.



**OUR KIT REF 444 £19.58**

### DIGITAL CAPACITANCE METER

Simple and accurate (1%) measurements of capacitors from a few pF up to 1,000 uF. Clear 5 digit LED display indicates exact value. Three ranges - pF, nF, and uF. Just connect the capacitor, press the button and read the value.

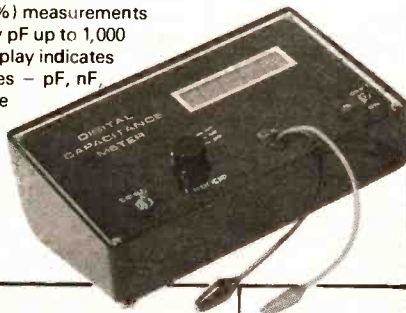

**£41.55  
OUR KIT  
REF 493**

### EE TREASURE HUNTER



**£39.95  
OUR KIT  
REF 815**  
Suitable  
head phones  
£1.99

### 3 BAND SHORTWAVE RADIO



**OUR KIT  
REF 718 £26.53**

Covers 1.6-30 MHz in 3 bands using modern miniature coils. Audio output is via a built-in loudspeaker. Advanced design gives excellent stability, sensitivity and selectivity. Simple to build.

### DIGITAL CAPACITANCE METER

Simple and accurate (1%) measurements of capacitors from a few pF up to 1,000 uF. Clear 5 digit LED display indicates exact value. Three ranges - pF, nF, and uF. Just connect the capacitor, press the button and read the value.

**£41.55  
OUR KIT  
REF 493**

### P.I. METAL DETECTOR

A sensitive pulse induction Metal Detector. Picks up coins and rings etc. up to 20cms deep. Low "ground effect". Can be used with search-head underwater. Easy to use and build, kit includes search-head, handle, case, P.C.B. and all parts as shown.

### ULTRASONIC PET SCARER



Produces high power ultrasound pulses. L.E.D. flashes to indicate power output and level. Battery powered (9V-12V or via \*Mains Adaptor).

**KIT REF 812 £13.80**  
\*Mains Adaptor £1.98

### MOSFET VARIABLE BENCH 25V 2.5A POWER SUPPLY

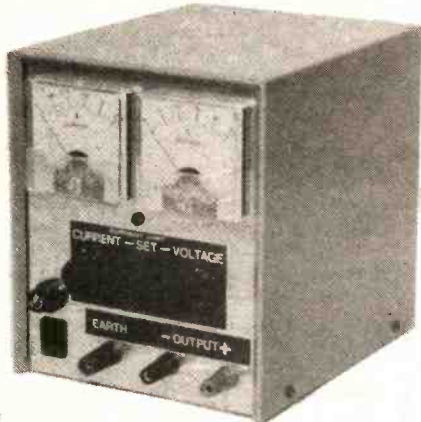

**OUR KIT REF. 769 £49.73**

A superb design giving 0-25V and 0-2.5A. Twin panel meters indicate Voltage and Current. Voltage is variable from zero to 25V. Current-Limit control allows Constant Current charging of NICAD batteries, and protects circuits from overload. A Toroidal transformer MOSFET power output device, and Quad op-amp IC design give excellent performance.

## TOP KITS

**COMPONENTS, KITS, BOOKS, TOOLS, MOTORS, GEARS, PULLEYS, OPTICAL FIBRES, ROBOTICS, AND MUCH MUCH MORE - IN OUR CATALOGUE £1.00**

## PROJECT KITS FOR E.E.

(Just a selection more in our catalogue)

Magenta supply Full Kits: Including PCB's (or Stripboard), Hardware, Components, and Cases (unless stated). Please state Kit Reference Number, Kit Title, and Price, when ordering. REPRINTS: If you do not have the issue of E.E. which includes the project, you will need to order the instruction reprint as an extra: 80p each. Reprints are also available separately - Send £1 in stamps.

REF NO.	KIT-TITLE	PRICE	REF NO.	KIT-TITLE	PRICE
815	EE TREASURE HUNTER Aug 89	Full Kit £39.95	700	ACTIVE I/R BURGLAR ALARM Mar 87	£35.65
814	BAT DETECTOR Jun 89	£19.98	581	VIDEO GUARD Feb 87	£8.39
812	ULTRASONIC PET SCARER May 89	£13.80	584	SPECTRUM SPEECH SYNTH. (no case) Feb 87	£20.92
811	MIDI PEDAL Mar 89	£39.98	578	SPECTRUM I/O PORT less case Feb 87	£9.44
810	MIDI MERGE Mar 89	£11.59	569	CAR ALARM Dec 86	£12.47
809	CALL ALERT Mar 89	£13.51	563	200MHz DIG. FREQUENCY METER Nov 86	£62.98
807	MINI PSU Feb 89	£22.71	561	LIGHT RIDER LAPEL BADGE Oct 86	£10.20
806	CONTINUITY TESTER Feb 89	£10.28	560	LIGHT RIDER DISCO VERSION	£18.62
805	4 CHANNEL LIGHT DIMMER Feb 89	£37.99	559	LIGHT RIDER LED VERSION	£13.64
803	REACTION TIMER Dec. 88	£29.98	556	INFRARED BEAM ALARM Sept 86	£28.35
802	PHASOR (Light Controller) Dec 88	£25.61	544	TILT ALARM July 86	£7.82
801	DOWNBEAT METRONOME Dec 88	£17.57	542	PERSONAL RADIO June 86	£11.53
800	SPECTRUM EPROM PROGRAMMER Dec 88	£24.98	528	PA AMPLIFIER May 86	£26.95
796	SEASHELL SYNTHESISER Nov 88	£29.63	523	STEREO REVERB Apr 86	£26.44
795	I.R. OBJECT COUNTER Nov 88	£24.95	513	BBC MIDI INTERFACE Mar 86	£27.94
790	EPROM ERASER Oct 88	£24.95	512	MAINS TESTER & FUSE FINDER Mar 86	£8.82
786	UNIVERSAL NICAD CHARGER July 88	£6.99	497	MUSICAL DOOR BELL Jan 86	£18.72
780	CABLE & PIPE LOCATOR April 88	£15.35	493	DIGITAL CAPACITANCE METER Dec 85	£41.55
775	ENVELOPE SHAPER Mar 88	£14.99	481	SOLDERING IRON CONTROLLER Oct 85	£9.47
769	VARIABLE 25V-2A BENCH POWER SUPPLY Feb 88	£49.73	464	STEPPER MOTOR INTERFACE FOR THE BBC COMPUTER less case Aug 85	£11.68
763	AUDIO SIGNAL GENERATOR Dec 87	£13.64		1035STEPPER MOTOR EXTRA	£14.50
739	ACCENTED BEAT METRONOME Nov 87	£20.95		OPTIONAL POWER SUPPLY PARTS	£5.14
740	ACOUSTIC PROBE Nov 87 (less bolt & probe)	£16.26	461	CONTINUITY TESTER July 85	£6.20
744	VIDEO CONTROLLER Oct 87	£29.14	455	ELECTRONIC DOORBELL June 85	£7.56
745	TRANSEST Oct 87	£9.70	453	GRAPHIC EQUALISER June 85	£26.94
734	AUTOMATIC PORCH LIGHT Oct 87	£17.17	444	INSULATION TESTER Apr 85	£19.58
736	STATIC MONITOR Oct 87	£8.66	430	SPECTRUM AMPLIFIER Jan 85	£6.91
723	ELECTRONIC MULTIMETER Sept 87	£46.96	392	BBC MICRO AUDIO STORAGE SCOPE INTERFACE Nov 84	£36.25
728	PERSONAL STEREO AMP Sept 87	£14.31	387	MAINS CABLE DETECTOR Oct 84	£9.53
720	BURST-FIRE MAINS CONTROLLER Sept 87	£13.57	386	DRILL SPEED CONTROLLER Oct 84	£8.68
724	SUPER SOUND ADAPTOR Aug 87	£38.39	362	VARICAP AM RADIO May 84	£13.15
718	3 BAND 1.6-300MHz RADIO Aug 87	£26.53	367	STEPPER MOTOR INTERFACE FOR THE BBC COMPUTER less case Aug 85	£24.14
719	BUCCANEER I.B. METAL DETECTOR inc. coils and case, less handle and hardware July 87	£26.45	337	BIOLOGICAL AMPLIFIER Jan 84	£5.68
720	DIGITAL COUNTER/FREQ METER (10MHz) inc. case July 87	£67.07	263	BUZZ OFF Mar 83	£5.68
722	FERMOSTAT July 87	£22.14	242	2-WAY INTERCOM no case July 82	£5.69
711	VISUAL GUITAR TUNER Jun 87	£22.99	240	EGG TIMER June 82	£6.86
715	MINI DISCO LIGHT Jun 87	£12.59	205	SUSTAIN UNIT Oct 81	£17.63
707	EQUALIZER (IONISER) May 87	£15.53	108	IN SITU TRANSISTOR TESTER Jun 78	£9.42
			106	WEIRD SOUND EFFECTS GEN Mar 78	£7.82
			101	ELECTRONIC DICE Mar 77	£6.26

### DIGITAL FREQUENCY 200 MHz METER

**KIT REF 563**

**£62.98**

An 8 digit meter reading from A.F. up to 200 MHz in two ranges. Large 0.5" Red LED display. Ideal for AF and RF measurements. Amateur and C.B. frequencies.



EE79 135 HUNTER STREET  
BURTON-ON-TRENT, STAFFS DE14 2ST  
ADD £1.00 P&P TO ALL ORDERS

PRICES INCLUDE VAT  
SHOP OPEN 9-5 MON-FRI, 9-2 SAT.  
OFFICIAL ORDERS WELCOME

**0283 65435**





# EVERYDAY ELECTRONICS

INCORPORATING ELECTRONICS MONTHLY

The Magazine for Electronic & Computer Projects  
VOL. 18 No. 8 August '89

## Editorial Offices

EVERYDAY ELECTRONICS EDITORIAL,  
6 CHURCH STREET, WIMBORNE,  
DORSET BH21 1JH

Phone: Wimborne (0202) 881749

FAX: (0202) 841692

See notes on **Readers' Enquiries** below—we regret that lengthy technical enquiries cannot be answered over the telephone

## Advertisement Offices

EVERYDAY ELECTRONICS ADVERTISEMENTS  
HOLLAND WOOD HOUSE, CHURCH LANE,  
GREAT HOLLAND, ESSEX CO13 0JS.  
Frinton (0255) 850596

## TREASURE

At this time of year most of us are thinking more about relaxing on a golden beach than sitting inside with a soldering iron. But, why not use your electronic skills to involve you in a new outdoor hobby. You may also be able to make a little money too! Our cover illustrates just what I mean.

We cannot promise that you will find a hoard of buried treasure — although some people have — but we can promise a fascinating project and hours of fun and interest using the *EE Treasure Hunter*.

The beauty of this design is that it is very easy to build — it contains one p.c.b. and employs a single coil of only 27 turns — and requires no complicated setting up procedures. We believe it will become the “standard” design by which others are judged for the next few years. (Our *Buccaneer* design has held that honour since it was published a couple of years ago).

## ON THE LEVEL

This issue also carries an electronic level — we do not believe such a simple and compact design has been published for a device of this type before. Our unit optically senses the position of the bubble in a normal miniature spirit level.

Unless you know better? this is another inexpensive project that is, at present, not available commercially. Back in April 1981 we published an “ultrasonic tape measure”, called the *Digital Rule*, at that time such a device was quite a breakthrough. Now commercial units are being advertised regularly but are still thought of as relatively new!



## SUBSCRIPTIONS

Annual subscriptions for delivery direct to any address in the UK: £15.70. Overseas: £19.00 (£36 airmail). Cheques or bank drafts (in £ sterling only) payable to Everyday Electronics and sent to EE Subscriptions Dept., 6 Church Street, Wimborne, Dorset BH21 1JH.

Subscriptions can only start with the next available issue. For back numbers see below.

## BACK ISSUES

Certain back issues of EVERYDAY ELECTRONICS are available price £1.50 (£2.00 overseas surface mail—£ sterling only please) inclusive of postage and packing per copy. Enquiries with remittance, made payable to Everyday Electronics, should be sent to Post Sales Department, Everyday Electronics, 6 Church Street, Wimborne, Dorset BH21 1JH. In the event of non-availability remittance will be returned. Please allow 28 days for delivery. We have sold out of Sept. Oct. & Dec. 85, April, May, Oct. & Dec. 86, April, May & Nov. 87, Jan., March, April, June & Oct. 88.

## BINDERS

Binders to hold one volume (12 issues) are available from the above address for £4.95 (£6.95 to European countries and £9.00 to other countries, surface mail) inclusive of postage and packing. Please allow 28 days for delivery. Payment in £ sterling only please.



Editor MIKE KENWARD

Secretary PAMELA BROWN

Deputy Editor

DAVID BARRINGTON

Business Manager

DAVID J. LEAVER

Editorial: WIMBORNE (0202) 881749

Advertisement Manager

PETER J. MEW Frinton (0255) 850596.

Classified Advertisements

Wimborne (0202) 881749

## READERS' ENQUIRIES

We are unable to offer any advice on the use, purchase, repair or modification of commercial equipment or the incorporation or modification of designs published in the magazine. We regret that we cannot provide data or answer queries on articles or projects that are more than five years old. Letters requiring a personal reply must be accompanied by a **stamped self-addressed envelope** or a **self-addressed envelope and international reply coupons**.

All reasonable precautions are taken to ensure that the advice and data given to readers is reliable. We cannot, however, guarantee it and we cannot accept legal responsibility for it.

## COMPONENT SUPPLIES

We do not supply electronic components or kits for building the projects featured, these can be supplied by advertisers.

## OLD PROJECTS

We advise readers to check that all parts are still available before commencing any project in a back-dated issue.

We regret that we cannot provide data or answer queries on projects that are more than five years old.

## ADVERTISEMENTS

Although the proprietors and staff of EVERYDAY ELECTRONICS take reasonable precautions to protect the interests of readers by ensuring as far as practicable that advertisements are *bona fide*, the magazine and its Publishers cannot give any undertakings in respect of statements or claims made by advertisers, whether these advertisements are printed as part of the magazine, or are in the form of inserts.

The Publishers regret that under no circumstances will the magazine accept liability for non-receipt of goods ordered, or for late delivery, or for faults in manufacture. Legal remedies are available in respect of some of these circumstances, and readers who have complaints should address them to the advertiser or should consult a local trading standards office, or a Citizen's Advice Bureau, or a solicitor.

## TRANSMITTERS/BUGS

We would like to advise readers that certain items of radio transmitting equipment which may be advertised in our pages cannot be legally used in the U.K. Readers should check the law before using any transmitting equipment as a fine, confiscation of equipment and/or imprisonment can result from illegal use.

The law relating to this subject varies from country to country; overseas readers should check local laws.

# EE TREASURE

# HUNTER

MARK STUART



*A highly developed pulse induction metal locator that has excellent performance for price and is easy to build and set up.*

**T**HIS metal detector project is the result of considerable thought and development. It is sensitive and easy to use and, most importantly, it can be assembled and tested without special tools and equipment.

The pulse induction principle is sensitive to both ferrous and non-ferrous metals and does not offer any discrimination between the two. It is relatively insensitive to foil and similar thin conductive items and very sensitive to coins, rings, and other small objects. Larger objects, of course, are easily detectable at considerable depth.

The best aspect of the pulse induction method is that it is virtually free of "ground effect". So much so that it works perfectly well with the search-head under water (in-

cluding sea water) provided the coil is adequately protected.

The sensitivity of this design is such that a 10p coin can be detected at up to 20cm from the centre of the coil.

## DESIGN POINTS

The object of this design was simplicity, and the avoidance of special "close tolerance" components. This has been achieved by using a 40kHz quartz crystal to provide highly accurate timing for all of the necessary pulses in the system. This approach also removes many sources of jitter and background noise and so allows stable highly sensitive performance.

The use of a power MOSFET to drive the coil also helps to simplify the circuit. It

can be driven directly from a standard CMOS gate and has a very low "on" resistance, a high voltage rating and also is able to switch rapidly between on and off. Such devices are almost ideal to work with especially as they are very forgiving, easily withstanding short overloads.

The final aspect of the circuit design is the use of a simple voltage converter to provide a higher voltage than the battery (the boost supply). This allows the pulse amplifier i.c. to work with both of its inputs at the battery positive supply level, and also provides a higher drive voltage to the MOSFET.

## HARDWARE

A full set of hardware is available for this detector, and provides a good looking, well balanced design at a reasonable price.

Other housings may be used and providing the coil is wound correctly the detector will work well. The search head must not have any metal parts within 60cm as this will be detected and reduce the sensitivity to wanted objects.

## PULSE INDUCTION PRINCIPLE

The pulse induction or P.I. method of metal detection works by subjecting objects to a rapidly changing magnetic field. The field is first produced electromagnetically by switching on current to the search coil. The field is then forced to change very rapidly by switching off this current. As the field decays it induces a voltage back into the coil and also into objects near the coil.

Poor or non-conductive objects near the coil are unaffected. In conductive items however, a current flows producing a small magnetic field which opposes the decay of the original field. This opposing field means that when detecting metal objects the magnetic field around the search coil falls more slowly than it does without metal objects. The voltage in the search coil is produced by the falling magnetic field and so changes in the presence of metal.

An exaggerated view of the search coil voltage, measured at point B of the circuit diagram (Fig. 2) for one complete pulse is shown in Fig. 1. Initially TR1 is on and the coil current is building up from the battery. When TR1 turns off the voltage at point B



flies to a very high voltage as the magnetic field around the coil falls rapidly. After a time the field has fallen almost to zero and the voltage across the coil also falls. Note that as point A of the coil is held at +9V, point B will also end up at +9V when the voltage across the coil is zero.

The dotted section of the curve shows how metal near the coil reduces the rate of decay of the field so that the coil voltage is higher when metal is being detected. The scale of the voltage waveform has been stretched for clarity, and in fact the change detected is much less than one millivolt at the limit of detection. This must be detected following a pulse of over 400V!

### CIRCUIT-OSCILLATOR

The full circuit diagram for the EE Treasure Hunter is shown in Fig. 2. Crystal oscillator IC1c provides an output of 40kHz which is the master clock. Resistor R6 provides d.c. bias for IC1c, and R5, C4, and C5 provide the correct feedback conditions for X1 to resonate correctly.

The output from the clock drives transistors TR2 and TR3 via resistor R4. These devices are connected as a complementary output stage and produce a 40kHz square wave that is coupled via capacitor C3 to rectifiers D3 and D4 to produce an additional seven volts which is added to the battery positive supply. This boosted supply voltage is smoothed by capacitor C2 and used to power IC1, IC2 and IC4 directly and IC3 via additional decoupling components R11 and C7.

The 40kHz output from IC1 also drives the multi stage divider IC2. This i.c. consists of a series of divide-by-two stages the first of which is driven by an input to pin 10 and all of which can be reset simultaneously by a positive level on pin 11.

Two outputs from the chain of dividers are combined via IC1b and inverted by IC1a to produce a reset pulse. The two outputs are after 4 stages and 9 stages of division representing time intervals of 200 microseconds and 6.4 milliseconds. They are combined in such a way that a 200 microsecond pulse is produced after 6.4 mil-

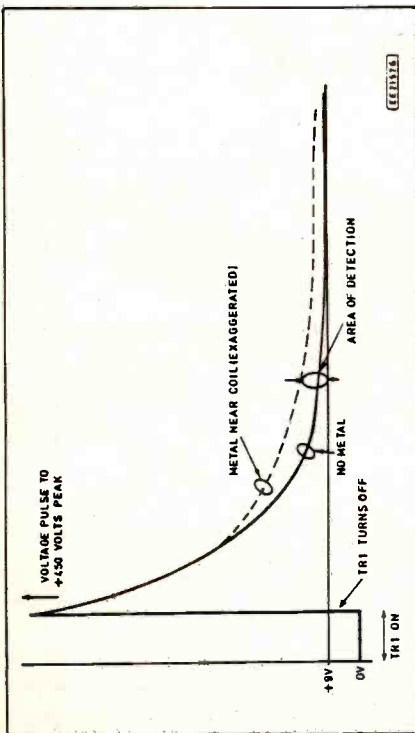
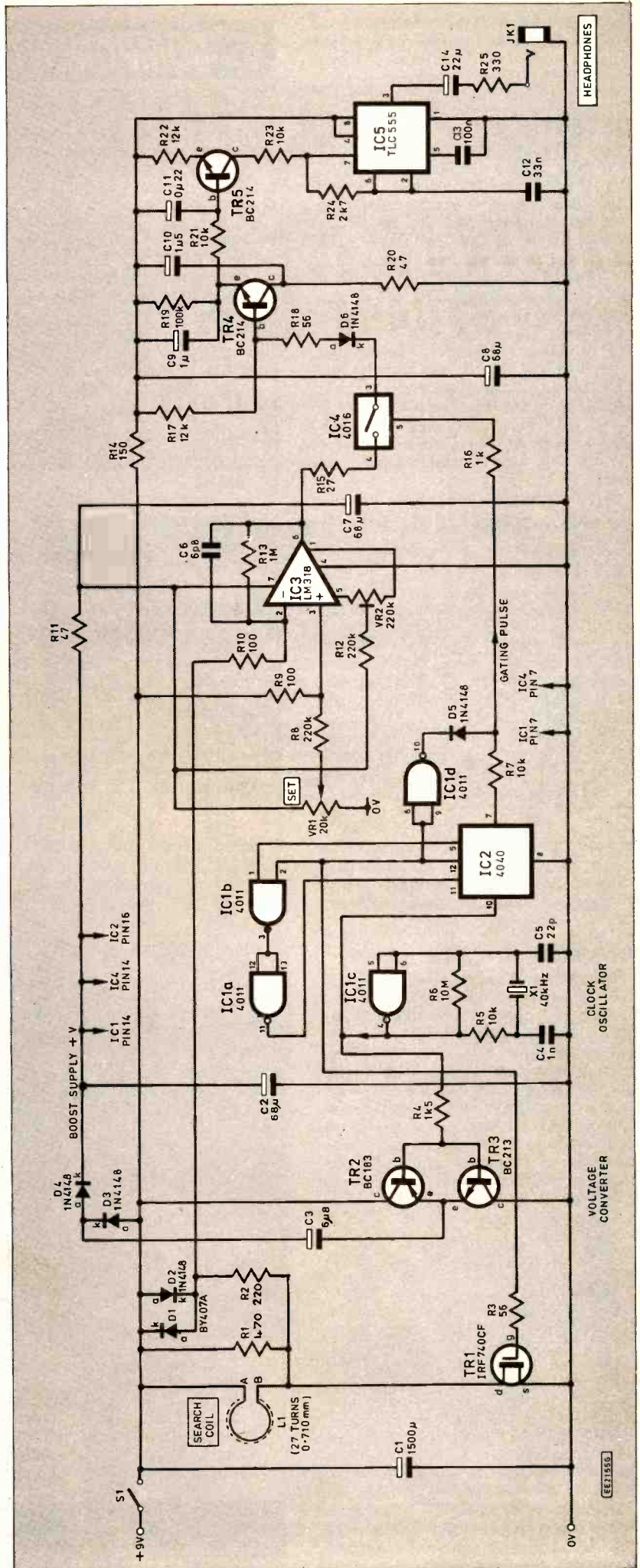

Fig. 1. Search coil voltage waveform, measured at point B on the circuit diagram.

Fig. 2. Complete circuit diagram for the EE Treasure Hunter. Note that the headphone socket (JK1) should be a stereo type.



liseconds whereupon the dividers are reset and the cycle repeats. This pulse output appears at pin 12 of IC2 and is used to drive the MOSFET TR1 via R3 directly.

## DETECTION

The pulses produced across the coil L1 have been discussed earlier. Resistors R1 and R2 provide loading for the coil so that the voltage pulse does not "backfire" into TR1, and also that the coil does not act like a tuned circuit and "ring" with its own self capacitance producing an undesirable a.c. waveform. Diodes D1 and D2 clip part of the coil voltage passed via R2 and so limit the voltage swing which is passed to the amplifier IC3 to one volt.

The diodes are of different types because D2 has to handle only 50mA during the time that TR1 is turned on, whilst D1 must handle 3A peaks from the coil as TR1 is turned off. This clipping only affects voltages from the coil above one volt, it leaves the low level area of interest completely intact.

After clipping, the coil pulses are fed via R10 to IC3. This is an extremely fast op-amp i.c. which is particularly suited to the amplification of pulses. It has a very high "slew rate" which is a measure of the ability to change its output voltage at a fast rate and so reproduce pulses accurately. In this circuit it is connected as a standard inverting amplifier with feedback via R13 and C6. The non-inverting input is taken from the positive supply via R9 so that the output is biased correctly with its output at the battery positive supply.

Two controls around IC3 allow the output voltage to be adjusted. Preset VR2 is the standard "offset null" control and is used to set the output of the i.c. to "zero" when its inputs are connected to the same point; potentiometer VR1 provides a means of unbalancing the circuit to allow the output to be set manually. This is used to set up the detector in operation to produce an audio signal to the preferred pitch.

## ANALOGUE GATE

The output from IC3 is a clipped and inverted version of the coil voltage. The next step is to separate the part containing the low level wanted signal from the preceding relatively high pulse. This is achieved by means of the analogue gate IC4. This is a switch which can be opened by applying a voltage to its control pin. This control voltage is derived from IC2 via IC1d, D5, and R7 and consists of a pulse which is timed to open the switch just as the output from IC3 approaches "zero" (zero in this circuit is the positive battery supply).

The pulse is timed at exactly 50 microseconds after TR1 turns off. At this point the switch is opened and the output voltage from IC3 passes via R15, D6, and R18, and is rectified by the base-emitter junction of TR4 so that C9 is charged to the peak level. This is a negative peak of course because IC3 is an inverting amplifier.

The use of a transistor as a rectifier in this way is necessary because in order to reach the peak value, C9 must charge very quickly indeed. The current gain of TR4 adds to the base-emitter current so that most of the charge in C9 is provided via R20 so reducing the loading on the output of IC3.

The time constant of C9 and R19 is 100mS, this is long enough to change very little between pulses and short enough to

# COMPONENTS

## Resistors

R1	470 2W carbon film 5%
R2	220 2W carbon film 5%
R3, R18	56 (2 off)
R4	1k5
R5, R7,	
R21, R23	10k (4 off)
R6	10M
R8, R12	220k (2 off)
R9, R10	100 (2 off)
R11, R20	47 (2 off)
R13	1M
R14	150
R15	27
R16	1k
R17, R22	12k (2 off)
R19	100k
R24	2k7
R25	330

All 0.25W 5% carbon film except R1 and R2

## Potentiometers

VR1	20k rotary, lin
VR2	220k skeleton preset, vertical

## Capacitors

C1	1500µ radial elect 10V
C2, C7, C8	68µ radial elect 16V (3 off)
C3	6µ8 radial elect 16V
C4	1n ceramic plate 50V
C5	22p ceramic plate 50V
C6	6p8 ceramic plate 50V
C9	1µ radial elect 10V
C10	1µ5 radial elect 10V
C11	0µ22 radial elect 10V
C12	33n polyester 100V
C13	100n ceramic disc 50V
C14	22µ radial elect 10V

## Semiconductors

D1	BY407A
D2-D6	1N4148 (5 off)
TR1	IRF740CF power MOSFET
TR2	BC183 npn general purpose
TR3	BC213 pnp general purpose
TR4, TR5	BC214 pnp high gain (2 off)
IC1	4011B CMOS quad NAND gate
IC2	4040B binary counter
IC3	LM318 high slew rate op-amp
IC4	4016B quad bilateral switch
IC5	TLC555 CMOS 555 timer

## Miscellaneous

S1 s.p.s.t. min toggle switch  
 JK1 panel mounting stereo 3.5mm jack socket  
 6×AA battery holder and clip; 20m of 0.71mm enamelled wire; p.c.b. available from the *EE PCB Service*, order code EE652; Paxolin panel to form battery compartment; p.v.c. tape and sleeving; i.c. sockets—2×8 pin, 2×14 pin, 1×16 pin; 7/0.2 connecting wire 0.5m; case 150×100×50mm; control knob; fixings and suitable headphones.

## Special Hardware

Search head moulding; search head reinforcing plate 100×150mm; 1m×20mm dia. plastic shaft; right angle bend 20mm plastic; plastic angle 2×100mm 25/25mm; handgrip 20mm; 2×threaded end couplers 20mm; 2×saddle clips 20mm; 6×M4×10mm nylon screws and nuts; M5×50mm nylon screw and wing nut with captive washer.

**Shop  
Talk**

See page 507

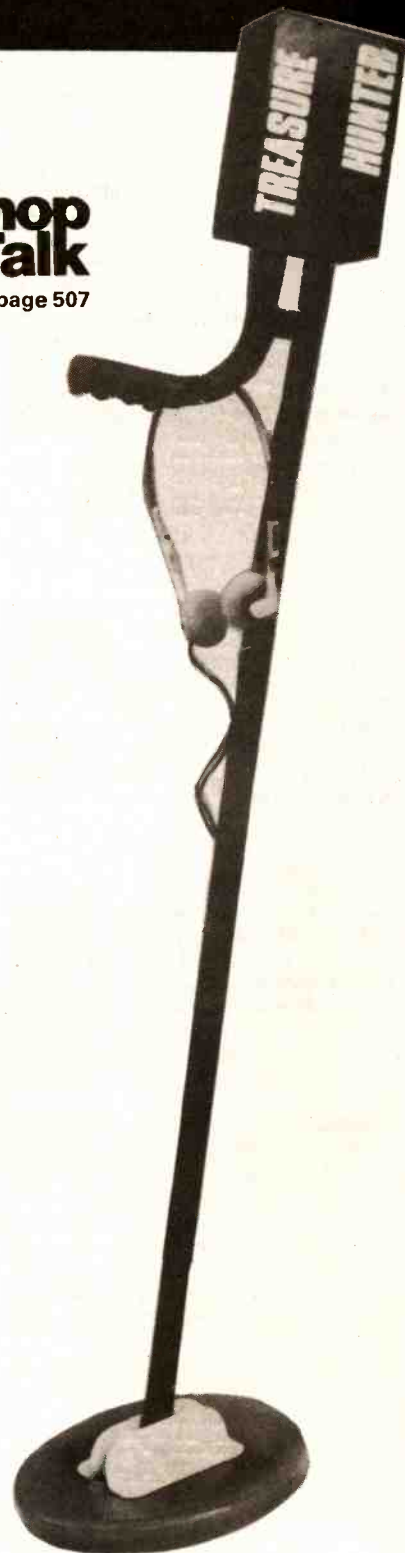

Approx. cost **£43** incl. Headphones  
 Guidance only

respond rapidly as a piece of metal is swept into and out of range.

To reduce the number of components in the circuit, the gating pulse logic is simplified by allowing more pulses to follow the initial one. This is not a problem because the signal voltage decays after the first gating pulse and so subsequent gating pulses pass levels only below the peak already stored thus having no effect.

## AUDIO

The final part of the circuit is the audio oscillator section, this is a conventional 555 circuit except that the charge circuit for the capacitor C12 is not a resistor but a transistor TR5. TR5 is driven from the peak detector TR4 via a low pass filter consisting of R21 and C11.

Large pulses cause TR5 to turn on more and so C12 charges more quickly and the output pitch rises. This arrangement is at its most sensitive for the lowest pulse levels and so provides the ideal characteristic for sensitivity.

The output from IC5 is fed directly to a pair of personal stereo headphones via C14 and R25. The two earpieces can be connected in series by connecting to the tip and ring connections of the 'phones. This is more efficient than parallel connection and although the earpieces are then connected in antiphase this does not seem to matter in this type of application.

## CONSTRUCTION

All components are mounted on a single printed circuit board (available from the *EE PCB Service*, code E652). Fig. 3 gives the component layout and the foil pattern, this is a compact board and so must be assembled with care. Before assembly it is wise to check that the board will fit into the guide slots of the case, and that all holes are clear.

Begin by fitting the resistors, diodes, and four wire links. Be careful to get all of the diodes the right way round with their cathode marking bands as shown.

Next fit sockets for the i.c.s and the smaller capacitors. Note that all of the electrolytic capacitors must fit the right way round. They are usually marked with a string of "-" signs down the side by the negative lead.

Depending on their size it may not be possible to get all of the capacitors flush to the board. This does not matter however, as the leads are generally thick and will support them well above the board.

Now fit the transistors, being careful to identify the different types and insert them the right way round; TR1 has a metal side which is shown as a thick line on Fig. 3. Take care with resistors R1 and R2 as these are large and must be mounted on end exactly as shown. A length of sleeving over the upper lead is advisable.

The crystal X1 should be fitted with care, its leads bent gently over, and its body glued to the board with Evo-Stick or similar. It can go either way round.

Larger components such as VR2 and C1 should be fitted last. Wires to the headphone jack, VR1, and the battery clip and switch should be connected directly to the board by stripping a short length of insulation from one end of the leads and passing the bared wire into the board from the component side and soldering it on the reverse.

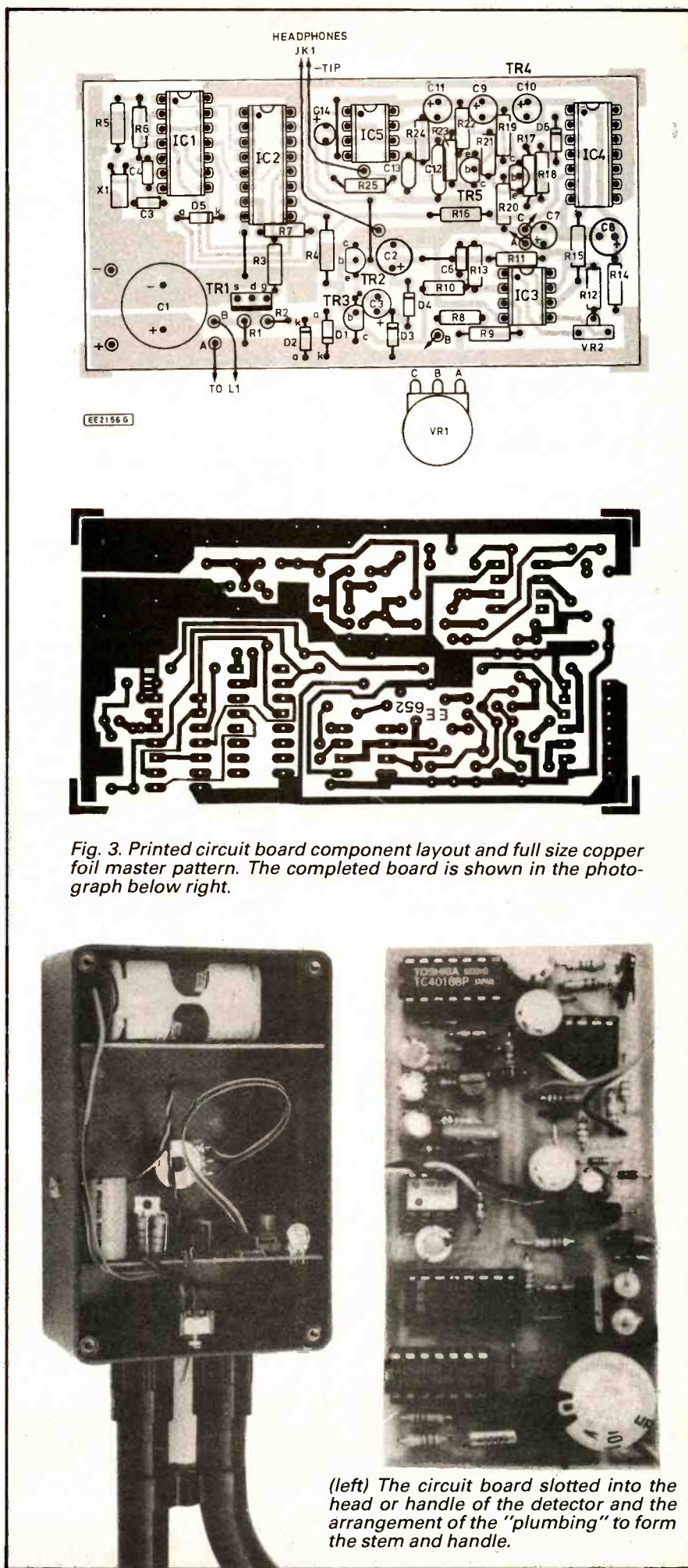

Fig. 3. Printed circuit board component layout and full size copper foil master pattern. The completed board is shown in the photograph below right.

(left) The circuit board slotted into the head or handle of the detector and the arrangement of the "plumbing" to form the stem and handle.

## SEARCH COIL

The winding of this coil is not difficult but the size and number of turns are critical. There must be 27 turns, each single turn being a loop from start to finish. This sounds obvious but it is surprisingly easy to misinterpret "one turn" especially the first and last ones.

To make a coil former all that is required is a piece of wood upon which a 190mm circle can be drawn. A veneered chipboard offcut is ideal. Use 16 panel pins or other small nails fitted with a 10mm length of sleeving and space them equally around the circle as shown in Fig. 4. The winding wire should be 0.71mm diameter enamelled copper and 20m long, leave a free length of 1.5m and carefully wind 27 turns around the pins.

It is not necessary to neatly layer the winding, as it will finally be bunched into a circular section. Secure the ends with p.v.c. insulating tape and then carefully slip short lengths of tape under the windings between the nails and fasten the ends together. Fit eight pieces of tape like this, then remove the winding from the board, either by bending or removing some of the pins. The result should be a neat coil that can now be bound with a spiral of tape to completely enclose it.

The start and finish of the winding must leave the binding at the same point and should be sleeved together with a 1m length of p.v.c. sleeving. The end 30mm of the sleeving should be bound to the coil and the whole coil can then be given a further two layers of binding.

The coil is now suitable for most applications without further protection. There are numerous possibilities for complete waterproofing, but dipping the coil in varnish and allowing it to dry is probably the simplest way. Several coats can be applied and apart from the drying time the method is convenient and effective. The final appearance of the coil should be tidy if it has been carefully made, but this is not important as it will rarely be seen.

## TESTING

Before connecting the coil, it is possible to check some parts of the board for correct operation. Connect a set of headphones

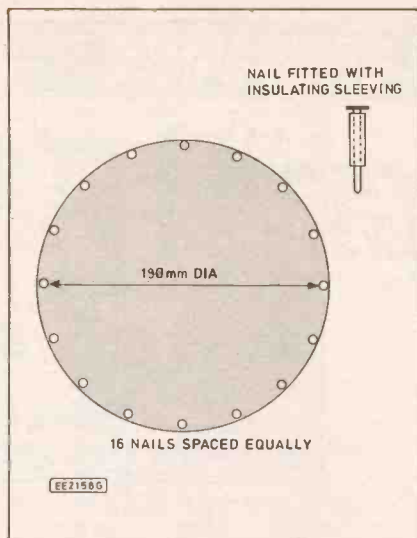

Fig. 4. Making up a search coil template from a piece of wood with insulated panel pins nailed around the circumference.

and a 9V supply preferably from six AA cells in a battery holder. Set both controls to mid position and switch on. A tone or clicking sound should be heard. Turn VR2 carefully until the tone becomes a steady clicking sound, and then check that VR1 has a similar but finer control over the pitch. Those with a multimeter can check that the voltage across C2 is approximately 16V and can set the output of IC3 to 9V (the battery supply voltage) using VR2, with VR1 set to mid position.

Connect the coil to the board (either way round) and position the coil on a cardboard box well away from any wiring and large metal objects. Note that as enamelled wire is used the thin coating must be scraped or melted from the wire ends before soldering. If a solderable enamel is used the wire can be tinned directly by applying solder and heat from the iron.

Leave sufficient wire on the coil leads to allow the p.c.b. to be slid out of the box, and for the search head to be folded down. Once the coil is connected it should now be possible to set the circuit for a steady click-

ing noise which increases as metal is brought near. There may be a slight warble or rise and fall in pitch due to mains wiring in the area (not a problem when in use).

By setting the circuit for very slow clicks it is possible to get the maximum sensitivity. Move a 10p coin near and the clicking rate should rise at good distances. Note that metal rivets in the cardboard box and jewellery on the hands of the tester will be detected as well—metal chairs make themselves known from over a metre away.

A large object near the coil will produce a rather harsh sounding high pitched note. This is breakthrough of the very large pulse signal to the output. In normal situations this is unimportant as smaller signals are normally being sought.

The current consumption is around 80mA giving a good day's use from a fully charged set of AA NiCads and much longer from alkaline cells.

## HARDWARE CONSTRUCTION

As discussed before the hardware can take many forms. The printed circuit board has been made to fit the guide slots in the specified case, but other cases could be used. It is important to get the mechanical balance of the detector right and this is achieved by fitting the handle some way between the electronics box and the search head. The batteries are a particularly good counterbalance and are fitted as far back as possible in the prototype and held in place by a panel slotted into the housing.

The detector head can be made from any plastic material and fixed to the shaft using plastic angle and plastic nuts and screws. The prototype used a special moulding for the head and 20mm plastic tubing and fittings for the shaft and handle, plus a bicycle handgrip. A wing nut allows the head to be swivelled flat for easy transit. Wood could be used but the weight is rather a problem after an hour or two's use. School CDT departments will no doubt be able to go to town on this project and produce wonderful results.

For the "kitchen table" constructors a full set of hardware (undrilled) as used in the prototype and pictured here is available from Magenta. □

The search coil is inserted in a small recess around the plastic search head. The cavity of the search plate can be filled with a resin so that it can be used when immersed in water.

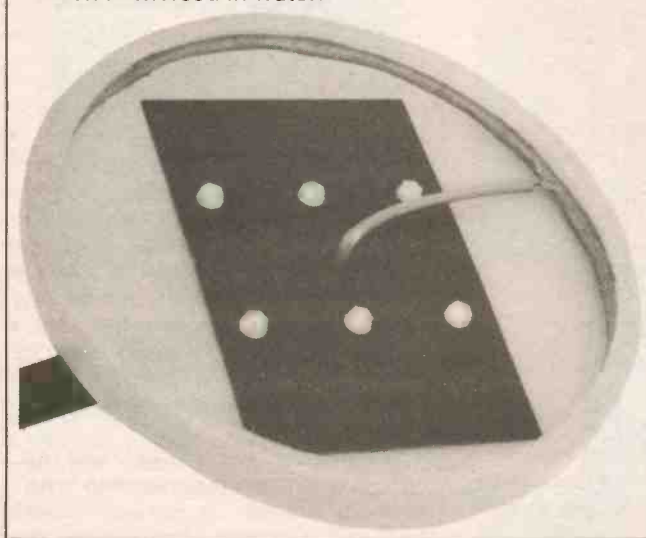

Mounting the detector stem to the search coil is accomplished by using nylon brackets, nut, bolts and wing nut. Metal fixings MUST NOT BE USED.

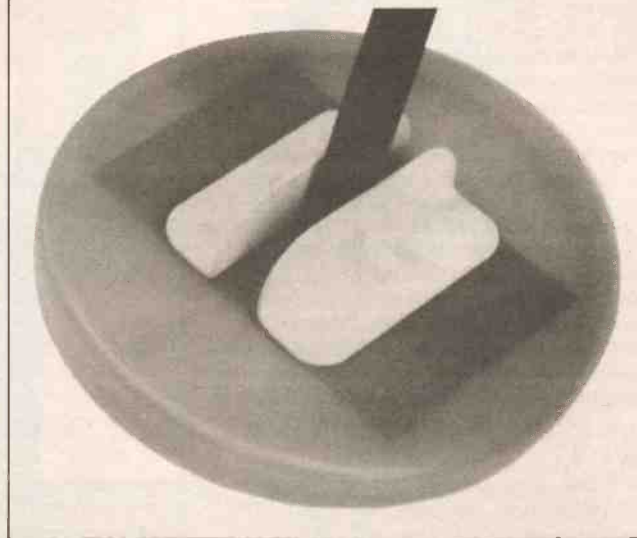

# THE IMAGE OF LIFE

GRAHAM HOUGH

## THE ELECTRIC PRIMARY CELL 1800 - 1900

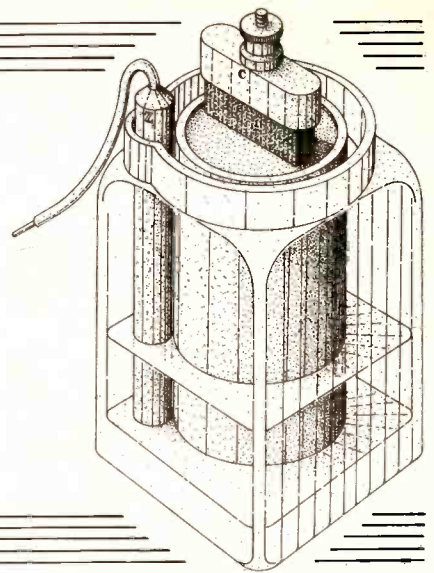

**N**APOLEON BONAPARTE, at a demonstration of the first electric battery in 1801, was so impressed that he pronounced that he had seen the "Image of Life". Electricity was then thought to be the source of all life, but in order to use it a means of generation and storage was needed. This is a short history of how the electric primary storage battery was invented and developed during the first one hundred years.

Few scientific discoveries belong to one person, but Luigi Galvani (1737-1798), professor of anatomy in the University of Bologna, is generally credited with initiating the researches that led to the invention of the battery and a form of electricity which carries his name, "Galvanism".

How galvanism was discovered about the year 1790, is unclear. Most stories feature a sick Madam Galvani, an electro-static machine and twitching frogs legs. Certainly the legs moved when brought near static electricity and Galvani believed he was on the brink of discovering the principle of life. His researchers found that muscles and nerves convulsed when touched with copper and zinc rods, but he believed that what he observed was "animal electricity" and he attributed the phenomenon to an electricity inherent in the animals.

### VOLTA

Alessandro Volta (1745-1827), professor of physics in the University of Pavia, followed the experiments of his friend Galvani who sent Volta copies of his papers. Volta took up the question of whether the electric current resulted from contact between the metals and the muscle. To check this he decided in 1784 to make use of the metals alone, without the flesh and found at once that an electric current resulted.

He found that when two plates of silver and zinc were moistened with

acidulated water much more powerful contractions were produced in the limbs of a dead frog and he constructed devices that could produce, for those times, a large flow of electricity. The first was his "Pile", which consisted of small round plates of silver and zinc separated by pieces of cloth moistened in a salt solution (Fig. 1).

Unfortunately the pile was not a successful system because the weight of the metal discs piled on each other pressed out all the brine or acidulated water from the saturated cloths. To avoid this Volta invented his "Crown of Cups". This was a simple system that used bowls of salt solution in which were placed zinc and copper plates connected together. This pro-

duced a steady flow of electric current. Since any similar objects working as a unit can be called a "battery", Volta's device was an "electric battery"—the first in history.

Previously electricity was produced by friction machines and stored in Leyden jars but its use was limited. Volta's invention immediately became an indispensable part of the laboratory, and in a few years it proved to be the key scientific tool that, subsequently lead to discoveries by Davy, Oersted, Faraday, Ampere, Arago, Maxwell, Hertz and the development of the science of electricity.

On the 20th of March 1800, Volta, in a letter to Sir Joseph Banks (1743-1820), President of the Royal Society, announced the invention of his "Voltaic Pile". In September of the same year, William Cruickshank (1745-1829) soldered copper and zinc plates together in pairs and fitted them into a wooden trough filled with acidulated water according to Volta's principle but set horizontally. (Fig. 2). It was this form of battery which became the main research tool for the early investigators, and examples can be seen at the Royal Institution's Faraday Museum, in London.

### DAVY

One of the greatest early investigators was Humphrey Davy (1778-1829). Before Volta's paper was even published news of his discovery reached Davy and he immediately recognised the possibilities it offered. Volta's use of copper and zinc discs led Davy to investigate the use of other materials, and he was the first to demonstrate that charcoal and zinc made a good combination, a major discovery still in use today in our common carbon/zinc cells.

Following Volta's announcement other researchers investigated ways of making the pile "drier". In 1812 the Abbe G. Zamboni used silvered paper

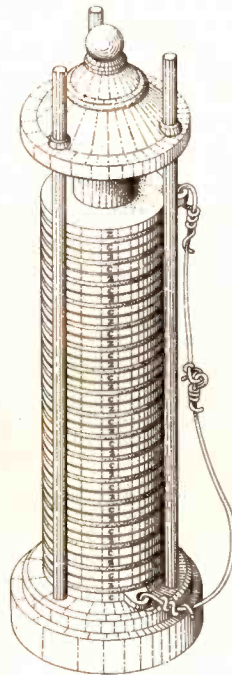

Fig. 1. Volta Pile, 1800; experimental model invented and made by Alessandro Volta (1745-1827), which was the first direct current cell ever made.



Fig. 2. Cruikshank Battery, 1800; invented by William Cruikshank (1745-1829). Davy and Faraday used batteries of this type for their major discoveries.

with the other side coated with finely powdered manganese peroxide, punched into 25mm diameter discs, to build his dry pile, a system revived during the Second World War to power infra-red telescopes (Fig. 3).



Fig. 3. Zamboni Dry Pile, 1812; invented by Abbe G. Zamboni (c1800). One of the first attempts to produce a dry cell.

### CONSTANT CELL

Unfortunately it was soon discovered that the early "simple cells", consisting of two untreated metals and one liquid, rapidly stopped producing a current. The cause was found to be "local action" on the plates, the effects of "polarisation", and the reduction of the power of the exciting fluids (later called the electrolyte). These simple cells, therefore, soon went out of use, and were replaced by cells that avoided these problems by either mechanical or chemical means called "constant cells", because their action continued without material alteration for a considerable period of time.

In 1829, Cesar Becquerel (1788-

1878), announced his double-fluid cell which consisted of copper, salt of copper, dilute sulphuric acid or sulphate of zinc, and zinc. However it was seven years later in 1836 that Professor Frederic Daniell (1790-1845), published an

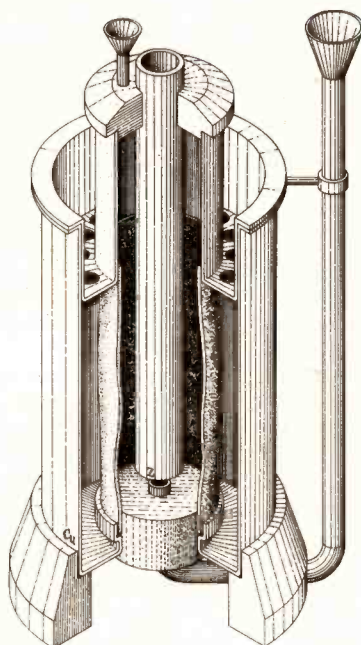

Fig. 4. Daniell Cell, 1836; invented by Frederic Daniell (1790-1845). Early examples used a copper outer vessel. Used at one time as the "standard-one-volt" by which other cells were measured.

account of his famous constant cell.

Daniell used a copper container, which acted as the negative element, a solution of copper sulphate with provision to keep it up to strength, a porous membrane keeping separate the second exciting fluid of dilute sulphuric acid and a zinc element (Fig. 4). These well designed cells remained in use for many years, certainly well into the 20th century, and spawned numerous variations.

### GAS CELL

Sir Wiliam Grove (1811-1896), in 1839, produced his nitric acid battery which used platinum and zinc plates. His first battery was housed in a small

box containing glass tumblers and clay pipe bowls, which can still be seen at the Science Museum, London. Four years later he produced his gas cell, which is still in use today. This cell, using two platinum plates, one in oxygen and the other in hydrogen, has been used in every space flight, because in addition to producing electricity its by-product is drinking water.

Robert Wilhelm Bunsen (1811-1899), in 1842 replaced Grove's expensive platinum plates with his own carbon block elements, (Fig. 5), but he continued to use nitric acid as one of the exciting fluids which produced clouds of noxious fumes and many investigators tried to find an alternative exciting fluid. A mixture of potassium bichromate and dilute sulphuric acid proved to be a successful substitute and was used in "Chromic acid" cells produced from 1841, finally appearing in, possibly, its finest form as the splendid cell invented by the

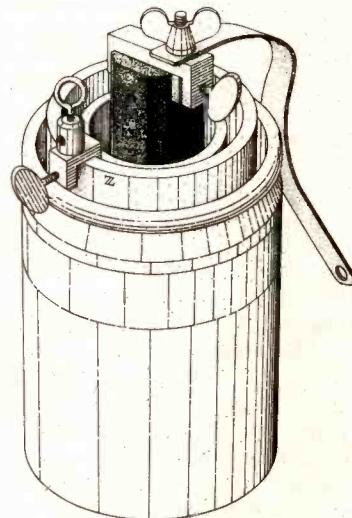

Fig. 5. Bunsen Cell, 1842; invented by Robert Wilhelm Bunsen (1811-1899). First commercially produced carbon/zinc cell. Unfortunately produced large quantities of noxious fumes.

Frenchman Eugene Grenet in 1856. This bichromate bottle cell consisted of a specially shaped glass flask (Fig. 6) with twin carbon plates and a zinc plate mounted on a rod so that it could be withdrawn from the exciting fluid.

### LECLANCHE

By the 1860's most inventors of cells had polarised into two main camps; those that used copper/zinc elements, first used by Volta, and those who based their designs on carbon/zinc elements, first used by Davy. Also, although the chemical compositions may have become more complex, inventors were returning to the early principle of using a single exciting fluid.

The most famous later single fluid cell must be the Leclanche cell,



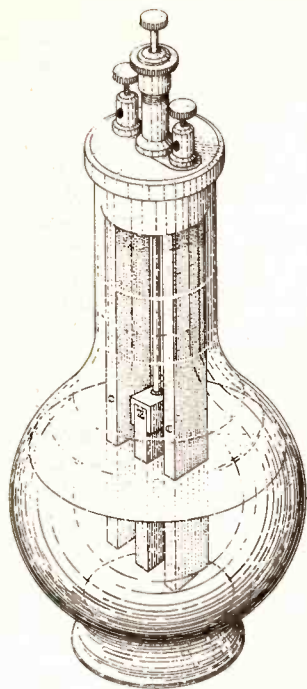

Fig. 6. Grenet or Bichromate Cell, 1856; invented by Eugene Grenet (c1860). Many different versions of this cell were made ranging in size from large flasks to small, square glass jars.

invented by the French engineer Georges Lionel Leclanche (1839-1882). Working in Paris for a railway company, his first patent was granted in March 1866 for a copper/zinc gravity cell. His work on cells was a private venture and two years later in 1868 he announced the cell that made his name and his fortune. This cell was entirely different from his first patent and was a carbon/zinc cell with a single fluid and a pyrolusite depolariser.

In its classic form the Leclanche cell (Fig. 7) was a square glass jar in which stood a zinc rod and a porous pot containing a carbon plate packed around with a mixture of peroxide of man-

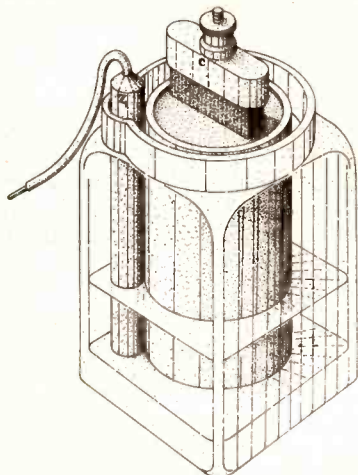

Fig. 7. Leclanche Cell, 1868; invented by Georges Leclanche (1839-1882). Very common wet cell still in use after the Second World War.

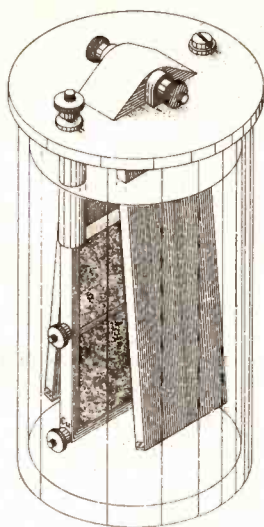

Fig. 8. Edison-Lalande Cell, 1880; invented by Thomas Alva Edison (1847-1931). An efficient wet cell based on systems developed by the Frenchmen Chaperon and Lalande.

ganese and graphite. The jar was partially filled with sal-ammoniac. This cell was an immediate success and made a lot of money for Leclanche, although he was not involved in its commercial exploitation. One of the main reasons for its success was the increasing popularity of the telephone that needed a small, safe cell in the home of each subscriber. Leclanche's original cell continued to be made until the 1950's.

Although Leclanche's cell was proving to be very successful research continued into the use of copper/zinc elements to improve upon Leclanche's system. The French scientists Georges Chaperon and Felix Lalande used copper sulphate powder compressed into trays and blocks in their single fluid cells. Their cells, produced in 1883, were amongst the most efficient produced at the turn of the century. They were rugged in construction and relatively cheap to make and run.

Chaperon and Lalande's use of solid copper sulphate blocks was taken up in the Edison Laboratories in America. Thomas Alva Edison (1847-1931), ran a highly successful "inventions factory" and they produced their own cells, some based on the Lalande design. The Edison-Lalande cell, produced in the late 1880's, used zinc electrodes with black oxide of copper packed into a copper frame (Fig. 8).

### DRY CELL

However all these excellent and sophisticated wet cells became redundant with the introduction of the "dry cell". As has been seen, as soon as Volta announced his battery, inventors searched for ways of making his design drier. Behrens, De Luc, Rousseau, Zamboni, Scrivanow (Fig. 9), all used damp paper or cloth for their "drier" cells, but the real breakthrough came with the invention of the Leclanche cell.

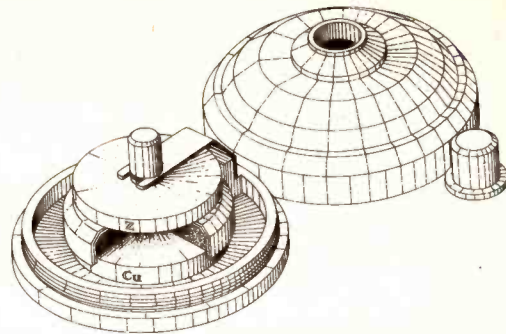

Fig. 9. Scrivanow Dry Cell, 1880; a simple cell built into a door bell switch using electrolyte impregnated blotting paper.

The depolariser was in the form of a paste, the sal-ammoniac was the only liquid and it was a relatively small step to making this too, into a paste. At first inventors added sand or sawdust to the sal-ammoniac and this certainly made the cells unspillable but the internal resistance of the cell was greatly increased and the cells could still not be described as truly portable, compact nor unbreakable.

It took the genius of a German Dr. Carl Gassner to come up with the design in 1888, which has virtually remained unchanged to this day. His first dry cell (Fig. 10) was a zinc box which served as both container and positive electrode, a carbon element surrounded by a depolarising mixture, and the electrolyte in the form of a jelly.

Other types of dry cell appeared such as the Obach, Burnley, Hellesen, and Lessing but they were all based upon Leclanche's principles and Gassner's arrangement. It was a type of cell which superseded all other types of cell and had no serious competition until the mercury cell developed during the 1940's. □

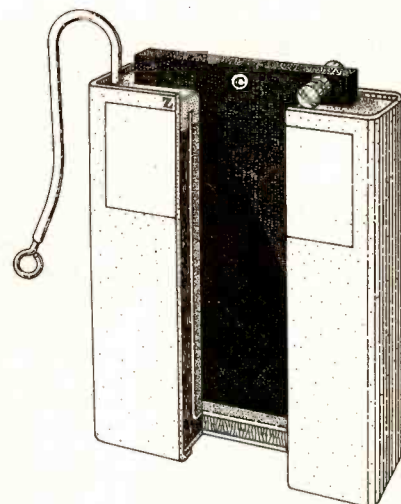

Fig. 10. Gassner Dry Cell, 1888; invented by Dr. Carl Gassner. This was the first practical dry cell and, in principle, is still in use today.

# DISTANCE RECORDER



P. LEWIS

Build a "measuring wheel" for your golf trolley or use the counter with any wheel to record distance travelled.

green, and hence choose the right club for the next shot.

### PRINCIPLE OF OPERATION

Referring to the block diagram in Fig.1, the pick-up from the wheel produces one pulse for each revolution of the wheel. This pulse is shaped by the monostable which produces an output pulse to reset the calibration counter. At the falling edge of this

**D**ISTANCE travelled by any form of transport which relies on a wheel is most easily measured by noting the number of revolutions of a wheel as a vehicle moves along and multiplying that number by the circumference of the wheel. The disadvantage of this type of measurement is that it is relatively inaccurate when measuring short distances and, as the wheel is unlikely to be an integral number of yards or meters, some form of calibration is required.

This article describes a means of electronically measuring, calibrating and displaying the distance travelled by a wheel. A golf trolley wheel has been used in the prototype but the principle of operation could be applied to any application where distance measurement using a wheel is required.

Golfers among the readership will appreciate the importance of knowing, during practice, how far a ball has been hit, in order to calculate the distance to the

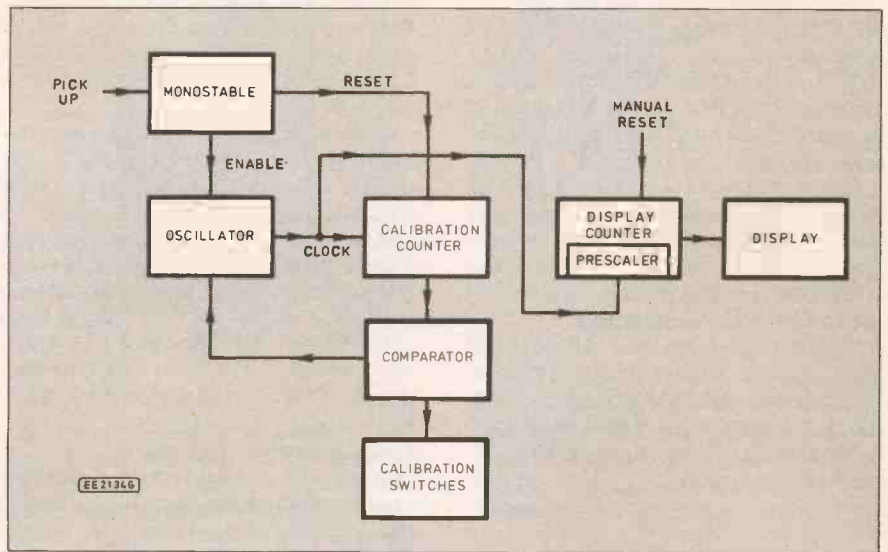
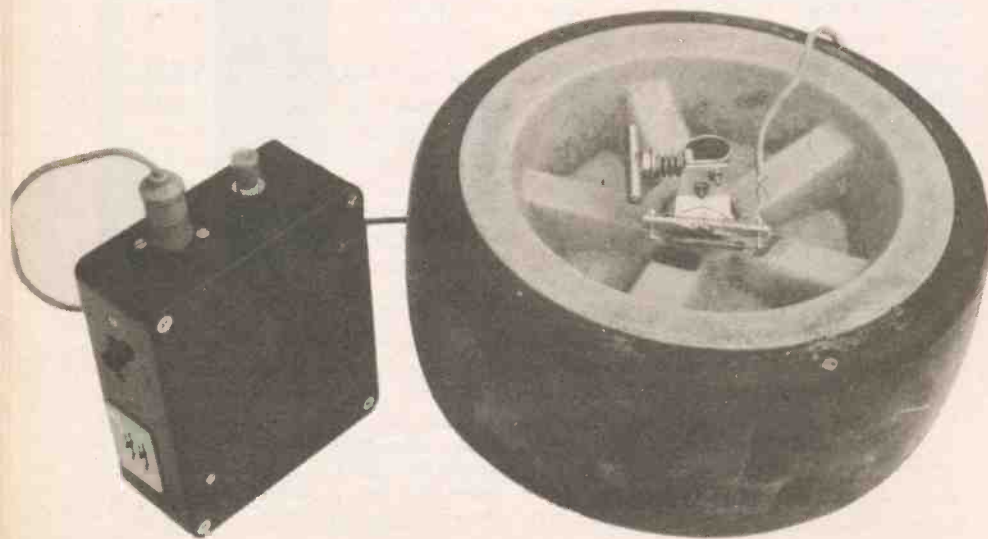

Fig. 1. Block diagram of the Distance Recorder.

pulse, the oscillator is enabled which sends clock pulses to the display counter and the calibration counter. The binary coded decimal output from the calibration counter is compared with the settings of the calibration switches.

When the number of pulses from the clock equals the preset number on the calibration switches, the clock is disabled. At this point the display counter has also counted the preset number of clock pulses. At the next pulse from the pick-up, the calibration counter will be reset and the cycle will be repeated as previously explained. The display counter will not reset however, and this next set of clock pulses will be added to the previous count.

The display counter may be reset manually when a new measurement is to start. To make the prototype as portable as possible, a three digit display/counter has been used in the prototype which has necessi-



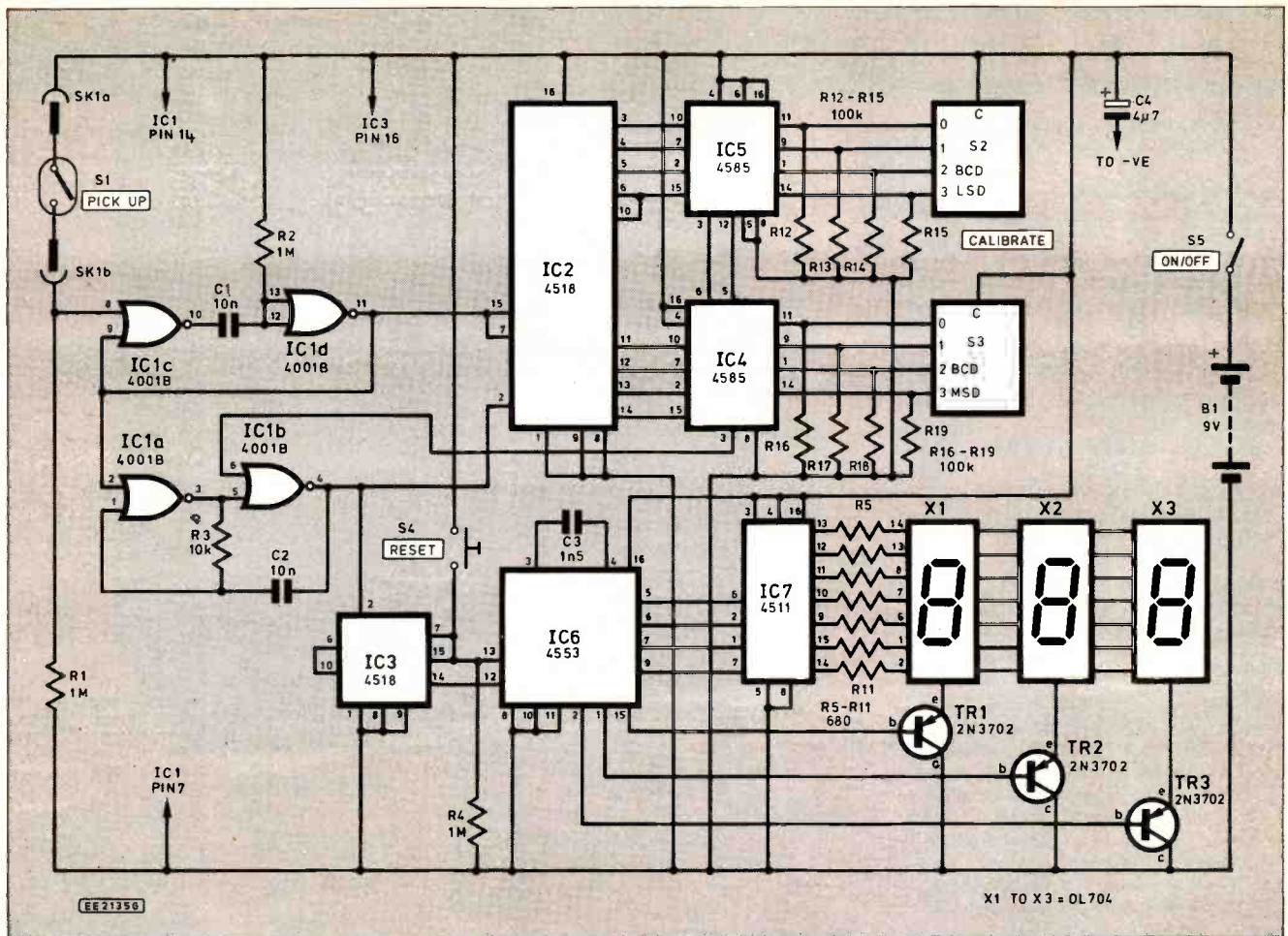

Fig. 2. Circuit diagram of the Distance Recorder.

tated a 1/100 prescaler to be added between the display counter and the clock.

### CIRCUIT DESCRIPTION

Referring to Fig.2, the circuit diagram for the distance recorder, IC1 is a quad two input NOR gate. Two of the gates (a and b) are connected together to form the oscillator while gates c and d are connected together to form a monostable. The oscillator is a simple, free running RC design which provides a clock frequency of approximately 2kHz. The clock is normally inhibited however, by a logical 1 level being applied to either pin 2 of gate a or pin 6 of gate b. The timing diagram Fig.3 shows precisely when the oscillator is enabled during the measurement cycle.

The monostable is also a simple RC design. The input at pin 8 of gate c is connected to the reed relay pick up which is attached to the wheel support. A small magnet is attached to the wheel itself. At each revolution of the wheel the reed switch operates when it comes within close proximity of the magnet and the reed operates, closing the contacts.

One side of the reed switch contacts is connected to positive, while the other side is connected to IC1 pin 8 as well as a 1M pull down resistor R1. Hence pin 8 is usually at logical 0 until the reed switch is operated. At the rising edge of the pick up pulse, the monostable output at pin 11 will change from a logical 0 to a 1 state, and remain at 1 for approximately 8ms. During this time, any further changes at the monostable input due to contact bounce or

double switching will be ignored. The 8ms monostable output is used to inhibit the oscillator further counting until another pulse from the monostable arrives which resets the calibration counter and the output at pin 3 of IC4 reverts to a logical 0 level. Resistors R12 to R19 are pull down resistors for the thumbwheel switch outputs.

The output from the oscillator is also counted by the prescaler IC3, which is also a dual BCD counter connected in series. Hence this counter divides the clock pulses by 100 before clocking the display counter IC6. Both IC3 and IC6 are reset only when the master reset switch S4 is operated. IC6 is in fact a three digit BCD counter which provides a multiplexed output, ideal for use with l.e.d. displays.

The four BCD outputs are connected to IC7, a BCD to seven segment decoder driver which drives the l.e.d. displays X1,

changes to a logical 1 level. This output disables the oscillator and hence prevents further counting until another pulse from the monostable arrives which resets the calibration counter and the output at pin 3 of IC4 reverts to a logical 0 level. Resistors R12 to R19 are pull down resistors for the thumbwheel switch outputs.

The output from the oscillator is also counted by the prescaler IC3, which is also a dual BCD counter connected in series. Hence this counter divides the clock pulses by 100 before clocking the display counter IC6. Both IC3 and IC6 are reset only when the master reset switch S4 is operated. IC6 is in fact a three digit BCD counter which provides a multiplexed output, ideal for use with l.e.d. displays.

The four BCD outputs are connected to IC7, a BCD to seven segment decoder driver which drives the l.e.d. displays X1,

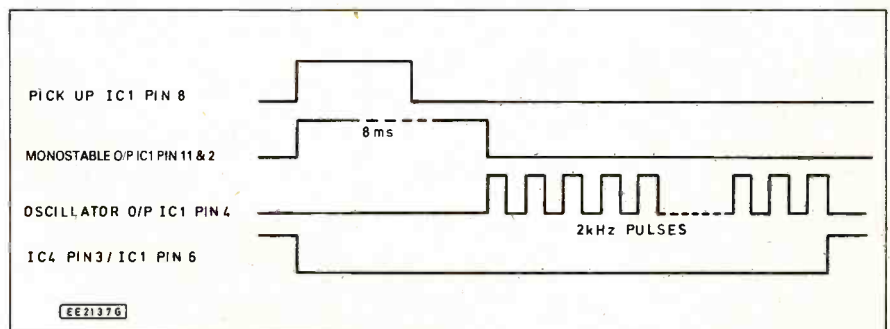

Fig. 3. Timing diagram.

# COMPONENTS

**Shop  
Talk**

See page 507

## Resistors

R1, R2, R4 1M (3 off)  
R3 10k  
R5 to R11 680 (7 off)  
R12 to R19 100k (8 off)

## Capacitors

C1, C2 10n  
C3 1n5  
C4 4 $\mu$ 7 tantalum 15V

## Semiconductors

TR1 to TR3 2N3702 (3 off)  
IC1 4001B  
IC2, IC3 4518B (2 off)  
IC4, IC5 4585 (2 off)  
IC6 4553B  
IC7 4511B  
X1 to X3 DL704 seven segment displays (3 off)

## Miscellaneous

S1 Reed switch and operating magnet plus mounting bracket (see text)  
S2, S3 BCD thumbwheel switch (2 off)  
S4 s.p.s.t. push to make switch  
S5 s.p.s.t. slide switch  
B1 9V PP3 battery and connecting clip  
SK1 DIN loudspeaker plug and socket

Red display filter; case 120 x 100 x 45mm; p.c.b. available from the EE PCB Service, order code EE651; wire; fixings ect.

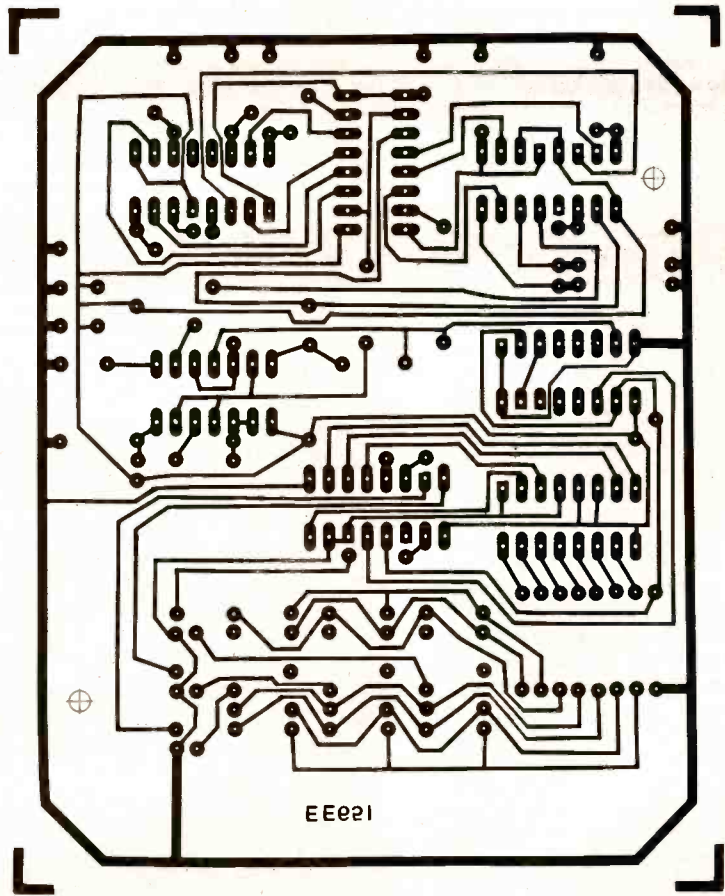
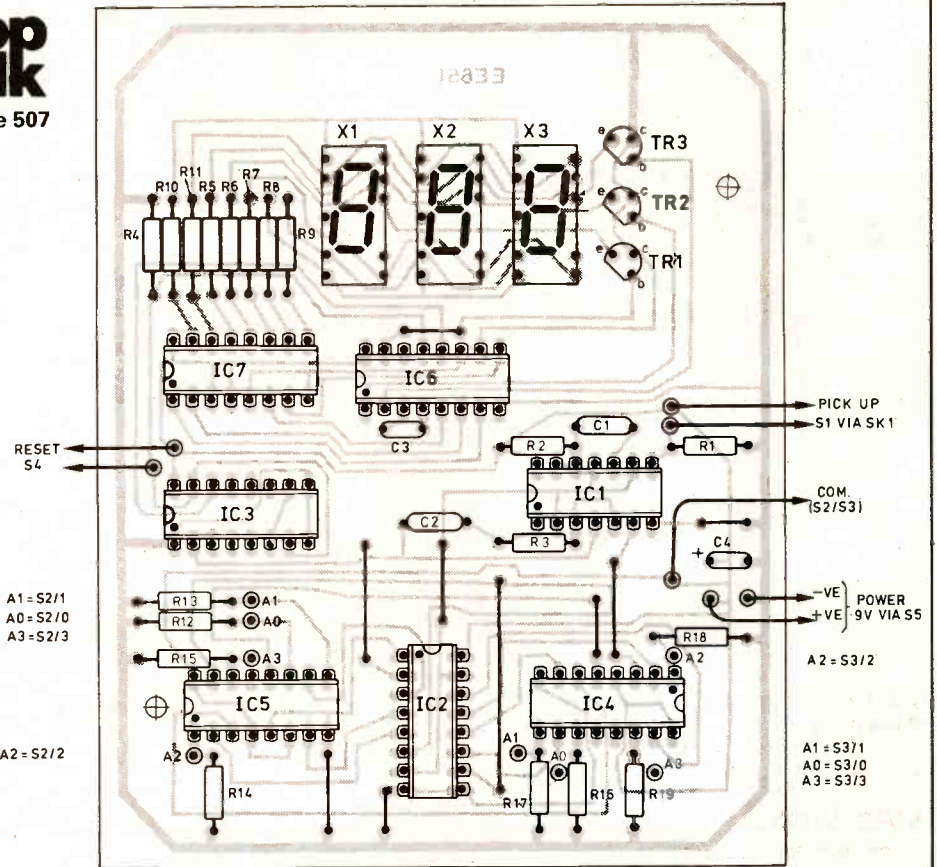

Fig. 4. P.C.B. layout and wiring diagram.

Approx. cost  
Guidance only

**£23**

X2 and X3 directly via current limiting resistors R5 to R11. The digit driver transistors TR1, TR2 and TR3 operate directly from the digit select outputs of IC6 to switch the displays as appropriate.

Switch S5 is the on-off switch which connects the positive lead of the 9V battery to the circuit. Capacitor C4 is a decoupling capacitor. The current requirement of the prototype is 60 milliamps, most of the current being taken by the display resistors R5 to R11. If the display is not considered bright enough, these resistors should be changed to 470 or even 330ohm. There will be a proportional increase in power consumption, however, and decrease in battery life.

## PRINTED CIRCUIT BOARD

The complete circuit is laid out on a single sided printed circuit board. The component layout and track pattern artwork are shown in Fig.4. The artwork is shown full size and all holes are 1mm diameter except for the mounting holes which are 3mm.

Particular attention should be made in placing the CMOS devices on the p.c.b. as the orientation of the i.c.s vary. This was necessary to aid track layout. Also, a number of wired links are necessary as

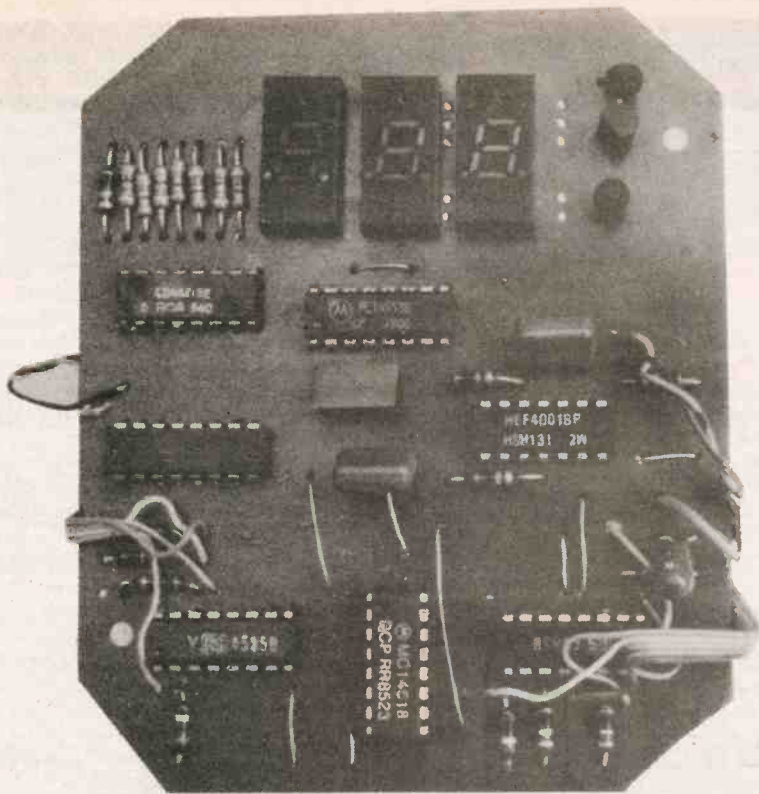

cross overs could not be avoided. The use of low profile i.c. sockets is recommended, or Soldercon pins so that i.c.s may be removed without damage to the board.

### MECHANICAL ASSEMBLY

The instrument was designed to be either hand-held or small enough to fit into a small pocket of a golf bag. For ease of use, the reset push button and the connector socket were placed at the top of the case, while the on-off switch and the thumbwheel switches were placed at the side of the instrument case to avoid being inadvertently knocked.

The display is positioned at the front of the instrument case where a rectangular hole 13mm by 33mm must be cut. The hole for the display should be backed by red polarised Perspex to emphasise the digits and reduce the glare of the sun.

Take particular care when wiring the thumbwheel switches to the two comparators IC4 and IC5. Fig. 4 shows the connections from the comparators. A0 refers to the least significant bit while A4 refers to the most significant bit of each comparator. COM is the common positive supply which must be connected to the common of both thumbwheel switches. Also, remember that IC5 is the least significant digit and must be connected to the unit's thumbwheel switch. IC4 is the most significant digit and must be connected to the tens thumbwheel switch.

The 9V battery is held in place by a piece of foam rubber which fills the space between the base of the instrument case and the p.c.b.

The connection between the reed and the instrument case should use a light double insulated cable — such as telephone cable. There is no need for an electrically screened cable, but a degree of mechanical protection has been found worthwhile. The cable was secured to the trolley using insulating tape. The connection between the instrument case and the pickup cable needs to be detachable. A loudspeaker

DIN type plug and socket was found to give the best compromise of ease of use, robustness and flexibility.

### PICK UP

The positioning of the reed switch and magnet are the only "critical" assembly operations of the instrument. It is essential that the reed operates once and only once during each revolution of the wheel. For the prototype, the reed switch was mounted on an aluminium bracket which was attached to the wheel mounting with 6BA nuts and bolts.

The bar magnet was mounted on the wheel using a double sided sticky pad — the type used to stick reversing mirrors onto car windscreens. The positioning of the magnet and the reed must be decided

by experiment, allowing for play in the wheel. The distance between the reed and the magnet should not be more than 1 cm at the closest point.

### TESTING AND FAULT FINDING

There is no easy way of fault finding. It's a case of laboriously plodding through the circuitry with a multimeter and signal tracer or an oscilloscope probe. Check the easy things first such as the power connections and the signal connections between the switches and the p.c.b.

To check that the input pulse is OK, test that a rising edge is being seen from the reed relay at the input to the monostable pin 8 IC1. Check then that an (approximately) 8ms pulse is being output from pin 11 IC1.

To check the clock circuit, the two inhibiting inputs to the oscillator (pins 2 and 6 IC1) must be at logical 0. As long as the monostable is not activated, pin 2 IC1 will be at logical 0. Under normal circumstances, pin 6 IC1 will be at logical 1 however, and this must be set to a logical 0. This logic level comes from the output of the comparator IC4 and indicates the number that the thumbwheel switches are set to, equals the pulses counted by IC2.

Depending on the type of thumbwheel switches used, it may be possible to set the switches half way between the 7 and 8. This effectively shorts the binary values of 7 and 8 to give a binary E. As this setting will never be equal to the output from the counter IC2, the comparator output at pin 3 IC4 will always be logical 0. Hence the oscillator will oscillate freely. Alternatively, the connection between IC4 and IC1 pin 6 on the p.c.b. uses a wire link, disconnect this link and connect the input to pin 6 IC1 to the 0V supply lead. The oscillator output of around 2kHz from pin 4 IC1 may then be detected.

Whilst the oscillator is free running, the counters IC2 and IC3 may be checked by monitoring their outputs pins 3 to 6 and 11 to 14.

Check the outputs of the thumbwheel switches to ensure they give the correct binary coded decimal output. Pin 3 of IC4

Close up of the reed switch and magnet mounting.

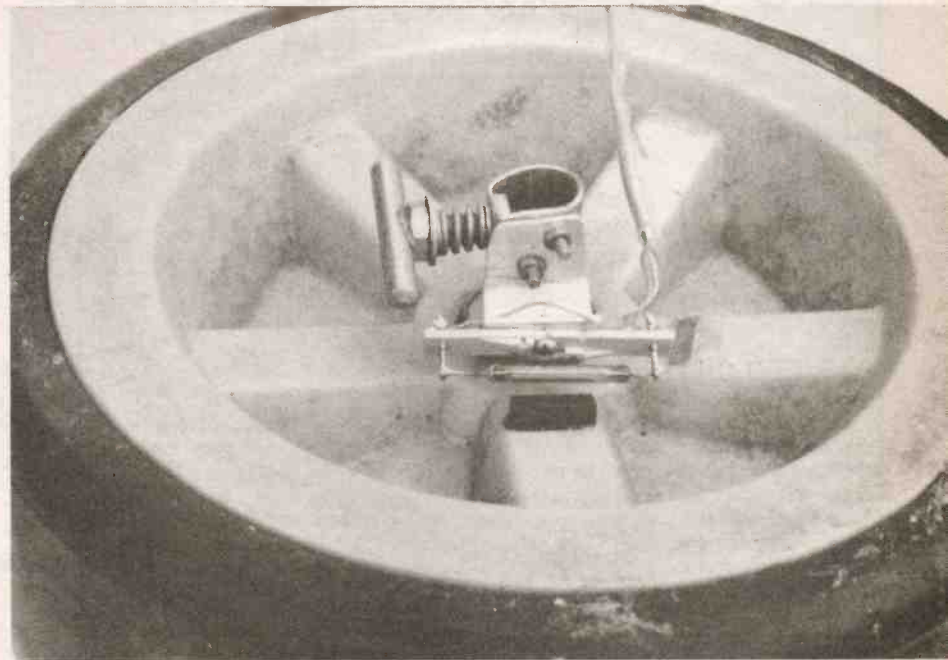

and IC5 should go from a logical 0 to a logical 1 when the output from the thumbwheel switches equals the counter output.

Finally the display circuit should be checked. This is fairly self evident if faults exist. If any display is available it proves that the counter/display chip IC6 is working. If strange looking characters are displayed then the tracks to the l.e.d. displays are shorting between each other. If one of the l.e.d. displays isn't working, then check the driver connections to the transistors TR1, TR2 or TR3.

### CALIBRATION AND SETTING UP

It is important to measure the circumference of the wheel accurately. Merely passing a tape measure around the wheel has not been found to be accurate. A better method is to rotate the wheel along a known distance — the longer the better — and count the number of revolutions of the wheel. A hundred metre running track would be ideal. Repeat the measurement several times to ensure a consistent measurement. The circumference of the wheel is equal to the distance/number of revolutions.

This figure must be converted into a percentage of either a yard or a metre, so that the calibration switches can be set to that percentage figure. The circumference of the prototype golf trolley wheel was found to be 28.8 inches which equals 0.8yd. The calibration switches would hence be set to 80 ( $0.8 \times 100$ ). If measuring in metres, the calibration switches would be set to 73 ( $28.8 \text{ ins} = 73.15 \text{ cm}$ ).

TABLE 1

Wheel Rotations	Total Pulses Counted	Number Displayed	Number in Prescaler
0	0	0	0
1	80	0	80
2	160	1	60
3	240	2	40
4	320	3	20
5	400	4	00
6	480	4	80
7	560	5	60
8	640	6	40
9	720	7	20
10	800	8	00
11	880	8	80
12	960	9	60
13	1040	10	40

### PRACTICAL CONSIDERATIONS

Several points should be borne in mind when using the instrument. The first is that the display will be incremented in bursts, and these bursts will NOT occur every time the wheel rotates, due to the introduction of the 1/100 prescaler.

Table 1 explains where the pulses are counted and what is displayed, assuming a calibration switch setting of 80. In this example, the display will NOT be incremented at the first rotation of the wheel, neither will it be after each subsequent fifth pulse.

The circumference of the wheel from which the measurement is taken is critical to the measurement. If the wheel is pulled through mud or snow which clings to wheels, then the circumference of the wheel will increase and an error in measurement will result.

If the instrument is found to be giving inconsistent readings whilst travelling over the same distance, it is probably due to the distance between the reed relay and magnet becoming excessive. Due to the tolerance of the wheel bearings this distance has been found to vary depending on whether the trolley is travelling on an upward or downward slope or turning left or right corners. A simple adjustment to the reed position should cure this problem.

Finally, a word of warning to golfing enthusiasts. Rule 14.3 states that "no artificial device shall be used for the purpose of gauging or measuring distance". So don't use the recorder in competitions — only on a practice round. □

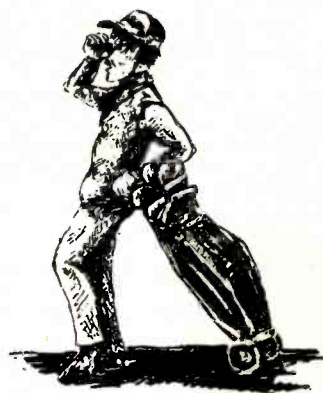

**OUT NOW!**

# CRICKLEWOOD ELECTRONICS

**1989 100 PAGE COMPONENT CATALOGUE** PRICE £1

SEND OFF FOR YOUR COPY TODAY...

- WE STOCK AN UNRIVALLED RANGE
- ALL OUR COMPONENTS ARE FIRST CLASS BRANDED ITEMS
- WE OFFER A SAME DAY SERVICE ON ALL STOCK ITEMS
- NO MINIMUM ORDER—IF YOU NEED ONE COMPONENT WE CAN SUPPLY ONE COMPONENT
- WE HAVE ADOPTED A NEW LOWER PRICING POLICY + QUANTITY DISCOUNTS
- FREE VOUCHERS WITH YOUR CATALOGUE—ORDER ONE NOW!...

JUST FILL IN THE COUPON OPPOSITE AND POST IT WITH YOUR £1 PAYMENT TO THE ADDRESS BELOW. YOU WILL RECEIVE NOT ONLY OUR SUPERB 100 PAGE CATALOGUE, BUT ALSO FREE VOUCHERS WHICH YOU CAN USE ON YOUR NEXT COMPONENTS ORDER.

CRICKLEWOOD ELECTRONICS LTD 40 CRICKLEWOOD BROADWAY LONDON NW2 3ET TEL: 01-450 0995/452 0161 FAX: 01-208 1441 TELEX: 914977

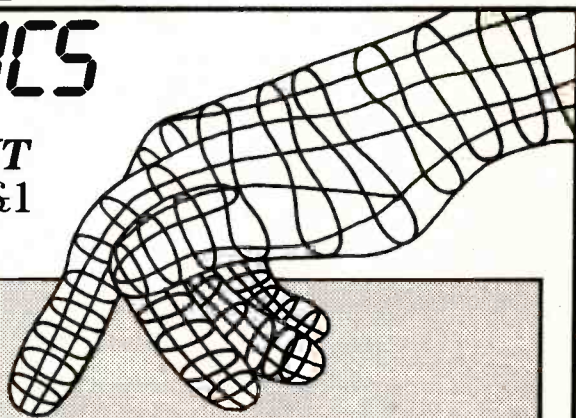

### FREE VOUCHERS!

SEND OFF FOR YOUR CATALOGUE AND VOUCHERS TODAY.

I WOULD LIKE TO RECEIVE..... COPY(COPIES) OF THE 1989 CRICKLEWOOD ELECTRONICS COMPONENT CATALOGUE. I ENCLOSE £..... PLEASE ENCLOSE MY FREE VOUCHERS.

Tape your £1 coin here, or send a cheque or postal order for £1.00 for every catalogue you require.

NAME.....

ADDRESS.....



# FOR YOUR ENTERTAINMENT

BY BARRY FOX

## Program for Chaos

The first company to put forward the idea of using CD ROM as a car navigator aid was Philips. The system, called *Carin*, relies on an on-board computer reading routes from maps stored as digital code on a CD. The car continually monitors its own position and makes synthesized speech announcements at each turning, so that the driver knows which way to go.

Initially *Carin* will rely on dead reckoning, using sensors on the wheels and steering. In the longer term *Carin* will use digital time code signals transmitted from US navigation satellites.

A comparison of several signals from different satellites gives a very accurate position fix. The satellites belong to the US military, but the Government only gave funds to launch them on condition that some of the signals were available in unencrypted form, for civilian use.

With *Carin* you key in the start point and end point for a journey, and set off with the computer telling you when to turn left or right. If it all sounds too good to be true, yes, it is all too good to be true.

Recently a friend was enthusing over a desktop PC program he had just bought. It plots road routes ahead of a journey. You key in the start point, then the end point, and the computer displays (and prints out) a list of instructions, including road numbers and mileages between left and right turns.

He offered to plot me some routes. I chose one I already knew well, from London to Sussex. The computer obediently churned out four routes, ranging from quickest to shortest.

Not a single route matched the one which years of experience has taught me to be best. But as an experiment, I decided to try a couple of the computers' routes. Who knows, I could have been wrong all those years.

For the quickest route the program looked for motorways and chose a lengthy roundabout trek via the M4, M25 and Guildford By-Pass. The stupid dumb thing didn't know that the M25 is a nightmare, even if there are no roadworks. And it certainly had no way of knowing that the day I set off the M25 was, as usual, heavily dug up.

It also didn't know that there were equally bad roadworks near Guildford which snarled traffic and blocked a vital turn off. Two hours after setting off on a journey that normally takes two hours I was stuck on a dual-carriageway pointing in the wrong direction. I gave up, turned tail at the next roundabout and drove back to London to pick up the route I knew best.

In all, the journey took nearly twice as long as usual, and clocked up nearly twice the mileage!

## Dumb Beast

On the way back, I tried another of the computer's recommendations. This time the dumb beast had to choose between two A roads. One is clear dual-carriageway most of the way; the other is slightly shorter but winds through South London suburbia, with traffic lights, roundabouts and one-way diversions every few hundred yards.

Needless to say the stupid computer chose the shorter, but far worse, route. It took a lot longer, and the stop-start driving used more petrol.

## Expensive Toy

Philips are now not the only ones planning to offer an in-car navigation system. All the Japanese are promising similar toys.

## POCKET COMPUTER

The world is now working on the run. Mobile telephones make it possible to talk and send fax or telex messages from the middle of a field. Pocket calculators and lap-top computers are old hat. The next step is the pocket computer.

Psion has already succeeded with the pocket *Organiser*. Both Sharp and Casio have similar devices. But they are all really just upgraded calculators. The Sharp IQ, like the *Organiser*, has an alphanumeric keyboard. The Casio JF-7500 is Qwerty. All typify the insuperable problem facing designers. If the keyboard is too small, no-one wants to use it for text entry—especially if the layout is alphanumeric; if the keyboard is Qwerty and comfortably large, the unit is too big for a pocket. I struggled for many months with a "typing" course for the alphanumeric *Organiser*. Although I reached nearly 30 words a minute, when copying exercises that the course displays on the screen, I never could get to grips with using it to write original text.

The *Organiser* comes into its own when used as a portable store for large quantities of data, either contained in a commercially available program or transferred from a data base created on desk top PC. But there is still no pocket PC which does the job of a desk-top.

## MICROWRITER

The *Microwriter* was supposed to change all this; a hand-held unit with a few keys which can be used to type text with one hand. When I last wrote about the *Organiser*, I was offered loan of a *Microwriter* as soon as production models were ready. Many months later I am still waiting. The *Microwriter* is one

So let them all be warned. None of these systems will be worth "diddeley-squat" unless they are combined with some kind of broadcast traffic system which continually tells the computer the state of the road it has chosen, and gives the driver warnings and the chance to override one route with another.

The broadcasts would be inaudible digital code carried piggy back on conventional radio programmes. The BBC's *Radio Data System* has the capacity to do the job.

With updating information from RDS and computer intelligence to use it, in-car navigation will be a winner. Without them, it will be written off as an expensive toy which is more trouble than it is worth.

of those products that is always almost, but not quite, ready for sale.

## FOLIO

Atari hopes to fill the market gap with the *Folio*, an IBM compatible pocket computer designed by three ex-Psion employees. The *Folio* has a Qwerty keyboard and flip-top 8 line, 40 column LCD screen. MS DOS is stored in ROM, and there is 128K onboard RAM. Long term storage is by Mitsubishi memory card (68K, or 128K) which the machine treats as a floppy disk. Although the card is RAM, it has a lithium battery to preserve data.

Atari promises a card reader that connects with a PC for direct data transfer. Alternatively the *Folio* can take a plug-in module, which connects with a printer, PC or modem, and offers additional memory.

The *Folio* looks like the best pocket PC compromise so far. But when the *Folio* was "launched" early this year in a blaze of publicity (at the Which Computer show in Birmingham and CeBIT business show in Hanover) the Taiwan factory making it had delivered only a very few pre-production prototypes which no-one was allowed to touch, let alone borrow for typing.

Also the cost is likely to be rather higher than advance publicity suggests; £199 plus VAT for the *Folio*, plus memory cards at around £100 each, plus an as-yet unknown price for the communication module and the card reader. Saleable product was being promised for May. I look forward to trying one under real life conditions—writing stories on trains and planes and then either plugging into someone's office printer or using the module modem to send the text down a telephone line back to Britain.

# STABILIZED POWER SUPPLIES



STEVE KNIGHT

Part Two

Apart from delving into the basic theory of p.s.u. design and potential problems, this short five part series will introduce three practical projects which are fairly simple to build and have reasonably good specifications.

The three stabilized units are: Variable 0V to 12V 1.5A; Variable 0V to 25V 1A; Variable 1.5V to 25V, with switched current limits of 0.5A, 1A, 1.5A and 2A.

LAST month we gave a general overall survey of regulated power supplies and saw how the circuitry consists essentially of an automatic series control element which, in turn, is protected against overload by feedback control.

This month we look at a series of circuit systems which start with the simple Zener diode stabilizer and build up to hints and tips on the full blooded regulators available (in the main) for fixed voltage applications in convenient integrated circuit form.

## ZENER STABILIZER

The Zener stabilizer is the most basic of all regulators. A Zener diode is essentially identical with the ordinary *p-n* junction diode but is designed to operate continuously in the reverse-bias condition beyond the point at which reverse breakdown occurs; see Fig.2.1.

In an ordinary diode, great care has to be taken to ensure that the applied reverse voltage never gets close to, let alone exceeds, the breakdown point. If it does and the condition is not immediately rectified, a very large reverse current will flow and the diode will burn itself out before you can say "Tut!" or words to that effect.

Zeners, on the other hand, are deliberately operated with an applied reverse voltage which is greater than the breakdown, but with the proviso that the current through the junction is kept within bounds by the use of a resistance in series with the junction. Without such a limiter, the Zener will go the way of all flesh in a remarkably short space of time.

The Zener voltage is usually marked on the body of the device; this can range from about 2.5V up to 200V. The values are marked off in the usual "preferred" series: 2.7, 3.0, 3.3V and so on, and in general have a tolerance of  $\pm 5\%$ .

The cathode end of the Zener, like ordinary diodes, is marked with a coloured band (and sometimes a "k" on circuit diagrams). Zeners also come in a range of power ratings, typically 400 or 500mW, 1.3W, 5W and 20W.

The basic Zener stabilizer circuit is shown in Fig.2.2 where the essential components are resistor *R* and Zener diode *Z*. Notice that the diode has its cathode (k)

connected to the positive rail. The transformer T1, bridge rectifier REC1 and reservoir capacitor *C* are components common to most power supplies and are not our particular concern here.

At the particular voltage for which it has been designed, the Zener diode *Z* will break down and thereafter, as Fig.2.1

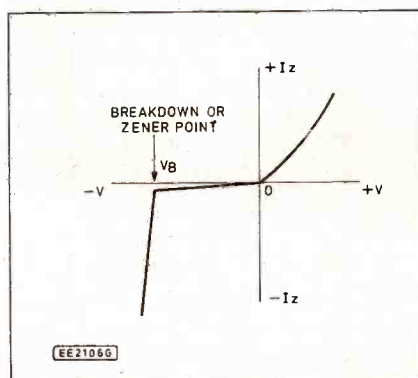

Fig.2.1. Zener diode characteristics.

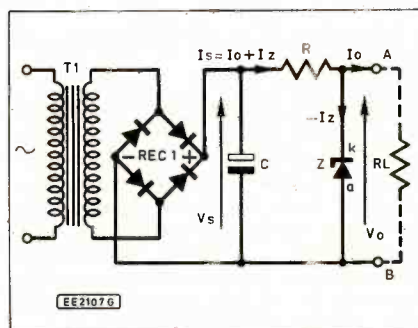

Fig.2.2. The basic Zener regulator circuit diagram.

shows, the voltage across the junction will remain substantially constant, irrespective of the (reverse) current flowing through it. This reverse flow is limited to a safe value by resistor *R* and, providing the applied voltage  $V_S$  does not drop below the breakdown level  $V_B$ , the Zener behaves as a current reservoir.

Referring to Fig.2.2, it is not difficult to understand how the diode provides a constant output voltage  $V_o$  at terminals A and B in spite of variations in either the input voltage  $V_S$  or in the load current  $I_o$  flowing through  $R_L$ . Suppose the input voltage across *C* increases for some reason, then the current through the Zener increases but as the voltage across it remains constant, the increase in voltage appears across *R*.

If the input voltage falls, the Zener surrenders the extra current and the voltage across *R* also falls. In either situation, the input variation is absorbed by resistor *R* and the output voltage is unaffected.

Suppose now the load current  $I_o$  increases for some reason. The Zener current will decrease by the same amount. Likewise, if the load current decreases, the Zener current will increase by the same amount. This time the Zener takes up the excess current and sheds the current difference required by the load, so acting as a current reservoir.

## ZENER SELECTION

Whenever you plan to use such a simple system (which is nevertheless sufficient and practical for quite a number of projects requiring a stable supply), a number of points have to be taken into consideration. We will illustrate with some typical figures.

First, choose the Zener diode to suit the output voltage you want. For a 9V supply, you will use a 9.1V Zener, or two 4.7V types in series will do.

Then you will need to know what power rating is necessary. A 500mW (0.5W) Zener rated at 9.1V will be dissipating its maximum permissible power when the current through it is 0.5/9.1A, or 55mA. Remember,  $W = V \times I$ . Hence, under no circumstances must the Zener current  $I_z$  exceed 55mA.

If you look at Fig.2.2 again, the greatest Zener current flow will occur when the load  $R_L$  is removed; hence from a knowledge of what voltage you have across capacitor *C*, you can calculate the value of the series resistor *R* so that it is impossible for a current greater than 55mA to flow.

Suppose the input d.c. voltage across *C* is 15V; this voltage, of course, must always



be greater than the output you require. Then to restrict  $I_z$  to 55mA, we can calculate resistor  $R$  to be  $(15-9.1)/55 \times 10^{-3} = 107\Omega$ .

This is not a preferred value, so to play safe we go to a higher value (*not lower!*) and choose 120 $\Omega$ . This value will restrict our maximum Zener current to 50mA whatever happens.

Now, when the load ( $R_L$ ) is connected, current  $I_o$  will flow into it and current  $I_z$  will fall. If  $I_z$  falls too far (typically below a milliamp or so) the Zener action ceases because the diode is no longer in its breakdown region. Hence, we must never allow the load to draw so much current that the Zener is starved; it won't be damaged by this but it won't be doing its job either.

The greatest permissible load current is therefore  $I_s - I_z$  (minimum). In our example above, this would reasonably be 45mA. Always be generous with tolerances, never work things on their "theoretical edges".

So with this circuit we could draw any current from zero to about 45mA and the voltage would remain almost (but not quite) constant at 9.1V. The slight variation occurs because the breakdown characteristic is not precisely a vertical line but exhibits a slight slope which is the same thing as saying the Zener has an internal resistance.

Zener diodes rated at 5W and above are usually bolted to suitable heatsinks; 0.5W and 1.3W types can generally go directly on to circuit boards without any additional heat precautions other than that provided by the board copper itself.

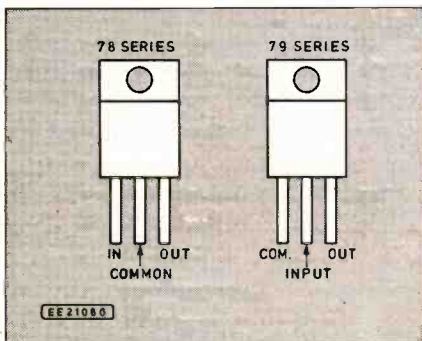

Fig.2.3. Pinout connections for TO220 style 78/79 series regulators.

## FIXED VOLTAGE REGULATORS

Getting away from the simple Zener diode, the easiest way to build a stabilized power supply — provided you don't want to vary the output voltage — is to use one or more of the many integrated regulators now available at prices ranging from fifty pence to a few pounds. Most of these regulators are housed in three-terminal TO220 or TO3 packages.

The voltage ranges available cover most common applications; 5V for TTL logic systems and 12V to 24V for CMOS and operational amplifier projects. These regulators contain up to 20 transistors, two reference diodes and 20 resistors and are available in both *positive* and *negative* output polarities.

The popular 78L and 79L series are housed in plastic TO92 style cases and are made for low power applications where the device is mounted directly onto a printed circuit board and there is normally no need for heatsinking. The maximum current rating for this series is 100mA and this is sufficient for most small project supplies.



The three power supply units that will be described over the following three months.

The 78 and 79 series proper are housed in plastic TO220 packages and are used where greater output currents are required. The standard rating for the basic range is 1A, but the 78S and the 78T series provide outputs of 2A and 3A respectively. All types feature internal limiting and overload protection.

The pin connections for these regulators are shown in Fig.2.3; in all cases the heat-sink surface is connected to the centre pin. When bolted to a heatsink, the usual insulated mounting must be used as for a power transistor.

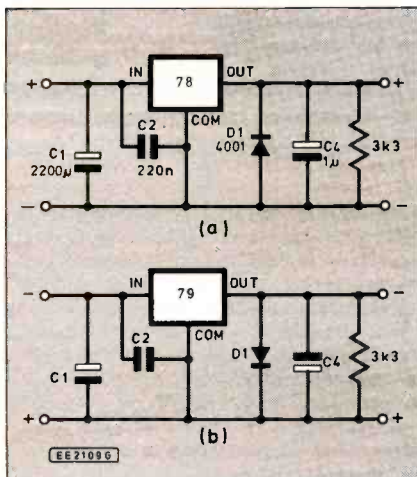

Fig.2.4. Basic circuit diagrams for the positive 78 series and the negative 79 series.

Although apart from the transformer and reservoir capacitor, the whole of the regulated power supply is neatly built into the i.c., a few precautions are necessary whenever these devices are put to use. As mentioned above, both positive and negative polarities are available, the 78 series for positive and the 79 series for negative. Basic circuits for both types are shown in Fig.2.4(a) and Fig.2.4(b) respectively.

The simplicity of these circuits is apparent at once, but one or two points must be mentioned: the transformer current rating should be at least 1.5A (2.5A for the 78S series) and its voltage must be such that it is 2.5V to 3V above the specified output voltage. For example, the 7805 provides an output of  $5V \pm 0.2V$ , so it wants an input of about 8V minimum.

This input is derived from the reservoir capacitor C1 which in turn charges up to the peak value ( $1.4 \times \text{r.m.s.}$ ) of the trans-

former output when no current is being drawn. This falls as the load current increases and it is possible for it to drop far enough for the regulating action to cease when a large current is being asked for. The output voltage is then no longer stabilized. There is also a drop of about 1V in the rectifier.

It is a good design point always to make the transformer r.m.s. output 3V above the required d.c. output, so for the 7805 (or 7905), 8V is O.K. The same applies to all other regulators in the range.

It is quite permissible, however, for the transformer output to be higher than that giving a 3V differential relative to the stated output. In general, it may be anything up to 25V but this means, of course, that the drop across the regulator chip is unnecessarily high and the power dissipation is consequently greater for a given current level.

## RIPPLE RATING

Another point to watch is the ripple rating of C1; this must be at least 1A for the 78/79 series or 2A for the 78S series. If you can make it 50 per cent higher, so much the better.

The 220nF capacitor C2 should be placed as close to the relevant package pins as possible, *not* wired simply in parallel with C1. Its job is to prevent any self-oscillation and reduce noise.

On the output side there is nothing to be gained by making C4 greater than 10 $\mu\text{F}$ ; a solid tantalum should be used in preference to an ordinary electrolytic. The diode D1 (a 1N4001 is suitable) protects the regulator against reverse voltages being applied at the output terminals. This might seem an unlikely event, but inductive devices in the connected circuitry can produce reverse voltage spikes at switch-off; capacitor C4 discharging suddenly into a short-circuit can also generate a short term negative voltage.

It is the writer's experience that these integrated regulators are very sensitive to reverse voltages. They are also sometimes sensitive to short-circuits on the output, something that occasionally happens even on the best organised electronics bench!

The manufacturers claim that their regulators are overload protected by automatic "foldback" if a short-circuit or excessive overload appears, that is, the current quickly drops back to a safe level after the overload is applied. For the 7805, for example, the short-circuit current is stated to be 750mA.

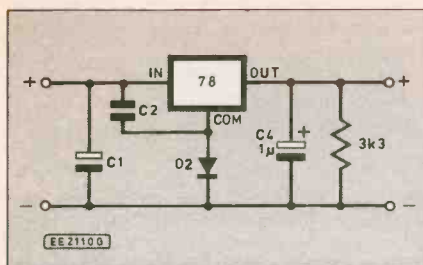

Fig.2.5. The addition of diode D2, typically a 1N4148, gives a small increase in output.

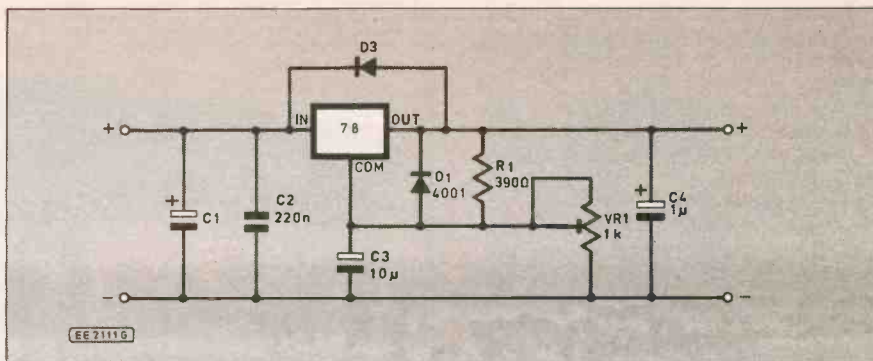

Fig.2.6. This circuit gives a relatively large range of output voltages.

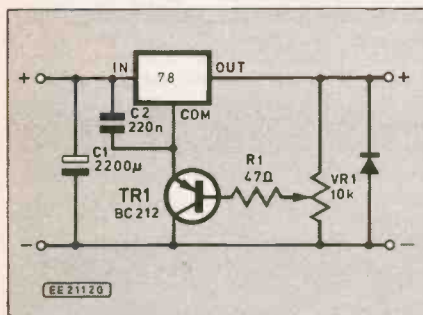

Fig.2.7. Circuit diagram for improved regulation.

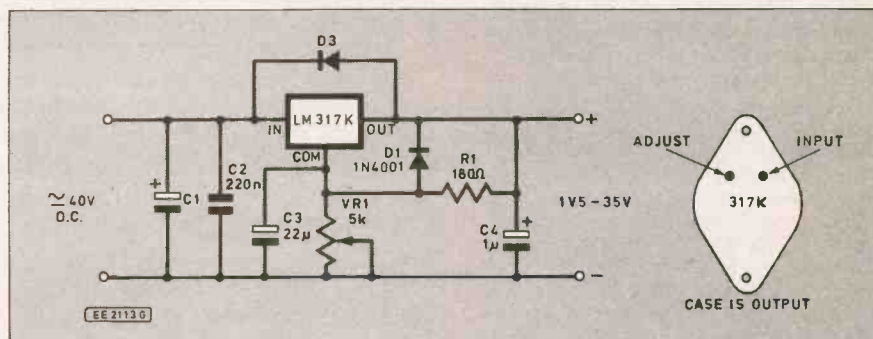

Fig.2.8. Practical circuit diagram for variable voltage output. Note that an insulation kit should be used for mounting the regulator i.c.

Provided this comes about, there's no problem, but the writer is aware from personal experience of at least two cases where the current rocketed to over 2A and the devices were damaged. This was under deliberate test conditions and perhaps I was just unlucky. However, it does show that unless the regulator is being used in a piece of equipment where the load current is fixed, care should be taken where overload conditions might occur in the course of experimenting or setting things up.

A heatsink is necessary for all regulators, except the 78L series. Normally a piece of 16-gauge blackened aluminium measuring 100mm by 75mm will be sufficient; very often the instrument case itself can be used to extend the available area. If you buy a ready made finned heatsink, a rating of 4 to 5°C/W is suitable for the 78 series, but something a bit larger, say 3°C/W for the 78S (2A) series will be adequate.

### CHANGING THE OUTPUT

The fact that the 78/79 series of regulators are designed for fixed voltage applications in the range 5V to 24V, does not mean that they cannot be made to provide odd intermediate voltage outputs such as 9V or that one needs to buy other than the 5V type in order to get higher outputs. This can be done by external adjustment to the internal reference diodes by way of the common terminal.

For small increases, a diode or a small resistance can be used as shown in Fig.2.5. If a diode D2, typically a 1N4148, is placed in the common line, the output voltage will be increased by about 0.7V, equal to the forward voltage drop of the diode. A 7805 will therefore give an output of about 5.7V. Notice the polarity of the diode, it must be in the normal forward direction and would

be reversed if used with a 7905. The same output can be obtained by using a resistor of about 100Ω in place of the diode D2.

This method is no use if substantial voltage increases are wanted, say, raising the output of a 5V regulator to 9V or more. A better arrangement would be to use the system shown in Fig.2.6. Here the common terminal is taken to a potential divider made up of a resistor R1 and preset VR1.

With the values shown, the output can be set to anything between about 5V and 15V using the 7805 package. The preset potentiometer VR1 is bypassed by capacitor C3 which improves the ripple rejection and diode D1 gives protection in the manner already discussed.

If you prefer "belt and braces", a second diode D3 across the regulator itself prevents a reverse voltage developing between input and output. The preset potentiometer VR1 should be set midway before switching on, and then carefully adjusted until the required output is obtained.

It is NOT a good idea to put this control on the front panel and use the circuit as an adjustable power supply. There are better ways of doing this, and in any event the actual range of voltage available is restricted.

An alternative method of adjustment is shown in Fig.2.7. This is rather better than the previous method as it gives an improved regulation figure. Here a transis-

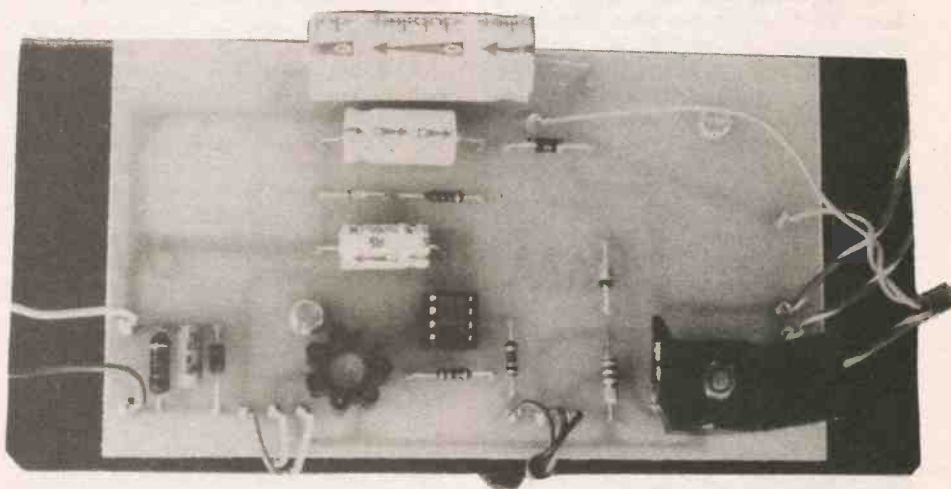

Some of the smaller components needed for a stabilized power supply can be mounted on a printed circuit board (p.c.b.). The design of such a p.c.b. will be published next month. The circuit of Fig. 2.6 could also be built on this board.

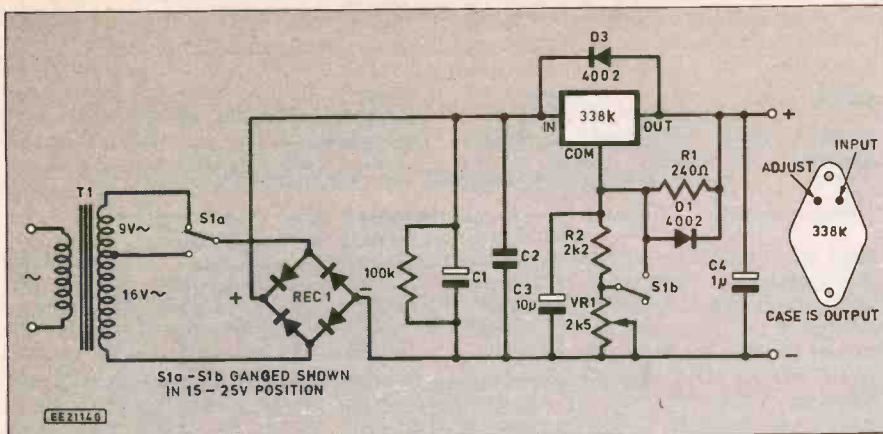

Fig.2.9. Practical circuit diagram for a 0-25V 5A stabilized power supply.

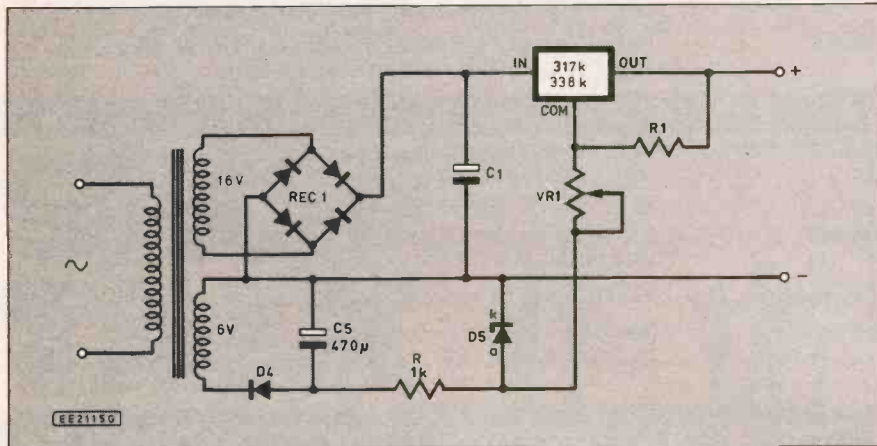

Fig.2.10. Modification which enables the output to be reduced to zero.

tor TR1, with adjustable base voltage acts as an effective resistance in the regulator common connection.

This arrangement provides a measure of feedback, with gain, since a change in the output affects the base voltage of TR1 which in turn adjusts the feedback into the common terminal in such a direction that the change is reduced. With the values shown, a range of about 8V to 12V is possible using the 7805 regulator.

The transistor has to be a *pnp* type and a BC212 or BC447 is suitable. For a 7905 regulator (negative output), an *nnp* is needed and a BC107 is suitable here. The diode must also be reversed in this case, of course.

## VARIABLE VOLTAGE REGULATORS

Regulators are available which are designed to provide an adjustable output over a wide range. These are usually found in TO3 packaging and have to be mounted on heatsinks in the same way as power transistors. Commonly available types are the LM317K and the 338K, the 317K providing an output adjustable from about 1.5V to 36V at 1.5A, and the 338 providing a similar output range at a current of 5A.

A basic practical circuit for the 317K is shown in Fig.2.8 and is similar to that shown in Fig.2.6 but with the values for R1 and VR1 being 180Ω and 5000Ω (5k) respectively. The range covered is from about 1.5V to 35V at a current maximum of 1.5A, and this makes a useful variable stabilized supply for experimental work.

again the basic arrangement is similar to Fig.2.8, but a switching system is introduced to break the output into two ranges: 1.5V to 15V and 15V to 25V.

The purpose of this range switching is to avoid excessive power dissipation in the regulator which would come about if large currents were being drawn at low output voltages. For instance, suppose the transformer provides a single output winding of 25V r.m.s; this appears across the reservoir-capacitor C1 as about 30V d.c on average.

If the output is set to, say, 5V, then there is a drop across the 338K of 25V which, at a current of 5A, represents a dissipation of 125W. This would call for a massive heat-sink. By restricting the transformer output to 16V or thereabouts on an output range of 1.5V to 15V, low voltage output levels, even at 5A current, lead to a much lower internal dissipation.

## GETTING DOWN TO ZERO

It is not usually inconvenient that the outputs of the circuits discussed above do not go down to zero, but if you are a purist who likes to see a complete range coverage on your power supply, a simple modification will put things right. The circuit arrangement to achieve this is shown in Fig.2.10.

A small additional winding on the transformer of about 6V r.m.s is rectified by a single diode D4 and smoothed by capacitor C5. The current requirement is very small and a 470µF capacitor is adequate. This then connects to the circuit systems of either Fig.2.8 or Fig.2.9; only the relevant connections are shown.

A 3V Zener diode D5 is suitable for this circuit, but the value of resistor R may need adjustment depending upon the actual d.c. level you get from the rectifier. The notes at the beginning of this article should enable you to do this without difficulty.

It is possible to get down to zero volts output by providing a negative supply, but we will come to this aspect in due course. A 2°C/W heatsink is necessary; a piece of 14-gauge blackened aluminium 150mm by 100mm is suitable.

By using a 338K regulator, an output of about 1.5V to 25V at a current of 5A can be obtained using the circuit of Fig.2.9. Here

**Next Month:** A universal printed circuit board (p.c.b.) design will be given which, using the circuit of Fig.2.6, will enable any fixed voltage between 6V and 15V to be obtained using only the 7805 regulator. We will also start looking at project designs for stabilized (non-integrated) power supplies over the range 0-30V at currents up to 2A.



The first of the stabilized power supply units to be described next month

# ON SPEC

*a regular  
feature for  
the Spectrum  
Owner...*

by Mike Tooley BA

IN THIS month's instalment of On Spec we reveal the detailed specification of the exciting new Spectrum-compatible SAM computer from MGT. For good measure, we begin with a roundup of Hints and Tips received from readers over the past few months.

## Hints and Tips

David Smythe writes from Essex with a bumper crop of POKEs which can be used to enable or disable a number of the Spectrum's features. There is nothing particularly remarkable about any of these (many have appeared before in various publications) however David's list includes all of the most useful POKEs and is well worth repeating for the sake of newcomers:

ADDRESS	VALUE	EFFECT
23658	8	Enables CAPS LOCK.
23658	0	Disables CAPS LOCK.
23692	0	Enables automatic scrolling.
23755	0	Enables LIST command.
23755	100	Disables LIST command.
23613	84	Enables BREAK key.
23613	82	Disables BREAK key.
23570	10	Disables EDIT key
23570	16	Disables LISTing each time ENTER key is pressed.
23659	0	Enables PRINTING on 24 lines but crashes the system if the BREAK key is pressed during loading or running (useful for protection!). Should not be entered as a direct command.
23659	1	Enables PRINTING on 23 lines. Note that 2 must be POKEd back into this location <i>before</i> the next INPUT, STOP, or CLS command or statement. Should not be entered as a direct command.
23756	0	First line of the program becomes renumbered to line 0. Thereafter this line cannot be deleted or erased (useful for copyright messages).
23652	x	Sets keyboard repeat (x can be any value from 0 to 255). Smaller values produce faster repeats.
23609	x	Sets the keyboard beep. Small values for x produce clicks rather than beeps! When x = 0 the keyboard beep is effectively disabled.
23617	x	Sets cursor mode (K, L, G, E, etc) depending upon the value for x (x = 0, 1, 2, 4 etc).

## SAM COUPE SPECIFICATION

<b>Processor:</b>	Z80B running at 6MHz.
<b>ROM:</b>	32K (containing SAM BASIC, disk bootstrap, and BIOS).
<b>RAM:</b>	256K (expandable to 512K on-board).
<b>Video:</b>	Philips TEA2000 (ASIC serves as graphics processor).
<b>Graphics modes:</b>	<p><b>Mode 1</b> 32 × 24 character cells per screen, each cell capable of 2 colours; 16 colours selectable from 64; Spectrum attribute compatible.</p> <p><b>Mode 2</b> As Mode 1 but with 32 × 192 cells, each cell capable of 2 colours; 16 colours selectable from 64.</p> <p><b>Mode 3</b> 80 column text display; 512 × 192 pixel screen; each pixel selectable for colour; 4 colours selectable from 64.</p> <p><b>Mode 4</b> 256 × 192 pixel graphics screen; each pixel selectable for colour; 16 colours selectable from 64.</p>
	NB: in all modes, colours may be redefined at line interrupt, allowing the whole palette to be displayed on screen.
<b>Sound:</b>	Philips SAA1099 (providing 6 channels, 8 octaves, stereo, with waveform, amplitude and envelope control).
<b>Interfaces:</b>	UHF (channel 39), composite video, digital and linear RGB, joystick (Atari standard) with dual capability, mouse, lightpen, Spectrum compatible cassette, MIDI In, MIDI Out, (MIDI through via software switch), network, RS 232 and parallel printer via Smart cable.
<b>Storage:</b>	0, 1 or 2 removable and internally mounted 3.5 inch ultra slim Citizen disk drives, 780K formatted.
<b>Keyboard:</b>	71 full travel keys, membrane type, including 10 function keys.
<b>BASIC:</b>	Specially written for the SAM range by Dr. Andy Wright (author of Beta BASIC). Features include procedures, DO UNTIL, WHILE, calls to and from machine code, and a host of new graphics commands.

It is, perhaps, worth reminding readers that address 23617 contains a System Variable which is *updated* by the Spectrum's operating system to indicate the current

input mode (lower-case, upper-case, graphics, extended, etc). Some interesting (but not always very useful!) results can be obtained by POKeing values into this address before an INPUT statement.

As an example, try each of the following:

**10 POKe 23617,213**

**20 INPUT x**

**30 PRINT x**

and

**10 POKe 23617,199**

**20 INPUT x**

**30 PRINT x**

The first example produces a flashing "?" whilst the second provides a flashing INPUT cursor.

Andrew Swann writes from Malvern with a timely warning for those using external modules connected to the Spectrum's expansion bus. Andrew has noticed that the key fitted to the 2-way open ended bus connector can sometimes become loose and detach itself from the connector. Without the key in place, there is a very real danger of the connector becoming misaligned and this can cause extensive failure of chips within the Spectrum.

Andrew suggests that users carry out a regular check of expansion module connectors in order to ensure that the key does not become dangerously loose. Such a check could obviously be instrumental in preventing considerable agony later on!

Martin Walker, a regular reader of this column, has provided a series of tips concerning tape loading problems. Martin recommends regular head cleaning and alignment but has noticed that different tapes may require different alignments. It is all too easy to get into a situation where one is constantly realigning a tape head for

optimum performance however Martin suggests that a thorough overhaul (including cleaning of the tape guides and head surface with an ethyl alcohol solution) should cure most ills. Martin recommends the use of a miniature vacuum cleaner for removing dust particles and cotton buds for applying the cleaning solution.

## SAM COUPE

By the time that you read this, MGT's SAM COUPE should be steadily rolling off the production lines at Phoenix Way, Swansea. This is great news for all Spectrum addicts as SAM offers a logical route to upgrading with a machine which offers a specification which will be very hard to beat at the price.

MGT's entry-level SAM machine is to be called the COUPE and it has the specification shown left.

All in all, the SAM COUPE promises to be a remarkable machine. In future instalments of *On Spec* we shall be delving into

the inner depths of this machine and will be providing constructional details of a variety of hardware add ons for the COUPE during the autumn.

Further details of the SAM COUPE can be obtained from Miles Gordon Technology at Lakeside, Phoenix Way, Swansea, SA7 9EH (Tel: 0792 791100).

## Next Month

In next month's instalment of *On Spec*, we shall be reviewing two recently updated compilers (FORTRAN and Pascal) from Mira Software (this item has been held over from this month in order to include information on the SAM COUPE). We shall also be including some comparative software routines for those of you who may be contemplating a change from BASIC to Pascal.

## Update

Finally, an apology to those of you who have been waiting several weeks to receive a copy of our *On Spec Update*. The reason

for these extraordinarily long delays is that I have had to move office several times over the past six months and this has resulted in a number of complications not the least of which is that my filing system has been consigned to a mountain of inaccessible packing cases!

I hope to be installed in my new office early in September and, by that time the response to *Update* requests should be a little more immediate than it has been over the past three months. Many apologies to those of you who may have been kept waiting!

For those of you who would like a copy of the *Update*, please drop me a line enclosing a large (250mm x 300mm) adequately stamped (currently 42p for UK postage) and addressed envelope. Please note that I can no longer provide individual replies to queries but instead will do my best to provide answers through *On Spec* or through the *Update*. Mike Tooley, Faculty of Technology, Brooklands College, Heath Road, Weybridge, Surrey, KT13 8TT.

# SHOP TALK

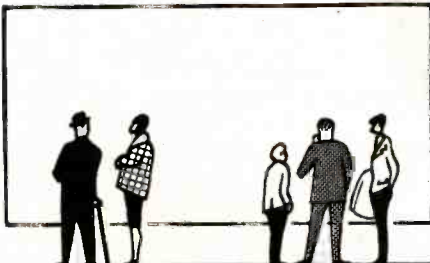

BY DAVID BARRINGTON

## Catalogue Received

From security systems to the humble resistor, they are all contained in the latest Marco Trading components catalogue. The 217-pages are packed with many special components and they claim to be the only officially appointed UK mail order/retail outlet for the famous Eddystone Radio range of die-cast boxes.

Over 21-pages of "unrepeatable" "Special Offer" bargains are listed and it also carries special redeemable discount tickets for use on orders from £5 up to £50.

Copies of the new catalogue can be obtained from Marco Trading, Dept EE, The Maltings, High Street, Wem, Shrewsbury, SY4 5EN for the sum of £1. All listed prices include VAT.

## EE Treasure Hunter

We have only been able to find one source of supply for the power MOSFET type IRF470CF required for the *EE Treasure Hunter* project. This device was purchased from Magenta Electronics and they will supply it as long as stocks last and may then switch to the IRF840, which is a similar MOSFET device. Incidentally, the chip can also be found listed as the MRF740.

A complete kit of electronic parts, including case, p.c.b. and wire for the search coil, may be purchased from Magenta Electronics, Dept EE, 135 Hunter Street, Burton-on-Trent, Staffs DE14 2ST, for the sum of £29.33. To obtain a semi-professional finish they are also making up a special hardware

pack, as listed in the article, for the sum of £11.90.

For those constructors who want an all inclusive kit for the *EE Treasure Hunter*, they are making one available for the price of £39.95. Suitable Headphones will cost an extra £1.99 and £1 must be added to all orders for post and packing.

The small printed circuit board is available through the *EE PCB Service*, code EE652 (see page 540).

## Distance Recorder

The binary thumbwheel switches called up for the *Distance Recorder* are now commonly listed amongst suppliers wares and should not cause any buying problems. This switch usually interlocks together to form a single module.

Most of our component suppliers should be able to supply a suitable 7-segment display if they do not stock the DL704 type. The only point to look out for is that the pinouts correspond to the board layout.

Some component stockists will sell the "reed switch" and bar magnet as a single item, but you may have to purchase these as separate items. Although the designer suggests that the magnet be mounted on the wheel using double-sided sticky pads, and knowing some of the conditions that keen golfers play in, it might be wise to secure the magnet with a good waterproof impact adhesive.

The printed circuit board for the *Distance Recorder* is available from the *EE*

*PCB Service*, code EE651. See page 540 for details.

Finally, it should be pointed out that it is illegal, under the rules of golf, to use this unit during any competition. But for marking out and staking distances on the "practice ground" this unit should prove an invaluable aid for future club selection and distance "awareness".

## Two LED Flasher

The transistor called for in the *Two LED Flasher* — one of this month's "pocket money" projects seems to be a fairly elusive device.

The only current listing for the BC237 transistor we have been able to find is from SCS Components, Omni and Cricklewood Electronics. However, looking at the circuit diagram it would seem that almost any general purpose transistor would operate in this application.

## Pulsating Alarm

The transistor type ZTX453 called for in the *Pulsating Alarm*, this month's "pocket money" project, could cause local sourcing problems.

The only source we have been able to locate for this device is from Electromail (☎ 0536 204555), the mail order arm of RS Components. This is another case where a general purpose npn transistor should work in this circuit, but we have not "bench tested" any other device.

## Electronic Spirit Level

The only item that could prove troublesome when purchasing components for the *Electronic Spirit Level* is the "torpedo spirit level".

This level sensor was purchased from Maplin (code YP56L — Multi Level) comes as a dual unit and is easily modified to a single unit, with a hacksaw, for this project.

The infra red emitter (TIL38); and the phototransistors (TIL78) should be generally available. Maplin actually sell them as "matched" sets.

The piezoelectric buzzer used in the prototype is the familiar PB2720, with case, and is sold by most component suppliers. The small printed circuit board is obtainable through the *EE PCB Service*, code 649 (see page 540).

# TWO LED FLASHER

CHRIS BOWES



This simple educational project will find many uses ranging from a visual warning device to model railway crossing lights.

**T**HIS month's "pocket money" project features the classic *Multivibrator Circuit*. Although this circuit has been superseded by the use of i.c. based clock circuits, it still has a place in the project designer's repertoire, because of its relatively small cost and the fact that it offers two outputs which are energised in opposition to each other. The circuit may be used on its own or can be incorporated with other circuits from this series to form more complex circuits.

## HOW IT WORKS

The circuit (Fig. 1) makes use of the switching action of a pair of transistors, TR1 and TR2. These are arranged so that they each energise an output and control the charging and discharging of the two capacitors incorporated in the bias circuit of the opposite transistor.

When the base-emitter voltage of any transistor rises above about 0.7V then the transistor is biased to the "ON" condition and, as a result, conducts through its collector/emitter junction which turns on the output device (in this circuit a l.e.d.). The switching action of the transistors is controlled by charging a capacitor through a resistor.

This type of circuit forms a simple time delay. The multivibrator circuit actually consists of two such switching/charging circuits which are so arranged as to cause each circuit to control the other circuit.

## CIRCUIT DESCRIPTION

The circuit diagram for the Two L.E.D. Flasher is shown in Fig.1. and, as you can see, it consists of two symmetrical circuits interlinked to each other.

The circuit is self starting and immediately it is switched on one of the l.e.d.s (D1 or D2) will light. The transistor which conducts at switch on is governed by the exact values of the components fitted. In this description it is assumed that D1 lights first.

The l.e.d. D1 is controlled, through its associated series resistor R1, by transistor TR1, which is biased by resistor R2. When the voltage measured between the emitter and base of TR1 exceeds about 0.7V then

TR1 conducts, causing a current to flow through the base/emitter junction of the transistor which in turn makes a current flow through the collector/emitter circuit of the transistor which in turn makes D1 light.

When transistor TR1 starts to conduct it causes the voltage at the junction of capacitor C1 and resistor R1 to fall to 0 volts which effectively causes capacitor C1 to start charging and causes the base-emitter voltage of transistor TR2 to fall to 0 volts, thus turning off TR2. Capacitor C1 charges slowly through resistor R3 until the

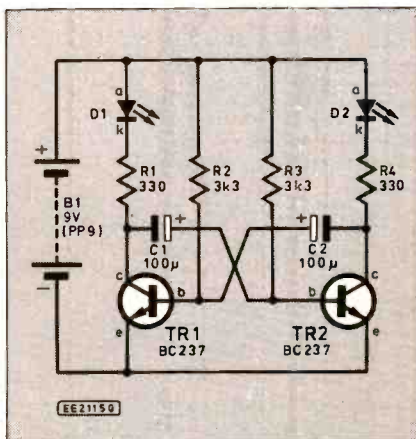

Fig. 1. Circuit diagram for the Two L.E.D. Flasher.

base-emitter voltage of TR2 rises to its *turn-on* voltage, at which point TR2 turns on, illuminating D2, extinguishing D1, discharging capacitor C1 and starting to charge capacitor C2. This process continues uninterrupted until the supply of current is removed.

## CONSTRUCTION

The project is easily made up using stripboard (Veroboard). The finished board is shown in the photographs and in Fig.2 so you will probably find it helpful to look at those whilst you make up the circuit.

The first task is to cut a piece of stripboard to the correct size. You will need a

piece which is at least 14 strips deep and 23 holes wide.

The stripboard shown in the photographs and diagrams is wider than this because allowance has been made for mounting holes at the positions shown on the stripboard diagram. If you are going to mount the project into a box you will need to drill the mounting holes in the positions shown, using a 4mm drill, before starting to construct the circuit.

Once the board has been prepared you can start the electronic construction. Although it does not make any difference to the operation of the circuit which order you insert the components onto the stripboard you will find it easier to construct the circuit if the components are inserted in ascending order of size.

The first stage in constructing this circuit is to insert the wire link into place. To do this you should place the stripboard so that the strips of copper on it are underneath the board and run from left to right and not up and down.

## COMPONENTS

### Resistors

R1, R4 330 (2 off)  
R2, R3 3k3 (2 off)  
All 0.25W  
5% carbon

**Shop  
Talk**  
See page 507

### Capacitors

C1, C2 100µ axial Elec. 10V  
(2 off)

### Semiconductors

D1, D2 Standard l.e.d.s  
(2 off)  
TR1, TR2 BC237 npn silicon  
(or similar) (2 off)

### Miscellaneous

B1 9V battery (PP9 or similar)

Stripboard, 0.1 in. matrix 14 strips × 28 holes; battery connector; connecting wire; solder etc.

Approx. cost  
guidance only

**£4**

Starting at the top left hand corner of the board count across and then down the correct number of holes until you can place one end of the wire link in the position shown in Fig.2. then turn the board over and solder the wire into place. Cut off the extra wire on the underside of the board with your cutters and turn the board over again and repeat the process for the other end of the link wire.

The wire link is made with insulated single core wire but before connecting it you will need to strip off the insulation from one end with the wirestrippers, leave about 3mm more of the conductor exposed than you expect to need. (This is more difficult than it looks so, unless you have done this task before, it is a good idea to practice on a bit of scrap wire first.)

The stripped wire should be tinned, by melting a little solder onto the bit of a soldering iron and then placing the wire onto

Now fit capacitors C1 and C2 into the correct positions, first bending the component leads at right angles as for the resistors. You should take care to make sure that the part of the capacitor marked with a plus or minus sign on the case is placed in the correct hole in the board, see Fig.2. Fit the two transistors in the positions, taking care to ensure that they are also correctly orientated, and solder them carefully in place.

The final items to be inserted into position are the l.e.d.s. These are also polarised (a small flat area on one side denoting the cathode—k) but the result of not connecting them into the circuit the correct way round is simply for the circuit not to work. The case of the l.e.d. has a small flat on one side of the otherwise circular body and the connection nearest to this should go to resistor R1 for D1 and resistor R4 for D2. If you wish you may

connect the l.e.d.s to the stripboard by long wires instead of mounting them directly onto the stripboard.

The wires connecting the battery to the circuit board can now be tinned and soldered into place. The black wire from the battery connector goes to the point on the stripboard shown as B1- and the red wire of the battery connector to the place marked B1+. You can, if you wish, add an on/off switch, in which case the battery connector red wire will need to go to one of the switch terminals and the other terminal taken to B1+ connection on the stripboard.

## TESTING

Before connecting the battery and testing the circuit, you should carefully examine the stripboard to make sure that all of the components are inserted into their correct places, are the correct way round and that there are no blobs of solder shorting out any copper tracks. Once the board has been checked then the battery should be connected and you should be able to see the l.e.d.s flashing off and on alternately.

If the circuit does not operate correctly it will be necessary to check for faults. The first step in fault finding is to, once more, check carefully that all of the components are in the correct places and are the correct way round. In this project the components most at risk of being connected the wrong way round are capacitors C1, C2, transistors TR1, TR2, and l.e.d.s D1 and D2.

The next stage is to check carefully that all of the soldered joints are good joints. This is probably best done by reheating the joint with a soldering iron.

The final mechanical check is to carefully examine the stripboard underneath to make sure that there are no minute (or larger) slivers of solder shorting out adjacent tracks or any breaks in the track where there should be continuous track. If no mechanical problems of this sort are found then it will be necessary to check the circuit through to see whether there is a faulty component or not. You will probably find that you will need to use a test meter to perform some of the stages of this process.

If neither of the l.e.d.s lights then the first stage is to measure the battery voltage firstly without the circuit connected and then with the battery connected to the circuit. If the battery voltage measured is the

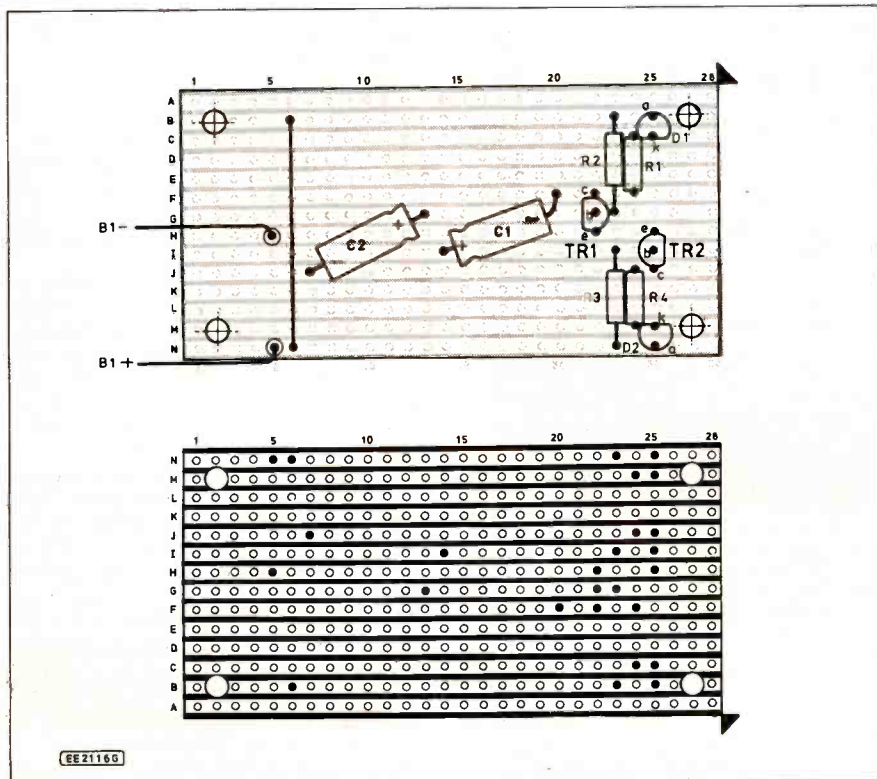

Fig. 2. Component board layout and underside view. Although no breaks are required in the copper strips, it might be wise to break the tracks around the mounting holes at the four corners to prevent any possibility of the mounting nuts shorting across tracks.

the iron's tip with the solder on the opposite side of the wire to the iron. The solder is left there until it melts and flows evenly over the wire.

Removing the wire from the iron and molten solder will probably leave a little blob on the end of the wire which you should then cut off (which is why you stripped the wire slightly longer than required in the first place). The tinned wire should now fit easily through the hole in the stripboard.

## MOUNTING COMPONENTS

The next task is to put the resistors into their correct places, first bending the wires of the resistor at right angles to the body of the component so that they will fit through the holes, as shown in Fig.2. Using the same counting technique as for the wire link put all of the remaining resistors into their correct position and solder them into place.

The completed circuit board showing the layout of components. Note the orientation of the transistors and two electrolytic capacitors.



normal 9V (or thereabouts) without the circuit connected but this suddenly plummets to very little, then it is most likely that there is either a short circuit across the positive and negative power supply rails, or that capacitor C1 and/or C2 is connected with reverse polarity.

If the battery voltage remains normal when the circuit is connected then the circuitry associated with the l.e.d.s should be investigated. The first step is to make a temporary short circuit across the emitter and collector of TR1 or TR2.

If all is well with the l.e.d. and its associated resistor then the l.e.d. should light. If this does not happen then you should check that the polarity of the l.e.d. is correct and that there is a sound connection from the positive (+) volts rail, through the l.e.d. and its associated 330 ohm resistor to the emitter of the appropriate transistor.

This test should be repeated for both l.e.d.s if neither is lit but if one l.e.d. lights then the above test should be carried out

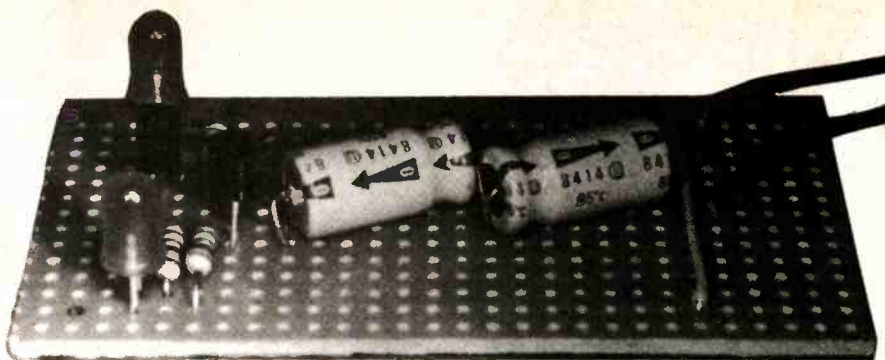

with the inoperative l.e.d. and its associated components. If shorting out the emitter and collector of one of the transistors causes the l.e.d. to be illuminated then the resistor and capacitor connected to the base of the inoperative l.e.d.'s transistor should be investigated.

The most common faults are likely to be components connected with incorrect polarity and poor soldered joints.

### IN USE

The Two L.E.D. Flasher can be used in a number of ways — the limit is that of your imagination. However, to make the circuit work in conjunction with another circuit you will have to arrange for the other circuit to switch it on.

A number of the other projects in this series can do this and the details are given with those projects. □

# MARKET PLACE

**TWO MEGGER METERS** models 70143 one in good condition and other for spares only. Tel: 593-8522. Mr. S. Fowell, 5, Woodward Road, Dagenham, Essex RM9 4SH.

**WANTED:** Walkie Talkie Projects. Penfold BP186. C. Mayer, 4 Humber Road, Ronkswood, Worcestershire. Tel: Worcs. 351203 after 4.30 p.m.

**WANTED:** 10x probe atten. for Cossor CDV150 scope. Also maint. manual for same. A. Meade. 0224-781496.

**WANTED:** manual for Philips G7000 computer. Will pay up to £1 (including p&p) Trevor Page, 12 Ffordd Cadvan, Tywyn, Gwynedd LL36 9EE.

**WANTED:** technical and user manual Decwriter 3 - LS120. Copy, buy or borrow. 01-549-8157. D. E. Griffiths, 5 Alexandra Road, Kingston upon Thames, Surrey KT2 6SD.

**RECORDING EQUIPMENT** Seck 12:8:2 mixer £695. Promark 8:4:2 mixer £295. Akai GX655 tape 10½ reels £295. Mike, 3, Glenfield, Greetland, Halifax. 0422-72246.

**WANTED:** i.c. TDA1050. Zener diode 0.8V. or information as to suppliers. Tel: 01-253-8557. L. Myers, 48 St. John's Square, London EC1V 4JJ.

**WANTED:** for BBC Model B 32K Shadow RAM and ROM. Tel. 0792-201898. G. C. Martin, 23 Wimmerfield Drive, Swansea SA2 7BR.

**WANTED:** Spectrum or any computer with 48K or 32K RAM including power supply and manual. P. Morris, 31 Cobnar Drive Estate, Dunston Newbold, Chesterfield S41 8DB.

**SURPLUS LEDs.** 10p each. For details send s.a.e. to G. Mays, "Rayford", Chobham Road, Knaphill, Woking.

**WANTED:** circuit diagrams for CD compatible amplifier with full remote control. Details and/or specification, please. John Sterry, 60 Welwyn Park Avenue, Beverley High Road, Hull, N. Humberside HU6 7DJ.

**TRANSISTOR CURVE TRACER** Textronix type 575 power supplies s.m.p.s. +5V. ±12. offers. 088926-446. B. Kollar, Quarry Grange, Quarry Road, Hollington, Stoke on Trent.

**BEGINNER** seeks help. Little knowledge. Interested in radio (listening and TV). Am 15 years old. David Nicholls, 6 Egremont Lawn, Woodlands, Liverpool L27 5RB.

**ZX81 COMPUTER** + Maplin keyboard with manuals, software. No power pack. Offers. Tel: 07974-2217 evenings. N. Johnson, 2 Chapel Field, Dixer Road, Northiam, East Sussex TN31 6PQ.

**SPECTRUM PLUS** £10. Interface 1 £5. Alphacom 32 printer £10. Joystick interface for Electron £5. Ray Williamson, 26 Handel Walk, Tonbridge, Kent TN10 4DG. Tel: 0732 352020.

**COMMUNICATIONS RECEIVER** Realistic DX-160 very good condition £50 o.n.o. Will exchange for a.f. signal generator. Mr. M. Minns, 154 Priors Grange, Pitlington, Co. Durham, DH6 1DE. Tel. 091 3721943.

**MILITARY RECEIVER** R210 + power supply, operating and service manuals £45 carr. ex. Tel. 0436 71181.

### FREE READERS ADS.

**RULES** Maximum of 16 words plus address and/or phone no. Private advertisers only (trade or business ads. can be placed in our classified columns). Pen pals or items related to electronics only. No computer software. EE cannot accept responsibility for the accuracy of ads, or for any transaction arising between readers as a result of a free ad. We reserve the right to refuse advertisements. Each ad. must be accompanied by a cut-out valid "date corner". Ads. will not appear (or be returned) if these rules are broken.

**TEN INDUCTOR COILS** for Marconi Q-Meter TP1245, 0.2μ H-5mH. Send s.a.e. for details, then offers. P. V. Hardy, 16 Margaret Street, Beaumaris, Anglesey, Gwynedd.

**BREAKING BBC-B** for spares also Z80 second processor complete £95. Acorn speech £10. BBC pen-pals write Tim Hargreaves, 23 Clendon Avenue, Tunstall, Stoke on Trent ST6 5UX.

**PHILIPS 15" CTV** amd VCR remote controlled, unused great set, mint condition £450. Tel. 683 1394.

**HEATHKIT**, two MA.12 amplifiers USC control unit AFM-TI AFM tuner TA15 tape record replay amplifier with manuals. Offers. H. Davies, 74 Stockton Road, Middlesbrough, Cleveland TS5 4AQ.

**EPROMS 2716, 2732, 2764** used £1 each. 5¼ DSDD BBC disk drive £32. Tel. 0383 731193.

**ATMOS** keyboard £5. ORIC 1 board non worker with circuit diagram £5 both plus postage. Roy Fletcher, 29 Hirst Close, Long Lawford, Rugby, Warks.

**COMMODORE 64** Joystick, data recorder £70. Wanted info to connect Hitachi LM236XB dotmatrix display. Mr. G. Lumb, 6 Beadle Garth, Copmanthorpe, York YO2 3YJ. Tel. 0904 704657.

Name & Address:			

BLOCK CAPITALS PLEASE

Please read the **RULES** then write your advertisement here — one word to each box. Add your name, address and/or phone no. Please publish the following small ad. FREE in the next available issue. I am not a dealer in electronics or associated equipment. I have read the rules. I enclose a cut-out valid date corner.

Signature ..... Date .....

**COUPON VALID FOR POSTING BEFORE 4 AUGUST '89**

(One month later for overseas readers)

**SEND TO: EE MARKET PLACE, EVERYDAY ELECTRONICS, 6 CHURCH STREET, WIMBORNE, DORSET BH21 1JH.**

For readers who don't want to damage the issue send a photostat or a copy of the coupon (filled in of course) with a cut-out valid "date corner"

EE MARKET PLACE  
AUGUST 89



# GREENWELD

## ELECTRONIC COMPONENTS

# SALE

NEARLY EVERYTHING ON THESE PAGES IS

### HALF PRICE OR LESS!!

We must clear last years surplus to make room for more parcels we are expecting soon!! So snap up these unrepeatable bargains now - most goods will not be

available once existing stocks are sold!!

In order to sell at these low, low prices and cover our costs, the **minimum order value is £10 & postage is £3.00** regardless of quantity (orders can be made up with non-sale goods if required) state "Sale prices" when you order, whether by post, phone or fax. See back page for more info.

## KRAZY KEYBOARD KLEARANCE



**Z8852** Keyboard: Superb brand new keyboard 392 x 181 with LCD displaying 1 line of 10 characters and a further line with various symbols. 100 keys, inc separate numeric keypad. Chips on board are 2x77HO5, 80C48. LCD + driver chips are easily removable from board. Looks like it was used with a comms package. Has anyone any more info?

£15.00  
£7.50

SALE PRICE



**Z8857** High quality Alphameric keyboard on aluminium frame 314 x 150mm. Contactless keys good for 20 million operations. Originally sold at over £100 each, they were used in a 'Printcom' portable terminal. Fully ASCII encoded output. Power supply + 5v and -12v @ 35mA supplied with comprehensive data.

£14.95  
£7.50

SALE PRICE



**Z8856** Cherry computer keyboard. Very slim model 340 x 130 by only 14mm deep, including keys. Matrix output. 67 keys in pale/dark brown. No idea what computer they're from - but they're an absolute bargain at only £4.

SALE PRICE

£2.00



**Z8848** Keyboard Alpha numeric separate numeric keypad. 104 keys. Also chips on board: LS373x2, LS374, LM3086x2. LS138x3, 555, LS08, 6805. Size 442x175mm. £12.00  
SALE PRICE £6.00



**Z8863** Keyboard. High quality unit made by Micro Switch 69 pale grey and blue keys. 6 red 5mm LED's, 15 various LS chips and socketed D8048 by Intel. Output via 7 way plug and there's a 4 way edge connector too. Keyboard frame is 317 x 128mm. PCB on which it's mounted is 285 x 170mm. Excellent value at £12.00  
SALE PRICE £6.00



**Z4116** 24 way (8 x 3) membrane keypad. Large (200 x 90mm) area - these were originally used as a teaching aid. Overlay template and pinout supplied. Now only £2.00

£1.00

SALE PRICE



**Z8833** Tatung VT4100 Keyboard. As previously advertised on earlier bargain lists (but these do not have a lead attached). New stocks just received of this popular cased 85 key with separate numeric pad keyboard. Supplied with circuit diagram. 450x65x125mm. £14.95  
SALE PRICE £7.50

**Z8842** Also available are some with broken keytops (usually 2 or 3) Only £9.95  
SALE PRICE £5.00



**Z8835** Keytronic keyboard. We've had these before, too, PCB contains MCT210, 7406, INS8035, LS373, 2708. 95 x 405 x 180mm. £14.95  
SALE PRICE £7.50

## CURRAH

### MSPEECH & SPEECH 64



**Z4140** New complete set for ZX. Spectrum unboxed. (They were bulk packed) £7.95  
SALE PRICE £4.00

**Z4142** Speech 64 for the C64 computer. Better than the Spectrum version as no software needed, and can be programmed in plain English! We only have the bare boards but these are new and working. A photocopy instruction book is included.

£6.00

SALE PRICE

£3.00

**Z4138** µSlot. 'T' connector (1 female, 2 male) for the Spectrum enabling 2 peripherals to be connected to one time. Further µSlots can be added allowing more peripherals to be added: New and boxed.

£2.00

SALE PRICE

£1.00

**OUR 1989 PAGE  
CATALOGUE +  
SUPPLEMENTS GIVING  
FULL DETAILS OF ALL  
ITEMS IN THIS PULL OUT  
COSTS JUST £1 POST  
FREE BUT WE HAVEN'T  
MANY COPIES LEFT, SO  
BE QUICK!**

# COMPONENT PACKS – ALL 1/2 PRICE

## GREENWELD – THE PACK PEOPLE!

More packs – more in them – more value! All our packs contain brand new, marked full spec. components (unless otherwise stated) at a fraction of the normal price and offer constructors the widest range of parts at the lowest cost! How do we do it? By buying manufacturers end-of-run and surplus components. Because we purchase from many sources, we have an extremely wide range of top quality parts – too costly to sort hence the packs described below. Our larger packs are ideal for schools, groups or clubs.

### SEMICONDUCTORS

**K517 Transistor Pack** – 50 assorted full spec. marked plastic devices PNP NPN RF AF. Type numbers include BC114 117 172 182 183 198 239 251 255 320 BF198 255 394 2N3904 etc. etc.

Retail cost £7+ Special low price £2.75

**SALE PRICE** £1.37

**K547 Zener Diodes** – Glass and plastic, 250mW to 5W ranging from 3V to 180V. All ready identifiable. 100 for £4.50

**SALE PRICE** £2.25

**K537 I.C. Pack** – a mix of linear and logic chips, from 6 to 40 pin. All are new and marked, but some may not be full spec.

100 £6.75

**SALE PRICE** £3.37

**K538 Diode Pack** – untested small signal diodes like IN4148 etc. at a price never before seen!! 1000 £2.50

**SALE PRICE** £1.25

**K560 Semiconductors** – Over the years we have purchased many transistors, diodes, ICs etc which for one reason or another have accumulated in one of our stock rooms. Rather than spend weeks sorting and listing them, we have decided to make them into packs. All components are full spec marked devices. Some may be coded. We believe this to be one of the best value packs ever offered, as many high value components are included. Packs are made up by weight; this means contents are very approximate – if there are several bulky power devices, there will be considerably fewer parts than those packs containing all small signal items.

Normally **SALE PRICE**

Pack of approx 100 £5.00 £2.75

Pack of approx 250 £12.00 £6.00

Pack of approx 1000 £40.00 £20.00

### RESISTORS

**K540 Resistor Pack** – mostly 1/8, 1/4 and 1/2W, also some 1 and 2W in carbon, film, oxide etc. All have full length leads.

Tolerances from 5 to 20%. Excellent range of values. 500 £2.50 2,500 £11.00

**SALE PRICES** 500 £1.25 2,500 £5.50

**K503 100 Wirewound Resistors** – From 1W to 12W, with a good range of values.

£2.00

**SALE PRICE** £1.00

**K523 Resistor Pack** – 1000 – yes, 1000 1/4 and 1/2 watt 5% hi-stab carbon film resistors with preformed leads for PCB mounting.

Enormous range of preferred values from a few ohms to several megohms.

Only £2.50

**SALE PRICE** £1.25

**K531 Precision Resistor Pack** – High quality, close tolerance R's with an extremely varied selection of values mostly 1/4 and 1/2w tolerances from 0.1% to 2% – ideal for meters, test gear etc.

250 £3.00 1000 £10.00

**SALE PRICES** 250 £1.50 1000 £5.00

**K505 20 Assorted Potentiometers** – All types including single, ganged, rotary and slider. £1.70

**SALE PRICE** £0.85

**K572 Networks** 7,8,9 pin SIL; 14 & 16 pin DIL. Lots of different values.

Pack of 100 £4.50

**SALE PRICE** £2.25

**K554 Thermistors** – Mostly disc, rod and some valuable bead types. Identification/data sheet included. Big variety up to 40mm dia! Catalogue value over £50.00

100 for £8.00

**SALE PRICE** £4.00

**K525 Preset Pack** – Big, big variety of types and sizes – submin, min and std, MP slider, multiturn and cermet are all included. Wide range of values from 20R to 5M.

100 assorted £6.75 250 £12.95

**SALE PRICES** 100 assorted £3.37 250 £6.50

### CAPACITORS

**K549 Variable Capacitors** – Mostly small trimmers – airspace, mica and polyprop dielectrics, but also included are a few full size tuning caps. 25 for £5.75

**SALE PRICE** £2.87

**K544 Mullard Polyester Caps** – Cosmetic imperfections, electrically OK. Wide range of values from 0.01 to 0.47µF in 100, 250 and 400V working. 200 for £4.75

**SALE PRICE** £2.37

**K546 Polystyrene/mica/ceramic caps.** – Lots of useful small value caps up to about .01µF in voltages up to 8kV. Good variety.

100 £2.75

**SALE PRICE** £1.37

**K528 Electrolytic Pack** – All ready cropped for PCB mounting, this pack offers excellent value for money. Good range of values and voltages from 0.47µF to 1000µF, 6V to 100V.

£3.95 250 £8.95

**SALE PRICES** 100 £2.00 250 £4.50

**K518 200 Disc Ceramic Caps** – Big variety of values and voltages from a few pF to 2.2µF; 3V to 3kV. £1.00

**SALE PRICE** 50P

**K530 100 Assorted Polyester Caps** – All new modern components, radial and axial leads. All values from 0.01 to 1µF at voltages from 63 to 1000V!

Super value at £3.95

**SALE PRICE** £2.00

**K558 Jumbo electrolytic pack** – 10kg of screw top computer grade electrolytic capacitors. Values from 400µF to 83,000µF, voltages 15V to 200V. About 40 caps per parcel. Value if bought individually over £100! Our price? Just £20.00. Order now!

**SALE PRICE** £10.00

### SWITCHES & RELAYS

**K520 Switch Pack** – 20 different assorted switches – rocker, slide, push, rotary, toggle, micro etc.... Amazing value at only £2.00

**SALE PRICE** £1.00

**W4700 Push Button Banks** – An assortment of latching and independent switches on banks from 2 to 7 way, DPCO to 6PCO. A total of at least

40 switches for £2.95 100 £6.50

**SALE PRICES** 40 £1.50 100 £3.25

**K532 Relays** – Wide selection of styles voltages and contacts. 4v-240v, AC/DC, SP and 4PCO 20 for £6.00

**SALE PRICE** £3.00

### K542 Reed Relays

Mostly DIL, single pole & double pole also some changeover, these are manufacturers rejects, but a good proportion work. 5V-50V coils 50 assorted £3.30

**SALE PRICE** £1.65

**K569 Reed Switch Pack.** A selection of about 15 types of reed switch from submin 12mm long to 5A rated 50mm long, mostly form A (make), few form C (Changeover).

Pack of 30 £2.75

**SALE PRICE** £1.37

### OPTO

**K539 Led Pack** – not only round but many shaped leds in this pack in red, yellow, green, orange and clear. Fantastic mix.

100 £5.95 250 £13.50

**SALE PRICES** 100 £3.00 250 £6.75

**K524 Opto Pack** – A variety of single point and seven segment LEDs (incl. dual types) of various colours and sizes, opto isolators, numicators, multi digit gas discharge displays, photo transistors, infra red emitters and receivers.

25 assorted £3.95

**SALE PRICE** £2.00

### HARDWARE

**K551 6BA screws** – In a variety of lengths and heads from 3/16" to 20mm long. Steel. 200 £2.00

**SALE PRICE** £1.00

**K559 Knobs** – Wide selection of sizes, shapes and styles for various diameter shafts and sliders 25 for £1.95

**SALE PRICE** £1.00

**K535 Spring Pack** – approx. 100 assorted compression, extension and torsion springs up to 22mm dia. and 30mm long £1.70.

**SALE PRICE** 85P

**K571 Cable Clips** – 6 or 7 different sizes from 3.5mm to double T & E mostly black and grey. 100 assorted 99p

**SALE PRICE** 50P

**K564 PCB stand-offs.** A mixture of 8 different styles and sizes from 4.75 to 12.7mm high. 100 £2.40

**SALE PRICE** £1.20

**K567 Wire Ties.** 5 types to take 4-15mm dia cable bundles. 100 £1.70

**SALE PRICES** 85P

**K565 Miniature PCB supports** in nylon. 6 different styles – sizes from 6.35 to 13.24mm high. 100 £2.20

**SALE PRICE** £1.10

**K566 Self adhesive cord clips** in moulded nylon. 5 styles/sizes. Base size from 15.9 to 31.8mm square

Pack of 100 £2.70

**SALE PRICE** £1.35

**K568 Giant Plastic Pack** Approx. 1000 pieces – standard and miniature PCB supports, self adhesive ribbon cable clips, straps, ties, cord clips. This lot would normally cost around £50.00

Our Special Price £12.00

**Sale price** £6.00

**K563 Cable markers** (ident sleeving). Over 1000 pieces, all with either letter or number. Assorted colours and sizes from 1-5mm dia. over 50 different!

Pack of 1000 £2.50

**SALE PRICE** £1.25

## Hi-Res Monitor



**Z497 AM/FM Stereo Tuner Panel.** Complete radio chassis with push-button selection for LW/MW/FM and ON/OFF. Ferrite rod for LW & MW selection, co-ax socket for FM aerial. Supplied with mains transformer and rectifier/smoothing cap, and wiring details. PCB is 330 x 90mm. Reduced to £7.95  
**SALE PRICE** £4.00

### 1W Amplifier - mono



**Z914 Audio amp panel 95x65mm with TBA820 chip.** Gives 1W output with 9V supply. Switch and vol. control. Just connect batt. and speaker. Full details supplied. Only £1.50; 10 for £12.00; 25 for £25.00; 100 for £75.00

#### SALE PRICES

75p each; 10 £6.00; 25 £12.50; 100 £37.50

### 1W Amplifier - stereo

**Z915 Stereo version of above 115x65mm featuring 2xTBA820M and dual vol. control.**

£3.50, 10 for £30, 25 for £65, 100 for £200

#### SALE PRICES

£1.75, 10 £15, 25 £32.50, 100 £100

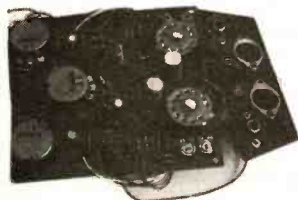

**Z974 Mixer Amp Panel - 115x115mm and gives 1W O/P from a TBA820M chip.** There are two inputs, one via a pre-amp, from phono sockets and separate volume controls. A third pot is used to fade from one input to the other. There are also 2 4p 3w rotary switches. Attached to the PCB by flying leads is a panel on which are mounted the 2 input skts, 2x5 pin DIN skts and 2 pin DIN speaker skt. A data sheet is supplied. All this for just £2.50  
**SALE PRICE** £1.25



**Z4134 Speaker remote control box.** This is a cream case 125x95x42mm housing a 57mm dia speaker and 2 control knobs, one for volume and one to switch main-remote-dual, the 3 core 6m long lead enables volume to be controlled from chair or bed. Simple to fit, instructions included. £3.95  
**SALE PRICE** £2.00



**Z4135 'STETHOPHONE' mini stereo head-phones,** complete with stereo jack plugs, 8R. Hinged headband. £1.75  
**SALE PRICE** 87P



Brand new and boxed, complete apart from case, the super high definition (1000 lines at centre) makes this monitor ideal for computer applications. Operated from 12V DC at 1.1A. Supplied complete with circuit and 2 pots for brilliance/contrast + connecting instructions. Standard input from IBM machines, slight mod (details included) for other computers.

Price £24.95 4 for £99.00  
**£12.50; 4 FOR £45.00**

#### SALE PRICE

**Z494 Newbrain Motherboard.** Micro-processor panel 265 x 155mm. Complete PCB for computer, Z80, EPROM, etc. 68 chips altogether + other associated components, plugs, sockets, etc. Brand new in original packing. £5.50

#### SALE PRICE

£2.75

**Z672 Newbrain motherboards.** Complete but probably faulty. £3.50

#### SALE PRICE

£1.75

**Z620 68000 PANEL PCB 190 x 45mm** believed to be from ICL's 'one per desk' computer containing MC68008P8 (8MHz 16/8 bit microprocessor) + 4 ROMs all in sockets. TMP52220CNL, 74HCT245, HCT138, LS38 & LS08, also 2 x 20w SIL sockets & 2 x 14w SIL sockets. £5.00

#### SALE PRICE

£2.50

### Set Top Converter



**Z8828** Made by Thorn EMI, this was used to receive cable television. 2 part aluminium case 211x158x82mm (no front panel) contains 2 PCB's: (a) control board with multiway switch, dual 7 seg plug in display, couple of chips. (b) main board with mains transformer, tuner, RF section etc. Rear panel has input and output sockets. 2m mains lead with moulded on 13A plug. £9.00  
**SALE PRICE** £4.50

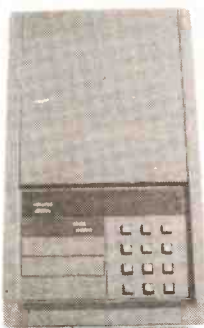

**Z803 Auto Dialler.** Sloping front case 240 x 145 x 90/50mm contains 2 PCBs: one has 4 keypads (total 54 switches) + 14 digit LED display. 2xULN 2004, ULN2033 and 4067; the other has 12 chips +4 power devices etc. Case contains speaker. For use with PABXs, could probably be modified for exchange line. Needs 12V ac supply £9.00  
**SALE PRICE** £4.50

### Prestel Unit



**Z819** Brand new and boxed, complete with co-ax T connector, aerial lead and instruction book. Only one snag - the remote control hand-set is missing. Size of smart wooden case is 347x187x100mm. Mains operated. Old style BT plug. Made by Ayr Electronics, Model P £22.00  
**SALE PRICE** £11.00



**Z8862** Video game unit with 10 games, utilizing, the AY-3-8610 chip. Consists of 2 handheld units 145 x 60 x 45mm made of light and dark grey high impact plastic. Unit 1 has a control panel with 0-9, serve and reset buttons, 3 switches for bat size, ball speed and sound on or off, and built in joystick. Unit 2 has a serve button and joystick. The two units have 2m of 5 core cable between them, and the 3m lead from unit 1 has 3 x 3.5mm plugs; 1) 7-5V input; 2) audio out; 3) composite video out. Worth what we're asking just for the cases! £9.95  
**SALE PRICE** £5.00

### Dual Sheet Feeder



**Z8837 EXXON DUAL SHEET FEEDER Z200.** Overall 395x210x285mm. Brand new and containing some very high class electronics. although of little practical use as it stands, it makes a great break down unit. It contains:  
 3x12V 36R 7.5° stepper motors by Airpax and associated gear trains drive belt etc.  
 2x12V Solenoids  
 1x12V electronic buzzer  
 2 extremely sensitive micro-switches.  
 1 PCB containing 4xTIP115, 4xTIP110, 2x7407, LM3302 comparator + T's, R's, C's, plugs, sockets etc.  
 1 control panel containing 4 LED illuminated push buttons + green LED on small PCB  
 1xOPB703A opto coupler  
 1xOPB7111 opto coupler

Obviously, a very expensive piece of machinery to produce - but once again our contacts in the trade have enabled GREENWELD to procure a few hundred for a fairly modest sum, allowing us to offer them at the bargain price of £24.95  
**SALE PRICE** £12.50

### Touch Pad

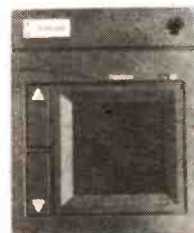

**Z811** Cumana Touch Pad for the BBC 'B' computer. This remarkable add-on enables you to draw on the screen using a stylus with the touch sensitive pad. Supplied with 2 stylii, power/data connecting lead and demo tape with 4 progs. Contains state-of-the-art electronics. Originally being sold at £79.95 - but we can offer a limited quantity of these brand new and boxed for just £19.95  
**SALE PRICE** £10.00

### Fibre Optics



Scoop purchase of single and twin cable. For use with visible light or infra-red. Core 1mm dia, overall 2.25mm dia.

Single 50p/m; 20m coil £4.00  
 Twin 90p/m; 20m coil £6.00

#### SALE PRICES

20M SINGLE £2.00  
 20M TWIN £3.00

# JIMMY

the electronic football game of skill

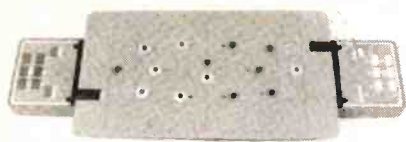

**Z817** Exciting electronic football game - Waddingtons' 'JIMMY'. Brand new models in full working order, but without plastic peripherals, stickers etc. Red plastic case 420mm long x 93mm wide contains keypad and seven segment LED's to keep score either end. The centre section 'players' are represented by red 5mm LED's, 14 altogether. The main chip is the TMS1000, programmed to make odd noises whilst playing and a tune when a goal is scored. Also inside are 13 plastic transistors, 57mm 8R speaker, power supply socket, R's, C's etc. Powered by 2xPP3 batts. Solo or dual play. Supplied with instruction sheet, playing field complete with coloured 'players'. Good fun to play as a game and good value for the electronics within. Originally retailed at £19.95.

**Only £5.00**

Sale price

**£2.50**

## SPEECH CHIPS

SPO256A

**Only £1.00**

10 for **£7.00** 100 for **£50.00**

## OTHER SEMICONDUCTORS:

See pages 82-83 of catalogue 25% off all prices!!

## POWER FET'S

Pair of 140V 100W Hitachi devices 2SJ49 & 2SK134. List price **£10.72**

Our Price

**£6.00**

# SWITCH MODE PSU BARGAINS



## ASTEC Model AA12531

I/P: 115/230V ac 50/60Hz

O/P: V1 + 5v 5A

V2 + 12v 0.15A

Size: 160 x 104 x 45mm

Partially enclosed panel with fixing holes in steel case on 120 x 125mm centres.

Inputs and Outputs are on colour coded leads; there is also an EEC socket on a flying lead.

**£6.95**



## ASTEC Model AC9231

I/P: 115/230V ac 50/60Hz

O/P: 50Watt max:

V1 + 12v 2.5A

V2 + 5v 6.0A

V3 12v 0.5A (+ or -)

V4 5v 0.5A (+ or -)

Size: 203 x 112 x 60mm

Fully enclosed case with built in tapped mounting holes.

Inputs and Output pins on edge of panel.

**£9.95**

## KNOCKOUT KNOBS!!

Sim to K9 - 19mm high x 20mm dia with coloured tops.

Pack of 25 **£3.00**

## DISK DRIVE PSU KIT

Ideal for powering single 3 1/2" or 5 1/4" drive. Mains input, stabilized smoothed outputs, 5V@1A + 12V@1A. Simple, easy to assemble kit with all parts and full instructions. **£4.95**

## VEROBLOC

AMAZING OFFER!!

RRP **£6.69**

ONLY

**£4.95**



## ANTEX

All Soldering Equipment 15% off!!

## SOLDER

16g 500gm reels resin-cored solder. Only **£3.95**; 10 reels **£33.00**

**PHONE YOUR ORDER THROUGH NOW - VISA & ACCESS ACCEPTED.**  
**(0703) 772501**

**GREENWELD**  
**ELECTRONIC COMPONENTS**

**443D MILLBROOK ROAD, SOUTHAMPTON, SO1 0HX**  
**ORDERING INFORMATION**

All prices include VAT; just add £3.00 P&P; Min order value £10.00. Official orders from schools welcome - Min invoice charge £10.00. Our shop has enormous stocks of components and is open 9-5.30 Mon-Sat. Come and see us!

## HOW TO CONTACT US:

By post using the address above; by phone (0703) 772501 or 783740 (ansaphone out of business hours); by FAX (0703) 787555; by E Mail Telecom Gold 72:MAG36026; by Telex 9312131093 (GWG)

## 1989 CATALOGUE SALE PRICES BY PAGE NUMBER

P1-18	10% off	P72	All 1/2 price	P87	Relays 25% off
P25	10% off	P73	All 1/2 price		Rest 1/2 price
P31-34	10% off		except SB15	P88	All 1/2 price
P35-36	5% off	P74	All 1/2 price	P89	All 1/2 price
P55	10% off	P75	All 1/2 price		except:
P57-59	10% off	P76	All 1/2 price		Z4072 25% off
P62-63	20% off	P77	All 1/2 price		Z656 25% off
		P78	All 1/2 price		Z802 20% off
<b>BARGAIN LIST PAGES</b>		P79	All 1/2 price	P90	All 25% off
P68	All 1/2 price	P80	All 1/2 price	P91	All 25% off
P69	All 1/2 price	P81	All 1/2 price	P92	Z4100 £2.00
P70	SB17 £1.00	P82-83	25% off		Z488 £2.00
	Z8827 £2.00	P84	All 1/2 price		J001-3 £1.20/10
	Hi-Res Monitor	P85	All 1/2 price		Rest 1/2 price
	£12.50	P86	All 1/2 price	P93	All 1/2 price
	SB14 £1.50		except joysticks	P94	All 1/2 price
P71	All 1/2 price				

## 1989 SPRING SUPPLEMENT SALE PRICES

P3-10	10% off		Rest 1/2 price	P26	All 25% off
P12-13	10% off	P24	SB10 £2.00	P27	Z8862 1/2 price
P15-17	10% off		Rest 1/2 price		Rest 25% off
P18	20% off	P25	Z4162 20% off	P28	All 1/2 price
P19-22	All 1/2 price		Z4163 20% off	P29	All 1/2 price
P23	Z8858 20% off		Z4164 Sold out	P30	10% off
	Z4167 20% off		SB6 Sold out	P32	Headphones all given away
	Z8861 20% off		Rest 25% off		

# REPORTING AMATEUR RADIO

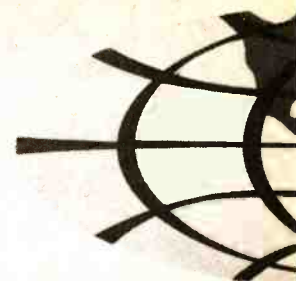

TONY SMITH G4FAI

## NEW DXCC COUNTRY

In the January issue I mentioned the strict rules applied by the American Radio Relay League in defining what constituted a "country" for awards of the prestigious DX Century Club. A group of amateurs had mounted a DXpedition to the Pacific island of Rotuma and applied to the ARRL to give DXCC status to the Fijian administered island, submitting nautical charts to prove that there was over 225 miles of water between Rotuma and its "parent" country.

The application has now been approved. DXCC credit can be given for contacts with last year's DXpedition and also for those with the 1982 German expedition which failed to get recognition at the time. There have apparently been a few other contacts with Rotuma over the years which were credited as contacts with Fiji and any such contact back to 15th November, 1945, can now be re-credited as a "new" country.

## END OF A SAGA

On 17th February, the Belfast, Edinburgh and London Gazettes published a special authority under Section 7 of the Wireless Telegraphy Act 1967.

The controversial situation mentioned previously, which prohibited radio amateurs from constructing or converting transmitters for operation in the 10 metre band without special permission, has now been resolved. The Gazette Notice is in effect a blanket authority exempting licensed radio amateurs from the provisions of the Wireless Telegraphy (Citizens' Band and Amateur Apparatus) (Various Provisions) Order 1988 (SI 1988/1215).

The legislation is in fact aimed at controlling the use of unauthorised equipment on the CB frequencies which are adjacent to the amateur 10 metre band. As far as amateurs are concerned, everything is now more or less back to where it used to be. Without having to obtain special authority they can now buy or build transmitters for 10 metres for their own use, providing they are not capable of operating in the CB band. They can convert legal CB rigs for use on 10 metres. They can even convert non-approved CB sets for amateur use, although in this case it is necessary to obtain authority for "possession for conversion" from the DTI.

## WORLD BAND RADIOS

My comments in the May column about the Matsui, Sangean and other world band radios have produced a surprising response. Some readers have had their interest in short-wave listening re-awakened. Some have actually bought new sets on the strength of my comments, although regretfully the price of the Matsui had gone up by £10 in the period between the writing and publication of my remarks (*we under-*

*stand these radios have now sold out in the UK - Ed).*

In every case the correspondents asked for details of the simple home-made active antenna which I mentioned. This put me in a difficult position as although the circuit I had made worked well, it was still in an experimental stage capable of improvement and I would not normally wish to pass details on until I was satisfied with the final design and could give advice on its use.

As it was so simple, however, I did send out the circuit inviting recipients to experiment with it themselves and let me know of any improvements they were able to devise. I was unable to pass on exact tuning coil/capacitor details however because I was still experimenting with various configurations to match the telescopic antenna to the r.f. amplifier. I shall construct a purpose built unit in due course and will then publish fuller details. In the meantime, no more correspondence please!

Incidentally, I have been rather disappointed when using my Sangean to find so few stations on the 11 metre (25MHz) broadcast band. With the current increased sunspot activity I had assumed that it would be possible to bring in some interesting dx on this band.

This is the subject of comment in the SWL column of the February issue of *Amateur Radio*, journal of the Wireless Institute of Australia, which could explain the situation. It is apparently the view of the broadcasters that the vast majority of their listeners use portable cheap radio sets which do not have 11 metre coverage. They see no point in transmitting on this band just for the relatively few Dxers who have receivers capable of all-band reception.

It seems that experimental transmissions from Norway, Denmark, and Abu Dhabi have been heard at good strength in Australia recently but all have now ceased leaving "only the BBC World Service and Radio France International" to be heard "down under". As I write this I am monitoring 11 metres myself and can hear just three stations, the BBC, Radio South Africa and an Arabic station. This is in direct contrast to 13 metres which is full of activity.

## SCOUTS AND AMATEUR RADIO

The 1988 Jamboree-on-the-Air was another successful event enabling Scout friendships to be renewed around the world via amateur radio. In the UK some 490 scout and 1120 non-scout operators took part. Around 4410 scouts and 350 guides were involved in running the stations, and over 8000 scouts and guides paid short-term visits to them. According to the official report of the Jamboree, the average UK JOTA station made contact with about 23 other UK, and 7 overseas, JOTA stations during the weekend event. This

year's JOTA, the 32nd, takes place on October 20-22.

The Scout Association has now proposed the formation of Radio Scouting Fellowships. These could bring together, in a more organised way than previously, radio amateurs, shortwave listeners, electronic enthusiasts, constructors or serious CB enthusiasts, wishing to share their expertise in support of local scouting.

They could be members/ex-members of the Scout Movement, or total newcomers. There is a wide range of potential activity, including encouraging and helping scouts who have an interest in radio activities, acting as radio badge instructors or examiners, advising on, or helping run, amateur stations at scout events including JOTA, joining a service team running a station throughout the year at a permanent camp site, organising radio orienteering events, and so on.

While the accent would be on the provision of a technical service to the Movement, activities of sole interest to RSF members would also be encouraged. Existing Scout Radio Groups, etc, could re-form as RSFs if they wished. Newcomers could either join an existing Scout Fellowship and start a Radio Scouting "segment" within it or, where there is no Fellowship locally, start a new RSF. These ideas are still at the discussion stage but anyone interested can obtain information from The Public Relations Officer, The Scout Association, Baden-Powell House, Queen's Gate, London, SW7 5JS.

An example of a station on a permanent camp site is the one at Gilwell Park which has been operating since the early '70s, latterly as GB2GP. The Scout Association is spending £5000 on equipment and building work for a new upgraded station at the site.

## AND GUIDES TOO

The Girl Guides Association has introduced a new Radio Communication Interest badge in response to requests from Guides who have enjoyed taking part in Thinking Day on the Air, the Guide's own amateur radio event.

The girls are required to listen to amateur stations and enter essential information in a log. Where possible overseas stations are to be included to demonstrate that, like Guiding, amateur radio is international.

The guides need to know the phonetic alphabet, and a number of country prefixes and Q-codes to help them understand amateur contacts more easily. They are required to have a knowledge of the components of a radio system, propagation characteristics, and the importance of safety in an amateur station. They also need to carry out two specific tasks from a list of activities ranging from helping with a special event station to constructing a simple receiver and explaining how it works.



City and  
Guilds

Certificate Course

# Introducing DIGITAL ELECTRONICS

## Part 11 Combinational Logic

By Michael J. Cockcroft  
Training Manager, Peterborough ITeC

**D**IGITAL electronic circuits (devices) can be divided into two general types: (a) **combinational logic**—circuits which produce an output depending on the *present* state of the input, regardless of its state at any time in the past, and (b) **sequential logic**—circuits which produce an output depending on the state of the input but influenced by the *previous* state of that input. This penultimate part of the series introduces the concept of digital electronics and investigates those circuits and devices in the category of combinational logic. The corresponding City and Guilds objectives are as follows:

### 5. Logic families

#### 5.1 Integrated circuits—types and characteristics

5.1.1. Define the terms, SSI, MSI, LSI and VLSI as applied to integrated circuits.

5.1.2 Identify the major logic families by reference to the device coding (i.e. 7400 series TTL/LS and 4000 series (CMOS).

5.1.3 Identify the major logic manufacturers and logic sub-families by reference to the device coding (prefix, infix, and suffix) as shown in Appendix F.

5.1.4 State normally acceptable voltage ranges for the power supply rails used with TTL and CMOS devices.

5.1.5 Define normally acceptable voltage ranges for the logic levels 0 (low) and 1 (high) for TTL and CMOS devices.

### 6. Logic elements

#### 6.1 Gates

6.1.1 Use manufacturers' literature to determine the supply voltages, pin-out, and logic function of various logic gates including at least FOUR TTL and FOUR CMOS devices from Appendix N.

6.1.2 Connect each of FOUR TTL and FOUR CMOS devices selected from those listed in Appendix N to a logic tutor or breadboard system and derive the truth table for each device.

### Digital Electronics

Electronic technology has, in recent years, undergone exceptional advancement. Extremely complex circuits have been miniaturised and produced in vast quantities as integrated circuits (i.c.s). Every few years these microscopic circuits get more complex, smaller, faster, cheaper, and better for one reason or another.

Digital electronics has played an important role in these radical changes and in modern electronics generally. Digital techniques are no longer confined to computers, as was once the case, but are now being applied more and more to domestic and industrial applications on a grand scale.

### What is digital electronics?

When we speak of digital electronics we mean circuits which use digital integrated circuit devices (i.c.s—see Parts 2 and 5).

Digital electronics is a branch of electronics that operates on the principle of making decisions by testing a point in a circuit for a "true" or "false" condition. This isn't as complicated as it seems; for example, the simple circuit of Fig. 11.1 makes all of the following decisions:

- (a) Are both switches off?
- (b) Are both switches on?
- (c) Is switch A (only) on?
- (d) Is switch B (only) on?

The circuit is a "two way light switch" system (you may have such a system in your hallway or at either end of a large room in your house) and it needs to make all these decisions in order to turn on the light if (and only if) one or the other switch is closed but not both.

There are only two states to the devices (switches) in this circuit, they can either be on or they can be off. Similarly, the components used in digital electronics are two state devices and, despite this apparent simplicity, can be used to make decisions of any complexity. The secret to applying decision making tasks to digital electronic systems is in the method of translating the required task from English into digital logic.

### The Language of Logic

Logic is the reasoning method used to arrive at digital electronic systems; it provides the basis for testing a condition and producing a two-state ("true" or "false") ans-

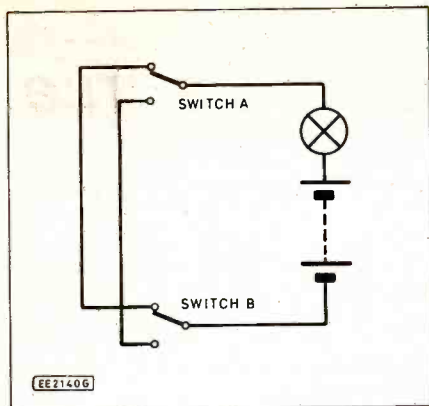

Fig. 11.1. Simple two-way switch circuit.

wer according to the result of the test. Translating a given task into a digital electronic representation is a simple matter of phrasing the task to produce a result having one of only two possible conditions; the result may be "true" or "false", "on" or "off", "yes" or "no", or any other condition that has only two possible states. For example, instead of saying, "which i.e.d. indicator is on?" we would ask a series of questions:

- "Is the 'Oil Warning' i.e.d. on?"
- "Is the 'Battery Low' i.e.d. on?"
- "Is the 'Bulb Blown' i.e.d. on?"
- "Is the 'Engine Overheating' i.e.d. on?"
- "Is the 'Petrol Low' i.e.d. on?"

There would be an appropriate action (output response) if the result of testing any one of these (input) conditions became true. The output requirement for the given input conditions may be expressed as follows:

TABLE 11.1

Input Conditions	Output
A the "Oil Warning" i.e.d. is on B the "Battery Low" i.e.d. is on C the "Bulb Blown" i.e.d. is on D the "Engine Overheating" i.e.d. is on E the "Petrol Low" i.e.d. is on	Z Sound alarm

There can, of course, be a different output action for each input condition; a similar table for a simple TTL logic probe (see Part 5) may look like this:

TABLE 11.2

Input Conditions	Outputs
A voltage at probe >2 volts	X Red i.e.d. indicator (only) on
B voltage at <0.8 volts	Y Green i.e.d. (only) on
C probe open circuit	Z Both indicators off

We can use a shorthand notation from **Boolean algebra** to represent any of the situations in the above tables. Boolean algebra, named after a mathematician of the last century called George Boole, uses "logical variables" which can only take two values: 0 (false) and 1 (true). The "Oil Warning" variable (A in Table 11.1, above), for example, can be abbreviated to A=0 to

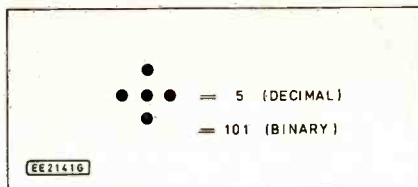

Fig. 11.2. Five in binary and decimal.

represent the oil warning light in the off condition; and the abbreviation A=1 represents the oil warning light on condition. The 0 and 1 in this context are **binary** digits.

### Binary

It is often necessary in digital electronics to operate on numbers. In ordinary everyday events we use the decimal (or scale of ten) number system, but in digital electronics we need to use the binary (or scale of two) number system. The difference between the two systems is the notation used to describe the value of a number; for example, the decimal number used to describe the number of dots in Fig. 11.2 is 5, but in binary there are 101 dots.

The number of digits used in a numbering system is known, in mathematical parlance, as the *base* of the number system. The base of the decimal (we should say denary) system is 10, the base of the binary system is 2.

In the decimal system numbers are written using the *ten* symbols 0, 1, 2, 3, 4, 5, 6, 7, 8, and 9.

These numbers have a value according to the position they hold in a written number; for example

TEN THOUSANDS	HUNDREDS	TENS	UNITS	TENTHS	HUNDREDTHS	TEN THOUSANDTHS
2	1	4	2	6	3	7

21426.37 IS:  
 2 "TEN THOUSANDS"  
 1 "THOUSANDS"  
 4 "HUNDREDS"  
 2 "TENS"  
 6 "UNITS"  
 3 "TENTHS"  
 7 "HUNDREDTHS"

Table 11.3. Digits in their columns.

it is the third symbol to the right of the decimal point, one hundredth (1/100) if it is the second symbol to the right of the decimal point, and one tenth (1/10) if it is the first symbol to the right of the decimal point:

$$0.001 \quad 0.01 \quad 0.1$$

Each digit holds a place in an imaginary column, as shown in Table 11.3 and has a value according to that place. The number as a whole is derived by adding all the digits together, taking each digit's place value into account; for example, the number 21426.37 is the sum of:

$$\begin{aligned}
 2 \times 10,000 &= 20000 \\
 + 1 \times 1,000 &= 1000 \\
 + 4 \times 100 &= 400 \\
 + 2 \times 10 &= 20 \\
 + 6 \times 1 &= 6 \\
 + 3 \times 0.1 &= 0.3 \\
 + 7 \times 0.01 &= 0.07 \\
 \hline
 &21426.37
 \end{aligned}$$

The positional weight of a given digit within a *decimal* number (the value of a digit according to its place in the number) is a power of ten; the above decimal number, for example, is made up like this:

$$2 \times 10^4 + 1 \times 10^3 + 4 \times 10^2 + 2 \times 10^1 + 6 \times 10^0 + 3 \times 10^{-1} + 7 \times 10^{-2}$$

The positional weight of a given digit within a *binary* number is a power of two, the weight of a digit within a *ternary* number (a number to base three) is a power of three... and so on.

In the binary system numbers are written using only two symbols: 0 and 1

Binary numbers, which are made up on the same basis as the decimal system, have corresponding place values which are powers of two:

$$101 = 1 \times 2^2 + 0 \times 2^1 + 1 \times 2^0 = 5 \text{ (decimal).}$$

The greater the number, the more digits are added to the left (just like the decimal system) representing  $2^3, 2^4, 2^5, \dots$  and so on.

Binary digits are abbreviated to *bits* (binary digits) and the bits at the extreme right and extreme left are identified as the *least significant*

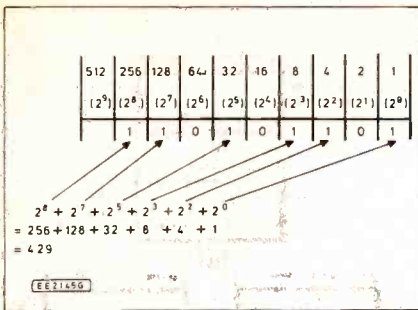

Table 11.4. Binary to decimal.

bit (LSB) and most significant bit (MSB) respectively.

A binary number can be converted to decimal by adding together the powers of two, as shown above and in Table 11.4. To convert from decimal to binary, repeatedly divide by two and list the remainder after each division as follows:

- 429 : 2 = 214 remainder 1 ← LSB
- 214 : 2 = 107 remainder 0
- 107 : 2 = 53 remainder 1
- 53 : 2 = 26 remainder 1
- 26 : 2 = 13 remainder 0
- 13 : 2 = 6 remainder 1
- 6 : 2 = 3 remainder 0
- 3 : 2 = 1 remainder 1
- 1 : 2 = 0 remainder 1 ← MSB

Read the remainders from bottom to top:

$$429 = 110101101$$

Check this by converting the binary result back to decimal:

$$1 + 4 + 8 + 32 + 128 + 256 = 429$$

(see Table 11.4)

Binary is the obvious representation to use for all inputs to, and outputs from, digital devices—whether they represent numbers or conditions such as “true” and “false”, binary 0 and 1 is a convenient shorthand. The relationship between the inputs and outputs of any particular function can be expressed precisely by tabulating them, in binary, in the form of a truth table.

### Truth Tables

A truth table is a complete listing of all possible combinations of inputs with the required output for a given logic function. Such a table is compiled by considering every

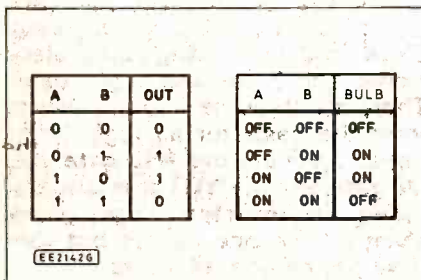

Fig. 11.3. Truth table of Fig. 11.1.

possible input combination in turn and writing the required outputs for that input combination. Consider, for example, the truth table in Fig. 11.3 of the “two way light switch” circuit above (Fig. 11.1). There are four possible input combinations (both switches open, both closed, only A closed, and only B closed), two of which produce OUT=1.

How do we know that we have included all input combinations? We know this if we set up the list of inputs by counting (in binary, of course) from nought to the point where all inputs are 1:

- 00
- 01
- 10
- 11

We can answer your next question (“How does one count in binary?”) with a question: how do we count normally (in denary)? We count by naming or listing all the numbers in order: starting from somewhere, say nought, add 1 to it, take the result and add 1 to that, and continue the process to some number, like this:

- 0
- 1+
- 
- 1 ..... 1
- 1+
- 
- 2 ..... 2
- 1+
- 
- 3 ..... 3
- and so on until we have used up all the symbols in the denary number system. When that happens and we wish to continue counting, we start again from nought and carry a 1 into the left hand column:
- 8
- 1+
- 
- 9 ..... 9
- 1+
- 
- 10 ..... 10
- 1+
- 
- 11 ..... 11

The same process applies to the binary system, only the carry occurs much more often since there are only two symbols:

- 0 ..... 0
- 1+
- 
- 1 ..... 1
- 1+
- 
- 10 ..... 10
- 1+
- 
- 11 ..... 11
- 1+
- 
- 100 ..... 100

Can you see, from where the carry occurs in Table 11.5, that one input has 2 possible combinations

TABLE 11.5

Binary	Number of "0" and "1" combinations	Maximum combinations for number of inputs
0	0	1
1+		
1	1	2 ← 1 input
1+		
10	10	3
1+		
11	11	4 ← 2 inputs
1+		
100	100	5
1+		
101	101	6
1+		
110	110	7
1+		
111	111	8 ← 3 inputs
1+		
1000	1000	9
1+		
1001	1001	10
1+		
1010	1010	11
1+		
1011	1011	12
1+		
1100	1100	13
1+		
1101	1101	14
1+		
1110	1110	15
1+		
1111	1111	16 ← 4 inputs

of 0 and 1, two inputs have 4 possible combinations, and three inputs have 8 possible combinations. In fact, you will now understand that the maximum combinations of an n-bit input is  $2^n$ :  $2^1=2$ ,  $2^2=4$ ,  $2^3=8$ ,  $2^4=16$  . . . and so on.

### Logic Levels

To convert the logical language of what is required into a digital electronic circuit, the electronic representation must be able to distinguish between the two states “true” and “false”. There are many possible ways of doing this. A true condition, for example, could be recognised by detecting a current flow, and a false condition by detecting the absence of current; or it could be that a particular voltage exists or does not exist depending on whether the condition is true or false.

The actual values for logic 1 and logic 0 vary according to the “logic family” to which the i.c. device belongs. A typical voltage for a



logic 1 in the TTL family of devices, for example, might be 3.4 volts, a typical logic 0 might be 0.2 volts; however, any voltage in the range 2 to 5V will be detected as logic 1 (high) and any voltage in the range 0 to 0.8 will be detected as logic 0 (low).

The CMOS family of devices operate over a range of supply voltages (between 3 and 15 volts — the power supply to TTL devices must be regulated at about 5V [in the range of 4.75 to 5.25 volts]). For this reason the input threshold (the values for logic "0" and "1") for CMOS is less distinct than it is for TTL. As an approximate guide for CMOS, consider a logic "0" to be less than 30 per cent of the supply voltage and a logic "1" to be greater than 70 per cent of the supply voltage.

### Logic Families

The semiconductor technology used in the manufacture of integrated circuits characterises the logic family to which a particular i.c. device belongs. Each family provides the same basic logic functions but uses different circuits and have different standards for logic levels and supply voltages; other characteristics, such as power dissipation and switching speeds, vary enormously between families.

A number of logic families have been developed. Some of the earlier (starting in the early nineteen-sixties) integrated circuit families are now no longer in use except, perhaps, as repair parts for old equipment; for example:

- (a) DCTL — Direct-Coupled Transistor Logic
- (b) RTL — Resistor Transistor Logic
- (c) DTL — Diode Transistor Logic
- (d) HTL — High Threshold Logic (very similar to DTL)

Of the integrated circuits in use today, there are two very common logic families:

- (a) TTL — Transistor Transistor Logic
- (b) CMOS — Complimentary Metal-Oxide Semi-conductor

There are subfamilies within both the TTL and CMOS integrated circuit families; for example TTL, in addition to the standard (74 series), has the following subfamilies:

- (a) LSTTL
- (b) STTL
- (c) ASTTL
- (d) ALSTTL
- (e) FAST

and CMOS, in addition to the standard (4000 series), has the following subfamilies:

- (a) HCMOS
- (b) HCT

**TABLE 11.6**  
C&G Appendix F  
**INTEGRATED CIRCUIT CODING**

The most common family of TTL devices is the 74-series in which the device code is prefixed by the number 74. The most common family of CMOS devices is the 4000 series in which the device code is prefixed by the number 4. In addition, manufacturers may introduce their own identifying prefix letters. Common examples are:

- SN = Texas Instruments
- DM = National Semiconductor
- N = Signetics
- NSC = National Semiconductor

Additional letters may be inserted within TTL device coding to indicate the sub-family to which the device belongs:

- H = high speed
- L = low power
- S = Schottky
- LS = low power Schottky
- ALS = advanced low power Schottky
- F = fast
- C = CMOS version of the TTL device
- HC = high speed CMOS
- HCT = high speed CMOS direct TTL replacement

A suffix letter may also be added to denote the type of package. The most common is N which describes the conventional plastic dual-in-line package.

#### Examples

1. SN7400N is a quad 2-input NAND gate manufactured by Texas Instruments and supplied in a plastic dual-in-line package.
2. MM74HC32N is a quad 2-input NOR gate using high speed CMOS technology which is function and pin-out compatible with its TTL counterpart. The device is supplied in a plastic dual-in-line package.
3. N74LS373N is a low power Schottky octal tri-state latch. The device is manufactured by Signetics and supplied in a plastic dual-in-line package.

Suffix letters for CMOS devices may be as follows:

- A (or no suffix) = an original ('A-series') device
- B = a buffered 'B-series' device
- UB = an un-buffered 'B-series' device

- (c) AC
- (d) ACT
- (e) 4000B (Metal Gate)
- (f) 4000B (Silicon Gate)
- (g) ACL

The function of a digital i.c. is identified by a number code printed on the body of the device; there are also prefix and suffix codes to this number to indicate such things as manufacturer, logic subfamily, and type of package. This is explained in Appendix F of the City and Guilds

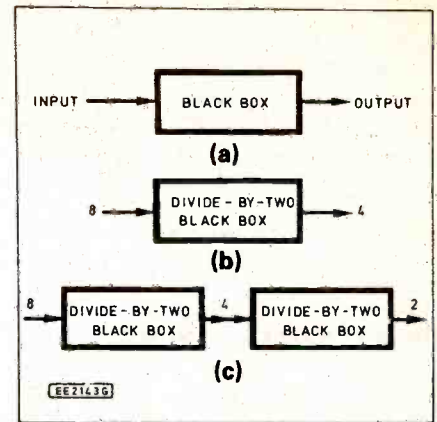

Fig. 11.4. The "black box" concept.

Resource Document (reprinted as Table 11.6).

### Digital Circuits

Various basic logic circuits, in integrated circuit form, have been devised to provide "black box" building blocks for designing digital circuits. The concept of a "black box" is simple: it describes the function of a system by *what* it does leaving out the detail of *how* it does it. Any system processes an input in some way to produce an output; this idea is illustrated graphically in Fig. 11.4a. The function of the system in Fig. 11.4b is to accept a number as an input, divide that number by two and output the result.

It is not always necessary to know what is inside a system or how it works in order to be able to use it; often the important thing to know is the relationship between its input and its output—what does the system do to the input to produce the output? In the case of the system in Fig. 11.4b, it divides the input by two.

It is feasible to use the output of one black box as the input of another one; for instance, two divide-by-two systems can be combined, as shown in Fig. 11.4c, to produce a divide-by-four system.

### Logic Gates

By suitably combining standard logic functions, operations of any complexity can be built up. One type of standard black box building block used for building digital electronic circuits is the logic gate. There are three basic gates which form the basis for all logic functions; these are the **AND gate**, the **OR gate**, and the **NOT gate** (usually called the **inverter**). Logic gates always have one output but can have any number of inputs.

### AND and OR Gates

We previously stated that each logic family provides the same

basic logic functions (e.g., gates) but use different circuits and have different standards for logic levels and supply voltages; Fig. 11.5, for example, shows the internal circuitry of the AND gate for each of the logic families DTL, TTL and CMOS.

Since an i.c. cannot be broken down into discrete components for design purposes or repaired when defective (if an integrated circuit is faulty it has to be replaced), the precise circuit operation within the i.c. is of little practical interest. We may, therefore, treat an integrated circuit function as a black box. Having said that, however, it is useful to look at simplified versions of logic functions to help understand them.

The circuit of Fig. 11.6 is not an AND gate but it performs the logic AND function: the bulb is on only if both switches A and B are closed—current can only flow when there is a complete unbroken circuit. A true AND gate responds to the presence of a logic "1" or "0"; the actual voltage level for "0" and for "1" depends on the logic family. A two input AND gate symbol is shown in Fig. 11.7a, the function of which is to produce a "1" output only if all of its inputs are at "1", otherwise produce a "0" output (Fig. 11.7b). AND gates correspond to decisions where *all* input conditions must be met; for example, if:

the "Oil Warning" i.e.d. is off  
and the "Battery Low" i.e.d. is off  
and the "Bulb Blown" i.e.d. is off  
and the "Engine Overheating" i.e.d. is off  
and the "Petrol Low" i.e.d. is off  
and the ignition is switched on  
then activate the "Self-test-Passed" indicator.

The AND gate symbol (as with all other gates) is the same no matter how many inputs, the corresponding number of input lines are simply added as shown in Fig. 11.8.

The symbol for the OR gate is shown in Fig. 11.9. The OR gate produces a "1" output if one *or* the other input is at "1". The switch analogy for this is given in Fig. 11.10. OR gates correspond to decisions where *any* of the input conditions can be met; for example, if:

the "Oil Warning" i.e.d. is on  
or the "Battery Low" i.e.d. is on  
or the "Bulb Blown" i.e.d. is on  
or the "Engine Overheating" i.e.d. is on  
or the "Petrol Low" i.e.d. is on  
then sound the alarm.

The diagram of Fig. 11.11 shows how the AND and OR gates can be combined to make the decision to sound the alarm if:

any of the warning indicators are on  
and the ignition is switched on

The combined AND and OR gate configuration in Fig. 11.12 shows

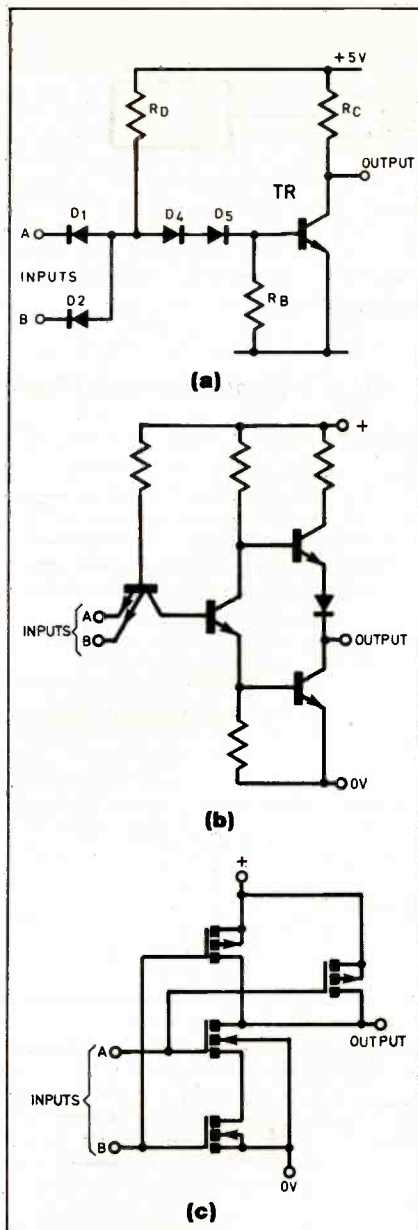

Fig. 11.5. Internal circuit of an AND gate (a) DTL (b) TTL (c) CMOS.

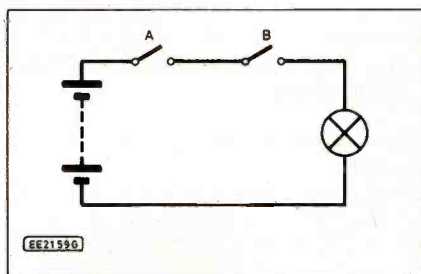

Fig. 11.6. Circuit which performs the AND function.

the logic levels at every point in the circuit for the input combination A=1, B=0, and C=1. The output of the OR gate is "1" because one of the inputs (A) is "1" and it only needs one *or* the other input to be "1" to produce a "1" output. This output is connected to one of the inputs of the AND gate; the other input (C) is at "1", so the output of the entire circuit is "1" because *both* inputs to the AND gate are at "1".

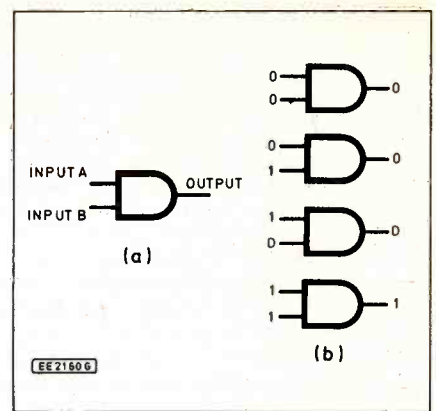

Fig. 11.7. Two input AND gate.

We can map out this circuit's response to any possible situation by listing out the eight ( $2^3=8$ ) binary inputs in the form of a truth table. We then trace through the circuit (as we did for A=1, B=0, and C=1 above) for every input combination.

### The Inverter

The inverter (NOT gate) only has one input and one output, its symbol is shown in Fig. 11.13. The output of the inverter is always opposite to the input: a "1" at the input gives a "0" at the output and vice versa.

Inverters are used to compliment (change to the opposite logic level) a logic signal. Suppose, for instance, that in the above example (Fig. 11.11) the sensor that tests for a blown bulb outputs a "0" instead of a "1" when a bulb becomes open circuit. An inverter might be placed in the circuit as shown in Fig. 11.14.

All logic circuits are combinations of the three basic gates we have just discussed—AND, OR, and NOT. The three circuit combinations in Fig. 11.15 are so widely used that they have been added to the list of basic gates and named NAND (for Not-AND), NOR (for Not-OR), and EXOR (for EXclusive-OR—meaning the output is "1" if A or B is at "1" but not both).

Table 11.7 shows the symbols, truth tables, and example i.c. pinouts for each of the basic gates. gates.

### Integrated Circuit

Digital integrated circuits are made up mostly of transistors and diodes connected together within a tiny "chip" of silicon. Fig. 11.16 shows a scaled photograph of a 24-pin integrated circuit, emphasising the tiny silicon chip at the centre. The size of the chip of silicon varies, although not very much, according to the complexity of the i.c.; however, most of the bulk of these devices provides the physical connecting points to, and protection from (try breaking into one!), the outside world.

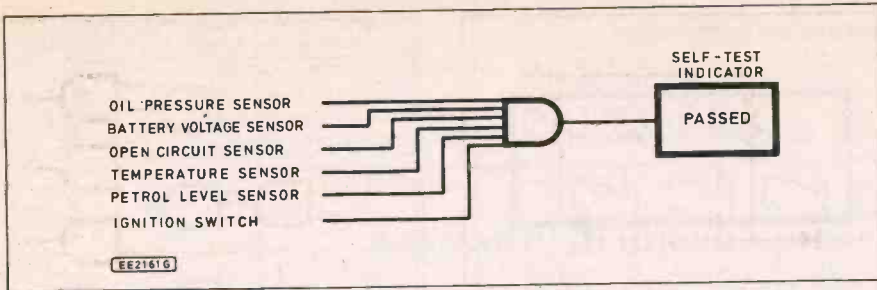

Fig. 11.8. Multiple input AND gate.

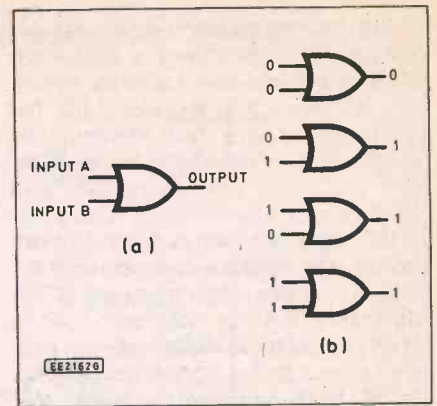

Fig. 11.9. (right) Two input OR gate.

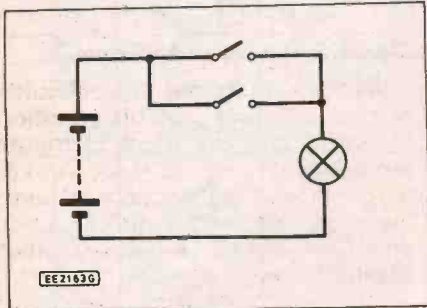

Fig. 11.10. Switch analogy for an OR gate.

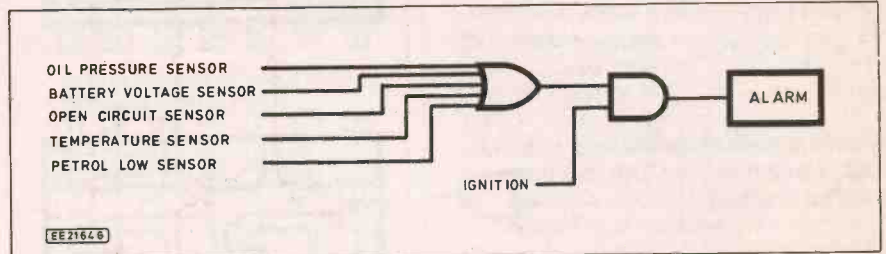

Fig. 11.11. Combining an AND and an OR gate.

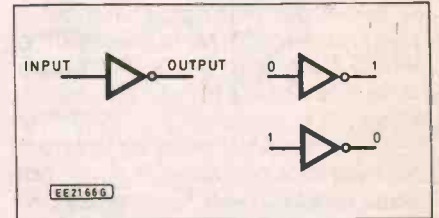
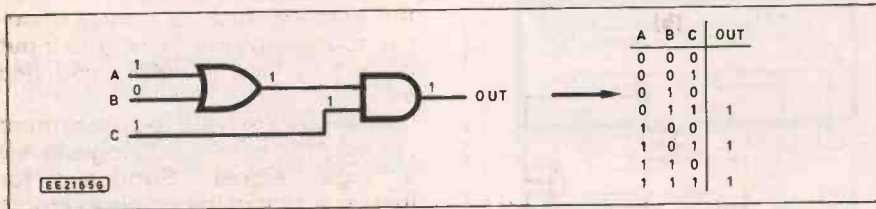

Fig. 11.12. (above left) Logic levels of Fig. 11.11.

Fig. 11.13. (above) The inverter (NOT gate).

Fig. 11.14. (left) Using an inverter.

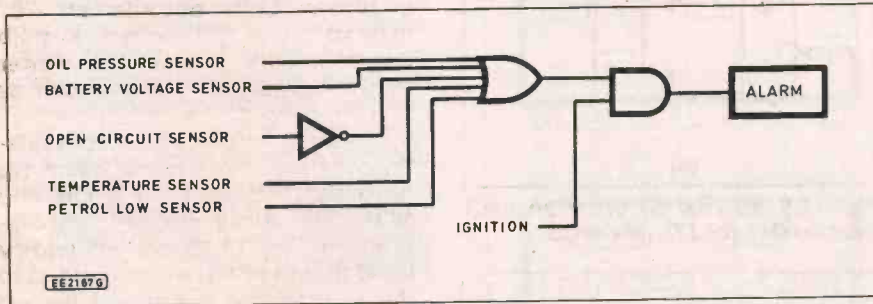

Fig. 11.15. (left) (a) NAND (b) NOR (c) EXOR gates.

Fig. 11.16. (below) A chip in its carrier. The chip shown is a programmable memory device — the photograph has been enlarged for clarity.

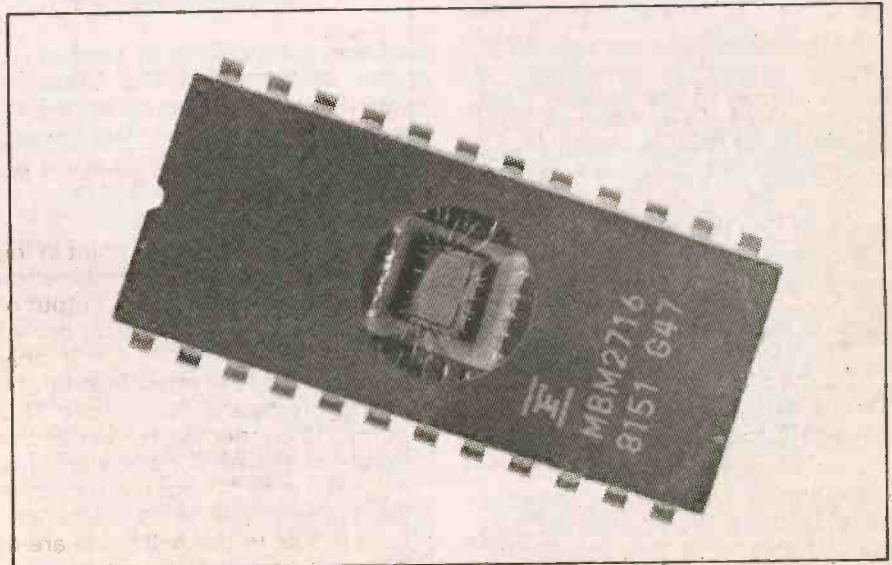
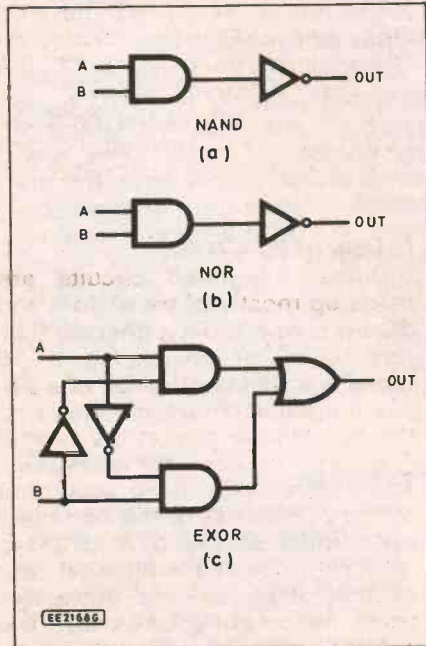

Table 11.7. Truth tables, symbols and pin connections.

NOT	<table border="1"> <thead> <tr> <th>A</th> <th>OUT</th> </tr> </thead> <tbody> <tr> <td>0</td> <td>1</td> </tr> <tr> <td>1</td> <td>0</td> </tr> </tbody> </table>	A	OUT	0	1	1	0											
A	OUT																	
0	1																	
1	0																	
AND	<table border="1"> <thead> <tr> <th>A</th> <th>B</th> <th>OUT</th> </tr> </thead> <tbody> <tr> <td>0</td> <td>0</td> <td>0</td> </tr> <tr> <td>0</td> <td>1</td> <td>0</td> </tr> <tr> <td>1</td> <td>0</td> <td>0</td> </tr> <tr> <td>1</td> <td>1</td> <td>1</td> </tr> </tbody> </table>	A	B	OUT	0	0	0	0	1	0	1	0	0	1	1	1		
A	B	OUT																
0	0	0																
0	1	0																
1	0	0																
1	1	1																
OR	<table border="1"> <thead> <tr> <th>A</th> <th>B</th> <th>OUT</th> </tr> </thead> <tbody> <tr> <td>0</td> <td>0</td> <td>0</td> </tr> <tr> <td>0</td> <td>1</td> <td>1</td> </tr> <tr> <td>1</td> <td>0</td> <td>1</td> </tr> <tr> <td>1</td> <td>1</td> <td>1</td> </tr> </tbody> </table>	A	B	OUT	0	0	0	0	1	1	1	0	1	1	1	1		
A	B	OUT																
0	0	0																
0	1	1																
1	0	1																
1	1	1																
NAND	<table border="1"> <thead> <tr> <th>A</th> <th>B</th> <th>OUT</th> </tr> </thead> <tbody> <tr> <td>0</td> <td>0</td> <td>1</td> </tr> <tr> <td>0</td> <td>1</td> <td>1</td> </tr> <tr> <td>1</td> <td>0</td> <td>1</td> </tr> <tr> <td>1</td> <td>1</td> <td>0</td> </tr> </tbody> </table>	A	B	OUT	0	0	1	0	1	1	1	0	1	1	1	0		
A	B	OUT																
0	0	1																
0	1	1																
1	0	1																
1	1	0																
NOR	<table border="1"> <thead> <tr> <th>A</th> <th>B</th> <th>OUT</th> </tr> </thead> <tbody> <tr> <td>0</td> <td>0</td> <td>1</td> </tr> <tr> <td>0</td> <td>1</td> <td>0</td> </tr> <tr> <td>1</td> <td>0</td> <td>0</td> </tr> <tr> <td>1</td> <td>1</td> <td>0</td> </tr> </tbody> </table>	A	B	OUT	0	0	1	0	1	0	1	0	0	1	1	0		
A	B	OUT																
0	0	1																
0	1	0																
1	0	0																
1	1	0																
EXOR	<table border="1"> <thead> <tr> <th>A</th> <th>B</th> <th>OUT</th> </tr> </thead> <tbody> <tr> <td>0</td> <td>0</td> <td>0</td> </tr> <tr> <td>0</td> <td>1</td> <td>1</td> </tr> <tr> <td>1</td> <td>0</td> <td>1</td> </tr> <tr> <td>1</td> <td>1</td> <td>0</td> </tr> </tbody> </table>	A	B	OUT	0	0	0	0	1	1	1	0	1	1	1	0		
A	B	OUT																
0	0	0																
0	1	1																
1	0	1																
1	1	0																

TYPE OF LOGIC GATE	COMMONLY USED LOGIC SYMBOLS	BRITISH STANDARD
AND		
NAND		
OR		
NOR		
EXCLUSIVE-OR		
NOT - INVERTER		
BUFFER - NON INVERTING		

The various types of gate, and their common and BS symbols.

stock, and to assemble into the finished product results in significant cost savings alone.

There are obvious advantages of small size such as the miniaturisation of circuitry as equipments increase in complexity. But there are also some not so obvious advantages; for example, small circuits consume less power and, therefore, allow for cheaper power supplies. Also, the operating speed of a system is increased when the distance between parts is reduced; a miniature computer, for example, can perform more calculations in a given time than a larger version of the same computer.

### Scale of Integration

Complex i.c.s, which contain functions deriving from the basic gates, are available. A measure of the number of basic gates contained in a single chip describes the devices "scale of integration". There are (at the time of writing) five levels of integration: small scale, medium scale, large scale, very large scale, and super large scale integration. The number of gates per level of integration is given in Table 11.8.

### Exercises

1. Use manufacturers' literature to determine the supply voltages, pin-out, and logic function of various logic gates including at least four TTL and four CMOS devices selected from appendix

Integrated circuits are applied to circuits simply by connecting a power supply to the  $V_{cc}$  and GND pins (according to the device family specification) of the i.c. device, and connecting up the inputs and outputs of the logic functions as required (see Part 5).

It is possible to build the exact circuit within any i.c. chip using ordinary transistors, diodes, resistors etc.; however, there are distinct advantages to using i.c.s for many applications—i.c.s provide for:

- (a) High reliability
- (b) Low cost
- (c) Small size

Integrated circuits are reliable because there are no internal soldered joints; it is the connection

between components in semiconductor systems, not the components themselves, that account for the majority of failures. The fewer discrete components there are in a system, the less likely it is to fail.

Apart from the obvious saving in design time, economy also comes from very low cost of the i.c.s: manufacturing costs of the devices are decreased as more and more components are packed into less chip area. The cost of producing a semiconductor chip is roughly proportional to its area since (about) the same number of manufacturing steps are involved whether it contains a single transistor or a complex i.c. Of course, fewer component parts to order,

TABLE 11.8

SSI	Small-scale integration	less than 12 gates
MSI	medium-scale integration	12-100 gates
LSI	large-scale integration	100-1,000 gates
VLSI	very-large scale integration	1,000-10,000 gates
SLSI	super-large scale integration	more than 10,000 gates

Appendix N

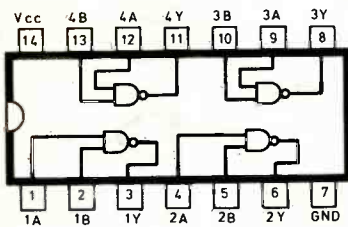

QUAD 2 INPUT NAND GATES  
TTL 7400 (CMOS 4011)

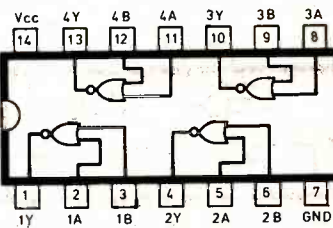

QUAD 2 INPUT NOR GATES  
TTL 7402 (CMOS 4001)

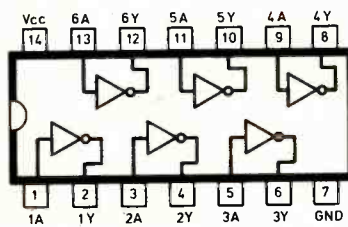

HEX NOT/INVERTER GATES  
TTL 7404 (CMOS 4049)

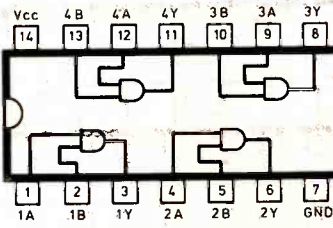

QUAD 2 INPUT AND GATES  
TTL 7408 (CMOS 4081)

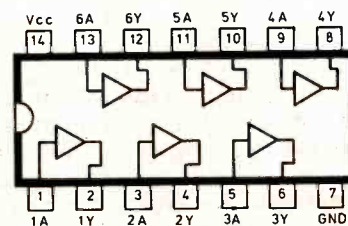

HEX BUFFER GATES  
TTL 6417 (CMOS 4050)

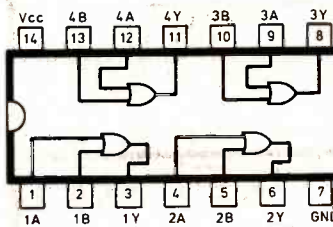

QUAD 2 INPUT OR GATES  
TTL 7432 (CMOS 4071)

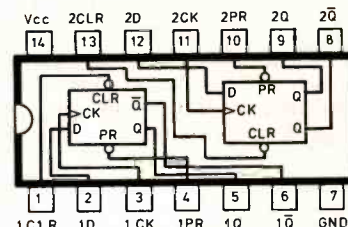

'D' (DATA OR DELAY) TYPE FLIP  
FLOP TTL 7474 (CMOS 4013)

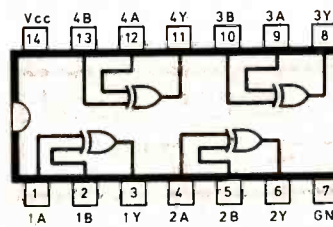

QUAD 2 INPUT EXOR GATES  
TTL 7486 (CMOS 4070)

- What is the recommended supply voltage range for CMOS?
- What is the range of input voltages recognised as logic "0" for TTL devices.
- What is the range of input voltages recognised as logic "1" for TTL devices.
- What is the range of input voltages recognised as logic "0" for CMOS devices with the following supply voltages:
  - 5V
  - 10V
  - 15V
- What is the range of input voltages recognised as logic "1" for CMOS devices with the following supply voltages:
  - 5V
  - 10V
  - 15V
- Complete the truth table for the following circuit (hint: this is a NAND gate equivalent for one of the basic gates).

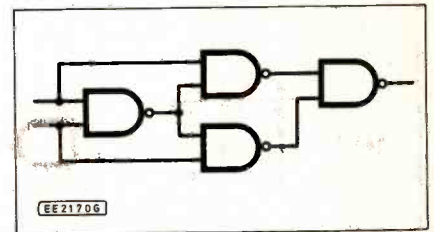

- What are the recommended operating conditions for:
  - Pin 14 of a 7413 i.c.
  - Pin 16 of a 4017 i.c.

Next Month: Sequential Logic.

ANSWERS TO PART 10

- Voltage regulation in a d.c. power supply.
- Power on indicator.
- Rectifier in a power supply.
- (a) The top bulb, (b) both bulbs — the diode will be forward biased with the switch in position B.
- The end marked 2 is the cathode.
- Forward bias.
- Reverse bias.
- A = -13.8V; B = -14.4V (voltages are usually measured from the 0V rail).
- False (see Figs. 10.16 and 10.18).
- a.c. to d.c.

BACK NUMBERS

We can supply back numbers containing the *Introducing Digital Electronics* series, with the exception of the October '88 issue (Part 1). Part 1 and the booklet that also appeared in Oct '88 can be supplied as photo-stats for the same price as a back number. See the Editorial page for ordering details.

N of the C&G Resource Document (reproduced above).  
2. Connect up four TTL and four CMOS devices, selected from Appendix N (above), to a logic tutor (e.g., PencilBox) and derive a truth table for each device by experiment.

Questions

- Draw the truth table for the two-way-switch circuit of Fig. 11.1. Which basic gate does it represent?
- Draw the truth table for the following circuit.

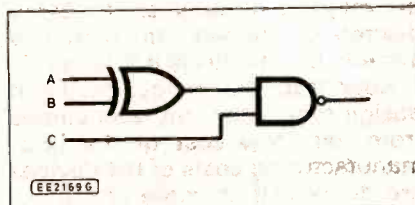

- A NOR gate is an inverter connected to the output of a ..... gate.
- What does a B' suffix tell about a CMOS i.c.?
- What is the recommended supply voltage range for TTL?

# ELECTRONIC SPIRIT LEVEL

PETER CARTWRIGHT

An audio/visual aid for the DIY enthusiast. Ideal for those awkward situations where to divert ones eyes from the workpiece could result in a calamity.



**A** CONVENTIONAL spirit level is perfectly adequate for most jobs. But a situation can arise in which to look at the level would be inconvenient. For this an audible indication would be just the thing.

The Electronic Spirit Level described here includes this feature as well as a visual output. It is also able to assess verticals as well as horizontals.

Coincidentally, an electronic level employing a pivoted weight was recently shown on *Tomorrow's World*. This was rather sophisticated with the capacity to remember angles. The following electronic level doesn't have "whistles and bells" but is still very useful. It is also easy to make.

## SENSOR

The level sensor at the heart of the unit is a low-cost torpedo spirit level. They come as pairs incorporated in a two-way level (see *Shoptalk*), but it can be easily modified to a single unit suitable for this project.

Obviously the position of the bubble has to be electrically represented. This can be achieved by an optical system comprising an infra-red source (l.e.d) and two transistor type detectors (phototransistors) joined

in series. The bubble must then necessarily engage the beam on the way to the detectors. With the infra-red emitter situated centrally relative to the spirit level and the receivers near each crossline, a voltage at their mutual junction will express the bubble's position.

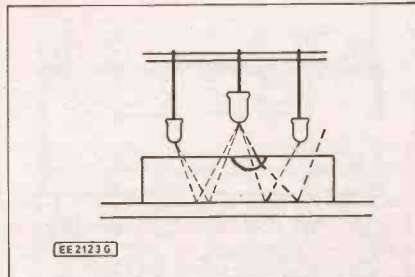

Fig. 1. Effect of the "bubble" on the path taken by the infra-red beam through the level.

It might be thought at first that pointing the beam horizontally through the level directly towards the detectors would do the trick. Unfortunately in practice the unpredictable reflections off the meniscus — the curved upper surface of the liquid in the tube — prevent the required smooth change.

The next likeliest method is to direct the beam from above with the detectors also above picking up the reflection off the back plate. This works well but not in the way imagined. The bubble's transparency could lead one to expect the radiation reaching the nearest detector to increase. But in fact the opposite is the case.

The simplest interpretation is that the concave surface of the liquid disperses the beam as it enters and exits (see Fig. 1). This arrangement is extremely sensitive to the bubble's position. So much so that the emitter's output has to be kept very low to maintain the junction voltage within useful levels.

## CIRCUIT DESCRIPTION

The full circuit diagram for the Electronic Spirit Level is shown in Fig. 2. A conventional level can be regarded as a three state device. That is, the bubble is between the cross lines or somewhere either side. So it is with the electronic level.

Three miniature l.e.d.s D3 to D5 set in a line, light up one at a time, taking the place of the bubble. The outer l.e.d.s are red and the centre l.e.d. green.

Looking at the front end of the circuit, a stabilized voltage supplies the infra-red emitter D2, detectors TR1, TR2 and resistors R2, R3, R4. This is to prevent the resistances of the phototransistors changing proportionally as the battery voltage falls.

Going on we see that the receiver's junction is connected to the non-inverting (+) inputs of op amps IC1a and IC1b. The inverting (-) inputs are however set at different levels by the three resistors R2, R3, R4 connected in series.

With the resistor values shown, the bottom l.e.d. D3 is lit until the bubble just crosses between the lines. At this point the voltage of the receiver junction exceeds the inverting input of the second op amp. So its output goes high lighting the middle green l.e.d. This op amp was initially sinking the current from the bottom l.e.d., so it switches off.

As the bubble reaches the next crossline, the receiver junction voltage rises above that of the inverting input on the first op amp. Likewise its output goes high cutting off the middle l.e.d. and lighting the top one D5.

## AUDIO OUTPUT

For the audio output we want an easily recognizable equivalent to the three states of the l.e.d.s. It was decided that a continuous tone should indicate the centre or "level" condition. The other two states are pulsed tones with the frequency of the pulsing noticeably different from each other.

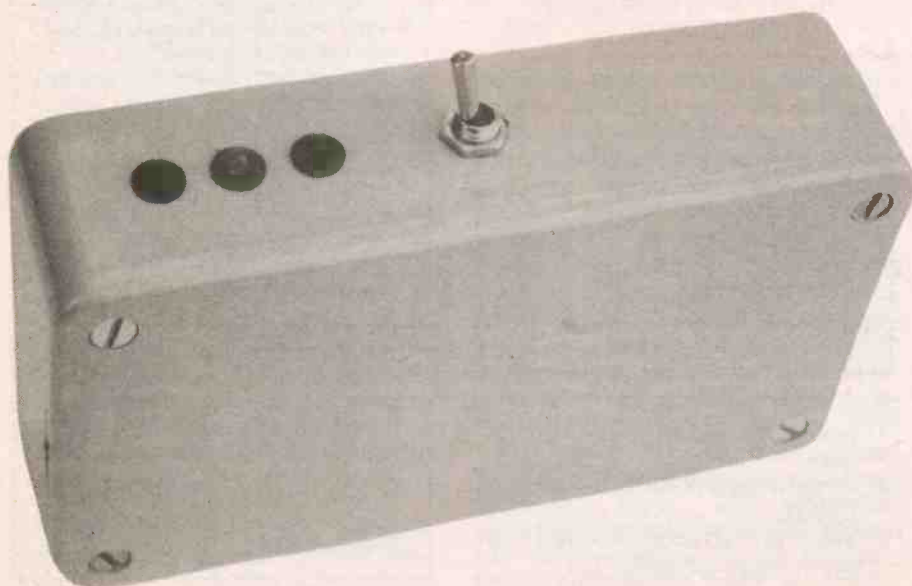

In the circuit diagram Fig.2 we have two oscillators made from the 556 dual timer i.c., configured as equal mark/space astables. The pulsing is produced by the first oscillator IC2a, its frequency determined by resistor R12 and capacitor C2. The control pin voltage is the threshold to which the capacitor must charge before flipping the output low. In other words it also determines the frequency.

The second oscillator IC2b is responsible for the tone. Its reset pin 10 must be kept high for oscillations to continue, so connecting it to the output (pin 5) of the first oscillator will produce the required pulsing.

To create the two rates of pulsing, the control pin (3) of the first oscillator IC2a is tied to the output of the first op amp IC1a, via resistor R11. To create the continuous tone the output of the first timer must remain high, which it does if the trigger pin (6) is kept low. This is achieved when the second op amp IC1b goes high, switching on transistor TR3. Naturally the first op amp going high cuts the current off.

The transistor TR3 is only used as a switch, so any npn of the right size will do. Base resistor R9 also isn't critical.

### BUBBLE MOVEMENT

One other feature requires explanation. As the level state approaches the tone frequency begins to change. This is designed to express the direction of the bubble's movement and prevent overshooting. For this the control pin (11) of the second oscillator IC2b is connected to the output (via resistor R10) of the third op amp IC1c, configured as a buffer amp.

The current consumption of the Electronic Spirit Level is 15mA. The CMOS ICM7556 i.c. is the low power version of the dual timer. Using this would significantly reduce the figure, but it is a bit more expensive.

## COMPONENTS

Approx. cost **£16**  
Guidance only

### Resistors

R1	2k.2
R2, R4	33k
R3	47k
R5, R9	10k (2 off)
R6, R7, R8	1k (3 off)
R10, R11	4k7 (2 off)
R12	18k
R13	100k

All 0.25W 5% carbon

### Capacitors

C1	0.01µ disc ceramic
C2	10µ miniature radial elec. 16V
C3	100µ miniature radial elec. 16V

### Semiconductors

D1	5V6 Zener ½W
D2	TIL38 infra-red emitter
D3, D5	Red 3mm l.e.d.s (2 off)

D4	Green 3mm l.e.d.
D6	1N4148 signal diode
TR1, TR2	TIL78 npn phototransistor (2 off)
TR3	BC109 npn silicon
IC1	LM324 quad op. amp
IC2	NE556 dual timer

### Miscellaneous

S1	spst toggle switch
B1	9V battery (PP3)

Printed circuit board, available from EE PCB Service—code EE649; miniature piezoelectric buzzer; miniature l.e.d. clips (3 off); 1mm p.c.b. pins (5 off); 2mm nut and bolt (2 off); torpedo spirit level; battery connector; grey ABS box, 112mm × 62mm × 31mm; connecting wire; solder etc.

**Shop Talk**  
see page 507

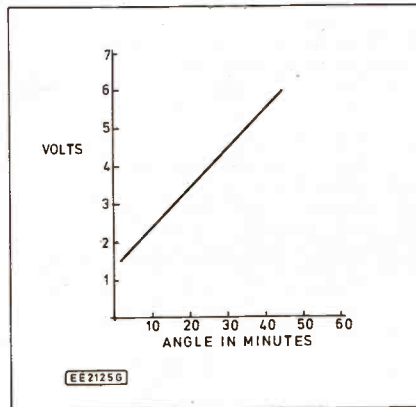
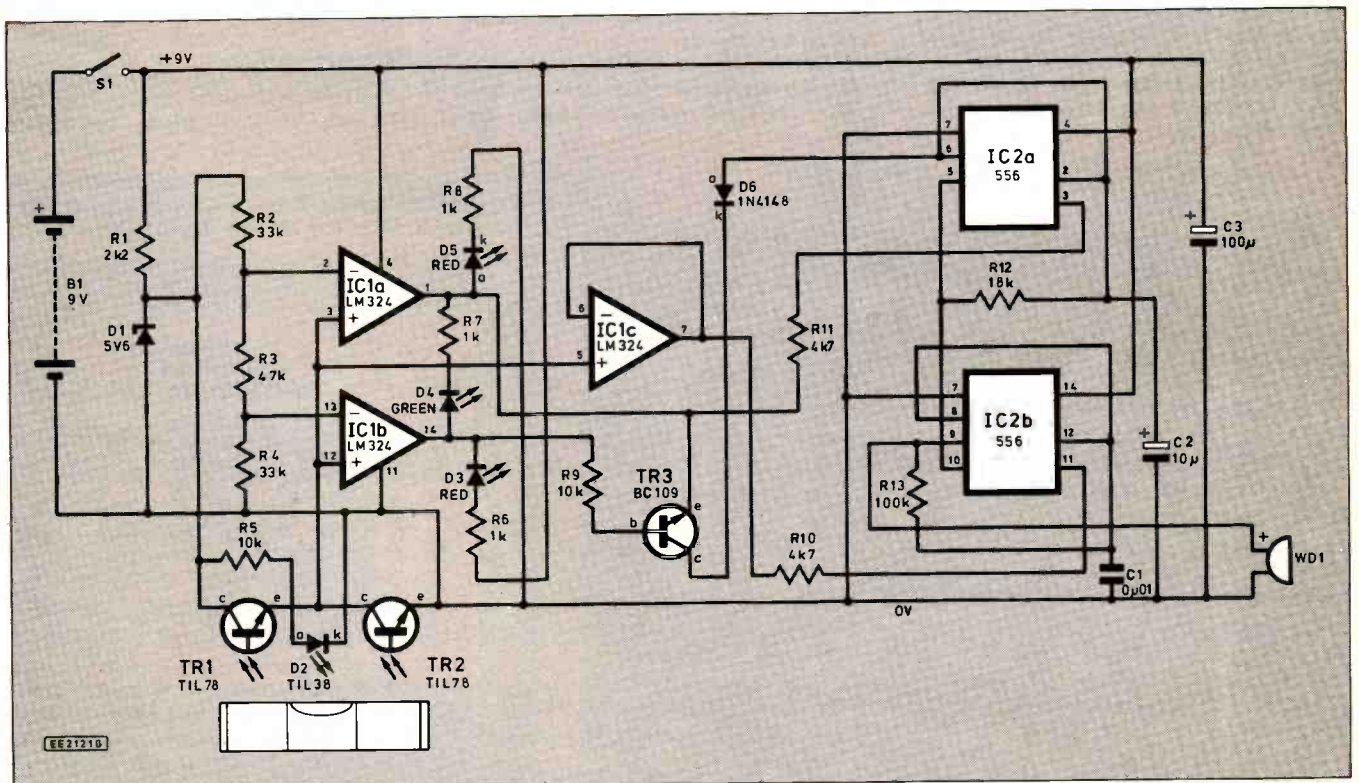

Fig. 3. How the detector voltage junction varies with angle.

As stated earlier the device is extremely sensitive, an angle of less than one second can be resolved! Fig.3 shows how the voltage of the detectors (TR1, TR2) junction varies with the angle. These measurements were taken with the voltage across the detectors at 9V. Increasing the power of the emitter steepens the slope and reduces the voltage over which it is linear.

For our electronic level this linearity isn't important. But if for instance one wished to express the angle directly with a meter, one could do so. As it stands the horizontal state is on over an angle of approximately thirty minutes. To reduce this a smaller value for resistor R3 should be substituted. But it is well to think of how you intend to perform the calibration. Precision engineering levels can be very costly,

Fig. 2. Complete circuit diagram for the Electronic Spirit Level. The base connections of the phototransistors are not used.



## CONSTRUCTION

The component layout and full size copper foil master pattern for the Electronic Spirit Level is shown in Fig. 4. This board is available from the EE PCB Service, code EE649.

The spirit level sensor used in this project comes as a dual unit and will need to be modified. The plastic support can be easily hack-sawed to provide the single unit required for this circuit, see Fig. 5.

It will be noticed that the red plastic surround stands slightly proud of the white reflective backplate. This should be filed down to ensure a good seating.

The usual rules for construction should be followed. That is solder the resistors and capacitors first and finish with the semiconductors. The three l.e.d.s should be mounted proud of the board so that they can protrude through one side of the case.

In the design the integrated circuits are soldered directly to the printed circuit board. If you wish to use sockets more room would be required between IC1 the LM324, and the toggle switch S1. To do this the ribbing around the switch hole would have to be chiselled off.

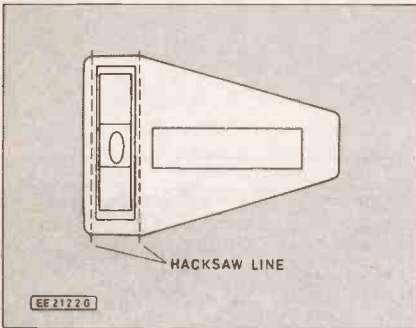

Fig. 5. Modifying the twin level to a single unit.

When soldering the phototransistors and infra-red emitters, mounted on the copper side of the board, they should extend from the p.c.b. as far as they can. Otherwise reflections off the meniscus will give misleading results. It is also a good idea to use a heat shunt on these components. The infra-red emitter can be situated a bit above the detectors.

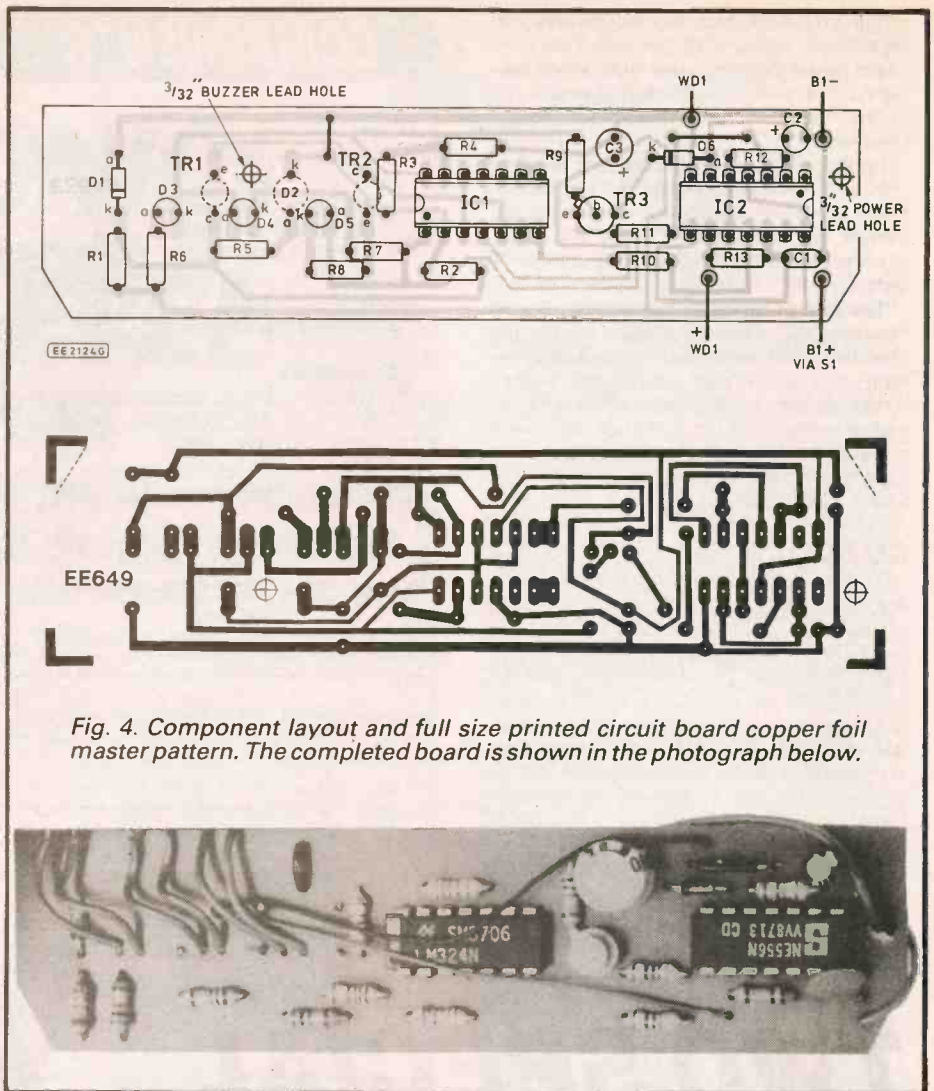
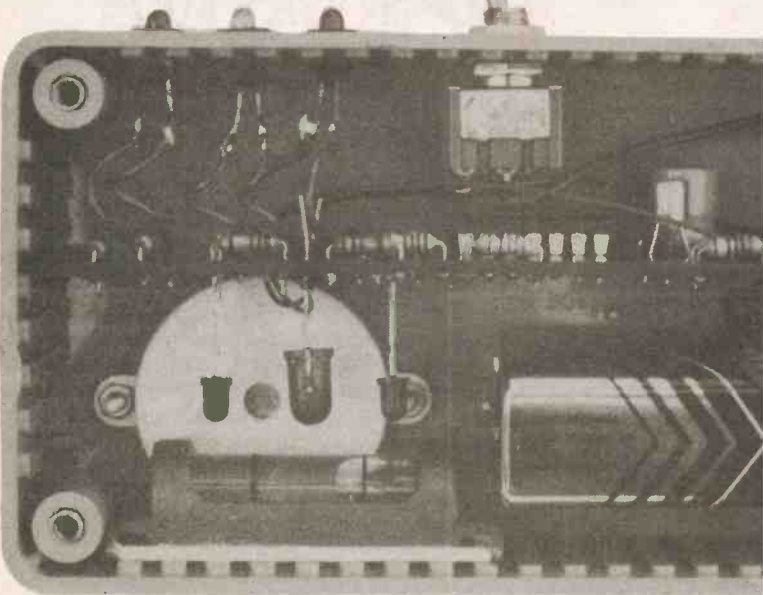

Fig. 4. Component layout and full size printed circuit board copper foil master pattern. The completed board is shown in the photograph below.

Next the three l.e.d.s should be pushed into place. Before slotting the board into the case, the buzzer and power leads should be threaded through their respective holes and soldered in. The positive battery lead is soldered to the switch and the return to the PCB.

Bolt the buzzer to the case, then glue the spirit level directly under the detectors (TR1, TR2) and emitter D2. Make sure

that it is parallel to the case. If isn't, rolling will cause the bubble to move longitudinally. The glue used was modellers polystyrene cement. Finally the backs of the l.e.d.s should be plugged with blackened tissue paper

## SETTING UP

Place the electronic level on a horizontal board in a dimly lit room. The bubble

Fig. 6. Suggested drilling layout for one side and bottom of the case. The p.c.b. pins are required to hold the battery in position.

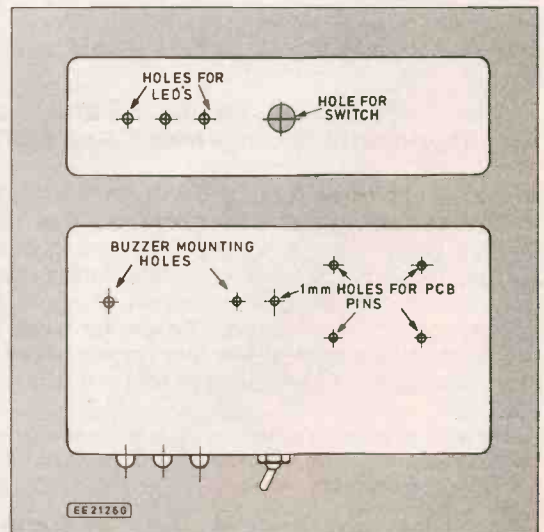



should now be central, but don't worry if it isn't exactly. Now rock the board slightly whilst looking at a separate spirit level resting on it. The green light should switch off as the bubble moves out and traverses a cross line.

Looking from the open end, if the left red l.e.d. lights before the bubble of the board spirit level crosses the left line, bend the emitter leftwards. If the right l.e.d. lights prematurely, it should be bent to the right.

The green light might not be on precisely between the crosslines, but clearly the objective is to have it switch on and off symmetrically about the dead level point. Although the adjustments are quite fine and unlikely to be successful first time, ten minutes work should suffice. The green l.e.d. might light twice. If so, splaying the detectors will cure it.

### CONCLUSION

To assess verticals as mentioned earlier, simply use the upright face of the enclosure. For some jobs a level attached to a beam is essential.

To adapt the Electronic Spirit Level, holes for self-tapping screws could be drilled through the plastic pillars on the base. It could then be fastened to a length of aluminium angle for instance.

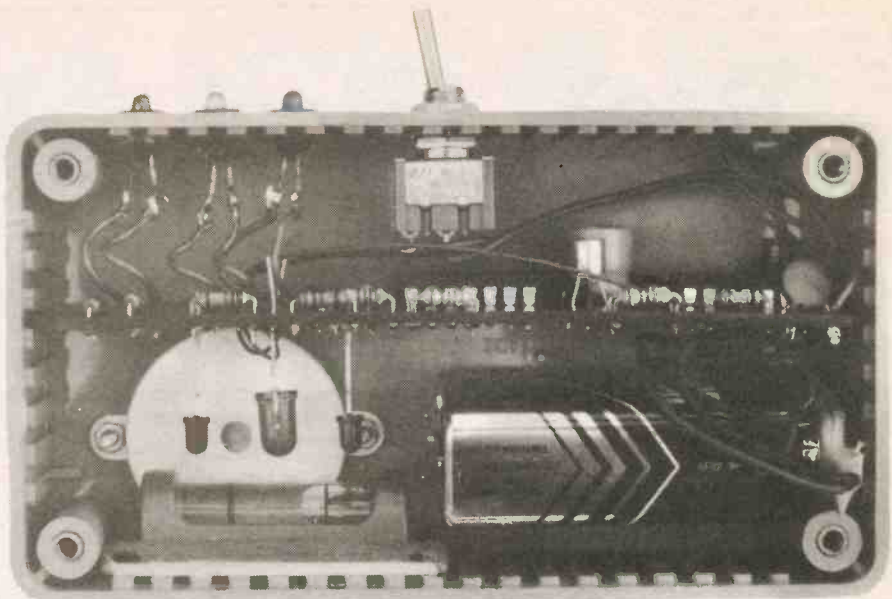

The completed Electronic Spirit Level showing the mounting of the circuit board and level sensor. Also note the infra-red emitter and phototransistors standing proud of the circuit board just above the "sensor".

## TEACH-IN SERIES

# TWO SPECIAL PUBLICATIONS

FROM EVERYDAY ELECTRONICS

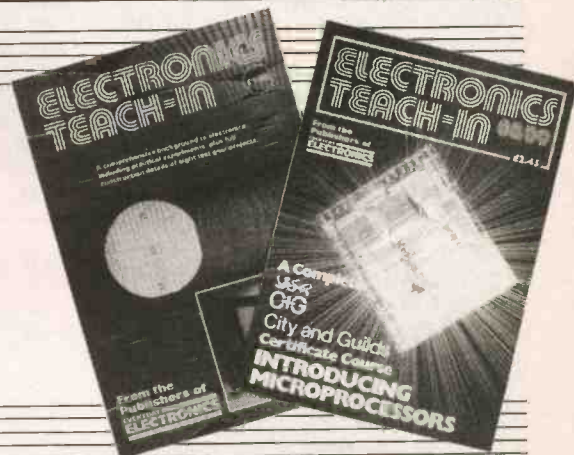

## THE FIRST "TEACH-IN" BOOK

**ONLY £1.95** plus P & P

By Michael Tooley BA and David Whitfield MA MSc CEng MIEE

A comprehensive background to modern electronics including test gear projects. This 104 page, A4 size book forms a complete course in basic electronics; designed for the complete newcomer it will, however, also be of value to those with some previous experience of electronics. Wherever possible the course is related to "real life" working circuits and each part includes a set of detailed practical assignments.

This book is an excellent companion for anyone interested in electronics and will be invaluable for those taking G.C.S.E. or B.T.E.C. electronics courses. **ORDER CODE: EE/T-1**

## TEACH-IN 88/89 BOOK

**£2.45** plus P & P

A complete City and Guilds Certificate Course for 726/303 Introductory Microprocessors

Written by Mike Tooley BA this course can lead successful readers to a City and Guilds Certificate. Everything you need to know is included—even pre-test papers, etc.

From Terminology, Integrated Circuits and Logic Families in Part One, the course progresses in easy stages up to High- and Low-level Languages, Flow Charts and Assembly Language. Also featured is a range of eight Data Pages giving information on popular microprocessor chips. A comprehensive index is included, making this a valuable reference manual. **ORDER CODE: TI 88/89**

**SEE DIRECT BOOK SERVICE pages—for full ordering details**

# b...Beeb...Beeb...Beeb...Beeb...Beeb

## ... 6821 PIA Handshaking ... MC1489 Line Receiver

CARRYING on from last month's article about adding 6821 PIAs to the 1MHz Bus, we will now consider use of the handshake lines of this device. These will not always be needed, and are certainly not necessary for applications where the data lines of a port are being used to control relays, i.e.d.s, etc.

Even when driving something like a ZN426 digital to analogue converter it is unlikely that any handshaking will be necessary. You simply output 8-bit codes to the converter which almost instantly converts each value to the appropriate output voltage.

Handshaking is more likely to be necessary with something like an analogue to digital converter, where a properly synchronised flow of data is needed if erroneous results are to be avoided. With our example of an analogue to digital converter, the computer is normally required to supply a pulse to initiate each conversion, and it must read a status output of the converter to determine when a conversion has been completed and valid data is available.

This one output and one input arrangement is probably the most common form of handshaking. However, each set of two 6821 handshake lines can operate as one input and one output, or as two inputs, but twin output operation is not catered for.

### In Control

The operating mode for both pairs of handshake lines is determined by the bit patterns written to their respective control registers. The function of each bit of both control registers is shown in Fig. 1. Bit 2 of each register is used to select either the data direction register or the peripheral register, as described in the previous *Beeb Micro* article, and does not affect the handshake lines.

Bits 6 and 7 of each control register are the interrupt flags. these cannot be set by the computer, but are set by active transitions on a handshake line that has been set as an input. Note that, like the 6522 handshake lines, those on the 6821 can only operate as edge triggered types. You cannot read the static level of a handshake input.

CONTROL REGISTER A							
Bit 7	Bit 6	Bit 5	Bit 4	Bit 3	Bit 2	Bit 1	Bit 0
IRQA1	IRQA2	CA2 Control			DDRA Access	CA1 Control	
CONTROL REGISTER B							
Bit 7	Bit 6	Bit 5	Bit 4	Bit 3	Bit 2	Bit 1	Bit 0
IRQB1	IRQB2	CB2 Control			DDRB Access	CB1 Control	

Fig. 1. Details of the 6821 i.c. control registers.

Control of CA1 and CA2 is very similar to that of CB1 and CB2, but there are a few differences. We will consider CA1 and CA2 first, with any differences in the way CB1 and CB2 operate being pointed out later.

CA1 is the more simple of the two port A handshake lines, since it is controlled by only two bits of the control register, and it has no output modes. It therefore has four input modes, as detailed below.

CR Bit 1	CR Bit 0	Mode
0	0	High to low transition, interrupts disabled
0	1	High to low transition, interrupts enabled
1	0	Low to high transition, interrupts disabled
1	1	Low to high transition, interrupts enabled

An active transition on CA1 causes bit 7 of the control register to go high. This interrupt flag is automatically cleared when the control register is read by the microprocessor. Control of CB1 is identical, but is obviously accomplished using control register B. CA2 has four input and three output modes, as detailed below.

CR Bit 5	CR Bit 4	CR Bit 3	Mode
0	0	0	Input—High to low transition, interrupts disabled
0	0	1	Input—High to low transition, interrupts enabled
0	1	0	Input—Low to high transition, interrupts disabled
0	1	1	Input—Low to high transition, interrupts enabled
1	0	0	Output—set when CR bit 7 is set high by active transition on CA1, set low by read operation to data register
1	0	1	Output—Pulses low for about one clock cycle after a read operation to the data register
1	1	0/1	Output—Reflects the value written to bit 3 of the control register

The input modes of CA2 are much the same as those of CA1. CB2 has exactly the same four input modes. The most simple output mode is where bits 4 and 5 are set to 1, and CA2 latches at a state that is controlled by the value written to bit 3.

The pulse output mode is a useful one. When interfacing to an analogue to digital converter for example, it can be

used to automatically initiate a new conversion after each completed conversion has been read.

### Automatic Handshaking

The remaining mode is sometimes called the "handshake" output mode, and in conjunction with CA1 as an input it is designed to provide largely automatic handshaking. There is probably more than one method of tackling handshaking using this mode, but the basic idea is for the peripheral circuit to strobe CA1 when fresh data is made available. CA2 then goes high in order to acknowledge that the data has been received and is waiting to be read.

A read operation to the data register then clears CA2 to the low state to indicate to the peripheral register that the data has been read, and the port is ready to receive the next byte of data. This would seem to be a very useful means of handling the flow of data, but I must admit that it is a mode which I have never used in earnest.

CB2 has what are almost the same output modes, but there are slight differences. In fact, the mode where CB2 operates as a latching output is exactly the same as CA2's latching output mode.

The pulse mode differs in that it produces the pulse after a write operation, not after a read type. Similarly, the handshake mode resets CB2 to the low state after a write operation to the data register.

The pulse mode enables a strobe pulse to be automatically generated each time fresh data is written to the data register. This pulse indicates to the peripheral circuit that a fresh byte of data is present and ready to be acted on.

In the handshake mode the peripheral circuit indicates that it is ready to receive a new byte of data by activating CB1. CB2 then goes high in order to acknowledge the request. When data is written to PB0 to PB7, CB2 goes low again to indicate that fresh data is available.

If you are going to use one port as an input and one as an output, with either or both making use of the handshake lines, it makes sense to use port A as the input and port B as the output. The handshake lines of port A are designed to simplify handshaking on read operations, while those of port B are designed for easy handshaking on write operations.

You can use a port in the "wrong" role, but the handshake output must then be used in the latching mode and directly controlled by the software. Alternatively, one of the automatic modes might be usable in conjunction with dummy read or write operations (a method I have found to work perfectly well on several occasions).

Obviously a lot of peripheral circuits, including such things as digital to analogue and analogue to digital converters, could be directly interfaced to the 1MHz Bus, or interfaced via an 8-bit latch and (possibly) some simple logic circuitry. However,

interfacing through ports of a 6821 is perhaps a better way of doing things. It is not a particularly expensive chip, and it should avoid any potential problems with bus incompatibilities.

### Serial Ports

The 6850 ACIA (asynchronous serial interface adaptor) can fulfil most serial interfacing requirements, although it is only fair to point out that it does not have the full range of word formats provided by a UART (universal asynchronous receiver/transmitter) such as the industry standard 6402 device. To be of any practical value the 6850 must be used with some extra hardware to provide a baud rate clock signal, plus input and output signal conditioning.

Before going on to consider this aspect of the device we will take a look at its registers. The 6850 has four registers; two write types and two read registers.

One of the write registers is the data register to which bytes that must be transmitted are written. Similarly, one of the read registers is the data register from which received bytes of data are read. The other read and write registers are respectively a status register and a control register.

Taking the control register first, bits 0 and 1 provide the reset function and control the division rate applied to the baud rate clock, as detailed below:

Bit 1	Bit 0	Function
0	0	Divide by 1
0	1	Divide by 16
1	0	Divide by 64
1	1	Reset

There is no reset input on the 6850 device. It is therefore essential to write a value of three to the control register to reset the device, and then write the appropriate value for the required division rate etc., before starting to use the chip. In practice the divide by one option is not very useful as it does not provide automatic synchronisation to received signals.

Bits 2 to 4 provide a choice of eight different word formats. Table 1 below provides details of the available formats.

Table 1: Word Formats

Bit 4	Bit 3	Bit 2	Word Format
0	0	0	7 bits, even parity, 2 stop bits
0	0	1	7 bits, odd parity, 2 stop bits
0	1	0	7 bits, even parity, 1 stop bit
0	1	1	7 bits, odd parity, 1 stop bit
1	0	0	8 bits, no parity, 2 stop bits
1	0	1	8 bits, no parity, 1 stop bit
1	1	0	8 bits, even parity, 1 stop bit
1	1	1	8 bits, odd parity, 1 stop bit

Unusual word formats, such as the 5 data bits with 1.5 stop bits used for RTTY are not available, but the popular ones of 8 data bits with no parity and one or two stop bits are available.

Bits 5 and 6 control transmitter interrupts and the state of the RTS handshake output. Assuming transmitter interrupts are not required, bit 5 is always low, and bit 6 is set to the state you require RTS to assume. Bit 7 is the receive interrupt control bit, and is set low to disable receive interrupts.

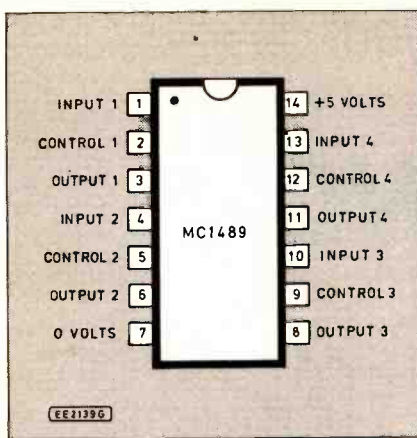

Fig. 2. Pinout details for the MC1489 quad line receiver.

Of course, after writing a value of 3 to the control register to reset the 6850, all the bits must be set to the appropriate states by a single write operation. Suppose that a division rate of 16 is required, together with a word format of 8 data bits and two stop bits. This requires only bits 0 and 4 to be set high, which gives a value of 17 (1+16) to be written to the control register. It would be necessary to add 64 to this value if RTS had to be set to the high state,

### Status Symbols

The status register provides a number of important pieces of information that are needed to give a well controlled flow of data into and out of the 6850. The purpose of all eight bits are listed below:

Bit	Function
0	Receive data register full (cleared by a read operation).
1	Transmit data register empty.
2	DCD flag (reflects the state of the DCD input).
3	CTS flag (reflects the state of the CTS input).
4	Framing error flag (set high while the incorrectly decoded byte is available in the receive register).
5	Receiver overrun flag (reset by a read operation to the receive register).
6	Parity error flag (set for as long as the incorrectly decoded byte of data is available in the receive register).
7	Interrupt request flag (reflects the state of the IRQ output).

Apart from controlling the flow of data via the CTS and RTS lines of the interface,

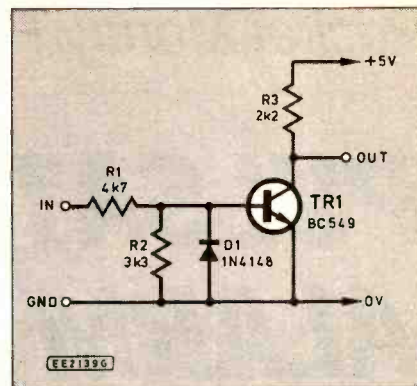

Fig. 3. A simple and inexpensive line receiver circuit.

you must also ensure that data is not sent to the interface faster than it can be transmitted, and that received bytes are not read more than once. Bits 0 and 1 plus software routines are used to ensure that the flow of data in and out of the chip is properly regulated.

### Signal Conditioning

The RS232C interfaces do not operate with normal 5V logic levels. The signal voltages are nominally plus and minus 12V, with minimum acceptable loaded voltages of plus and minus 3V. Connecting such a signal directly to the 6850 could easily result in its destruction, and it clearly does not generate output voltages at these levels. Also, inversions are required at inputs and outputs in order to get the signal polarities correct.

There are special line receiver chips to convert RS232C levels to standard 5V logic signals, the most popular of these being the MC1489 quad type. Pinout details for this device are shown in Fig. 2. The control inputs of this device enable the switching threshold voltage to be altered, but these pins are normally left unconnected.

Unless you are using a serial interface over a fairly long range, a simple common emitter switch such as the one shown in Fig. 3 acts as a good line receiver, and probably represents the cheapest solution if only a couple of line receivers are needed.

**Next Month:** We will consider line drivers, baud rate generators, and a BBC MIDI Interface.

## SOFTMACHINE DISTRIBUTION LTD FOR OEMs/TRADE

- ★ EPROM WRITER
- ★ PC HAND TOOLS
- ★ COMPUTER CASES
- ★ MAIN BOARDS
- ★ EPROM ERASER
- ★ CPU STANDS
- ★ POWER SUPPLY
- ★ MONITORS

TRADE HOURS: 10 - 6pm

TEL: 01-8077644

FAX: 01-807 2748

**SOFTMACHINE**  
DISTRIBUTION LTD

SOFTMACHINE DISTRIBUTION LTD  
UNITS F18/F25, HARBET ROAD,  
LEA VALLEY, EDMONTON,  
LONDON, N18 3LR ENGLAND.



# PULSATING ALARM

CHRIS BOWES

A very simple and inexpensive unit that can produce pulsating sounds similar to a pedestrian crossing. With little ingenuity it can be adapted to provide an audible alarm function.

**T**HIS project is designed to provide a sound output which pulsates off and on in the same manner as the "WALK" sound indication produced by a "Pelican" pedestrian crossing. It can be used in it's own right or incorporated into other circuits, for example to provide an audible alarm function for a sensor circuit.

### HOW IT WORKS

The Pulsating Alarm makes use of the fact that the 555 timer has a Reset input (pin 4) which can be used, when the timer is "running" in the "Astable" mode, to inhibit the output. However, this project uses one half of a 556 (dual version of the 555 timer) configured as a slow speed astable, to provide a signal which, when fed to the reset input of the other half of the i.c. (configured as a high speed — audio frequency — astable circuit) utilises the action of the reset input of the second circuit to produce a pulsating sound.

The basic circuit of the 555 timer when configured as an astable is shown in Fig. 1a. When it is set up in this way the timer produces an output which is continuously switched off and on as shown in Fig. 1b at a frequency determined by the values of  $R_A$ ,  $R_B$  and  $C$ .

This only occurs when the reset input is held at the battery positive voltage. When the reset input's voltage falls to 0V then the output is turned off, resulting in an output voltage of 0V.

### CIRCUIT DESCRIPTION

The full circuit diagram for the Pulsating Alarm is shown in Fig. 2. You should have no difficulty in recognising that IC1a and IC1b are two circuits identical to that shown in Fig. 1a, with  $R_A$  being replaced, in the case of IC1a, by the combination of resistor R1 and preset VR1.

A slow speed astable circuit is formed by IC1a, the frequency of which is set by the values of preset VR1, resistors R1, R2 and capacitor C1. The output from this astable (pin 5) is connected to the reset input (pin 10) of the IC1b.

When the output of IC1a is at the battery positive voltage then IC1b acts as an oscillator producing a square wave output from

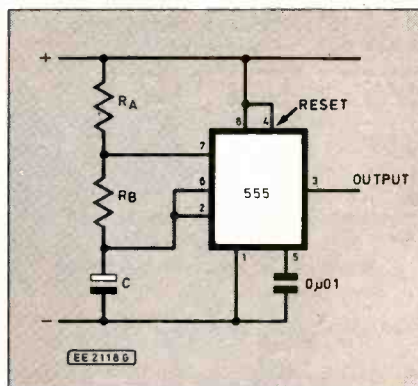

Fig. 1a. Using the 55 timer in the astable mode.

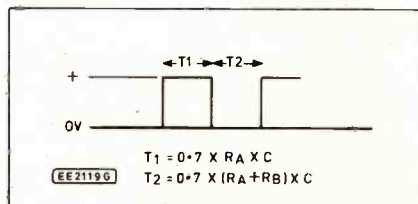

Fig. 1b. 555 timer astable timing diagram.

pin 9, at a frequency determined by the values of resistors R3, R4 and capacitor C3. With the component values shown in Fig. 2, the output frequency of this circuit is approximately 1kHz. This frequency can be changed, if required, by altering the values of these components.

When the input voltage to pin 10 falls to 0V the oscillating action of IC1b is inhibited and the output voltage at pin 9 is locked at 0V. Capacitors C2 and C4 are required by the 556 timer in order to set the control voltage input of each of the timers to the correct level. If the CMOS version of the i.c. is used then these components may be omitted.

The output from the i.c. is insufficient to drive the loudspeaker directly so a simple emitter-follower amplifier, comprising transistor TR1 and resistors R5 and R6, is used to provide the necessary current amplification. The amplifier functions because the transistor acts to prevent its base/emitter voltage becoming greater than 0.7V.

Thus, when the output voltage at pin 9 of IC1b reaches the battery voltage the voltage at the emitter of TR1 increases to about 8.3V. This causes current to be drawn through resistor R6, the collector/emitter circuit of TR1 and the loudspeaker, causing the latter to produce an audible sound at the oscillating frequency of IC1b.

Resistors R5 and R6 are included in the circuit to protect the transistor and

Fig. 2. Complete circuit diagram for the Pulsating Alarm.

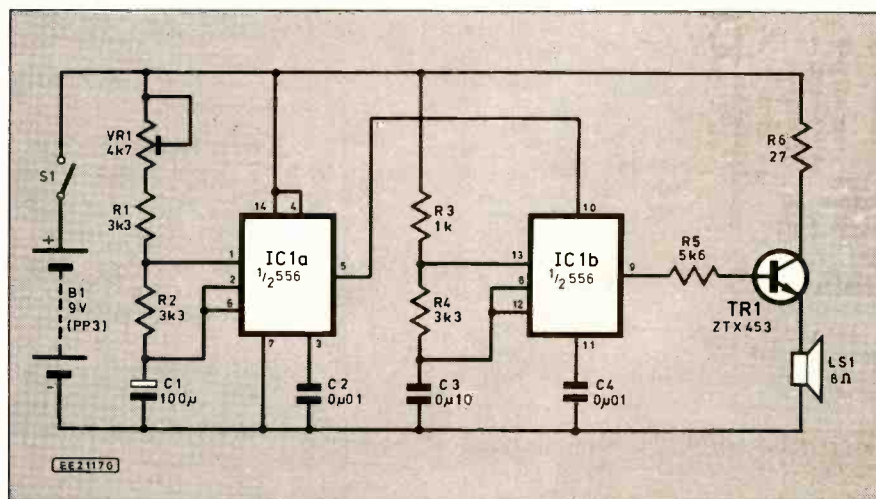

loudspeaker by limiting the currents that can be drawn through the output circuit to levels which the components can safely handle.

## CONSTRUCTION

The first stage of construction is to cut a piece of Veroboard to the correct size, 18 strips by 25 holes. The component layout and details of breaks required in the underside copper strips is shown in Fig.3. The finished board is shown in the photographs and in Fig.3 so you will probably find it helpful to look at those whilst you make up the circuit.

It is important that the track breaks are made completely so that not even the merest sliver of copper remains to bridge across the track break. Once the track breaks have been made, the board can be turned over and construction commenced. To help with this the strips and holes have been lettered and numbered, see Fig.3.

Commence the construction of this circuit by inserting and soldering the six wire links into place, as shown in Fig.3. Starting at the top left corner of the board count across and then down the correct number of holes until you can place one end of the link wire in the required position, turn the board over and solder the wire into place. Cut off the excess wire on the underside of the board with your cutters, turn the board over again and repeat for the other end of the link wire.

The wire links are made with insulated single core wire but before connecting the wire you will need to strip off the insulation from one end with wire strippers to leave

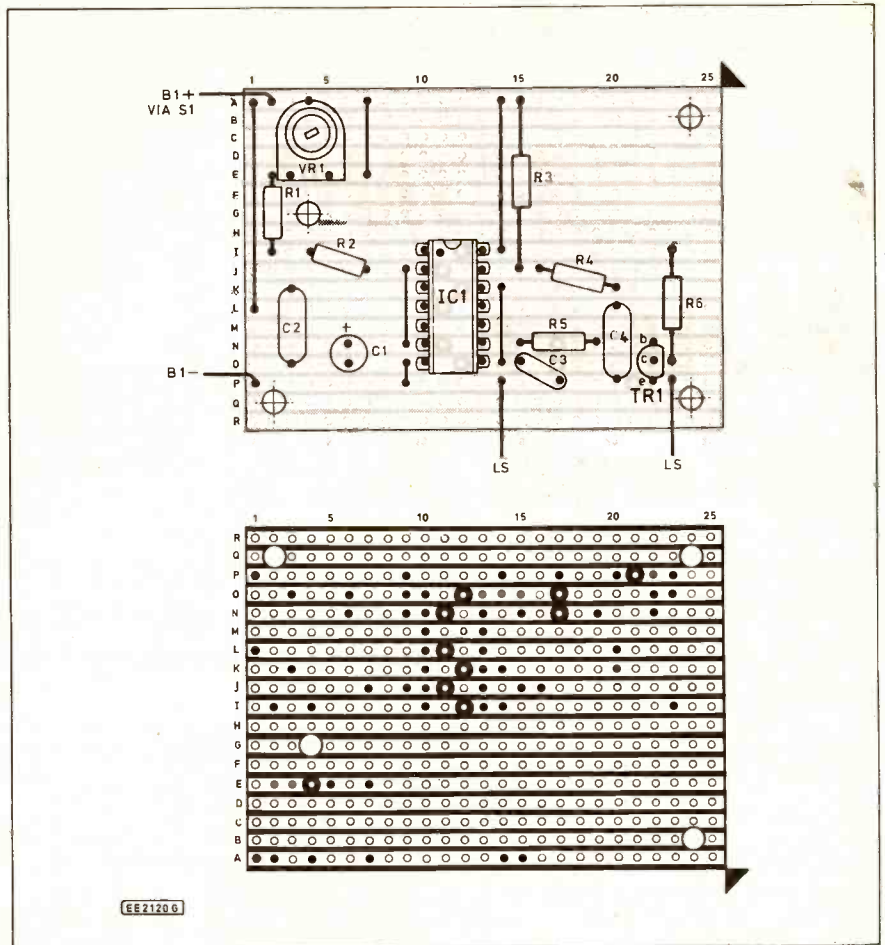

Fig. 3. Stripboard component layout and details of breaks required in the underside copper strips.

about 3mm more of the conductor exposed than you expect to need. The stripped wire should then be tinned, by melting a little solder onto the bit of the soldering iron and then placing the wire onto the iron's tip with the solder on the opposite side of the wire to the iron. The solder is left there until it melts and flows evenly over the wire.

Removing the wire from the molten solder will probably leave a little blob on the end of the wire which you should then cut off (which is why you stripped the wire slightly longer than required in the first place). The tinned wire should then fit easily through the hole in the stripboard.

The next task is to put the resistors in their correct places by first bending the wires of the resistor at right angles to the body of the component so that they will fit

through the holes, as shown in Fig.3. Also fit preset VR1 into the correct position and solder it into place.

The capacitors can next be inserted into the correct places and soldered. Most of the capacitors are not polarised so it does not matter which way round they are connected. However, C1 is polarised and care should be taken to insert it into the stripboard with the polarity of the capacitor corresponding with that shown in Fig.3. Similarly TR1 is polarity sensitive and it should also be installed so that the outline of its case corresponds with that shown in Fig.3.

The final item to be inserted into position on the board is the i.c. holder. Although it is possible to solder the i.c. directly into place, using a socket will both make the construction simpler and make for easier replacement if a fault should

## COMPONENTS

### Resistors

R1	3k3
R2	3k3
R3	1k
R4	3k3
R5	5k6
R6	27

All 0.25W 5% carbon

**Shop  
Talk**  
see page 507

### Potentiometer

VR1	4k7 Min. skeleton preset, horizontal
-----	--------------------------------------

### Capacitors

C1	100 $\mu$ radial elec. 16V
C2, C4	0 $\mu$ 01 Mylar 16V (2 off)
C3	0 $\mu$ 1 Mylar 16V

### Semiconductors

TR1	ZTX453 npn silicon
IC1	556 Dual timer

### Miscellaneous

LS1	8 ohm loudspeaker
S1	Miniature toggle switch (optional)
SK1	3.5mm switched jack socket (optional)
B1	9V (PP3 or equivalent) battery

Stripboard, 0.1in. matrix 18 strips X 25 holes; plastic case to suit (optional); 14-pin i.c. socket; battery connector; connecting wire; solder etc.

Approx. cost  
Guidance Only

**£7.50**

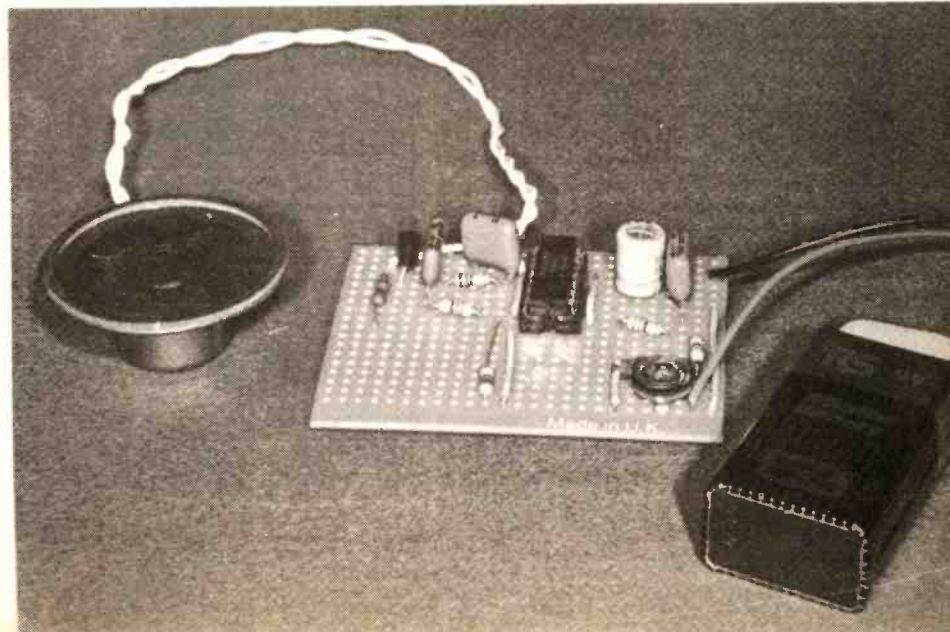

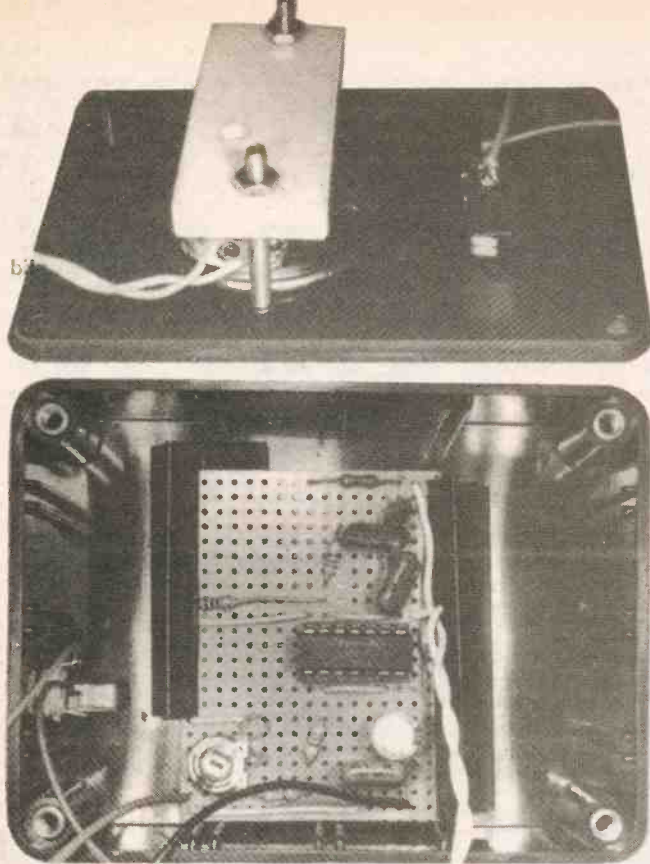

(top left) One method of mounting the loudspeaker on the case lid is to clamp it in position with a strip of plastic material and nuts and bolts.

(left) To save drilling mounting holes in the circuit board it can be held in place, on the bottom of the case, by plastic self-adhesive p.c.b. mounting strips.

(above) The completed unit showing the series of holes drilled in the case lid to form a speaker "fret". The jack plug on the side is for remote switching.

occur. It is important that you take care to make sure that the notch on the i.c. holder is facing towards the top of the board as this will help you when inserting the 556 timer into place.

The wires connecting the battery to the circuit board can then be tinned and soldered into place. The black wire from the battery connector goes to the point on the stripboard shown as B1- and the red wire of the battery connector goes to the switch S1, via one of the switch terminals if this component is required. Another wire is connected from the other switch terminal to the B1+ connection on the stripboard. A pair of wires must also be connected between the loudspeaker and the two LS connections on the stripboard.

The final step is to insert IC1 into its holder making sure that the notch on the i.c. corresponds with the notch on the i.c. holder. Some versions of the 556 timer do not have a notch in one end but have a slight, circular dent near one pin (pin 1). In this case the end with the indentation near pin 1 goes nearest to the edge of the i.c. holder which has the notch.

## TESTING

Once the board has been double-checked for any wiring errors or track short circuits, the battery can be connected and you should be able to hear a pulsating tone from the loudspeaker. Adjustment of VR1 should alter the rate of the bleeps from the loudspeaker.

If the circuit does not operate correctly it will be necessary to check for faults. The first step is to check carefully that all of the components are in the correct places and are the correct way round. In this project the only components which will cause problems if they are connected the wrong way round are C1, TR1 and IC1.

Check carefully that all of the soldered connections are good joints. This is probably best done by reheating the joint with a soldering iron.

The final mechanical check is to carefully examine the underside of the board to

make sure that there are no minute (or larger) slivers of solder shorting out adjacent copper tracks, or any breaks in the track where it should be continuous.

If no mechanical problems of this sort are found then it will be necessary to check the circuit through to see whether there is a faulty component or not. You will probably find that you will need to use a test meter to perform this stage of the process.

## FAULT FINDING

Fault finding is best done in a logical manner, starting with checking to see that the battery voltage is present at the points labelled B1- and B1+ on the board, see Fig.3. If the battery voltage is not present here it is advisable to check that the battery is in good condition by testing it out of circuit. If the battery condition is good when the circuit is not connected but falls markedly when the circuit is connected the most likely cause is either a short circuit on the stripboard or that a polarity sensitive component (C1, IC1 or TR1) has been connected the wrong way round.

If the battery is not being shorted out by the circuit you should be able to measure the battery voltage between any 0V connection and pins 14, and 4 of IC1, as well as between the battery positive connection to the board and pin 1. If these voltages are not present this will indicate faulty wiring up of the stripboard.

The next step is to check the voltage at the slow speed astable output (pin 5) of IC1. If the circuit is working correctly this voltage should be regularly switching between 0V and the battery voltage.

If this does not occur and the output is locked permanently at a fixed voltage then you should remove the i.c. from its socket and check the voltage at the pin 5 connection again. If the voltage persists with IC1 removed then the fault does not lie with IC1 but most possibly with the wiring associated with the i.c. in the vicinity of pins 5 and 10.

Replace the i.c. in its holder and check

the voltages at pins 1, 2, and 6. The voltage at pin 1 should be fluctuating around a value which is roughly two-thirds of the battery voltage. The voltages at pins 2 and 6 should be identical (because these two pins are connected together by a wire link) and these should also be fluctuating but at a voltage slightly less than that found at pin 1.

If both of these voltages are not present then the most likely cause is that the circuit from the positive voltage rail, through preset VR1, resistors R1, R2 and capacitor C2 is not correctly made. This is best checked by measuring the voltage present between 0V and each of the points in the component chain through VR1, R1, R2 and C1 and investigating at the point where no voltage is measured.

If a voltage is present between 0V and pin 1 but no voltage, or only a very small voltage, is measured between the 0V rail and pins 2 or 6 of IC1 then you should check that the resistance between pins 7 and 6 of IC1 is roughly equal that of resistor R2. If this is correct then check the resistance of C1 with the resistance range of your meter. If the resistance is very low (less than about 500 ohms) then you should replace C1.

If there is no voltage measurable between pins 6 and 2 of IC1 then this could be caused by a short circuit between the connections of C1 or by a short circuit within C1 or its connections to the stripboard.

If voltage is present at pins 2 and 6 of IC1 but it does not fluctuate then the likely causes are that C1 is not correctly connected, is faulty or that IC1 is faulty. To check C1 you should touch connect another capacitor of similar value across the connections to see if this cures the fault.

If touching another capacitor across C1 does not cure the fault check that the connection between the positive connection of C1 and pins 2 and 6 of the i.c. is correctly made. If all is correct here then the output from IC1a should be oscillating correctly and this should also be measurable at pin 10.

## TESTING THE OSCILLATOR

The second stage of the fault finding process is to check the operation of IC1b. Because of the high frequency of operation of this circuit fault finding with a test meter can be somewhat difficult.

Testing can be made easier by connecting a capacitor of between 22 $\mu$  and 100 $\mu$  across C3 and temporarily connecting pin 10 to the battery supply positive rail. This will cause the output frequency of the circuit to be slowed down to a level where fault finding becomes the same as for the slow speed astable.

Unfortunately, this might cause problems with the output of IC1a so it will be necessary to break the copper track between pins 5 and 10 of the i.c. If this connection is broken it will be necessary to remember to remake it with a piece of wire soldered across the break when fault finding is finished. The checks described earlier should now be repeated, remembering of course that pins 1, 2, 3, 4, 5, and 6 of IC1a correspond, respectively, to pins 13, 12, 11, 10, 9 and 8 of IC1b.

## TRANSISTOR AMPLIFIER

If the voltage switching at pins 5 and 10 is taking place as described above then the i.c. is working correctly and the fault will most probably lie in the area of transistor TR1 and its associated components. Using a meter, the first point to check is the junction of resistor R5 and the base of TR1.

The voltage at this point should fluctuate between 0V and nearly the full battery voltage in time with the fluctuations in the output of IC1. If this is happening then you

should be able to measure a similar voltage change at the junction of the emitter of TR1 and the loudspeaker LS1.

The voltages between 0V and the emitter and collector of TR1 should both be measured. The voltage at the emitter should rise and fall, following the fluctuations of the output from IC1. If the voltage at the emitter does not rise and fall but stays at 0V then the connections to the loudspeaker should be checked out.

Should the voltage remain at a higher level then the transistor should be checked for correct function by removing it from the circuit and measuring the resistance between the base and emitter and the base and collector leads. It is important to measure these resistances with *both* polarities of the meter current.

Because of the construction of the transistor, a *high* resistance should be measurable between the base and the other connections with the base connected to one of the meter leads. A *low* resistance should be measured when these checks are repeated with the base of the transistor connected to the other (reverse polarity) lead of the meter. If the resistances measured in this way do not agree with the results described above then the transistor should be substituted for a new one.

## CASE

Although the project can be easily used as it stands or by being incorporated into another device you may wish to mount it into its own case. To do this the positions of the mounting holes drilled in the circuit board should be carefully marked on the body of the case and the appropriate stand-

offs mounted in suitable positions to support the circuit board.

Similarly suitable mounting holes must be drilled to accommodate the switch S1 and loudspeaker LS1. In the prototype version, shown in the photographs, the loudspeaker used was not provided with mounting holes so it was necessary to mount the loudspeaker against the case lid holding it there by means of a strip of material spanning the width of the loudspeaker and being held in place by means of two bolts, accommodated in suitable holes drilled into the case. It will also be necessary to drill a matrix of holes to allow the sound from the loudspeaker to be transmitted through the case lid.

In order to provide remote switching of the project, the case can be fitted with a small switched jack socket which is mounted in the side of the case and wired in series with the battery and switch S1. If desired the switched socket can be wired in such a way that when the jack plug is removed the socket is shorted out — thus allowing the circuit to be controlled solely by S1.

When preparing the case all of the holes required should be drilled before installing the circuitry. Similarly if the case is to be painted or lettered this should be completed before the circuitry is installed.

## SETTING UP

Once construction and testing are complete the circuit can be very easily set up by installing the battery, switching the circuit on and adjusting preset VR1 until the sound is heard to switch off and on as desired. □

**EDU-SCOPE** Build your own solid state oscilloscope - complete kit of parts excluding case . . . . . £29.99  
**EDU-SCOPE CASE KIT** . . . £10.95  
**LOW COST LEAD/PROB.** £3.95

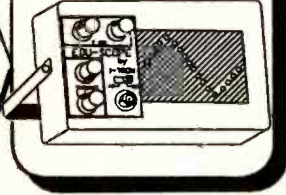

**BUG-89** Micro sized surveillance transmitter - can be received by any FM/VHS radio or our MICRO-FM - PCB size only 50x20mm . . . £4.99  
**MICRO-FM** A micro miniature personal FM receiver - High quality IC design (no alignment problems) - Great for surveillance work or for just listening to your favourite radio shows! (cased) . . . . . £7.99  
**ROBO-VOX** Instantly transforms your voice into Dalek/Robot type - also amazing feedback sound effects possible (cased) . . . . . £9.95  
**ROBOT CIRCULAR** Unique radio controlled robot - can also be converted to control via computer . . . . . £16.95  
**THERAMIN MUSIC GENERATOR** An electronic device based on an ancient legendary mystical instrument (cased) . . . . . £12.75  
**SOLARTRONICS-88** Enter the exciting world of Solar Electronics with our Solar Designer's experimenter kit . . . . . £7.75  
**SUPER SOUND-FX MICROCOMPUTER** An easy to use and program single chip sound effects Micro completely self contained - Incredible sound routines already masked programmed into the device - this is our most popular kit at present . . . . . £9.95  
**SOUND-FX PRO CONSOLE CASE KIT** . . . . . £3.99

Please add 15% VAT and £0.95 per order for P&P. For FREE Datapack on all our Kits/ Products send SAE. - Allow up to 14 days for delivery - Make Cheques/Po's payable to :-

**ITRON U.K.**  
 Castle Mill, Lower Kings Road  
 BERKHAMSTED  
 Hertfordshire HP4 2AD

**I-TRON**  
 U.K.

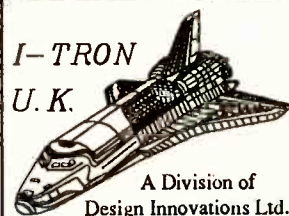

A Division of  
 Design Innovations Ltd.

## SHERWOOD ELECTRONIC COMPONENTS

45 Rutland St., Mansfield, Notts NG18 4AP

### RESISTOR PACKS

0.25W C.Film 5 ea (305)	265p
0.25W C.Film 10 ea (610)	425p
0.25W C.Film Popular (1000)	600p
0.25W C.Film—100 one value	75p
0.1W Min. Hor. presets 5 ea (65)	385p
0.1W Min. Vert. presets 5 ea (65)	385p

### SPECIAL PACKS All at £1 each

SP1 12x5mm Red LEDs	LM339	55p
SP2 12x5mm Green LEDs	LM380	120p
SP3 10x5mm Yellow LEDs	LM723	55p
SP4 10x5mm Amber LEDs	LM1458	55p
SP5 30x5mm 1 part LED clips	TL071	60p
SP6 10x3mm Red LEDs	TL072	80p
SP7 10x3mm Green LEDs	TL081	40p
SP8 10x3mm Yellow LEDs	TL082	55p
SP9 40x3mm 1 part LED clips		
SP10 50x1N4148 signal diodes		
SP11 25x1N4001 rectifier diodes		
SP12 25x1N4002 rectifier diodes		
SP13 25xRad.Elec.Caps. (1-1000 $\mu$ F)		
SP14 10x5K Min. Hor. presets 0.1W		
SP15 20x2K2 Min. Hor. presets 0.1W		
SP16 20x4K7 Min. Hor. presets 0.1W		
SP17 20x100K Min. Hor. presets 0.1W		
SP18 12xBC182 Transistors		
SP19 12xBC183 Transistors		
SP20 12xBC184 Transistors		
SP21 10xBC212 Transistors		
SP22 10xBC214 Transistors		
SP23 10xBC549 Transistors		
SP24 5xCmos 4001		
SP25 5x555 Timer		
SP26 5x741 Op-Amp		
SP27 5xCmos 4002		
SP28 5xCmos 4011		
SP29 3xCmos 4013		
SP30 5xCmos 4025		
SP31 4xCmos 4071		
SP32 4xCmos 4077		
SP33 4xCmos 4081		
SP34 2xCmos 4510		
SP35 2xCmos 4511		
SP36 20x10 $\mu$ F/25V Radial Elect.		
SP37 15x100 $\mu$ F/35V Radial Elect.		
SP38 20x47 $\mu$ F/25V Radial Elect.		
SP39 12x470 $\mu$ F/16V Radial Elect.		
SP40 10xBC237 Transistors		

1 pack of your choice FREE when you buy any 10 of the above packs.

Send 25p for catalogue, contains vouchers redeemable against orders over £5.00.

Cheques or P.O. to:

**SHERWOOD ELECTRONIC COMPONENTS**

Please add £1 P&P NO VAT

### I.C.s

555	22p
556	75p
741	22p
747	65p
CA3140E	45p
CA3240E	125p
LM339	55p
LM380	120p
LM723	55p
LM1458	55p
TL071	60p
TL072	80p
TL081	40p
TL082	55p

### CMOS

4000	25p
4001	25p
4002	25p
4011	25p
4013	38p
4017	55p
4023	30p
4025	25p
4027	50p
4047	65p
4066	45p
4070	27p
4071	27p
4075	27p
4077	30p
4081	27p
4093	35p
4510	65p
4511	65p
4514	125p
4515	130p
4516	65p
4528	70p

### TRANSISTORS

BC107	13p
BC108	13p
BC109	14p
BC179	22p
BC182	12p
BC183	12p
BC184	12p
BC212	12p
BC213	12p
BC214	12p
BC237	15p
BC537	15p
BC547	14p
BC548	14p
BC549	14p
2N2222	28p
2N3053	38p
2N3702	12p
2N3703	12p
2N3706	12p
2N3708	12p

### V. REGS.

100mA	
78L05	25p.
78L12	26p
78L15	26p
78L05	30p
78L12	30p
78L15	30p
1A	
7805	35p
7812	35p
7815	36p
7905	36p
7912	38p
7915	38p

### ADDITIONAL PACKS

SP50 25x5mm Red LEDs	200p
SP51 25x5mm Green LEDs	200p
SP52 50xRad. Elec. Caps.	195p
SP53 30xI.C. sockets—8 pin, 14 pin, 16 pin (10 off)	200p
SP54 1xTIL38+1xTIL100 I.R. emitter+sensor	160p
SP55 250x0.25W Metal glaze 2% res. (at least 20 values)	150p
SP56 36xRad. Polyester Caps.	180p
SP57 100x1N4148 diodes	175p

# DIRECT BOOK SERVICE

The books listed have been selected as being of special interest to everyone involved in electronics and computing. They are supplied by mail order direct to your door. Full details are given on the last book page.

For another selection of books see next month's issue.

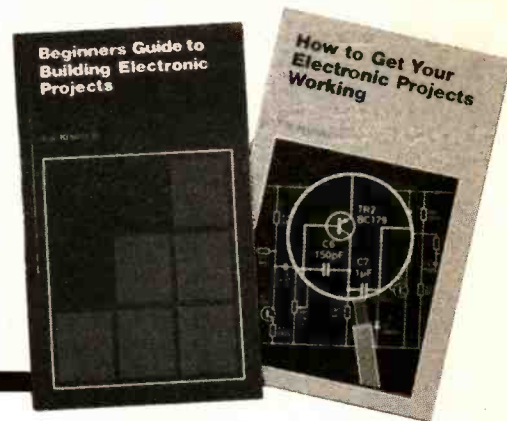

## MORE BOOKS NEXT MONTH—MORE BOOKS NEXT MONTH

### HOW TO GET YOUR ELECTRONIC PROJECTS WORKING

R. A. Penfold

We have all built projects only to find that they did not work correctly, or at all, when first switched on. The aim of this book is to help the reader overcome just these problems by indicating how and where to start looking for many of the common faults that can occur when building up projects.

96 pages Order code BP110 £2.50

### HOW TO DESIGN AND MAKE YOUR OWN P.C.B.s

R. A. Penfold

Deals with the simple methods of copying printed circuit

board designs from magazines and books and covers all aspects of simple p.c.b. construction including photographic methods and designing your own p.c.b.s.

80 pages Order code BP121 £2.50

### BEGINNER'S GUIDE TO BUILDING ELECTRONIC PROJECTS

R. A. Penfold

Shows the complete beginner how to tackle the practical side of electronics, so that he or she can confidently build the electronic projects that are regularly featured in magazines and books. Also includes examples in the form of simple projects.

112 pages Order code No. 227 £2.25

### ELECTRONIC SCIENCE PROJECTS

O. Bishop

These projects range in complexity from a simple colour temperature meter to an infra-red laser. There are novelties such as an electronic clock regulated by a resonating spring, and an oscilloscope with solid-state display. There are scientific measuring instruments such as a pH meter and an electro-cardiometer. All projects have a strong scientific flavour. The way they work, and how to build and use them are fully explained.

144 pages Order code BP104 £2.95

## CIRCUITS & DESIGN

### PRACTICAL ELECTRONIC BUILDING BLOCKS—BOOK 1

### PRACTICAL ELECTRONIC BUILDING BLOCKS—BOOK 2

R. A. Penfold

These books are designed to aid electronic enthusiasts who like to experiment with circuits and produce their own projects, rather than simply following published project designs.

**BOOK 1** contains: Oscillators—sinewave, triangular, squarewave, sawtooth, and pulse waveform generators operating at audio frequencies. Timers—simple monostable circuits using i.c.s., the 555 and 7555 devices, etc. Miscellaneous—noise generators, rectifiers, comparators and triggers, etc.

**BOOK 2** contains: Amplifiers—low level discrete and op-amp circuits, voltage and buffer amplifiers including d.c. types. Also low-noise audio and voltage controlled amplifiers. Filters—high-pass, low-pass, 6, 12, and 24dB per octave types. Miscellaneous—i.c. power amplifiers, mixers, voltage and current regulators, etc.

**BOOK 1** 128 pages Order code BP117 £1.95  
**BOOK 2** 112 pages Order code BP118 £1.95

### ELECTRONIC ALARM CIRCUITS MANUAL

R. M. Marston

One hundred and forty useful alarm circuits, of a variety of types, are shown in this volume. The operating principle of each one is explained in concise but comprehensive terms, and brief construction notes are given where necessary.

Aimed at the practical design engineer, technician and experimenter, as well as the electronics student and amateur.

124 pages Order code NE11 £9.95

### DESIGNING DC POWER SUPPLIES

G. C. Loveday C. Eng MIERE

Covers all aspects of the design of regulated power units, using discrete, i.c. regulators and switched units. It also covers protection circuits and reference supplies. Many design examples and exercises all with fully worked solutions are given.

131 pages Order code BM2 £6.95

### MODERN OPTO DEVICE PROJECTS

R.A. Penfold

In recent years, the range of opto devices available to the home constructor has expanded and changed radically. These devices now represent one of the more interesting areas of modern electronics for the hobbyist to experiment in, and many of these devices have useful practical applications as well. This book provides a number of practical designs which utilize a range of modern opto-electric devices, including such things as fibre optics, ultra bright I.e.d.s and passive IR detectors etc.

While many of these designs are not in the "dead simple" category, they should be within the capabilities of anyone with a reasonable amount of experience in electronics construction and some of the more simple designs are suitable for beginners.

104 pages Order code BP194 £2.95

### DIGITAL LOGIC GATES AND FLIP-FLOPS

Ian R. Sinclair

This book, intended for enthusiasts, students and technicians, seeks to establish a firm foundation in digital electronics by treating the topics of gates and flip-flops thoroughly and from the beginning. This is not a constructor's book in the sense of presenting circuits to build and use, it is for the user who wants to design and troubleshoot digital circuitry with considerably more understanding of principles.

Topics such as Boolean algebra and Karnaugh mapping are explained, demonstrated and used extensively, and more attention is paid to the subject of synchronous counters than to the simple but less important ripple counters.

No background other than a basic knowledge of electronics is assumed, and the more theoretical topics are explained from the beginning, as also are many working practices. The book concludes with an explanation of microprocessor techniques as applied to digital logic.

200 pages Order code PC106 £8.95

### HOW TO USE OP-AMPS

E. A. Parr

This book has been written as a designer's guide covering many operational amplifiers, serving both as a source book of circuits and a reference book for design calculations. The approach has been made as non-mathematical as possible.

160 pages Order code BP88 £2.95

### MICRO INTERFACING CIRCUITS—BOOK 1

### MICRO INTERFACING CIRCUITS—BOOK 2

R. A. Penfold

Both books include practical circuits together with details of the circuit operation and useful background information. Any special constructional points are covered but p.c.b. layouts and other detailed constructional information are not included.

Book 1 is mainly concerned with getting signals in and out of the computer. Book 2 deals primarily with circuits for practical applications.

**Book 1** 112 pages Order code BP130 £2.25  
**Book 2** 112 pages Order code BP131 £2.75

### SENSORS AND TRANSDUCERS

Keith Brindley

There are a considerable number of transducers. Look through any electronic components catalogue and you'll find a wide variety of types, and each type has many versions. It's not easy to choose a transducer correctly for a particular function. In many specifications, terms and procedures are referred to which might deter you from using one that is, in fact, the best for the job. Yet, opting to use a transducer merely because it is easier to interface into the measuring system is not the answer. A greater knowledge of all types of transducers capable of doing the task is the ideal, and only then can a totally satisfactory decision be made to use one in particular.

176 pages Order code NE17 £12.95

### ELECTRONIC CIRCUITS FOR THE COMPUTER CONTROL OF ROBOTS

Robert Penfold

Robots and robotics offer one of the most interesting areas for the electronics hobbyist to experiment in. Today the mechanical side of robots is not too difficult, as there are robotics kits and a wide range of mechanical components available. The micro controller is not too much of a problem either, since the software need not be terribly complex and many inexpensive home computers are well suited to the task.

The main stumbling block for most would-be robot builders is the electronics to interface the computer to the motors, and the sensors which provide feedback from the robot to the computer. The purpose of this book is to explain and provide some relatively simple electronic circuits which bridge this gap.

92 pages Order code BP179 £2.95

### 50 SIMPLE LED CIRCUITS

R. N. Soar

Contains 50 interesting and useful circuits and applications, covering many different branches of electronics, using one of the most inexpensive and freely available components—the light-emitting diode (LED). Also includes circuits for the 707 common anode display

64 pages Order Code BP42 £1.95  
**BOOK 2** 50 more I.e.d. circuits Order code BP87 £1.35

### ELECTRONICS SIMPLIFIED

### —CRYSTAL SET CONSTRUCTION

F. A. Wilson, C.G.I.A., C.Eng., F.I.E.E., F.I.E.R.E., F.B.I.M.

Especially written for those who wish to participate in the intricacies of electronics more through practical construction than by theoretical study. It is designed for all ages upwards from the day one can read intelligently and handle simple tools.

80 pages Order Code BP92 £1.75







**ELECTRONICS TEACH-IN**

Michael Tooley BA and David Whitfield MA MSc  
CEng MIEE (published by *Everyday Electronics*)

This value for money *EE* book provides a comprehensive background to modern electronics including test gear projects. A complete course in basic electronics; designed for the complete newcomer it will however also be of value to those with some previous experience of electronics. Wherever possible the course is related to "real life" working circuits and each part includes a set of detailed practical assignments. Includes details of eight items of related test gear giving full constructional information and diagrams for each one. They are: Safe Power Supply; Universal LCR Bridge; Diode/Transistor Tester; Audio Signal Tracer; Audio Signal Generator; RF Signal Generator; FET Voltmeter; Pulse Generator. An excellent companion for anyone interested in electronics and invaluable for those taking G.C.S.E. and BTEC electronics courses.

104 pages (A4 size) **Order code EE/T-I £1.95**

**FROM ATOMS TO AMPERES**

F. A. Wilson

Explains in crystal clear terms the absolute fundamentals behind electricity and electronics. Really helps you to discover and understand the subject, perhaps for the first time ever.

Have you ever: Wondered about the true link between electricity and magnetism? Felt you could never understand the work of Einstein, Newton, Boltzmann, Planck and other early scientists? Just accepted that an electron is like a little black ball? Got mixed up with e.m.f. and p.d.? Thought the idea of holes in semiconductors is a bit much?

Then help is at hand with this inexpensive book, in as simple a way as possible and without too much complex mathematics and formulae.

244 pages **Order code BP254 £3.50**

**BEGINNERS GUIDE TO MICROPROCESSORS**

E.A. Parr

An excellent grounding in microprocessors, this book is broadly relevant to the whole of our Introducing Microprocessors course. It is easy to read and well illustrated.

224 pages **Order code NE03 £5.95**

**ELECTRONICS TEACH-IN 88/89—  
INTRODUCING MICROPROCESSORS**

Mike Tooley BA (published by *Everyday Electronics*)

A complete course that can lead successful readers to the award of a City and Guilds Certificate in Introductory Microprocessors (726/303). The book contains everything you need to know including full details on registering for assessment, etc.

80 pages (A4 size) **Order code TI-88/89 £2.45**

**NEWNES ELECTRONICS  
POCKET BOOK**

E. A. Parr

Newnes Electronics Pocket Book has been in print for over twenty years and has covered the development of electronics from valve to semiconductor technology and from transistors to LSI integrated circuits and microprocessors. To keep up to date with the rapidly changing world of electronics, continuous revision has been necessary. This new Fifth Edition takes account of recent changes and includes material suggested by readers of previous editions. New descriptions of op.amp. applications and the design of digital circuits have been added, along with a totally new chapter on computing, plus other revisions throughout.

315 pages (hard cover) **Order Code NE02 £9.95**

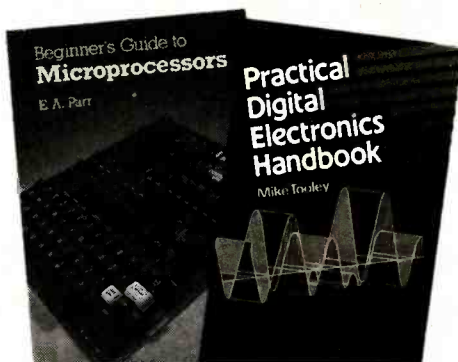

RECOMMENDED READING

FOR INTRODUCING  
DIGITAL ELECTRONICS

**ELECTRONICS—A "MADE SIMPLE" BOOK**

G. H. Olsen

This book provides excellent background reading for our *Introducing Digital Electronics* series and will be of interest to everyone studying electronics. The subject is simply explained and well illustrated and the book assumes only a very basic knowledge of electricity.

330 pages **Order code NE10 £4.95**

**ELECTRONIC HOBBYISTS HANDBOOK**

R. A. Penfold

Provides an inexpensive single source of easily located information that the amateur electronics enthusiast is likely to need for the day-to-day pursuance of this fascinating hobby. Covers common component colour codes. Details the characteristics and pinouts of many popular semiconductor devices, including various types of logic ICs, operational amplifiers, transistors, FETs, unijunctions, diodes, rectifiers, SCRs, diacs, triacs, regulators and SMDs, etc. Illustrates many useful types of circuits, such as timers and oscillators, audio amplifiers and filters, as well as including a separate section on power supplies. Also contains a multitude of other useful data.

88 pages **Order code BP233 £4.95**

**ESSENTIAL THEORY FOR THE  
ELECTRONICS HOBBYIST**

G. T. Rubaroe, T. Eng (C.E.I.), Assoc. I.E.R.E.

The object of this book is to supply the hobbyist with a background knowledge tailored to meet his or her specific requirements and the author has brought together the relevant material and presented it in a readable manner with minimum recourse to mathematics.

128 pages **Order Code 228 £2.50**

**PRACTICAL DIGITAL ELECTRONICS HANDBOOK**

Mike Tooley (Published in association with *Everyday Electronics*)

The vast majority of modern electronic systems rely heavily on the application of digital electronics, and the *Practical Digital Electronics Handbook* aims to provide readers with a practically based introduction to this subject. The book will prove invaluable to anyone involved with the design, manufacture or servicing of digital circuitry, as well as to those wishing to update their knowledge of modern digital devices and techniques. Contents: Introduction to integrated circuits; basic logic gates; monostable and bistable devices; timers; microprocessors; memories; input and output devices; interfaces; microprocessor buses. Appendix 1: Data. Appendix 2: Digital test gear projects; tools and test equipment; regulated bench power supply; logic probe; logic pulser; versatile pulse generator; digital IC tester; current tracer; audio logic tracer; RS-232C breakout box; versatile digital counter/frequency meter. Appendix 3: The oscilloscope. Appendix 4: Suggested reading. Appendix 5: Further study.

208 pages **Order code PC100 £8.95**

COMPUTING

**NEWNES COMPUTER ENGINEER'S  
POCKETBOOK**

Michael Tooley

An invaluable compendium of facts, figures, circuits and data, indispensable to the designer, student, service engineer and all those interested in computer and microcomputer systems. It will appeal equally to the hardware or software specialist and to the new band of "software engineers". This first edition covers a vast range of subjects at a practical level, with the necessary explanatory text. The data is presented in a succinct and rapidly accessible form so that the book can become part of an everyday toolkit.

205 pages (hard cover) **Order code NE01 £8.95**

**GETTING THE MOST FROM YOUR PRINTER**

J. W. Penfold

Details how to use all the features provided on most dot-matrix printers from programs and popular word processor packages like Wordwise, Visawrite and Quill, etc. Shows exactly what must be typed in to achieve a given effect.

96 pages **Order Code BP181 £2.95**

**AN INTRODUCTION TO Z80 MACHINE CODE**

R. A. & J. W. Penfold

Takes the reader through the basics of microprocessors and machine code programming with no previous knowledge of these being assumed. The Z80 is used in many popular home computers and simple programming examples are given for Z80-based machines including the Sinclair ZX-81 and Spectrum, Memotech and the Amstrad CPC 464. Also applicable to the Amstrad CPC 664 and 6128.

144 pages **Order code BP152 £2.75**

**AN INTRODUCTION TO PROGRAMMING THE  
ACORN ELECTRON**

R. A. & J. W. Penfold

Designed to help the reader learn more about programming and to make best use of the Electron's many features. Adds considerably to the information already supplied in the manufacturer's own instruction manual.

144 pages **Order code BP142 £1.95**

**AN INTRODUCTION TO PROGRAMMING THE  
ATARI 600/800 XL**

R. A. & J. W. Penfold

Especially written to supplement the manufacturer's own handbook. The information supplied will help the reader to master BASIC programming and to make best use of the Atari's many powerful features.

128 pages **Order code BP143 £1.95**

**AN INTRODUCTION TO PROGRAMMING THE  
SINCLAIR QL**

R. A. & J. W. Penfold

Helps the reader to make best use of the fantastic Sinclair QL's almost unlimited range of features. Designed to complement the manufacturer's handbook.

112 pages **Order code BP150 £1.95**

**A Z80 WORKSHOP MANUAL**

E. A. Parr, B.Sc., C.Eng., M.I.E.E.

This book is intended for people who wish to progress beyond the stage of BASIC programming to topics such as machine code and assembly language programming, or need hardware details of a Z80 based computer.

192 pages **Order Code BP112 £3.50**

**A CONCISE INTRODUCTION TO MS-DOS**

N. Kantaris

This guide is written with the non-expert, busy person in mind and, as such, it has an underlying structure based on "what you need to know first, appears first". Nonetheless, the guide is also designed to be circular, which means that you don't have to start at the beginning and go to the end. The more experienced user can start from any section.

The guide covers versions 3.0, 3.1 and 3.2 of both PC-DOS and MS-DOS as implemented by IBM and other manufacturers of "compatible" microcomputers, including the AMSTRAD PC's. It covers both floppy disc-based systems and hard disc-based systems.

64 pages **Order code BP232 £2.95**

**AN INTRODUCTION TO 68000 ASSEMBLY  
LANGUAGE**

R. A. & J. W. Penfold

Obtain a vast increase in running speed by writing programs for 68000 based micros such as the Commodore Amiga, Atari ST range or Apple Macintosh range etc., in assembly language. It is not as difficult as one might think and this book covers the fundamentals.

112 pages **Order code BP184 £2.95**

**THE ART OF PROGRAMMING THE ZX  
SPECTRUM**

M. James, B.Sc., M.B.C.S.

It is one thing to have learnt how to use all the Spectrum's commands and functions, but a very different one to be able to combine them into programs that do exactly what you want them to. This is just what this book is all about—teaching you the art of effective programming with your Spectrum.

144 pages **Order code BP119 £2.50**

**BEGINNER'S GUIDE TO HI-FI**

Ian Sinclair

The *Beginner's Guide to Hi-Fi* will appeal to the audio enthusiast, whether newly won over by advances in technology or well established and wondering whether to update equipment. The book deals with the sound from its sources in the studio to its ultimate end in your ears, and shows what sound is, how it is recorded and how it is reproduced.

Every aspect of Hi-Fi, from pickup cartridges to loudspeakers, has been covered, and the emphasis has been on explaining design aims. Cassette systems have been given considerable prominence, including the more modern Dolby C and dbx noise reduction systems. The CD record has been covered in detail so that you can find out just why this system of sound reproduction is so superior.

194 pages

Temporarily out of print.

**DATA & COMPONENT IDENTIFICATION**

**HOW TO IDENTIFY UNMARKED ICs**

K. H. Recorr

Shows the reader how, with just a test-meter, to go about recording the particular signature of an unmarked i.c. which should enable the i.c. to then be identified with reference to manufacturers' or other data. An i.c. signature is a specially plotted chart produced by measuring the resistances between all terminal pairs of an i.c.

Chart

Order code BP101

£0.95

**INTERNATIONAL DIODE EQUIVALENTS GUIDE**

A. Michaels

Designed to help the user in finding possible substitutes for a large selection of the many different types of diodes that are available. Besides simple rectifier diodes, also included are Zener diodes, i.e.d.s, diacs, triacs, thyristors, OCIs, photo and display diodes.

144 pages

Order code BP108

£2.25

**LINEAR IC EQUIVALENTS AND PIN CONNECTIONS**

A. Michaels

Shows equivalents and pin connections of a popular selection of European, American and Japanese linear i.c.s. Also includes details of functions, manufacturer and country of origin.

320 pages

Temporarily out of print

**RADIO AND ELECTRONIC COLOUR CODES AND DATA CHART**

B. B. Babani

Although this chart was first published in 1971 it provides basic information on many colour codes in use throughout the world, for most radio and electronic components. Includes resistors, capacitors, transformers, field coils, fuses, battery leads, speakers, etc. It is particularly useful for finding the values of old components.

Chart

Order code BP7

£0.95

**AN INTRODUCTION TO LOUDSPEAKERS AND ENCLOSURE DESIGN**

V. Capel

This book explores the various features, good points and snags of speaker designs. It examines the whys and wherefores so that the reader can understand the principles involved and so make an informed choice of design, or even design loudspeaker enclosures for him or herself. Crossover units are also explained, the various types, how they work, the distortions they produce and how to avoid them. Finally, there is a step-by-step description of the construction of the *Kapellmeister* loudspeaker enclosure.

148 pages

Order Code BP256

£2.95

**MUSICAL APPLICATIONS OF THE ATARI ST's**

R. A. Penfold

The Atari ST's are now firmly established as the computers to use for electronic music applications. The range and sophistication of these applications are much greater than most people may realise, but there are still a lot of misconceptions about just what can and cannot be achieved. This book will help you sort out the fact from the fallacy and to get the most musically from the ST's.

A wide selection of topics are covered, including the internal sound chip; MIDI; applications programs such as sequencing and score writing, etc; simple but useful add-on projects and MIDI programming.

90 pages

Order code BP246

£5.95

**TESTING & TEST GEAR**

**TRANSISTOR RADIO FAULT-FINDING CHART**

C. E. Miller

Used properly, should enable the reader to trace most common faults reasonably quickly. Across the top of the chart will be found four rectangles containing brief description of these faults, viz—sound weak but undistorted, set dead, sound low or distorted and background noises. One then selects the most appropriate of these and following the arrows, carries out the suggested checks in sequence until the fault is cleared.

Chart

Order code BP70

£0.95

**OSCILLOSCOPES: HOW TO USE THEM—HOW THEY WORK**

Ian Hickman

Oscilloscopes are essential tools for checking circuit operation and diagnosing faults, and an enormous range of models is available. But which is the right 'scope for a particular application? Which features are essential, which not so important? What techniques will get the best out of the instrument?

Ian Hickman, experienced in both professional and hobbyist electronics, has revised this well-established book to help all oscilloscope users—and potential users.

133 pages

Order code NE09

£6.95

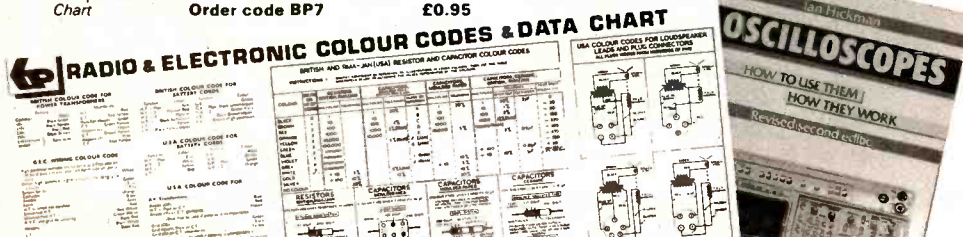

**RADIO, TV, SATELLITE**

**INTERNATIONAL RADIO STATIONS GUIDE**

P. Shore

Provides the casual listener, amateur radio DXer and the professional radio monitor with an essential reference work designed to guide him or her around the ever more complex radio bands. This new edition has been completely revised and rewritten and incorporates much more information which is divided into the following sections:

Listening to Short Wave Radio; ITU Country Codes; World-wide Short Wave Radio Stations; European, Middle East and North African Long Wave Radio Stations; European, Near East and North African Medium Wave Radio Stations; Canadian Medium Wave Radio Stations; USA Medium Wave Radio Stations; Broadcasts in English; Programmes for DXers and Short Wave Listeners; UK FM Radio Stations; Time differences from GMT; Abbreviations; Wavelength/Frequency Conversion.

320 pages

Order code BP255

£4.95

**AERIAL PROJECTS**

R. A. Penfold

The subject of aerials is vast but in this book the author has considered practical aerial designs, including active, loop and ferrite aerials which give good performances and are relatively simple and inexpensive to build. The complex theory and mathematics of aerial design have been avoided.

Also included are constructional details of a number of aerial accessories including a pre-selector, attenuator, filters and tuning unit.

96 pages

Order code BP105

£2.50

**AN INTRODUCTION TO SATELLITE TELEVISION**

F. A. Wilson

As a definitive introduction to the subject this book is presented on two levels. For the absolute beginner or anyone thinking about purchasing or hiring a satellite TV system, the story is told as simply as such a complex one can be in the main text.

For the professional engineer, electronics enthusiast, student or others with technical backgrounds, there are numerous appendices backing up the main text with additional technical and scientific detail formulae, calculations, tables etc.

There is also plenty for the DIY enthusiast with practical advice on choosing and installing the most problematic part of the system—the dish antenna.

104 pages

Order Code BP195

£5.95

**COMMUNICATION**

F. A. Wilson, C.G.I.A., C.Eng., F.I.E.E., F.I.E.R.E., F.B.I.M.

A look at the electronic fundamentals over the whole of the communication scene. This book aims to teach the important elements of each branch of the subject in a style as interesting and practical as possible. While not getting involved in the more complicated theory and mathematics, most of the modern transmission system techniques are examined including line, microwave, submarine, satellite and digital multiplex systems, radio and telegraphy. To assist in understanding these more thoroughly, chapters on signal processing, the electromagnetic wave, networks and transmissions assessment are included, finally a short chapter on optical transmission.

256 pages

Order Code BP89

£2.95

**PRACTICAL MIDI HANDBOOK**

R. A. Penfold

The Musical Instrument Digital Interface (MIDI) is surrounded by a great deal of misunderstanding, and many of the user manuals that accompany MIDI equipment are quite incomprehensible to the reader.

The *Practical MIDI Handbook* is aimed primarily at musicians, enthusiasts and technicians who want to exploit the vast capabilities of MIDI, but who have no previous knowledge of electronics or computing. The majority of the book is devoted to an explanation of what MIDI can do and how to exploit it to the full, with practical advice on connecting up a MIDI system and getting it to work, as well as deciphering the technical information in those equipment manuals.

128 pages

Order code PC101

£5.95

**MORE BOOKS NEXT MONTH**

**DIRECT BOOK SERVICE**

(A Division of Wimborne Publishing Ltd.)

**TO ORDER**

Please state the title and order code clearly, print your name and address and add the required postage to the total order.

Add 75p to your total order for postage and packing (overseas readers add £1.50 for countries in Europe, or add £2.00 for all countries outside Europe, surface mail postage) and send a PO, cheque or international money order (£ sterling only) made payable to **Direct Book Service** quoting your name and address, the order code and quantities required to **DIRECT BOOK SERVICE, 33 GRAVEL HILL, MERLEY, WIMBORNE, DORSET, BH21 1RW** (mail order only).

See next month's issue for another three page selection of books.

Although books are normally sent within seven days of receipt of your order, please allow a maximum of 28 days for delivery. Overseas readers allow extra time for surface mail post.

Please check price and availability (see latest issue of *Everyday Electronics*) before ordering from old lists.

Note—our postage charge is the same for one book or one hundred books!

**MORE BOOKS NEXT MONTH**

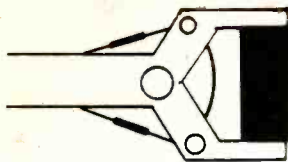

# Robot Roundup

NIGEL CLARK

## ROBOT SURVEY

The UK was the only major industrialised country where investment in robots fell between the periods 1982/4 and 1985/7. Comparing the two periods shows that installations in this country fell by 32 per cent whereas the rate doubled in West Germany, in France it showed a 72 per cent increase and there was 62 per cent growth in Italy.

The figures are revealed in the latest detailed survey of growth in the use of robots by the British Robot Association.

The survey shows that the largest area of use in the UK is in injection moulding with 20 per cent of total robots installed to date, a far greater percentage than any other country. It is also pointed out that the machines used in injection moulding are at the cheaper end of robots available, representing 71 per cent of the machines installed in Britain costing £20,000 or less.

Japan, which has the largest number of installed robots in the world, by far, has most robots in the electronics industry, which claims 32 per cent of Japan's total. The automotive industry is next with 27 per cent.

That compares with the UK where the automotive industry takes precedence and 31 per cent of this country's total. The electronics and electrical sector accounts for just 11 per cent, the third biggest after rubber and plastics (19 per cent).

Comparisons with Japan can however seem meaningless. The figures reveal that by the end of 1988 Japan had installed 141,000 robots against 70,800 in the rest of the world. The UK came sixth with a little more than 5,000 after the US, West Germany, France and Italy.

Installations in the UK during the year confirmed earlier trends with the automotive industry putting in most robots, 270 or 37 per cent of the year's total of 731. Rubber and plastics came next with 133. These have been the two front runners in total installations to date.

In third position in the total to date is electrical and electronics industry. But its lead over the metal goods and the mechanical engineering industries was cut in 1988 as both installed more robots with 103 and 60 respectively against 32.

As in previous years most, 36 per cent, of the devices cost between £10,000 and £20,000 with injection moulding and machine handling being the applications which accounted for nearly all these. Arc welding was the most common application of the machines costing £20,000 to £35,000, the next largest grouping.

Education and research uses at 50 was the fifth most common application in the list of 16. Machine handling was the most common overall with 190 installations and injection moulding and arc welding joint second with 121.

The figure for arc welding enabled it to overtake spot welding in the total number of machines installed to date. Only 27 spot welding machines were installed during the year taking its total to 591 against 679 for arc welding.

## EDUCATION AND RESEARCH

However, the figures for education and research do not include many of what this column regularly refers to as robots, because of the definition of the BRA. The association insists on a robot being defined as a reprogrammable device designed to manipulate and transport parts, tools or specialised manufacturing implements through variable programmed motions for the performance of specific manufacturing tasks.

Most of the machines installed under the education and research heading were in the cheapest category, below £10,000. Of the 50 total, 45 cost less than £10,000, the largest application of machines in the cost category. Assembly was next with 36.

Machine loading was the application which saw the greatest growth rate during the year. Its numbers increased by 31.7 per cent. Education was fourth fastest behind arc welding and handling/palletising.

For the first time the BRA has given some interesting comparisons with other countries. One point it made was that in 1987 the largest robot application in Japan was assembled with 45 per cent of the total installed that year. Arc welding was the second most popular with 21 per cent of the total. The industry with the highest total number of robots in Japan was electronics, having 32 per cent of the total with automotive next at 28 per cent.

## HOME GROWN

One possibly surprising piece of information was that of the 731 UK total in 1988, UK companies supplied 280, the largest source. A further 210 came from non-EEC countries and there were 100 from EEC countries. Japan's contribution was about 130.

BRA calculated that 58 per cent of the largest cost groups were UK-built while 50 per cent of the most expensive group were of European origin. This matches the experience of France where its 1987 figures show that 62 per cent of robots were homemade with 20 per cent from the rest of Europe.

## ROBOT KITS

The drainpipe robots kit people, Tribotics, have expanded their range. They are now offering a large catalogue of kits and individual items at prices which start at £1 for a link of conveyor belt or tank track up to £2,100 for a biped. In between there are bits of pipe, gears, motors, linkages and controllers which are all used in building up the kits.

The kits start with the aptly-named Starter Unit at £230 which includes a position controller, a hinge unit and a motor/gearbox. However, extra items are needed to create something workable. The starter kit at £750 has sufficient parts to build a three-axis arm similar to the one in the picture but without the gripper. There are also kits for a crawler and conveyor as well as the biped.

To achieve computer control the power unit and communications box are also required at a total cost of a little more than £200 plus VAT for the two. The communications box has been designed for the BBC series.

The biped is perhaps the most interesting kit and was certainly the one which attracted most interest when Tribotics first displayed their unique system about two years ago. It had been hoped to supply software which would allow it to walk but in the intervening months the Tribotics staff, all with long experience in industrial robots, have been concentrating on getting the engineering and the product mix correct.

The company says, however, that although the software provided will not make it walk directly simple routines are supplied which will allow students to experiment with different approaches. And with seven axis controllers, seven motor/gearboxes and two tube drives there is plenty of scope for experimenting.

Throughout all the changes though the gripper, which is offered with two or three fingers, has kept its ingenious balloon and elastic band mechanism. The balloon is inflated to close the fingers, the elastic band opening them again when the balloon deflates.

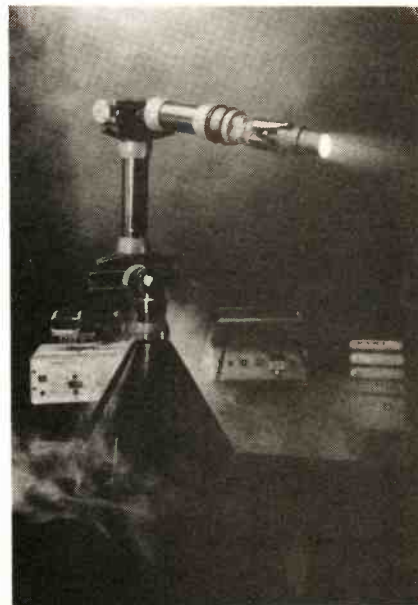

Part of the Tribotics range

# ACTUALLY DOING IT! by Robert Penfold

**M**OST integrated circuits operate at very low power levels. Something like a humble  $\mu$ A741C or NE555 integrated circuit will usually operate at a supply power of only about 10 to 100 milliwatts. Similarly, most transistors and diodes operate at power levels of under 100 milliwatts. Power levels of this order do not present any problems with overheating, since the small amount of heat that is generated is conducted away from the component and into the surrounding air at a rate which keeps it quite cool in normal operation.

Some semiconductors operate at much higher power levels, and without the aid of some outside assistance will soon overheat and be destroyed. Overheating is something that must be avoided as far as reasonably possible, since apart from the cost of replacement components, there is also the fire risk to consider. Also, overheated semiconductors have a tendency to explode with a loud "crack", sending small bits of hot plastic flying in all directions. These splinters of plastic could obviously damage other components or, more importantly, could harm the eyes of anyone who happened to be close by.

## HOT CHIPS

In the past the only reason for a component to consume a high power level was because it was used to control high power levels. Even in a simple switching application the voltage drop through a transistor is such that it can dissipate several watts if it is handling a current of a few amps. When used in a linear role the power levels can be very much higher — possibly in excess of a hundred watts in some applications.

These days there is a new category of "power" device in the form of "mega" integrated circuits which contain the equivalent of many thousands of components. In fact some have the equivalent of a few hundred thousand components, and a few top the million mark! The problem with these devices is that although each transistor etc. on the chip consumes only a minute current, with so many components on the chip the total current consumption is quite high. The computer I am using to word process and CAD this article has a micro-processor which needs the aid of metal cooling fins in order to stay within its maximum operating temperature rating, and one of the integrated circuits inside the BBC micro needs a simple metal cooling fin to prevent it overheating.

Integrated circuits of this type do not seem to be a prominent feature in electronic projects for the home constructor. You are more likely to encounter something like an audio power amplifier device which needs the benefit of a cooling fin, or "heatsink" as it is usually termed.

## OLD AMPS

Several early audio power amplifier integrated circuits had a form of d.i.l. package, but the central pins of each row were replaced by a copper heat fin. For low and medium output powers these fins were adequate to conduct heat away from the device. If used at higher powers it was necessary for them to be soldered to an area of copper on the printed circuit board which provided further heatsinking.

These integrated circuits (the TBA800 etc.) were very popular a few years ago, but are now largely obsolete. They are still available, and you might need to use one if you try to build an audio project from some years ago.

The main point to watch if you build a project of this type is to ensure that you accurately follow the printed circuit design which will provide a large enough area of copper to act as the heatsink. Using a stripboard construction for a circuit that relies on the printed circuit for extra heatsinking is a bit risky. There is a real danger of the device overheating unless it is fitted with a heatsink of some kind. A method I have used successfully is to solder a couple of pieces of copper laminate board to the heat-tabs.

## MODERN POWER ICs

Modern power integrated circuits do not seem to make much use of ordinary d.i.l. style encapsulations. It is more common for them to have a package that is rather like an enlarged plastic power transistor. These are generally much more straight-forward to use. For low and medium power applications, little or no extra heatsinking will be

required. The heatsink might then just consist of a small piece of aluminium bolted onto the heat-tab, or something a little more exotic could be required. There are several types of small bolt-on finned heatsinks available.

Things can get a bit more difficult if a large heatsink is needed. These are generally aluminium extrusions, and they come in a variety of styles. They almost invariably have a flat middle section onto which the power device or devices are bolted, with finned sections on either side of this. A typical shape is shown in Fig.1. It is worth mentioning that some projects utilize the metal chassis or case as the heatsink, and that where this is possible it can provide a very worthwhile cost saving.

## INSULATION

Heatsinks are often supplied pre-drilled with mounting holes for a certain type of power device, or possibly with holes to suit several types. Drilling mounting holes yourself is not too difficult since most modern power devices have single hole fixing. The TO-3 and TO-66 (diamond shaped) power devices are a little more awkward to use, since they require holes for two mounting bolts, plus two holes for prong-like terminals. The easiest way of marking the positions of the mounting holes for these components is to use a plastic insulating washer of the appropriate type as a template.

These insulating washers are needed because the metal heat-tab of plastic power devices often connects internally to one of the device's leadout wires. For metal cased power devices the casing is actually one of the terminals, (it is usually the collector of power transistors for instance). In addition to the insulating washer a couple of plastic bushes are required. These are needed to keep the mounting bolt or bolts insulated from either the power device or the heatsink. Provided these bolts are only allowed to come into electrical contact with the heatsink or the power device, they obviously will not provide any direct connection between the two.

The way in which the insulating washers and bushes are used is shown in Fig.2. This looks simple enough, but things can be more difficult than you might think in practice. The first problem is that the washers are very thin. They need to be, as they would otherwise seriously hamper the flow of heat from the power device to the heatsink. As it is, the addition of the washer still significantly reduces the effective efficiency of the heatsink.

The thinness of the washers results in them being vulnerable to damage that will prevent them from providing electrical insulation. You need to make quite sure that the mounting holes in the heatsink are all fully de-burred before fitting the washer in place. Make sure

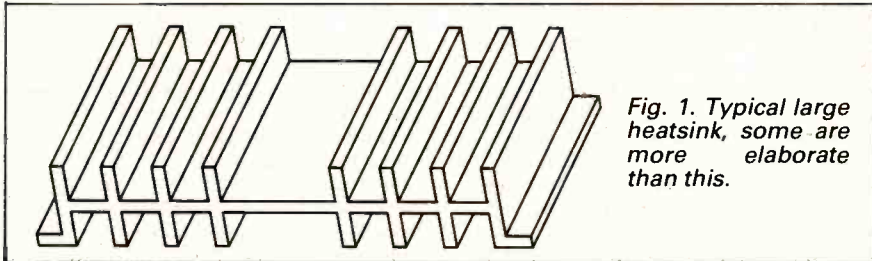

Fig. 1. Typical large heatsink, some are more elaborate than this.

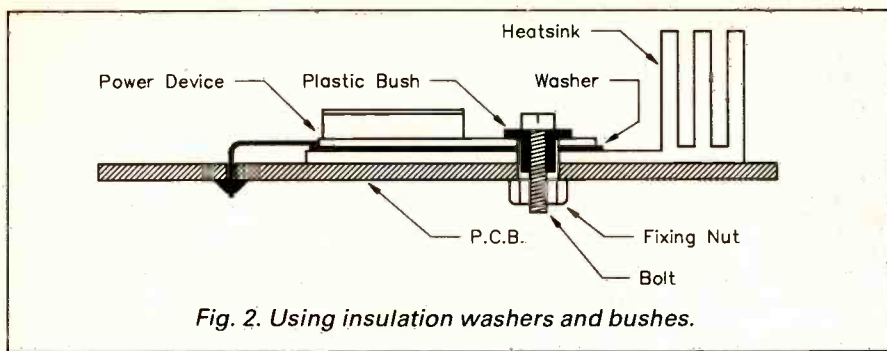

Fig. 2. Using insulation washers and bushes.

that the heatsink, washer, and power device are clean and smooth before fitting everything together.

### HEATSINK COMPOUND

In order to aid good thermal conduction between the power device and the heatsink/washer some silicon grease is often smeared over the underside of the power device — at least, a few years ago it would have been silicon grease that was used. These days it is more likely to be a silicon grease substitute, probably simply sold as "heatsink compound".

I presume that the main point of this compound is to compensate for the fact that the top surface of the heatsink and the underside of the power device might not be completely flat. This would result in gaps between the two at various places, hindering the conduction of heat. The heatsink compound fills in the gaps with something that conducts heat better than air, and thus improves the flow of heat from the power device to the heatsink.

With plastic power devices I have not found the addition of heatsink compound to have much effect, but if an article states that it should be used, then it would be wise to do so. Note that some recently introduced insulating washers achieve an excellent heat transfer without the addition of heatsink compound. Using a compound with these would actually reduce performance.

Once a power device has been fitted onto its heatsink it is a good idea to check with a continuity tester that the heat-tab and the heatsink are properly insulated from one another. Remember that there could be disastrous consequences if the insulation is broken.

I should point out that not all power semiconductors require the use of an insulating kit. Some of the more recent devices, particularly thyristors and triacs, have the heat-tab electrically insulated from all three terminals. Hopefully this trend will spread, as it makes things very much easier.

### AUDIO ICs

Some other power semiconductors (mainly audio power integrated circuits) have the heat-tab internally connected to the ground terminal. Insulation from the heatsink is then unnecessary, since both the tab and the heatsink will be at earth potential.

In some cases the heatsink might not be in electrical contact with anything other than the power device, and the use of an insulation set is then not essential. It might still be worthwhile

though, as it would eliminate the risk of any damage if a wire should accidentally come into electrical contact with the heatsink.

### CLIP-ON

There are heatsinks available for ordinary metal and plastic cased transistors. They permit these devices to be used at higher than normal powers, but the increase is likely to be only about 50 per cent at best. The heatsinks for TO-18 and TO-5 transistors (the round metal cased types) are mostly of the lobed variety, and simply push onto the top of the transistor. Sometimes they are a rather tight fit, and they need to be prised open slightly as they are fitted into place.

There used to be a type which was designed to be bolted into place on the chassis of the project, with the transistor then being pushed into place inside the heatsink. These never seemed to be used a great deal, and there is a potential problem in that the case of a TO-18 or TO-5 transistor generally connects to the collector terminal of the device. With this type of heatsink there is no easy way of providing insulation between the body of the transistor and the chassis, and they are generally not very convenient in use.

The clip-on heatsinks for TO-92 cased components (the type which have a small plastic case with a "flat" on one side of the body) take a somewhat different form. They usually consist of a simple metal clip which can be fitted onto the body of the component, and they often have a couple of tags which can be soldered to the printed circuit board. By soldering the heatsink to an area of copper, heat can be more efficiently extracted from the component.

There are clip-on heatsinks for plastic power devices as well. It is fine to use one of these if the project designer specifies a clip-on type, but it is probably not advisable to use a heatsink of this type if a bolt-on version is called for in the components list. In general, clip-on heatsinks are smaller and less efficient than the bolt-on variety.

### MATHEMATICS

If a project calls for a heatsink having a rating of say five degrees Centigrade per watt, you could be forgiven for thinking that one having a higher rating would be a suitable substitute. This is not correct though, and you must use a heatsink having a rating which is *equal to or lower than* the one specified in the components list.

The rating of a heatsink is its thermal resistance. In our example above, a five degree per watt type will be subjected to a rise in temperature of five degrees

Centigrade for each watt of power it has to dissipate. One with a higher rating will permit a larger increase in temperature for a given power level, and is therefore a less efficient heatsink.

Readers' letters from time to time enquire about the mathematics of heatsinks. These are basically quite simple, but a few figures must be known before you can work out the rating of a heatsink to suit your application. First you need to know the thermal resistance of the component you are using, which is something that must be looked up in a data sheet or book. Unfortunately, most short-form data gives the maximum power rating, not the thermal resistance. Next you must find the maximum ambient temperature in which the power device will need to operate, and decide on the maximum permissible operating temperature.

The reliability of most electronic components reduces dramatically at high temperatures, and the maximum operating temperature should ideally be much lower than the absolute maximum operating temperature of the device. Finally, you need to work out the maximum power the device will have to dissipate.

### EXAMPLE

Deducting the maximum ambient temperature from the selected maximum operating temperature gives the temperature rise that must not be exceeded. Suppose that the relevant figures are 35 and 95 degrees. This obviously gives a maximum acceptable temperature rise of 60 degrees. Dividing this by the maximum power rating gives a figure for the total acceptable thermal resistance. If, for the sake of this example, we assume a power of 15 watts, then 60 divided by 15 gives an answer of four degrees per watt. Note though, that *this is the total permissible thermal resistance, not the rating of the heatsink.*

To obtain the heatsink rating you must deduct from this figure the thermal resistance of the power device. Also, as the heatsink and the power device will not be in perfect thermal contact, there is more thermal resistance to be taken into account here.

In this example we will assume that the power device has a thermal resistance of three degrees per watt, and that the device to heatsink resistance is 0.5 degrees per watt. Deducting three and 0.5 from four gives us a final answer of 0.5 degrees Centigrade per watt. A heatsink having a rating of 0.5 degrees Centigrade per watt or less would therefore be required. This would necessitate the use of a pretty huge heatsink, but a few commercially produced units have ratings of less than this figure.

### IN PRACTICE

In practice it is difficult to work out an accurate figure, since the maximum ambient temperature and case to heatsink thermal resistance might not be totally predictable. Also, the true rating of a heatsink depends to some extent on the way in which it is used. Therefore, it is advisable to use a heatsink having a somewhat lower thermal resistance than the calculated figure.

# PCB SERVICE

Printed circuit boards for certain constructional projects are available from the PCB Service, see list. These are fabricated in glass fibre, and are fully drilled and roller tinned. All prices include VAT and postage and packing. Add £1 per board for overseas airmail. Remittances should be sent to the PCB Service *Everyday Electronics*, 6 Church Street, Wimborne, Dorset BH21 1JH. Cheques should be crossed and made payable to *Everyday Electronics* (Payment in £ sterling only). **Readers are advised to check availability and prices appearing in the current issue before ordering.**

**NOTE: Boards for some older projects – not listed here – can often be obtained from Magenta Electronics, 135 Hunter St., Burton-on-Trent, Staffs DE14 2ST. Tel: 0283 65435 or Lake Electronics, 7 Middleton Close, Nuthall, Nottingham NG16 1BX. Tel: 0602 382509.**

**NOTE: please allow 28 days for delivery. We can only supply boards listed in the latest issue. Boards can only be supplied on a payment with order basis.**

PROJECT TITLE	Order Code	Cost
200MHz Digital Frequency Meter <b>NOV '86</b>	548	£5.14
Automatic Car Alarm <b>DEC '86</b>	550	£3.00
BBC 16K Sideways RAM (Software Cassette)	551 551S	£3.00 £3.88
Car Voltage Monitor <b>FEB '87</b>	553	£3.00
Mini Amp	554 & 555	£5.68
Video Guard	556	£3.80
Spectrum I/O	557	£4.35
Spectrum Speech Synthesiser	558	£4.86
Computer Buffer/Interface <b>MAR '87</b>	560	£3.32
Infra-Red Alarm: Sensor Head	561	£4.19
PSU/Relay Driver	562	£4.50
Alarm Thermometer <b>APR '87</b>	559	£3.00
Experimental Speech Recognition	563	£4.75
Bulb Life Extender	564	£3.00
Fridge Alarm <b>MAY '87</b>	565	£3.00
EE Equaliser-Ioniser	566	£4.10
Mini Disco Light <b>JUNE '87</b>	567	£3.00
Visual Guitar/Instrument Tuner	568	£3.97
Fermostat <b>JULY '87</b>	569	£3.34
EE Buccaneer Metal Detector	570	£4.10
Monomix	571	£4.75
Super Sound Adaptor <b>AUG '87</b>		
Main Board	572	£4.21
PSU Board	573	£3.32
Simple Shortwave Radio, Tuner	575	£3.15
Amplifier	576	£3.00
Noise Gate <b>SEPT '87</b>	577	£4.41
Burst Fire Mains Controller	578	£3.31
Electronic Analogue/Digital Multimeter	579	£6.40
Transtest <b>OCT '87</b>		
Video Controller	580 581	£3.32 £4.83
Accented Metronome <b>NOV '87</b>	582	£3.77
Acoustic Probe	584	£3.00
BBC Sideways RAM/ROM	585	£4.10
Pseudo Echo Unit <b>DEC '87</b>	586	£4.60
Dual Mains Light Flasher	587	£3.66
Twinkling Star	588	£3.00
Audio Sine Wave Generator	589	£3.03
Capacitance Meter <b>JAN '88</b>	590	£4.10
Bench Amplifier	591	£5.51
Transistor Curve Tracer	592	£3.00
Bench Power Supply Unit <b>FEB '88</b>	593	£4.01
Game Timer	583	£3.55
Semiconductor Tester <b>MAR '88</b>	594	£3.19
SOS Alert	595	£3.00
Guitar/Keyboard Envelope Shaper	596	£4.23
Stereo Noise Gate <b>APR '88</b>	597	£6.65
Pipe & Cable Locator	598	£3.00
Inductive Proximity Detector	574	£3.00

Multi-Chan Remote Light Dim <b>MAY '88</b>		
Transmitter	599	£3.00
Receiver	600	£3.07
Door Sentinel	605	£3.00
Function Generator – Main Board	606	£5.91
Function Generator – Power Supply	607	£4.19
Super Sound Effects Generator	608	£4.78
Multi-Chan Remote Light Dim <b>JUNE '88</b>		
Relay/Decoder	601	£4.86
Dimmer Board	602	£3.07
Power Supply	603	£3.00
Mother Board	604	£7.76
Headlight Reminder	611	£3.00
Video Wiper <b>JULY '88</b>		
Isolink	612 613	£6.75 £4.21
Tea Tune <b>AUG '88</b>		
Time Switch	609	£3.00
Suntan Timer	614	£4.84
Car Alarm	610 615	£3.07 £3.12
Breaking Glass Alarm <b>SEPT '88</b>		
Amstrad PIO	617 618	£4.27 £6.77
Eprom Eraser <b>OCT '88</b>	620	£4.07
Doorbell Delay <b>NOV '88</b>		
Micro Alarm	616 621	£3.56 £3.12
Infra-Red Object Counter Trans Receiver Display } £9.28 as a set	622 623 624 625	£4.61 £3.23 £3.05 £4.84
Seashell Sea Synthesiser		
Reaction Timer Main Board <b>DEC '88</b>		
Display Board	626 627	£3.46 £3.00
Downbeat Metronome	629	£4.84
EPROM Programmer (On Spec)	630	£8.29
Phasor	631	£5.64
Monkey/Hunter Game <b>JAN '89</b>	634	£3.36
Continuity Tester <b>FEB '89</b>		
4-Channel Light Dimmer	619 635	£2.67 £7.67
Mini PSU	636	£3.23
Sound-to-Light Interface <b>MAR '89</b>		
Midi Pedal	637 639	£6.24 £7.00
Midi Merge	640	£3.00
Audio Lead Tester	641	£5.77
Light Sentinel <b>APR '89</b>		
Main Control Board	632	£9.20
Remote Interface (4 boards)	633	£4.59
Electron User Port	638	£6.64
4-Channel Auto-Fader Interface	642	£6.80
Pet Scarer <b>MAY '89</b>		
Electron A/D Interface	644 645	£3.00 £4.84
Spectrum EPROM Programmer <b>JUNE '89</b>		
Bat Detector	628 647	£7.87 £4.95
Programmable Pocket Timer <b>JULY '89</b>	648	£3.82
Electronic Spirit Level <b>AUG '89</b>		
Distance Recorder	649 651	£3.85 £5.23
Treasure Hunter	652	£3.73

Please note that when ordering it is important to give project title as well as order code. Please print name and address in Block Caps. Do not send any other correspondence with your order.

## EE PRINTED CIRCUIT BOARD SERVICE

Please send me the following p.c.b.s.  
Make cheques/PO payable to: **Everyday Electronics**  
(payment in £ sterling only)

**Order Code    Project    Quantity    Price**

.....

.....

.....

.....

.....

.....

I enclose cheque/PO for £.....

Name.....

Address.....

.....

.....

.....

.....

.....

Please allow 28 days for delivery

BLOCK CAPITALS PLEASE

# NATIONAL COMPONENT CLUB

## SPECIAL OFFERS \* SPECIAL OFFERS

### SCANNER KIT(T)

A complete, six channel LED chaser kit for less than a fiver! The kit comes complete with all components, including PCB and instructions simple enough for even a complete novice. Works from 6-15vdc.

Only £4

MAINS POWER SUPPLY FOR ABOVE £1

### \* SPECIAL OFFER PACKS \*

100	ASSORTED CAPACITORS	£1
30	ASSORTED TRANSISTORS	£1
25	ELECTROLYTIC CAPACITORS	£1
12	LED's (5mm red or green)	£1
5	555 TIMER IC's	£1
5	741 OP-AMPS	£1

### FREE MYSTERY PACK WITH ALL ORDERS OVER £6

Please add £1 P&P, but do not add VAT.  
P.O. or cheque to: NATIONAL COMPONENT CLUB, DEPT EE,  
BAILEY HILL, CASTLE CARY,  
SOMERSET BA7 7AD

We now accept Access - phone (0963) 51171

\* FREE CLUB MEMBERSHIP \*

Just phone above number or write for details

Carbon Film resistors 1/4W 5% E24 series 0.51R to 10MΩ	1p
100 off per value—75p, even hundreds per value totalling 1000	£6.00p
Metal Film resistors 1/4W 10R to 1MΩ 5% E12 series—2p, 1% E24 series	3p
Mixed metal/carbon film resistors 1/2W E24 series 1R0 to 10MΩ	1 1/2p
1 watt mixed metal/Carbon Film 5% E12 series 4R7 to 10 Megohms	5p
Linear Carbon pre-sets 100mW and 1/4W 100R to 4M7 E6 series	7p
<b>Miniature polyester capacitors 250V working for vertical mounting</b>	
.015, .022, .033, .047, .068-4p, 0.1-5p, 0.12, 0.15, 0.22-6p, 0.47-8p, 0.68-8p, 1.0-12p	
<b>Mylar (polyester) capacitors 100V working E12 series vertical mounting</b>	
1000p to 8200p - 3p, .01 to .068 - 4p, 0.1 - 5p, 0.12, 0.15, 0.22-6p, 0.47/50V-8p	
<b>Submin ceramic plate capacitors 100V wkg vertical mountings, E12 series</b>	
2% 1.8pf to 47pf - 3p, 2% 56 pf to 330pf - 4p, 10% 390p - 4700p	4p
Disc/plate ceramics 50V E12 series 1P0 to 1000P, E6 Series 1500P to 47000P	2p
<b>Polystyrene capacitors 63V working E12 series long axial wires</b>	
10pf to 820pf - 3p, 1000 pf to 10,000pf - 4p, 12,000 pf	5p
741 Op Amp - 20p, 555 Timer	22p
cmos 4001 - 20p, 4011 - 22p, 4017	40p
<b>ALUMINIUM ELECTROLYTICS (Mids/Volts)</b>	
1/50, 2/250, 4/750, 10/25, 10/50	5p
22/16, 22/25, 22/50, 47/16, 47/25, 47/50	6p
100/16, 100/25 7p; 100/50 12p; 100/100	14p
220/16 8p; 220/25, 220/50 10p; 470/16, 470/25	11p
1000/25 25p; 1000/35, 2200/25 35p; 4700/25	70p
<b>Submin, tantalum bead electrolytics (Mids/Volts)</b>	
0.1/35, 0.22/35, 0.47/35, 1.0/35, 3.3/16, 4.7/16	14p
2.2/35, 4.7/25, 4.7/35, 6.8/16 15p; 10/16, 22/6	20p
33/10, 47/6, 22/16 30p; 47/10 35p; 47/16 60p; 47/35	80p
<b>VOLTAGE REGULATORS</b>	
1A + or - 5V, 8V, 12V, 15V, 18V & 24V	55p
<b>DIODES (piv/amps)</b>	
75/25mA 1N4148 2p, 800/1A 1N4006 6p, 400/3A 1N5404 14p, 115/15mA OA91	6p
100/1A 1N4002 4p, 1000/1A 1N4007 7p, 60/1.5A S1M1 5p, 100/1A bridge	25p
400/1A 1N 4004 5p, 1250/1A BY127 10p, 30/15A OA47	8p
Zener diodes E24 series 3V3 to 33V 400 mW - 8p, 1 watt	12p
Battery snaps for PP3 - 6p for PP9	12p
L.E.D.'s 3mm, & 5mm, Red, Green, Yellow - 10p, Grommets 3mm - 2p, 5mm	2p
Red flashing L.E.D.'s require 5V supply only	50p
Mains indicator neons with 220k resistor	10p
20mm fuses 100mA to 5A Q/blow 5p, A/surge 8p, Holders pc or chassis	5p
High speed pc drill 0.8, 1.0, 1.3, 1.5, 2.0mm - 30p, Machines 12V dc	£7.00
HELPING HANDS 6 ball joints and 2 croc clips to hold awkward jobs	£3.50p
AA/HP7 Nicad rechargeable cells 80p each, Universal charger unit	£6.50p
Glass reed switches with single pole make contacts - 8p, Magnets	12p
<b>TRANSISTORS</b>	
BC547/8-9-8p, BC557/8-9-8p, BC182L/4L-10p, BC183, 183L-10p, BC212, 212L-10p, BC337, 337L-12p, BC727/737-12p, BD135/67/8-9-25p, BCY70-15p, BFY50, 52-20p, BFX88-15p, 2N3055-50p, TIP31, 32-30p, TIP41, 42-40p, BU208A-£1.20, BF195, 197-12p	

**THE CR SUPPLY CO**  
127 Chesterfield Rd, Sheffield S8 0RN  
Return posting



**MARCO Trading**  
ELECTRONIC COMPONENTS & EQUIPMENT

THE MALTINGS, HIGH STREET, WEM,  
SHROPSHIRE SY4 5EN. DEPT EE7  
Tel: 0939 32763. Telex 35565. Fax 33800

Electronic Component Mail Order Company—Established 1972  
100+ PAGE CATALOGUE AVAILABLE—SEND £1 FOR YOUR COPY  
Including Discount Tickets—50p off £5+order; £1 off £10+order; £5 off £50+order.  
Please add £1.00 postage and packing to all orders unless stated.

**FM TRANSMITTER**  
Very High Quality "MINI-BUG"  
—ideal for Baby Alarm, etc!  
A very good range is obtainable—We have obtained over 1/2 mile, but it does depend on conditions. Simply remove cover—insert battery—and you're ready to go. Reception can be obtained on any FM radio.  
Frequency: 06-109 MHz-Fm  
Power: PP3 9V. **£9.78**

**MARCO TRADING'S LATEST 217 PAGE CATALOGUE NOW READY ONLY £1**

FULL OF CMOS, TRANSISTORS, LS, ICS, DIODES, BRIDGES, VALVES, RESISTORS, BOXES, BOOKS, SOLDERING TOOLS, TEST GEAR, METERS, CABLE, KITS, SPEAKERS, AERIALS, AUDIO ETC, ETC AND INCLUDING £6.50 OFF IN DISCOUNT TICKETS.

**AUGUST SPECIAL OFFER**

**HITACHI FM/MW RADIO CASSETTE MODEL TRK-510E**

**£17.50**  
+ £1.50 P.P.  
(Current Price £29.99)



Made by the famous Hitachi company, this portable stereo radio cassette player is ideal for the person who is limited for space but still requires good sound and reliability. Small and compact, the TRK-510E offers FM/MW radio and tape recorder, powered by 4 x 'D' type batteries or 240V mains lead supplied.  
A FEATURE OF THE TRK-510E IS THAT YOU CAN RECORD ONTO CASSETTE DIRECT FROM THE RADIO.  
We have, yet again, bought a bulk purchase of refurbished electrical goods. All radios are fully tested and we are giving a full "No Quibble" guarantee for three months from the date of purchase.

**"CLOSED-CIRCUIT" TELEVISION SYSTEM**

PRICES **£160** COMPRISING:  
1x CAMERA 1x MONITOR 1x CAMERA BRACKET



COMPLETE WITH LENSE (USED) (Plus £12.00 carriage)

**CHARGER FOR NI-CAD BATTERIES**

Charges AA, AA, C, D & PP3 NI-CADS  
**£4.99**



**12 VOLT RECHARGEABLE UNIT**

10x D size Ni-Cads (4Ah) encapsulated in a black plastic case, fused holder, gives 12V output when fully charged. Ex-equipment—fully tested and guaranteed. 245x75x75mm.  
**£9.19 PLUS £2.12 CARRIAGE**

**12V Twin Fluorescent lamp 12" Double Tubes**  
IDEAL FOR BOATS, CARAVANS, VANS, ETC



ATTRACTIVE WHITE FITTING, RIBBED PERSPEX DIFFUSER, ON/OFF SWITCH, 3ft CABLE, TRANSISTORISED CIRCUITRY, KEYHOLE FIXING.  
12V D.C. 8W TUBES 368x67x43mm  
**£5.99 EACH**

**QUARTZ-HALOGEN SPOTLIGHT**



**£5.99**

**NI-CAD RECHARGEABLE BATTERIES**

	1 off	10 off
AAA	£1.50	£1.30
AA	95p	85p
C	£1.95	£1.80
D	£2.00	£1.85
PP3	£3.90	£3.20

Resistors at bulk prices *Your Mix*  
Carbon film, 0.25W, 5% 1p each or 45p for 50  
Metal film, 0.25W, 1% 3p each or 1.35p for 50  
I/C sockets, solder type (pin:price)  
14:10p, 16:11p, 20:14p, 24(0.6 or 0.3):16p.  
I/C sockets with 0.1uF decoupler 14:60p, 16:65p.

Prototyping boards (Vero) IBM XT 45.00, IBM AT 52.00

ACCESS welcome. Callers by appointment please. Lists free. VAT included. Please add 50p for post and packing.

**BLACKMORE ELECTRONICS LTD.**  
FREEPOST, Blandford Forum  
Dorset DT11 7BR

0258 451347 (24hr answerphone)

**WALTONS OF WOLVERHAMPTON**

Established since 1947 - offering a complete range - I.C.s, transformers, switches, pots, capacitors, resistors, kits, speakers, test equipment, books and lots, lots more!

COME AND SEE US AT: MON-SAT 9-6.00 pm  
55A WORCESTER STREET, WOLVERHAMPTON TEL: 0902 22039

**ELECTRONIC COMPONENTS**

EVERYTHING FOR YOUR NEXT PROJECT

THE BIGGEST DISPLAY IN THE SOUTH IS AT

**FRASER ELECTRONICS**

42 ELM GROVE \* SOUTHSEA \* HANTS  
Telephone 0705-815584

100 WATT POWERAMPS £7-new! Fully assembled + leads, directions. KIA 8 Cunliffe Road, Ilkley. Hear-it! Free demo cassette - £1.50 p & p.

SALE OF SURPLUS COMPONENTS Send for details. Also our popular G.C.S.E. electronics kits. Sir-Kit Electronics, 70 Oxford Road, Clacton, CO15 3TE.

**BCS VARIABLE VOLTAGE D.C. BENCH POWER SUPPLY**  
1 to 24 volts up to 1/2 amp, 1 to 20 volts up to 1 amp, 1 to 16 volts up to 1 1/2 amps A.C. Fully stabilised. Twin panel meters for instant voltage and current readings. Overload protection.  
Fully variable.  
Operates from 240V AC.  
Compact Unit, size 9 x 5 1/2 x 3 in.



**£39** inc. VAT  
+ Post £2

**RADID COMPONENT SPECIALISTS**

337 WHITEHORSE ROAD, CROYDON SURREY, U.K. Tel: 01-684 1665  
List, Large SAE. Delivery 7 days. Callers welcome. Closed Wednesday

**CAMBRIDGE COMPUTER SCIENCE LIMITED**  
5.25" Disk Drives, 80 Tk, DSDD £34.00 each  
3" Disk Drives, 40 Tk, SSDD £28.00 each  
5.25" Disk Drives, 80 Tk, DSDD Used, No Wty. £3.00 each  
5.25" Disks, DSDD, 48tpi boxes of 10 £3.00/box  
Dual Disk Drive Power Supply £20.00 each  
Lead to connect one drive to psu £2.00 each  
50W PSU 5V 6A, 12V 2.5A, -5V 0.5A, +12V 0.5A £16.00 each  
Bench PSU 0-30V @5A Limited quantity only at £45.00 each  
Single Data lead (BBC Micro to Disk Drive) £2.00 each  
Dual Data lead (BBC Micro to 2 Disk Drives) £4.00 each  
Power lead (BBC Micro to Disk Drive) £1.00 each  
Dual leads (BBC Micro to 2 Disk Drives) £2.00 each  
68000 CPUs (The first orders get 12MHz chips) £3.50 each  
74LS TTL assortments, 10 different devices £1.20 pack  
8K Byte NV ram chips £3.00 each £10.00 four  
20 pin dif low profile IC sockets £0.50/10 £4.00/100  
40 pin dif low profile IC sockets £0.60/10 £5.00/100  
Keyboard, 100 keys on board LCD & micro i/f £8.00 each  
Toroidal mains transformer, 12V 4A & 0.4A, 12-0-12, 1A & .2A, 9-0-9, 2A £4.00/1, £6.00/2, £8.00/3  
All items new unless stated. Add 15% VAT to all prices. Prices include postage. Add 50p to orders below £5.00.  
Send an SAE for our latest list or for more info.  
Dept EE, 374 Milton Road, Cambridge, CB4 1SU  
Telephone: 0223 327602

**TRANSMITTERS**—tunable—70:150—p.c.b. TX1 £5.00—FM5 £9.95—FM100 £16.95 3 miles, s.s.a.e. other details. Gemtronics, 40 Baker, Crawley, Sussex RH10 6HA.

**A & G ELECTRONICS LTD.**

If you are buying Electronic Components elsewhere you are almost certainly paying too much! Write to us for a free 1989 catalogue and start saving money. (Please send two 19p stamps towards postage.)

100 Park Avenue, London E6 2SR  
Tel 01-552 2386

**\*\*\*RESISTOR PACKS\*\*\***

1/4W 5% CARBON FILM  
E12 range 10R to 10M

10 of any 1 value 8p

10 OF EACH VALUE  
Total 730 resistors **£4.95**

Add 25p p&p and 15% VAT

**RMOS P.O. BOX 3**  
USK GWENT NP5 2YF

**ENJOY SATELLITE TV**

**DO-IT-YOURSELF AND SAVE**

Electronic Know-how not required. Easy to build from our plans or kits. Dishes, Receivers, Down Converters. Guaranteed proven plans, and more.

ELECTRONIC CONCEPTS UNLIMITED  
M.P.O. Box 476, Saint John, N.B. Canada, E2L 3Z6  
FREE CATALOGUE: Postage £1



**LEARN**

**ELECTRONICS WITHOUT SOLDER**

Build electronic circuits without solder on a S-Dec.

This has built-in contacts and holes into which you plug your components. Suitable for all ages. Can be used time after time. Ideal gift for students or experimenters. Full instructions and 2 circuit diagram with each S-Dec.

Send Cheque or P.O. to:  
Vistaplus, Dep EE  
High March, Daventry  
Northants, NN11 4QE

**£5.75** including p & p



**RF PROJECTS** and kits including transmitters. For catalogue send s.a.e. to TM Electronics, 39 Mayeswood Road, Grove Park, London SE12.

**EPROM PROGRAMMING SERVICE** From master or listing. S.A.E. to M. G. O'Hare, 345 The Ridgeway, Erdington, Birmingham, B23 7TB.

**SERVICE MANUALS**

Most available for Amateur Radio, Military/Surplus, Test Equipment, Vintage Valve, Colour TV, Mono TV, Video Recorders etc. etc

Over 100,000 stocked. LSAE Enquiries with Make/Model wanted.

FREE catalogue unique repair and data guides for LSAE

**MAURITRON (EE)**  
8 Cherry Tree Road, Chinnor, Oxon OX9 4QY

Tel: (0844) 51694

**TRANSMITTER CIRCUIT DIAGRAMS** - f.m., medium, shortwave, C.B., some crystal controlled, minimum 17 circuits. Includes constructors' guide and price list for kits. Cheques/P.O.s, £4.25 to D. Davies, 33 Gwacodygarth, Merthyr Tydfil CF47 8YU.

**PROTOTYPE PRINTED CIRCUIT BOARDS**, one offs and quantities, for details send s.a.e. to Mr B. M. Ansbro, 38 Poynings Drive, Sussex BN3 8GR, or phone Brighton 720203.

The prepaid rate for semi-display space is £8.00 (plus VAT) per single column centimetre (minimum 2.5cm). The prepaid rate for classified advertisements is 30 pence (plus VAT) per word (minimum 12 words).

All cheques, postal orders, etc., to be made payable to Everyday Electronics. VAT must be added. Advertisements, together with remittance, should be sent to the Classified Advertisement Dept., Everyday Electronics, 6 Church Street, Wimborne, Dorset BH21 1JH. Tel: (0202) 881749.

**TECHNICAL INFO SERVICES (EE)**  
76 Church St, Larkhall, Lanarkshire ML9 1HE  
Phone 0898-803334 Mon-Fri, 9-5  
any other time 0898-803334 FOR FAST QUOTES

WORLD'S LARGEST COLLECTION SERVICE MANUALS—Most unobtainable elsewhere. Prices range from only £4.50—large s.a.e. any quotation, no obligation to buy.

WORLD'S SOLE Suppliers of TV & Video Repair manuals, etc. from TV TECHNIC, also such publishers as Heinemann, Newnes, TV Technic, Thorn etc. Every published service sheet in stock, supplied full size, not bits & pieces. CTV's or any combination £2.50 plus Lsae; any other single item £2.50 plus Lsae. Complete Circuit Sets for most Videorecorders only £7 set (no serv. kits incl).

LSAE for QUOTATIONS plus GIANT CATALOGUE—NEWSLETTERS—BARGAINS—FREE 5/8" as available.

Comprehensive TV Repair Manual £3.50. Complete Radio Service and Repair Course £3.50. Complete Repair & Service Manuals—Mono TV £12.50. CTV £17.00. Video £19.50. Complete Repair Data with circuit—Mono TV £9.50. CTV £12.50. Video £10.50.

£21.00 plus LSAE BRINGS THE ONLY COMPREHENSIVE SERVICE SHEETS & MANUALS, CATALOGUES plus FREE CHASSIS GUIDE and £4.00 OF VOUCHERS

**F.M. MICRO TRANSMITTER** kit 20mm x 28mm. Long range, £3.99 inc. P&P. Cheques/P.O. to Minral, 39 Parkside, Orrell, Wigan WN5 8LU.

**PROFITS FROM CAMERA REPAIRS.** Our comprehensive training manual explains how to repair all types of cameras. Our step by step guide shows all the trade secrets. Get started today. Full manual and training notes £17.50 inc p&p. Camrep Publications, Dept EE, 3 Alnwick Drive, Bury BL9 8BZ.

**NEW VHF MICROTRANSMITTER KIT**  
Tuneable 88-115 MHz, 500 metre range, sensitive electret microphone, high quality p.c.b. SPECIAL OFFER complete kit ONLY £5 POST FREE. Access orders telephone 021-411 1821 (24 hrs).

Cheques/P.O.s payable to:  
**QUANTEK ELECTRONICS LTD**  
(Dept. EE), 45a Station Road  
Northfield, Birmingham B31 3TE

**STATE OF THE ART SEAS LOUDSPEAKERS**  
10" 100 WATT BASS £42.05 inc. p+p  
1" 100 WATT TWEETER £17 inc. p+p  
CROSSOVERS £19.98 PER PAIR inc. p+p  
FULL INFORMATION IN OUR LATEST ILLUSTRATED CATALOGUE OF QUALITY ELECTRONIC AND ELECTRICAL SPARES AND ACCESSORIES  
SEND 75p TODAY FOR YOUR COPY FAST BY-RETURN SERVICE

**STRACHEN ELECTRONICS (ES2)**  
9 CROALL PLACE, EDINBURGH, EH7 4LT

**KITS, MICROTRANSMITTER, v.h.f./f.m.,** 25x15mm, £3.95. We also stock telephone transmitters/recording switches, beepers, radio transmitting alarms, circuit diagrams, etc. Kits and built available. Send s.a.e. to A.C.E., 99 Greenheath, Hednesford, Staffs.

74LS02	£0.10	74LS139	£0.25	CD40174	£0.55
74LS04	£0.10	74LS148	£0.70	4116N-3	£0.75
74S04	£0.10	74LS166	£0.45	2732	£1.50
74LS10	£0.10	74LS221	£0.45	2764	£1.50
74LS12	£0.10	74LS243	£0.30	Z80A	£1.50
74LS26	£0.10	74LS273	£0.30	Z80B	£2.50
74LS30	£0.10	74LS373	£0.30	Z80C	£3.00
74LS32	£0.10	74LS374	£0.30	8255	£1.50
74LS32	£0.10	74LS393	£0.25	6845	£2.50
74LS74	£0.15	7406	£0.25	MC14001B	£0.15
74LS86	£0.15	7406	£0.25	MC1489	£0.35
74LS138	£0.25	CD4538	£0.45		

**QWERTY KEYBOARD (LYNX COMPUTER)** £3.75  
P & P ADD 60p. Order by return  
Send Cheque, Postal Order to:  
D. J. DESIGN, 18 CLARE STREET, CAMBRIDGE  
CB4 3BY



## POWER CONDITIONER

FEATURED IN ETI  
JANUARY 1988

The ultimate mains purifier. Intended mainly for lowering the noise floor and improving the analytical qualities of top-flight audio equipment.

The massive filter section contains thirteen capacitors and two current balanced inductors, together with a bank of six VDRs. To remove every last trace of impulsive and RF interference. A ten LED logarithmic display gives a second by second indication of the amount of interference removed. Our approved parts set consists of case, PCB, all components (including high permeability toroidal cores, ICs, transistors, class X and Y suppression capacitors, VDRs, etc.) and full instructions.

PARTS SET £29.80 + VAT

Low cost (but high performance) mains conditioner is also available  
MAINS CONDITIONER PARTS SET £5.40 + VAT  
RUGGED PLASTIC CASE £1.80 + VAT

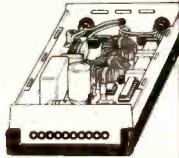

## KNIGHT RAIDER

FEATURED IN ETI JULY 1987

The ultimate in lighting effects for your Lamborghini, Maserati, BMW (or any other car, for that matter). Picture this: eight powerful lights in line along the front and eight along the rear. You flick a switch on the dashboard control box and a point of light moves lazily from left to right leaving a comet's tail behind it. Flip the switch again and the point of light becomes a bar, bouncing backwards and forwards along the row. Press again and try one of the other six patterns. An LED display on the control box lets you see what the main lights are doing.

The Knight Raider can be fitted to any car (it makes an excellent fog light!) or with low powered bulbs it can turn any child's pedal car or bicycle into a spectacular TV-age toy!

The parts set consists of case, PCB and components for control, PCB and components for sequence board, and full instructions.

Lamps not included  
PARTS SET £24.80 + VAT



## RAINY DAY PROJECTS



All can be built in an afternoon!

JUMPIN' JACK FLASH (ETI March 1988)

£6.90 + VAT

Spectacular rock, stage and disco lighting effect!

CREDIT CARD CASINO (ETI March 1987)

£5.90 + VAT

The wicked pocket gambling machine

MAINS CONTROLLER (ETI January 1987)

£6.20 + VAT

Isolated logic to mains interface

MATCHBOX AMPLIFIERS (ETI April 1986)

£6.50 + VAT

Listen: 50W of Hi-Fi power from an amp small enough to fit in a matchbox!

Matchbox Amplifier (20W)

£8.90 + VAT

Matchbox Bridge Amplifier (50W)

£3.90 + VAT

1.65V Power Amplifier (C, with data and circuits)

TACHO/DWELL METER (ETI January 1987)

£16.40 + VAT

Turn your Metro into a Porsche!

HI-FI POWER METER (ETI May 1987)

£3.90 + VAT

Measures Hi-Fi output power up to 100W

- Includes PCB, components, meters

Mono power meter

£7.20 + VAT

Stereo power meter



FEATURED IN ETI  
AUGUST 1988

There's nothing quite so encouraging as having a quantifiable result to show for your training efforts. If you are not particularly fit, your resting heart rate will be around 80 beats per minute. As your jogging, aerobics or sport strengthens your heart, the rate will drop dramatically - possibly to 60bpm or less. With the S101, you can watch your progress day by day.

Breathing is important too. How efficiently do you take up oxygen? How quickly do you recover from oxygen debt after strenuous activity? The S101 will let you know.

The approved parts set consists of: case, 3 printed circuit boards, all components (including 17 ICs, quartz crystal, 75 transistors, resistors, diodes and capacitors), LCD, switches, plugs, sockets, electrodes, and full instructions for construction and use.

PARTS SET £33.80 + VAT

Some parts are available separately. Please send SAE for lists, or SAE + £2 for lists, circuit, construction details and training plan (free with parts set).



## THE DREAM MACHINE

FEATURED IN ETI  
DECEMBER 1987

Adjust the controls to suit your mood and let the gentle, relaxing sound drift over you. At first you might hear soft rain, sea surf, or the wind through distant trees. Almost hypnotic, the sound draws you irresistibly into a peaceful, refreshing sleep.

For many, the thought of waking refreshed and alert from perhaps the first truly restful sleep in years is exciting enough in itself. For more adventurous souls there are strange and mysterious dream experiences waiting. Take lucid dreams, for instance. Imagine being in control of your dreams and able to change them at will to act out your wishes and fantasies. With the Dream Machine it's easy!

The approved parts set consists of PCB, all components, controls, loudspeaker, knobs, lamp, fuseholders, fuse, mains power supply, prestige case and full instructions.

PARTS SET £19.80 + VAT

Ben Swetland's best seller GROW RICH WHILE YOU SLEEP is now in stock.

£2.95 (NO VAT)



## THE MISTRAL AIR IONISER

The best ioniser design yet - this one has variable ion drive, built-in ion counter and enough power to drive five multi-point emitters. For the technically minded, it has nine main drive stages, five secondary drives, and a four section booster to give an output capability of almost fifteen billion ( $1.47 \times 10^{13}$ ) ions every minute, or  $2.45 \times 10^{11}$  ions per second. With extra emitters this can be increased still further!

PARTS SET £28.40 + VAT

The parts set includes case, printed circuit boards, 126 top grade components, all controls, lamps, hardware, a multi-point phosphor-bronze emitter and full instructions.

Some parts are available separately - please send SAE for lists, or SAE + £1 for lists, circuit and construction details and further information (free with parts set).

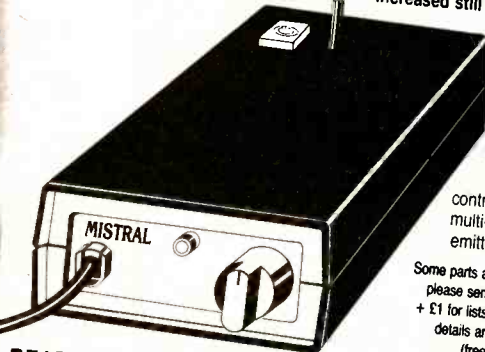

### READY-BUILT MISTRAL

The Mistral Ioniser (and most of our other projects) can now be supplied built, tested and ready to go. For details, please contact Peter Leah at P.L. Electronics, 8 Woburn Road, Eastville, Bristol BS5 6TT. Tel: 0272 522703. Evenings Only

INTERNAL EMITTER £2.80 + VAT

Can be used in place of the P-B external emitter, or both can be used together for the highest ion output. Parts set includes PCB, ion emitters, components and instructions.

### IPA BOARD CLEANER

£0.98 + VAT

Essential for removing grease and flux residues from the Mistral PCB to achieve peak performance. Applicator brush supplied.

### ION FAN

£9.80 + VAT

An almost silent piezo-electric fan, mains operated, to pump ions away from the emitter and into the room. Increases the effectiveness of any ioniser by five times!

## TV BOOSTER

Good TV pictures from poor aerials is what this project is all about. Keith Brindley's Aerial Booster gives a massive 20dB gain to ensure good viewing for campers and caravaners, from indoor aerials, or wherever a properly positioned high-gain antenna is not practical.

Based on the OMC35 hybrid amplifier, the booster has specifications to rival the best: wideband operation from 10MHz to 1.4 GHz, mid-band gain of up to 25dB and a wide supply range of 9V to 25V (it will run from car batteries for caravaners, dry batteries for campers, or a mains 'battery eliminator' in the home). No special UHF construction skills are needed - the project could be made by a careful beginner.

There are two parts sets for the project. AA1 contains the printed circuit board, OMC35 hybrid amplifier, components and instructions. AA2 is the optional case set: rugged screened box, front and rear panels, waterproofing gaskets, feet, sockets and hardware.

AA1 PARTS SET £12.80 + VAT

AA2 PARTS SET £4.80 + VAT

AA3 OPTIONAL MAINS POWER SUPPLY PARTS SET £6.80 + VAT.

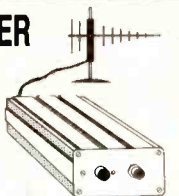

## POWERFUL AIR IONISER

FEATURED IN ETI  
JULY 1986

Ions have been described as 'vitamins of the air' by the health magazines, and have been credited with everything from curing hay fever and asthma to improving concentration and putting an end to insomnia. Although some of the claims may be exaggerated, there is no doubt that ionised air is much cleaner and purer, and seems much more invigorating than 'dead' air. The DIRECT ION ioniser caused a great deal of excitement when it appeared as a constructional project in ETI. At last, an ioniser that was comparable with (better than?) commercial products, was reliable, good to build... and fun! Apart from the serious applications, some of the suggested experiments were outrageous! We can supply a matched set of parts, fully approved by the designer, to build this unique project. The set includes a roller tinned printed circuit board, 66 components, case, mains lead, and even the parts for the tester. According to one customer, the set costs 'about a third of the price of the individual components. What more can we say?'

PARTS SET WITH BLACK CASE £12.60 + VAT

PARTS SET WITH WHITE CASE £12.80 + VAT



## BURGLAR BUSTER

Be safe from intruders with our Burglar Buster alarm system! It has all the features you'd expect from a high-tech alarm: entry and exit delay, anti-lamp loop, delay warning and control-box protection.

The parts set includes all four PCBs and all components to go on them. Other parts (case, switches, etc.) are available separately, if you haven't got anything suitable in your spare box. Set contains 4 PCBs, ICs, transistors, relays, capacitors, resistors, diodes, regulator, piezo sounder and full instructions.

BB1 PARTS SET £12.80 + VAT

## LEDs

Green rectangular LEDs for bar-graph displays  
50 for £3.50 500 for £25  
100 for £6 1000 for £45

DIGITAL AND AUDIO EQUIPMENT LEDs  
Assorted 3mm LEDs: red, green, yellow and orange.  
25 of each (100 LEDs) for £6.80

U.K. orders: please add 80p post and packing and 15% VAT to total.  
Ire and overseas: no VAT. Carriage and insurance £4.50.  
Please allow up to 14 days for delivery.

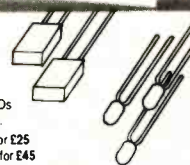

## BRAINWAVE MONITOR

The most astonishing project ever to have appeared in an electronics magazine. Similar in principle to a medical EEG machine, this project allows you to hear the characteristic rhythms of your own mind! The alpha, beta and theta forms can be selected for study and the three articles give masses of information on their interpretation and powers.

In conjunction with Dr. Lewis's Alpha Plan, the monitor can be used to overcome shyness, to help you feel confident in stressful situations, and to train yourself to excel at things you're 'no good at'.

Our approved parts set contains case, two PCBs, screening can for bio-amplifier, all components (including three PMI precision amplifiers), leads, brass electrodes and full instructions.

PARTS SET £39.80 + VAT ALPHA PLAN BOOK £2.50 SILVER SOLUTION (for pairing electrodes) £3.80 + VAT

Parts set available separately. We also have a range of accessories, professional electrodes, books, etc. Please send SAE for lists, or SAE + £2 for lists, circuit, construction details and further information (free with parts set).



FEATURED IN ETI  
AUGUST 1987

Specialist SEMICONDUCTORS LIMITED

Tel: (0600) 3715

SALES DEPT., ROOM 111, FOUNDERS HOUSE, REDBROOK, MONMOUTH, GWENT.

## BTEC ELECTRONICS TECHNICIAN FULL-TIME TRAINING

**2 YEAR**  
**BTEC National Diploma (OND)**  
**ELECTRONIC &  
COMMUNICATIONS ENGINEERING**  
(Electronics, Computing, Television, Video, Testing &  
Fault Diagnosis)

**1 YEAR**  
**BTEC National Certificate (ONC)**  
**ELECTRONIC ENGINEERING**  
1—INFORMATION TECHNOLOGY  
(Electronics, Satellite TV, Networks, Telecomms)

2—ELECTRONIC EQUIPMENT SERVICING  
(Electronics, Television, Video Cassette Recorders, CCTV,  
Testing and Fault Diagnosis)

3—SOFTWARE ENGINEERING  
(Electronics, Assembler, BASIC, Pascal, CAD/CAM)

4—COMPUTING TECHNOLOGY  
(Electronics, Computing Software/Hardware, Microelectronics)

**10 MONTHS**  
**BTEC Higher National Certificate (HNC)**  
**COMPUTING TECHNOLOGY & ROBOTICS**  
(Microprocessor Based Systems, Control, Robotics)

*These courses include a high percentage of college based  
practical work to enhance future employment prospects  
No additional fees for overseas students*

*Shortened courses of from 3 to 6 months can be arranged for  
applicants with previous electronics knowledge*

THOSE ELIGIBLE CAN APPLY FOR E.T. GRANT SUPPORT  
AN EQUAL OPPORTUNITIES PROGRAMME

**O.N.C. and H.N.C.**  
**Monday 18th September 1989**

FULL PROSPECTUS FROM

**LONDON ELECTRONICS COLLEGE**  
(Dept. EE), 20 PENYERN ROAD  
EARLS COURT, LONDON SW5 9SU  
Tel: 01-373 8721

## ADVERTISERS INDEX

B K ELECTRONICS	Cover (iii)
BULL, J. & N.	Cover (ii)
CHAFFORD VALLEY PRODUCTS	544
CIRKIT DISTRIBUTION	482
CRICKLEWOOD ELECTRONICS	500
CR SUPPLY CO.	541
C-SCOPE INTERNATIONAL	484
EVERETT WORKSHOP ACCESS	544
GREENWELD ELECTRONICS	511/514
HART ELECTRONIC KITS	485
ICS	544
I-TRON UK	533
JAYTEE ELEC. SERVICES	482
LONDON ELECTRONICS COLLEGE	544
MAGENTA ELECTRONICS	486
MAPLIN ELECTRONICS	Cover (iv)
MARCO TRADING	541
NATIONAL COMPONENT CLUB	541
NUMBER ONE SYSTEMS	485
OMNI ELECTRONICS	544
SHERWOOD ELECTRONIC COMPONENTS	533
SM ENGINEERING	484
SOFTMACHINE DISTRIBUTION	529
SPECIALIST SEMICONDUCTORS	543
SUMA DESIGN	484
TK ELECTRONICS	484

## A Fair Deal For Our Advertisers

*No guesses, no wishful  
thinking—the circulation of  
this magazine is audited to the  
strict professional standards  
administered by the Audit  
Bureau of Circulations*

**ABC**

The Hallmark of Audited Circulation

Marconi Pattern Generator and SLMS TF2802/2 combined Digital  
Pattern Generator and selective level measuring set. P.O.A.  
Philips PM5324 HF Generator 100kHz-110MHz. 120.00p  
Centronics type C036E 36 Way Data Interface Plug, complete  
with shielded metal cover and rubber cable gland. 3.25p  
Chairtronics Encapsulated Transformer 9421, 3.50p  
rated at 0.75mA 15V+0.75mA 15V PCB Mounting. 5.00p  
Spectrol HIL-05-B05 10 turn wirewound potentiometer. 6.25p  
5 way miniature DIP switch SPST PCB mounting. 50p  
5mm LEDs red or green standard. 12p  
Varta Mernpak Nic/Cad. rechargeable batteries 3.6V 100mA 1.85p  
MC6800P 8 bit microprocessor 1MHz 3.18p

## PRINTER CABLES

DM25-36CENM-6 IBM Printer Cable 6ft.	7.50p
DM25-DM25-6 RS232 Male to Male 6ft.	8.50p
DM25-DM25-6 Male to Female 6ft.	8.50p
Centronic-6 Cable Extender 6ft.	13.50p
25 Pin Modem Cable 9 Conductors — 6ft.	5.50p
25DM-8 Pin-6, Apple Cable Male 6 Conductor 6ft.	4.00p
Apple 6 Conductor 8 Pin Din — 6ft.	4.00p
RGB Monitor Cable — 6ft.	4.50p
Piezo Sounder round electronic buzzer PCB	51p
10 piece VHS Video/Audio Dubbing Kit.	5.95p
URM76 50R RF, Uniradio Cable.	.35p per mtr.

## TANTALUM BEADS

VALUE	VOLTS	PRICE	VALUE	VOLTS	PRICE
10µF	6.3	.11p	10µF	25	.16p
22µF	6.3	.15p	22µF	35	.09p
47µF	6.3	.24p	33µF	35	.09p
4.7µF	10	.14p	47µF	35	.09p
10µF	10	.16p	1µF	35	.09p
22µF	16	.09p	1µF	35	.09p
6.8µF	16	.14p	1.5µF	35	.10p
22µF	16	.25	2.2µF	35	.11p
47µF	16	.49	4.7µF	35	.14p
6.8µF	20	.19p	6.8µF	35	.19p
4.7µF	25	.14p	47µF	35	.69p

QUALITY SCREWDRIVER SET Manufactured in West Germany to  
Din Standards. Rated at 1000V consisting of Four Parallel Blade  
Drivers, Blade Sizes 75mm x 2.5mm, 100mm x 4mm,  
125mm x 5.5mm, 150mm x 6.5mm. Two Cross Point, Blade Sizes  
80mm x 5mm, 100mm x 6mm, One 70mm 240V Mains Screw-  
driver, £9.36, per set.  
LONG NOSE PLIERS 8"(200mm) 1000V VDE Approved £4.90, each  
SIDE CUTTERS 6 1/2"(160mm) 1000V VDE Approved £4.67, each  
WIRE STRIPPER 6 1/2"(160mm) 1000V VDE Approved £5.50, each  
ANTEX SK5 SOLDERING KIT consisting of a CS240 17 watt 240V  
Soldering Iron, an ST4 Solder Stand Approx 1mtr of Solder and a  
booklet on How To Solder £9.12, each

Substantial range of SILVA MICA/WAX POLYSTYRENE AND  
ELECTROLYTIC CAPACITORS in stock.  
Catalogue free with FIRST ORDER.

**CHAFFORD VALLEY PRODUCTS**  
Chafford Lane, Fordcombe, Kent TN3 0SH.

Tel. 089 274 287 Fax. 089 274 216.  
MAIL ORDER ONLY. ALL PRICES EXCLUDING VAT.  
ADD 1.00p P&P UNLESS OTHERWISE STATED.  
TERMS CASH, CHEQUE OR POSTAL ORDER WITH  
ORDER. SCHOOL ACCOUNTS AVAILABLE

## Need an extra pair of hands?

*It's often the case that conventional methods just won't  
do. Fortunately there is now an alternative with the*

### MULTI-PURPOSE JIG

It will hold a circuit board steady for assembly and wiring—  
It can hold things while glue sets—  
It can hold models for painting and repair—  
All its interchangeable heads rotate through 360 degrees so  
you can position your workpiece to best advantage—no need  
to take it out to turn it over either—just rotate it to where you  
want it.  
Precision spring loaded head for holding pressures of up to  
5.5lbs.

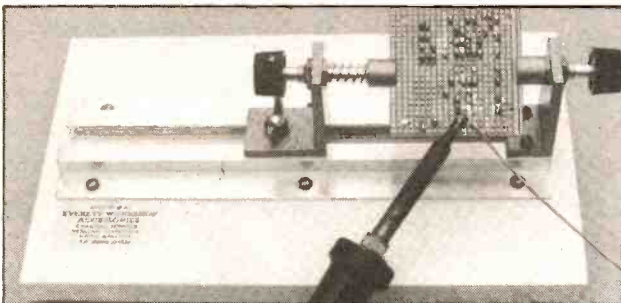

Each jig is hand built for a lifetime of use.  
Supplied with circuit board assembly head, 12.5mm rubber  
faced heads and static discharge lead.  
Other heads and accessories available.

Standard jig takes items up to 310 x 145mm **£19.50**  
Mini jig takes items up to 148 x 85mm **£16.50**  
inc. VAT and carriage

Local authority, school and college orders welcome

**EVERETT WORKSHOP ACCESSORIES**  
5 Railway Terrace, Henllan, Llandyssul,  
Dyfed SA44 5TH Tel: 0559 371226

## OMNI ELECTRONICS

174 Dalkeith Road, Edinburgh EH16 5DX • 031 667 2611



Have you sent for your copy of our  
catalogue yet?

If not, simply send 2 x 19p stamps  
for a copy by return.

A COMPREHENSIVE RANGE  
WITH SERVICE SECOND TO  
NONE

Open: Monday-Friday 9.00-6.00  
Saturday 9.00-5.00



## MAKE YOUR INTERESTS PAY!

More than 8 million students throughout the world have found it worth their  
while! An ICS home-study course can help you get a better job, make more  
money and have more fun out of life! ICS has over 90 years experience in  
home-study courses and is the largest correspondence school in the world.  
You learn at your own pace. When and where you want, under the guidance  
of expert 'personal' tutors. Find out how we can help YOU. Post or phone  
today for your **FREE INFORMATION PACK** on the course of your choice.

<b>GCSE / GCE / SCE</b> ELECTRONICS BASIC ELECTRONIC ENGINEERING (City & Guilds) ELECTRICAL ENGINEERING ELECTRICAL CONTRACTING/ INSTALLATION	<b>CAR MECHANICS</b> COMPUTER PROGRAMMING TV, VIDEO & HI-FI SERVICING RADIO AMATEUR LICENCE EXAM (City & Guilds)
Course of Interest	
Name: _____ P.Code _____	
Address: _____ International Correspondence School, Dept ECS89, 312/314 High Street, Sutton, Surrey SM1 1PR. Tel: 01-643 9568 or 041-221 2926 (24 hrs)	

# OMP POWER AMPLIFIER MODULES-TURNABLES-DIMMERS-LOUDSPEAKERS-19 INCH STEREO RACK AMPLIFIERS

**OMP POWER AMPLIFIER MODULES** Supplied ready built and tested.  
**OMP POWER AMPLIFIER MODULES** Now enjoy a world-wide reputation for quality, reliability and performance at a realistic price. Four models available to suit the needs of the professional and hobby market, i.e. Industry, Leisure, Instrumental and Hi-Fi etc. When comparing prices, NOTE all models include Toroidal power supply, Integral heat sink, Glass fibre P.C.B. and Drive circuits to power compatible Vu meter. Open and short circuit proof.

## THOUSANDS OF MODULES PURCHASED BY PROFESSIONAL USERS



**OMP100 Mk 11 Bi-Polar** Output power 110 watts R.M.S. into 4 ohms, Frequency Response 15Hz - 30KHz - 3dB, T.H.D. 0.01%, S.N.R. - 118dB, SENS. for Max. output 500mV at 10K, Size 355 x 115x65mm. PRICE £33.99 + £3.00 P&P.



**NEW SERIES II MOS-FET MODULES**  
**OMP/MF 100 Mos-Fet** Output power 110 watts R.M.S. into 4 ohms, Frequency Response 1Hz - 100KHz - 3dB, Damping Factor, >300, Slew Rate 45V/uS, T.H.D. Typical 0.002%, Input Sensitivity 500mV, S.N.R. - 125dB, Size 300 x 123 x 60mm. PRICE £39.99 + £3.00 P&P.



**OMP/MF200 Mos-Fet** Output power 200 watts R.M.S. into 4 ohms, Frequency Response 1Hz - 100KHz - 3dB, Damping Factor >300, Slew Rate 60V/uS, T.H.D. Typical 0.001%, Input Sensitivity 500mV, S.N.R. - 130dB, Size 300 x 155 x 100mm. PRICE £62.99 + £3.50 P&P.



**OMP/MF300 Mos-Fet** Output power 300 watts R.M.S. into 4 ohms, Frequency Response 1Hz - 100KHz - 3dB, Damping Factor >300, Slew Rate 60V/uS, T.H.D. Typical 0.0008%, Input Sensitivity 500mV, S.N.R. - 130dB, Size 330 x 175 x 100mm. PRICE £79.99 + £4.50 P&P.

NOTE:- MOS-FET MODULES ARE AVAILABLE IN TWO VERSIONS, STANDARD - INPUT SENS. 500mV BAND WIDTH 100KHz, PEC (PROFESSIONAL EQUIPMENT COMPATIBLE) - INPUT SENS. 775mV, BAND WIDTH 50KHz, ORDER STANDARD OR PEC



**Vu METER** Compatible with our four amplifiers detailed above. A very accurate visual display employing 11 L.E.D. diodes (7 green, 4 red) plus an additional on/off indicator. Sophisticated logic control circuits for very fast rise and decay times. Tough moulded plastic case, with tinted acrylic front. Size 84 x 27 x 45mm. PRICE £8.50 + 50p P&P.

## LOUDSPEAKERS



**LARGE SELECTION OF SPECIALIST LOUDSPEAKERS AVAILABLE, INCLUDING CABINET FITTINGS, SPEAKER GRILLES, CROSS-OVERS AND HIGH POWER, HIGH FREQUENCY BULLETS AND HORNS, LARGE S.A.E. (30P STAMPED) FOR COMPLETE LIST.**

### McKENZIE:- INSTRUMENTS, P.A., DISCO, ETC.

- ALL MCKENZIE UNITS 8 OHMS IMPEDENCE**
- 8" 100 WATT C8100GPM GEN. PURPOSE, LEAD GUITAR, EXCELLENT MID., DISCO. RES, FREQ. 80Hz FREQ. RESP. TO 14KHz SENS. 99dB. PRICE £28.59 + £2.00 P&P.
  - 10" 100 WATT C10100GP GUITAR, VOICE, ORGAN, KEYBOARD, DISCO, EXCELLENT MID RES, FREQ. 70Hz FREQ. RESP. TO 6KHz SENS. 100dB. PRICE £34.70 + £2.50 P&P.
  - 12" 200 WATT C10200GP GUITAR, KEYBOARD, DISCO, EXCELLENT HIGH POWER MID RES, FREQ. 45Hz FREQ. RESP. TO 7KHz SENS. 103dB. PRICE £47.48 + £2.50 P&P.
  - 12" 100 WATT C12100GP HIGH POWER GEN. PURPOSE, LEAD GUITAR, DISCO. RES, FREQ. 45Hz FREQ. RESP. TO 7KHz SENS. 99dB. PRICE £36.66 + £3.50 P&P.
  - 12" 100 WATT C12100TC TWIN CONE) HIGH POWER WIDE RESPONSE, P.A., VOICE, DISCO. RES, FREQ. 45Hz FREQ. RESP. TO 14KHz SENS. 100dB. PRICE £37.63 + £3.50 P&P.
  - 12" 200 WATT C12200B HIGH POWER BASS, KEYBOARDS, DISCO, P.A. RES, FREQ. 40Hz FREQ. RESP. TO 7KHz SENS. 100dB. PRICE £64.17 + £3.50 P&P.
  - 12" 300 WATT C12300GP HIGH POWER BASS LEAD GUITAR, KEYBOARDS, DISCO, ETC. RES, FREQ. 45Hz FREQ. RESP. TO 5KHz SENS. 100dB. PRICE £85.79 + £3.50 P&P.
  - 15" 100 WATT C15100BS BASS GUITAR, LOW FREQUENCY, P.A., DISCO. RES, FREQ. 40Hz FREQ. RESP. TO 5KHz SENS. 99dB. PRICE £53.70 + £4.00 P&P.
  - 15" 200 WATT C15200BS VERY HIGH POWER BASS. RES, FREQ. 40Hz FREQ. RESP. TO 4KHz SENS. 99dB. PRICE £73.26 + £4.00 P&P.
  - 15" 250 WATT C15250BS VERY HIGH POWER BASS. RES, FREQ. 40Hz FREQ. RESP. TO 4KHz SENS. 99dB. PRICE £80.53 + £4.50 P&P.
  - 15" 400 WATT C15400BS VERY HIGH POWER, LOW FREQUENCY BASS. RES, FREQ. 40Hz FREQ. RESP. TO 4KHz SENS. 102dB. PRICE £94.12 + £4.50 P&P.
  - 18" 400 WATT C18400BS EXTREMELY HIGH POWER, LOW FREQUENCY BASS. RES, FREQ. 27Hz FREQ. RESP. TO 3KHz SENS. 99dB. PRICE £167.85 + £5.00 P&P.

### EARBENDERS:- HI-FI, STUDIO, IN-CAR, ETC.

- ALL EARBENDER UNITS 8 OHMS EXCEPT EB8-50 AND EB10-50 DUAL 4 AND 8 OHM. BASS, SINGLE CONE, HIGH COMPLIANCE, ROLLED FOAM SURROUND**
- 8" 50 WATT EB8-50 DUAL IMPEDENCE, TAPPED 4/8 OHM BASS, HI-FI, IN-CAR. RES, FREQ. 40Hz FREQ. RESP. TO 7KHz SENS. 97dB. PRICE £8.90 + £2.00 P&P.
  - 10" 50 WATT EB10-50 DUAL IMPEDENCE, TAPPED 4/8 OHM BASS, HI-FI, IN-CAR. RES, FREQ. 40Hz FREQ. RESP. TO 1KHz SENS. 99dB. PRICE £12.00 + £2.50 P&P.
  - 10" 100 WATT EB10-100 BASS, HI-FI, STUDIO. RES, FREQ. 35Hz FREQ. RESP. TO 3KHz SENS. 96dB. PRICE £27.50 + £3.50 P&P.
  - 12" 60 WATT EB12-60 BASS, HI-FI, STUDIO. RES, FREQ. 28Hz FREQ. RESP. TO 3KHz SENS. 92dB. PRICE £21.00 + £3.00 P&P.
  - 12" 100 WATT EB12-100 BASS, STUDIO, HI-FI, EXCELLENT DISCO. RES, FREQ. 26Hz FREQ. RESP. TO 3KHz SENS. 93dB. PRICE £32.00 + £3.50 P&P.
- FULL RANGE TWIN CONE, HIGH COMPLIANCE, ROLLED SURROUND**
- 5 1/2" 60 WATT EB5-60TC (TWIN CONE) HI-FI, MULTI-ARRAY DISCO ETC. RES, FREQ. 63Hz FREQ. RESP. TO 20KHz SENS. 92dB. PRICE £9.99 + £1.50 P&P.
  - 6 1/2" 60 WATT EB6-60TC (TWIN CONE) HI-FI, MULTI-ARRAY DISCO ETC. RES, FREQ. 38Hz FREQ. RESP. TO 20KHz SENS. 94dB. PRICE £10.99 + £1.50 P&P.
  - 8" 60 WATT EB8-60TC (TWIN CONE) HI-FI, MULTI-ARRAY DISCO ETC. RES, FREQ. 40Hz FREQ. RESP. TO 18KHz SENS. 89dB. PRICE £12.99 + £1.50 P&P.
  - 10" 60 WATT EB10-60TC (TWIN CONE) HI-FI, MULTI-ARRAY DISCO ETC. RES, FREQ. 35Hz FREQ. RESP. TO 12KHz SENS. 86dB. PRICE £16.49 + £2.00 P&P.

## TRANSMITTER HOBBY KITS

**PROVEN TRANSMITTER DESIGNS INCLUDING GLASS FIBRE PRINTED CIRCUIT BOARD AND HIGH QUALITY COMPONENTS COMPLETE WITH CIRCUIT AND INSTRUCTIONS**

**3W FM TRANSMITTER 80-108MHz, VARICAP CONTROLLED PROFESSIONAL PERFORMANCE, RANGE UP TO 3 MILES, SIZE 38 x 123mm, SUPPLY 12V @ 0.5AMP, PRICE £14.49 + £1.00 P&P**

**FM MICRO TRANSMITTER (BUG) 100-108MHz VARICAP TUNED COMPLETE WITH VERY SENS FET MIC, RANGE 100-300m, SIZE 56 x 46mm, SUPPLY 9V BATT, PRICE £8.62 + £1.00 P&P**



3 watt FM Transmitter

\* PRICES INCLUDE V.A.T. \* PROMPT DELIVERIES \* FRIENDLY SERVICE \* LARGE S.A.E., 30p STAMPED FOR CURRENT LIST.

## OMP VARISPEED TURNTABLE CHASSIS



\* MANUAL ARM \* STEEL CHASSIS \* ELECTRONIC SPEED CONTROL 33 & 45 \* VARI PITCH CONTROL \* HIGH TORQUE SERVO DRIVEN DC MOTOR \* TRANSIT SCREWS \* 12 DIE CAST PLATTER \* NEON STROBE \* CALIBRATED BAL WEIGHT \* REMOVABLE HEAD SHELL \* CARTRIDGE FIXINGS \* CUE LEVER \* POWER 220 240V 50 60Hz \* 390x305mm \* SUPPLIED WITH MOUNTING CUT-OUT TEMPLATE. PRICE £59.99 + £3.50 P&P.

### OPTIONAL MAGNETIC CARTRIDGES

**STANTON AL500**  
PRICE £16.99 + 50p P&P

**GOLDRING G850**  
PRICE £6.99 + 50p P&P

## OMP MOS-FET POWER AMPLIFIERS, HIGH POWER, TWO CHANNEL 19 INCH RACK

## THOUSANDS PURCHASED BY PROFESSIONAL USERS

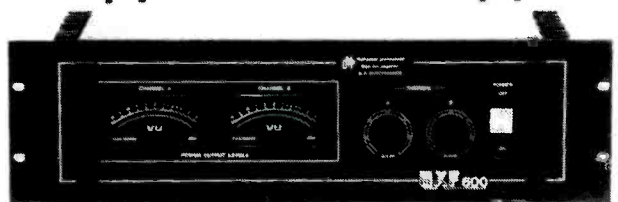

## NEW MXF SERIES OF POWER AMPLIFIERS THREE MODELS:- MXF200 (100w + 100w) MXF400 (200w + 200w) MXF600 (300w + 300w)

All power ratings R.M.S. into 4 ohms.

**FEATURES:** \* Independent power supplies with two Toroidal Transformers \* Twin L.E.D. Vu meters \* Rotary indented level controls \* Illuminated on/off switch \* XLR connectors \* Standard 775mV inputs \* Open and short circuit proof \* Latest Mos-Fets for stress free power delivery into virtually any load \* High slew rate \* Very low distortion \* Aluminium cases \* MXF600 Fan cooled with D.C. loudspeaker and thermal protection.

### USED THE WORLD OVER IN CLUBS, PUBS, CINEMAS, DISCOS ETC.

**SIZES:-** MXF 200 W19" x H3 1/2" (2U) x D11"  
MXF 400 W19" x H5 1/4" (3U) x D12"  
MXF 600 W19" x H5 1/4" (3U) x D13"

**PRICES:-** MXF200 £171.35  
MXF400 £228.85  
MXF600 £322.00

SECURICOR DELIVERY £12.00 EACH



## OMP LINNET LOUDSPEAKERS

THE VERY BEST IN QUALITY AND VALUE



MADE ESPECIALLY TO SUIT TODAY'S NEED FOR COMPACTNESS WITH HIGH OUTPUT SOUND LEVELS, FINISHED IN HARDWEARING BLACK VINYL WITH PROTECTIVE CORNERS, GRILLE AND CARRYING HANDLE, INCORPORATES 12" DRIVER PLUS HIGH FREQ HORN FOR FULL FREQ. RANGE: 45Hz-20KHz BOTH MODELS 8 OHM, SIZE H18" x W15" x D12".

CHOICE OF TWO MODELS

POWER RATINGS QUOTED IN WATTS RMS FOR EACH CABINET

OMP 12-100 (100W 100dB) PRICE £159.99 PER PAIR

OMP 12-200 (200W 102dB) PRICE £209.99 PER PAIR

SECURICOR DEL:- £12.00 PER PAIR

## OMP SLIDE DIMMER 1K WATT & 2.5K WATT

CONTROLS LOADS UP TO 1KW & 2.5KW, SUITABLE FOR RESISTIVE AND INDUCTIVE LOADS BLACK ANODISED CASE, READILY FLUSH MOUNTED THROUGH PANEL CABINET CUT-OUTS. ADVANCED FEATURES INCLUDE:-

- \* FULL 65mm SLIDE TRAVEL
- \* NEON MONITOR INDICATOR
- \* FLASH OVERRIDE BUTTON
- \* HIGH & LOW LEVEL PRESETS
- \* FULLY SUPPRESSED TO BS 800

**SIZES:-** 1KW H128xW40xD55mm  
2.5KW H128xW76xD79mm

**PRICES:-** 1K WATT £15.99  
2.5K WATT £24.99 + 60p P&P

## PIEZO ELECTRIC TWEETERS-MOTOROLA

### PIEZO ELECTRIC TWEETERS - MOTOROLA

Join the Piezo revolution. The low dynamic mass (no voice coil) of a Piezo tweeter produces an improved transient response with a lower distortion level than ordinary dynamic tweeters. As a crossover is not required these units can be added to existing speaker systems of up to 100 watts (more if 2 put in series). FREE EXPLANATORY LEAFLETS SUPPLIED WITH EACH TWEETER.

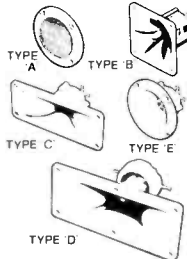

**TYPE 'A' (KSN2036A)** 3" round with protective wire mesh, ideal for bookshelf and medium sized Hi-fi speakers. Price £4.90 each + 50p P&P.

**TYPE 'B' (KSN1005a)** 3 1/2" super horn. For general purpose speakers, disco and P.A. systems etc. Price £5.00 each + 50p P&P.

**TYPE 'C' (KSN6016A)** 2" x 5" wide dispersion horn. For quality Hi-fi systems and quality discos etc. Price £6.99 each + 50p P&P.

**TYPE 'D' (KSN1025A)** 2" x 6" wide dispersion horn. Upper frequency response retained extending down to mid range (2KHz). Suitable for high quality Hi-fi systems and quality discos. Price £9.99 each + 50p P&P.

**TYPE 'E' (KSN1038A)** 3 3/4" horn tweeter with attractive silver finish trim. Suitable for Hi-fi monitor systems etc. Price £5.99 each + 50p P&P.

**LEVEL CONTROL** Combines on a recessed mounting plate, level control and cabinet input jack socket. 85x85mm. Price £3.99 + 50p P&P.

## STEREO DISCO MIXER

**STEREO DISCO MIXER** with 2 x 5 band L & R graphic equalisers and twin 10 segment L.E.D. Vu Meters. Many outstanding features 5 Inputs with individual faders providing a useful combination of the following:-  
 3 Turntables (Mag). 3 Mics. 4 Line including CD plus Mic with talk over switch Headphone Monitor. Pan Pot L & R. Master Output controls. Output 775mV. Size 360x280x90mm. Supply 220-240V.  
 Price £134.99 - £4.00 P&P

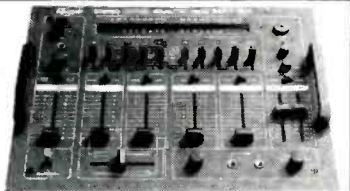

**B. K. ELECTRONICS** Dept EE  
 UNIT 5, COMET WAY, SOUTHEND-ON-SEA, ESSEX, SS2 6TR  
 TEL: 0702-527572 FAX: 0702-420243



POSTAL CHARGES PER ORDER £1.00 MINIMUM. OFFICIAL ORDERS WELCOME FROM SCHOOLS, COLLEGES, GOVT BODIES, ETC. PRICES INCLUSIVE OF V.A.T. SALES COUNTER. VISA ACCESS ACCEPTED BY POST, PHONE OR FAX.



# Superb Triple-Trace 20MHz Oscilloscope

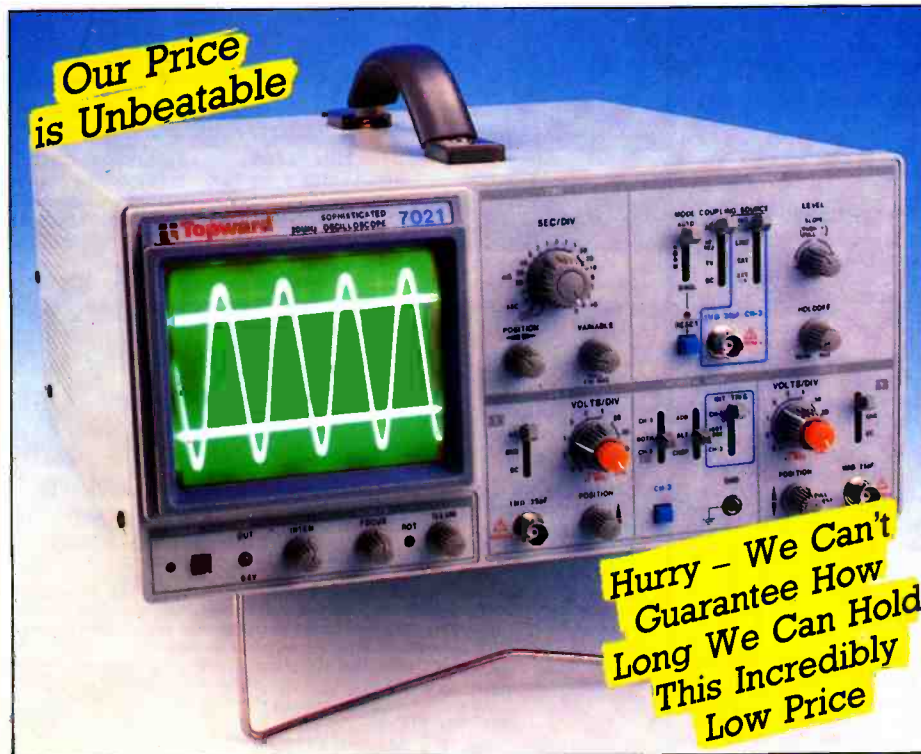

Precision laboratory oscilloscope. 3 Channels - 3 Trace. Sensitive vertical amplifier 1mV/div allows very low level signals to be easily observed. 150mm rectangular CRT has internal graticule to eliminate parallax error. X-Y mode allows Lissajous patterns to be produced and phase shift measured. TV sync separator allows measurement of video signals. 20ns/div sweep rate makes fast signals observable. Algebraic operation allows sum or difference of Channel 1 and 2 to be displayed. Stable triggering of both channels even with different frequencies is easy to achieve. 50mV/div output from Ch 1 available to drive external instrument e.g. frequency counter. A hold-off function permits triggering of complex signals and aperiodic pulse waveforms.

**ONLY**  
**£ 287<sup>49</sup>**  
 XJ61R

# 40MHz Triple-Trace Oscilloscope

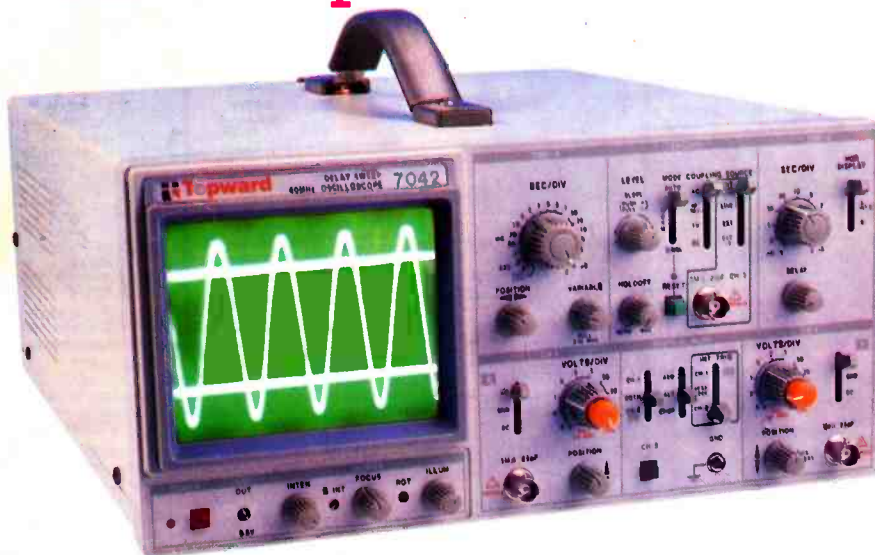

As above, but with 40MHz bandwidth and super bright 12kV tube even at the highest frequencies. This instrument also has a delayed sweep time base to provide magnified waveforms and accurate time interval measurement. Truly superb precision instrument.

Includes VAT & Carriage As Well!

**ONLY**  
**£ 499<sup>95</sup>**  
 XJ60Q

✂

Order Coupon		Send to P.O. Box 3, Rayleigh, SS6 8LR	
Qty.	Description	Code	Price
Add carriage			50p
Name .....			Total
Address .....			
Post Code .....			

I authorise you to debit my Credit Card account for the cost of goods despatched.

Card No.

Access, Amex, Visa ..... delete as required

If ordering by Credit Card please sign .....

Expiry date of Credit Card .....

EE

## Maplin ELECTRONICS

P.O. Box 3, RAYLEIGH, ESSEX SS6 8LR.



**PHONE BEFORE 5PM FOR SAME DAY DESPATCH**

**0702 554161**

ALL PRICES INCLUDE VAT.

All items subject to availability. Subject to availability both items will be on sale in our shops in Birmingham, Bristol, Leeds, London, Manchester, Nottingham, Southampton and Southend-on-Sea.

Known 29 Finance Place S/S