

EVERYDAY ELECTRONICS

MAY 1987

INCORPORATING ELECTRONICS MONTHLY

£1-20

EE EQUALISER - Ioniser Project

WINDSCREEN
WASHER WARNING

AUDIO LOGIC TRACER

EXPLORING ELECTRONICS...
SIMPLE TIMER



Special Feature... OP.AMP.LIMITS

The Magazine for Electronic & Computer Projects



£1 BAKERS DOZEN PACKS

Price per pack is £1.00.* Order 12 you may choose another free. Items marked (sh) are not new but guaranteed ok.

1. 5-13 amp ring main junction boxes
2. 5-13 amp ring main spur boxes
4. 5-surface mounting
5. 3-electrical switches, white flush mounting
7. 4-in flex line switches with neons
9. 2-mains transformers with 6V 1A secondaries
10. 2-mains transformers with 12V 1/2A secondaries
11. 1-extension speaker cabinet for 6 1/2" speaker
12. 1-glass reed switches
17. 2-ultrasonic transmitters receivers with circuit
19. 2-light dependent resistors
25. 4-wafer switches - 6p 2 way, 4p 3 way, 2p 5 way, 1p 12 way small one hold fixing and good length 1/2 spindle your choice
28. 1-6 digit counter mains voltage
30. 2-Nicad battery chargers
31. 1-key switch with key
33. 2-aerosol cans of ICI Dry Lubricant
34. 96-1 metre lengths colour-coded connecting wire
39. 1-long and medium wave tuner kit
41. 8-rocker switch 10 amp mains SPST
45. 1-24 hour time switch mains operated (s.h.)
49. 10-neon valves - make good night lights
50. 2-12V DC or 24V AC, 3 CO relays
51. 1-12V 2 CO miniature relay very sensitive
52. 1-12V 4 CO miniature relay
54. 10-rows of 32 gold plated IC sockets (total 320 sockets)
55. 1-locking mechanism with 2 keys
56. 1-miniature uniselector with circuit for electric jigsaw puzzle
60. 5-ferrite rods x 5/16" diameter aerials
61. 4-ferrite slab aerials with L & M wave coils
63. 1-Mullard thyristor trigger module
66. 1-magnetic brake - stops rotation instantly
67. 1-low pressure 3 level switch can be mouth operated
69. 2-25 watt pots 8 ohm
70. 2-25 watt pots 1000 ohm
71. 4-wire wound pots - 18, 33, 50 and 100 ohm your choice
77. 1-time reminder adjustable 1-60 mins clockwork
85. 1-mains shaded pole motor 3/4" stack - 1/2 shaft
89. 1-mains motor with gear box 1 rev per 24 hours
91. 2-mains motors with gear box 16 rpm
96. 1-thermostat for fridge
98. 1-motorsad stud switch (s.h.)
101. 1-2 1/2 hrs delay switch
103. 1-mains power supply unit - 6V DC
104. 1-mains power supply unit - 4 1/2V DC
107. 1-5" speaker size radio cabinet with handle
112. 1-heating pad 200 watts mains
114. 1-1W amplifier Mullard 1172
115. 1-wall mounting thermostat 24V
118. 1-teak effect extension 5" speaker cabinet
120. 2-p.c. boards with 2 amp full wave and 17 other recs
121. 4-push push switches for table lamps etc.
122. 10-mtrs twin screened flex white p.v.c. outer
124. 25-clear plastic lenses 1 1/2" diameter
127. 4-pilot bulb lamp metal clip on type
128. 10-very fine drills for pcb's etc.
129. 4-extra thin delay switches for instruments
132. 2-plastic boxes with windows, ideal for interrupted beam switch
134. 10-model aircraft motor - require no on/off switch, just spin to start
137. 1-6 1/2" x 4 ohm 10 watt speaker
142. 10-4 BA spanners 1 end open, other end closed
145. 2-4 reed relay kits 3V coil normally open or c/o if magnets added
146. 20-pilot bulbs 6.5V, 3A Philips
151. 4-12V drip proof relay - ideal for car jobs
155. 3-varicap push button tuners with knobs
169. 4-short wave air spaced trimmers 2-30f
172. 10-12V 6W bulbs Philips m.e.s.
178. 3-oblong amber indicators with lilliputs 12V
180. 6-round amber indicators with neons 240V
181. 100-p.v.c. brackets 3/4 hole size
182. 1-short wave tuning condenser 50 pf with 1/2" spindle
184. 1-three gang tuning condenser each section 500 pf with trimmers and good length 1/2" spindle
188. 1-plastic box sloping metal front, 16 x 95mm average depth 45mm
193. 6-5 amp 3 pin flush sockets brown
195. 5-B.C. lampholders brown bakelite threaded entry
196. 1-in flex summerstat for electric blanket soldering iron etc.
197. 2-thermostats, spindle setting - adjustable range for ovens etc.
199. 1-mains operated solenoid with plunger 1" travel
200. 1-10 digit switch pad for telephones etc.
201. 8-computer keyboard switches with knobs, pcb or vero mounting
206. 20-mtr 80 ohm, standard type co-ax off white
211. 1-electric clock mains driven always night time - not cased
212. 1-stereo pre-amp Mullard EP9001
236. 2-12V solenoids, small with plunger
237. 1-mains transformer 9V 1 amp secondary C core construction
241. 1-car door speaker (very flat) 6 1/2" 15 ohm made for Radiomobile
242. 2-speakers 6" x 4" 4 ohm 5 watt made for Radiomobile
243. 2-speakers 6" x 4" 16 ohm 5 watt made for Radiomobile
244. 1-mains motor with gear-box very small, toothed output 1 rpm
245. 4-standard size pots, 1/2 meg with dp switch
249. 1-13A switched socket on double plate with fused spur
266. 2-mains transformers 9V 1/2 A secondary
267. 1-mains transformers 15V 1A secondary p.c.b. mounting
291. 1-ten turns 3 watt pot 1/2 spindle 100 ohm
296. 3-car cigar lighter socket plugs
298. 2-15 amp round pin plugs brown bakelite
300. 1-mains solenoid with plunger compact type
301. 10-ceramic magnets Mullard 1" x 3/8 x 5/16
303. 1-12 pole 3 way ceramic wave charge switch
305. 1-tubular dynamic microphone with desk rest
308. 1-T.V. turret tuner (black & white T.V.)
310. 2-oven thermostats
313. 5-sub miniature micro switches
316. 1-round pin kettle plug with moulded on lead
453. 2-2 1/2 in. 80ohm loudspeakers
454. 2-2 1/2 in. 80ohm loudspeakers
463. 1-mains operated relay with 2 sets c/o contacts
464. 2-backets resin filler/sealer with cures
465. 3-5A round 3 pin plugs will fit item 193
466. 4-7 segment I.C. displays
470. 4-pc boards for stripping, lots of valuable parts
473. 1-5" 4ohm speaker with built in tweeter Radio mobil
480. 1-3A double pole magnetic trip, saves repairing fuses
498. 4-1000uf 25V axial electrolytic capacitors

FROZEN PIPES Can be avoided by winding our heating cable around them, 15 mtrs connected to mains cost only about 10p per week to run. Hundreds of other uses as it is waterproof and very flexible. Resistance 60ohms/metre. Price 28p/metre or 15m for £3.95.

CAR STARTER/CHARGER KIT

Flat Battery! Don't worry you will start your car in a few minutes with this unit - 250 watt transformer 20 amp rectifiers, case and all parts with data £17.50 post £2.



Ex-Electricity Board. Guaranteed 12 months.

SOUND TO LIGHT UNIT



Complete kit of parts of a three channel sound to light unit controlling over 2000 watts of lighting. Use this at home if you wish but it is plenty rugged enough for disco work. The unit is housed in an attractive two tone metal case and has controls for each channel, and a master on/off. The audio input and output are by 1/2" sockets and three panel mounting tube holders provide thyristor protection. A four pin plug and socket facilitate ease of connecting lamps. Special price is £14.95 in kit form.

12 volt MOTOR BY SMITHS

Made for use in cars, etc. these are very powerful and easily reversible. Size 3 1/2" long by 3" dia. They have a good length of 1/2" spindle - 1/10 hp £3.45, 1/8 hp £5.75, 1/6 hp £7.50

25A ELECTRICAL PROGRAMMER

Learn in your sleep. Have radio playing and kettle boiling as you wake - switch on lights to ward off intruders - have a warm house to come home to. You can do all these and more. By a famous maker with 25 amp on/off switch. A beautiful unit at £2.50

THIS MONTH'S SNIP

3" floppy disc drive unit plug in and with all electronics. Japanese made, brand new. We are told that this is a standard replacement in many Amstrad and other popular computers, and we supply with technical information. Special snip price £29.50 including post and VAT.

12V BATTERY OPERATED SIREN

(Or you can work this off a 24V transformer). Makes a shocking noise, will frighten away any intruder. Japanese made one 50p each, 2 for £1, ref. R0106. American, storage soiled but unused and guaranteed perfect, only 20p each, 5 for 21, ref. R0221.

WONDERFUL BREAKDOWN VALUE - HAND HELD STEREO UNIT

Contains two beautiful miniature moving coil loud speakers. These could also be used as microphones, also contains many other useful parts including mini stereo amp, transistors, condensers, rocker switches etc. etc. To use this as a personal amplifier simply add a cethoset, only £1, ref. R029.

SPIT MOTOR

Powerful mains operated induction motor with gearbox attached. Shaft has square hole which gives very easy coupling and quick release if required. Shaft speed 5rpm. Price £5, ref. SP54.

PUSH SWITCH REF 14DM

Double pole c/o switch, able to handle 10A at mains voltage. Mounts through an oblong hole like a rocker switch. Has its own push rod, so does not require a knob. Change over occurs when switch is depressed and returns to normal when pressure removed. 3 for £1, ref. R0489.

20V-0-20V 1A MAINS TRANSFORMER

Upright mounting. Primary thermal cutout to interrupt the supply if transformer overheats. Price £2, ref. 2P138.

4 BOOKS FOR £1

Book 1 describes the Mullard Uniflex amplifier and gives details of a suitable cabinet. Book 2 describes several useful pieces of test equipment which could be quite easily constructed. Book 3 is electronic projects. Book 4 describes short wave receivers which can be easily constructed and is intended for mainly beginners. Our ref. R0400.

TRANSFORMER IN WATERPROOF METAL CASE

24V 5A output. Ideal for garden lighting or to operate pond pump etc. Case has cable glands for mains in and low voltage output leads. Price £5 plus £1 post, ref. 5P88.

MAINS RELAY

With transparent plastic cover. Could be pcb or clip mounted, has single 8-10A c/o contact. Real bargain 2 for £1, ref. R0486.

PANEL METERS

Engraved vtu, approximately 1 1/2" square. Luminates these from behind and you will have a really super looking panel. Real bargain 2 for £1, ref. R0366.

TRANSMITTER TUNING CONDENSOR

160pf mount for a very famous RAF transmitter, only £1 each. Unused but mounting brackets will need a bit of cleaning up due to storage. Our ref. R0424.

MAGNETIC READ/WRITE UNIT

A read/write head mounted on a thumb operated lever is made to traverse magnetisable paper. The paper is held between top and bottom rollers which can be spun for localisation of the written message - new and unused only £1 each, R0381.

IONISER KIT

Refresh your home, office, shop, work room, etc. with a negative ION generator. Makes you feel better and work harder - a complete mains operated kit, case included. £9.50 plus £2.00 post.

TELEPHONE BITS

Master socket (has surge arrester - ringing condenser etc) and takes B.T. plug.....	£3.95
Extension socket.....	£2.95
Dual adaptors (2 from one socket).....	£3.95
Cord terminating with B.T. plug 3 metres.....	£2.95
Kit for converting old entry terminal box to new B.T. master socket, complete with 4 core cable, cable clips and 2 BT extension sockets.....	£11.50
100 mtrs 4 core telephone cable.....	£8.50

J & N BULL ELECTRICAL
Dept. E.E., 250 PORTLAND ROAD, HOVE, BRIGHTON, SUSSEX BN3 5QT

MAIL ORDER TERMS: Cash, P.O. or cheque with order. Orders under £20 add £1 service charge. Monthly account orders accepted from schools and public companies. Access & B/card orders accepted. Brighton 0273 734648. Bulk orders: write for quote.

£2 POUNDERS*

- 2P2 - Wall mounting thermostat, high precision with mercury switch and thermometer
- 2P3 - Variable and reversible 8-12v psu for model control
- 2P4 - 24 volt psu with separate channels for stereo made for Mullard UNILEX
- 2P6 - 100W mains to 115V auto-transformer with voltage tapping
- 2P8 - Mains motor with gear box and variable speed selector. Series wound so suitable for further speed control
- 2P9 - Time and set switch. Boxed, glass fronted and with knobs. Controls up to 15 amps. Ideal to program electric heaters
- 2P10 - 12 volt 5 amp mains transformer
- 2P12 - Disk or Tape precision motor - has balanced rotor and is reversible 230V mains operated 1500 rpm
- 2P14 - Mug Stop kit - when thrown emits piercing squawk
- 2P15 - Interrupted Beam kit for burglar alarms, counters, etc.
- 2P17 - 2 rev. min. mains driven motor, ideal to operate mirror ball
- 2P18 - Liquid/gas shut off valve mains solenoid operated
- 2P19 - Disc switch-motor drives 6 or more 10 amp change over micro switches supplied ready for mains operation
- 2P20 - 20 metres extension lead, 2 core - ideal most Black and Decker garden tools etc.
- 2P21 - 10 watt amplifier, Mullard module reference 1173
- 2P22 - Motor driven switch 20 secs on or off after push
- 2P26 - Counter resettable mains operated 3 digit
- 2P27 - Goodmans Speaker 6 inch round Bohm 12 watt
- 2P28 - Drill Pump - always useful couples to any make portable drill
- 2P31 - 4 metres 98 way interconnecting wire easy to strip
- 2P32 - Hot Wire amp meter - 4 1/2" round surface mounting 0-10A - old but working and definitely a bit of history
- 2P34 - Solenoid Air Valve mains operated
- 2P38 - 200 R.P.M. Geared Mains Motor 1" stack quite powerful, definitely large enough to drive a rotating aerial or a tumbler for polishing stones etc.
- 2P43 - 3 mini turbine blower or extractor fan, motor inset so very compact, 230V
- 2P46 - Our famous drill control kit complete and with prepared case.
- 2P49 - Fire Alarm break glass switch in heavy cast case
- 2P51 - Stereo amplifier, 3w per channel
- 2P55 - Mains motor, extra powerful has 1 1/2" stack and good length of spindle
- 2P62 - 1 pair Goodmans 15 ohm speakers for Uniflex
- 2P64 - 1 five bladed fan 6 1/2" with mains motor
- 2P66 - 1 2kw tangential heater 115v easily convertible for 230V
- 2P67 - 1 12v-0-12v 2 amp mains transformer
- 2P68 - 1 15v-0-15v 2 amp mains transformer
- 2P69 - 1 250v-0-250v 60 mA & 86.3v 5A mains transformer + 50p post
- 2P70 - 1 E.M.I. tape motor two speed and reversible
- 2P72 - 1 115v Muffin fan 4" x 4" approx. (s.h.)
- 2P75 - 1 2 hour timer, plugs into 13A socket
- 2P82 - 9v-0-9v 2 amp mains transformer
- 2P84 - Modem board with press keys for telephone redialer
- 2P85 - 20v-0-20v 1A Mains transformer
- 2P88 - Sangamo 24 hr time switch 20 amp (s.h.)
- 2P89 - 120 min. time switch with knob
- 2P90 - 90 min. time switch with edgewise engraved controller
- 2P94 - Telephone handset for EE home telephone circuit
- 2P95 - 13A socket on satin chrome plate
- 2P97 - mains transformer 24V 2A upright mounting
- 2P98 - 20m 4 core telephone cable, white outer
- 2P99 - 500 hardened pin type staples for telephone cable
- 2P101 - 15v mains transformer 4A upright mounting
- 2P105 - capillary tube thermostat for air temperature with c/o switch
- 2P108 - mains motor with gear box giving 110rpm
- 2P109 - 5" wide black adhesive pvc tape 33m, add £1 post if not collecting

OVER 400 GIFTS YOU CAN CHOOSE FROM

There is a total of over 400 packs in our Baker's dozen range and you become entitled to a free gift with each dozen orders you spend on these packs.

A classified list of these packs and our latest "News Letter" will be enclosed with your goods, and you will automatically receive our next news letter.

£5 POUNDERS*

- 5P1 - 12 volt submersible pump complete with a tap and switch, an ideal caravan unit.
- 5P2 - Sound to light kit complete in case suitable for up to 750 watts.
- 5P6 - 12V alarm bell with heavy 6" gong, suitable for outside if protected from direct rainfall. Ex GPO but in perfect order.
- 5P12 - Equipment cooling fan - mini snail type mains operated.
- 5P13 - Ping pong ball blower - or for any job that requires a powerful stream of air - ex computer. Collect or add £2 post.
- 5P15 - Uniselector 4 pole, 25 way 50 volt coil
- 5P18 - motor driven water pump as fitted to many washing machines
- 5P20 - 2 kits, matchbox size, surveillance transmitter and FM receiver
- 5P23 - miniature (appr. 2 1/2" wide) tangential blow heater, 1-2kw
- 5P24 - 1/2 hp motor, ex computer, 230V, mains operation 1450rpm. If not collect add £3 post
- 5P25 - special effects lighting switch. Up to 6 channels of lamps can be on or off for varying time periods
- 5P27 - cartridge player 12V, has high quality stereo amplifier
- 5P34 - 24V 5A toroidal mains transformer
- 5P35 - modem board from telephone auto dialler, complete with keypad and all ICs
- 5P37 - 24 hour time switch, 2 on/off and clockwork reserve, ex Elec. Board loading up to 50A. Add £1 post
- 5P41 - 5" extractor fan, very quiet runner (s.h.), gntd 12 mths
- 5P48 - telephone extension bell in black case, ex-GPO
- 5P52 - mains transformer 26V 10A upright mounting, add £2 post
- 5P54 - mains motor with gear box, final speed 5rpm
- 5P58 - Amstrad stereo tuner FM and LM. AM
- 5P60 - DC Muffin type fan 18 to 27V, only 3W
- 5P61 - drill pump mounted on frame, coupled to mains motor
- 5P62 - 2 1/2 kw tangential blow heater, add £1.50 post if not collecting
- 5P73 - high pressure mains operated gas or water valve with tube connection suitable soldering
- 5P74 - 6rpm 60W mains motor and gearbox with instant stop
- 5P79 - 30rpm 80 watt mains driven motor with gearbox
- 5P82 - 1 25rpm mains 60W motor with gearbox
- 5P84 - 1 delay time switch, adjust 0-20 seconds
- 5P89 - 1 light box size 14" x 12" for circuit tracing pcb's. Add £3 for postage and packing
- 5P72 - 1 turntable for vdu or scope
- 5P81 - 1 stepper motor bi-directional, 7.5" steps 12-14V coil
- 5P86 - 1 mains transformer with 2 x 100V 1A secondaries. Add £1.50 post
- 5P88 - 1 24V 5A mains transformer in waterproof case, ideal for garden lighting, pond pump etc.

LIGHT CHASER KIT motor driven switch bank with connection diagram, used in connection with 4 sets of xmas lights makes a very eye catching display for home, shop or disco, only £5 ref 5P56.

EVERYDAY ELECTRONICS

INCORPORATING ELECTRONICS MONTHLY

VOL 16 No.5

MAY '87

The Magazine for Electronic & Computer Projects

ISSN 0262-3617

PROJECTS ... THEORY ... NEWS ...
COMMENT ... POPULAR FEATURES ...

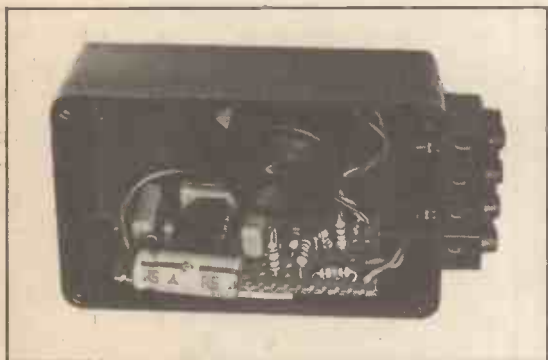
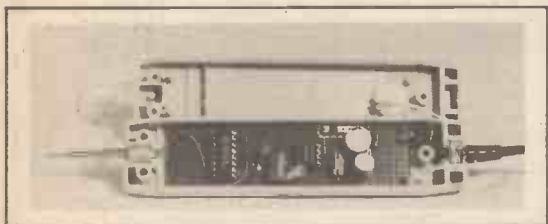

Projects

- EE EQUALISER** by Andy Flind 240
Create a better environment with this low cost ioniser
- WINDSCREEN WASHER WARNING** 244
by T. R. de Vaux-Balbirnie
No more smeared screens
- SPECTRUM SOUND SYNTHESISER** by Mike Tooley BA 246
Add some exciting sound effects and music to your programs
- AUDIO LOGIC TRACER** by Mike Tooley BA 262
Listen-in to the internal workings of microprocessor-based systems
- SIMPLE TIMER** 268
Uses a 555 timer chip to give delays from 1 to 5 minutes plus.
—An "Exploring Electronics" project
- EE APEX AMPLIFIER—3** by Graham Nalty 272
50W per channel top quality hi fi amplifier—Power Amplifier
- FRIDGE ALARM** by T. R. de Vaux-Balbirnie 278
Self-contained alarm that monitors the temperature inside your fridge

Series

- ON SPEC** by Mike Tooley BA 246
Readers' Sinclair Spectrum page
- AMATEUR RADIO** by Tony Smith G4FA 1 250
RRD Report; Call the Doctor
- DIGITAL TROUBLESHOOTING** by Mike Tooley BA 258
Part Seven: We examine the I/O requirements of microprocessor system
- ACTUALLY DOING IT** by R. A. Penfold 266
Understanding the colour coding of components—The Resistor
- EXPLORING ELECTRONICS** by Owen Bishop 268
Part Eleven: More timer circuits
- BBC MICRO** by R. A. & J. W. Penfold 270
Regular spot for Beeb fanatics

Features

- EDITORIAL** 239
- OP AMP LIMITS** by David J. Silvester 252
Don't ask too much of your op-amp
- SHOPTALK** by David Barrington 255
Product news and component buying
- FOR YOUR ENTERTAINMENT** by Barry Fox 256
On Cue; Business Sense
- NEWS** 264
What's happening in the world of electronics
- NEW PRODUCTS** 271
Facts and photos of instruments and tools
- BOOK SERVICE** 280
Our own service for readers of EE
- DOWN TO EARTH** by George Hylton 282
Diode resistance; Rectifier circuits
- MARKET PLACE** 283
Free readers buy and sell spot
- PRINTED CIRCUIT BOARD SERVICE** 284
- ADVERTISERS INDEX** 288

SPECIAL OFFERS

- Magenta Servo Motor Kit** 249
- Black Star Digital Multimeters** 257

© Wimborne Publishing Ltd 1987. Copyright in all drawings, photographs and articles published in EVERYDAY ELECTRONICS is fully protected, and reproduction or imitations in whole or in part are expressly forbidden.

Our June 1987 issue will be published on Friday, 15 May 1987. See page 277 for details.

Readers' Services • Editorial and Advertisement Departments 239

OUR NEW CATALOGUE NOW AVAILABLE !!

WIDE RANGE OF COMPONENTS LISTED.
MANY NEW LINES ADDED TO OUR RANGE.
SEND £1 NOW FOR YOUR COPY. £2.50 OVERSEAS.
(FREE TO SCHOOLS AND COLLEGES.)

**Electrical and Electronic Components for the
Electronics Industry and the D.I.Y. Enthusiast.**

<p>ANTEX SOLDERING</p> <p>25W XS IRON £6.00 18W CS IRON £5.90 15W C IRON £5.70 S4 STAND £2.20 SPARE BITS £1.20 ELEMENTS FROM £3.20 DIGITAL TEMPERATURE CONTROLLED STATION TCSV-D £72.50</p> <p>LIMITED OFFER WHILE STOCKS LAST!! MICRO COMPUTER DATA RECORDER BRAND NEW FULLY GUARANTEED NORMALLY £27.95 OUR PRICE ONLY £9.99</p>	<p>NI-CADS AA 95p (10+ 85p each) C £2.14 (10+ £1.98 each) D £2.30 (10+ £2.10 each) PP3 £3.75 (10+ £3.65 each)</p> <p>NI-CAD BATTERY CHARGER THIS BATTERY CHARGER IS SUITABLE FOR AAA, AA, C, D & PP3 TYPE NI-CAD CHARGING £4.50</p> <p>SERVISOL SUPA FREEZE-IT £1.40 SWITCH CLEANER £1.24 FOAM CLEANER £1.22</p>	<p>12V RECHARGEABLE UNIT 10 x D SIZE NI-CADS (4 Ah) ENCAPSULATED IN A BLACK PLASTIC CASE. FUSE HOLDER, GIVES 12V OUTPUT CHARGED.</p> <p>EX-EQUIPMENT £5.99 + £1.85 P&P + 15% VAT 245 x 75 x 75mm</p> <p>FULLY GUARANTEED</p> <p>B.T. APPROVED MASTER SOCKET 2/4 £2.85 SECONDARY 2/6 £1.95 BT LINE JACK CORD £1.25 ADAPTOR 10/3A— £2.95 BELL TONE RINGER £7.50</p>
--	--	---



NEW! MAY SPECIAL OFFER
DRAPER RECHARGEABLE CORDLESS SOLDERING IRON LENGTH: 210MM
COMPLETE WITH RECHARGING STAND, 13A - 240V MAINS ADAPTOR, WORKPIECE ILLUMINATION, PROTECTION CAP, 2 X 1.2V RECHARGEABLE BATTERIES.
£15.99 + 75p P&P + 15% VAT

MARCO TRADING,
Dept. EE5, The Maltings,
High Street, WEM,
Shrewsbury, SY4 5EN.

ALL ORDERS ARE PLUS 75p P & P PLUS 15% V.A.T.
TEL: (0939) 32763
TELEX: 35565

AFFORDABLE ACCURACY

Quality Multimeters from

Cirkit

A comprehensive range of Analogue and (Pushbutton or Rotary Switched) Digital Models

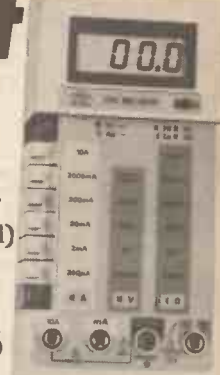
HC-7030

ANALOGUE

HM-102BZ — Illustrated above. 20kΩ/V DC. DC voltage range, 2.5-1000V; AC volts 10-1000V; resistance, 10kΩ-1MΩ; DC current, 5-500mA + 10A; battery test and continuity buzzer£12.50
HM-1015 — Rugged, Pocket sized meter, for general purpose use£7.50
16 measuring ranges

Battery, Test Leads and Manual included with each model.

Please add 15% for VAT and 70p for p&p

DIGITAL

HC-7030 0-1% Accuracy. Standard Model£39.50
HC-6010 0-25% Accuracy. Standard Model£33.50
HC-6010T 0-25% Accuracy. TR Test Facility£39.50
DM-105 0-5% Accuracy. Pocketable£21.50

All models have full functions and ranges and feature: 3½ digit 0-5" LCD display — low battery indication — auto zero & auto polarity — ABS plastic casing — DC AC 10amp range (not DM-105) — Overhead protection on all ranges — battery, spare fuse, test leads and manual.

Full details and specification from:

Cirkit Distribution Ltd

Park Lane, Broxbourne, Herts, EN10 7NQ
Telephone (0992) 444111 Telex 22478
TRADE ENQUIRIES WELCOME

C.P.L. ELECTRONICS

EVERYDAY ELECTRONICS KITS		COMPONENTS	
Modern Tone Decoder	Nov. '86 £15.90	TRANSISTORS	LINEAR
Car Flashing Warning	Nov. '86 £6.85	BC107	.14 CA3046 .60 4080 .16
Optically Isolated Switch	Nov. '86 £8.00	BC108	.14 CA3140E .42 4001 .16
Freezer Failure Alarm	Sept. '86 £9.65	BC109	.14 CL7860 2.50 4007 .16
Micro Mini Tuner (Excluding PCB)	Aug. '86 £17.00	BC109C	.16 LF351 .46 4011 .16
Battery Tester	Aug. '86 £6.00	BC183	.11 LF353 .82 4013 .24
Caravan Battery Monitor	July '86 £14.70	BC184L	.11 LF441 1.26 4016 .20
Vox Box Amp.	July '86 £10.50	BC187	.11 LM324 .50 4017 .36
Headphone Mixer	July '86 £21.50	BC206	.23 LM358 .42 4021 .38
Watchdog	June '86 £6.65	BC212	.11 LM380 .90 4023 .16
Personal Radio	June '86 £11.40	BC214	.11 LM384 1.72 4024 .30
Percussion Synthesiser (Excl. PCB)	June '86 £13.75	BC547	.11 LM386 .92 4026 .88
Versatile PSU	Apr. '86 £16.95	BC548	.11 LM566 1.28 4027 .22
Stereo Reverb	Apr. '86 £20.20	BC557	.11 LM741 .20 4040 .38
Mains Tester & Fuse Finder (Excl. PCB)	Mar. '86 £5.30	BC558	.11 LM747 .64 4046 .43
Interval Timer	Mar. '86 £13.90	BD131	.45 LM748 .40 4060 .45
Stereo Hi-Fi Preamp	Mar. '86 £37.65	BD132	.47 LM1458 .40 4068 .16
Touch Controller	Feb. '86 £10.70	BD140	.34 L200 1.58 4075 .16
Mains Delay Switch	Jan. '86 £15.95	BF224	.38 MC1458 .42 4077 .28
One Chip Alarm	Jan. '86 £6.50	BF241	.31 MF10CN 3.60 4078 .22
Dport	Jan. '86 £8.65	BF244	.64 NE555 .22 4093 .22
Caravan Alarm (Excl. Horn)	Sept. '85 £13.30	BF256	.43 NE568 .62 4503 .46
Fridge Alarm	Sept. '85 £5.55	BF494	.40 NE568 1.28 4512 .48
Tremolo/Vibrato	Aug. '85 £27.50	BF961	.77 SG640 4.80 4555 .35
Drill Control Unit (Excl. Case)	Aug. '85 £16.35	BFY50	.26 SO42P 2.30 40105 1.45
Low cost PSU	Aug. '85 £12.45	BFY51	.26 SL1621 6.10 REGULATORS 42
Train Signal Controller	July '85 £9.20	BFY90	.88 SL1640 5.10 7805 42
Continuity Tester	July '85 £7.40	BU208A	1.20 SL560CDP/8 2.20 7812 42
Electronic Doorbell	June '85 £5.65	J309	.74 SG640 4.80 7815 42
Caravan PSU	June '85 £8.95	J310	.74 SP8229 3.00 7824 42
Across The River	June '85 £11.80	MPF102	.52 TL071 .46 7805 29
High Z Multimeter (Excl. Case)	June '85 £26.90	VN10KM	.80 TL072 .65 7812 29
Graphic Equaliser	June '85 £22.00	VN10LM	.76 TL081 .66 7815 29
		TX3300	.20 TL082 .62 78124 29
		2N3702	.14 TL084 1.00 DM1377 1.05
		2N3704	.14 XR2206 4.80
		2N3819	.40 XR2211 3.46
		2N3866	1.42 SBL1 8 Pin .06
		2N3904	.14 MIXER 6.55 18 Pin .09
		2N3906	.14 BRIDGES 18 Pin .10
		1N914	.04 W005 .22 20 Pin .11
		1N4001	.05 SKB2/02LSA 7.20 24 Pin .13
		1N4002	.06 THYRISTORS 28 Pin .14
		1N4005	.08 C106D .45 ZENERS 8 Pin .08
		1N4007	.08 BT151/500R .96 BZ768 Series .07
		1N4148	.025 BT151/850R .96 BZ6X3 Series .13
		0A47	.14 TRIACS POTS 42
		0A30	.09 TRIACS POTS 42
		0A91	.10 C2050 .56 Presets .09
			RESISTOR KITS 1/2W 5%, 84 Values, 5 per Value = 420 Resistors 3.90
			Article Reprints—50p (if required).
			POSTAGE 70p EXCEPT WHERE INDICATED *≠£1.50
			†=£2. PRICES EXCLUDE VAT WHICH SHOULD BE ADDED TO THE TOTAL ORDER INCL. P&P VALUE. ALL KITS COMPLETE (LESS BATTERIES) UNLESS SPECIFIED INCLUDING ALL COMPONENTS, PCB OR VERD, CASE AND HARDWARE. COMPONENTS NEW/FULL SPEC. CHEQUE OR P.O. TO—

C.P.L. ELECTRONICS
8 Southdean Close, Hemlington, Middlesbrough,
Cleveland TS8 9HE. Tel: 0642 691157
FREE PRICE LIST ON REQUEST

A Great Reverb Amp for £75!



Shown — 45W Reverb Amp with Master Volume

Instrumentalists — are you looking for a great professional sound from your guitar or keyboard? Delta Physics' range of built and tested boards give you a convincingly valve-like sound at the lowest possible cost. Our custom-built chassis, control panels, and other accessories help you to produce a robust, reliable and good-looking unit for stage and studio use. Compact units can be made with up to 100 watts of power for any electric instrument. They are simple to wire and assemble with full instructions.

Our products include:

P.66 Reverb Preamp (spring and controls included)	£27.50
P.36 Power Amp — 45W into 4 ohms — fully protected	£14.75
P.45 Power Supply for up to 45W	£13.45
P.47 Power Supply for up to 100W	£18.50
P.48 Power Supply for preamps only	£9.50
C.34 Bridge Driver — use with 2 x P.36 for 100W system	£4.50

A full range of chassis, control-panels and accessories is also available. Details and prices are given in our brochure.

Please add £1.80 postage, packing & insurance and 15% VAT to each order.

For FREE brochure, phone or write to:

DELTA PHYSICS

52 Codrington Hill, London SE23 1ND
Tel: 01-690 1512

RUSH ME A BROCHURE, PLEASE!

Name.....
Address.....

INSTALL YOUR OWN SYSTEM AND SAVE

SECURITY

MODULES ACCESSORIES KITS

NEW

"PASSIVE INFRARED INTRUDER DETECTOR RP33"



- 12 metre detection range.
- Size only 80 x 60 x 40mm.
- 24 Detection zones.
- Wide 85° coverage.
- Switchable LED indicator.

This advanced new intrusion detector operates by detecting the body heat of an intruder moving within the detection field. The use of a dual element pyroelectric sensor means that changes in ambient temperatures are ignored, thus providing a stable and reliable performance. Easily installed in a room or hallway, the unit will provide effective detection of any intrusion. Operating from a 12V supply and consuming only 15mA, it is ideal for use with the CA 1382, CA 1250 or any equivalent high quality control unit. Supplied with full instructions, its performance compares with detectors costing more than twice the price.

ONLY
£23.95 + V.A.T.

CA 1382 An advanced control unit with automatic loop testing.



- Fully automatic siren re-set.
- Audible entry/exit warning.
- Alarm Sounded memory.
- 2 separate loop inputs + 24hr circuits.
- Built-in electronic siren.
- Easily installed, full instructions supplied.

This latest control panel provides effective and reliable control for all types of security installations. Its advanced circuitry checks the loop circuits every time it is switched on, preventing incorrect operation. Using a simple 'on/off' key switch, it is easily operated by all members of the family. In addition it provides 24 hr. personal attack protection. Housed in a steel case, it is supplied with full operating instructions.

Only **£44.95 + VAT**
Available in kit form with fully-built electronics, **£39.95 + V.A.T.**

Digital Ultrasonic Detector US 5063 only £13.95 + VAT

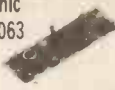

- 3 levels of discrimination against false alarms.
- Crystal control for greater stability.
- Adjustable range up to 25ft.
- Built in delays.
- 12V operation.

This advanced module uses digital signal processing to provide the highest level of sensitivity whilst discriminating against potential false alarm conditions.

Individual Enclosure SC 5063 only £2.95 + VAT

Suitable metal enclosure for housing the ultrasonic module type US 5063. Supplied with the necessary mounting pillars and screws etc.

Control Unit CA 1250 Price £19.95 + VAT



This tried and tested control unit represents the finest value for money in control systems, providing the following features:

- Built-in electronic siren drives 2 loud speakers.
- Provides exit and entrance delays together with fixed alarm time.
- Battery back-up with trickle charge facility.
- Operates with magnetic switches, pressure pads, ultrasonic or I.R. units.
- Anti-tamper and panic facility.
- Stabilised output voltage.
- 2 operating modes full alarm anti-tamper and panic facility.
- Screw connections for ease of installation.
- Separate relay contacts for external loads.
- Test loop facility.

500W Quartz Halogen Floodlight FL 500



only **£14.95 + VAT**

Whilst intended for security lighting applications, this unit is suitable for lighting patios, pathways and gardens etc. Supplied complete with 500W lamp, priced only £14.95 + VAT. Protective grill, £1.95 + VAT.

Lighting Controller DP 3570 only £13.95 + VAT



This versatile module provides timed switching of loads up to 3A for pre-set times between 10 secs and 5 mins, the timed period being triggered by the opening or closing of an external loop or switch. The built in 12V 250mA power supply is available for operating external sensors. Priced only £13.95 + VAT. Suitable plastic enclosure £2.85 + VAT.

HW 1250 - Enclosure & fixings for CA 1250



only **£9.50 + VAT**
This attractive case is designed to house the control unit CA 1250, together with the appropriate LED indicators and key switch. Supplied with the necessary mounting pillars and punched front panel, the unit is given a professional appearance by an adhesive silk screened label. Size 200 x 180 x 700mm.

Infra-red System IR 1470



only **£25.61 + VAT**

Consisting of separate transmitter and receiver both of which are housed in attractive moulded cases, the system provides an invisible modulated beam over distances of up to 50ft operating a relay when the beam is broken. Intended for use in security systems, but also ideal for photographic and measurement applications. Size 80 x 50 x 35mm.

SAMPLE OF OUR WIDE RANGE OF ACCESSORIES

- AL 243 - Automatic Light Switches 3A at 240V - £4.30.
- VS 39 - Vibration Contact - £2.30.
- IS 128 - Miniature 12V Siren provides 100db output - £6.95.
- SL 187 - Siren Module - £2.95.
- MS 588 - 5 1/2" Horn Speaker for use with control unit, siren module etc - £6.25.

The above prices are plus V.A.T.

Complete systems from only **£39.95 + VAT**

For full information of systems and accessories send or call for details

RISCOMP LIMITED

Dept. EE75,
51 Poppy Road,
Princes Risborough,
Bucks HP17 9DB.
Tel: (084 44) 6326



Order by 'phone or mail or call at our showroom and see

UNITS ON DEMONSTRATION

Monday to Friday 9.00 - 5.00 p.m.
Saturday 9.00 - 1.00 p.m.

Please add 15% VAT and 75p P&P to all UK orders
Export no VAT - postage at cost

The Archer Z80 SBC

The SDS ARCHER - The Z80 based single board computer chosen by professionals and OEM users.

- ★ Top quality board with 4 parallel and 2 serial ports, counter-timers, power-fail interrupt, watchdog timer, EPROM & battery backed RAM.
 - ★ **OPTIONS:** on board power supply, smart case, ROMable BASIC, Debug Monitor, wide range of I/O & memory extension cards.
- from £185 + VAT.

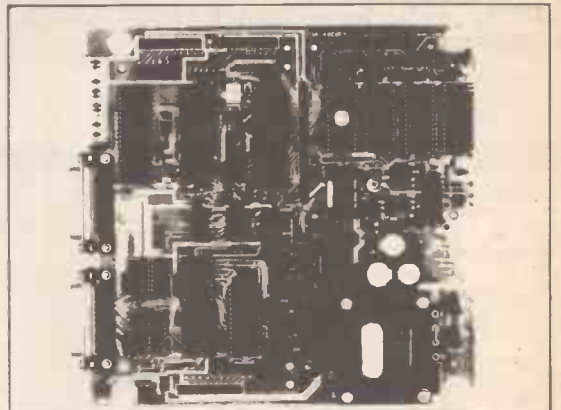

The Bowman 68000 SBC

The SDS BOWMAN - The 68000 based single board computer for advanced high speed applications.

- ★ Extended double Eurocard with 2 parallel & 2 serial ports, battery backed CMOS RAM, EPROM, 2 counter-timers, watchdog timer, powerfail interrupt, & an optional zero wait state half megabyte D-RAM.
 - ★ Extended width versions with on board power supply and case.
- from £295 + VAT.

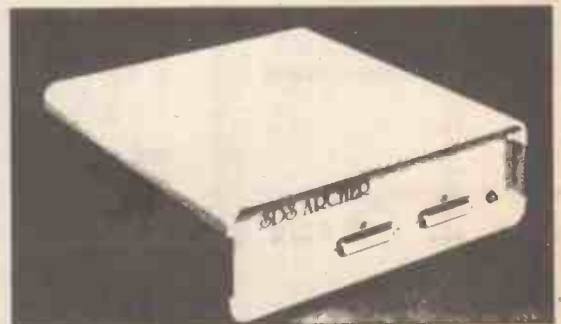

Sherwood Data Systems Ltd

Sherwood House, The Avenue, Farnham Common, Slough SL2 3JX. Tel. 02814-5067

sinclair

MICROVISION

We have a large quantity of the PCB from this innovative flat screen TV. They are, however, incomplete with the main chip, tuner and vol control missing. This means of course they won't cost a lot. By the time this ad appears we'll have more information, so ring or write for details.

RECENT ADDITIONS

Full details on Bargain List 27/28

CB MICROPHONE. Hand held with push to talk switch. Output lead. 600R Dynamic £2.95

CIRCUIT TESTER. DC continuity tester. Needs 2 x AA cells. 90cm long lead has croc clip 50p

MINI DRILL. Precision geared plastic. Brass chuck takes up to 1.2mm bit. Storage in handle. 115mm long £1.69

TELEPHONE. Non-BT approved single piece. Push button with auto redial. Ivory. Wall bracket. 4m lead (half is coiled) £5.99

CRAFT KNIVES. Miniature type has 12 snap off sections. 9mm wide blade is fully retractable and can be locked in position. Supplied with spare blade. 125mm long. 50p

Heavy duty version of above—18mm wide blade, 7 sections, 150mm long. 95p

LOGIC PROBE. For TTL, CMOS etc. LED and sound indication. Pulse enlargement capability allows pulse direction down to 25nsec. Max f = 20MHz 4-16V. I/P 2:1M £9.99

STEREO TUNER. Z497 AM/FM STEREO TUNER PANEL. Complete radio chassis with push button selection for LW/MW/FM and ON/OFF. Ferrite rod for LW & MW selection, co-ax socket for FM aerial. Supplied with mains transformer and rectifier/smoothing cap, and wiring details. PCB is 333 x 90mm £12.95

POWER SUPPLIES

Z993 65 Watt switch mode multi-output power supply. Astec Model AA12790. Offered at around one-third normal price, this has to be the Bargain of the Year!! Compact unit 195x105x50mm accepting 115/230V ac input. Outputs:

- +5V @ 3A
- +12V @ 2.9A
- +18V @ 1.0A
- 5V @ 0.2A

£29.95

Z488 Switched mode PSU by Euro-power model EP3008/MMS. Eurocard size 160 x 100mm. 230V Input, 5V at 3A and 12V at 1/2 A output. Excellent value. £19.95

Z482 Siliconix mains input, 4.5V DC 150mA output to 3.5mm jack plug on 2m lead. Built-in continental 2-pin plug. Size 62 x 46 x 35. £1.50

INVERTERS & CVT'S

50V DC in, 240V AC 50Hz out. 1kVA, 2kVA & 4kVA from £150

24V DC in, 240V AC 50Hz sine wave out. 600VA. In transit case £240

CVT's: 192-264V in, 240V 1% out 2kVA, 4kVA, 5kVA, 6kVA from £160 Carr. extra. Details on request.

COMPONENT PACKS

Greenweld are No. 1 in component packs—No. 1 for value and No. 1 for variety! We sell thousands of packs containing millions of components every year! They all offer incredible value for money—order some now and see how much you save over buying individual parts!

Full details in catalogue.

GREENWELD

ELECTRONIC COMPONENTS

All prices include VAT; just add 60p P&P Min Access order £5. Official orders from schools etc. welcome—min invoice charge £10. Our shop has enormous stock of components and is open 9-5.30 Mon-Sat. Come and see us!

443D Millbrook Road, Southampton, SO1 0HX. Tel. (0703) 772501/783740

1987 CATALOGUE OUT NOW

BIGGER & BETTER THAN EVER.

—80pp packed with components & equipment. Bargain List, order forms & £1.50 discount vouchers all included for just £1 inc. post.

+ FREE! KIT-CAT

24 page illustrated catalogue with over 100 kits from simple amplifiers to complex EPROM programmers—also computer interface kits enabling many popular computers to be linked with the outside world. PLUS kits utilizing breadboards for beginners.

PANELS

Z469 AL30A amp. Panel 90 x 64mm. 10W RMS O/P with 30V supply. Popular audio amp module—these are ex-equip but believed to be working. £2.50

Z475 TRIAC PANEL—240 x 165mm. 14 triacs 2N6346, TXAL116B or sim. 200V 6-8A; 16 SCR's C106A1 4A 30V; 6 x 4099 in skts; 15 suppressors; 37 ZTX450; min 12V relay; R's, C's plugs, etc. Only £4.50

FLASH UNIT

Z488 complete apart from case. Xenon tube, neon indicator, on/off switch, trigger wires. Requires 3V supply. 50 x 55 x 30mm. Brand new, with data.

Z483 NI-CAD Panel 177 x 144mm PCB with one massive Varta Deac 57 x 50mm Ø rated 7.2V 1000mA and another smaller Deac 32 x 35mm Ø rated 3.6V 600mA. The price of these Ni-cad stacks new is over £20. Also on the panel is a mains input charger transformer with two separate secondaries wired via bridge rectifiers, smoothing capacitors and a relay to the output tags. The panel weighs 1kgm. All this for just £6.00

COMPUTER BOOKS

C64, VIC20, BBC, MSX, Spectrum, Dragon, etc. Originally up to £9.95 each. All now £1 each. Full details in catalogue.

KEYBOARDS

TATUNG VT1400 Video Terminal Keyboard. Brand new case unit 445 x 225 x 65/25mm 71 Alpha-numeric and function keys, + separate 14 key numeric keypad. ASCII output via curly cord and 6 way plug. Data and connection sheet supplied. Now only £17.50

CAMPUS LYNX keyboard 58 full travel keys. Size 334 x 112mm. Brand new. Reduced to £5.95

SOLDER

500g reels resin cored. 18g £5.95
500g reels resin cored 22g £7.95

'NEUBRAIN' PANELS

Z494 Motherboard microprocessor panel 265 x 155mm. Complete PCB for computer, Z80, char EPROM, etc. 68 chips altogether + other associated components, plugs, skts, etc. £5.50

Z495 RAM panel. PCB 230 x 78mm with 14 x MMS290-2 (4116) (2 missing) giving 28k of memory. Also 8 LS chips. These panels have not been soldered, so chips can easily be removed if required. £5.00

'NEUBRAIN' PSU Z467

BRAND NEW Stabilized Supply in heavy duty ABS case with rubber feet. Input 220/240V ac to heavy duty transformer via suppressor filter. Regulated DC outputs: 6.5V @ 1.2A; 13.5V @ 0.3A; -12V @ 0.05A. All components readily accessible for mods etc. Chunky heatsink has 2 x TIP31A. Mains lead (fitted with 2 pin continental plug) is 2m long. 4 core output lead 1.5m long fitted with 6 pole skt on 0.1" pitch. Overall size 165 x 75 x 72 mm. £5.95 ea 10 for £40

For KITS & COMPONENTS - Choose the easy way - with *refundable with first order

Send 50p* & SAE for CATALOGUE

ORDERS: RING (01) 567 8910 - 24 HRS.

NEW POWER STROBE KIT

Designed to produce a high intensity light pulse at a variable frequency of 1 to 15Hz this kit also includes circuitry to trigger the light from an external voltage source (eg. a loudspeaker) via an opto isolator. Instructions are also supplied on modifying the unit for manual triggering, as a slave flash in photographic applications or as a warning beacon in security applications. The kit includes a high quality pcb, components, connectors, 5W's strobe tube and full assembly instructions. Supply: 240V ac. Size: 80 x 50 x 45. **£12.50**

REMOTE CONTROL SWITCH KIT

Comprises a compact 9V (PP3) powered single channel un-coded infra-red transmitter and a mains powered receiver, this kit is ideal for switching table lamps, radios, etc. on and off remotely. Range 20ft. Max. load 500W (240V a.c. only). Size—Transmitter: 7 x 5 x 3cm (including box). Receiver: 7 x 3.5 x 3cm. **£4.95**
MK6 TRANSMITTER £4.95
MK7 RECEIVER £11.50

PASSIVE INFRA-RED DETECTORS

The INVADER is a Passive Infra Red Detector with 12 metre range and 110 angle of detection and a memory. Its 9-16V operation and attractive styling make it easy to install and use with virtually any control panel in a domestic alarm system. Size: 105 x 65 x 50mm. **£33.00**

950 136

AUTOLITE—replaces a standard wall switch and saves energy by switching lights when movement is detected within its 4m range. Includes a dimmer and daylight sensor. 250W max. **£34.50**

ELECTRONIC SIREN KIT

Produces an extremely loud piercing swept frequency tone from a 9-15V supply. Enable input for easy connection to alarm circuits. Includes 5in. Horn Speaker. **£8.65**

Mini Siren
As above, but with a small speaker (instead of horn speaker) for internal use. Complete with box. **£4.70**

PROPORTIONAL TEMPERATURE CONTROLLER KIT

Uses "burst fire" technique to maintain temperature to within 0.5°C. Ideal for photography, incubators wine-making, etc. Max. load 3kW (240V a.c.). Temp. range up to 90°C. Size: 7 x 4 x 2.5cms. **£7.10**

NEW HIGH SECURITY LOCK KIT

Designed for use with our lock mechanism (701 150) this kit will operate from a 9V to 15V supply drawing a standby current of only 50µA. There are over 5000 possible 4-digit combinations and the sequence can be easily changed. To make things even more difficult for an unauthorised user an alarm can be sounded after 3 to 9 incorrect entries—selectable by means of a link. The alarm can sound for a few seconds to over 3 minutes during which time the keyboard is disabled preventing further entries. A latched or momentary output is available making the unit ideal for door locks, burglar alarms, car immobilisers, etc. A membrane keyboard or pushbutton switches may be used and a beep sounds when a key is depressed. Kit includes high quality PCB, all components, connectors, high power piezo buzzer and full assembly and user instructions. **£16.50**

XK121 LOCK KIT £15.95
350 118 Set of Keyboard Switches £4.00
701 150 Electric Lock Mechanism 12 volt £16.50

TEN EXCITING PROJECTS FOR BEGINNERS

This Kit has been specially designed for the beginner and contains a SOLDERLESS BREADBOARD, COMPONENTS, and a BOOKLET with instructions to enable the absolute novice to build TEN fascinating projects including a light operated switch, intercom, burglar alarm, and electronic lock. Each project includes a circuit diagram, description of operation and an easy to follow layout diagram. A section on component identification and function is included, enabling the beginner to build the circuits with confidence. **£13.75**

XK102-3-NOTE DOOR CHIME

Based on the SAB0600 1C the kit is supplied with all components, including loudspeaker, printed circuit board, a pre-drilled box (95 x 71 x 35mm) and full instructions. Requires only a PP3 9V battery and push-switch to complete. **£6.00**

HOME LIGHTING KITS

These kits contain all necessary components and full instructions & are designed to replace a standard wall switch and control up to 300W of lighting.

TDR300K Remote Control Dimmer Transmitter for above £16.45
MK6 Touchdimmer £4.95
TD300K Touchswitch £8.50
TS300K Extension kit for 2-way switching for TD300K £2.70
LD 300K Light Dimmer £4.35

TH ELECTRONICS 13 BOSTON RD LONDON W7 3SJ Tel: 01-567 8910

SEND 9"x6" S.A.E. & 50p FOR CATALOGUE OR CALL AT SHOP MON-FRI 9-5pm SATURDAY 10-4pm

ORDERING INFORMATION: ALL PRICES EXCLUDE VAT

FREE P&P on orders over £20 (UK only), otherwise add 75p + VAT. Overseas P&P: Europe £2.75. Elsewhere £6.50. Send cheque/PO/Barclaycard/Access No. with order. Giro No. 529314002.

LOCAL AUTHORITY AND EXPORT ORDERS WELCOME GOODS BY RETURN SUBJECT TO AVAILABILITY



EVERYDAY ELECTRONICS

INCORPORATING ELECTRONICS MONTHLY

The Magazine for Electronic & Computer Projects

VOL 16 N°5

MAY '87

Editorial Offices
EVERYDAY ELECTRONICS EDITORIAL,
6 CHURCH STREET, WIMBORNE,
DORSET BH21 1JH
Phone: Wimborne (0202) 881749

See notes on **Readers' Enquiries** below—we regret that lengthy technical enquiries cannot be answered over the telephone

Advertisement Offices
EVERYDAY ELECTRONICS ADVERTISEMENTS
4 NEASDEN AVE., CLACTON-ON-SEA, ESSEX
CO16 7HG. Clacton (0255) 436471

HAVE YOU GOT A JOB YET?

FOR many people the problem of finding a job when leaving school is now a very real one. Ten or twenty years ago you knew that there would be something to do when you finished studying but nowadays things are different. Of course electronics is one of the career areas that has excellent potential and plenty of jobs available at nearly all levels. Our electronics and associated industries are crying out for qualified engineers and look as though they will be for some time.

All this should mean plenty of school leavers aiming themselves at this potential area of employment. However, in many places this is not the case and I feel that the problem lies in the schools themselves—or more accurately, in teacher training. This magazine used to run a school scheme subscription service but it has now been discontinued through lack of interest from the schools.

In some cases subscriptions going to teachers are not renewed and at least one teacher has told us this is due to lack of pupil interest. Of course many schools do still subscribe and report on how useful the magazine is to both teachers and students. This is perhaps the crux of the matter; the teachers need the Teach In courses as much as the pupils! Most schools have no-one who has been trained to teach electronics and the maths or science teacher gets roped in.

How can we try to stimulate students when we have no-one who can teach them? Electronics has been around in its present popular (semiconductor) form for about 20 years and only recently have our educational authorities woken up to it.

EXCELLENT WORK

To be fair, a great deal of excellent work is now being done and we sell many magazines to colleges, ITECs and various other training or retraining establishments. Indeed, our circulation is steadily increasing and EE is the most popular hobby electronics magazine in the UK. But it seems to me that we still have a long way to go with teaching the under 16s. I would like to hear from teachers, students and anyone else interested in this area. Let us know what you feel on this subject. You might all write and say I'm wrong; I hope you do, I would be delighted to put the record straight if I am.

EE is aiming to publish a very important series for students this autumn, a series that will lead to real benefits for those wishing to find a career in electronics. We would like more people to be able to move into this rewarding area of employment. Let's hear your views on what can be done or what is being done in this important field.

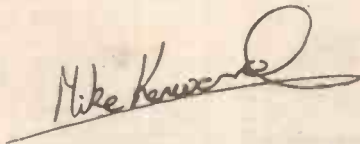

BACK ISSUES & BINDERS

Certain back issues of EVERYDAY ELECTRONICS and ELECTRONICS MONTHLY are available price £1.50 (£2.00 overseas surface mail) inclusive of postage and packing per copy. Enquiries with remittance, made payable to Everyday Electronics, should be sent to Post Sales Department, Everyday Electronics, 6 Church Street, Wimborne, Dorset BH21 1JH. In the event of non-availability remittances will be returned. *Please allow 28 days for delivery. (We have sold out of Oct. and Nov. 85, April and May 86.)*

Binders to hold one volume (12 issues) are available from the above address for £4.95 (£9.00 overseas surface mail) inclusive of p&p. *Please allow 28 days for delivery.*

Payment in £ sterling only please.

Editor MIKE KENWARD

Personal Assistant
PAULINE MITCHELL

Assistant Editor/Production
DAVID BARRINGTON

Assistant Editor/Projects
DAVID BRUNSKILL

Editorial: WIMBORNE (0202) 881749

Advertisement Manager
PETER J. MEW Clacton (0255) 436471

Classified Advertisements
Wimborne (0202) 881749

READERS' ENQUIRIES

We are unable to offer any advice on the use, purchase, repair or modification of commercial equipment or the incorporation or modification of designs published in the magazine. We regret that we cannot provide data or answer queries on articles or projects that are more than five years old. Letters requiring a personal reply must be accompanied by a **stamped self-addressed envelope** or a **self-addressed envelope and international reply coupons**.

All reasonable precautions are taken to ensure that the advice and data given to readers is reliable. We cannot, however, guarantee it and we cannot accept legal responsibility for it.

COMPONENT SUPPLIES

We do not supply electronic components or kits for building the projects featured, these can be supplied by advertisers.

OLD PROJECTS

We advise readers to check that all parts are still available before commencing any project in a back-dated issue.

We regret that **we cannot provide data or answer queries on projects that are more than five years old.**

ADVERTISEMENTS

Although the proprietors and staff of EVERYDAY ELECTRONICS take reasonable precautions to protect the interests of readers by ensuring as far as practicable that advertisements are *bona fide*, the magazine and its Publishers cannot give any undertakings in respect of statements or claims made by advertisers, whether these advertisements are printed as part of the magazine, or are in the form of inserts.

The Publishers regret that under no circumstances will the magazine accept liability for non-receipt of goods ordered, or for late delivery, or for faults in manufacture. Legal remedies are available in respect of some of these circumstances, and readers who have complaints should address them to the advertiser or should consult a local trading standards office, or a Citizen's Advice Bureau, or a solicitor.

SUBSCRIPTIONS

Annual subscription for delivery direct to any address in the UK: £14.00. Overseas: £17.00 (£33 airmail). Cheques or bank drafts (**in £ sterling only**) payable to Everyday Electronics and sent to EE Subscription Dept., 6 Church Street, Wimborne, Dorset BH21 1JH. **Subscriptions can only start with the next available issue.** For back numbers see the note on the left.



E.E. EQUALISER

ANDY FLIND



You can have a fresh start if you call in the Equaliser

An ioniser is a device for injecting a stream of negative ions into the surrounding air. The reason for doing so is based on the discovery that rural areas, where the air is supposedly "Fresh", have far higher concentrations of natural negative ions in the air than urban places; ergo, if the ion levels in our living rooms are artificially increased, we should become healthier, or at least feel better! There is still much debate regarding this, but commercially produced ionisers are now freely available and many users swear by them.

The author's personal experience is that ionised air does indeed seem "fresher", odours are reduced to some extent, and a room with an ioniser is generally a more pleasant place to inhabit. Whilst prices of commercial models remain at their present level however, home construction makes good sense.

Readers of long standing may recall an earlier design by the present author. This

was produced at a time when there was still some mystique surrounding the subject and incorporated one or two features that have since proved unnecessary, resulting in extra expense and complexity.

A negative ion is simply an atom to which an extra electron has been added, giving it a net negative charge. To produce them in air all that is necessary is a high negative voltage, in excess of 4kV, applied to some sharp points.

Once ionised, the air will be repelled from the points (since like charges repel, remember those pith balls from the school lab?) so an actual "wind" of negative ions will be created. The aim of this design is to raise the

disadvantages. These are greater complexity for a start, then low efficiency, since the 1N4007 diodes normally used have very poor recovery characteristics above a couple of kHz. Finally, such circuits tend to generate lots of nasty r.f. harmonics, rather difficult to keep from the house wiring if they're mains operated.

A multiplier circuit run directly from the 240V 50Hz mains has much to recommend it, so long as some basic safety precautions are properly observed. Cheap, simple and noise free, it also has greatly improved reliability, an important consideration in an item intended to be operated continuously for literally years.

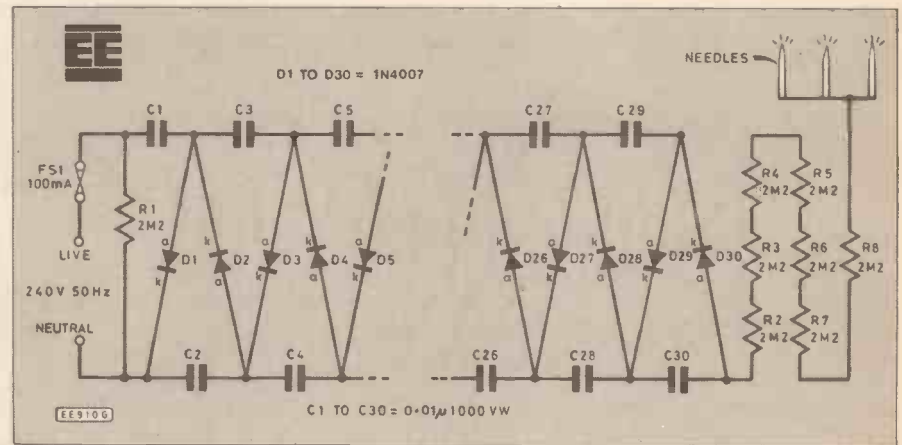

Fig. 1. Complete circuit diagram for the EE Equaliser air ioniser.

COMPONENTS

Resistors

R1 to R8 2M2 high voltage resistor (3500V d.c.) (8 off)

Capacitors

C1 to C30 0.01µF 1000V d.c. disc ceramic (30 off)

Semiconductors

D1 to D30 1N4007 (30 off)

Miscellaneous

ABS Box 150 x 80 x 50mm, 20mm fuseholder and 100mA quickblow fuse, pins (3 off), 5A twin mains lead and plug, printed circuit board available from the EE PCB Service, order code EE566.

It is essential that the correct working voltage resistors and capacitors are used.

Approx. cost Guidance only **£12.50**

required voltage as simply and cheaply as possible.

DESIGN

A number of ioniser designs have been published in recent years using various methods of raising the voltage, though all of them end with a circuit known as the "Cockroft-Walton Multiplier", a ladder-like string of diodes and capacitors used for pumping the output voltage up to the final level required. Commercially made units usually start with a transformer to raise the mains voltage to 1kV or so, then continue with around five multiplier stages built with 5kV rated components. This is impractical for home constructors since both the transformer and the 5kV rated parts would be difficult to obtain.

Another approach employs a 12V power supply feeding an oscillator running at several kHz. This in turn drives a ferrite-cored transformer followed by the multiplier. The claimed benefit is that the higher frequency permits the use of smaller capacitors, but unless battery operation is required this is heavily outweighed by the

CIRCUIT

The basis of the EE Equaliser circuit, Fig. 1, is a thirty-stage multiplier, using 1000V diodes and 1000V disc ceramic capacitors. A 100mA fuse is provided in the supply, as a safety precaution against the unlikely event of catastrophic failure of several chain components. R1 has little effect during normal operation, but when the unit is disconnected it ensures the discharge of any stored voltage that might cause a shock to be received from the plug. In theory the multiplier produces over 20kV, but its regulation is fairly poor and the impedance so high that even the tiny ionising current drawn from it pulls the output down to around 5kV; ideal for ion generation.

Safety is a major consideration with a circuit of this type, of course, and this is ensured by the chain of resistors between the output and the ion emitters. These are special high-voltage rated types; on no account should they be omitted or replaced by a single resistor of a higher value, which may not have an adequate voltage rating. The "ion emitters" are ordinary needlework pins positioned so that they project just above the surface of the unit's case.

CLEANLINESS

Constructors should ensure both their hands and the board are clean before starting to build the board, as losses through natural skin oils, etc. on the surface can significantly reduce the ion output.

Note that the edge of the board is undercut where the emitters are positioned; if this hasn't been provided it can be done with a small file. The edge should be smoothed here too, with some fine emery paper.

CONSTRUCTION

Construction could hardly be simpler, though the compact layout calls for careful use of a soldering iron with a small tip. The component layout and p.c.b. master pattern is shown in Fig. 2 and Fig. 3. This board is available from the EE PCB Service: code EE566.

Since all the resistors, capacitors and diodes are of the same type it would be difficult to get it wrong! The diodes are

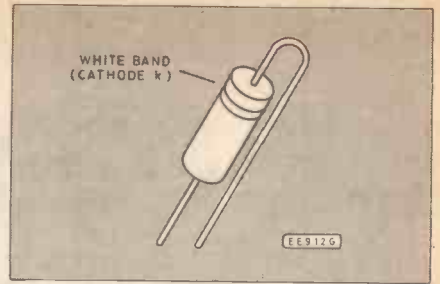

Fig. 4. Preforming the diodes, cathode (band) at top of the bend, prior to inserting on the board.

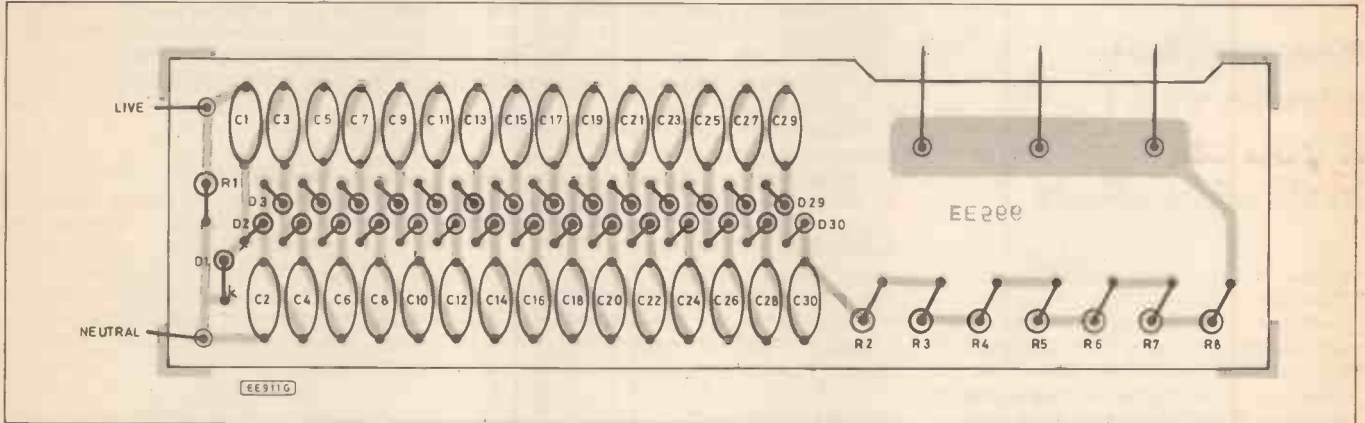

Fig. 2. Printed circuit board component layout.

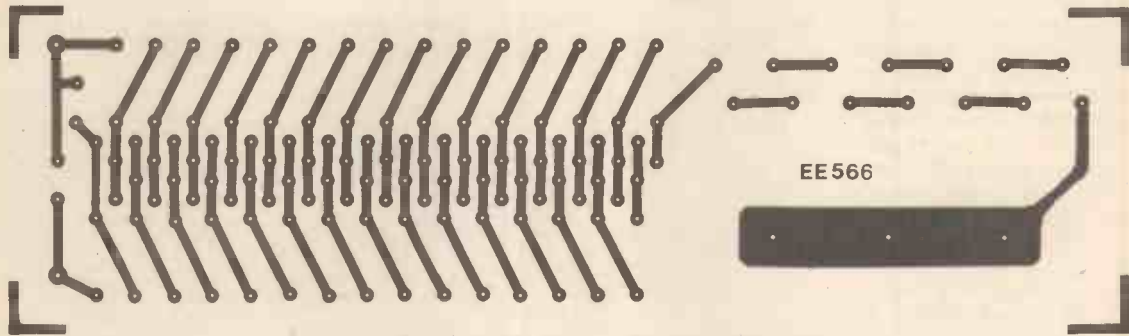

Fig. 3. Full size printed circuit board master pattern. This board is available from the EE PCB Service: code EE566.



The finished board showing the preformed diodes.



The completed unit showing the tips of the "ion" emitter pins.

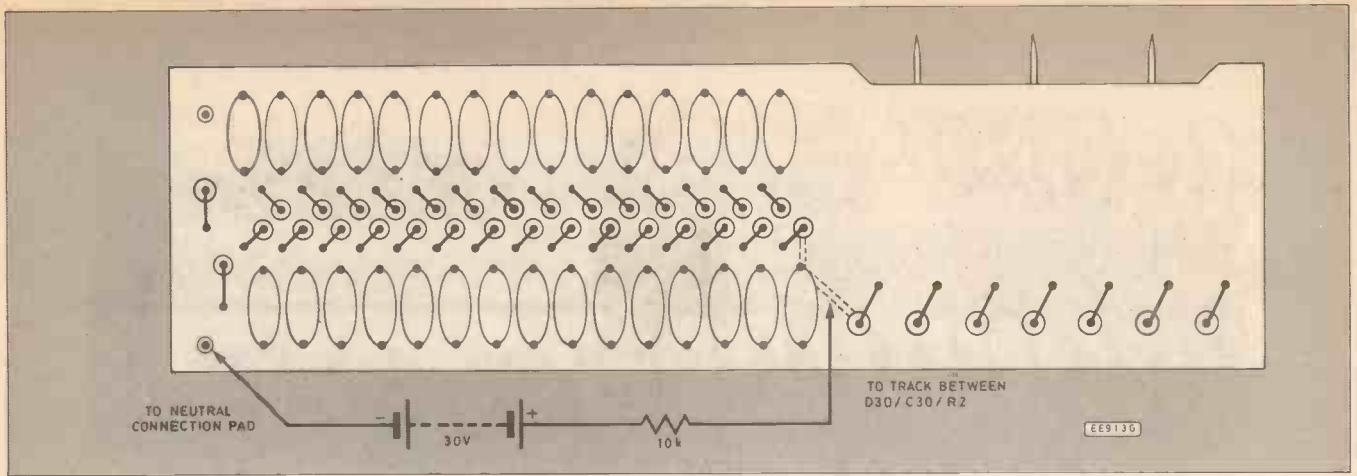

Fig. 5. Low voltage set-up for testing the board. Check voltage drop across each diode.

polarity-conscious of course; start by bending them all to the shape shown in Fig. 4 with the cathode (band) at the top, then they will all be correct when fitted to the board. Solder these in first, then fit the capacitors, then the resistors.

Because ions are emitted from sharp points, the solder joints should be smooth and rounded, especially towards the output end of the board. The easiest way to achieve this is to solder the components in place

as shown in Fig. 5. Silicon diodes exhibit a voltage drop of about 0.6V in the forward direction, so the drop across the chain will be of the order of 16V to 18V. The remainder will appear across the resistor, which thus limits the current to one or two milliamps. It's now a simple matter to check that the appropriate voltage is appearing across each diode; faults in either components or construction will be immediately apparent.

emitter points end up nearly central. Try it in position and mark the position of the points, so that holes, about 4mm dia., can be accurately drilled for them. A suitable cord-grip should be fitted to the mains lead.

Cable entry and fuse are on the copper side of the board, as there's more room here. The Neutral is connected directly to the board, the Live goes via the fuse. Ensure the connections are the right way round, as a peak-to-peak mains ripple superimposed

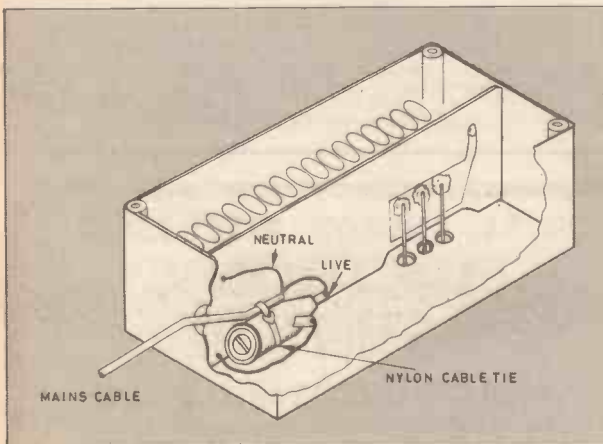

Fig. 6. Interwiring and layout of components inside the case.

with the leads projecting vertically from the board, crop them, remove all the sharp bits with a large flat file, then run over them all again with the iron and some extra solder to achieve the smooth rounded joints required.

The emitter points are made from ordinary pins. Cut these to length so that, when the points are positioned to project 1mm or so above the top of the case, the bottoms are within the area of the mounting pad. The easiest method of fitting is to stick them into something, cardboard perhaps, at the correct spacing, and prop them in place whilst soldering is carried out. Once again the joints should be made smooth and rounded.

TESTING

The board should be tested next. *Live testing should never be attempted owing to the obvious dangers involved*, but an excellent low-voltage check is quite easy to carry out. A d.c. supply of around thirty volts (three 9V batteries will suffice) should be connected across the diode chain with a series resistor of 10k or so, in the forward direc-

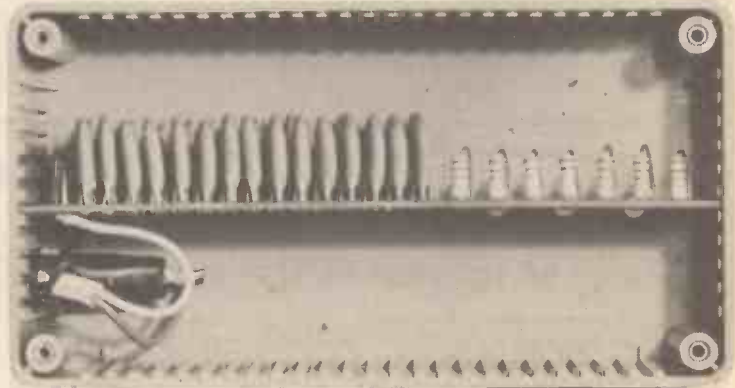

The printed circuit board slotted into the case of the ioniser.

ASSEMBLY

Final assembly is just as simple. The board is designed to fit into the moulded slots in the specified case as shown in Fig. 6, slightly to one side of centre, so that the

on the output voltage is not to be recommended, even though it wouldn't prevent it from working. A small piece of foam plastic suffices to hold the board firmly in place when the base is screwed home; on the prototype pieces of draught excluder strip were used.

Fig. 7. Neon test/demonstration indicator.

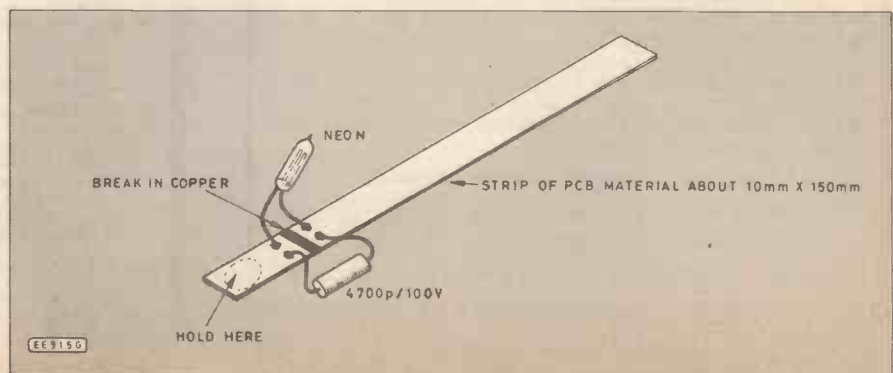

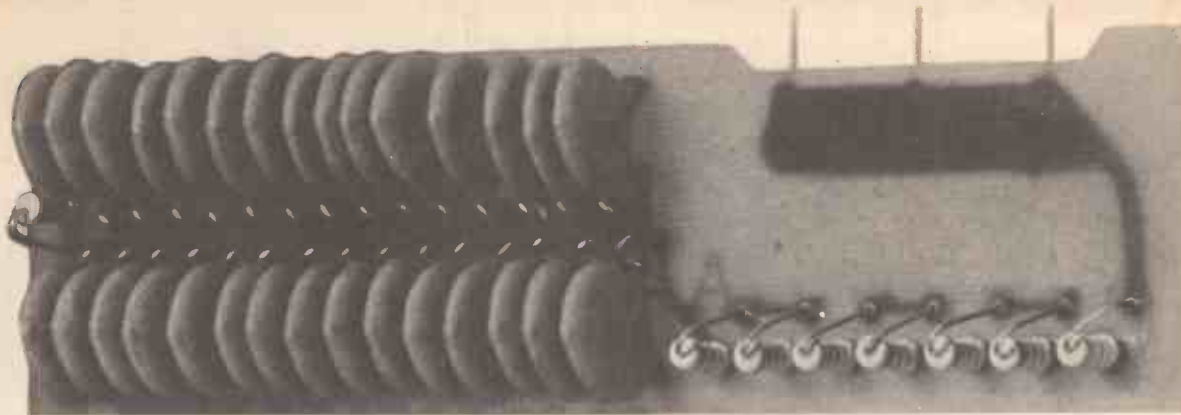

OPERATION

Fifteen seconds or so after the ioniser is plugged in, it should be possible to hear a very faint "rushing" noise from the emitters. The impedance of the multiplier is such that it takes this long to build up to full voltage. It may be possible to feel a slight coldness against a hand held some 5-10cm above it, due to the "ion wind" of ionised air being repelled from the emitters.

A body or object placed too close seems to raise the potential difference and may cause the production of ozone, which has a distinct smell like arcing motor brushes: these tests may cause this. In normal use though, this unit will not produce ozone. If your body is well insulated, holding your hand

over it for a few seconds will cause a charge to accumulate. Subsequent touching of an earthed object will produce a faint discharge, similar to static.

TEST WAND

The most effective test can be carried out if desired with the indicator shown in Fig. 7, made from a piece of scrap p.c.b. This is a simple neon relaxation oscillator; ions picked up from the air charge the capacitor until the striking voltage of the neon is reached, when it will flash. Simply hold the device between thumb and forefinger with the other end close to the emitters. The neon should begin to flash some fifteen centimetres away and the rate will increase rapidly as the distance is reduced.

The ioniser will probably cause your air to seem fresher and cleaner, especially if used in a small "stuffy" room. It may help to clear odours such as tobacco smoke; it certainly does this in the author's home. Whether it confers any health benefit is open to conjecture, though the cost of this design is certainly low enough to encourage trial!

One unwanted effect that should be noted is that airborne dust and dirt particles become charged and promptly stick to the nearest neutral object. Over a period of months this can amount to a surprising amount of dirt, which seems to ingrain itself right into the surface and becomes difficult to clean off. Ionisers, therefore, should not be operated for long periods in close proximity to expensive decorations. □

Zenith Electronics.®

Kits - Modules - Hardware

YOU KNOW US FOR OUR TRANSMITTER KITS—NOW
TAKE A LOOK AT OUR GROWING RANGE OF
QUALITY KITS AND READY-BUILT PROJECTS
MODULES AND ELECTRONIC HARDWARE

The following are examples of our proven product designs in kit form:

- ★ Miniature FM Transmitter; 60-145MHz. Kit £6.95; R/Built £8.95.
- ★ 3 Watt FM Transmitter, 80-108MHz. Kit £13.99; R/Built £18.99.
- ★ 10 Channel Variable Speed Running Light; Drives LEDs or mains lamps. Kit £14.97.
- ★ 3 Note Electronic Door Chime unit; 9 volt operation, 3 melodious tones; variable frequency. Kit £9.83.
- ★ 300 Watt Light Dimmer unit for 240 volt mains lights. Kit £6.95.
- ★ 5 Code Digital Code unit plus Key Pad—select own code; 9 volt. Kit £14.21.
- ★ 5-100 Watt Electronic Loudspeaker Overload Protector, adjustable. Kit £11.11.
- ★ VU Meter 10 LED indicator; -5 to +12dB range. Kit £12.59.
- ★ Automatic light controller; automatically turns on and off lights at pre-set times and triggered by darkness. Kit £25.08.
- ★ Mains Wiring and Metal Detector; complete with case. £11.00
- ★ Digital Clock module; 12-24 hour timing; LED type—£17.49, or LCD type—£22.80.
- ★ Amplifier Power Meter; 10 LED indicator from 0-25-100 Watt Input—9 volt operation. Kit £9.52.
- ★ Light sensitive relay unit; variable sensitivity trigger control; senses light or dark—selectable. Kit £8.45.

ALL KITS CONTAIN FULL INSTRUCTIONS: P.C.B.s AND COMPONENTS.

ALL PRICES INCLUDE VAT AND POSTAGE & PACKING.

OVERSEAS ORDERS—ADD 10% TO ABOVE PRICES.

PLEASE SEND CHEQUE OR POSTAL ORDERS WITH ORDER.

S.A.E. For
FREE
Data Pack ★

Zenith Electronics, 14 Cortlandt Business Centre,
Hailsham, E. Sussex, U.K. BN27 1AE.
Tel: 0323 847973

TOTAL ENERGY DISCHARGE ELECTRONIC IGNITION

IS YOUR CAR AS GOOD AS IT COULD BE ?

- ★ Is it **EASY TO START** in the cold and damp? Total Energy Discharge will give the most powerful spark and maintain full output even with a near flat battery.
- ★ Is it **ECONOMICAL** or does it "go off" between services as the ignition performance deteriorates? Total Energy Discharge gives much more output to fire lean fuel mixtures.
- ★ Has it **PEAK PERFORMANCE** or is it flat at high and low revs. where ignition output is marginal? Total Energy Discharge gives a more powerful spark from idle to the engines maximum (even with 8 cylinders).
- ★ Is the **PERFORMANCE SMOOTH?** The more powerful spark of Total Energy Discharge eliminates the near "misfires" whilst an electronic filter smooths out the effects of contact bounce etc.
- ★ Do the **PLUGS AND POINTS** always need changing to bring the engine back to its best? Total Energy Discharge eliminates contact arcing and erosion by removing the heavy electrical load. The timing stays "spot on" and the contact condition does not affect the performance either. Larger plug gaps can be used, even wet or badly fouled plugs can be fired with this system.
- ★ **TOTAL ENERGY DISCHARGE** is a unique system and the most powerful on the market - 3.5 times the power of inductive systems - 3 times the energy and 3 times the duration of ordinary capacitive systems. Send for full technical details
- ★ **ALSO FEATURES**
EASY FITTING, STANDARD/ELECTRONIC CHANGEOVER SWITCH,
STATIC TIMING LIGHT and DESIGNED IN RELIABILITY (14 years experience and a 3 year guarantee)
- ★ In **KIT FORM** it provides a top performance system at less than half the price of a comparable ready built unit. The kit includes: pre-drilled fibreglass PCB, pre-wound and varnished ferrite transformer, high quality 2µf discharge capacitor, case, easy to follow instructions, solder and everything you need to build and fit to your car. All you need is a soldering iron and a few basic tools.

TOTAL ENERGY DISCHARGE KIT £17.95 { Prices Include VAT
ASSEMBLED READY TO FIT £23.90 Add £1.00 P&P

ALSO AVAILABLE: Other Ignition systems and electronic car alarms

Order now or send for further details:

ELECTRONIZE DESIGN tel 021 308 5877
2 Hillside Road, Four Oaks, Sutton Coldfield B74 4DQ

WINDSCREEN WASHER WARNING

T. R. de VAUX-BALBIRNIE

Stay within the law with this simple add-on unit

THE LAW requires car windscreen washers to be kept in good working order. The water bottle is often badly located, however, and the average motorist does not check the contents before every journey. Driving under poor weather conditions, the water can be used up very quickly and a dangerous situation develops.

This unit delivers a bleep each time the washers are used if the water has fallen below some predetermined level. There is then time to refill at the next service station. This circuit is suitable for all cars having electrically-operated windscreen washers and will operate with plain water, windscreen cleaners or antifreeze mixtures in the bottle.

CIRCUIT DESCRIPTION

The circuit diagram for the Windscreen Washer Warning is shown in Fig. 1. IC1 is an integrated circuit timer connected as a monostable. This means that once triggered by making pin two low (supply negative voltage), the output (pin three) goes high (positive supply voltage) for a certain time then reverts to low. Pin two is normally kept high since the potential divider R5 and R6 applies almost 12V to it. The time during

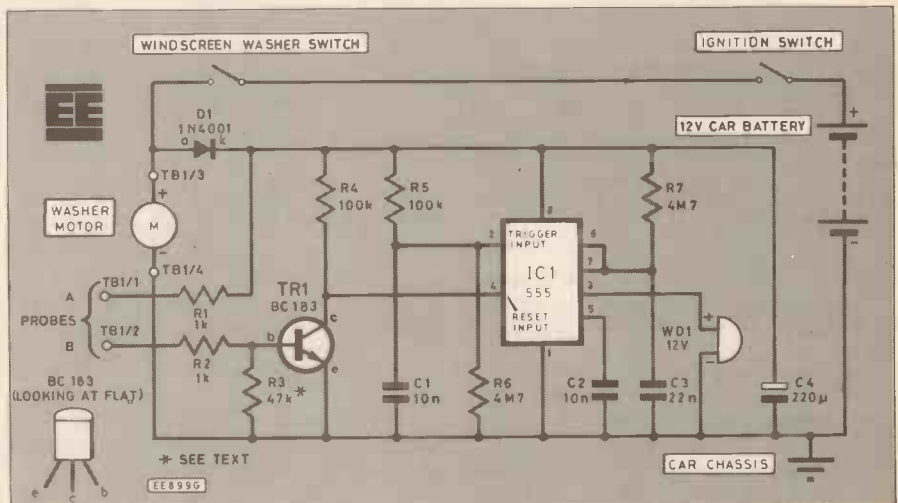

Fig. 1. Complete circuit diagram for the Windscreen Washer Warning.

which the output remains high depends on the values of C3 and R7—with those used this will be approximately one second.

The circuit receives current from the existing wires feeding the washer pump motor so that when this is operated, IC1 pin two receives a momentary trigger pulse as C1 charges through R5. Note that Fig. 1 shows the washer motor switch in the positive battery wire but there will be no difference in operation if it is in the negative one.

The trigger pulse will have no effect if IC1 is disabled by keeping the reset input (pin four) low and this is the case when there is sufficient water in the reservoir. Then, probes A and B situated in the bottle, are effectively short-circuited by the water

which is a reasonable conductor of electricity. Base current then flows to TR1 turning it on. The collector—hence IC1 pin four—is thus kept low and IC1 disabled.

With a low water level, there is no conducting path between A and B so TR1 remains off. The collector is then high and IC1 allowed to operate. Diode D1 prevents possible damage if the circuit is connected with the wrong polarity. Also, in conjunction with C4, it smooths the supply from the charging system and allows for correct operation in cases where the washer switch contacts do not "make" cleanly.

CONSTRUCTION

Construction is based on the layout shown in Fig. 2. This uses a piece of 0.1 inch matrix stripboard size seven strips by 20 holes. Begin by making the breaks in the copper tracks and soldering the link wires as indicated. Follow with the on-board components including the i.c. socket. Do not insert the i.c. itself until construction is complete, however. Take care to observe the polarity of D1 and C4. After a careful check for errors—particularly for accidental "bridging" of adjacent copper tracks—solder 10cm pieces of light-duty stranded connecting wire to strips A, B, C, F (2 off) and G as shown.

Prepare the case by drilling a small hole for the wires passing through to the terminal block, TBI. Mount TBI on the side using two small fixings (see photograph). Attach the circuit panel to the side and the buzzer to the base of the box with adhesive fixing pads. Refer to Fig. 3 and complete all wiring.



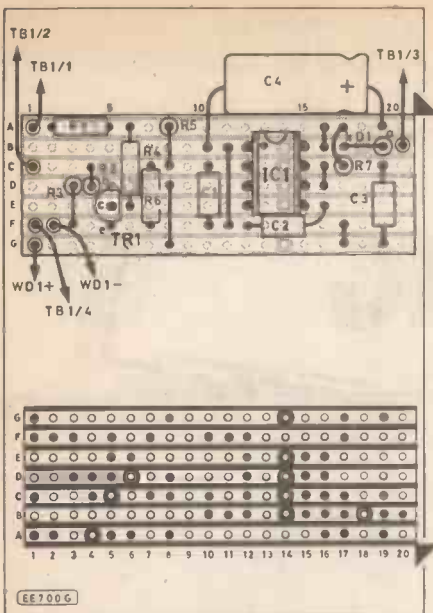
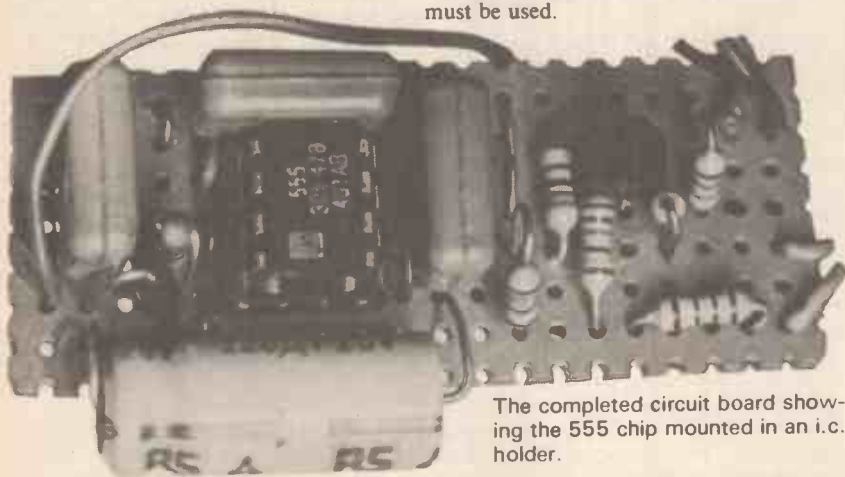

Fig. 2. Circuit board component layout and details of breaks to be made in the underside copper tracks.



The completed circuit board showing the 555 chip mounted in an i.c. holder.

Most small solid-state buzzers may be used except for the *driven* type which is not suitable. A high-intensity buzzer should be used if the unit is intended for a vehicle where the washer system is situated near the driving position and therefore noisy. The lid of the case may be drilled with a matrix of holes, if necessary, for the sound to pass through.

It now only remains to test the system under real conditions. Note that R3 determines the sensitivity of the circuit. If the buzzer sounds with the probes in water, R3 should be increased in value. If, on the other hand, it fails to sound when the probes are removed and are just slightly damp, its value should be reduced. Do not alter the value of resistor R3 unless a check reveals

Fig. 3. Interwiring to the terminal block, buzzer and circuit board.

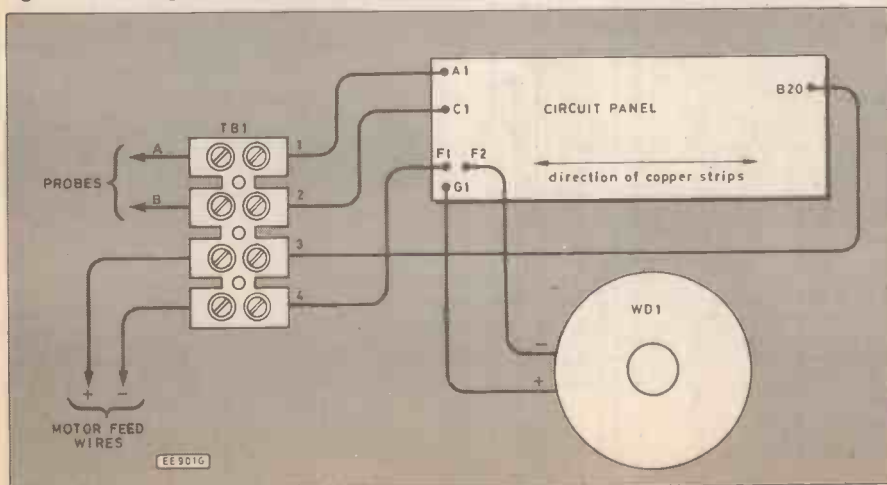

PROBES

For the prototype unit, the probes consisted of a piece of "figure 8" twin stranded wire (see Fig. 4). This has the advantage of being easily replaced should the need arise. The wire is passed through a small hole drilled in the top of the water bottle. Fit this with a rubber grommet to grip the wire and keep it at the required level. Decide on a suitable place for the unit behind the car dashboard. Connect the probes to TB1/1 and TB1/2 then connect TB1/3 and TB1/4 to the positive and negative terminals respectively of the windscreen washer pump motor—use auto-type stranded wire of 3A rating for these connections. If the polarity of the motor is not known, connect either way and test the unit for correct operation—it will not work if it is the wrong way round.

If the motor is fitted with spade terminals, the additional wires may be added using "piggy-back" converters. Many cars, however, use a special block connector. In this case attach the new wires, if possible, using connectors which do not involve breaking the wires. These are available from car accessory shops. Wherever wires pass through a hole in metal, a rubber grommet must be used.

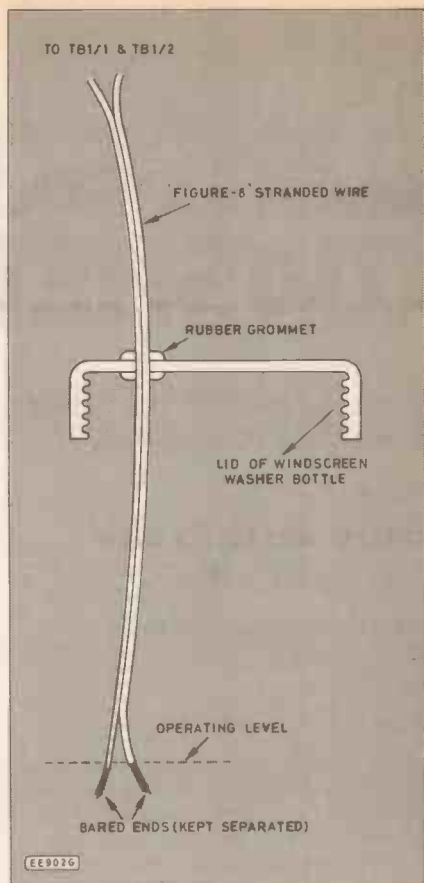

Fig. 4. Suggested arrangement for using "twin-flex" wire as the level sensor probes.

that there are no circuit faults, however. When testing, allow a pause of at least 10 seconds between operations for capacitor C4 to discharge. □

COMPONENTS

Resistors

R1,R2	1k (2 off)
R3	47k (see text)
R4,5	100k (2 off)
R6,R7	4M7 (2 off)

Capacitors

C1,C2	10n (2 off)
C3	22n
C4	220µ elect. 16V

Semiconductors

D1	IN4001
TR1	BC183
IC1	555 timer

See
**Shop
Talk**
page 255

Miscellaneous

WD1 12V solid-state buzzer—see text.
TB1—3A terminal block—4 sections required; 0.1 inch matrix stripboard, size 7 strips x 20 holes; plastic box size 72 x 46 x 22mm (internal); connecting wire; stranded "figure 8" wire for probes; 3A auto-type wire.

Approx. cost
Guidance only

£6

ON SPEC

*a regular
feature for
the Spectrum
Owner...*

by Mike Tooley BA

THIS month, as promised, we shall be turning our attention to the construction of a Versatile Sound Synthesiser for use with the Spectrum. Before we get started, however, a number of readers have asked whether a Spectrum can produce specialised electrical symbols. The answer, of course, is "yes"; all that is required is a knowledge of the Spectrum's User Defined Graphics which can be gained from the *User Guide*.

As an example (see listing 1), we show how it is possible to print the Greek letters Ω , μ , and λ whenever the O, U, and L keys respectively are depressed when in graphics mode (G cursor). Those familiar with the software package which formed part of our 'Teach-In '86' series will have already seen these UDG's in action!

```
10 REM Set User Defined Graphics
12 DATA 0,60,66,66,66,36,102,0
14 FOR j=0 TO 7
16 READ k
18 POKE USR "O"+j,k
20 NEXT j
22 DATA 0,0,68,68,68,124,64,64
24 FOR j=0 TO 7
26 READ k
28 POKE USR "U"+j,k
30 NEXT j
32 DATA 0,0,32,80,8,20,34,0
34 FOR j=0 TO 7
36 READ k
38 POKE USR "L"+j,k
40 NEXT j
```

SOUND SYNTHESISER

One of the principal shortcomings of the early versions of the Spectrum (16K, 48K, and Plus) is associated with the inability to produce any sound other than a strangled "beep"! Whilst some programmers have managed to provide some surprisingly good results from this, the 128K and Plus Two machines with their built-in sound synthesiser chips must be heralded as a major step forward. Those not lucky enough to own the latest breed of Spectrum machines may like to know that it is not too difficult to add a sound synthesiser to an existing Spectrum.

Such an addition will NOT make your 48K Spectrum compatible with any soft-

ware which runs exclusively on the newer machines, however, it will allow you to add some really exciting sound effects and music to your own programs. Indeed, there is a great deal of fun to be had simply in experimenting with the sound synthesiser—it is eminently possible to produce some astounding sound effects using very simple BASIC, assembly language, or FORTH routines.

The Sound Synthesiser is based on a General Instrument device, the AY-3-8913. As this device is quite complex, it is worth spending a little time describing its principal features and architecture before discussing the detailed circuitry of the Sound Synthesiser.

The AY-3-8913 has a well proven track record (close relatives are used in Z80 based MSX machines as well as in the powerful 68000 based Atari ST series of "top-of-the-range" home computers) and is one of the latest of a family of sound synthesiser chips from General Instruments. Several of these devices include parallel I/O capability (see table below), however, all have virtually identical circuitry for sound synthesis.

Device	Number of analogue output channels	Number of I/O ports	Package
AY-3-8910	3	2 x 8-bit	40-pin DIL
AY-3-8912	3	1 x 8-bit	28-pin DIL
AY-3-8913	3	nil	24-pin DIL

The AY-3-8913 has three independently programmable tone generators, a programmable noise generator, a programmable mixer (for combining tones with noise) and is capable of producing fifteen logarithmically raised volume levels, with programmable attack, delay, sustain, and release (ADSR). The device is TTL compatible and designed for direct connection to a micro-processor bus.

The simplified internal architecture of the AY-3-8913 is shown in Fig. 1. The heart of the device is the array of sixteen registers which define the sounds produced. Data can be transferred to/from the control register array by means of eight bi-directional buffers. An eight-bit latch is also driven from the system data bus and this is used to select a particular control register depending upon the state of the bus control (BC1) and bus direction (BDIR) lines.

Individual bits stored in the control register array are responsible for determining, amongst other things, the frequency and amplitude of the outputs of the three tone generators. In addition, bits are used to determine the envelope of the waveform (more on this topic next month!) and the amount of noise mixed into the output.

The complete circuit of the Spectrum Sound Synthesiser is shown in Fig. 2. The AY-3-8913 is enabled whenever the Spectrum's $\overline{\text{IORQ}}$ and A7 lines are simultaneously taken low. Thereafter, the action of IC1 is determined by the state of the BC1 and BDIR control inputs, as shown below:

CPU operation	AY-3-8913 control inputs		IC1 action
	BC1	BDIR	
Read, A7 taken low	0	0	inactive
Read, A7 taken high	1	0	read data from registers
Write, A7 taken low	0	1	write data to registers
Write, A7 taken high	1	1	latch data, write register numbers

COMPONENTS

Resistors

R1 1k
R2 3k9
R3 3k9
R4 3k9
R5 22k
R6 470
R7 470
R8 270

All 0.25W 5% carbon

See

**Shop
Talk**

page 255

Potentiometer

VR1 10k miniature skeleton preset

Capacitors

C1 100 μ p.c. elec. 16V
C2 10 μ p.c. elec. 16V
C3 10 μ p.c. elec. 16V
C4 100n polyester

C5 100n polyester
C6 100 μ p.c. elec. 16V
C7 10 μ p.c. elec. 16V
C8 100 μ p.c. elec. 16V
C9 220 μ p.c. elec. 16V
C10 10n polyester

Semiconductors

D1 Red l.e.d.
IC1 AY-3-8913 sound generator
IC2 74LS08 Quad 2-input AND gate
IC3 74LS27 Triple 3-input NOR gate
IC4 74LS04 Hex inverting buffers
IC5 LM380N 2W audio amp

Miscellaneous

LS1 8ohm loudspeaker.
X1 2 MHz crystal.
Low-profile d.i.l. sockets, 1 x 24-pin, and 4 x 14-pin; 0.1in matrix stripboard, measuring approx. 80mm x 100mm; 28-way open end double-sided 2.54mm (0.1in) pitch edge connector, (e.g. Vero part number 838-24826A); terminal pins (2 required).

Approx. cost

Guidance only

£16.50

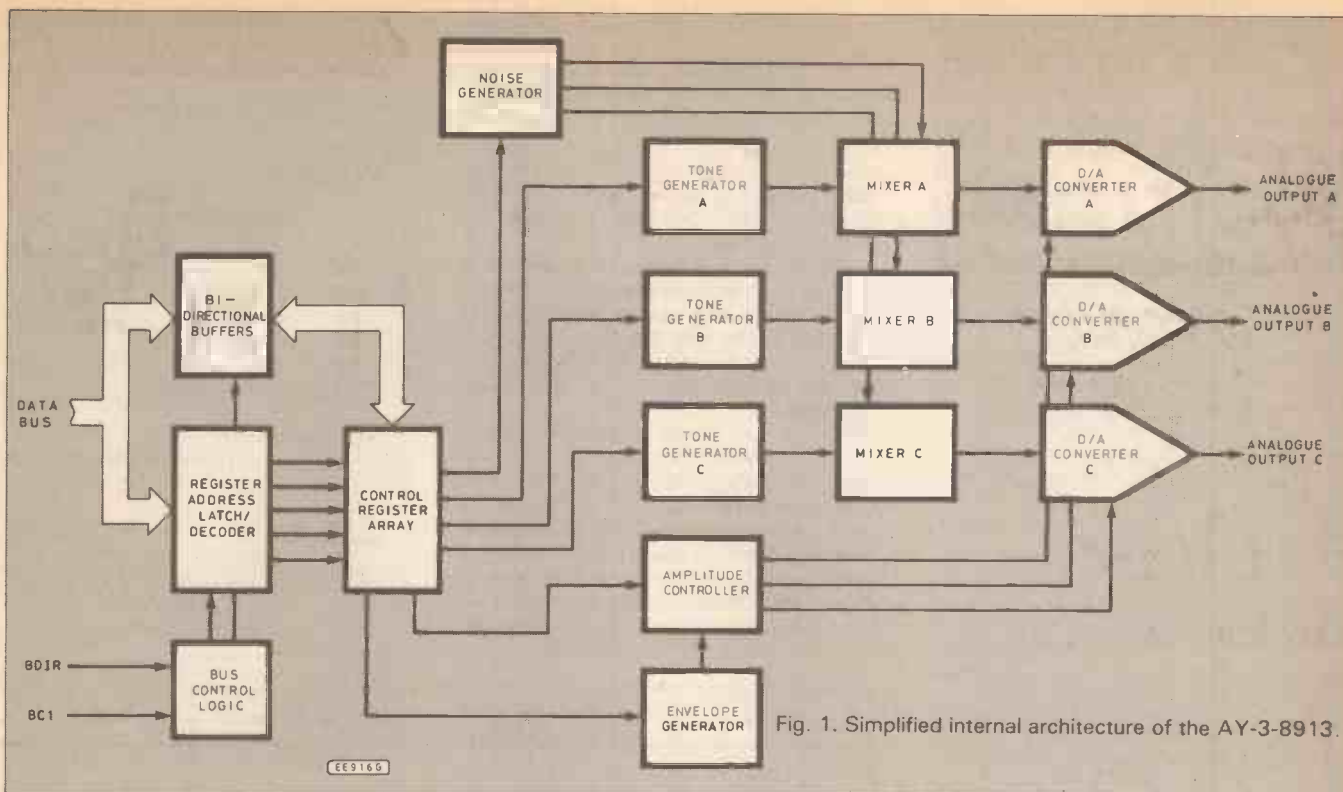

Fig. 1. Simplified internal architecture of the AY-3-8913.

When assigning port addresses to the sound synthesiser, it is important to avoid using any address for which the five least significant address lines go low. This precaution is necessary to avoid conflicts which may arise from the simplified method of address decoding employed in the Spectrum's uncommitted logic array (more of this in a future instalment of *On Spec*).

We must thus ensure that address lines A0 to A4 are all high when the Sound Synthesiser is being addressed. Assuming that A5 is also high (e.g. for controlling some other external hardware) we are left with just two possible addresses, as shown:

Operation	Address								Address	
	A7	A6	A5	A4	A3	A2	A1	A0	dec.	hex.
Read/write data from/to last register selected	0	0	1	1	1	1	1	1	63	3F
Write register number	1	0	1	1	1	1	1	1	191	BF

The AY-3-8913 requires a stable 2MHz clock. This is generated by crystal X1, inverters IC4a, IC4b, and IC4c and associated circuitry. The three analogue outputs, pins 15, 17 and 18, of IC1 are summed and applied to a simple 1W audio amplifier stage configured around the ubiquitous LM380N (IC5).

Construction

The Sound Synthesiser may be assembled on a piece of Veroboard measuring approximately 80mm x 100mm. The precise dimensions of the board are unimportant provided that it has a minimum of 28 tracks aligned in the vertical plane sufficient to allow the mounting of a 28-way double-

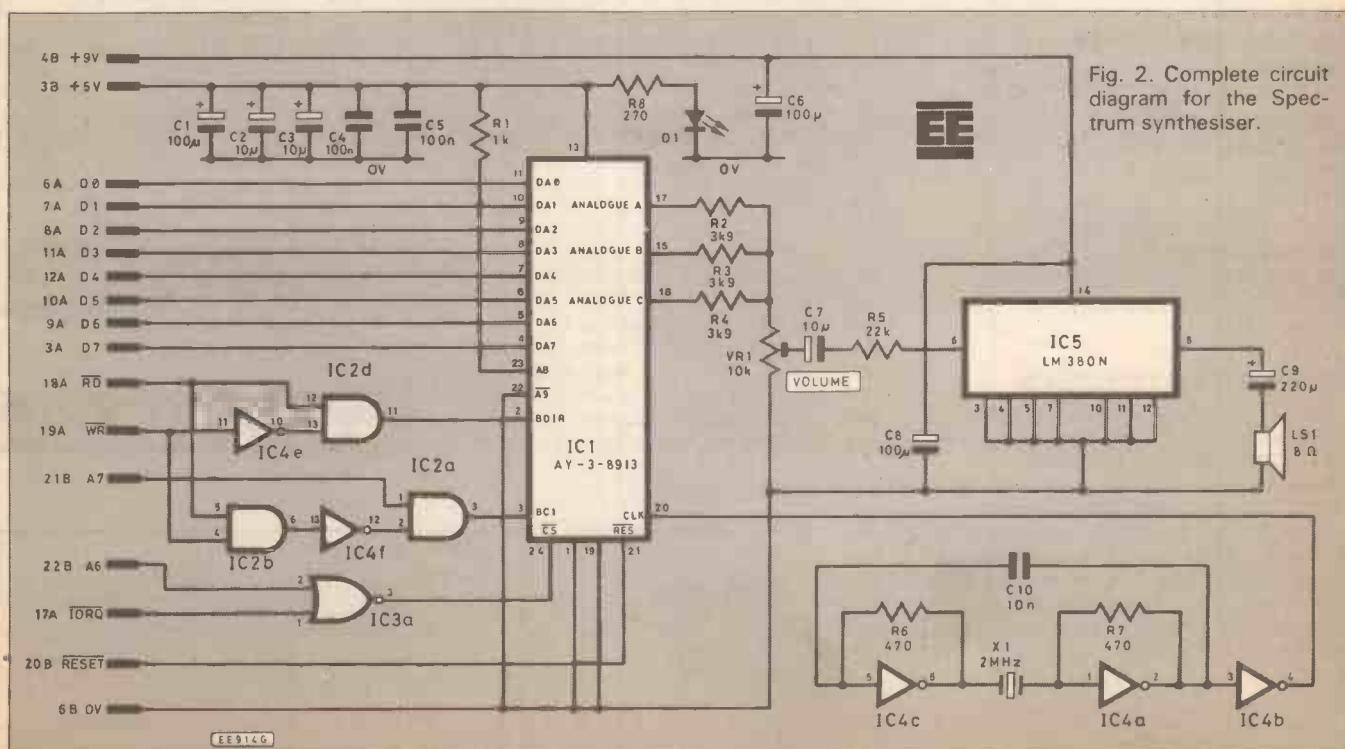

Fig. 2. Complete circuit diagram for the Spectrum synthesiser.

sided edge connector. This connector should be fitted to the lower edge of the board and will require five holes across the full width of the stripboard so that the board stands vertically when the connector is mated with the Spectrum.

Before soldering any of the components (including the four i.c. sockets) it is important to allow some clearance for the rear overhang of the case. For the Spectrum this gap should correspond to 8 rows of holes (20mm approx.) whilst for the Spectrum Plus and 128, the gap should be increased to 12 rows of holes (30mm approx.).

Component layout is generally uncritical though, as with most of our *On Spec* projects, considerable economies can be made by carefully planning the layout in advance of mounting the components and i.c. sockets. Readers are advised to carry out this exercise on paper first (using, if desired, the layout sheet provided with our *On Spec Update*).

After mounting the five i.c. sockets, great care must be taken to ensure that all unwanted tracks are cut (including, in particular, those which link the upper and lower sides of the 28-way connector). A purpose designed "spot-face" cutter is ideal for this purpose or, if such a tool is not obtainable, a small sharp drill bit may be used.

The remaining components (resistors, capacitors, variable pre-set resistor, crystal, and i.e.d.) should then be fitted to the board. As usual, the decoupling capacitors (C1 to C6 and C8) should be distributed around the board with the smaller value capacitors (C4, C5 and C8) being placed as close as possible to the supply inputs of IC1, IC4, and IC5 respectively. Care should also

be exercised when soldering the crystal X1 to the board as excessive heat from the soldering iron can cause permanent damage to the quartz element.

Links on the underside of the board should make use of appropriate lengths of miniature insulated wire (of the type normally used for wire wrapping). Readers requiring further information on the connector should refer to March 1985 *On Spec*.

When the stripboard wiring has been completed, the integrated circuits should be inserted into their respective sockets (taking care to ensure correct orientation of each device), preset VRI should be set to mid-position, and an 8 ohm loudspeaker should be connected. Finally, the entire board and wiring should be very carefully checked *before* attempting to connect it to the Spectrum. (Note that the Spectrum should ALWAYS be disconnected from its supply before either connecting or disconnecting any interface module).

If all is well, when power is re-applied, the normal copyright message should appear. If not, disconnect the power, remove the interface and carefully check again!

Simple Test

For those anxious to test the interface in advance of next month's instalment, the following simple BASIC program can be used to load the internal registers of the AY-3-8913:

```
10 INPUT "Register number"; rn
20 INPUT "Data value "; val
30 OUT 191,rn
40 OUT 63,val
50 GO TO 10
```

Enter the test program and reply to the prompts which the following values:

Register Number	Data Value
0	28
1	1
7	62
8	8

The data entered should produce a continuous tone of moderate volume having a frequency of approximately 440Hz (for the musical, this should be reasonably close to middle-A). Once enabled, the Sound Synthesiser will continue producing its output until the power is disconnected (or the reset button is pressed). To switch the tone off, it is merely necessary to load a data value of 8 into register 8.

If you have any comments or suggestions or would just like a copy of our *On Spec Update*, please drop me a line at the following address and enclose a large (A4 size) stamped addressed envelope:

Mike Tooley,
Department of Technology,
Brooklands Technical College,
Heath Road, Weybridge,
Surrey, KT13 8TT.

Next month: We shall take a detailed look at programming the Versatile Sound Synthesiser. We shall also include some routines for rapidly manipulating the Spectrum's video memory to provide a simple "screen swap" facility.

Xen-Electronics

Specialised Electronic Component Supplies
Just a small selection from 100's of thousands of stock items

4000 SERIES	74LS SERIES	MICRO & LSI	IR REMOTE IC'S	ZENER DIODES	TIP146	CAPACITORS	POLYESTER	RESISTORS
4001UB 0.16	74LS00 0.20	MC3448AP 3.90	SL486DP 2.20	BZY88C2V7 0.05	2N2646 0.55	ELECTROLYTIC	0.01µF250V 0.05	CARBON FILM
4001B 0.16	74LS04 0.20	MC6848BP 8.04	SL490DP 1.92	BZY88C4V3 0.06	2N3055 0.50	A=AXIAL	0.022µF250V 0.05	0.25W 5%
4011UB 0.16	74LS13 0.28	Z80A-CPU 1.80	ML926DP 2.73	BZY88C5V1 0.06	2N3704 0.10	10µF35V 0.05	0.033µF250V 0.06	IR - 10M 0.02
4012R 0.21	74LS14 0.42	Z80A-DART 4.28	ML928DP 2.73	BZY88C7V5 0.06	2N3819 0.40	100µF25V 0.07	0.047µF250V 0.06	0.5W 5%
4013B 0.30	74LS20 0.42	Z80A-F10 1.68	VOLTAGE REG'S	BZY88C9V1 0.06	2N5307 0.20	100µF50V 0.17	0.068µF250V 0.06	10R - 10M 0.03
4017B 0.28	74LS32 0.20	Z80A-B10/0 4.96	LM317L 0.72	BZY88C10 0.06	2N5308 0.20	1000µF10V 0.15	0.1µF250V 0.08	METAL FILM
4019R 0.50	74LS37 0.20	UPD41256-15 2.65	7805 0.40	BZY88C11 0.06	IC SOCKETS	10000µF40V 3.12	0.47µF250V 0.14	0.4W 1%
4020B 0.66	74LS42 0.42	TC5516APL-2 3.00	7808 0.45	BZY88C15 0.06	TURNED PIN	2200µF16V 0.30	POLYPROPOLNE	10R - 1M 0.04
4023B 0.25	74LS85 0.62	ICM7217IP1 4.21	7812 0.40	BRIDGE REC'S	8 PIN 0.21	33µF16V 0.05	2200pF1KV 0.13	ENAMEL
4024B 0.40	74LS123 0.67	AD & DA CONVERTERS	7815 0.45	KBPC808 1.42	14 PIN 0.26	330µF16V 0.12	470pF1KV 0.13	WIRE WOUND
4025B 0.20	74LS132 0.54	AD7525LN 19.25	7824 0.45	SKB202L5A 0.43	16 PIN 0.29	4.7µF63V-A 0.08	POLYSTYRENE	2.5W 5%
4028B 0.26	74LS139 0.46	DAC80N-CBI-V 19.50	78L05 0.24	KBU4D 0.95	18 PIN 0.33	470µF10V-A 0.30	33pF160V 0.07	1R2 - 1K5 0.27
4030B 0.29	74LS193 0.98	ADC1210HCD 45.55	78L08 0.25	W005 0.26	20 PIN 0.37	470µF50V 0.30	47pF160V 0.07	6W 5%
4040B 0.50	74LS240 0.67	ADC1211HCD 39.96	78L12 0.25	TRANSISTORS	24 PIN 0.46	4700µF25V 1.58	100pF160V 0.07	1R2 - 2K4 0.46
4042B 0.41	74LS244 0.58	DAC0800LCN 2.45	DIODES	BC107 0.09	28 PIN 0.54	0.047µF50V 0.04	470pF160V 0.07	CERAMIC
4050B 0.29	74LS245 0.75	DAC1200HCD 18.84	1N4001 0.03	BC108 0.08	40 PIN 0.75	0.1µF25V 0.06	1000pF250V 0.11	17W 10%
4053B 0.50	74LS365 0.42	DAC1201HCD 15.15	1N4148 0.02	BC182 0.08	IC SOCKETS	0.1µF63V 0.14	1800pF160V 0.08	1R0 - 10K 0.28
4063B 0.70	74LS373 0.58	ICL7109CPL 8.40	1N4933 0.25	BC212 0.09	PLAIN	47pF63V 0.03	SIEMENS	SIL NETWORKS
4066B 0.20	74HC SERIES	AD7542KN 18.94	1N3891 1.89	BC327B 0.08	6 PIN 0.07	47pF63V 0.03	0.1µF100V 0.11	0.125W 5%
4068B 0.21	74HC00 0.33	LINEAR	1N5339B 0.36	BC346B 0.09	8 PIN 0.08	120pF63V 0.05	0.47µF100 0.19	BCOM (9PIN)
4069B 0.20	74HC02 0.33	LF398N 3.95	1N5401 0.12	BC556A 0.08	14 PIN 0.09	MONOLITHIC	1.0µF100V 0.22	100R - 100K 0.31
4070B 0.20	74HC04 0.33	LM311N 0.44	31D003 0.64	BD131 0.40	16 PIN 0.10	MULTI-LAYER	100pF50V 0.13	THERMISTOR
4071B 0.28	74HC11 0.33	LM324N 0.41	BAT85 0.10	BD233 0.33	18 PIN 0.15	100pF50V 0.13	MONOLITHIC	BEAD (NTC)
4078B 0.21	74HC85 0.83	LM308N 0.65	BVY32-100 1.24	BF259 0.26	20 PIN 0.17	220pF50V 0.12	SINGLE-LAYER	4K7 6M472W 1.95
4081B 0.16	74HC139 0.58	LM741CN 0.32	BVY95B 0.18	BSR50 0.44	22 PIN 0.19	470pF50V 0.10	100pF50V 0.03	POTENTIOMETERS
4510B 0.46	74HC200 1.01	MC1458CP1 1.01	BVY95C 0.20	BU548P 2.65	24 PIN 0.23	1000pF50V 0.10	1000pF63V 0.02	CERMET 3/8" 80
4511B 0.46	74HC240 0.58	MC3340P 1.30	BYX71-600 1.10	BU98H 5.70	28 PIN 0.25	2200pF50V 0.10	2200pF63V 0.03	PCB TOP ADJUST
4514B 0.91	74HC244 0.95	ICL7660CPA 1.76	BY206 0.20	IRF520 1.75	40 PIN 0.30	4700pF50V 0.12	4700pF63V 0.04	100R - 200K 0.30
4518B 0.40	74HC245 0.92	SG5526N 4.92	40HF20 1.16	J112 0.30	IC SOCKET	6800pF50V 0.14	TANTALUM	PCB SIDE ADJUST
4543B 0.58	74HC251 0.43	SG5526J 4.92	40HF200 1.16	IRF840 1.85	TRANSISTOR	0.01µF50V 0.08	1.0µ16V 0.09	500R - 200K 0.30
4547B 1.23	74HC273 0.83	TL074CN 0.66	M16-100 0.93	MTP8N10 7.59	3 PIN 0.17	0.022µF50V 0.08	6.8µF10V 0.12	MULTITURN
40174B 0.48	74HC354 0.51	TL072CP 0.65	M16-100R 0.93	MJ3001 1.46	8 PIN 0.38	0.033µF50V 0.15	10µF10V 0.10	PCB TOP ADJUST
40192B 0.56	74HC373 0.79	TL071CP 0.39	M25-100 1.27	MJ2501 1.52	10 PIN 0.42	0.047µF50V 0.14	10µF16V 0.13	100R - 200K 0.85
40193B 0.56	74HC374 0.79	UA714HC 4.48	M25-100R 1.27	TIP110 0.36	SIL SOCKET	0.068µF50V 0.10	22µF16V 0.21	PCB SIDE ADJUST
40194B 0.65	74HC4002 0.71	OP07DP 1.43	I.R. OPTO	TIP115 0.39	STRIP	0.1µF50V 0.08	33µF16V 0.32	200R - 200K 0.85
40195B 0.83	74HC4022 0.54	UA759U1C 2.72	TPS705A 1.25	TIP121 0.39	6 WAY 0.12	0.22µF50V 0.25	47µF6.3V 0.23	PLASTIC TRACK
40374B 1.10	74HC4040 0.54	MC1436CG 5.70	TLN105A 0.44	TIP126 0.39	12 WAY 0.22	0.47µF50V 0.49	100µF6.3V 0.57	SINE/COSINE
40374 1.10	74HC4060 0.56	UGN3020T 2.58	TLN105 0.40	TIP141 1.59	20 WAY 0.56	1.0µF50V 0.84	150µF6.3V 0.94	2 x SK 5% 18.25
RM FERROXCUBE		L.E.D.'S .2" DIA						
RM6+BOBBIN+ADJ+CLIP 1.07	RED TLR113A 0.10	0.43"						
RM7+BOBBIN+ADJ+CLIP 1.07	GRN TLR113A 0.13	CA TLR342 0.89						
RM10+BOBBIN+ADJ+CLIP 1.85	YEL TLY113A 0.17	AN TLR343 0.89						
FERROXCUBE		0.53"						
FX3607 (PAIR)+BOBBIN 2.35	ORG TLO113A 0.21	CA TLR350 0.89						
FX3720 (PAIR)+BOBBIN 1.14	L.E.D. DISPLAYS	AN TLR359 0.89						
FX3730 (PAIR)+BOBBIN 1.59	0.3"	CA TLR358 1.10						
FX3845 (PAIR)	CATH TLR332 0.89	AN TLR359 1.10						
	ANOD TLR333 0.89							
		ISLE OF WIGHT						
		PO31 7LP						
		ORDERS TO:-						
		Xen-Electronics						
		UNIT 4						
		SAMUEL WHITES EST						
		BRIDGE RD						
		COWES						
		PLEASE ADD £1.00 p&p & 15% VAT.						
		Orders Over £20 Post and Packing Free						
		Minimum Order Value £2. No Export orders please						
		Stock Items normally by return of post.						
		Ask for details of items not listed and pricing.						
		*Coil Winding Facility Available						
		Part Numbers are exact or near equivalents.						
		Prices correct at time of going to printers.						

SPECIAL OFFER...

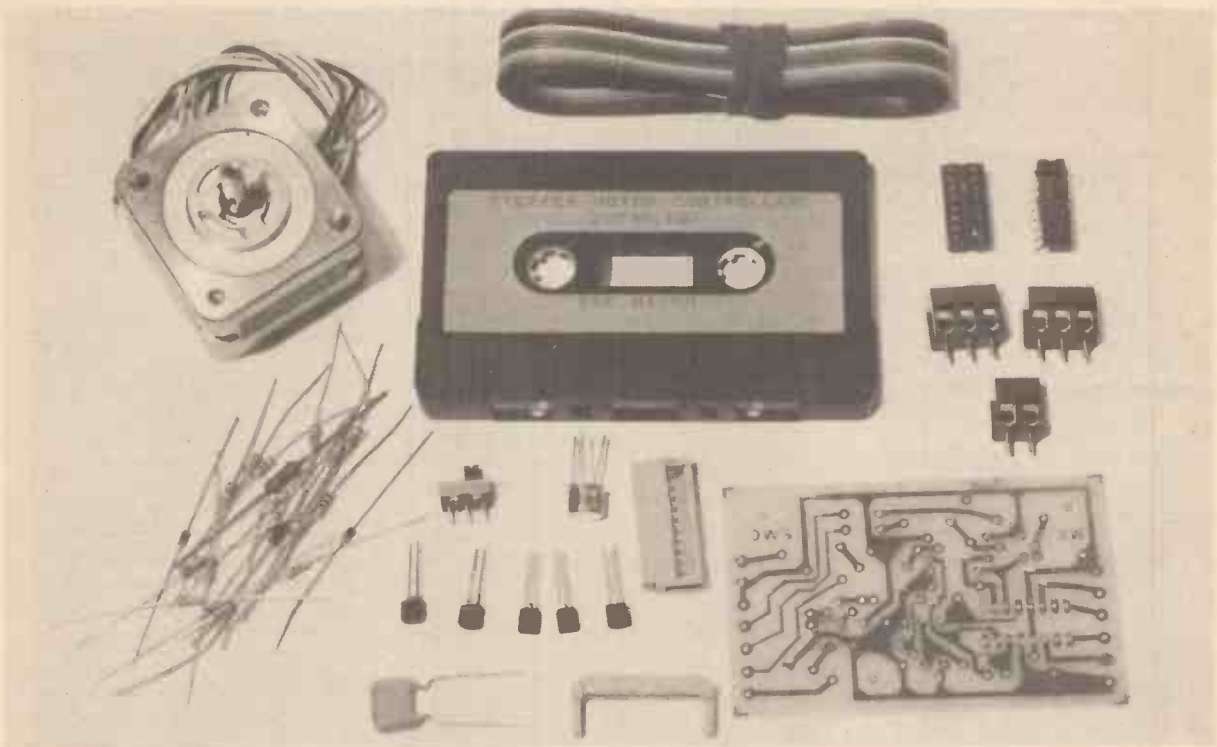

STEPPING MOTOR, MOTOR INTERFACE KIT PLUS SOFTWARE AND INSTRUCTIONS £24.65 including VAT (plus £1 postage)

This offer is based on an EE project, it combines the interface kit with a stepping motor and demonstration software. The special price to readers represents a saving of 20% on the normal price, £1 postage should be added to your order no matter what you buy.

Stepping Motors are currently being used a lot in schools and CDT courses in particular for various positioning and robotics applications. This particular motor is superb in construction and performance. It has ball-race bearings at both ends of the spindle, so that spindle end float and runout are extremely small.

The motor has excellent performance with a pull-out torque of 7Ncm and maximum stepping rate in excess of 500 steps per second. It is of hybrid construction, 4 phase unipolar, 200 steps per revolution. Winding resistance is 34 ohms and so total operating current (at 12V) is around 700mA (2 windings energised 350mA each). It is fully compatible with all standard drive circuits used for the common ID35 type motors.

The Interface was first published in EE August, 1985 (this issue is not required to build the kit) and has been very popular. It is ideal for driving either the ID35 or our MD200 Motor.

Care has been taken in the design to ensure that the computer cannot be damaged even if it is switched off when the Interface is on. A power supply giving 12 volts at 700mA is required to power the motor and interface. No power is taken from the computer. A suitable supply kit is available priced at £9.99 including plastic case, mains and output leads, instructions etc. The interface provides full step operation, forward, reverse, standby and hold facilities.

Extra motors may be bought at the same time for £13.45, this is again a 20% reduction. The Interface Kit includes etched, drilled and tinned p.c.b., ribbon cable (1 metre), 20 way IDC connector, full instructions, circuit diagram, software demonstration cassette and listing for the BBC "B" Micro.

Post coupon to: **EE Offer, Magenta Electronics Ltd.** 135 Hunter St., Burton-on-Trent, Staffs DE14 2ST. Tel. 0283 65435

Please supply:

Quantity	Item	Value
	Basic Motor & Interface Kit (£24.65) & Software Offer	£
	Extra Stepping Motors (£13.45 ea.)	£
	Power Supply Kit (£9.99)	£
	Postage	£1.00
	Total	£

Visa/Access or cheque No.

Signature

Name

Address

.....

.....

OFFER CLOSES Friday, June 5, 1987

Name

Address

.....

.....

Post to: **Magenta Electronics Ltd.** 135 Hunter St.,
Burton-on-Trent, Staffs DE14 2ST. Tel. 0283 65435

Please complete both parts of the coupon in BLOCK CAPITALS

...REPORTING AMATEUR RADIO...

TONY SMITH G4FAI

RRD REPORT

The report on the activities of the Radio Regulatory Division of the DTI for 1985/86 makes interesting reading from the radio amateur's point of view. Published in December, it is introduced by Geoffrey Pattie, Minister of State for Industry and Information Technology, as an attempt to improve openness and consultation with users of the radio spectrum, and provides a lot of factual information.

The RRD, renamed the Radiocommunications Division since the period covered by the report, is concerned with the use and management of the radio frequency spectrum, excluding broadcasting policy and sponsorship of the radio communications industry.

Amateur radio is just one of 13 different types of licence category, and like those other categories it depends on the Division for the allocation and protection of frequency bands, both nationally and internationally. The Division is concerned with preventing and overcoming radio pollution, eg, illegal or unsatisfactory transmissions: and is dedicated to a policy of deregulation wherever possible.

FEWER CONTROLS

Traditionally, radio has been regulated in immense detail but, says the report, it is now becoming apparent that the spectrum can be safeguarded with fewer controls, provided there is rigorous enforcement of those which remain. The aim is to make radio more readily and widely available, eliminating licensing altogether where this can be done without damage to licensed use—for example it is proposed to exempt a wide range of low power devices.

A potentially worrying development is the DTI Spectrum Pricing Study which was due for completion by the end of 1986. Phrases like "pricing (as a resource rationing mechanism)", and "promoting competition and consumer choice in the communications market", make one wonder what is to come. It is understood that the Study report proposes detailed control of blocks of radio frequencies by Spectrum Management Licensees (SMLs), who would "sell" them to users. It is also understood that, at this time, amateur radio has been excluded from the new proposals.

For radio amateurs, the RRD report records three major events in the year ending 31st March, 1986. Firstly, the granting of an allocation at 50MHz from 1st February, 1986; secondly, the DTI's acceptance of the Radio Society of Great Britain's tender for the running of the amateur Morse test, with the new arrangements commencing on 1st April, 1986; and, lastly, following a successful experimental period, the decision to allow class B licensees to use Morse permanently on the v.h.f. bands.

Computerisation of the licence records by the Post Office, acting as agents for the DTI, was completed in 1984, and the issue

of licences is now normally completed in five days. The report also records that during 1985 agreements were concluded with the USA, Canada, and the Falkland Islands, enabling international greetings messages to be passed from special event stations, in time for the Scouts' Jamboree-on-the-Air that year.

CONSULTATION

It is important for radio amateurs that their national society, the RSGB, is involved in ongoing discussions with the DTI on both national and international matters. The report records that regular meetings are held with the Society at which a wide range of amateur topics are discussed. During the year in question, topics covered included a strategy for dealing with interference to television and radio reception, crossband working, packet radio, licence revision and research permits.

Some interesting statistics emerge. Prosecutions under the Wireless Telegraphy Act for illegal transmitting activities show five convictions for unlicensed use of the amateur bands as opposed to 896 convictions for illegal CB operation and 124 on the broadcast bands. As at 31st March, 1986, there were 56,346 amateur licences on issue. The total income from these was £700,000 for the year, and since 1970 increases in the cost of an amateur licence have more or less kept in step with increases in the retail price index.

LOW PRIORITY

It should be a sobering thought for hobby users of the radio spectrum to realise that in 1985/86 the RRD issued 290,173 licences which permitted a further (approximate) 900,000 mobile stations to operate. The management of the entire spectrum is subject to national and international legislation, resulting in a great deal of work for the DTI. Realistically, the interests of hobbyists can't attract a very high priority within the Department unless there is a great deal of responsible and authoritative input from the users themselves, via a representative body, to protect their own interests. There has been a certain amount of internal unrest in the RSGB in recent years, but this first annual report of the RRD must surely demonstrate to all amateurs the continuing need to have, and to support, a national society.

The DTI has three radio amateur information sheets available, free of charge: Explanatory leaflet on the licensing work of the RRD (RALIS 1); Amateur Service allocation in the 50MHz band (BR42); and Morse (BR41). For copies write to: The Library, Room 605, Waterloo Bridge House, Waterloo Road, London SE1 8UA.

CALL THE DOCTOR

I have been reading, in Australia's *Amateur Radio* magazine*, about the early radios used by the Royal Flying Doctor Service, which were developed by radio

amateur Alf Traeger. The Aerial Medical Service, as it was originally called, the brain-child of the Rev. John Flynn, first flew an aircraft on 15th May, 1928, without radio equipment. It was soon realised that cheap but reliable communication would be necessary, and Flynn employed Traeger to devise suitable equipment.

Within twelve months, the first set was on the air. The operator cranked a handle, to provide power, with one hand, and sent Morse code with the other. The first successful experiment was conducted from a nursing home in Alice Springs to Hermannsburg Mission, 150km to the west. To overcome difficulties with the hand-cranking, Traeger substituted the now well-known foot-pedal system, and pedal sets were installed at remote outstations to provide vital links with the flying doctor bases.

The next improvement was the development of the keyboard transmitter, first used in 1931, to send Morse signals without the need to learn Morse code. Around 1937 came the beginning of voice transmission, while more reliable batteries, with vibrators, began to replace the pedal generators. Traeger's first transmitter, at the AMS original base in Conclurry, Western Queensland, remained in use until the 1940s, and in 1947 was used at a new base in Charleville until improved equipment became available.

ROUND THE CLOCK

Until the mid-50s all equipment was either a.m. or d.s.b. (double sideband) but since January 1978 all communications have used s.s.b. (single sideband). Nowadays, there is a round-the-clock service with a medical officer always on call. When receivers are unattended an incoming signal actuates an alarm which can only be silenced by operating the transmitter.

The RFDS radio system provides the only form of communication for many people living in complete isolation in the outback. When the channels are not occupied for official traffic, telegrams, etc, time is set aside each day for a "galah" session, a general chat session for all-comers.

Alfred Hermann Traeger, OBE, ex VK5AX/VK8XT, died on the eve of his 85th birthday in 1980. His ingenuity brought immediate medical assistance to innumerable homesteads across the vast spaces of Australia. His invention was the forerunner of the School of the Air, and other communication facilities of today. It is thought there were 30 stations in 1934. Today there are thousands. Traeger has an honoured place in the history of the RFDS. He also stands among the ranks of members of the "amateur fraternity" who have made significant contributions to the development of communications.

*"The Flying Doctor, Pedal Radio and Alf Traeger", by K. McLachlan, VK3AH, October '85.

Super alpha electronics

Dept. EE, P.O. Box 21,
Selsey, Chichester,
West Sussex PO20 0TH



0243
607108

— ALL ORDERS DESPATCHED SAME DAY BY FIRST CLASS POST —

TRANSISTORS

BC107	0.15
BC107A	0.15
BC107B	0.15
BC108	0.15
BC108A	0.18
BC108B	0.15
BC108C	0.15
BC109	0.18
BC109B	0.18
BC109C	0.18
BC182	0.12
BC182B	0.12
BC183	0.12
BC183B	0.12
BC184	0.12
BC212	0.12
BC212B	0.12
BC213	0.12
BC213B	0.12
BC214	0.12
BC327	0.16
BC337	0.16
BC548	0.12
BCY70	0.22
BCY71	0.22
BD131	0.60
BD132	0.60
BD135	0.34
BD136	0.35
BF258	0.60
BFX85	0.40
BFX88	0.40
BFY50	0.37
BFY51	0.37
BFY52	0.39
TIP31	0.42
TIP31A	0.48
TIP31B	0.56
TIP31C	0.54
TIP32A	0.42
TIP32C	0.42
TIP33A	1.00
TIP41A	0.63
TIP42A	0.55
TIP3055	0.76
TIP2955	0.76
ZTX300	0.17
ZTX500	0.17
2N3053	0.60
2N3054	1.60
2N3707	0.12
2N3703	0.12
2N3705	0.12
2N3771	1.40
2N3904	0.15
2N3906	0.15

DIODES

IN4001	0.05
IN4002	0.05
IN4003	0.06
IN4004	0.06
IN4448	0.06

OPTO ISOLATORS

TIL 111 transistor o/p	1.10
TIL 113 Darlington o/p	1.20
3021 Triac driver	1.50

LEDs

T1 3/4 5mm	
Red	0.18
Yellow	0.18
Green	0.18
Super bright	
T1 3/4 5mm	
Red	0.35

TRIACS

3 Amp 400V	0.75
8 Amp 400V	0.90

ZENER DIODES

BZY88C 500m W	
4V7	0.10
10V	0.10
12V	0.10
BZX55C 500m W	
24V	0.10
BZX85C 1.3 Watt	
4V7	0.20
10V	0.20
12V	0.20
24V	0.20

VOLTAGE REGULATORS

LM317T	
+1.2V to 37V	1.50
LM341P	
+5V	0.60
LM7905	
-5V	0.70

BRIDGE RECTIFIERS

W004 1.5A	0.50
6005 6A	0.90

CAPACITORS

Electrolytic

47uF	25V	0.10
100uF	25V	0.12
470uF	25V	0.28
1000uF	25V	0.36

Tantalum

0.1uF	35V	0.10
0.22uF	35V	0.10
0.47uF	35V	0.10
1uF	35V	0.10
2.2uF	35V	0.15
4.7uF	35V	0.20

Ceramic

220pF	500V	0.06
470pF	500V	0.06
1000pF	100V	0.06
2200pF	100V	0.06
4700pF	100V	0.06

RESISTORS

Metal Film 5% 1/3 Watt
2p each

100R 680R 1K 1K2 2K2
4K7 5K6 6K8 10K 12K
15K 22K 27K 33K 39K
47K 56K 68K 82K 100K
120K 150K 180K 220K
270K 330K 390K 470K
560K 680K 820K 1M

SKELETON PRESETS

Horizontal	0.19
Vertical	0.19

LINEAR ICs

741	0.18	NE5534	0.80
555	0.30	ZN414	0.90
556	0.65	ZN416	1.60
LM301	0.28	LM308	0.70
NE5532	1.20	TL081	0.50

B.T. APPROVED TELEPHONES

B.T. Statesman with last number redial

Stone	31.26
Brown	31.26
Maroon	31.26
Grey	31.26

B.T. Viscount with last number redial

Beige	26.04
Ice Grey	26.04
Red	26.04
White	26.04

B.T. Freeway cordless 700ft range Security coded, last number redial with base paging

Ivory	85.00
-------	-------

Carriage on telephones and telephone accessories £1.50
Add 15% VAT to total allow ten days for delivery.

SUPER ALPHA GUARANTEE

All components brand new and by top manufacturers to full specification.

ORDERING: Cash, Postal-Order, Access and Visa, orders despatched same day by first class post. Add 50p p&p to order then add 15% VAT. Telephone orders welcome with Access or Visa, orders accepted by answer service outside office hours. Overseas orders add £2.00 no VAT. Prices subject to alteration.

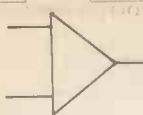

OP AMP LIMITS

DAVID J. SILVESTER

Do not exceed the limitation of your Op-Amp circuit

THIS article actually started life in response to a letter in *Everyday Electronics*, in which it was asked why more articles are not written using the 741C operational amplifier rather than the modern f.e.t. types as many constructors will have a small supply of 741's. In this article it is hoped to present information on the limiting and guaranteed specifications for a number of devices and hope to show why so many of the f.e.t. devices are now in use and will continue to be used to the exclusion of the 741C.

LIMITATIONS

A list of the limiting conditions of a small selection of op-amps, from the old 709C (the grandad of op-amps) to the more recent 741C and the latest j.f.e.t. and MOSFET types is contained in Table 1. The op-amps used in the list were chosen for no better reason than that they are types used by the author in different applications.

In addition many devices are available in dual or quad amplifier packages i.e. the TL071 single, TL072 dual and TL074 quad and also devices without internal frequency compensation such as the TL070. All of these types have identical limiting characteristics.

The ideal op-amp should have the following characteristics:

- 1) Infinite input impedance.
- 2) Zero output impedance.
- 3) Infinite voltage gain.
- 4) Common mode gain of zero—zero output with inputs tied together.
- 5) Inputs and outputs usable over the full power supply range.
- 6) Instantaneous output changes—infinite slew rate.
- 7) All of the above independent of temperature and supply voltage.

No amplifier is able to meet this ideal and it is Table 1 that shows either the maximum or minimum that a particular op-amp can be expected to achieve and still be within specification. In many cases these values are

very different from the typical values.

Whilst for a one-off design a constructor can select an op-amp from a batch which is close to the typical characteristics to obtain a working circuit, where the designer is building for mass manufacture or publication then if the designer does not allow for these maxima or minima there is no guarantee that the circuit will work. Failure to design to these limits can result in the output being controlled by the amplifier itself not by the amplifier acting on its input signals.

the impedance that the circuit can achieve.

INPUT BIAS CURRENT

The input terminations sink or source a small current, the direction of current flow depending on the input device. This current is the base or gate current of the input transistor.

The significance of the input bias current is that it causes a voltage drop in the feedback network (resistors R1 and R2 in Fig. 1b) and across the bias resistor (Fig. 1a, R3). For a 741C the

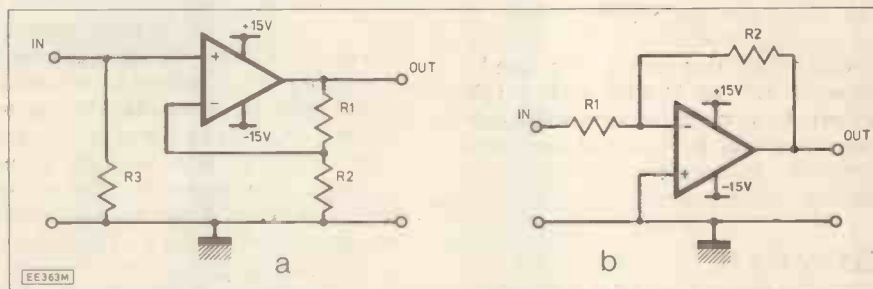

Fig. 1. Input biasing and feedback arrangement for (a) non-inverting and (b) inverting inputs.

SUPPLY VOLTAGE

Although not covered by our list of ideals the supply voltage limits have been shown in Table 1. With the exception of the CA3160 the limits are $\pm 18V$ or $36V$ for a single supply rail, all the devices having bipolar (normal transistor) output stages.

It is common to operate op-amps from $\pm 15V$ or $30V$ to give a safety margin as beyond $\pm 18V$ damage to the device may result. The CA3160 differs in having a CMOS output stage identical to CMOS logic and this limits the maximum supply to $16V$ for single rail, but the design of its output stage provides some interesting output differences which we shall discuss later.

INPUT RESISTANCE

Input resistance is the apparent resistance between the two input terminals. In practice when using the operational amplifier circuits in Fig. 1a and Fig. 1b the feedback network attempts to retain both inputs at the same voltage.

This bootstrap effect virtually increases the input resistance to infinity, even for the low input resistance of the 709C device. In normal circumstances it is the input bias current that limits

typical bias current is $80nA$ and with a $47k\Omega$ resistor for R3 the non-inverting input will be offset from zero by $4mV$ and with a 100 times gain amplifier the output, assuming this is not offset by high resistance in the feedback loop, will be $400mV$.

In a d.c. amplifier we would need to offset this voltage by a change in design of which the simplest would be the addition of a $47k\Omega$ resistor between the inverting input and the junction of the feedback resistors R1 and R2. There is in fact a small difference in current to the two inputs due to manufacturing tolerances but this is substantially smaller than the input current itself. This difference is called the *input offset current*.

In the limiting conditions we must remember that the input bias current can rise to $500nA$ rather than the typical $80nA$ and to guarantee that any 741C will work, the designer must allow for this maximum input current. Consequently a circuit design with the 741C will often call for a low value for resistor R3 and it is substantially easier to choose a f.e.t. input device to overcome the input bias current difficulty, as the f.e.t. types have maximum input currents of 50 to $200pA$ ($0.05nA$ to $0.2nA$).

OUTPUT IMPEDANCE AND VOLTAGE SWING

In our ideal op-amp the output impedance could be zero ohms and the output voltage range would extend to both the positive and negative supply rails. In practice the op-amp's intrinsic output impedance is about 50 to 75 ohms, that is without feedback, but feedback lowers this value to insignificance for a voltage amplifier or raises it to very high values for a current source. Thus output impedance becomes a parameter that is controlled by circuit design.

The output swing remains controlled by the op-amps characteristics and as shown in Table 1 a 741C with a 2 kilohm load can only be guaranteed to give outputs of $\pm 10V$ with a dual supply system i.e. outputs of +5 to +25V with a single 30V supply referenced to the lowest potential. Typical values will again be better than this but we must still design for the worst case.

The interesting point about the CA3160 is that with high load impedances say above 10 kilohms the output can reach the supply voltage to within very small limits. With an open circuit output this output range can be from +0.01V to 14.99V with a 15V supply. In some applications this output range may be essential and overcome the choice of a device with a normal output range.

SLEW RATE

The output voltage of an op-amp is not only controlled by the output voltage limits but also by the rate at which the output transistors are able to change the output voltage. This is known as the *slew rate* and is measured in V/ μ s (volts per micro-second).

The implication is that for high frequencies even with a $\times 1$ amplifier which would give an unaltered gain up to 1MHz, due to its compensation

capacitors, the output voltage is limited by the slew rate. Hence whilst a 741C may give a peak to peak output of 26V (typical) on a 1kHz signal this reduces to 20V at 10kHz and to 8V at 20kHz. It is obvious that some care is needed if the device is to form the driver stage of an a.f. amplifier, and it would be safer to ensure that the design only calls for an op-amp output of say 4V over the full audio range remembering that the values given are typical.

INPUT VOLTAGE RANGE

The input voltage range in fact consists of two parts, which in Table 1 are called the *operational input voltage range* and the *safe input range*. The safe input range is the value of common mode (i.e. both inputs tied together) voltage that can be fed to the inputs of the op-amp without causing damage.

In all cases except the old 709C the input may go up and down over the full power supply range, but to exceed this range will damage the op-amp. We can therefore apply voltages between +15 and -15V to all our op-amps without damage but to have an input at + or - 10V with a $\pm 9V$ supply from batteries will result in irreparable damage to the op-amp. This is however the safe input range, it says nothing about whether the op-amp will act as an op-amp with very high or low input voltages. If the inputs go beyond the input voltage range the gain of the op-amp may change drastically or even reverse sign.

All operational amplifiers except the 709C will accept as safe voltages up to $\pm 15V$ or the supply limits whichever is the smaller, the 709C being limited to 10V. As to the input voltage range over which the op-amp is usable the values vary considerably depending on the input device design, but for the bipolar and j.f.e.t. devices the limits

are symmetrical about zero volts but substantially less than the supply voltage of $\pm 15V$ if correct operation is to be assured.

In the MOSFET input devices CA3140 and CA3160 the common mode voltage may exceed the power supply by +8V or -0.5V without damage and these devices will operate correctly with input down to the negative supply rail. The positive operational limit is similar to the other op-amps.

SAFE DIFFERENTIAL INPUTS

The safe differential input parameter shows the maximum voltage that can be applied to the inputs of an op-amp without damage. The voltage is measured with respect to the non-inverting input.

The value of $\pm 30V$ for the 741C shows that one input can be shorted to one power supply rail whilst the other is connected to the opposite supply. The 741C will be safe and undamaged no matter what input voltages are placed on the input terminals providing we do not exceed the power supply voltages.

Not so the 709C or the CA devices. The old design of the 709C will suffer damage if the difference in input exceeds 5V in either direction. Any designer using one of these must seriously consider this limitation, and it is a primary reason for the immediate take over of the 741C when it was released.

Again we should note that the CA devices also suffer from a low differential input range but this is due to the metal oxide gate protection diodes rather than the limits of the input transistors themselves. In fact this only serves to show that whilst the MOSFET inputs of the CA devices excel in common mode input range their design also suffers a limitation in differential input range that needs to be considered.

Table 1.
All values based on split power supply of $\pm 15V$ except CA3160 which is 0 to 15V single supply

Characteristic	709C			741C			TL071C			LF351			CA3140			CA3160		
	min.	typ	max.	min.	typ	max.	min.	typ	max.	min.	typ	max.	min.	typ	max.	min.	typ	max.
Supply voltage range (V)	—	—	± 18	—	—	± 18	—	—	± 18	—	—	± 18	± 2	—	± 18	± 5	—	± 16
Input resistance (ohms)	50k	250k	—	300k	2M	—	—	10^{12}	—	—	10^{12}	—	—	1.5×10^{12}	—	—	1.5×10^{12}	—
Input bias current (Amps)	—	0.3 μ	1.5 μ	—	80n	500n	—	30p	200p	—	50p	200p	—	10p	50p	—	5p	50p
Input offset current (Amps)	—	100n	500n	—	20n	200n	—	5p	50p	—	25p	100p	—	0.5p	30p	—	0.5p	30p
Output resistance ohms	—	150	—	—	—	—	—	—	—	—	—	—	—	60	—	—	—	—
Output current mA	—	—	—	—	—	—	—	—	—	—	—	—	—	—	—	12	22	45
Output voltage swing (2k load)	± 10	± 13	—	± 10	± 13	—	± 10	± 12	—	± 12	± 13.5	—	+12 -14	+13 -14.4	—	12	13.3 0.002	0.01
Safe common mode input voltage range	—	—	± 10	—	—	± 15	—	—	± 15	—	—	± 15	—	—	± 15	-0.5	—	23
Safe differential input voltage range	—	—	± 5	—	—	± 30	—	—	± 30	—	—	± 30	—	—	± 8	—	—	± 8
Operational input voltage range	± 8	± 10	—	± 12	± 13	—	± 10	± 11	—	± 11	+15 -12	—	-15	-15.5 to +12.5	+11	0	-0.5 to 12	10
Slew rate V/ μ S	—	—	—	—	0.5	—	—	13	—	—	13	—	—	9	—	—	10	—

min = minimum

typ = typical

max = maximum

CIRCUIT EXAMINATION

Before leaving the reader to look at a number of his or her own circuits let us examine a few simple projects and see what limits are placed on us by the op-amp in use.

In 1971 the author constructed a regulated power supply unit using a 709C amplifier using the circuit shown in Fig. 2. The frequency compensating capacitors and resistors needed to stabilise the 709C have been left out for simplicity. This design was carried out before the introduction of dedicated power supply chips notably the 723C. The power supply unit is still in use after 15 years.

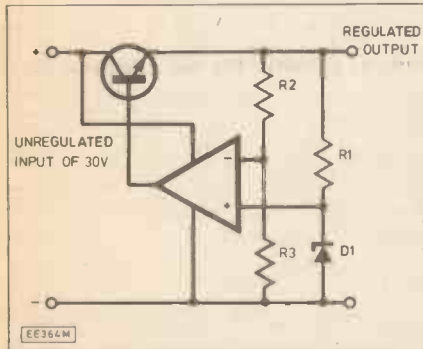

Fig. 2. Circuit diagram for a regulated power supply.

Looking carefully at Fig. 2 what can we decide as the limits for this power supply. If we assume that the input voltage is 30V, the guaranteed maximum and minimum output voltages from the op-amp will be +5V to +25V referred to the negative rail. With a single transistor drop of 0.6V this will limit our output range to +4.4V to +24.4V for a 741C device.

With this output limit what limits are imposed by the input conditions? For the 741C it is impossible to guarantee satisfactory operation if the Zener diode D1 has a voltage less than 3.0V a better choice will be 3.3V. This will, however, limit the minimum output in this circuit to a voltage which will allow resistor R1 to provide a voltage drop from the output voltage to allow stable Zener operation. A suitable output minimum may therefore be 5.0V.

Resistors R2 and R3 in Fig. 2 provide a potential divider such that in normal operation the voltage at the junction of the resistors R2 and R3 will be equal to the Zener voltage. The input bias current maximum of 500nA will not cause us any difficulty as in this case the values of R1 and hence the Zener current and the current through R2 and R3 can be made to swamp any variation in the op-amp input current.

We must, however, look at the minimum gain of the transistor (this again varies with collector current) and the maximum output current of the op-amp, to ensure that at the maximum

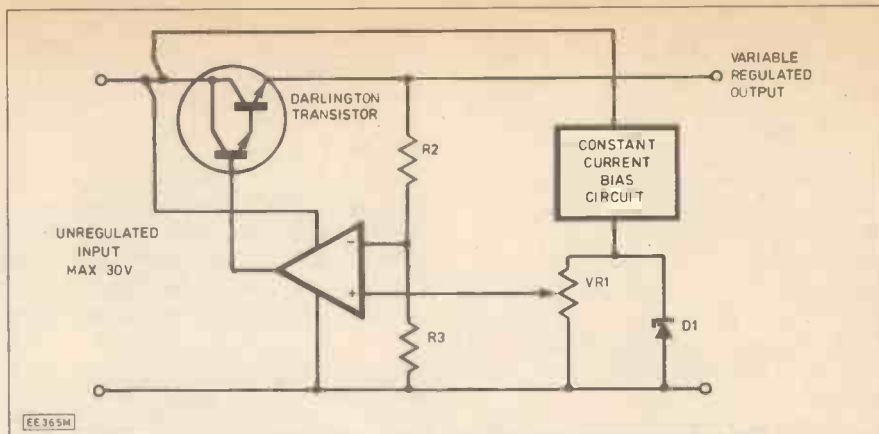

Fig. 3. Circuit diagram for a variable regulated power supply.

current output of the PSU, the op-amp can supply sufficient drive to the transistor. To overcome this current difficulty the transistor could be made a Darlington type but the transistor voltage drop then increases to 1.2V.

Thus with a 741C it is impossible to guarantee satisfactory operation except where the output exceeds 5V. The j.f.e.t. op-amps are only marginally better being limited in output and input as is the bipolar 741C, and we are unable to take any advantage from their low input requirements.

The MOSFET input devices however offer some possibilities. With either CMOS's output of below -14V to +12V this equates to a power supply output voltage of 0.4V to 26.4V. The input can be allowed down to zero volts without trouble, hence with these devices we could, with a small modification, build a 0.5V to 25V power supply, and with a Darlington transistor this output becomes 0V to 25V (Fig. 3).

In Fig. 2 we derived the Zener current from the stable PSU output voltage, but in Fig. 3 we need to provide a stable reference voltage to the non-inverting input of the op-amp. Potentiometer VR1 allows a proportion of this stable reference voltage, down to zero volts to be fed to the non-inverting input of the op-amp and allows the output voltage to be varied linearly over the full range.

Our greatest problem is the heat output of the Darlington transistor. In the worst case where the output is at a very low voltage say 0.1V this leaves the balance of 29.9V across the transistor. With a 1A output the transistor dissipates nearly 30 watts ($29.9V \times 1A$) which must be dissipated.

In normal power supply designs a transformer feeds a capacitor via a diode bridge and if a value of capacitor of 2000 μ F per amp of output current is selected an additional drop of 3-5V at 100Hz needs to be accommodated. Thus for a peak input of 30V the minimum input voltage to the op-amp will be 26.5V and the op-amp's maximum output will be 21.5V (741C)

limiting the practical PSU output to 20-9V.

PEAK VALUE DETECTOR

Let us now consider the circuit in Fig. 4. This is the circuit of a peak value detector. Op-amp A1 pumps a voltage via the diode D1 into the capacitor C1 until the voltage at the output equals the input voltage.

With an input below the output the capacitor discharges via the resistor R1, the diode reverse current and through the input of A2 (its input bias current). If the value of bias current of A2 is not to affect the discharge time then it is certain that A2 will be a j.f.e.t. or MOSFET type.

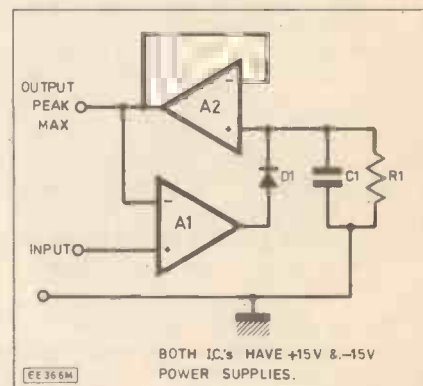

Fig. 4. Peak value detector circuit.

The reverse leakage current of the diode D1 can be ignored being similar to a j.f.e.t. input bias current. There are however no limits set on A1 at present. The input to the inverting input of A1 from A2 will be very low impedance and can be ignored.

The input to the non-inverting input will decide the choice of device for A1. With a low input impedance to be matched A1 could be a 741C, but the packages containing more than one op-amp will be more useful. Therefore if A2 is a TL071 type it is as easy to use a TL072 with two amplifiers in the one 8-pin package and make A1 and A2 identical devices. In this case device selection has been made through considerations of p.c.b. space and cost.

RIAA INPUT AMPLIFIER

For our final circuit we return to the non-inverting amplifier Fig. 1a and take a look at the use of an op-amp as the input and matching stage of an audio power amplifier. The practical circuit of an RIAA input amplifier is shown in Fig. 5.

Remembering the circuit of Fig. 1a we could at d.c. achieve an output of 400mV with a typical 741C (actually it is better to use the 748C uncompensated op-amp with an external 10pF capacitor rather than the 30pF internal capacitor of the 741C), but at a maximum the output voltage could rise to 100x max. input bias current x 47k ohms) i.e. 2.35V which is unacceptable.

However, if we alter the circuit slightly we can overcome this difficulty. Since with an audio amplifier we

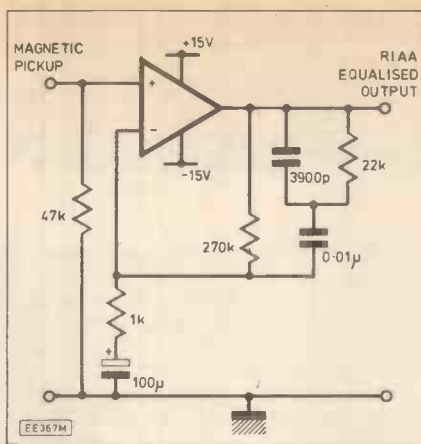

Fig. 5. RIAA input amplifier circuit.

do not need gain below say 10Hz we can arrange the circuit so that at d.c. the gain is x1. Looking at Fig. 5,

capacitor C1 blocks the d.c. path from the output to the ground in the feedback loop and so at d.c., if we look back and compare with Fig. 1a, the value of resistor R2 becomes infinity and the d.c. gain becomes 1. But at a frequency of 10Hz, the capacitor C1 represents about 160 ohms which is small compared to the 1 kilohms of R3 and decreases with increasing frequency. I have included this to show that all is not too black for the 741C.

Hopefully, the reader will now be able to look at a circuit and decide why an op-amp other than the 741C has been chosen but as now the price differences of the 741C and the alternatives is so small the author cannot see any other effect other than the reduction in use of 741C's.

In the long term it will surely be "so long 741 goodbye but not forgotten". □

SHOP TALK



BY DAVID BARRINGTON

Super Alpha

For those constructors living in the Sussex area, we have received news of yet another new mail order component supplier starting up trading. (There must be a "high-tech component corridor" in the Sussex/Hampshire area, or is it that people are again waking up to the excitement and opportunities of electronics?)

Offering a comprehensive range of components, we have been informed by the proprietor, Roy McKenzie, that the aims and intentions of **Super Alpha Electronics** is to run a fast mail order service tailored to meet the needs of the constructor. All the popular components will be available off-the-shelf and no minimum order restrictions will be levied.

It is also hoped that complete kits, including printed circuit boards, will eventually be produced. For further information **Super Alpha Electronics** can be contacted on **0243 607108**.

Spring Sale

We have just had the "Spring Fashion Shows", now we have the "Spring Component Sales". Although sales are usually the result of annual stocktaking, the items offered are nearly always excellent value for money and a trip to your local supplier or a browse through forthcoming advertisements can usually unearth real bargains.

Leading the spring "star buys" must be the **Elan Enterprises 64** home computer available from **Greenweld**. Launched on the market just too late to establish a strong public following, the **Enterprise 64** is a Z80 based machine which boasts 64K of RAM, built-in wordprocessor, colour,

graphics, built-in joystick, stereo sound, printer port and cassette interface.

Originally priced at about £199, **Greenweld** are offering the last few hundred, in their original boxes, at only £39.95.—Yes £39.95, including VAT and postage!

If you want one, we suggest you ring them on **0703 772501/783740** before they disappear forever. Whilst you are phoning, ask about their special "Sinclair Microvision TV" bargain offer.

EE Equaliser

Because of the very high voltages present in the **EE Equaliser** air ioniser, we strongly recommend that constructors only use top quality components rated as indicated in the "comp list".

The high voltage disc ceramic capacitors should not be too difficult to locate. These are currently stocked by **Electromail**, **Omega**, **Marco** and **Circuit**.

The high voltage resistors appear to be only available from **Maplin**, code HV Res V2M2. The case used to house the components for this project *must* be a plastic type. The printed circuit board is available through the **EE PCB Service**, code **EE-566**—see page 284.

Spectrum Sound Synthesiser

In this month's On Spec pages, details are given for a *Sound Synthesiser*.

This circuit is built around the **AY-3-8913** sound generator chip. If readers experience any difficulties in locating this device, it is available through **Maplin**; order code **RA91Y**.

The audio amplifier chip, 1MHz crystal and the LS series i.c. devices are now fairly common items and most component suppliers should carry stocks.

We understand, from a reader's phone call and subsequent checks, that stocks of the 28-way edge connector are in very short supply and, in some cases up to three weeks delivery times are being quoted to customers.

EE Apex Hi Fi Amplifier

If readers are to obtain the very high performance expected from the **EE Apex Hi Fi Amplifier** then we strongly advise constructors to adhere to the components specified.

A complete kit of parts, including printed circuit boards, for the "standard" or "enhanced" version may be purchased from **Audiokits Precision Components**. Also, separate individual circuit stage kits, to enable the constructor to spread the costs over several months, are available. The p.c.b.s. are also available separately.

For a complete listing and prices write to **Audiokits Precision Components, Dept EE, 6 Mill Close, Borrowwash, Derby DE7 3GU**.

Fridge Alarm

The glass bead thermistor type **G16/GL16** used in the *Fridge Alarm* should not prove too difficult to source. However, we have only been able to find one source which lists the **ICL7611 CMOS** op amp i.c. This device is currently listed by **Omega Electronics**.

Also, the only stockist we have been able to find for the 4-pole 3-position slide switch is **Maplin** and should be ordered as: **FH38R** (4-pole slide). You can, of course, replace the slide switch with the more common 2-pole 3-way slide or rotary switch.

Audio Logic Tracer

If readers wish to use the same probe case as shown in the photographs of the *Audio Logic Tracer*—this month's *Digital Troubleshooting Test Gear* project—this was purchased from **Electromail**: stock no. **508 217**.

The earpiece used in this project is an 8 ohm magnetic type and should be available from most of our advertisers. The rest of the components are all readily available and should not cause buying problems.

We do not envisage any component purchasing problems for the *Windscreen Washer Warning* or the *Simple Timer* (Exploring Electronics) projects.

FOR YOUR ENTERTAINMENT

BY BARRY FOX

Business Sense

Two old stories with a modern twist.

Forty years ago Joel Tall invented the Editall tape editing block which most professional studios use. An American, Tall had volunteered for the Navy in 1942 but was turned down because there was something wrong with his mouth, "I am not going to eat the Japs", he argued but Uncle Sam was adamant.

The CBS radio network offered Joel Tall a job and he stayed 21 years. He started off as a technical trouble shooter. His first job was solving the mystery of a transmitter that went unstable as soon as a maintenance engineer had checked it, pronounced it perfect and gone home. Tall realised that closing the transmitter cabinet's door produced a resonant cavity which sent it into oscillation.

At that time all recordings were made on wire or disc. Tall developed a technique for making wire recording edits. After cutting and tying the wire in a knot he would aneal the joint with the hot end of a cigarette. This erased all magnetism at the knot and produced the equivalent of a "blooped" optical film edit—black ink masks the cemented joint in the film sound track.

At the end of the war Jack Mullin, who was subsequently Bing Crosby's tape engineer, brought a German Magnetofon tape recorder back to America. CBS first used it in 1947 to put together a radio documentary called "The British Crisis". (Nothing changes!) They had to use very fragile paper tape because there were no plastics available. The tape was cut with scissors, held flat with a steady hand and stuck together.

One night in 1949 Tall quite literally dreamed up the answer—a curved and grooved channel, precision machined so that it held the tape firm for a cut and splice. In Tall's own words, the Editall made him "scads of money".

The Depression

Cut to before the war. Tall, like millions of other young Americans, was trapped by the Depression. He had a fascination for radio and during the 20s survived by going from door to door offering to "fix anything for one dollar".

In the 30s, radio firms employed him to troubleshoot on a professional basis. One had replaced rubber-wound components with cotton-wound replicas because they were cheaper. Once sold, the sets flickered on and off as the humidity changed. Tall pinpointed the fault just ahead of the firm going bust. It was work like that that prepared him for the years with CBS, the Editall block and those "scads of money".

Homework

Cut to Boston, Massachusetts. The Bose Corporation is by far the most successful loudspeaker company in America. It employs 1,500 people and has a 10 per cent share of the enormous US market—in which literally hundreds of loudspeaker firms battle for sales.

The Bose Corporation was started by Dr. Amar Bose who was Professor of Electrical Engineering at the Massachusetts Institute of Technology. Bose began teaching at MIT in 1956 and founded the Bose Corporation in 1964.

During the war, Bose's father had no work and the young Amar supported his family by repairing valve radios. He was so successful at it that, with other kids on the block, he organised a primitive home production line. Faulty radios were booked in at one end and repaired radios came out at the other.

Often early radios would have several completely redundant valves; they were built in simply to glow in the dark and look like value for money. Bose soon learned how to spot what was wrong with the parts that mattered and then just told one of the other kids how to fix it. He then tracked down the fault on the next set in line.

Call For Jobs

Cut to today. I have often thought that anyone with electrical and electronic skills could earn a very good living today by knocking on doors and offering to repair things. But there are two snags in this idea. Most modern electronics is unrepairable—it relies on replacement modules or i.c.s which may well be unobtainable for equipment more than few years old.

— On Cue —

If you are in a disco and see the disc jockey doing impossible things with a compact disc record, he is probably using the new professional player from Technics.

The laser head in the SL-PI200 tracks across the disc on a linear motor. The optics are attached to a coil which moves along a guide rod between two bar magnets. In this way the laser can search out any part of a one hour recording within 0.6 seconds. Other players move the pick-up with a train of gears and have much slower access time.

By using the new system, the DJ can now pre-set a start or cue point with an accuracy better than 0.1 seconds. So he can cut between musical tracks almost as quickly with a single pro player as with two conventional players.

The player chassis is die cast from heavy metal. Even the most clumsy DJ cannot knock the laser off its cue point and make the music start in the wrong place.

Playing speed and musical pitch can be varied by 8 per cent up or down with a slider control. This lets a DJ alter the playing time of a piece of record to fit an available slot, for instance at the end of a broadcast or before a commercial break. The pitch varia-

The other problem was summed up to me by Joel Tall. "I was lucky, I was blessed with a troubleshooter's sixth sense. It's something that engineers either have or have not got. If I can hear something wrong I know where to look, and if I can't hear anything then I also know where to look."

Not many people have that sixth sense. Like a musical ear, you can't acquire it.

But a casual remark by a self-made millionaire on television recently triggered an alternative thought. I'll pass it on for the benefit of anyone out there who is without a job, but with initiative.

Every home in Britain now has electronic equipment which is too complicated for most or all of the family to use. For instance, people with video recorders never learn to set the clock timer or they are baffled by the electronic self-seeking circuitry which is supposed to make tuning easier on modern TV sets.

Also, we have the people who have a word processor but can't make head nor tail of the manual; or they have bought a compact disc player which can be programmed to play selected tracks of a record in any order, but only if they can work out how to program the programmer. Then there are those who have a gramophone which needs baffling adjustments of the pickup arm and cartridge, or can't wire in a new phone with a non-standard socket.

Good Money

There is good money to be made from doing the modern equivalent of what Joel Tall and Amar Bose did all those years ago. All you have to do is walk from door to door over a weekend, knocking on doors and asking "Do you have anything in your house which you don't know how to use—if you do, I'll teach you."

tion lets a DJ with a good musical ear match the last note of one piece of music with the first note of the next.

The oddest feature of all is the facility for "scratch play". On a conventional gramophone, "scratching" is done by moving the record by hand, backwards and forwards under the pickup. It creates the stutter effect now heard on some pop records. The same technique cannot normally work with CD; the decoder which converts the digital pulses into analogue music relies on a stream of digital bits arriving at a constant speed of just over four million a second.

The Technics player "scratches" with a modified pause control. Normally when the pause control of a CD player is pressed, the laser stops tracking across the disc and the sound mutes. In the new player the laser stops tracking but the player does not mute. It repeats the same musical phrase over and over again, like an old-fashioned gramophone record stuck in the groove. The repetition time varies depending on where on the disc the laser is reading, because the rotational speed for a compact disc varies as the laser moves from the short inside spiral tracks to the longer ones at the outside.

SPECIAL OFFER...

**3210 TRUE RMS
MULTIMETER**

£119

including VAT
and carriage



**3225
MULTIMETER**

£89

including VAT
and carriage

These high quality digital multimeters are designed and manufactured in Britain by Black Star and are guaranteed for one year. We are pleased to be able to offer them to readers at a special discount (a saving of over 15% on the normal price). The units are

battery operated (>7000 hours battery life) and come complete with instruction manual, test leads and batteries.

Overseas readers please write for a quote on delivery etc.

Post coupon with remittance to Black Star Ltd. (EE Multimeter Offer), 4 Stephenson Road, St. Ives, Huntingdon, Cambs PE17 4WJ. Tel: 0480 62440.

SPECIFICATION

DC VOLTAGE		Accuracy (3225)	
Range	Resolution	Accuracy (3210)	Accuracy (3225)
200mV to 1000V (five ranges)	100µV to 1V	± (0.1% rdg + 1 d)	± (0.25% rdg + 1 d)
Maximum permissible input voltage: 1100V d.c. or peak a.c. Input impedance: 10M Ω ± 0.1%			
DC CURRENT		Accuracy (3225)	
Range	Resolution	Accuracy (3210)	Accuracy (3225)
200µA to 10A	100nA to 10mA	± (0.15% rdg + 1 d)	± (0.3% rdg + 1 d)
Overload protection: 2A (250V) fuse except 10A range. Max. on 10A range is 20A for 10 sec.			
AC VOLTAGE TRUE RMS (3210) AND AVERAGE READING (3225)			
Range	Resolution	Accuracy	
200mV to 750V	100µV to 1V	45Hz-1kHz	1kHz-10kHz, 10kHz-20kHz
		± (0.5% rdg + 2 d)	± (1.5% rdg + 2d), ± (3% rdg + 5 d)
		45Hz-400Hz	± (2% rdg + 2 d), ± (5% rdg + 5 d)
		± (0.5% rdg + 2 d)	± (3% rdg + 5 d), ± (5% rdg + 5 d)
Accuracy specifications apply for inputs between 20% and 100% of full scale. Maximum permissible input voltage: 200mV range 250V rms, 400V d.c. All other ranges 750Vrms, 1100V peak a.c. 10 ⁶ VxHz. Input impedance: 10M Ω.			
AC CURRENT		Accuracy 3210 True RMS and 3225 Average Reading 45Hz-1kHz	
Range	Resolution	Accuracy	
200µA to 10A	100nA to 10mA	± (1% rdg + 2 d)	
		± (2.5% rdg + 2 d)	
Overload protection: 2A (250V) fuse except 10A range. Max. on 10A range is 20A for 10 sec.			
RESISTANCE		Accuracy (3225)	
Range	Resolution	Accuracy (3210)	Accuracy (3225)
200Ω to 20MΩ	100mΩ to 10kΩ	± (0.15% rdg + 1 d)	± (0.3% rdg + 1 d)
		± (0.2% rdg + 1 d), ± (1% rdg + 2 d)	± (0.4% rdg + 1 d), ± (1% rdg + 2 d)
Maximum permissible input voltage: 250V d.c. or a.c. r.m.s. Plus diode test and continuity test.			

Please supply:

Quantity	Item	Value
	3210 True RMS Multimeter	£
	3225 Multimeter	£
	Total	£

Visa/Access/American Express
 or cheque No
 Signature
 Name
 Address

OFFER CLOSSES Friday, June 5, 1987
 Name
 Address

 Post to: **Black Star Ltd. (EE Multimeter Offer), 4 Stephenson Rd, St Ives, Huntingdon, Cambs PE17 4WJ. Tel: 0480 62440**

Please complete both parts of the coupon in BLOCK CAPITALS

DIGITAL Trouble Shooting Part Seven

MIKE TOOLEY BA

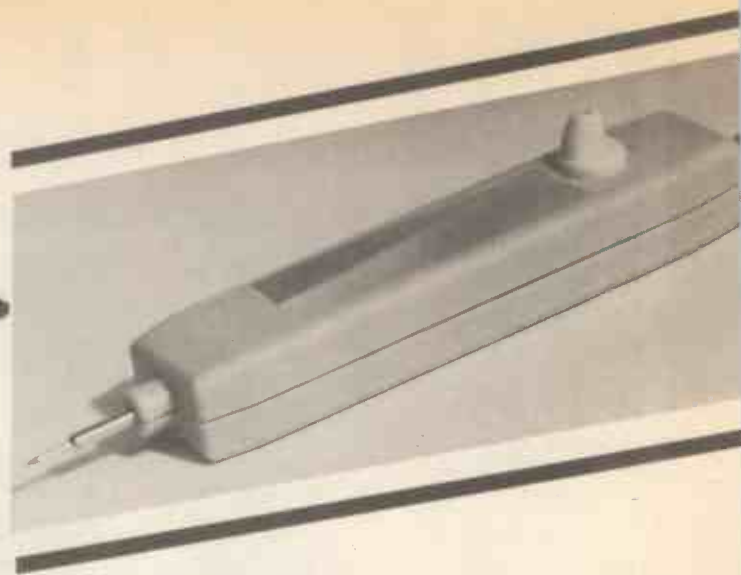

Our nine part series on Digital Troubleshooting aims to provide readers with a practically biased introduction to the diagnosis of faults within digital equipment. The series should also be of interest to anyone wishing to update their knowledge of modern digital devices and circuitry.

IN LAST month's instalment of *Digital Troubleshooting* we dealt with semiconductor memories. This month we examine techniques for input to, and output from, microprocessor systems. We shall be explaining some fundamental concepts associated with parallel and serial data transfer, describing methods used for controlling input and output, and introducing several of the more popular programmable input/output (I/O) devices.

Our companion Digital Test Gear project involves the construction of an *Audible Logic Tracer*. This unusual device provides a means of investigating the nature of signals present in a microprocessor based system without recourse to an oscilloscope.

I/O REQUIREMENTS

Without a means of input and output (I/O), a microprocessor system would be of little use. The amount of I/O provided in any particular microprocessor system is, of course, largely determined by the range of applications envisaged. A simple home computer, for example, would, as an absolute minimum, be expected to accept inputs from a keyboard and send its output to a conventional TV receiver—the output being modulated on an r.f. carrier.

In addition, the system might provide input and output facilities for use in conjunction with a conventional domestic tape recorder as well as a further output for driving a printer. The minimum I/O

requirement to be expected from a simple home computer is shown in the block diagram Fig. 7.1.

On the other hand, a microprocessor based system for controlling an industrial process might have no need for a keyboard or display since it would almost certainly be remotely programmed and monitored by a "ghost" microcomputer (using a conventional serial RS-232C link). The controller might provide for as many as twenty-four separate input and output lines for controlling such external hardware as relays, motors, and lamps (see Fig. 7-2).

MEMORY MAPPED I/O VERSUS PORT I/O

A basic distinction exists between systems which treat I/O devices as one, or more, memory addresses and those which assign specific port addresses to each I/O device. In either case, data is output by simply writing data to the appropriate memory or port address. Conversely, data is input by simply reading it from the appropriate memory or port address.

Using memory mapped I/O, the CPU treats I/O operations in exactly the same way as operations performed on memory. A proportion of the memory space is then reserved for I/O (it cannot, at the same time, be assigned to RAM or ROM!). Port I/O, on the other hand, reserves a set of port addresses which are quite independent of the conventional memory space. Port addresses are

Fig. 7.1. The I/O provision in a simple home computer.

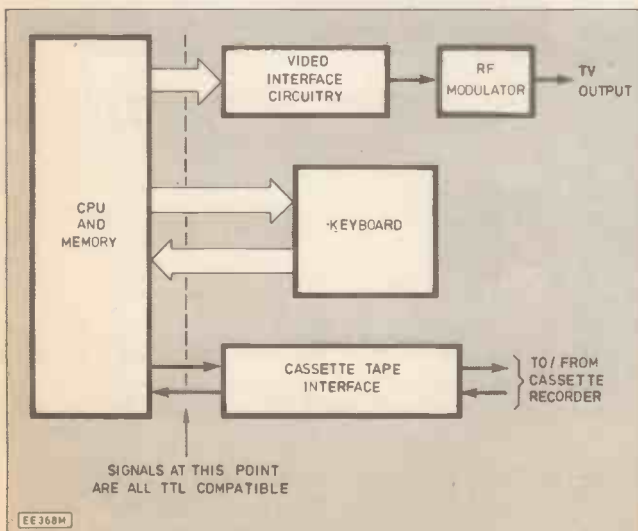
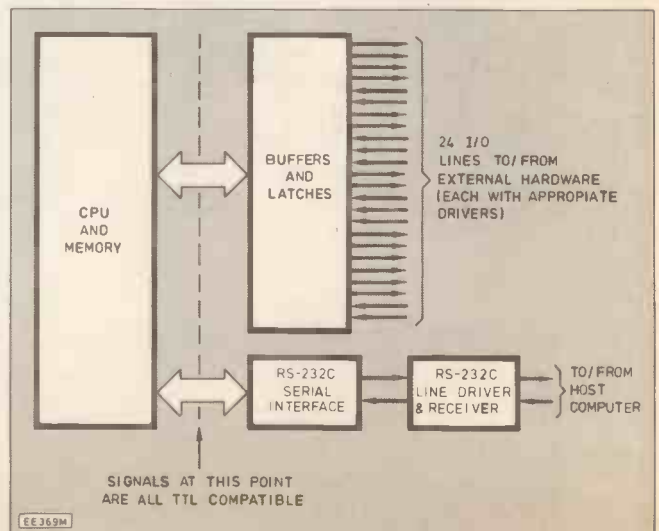
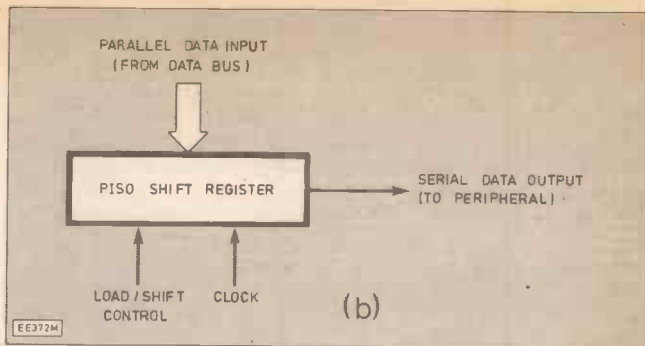
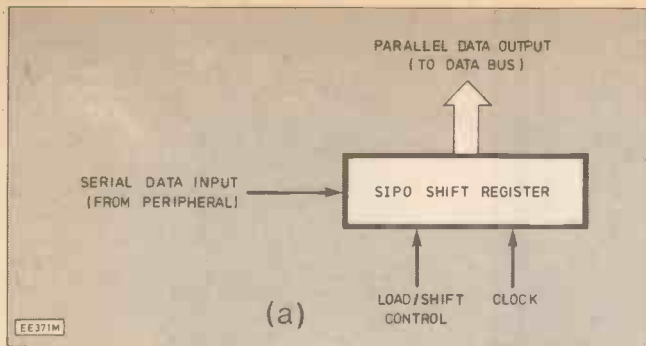

Fig. 7.2. The I/O provision in an industrial control system.





distinguished from memory addresses by means of signals present on the control bus.

Taking the Z80 microprocessor as an example, the following (active low) control signals are used to distinguish memory and port I/O operations:

MREQ—the memory request line goes low whenever the CPU is performing a memory read or write operation

IORQ—the input/output request line goes low whenever the CPU is performing an I/O operation

To aid the process of port I/O, instructions are available in the Z80 instruction set which deal specifically with port input and output. As examples:

OUT (FFH),A—writes the contents of the accumulator (an eight bit value) to hexadecimal port address of FF

IN A,(FFH)—reads the contents of hexadecimal port address FF and places the result in the accumulator

PARALLEL VERSUS SERIAL I/O

Another important distinction has to be made between parallel and serial I/O. In the former case, a byte of data is transferred at a time (thus necessitating an 8-bit buffer or latch) whereas, in the latter case, data must be transferred a bit at a time.

Parallel I/O is thus reasonably straightforward as witnessed by the simple single-byte parallel I/O arrangement shown in Fig. 7.3. Here a standard 8-bit latch is used for output and an octal tri-state buffer is used for input. This arrangement is simple but not very flexible and a better solution would be that of making use of a programmable parallel I/O device.

Since the data present on a microprocessor bus exists primarily in parallel form (it is "byte wide"), serial I/O is a little more complex. Serial input requires a means of conversion of the serial input data to parallel data in a form which can be presented to the bus. Serial output, on the other hand, requires a means of conversion of the parallel data present on the bus into serial output data.

In the first case, conversion can be performed with a serial input parallel output (SIPO) shift register whilst in the second case a parallel input serial output (PISO) shift register is required. These arrangements are depicted in Fig. 7.4 and, whilst both may be

Fig. 7.4. (a) Serial input using a SIPO shift register. (b) Serial output using a PISO shift register.

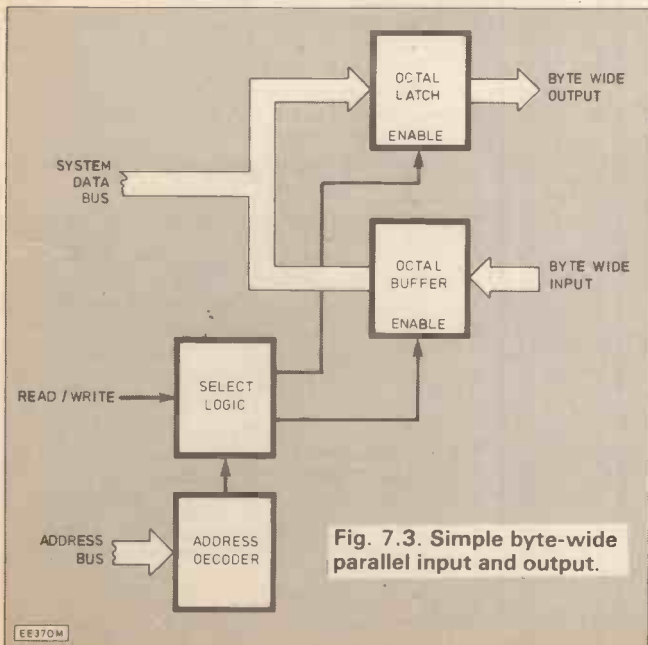

Fig. 7.3. Simple byte-wide parallel input and output.

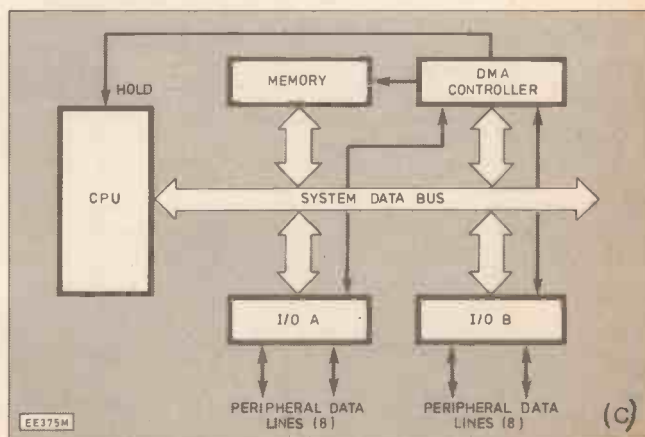
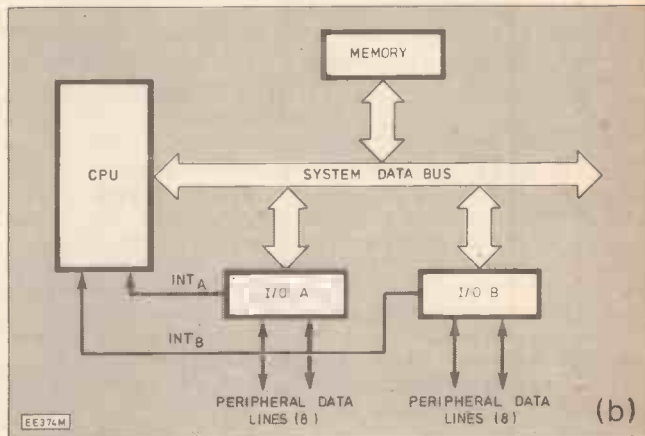
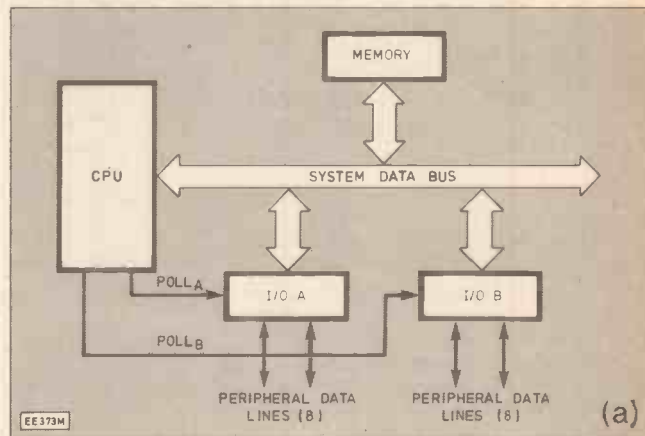

Fig. 7.5. Basic I/O control methods. (a) Programmed (polled), (b) Interrupt, (c) Direct memory access (DMA).

implemented using conventional logic devices, the most effective solution to implementing such an interface is again with the aid of a dedicated programmable device.

I/O CONTROL METHODS

There are three basic methods of controlling I/O operations. These vary in complexity and flexibility and each has its advantages and disadvantages. The simplest method, and that which is perhaps the most obvious, is that of allowing the CPU to control *all* I/O operations using its control program. This method, known as "programmed I/O" or "polled I/O", ensures that the CPU has full control of the situation but is particularly inflexible and rather slow.

Essentially, the CPU periodically asks (polls) each peripheral device (via its respective I/O device) whether it requires service. If a service request is detected the CPU will then execute the necessary service routine. Once a service request has been honoured, any requests for service generated by other peripheral devices will be ignored; they will simply have to wait until the CPU becomes available to process their request for service!

An arguably better method, but slightly more complex, is that of allowing peripheral devices to "interrupt" the normal CPU operation. In such a case, and depending upon the state of its "interrupt flag", the CPU will have to suspend its current operation (preserving any important parameters as well as the return address on the stack) before executing the required service routine.

Interrupts may be "prioritised" in hardware such that the most important peripheral device is attended to first. A particular example might be a vehicle braking system; we would probably want the CPU to respond to brake failure and generate a warning regardless of what else was happening at the time!

A third, and much more complex alternative, is that of giving external devices full access to the memory space of the system without involving the CPU in any of the data transfers. This is known as "direct memory access" (DMA) and is a very powerful technique. It has the advantage that data can be transferred at an exceptionally fast rate (since CPU intervention is not required) and is the means by which, for example, data is transferred to and from a hard disc drive.

DMA is not really appropriate in simple control applications but it is worth mentioning in order to make the story complete! The three I/O control methods are illustrated, in simplified block schematic form, in Fig. 7.5.

PARALLEL I/O DEVICES

Having attended to the basic concepts of microprocessor system I/O, it is about time we turned our attention to some common programmable I/O devices. The internal registers of a typical programmable parallel I/O device is shown in Fig. 7.6

Parallel I/O devices enjoy a variety of names depending upon their manufacturer. Despite this, parallel I/O devices are remarkably similar in internal architecture and operation with only a few subtle differences distinguishing one device from the next. The pinning details for some common programmable parallel I/O devices is shown in Fig. 7.7.

The following types are commonly encountered:

- 6520 Peripheral Interface Adaptor (PIA)
- 6521 Peripheral Interface Adaptor (PIA)—similar to the 6520
- 6522 Versatile Interface Adaptor (VIA)
- 6820 Peripheral Interface Adaptor (PIA)
—equivalent to the 6520
- 6821 Peripheral Interface Adaptor (PIA)
—equivalent to the 6521
- 8255 Programmable Parallel Interface (PPI)
- Z80-PIO Programmable Input/Output (PIO)

As their names imply, programmable parallel I/O devices can normally be configured (under software control) in one of several modes:

- (a) all eight lines configured as inputs
- (b) all eight lines configured as outputs
- or (c) lines individually configured as inputs or outputs

In addition, extra lines are usually provided for "handshaking". This is the aptly named process by which control signals are exchanged between the microcomputer and peripheral hardware.

The nomenclature used to describe port lines and their function tends to vary from chip to chip but here again there is a reasonable degree of commonality. The following applies to most of the devices listed previously:

PA0 to PA7 Port A I/O lines; 0 corresponds to the least significant bit (LSB) whilst 7 corresponds to the most significant bit (MSB).

CA1 to CA2 Handshaking lines for Port A; CA1 is an interrupt input whilst CA2 can be used as both an interrupt input and peripheral control output.

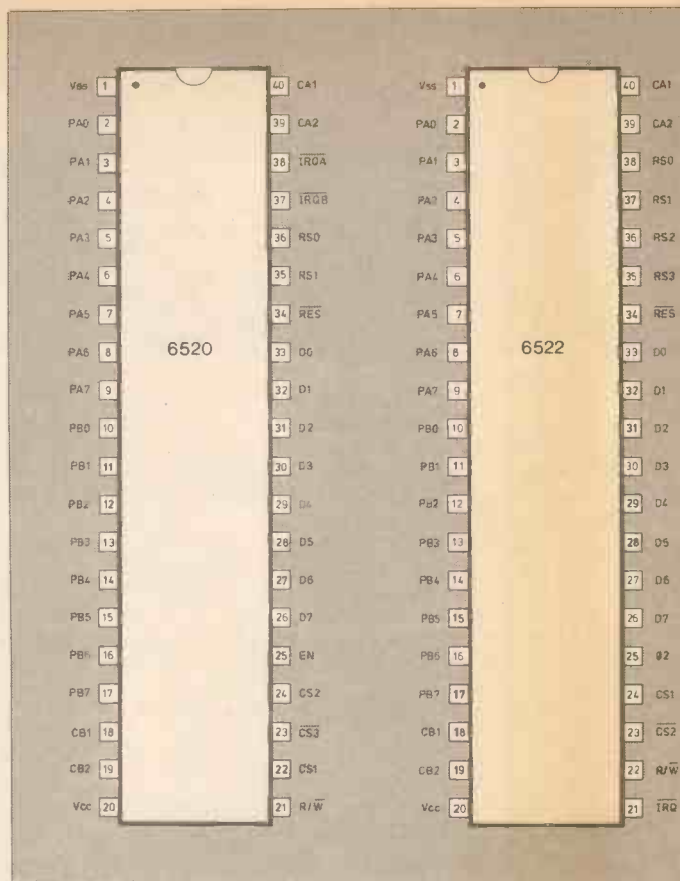

PB0 to PB7 Port B I/O lines; 0 corresponds to the least significant bit (LSB) whilst 7 corresponds to the most significant bit (MSB).

CB1 to CB2 Handshaking lines for Port B; CB1 is an interrupt input whilst CB2 can be used as both as interrupt input and peripheral control output.

The electrical characteristics of an I/O port tend to vary from chip to chip however signals are invariably TTL compatible. Several programmable parallel I/O devices have port output lines (usually the B group) which are able to source sufficient current to permit the direct connection of the base of a conventional; or Darlington type transistor. This device can then be used as a relay or lamp driver. Alternatively, high-voltage open-collector octal drivers may be connected directly to the port output lines.

SERIAL I/O DEVICES

Serial data may be transferred in either synchronous or asynchronous mode. In the former case, all transfers are carried out in accordance with a common clock signal (the clock must be available at both ends of the transmission path). The pin connections for some common programmable serial I/O devices is shown in Fig. 7.8.

Asynchronous operation involves transmission of data in "packets"; each packet containing the necessary information required to

Fig. 7.6. Internal registers of a typical programmable parallel I/O device.

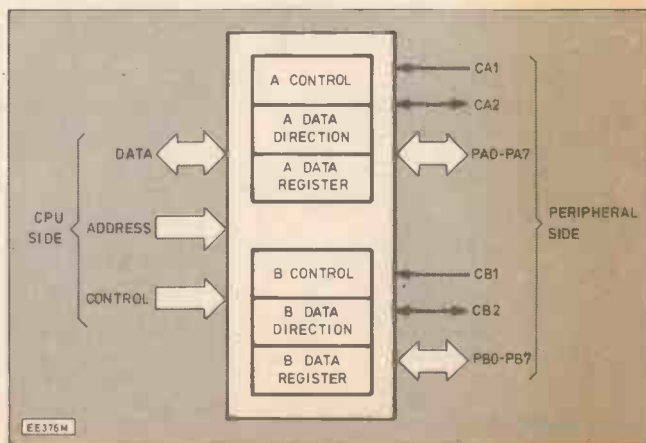

The signals generated and used by programmable serial I/O devices are invariably TTL compatible. It should be noted that, in general, such signals are unsuitable for anything other than the shortest of transmission paths (e.g. between a keyboard and a computer system enclosure). Serial data transmission over any appreciable distance invariably requires additional buffers and level shifters between the serial I/O device and its associated transmission path.

Fault finding on I/O devices

Since programmable parallel I/O devices are reasonably predictable in operation, it is possible to detect faults by simply measuring the conditions present on the various input and output lines. Fault finding on parallel I/O devices is thus a fairly straightforward task—the same cannot be said for their serial counterparts!

One should first ensure that a suspect programmable parallel I/O device is actually being selected by the CPU. This can be achieved by monitoring the state of the various chip control lines using nothing more than a logic probe.

Having established that a particular device is being selected, the next task involves determining what, if anything, is happening on the peripheral side of the chip. If possible, a short routine should be written to "exercise" the port (i.e. read or write data as appropriate) and the resulting logic conditions should be checked.

Failure of an external driver transistor will often result in damage to an associated latching buffer/driver within a programmable I/O device (note, however, that damage may not necessarily extend to all eight lines in a particular port group). It is, therefore, well worth checking external devices and hardware before replacing a failed parallel I/O device!

Where devices are socketed, it may be expedient to substitute a device which is known to be operational for one which is suspect. *Do ensure that you switch off and disconnect any external hardware before attempting to do this!* As with semiconductor memories, it is advisable to fit a socket before replacing a device which is considered suspect.

Faults on programmable serial I/O devices are, unfortunately, less easy to pinpoint. Here again it is important to investigate the conditions which are prevalent on the CPU side of a device (notably the various control bus and chip select signals) before making any other tests.

Having ascertained that the device is being selected, it is then worth checking the state of the RTS and CTS lines (for output) and IRQ or INT lines (for input). It is also worth checking that the clock signals are present and correct (a typical transmit/receive clock would be at 500kHz). Furthermore, due to variations in circuitry it is highly desirable to have access to the original manufacturer's service information.

Finally, as with parallel I/O devices, a short routine to "exercise" the port may be useful (e.g. a loop which continuously outputs a particular byte value). Note, however, that an RS-232C serial interface requires the use of handshake signals and it is thus important to check associated line-drivers, line-receivers, connectors and cables as well as the peripheral itself before blaming the serial I/O device!

Next month: We shall be delving into the circuitry and operation of a standard RS-232C serial interface. We shall also be taking a look at the popular IEEE-488 Instrument Bus. Our Digital Test Gear Project will feature a Versatile RS-232C Break-out Box.

AUDIO LOGIC TRACER

MIKE TOOLEY B.A.

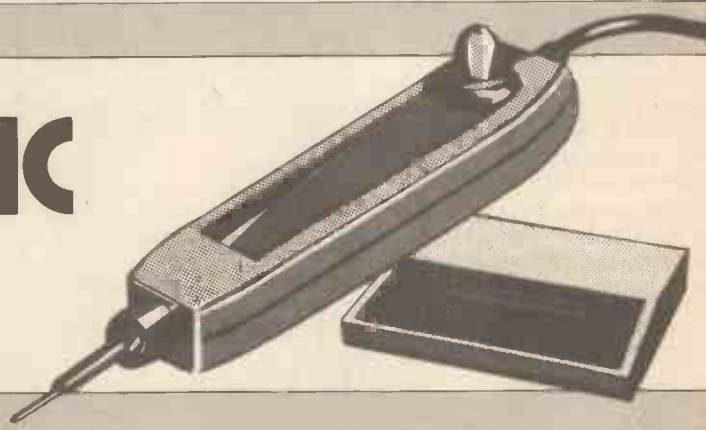

THIS month's Digital Test Gear Project deals with the construction of an Audible Logic Tracer. This somewhat unusual device allows the user to listen to the signals present in a microprocessor-based system. It thus provides an alternative to the conventional logic probe which is somewhat limited in that it only provides visual indications of logic states and thus it is not usually possible to make a meaningful as-

essment of the activity on a line that is pulsing.

By listening to the signals in a microprocessor-based system, it is possible to gain a meaningful impression of what is going on. The Audible Logic Tracer will not only indicate that a particular line is active but it will also provide an indication of the frequency at which the line is pulsed and whether or not the pattern is repetitive. It is

thus possible to distinguish between the signals present on the various bus, clock and chip enable lines.

Anyone who still has doubts about the potential of this simple instrument and is regularly involved in fault finding in microprocessor systems is well advised to check the audible logic tracer out!

CIRCUIT DESCRIPTION

The operating principle of the Audio Logic Tracer is delightfully simple. Signals that are pulsing at a fast rate (e.g. those present in a microprocessor bus) may be converted to signals which pulse at a fairly slow rate (within the audio frequency band) simply by applying them to a multi-stage binary divider. These frequency scaled signals can then be shaped and fed to a conventional audio amplifier stage.

The complete circuit of the Audio Logic Tracer is shown in Fig. 1. A CMOS divider, IC1, provides frequency division of the input by a factor of 1024 (2¹⁰). Resistor R1 together with diodes D1 and D2 provide protection for IC1 in the event of the probe tip being applied to a voltage source which is outside the normally acceptable input range (maximum ±50V).

The second stage, IC2, is a simple fixed-gain audio amplifier stage based on the popular TBA820M. The frequency re-

Fig. 1. Complete circuit diagram for the Audio Logic Tracer.

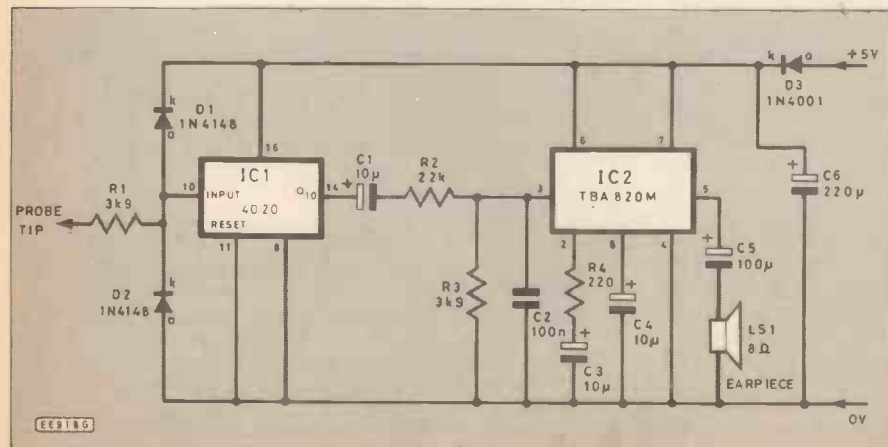

sponse of this stage extends from a few Hz to beyond 20kHz.

CONSTRUCTION

All components for the Audio Logic Tracer are mounted on a 0.1in matrix board comprising 10 strips of 37 holes. This can easily be cut from the standard size stripboard used in this series (24 strips of 37 holes).

The stripboard layout of the Audio Logic Tracer is shown in Fig. 2. Constructors should note that a total of 21 track breaks are required and these should be made using a spot face cutter. If such a tool is unavailable, a sharp drill bit of appropriate size may be substituted.

The following sequence of component assembly is recommended; i.e. sockets, terminal pins, links, resistors, diodes, and capacitors. The earpiece is mounted in the upper section of the probe case. A round hole (approximately 14mm in diameter) should be cut and the earpiece glued into place using an epoxy resin-based adhesive. The supply leads should then be connected, taking care to ensure the correct polarity (red crocodile clip/striped lead to positive).

Before inserting the two integrated sockets into their holders and mounting the stripboard in its final position, constructors should very carefully check the components, links, and track breaks. Furthermore, it is also worth checking that all of the polarised components have been correctly oriented. Constructors should also carefully examine the underside of the board for dry joints, solder splashes, and bridges between adjacent tracks.

COMPONENTS

Resistors

R1	3k9
R2	22k
R3	3k9
R4	220

See
**Shop
Talk**
page 255

All 0.25W 5% carbon

Capacitors

C1	10µ tant 25V
C2	100n polyester
C3	10µ p.c. elec. 16V
C4	10µ axial elec. 25V
C5	100µ p.c. elec. 16V
C6	220µ p.c. elec. 16V

Semiconductors

D1	1N4148
D2	1N4148
D3	1N4001
IC1	4020B CMOS 14-stage binary counter
IC2	TBA820M 2W audio power amp.

Miscellaneous

LS1 8ohm earpiece.
8-pin low profile i.c. socket; 16-pin low profile i.c. socket; probe case, measuring 140mm x 30mm x 20mm approx; single-sided 1mm terminal pins (5 off); 0.1in. matrix stripboard (10 strips, 37 holes) measuring 95mm x 63mm approx; connecting wire.

Approx. cost
Guidance only **£5 (case extra)**

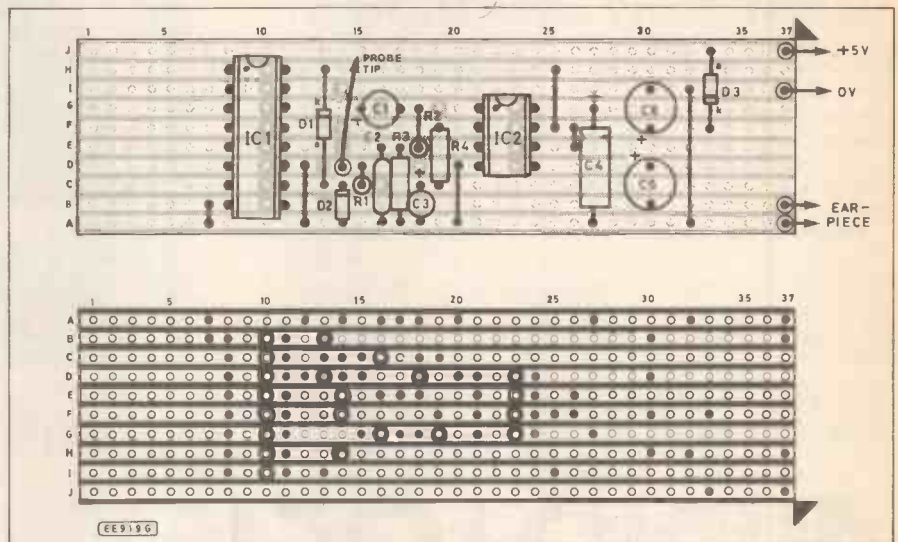
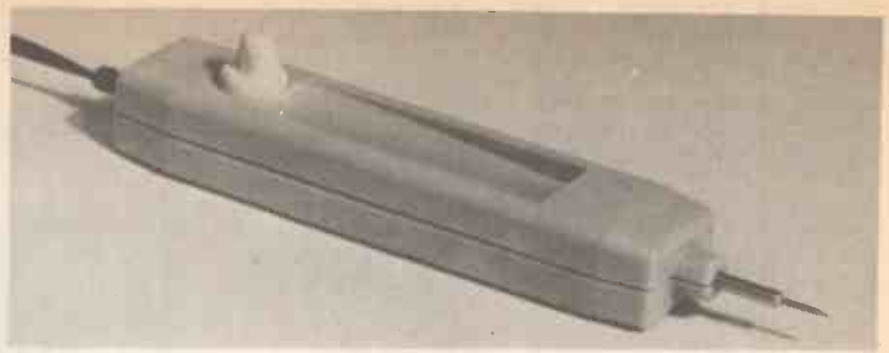
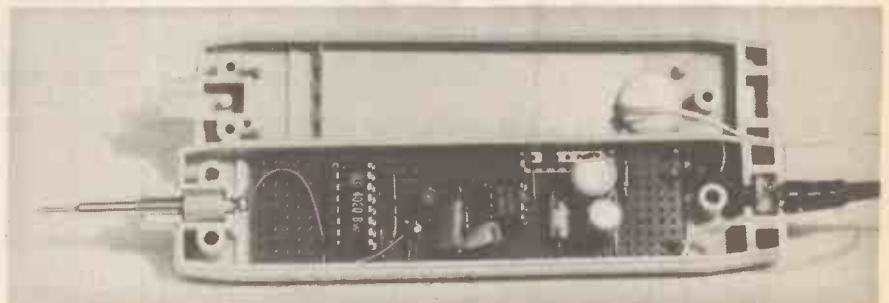

Fig. 2. Circuit board component layout and details of breaks to be made in the underside copper tracks. The completed board wired inside the probe case can be seen in the photograph below.



When the board has been thoroughly checked, the two integrated circuits should be inserted into their holders—taking care to ensure correct orientation. The circuit board should then be mounted in the base of the probe case, no mounting hardware is required as the board should be held snugly in place when the two probe case halves are mated together. The probe tip mounting boss should now be connected to the probe input using a short length of insulated wire and the tip screwed in place.

TESTING

The Audio Logic Tracer should be tested using a known operational microprocessor-based system, for example a home computer. The 5V supply should be derived from a convenient point on the main TTL supply rail (taking care to observe correct polarity).

With the probe tip left unconnected, no output should be detected. Now take the probe tip to the output of the clock generator (ideally this should be in the range 1MHz to 4MHz); a "clean" sounding tone should be produced (of between 1kHz and 4kHz respectively). Now transfer the logic probe to one of the data bus lines; a

"rasping" note (of typically between 100Hz and 1kHz) should result.

If the Audio Logic Tracer should fail to produce these indications, the circuit board should be removed from the probe case and carefully checked with particular emphasis on the orientation of polarised components (diodes, electrolytic capacitors, and integrated circuits) and on the placement of links and breaks.

Finally, it is well worth familiarising oneself with the indications produced by the Audio Logic Tracer when presented with various common types of microprocessor signal. As a first step constructors should transfer the logic probe to the following lines in turn and note the sounds produced:

- remaining data bus lines
- address bus lines (can you detect any differences between the high and low order address lines?)
- control bus lines (including read and write lines)
- chip select lines

Next month: RS-232C Break-out Box

GROWTH AWARD

Optoelectronic scientist wins medal for his pioneering work

A SCIENTIST whose pioneering work has helped to put Britain in the world forefront of optoelectronic technology has been awarded the Martlesham Medal.

Dr Marc Faktor, who spent more than two decades researching the optical and electrical properties of materials, was presented with the medal at a ceremony in the London Telecom Tower recently.

Sir George Jefferson, Chairman of British Telecom, described Dr Faktor's achievements as "quite outstanding in their versatility and significance."

"He has demonstrated an immense grasp of materials science—both in principle and detail—and a high degree of originality."

Dr Faktor's work ranged widely over the field of optoelectronics and other semiconductors. During the early 1970s he headed a team which used organic materials to build reliable "directly modulatable" semiconductor lasers.

He also devised the electrochemical technique at the heart of the British Telecom profile plotter, which produces an accurate profile of the electric-current carriers in semi-conductors. This is now manufactured under licence and the third-generation is sold worldwide.

Growth

Much of his work with British Telecom concerned growing crystals from vapour—building

THE MARTLESHAM MEDAL

The Martlesham Medal gives recognition to members of British Telecom, past or present, who have made an outstanding personal contribution to science or technology with a particular relevance to telecommunications. It takes its name from British Telecom's research laboratories at Martlesham Heath, near Ipswich.

A particular discovery, contribution to knowledge or an innovation, is sought by the award panel.

The first recipient of the Martlesham Medal in 1980 was Dr Tommy Flowers, the man who invented Britain's and possibly the world's first computer and the acknowledged father of electronic switching. During the war, Dr Flowers played a leading part with his invention Colossus, which performed a major role in breaking German High Command codes.

up layers of semiconductor material no more than a millionth of an inch thick—on which the



Dr Faktor with the core of his contribution to the development of thin-film technology—building up layers of semiconductor material no more than a millionth of an inch thick.

fabrication of today's optical devices are based. The techniques which he pioneered, such

as metallo organic vapour phase epitaxy (MOVPE) are now sufficiently well defined as to be capable of commercial exploitation. The joint venture company set up in 1986 between British Telecom and du Pont is to develop, manufacture and market optoelectronic components and devices which stem directly from Dr Faktor's work.

The worldwide market for these devices is worth more than £350 million now and is expected to grow by 30 per cent a year to more than £4 billion by the mid 1990s.

DO YOU BELIEVE IT?

Most people have heard of solar-powered calculators — but a water-powered one? It sounds incredible, but the latest news from the Hong Kong Trade Development Board is that a Hong Kong based firm has developed a revolutionary "hydro-powered" LCD calculator.

The water-resistant calculator was developed by engineers of Swank International Electronic early last year and a decision to manufacture taken last August. Patents have already been secured in the UK and USA, which Swank sees as its main markets.

"The actual operation is quite simple", says Swank's general manager, Mr. T. M. Lee.

"The calculator is immersed in water, which enters the calculator body through special holes, even though the general body is water-resistant.

"This water is then used to power the calculator through a specially-designed water generator which keeps the calculator going for three months, after which it simply has to be immersed in water to renew the power source," Mr Lee explained.

JOB LINE

The trade newspaper *Electronics Weekly* has just introduced a new daily phone-in service for those wanting industry news updates and the latest info' on the jobs front.

Every day their "Jobs Line" will give details of two different jobs with a contact number. The new service number to ring is: 0898 200103.

British manufacturers of dry cell batteries have joined together to form the British Battery Manufacturers Association. The new trade association will look after the common interest of the members in relation to central and local government, dealers, users and other trade associations.

A new range of industry standard soldering tips for their cordless 3 in 1 tool, the Ultra-torch 3, has been announced by Master Heat Tools.

Intelligence Fund

An investment of over £600,000 to develop artificial intelligence-based manufacturing systems has just been announced by IBM. They are sponsoring a research project at the Heriot-Watt University to apply the latest AI techniques to manufacturing requirements.

The aim of the two year project is to develop a robot manufacturing cell which can cope with unexpected production changes. Even the most advanced automation systems are unable to do so, since they can only cope with situations they are programmed to deal with.



ANGLO-JAPANESE SPACE VENTURE

The successful launch, on 5 February, of a satellite carrying the largest-ever X-ray sensor marks the first Anglo-Japanese collaboration in space, and will enable the study of some of the most exotic and powerful objects in the Universe.

The sensor, known as a Large Area Counter (LAC) weighs over 100kg and has a sensitive area of 0.5m². The LAC was launched on a Japanese ASTRO-C satellite from the Kagoshima Space Centre, Japan.

The project is the result of collaboration between research groups at the British National Space Centre's (BNSC) Rutherford Appleton Laboratory (Space Department); the University of Leicester; the Tokyo Institute of Space and Astronautical Science (ISAS) and the University of Nagoya.

The eight flight detectors which form the full LAC were delivered to Japan at roughly monthly intervals during 1986 to be installed on the satellite in the clean rooms at ISAS. The Tokyo group then tested the completed satellite with support for critical tests from British specialists. The satellite was mounted on the Japanese Mu III rocket.

When in orbit, ASTRO-C will be the only active observatory for X-ray astronomy available to astronomers worldwide.

More than 2,500 customers in the City of London are to be offered more details on their telephone bills in a British Telecom trial scheme beginning this month.

Bills will show details of all dialled calls of 10 units and more (i.e., which cost more than about 50p, including VAT). Details to be shown on the bill will be: date and time that the call is made; number called; duration of the call and charge for the call.

Customers opting for this new service will be charged £1 per quarter for each exchange line on which calls are itemised. The six-month trial will cover about 10,000 lines on three exchanges in the City of London.

MIDDLE EAST AWARD

Over 200 students at the Dhahran Technical Training Institute are using construction kits supplied by Cirkuit, UK, as part of their official 2-year practical training programme.

The British company has supplied the DTTI with a broad range of electronic construction kits covering robotics to transmission lines and recently presented the Cirkuit Award to the top student at the Institute's graduation ceremony.

Saleh Hashbool Al-Ghamdi receives his certificate from Sheikh Nasser Assar, President of Civil Aviation, Dhahran. Also pictured (left) is Saleem S. Al-Quarni, Director of the Technical Training Institute, Dhahran.



ON THE AIR

With the full approval of the Irish Minister of Communications, Radio Tele Luxembourg (RTL) in association with Radio Telefis Eireann (RTE) are to commence transmitting from the Irish mainland on 254kHz (1181 metres) long wave.

The radio station will operate on the long wave band and will broadcast from a transmitter on the East Coast of Ireland, permitting daytime coverage of the majority of Britain as well as Ireland itself.

Mr Gust Graas, Director General of RTL said: "The joint venture is a natural extension of our company's European broadcasting philosophy which has become so well established for over 50 years. In this case, the three countries of Ireland, Britain and Luxembourg will pool their considerable resources to produce a high-quality mixture of entertainment and information that will be popular with the public."

A US electronics company is to set up a new manufacturing plant in the Vale of Leven this year, creating 34 new jobs.

JMK Inc., based in Amherst, New Hampshire, USA, makes radio-frequency filters and other products for computers and medical equipment.

ON THE RAILS

An order from the State Rail Authority of New South Wales, Australia, for electric equipment for 450 railcars, which feature such state-of-the-art technologies as electric propulsion equipment with gate turn-off (GTO) thyristors, has been won by Mitsubishi Electric Corp.

They will supply the entire electric equipment incorporating high technologies such as power electronics for a four-quadrant chopper-control system with GTO thyristors for energy savings, microelectronics for destination display and speed control using 16-bit micro computers, and opto-electronics in train management systems.

It is hoped that the motor technology and peripheral equipment will be transferred to several Australian local manufacturers so that they can be produced locally.

ADVANCED TESTING

In what is thought to be the largest order of VLSI test equipment for two years, Advanced Micro Devices (AMD) has agreed to purchase over \$7 million worth of VLSI test systems from Teradyne. The centrepiece of the order is a pair of J953 Test Systems which offer unrestricted 50MHz operation at up to 256 pins.

AMD has also ordered a J967 Test System for use in its new Test and Design Centre near Tokyo, Japan, and a second J983 VLSI Test System as part of the multiple-system purchase.

After a career spanning 46 years with A.F. Bulgin & Co. plc, Tom Smith is to retire from his position as Divisional Director of Design. He will, however, continue his association with the company as a consultant.

Yellow Pages Goes Live

British Telecom's Electronic Yellow Pages (EYP) is now up and running, allowing most on-line communicating terminals in the UK and abroad free access to a database of Yellow Pages advertisers.

Information on EYP will initially cover the whole of London, Reading, Guildford, Watford and St. Albans. The information will be broken down by classification headings as in the printed books. EYP is available to users free of subscription and computer time based charge. Connection to EYP can be either via a Gateway on Prestel or by direct dialling over the telephone network (PSTN) at the normal tariff.

Full instructions on how to access EYP will be published in all Yellow Pages books where EYP is available. The first book to carry such information is London South West covering the Richmond, Egham and Leatherhead areas.

All Yellow Pages display advertisers will be entitled to "space" on the system to publicise fast-changing information such as availability, pricing, and special offers about their products and services, as well as a listing of names, addresses and telephone numbers. Businesses taking out advertising at semi-display level will automatically be listed.

Actually Doing it!!

COLOUR coding of components is a subject that has been covered in previous articles in this series, but no apologies are made for returning to this subject. It is potentially a very confusing aspect of electronics for the beginner, and one which has to be mastered before even the most simple of projects can be tackled.

Colour codes are probably used somewhat less these days than in the past, and they are now relatively rare as a means of value marking on capacitors. However, on resistors they are still by far the most common method of value indication, and things are complicated by the use of several slightly different systems of coding. A recent development seems to be the use of colour coding on small inductors of the r.f. choke type, and they are still used to some extent on capacitors. You may also encounter components that are not of recent manufacture which use colour coding, where their modern equivalents do not.

FOUR BAND CODING

By far the most common type of colour coding is the four band type used for most resistors. Fig. 1 helps to explain the way in which this type of coding operates. The first task when deciphering a colour code is to determine the correct order of the coloured bands (i.e. which end of the component has the first band in the sequence). This is quite easy as the first band at one end of the resistor will be practically right at the end of the component, while the first band at the opposite end will be positioned somewhat further onto the body of the component. The sequence begins with the band that is nearest to one end of the component. In most cases the "wrong" band will be gold in colour, and obviously not the first colour in the sequence as this can never be gold.

Bands one and two indicate the first two digits of the value, and Table 1 shows which numbers correspond to each colour. As a couple of examples, if bands one and two are red and violet respectively, this indicates that the first two digits of the value are two and seven, or if they are orange and orange this indicates that the first two digits are three and three.

The third band gives the rest of the value, but it operates in a different way to the first two bands. It is the "multiplier", and it indicates the figure by which the first two digits must be multiplied in order to give the full value. This is more simple in practice than one might expect though, since the multiplier is always a straightforward 1, 10, 100, etc., and never an awkward value. It is really just indicating the number of zeros to be added to the first two digits, or in the case of a very low value component it shows the position of the decimal point. Table 1 shows the multiplier value for each of the applicable colours.

If we again take a couple of examples this should help to clarify the way in which this system operates. If the first three bands are respectively yellow, violet, and red, the first two digits are four and seven, and the multiplier value is 100. This gives 47×100 which is 4,700 ohms. A convenient way of looking at things is to take the multiplier value as being the same as when it appears in the first two bands, but with it signifying the number of zeros to be added to the value rather than a digit. Thus in the example given above, the red multiplier would indicate two zeros to be added to the first two digits, which again gives us a value of 4,700 ohms (47 plus 00—4,700).

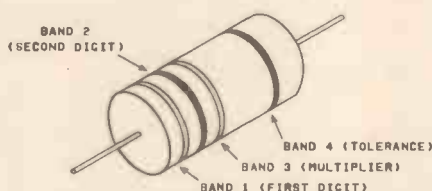

Fig. 1. Standard four band colour coding.

Table 1

Colour	1st	2nd	3rd	4th
Black	—	0	x1	—
Brown	1	1	x10	1%
Red	2	2	x100	2%
Orange	3	3	x1000	—
Yellow	4	4	x10000	—
Green	5	5	x100000	0.5%
Blue	6	6	x1000000	0.25%
Violet	7	7	—	0.1%
Grey	8	8	—	—
White	9	9	—	—
Gold	—	—	x0.1	5%
Silver	—	—	x0.01	10%
None	—	—	—	20%

This system is not usable with very low value resistors as the multiplier is then 0.1 or 0.01, but you will not often encounter resistors so low in value that they have these multiplier values. As an example of a very low value coding, green, blue, gold would mean that the first two digits of the value are five and six, and that the multiplier is 0.1. This gives 56×0.1 which equals 5.6 ohms.

k AND M

It is quite common for electronic circuits to utilize resistors having values of many thousands of ohms, or even a few million ohms. This gives very large numbers to deal with, and matters are generally rendered more convenient by the use of "kilohm" or just "k" to indicate a value in thousands of ohms, or "megohm" or just "M" where a value is expressed in millions of ohms. Thus a value of 560,000 ohms would more normally be given as 560k, and a value of 3,300,000 ohms would be given as 3.3M.

It is now quite common for the "k" or "M" to be used to show the position of the decimal point where appropriate. Therefore, a value such as 2,700 ohms could be given as 2.7k or 2k7. Where the value is in ohms the letter "R" is often used in much the same way as the "k" and "M" in higher values, and a component with a value of 6.8 ohms would often be referred to as a 6.8R component, or a 6R8 type.

The point of using a letter to indicate both the units in which the value is expressed and the position of the decimal point is that it enables values to be given on circuit diagrams using as few characters as possible. This might seem like a very minor point, but the complexity of many modern circuits is such that it can be difficult to compress everything into the available space, and this system does help to make diagrams as clear as possible.

The fourth band shows the "tolerance" of the component. This simply means the maximum error between the marked value and the actual value of the component. As with any component, electronic or mechanical, a resistor will not have precisely its specified characteristics, and its actual value will not be exactly the same as its marked value. The value is guaranteed to be within a certain percentage of the marked value, and the most common tolerance is ± 5 per cent (a gold band). Thus, if a component has a value of 1k (1,000 ohms) and a tolerance of ± 5 per cent, its actual value could be anywhere between 950 and 1,050 ohms.

Although five per cent carbon resistors are the most common type, some suppliers now supply one per cent metal film types as standard, and do not offer five per cent carbon types at all. Obviously a one per cent component can be used where a higher tolerance is specified in the components list, but a five per cent tolerance component can not be guaranteed to have adequate accuracy for an application where a one or two per cent component is called for. You should therefore never use a component having a tolerance rating that is inferior to the one specified in the components list.

POWER RATING

Components lists normally specify power ratings for the resistors, and nine times out of ten all the resistors are low power types having a rating of $\frac{1}{4}$ watt or thereabouts. In most cases the actual power fed to the resistor is a matter of a few milliwatts or even less, and something like $\frac{1}{3}$ or $\frac{1}{4}$ watt resistors are specified merely because they are the smallest type that are generally available.

You should not use small resistors where higher power types are called for as inadequately rated resistors will soon overheat and be destroyed. From the electrical point of view there is no reason why (say) a one watt resistor should not be used where a $\frac{1}{4}$ watt or other small type is called for. In practice higher power resistors will normally be unusable as they are physically much bigger than lower power types, and will simply not fit into the available space on the printed circuit board.

The power rating is not something that is indicated in the colour coding, but you should find that before too long you can accurately judge the power rating of a component from its physical size and appearance.

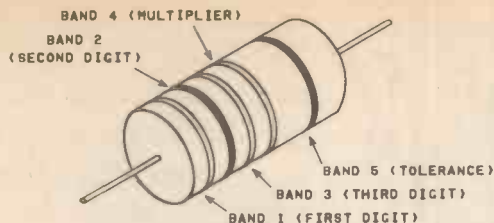

Fig. 2. Five band colour coding.

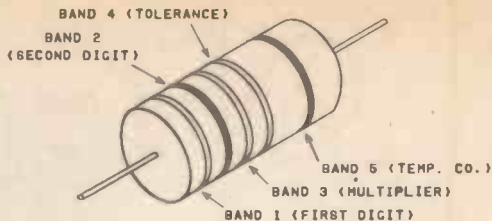

Fig. 3. An alternative system of five band coding.

Table 2 Preferred Values

Value	E12	E24
1.0	YES	YES
1.1	NO	YES
1.2	YES	YES
1.3	NO	YES
1.5	YES	YES
1.6	NO	YES
1.8	YES	YES
2.0	NO	YES
2.2	YES	YES
2.4	NO	YES
2.7	YES	YES
3.0	NO	YES
3.3	YES	YES
3.6	NO	YES
3.9	YES	YES
4.3	NO	YES
4.7	YES	YES
5.1	NO	YES
5.6	YES	YES
6.2	NO	YES
6.8	YES	YES
7.5	NO	YES
8.2	YES	YES
9.1	NO	YES
10	YES	YES

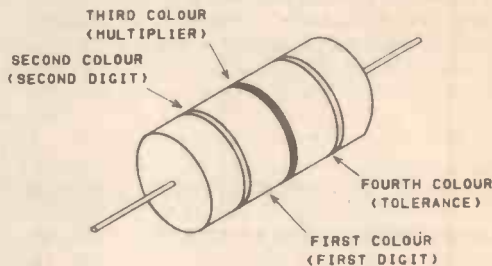

Fig. 4. An old system of coding used on some high power resistors.

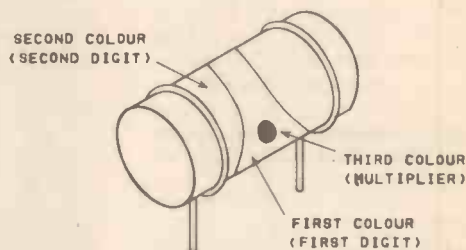

Fig. 5. A more common (but obsolete) method of colour coding used on some high power resistors.

Terms such as "carbon film" and "metal film" refer to the composition of the resistor, and metal types generally have better stability and lower noise than do carbon types. It is consequently quite in order to use a metal type where a carbon resistor is specified, but probably not advisable to use a carbon resistor where a metal type is called for.

With most circuits the type of composition is not important and carbon types are stipulated in the components list, but a few critical applications, particularly some hi fi and test gear applications, do require high quality resistors in order to obtain and maintain a high level of performance.

OTHER CODES

There are variations on the basic four band resistor coding, and you are quite likely to encounter resistors having these alternative codings. The most common alternative is the five band type shown in Fig. 2. This is very similar to the four band type, but it differs in that there is an extra band which indicates a third digit ahead of the multiplier. This coding is designed for use with close tolerance resistors where values other than the standard resistor ranges are available, and values like 29k4 can be accommodated whereas the ordinary method of coding could get no nearer than 29 or 30k.

This is all rather academic to the amateur user as normal retail outlets only handle values in the E12 and E24 ranges (see Table 2). The third band will always be

black (0), making it quite easy to decipher the value. In fact with this type of resistor I generally ignore the third band, work out the value in the normal way using the other three bands, and then multiply the answer by ten to compensate for the ignored band. This is likely to be the easiest way of doing things if you are already used to the four band codes, or predominantly deal with resistors of the four band type.

The other system of five band coding is shown in Fig. 3, and this is somewhat easier to deal with. The first four colours show the value and tolerance in the normal way, and the fifth band indicates the temperature coefficient of the resistor. The temperature coefficient is simply the amount by which the value of the component changes with variations in temperature, and is generally given in parts per million per degree Centigrade. This is a parameter which is very unlikely to be specified in a components list, and you can simply ignore the last band and treat the component as an ordinary four colour type.

There are no other resistor colour codes in common use, but there are a couple of codes that were once commonly used for high power resistors. I must admit that all the high wattage resistors I have encountered over the last few years have had the value etc. written on them, and this is probably a more practical way of doing things on these larger components. It might seem like a more sensible way of doing things with small resistors, but modern $\frac{1}{4}$ watt and other low power

resistors are so small that the lettering would be illegible to all but those with the keenest of eyesight.

For the sake of completeness, and because there may well be resistors using these codes still in circulation, Fig. 4 and Fig. 5 give details of these methods of coding. They are actually just standard four colour codes which indicate the value and tolerance in the normal way, but the method of arranging the colours on the body of the component is different, and with the method of Fig. 5 the tolerance is not indicated.

If you are familiar with the methods of colour coding described here you should be having little difficulty in determining the values of the vast majority of resistors. Problems can arise though, with codes becoming partially obliterated, colours being indistinct, or with the five band codes it might not be apparent which of these codes has been used. A multimeter, even an inexpensive type, is invaluable in these situations as it should enable the value to be read accurately enough to eradicate any doubt as to the marked value of the component.

INDUCTORS

Some inductors use colour coding, but these just seem to use standard four band resistor fashion coding. However, the value is given in micro henries and not ohms.

Robert Penfold

exploring electronics

OWEN BISHOP

This series is designed to explain the workings of electronic components and circuits by involving the reader in experimenting with them. There will not be masses of theory or formulae but straightforward explanations and circuits to build and experiment with.

Part 11 Another versatile timer circuit

LAST month we saw how the versatile 555 Timer i.c. can be used to build an astable multivibrator circuit. This month's project uses the 555 as the basis of a monostable multivibrator.

SIMPLE TIMER

The circuit diagram for a Simple Versatile Timer is shown in Fig. 11.1. This circuit lights a light emitting diode (l.e.d.) for a given period of time and comes on when the timer circuit is first triggered and extinguishes at the end of the predetermined time interval.

The timer can be adapted to run for periods of different length, so it has many uses. It can be used for timing moves in Chess or Scrabble. Use it for timing the various stages in developing a film. Use it to warn yourself when it is almost time to switch on your favourite TV programme or, even, use it to boil an egg!

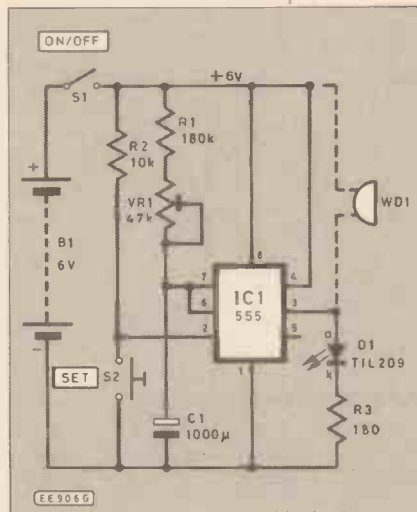

Fig. 11.1. Circuit diagram for the Simple Timer using the versatile 555 timer i.c.

HOW IT WORKS

The method of operation is similar to that described for the *Metronome*

last month. One difference is that the trigger input (pin 2) is connected so that it can be brought low by "activating" the push-button switch, S2. Thus, the i.c. is *not* automatically re-triggered when it completes its operation.

Another difference is that pins 6 and 7 are joined directly; there is no resistor between them. The result is that the capacitor C1 is discharged instantly at the end of the charging phase.

The output from IC1 pin 3 goes to an l.e.d., which lights when the i.c. has been triggered and stays on until the end of the charging phase. Since we need to run the circuit for periods of several minutes, we need a large value for capacitor C1.

Fig. 11.2. Demonstration layout for the Simple Timer.

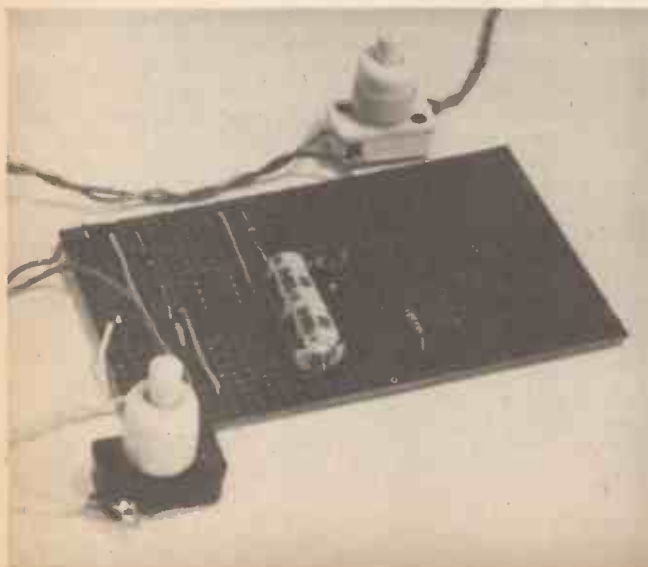
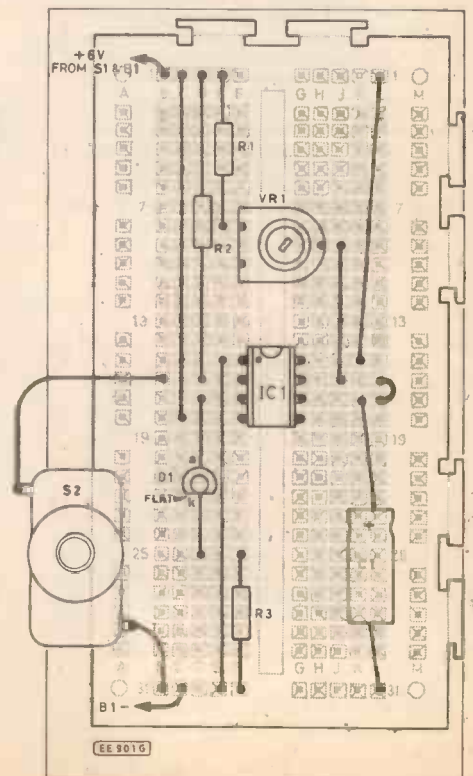

The completed stripboard version of the Simple Timer. The "skeleton" preset VR1 may be substituted for an ordinary rotary type, with spindle. Make sure that the copper tracks have been cut at points L9, M9, N9, O9 and /18.

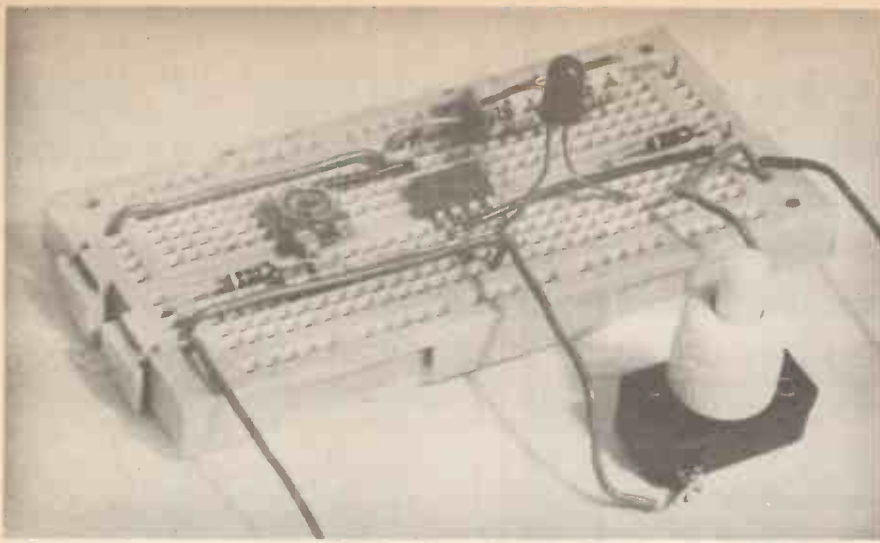

CONSTRUCTION

The demonstration breadboard component layout for the Simple Timer is shown in Fig. 11.2. A stripboard version is shown in Fig. 11.3. There are five breaks to be made in the copper strips and these can be made by using a medium sized twist drill. It is important that the small link wire, inserted at points M12 and N12, is not overlooked.

If the value of capacitor C1 is 1000µF, the values for resistor R1 and preset potentiometer VR1 depend on the time periods you require:

Period (minutes)	VR1	R1
1	22k	33k
2	22k	68k
3	22k	100k
4	47k	150k
5	47k	180k

The values given above allow you to set the timer fairly accurately to the chosen single value.

If you would prefer to be able to set the timer to several different delay periods, select the value of resistor R1

from the table above for the shortest time period you need. Then, by replacing the skeleton preset VR1 with a carbon track variable potentiometer, having a value between 100k and 1M, you can alter the timing period by simply rotating the potentiometer spindle to another setting.

For different positions of the variable resistor, find how long the timer takes and from this information you can mark out a time scale against which a pointer knob can be set. You can then run the timer for any set period up to about 18 minutes.

To obtain longer periods, increase the resistance or replace C1 with a capacitor of even greater value. With very high values, the small charging current will mostly leak away through the capacitor and the timer may never complete its operation. For this reason the longest practicable period is about one hour.

VARIATIONS

Instead of, or as well as, an l.e.d. that goes out when the period is over, you can arrange for an audible alarm to be triggered at the end of the period.

Fig. 11.3. Component layout for the stripboard version.

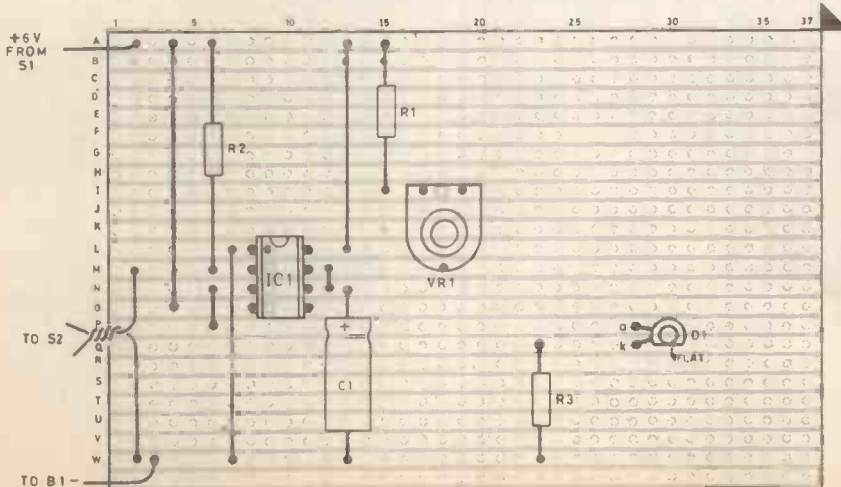

Resistors

R1 180k
R2 10k
R3 180k
All 0.25W
5% carbon

See

**Shop
Talk**
page 255

Potentiometer

VR1 47k min. horizontal skeleton preset, lin. (single-period timer), or carbon track spindle type pot. (variable timer)

Capacitor

C1 1000µ electrolytic

Semiconductors

D1 TIL 209 light-emitting diode
IC1 555 timer

Miscellaneous

S1 S.P.S.T. switch
S2,S3 Push-to-make push-button (S3 optional)
Breadboard; 0.1in. matrix stripboard, measuring 95mm x 63mm; audible warning device (optional); 8-pin d.i.l. i.c. socket (optional); connecting wire; 6V battery.

Approx. cost
Guidance only

£5

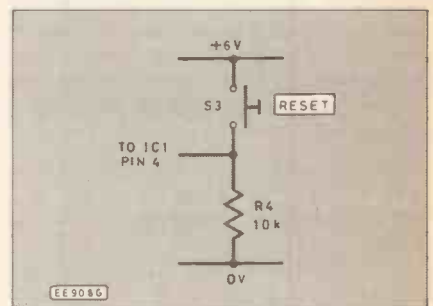

Fig. 11.4. Adding a "reset" button to the timer.

Simply connect the buzzer WD1 as shown by the dashed lines in the circuit diagram Fig. 11.1. It sounds as soon as the circuit is switched on, is silent when the circuit is triggered, and sounds again when the time is up.

If you trigger the circuit by mistake, it is a nuisance to have to wait about 5 minutes or more for it to complete its "cycle" of operation before you can use it again. It is useful to be able to reset the circuit at any time during its operation. This can be accomplished by adding a resistor and a "Reset" push-button switch, S3, connected to the reset input (pin 4), as shown in Fig. 11.4. Remove the connection between pin 4 and the positive 6V line, shown in Fig. 11.1.

Next Month: Introducing the operational amplifier.

... timer and frequency meter ...

IN LAST month's article the use of the two Timer/Counters in frequency counting and event timing were outlined, and in this article we will look at some simple software and hardware for these applications.

With the aid of a computer such as the BBC model B it is surprising how little hardware is needed to give good results in these applications. The software does not need to be particularly complex either.

Eventing

The timer set up that is featured here is very much along the lines of the system described last month, with Timer 1 generating a clock signal at the desired frequency, and Timer 2 counting the clock pulses fed to it via a gate circuit. In practical applications there is a minor problem with this basic arrangement in that some means of generating a suitable gate pulse is needed.

Just how this is done depends on the particular applications, but in some cases the gate pulse generator will need to be based on a simple set/reset flip/flop circuit. The output of a circuit of this type goes high when the "set" input is pulsed low, and high again when the "reset" input is pulsed low.

In this case the idea is to have a sensor to provide the "set" pulse at the beginning of the timing period, and another to give the "reset" pulse at the end of the timing period. This system does not lend itself well to all applications, and in some cases a single sensor might be sufficient to directly provide the gate pulse. However, this flip/flop method is probably the one which is most generally applicable.

A practical gate pulse generator of this type is shown in Fig. 1. This circuit also includes the gate itself (IC1c).

The circuit uses two photocells to provide the "set" and "reset" pulses, and these are TR1 and TR2. These are silicon npn photo-transistors, and virtually any devices of this general type will function well in this circuit (the TIL81 for example). Types which have a built-in lens are generally preferable in an application of this type though.

The photocells should normally be under fairly bright conditions, with suitable light sources being provided if the ambient light

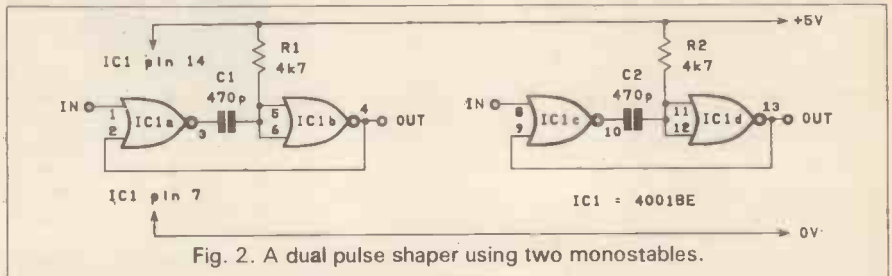

Fig. 2. A dual pulse shaper using two monostables.

level is unlikely to be sufficient. The timing period is started by a shadow being cast on TR1, and ended by a shadow being cast onto TR2.

A system of this type can, for example, be used in physics experiments in schools where acceleration of a ball-bearing running down an inclined plane has to be measured. The photo-transistors could be illuminated by separate ultra-bright light emitting diodes, with things arranged so that the ball-bearing passes between each photo-transistor and its light source as it moves down the inclined plane.

A system of this type can also be used as a sports timer, although in this application each light source would need to be a considerable distance from its photo-transistor, and a simple optical system would probably be needed in order to obtain usable results.

The circuit, Fig. 1, is very straightforward in operation. Phototransistors TR1 and TR2 are both operated as what are effectively light dependent resistances. When subjected to low light levels they are effectively ordinary silicon npn transistors with very low collector to emitter leakage levels. If the light level to which they are subjected is steadily increased, the leakage level increases, producing a reduction in the collector to emitter resistance. Normally both devices are subjected to quite high light levels, and this produces a high enough leakage level to take their collector voltages down to little more than 0V. Note that no connection is made to the base terminal of either device.

A conventional CMOS bistable circuit is formed by IC1a and IC1b, and under stand-

by conditions the output at pin 4 of IC1 is high. IC1c is the signal gate, and as it is a NOR type, the high signal from the flip/flop blocks the flow of clock pulses from PB7, through the gate, and into PB6. Switch S1 is a manual reset control which can be used to make sure that the flip/flop commences in the correct state, or to reset it if the photocells fail to trigger it properly for some reason.

When a shadow is cast onto TR2 it sets the flip/flop, taking the control input of IC1c low and enabling the clock pulses to flow through to PB6. When a shadow is cast onto TR1, it resets the flip/flop, and cuts off the clock signal again. This gives the required gating effect, with a certain number of clock pulses from PB7 being fed through the Timer 2 via PB6.

Other forms of sensor can be used to activate the unit, and something as basic as a couple of microswitches are often adequate. Note though, that the flip/flop is a type which requires positive set and reset pulses, and not the negative pulses required by most types. The sensors must therefore be wired accordingly.

The flip/flop is a simple type which will only operate properly if it is never taken to the state where both inputs are simultaneously fed with trigger pulses. If it is likely that the set and reset pulses will overlap, this must be avoided by adding a pulse shaper circuit to shorten the two pulses.

This can be achieved using the circuit of Fig. 2, which is just two positive edge triggered, non-retriggerable monostables, which are formed from the four NOR gates of another 4001BE device. The output pulse duration is only a few microseconds, which should be short enough to ensure proper operation of the system.

Software

The simple program below provides a basic Event Timer action:

```
5 REM event timer prog
10 CLS
20 ?&FE6B = 224
30 ?&FE64 = 80
40 ?&FE65 = 195
50 ?&FE68 = 255
```

Fig. 1. Circuit diagram for a simple optical sensor, bistable and gate circuit for event timing.

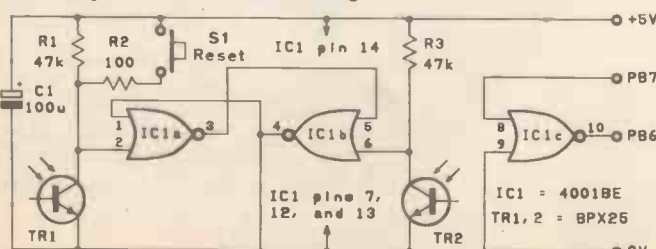

```

60 ?&FE69 = 255
70 A = ?&FE68
80 B = ?&FE69*256
90 C = 65535 - (A+B)
100 PRINTTAB(10,10)"
110 PRINTTAB(10,10)C/10
120 IF INKEY(-99) THEN GOTO
50
130 FOR D = 1 TO 300:NEXT
140 GOTO 70

```

This simple program is very much the same as the Running Timer program provided in the previous article, but in this case, of course, the count only runs during the gate period. The figure initially displayed will therefore be zero. The display will increment during the gate period, and will "freeze" with the event time (to the nearest tenth of a second) when the gate pulse ends.

For timing in one hundredths of a second the values written to Timer 1 at lines 30 and 40 should be altered to 136 and 19 respectively, and the division rate at line 110 should be increased to 100. For timing in milliseconds the values written to timer 1 are 244 and 1, and the division rate at line 110 should be 1000.

Increasing the resolution reduces the maximum time available before Timer 2 cycles through zero and back to 65535, with this taking just 65.535 seconds with 1 millisecond resolution. Line 120 enables the timer to be reset to zero by depressing the spacebar.

This routine should enable the timer to be set up and tested satisfactorily, but there is obvious room for improvement. However, this is something that must be tailored to suit the particular application involved.

Frequency Meter

The obvious method of using the timers for frequency measurement is to have Timer 1 in the single-shot mode to generate a gate pulse, and then count input pulses using Timer 2. In practice this method does not work very well because Timer 1 cannot produce gate times of more than about a fifteenth of a second in duration. Short gate times give relatively poor resolution and prevent low frequency measurement.

Although the maximum possible count would suggest that quite high frequencies can be accommodated, due to the maxi-

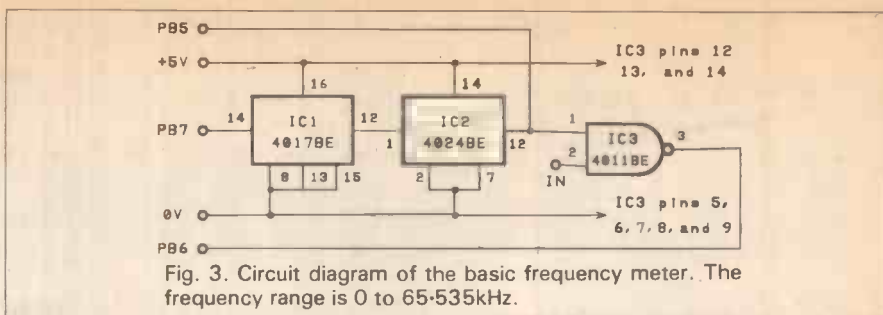

Fig. 3. Circuit diagram of the basic frequency meter. The frequency range is 0 to 65.535kHz.

imum input frequency restrictions of the 6522 VIA this is not actually the case. This gives the worst of both worlds, with poor resolution and limited maximum input frequency.

A much better method is to use Timer 1 in the free-running mode to feed into a divider circuit, and to use one set of output half cycles as the gate pulses. In this way accurate gate periods of a second or more can be produced. This is the general scheme of things in the basic frequency meter circuit of Fig. 3.

Timer 1 generates an output at a frequency of 10Hz on PB7, and this is divided by IC1 to give a 1Hz output. The output of IC1 is divided by two in IC2 to give a 0.5Hz output, and a high output period of one second. It is this high output period that constitutes the gate pulse.

IC3 is the signal gate, and is a NAND type. Therefore, it enables input pulses to pass through to PB6 during the period when the output of IC2 is high. The other four gates of IC3 are left unused incidentally.

Note that in this basic form the circuit will only respond to inputs at normal logic levels. The frequency range is 0 to 65.535kHz with 1Hz resolution.

The simple program below can be used to test the Frequency Meter.

```

5 REM DFM PROG
10 CLS
20 ?&FE6B = 224
30 ?&FE64 = 80
40 ?&FE65 = 195
50 ?&FE68 = 255
60 ?&FE69 = 255
70 IF (?&FE60 AND 32) =
0 THEN 70
80 IF (?&FE60 AND 32) =
32 THEN 80

```

```

90 A = ?&FE68
100 B = ?&FE69*256
110 C = A + B
120 PRINTTAB(10,10)"
130 PRINTTAB(10,10)65535 - C
140 GOTO 50

```

The above program sets up the timers in exactly the same way as in the Event Timer program. A slight problem with this general set up (Fig. 3) is that of determining just when a gate pulse has been completed and a new reading should be taken and displayed.

There is more than one way of tackling this, but the method used here is to use PB5 as an input line which monitors the gate signal, with lines 70 and 80 of the program then periodically inspecting PB5 and holding off reading of Timer 2 until the end of a new gate pulse. Although the gate period is one second, there is a one second delay between readings, and the display is therefore updated once every two seconds.

The frequency range of the unit is a useful one for audio frequency measurement, and other low frequency applications such as r.p.m. measurement. The frequency range could be boosted by a factor of ten by eliminating IC1 from the external divider chain, or simply altering the values fed to Timer 1 so as to give a 100Hz output signal.

The maximum input frequency parameter of the 6522 VIA does not permit higher frequencies to be handled, although this can be overcome by adding a prescaler at the input of the circuit. However, raising the full scale value of the circuit is achieved at the expense of reduced resolution.

Next month we will conclude our look at timing and frequency measurement using the BBC Micro with some more versatile and sophisticated hardware and software.

NEW · NEW · NEW · NEW PRODUCTS NEW · NEW · NEW · NEW

ONE FOR THE RECORD

THOSE constructors who are looking for a new record turntable for their audio equipment might find that the latest product from B.K. Electronics is just what they had in mind.

The OMP Vari-Speed turn-

table features electronic speed control, 33½ and 45 r.p.m. with separate variable pitch control; high torque d.c. motor, with electronic servo drive and a full size 12in machined die-cast platter, with strobe rim. The

deck is belt driven and also incorporates an optically illuminated neon strobe prism.

The pick-up arm is a precision balanced "S" shaped type which accepts standard ½in cartridge fixings. The arm also has a precision calibrated counter balance; an anti-skate device and damped cue lever.

Aimed at the person who requires "quality" reproduction

at a realistic price, the OMP Vari-Speed cost £49.99 (including VAT) plus £3 post and packing and is available direct from:

B.K. Electronics,
Dept EE, Unit 5,
Comet Way,
Southend-on-Sea,
Essex, SS2 6TR.
Tel. 0702 527572



EE APEX

RIFI AMPLIFIER

PART 3

GRAHAM NALTY

THE APEX power amplifier has been designed to compliment the Apex preamp both in styling and in performance. Considerable attention has been paid to those factors which affect the sound quality and these will be explained in this article. The heart of the power amplifier is a massive 300VA mains transformer. This is far in excess of the power requirements of the amplifier, but its justification lies in the extra improvement in sound quality that a larger transformer gives in relation to its cost. For high current rectification a 25amp bridge rectifier is used and this is bolted directly to the heat sink to minimise any possible effects of temperature generated distortion. I myself have yet to investigate the effects on sound quality of different rectifiers, but I have heard claims from various sources that differences in sound quality do exist for different rectifiers.

Power supply reservoir capacitors are known to have a large effect on sound quality. For this reason, the capacitors I have specified for the main high current reservoirs are a special kind developed for audio use. The internal construction of the capacitor is based upon the ideas of Denis Morecroft of DNM Supplies who is known for his preamps of outstanding sound quality. These capacitors are manufactured under the brand name Filmcap DNM and are used in a number of popular brands of hifi amplifiers. Although these capacitors are quite expensive, it is not prudent to save on such basic electronic components.

The power supplies for the low current voltage amplifiers of each power amplifier have been taken via separate rectifiers for each channel and then fed into a high

performance i.c. regulator. This gives considerable isolation from the effects of the current drawn from the output stages when driving a loudspeaker at high levels. Under such circumstances the voltage on the main reservoir capacitors fluctuates considerably. In most amplifiers, this voltage fluctuation is fed back into the sensitive input circuitry. Even with high quality input circuitry its effect is easily audible and results in distortion of the sound rather like the visual distortion of a telescope out of focus. As very few hifi amplifiers use separate supplies for high and low current parts of a power amplifier, the amplifier you are about to build should represent a worthwhile improvement in sound over comparable (in power rating but costing at least twice as much) manufactured hifi power amplifiers.

POWER AMPLIFIER

Unless you have perfected the perfect power supply, you still need a good power amplifier circuit with good power supply ripple rejection. In simple terms, if an unwanted signal voltage is present on a power supply line, the power supply ripple rejection is the ability of the circuits to prevent such a signal from reaching the output. When you get down to the nitty gritty of defining ripple rejection for measurement purposes things get a little complicated and confusing. However, measurement of ripple rejection of an audio circuit is quite easy to set up and circuits can easily be evaluated in a way in which measured performance relates quite closely to sound quality. In the Apex power ampli-

fier, excellent ripple rejection performance is achieved on the positive side by cascode circuitry (see first article on preamp for a description of cascode circuitry and its effects on power supply ripple rejections) and on the negative side by constant current sources of high dynamic impedance.

A simple definition of high dynamic impedance is that changes in the amount of current supplied by the circuit are very small in comparison with the change in voltage across the constant current circuit. The two transistor constant current sources used in the Apex power amplifier give a higher impedance (about four times) than the more popular two diode plus transistor constant current source used in many power amplifiers, and it will sound better. Even better results would be achieved by replacing the resistor from the constant current circuit to 0V with a J500 series current diode (eg. J507 at 1.8mA).

TRANSISTOR SOUND

For many years people have talked about the transistor sound and described it as hard and brittle and not as natural as valves. Many explanations have been put forward over the years, but the best explanation I have found is that such differences are caused by temperature generated distortion in transistors. The amplifying parameters of a transistor are its gain and its base-emitter junction voltage. These parameters are not constant, but vary with different temperatures at the transistor semiconductor junction. When an audio signal is being amplified by a transistor, its current and voltage will vary in relation to the instantaneous magnitude of signal.

The power dissipated will vary in relation to the instantaneous product of current times voltage. If the transistor has a high thermal resistance, the temperature at the semiconductor junction will rise and fall as the power level varies above and below its mean value. Although the heat generated in relation to the power is instantaneous, its dissipation takes time. As a result of this time-smearing effect the sound signal is distorted by the temperature generated gain changes. By changing to transistors of low thermal resistance, the temperature variations of the junction are minimised and the sound quality is audibly improved. In the Apex power amplifier the driver transistors TR8 and TR10 are 65 watt TO-220 types and the extra cost over TO-92 types (e.g. MPSA06 and 56), is more than justified by the improvement in sound quality. Further improvements in sound quality can be achieved by attaching an aluminium heat-sink to both transistors (remember to insulate at least one transistor from the heat-

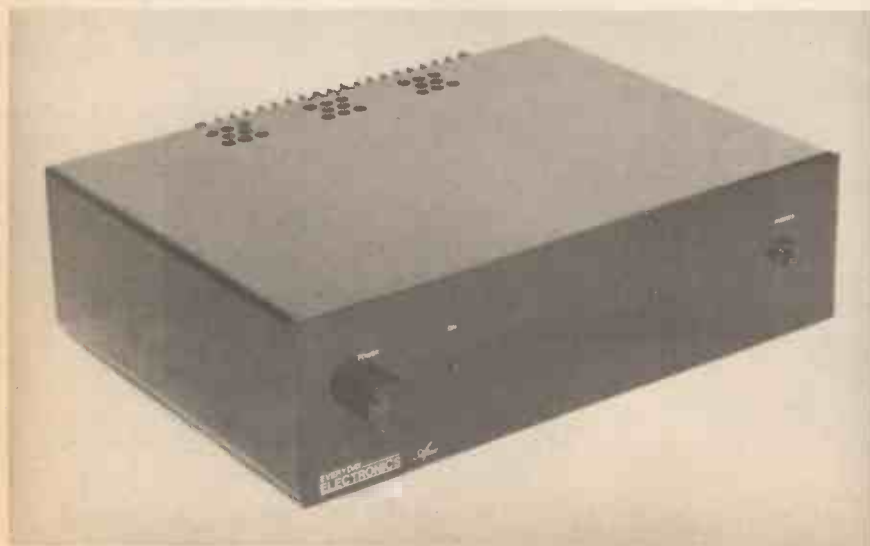

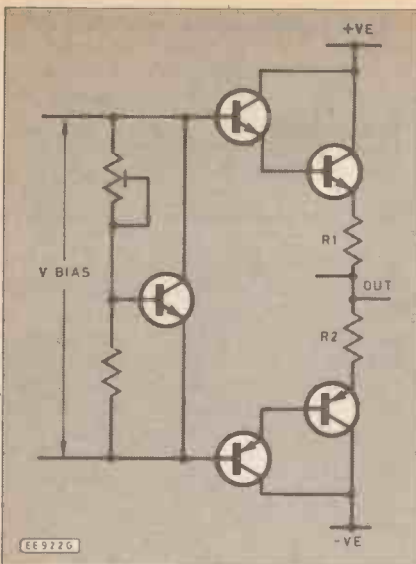

Fig. 23. Class AB amplifier.

sink). Another example of the way in which the Apex is designed for low temperature generated distortion in the use of Darlington transistors for TR12 and TR13. Put quite simply, Darlington transistors sound better because the driver transistor enjoys a much lower thermal resistance. Temperature generated distortion of the output transistors is kept very low by the use of a generously large heatsink.

CLASS "A"

A great deal of emotional hot air is talked about class A operation in power amplifiers. Whilst class A operation is a good idea, because it avoids any effects of the switching characteristics of the output devices, it is not really the most important feature in the design of an amplifier. In fact the most significant benefits in sound quality of a class A amplifier are a direct result of: (a) using a much bigger power supply and (b) much lower temperature generated distortion caused by large heat sinks. If you build a class B amplifier with the same power supply and heat sink its sound quality will

almost approach that of the class A. The class A amplifier will have more "depth" to the sound. Now we can take the class B amplifier and "upgrade" it by the following measures:

- (1) Replace the driver transistors with high power (i.e. low thermal resistance) transistors fixed to the heatsink (or replace these and the output transistors with Darlington).
- (2) Replace the bias transistor with a low thermal resistance type. Mount it on the heatsink with all the output devices very close.

For a typical class B amplifier in which these measures have not been provided, the sound quality will be improved quite considerably. It may even sound quite a bit better than the class A amplifier. Because of the high dissipation in a class A amplifier, it might not prove possible to mount the output transistors close together or attach the bias transistor close to each one. The class A might not be capable of further improvement without a complete change of design.

Most commercial class A amplifiers are class AB designs run at a high bias current. They still require the emitter load resistors R1 and R2 (Fig. 23). From my own test, I can confirm these components contribute considerable distortion to the sound in two ways:

- (a) Non linearity caused by VI drop across the resistors. This can be tested by replacing another resistor in parallel — and resetting the bias.
- (b) Losses caused by the component quality.

Change the resistors from wirewound types or 1/2 watt metal film types in parallel (low power amps mainly) to a batch of 1W IRO Holco H2 resistors in parallel to the same value and significant improvement in sound quality will be obtained. I have yet to try bulk foil resistors in TO3 cans, but these should yield further sonic benefits at a price.

Eliminating these resistors would result in considerable sonic benefits and the class A circuit of Fig. 24 almost achieves that. Although R1 and R2 have been eliminated, Resistor R3 needs to be of the highest sonic quality as it determines the constant current

supply. This is a better output stage, but it limits the output current to the current supplied by the current source and power dissipation in the output stage is very high in relation to the power available to drive the speakers. With the use of bipolar transistors there is a disadvantage that emitter resistors are required to share the output current if more than one output device is required. Back to square one. However, these resistors are not required if mosfet output devices are used (Fig. 25). But here we have the disadvantage of a larger voltage drop between gate and source of mosfets.

APEX OUTPUT STAGE

The output stage of the Apex power amplifier combines a number of the advantages of both class A and class B design (Fig. 26). The driver transistors are Darlington types which are run at a current of around 200mA. The output transistors are TO3 types operating in class B. By mounting the power transistors very close to the bias transistors, the resistors R6 and R7 can be made very small (0.15 ohms) without thermal runaway and the driver transistors operate in class A via R4 and R5 up to quite high output currents.

Another advantage of the close thermal tracking between the bias and output transistors is that a variable resistor is not required in the bias circuit.

Substantial sonic improvements would be obtained by replacing R6 and R7 with a direct wire, but this would increase the possibility of thermal runaway. Other sonic improvements which may be obtained at the expense (!) of reduced safety margin against thermal runaway are:

- (a) Reduce the value of R4 and R5 to increase the current in TR1 and TR2.
- (b) Increase bias voltage marginally.

Such measures are only recommended to readers with considerable experience of amplifiers and good supplies of the output transistors.

CIRCUIT DESCRIPTION

The power amplifier is based on the circuit shown in Fig. 27 but with a number of refinements which have been added to

Fig. 24. Genuine class A amplifier.

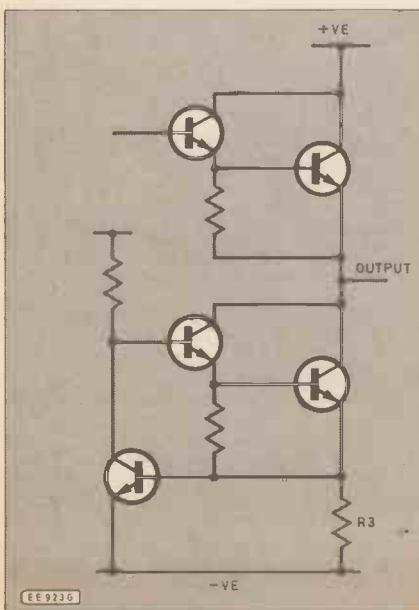
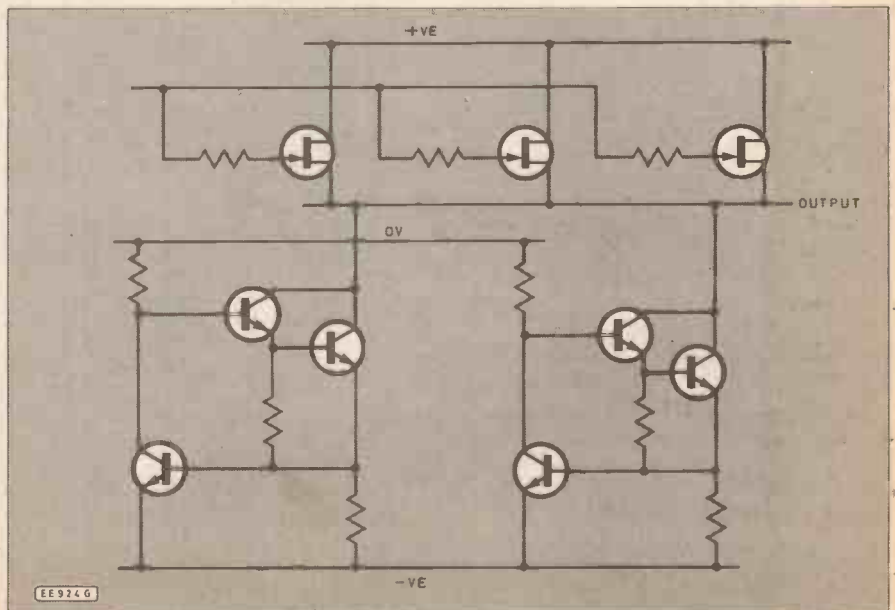

Fig. 25. Class A output stage with bipolar constant current source.



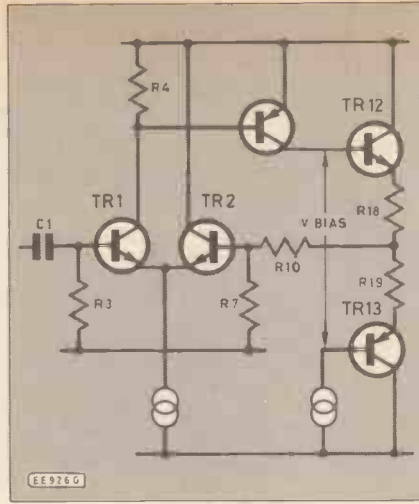
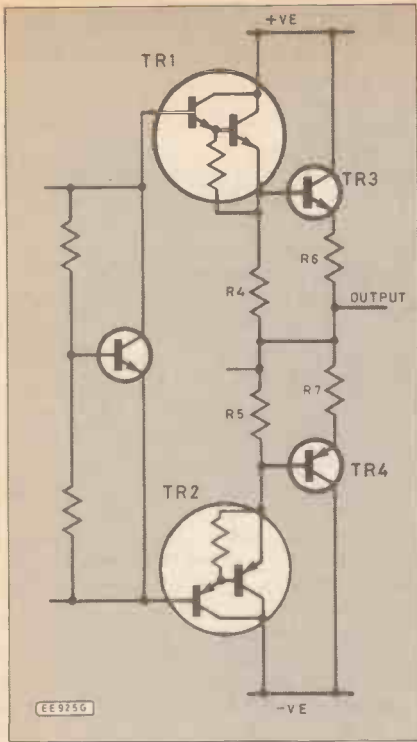

Fig. 27 (above). Power amplifier basic circuit.

Fig. 26 (left): Class A plus class B output stage.

improve the performance. The best way to understand the full circuit is to describe the operation of the circuit of Fig. 27 and then cover each refinement to it separately. To assist in relating the circuit of Fig. 27 to the full circuit, particular components have been given identical component numbers. The first stage consists of a long tail pair

TR1, TR2 fed by a constant current source (TR5, TR6 in final circuit). A positive going input at the base of TR1 raises its base voltage above the base of TR2. As the feed to the emitters of TR1 and TR2 is constant, the shift in base voltage of TR1 causes the collector current of TR1 to increase (and TR2 to decrease). The increase in TR1

collector current causes an increase in the voltage across R4, and also across TR9 base-emitter junction. This results in more current flowing from the collector of TR9. As its load is a constant current source, the increased current feeds the base of TR12. This causes more current in TR12 and TR13 and this current difference is the current available to drive the load. The voltage at the output rises to feed the load. At the same time a part of the output is feedback into the base of TR2 via R10. The ratio of the voltage at TR2 base to the output voltage is $R7/R7+R10$. As the open loop gain of the amplifier is quite high, the difference between the bases of TR1 and TR2 is very small compared to the input voltage. So if the voltage at TR1 base is approximately equal to the voltage at TR2 base, the output voltage is approximately equal to

$$\frac{R7+R10}{R7} \times \text{input voltage}$$

The overall gain of the amplifier is determined by resistors R7 and R10.

The full circuit is shown in Fig. 28. A description of all the additional circuitry now follows. Capacitor C1 is the d.c. blocking capacitor, this prevents d.c. voltage reaching the input transistors. It also has the important function of keeping the offset voltage at TR1 base constant when connected to preamps of different d.c. output resistance. Resistor R1 holds the input point at zero volts. d.c. If R1 were omitted the free end of C1 would be charged to a small d.c. voltage, depending on the signal at its other end. If an input were connected with the amplifier on, the input would short

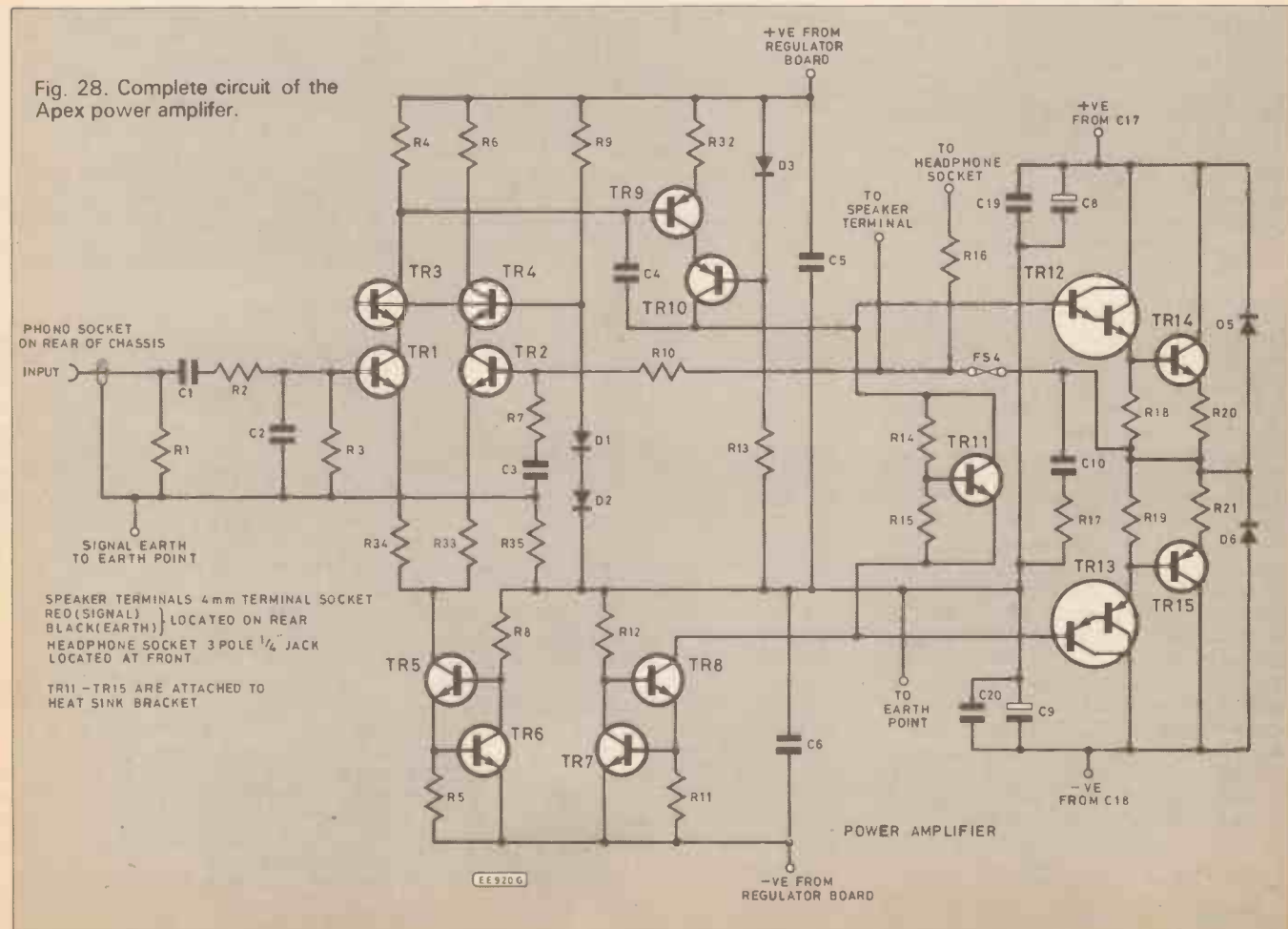

Fig. 28. Complete circuit of the Apex power amplifier.

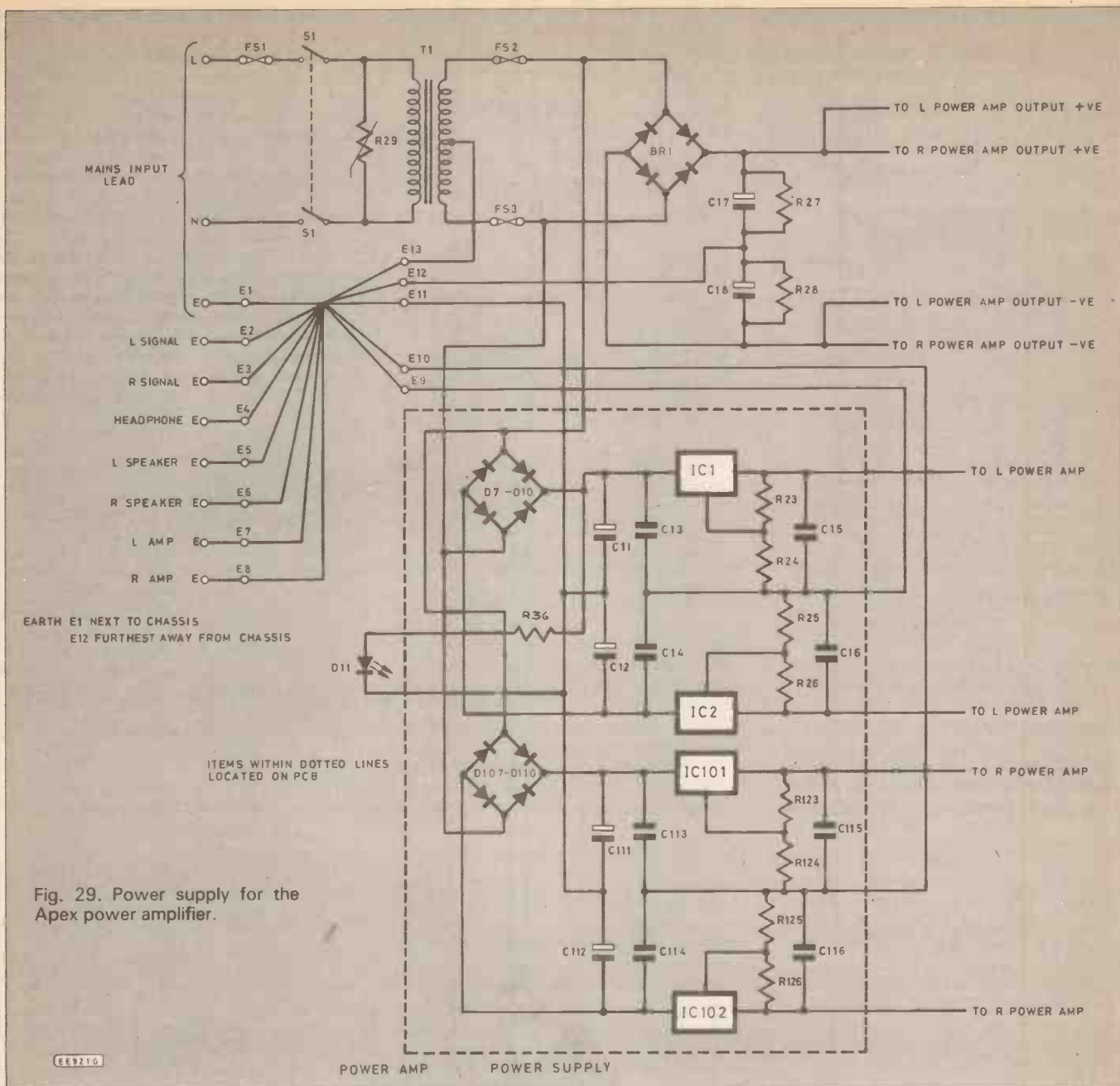

Fig. 29. Power supply for the Apex power amplifier.

the d.c. to ground and cause a thump from any speakers connected to the amplifier output. Resistor R3 holds the base of TR1 at a small negative voltage $= R1 \times I_b$ (of TR1). Resistor R3 can be varied to adjust the output d.c. offset. If transistors TR1 and TR2 are closely matched the lowest output offset will be obtained with $R3 = R10$. As the low frequency response of the input is determined by the values of C1 and R3 (R2 being small by comparison to R3), there is a practical lower limit on the value of R3. The final part of the input circuit is the high frequency filter made of R2 and C2. As the input circuit will have a finite impedance at audio frequencies, the actual filter frequency is determined by the combined impedance with R2 in relation to C2. C2 will have an additional advantage as its low impedance at very high frequencies improves high frequency stability of the amplifier.

CONSTANT CURRENT

The first stage constant current source is formed from TR5 and TR6. The current is

defined by the value of resistor R5 and the base emitter voltage of TR6. As the collector of TR6 is held constant at close to 1.2V above the emitter, its base/emitter voltage variations are kept very low in relation to ripple in the power supply or changes in voltages of the emitters of the long tail pair due to the input signal voltage. Hence the current through R5 is constant and the circuit offers a high dynamic impedance at the collector of TR5.

Transistors TR1 and TR2 form the input long tail pair. TR3 and TR4 are cascode transistors. Resistor R9 and diodes D1 and D2 act as a filter to ripple in the power supply and hold the bases of TR3 and TR4 at approximately 1.2V above earth. Their emitters are thus at approximately 0.6V above earth. The collectors of TR1 and TR2 are held at the same voltage. As ripple voltages on the power supplies have been filtered, modulation of the gain of TR1 and TR2 due to power supply ripple is greatly reduced and hence the sound quality much better with the addition of TR3 and TR4. TR9 acts as a second stage amplifier with its

collector voltage held constant relative to power supply ripple by TR10. TR10 is a TO-220 high power device BD243C chosen for low temperature generated distortion and high minimum gain specification.

Capacitor C4 provides local feedback to reduce high frequency open loop gain and improve the stability of the circuit. The constant current source formed by TR7, TR8, R11 and R12 provides a load for the second stage.

OUTPUT STAGE CIRCUIT

The output consists of a class A stage (TR12 and TR13) and a class B stage (TR14 and TR15). The quiescent current is controlled by a bias transistor TR11 and resistors R14 and R15. This is set to give just under $5V_{be}$ voltage drops, four of which are used for TR12 and TR13 Darlington's with about 0.3V to 0.4V across the output transistors TR14 and TR15.

The values of R20 and R21 are kept very low so that when a large current flows through either TR14 or TR15, the com-

COMPONENTS

Amendments to the components list

Resistors	Standard kit	Improved version
R5	220 metal film	221 Holco H8
R14	1k4 Holco H8	
R15	332 Holco H8	
R32	68 metal film	68Q1 Holco H8
R33,34	330 metal film	332 Holco H8
R35	see text	
R30,31,130,131	47 5W w/w	
R36	4k7 carbon	
Capacitors		
C7	not used	
C8,9	10 μ F radial elect. 63V	
C19,20	470nF polyester	470n polypropylene
Semiconductors		
TR3,4	BC547C	
TR12	TIP121	
TR13	TIP126	
D3	red l.e.d.	
D4	not used	
D11	red l.e.d.	

bined value of its V_{be} drop and voltage across the resistor prevents TR12 or TR13 from cutting off. With the values as published, TR12 and TR13 will not cut off until a current of at least two to three amps is reached. Safe operation of the circuit depends on TR11 being mounted as close as possible to TR14 and TR15. Any increase in temperature of TR14 and TR15 will result in increased current. Close thermal coupling to TR11 will ensure that TR11 heats up and its base/emitter voltage falls. As a result the bias voltage to the output stages falls reducing the quiescent current and maintaining equilibrium. Capacitor C10 and R17 are provided to ensure low output impedance at high frequencies and diodes D5 and D6 are used to prevent damage to the output stage as a result of the high voltages that might occur when loudspeakers are disconnected. Capacitor C3 ensures that the gain at d.c. is reduced to

one so that any d.c. offsets caused by changes of temperature in the input stage are not multiplied by the gain of the amplifier (X48) at the output stage. A large value of C3 is required to ensure that full amplification is maintained down to the lowest audio frequency. With the values used the frequency at which the power is halved (-3db) is around 6Hz. Loudspeaker protection is provided by FS4 which is contained within the feedback loop for better sound.

SUPPLY

The output stage is powered from a single unregulated supply of +36V using BR1 and two large reservoir capacitors C17 and C18. Resistors R27 and R28 are mounted on the capacitors themselves. These are particularly useful when testing power supplies as

they will discharge the capacitors slowly within five minutes.

Separate power supplies including rectifiers and reservoirs are provided for the low current side of each power amplifier. These are mounted on a separate board. The earth returns from the reservoir have their own direct connection to the earth point. The resistance of the earth return wire will cause ripple voltages at the earth point due to the high ripple currents used in charging the reservoir capacitors. If not taken directly to earth, these ripple voltages will be present at the output of the regulators. The output voltages are set to $\pm 30V$ by i.c. regulators IC1, IC2, IC101, IC102. The voltage is adjusted by the resistors R23 to R26, R123 to R126 and is set close to $\pm 30V$. The regulators require a minimum of 3V from input to output for correct operation and the output voltage is set to allow for variations in mains supply as well. If your mains supply varies by more than +10 per cent, you may wish to reduce the value of the 4k75 resistors to reduce the output voltage. High frequency stability of the regulators is provided by C15, C16, C115, C116. Fuses FS2 and FS3 will blow in the event of failure of one of the output transistors. Resistor R29 is a voltage dependent resistor which removes high voltage spikes from the mains.

Resistor R35 is included to maintain stability at high frequencies when long (inductive) leads are used for signal and supply earths. Typical values might be 2 Ω to 10 Ω , but this resistor is not strictly necessary if the Apex is built into its case.

Next month: final construction and testing.

PLEASE NOTE. Some components have been changed from the original components lists to ensure amplifier stability on different power supplies (see list above).

We apologise for a mistake in part 2—components IC4 to IC7 and IC104 to IC107 are shown the wrong way around (Fig. 19). The metal tabs should be on the right.

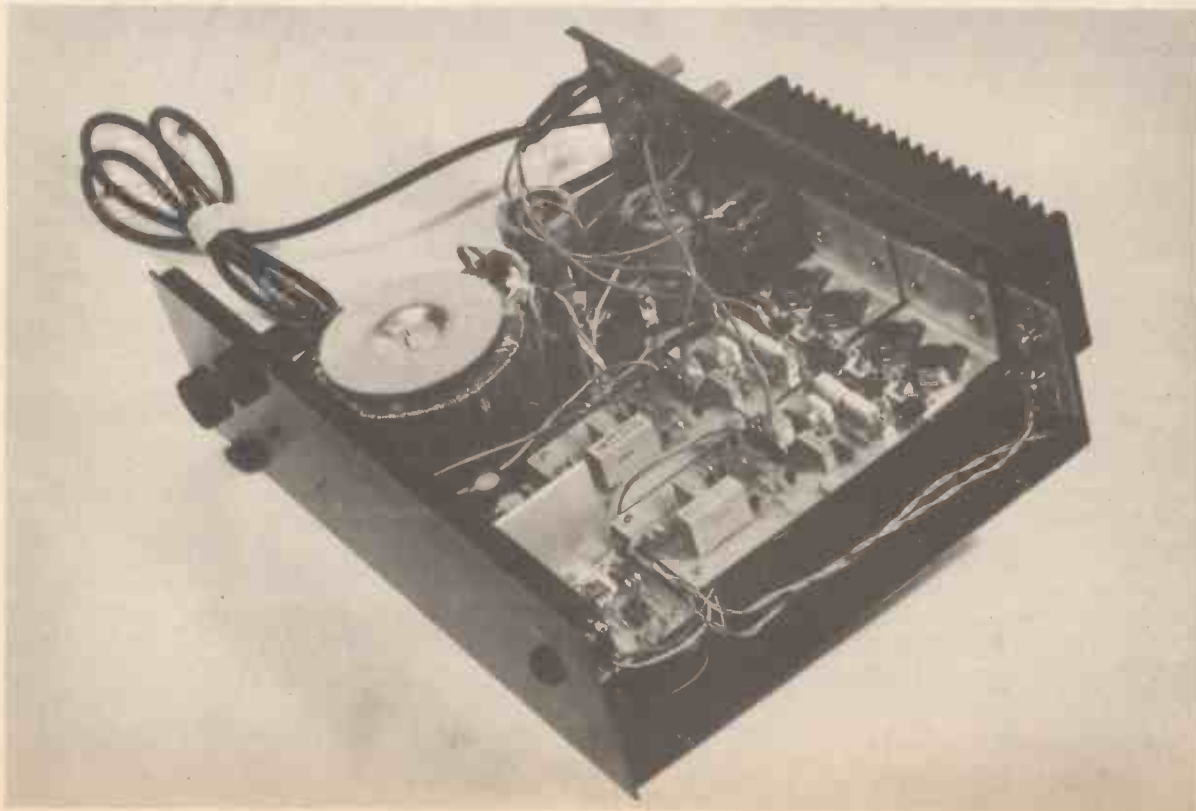

JUNE FEATURES...

VISUAL GUITAR TUNER

This circuit was designed as a multi-purpose musical instrument tuner that could be pre-set to cover a wide range of crystal controlled reference frequencies. Tuning the instrument is achieved by a novel and very effective display using a ring of l.e.d.s.

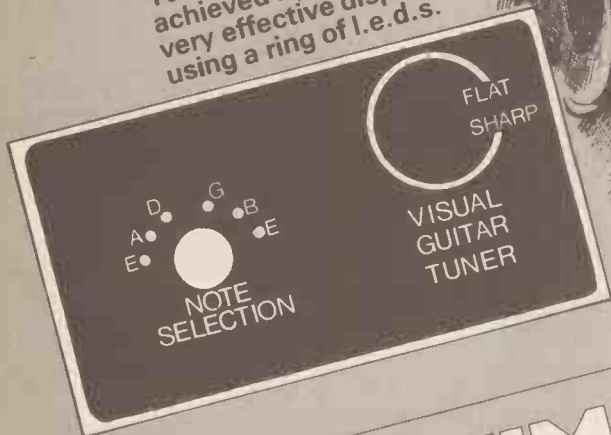

MINI DISCO LIGHT

Of all the disco effects available, lights which flash to the beat of the music continue to enjoy the greatest popularity. This circuit fills the gap between simple low-voltage circuits and high-power multi-channel systems.

REGENERATIVE RECEIVERS

The regenerative receiver, a radio set that's just about the oldest of all the useful amateur designs, is still effective today and is cheap to build. In a series of two articles we explore the theory and practice of regenerative radio sets, their operation, some practical ideas, and the results you can expect from the circuits described.

DOOR CHIME

It is possible to emulate the ding dong chime effect electronically and it is a simple matter to generate uncomplicated tones over a loudspeaker: the trick however is to modify this by modulating the tones to introduce the reverberation and decay characteristics of a "Friedland". The Door Chime to be described utilises a single eight-pin integrated circuit.

EVERYDAY ELECTRONICS

JUNE ISSUE ON SALE FRIDAY MAY 15, 1987

FRIDGE ALARM

T.R. de VAUX-BALBIRNIE

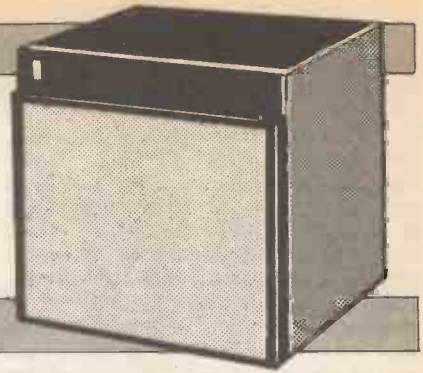

Designed for caravanning but equally suitable for household use

MOST caravans are fitted with a refrigerator. This uses a gas flame or electric element to heat the refrigerant contained in a small boiler to the rear of the food cabinet. Interruption of the supply, for whatever reason, will soon result in ruined food—especially in warm weather.

This project is a self-contained alarm of very small physical size and near-zero power consumption. Placed inside the refrigerator, it emits a loud tone if the internal temperature rises above a preset level.

When used in a trailer caravan the sound cannot, of course, be heard while driving so the device is limited to on-site operation. In a motor caravan, however, it may be heard from the driving seat—although not, perhaps, with the engine running. The alarm is equally suitable for household use and is especially useful where children leave the door open.

The prototype unit has been shown to be loud enough for all normal purposes but there could be times when it is insufficient—under noisy conditions, for example. In case of doubt, obtain the buzzer only (make sure it is the *high intensity* type as specified) and by connecting this *direct* to a 9V battery inside the fridge, the value or loudness of the device may be assessed.

Standby current consumption of the

alarm is less than 5 μ A so the internal battery will give excellent service. Consumption rises to approximately 35mA with the alarm sounding. The on-off switch provides a test facility whereby the battery may be checked periodically. The small size of the unit ensures that very little food space is lost—this is especially important with one cubic foot fridges.

CIRCUIT

The circuit for the Fridge Alarm is shown in Fig. 1. IC1 is an operational amplifier of a type chosen for its extremely small current requirement. R2 is a negative temperature coefficient thermistor which, together with R1, forms a potential divider connected across the supply. Thus, a certain voltage exists at the op-amp inverting input (pin two). This voltage falls as the temperature of R2 rises.

A second potential divider consisting of R3 in the upper section in conjunction with R4 and VR1 in the lower one is connected to the op-amp non-inverting input (pin three). With VR1 correctly adjusted and with R2 below the required operating temperature, the voltage at the inverting input will exceed that at the non-inverting one. The op-amp is then off with pin six low (battery negative voltage) and having no further effect. With R2 sensing a higher temperature, the voltage at the inverting input falls below that at the non-inverting one and the op-amp switches on with pin six high (battery positive voltage). This operates TR1 hence the buzzer, WD1, in the emitter circuit.

Switch S1 is a three-position four-pole

type. In this application only two poles are used. Pole one directs current to the circuit when the switch is set to either of the extreme positions (Test and On)—the centre position is Off. Battery checking is provided by Pole 2. When S1 is in the Test position, R5 makes IC1 pin three go high so operating WD1 irrespective of the temperature of R2. Note that very high value resistors are used in the potential dividers to reduce the continuous current drain whenever the circuit is switched on.

CONSTRUCTION

Warning: since IC1 is a C-MOS device and therefore vulnerable to static damage, do not unpack it until it is required. When inserting it into its holder, do not touch the pins.

The prototype was constructed in an aluminium case but a plastic one of similar size would serve just as well. The circuit is based on a printed circuit panel size 40 x 27 mm. The master pattern to be etched is shown full size in Fig. 2. The component layout is also shown in Fig. 2. This small printed circuit board is available from the EE PCB Service—Code EE 565.

Mount the on-board components. Using light-duty stranded connecting wire, extend R2 connecting wires by 5cm and sleeve them using pieces of insulation removed from connecting wire (see photo). Solder 5cm pieces of stranded connecting wire to the points indicated on the p.c.b. Drill countersunk holes in the base of the case for circuit panel mounting and make the holes for WD1 and S1.

Note the manner in which WD1 is mounted—this is neater than direct surface mounting. Measure the position of VR1 and drill a hole in the case so that this component may be adjusted with the lid in position using a small screwdriver. Drill a small hole near R2 position and fit it with a rubber grommet. Mount the buzzer and switch and complete all wiring (see Fig. 3). WD1 is polarity-sensitive and will not work if connected the wrong way round.

Attach the circuit panel to the base of the box using small countersunk fixings through the holes drilled for the purpose. If a metal case is used, prevent short-circuits occurring between the copper tracks on the underside of the p.c.b. and the metalwork by using small stand-off insulators. Alternatively, place a thick piece of cardboard between the base of the case and the circuit panel.

TESTING

Switch S1 off (centre position) and rotate VR1 sliding contact fully clockwise. Connect the battery and place in position—this is self-wedging if the specified case is used.

Fig. 1. Complete circuit diagram for the Fridge Alarm.

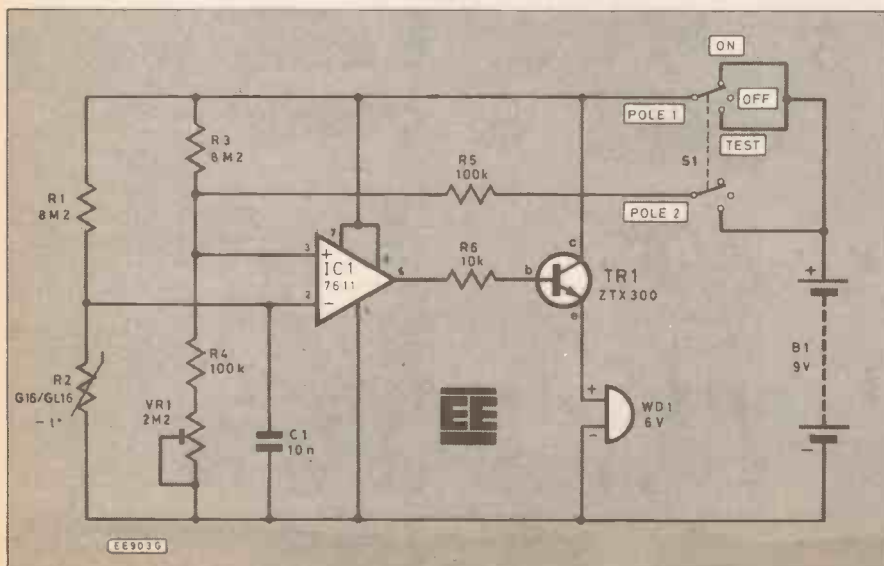

Switch S1 to Test and check that the buzzer sounds. Switch to On—the buzzer should sound—and adjust VR1 to silence it. Warm R2 between the fingers whereupon the buzzer should sound again. If this basic operational test reveals that all is well, offer the lid into position and gently coax R2 so that the body protrudes through the rubber grommet (see photo). Secure the lid and check that VR1 can be adjusted through the hole in the case using a small screwdriver.

Often the best place for the unit is attached to the inside of the fridge door. Heavy-duty double-sided adhesive tape may be used to secure it. The door will then act as a sounding board and give loudest results. It also leads to a fast response time if the door is left open.

USING THE ALARM

With the unit in position, allow the fridge to reach operating temperature before switching on. If the fridge is already at operating temperature, allow half an hour at least before making adjustments. VR1 should be adjusted quickly (before the temperature rises unduly) so that the buzzer just remains off. This adjustment is critical and should be made over a trial period. Check that the buzzer sounds when the door is left open. The unit may now be forgotten except to check the battery every few months. If ever the alarm sounds for a long time, it is advisable to replace the battery and this should be done, as a matter of routine, before each season's use. □

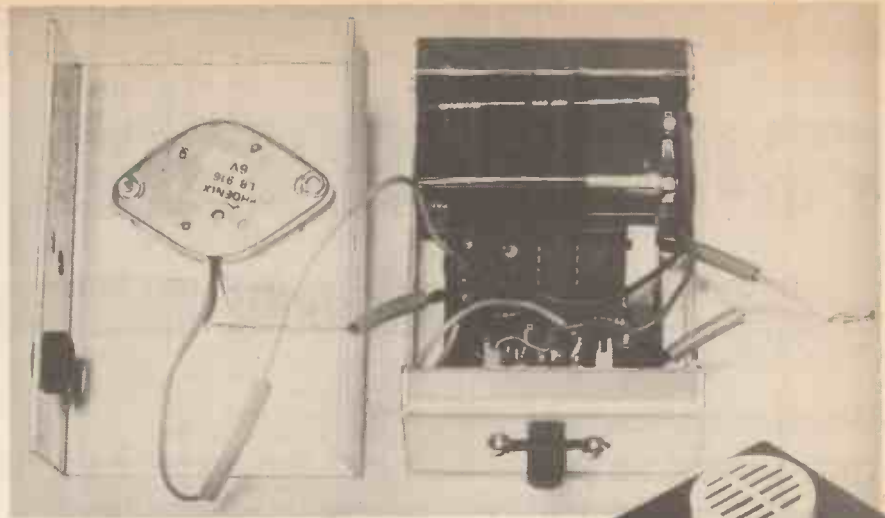

(above) The completed unit with top removed showing the compact component layout. (below) The completed circuit board with thermistor attached.



Completed alarm with thermistor protruding through rubber grommet in side of the case

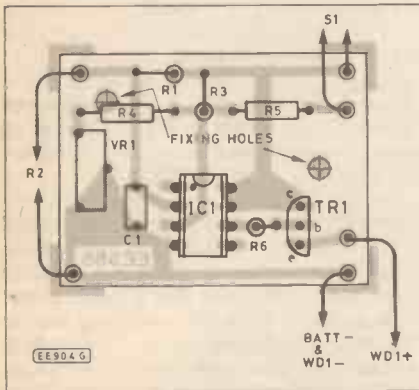

Fig. 2. Printed circuit board component layout and full size p.c.b. master pattern.

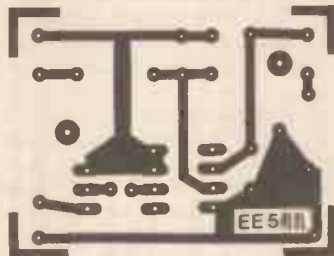
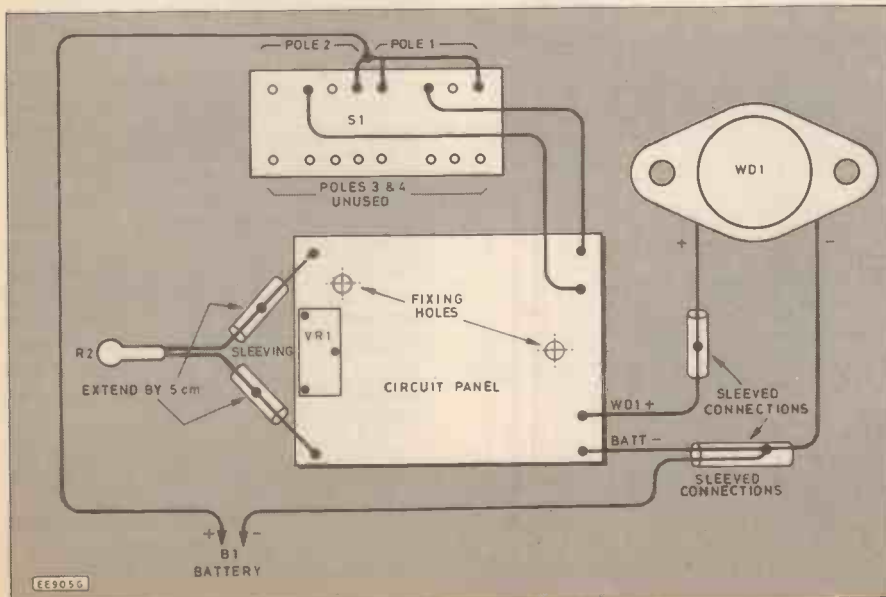

Fig. 3. Interwiring to the thermistor (R2), switch and buzzer. Note the use of plastic sleeving when extending WD1 and R2 leads.



COMPONENTS

Resistors

- R1,R3 8M2 (2 off)
- R2 G16/GL16 bead thermistor
- R4,R5 100k (2 off)
- R6 10k

See **Shop Talk** page 255

0.25W ± 5% except where stated

Potentiometer

- VR1 2M2 standard preset —vertical mounting

Capacitor

- C1 10nF

Semiconductors

- IC1 ICL7611 CMOS op. amp.
- TR1 ZTX300 npn silicon.

Miscellaneous

- S1 miniature 4-pole 3-position slide switch
- WD1 6V high intensity solid-state buzzer; approx. operating frequency 450 Hz, current 35 mA.
- B1 PP3 battery and connector

AB12 aluminium box size 76 x 51 x 25 mm; stranded connecting wire; fixings; rubber grommet; printed circuit board available from the EE PCB Service, order code EE 565; eight pin d.i.l. i.c. socket.

Approx. cost
Guidance only

£12

BOOK SERVICE

The books listed below have been selected as being of special interest to our readers, they are supplied from our editorial address direct to your door.

DATA AND REFERENCE

PRACTICAL ELECTRONICS CALCULATIONS AND FORMULAE

F. A. Wilson, C.G.I.A., C.Eng., F.I.E.E., F.I.E.R.E., F.B.I.M.

Bridges the gap between complicated technical theory, and "cut-and-try" methods which may bring success in design but leave the experimenter unfulfilled. A strong practical bias—tedious and higher mathematics have been avoided where possible and many tables have been included.

The book is divided into six basic sections: Units and Constants, Direct-current Circuits, Passive Components, Alternating-current Circuits, Networks and Theorems, Measurements.

256 pages Order Code BP53 £2.95

ESSENTIAL THEORY FOR THE ELECTRONICS HOBBYIST

G. T. Rubaroo, T.Eng (C.E.I.), Assoc.I.E.R.E.

The object of this book is to supply the hobbyist with a background knowledge tailored to meet his or her specific requirements and the author has brought together the relevant material and presented it in a readable manner with minimum recourse to mathematics.

128 pages Order Code 228 £2.50

MICROPROCESSING SYSTEMS AND CIRCUITS

F. A. Wilson, C.G.I.A., C.Eng., F.I.E.E., F.I.E.R.E., F.B.I.M.

A truly comprehensive guide to the elements of micro-processing systems which really starts at the beginning. Teaches the reader the essential fundamentals that are so important for a sound understanding of the subject.

256 pages Order Code BP77 £2.95

COMMUNICATION

F. A. Wilson, C.G.I.A., C.Eng., F.I.E.E., F.I.E.R.E., F.B.I.M.

A look at the electronic fundamentals over the whole of the communication scene. This book aims to teach the important elements of each branch of the subject in a style as interesting and practical as possible. While not getting involved in the more complicated theory and mathematics, most of the modern transmission system techniques are examined including line, microwave, submarine, satellite and digital multiplex systems, radio and telegraphy. To assist in understanding these more thoroughly, chapters on signal processing, the electro-

magnetic wave, networks and transmissions assessment are included, finally a short chapter on optical transmission.

256 pages Order Code BP89 £2.95

AUDIO

F. A. Wilson, C.G.I.A., C.Eng., F.I.E.E., F.I.E.R.E., F.B.I.M.

Analysis of the sound wave and an explanation of acoustical quantities prepare the way. These are followed by a study of the mechanism of hearing and examination of the various sounds we hear. A look at room acoustics with a subsequent chapter on microphones and loudspeakers then sets the scene for the main chapter on audio systems—amplifiers, oscillators, disc and magnetic recording and electronic music.

320 pages Order Code BP111 £3.50

HOW TO IDENTIFY UNMARKED ICs

K. H. Reconr

Shows the reader how, with just a test-meter, to go about recording the particular signature of an unmarked i.c. which should enable the i.c. to then be identified with reference to manufacturers' or other data. An i.c. signature is a specially plotted chart produced by measuring the resistances between all terminal pairs of an i.c.

Chart Order Code BP101 £0.95

RADIO AND ELECTRONIC COLOUR CODES AND DATA CHART

B. B. Babani

Although this chart was first published in 1971 it provides basic information on many colour codes in use throughout the world, for most radio and electronic components. Includes resistors, capacitors, transformers, field coils, fuses, battery leads, speakers, etc. It is particularly useful for finding the values of old components.

Chart Order Code BP7 £0.95

CHART OF RADIO, ELECTRONIC, SEMICONDUCTOR AND LOGIC SYMBOLS

M. H. Banani, B.Sc.(Eng.)

Illustrates the common, and many of the not-so-common, radio, electronic, semiconductor and logic symbols that are used in books, magazines and instruction manuals, etc., in most countries throughout the world.

Chart Order Code BP27 £0.95

TRANSISTOR RADIO FAULT-FINDING CHART

C. E. Miller

Used properly, should enable the reader to trace most common faults reasonably quickly. Across the top of the chart will be found four rectangles containing brief description of these faults, viz—sound weak but undistorted, set dead, sound low or distorted and background noises. One then selects the most appropriate of these and following the arrows, carries out the suggested checks in sequence until the fault is cleared.

Chart Order Code BP70 £0.95

DIGITAL IC EQUIVALENTS AND PIN CONNECTIONS

A. Michaels

Shows equivalents and pin connections of a popular selection of European, American and Japanese digital i.c.s. Also includes details of packaging, families, functions, manufacturer and country of origin.

256 pages Order Code BP140 £4.95

LINEAR IC EQUIVALENTS AND PIN CONNECTIONS

A. Michaels

Shows equivalents and pin connections of a popular selection of European, American and Japanese linear i.c.s. Also includes details of functions, manufacturer and country of origin.

320 pages Order Code BP141 £4.95

INTERNATIONAL TRANSISTOR EQUIVALENTS GUIDE

A. Michaels

Helps the reader to find possible substitutes for a popular selection of European, American and Japanese transistors. Also shows material type, polarity, manufacturer and use.

320 pages Order Code BP85 £2.95

INTERNATIONAL DIODE EQUIVALENTS GUIDE

A. Michaels

Designed to help the user in finding possible substitutes for a large selection of the many different types of diodes that are available. Besides simple rectifier diodes, also included are Zener diodes, i.e.d.s, diacs, triacs, thyristors, OCIs, photo and display diodes.

144 pages Order Code BP108 £2.25

CIRCUITS AND DESIGN

ELECTRONICS SIMPLIFIED —CRYSTAL SET CONSTRUCTION

F. A. Wilson, C.G.I.A., C.Eng., F.I.E.E., F.I.E.R.E., F.B.I.M.

Especially written for those who wish to participate in the intricacies of electronics more through practical construction than by theoretical study. It is designed for all ages upwards from the day one can read intelligently and handle simple tools.

80 pages Order Code BP92 £1.75

50 CIRCUITS USING GERMANIUM SILICON AND ZENER DIODES

R. N. Soar

Contains 50 interesting and useful circuits and applications, covering many different branches of electronics, using one of the most simple and inexpensive of components—the diode. Includes the use of germanium and silicon signal diodes, silicon rectifier diodes and Zener diodes, etc.

64 pages Order Code BP36 £1.50

50 SIMPLE LED CIRCUITS

R. N. Soar

Contains 50 interesting and useful circuits and applications, covering many different branches of electronics, using one of the most inexpensive and freely available components—the light-emitting diode (LED). Also includes circuits for the 707 common anode display.

64 pages Order Code BP42 £1.95

COIL DESIGN AND CONSTRUCTION MANUAL

B. B. Babani

A complete book for the home constructor on "how to make" RF, IF, audio and power coils, chokes and transformers. Practically every possible type is discussed and calculations necessary are given and explained in detail. Although this book is now rather old, with the exception of toroids and pulse transformers little has changed in coil design since it was written.

96 pages Order Code 160 £2.50

MICRO INTERFACING CIRCUITS—BOOK 1

MICRO INTERFACING CIRCUITS—BOOK 2

R. A. Penfold

Both books include practical circuits together with details of the circuit operation and useful background information. Any special constructional points are covered but p.c.b. layouts and other detailed constructional information are not included.

Book 1 is mainly concerned with getting signals in and out of the computer; Book 2 deals primarily with circuits for practical applications.

Book 1 112 pages Order Code BP130 £2.25

Book 2 112 pages Order Code BP131 £2.25

A MICROPROCESSOR PRIMER

E. A. Parr, B.Sc., C.Eng., M.I.E.E.

Starts by designing a small computer which, because of its simplicity and logical structure, enables the language to be easily learnt and understood. The shortcomings are then discussed and the reader is shown how these can be overcome by changes and additions to the instruction set. In this way, such ideas as relative addressing, index registers, etc., are developed.

96 pages Order Code BP72 £1.75

A PRACTICAL INTRODUCTION TO MICROPROCESSORS

R. A. Penfold

Provides an introduction which includes a very simple microprocessor circuit which can be constructed so that the reader can experiment and gain practical experience.

96 pages Order Code BP123 £1.95

HOW TO USE OP-AMPS

E. A. Parr

This book has been written as a designer's guide covering many operational amplifiers, serving both as a source book of circuits and a reference book for design calculations. The approach has been made as non-mathematical as possible.

160 pages Order Code BP88 £2.95

PRACTICAL ELECTRONIC BUILDING BLOCKS—BOOK 1

PRACTICAL ELECTRONIC BUILDING BLOCKS—BOOK 2

R. A. Penfold

These books are designed to aid electronic enthusiasts who like to experiment with circuits and produce their own projects, rather than simply following published project designs.

BOOK 1 contains: Oscillators—sinewave, triangular, squarewave, sawtooth, and pulse waveform generators operating at audio frequencies. Timers—simple monostable circuits using i.c.s, the 555 and 7555 devices, etc. Miscellaneous—noise generators, rectifiers, comparators and triggers, etc.

BOOK 2 contains: Amplifiers—low level discrete and op-amp circuits, voltage and buffer amplifiers including d.c. types. Also low-noise audio and voltage controlled amplifiers. Filters—high-pass, low-pass, 6, 12, and 24dB per octave types. Miscellaneous—i.c. power amplifiers, mixers, voltage and current regulators, etc.

BOOK 1 128 pages Order Code BP117 £1.95

BOOK 2 112 pages Order Code BP118 £1.95

HOW TO DESIGN ELECTRONIC PROJECTS

R. A. Penfold

The aim of this book is to help the reader to put together projects from standard circuit blocks with a minimum of trial and error, but without resorting to any advanced mathematics. Hints on designing circuit blocks to meet your special requirements are also provided.

128 pages Order Code BP127 £2.25

POPULAR ELECTRONIC CIRCUITS

—BOOK 1

POPULAR ELECTRONIC CIRCUITS

—BOOK 2

R. A. Penfold

Each book provides a wide range of designs for electronic enthusiasts who are capable of producing working projects from just a circuit diagram without the aid of detailed construction information. Any special setting-up procedures are described.

BOOK 1 Temporarily out of print

BOOK 2 160 pages Order Code BP98 £2.25

GETTING THE MOST FROM YOUR PRINTER

J. W. Penfold
Details how to use all the features provided on most dot-matrix printers from programs and popular word processor packages like Wordwise, Visawrite and Quill, etc. Shows exactly what must be typed in to achieve a given effect.
96 pages **Order Code BP181 £2.95**

A Z80 WORKSHOP MANUAL

E. A. Parr, B.Sc., C.Eng., M.I.E.E.
This book is intended for people who wish to progress beyond the stage of BASIC programming to topics such as machine code and assembly language programming, or need hardware details of a Z80 based computer.
192 pages **Order Code BP112 £3.50**

AN INTRODUCTION TO 68000 ASSEMBLY LANGUAGE

R. A. & J. W. Penfold
Obtain a vast increase in running speed by writing programs for 68000 based micros such as the Commodore Amiga, Atari ST range or Apple Macintosh range etc., in assembly language. It is not as difficult as one might think and this book covers the fundamentals.
112 pages **Order Code BP184 £2.95**

THE ART OF PROGRAMMING THE ZX SPECTRUM

M. James, B.Sc., M.B.C.S.
It is one thing to have learnt how to use all the Spectrum's commands and functions, but a very different one to be able to combine them into programs that do exactly what you want them to. This is just what this book is all about—teaching you the art of effective programming with your Spectrum.
144 pages **Order code BP119 £2.50**

AN INTRODUCTION TO PROGRAMMING THE COMMODORE 16 & PLUS 4

R. A. Penfold
Helps you to learn to use and program these two Commodore machines with the minimum of difficulty by expanding and complementing the information supplied in the manufacturer's own manuals.
128 pages **Order code BP158 £2.50**

AN INTRODUCTION TO PROGRAMMING THE BBC MODEL B MICRO

R. A. & J. W. Penfold
Written for readers wanting to learn more about programming and how to make best use of the incredibly powerful model B's versatile features. Most aspects of the BBC micro are covered, the omissions being where little could usefully be added to the information provided by the manufacturer's own manual.
144 pages **Order code BP139 £1.95**

AN INTRODUCTION TO PROGRAMMING THE ACORN ELECTRON

R. A. & J. W. Penfold
Designed to help the reader learn more about programming and to make best use of the Electron's many features. Adds considerably to the information already supplied in the manufacturer's own instruction manual.
144 pages **Order code BP142 £1.95**

AN INTRODUCTION TO PROGRAMMING THE ATARI 600/800 XL

R. A. & J. W. Penfold
Especially written to supplement the manufacturer's own handbook. The information supplied will help the reader to master BASIC programming and to make best use of the Atari's many powerful features.
128 pages **Order code BP143 £1.95**

AN INTRODUCTION TO PROGRAMMING THE AMSTRAD CPC 464 AND 664

R. A. & J. W. Penfold
The Amstrad CPC 464 or 664 running with Locomotive BASIC makes an extremely potent and versatile machine and this book is designed to help the reader get the most from this powerful combination. Written to complement rather than duplicate the information already given in the manufacturer's own manual. Also applicable to the CPC 6128.
144 pages **Order Code BP153 £2.50**

AN INTRODUCTION TO PROGRAMMING THE SINCLAIR QL

R. A. & J. W. Penfold
Helps the reader to make best use of the fantastic Sinclair QL's almost unlimited range of features. Designed to complement the manufacturer's handbook.
112 pages **Order code BP150 £1.95**

AN INTRODUCTION TO Z80 MACHINE CODE

R. A. & J. W. Penfold
Takes the reader through the basics of microprocessors and machine code programming with no previous knowledge of these being assumed. The Z80 is used in many popular home computers and simple programming examples are given for Z80-based machines including the Sinclair ZX-81 and Spectrum, Memotech and the Amstrad CPC 464. Also applicable to the Amstrad CPC 664 and 6128.
144 pages **Order code BP152 £2.75**

AN INTRODUCTION TO 6502 MACHINE CODE

R. A. & J. W. Penfold
No previous knowledge of microprocessors or machine code is assumed. Topics covered are: assembly language and assemblers, the register set and memory, binary and hexadecimal numbering systems, addressing modes and the instruction set, and also mixing machine code with BASIC. Some simple programming examples are given for 6502-based home computers like the VIC-20, ORIC-1/Atmos, Electron, BCC and also the Commodore 64.
112 pages **Order code BP147 £2.50**

THE PRE-BASIC BOOK
F. A. Wilson, C.G.I.A., C.ENG., F.I.E.E., F.I.E.R.E., F.B.I.M.

Another book on BASIC but with a difference. This one does not skip through the whole of the subject and therefore leave many would-be programmers floundering but instead concentrates on introducing the technique by looking in depth at the most frequently used and more easily understood computer instructions. For all new and potential micro users.
192 pages **Order code BP146 £2.95**

HOW TO GET YOUR COMPUTER PROGRAMS RUNNING

J. W. Penfold
Have you ever written your own programs only to find that they did not work? Help is now at hand with this book which shows you how to go about looking for your errors, and helps you to avoid the common bugs and pitfalls of program writing. Applicable to all dialects of the BASIC language.
144 pages **Order code BP169 £2.50**

AN INTRODUCTION TO COMPUTER COMMUNICATIONS

R. A. Penfold
Provides details of the various types of modem and their suitability for specific applications, plus details of connecting various computers to modems, and modems to the telephone system. Also information on common networking systems and RTTY.
96 pages **Order code BP177 £2.95**

AN INTRODUCTION TO COMPUTER PERIPHERALS

J. W. Penfold
Covers such items as monitors, printers, disc drives, cassette recorders, modems, etc., explaining what they are, how to use them and the various types and standards. Helps you to make sure that the peripherals you buy will work with your computer.
80 pages **Order code BP170 £2.50**

COMPUTER TERMINOLOGY EXPLAINED

I. D. Poole
Explains a wide range of terms that form the computer jargon used by enthusiasts. Includes a reference guide to the more commonly used BASIC commands.
96 pages **Order code BP148 £1.95**

THE PRE-COMPUTER BOOK

F. A. Wilson
Aimed at the absolute beginner with no knowledge of computing. An entirely non-technical discussion of computer bits and pieces and programming.
96 pages **Order code BP115 £1.95**

PROJECT CONSTRUCTION

HOW TO GET YOUR ELECTRONIC PROJECTS WORKING

R. A. Penfold
We have all built projects only to find that they did not work correctly, or at all, when first switched on. The aim of this book is to help the reader overcome just these problems by indicating how and where to start looking for many of the common faults that can occur when building up projects.
96 pages **Order code BP110 £1.95**

HOW TO DESIGN AND MAKE YOUR OWN P.C.B.s

R. A. Penfold
Deals with the simple methods of copying printed circuit

board designs from magazines and books and covers all aspects of simple p.c.b. construction including photographic methods and designing your own p.c.b.s.
80 pages **Order code BP121 £1.95**

BEGINNER'S GUIDE TO BUILDING ELECTRONIC PROJECTS

R. A. Penfold
Shows the complete beginner how to tackle the practical side of electronics, so that he or she can confidently build the electronic projects that are regularly featured in magazines and books. Also includes examples in the form of simple projects.
112 pages **Order code No. 227 £1.95**

RADIO

AN INTRODUCTION TO RADIO DXING

R. A. Penfold
Anyone can switch on a short wave receiver and play with the controls until they pick up something, but to find a particular station, country or type of broadcast and to receive it as clearly as possible requires a little more skill and knowledge. The object of this book is to help the reader to do just that, which in essence is the fascinating hobby of radio DXing.
112 pages **Order code BP91 £1.95**

INTERNATIONAL RADIO STATIONS GUIDE

Completely revised and updated, this book is an invaluable aid in helping all those who have a radio receiver to obtain the maximum entertainment value and enjoyment from their sets.
Clearly shown are the station site, country, frequency and/or wavelength, as well as the effective radiation power of the transmitter.
128 pages **Order code BP155 £2.95**

NEW RELEASE

COMPUTER ENGINEER'S POCKETBOOK

Michael Tooley
An invaluable compendium of facts, figures, circuits and data, indispensable to the designer, student, service engineer and all those interested in computer and microcomputer systems. It will appeal equally to the hardware or software specialist and to the new band of "software engineers". This first edition covers a vast range of subjects at a practical level, with the necessary explanatory text. The data is presented in a succinct and rapidly accessible form so that the book can become part of an everyday toolkit.
205 pages (hard cover) **Order code NE01**

PRICE £8.95

BOOK SERVICE

TO ORDER
Please check the latest issue for price and availability.

Add 50p per order postage (overseas readers add £1, surface mail postage) and send a PO, cheque or international money order (£ sterling only) made payable to Everyday Electronics (quoting the order code and quantities required) to **EE BOOK SERVICE, 6 CHURCH STREET, WIMBORNE, DORSET. BH21 1JH.**

Although books are normally sent within seven days of receipt of your order please allow a maximum of 28 days for delivery. Overseas readers allow extra for surface mail post.



DOWN TO EARTH

BY GEORGE HYLTON

DIODE RESISTANCE

If you measure the resistance of a diode with an ohmmeter you get different values on different ranges of the meter. I'm talking about the conducting or "forward" resistance, of course. For a silicon diode, the reverse resistance is so high that it doesn't register on an ordinary multimeter.

The reason for this variability is just that a diode is not a resistor. Its resistance is not constant but changes when the measuring conditions change. Before delving into the reasons for this, let's just do a brief recap on how proper resistances behave.

The effect of voltage on three different resistances is shown in Fig. 1. Take 20 ohms, apply 1V and 50mA flows. If this voltage is halved the current is halved. Current is strictly proportional to applied voltage, just as Ohm's Law says.

If the 20 ohms is halved to 10 ohms then for the same voltage the current is doubled; and if the resistance is doubled to 40 ohms then all the original currents are halved. The lower the resistance the steeper the slope of the graph, but it's always a straight line.

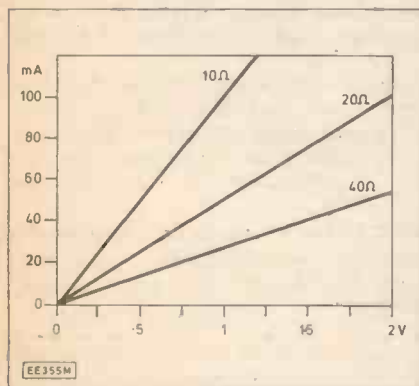

Fig. 1. Voltage-current graphs for three resistances.

GRADIENTS

This idea of the steepness of the slope—the gradient, if you like—comes in handy when looking at diode behaviour. The resistance is quite simply the gradient of the graph. For a straight line the gradient is the same at all points, but for a curve it isn't. Diodes give curved voltage-current graphs.

In Fig. 2, a graph for a silicon junction diode is superimposed on the graphs for our three resistances. The voltage range has been restricted because if you apply more than about 1V to a junction diode you are liable to destroy it. This is because the current doesn't rise in a straight line but in an upward curve of ever-increasing steepness.

One way of looking at the diode resistance is to note where the diode curve intersects a resistance line. At this point the diode's resistance and the real resistance are the same. Thus at point 1 the diode resistance is 40 ohms, at point 2, 20 ohms, and at point 3, 10 ohms. The curve doesn't attempt to represent a particular diode but it gives a good idea of the general behaviour of a diode.

The resistance values at these points of intersection are the "large-signal resistance" of the diode. The "signal", in this case, is just the applied voltage.

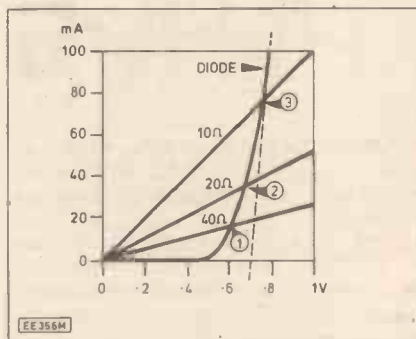

Fig. 2. Diode graph on resistance graphs.

SLOPE RESISTANCE

We saw, however, that the slope of the graph is also an indicator of resistance. For the diode, the slope at any point of intersection is much steeper than for the corresponding resistance. Steeper slope means lower resistance.

So, in one sense, the diode resistance is different from the real resistance at the intersections. We have TWO values for the diode resistance at each point: the "large-signal" value and the slope value.

The slope value is what would be seen by a very small extra voltage superimposed on the test voltage. For this reason it's called the "small-signal resistance". For a typical silicon junction diode the small-signal resistance is only a few per cent of the large signal value.

For a perfect semiconductor junction diode the small-signal resistance depends on the current rather than the voltage, and it's easy to estimate. At 1mA the resistance is about 25 ohms. If the current is doubled the resistance is halved and vice versa. The rule is, divide 25 by the number of milliamps of current and the answer is the small-signal resistance in ohms.

The rule works for both silicon and germanium diodes and for transistor junctions, and at low currents, say 10mA or less, it's fairly accurate. At high currents it gives an underestimate because in real diodes the junction isn't the only resistance. There's the "bulk resistance" of the piece of semiconductor material and this, though low, becomes significant as the current is increased.

The dotted line in Fig. 2 shows the slope of the diode graph at high current. The line intercepts the voltage axis at about 0.7V.

This is the voltage at which a silicon diode would begin to conduct if the electrons inside it had no thermal energy but were moved only by the applied voltage. Current would then start to flow when the voltage was large enough to overcome the internal potential barrier which develops across the junction.

This turn-on voltage is sometimes called the "forward Zener voltage". It's about 0.7V for ordinary silicon diodes and about 0.25V for germanium junctions. For the materials used to make i.e.d.s it's greater and varies with the i.e.d. colour because this is a function of the composition. The voltage is temperature dependent and reduces as the temperature is raised.

METER READINGS

It's a reasonable rule-of-thumb approximation to take the turn-on voltage as 0.7V for a silicon diode. When an ohmmeter is applied to the diode in the conducting direction about 0.7V of the meter's internal battery is used up in turning on the diode, leaving what's left to drive current through the internal resistor which sets the meter's ohms range.

For a 1.5V cell inside the meter this leaves 0.8V to drive current through the internal range resistor. The meter pointer then moves a certain distance. If the meter is switched to a higher range also operated by the same cell the current is reduced but the diode drop is still not very much less than its former value. So the pointer ends up in roughly the same position on both ranges. The result is that the indicated resistance increases from range to range by a bit less than the range factor.

The meter, in fact, indicates the large-signal resistance of the diode at the current set by the test voltage and the resistance standard. If the test voltage is well below 0.7V then the diode is not turned on and the meter reads "infinity".

Some electronic multimeters (and even a few non-electronic ones) are deliberately designed not to turn on diodes. This enables in-situ resistance measurements to be made on transistor circuits without the confusion caused by the meter driving junctions into conduction.

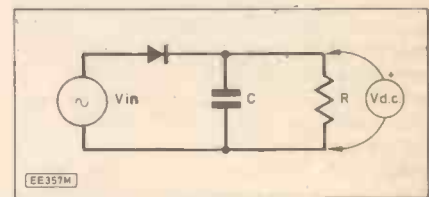

Fig. 3. Diode rectifier circuit.

RECTIFIER CIRCUITS

When you put a diode into a rectifier circuit, Fig. 3, you may be interested in the resistance seen by the a.c. source which drives it. In fact the current drawn from the source is time-varying. For a rectifier feeding a load R shunted by a reservoir capacity C the current flows in pulses near the positive peaks of the voltage.

The rest of the time the diode is non-conducting. So the resistance seen by the a.c. source is infinite for most of the time but quite low briefly when C recharges. However, this varying resistance can be averaged out over a period of time to give an equivalent steady value and this is what

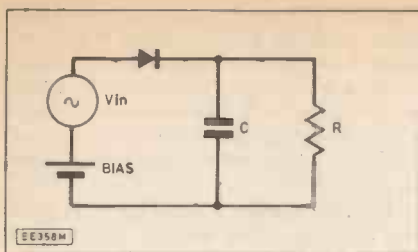

Fig. 4. Biased diode detector.

you want to know if you are interested in how much power the a.c. source must supply.

With a perfect diode with no resistance when conducting and zero turn-on voltage, a large reservoir capacity C would hold the d.c. output voltage steady at the peak a.c.

voltage. This peak is the r.m.s. voltage multiplied by $\sqrt{2}$.

Suppose R is 100 ohms and the peak voltage (i.e. the d.c. output voltage) is 100V. Then the current is 1A and the power 100W. The a.c. source must deliver 100W. But the r.m.s. voltage is not 100V but $100/\sqrt{2} = 70.7V$.

For 70.7V to deliver 100W the current must be 1.414A and the resistance must be $70.7V/1.414A = 50$ ohms. This is just half the value of R . So when a diode is used in this sort of rectifier circuit the resistance seen by the a.c. source is not R but $R/2$.

DETECTORS

If the a.c. voltage (V_{in}) is small, as it may be when the diode is used as the detector in an a.m. radio, then it needs help to turn on the diode. This help takes the form of

applying enough forward bias voltage, Fig. 4, to make the diode pass a few microamps d.c. The a.c. input then makes the diode conduct more, when positive, or less when negative.

For very small a.c. inputs the diode conducts about as well on both half cycles and V_{in} sees the small-signal resistance at the applied d.c. bias current. This, as we saw, is 25 ohms divided by the number of milliamps of current. For a typical bias of 10 μ A (1/100mA) the resistance is 2500 ohms.

If V_{in} is now made very large the effect of the bias is swamped and the circuit behaves like Fig. 3, the diode seeing $R/2$. It may be desirable to keep the resistance seen by V_{in} fairly constant. To do this R is made twice the small-signal resistance (or 5k with our bias).

MARKET PLACE

OSCILLOSCOPE FOR SALE—Philips dual trace £150 or part exchange for Alidin scope module (for Spectrum). Tel: Dean on 01-515 8823.

WANTED: Everyday Electronics August 1976. Andrew Griffiths, 12 Blenheim Drive, Great Barr, Birmingham B43.

L.C.R. passive bridge 10 μ H—100H 50pf—100 μ f 0.5 ohms—10Mohms £25. Tel: 0903 42927.

WANTED one hand held electronic game "Scare Kong". Mr. Ronald Hart, 29 Hillfoot Street, Dennestoun, Glasgow G31.

DRY CELL RECHARGER, tops up 9V batteries. Also includes safety feature. Simon Cross, 25 Melmerby Close, Gosforth, Newcastle NE3 5JA.

WANTED—any circuit diagrams of disco lighting effects units or audio effects units including looping/ECHO. John Scullard, 12 Higher Holcombe Close, Teignmouth, S. Devon TQ14 8RE.

WANTED—circuit diagram for Commodore 'Minuteman 3 metric' calculator. B. Cowton, 24 Guisborough Street, Sunderland SR4 7SD.

WANTED/borrow books on ZX81 Rom disassembly part 'A' or 'Your ZX81 Rom' by Dr. Ian Logan. Mr. A. J. Arch, 30 Thorn-Tree Gardens, Eastwood, Nottingham. Tel: 94 760244.

WANTED Everyday Electronics issue containing article about VLF oscillation detection, in good condition. State price. Anthony Quinn, 'Malarar', Boarbank Lane, Allithwaite, Grange-over-Sands, Cumbria LA11 7QR. Tel: 044 84 2773.

ADMIRALTY handbook of wireless telegraphy, 2 large volumes for wireless historians—£5. Tel: Coleshill (Warwicks.) 62308.

VIC 20, working, manual, no power supply. No. 7 key missing. Swap for working ZX80 and ram. Send details and address. Trevor Scott, 10 Central Drive, Urmston, Manchester M31 1AQ.

1000 assorted brand new components, resistors, capacitors, transistors, diodes, I.C.s, pots etc. Only £10. Post free. K. Bailey, 40 Seymour Close, Selly Park, Birmingham B29 7JD.

£5 paid circuit lernascope current model constructed in correspondence course by British National Radio & Electronics School. E. Mant, 14 Crofton Road, Milton, Portsmouth, Hants. PO4 8NX.

TRIUMPH ADLER quality computer. Basic and CPM disc drive, full specification, not HRG. £170. Tel: Taunton 432909.

WANTED printer 80COL in exchange NEC computer 8001, 8011 extension and disk card ideal for interfacing. Mr. A. Grabianski, 29 Lismore Road, Highworth, Swindon, Wilts. Tel: 0793 764552.

SCREWDRIVER turn Cermet preset resistors, 50 ohms and 250 ohms, 30p each. Please enclose 13p stamp. Not new. D. Gaunt, 23 Dickens Court, Newthorpe, Nottingham NG16 3RG.

GOLDRING Lenco GL75 deck plus Messe pick-up running slow. Offers L. T. Hill, 29 Stead Lane, Bedlington, Northumberland.

FREE READERS ADS.

RULES Maximum of 16 words plus address and/or phone no. Private advertisers only (trade or business ads. can be placed in our classified columns). Items related to electronics only. No computer software. EE cannot accept responsibility for the accuracy of ads. or for any transaction arising between readers as a result of a free ad. We reserve the right to refuse advertisements. Each ad. must be accompanied by a cut-out valid "date corner". Ads. will not appear (or be returned) if these rules are broken.

ICS WANTED YM1015D, LA4138, 78M09, IGO2590. Also circuit diagram, Yamaha synthesiser CS01. Will pay all charges. Ivan Comiskey, 33D north, Gt. Clarence Street, Dublin 1, Ireland.

EDDYSTONE crystal oscillator 100K to 1MHz. V.G.C. £8. Aerial rotator UHF or 144MHz V.G.C. £25. Mr. R. A. Pearson, 573 Pentregethin Road, Ravenhill, Swansea SA5 5ET. Tel: 0792 582941.

CLEARING WORKSHOP—2 transistor testers, 2 breadboards, i.c.s copper board etc. Worth £60. Bargain £20. Tel: 0408 21870 evenings.

WANTED "Lernascope" circuit—line up current model constructed with correspondence course B.N.R.E.S. "ceased trading". Cash or exchange. Tel: 0705 738326.

COMMODORE 64, VIC 20, MPS 801, 1541 drive, C2N, Brother HRC5 printer, extensive software. Literature £500 o.n.o. Buyer collects. Mr. D. D. Rees, The Old Rectory, Thurlbear, Taunton, Somerset TA3 5BW.

WANTED instruction booklet for TMK117 multi-tester. Also to buy Nombrex 41 Sig Gen. Tel: 0273 737838 (Hove).

Please read the **RULES** then write your advertisement here— one word to each box. Add your name, address and/or phone no. Please publish the following small ad. **FREE** in the next available issue. I am not a dealer in electronics or associated equipment. I have read the rules. I enclose a cut-out valid date corner.

Signature Date
COUPON VALID FOR POSTING BEFORE 15 MAY, 1987
 (One month later for overseas readers.)

SEND TO: EE MARKET PLACE, EVERYDAY ELECTRONICS, 6 CHURCH STREET, WIMBORNE, DORSET BH21 1JH.

BLOCK CAPITALS PLEASE

Name & Address:			

For readers who don't want to damage the Issue send a photostat or a copy of the coupon (filled in of course) with a cut-out valid "date corner"

PCB SERVICE

Printed circuit boards for certain constructional projects are now available from the PCB Service, see list. These are fabricated in glass-fibre, and are fully drilled and roller tinned. All prices include VAT and postage and packing. Add £1 per board for overseas airmail. Remittances should be sent to: The PCB Service, Everyday Electronics and Electronics Monthly Editorial Offices, 6 Church Street, Wimborne, Dorset BH21 1JH. Cheques should be crossed and made payable to Everyday Electronics. (Payment in £ sterling only.)

Please note that when ordering it is important to give project title as well as order code. Please print name and address in Block Caps. Do not send any other correspondence with your order.

Readers are advised to check with prices appearing in the current issue before ordering.

NOTE: Please allow 28 days for delivery. We can only supply boards listed in the latest issue. Boards can only be supplied by mail order on a payment with order basis.

PROJECT TITLE	Order Code	Cost
— JULY '83 —		
User Port Input/Output <i>M.I.T. Part 1</i>	8307-01	£4.82
User Port Control <i>M.I.T. Part 1</i>	8307-02	£5.17
— AUGUST '83 —		
Storage Scope Interface, BBC Micro	8308-01	£3.20
Car Intruder Alarm	8308-02	£5.15
High Power Interface <i>M.I.T. Part 2</i>	8308-03	£5.08
Pedestrian Crossing Simulation <i>M.I.T. Pt 2</i>	8308-04	£3.56
— SEPTEMBER '83 —		
High Speed A-to-D Converter <i>M.I.T. Pt 3</i>	8309-01	£4.53
Signal Conditioning Amplifier <i>M.I.T. Pt 3</i>	8309-02	£4.48
Stylus Organ	8309-03	£6.84
— OCTOBER '83 —		
D-to-A Converter <i>M.I.T. Part 4</i>	8310-01	£5.77
High Power DAC Driver <i>M.I.T. Part 4</i>	8310-02	£5.13
— NOVEMBER '83 —		
TTL/Power Interface for Stepper Motor <i>M.I.T. Part 5</i>	8311-01	£5.46
Stepper Motor Manual Controller <i>M.I.T. Part 5</i>	8311-02	£5.70
Speech Synthesiser for BBC Micro	8311-04	£3.93
— DECEMBER '83 —		
4-Channel High Speed ADC (Analogue) <i>M.I.T. Part 6</i>	8312-01	£5.72
4-Channel High Speed ADC (Digital) <i>M.I.T. Part 6</i>	8312-02	£5.29
Environmental Data Recorder	8312-04	£7.24
Continuity Tester [†]	8312-08	£3.41
— JANUARY '84 —		
Biological Amplifier <i>M.I.T. Part 7</i>	8401-02	£6.27
Temp. Measure & Control for ZX Compr Analogue Thermometer Unit	8401-03	£2.35
Analogue-to-Digital Unit	8401-04	£2.56
Games Scoreboard	8401-06/07	£9.60
— FEBRUARY '84 —		
Oric Port Board <i>M.I.T. Part 8</i>	8402-02	£9.56
Negative Ion Generator	8402-03*	£8.95
Temp. Measure & Control for ZX Compr Relay Driver	8402-04	£3.52
— MARCH '84 —		
Latched Output Port <i>M.I.T. Part 9</i>	8403-01	£5.30
Buffered Input Port <i>M.I.T. Part 9</i>	8403-02	£4.80
VIC-20 Extension Port Con. <i>M.I.T. Part 9</i>	8403-03	£4.42
CBM 64 Extension Port Con. <i>M.I.T. Part 9</i>	8403-04	£4.71
Digital Multimeter Add-On for BBC Micro	8403-05	£4.63
— APRIL '84 —		
Multipurpose Interface for Computers	8404-01	£5.72
Data Acquisition "Input" <i>M.I.T. Part 10</i>	8404-02	£5.20
Data Acquisition "Output" <i>M.I.T. Part 10</i>	8404-03	£5.20
Data Acquisition "PSU" <i>M.I.T. Part 10</i>	8404-04	£3.09
A.F. Sweep Generator	8404-06	£3.55
Quasi Stereo Adaptor	8404-07	£3.56

Simple Loop Burglar Alarm	8405-01	£3.07
Computer Controlled Buggy <i>M.I.T. Part 11</i>	8405-02	£5.17
Interface/Motor Drive	8405-03	£3.20
Collision Sensing — MAY '84 —	8405-04	£4.93
Power Supply		
— JUNE '84 —		
Infra-Red Alarm System	8406-01	£2.55
Spectrum Bench PSU	8406-02	£3.99
Speech Synthesiser <i>M.I.T. Part 12</i>	8406-03	£4.85
Train Wait	8406-04	£3.42
— JULY '84 —		
Ultrasonic Alarm System	8407-01	£4.72
Electronic Code Lock	8407-03	£2.70
Main Board	8407-04	£3.24
Keyboard		
— AUGUST '84 —		
Microwave Alarm System	8408-01	£4.36
Temperature Interface—BBC Micro	8408-02	£2.24
— SEPTEMBER '84 —		
Op-Amp Power Supply	8409-01	£3.45
— OCT '84 —		
Micro Memory Synthesiser	8410-01*	£8.20
Drill Speed Controller	8410-04	£1.60
— NOVEMBER '84 —		
BBC Audio Storage Scope Interface	8411-01	£2.90
Proximity Alarm	8411-02	£2.65
— DEC '84 —		
TV Aerial Pre-Amp	8412-01*	£1.60
Digital Multimeter	8412-02/03*	£5.20
Mini Workshop Power Supply	8412-04	£2.78
— JAN '85 —		
Power Lighting Interface	8501-01	£8.23
Games Timer	8501-02	£1.86
Spectrum Amplifier	8501-03	£1.70
— FEB '85 —		
Solid State Reverb	8502-01	£3.68
Computerised Train Controller	8502-02	£3.38
— MARCH '85 —		
Model Railway Points Controller	8503-01	£2.78
— APRIL '85 —		
Insulation Tester	8504-02	£2.53
Fibrealarm	8504-03	£3.89
— MAY '85 —		
Auto Phase	8505-01	£3.02
Amstrad CPC464 Amplifier	8505-02	£2.56
Mains Unit	8505-03	£2.56
Micro Unit	8505-04	£2.67
Voltage Probe		
— JUNE '85 —		
Graphic Equaliser	8506-01	£3.21
Computerised Shutter Timer	8506-02	£2.09
Mono-Bi-Astables (Experimenters Test Bed)	8506-03	£2.45
Across The River	8506-04	£2.63
— JULY '85 —		
Amstrad User Port	8507-01	£3.17
Nascom Printer Handshake	8507-02	£1.90
— AUGUST '85 —		
Electronic Building Blocks—1 to 4†	8508-01	£2.98
Tremolo/Vibrato	8508-02	£4.03
Stepper Motor Interface	8508-03	£2.40
Drill Control Unit	8508-04	£2.90
— SEPTEMBER '85 —		
RIAA Preamp Input Selector	8509-01	£2.36
Transducers Resistance Thermometer	8509-03	£2.64
Transducers Semiconductor Temp. Sensor	8509-04	£2.72
— OCT '85 —		
Transducers Strain Gauge	501	£2.87
Soldering Iron Power Controller	504	£2.09
— NOV '85 —		
Transducers—	505	£3.93
Magnetic Flux Density Amplifier	506	£2.68
Hallowe'en Projects (single board price)		
— DEC '85 —		
Electronic Building Blocks — 5 to 8†	508	£3.07
Opto Intensity Transducer	509	£2.70
Digital Capacitance Meter	512	£5.22
— JAN '86 —		
Mains Delay	503	£2.13
Musical Doorbell	507	£2.91
Tachometer—Transducers	513	£2.52
— FEB '86 —		
Touch Controller	510	£2.65
Function Generator	514	£3.10
Function Generator PSU Board	515	£2.09
pH Transducer	516	£2.75

*Complete set of boards.

M.I.T.—Microcomputer Interfacing Techniques, 12-Part Series.

†Four separate circuits.

PROJECT TITLE	Order Code	Cost
Mains Tester & Fuse Finder	517	£2.27
BBC Midi Interface	518	£3.26
Stereo Hi Fi Preamp	519	£5.70
Interval Timer	520	£2.36
Stereo Reverb — APRIL '86 —	521	£2.89
PA Amplifier	511	£2.67
Mini Strobe	522	£2.24
Auto Firing Joystick Adaptor	523	£2.73
Watchdog	524	£2.81
Percussion Synthesiser	525	£5.65
Personal Radio	526	£2.07
Tilt Alarm	527	£2.13
Electronic Scarecrow	528	£2.28
VOX Box Amplifier	529	£2.35
Headphone Mixer	530	£4.56
Solar Heating Controller — AUG '86 —	533	£3.32
Car Timer	538	£2.02
Freezer Failure Alarm	534	£1.90
Infra Red Beam Alarm (Trans)	536	£3.32
Infra Red Beam Alarm (Rec)	537	£3.32
Scratch Blanker	539	£5.43
10W Audio Amp (Power Amp)	543	£2.58
(Pre-Amp) £4.78 Pair	544	£3.18
Light Rider—Lapel Badge	540 & 541	£2.70
—Disco Lights	542	£4.55
—Chaser Light — OCT '86	546	£3.23
Modern Tone Decoder — NOV '86 —	547	£2.76
200MHz Digital Frequency Meter	548	£4.12
Dual Reading Thermometer	549	£5.87
Automatic Car Alarm	550	£2.35
BBC 16K Sideways RAM	551	£2.38
(Software Cassette)	551S	£4.95
Random Light Unit — JAN '87 —	552	£4.70
Car Voltage Monitor	553	£2.00
Mini Amp.	554 & 555	£4.55
Video Guard	556	£3.05
Spectrum I/O	557	£3.78
Spectrum Speech Synthesiser	558	£3.88
Computer Buffer/Interface — MAR '87 —	560	£2.66
Infra Red Alarm: Sensor head	561	£3.35
PSU/Relay Driver	562	£3.60
Alarm Thermometer — APRIL '87 —	559	£2.10
Experimental Speech Recognition	563	£3.80
Bulb Life Extender	564	£2.00
Fridge Alarm — MAY '87 —	565	£1.86
EE Equaliser—Ioniser	566	£3.28

Prices for **ELECTRONICS MONTHLY PCBs** are shown below.

PROJECT TITLE	Order Code	Cost
Cymbal Synth	EM/8412/2	£4.86
The Thing	EM/8412/4	£3.18
Speak Board — JAN '85 —	EM/8501/2	£3.97
Headphone Amp	EM/8502/1	£2.08
Intelligent Nicad Charger	EM/8502/2	£3.50
Anti Phaser — FEB '85 —	EM/8502/3	£4.56
Logical Lock	EM/8502/4	£3.58
Touch Dimmer	EM/8502/5	£3.29
Courtesy Light Extender — MAR '85 —	EM/8503/4	£3.29
Disco Light Chaser	EM/8503/5	£8.11
Sound to Light Unit	EM/8504/1	£4.02
Car Audio Booster — APRIL '85 —	EM/8504/2	£3.12
Short Wave Converter	EM/8504/3	£4.15
Car Burglar Alarm — MAY '85 —	EM/8505/3	£2.88
Metal Detector	EM/8506/1	£4.24
Power Supply Module — JUNE '85 —	EM/8506/3	£3.20
Flanger	EM/8506/4	£4.29
El Tom/El Tom+	EM/8507/1	£4.10
El Cymb — JULY '85 —	EM/8507/2	£4.10
Heartbeat Monitor	EM/8507/3	£3.98
Real Time Clock	EM/8507/4	£4.62
Intelligent Windscreen Wiper (incl. Terminal Board)	EM/8508/1/2	£4.12
HiFi Intercom (2 boards)	EM/8508/3	£2.92
Plug Power Supply — AUG '85 —	EM/8508/4	£2.28
Hot Water Alarm	EM/8508/5	£1.93
Sinewave Generator — SEPT '85 —	EM/8509/1	£2.76
Household Battery Checker	EM/8509/2	£1.97
Audio Signal Generator	EM/8509/3	£3.65
Compressor Pedal	EM/8510/1	£2.87
Computer Cont Filter — OCT '85 —	EM/8510/2	£2.94
Spectrum MIDI Interface	EM/8510/3	£3.20

BLOCK CAPITALS PLEASE

EE PRINTED CIRCUIT BOARD SERVICE

Please send me the following p.c.b.s.

Make cheques/PO payable to: **Everyday Electronics**
(Payment in £ sterling only)

Order Code	Quantity	Price
.....
.....
.....

I enclose cheque/PO for £

Name

Address

Make cheques/PO payable to: **Everyday Electronics**

TEACH-IN SOFTWARE

To complement each published part of the Teach-In series (Oct. '85 to June '86), we have produced an accompanying computer program. The Teach-In Software is available for both the BBC Microcomputer (Model B) and the Sinclair Spectrum (48k) or Spectrum-Plus. The programs are designed to reinforce and consolidate important concepts and principles introduced in the series. The software also allows readers to monitor their progress by means of a series of multi-choice tests, with scores at the end.

Tape 1 (Teach-In parts 1, 2 and 3), Tape 2 (parts 3, 4 and 5) and Tape 3 (parts 6, 7, 8 and 9) are available for £4.95 each (inclusive of VAT and postage) from Everyday Electronics and Electronics Monthly, 6 Church Street, Wimborne, Dorset BH21 1JH. **IMPORTANT** State BBC or Spectrum; add 50 pence for overseas orders; allow 28 days for delivery.

SUBSCRIPTIONS

Sell-out disappointment can upset even the less ambitious reader! So why not take out a year's subscription and make sure of every issue, straight from the Publisher? Complete the order form below and post to: **EVERYDAY ELECTRONICS and ELECTRONICS MONTHLY**, Subscription Dept., 6 Church Street, Wimborne, Dorset BH21 1JH. Tel. 0202 881749.

Annual subscription rates:
UK £14. Overseas £17 (£ sterling only)
Overseas air mail £33 (£ sterling only)

EVERYDAY ELECTRONICS and ELECTRONICS MONTHLY SUBSCRIPTION ORDER FORM

Annual subscription rates:
UK £14. Overseas £17 (surface mail) £33 (air mail)

To: Everyday Electronics and Electronics Monthly, Subscription Dept., 6 Church Street, Wimborne, Dorset BH21 1JH.

Name

Address

I enclose payment of £..... (cheque/PO in £ sterling only payable to Everyday Electronics)

Subscriptions can only start with the next available issue. For back numbers see the Editorial page

EVERYDAY ELECTRONICS

Reach effectively and economically today's enthusiasts anxious to know of your products and services through our semi-display and classified pages. The prepaid rate for semi-display spaces is £8.00 per single column centimetre (minimum 2.5cm). The prepaid rate for classified advertisements is 30 pence per word (minimum 12 words), box number 60p extra. VAT must be added. All cheques, postal orders, etc., to be made payable to Everyday Electronics. Treasury notes should always be sent registered post. Advertisements, together with remittance, should be sent to the Classified Advertisement Dept., Everyday Electronics, 6 Church Street, Wimborne, Dorset BH21 1JH. Tel.: 0202 881749.

Electronic Components

DELUXE WALKIE TALKIES 49MHZ, long range. £24.99/pair (normally £31.49). Satisfaction or refund. Send £3 now, pay balance upon receipt. 48hrs delivery. Xenon (Dept EE9), 24 Wharmcliffe Street, Barnsley, Yorkshire.

BULK PURCHASE MR2500 power diodes (legless). Ideal for P.S.U.s 1 packet/25 £1.00 + 25p p&p. Send cheque/PO to A. Rose, St. Anthony House, Milton Road, Oundle, Peterborough.

GOOD QUALITY electronic components. Send for free list. M. Porter, 21 Pulleys Lane, Hemel Hempstead, Herts. HP1 2PZ.



ELECTRONIC COMPONENTS

● Velleman Electronic Kits ● Test Equipment & Tools ● Instrument Cases

Send for New Catalogue 60p inc. P&P (Mon.-Sat. 9.30-5.30. Closed Thurs.)

13A Station Rd, Cullercoats, North Shields, Tyne & Wear NE30 4PQ Tel. 091 251 4363

Printed Circuit Boards

PRINTED CIRCUIT BOARDS produced to own personal requirements. Please send SAE for details to: Mr. B. M. Ansbro, 38 Poynings Drive, Hove, Sussex.

Service Manuals

SERVICE SHEETS from £2.50/1sac ctv/music/combis £3.50/1sac. Sae Newnes & TV Technic Books in stock. Thousands Service & Repair Manuals. SAE Free Review/pricelists. TIS (EE), 76 Church St, Larkhall (0698 883334), Lanarkshire.

WORKSHOP SERVICE MANUALS

'Thousands stocked, most makes, models, types, audio, TV, video, test, amateur etc. SAE enquiries/quotation. Bumper Catalogue £3.00 including FREE Phonograph speed disc. Details Unique Repair and Data Guides.

MAURITRON (EE), 8 CHERRYTREE ROAD, CHINNOR, OXON OX9 4QY.

Special Offers

FREE MEMBERSHIP to a new national electronics club. For details and a free pack of components worth over £10 send only £1 p&p to Dept. EE, Woodside, Dowsett Lane, Ramsden Heath, Billericay, Essex CM11 1JL.

**PLEASE MENTION
EVERYDAY ELECTRONICS
WHEN REPLYING TO
ADVERTISEMENTS**

Surveillance Transmitters

QUALITY TRANSMITTERS kits/made. SSAE details: GISO, 119 Downland Drive, Crawley RH10 6HA.

Fire Alarm

FIRE. Hundreds of deaths are caused by fire each year. Protect yourself and your family with this easy to fit pre-built Fire Alarm kit. We supply Control unit, 4 Sensors and Wire for only £68 inclusive of VAT etc. Extra sensors £6. Cheques/P.O./Cash to: Rainbow Computer and Electronic Products, Dept EE1, 98 Nelson Road, Ipswich IP4 4DU.

Miscellaneous

LEARNING ELECTRONICS Get to grips with the first principles of electronics. To learn more send for free leaflets. Electrotechniques, Selsley, Stroud, Glos. Tel: (04536) 3129.

TURN YOUR SURPLUS

ICS transistors etc into cash, immediate settlement. We also welcome the opportunity to quote for complete factory clearance. Contact **COLES-HARDING & CO**, 103 South Brink, Wisbech, Cambs. ***ESTABLISHED OVER 10 YEARS*** Tel: 0945 584188

ORDER FORM PLEASE WRITE IN BLOCK CAPITALS

Please insert the advertisement below in the next available issue of *Everyday Electronics* for Insertions. I enclose Cheque/P.O. for £..... (Cheques and Postal Orders should be made payable to Everyday Electronics)

--	--	--	--

HEADING REQUIRED:

NAME

ADDRESS

EVERYDAY ELECTRONICS
and **ELECTRONICS MONTHLY**
Classified Advertisement Dept.,
6 Church Street,
Wimborne,
Dorset BH21 1JH.
Telephone 0202 881749

RATE: 30p per word, minimum 12 words. Box No. 60p extra. VAT must be added.

5/87

TELEVISION/COMPUTER FULL-TIME TRAINING

(FULL TIME COURSES APPROVED BY THE BUSINESS & TECHNICIAN
EDUCATION COUNCIL)

2 YEAR
BTEC National Diploma (OND)
**ELECTRONIC &
COMMUNICATIONS ENGINEERING**
(Electronics, Computing, Television, Video, Testing & Fault Diagnosis)

15 MONTHS
BTEC National Certificate (ONC)
ELECTRONIC EQUIPMENT SERVICING
(Electronics, Television, Video Cassette Recorders, CCTV, Testing & Fault Diagnosis)

15 MONTHS
BTEC National Certificate (ONC)
COMPUTING TECHNOLOGY
(Electronics, Computing Software/Hardware, Microelectronic Testing Methods)

9 MONTHS
BTEC Higher National Certificate (HNC)
COMPUTING TECHNOLOGY & ROBOTICS
(Microprocessor Based Systems, Fault Diagnosis, ATE, Robotics)

**THESE COURSES INCLUDE A HIGH PERCENTAGE OF COLLEGE BASED
PRACTICAL WORK TO ENHANCE FUTURE EMPLOYMENT PROSPECTS**

NO ADDITIONAL FEES FOR OVERSEAS STUDENTS

**SHORTENED COURSES OF FROM 3 TO 6 MONTHS CAN BE ARRANGED FOR
APPLICANTS WITH PREVIOUS ELECTRONICS KNOWLEDGE**

O.N.C. 21st September 1987
FULL PROSPECTUS FROM

LONDON ELECTRONICS COLLEGE (Dept EE)
20 PENYWERN ROAD, EARLS COURT,
LONDON SW5 9SU. Tel: 01-373 8721.

EVERY MONTH . . .

**Make sure of getting your copy by
placing a regular order with your
Newsagent NOW! (Distributed by Seymour)**

BACK ISSUES & BINDERS

Certain back issues of **EVERYDAY ELECTRONICS** and **ELECTRONICS MONTHLY** are available price £1.50 (£2.00 overseas) inclusive of postage and packing per copy. Enquiries with remittance should be sent to Post Sales Department, Everyday Electronics, 6 Church Street, Wimborne, Dorset BH21 1JH. In the event of non-availability remittances will be returned. Please allow 28 days for delivery.

Binders to hold one volume (12 issues) are available from the above address for £4.95 (£9.00 overseas surface mail) inclusive of p&p world-wide. Payment in £ Sterling only please.

£1 BARGAIN PACKS

Buy 10 packs . . . get one free (your choice)

- | | |
|---|---|
| PK 1. 350 Assorted resistors. Full length leads | PK 22. 15 Assorted I.C.'s. All new & coded |
| PK 2. 400 Assorted resistors. Pin-formed leads | PK 23. 50 Assorted unmarked & untested LC's. |
| PK 3. 60 Assorted resistors. Wire wound. | PK 24. 100 Assorted diodes. |
| PK 4. 200 Assorted mixed capacitors | PK 25. 20 E.H.T. diodes |
| PK 5. 200 Assorted ceramic capacitors | PK 26. 3 Large power-fin heatsinks. TO3. |
| PK 6. 60 Electrolytic capacitors | PK 27. 1 4 section 7 segment I.e.d. clock display. |
| PK 7. 2 2200µl 100 volt capacitors | PK 28. 20 Assorted neons. Panel mounting & wire ended. |
| PK 8. 2 4700µl 30 volt capacitors | PK 29. 1 Microphone c/w lead, switch, plugs & stand. |
| PK 9. 12 Assorted rotary potentiometers. Single gang | PK 31. 3 Dynamic earpieces c/w lead & 3.5mm plug. |
| PK 10. 6 Assorted rotary potentiometers. Dual gang | PK 32. 2 Telescopic aerials. |
| PK 11. 12 Assorted slider potentiometers. | PK 35. 1 Large cassette motor. |
| PK 12. 40 Assorted pre-set potentiometers. | PK 36. 1 Wire pack. Mains cable. |
| PK 13. 5 100K lin multiturm potentiometers | PK 38. 1 Wire pack. Connecting wire. Assorted colours. |
| PK 14. 5 1 meg lin multiturm potentiometers | PK 39. 300 Assorted resistors. 1/2W or less. F/L leads. |
| PK 15. 12 Assorted switches | PK 40. 200 Assorted Polyester capacitors |
| PK 16. 1 bank 4-way push button switches c/w knobs | PK 41. 12 Push to make switches. pcb mounting. |
| PK 17. 1 4 pole 5-way water switch | PK 42. 12 Push on - Push off switches. |
| PK 18. 15 Assorted control knobs | PK 43. 4 Assorted toaster elements |
| PK 19. 20 Assorted plugs and sockets | PK 44. 3 Assorted record player styl. |
| PK 20. 2 Pairs D.C. plugs & sockets c/w leads & PP3 clip. | PK 45. 50 Assorted I.F. and tuning coils. |
| PK 21. 25 Assorted transistors. All new & coded. | PK 46. 35 Assorted resistors 1% tolerance. |

Postal order or cheque with order. Please add £1 postage & packing per order.
Access and Barclaycard orders welcome, minimum £10. Please phone orders before 4pm.
Electronics magazines, we have an extensive range of back issues. 50p for current lists.

MJR WHOLESALE, Unit 3, 238 Waterside,
Chesham, Bucks HP5 1PG. ☎ 0494 771033

OMNI ELECTRONICS

We stock a wide range of components:

transformers, switches, pots, ICs, capacitors, resistors, diodes, boxes, triacs, LEDs, cable, connectors, PCBs—
in fact, all you need for your projects.

NEW CATALOGUE NOW AVAILABLE

— send 20p + 13p or 18p stamp or call at our shop
Mon-Fri 9am-6pm, Sat 9am-5pm.

174 Dalkeith Road
EDINBURGH EH16 5DX
031-667 2611

MAKE YOUR INTERESTS PAY!

More than 8 million students throughout the world have found it worth their while! An ICS home-study course can help you get a better job, make more money and have more fun out of life! ICS has over 90 years experience in home-study courses and is the largest correspondence school in the world. You learn at your own pace, when and where you want under the guidance of expert 'personal' tutors. Find out how we can help YOU. Post or phone today for your FREE INFORMATION PACK on the course of your choice. (Tick one box only!)

Electronics	<input type="checkbox"/>	Radio, Audio and TV Servicing	<input type="checkbox"/>
Basic Electronic Engineering (City & Guilds)	<input type="checkbox"/>	Radio Amateur Licence Exam (City & Guilds)	<input type="checkbox"/>
Electrical Engineering	<input type="checkbox"/>	Car Mechanics	<input type="checkbox"/>
Electrical Contracting/Installation	<input type="checkbox"/>	Computer Programming	<input type="checkbox"/>
GCE over 40 'O' and 'A' level subjects			<input type="checkbox"/>

ICS

Name _____ P. Code _____
Address _____
International Correspondence Schools, Dept ECS57, 312/314 High St.,
Sutton, Surrey SM1 1PR. Tel: 01-643 9568 or 041-221 2926 (24 hrs.)

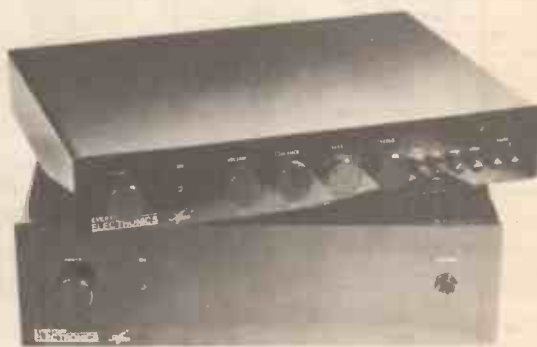

The EE APEX PREAMP AND POWER AMP KITS

Build this superb preamp and power amp kit and enjoy high fidelity sound at a fraction of the cost of comparable ready built amplifiers.

Complete kits as described in March - May issues of **Everyday Electronics** including high current transformers and attractively styled cases with high quality components.

Preamp £192.50
Power amp-stereo £192.50

Or build it with the very best components available including IAR Wonder caps, Extended foil polystyrene capacitors, bulk foil resistors, Holco precision resistors, silver plated switches, gold plated phono sockets and Kimber cable for internal wiring.

Preamp £410
Stereo Power amp £310
Mono Power amp £232

All components including PCBs available separately

**For full parts price list of the EE Apex preamp and
details of AUDIOKITS audiophile components and kits,
please send 9" x 4" SAE to:**

AUDIOKITS Precision Components

6 MILL CLOSE, BORROWASH, DERBY DE7 3GU. Tel: 0332 674929

OMP POWER AMPLIFIER MODULES

PRICES INCLUDE V.A.T. * PROMPT DELIVERIES * FRIENDLY SERVICE * LARGE S.A.E. 28p STAMP FOR CURRENT LIST

OMP POWER AMPLIFIER MODULES

Now enjoy a world-wide reputation for quality, reliability and performance at a realistic price. Four models available to suit the needs of the professional and hobby market i.e. Industry, Leisure, Instrumental and Hi-Fi, etc. When comparing prices, NOTE all models include Toroidal power supply, Integral heat sink, Glass fibre P.C.B., and Drive circuits to power compatible Vu meter. Open and short circuit proof. **Supplied ready built and tested.**

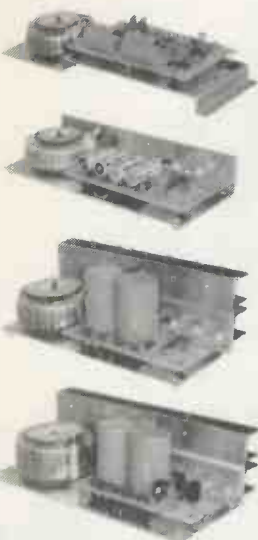

OMP100 Mk II Bi-Polar Output power 110 watts R.M.S. into 4 ohms, Frequency Response 15Hz - 30KHz -3dB, T.H.D. 0.01%, S.N.R. -118dB, Sens. for Max. output 500mV at 10K, Size 355 X 115 X 65mm. PRICE £33.99 + £3.00 P&P.

OMP/MF100 Mos-Fet Output power 110 watts R.M.S. into 4 ohms, Frequency Response 1Hz - 100KHz -3dB, Damping Factor 80, Slew Rate 45V/uS, T.H.D. Typical 0.002%, Input Sensitivity 500mV, S.N.R. -125dB. Size 300 X 123 X 60mm. PRICE £39.99 + £3.00 P&P.

OMP/MF200 Mos-Fet Output power 200 watts R.M.S. into 4 ohms, Frequency Response 1Hz - 100KHz -3dB, Damping Factor 250, Slew Rate 50V/uS, T.H.D. Typical 0.001%, Input Sensitivity 500mV, S.N.R. -130dB. Size 300 X 150 X 100mm. PRICE £62.99 + £3.50 P&P.

OMP/MF300 Mos-Fet Output power 300 watts R.M.S. into 4 ohms, Frequency Response 1Hz - 100KHz -3dB, Damping Factor 350, Slew Rate 60V/uS, T.H.D. Typical 0.0008%, Input Sensitivity 500mV, S.N.R. -130dB. Size 330 X 147 X 102mm. PRICE £79.99 + £4.50 P&P.

NOTE: Mos-Fets are supplied as standard (100KHz bandwidth & Input Sensitivity 500mV). If required, P.A. version (50KHz bandwidth & Input Sensitivity 775mV). Order - Standard or P.A.



Vu METER Compatible with our four amplifiers detailed above. A very accurate visual display employing 11 L.F.D. diodes (7 green, 4 red) plus an additional on/off indicator. Sophisticated logic control circuits for very fast rise and decay times. Tough moulded plastic case, with tinted acrylic front. Size 84 X 27 X 45mm. **PRICE £8.50 + 50p P&P.**

LOUDSPEAKERS 5" to 15" up to 400 WATTS R.M.S. Cabinet Fixing in stock. Huge selection of McKenzie Loudspeakers available including Cabinet Plans. Large S.A.E. (28p) for free details.

POWER RANGE
 8" 50 WATT R.M.S. Hi-Fi/Disco.
 20 oz. magnet. 1 1/2" ally voice coil. Ground ally fixing escutcheon. Res. Freq. 40Hz. Freq. Resp. to 6KHz. Sens. 92dB. PRICE £10.99 Available with black grille £11.99 P&P £1.50 ea.
 12" 100 WATT R.M.S. Hi-Fi/Disco
 50 oz. magnet. 2" ally voice coil. Ground ally fixing escutcheon. Die-cast chassis. White cone. Res. Freq. 25Hz. Freq. Resp. to 4KHz. Sens. 95dB. PRICE £28.60 + £3.00 P&P ea.

McKENZIE
 12" 85 WATT R.M.S. C1285GP Lead Guitar/Keyboard/Disco.
 2" ally voice coil. Ally centre dome. Res. Freq. 45Hz. Freq. Resp. to 6.5KHz. Sens. 98dB. PRICE £29.99 + £3.00 P&P ea.
 12" 85 WATT R.M.S. C1285TC P.A./Disco 2" ally voice coil. Twin cone. Res. Freq. 45Hz. Freq. Resp. to 14KHz. PRICE £31.49 + £3.00 P&P ea.
 15" 150 WATT R.M.S. C15 Bass Guitar/Disco.
 3" ally voice coil. Die-cast chassis. Res. Freq. 40Hz. Freq. Resp. to 4KHz. PRICE £57.87 + £4.00 P&P ea.
 10" 60 WATT R.M.S. C1060GP Gen. Purpose/Lead Guitar/Keyboard/Mid. P.A.
 2" voice coil. Res. Freq. 75Hz. Freq. Resp. to 7.5KHz. PRICE £19.99 + £2.00 P&P.
 10" 200 WATT R.M.S. C10200GP Guitar/Keyboard/Disco.
 2" voice coil. Res. Freq. 45Hz. Freq. Resp. to 7KHz. Sens. 101dB. PRICE £44.76 + £3.00 P&P.
 15" 200 WATT R.M.S. C15200 High Power Bass.
 Res. Freq. 40Hz. Freq. Resp. to 5KHz. Sens. 101dB. PRICE £62.41 + £4.00 P&P.
 15" 400 WATT R.M.S. C15400 High Power Bass.
 Res. Freq. 40Hz. Freq. Resp. to 4KHz. Sens. 102dB. PRICE £89.52 + £4.00 P&P.

WEM
 5" 70 WATT R.M.S. Multiple Array Disco etc.
 1" voice coil. Res. Freq. 52Hz. Freq. Resp. to 5KHz. Sens. 89dB. PRICE £22.00 + £1.50 P&P ea.
 8" 150 WATT R.M.S. Multiple Array Disco etc.
 1" voice coil. Res. Freq. 48Hz. Freq. Resp. to 5KHz. Sens. 92dB. PRICE £32.00 + £1.50 P&P ea.
 10" 300 WATT R.M.S. Disco/Sound re-enforcement etc.
 1" voice coil. Res. Freq. 35Hz. Freq. Resp. to 4KHz. Sens. 92dB. PRICE £36.00 + £2.00 P&P ea.
 12" 300 WATT R.M.S. Disco/Sound re-enforcement etc.
 1" voice coil. Res. Freq. 35Hz. Freq. Resp. to 4KHz. Sens. 94dB. PRICE £47.00 + £3.00 P&P ea.

SOUNDLAB (Full Range Twin Cone)
 5" 60 WATT R.M.S. Hi-Fi/Multiple Array Disco etc.
 1" voice coil. Res. Freq. 63Hz. Freq. Resp. to 20KHz. Sens. 86dB. PRICE £9.99 + £1.00 P&P ea.
 5 1/2" 60 WATT R.M.S. Hi-Fi/Multiple Array Disco etc.
 1" voice coil. Res. Freq. 56Hz. Freq. Resp. to 20KHz. Sens. 89dB. PRICE £10.99 + £1.50 P&P ea.
 3" 60 WATT R.M.S. Hi-Fi/Multiple Array Disco etc.
 1/2" voice coil. Res. Freq. 38Hz. Freq. Resp. to 20KHz. Sens. 89dB. PRICE £12.99 + £1.50 P&P ea.
 0" 60 WATT R.M.S. Hi-Fi/Disco etc.
 1/2" voice coil. Res. Freq. 35Hz. Freq. Resp. to 15KHz. Sens. 89dB. PRICE £16.49 + £2.00 P&P

PANTEC HOBBY KITS. Proven designs including glass fibre printed circuit board and high quality components complete with instructions.
FM MICROTRANSMITTER (BUG) 90/105MHz with very sensitive microphone. Range 100/300 metres. 57 x 46 x 14mm (9 volt) **Price: £8.62 + 75p P&P.**
3 WATT FM TRANSMITTER 3 WATT 85/115MHz varicap controlled professional performance. Range up to 3 miles 35 x 84 x 12mm (12 volt) **Price: £14.49 + 75p P&P.**
SINGLE CHANNEL RADIO CONTROLLED TRANSMITTER/RECEIVER 27MHz. Range up to 500 metres. Double coded modulation. Receiver output operates relay with 2amp/240 volt contacts. Ideal for many applications. Receiver 90 x 70 x 22mm (9/12 volt). **Price: £17.82 Transmitter 80 x 50 x 15mm (9/12 volt). Price: £11.29 P&P + 75p each. S.A.E. for complete list.**

BURGALAR ALARM

Better to be 'Alarmed' than terrified. Thandar's famous 'Minder' Burglar Alarm System. Superior microwave principle. Supplied as three units, complete with interconnection cable. **FULLY GUARANTEED.**
Control Unit - Houses microwave radar unit, range up to 15 metres adjustable by sensitivity control. Three position, key operated fascia switch - off - test - armed. 30 second exit and entry delay.
Indoor alarm - Electronic swept freq. siren. 104dB output.
Outdoor Alarm - Electronic swept freq. siren. 98dB output. Housed in a tamper-proof heavy duty metal case.
 Both the control unit and outdoor alarm contain rechargeable batteries which provide full protection during mains failure. Power requirement 200/260 Volt AC 50/60Hz. Expandable with door sensors, panic buttons etc. Complete with instructions.



SAVE £138.00 Usual Price £228.85
BKE's PRICE £89.99 + £4.00 P&P
 ? Why buy a collection of self-assembly boards!

OMP LINNET LOUDSPEAKERS

The very best in quality and value. Made specially to suit today's need for compactness with high sound output levels. Finished in hard wearing black vinyl with protective corners, grille and carry handle. All models 8 ohms. Full range 45Hz - 20KHz. Size 20" X 15" X 12". Watts R.M.S. per cabinet. Sensitivity 1W. 1mtr. dB.
OMP 12-100 Watts 100dB. Price £149.99 per pair.
OMP 12-200 Watts 102dB. Price £199.99 per pair. Delivery: Securicor £8.00 per pair



OMP 19" STEREO RACK AMPS



Professional 19" cased Mos-Fet stereo amps. Used the World over in clubs, pubs, discos etc. With twin Vu meters, twin toroidal power supplies, XLR connections. MF600 Fan cooled. Three models (Ratings R.M.S. into 4ohms). Input Sensitivity 775mV
MF200 (100 + 100)W. £171.35 Securicor
MF400 (200 + 200)W. £228.85 Delivery
MF600 (300 + 300)W. £322.00 £100

1 K-WATT SLIDE DIMMER

* Control loads up to 1Kw
 * Compact Size 4 3/4" X 1" X 2 1/2"
 * Easy snap in fixing through panel/cabinet cut out
 * Insulated plastic case
 * Full wave control using 8 amp triac
 * Conforms to BS800
 * Suitable for both resistive and inductive loads. Innumerable applications in industry, the home, and disco's, theatres etc.
PRICE £13.99 + 75p P&P

BSR P295 ELECTRONIC TURNTABLE

* Electronic speed control 45 & 33 1/2 r.p.m. * Plus/Minus variable pitch control * Belt driven * Aluminium platter with strobed rim * Cue lever * Anti-skate (bias device) * Adjustable counter balance * Manual arm * Standard 1/2" cartridge fixings * Supplied complete with cut out template * D.C. Operation 9-14V D.C. 65mA
Price £36.99 - £3.00 P&P.



ADC Q4 mag. cartridge for above. Price £4.99 ea. P&P 50p.

PIEZO ELECTRIC TWEETERS MOTOROLA

Join the Piezo revolution. The low dynamic mass (no voice coil) of a Piezo tweeter produces an improved transient response with a lower distortion level than ordinary dynamic tweeters. As a crossover is not required these units can be added to existing speaker systems of up to 100 watts (more if 2 put in series). **FREE EXPLANATORY LEAFLETS SUPPLIED WITH EACH TWEETER.**

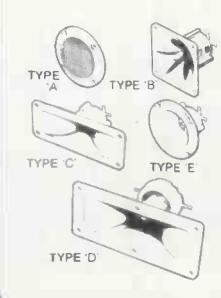

TYPE 'A' (KSN2036A) 3" round with protective wire mesh. Ideal for bookshelf and medium sized Hi-fi speakers. Price £4.90 each + 40p P&P.
TYPE 'B' (KSN1005A) 3 1/2" super horn. For general purpose speakers, disco and P.A. systems etc. Price £5.99 each + 40p P&P.
TYPE 'C' (KSN6016A) 2" X 5" wide dispersion horn. For quality Hi-fi systems and quality discos etc. Price £6.99 each + 40p P&P.
TYPE 'D' (KSN1025A) 2" X 6" wide dispersion horn. Upper frequency response retained extending down to mid range (2KHz). Suitable for high quality Hi-fi systems and quality discos. Price £9.99 each + 40p P&P.
TYPE 'E' (KSN103BA) 3 3/4" horn tweeter with attractive silver finish trim. Suitable for Hi-fi monitor systems etc. Price £5.99 each + 40p P&P.
LEVEL CONTROL Combines on a recessed mounting plate, level control and cabinet input jack socket. 85 X 85 mm. Price £3.99 + 40p P&P.

STEREO DISCO MIXER

STEREO DISCO MIXER with 2 X 5 band L & R graphic equalisers and twin 10 segment L.E.D. Vu Meters. Many outstanding features 5 Inputs with individual faders providing a useful combination of the following -
 3 Turntables (Mag), 3 Mics, 4 Line plus Mic with talk over switch. Headphone Monitor. Pan Pot. L & R Master Output controls. Output 775mV. Size 360 X 280 X 90mm.
Price £134.99 - £3.00 P&P

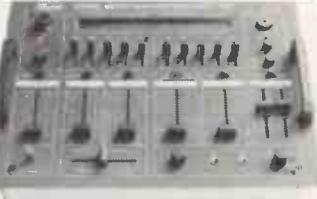

B. K. ELECTRONICS

UNIT 5, COMET WAY, SOUTHEND-ON-SEA, ESSEX. SS2 6TR TEL: 0702-527572

POSTAL CHARGES PER ORDER £1.00 minimum. OFFICIAL ORDERS WELCOME. SCHOOLS, COLLEGES, GOVERNMENT BODIES, ETC. PRICES INCLUSIVE OF V.A.T. SALES COUNTER VISA/ACCESS/C.O.D. ACCEPTED

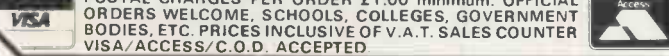

OUR DIGITAL THERMOMETERS ARE GUARANTEED ALCOHOL FREE!



Dual Scale Thermometer

A neat digital thermometer with internal and external sensors displaying °C or °F. The external sensor is a waterproof probe (max. length 3m). Temperature range -5°C to 50°C (internal), -20°C to 70°C (external). Includes a 12 hour clock.
Order Code FD25C Price £9.95

Pocket Thermometer

A well made temperature meter displaying °C or °F and a 12 hour clock. Temperature range -5°C to 50°C (internal), -20°C to 70°C using external probe (max. length 900mm). High and low temperatures can be set and an alarm sounds when these are reached. A set/lock switch prevents accidental resetting.
Order Code FD26D Price £14.95



Temperature Module

Versatile thermometer module displays in °C or °F, includes a 12 hour clock and serial data output. Temperature range -5°C to 50°C (internal), -20°C to 70°C with external probe. Overall size 68 x 35 x 23mm deep. Probe (max. length 3m) and bezel also available.
Module Order Code FE33L Price £6.95
Probe Order Code FE34M Price £2.50
Bezel Order Code FE35Q Price 15p

All prices include VAT. Please add 50p towards postage. Prices firm until 15th August 1987. Subject to availability.

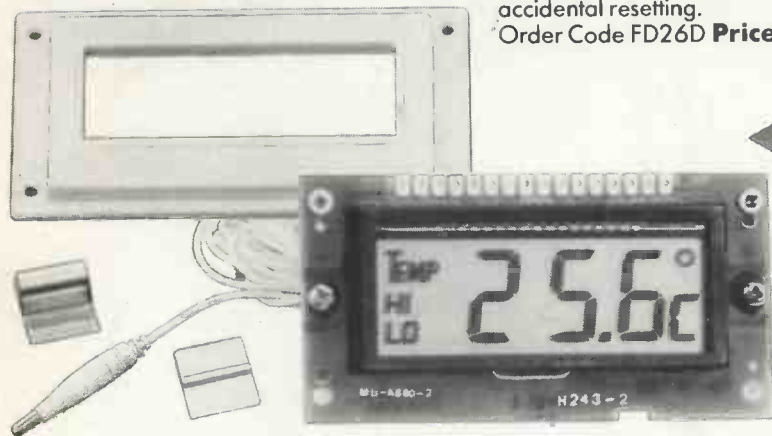

Maplin ELECTRONIC SUPPLIES LTD.

Mall Order: P.O. Box 3, Rayleigh, Essex SS6 8LR. Tel: Southend (0702) Sales: 554161, Enquiries: 552911; Trade sales: 554171, Trade enquiries: 552961.

Shops

Birmingham: Lynton Square, Perry Barr. Telephone: 021 356 7292.
London: 159-161 King Street, Hammersmith W6. Telephone: 01 748 0926.
Manchester: 8 Oxford Road. Telephone: 061 236 0281.
Southampton: 46-48 Bevois Valley Road. Telephone: 0703 225831.
Southend-on-Sea: 282-284 London Road, Westcliff-on-Sea, Essex. Tel: 0702 554000.
All shops except Manchester closed all day Monday.



Pick up a copy of our 1987 catalogue from any branch of W.H. Smith for just £1.50. Or to receive your copy by post just send £1.50 + 40p p & p to Mail Order address. If you live outside the U.K. please send £2.50 or 11 International Reply Coupons.