

Easy to build projects for everyone

Everyday

MARCH 81
60p

ELECTRONICS

PERFECT POWER FOR THE CONSTRUCTOR



Plus

**Treble Boost
Unit**

**Transistor/Diode
Tester**

**Model Railway
Point Controller**

- ORDER BY POST OR TELEPHONE WITH BARCLAYCARD/ACCESS
- ELECTRONIC TEST EQUIPMENT SPECIALISTS
- ALL PRICES INCLUDE VAT

AUDIO ELECTRONICS

- ALL MODELS ON DISPLAY
- RETAIL - MAIL ORDER - EXPORT - INDUSTRIAL
- OPEN SIX DAYS A WEEK
- CALL IN AND SEE FOR YOURSELF

ALL PRICES INCLUDE VAT

SCOPES

A range of Scopes in stock from 5mHZ Single Trace to 50mHZ Dual Trace. Mains and Battery/Mains Portables. Many on demonstration.

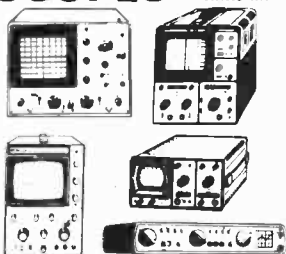

HAMEG ● TRIO ● LEADER
● SINCLAIR ● HITACHI

SINGLE TRACE (UK c/p etc £2-50)

Hm 307-3 10mHZ, 5mV, 6 x 7cm display plus component Test	£158.78
CO1303D 5mHZ, 10mHZ, 7 x 7cm display	£109.25
SC110 10mHZ Battery portable, 10mV, 3-2 x 2.6cm display (Optional case £8.80, Nicads £7.95, Mains unit £4.00)	£156.00
LB0512A 10mHZ, 10mV, 5" display	£195.50
CS1559A 10mHZ, 10mV, 5" display	£232.00
V151 15mHZ 1mV 5" display	£241.50

OPTIONAL PROBES (ALL MODELS)

X1 £6.50, X10 £8.50, X100 £12.95, X1-X10 £10.95

ALL SCOPES NOW WITH FREE PROBE(S)

DUAL TRACE (UK c/p etc £3-50)

CS1562A 10mHZ, 10mV, 5" display	£267.00
CS1575 5mHZ, 1mV, 5" display	£284.00
Hm 312-8 20mHZ, 5mV, 8 x 10cm display	£253.00
CS1566A 20mHZ, 5mV, 5" display	£339.00
LB03085 70mHZ, 2mV, 5 x 6.3cm display, Battery/Mains portable, built in Nicads	£481.85
Hm 412-4 20mHZ, 5mV, 8 x 10cm display plus Sweep Delay	£399.50
CS1577A 35mHZ, 2mV, 5" display	£478.00
CS1830 30mHZ, 2mV, 5" display plus Sweep Delay	£569.00
Hm 512-8 50mHZ, 5mV, 10 x 8cm display, Delay Sweep	£667.00
LB0514 10mHZ, 1mV (5mV), 5" display	£294.00
V152 15mHZ 1mV 5" display	£326.60
V302 30mHZ 1mV 5" display	£447.35
V550 50mHZ 1mV 10 x 8cm Delay sweep + 3 channel display	£799.25

GENERATORS

(UK c/p £1-75)

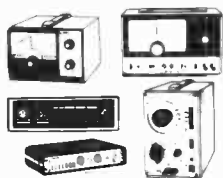

TRIO ● LEADER ● CSC
● SINCLAIR

RF SG402 100KHZ-30mHZ with AM modulation	£68.00
LSG16 100KHZ-100mHZ (300mHZ on Harmonics)	£63.25
SG2030 250KHZ-100mHZ low cost range	£46.95
ARF300 18HZ-200mHZ Low cost range	£76.95
AUDIO and RF PULSE	
2001 1HZ-100KHZ (Function)	£86.00
TG105 5HZ-5mHZ	£92.50
4001 0.5HZ-5mHZ	£105.00

A range of Signal Generators to cover Audio, RF and Pulsing. Mains operated (TG series Battery).
AUDIO (All sine/square)
AG202A 20HZ-200KHZ £69.00
LAG26 20HZ-200KHZ £73.60
AG203 10HZ-1mHZ Sine/Square £126.50
LAG120A 10HZ-1mHZ £146.00

LOGIC PROBES/MONITORS

Logic probes indicating high/low, etc. states that scopes can miss. All circuit powered for all IC's.	
LP3 50 mHZ logic probe	£55.95
LP1 10 mHZ logic probe	£35.50
LP2 1 1/2 mHZ logic probe	£19.95
LM1 Logic monitor	£33.00
LD1 50 mHZ Logic probe with case	£51.00

PRO MULTIMETERS

MI200 100K/Volt 30 range plus AC/DC 15 amp	£67.00
K1400 20K/Volt 23 range large scale	£79.95
MI500 20K/Volt 42 range plus AC/DC 10 amp	£53.50
K200 38 range FET 10m ohm input 20HZ to 30MHZ	£95.00

SWR/FS AND POWER METERS



Range in stock covering up to 150mHZ and up to 1K watt power.
PL259 sockets. 250UHZ Grid Dip.
SWR9 SWR/S 3-150mHZ £9.50
SWR50 SWR/Power meter £13.95
3 1/2 150mHZ 0-1000 watts £11.50
110 SWR/Power 1 1/2-144mHZ £11.50
0/10/100 watts £14.50
171 As 110 Twin meter plus FS £14.50
Plus large range of BNC/PL259/etc leads / plugs / adaptors / connectors always in stock.
176 SWR Power FS 1 1/2-144mHZ £16.60
5-50 watt £16.60
KDM6 Grid Dip 1 1/2-250mHZ £38.50

DIGITAL MULTIMETERS

KAISE ● SINCLAIR ● LASCAR ● THURLBY

HAND HELD (UK post etc 85p)

TM352 3 1/2 Digit LCD plus 10ADC and Hfe checker	£54.95
PDM35 3 1/2 Digit 16 range LED (no AC current)	£32.95
MES02 3 1/2 Digit LED plus 10A DC and Hfe checker	£43.95
LM2001 3 1/2 Digit LCD 2 amp AC/DC 0.1%	£51.70
6200 3 1/2 Digit LCD 0.2A AC/DC, Auto range	£39.95
6220 As 6200 plus 10A AC/DC	£49.95
6100 As 6200 plus Cont. test/range hold	£59.95
6110 As 6100 plus 10A AC/DC	£74.95

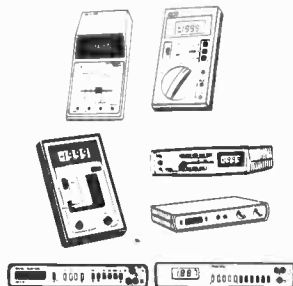

A range of LED and LCD Bench and Hand DMM's battery operated with optional Mains Adaptors—some with optional Nicads. All supplied with batteries and leads.

BENCH PORTABLES (UK c/p £1-00)

DM235 3 1/2 Digit LED 21 ranges, 0-5% AC/DC 2A	£56.50
DM350 3 1/2 Digit LED 34 ranges, AC/DC 10A	£78.50
TM353 3 1/2 Digit LCD AC/DC 2 amp	£86.50
TM351 3 1/2 Digit LCD AC/DC 10 amp	£107.95
LM100 3 1/2 Digit LCD AC/DC 2 amp	£86.50
DM450 4 1/2 Digit LED 34 ranges, AC/DC 10 amp	£107.95
IS03 4 1/2 Digit LCD 28 ranges, AC/DC 10 amp include Mains adaptor	£159.85

(DM series options: Carry case £8.80, Nicads £7.95, Mains adaptor £4.00.)

MULTIMETERS (UK post etc 75p)

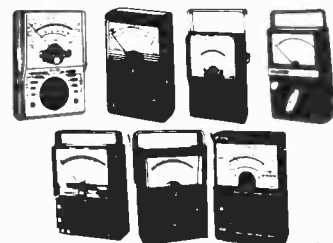

KRT101 1K/Volt 10 range pocket plus hfe test	£4.50
ATM1/LT1 1K/Volt 12 range pocket plus hfe test	£5.95
NH55 2K/Volt 10 range pocket	£6.95
AT1 2K/Volt 12 range pocket de luxe	£7.95
NH56 20K/Volt 22 range pocket	£10.95
YN360TR 20K/Volt 19 range pocket plus hfe test	£13.95
AT1020 20K/Volt 19 range de luxe plus hfe test	£16.95
7081 50K/Volt 36 range plus 10 amp DC	£19.95
TMK500 30K/Volt 23 range plus 12A DC/Cont. test	£21.50
AT20 20K/Volt 21 range de luxe plus 10A DC and 5KV DC	£21.95
AT205 50K/Volt 21 range de luxe plus 10A DC	£24.95
7080 20K/Volt 26 range large scale, 10A DC plus 5KV AC/DC	£26.95
AT2050 50K/Volt 18 range de luxe plus hfe test	£28.50
AT210 100K/Volt 21 range de luxe 12A AC/DC	£29.95
360TR 100K/Volt 23 range plus hfe checker and AC/DC 10 amps	£34.95

FREQUENCY COUNTERS



Portable and Bench LCD and LED Counters up to 600mHZ. Prices include batteries and leads.

HAND HELD (UK post etc 85p)

PFM200 20HZ to 200mHZ 8 Digit LED	£54.50
MAX50 100HZ to 50mHZ 6 Digit LED	£61.00
MAX550 30KHZ to 550mHZ 6 Digit LED	£106.00

BENCH PORTABLES (UK c/p £1-00)

MAX100 8 Digit LED 5 HZ to 100mHZ	£89.00
TF200 8 Digit LCD 10HZ to 200mHZ	£158.95
7010A 9 Digit LED 10HZ to 600mHZ	£169.00
200SPC 6 Digit 100mHZ LED built into 0-002HZ to 5-5mHZ pulse generator	£437.00
TP600 600mHZ Prescaler for TF200	£41.00

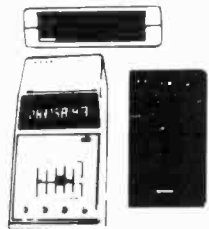

CSC ● SINCLAIR ● SPC ● OPTO ELECTRONICS

SOLDERLESS BREADBOARD AND KITS

EXP350 £3.45	EXP650 £3.95
EXP300 £5.95	EXP600 £6.50

KITS:	
PB6 £9.95	PB100 £12.95
PB101 £17.95	

(UK c/p—EXP's 30p, KITS 55p)

MINI DRILLS AND KITS

(9-12 Volt 1/2" chuck)	
Small Drill plus 3 collets	£7.25
Medium Drill plus 3 collets	£10.50
Small Drill plus 20 tools	£14.95
Medium Drill plus 20 tools	£17.95
Mains drill	£13.95
Mains Drill plus 20 tools	£21.50

CHOOSE FROM THE UK'S LARGEST SELECTION

Stockists of electronic equipment, speakers/kits, PA equipment plus huge range of accessories ● UK carriage/packing as indicated ● Export - prices on request ● All prices correct at 1/1/81 E & OE ● All prices include VAT.

AUDIO ELECTRONICS

Cubegate Limited

OPEN SIX DAYS A WEEK

301 EDGWARE ROAD, LONDON, W2 1BN, ENGLAND. TELEPHONE 01-724 3564



FREE CATALOGUE!
Send large SAE (17 1/2p UK) Schools, Companies, etc. free on request.

WATFORD ELECTRONICS

35 CARDIFF ROAD, WATFORD, HERTS., ENGLAND
 MAIL ORDER, CALLERS WELCOME. Tel. Watford 40588/9

ALL DEVICES BRAND NEW, FULL SPEC. AND FULLY GUARANTEED ORDERS DESPATCHED BY RETURN OF POST. TERMS OF BUSINESS: CASH/CHEQUE/P.O. OR BANKERS' DRAFT WITH ORDER. GOVERNMENT AND EDUCATIONAL INSTITUTIONS' OFFICIAL ORDERS ACCEPTED. TRADE AND EXPORT INQUIRY WELCOME. P & P Add 40p to ALL ORDERS UNDER £10.00. OVERSEAS ORDERS POSTAGE AT COST. AIR/SURFACE. (ACCESS orders by telephone welcome).

VAT Export orders no V.A.T. Applicable to U.K. Customers only. Unless stated otherwise all prices are exclusive of V.A.T. Please add 15% to total cost including P & P.

We stock many more items. It pays to visit us. We are situated behind Watford Football Ground. Nearest Underground/BR Station: Watford High Street. Open Monday to Saturday 9.00 am-8.00 pm. Ample Free Car Parking space available.

POLYESTER CAPACITORS: Axial Lead type (Values are in μF)
 400V: 1nF, 1n5, 2n2, 3n3, 4n7, 6n8 11p; 10n, 15n, 22n 12p; 33n, 47n, 68n 18p; 100n, 150n 20p; 220n 30p; 330n 42p; 470n 52p; 680n 60p; 1 μF 68p; 2 μF 82p; 4 μF 85p.
 160V: 10nF, 12n, 100n 11p; 150n, 220n 17p; 330n, 470n 30p; 680n 38p; 1 μF 42p; 1 μs 45p; 2 $\mu 2$ 48p; 4 $\mu 7$ 58p.

POLYESTER RADIAL LEAD CAPACITORS (250V)
 10nF, 15n, 22n, 33n, 47n, 68n, 100n 7p; 150n, 220n 10p; 330n, 470n 17p; 680n 19p; 1 μF 23p; 1 μs 40p; 2 $\mu 2$ 46p.

ELECTROLYTIC CAPACITORS: (Values are in μF) 500V: 10 52p; 47 78p; 250V: 100 65p; 63V: 0.47, 1.0, 1.5, 2.2, 3.3 8p; 4.7 9p; 6.8, 10 10p; 15, 22 12p; 33 15p; 47 17p; 100 19p; 150 20p; 220 22p; 330 24p; 470 32p; 2200 96p; 40V: 4.7, 15, 22 9p; 3300 90p; 4700 120p; 25V: 1.5, 6.8, 10, 22 8p; 33 9p; 47 9p; 68 10p; 100 11p; 150 12p; 220 15p; 330 22p; 470 25p; 680, 1000 27p; 1500 31p; 2200 36p; 3300 44p; 4700 79p.

TAG-END TYPE: 450V: 100 μF 65p, 70V: 4700 μF 24p, 64V: 3300 198p, 2200 139p, 50V: 3300 154p; 2200 110p, 40V: 4700 μF 160p, 25V: 4000 92p; 3300 98p; 2500, 2200 90p, 1500 345p

TANTALUM Bead Capacitors

35V: 0.1 μ , 0.22, 0.33 15p; 0.47, 0.58, 1.0, 1.5 16p; 2.2, 3.3 18p; 4.7, 6.8 22p; 10 25p; 16V: 2.2, 3.3 16p; 4.7, 6.8, 10 18p; 15 36p; 22 30p; 33, 47 40p; 100 75p. 10V: 1.5, 2.2 26p; 3.3, 4.7 35p; 100 55p.

MYLAR FILM CAPACITORS

100V: 1nF, 2n, 4n, 4n7, 10n 6p; 15nF, 22n, 30n, 40n, 47n 7p; 56n, 100n, 200n 9p, 470n/50V 112p.

MINIATURE TYPE TRIMMERS

4-6pF, 2-10pF 22p; 2-25pF, 5-65pF 30p; 10-88pF 35p.

COMPRESSION TRIMMERS

3-40pF, 10-80pF 20p; 20-250pF 28p; 100-560pF 39p; 400-1250pF 48p.

POLYSTYRENE CAPACITORS

10nF to 1nF 6p; 1-5nF to 12nF 3p, 4.7, 6.8, 8.2, 10, 12, 15, 18, 22, 27, 33, 39, 47, 50, 68, 75, 82, 95, 100, 120, 150, 180 15p; 200, 220, 250, 270, 300, 330, 360, 390, 470, 600, 800, 820 21p; 1000, 1200, 1800, 2000 30p; 3300, 4700 60p.

CERAMIC CAPACITORS: 50V

0.5pF to 10nF 4p; 22n to 100n 7p.

EURO BREADBOARD £5-20.

VOLTAGE REGULATORS*

1A	TO3	+ve	-ve	
5V	7805	145p	7905	220p
12V	7812	145p	7912	220p
15V	7815	145p	7915	220p
18V	7818	145p	-	-
1A	TO220	Plastic	Casing	50p
5V	7805	30p	7905	65p
12V	7812	30p	7912	65p
15V	7815	30p	7915	65p
18V	7818	30p	7918	65p
24V	7824	30p	7924	65p

100mA TO22 Plastic Casing

5V	7805	30p	7905	65p
12V	7812	30p	7912	65p
15V	7815	30p	7915	65p
18V	7818	30p	7918	65p
24V	7824	30p	7924	65p

LM3085 95 LM326N 240

LM3000	170	LM327N	270	595
LM305H	140	LM723	39	78HG 5A + 5V
LM309K	135	TLA555	50	to -25V 600
LM317K	350	TLA625B	95	79HG 5A -2.25
LM323K	625	TDA1412	150	to -24V 850p

JACKSONS VARIABLE CAPACITORS

Dilicon 1000/300pF 195p slow motion 1500p Drive 250p 00 208/176 395p
 4511/DAF 145p with slow motion drive 450p
 1/136 1 775p 25.50 pF 10 278p
 Drum 54mm 59p 100, 150pF 352p
 0-1-365pF 325p 'L' 3 x 310pF 725p
 00 2 365pF 395p 00 3 x 250pF 550p

DENCO COILS RFD2 120p

'DIP' VALVE TYPE RFD5 120p Range 1 to 5 Bl. RFC (19nmH) 135p
 Rd., Yl. Wht. 106p IFT 13; 14; 15; 6-7 B.Y.R. 95p 16; 17 105p
 1-5 Green 130p IFT 18/1-6 120p
 'T' 1 to 5 Bl., Yl., IFT 18/465 135p
 Rd., Wht. 140p TOC 1 110p
 B9A Valve Holder IN4007R 7p
 38p MW/LW 5FR 136p

VEROBOARDS .45"

2 1/2 x 3 1/2"	66p	47p
2 1/2 x 3"	75p	-
3 1/2 x 3"	86p	72p
3 1/2 x 5"	86p	72p
4 1/2 x 17"	286p	192p
4 1/2 x 17"	387p	-

Pkt. of 36 pins 20p
 Spot Face Cutter 107p
 Pin Insertion Tool 147p

POTENTIOMETERS (ROTARY)

Carbon Track. 0.25W Log & 0-5W Linear Value. 250K, 1K & 2K (Lin. only) Single 29p 5K-2 M Ω single gang 29p 5K-2 M Ω single with DP switch 89p 5K-2 M Ω double gang 89p

SLIDER POTENTIOMETER

0.25W log and linear values 60mm 5K Ω -500K Ω single gang 70p 10K Ω -500K Ω dual gang 112p Self Stick Graduated Bezels 36p

PRESET POTENTIOMETERS

Vertical & Horizontal
 0-1W 50 Ω -51M Ω Miniature 7p
 0-25W 100 Ω -3M Ω Horiz 16p
 0-25W 200 Ω -4-7M Ω Vert 10p

RESISTORS: Carbon Film, High Stability, Low Noise, Miniature Tolerance 5%.

Range	Val.	1-99	100+
1W 1/2-4M7	E24	2p	1p
1W 1/2-4M7	E24	2p	1p
1W 1/2-10M	E12	5p	4p
2% Metal Film 1/2-1M	5p	4p	
1% Metal Film 1/2-1M	5p	4p	

100+ price applies to Resistors of each value not mixed.

TGS 812 or 813 gas and smoke detector 415p. Socket for above 30p.

SLIDE 250V:

1A DPDT	14p
1A DP c/off.	18p
1A DPDT	15p
4 pole c/over	24p

PUSH BUTTON
 Latching or Push to Make 15p
 DPDT C/Over 99p
 DPDT C/Over 145p

SWITCHES Miniature Non-Locking

ROCKER: SPST on/off 10A 250V 28p
ROCKER: Illuminated DPST Lights when on: 10A 240V 85p
ROTARY: (ADJUSTABLE STOP) 1 pole/2-12 way sp/2-6W, sp/2-4W, sp/2-3W. 45p
ROTARY: Mains 250V AC, 4 Amp 86p

DIL SOCKETS (Low Profile - Taxes)

8 pin 10p; 14 pin 10p; 16 pin 10p; 18 pin 43p; 26 pin 22p; 24 pin 30p; 28 pin 35p; 40 pin 46p.

DIODES

AA129	22
BA100	15
BY125	12
BY127	12
CRO33	250
OA9	40
OA47	12
OA70	12
OA79	18
QA81	18
OA85	15
OA90	8
OA91	8
OA95	8
QA200	8
QA202	8
IN914	4
IN916	5
IN4001/2	5
IN4003	6
IN4004/5	6
IN4007/7	7
IN4148	4
IS44	9
3A/100V	18
3A/600V	17
6A/400V	95
10A/200V	215
10A/600V	315
25A/200V	215
25A/600V	395
BY184	56
VM18 DIL	55

NOISE

ZSJ 180

BRIDGE RECTIFIERS

(plastic case)
 1A/50V 20
 1A/100V 22
 1A/200V 25
 2A/50V 35
 2A/200V 40
 2A/400V 46
 2A/800V 65
 8A/100V 83
 8A/400V 95
 10A/200V 215
 10A/600V 315
 25A/200V 215
 25A/600V 395
 BY184 56
 VM18 DIL 55

TRIACS

3A/100V	48
3A/400V	58
8A/100V	95
8A/400V	95
8A/800V	115
12A/100V	78
12A/400V	82
12A/800V	135
16A/100V	103
16A/400V	105
25A/100V	185
25A/400V	195
25A/800V	315
30A/400V	525
T280000	120

DIAC

ST2 25

TTL 74 (TEKAS)	123	85	LS54	30	LS367	65	4086	90	ICM7216B	1950
7400 X1	126	50	LS55	30	LS368	90	4089	150	ICM7216C	1950
7415 12	125	45	LS73	45	LS373	150	4093	89	ICM7217A	790
7421 12	132	65	LS74	35	LS375	150	4094	245	ICM7255	89
03 14	136	65	LS75	45	LS376	180	4095	95	LD130	452
04 14	141	75	LS76	50	LS377	199	4096	95	LF356	90
05 18	142	185	LS83	105	LS378	140	4097	340	LM10	395
06 36	143	350	LS85	80	LS390	140	4098	115	LM301A	286
07 36	144	350	LS86	38	LS393	140	4099	190	LM308T	95
08 17	145	150	LS90	50	LS399	230	4161	115	LM311H	70
09 20	147	150	LS91	50	LS410	240	4162	115	LM312	245
10 17	148	125	LS92	75	LS670	270	4411	950	LM324	50
11 25	150	130	LS93	60	CMOS	-	4422	320	LM339	70
12 20	151	70	LS95	115	4433	570	4501	790	LM348	90
13 32	153	70	LS96	120	4501	18	4502	28	LM349	125
14 38	154	120	LS107	45	4502	24	4503	125	LM379	375
16 17	155	75	LS109	75	4506	66	4507	60	LM381	145
20 19	157	70	LS113	75	4508	22	4508	325	LM381A	248
21 38	159	165	LS114	40	4510	99	4510	99	LM382	125
22 25	160	99	LS122	70	4511	150	4511	90	LM386	90
23 28	162	99	LS123	75	4512	98	4512	98	LM387	120
25 28	162	99	LS124	180	4514	265	4514	265	LM389	99
26 43	163	99	LS126	45	4515	299	4515	299	LM390	95
27 32	164	120	LS126	45	4516	82	4516	82	LM1458	45
28 35	165	120	LS132	60	4517	105	4517	105	LM3900	60
30 19	166	130	LS136	35	4519	70	4519	70	LM3909N	70
32 27	167	205	LS138	70	4520	115	4520	115	LM3911	125
33 36	170	205	LS139	70	LM3914	240	LM3915	240	LM3915	240
37 35	172	375	LS151	90	LM3916	255	LM3916	255	LM3916	255
38 49	181	400	LS153	90	705C 8 pin	35	705C 8 pin	35	LM13600	135
40 20	174	100	LS155	75	710*	67	710*	67	M252AA	625
41 68	175	82	LS157	70	733	75	733	75	M253AA	11-10
42 58	176	80	LS158	70	741 8 pin	17	741 8 pin	17	MC1303	88
43 120	177	85	LS160	90	747C 14 pin	78	747C 14 pin	78	MC1304P	260
44 118	178	110	LS161	90	748 8 pin	36	748 8 pin	36	MC1310P	80
45 105	180	90	LS162	110	753 8 pin	15	753 8 pin	15	MC1494	89
46 132	181	280	LS163	95	801	159	801	159	MC1455	350
47 72	182	85	LS164	115	AY-1-0212	595	AY-1-0212	595	MC1496L	92
48 75	184	130	LS165	145	AY-1-1313A	660	AY-1-1313A	660	MC1596	225
50 20	185	130	LS166	175	AY-1-1320	225	AY-1-1320	225	MC3302	150
51										

Get a great deal from Marshall's

CRIMSON ELEKTRIK HI FI MODULES

CE 608 Power Amp	£20.09
CE 1004 " "	£23.43
CE 1008 " "	£26.30
CE 1704 " "	£33.48
CE 1708 " "	£33.48
CPS 1 Power Unit	£19.52
CPS 3 " "	£23.52
CPS 6 " "	£30.00
CPR 1 Pre Amp	£32.17
CPR 1S " "	£42.52

SINCLAIR INSTRUMENTS

Digital Multimeter	
PDM35	£34.50
" "	DM235 £52.50
" "	DM350 £72.50
" "	DM450 £99.00
Digital Frequency Meter	
PFM200	£49.80
Low Power Oscilloscope	
SC110	£139.00
TF200 Frequency Meter	
	£145.00
TGF 105 Pulse Generator	
	£85.00
NEW	
LCD Multimeter	
TM351	£99.00
LCD Multimeter	
TM352	£49.95
Prescaler	YP600 £37.50

ILP HI FI MODULES

Power Amplifiers	
HY30	£7.29
HY60	£8.33
HY120	£17.48
HY200	£21.21
HY400	£31.83
Pre Amplifiers	
HY6	£6.44
HY66	£12.19
Power Supplies	
PSU30	£4.50
PSU36	£8.10
PSU60	£13.04
PSU70	£15.92
PSU180	£21.34

MULTIPLEX NICKEL CADMIUM CELLS

Type S101 (HP4)	£0.98
Type SubC (HP11)	£1.75
Type SubD (HP2)	£1.95
Friwi Chargers for above	
Penlight 4: accommodates	
1-size HP7	£5.50
Combibox FW611:	
accommodates	
HP7, HP11	£13.25

**NOTE ALL PRICES
NET. EXCLUDING
VAT. POSTAGE/
PACKING**

New

Presensitised PC Boards, Developer. U.V. units, Toyo miniature Fans 230v AC £9.95

Mini Metal Detector/Voltage Tester for locating cable under plaster £9.95

Flow/Speed Sensors for monitoring fuel consumption electronically in vehicles

Just one of the exciting Leader range

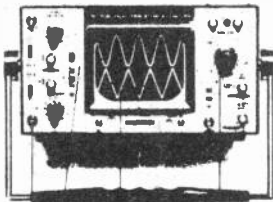

£299+ VAT

**LB0508A
OSCILLOSCOPE**
With 20MHz DC bandwidth and 10 mv input sensitivity on a 5" screen this universal oscilloscope is suitable for a wide range of applications.

Send SAE for details of full range

Marshall's 80/81 catalogue is now available by post, UK 75p post paid, Europe 95p post paid: Rest of world £1.35 post paid.

A. Marshall (London) Ltd., Kingsgate House, Kingsgate Place, London NW6 4TA. Industrial Sales: 01-328 1009. Mail Order: 01-624 8582 24hr service. Also retail shops: 325 Edgware Road, London W2. 40 Cricklewood Broadway, London NW2, 85 West Regent St., Glasgow, 108A Stokes Croft, Bristol.

INTERESTED IN ELECTRONICS?

**TRY A ZEDPACK!
COMPONENTS AT A PRICE
EVERYONE CAN AFFORD**

Z1 300 mixed 1/2 and 1/4 watt resistors	£1.95
Z2 150 mixed 1/2 and 2 watt resistors	£1.50
Z3 300 mixed capacitors, most types	£3.95
Z4 100 mixed electrolytics	£2.20
Z5 100 mixed polystyrene caps	£2.20
Z6 300 mixed printed circuit components	£1.95
Z7 300 mixed printed circuit resistors	£1.45
Z9 100 mixed miniature ceramic and plate caps	£1.20
Z10 25 assorted pots.	£1.50
Z11 25 assorted presets, skeleton etc.	£1
Z12 20 assorted vdr's and thermistors	£1.20
Z13 11b mixed hardware. Nuts, bolts self-tappers, sleeving, etc.	£1.20
Z14 100 mixed, new and marked, full spec. transistors. Pack Includes:— BC148, BF154, BF274, BC212L, BC238, BC184L, PBC108 and, or lots of similar types	£4.95
Z15 100 mixed diodes including:—zener, power, bridge, signal, germanium, silicon etc. All full spec.	£4.95
Z16 20 1N4148	£1
Z17 20 1N4003/10D2	£1
Z18 20 assorted zeners, 1 watt and 400mw	£1.50
Z19 12 .125" TIL 200 RED. LED'S	£1
Z20 10 Assorted switches, including push button, slide, multipole, miniature etc. Fantastic value. £1.20.	
TBA 900 Audio I.C. 80p ea. 3 for £2.	
BD181 (78V, 15A, TO3) 3 for £1.	
12V 1.5W ZENERS	10 for £1
Plastic BC108's	10 for 50p
200µA Miniature level/batt. meters, so fitted to many cassette recorders.	90p
Deluxe FIBREGLASS printed circuit etching kits.	
Includes 100 sq ins. of copperclad F/G board, 1lb ferric chloride, (made for U.S. army to MIL, SPEC.), 1 dato etch resist pen, abrasive cleaner, tweezers, etch resist dish and instructions. OUR PRICE £5.95	
1lb of FeCl. £2.25.	
150 sq. ins. single sided board.	£2.20
150 sq. ins. double sided board.	£3.30

To: "GEMINI ELECTRONIC COMPONENTS" DEPT EE "THE WAREHOUSE" SPEEDWELL ST. LONDON S.E.8. Please Quote ZED Code. Where shown, Send Cheque* or Postal Order. Plus 60p P&P. *Schools etc. SEND OFFICIAL ORDER ZED PACKS now available for Callers at 50 Deptford Broadway, London, S.E.8.

100 Miniature reed switches. £2.30
100 Subminiature Reed Switches. £4.20

P/B SWITCH BANKS
These cost a fortune! Were made for various music centres, includes independent and interdependent latching types multi pole c/o etc. Can be modified. Can't be repeated. 3 Banks for £1. **KNOB'S** for Switch Banks 10 for £1. Chrome or spun aluminium finish.

MINIATURE MAINS TRANSFORMERS
Top quality. Split bobbin construction will give 4.5V-0-4.5V at 250MA, 1/2" x 1/2" x 1/2", all sorts of uses. **ONLY £1** 3 for £2.50.

PP3 Battery Connectors 10 for 50p.
Miniature Press to Make Switches, Red knob, 3 for 50p.
Subminiature S.P.C.O. Slide Switches. 8 for 50p.
Miniature D.P.C.O. Slide Switches. 8 for 50p.
Standard 2P. 3 Position Slide Switch. 4 for 50p.
4 x HP11 Battery Holders (2 x 2 Flat type) with leads. 2 for 50p.
Assorted Fuse Holders including 20mm, P.C., Panel and chassis types. Pack of 7 for 50p.
3.5mm Jack Sockets, switched. Enclosed type. P.C. or panel mounting. With nuts and washers. 4 for 50p.
9" Section, Chrome on Brass Telescopic Aerial. Plugs into any 3.5mm socket. Approx 2'6" extended £1, each. 3 for £2.50.

R.C. SUPPRESSORS
250V. 1" x 1/2" x 1/2". Ideal for fluorescent light suppression, car, and relays. Also for snubber networks. 50p each. 3 for £1

ALTERNATOR RECTIFIERS
Make lovely 60 amp bridges. Ideal for High Power Battery Chargers. Type 4A.FI. Set of 4 (2 neg. case + 2 pos. case) £2.

Special Purchase enables us to offer Mullard C229 Polyester Capacitors (Liquorice Allsorts) at the unbeatable price of £2 for 100 mixed. £15 for 1000. These consist of factory clearance lots i.e. spillages, floor sweepings, cosmetic rejects etc. Also Mullard miniature electrolytics 200 mixed £2. Pack of each £3.50.

TECHNICAL TRAINING IN ELECTRONICS AND TELECOMMUNICATIONS

ICS can provide the technical knowledge that is so essential to your success; knowledge that will enable you to take advantage of the many opportunities open to you. Study in your own home, in your own time and at your own pace and if you are studying for an examination ICS guarantee coaching until you are successful.

City and Guilds Certificates:
Telecommunications Technicians
Radio, TV, Electronics Technicians
Technical Communications
Radio Servicing Theory
Radio Amateurs
Electrical Installation Work
MPT Radio Communications Certificate

Diploma Courses:
Colour TV Servicing
Electronic Engineering and Maintenance
Computer Engineering and Programming
Radio, TV, Audio Engineering and Servicing
Electrical Engineering, Installation and Contracting

POST OR PHONE TODAY FOR FREE BOOKLET

ICS To: International Correspondence Schools

Dept 268E, Intertext House, London SW8 4UJ or telephone 622 9911

Subject of Interest

Name

Address

Tel:

Age:

MAGENTA ELECTRONICS LTD.

E.E. PROJECT KITS

Make us YOUR No. 1 SUPPLIER OF KITS and COMPONENTS for E.E. Projects. We supply carefully selected sets of parts to enable you to construct E.E. projects. Project kits include **ALL THE ELECTRONICS AND HARDWARE NEEDED**—we have even included appropriate screws, nuts and I.C. sockets. Each project kit comes complete with its own **FREE COMPONENT IDENTIFICATION SHEET**. We supply—you construct. **PRICES INCLUDE CASES UNLESS OTHERWISE STATED. BATTERIES NOT INCLUDED.** IF YOU DO NOT HAVE THE ISSUE OF E.E. WHICH CONTAINS THE PROJECT—YOU WILL NEED TO ORDER THE INSTRUCTIONS/REPRINT AS AN EXTRA—45p. each.

LATEST KITS: S.A.E. OR 'PHONE FOR PRICES



CAR ACTUATED DRIVEWAY LIGHT. Feb. 81. £21.73 less mains socket.
THREE CHANNEL STEREO MIXER. Feb. 81. £15.89.
SIGNAL TRACER. Feb. 81. £6.95. Less Probe.
FOUR BAND RADIO. Feb. 81. £39.98.
NI-Cd BATTERY CHARGER. Feb. 81. £11.57.
UNIBOARD 3—POWER SUPPLY. Feb. 81. £15.20.
ULTRASONIC INTRUDER DETECTOR. Jan. 81. £45.98. Less case & chassis.
AUTO SLIDE CHANGER. Jan. 81. £8.44.
PHASER SOUND EFFECTS. Jan. 81. £22.83.
ICE ALARM. Jan. 81. £6.71.
LOGIC PULSE GENERATOR. Jan. 81. £8.80.
2 NOTE DOOR CHIME. Dec. 80. £8.78.
LIVE WIRE GAME. Dec. 80. £9.95.
SOUND TO LIGHT. Nov. 80. 3 channel, £18.95 Inc. etched & drilled pcb. Less light display.
PRECISION TIMER. Nov. 80. £24.48.
GUITAR PRACTICE AMPLIFIER. Nov. 80. £10.96 less case. Standard case £3.58. High quality case £8.33.
SOIL MOISTURE MONITOR. Nov. 80. £4.94 Inc. probes.
TRANSISTOR TESTER. Nov. 80. £9.89 Inc. test leads.
AUDIO EFFECTS UNIT FOR WEIRD SOUNDS. Oct. 80. £10.75
PHONE CALL CHARGE JOGGER. Oct. 80. £6.19
BICYCLE ALARM. Oct. 80. £8.80 less mounting brackets.
IRON HEAT CONTROL. Oct. 80. £4.99.
DARKROOM CONTROLLER. Oct. 80. £21.95 case differs.
BEDSIDE RADIO. Sept. 80. £15.98.
TTL LOGIC PROBE. Sept. 80. £4.41.
TTL POWER SUPPLY UNIT. Sept. 80. £13.72.
ELECTRONIC TOUCH SWITCH. Jan. 78. £2.33 less case.
AUTOPHASE. June 80. £21.41. Rectangular Case.
COURTESY LIGHT DELAY. June 80. £8.09.
A.F. SIGNAL GENERATOR. June 80. £22.54.
AUTOWAA. June 80. £21.33. Rectangular Case.
G.P. AMPLIFIER. June 80. £6.60.
SIGNAL TRACER. June 80. £5.50.
ZENER DIODE TESTER. June 80. £5.67.
CRICKET GAME. Aug. 80. £17.42.
WEATHER CENTRE. Aug. 80. £73.78 exc. hardware + wire for sensors.
AUDIO MILLIVOLTMETER. Aug. 80. £17.86.
4 STATION RADIO. May 80. £13.94 less case.
AUTOFADE. May 80. £9.96.
LIGHTS WARNING SYSTEM. May 80. £3.99.
BATTERY VOLTAGE MONITOR. May 80. £4.21.
AUDIO TONE GENERATOR. May 80. £3.53.
GAS SENTINEL. April 80. £26.32.
SPRING LINE REVERB. UNIT. Jan. 80. £21.05.
MICROCHIME DOORBELL. Feb. 79. £13.48.
AUTO LEVEL CONTROL. April 80. £7.69.
CABLE & PIPE LOCATOR. Mar. 80. £3.40 less coil former.
KITCHEN TIMER. Mar. 80. £12.46.
STEREO HEADPHONE AMPLIFIER. Mar. 80. £14.94.
5 RANGE CURRENT LIMITER. Mar. 80. £4.24.
MICRO MUSIC BOX. Feb. 80. £13.82. Grey Case £3.83 extra.
SIMPLE SHORT WAVE RECEIVER. Feb. 80. £21.65, headphones £3.28.
SLIDE/TAPE SYNCHRONISER. Feb. 80. £10.48.
MORSE PRACTICE OSCILLATOR. Feb. 80. £3.93.

UNIBOARD BURGLAR ALARM. Dec. 79. £9.13.
BABY ALARM. Nov. 79. £8.20
OPTO ALARM. Nov. 79. £5.77 Inc. optional parts.
MW/LW RADIO TUNER. Nov. 79. £15.50 less dial.
ONE ARMED BANDIT. Oct. 79. £18.39. case extra £3.98.
HIGH IMPEDANCE VOLTMETER. Oct. 79. £15.87.
CHASER LIGHTS. Sept. 79. £18.95.
VARICAP M.W. RADIO. Sept. 79. £8.98.
SIMPLE TRANSISTOR TESTER. Sept. 79. £6.26.
ELECTRONIC TUNING FORK. Aug. 79. £9.15. Suitable microphone + plug £1.59 extra.
WARBLING TIMER. Aug. 79. £6.25
9V POWER SUPPLY. Aug. 79. £9.94 Inc. pcb.
SWANEE WHISTLER. Aug. 79. £3.19
DARKROOM TIMER. July 79. £2.47.
TREMOLO UNIT. June 79. £11.26.
ELECTRONIC CANARY. June 79. £4.99.
LOW COST METAL LOCATOR. June 79. £5.44.
Handle & coil former parts extra £5.55.
QUAD SIMULATOR. June 79. £6.25.
INTRUDER ALARM. May 1979. £18.71. Less Ext. Buzzer & Lamp and Loop Components.
THERMOSTAT. 'PHOTO' SOLUTIONS. May 79. £18.02. Less socket, tube and grease.
TRANSISTOR TESTER. April 79. £4.95.
TOUCH BLEEPER. April 79. £3.52.
ONE TRANSISTOR RADIO. Mar. 79. with Amplifier & Headset. Less case. £8.93.
AUDIO MODULATOR. Feb. 79. £1.58 less case and pins.
THRISTOR TESTER. Feb. 79. £3.22.
ADJUSTABLE PSU. Feb. 79. £24.60. Case (horizontal layout) £5.21 extra.
FUZZ BOX. Dec. 78. £6.20.
VEHICLE IMMOBILISER. Inc. PCB. Dec. 78. £3.74.
AUDIO EFFECTS OSCILLATOR. Nov. 78. £3.99 inc. board.
FUSE CHECKER. Oct. 78. £1.97.
TREASURE HUNTER. Oct. 78. £17.88 less handle & coil former.
GUITAR TONE BOOSTER. Sept. 78. £4.99 Inc. p.c.b.
SOUND TO LIGHT. Sept. 78. £8.98.
FILTER. £1.66
SLAVE FLASH. Aug. 78. £3.20 less SK1.
LOGIC PROBE. July 78. £2.53.
IN SITU TRANSISTOR TESTER. June 78. £5.76.
FLASHMETER. May 78. £12.84 less calc and diffuser.
POCKET TIMER. April 78. £2.96.
WEIRD SOUND EFFECTS GENERATOR. Mar. 78. £4.80.
CHASER LIGHT DISPLAY. Feb. 78. £23.59 Inc. p.c.b. case extra £5.21.
AUDIO VISUAL METRONOME. Jan. 78. £5.12.
RAPID DIODE CHECK. Jan. 78. £2.34.
AUTOMATIC PHASE BOX. Dec. 77. £9.55 Inc. p.c.b.
VHF RADIO. Nov. 77. £14.36.
ULTRASONIC REMOTE CONTROL. Nov./Dec. 77. £16.99.
ELECTRONIC DICE. March 77. £4.83.
PHONE/DOORBELL REPEATER. July 77. £6.38.
CAR BATTERY STATE INDICATOR. Sept. 77. £1.79 less case Inc. PCB.
R.F. SIGNAL GENERATOR. Sept. 77. £18.17 less case.
ADD-ON CAPACITANCE UNIT. Sept. 77. £5.99.
HEADPHONE ENHANCER. Jan. 79. £2.80.
PASSIVE MIXER. Oct. 78. £3.72.
MIC AMP. Dec. 78. £2.80.
AUDIBLE FLASHER. Dec. 78. £1.21.

80/81 ELECTRONICS CATALOGUE

KITS
I.C.s
TRANSISTORS
CAPACITORS

Hundreds of illustrations, product data, circuits, and details of all our kits and educational courses.
 Up to date price list included. All products are stock lines for fast delivery. Send 70p in stamps (5 x 14p or 7 x 10p etc.).

TOOLS
RESISTORS
HARDWARE
CASES

ADVENTURES WITH ELECTRONICS by Tom Duncan

An easy to follow book suitable for all ages. Ideal for beginners. No Soldering. Uses an 'S Dec' breadboard. Gives clear instructions with lots of pictures. 16 projects—including three radios, siren, metronome, organ, Intercom, timer, etc. Helps you learn about electronic components and how circuits work. Component pack includes an S-Dec and the components for the projects.
Adventures With Electronics. £1.75. Component Pack £18.72 less battery.

ADVENTURES WITH MICROELECTRONICS

Same style as above book; 11 projects based on integrated circuits—includes: dice, two-tone doorbell, electronic organ, MW/LW radio, reaction timer, etc. Component pack includes a Bimboard, 1 plug-in breadboard and the components for the projects.
Adventures with Microelectronics £2.35. Component pack £27.95 less battery.

The INSTRUCTOR A FULLY CONSTRUCTIONAL PROJECT INCORPORATING AN INS8060 MICROPROCESSOR CHIP

The Instructor is a low cost assembly which provides a practical introduction to microprocessors and their functions. It is not a computer but it is a working circuit which allows microprocessor working to be followed, one program step at a time. Build the Instructor and you will gain microprocessor experience. The series is based on the INS8060 microprocessor IC, also known as the SC/MP Mk. 2. Circuits are built on a plug in Euroboard. Kit is available with or without the breadboard. **INSTRUCTOR COMPONENT PACK:** Including Euroboard £27.85; or less Euroboard £21.65.

INSTRUCTOR COURSE NOTES AND OPERATING INSTRUCTIONS—£2.98 extra.

3 BAND S.W. RADIO

Simple T.R.F. Design. Covering most Amateur Bands and Short Wave Broadcast Bands. Five controls:—Bandset, Bandspread, Reaction, Wavechange and Attenuator. Coil selection is by Wave-

change Switch. Use with Headphones or a Crystal earpiece. Kit contains all the components required, including the P.C. Board & Case. Instructions are included with this kit.

KIT: £18.97. Headphones extra £3.28.

TEACH - IN - 80

E.E. 12 part series. Oct '79—Sept '80. Covers the basics of electronics—lots of practical work. Circuits are built on a plug-in Euroboard, which is built into a wooden console which houses the power supplies, speaker, meter, pots and LED indicators. The series uses a range of electronic components in the experimental work including a photocell, I.C.s, transistors etc.

Wooden Console (Tutor Deck) kit £5.98 extra. Includes all the wood, glue, feet and strap handle.

Electronic components, including Euroboard, for the console and the experiments £25.40 (called list A + B + C by E.E.). Reprints available—Parts 1-12, 45p each. List 'C' only £2.45.

TOWERS INTERNATIONAL TRANSISTOR SELECTOR £10.35

ANTEX X25 SOLDERING IRON. 25W. £4.98.
SOLDERING IRON STAND. £2.03.
SPARE BITS. Small, standard, large. 65p each.
SOLDER. Handy size. 98p.
EUROBOARD LOG. £5.20.
LOW COST LONG NOSE PLIERS. £1.68.
LOW COST CUTTERS. £1.69.
SIREN. 12V. £5.18.
P.C.B. ASSEMBLY JIG. £11.98.
P.C.B. ETCHING KIT. £4.98.
MONO HEADPHONES. 2K Padded. Superior, sensitive. £2.98.
STEREO HEADPHONES. 8 ohm. Padded. £4.29.
DESOLDERING BRAID. 66p.

HOW TO SOLDER BOOKLET. 12p.
HEAT SINK TWEEZERS. 15p.
SOLDER BOBBIN. 30p.
DESOLDER PUMP. £5.98.
CONNECTING WIRE PACK. 5 x 1/2 yd coils. 65p.
VERO SPOT FACE CUTTER. £1.23.
VERO PIN INSERTION TOOL. 0-1". £1.66. 0-15". £1.67.
RESISTOR COLOUR CODE CALCULATOR. 21p.
MULTIMETER TYPE 1. 1,000 o.p.v. with probes. 2" x 3 1/2" x 1". £6.66.
MULTIMETER TYPE 2. 20,000 o.p.v. with probes. 5" x 3 1/2" x 1 1/2". £11.52.

MAGENTA ELECTRONICS LTD.

EG26, 98 CALAIS ROAD, BURTON-ON-TRENT, STAFFS., DE13 0UL. 0283-65435. 9-12, 2-5 MON.-FRI. MAIL ORDER ONLY

ADD 40p P. & P. TO ALL ORDERS.
ALL PRICES INCLUDE 15% V.A.T.
OFFICIAL ORDERS FROM SCHOOLS ETC. WELCOME.
ENQUIRIES MUST INCLUDE S.A.E. OVERSEAS: SEND ORDER WITH 3 INTERNATIONAL POSTAL COUPONS WE WILL QUOTE EXACT PRICE BY AIR MAIL.

EIRE & BPO ORDERS U.K. PRICES — LESS 10% (COVERS V.A.T. REFUND & EXPORT DOCUMENTS) PAYMENT: STERLING U.K. BANK DRAFT, U.K. POSTAL ORDERS OR U.K. CHEQUE.
ENQUIRIES: ENCLOSE 2 INTERNATIONAL POSTAL COUPONS.

MAGENTA gives you FAST DELIVERY OF QUALITY COMPONENTS AND KITS. All products are stock lines and are new and full specification. We give personal service and quality products to all our customers—HAVE YOU TRIED US?

JOIN UP WITH LITESOLD

New 'L' Series soldering irons, designed to latest safety standards. Outstanding performance, lightweight and easy maintenance. Heating elements enclosed in stainless steel shafts and insulated with mica and ceramic. Non-seize interchangeable bits, 'Copper' or 'Long-Life', fit over heating elements for high efficiency. Non-roll GRP handles and screw-connected 3-core mains leads.

Order direct at these special prices or send 25p for 4-page colour leaflet, or 60p for 16-page colour catalogue.

Model LC18 General purpose 18 watt iron for virtually all electronics assembly and servicing. Normally 240 volts but also available in 12 and 24 volt. Iron fitted with 3.2mm copper bit: £5.23. Iron with 3 spare bits 1.6, 2.4 and 4.7mm: £7.11

Model LA12 Intended mainly for fine work this 12 watt iron has a slimmer shaft and smaller bits. Normally 240 volts but available in 6, 12 and 24 volts. Iron with 2.4mm copper bit: £5.19. Iron with 2 spare bits 1.2 and 3.2mm: £6.29



No. 3 Spring Stand With heavy heat resisting plastic base, chromium plated spring and moulded phenolic top-piece. Holds 'L' Series irons and spare bits in safety. Complete with wiping sponge and non-slip pads: £5.00

'LOLA' Solder Suckers For trouble free solder removal. Thumb action operation and re-setting. Solder ejector and replaceable PTFE nozzle. 2 sizes — LOLA 'A' (standard): £7.37. LOLA 'D' (miniature).

All prices indicated include post, packing and VAT.

LITESOLD

LIGHT SOLDERING DEVELOPMENTS LTD

DEPT. EE1 . 97-99 GLOUCESTER ROAD, CROYDON, SURREY CR0 2DN. TELEPHONE: 01-689 0574. TELEX 8811945.

TOP PRIORITY for every constructor...

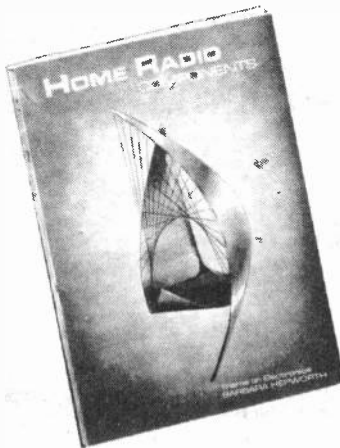

HOME RADIO CATALOGUE

- About 2,000 items clearly listed.
- Profusely illustrated throughout.
- Large catalogue, A-4 size pages.
- Bargain List, Order Form and Pre-paid Envelope included. Also 2 coupons each worth 25p if used as directed.
- Catalogue £1, plus 50p for post, packing and insurance.

HOME RADIO (Components) LTD.,
Dept. EE., P.O. Box 92, 215 London Road, Mitcham, Surrey.
Phone 01- 543 5659

POST THIS COUPON
with cheque or P.O. for £1.50

Please write your Name and Address in block capitals

NAME.....

ADDRESS.....

HOME RADIO (Components) LTD. Dept. EE
P.O. Box 92, 215 London Road, Mitcham, Surrey



(Regn. No
London 912964)

EVERGO

MULTIBAND RECEIVER WITH 27MHz

Frequency Range:
AIR 108-145 MHz
PB 145-176 MHz
WB 162.5 MHz
TV₁ 54-87 MHz
FM 88-108 MHz
CB 1-40 Channels

Output 280mW ● 6v D.C. ● 3" 8ohm Spk.
24" Telescopic Ant ● I.F. 465KHz CB 10.7 MHz others.

£21.95 + 75p post pack

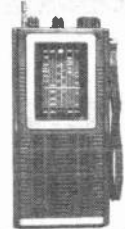

N.I.C.
UNIT 3, 61 BROAD LANE, LONDON N.15 4DJ
Day 01-808 0377; Eve 01-889 9736



(EE)

OHIO SCIENTIFIC COMPUTERS new series 2 Challenger CIP Cheapo version £219. Ohio version £259. Special offer—Superboard 3 with free power supply and modulator kit and guard band kit (gives 32 x 32 extended display, 1200 and 300 baud tape speeds, 50% higher computing speed and 50Hz conversion) £159 the lot. Guard band kit also sold separately £10. 4K extra ram £16.95. Case £27. Cassette recorder £16. Cegmon improved monitor rom £29.50. Assembler/Editor £25. Word processor £10p. Display expansion kit 30 lines x 54 characters for superboard TWO £20.

SHARP M280K COMPUTER with free tape of 50 programs 20K £415. 36K £437. 48K £459.

PRINTERS supplied with free interface and word processor for Superboard and Uk101. Seikosha GP80 £250. Oki Microline 80 £349. Base 2 800MST £299.

SINCLAIR PRODUCTS SC110 £145. PFM200 £51.95. DM450 £109. PDM35 £32.50.

BATTERY ELIMINATORS 3-way type 6/7 1/2 9v 300 ma £3.50. 100ma radio type with press studs 9v £4.77. 9+9v £5.99. car converter 12v input, output 4 1/2 6/7 1/2 9v 800ma £3.04.

TV GAMES AY-3-8650 + kit £12.99. Ay-3-8550 + kit £9.26.

MEMORIES 2114 450ns £2.15, 4116 200ns £2.83. 4027 £1.30. All low current.

BATTERY ELIMINATOR KITS 100ma radio types with press studs 9v £1.64. 9+9v. £2.30. stabilised 8-way types 3/4 1/2 6/7 1/2 9/12 1/2 18v 100ma £3.32. 1 Amp £3.10. stabilised power kits 2-18v 100ma £3.12. 1-30v 1A £8.30. 1-30v 2A £14.82. TTL and computer supplies 5V stabilised 2A £8.38. 4A £14.16. 12v car converter 6/7 1/2 9v 1A £1.62.

T-DEC AND S-DEC BREADBOARDS s-dec £3.79. 1-dec £4.59. exp d4 £2.64. exp 300 £6.61.

BI-PAK AUDIO MODULES AL30A £4.53. AL60 £5.62. SPM80 £5.26. BMT80 £6.36.

IC AUDIO AMPS with pcb. JC12 6W £2.50. JC20 10W £3.54.

SWANLEY ELECTRONICS
Dept. EE, 32 Goldsel Rd., Swanley, Kent
Post 40p extra. Add VAT except on sections marked*. Lists 27p post free. Phone Swanley 64851. Official and overseas orders welcome.

BI-AND SAVE SALE-81

DIODES		
AA119	£0.06	IN34 £0.06
BA100	£0.08	IN60 £0.07
BA148	£0.13	IN418 £0.05
BA173	£0.13	IN4002 £0.04
BA213	£0.05	IN4003 £0.05
BA216	£0.06	IN4004 £0.06
OA200	£0.06	IN4005 £0.07
OA202	£0.07	IN4006 £0.08
BY100	£0.18	IN4007 £0.09
BY126	£0.12	IN5400 £0.12
BY127	£0.14	IN5401 £0.13
OA47	£0.06	IN5401 £0.13
OA70	£0.06	IN5402 £0.15
OA79	£0.06	IN5404 £0.15
OA81	£0.08	IN5406 £0.19
OA90	£0.08	IN5407 £0.23
OA91	£0.08	IN5408 £0.28
OA95	£0.08	IS44 £0.03

AUDIO AMPLIFIER	
5 watt Audio Amplifier Module.	
Special Clearance Offer.	
O/No. AL20. £2.50	

CAPACITOR PAKS	
16201	18 electrolytics 4 7uF-10uF
16202	18 electrolytics 10uF-100uF
16203	18 electrolytics 100uF-680uF
All 3 at SPECIAL PRICE of £1.30	
16160	24 ceramic caps 22pF-82pF
16181	24 ceramic caps 100pF-390pF
16182	24 ceramic caps 470pF-3300pF
16183	24 ceramic caps 4700pF-0.047pF
All 4 at SPECIAL PRICE of £1.80	

RESISTOR PAKS	
Order No.	
16213	60Ω W 100ohm-820ohm
16214	60Ω W 1K-8-2K
16215	60Ω W 10K-82K
16216	60Ω W 100K-820K
16217	40Ω W 100ohm-820ohm
16218	40Ω W 1K-8-2K
16219	40Ω W 10K-82K
16220	40Ω W 100K-820K
ANY 4 at SPECIAL PRICE of £1.80	

SPECIAL OFFER	
MU2955 (PNP Complimentary To 2N3055) TO3	£0.75
ZN414	£0.75
ORP12	£0.50

POPULAR (CMOS)	
CD4001	1 Of each normal price £1.80 for 5—our price £1.30 for 5. O/No. SJ1245.
CD4007	
CD4011	
CD4017	
CD4081	

PCB	
O/No: 1609 PCB Etch Resist Pen	£0.55
SJ138 Paper PCB 5 pieces—approx. 200 sq. ins.	£1.75
SJ139 Glass Fibre PCB 5 pieces—approx. 200 sq. ins.	£2.25
SJ140 Mixed PCB single sided paper—single & double sided Glass Fibre—5 pieces—approx. 200 sq. ins.	£2.00

CAPACITORS	
SJ11 150 Caps. mixed types & values.	£0.50
SJ12 60 Electrolytics all sorts mixed.	£0.50
SJ13 40 Polystyrene/polystyrene capacitors mixed.	£0.50
SJ14 50 C280 type capacitors mixed.	£1.00
SJ15 15 Polystyrene Caps. 1, 160v.	£0.50
SJ16 40 Low volts electrolytics mixed values up to 10v.	£0.50

TRANSFORMERS	
MINIATURE MAINS Primary 240v	
No. Secondary	
2021 0v-0.5v 100mA	£0.75
2023 12v-0.12v 100mA	£0.95
2035 240v Primary 0-55v 2A Secondary	£5.50

BCT08 FALLOUTS	
50 NPN BC107/108 SJ124	£1.00
Manufacturers out of spec on volts or gain or neither—Metal TO18 case—You test.	
50 PNP BC177/178 SJ1244	£1.00

UJT's & FET's	
UT46/TI543	£0.18
BRY56	£0.25
2N4860	£0.40
2N4220	£0.30

Silicon Fast Switch	
NPN—like 2N706/2N2369	
You select by test!	
O/No. SJ125. 50 for £1.00	

Special Introductory Offer	
COMPUTER IC's	
EPROM 2708 @	£3.00
EPROM 2516/2716 @	£6.00
D.RAMS 4116 @	£2.25

SPECIAL OFFER LINEAR IC's	
NE555	5 for £0.90
741P	5 for £0.80
NE556	5 for £2.50
LM380	5 for £3.50
72723 14 pin	5 for £1.75
CA3085	1 for £0.75

Semiconductors from Around the World

100 A collection of Transistors, Diodes, Rectifiers, Bridges, IC's, SCR's, Triacs both Logic & Linear + Opto's, all of which are current everyday usable devices. **100**

Guaranteed Value over £10 at normal Retail Price yours for only £4.00

Data, etc. in every pak. Order No. SJ220.

SILICON TRANS	
SJ25 100 Silicon NPN transistors all perfect & coded—mixed types with data—equivalent sheet—no rejects.	£2.50
SJ26 100 Silicon PNP transistors all perfect & coded—mixed types and cases, data & equivalent sheet.	£2.50
SJ27 50 Assorted pieces of SCR's, diodes & rectifiers incl. stud types, all perfect—no rejects, fully coded—date incl.	£2.50

TTL's	
SJ28 20 TTL74 series gates—assorted 7401-7460.	£1.00

Mixed DTL All New and Coded	
930-9099 our mix 10 for £1.00	
O/No. SJ133	

RESISTORS	
SJ1 200 Resistors mixed values.	£0.50
SJ2 200 Carbon resistors 1/2 watt pre-formed.	£0.50
SJ3 100 1/2 watt miniature resistors mixed values.	£0.50
SJ4 60 1/2 watt resistors mixed values.	£0.50
SJ5 50 1-2 watt resistors mixed pot values.	£0.50
SJ7 30 2-10 watt wirewound resistors mixed.	£0.50

CASSETTES	
SUPER VALUE & A GREAT SAVING!!!	
C120 Dindy Cassettes—Low noise—astounding value and sound.	
O/No. SJ32. 10 for £3.50	

ASSORTED GERMTRANS	
SJ135 20 Assorted Germanium Transistors—ALL New & Coded types include AC's—2G's—GET's—ACY's etc.	£1.00

FM TUNER	
FM Tuner (Front End) with AM twin gang capacitor 87-109MHz 5-10 volts supply—data sheet supplier.	
£2.50	

AERIALS	
FM Indoor Tape/Ribbon Aerial.	
O/No. 107. 40p each	
HI-FI CAR AERIAL	
4-section fully retractable & locking.	
SPECIAL PRICE.	
O/No. 109. £1.40 each	

BI-PAK's OPTO BARGAIN!	
Valued at over £10—Normal Retail	
We offer you a pack of 25 Opto devices to include LED's large and small in Red, Green, Yellow & Clear. 7 segment Displays both Common Cathode and Common Anode PLUS bubble type displays—like DL-33. Photo Transistors—similar to OCP71 and Photo Detectors—like MEL11-12. This whole pack of 25 devices will cost you just £4!	
And we guarantee your money back if you are not completely satisfied.	
Full data, etc. included	
O/No. SJ120.	

IC SOCKET PARTS			
SJ36	14	8 pin	SJ41 6 22 pin
SJ37	12	14 pin	SJ42 5 24 pin
SJ38	11	16 pin	SJ43 4 28 pin
SJ39	8	18 pin	SJ44 3 40 pin
SJ40	7	20 pin	
ALL AT ONLY £1.00 each			

VOLTAGE REGULATORS			
Cast TO220			
Positive		Negative	
uA7805	£0.65	uA7905	£0.70
uA7812	£0.65	uA7912	£0.70
uA7815	£0.65	uA7915	£0.70
uA7818	£0.65	uA7918	£0.70
uA7824	£0.65	uA7924	£0.70

GERM TRANSISTORS	
The last of the Germanium PNP—OC71-71-75 etc. Mullard Black/Glass Type—You test (5 could cost you that!)	
O/No. SJ126. 50 pcs £1.00	
GERM. POWER TRANS.	
AD149-OC26-AD140 £0.50 each	
AD142-OC26-2N3614 £0.65 each	

GENUINE MULLARD TRANSISTORS		
AF116 £0.40	OC42 £0.18	AS217 £0.60
AF118 £0.45	OC44 £0.20	BC148C £0.07
OC71 £0.12	OC45 £0.18	BC149C £0.07
OC75 £0.25	AC187 £0.20	BC157 £0.08
OC76 £0.30	AC187K £0.35	BC159 £0.08
OC79 £0.35	AC188 £0.20	OC71 £0.30

DISC CERAMIC CAP	
100 Disc Ceramic Cap. Mixed values covering complete range 3P-F-4, 700PF.	
SUPER VALUE	
O/No. SJ121. £1.00	

SWITCHES	
Push-to-make. 6mm panel mounting.	
O/No. SJ131. 5 for £0.50	
Push-to-break as above.	
O/No. SJ132. 4 for £0.50	
Silicon Heat Sink Compound	
3mL in syringe £0.25	
SJ134 Slide Switches Low voltage and mains types	12 for £1.00

LED	
2nd Quality Paks	
1507 10 Assorted colours & sizes	£0.65
S122 10 125 RED	£0.50
S123 10 2 RED	£0.50
LED CLIPS	
1508/125 125	5 for £0.10
1508/2 2	5 for £0.12

MISCELLANEOUS	
SJ137 Assorted Cable Grips and Cabinet Feet 50 pieces for	£1.00
SJ136 Nickel Cadmium rechargeable Cell 3500D-HP2 size	£2.50
Calculator Chip Type: GOM2-C500	£0.50
2015 24 pin MOX with Data IC Insertion—Extraction Tool	£0.52

ODDMENTS	
16170 50 metres post. colours single strand wire.	£0.50
16187 30 metres stranded wire mixed colours.	£0.50
16178 5 Main slider switches assorted.	£0.50
SJ76 1 Board containing 2 × 5-pin DIN sockets 180° & 2 × 2-pin DIN loud-speaker sockets.	£0.30

KNOBS	
SJ62 5 15mm chrome knobs standard push fit.	£0.50
SJ63 Instrument knob—black winged (29 × 20mm) with pointer. 1/2" standard screw fit.	£0.15
SJ64 Instrument knob — black/silver aluminium top (17 × 15mm). 1/2" standard screw fit.	£0.12

BI-PAK

Send your orders to Dept EE3, BI-PAK, PO BOX 6, WARE, HERTS SHOP AT: 3 BALDOCK ST, WARE, HERTS
TERMS: CASH WITH ORDER, SAME DAY DESPATCH, ACCESS, BARCLAYCARD ALSO ACCEPTED. TEL (0920) 3182. GIRO 388 7006
ADD 15% VAT AND 50p PER ORDER POSTAGE AND PACKING

Why the Sinclair ZX80 is Britain's best-selling

Built: £99.95

Including VAT, post and packing, free course in computing, free mains adaptor.

Kit: £79.95

Including VAT, post and packing, free course in computing.

This is the ZX80. A really powerful, full-facility computer, matching or surpassing other personal computers at several times the price. 'Personal Computer World' gave it 5 stars for 'excellent value'. Benchmark tests say it's faster than all previous personal computers.

Programmed in BASIC – the world's most popular language – the ZX80 is suitable for beginners and experts alike. And response from enthusiasts has been tremendous – over 20,000 ZX80s have been sold so far!

Powerful ROM and BASIC interpreter

The 4K BASIC ROM offers remarkable programming advantages:

- * Unique 'one-touch' key word entry: the ZX80 eliminates a great deal of tiresome typing. Key words (RUN, PRINT, LIST, etc.) have their own single-key entry
- * Unique syntax check. A cursor identifies errors immediately.
- * Excellent string-handling capability – takes up to 26 string variables of any length. All strings can undergo all relational tests (e.g. comparison).
- * Up to 26 single dimension arrays.
- * FOR/NEXT loops nested up to 26.
- * Variable names of any length.
- * BASIC language also handles full Boolean arithmetic, condition expressions, etc.
- * Randomise function, useful for games and secret codes, as well as more serious applications.
- * Timer under program control.
- * PEEK and POKE enable entry of machine code instructions.
- * High-resolution graphics.
- * Lines of unlimited length.

Unique RAM

The ZX80's 1K-BYTE RAM is the equivalent of up to 4K BYTES in a conventional computer – typically storing 100 lines of BASIC.

No other personal computer offers this unique combination of high capability and low price.

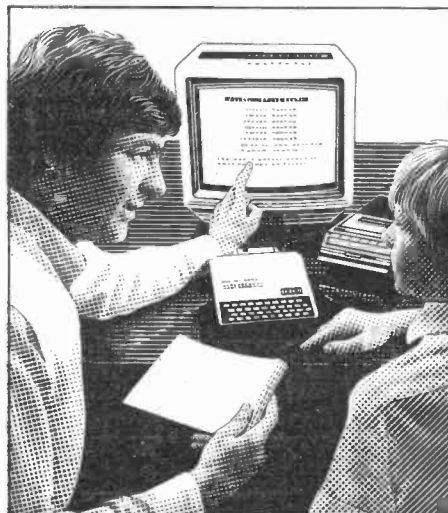

The ZX80 as a family learning aid. Children of 10 years and upwards are quick to understand the principles of computing – and enjoy their personal computer.

The Sinclair teach-yourself BASIC manual

If the specifications of the Sinclair ZX80 mean little to you – don't worry. They're all explained in the specially-written 128-page book (free with every ZX80). The book makes learning easy, exciting and enjoyable, and represents a complete course in BASIC programming – from first principles to complex programs.

Kit or built – it's up to you

In kit form, the ZX80 is pleasantly easy to assemble, using a fine-tipped soldering iron. And you may already have a suitable mains adaptor – 600 mA at 9V DC nominal unregulated. If not, see the coupon.

Both kit and built versions come complete with all necessary leads to connect to your TV (colour or black and white) and cassette recorder. Plug in and you're ready to go. (Built versions come with mains adaptor.)

personal computer.

Now available for the ZX80... New 16K-BYTE RAM pack



Massive add-on memory. Only £49.95.

The new 16K-BYTE RAM pack is a complete module designed to provide you – and your Sinclair ZX80 – with massive add-on memory. You can use it for those really long and complex programs – or as a personal database. (Yet it can cost as little as half the price of competitive add-on memory for other computers.)

For example, you could write an interactive or 'conversational' program to show people what your ZX80 can do. With 16K-BYTES of RAM, they could be talking to your computer for hours!

Or you can store a mass of data – perhaps in a fairly simple program – such as a name and address list, or a telephone directory.

And by linking a number of separate programs together into one giant, but modular, program, you can achieve the same effect as loading several programs at once.

We're also confident that it won't be long

before you can buy cassette-based software using the full 16K-BYTE RAM. So keep an eye on the personal computer magazines – and brush up your chess perhaps!

The RAM pack simply plugs into the existing expansion port on the rear of the ZX80. No wires, no soldering. It's a matter of seconds and you don't need another power supply. You can only add one RAM pack to your ZX80 – but with 16K-BYTES who could want more!

How to order

Demand for the ZX80 exceeds all other personal computers put together! So use the coupon to order today for the earliest possible delivery. All orders will be despatched in strict rotation. We'll acknowledge each order by return, and tell you exactly when your ZX80 will be delivered. If you choose not to wait, you can cancel your order immediately, and your money will be refunded at once. Again, of course, you may return your ZX80 as received within 14 days for a full refund. We want you to be satisfied beyond all doubt – and we have no doubt that you will be.

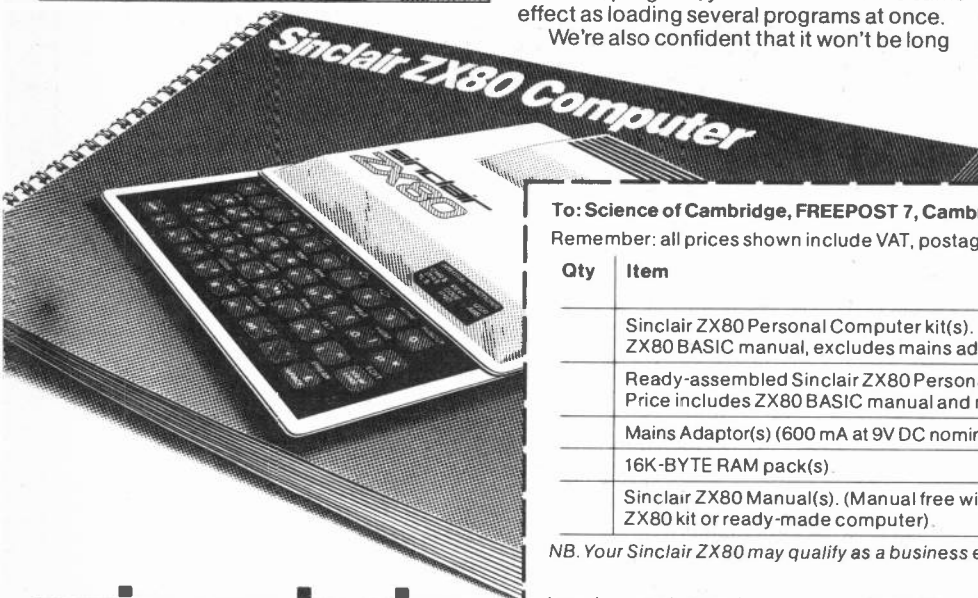

To: Science of Cambridge, FREEPOST 7, Cambridge CB2 1YY.

Remember: all prices shown include VAT, postage and packing. No hidden extras. Please send me:

Qty	Item	Code	Item price £	Total £
	Sinclair ZX80 Personal Computer kit(s). Price includes ZX80 BASIC manual, excludes mains adaptor.	02	79.95	
	Ready-assembled Sinclair ZX80 Personal Computer(s). Price includes ZX80 BASIC manual and mains adaptor.	01	99.95	
	Mains Adaptor(s) (600 mA at 9V DC nominal unregulated).	03	8.95	
	16K-BYTE RAM pack(s)	18	49.95	
	Sinclair ZX80 Manual(s). (Manual free with every ZX80 kit or ready-made computer).	06	5.00	

NB. Your Sinclair ZX80 may qualify as a business expense.

TOTAL: £

I enclose a cheque/postal order payable to Science of Cambridge Ltd for £ _____

Please print

Name: Mr/Mrs/Miss _____

Address _____

FREEPOST – no stamp needed.

EVE03

sinclair ZX80

Science of Cambridge Ltd.

6 Kings Parade, Cambridge, Cambs., CB2 1SN.
Tel: 0223 311488.

BIORHYTHMS ARE BACK!

With just about everything else but the kitchen sink

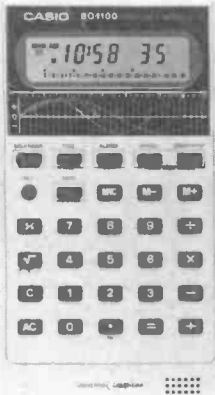

CASIO BQ 1100 BIOLATOR/WATCH

Clock, calendar, 2 alarms, countdown alarm, stopwatch, time memory, three date memories, biorhythm and date calculations, calculator, clock. Hours, minutes, seconds, am/pm. Day/date. Universal Calendar. Pre-programmed 1901 to 2099. Day, date, month and year display. Alarm. Two separate alarms. 24 hour system. Countdown alarm. 1/10 second to 24 hours, or Stopwatch. 1/10 second to 24 hours. Net times or Time memory. Dual time facility. 24 hour system. Calculator. 8 digits. Full memory. Sq roots. % Date calculations. Any monthly calendar from 1901 to 2099 can be displayed and utilised. Biorhythm Calculations. Forecast your physical, emotional and intellectual performance potential. Chart your peak, ebb and critical days and reschedule to avoid mistakes. Two silver oxide batteries last approx 1 year. Dims: 2 1/4 x 2 1/4 x 4 1/4 inches. Leatherette wallet.

**ALL THIS FOR ONLY
£14.95**

CASIO'S AMAZING NEW FX-3500P

Statistical regression and integrals. Non-volatile memories and stores. 38 functional (non-volatile) steps. 2 program storage capability. Unconditional and conditional jumps. 7 (non-volatile) memories; one independent, 6 constant memories. 18 pairs of parentheses, nestable in 6 levels. 61 built-in functions, including: Integrals (Simpson's rule). Linear regression, logarithmic regression exponential regression and power regression. Hyperbolics, sexagesimal and co-ordinates conversions. 10 digit mantissa or 10 + 2 exponent. Two silver oxide batteries give approximately 1000 hours continuous use with power-saving automatic cut-off, with data and memory protection. Dims: 9/32 x 2 1/4 x 5 1/2 inches. Supplied with leatherette wallet.

ALL THIS FOR ONLY £22.95

FX 180P. Hand held version without hyperbolics. 2 x AA batteries 3/4 x 3 x 5-7/8 **£19.95**
FX 2700P. As FX3500P but 8+2, 1 program. Without integrals, regression **£19.95**
New melody alarm clock/calculators. ML2000 **£22.95**, UC 360 **£19.95**, UC 365 **£19.95**.

★ star buy for 1981 ★ Our best selling watch

With around 40 functions LCD ANALOGUE/DIGITAL

Alarm Chronograph with countdown Analogue. Independent hours and minutes with synchronous digital seconds. Dual time ability.

Digital. Hours, minutes, seconds, day and date.

Stopwatch. 1/100 second to 12 hours. Net. lap and 1st and 2nd place. Start/stop and 10 minute signals.

Alarm. For 30 seconds with carousel display.

Countdown Alarm. Normal and net times to 1 hour, with amazing "Star Burst" flashing display.

Time signal. Half hourly and hourly chimes. Tone control. Lithium battery. Light, Water Resist case. 8.65mm thick. Mineral glass.

AA81 Chrome plated **£29.95**

AA81G Gold plated **£49.95**

AA82 Stainless steel **£39.95**

12 MELODY ALARM CHRONOGRAPHS with countdown alarm M12 Resin case/strap **£24.95**. M1200 all stainless steel **£29.95**.

100 METRE WATER RESISTANT Alarm Chronographs with countdown alarm. W100 Resin case/strap **£19.95**. W150C Stainless steel case/resin strap. **£25.95**.

W150B Stainless steel case/bracelet **£32.50**.

CASIO/TONE KEYBOARDS New model: CT 301 14 instruments and 16 rhythm voices (RRP **£285**) **£245**. CT E201 **£245**. M10 **£69**.

SEIKO. New calculator watch/stopwatch/FIVE alarms **£69.95**.

Send 25p for our illustrated catalogue of Casio and Seiko.



AA81
Analogue
Display

AA82
Digital
Display

PRICES

Include VAT and post and packing. Remember, we will beat any lower advertised price by 5% providing the advertiser has stocks and we will make a small profit. Just send details and your remittance for the lower amount.

Send cheques, PO or phone your ACCESS or B'CARD number to:

TEMPUS Dept. EE, Beaumont Centre, 164-167 East Road, Cambridge CB1 1DB Tel: 0223 312866

GREENWELD

443D MILLBROOK ROAD, SOUTHAMPTON SO1 0HX
All prices include VAT—just add 40p post. Tel (0703) 772501

THE SPECTACULAR 1981 GREENWELD

Component Catalogue
Bigger and better than ever!!!

- 60p discount vouchers
 - First Class reply paid envelope
 - Free Bargain List
 - Priority Order Form
 - VAT inclusive prices
 - Quantity prices for bulk buyers
- SEND 75p FOR YOUR COPY NOW!!!!**

VEROBLOC BREADBOARD

New from Vero, this versatile aid for building and testing circuits can accommodate any size of IC. Blobs can be joined together. Bus strips on X & Y axis—total 360 connexion points for just **£4.15**. (Photo shows 2 blobs)

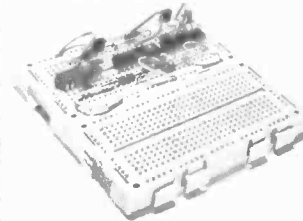

SCR PANEL & REED PANEL

Z525 Contains 11 800mA 60V 2N5061 SCR's, 11 6V8 zeners, 11 1N4004 diodes + R's, C's etc. Only **£1.00**.
Z527 2 x 6V reed relays, 6 x 2S030 or 2S230 6 x 400V reeds, + R's. Only 50p.

IN4006 DIODES

Special purchase of 1A reeds, Russian made. Packed in boxes of 300, **£8.50** per box; 4 boxes **£30.00**; 10 boxes **£75.00**.

DISC CERAMICS

0.22µF 12V 9mm dia. Ideal for decoupling. 100 for **£2.75**; 1000 **£20.00**.
0.05µF 12V 15mm dia. 100 **£1.50**; 1000 **£12.00**.

741 — 7 for **£1**

555 — 5 for **£1**

TRANSISTOR PACK K516

Take advantage of this unbelievable offer!! Small signal NPN/PNP transistors in plastic package at an incredibly low, low price!! Almost all are marked with type number—almost all are full spec devices, some have bent leads. Over 30 different types have been found by us, including BC184/212/238/307/328; BF196/7; ZTX107/8/9/342/450/550 etc. Only available as a mixed pack at **£3/100**; **£7/250**; **£25/1000**.

CALC CHIPS 60p!!!

New full spec, supplied with data. Type MK50321—full function inc memory. Only 60p.

DISPLAYS

8 and 9 digit 7-segment bubble type for above chips—most have minor faults dud segment etc. Mixture of 2 or 3 different types with data. 5 for **£1.00**.

REGULATED PSU PANEL

Exclusive Greenweld design, fully variable 0-28V & 20mA-2A. Board contains all components except pots and transformer. Only **£7.75**. Suitable transformer and pots **£6.00**. Send SAE for fuller details.

P.C. ETCHING KIT Mk V

The best value in etching kits on the market—contains 100 sq. inch copper clad board, Ferric Chloride, Etch resist pen, abrasive cleaner, two miniature drill bits, etching dish and instructions. All for **£4.95**.

SLIDER POT SCOOP!!!

Made by PIHER, types PL40CP. Silly prices for superb goods!!

PL40CP—69 x 16 x 9mm, 40mm slide length. 220R, 2k2 or 10k lin only. Prices (any mix): 1-24 20p; 25-99 17p; 100+ 14p.

COMPONENT PACKS

K503 150 wirewound resistors, 1W-12W. Wide range of values. **£2.00**.

K511 200 small value poly, mica, ceramic caps for a few pF to 0.2µF **£1.20**.

K518 200 disc ceramic caps. Big variety of values and voltages. **£1.00**.

£1 BARGAIN PACKS

Each pack **£1**; any 25 packs **£22**

- K101 16 BC239B transistors
- K102 15 BC349A transistors
- K103 10 BC546B transistors
- K104 18 BC132B transistors
- K105 50 1N4148 diodes
- K106 18 BC184L transistors
- K107 18 BC2131 transistors
- K108 8 2N5060 thyristors, 30V 0.8A T092 case
- K109 15 BC114 transistors
- K110 4 BD131 transistors
- K111 4 BD132 transistors
- K112 12 3A 100V reeds, wire ended
- K113 30 DA002 reeds 150V 0.5A
- K114 15 XK6116 (BF241) transistors
- K115 18 SP1218 (2N3702) transistors
- K116 10 MPS101 NPN 140V T092
- K117 10 BF450 PNP TV HF amp transistor
- K118 16 ME4101 NPN 60V AF low noise
- K119 10 2N5401 NPN 160V T092
- K120 6 prs 2SD96/2SB496 AF O/P sim to AC128/176
- K121 20 7V5 400mW zeners
- K122 10 VR525 5-25V 2-2W zener
- K123 10 6V 1W zener
- K124 50 .02µF disc ceramic
- K125 200 1k 5% 1W carbon film resistors
- K126 100 3000pF 63V polystyrene preformed caps
- K127 25 47µF 25V axial lead caps
- K128 25 1µF 40V dc
- K129 8 AA113 diodes
- K130 25 470V 0.1W presets
- K131 10 VA1086 thermistor
- K132 12 4.7µF 50V bead tants
- K133 20 3 way 5A term blocks
- K134 50 unmarked untested OC71 type transistors
- K135 30 4.7µF 50V radial elec
- K136 4 AC187k transistors
- K137 5 18µF 100V non-polarised caos
- K138 30 1" coll former with slug
- K139 40 .025µF 50V mylar caps
- K140 30 .05 dc
- K141 40 0.01µF 400V axial caps (C296)
- K142 25 wire ended neonals std size, 90V
- K143 200 squares mica insulation 25mm sq.
- K144 30 IR5 3W wirewound resistors
- K145 10 1500µF 16V caps—radial PC mntg
- K146 25 330µF 4V axial caps
- K147 3 150µF 350V caps—radial PC mntg
- K148 30 transformer former type X228
- K149 12 Ferrite rod type X036
- K150 10 switches type W430
- K151 12 0-125" red LED's
- K152 10 0-2" red LED's
- K153 30 T05 heat sinks, same as G104
- K154 15 5 pin 180° Din socket, clip fix
- K155 100 metres thin flex (50 x 2m lengths)
- K156 15 1/2" chassis mntg fuseholder
- K157 12 16 pin QIL-QIL IC sockets
- K158 6 SPC O centre off white rocker switches
- K159 20 0-3W presets 500k V with knurled knob
- K160 20 0-3W presets 2k5 V
- K161 20 0-3W presets 2M5 V with knurled knob
- K162 20 0-3W presets 2M5 V with knurled knob
- K163 400 15R 1W 5% preformed vert mntg resistors
- K164 50 22pF 2% silver mica caps
- K165 20 Sub-min reed switch, body 20mm long
- K166 100 3300pF 630V polyester PC mntg caps
- K167 30 10V 400mW zener, preformed for H mntg
- K168 50 AA144 diode preformed as above
- K169 30 8V2 400mW zener as K167
- K170 15 21V 1V do
- K171 12 1-5µF 25V tant bead caps
- K172 12 0.47µF 25V tant bead caps
- K173 10 2000pF 2 1/2 125V p/s caos
- K174 24 150R 0.1W vert presets
- K175 24 470R 0.1W vert presets
- K176 24 2K 0.1W horiz presets
- K177 24 470R 0.1W vert presets
- K178 24 470R 0.1W vert presets
- K179 24 2k 0.1W horiz presets
- K180 24 2k 0.1W vert presets
- K181 24 2k2 0.1W horiz presets
- K182 200 IR 1W CF preformed R's for Horiz mntg, 15mm centres
- K183 18 PE5030 NPN SI T092 transistors. Vce 35V, Hfe 75
- K187 18 FS44 PNP SI T092 transistors Vce 20V, Hfe 300
- K189 30 1N649 600V 0.4A diodes, preformed for H mntg.

ELECTRONICS

A NEW AND EXCITING HOBBY!!

BIG, WELL ILLUSTRATED BOOK
Ideal for beginners — gives lots of general information — explains how to build lots of projects
Intercom, Rain Alarm, Radios, Organ, Parking Light etc. All parts supplied and can be re-used on special deck provided, so NO SOLDERING is required. Just needs 4V battery.

£17.50 inc. VAT & Post

Also
ADVENTURES WITH MICROELECTRONICS
— Explore the world of silicon chips —
All components & Deck, **£27.95** inc. VAT & Post.

NEW

PRACTICAL ELECTRONICS PROJECT 125 WATT POWER AMP KIT



SPECIFICATIONS
 Max. Output power 125 watt RMS
 Operating voltage (DC) 50-80 Max.
 Loads 4-16 ohms
 Frequency response Measured at 100 watts 25Hz-20kHz
 Sensitivity for 100 watts 400mV @ 47K
 Typical T.H.D. @ 50 watts 4 ohms load 0.1 %
 Dimensions 205 x 90 and 190 x 36 mm

The P.E. power amp kit is a module for high power applications—disco units, guitar amplifiers, public address systems and even high power domestic systems. The unit is protected against short circuiting of the load and is safe in an open circuit condition. A large safety margin exists by use of generously rated components, the

output stage uses four 115 watt transistors normally only two would be used, result, a high powered rugged unit. The PC Board is backprinted, etched and ready to drill for ease of construction, and the aluminium chassis is preformed and ready to use, supplied with all parts and circuit diagrams.



£9.50 plus £1.00 p&p

125 watt power amp kit

ACCESSORIES

Suitable L.S. coupling electrolytic **£1.00** plus 20p p&p

Suitable Mains Power Supply Unit sufficient for one power amp **£7.50** plus £2.75 p&p

AS FEATURED IN PRACTICAL ELECTRONICS OCTOBER ISSUE

DIY STEREO BARGAIN PACKS FEATURING FAMOUS BUILT MULLARD PREAMP MODULES

MULLARD STEREO PREAMP MODULES AND TWO 12 WATT POWER AMP KITS.

In easy to build form P.C.B.s backprinted, etched and drilled ready to use.

BUILD A 12 WATTS PER CHANNEL STEREO AMPLIFIER ACCESSORIES AND L.S. KIT EXTRA (not available separately) £6.00

DIY PACK 1 2 x power amp kits LP1182/ preamp module, suitable for ceramic and auxiliary inputs. **£6.00** plus £1.10 p&p

DIY PACK 2 2 x power amp kits LP1184 preamp module suitable for magnetic ceramic and auxiliary inputs. **£8.50** plus £1.15 p&p

DIY SPEAKER KIT Two 8" x 5" approx. 4 ohm bass. **£3.50** plus £1.70 p&p

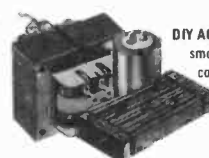

DIY ACCESSORIES Mains transformer smoothing capacitor rectifier 4 x slider controls, for base, treble and volume.

£3.00 plus £1.60 p&p

ACCESSORIES: Available only at time of purchase of Bargain Packs

12 + 12 WATT AMPLIFIER KIT NOTE: for use with 4 to 8 ohms speakers.

With up-to-the-minute features. To complete you just supply screws, connecting wire and solder. Features include din input sockets for ceramic cartridge, microphone, tape or tuner. Outputs—tape, speakers and headphones. By the press of a button it transforms into a 24 watt mono disco amplifier with twin deck mixing. The kit incorporates a Mullard LP1183 pre-amp module, plus 2 power amplifier assembly kits and mains power supply. Also featured 4 slider level controls, rotary bass and treble controls and 6 push button switches. Silver finish fascia panel with matching knobs. Easy to assemble teak simulate cabinet and ready made metal work. For further information instructions are available price 50p. Free with kit. Size 9 1/4" x 8 3/4" x 4" approx.

NOTE: for use with 4 to 8 ohms speakers.

£13.95 plus £2.55 p&p

BSR chassis record deck with manual set down and return, complete with stereo ceramic cartridge



£8.50 plus £2.75 p&p when purchased with amplifier. Available separately **£10.50** plus £2.75 p&p.

8" SPEAKER KIT. 2 Phillips 8" approx. speakers. **£4.75** per stereo-pair plus £1.50 p&p when purchased with amplifier. Available separately **£6.75** plus £1.50 p&p.

STEREO MAGNETIC PRE-AMP CONVERSION KIT all components including P.C.B. to convert your ceramic input on the 12 + 12 amp to magnetic. **£2.00** when purchased with kit featured above. **£4.00** separately inc p&p.

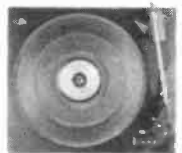

BSR Manual single play record deck with auto return and cueing lever. Fitted with stereo ceramic cartridge 2 speeds with 45 rpm spindle adaptor ideally suited for home or disco use.



£12.25 OUR PRICE plus £2.75 p&p Size approx 13" x 11"

PHILLIPS RECORD PLAYER DECK GC037 Size approx 15 1/4" x 12 1/2"

Hi Fi record player deck, 2 speed, damped cueing, auto shut-off, belt drive with floating sub chassis to minimise acoustic feedback. Complete with GP401 stereo magnetic cartridge—**LIMITED STOCK. UNBEATABLE OFFER AT**



£27.50 complete plus £2.75 p&p

OFFER! SAVE MONEY by purchasing 12 + 12 amp kit, BSR record deck and speaker kit together for only **£25.50** p&p £4.50.

PRACTICAL ELECTRONICS CAR RADIO KIT £10.50 (Constructors pack 7) plus £1.75 p&p

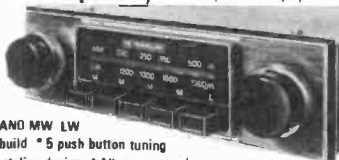

2 WAVE BAND MW LW
 * Easy to build * 5 push button tuning
 * Modern styling design * All new unused components
 * 6 watt output * Ready etched & punched P.C.B.
 * Incorporates suppression circuits * Now with tape input socket

All the electronic components to build the radio, you supply only the wire and solder as featured in the Practical Electronics March issue. Features: Pre-set tuning with five push button options, black illuminated tuning scale, with matching rotary control knobs, one, combining on/off volume and tone-control, the other for manual tuning, each set on wood simulated fascia. The P.E. Traveller has a 6 watts output, neg ground and incorporates an integrated circuit output stage, a Mullard IF module LP1181 ceramic filter type, pre-aligned and assembled and a Bird pre-aligned push button tuning unit. The radio fits easily in or under dashboards. Complete with instructions.

CONSTRUCTORS PACK 7A
 Suitable stainless steel fully retractable locking aerial and speaker (approx. 6" x 4") is available as a kit complete **£1.95** per pack, plus £1.00 p&p
 Pack 7A may only be purchased at the same time as Pack 7.
 NOTE: Constructor's pack 7A sold complete with radio kit **£15.20** including p&p.
FEATURED PROJECT IN PRACTICAL ELECTRONICS.



30 + 30 WATT STEREO AMPLIFIER BUILT AND TESTED

Viscount IV unit in teak simulate cabinet silver finished rotary controls and pushbuttons with matching fascia, red mains indicator and stereo jack socket. Functions switch for mic magnetic and crystal pickups, tape and auxiliary. Rear panel features fuse holder. DIN speaker and input socket 30 + 30 watts. RMS 60 + 60 watts peak for use with 4 to 8 ohm speakers. Size 14 1/2" x 10" approx.

READY TO PLAY £32.90 plus £3.30 p&p



323 EDGWARE ROAD, LONDON W2 21A HIGH STREET, ACTON W3 6NG

ACTON: Mail Order only. No callers
ALL PRICES INCLUDE VAT AT 15%
 All items subject to availability. Price correct at 1/1/81 and subject to change without notice.
 For further information send for instructions
 20p plus stamped addressed envelope.
NOTE: Persons under 16 years not served without parent's authorisation.

BARGAIN OFFER!!



ARISTON PICK UP
 Ariston pick-up arm manufactured in Japan. Complete with headshell. Listed price over £30.00 **OUR PRICE** **£11.95** plus £2.50 p&p

100 WATT MONO DISCO AMPLIFIER

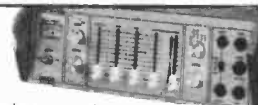

Brushed aluminium fascia and rotary controls. Size approx 14" x 4" x 10 1/2". Five vertical slide controls, master volume, tape level, mic level, deck level, PLUS INTER DECK FADER for perfect graduated change from record deck No. 1 to No. 2, or vice versa. Pre fade level controls (PRL) lets YOU hear next disc before fading it in. VU meter monitors output level. Output 100 watts RMS 200 watts peak. **£76.00** plus £4.00 p&p

50 WATT MONO DISCO AMPLIFIER

Size approx 13 1/2" x 5 1/4" x 6 1/4". 50 watts rms. 100 watts peak output. Big features include two disc inputs, both for ceramic cartridges, tape input and microphone input. Level mixing controls fitted with integral push-pull switches. Independent bass and treble controls and master volume.



£30.60 plus £3.20 p&p

Personal Shoppers EDGWARE ROAD LONDON W2 Tel: 01-723 8432. 9.30am-5.30pm. Closed all day Thursday ACTON: Mail Order only. No callers GOODS DESPATCHED TO MAINLAND AND N. IRELAND ONLY

EDITOR
F. E. BENNETT

ASSISTANT EDITOR
B. W. TERRELL B.Sc.

PRODUCTION EDITOR
D. G. BARRINGTON

TECHNICAL SUB-EDITOR
S. E. DOLLIN B.Sc.

ART EDITOR
R. F. PALMER

ASSISTANT ART EDITOR
P. A. LOATES

TECHNICAL ILLUSTRATOR
D. J. GOODING

EDITORIAL OFFICES
Kings Reach Tower,
Stamford Street,
London SE1 9LS
Phone: 01-261 6873

ADVERTISEMENT MANAGER
R. SMITH
Phone: 01-261 6871

REPRESENTATIVE
R. WILLET
Phone: 01-261 6865

CLASSIFIED MANAGER
C. R. BROWN
Phone: 01-261 5762

**MAKE-UP AND COPY
DEPARTMENT**
Phone 01-261 5615

ADVERTISEMENT OFFICES
Kings Reach Tower
Stamford Street,
London SE1 9LS

Projects... Theory...

and Popular Features ...

THE WAY AHEAD

Many traditional industries are under threat of extinction. Those that do pull through the present recession will have a reasonable fighting chance in the future only if they adopt new methods of production and administration. Essentially this implies computer controlled robots in the workshop areas, and computers and word processors in the offices. Likewise, small businesses of all kinds will be under increasing pressure to equip themselves with minicomputers. If they don't, they must lose out eventually to their more foresighted competitors.

Thus, the message comes over loud and clear. Brutal, but undoubtedly true.

There is, thankfully, some encouraging news. First, the setting up of a Small Systems Centre by the National Computing Centre. The purpose is to create greater awareness of modern developments and to help and guide businessmen and other individuals in their choice of suitable computing equipment.

It was at the launch of the Small Systems Centre in January that the recently appointed Minister for Information Technology Mr Kenneth Baker had some words to say about the vital importance of teaching young people the use of computers. Stating that only about one-quarter of our secondary schools have computer facilities on which to train the citizens of

tomorrow, the Minister made clear his intentions to encourage and promote a much wider appreciation of computers in the schools.

Exactly what tangible form this support will take, the Minister was not then prepared to say. We can, however, be reasonably optimistic that, despite the paralysing influence of ideological monetarists within the Cabinet, the public purse strings will be released for this investment in the future. For did not Kenneth Baker go on record, a few weeks before his appointment to the Government, with his view that the Department of Education's £9 million five-year programme for software and teacher-training was inadequate?

The wider application of computerised equipment means more job opportunities in the companies that design, manufacture and install computers and associated telecommunications equipment. Young people who have no particular leaning towards computer operation and programming but who do have an interest in the technical (hardware) side are well advised to "get into electronics".

A number of one-time stable industries are crumbling around us. But electronics *must* have a great future. So much depends upon it.



Our April issue will be published on Friday, March 20. See page 179 for details.

Readers' Enquiries

We cannot undertake to answer readers' letters requesting modifications, designs or information on commercial equipment or subjects not published by us. All letters requiring a personal reply should be accompanied by a stamped self-addressed envelope.

We cannot undertake to engage in discussions on the telephone.

Component Supplies

Readers should note that we do not supply electronic components for building the projects featured in EVERYDAY ELECTRONICS, but these requirements can be met by our advertisers.

All reasonable precautions are taken to ensure that the advice and data given to readers are reliable. We cannot however guarantee it, and we cannot accept legal responsibility for it. Prices quoted are those current as we go to press.

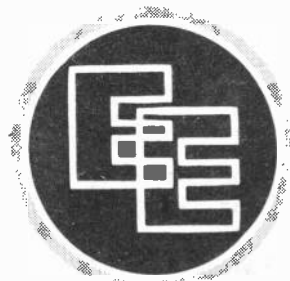

EVERYDAY ELECTRONICS

VOL. 10 NO. 3

MARCH 1981

CONSTRUCTIONAL PROJECTS

L.E.D. DICE For fun and games by A. P. Donleavy	156
TREBLE BOOST Lift for guitarists and vocalists by E. M. Terrell	160
MODEL RAILWAY POINTS CONTROLLER Capacitive discharge system for improved operation by S. J. Spreadborough	162
BENCH POWER SUPPLY Comprehensive unit for the serious constructor by A. R. Winstanley	166
MODULATED TONE DOORBELL Gives greater audibility by R. A. Penfold	180
L.E.D. FLASHER Electronic "Do Not Disturb" by K. B. Croft	188
SIMPLE TRANSISTOR/DIODE TESTERS Two designs for go/no-go testing by A. F. Olivera	190
I.C. UNIBOARDS: 4—MINI SIREN Realistic sounds for stage and recording by A. R. Winstanley	194

GENERAL FEATURES

EDITORIAL The Way Ahead—Information Technology a key to recovery	154
SHOP TALK Product news and component buying by Dave Barrington	159
COUNTER INTELLIGENCE A retailer comments by Paul Young	164
FOR YOUR ENTERTAINMENT The Spoilers by Barry Fox	165
SQUARE ONE Beginners Page: The circuit diagram	173
I.C.s EXPLAINED Part 6: Multivibrators by O. N. Bishop	174
IN MY CLASS Sir Explains by T. R. de Vaux Balbirnie	182
RADIO WORLD Radio travels and spectrum pollution by Pat Hawker G3VA	183
EVERYDAY NEWS What's happening in the world of electronics	184
BRIGHT IDEAS Readers' hints and tips	193, 196
BOOK REVIEWS A selection of recent releases	196, 198
CIRCUIT EXCHANGE A forum for readers' ideas	201
READERS LETTERS Your news and views	202
JACK PLUG AND FAMILY Cartoon by Doug Baker	202
DOWN TO EARTH Mains transformers by George Hylton	204

Back Issues

Certain back issues* of EVERYDAY ELECTRONICS are available worldwide price 80p inclusive of postage and packing per copy. Enquiries with remittance should be sent to Post Sales Department, IPC Magazines Ltd., Lavington House, 25 Lavington Street, London SE1 0PF. In the event of non-availability remittances will be returned.
* Not available: October 1978 to May 1979.

Binders

Binders to hold one volume (12 issues) are available from the above address for £4.40 (home and overseas) inclusive of postage and packing. Please state which Volume.

Subscriptions

Annual subscription for delivery direct to any address in the UK: £10.00, overseas: £11.00. Cheques should be made payable to IPC Magazines Ltd., and sent to Room 2013 Kings Reach Tower, Stamford Street, London SE1 9LS.

© IPC Magazines Limited 1981. Copyright in all drawings, photographs and articles published in EVERYDAY ELECTRONICS is fully protected, and reproductions or imitations in whole or in part are expressly forbidden.



L.E.D.

DICE

BY A. P. DONLEAVY

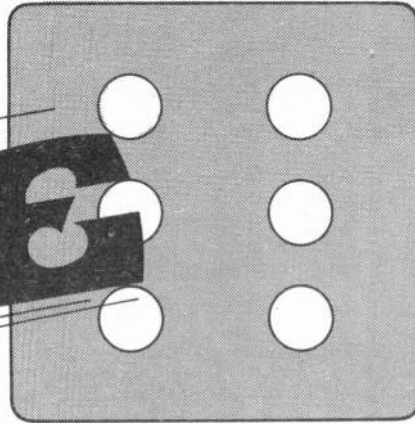

SO YOU WANT to play Monopoly but the dice have gone walkies and you don't know where. This electronic dice provides a useful alternative and gives completely random "throws".

CIRCUIT

The full circuit of the electronic dice is shown in Fig. 1. This consists of two parts; IC1, which forms an oscillator and IC2 which consists of six flip-flops with a common clock input. These drive five of the six display l.e.d.s, D2 to D6 (see later).

Each of the flip-flops has two terminals, a data terminal, *D*, and an output terminal, *Q*. When a positive clock pulse is applied to pin 9, the output will assume the same state as its *D* terminal.

The flip-flops are arranged so that the output of one is connected to the

D terminal of the next. When the first clock pulse arrives at pin 9 (all the flip-flop outputs being off), only the output of the first flip-flop goes high (pin 15) since all the rest of the *D* outputs are held low by the output of the preceding flip-flop.

The *D* input of the first flip-flop is held at nine volts. The *D* input of the second flip-flop will now be held high by the output of the first flip-flop so that at the next clock pulse, the output of the second flip-flop will then go high.

The subsequent clocking pulses will sequentially cause the outputs of the other flip-flops to go high. The output of the sixth flip-flop (pin 2) is connected via a gate (IC1d) to pin 1 to reset all the outputs to 0 on the sixth pulse.

The sequence then repeats itself. The outputs of each individual flip-

flop are connected to an l.e.d. which illuminates when the output is high. The reset pulse will extinguish all the l.e.d.s which are driven by the flip-flops leaving only one l.e.d., D7 alight. This is always alight when S1 is depressed and is driven by IC1d, a gate with its inputs permanently connected to ground. Thus the reset pulse (that is the sixth pulse) actually represents a one on the dice, first pulse a two and so on.

OSCILLATOR

Clocking pulses are provided by IC1a and IC1b. These are connected as an oscillator and operate at a frequency of about 4.5kHz. When S1 is pressed pin 13 of IC1 is grounded and the oscillator is stopped. The number of l.e.d.s alight will depend on the part of the sequence at which the oscillator is stopped.

The cathodes of the l.e.d.s are also connected to S1 so that the display only illuminates when S1 is depressed. This is a current saving device to prolong the life of the battery. The unit consumes about 800µA without any l.e.d.s illuminated and 25mA with all l.e.d.s on.

L.E.D.S

The colour of these components can be varied according to the constructor's taste although we have specified the red type. Similarly the values of the resistors R4 to R9 can be decreased if a brighter display is wanted although the minimum value should be about 470 ohms.

Fig. 1. Complete circuit diagram of the L.E.D. Dice.

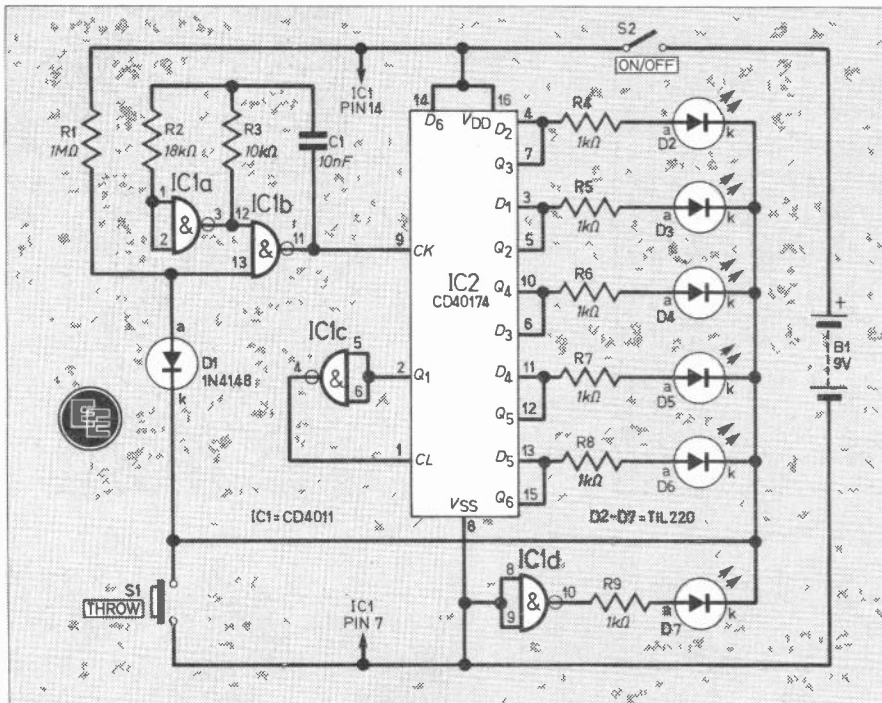

COMPONENTS

Resistors
 R1 1MΩ
 R2 18kΩ
 R3 10kΩ
 R4-R9 1kΩ (6 off)
 All 1/4W carbon ± 5%

See
**Shop
 Talk**
 page 159

Capacitor
 C1 10nF polyester C280 type

Semiconductors
 IC1 CD4011 CMOS quad 2-input NAND date
 IC2 CD4017 CMOS hex D-type flip-flop
 D1 1N4148 small signal silicon
 D2-D7 TIL220 5mm red l.e.d. (6 off)

Miscellaneous
 S1 push-to-make, release-to-break switch
 S2 s.p.s.t. toggle
 B1 9V, PP3 type
 Plastics case, 120 × 65 × 40mm, Verobox 202-21029J, or similar; Stripboard, 0.1 inch matrix, size 28 strips by 20 holes; battery clip; thin interconnecting wire; nuts, bolts and spacers to secure circuit board.

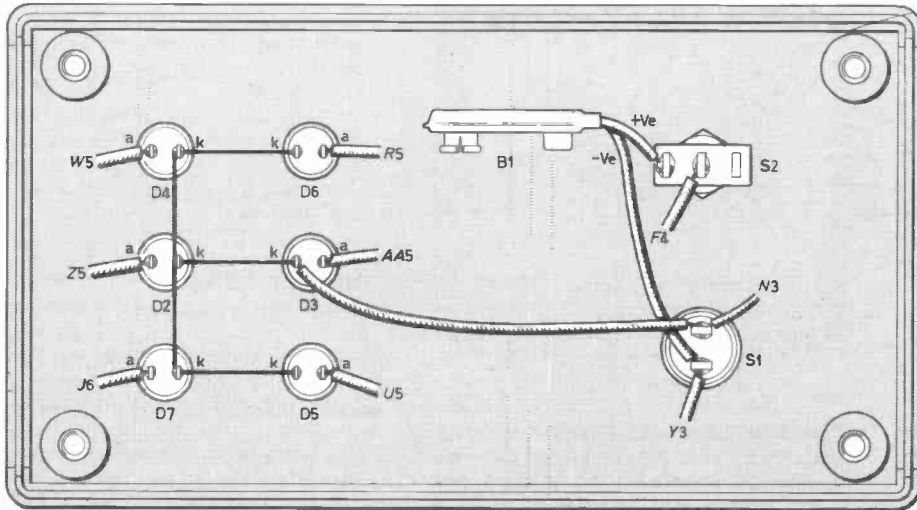
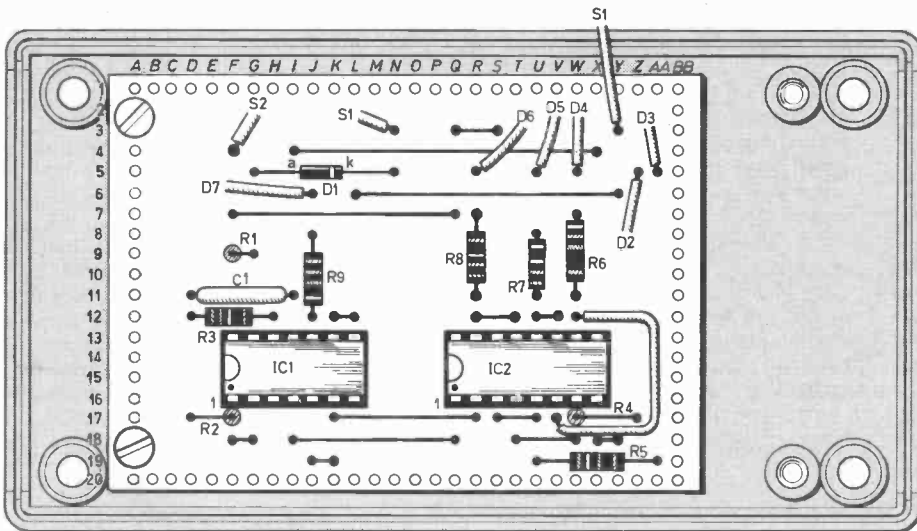

Photo above shows outside view of completed unit.



COMPONENTS
approximate
cost £7.50

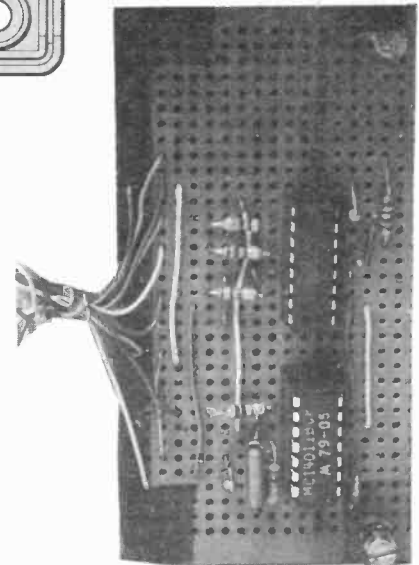
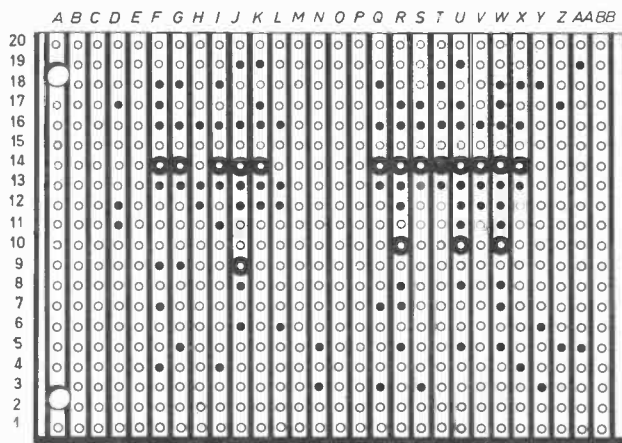

Fig. 2. Circuit board layout and interconnections between board and front panel. Note that the copper strips run from top to bottom of the board. Photo bottom right shows top view of prototype board. Layout has been slightly re-arranged for ease of construction.

Obviously the brighter the i.e.d.s the higher the current consumption and although the unit was designed to run from a 9 volt PP3 battery, the unit will work on any supply from 4 to 15 volts.

CONSTRUCTION

starts here

STRIPBOARD

The complete unit is built on a piece of 0.1 inch matrix stripboard, 20 holes by 28 strips. As both i.c.s are CMOS types they should be mounted in sockets, and only inserted when all assembly work has been completed. The stripboard layout is shown clearly in Fig. 2.

The completed unit is housed in a plastics box size 120 x 65 x 40mm, (Verobox type 202-21029J or similar), and the top of the box should be drilled to take the six i.e.d.s and the two switches. All the rest of the components, apart from the battery, are mounted on the circuit board. The electronic dice is completed by finishing the interwiring between the

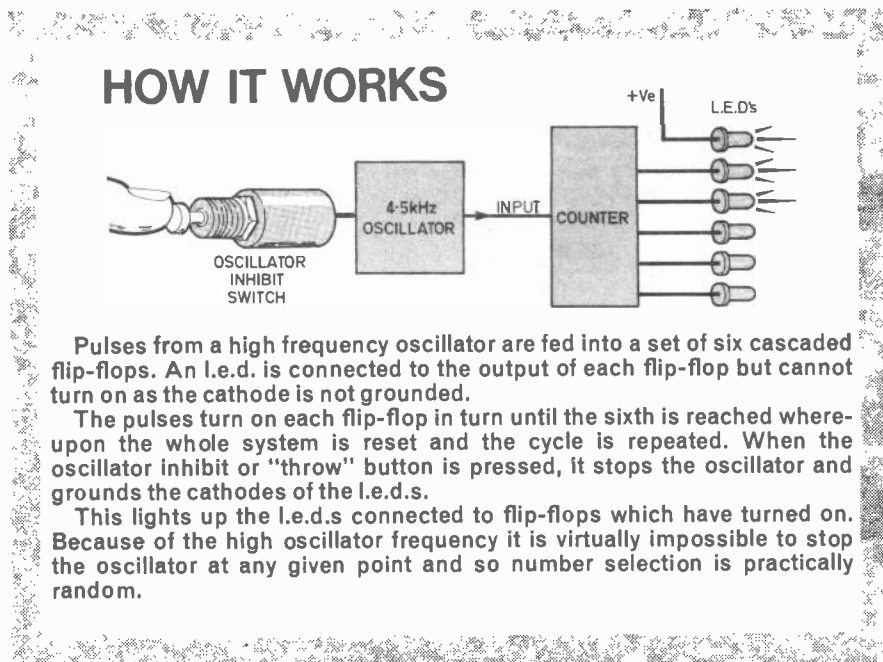

board and front panel. Keep the leads sufficiently long to allow easy access inside the box when the unit has been assembled.

The battery is secured in place using sticky backed, double sided mounting tabs, and the front panel may be finished off with dry transfer lettering protected by a coat of clear varnish.

TROUBLE SHOOTING

In the unhappy event that the instrument does not work properly when first switched on, the following procedure may be of help.

Disconnect the cathodes of the i.e.d.s from S1 and connect them directly to ground. All the i.e.d.s should then light up although they are in fact switching on and off in a very fast sequence. You, of course, cannot see this, as the frequency is too great.

If only some of the i.e.d.s light, check the polarity of the unlit diodes.

The cathode is the lead by the flat on the body of the device. Check also that the breaks in the copper tracks are complete and that there is no swarf or solder shorting across adjacent tracks.

NO LIGHTS

If none of the i.e.d.s light up, check the voltage at pin 1 of IC2. This should be about eight volts. If it is near zero then the reset is being held at zero and is therefore on when it should be off, and this can be investigated.

Measure the voltage at pin 9 of IC2. If this is about half the supply voltage then this is an indication that the oscillator section, IC1a and IC1b is working properly. If the voltage is near ground or supply voltage then something is amiss and this can be investigated.

For a really stubborn fault, connect a 4.7 μ F capacitor across C1. This will slow down the oscillations sufficiently to enable one to measure the input and output level voltages of the various stages of IC2 as the counting cycle proceeds and pinpoint the faulty section.

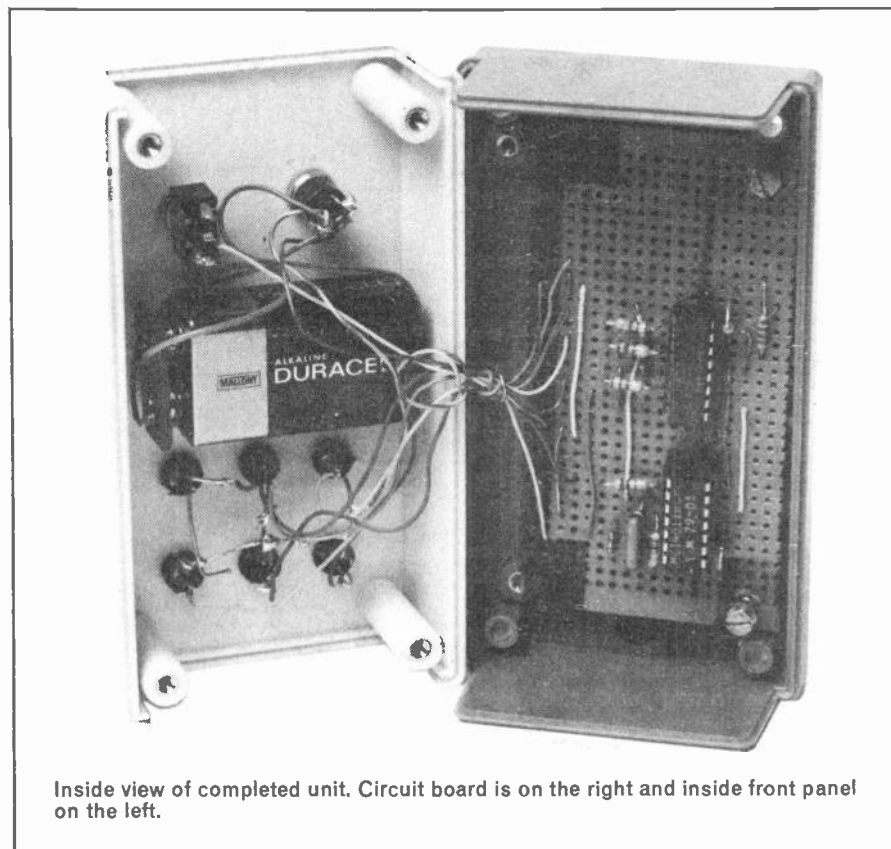

Inside view of completed unit. Circuit board is on the right and inside front panel on the left.

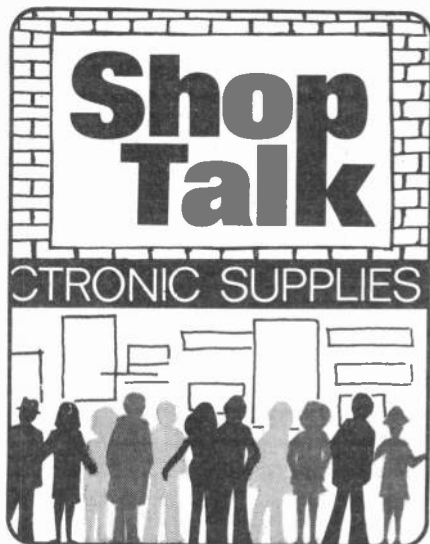

By Dave Barrington

Making Printed Circuit Boards

As a follow-up to our recent article on making printed circuit boards readers may like to investigate the possibilities of Fotoboards from Marshall's and a new Drillmaster Junior Kit from Microflame (UK) Ltd.

The Fotoboards are pre-sensitised printed circuit boards that are protected by a peel-off plastic sheet. Ideal for one-off and small batches, the boards are "developed" by exposing in ultra violet light for approximately 10 minutes or alternatively left in the sunshine for a day.

Available in single or double-sided versions the boards will accept standard transfers and track tape. The boards are developed using a Photo Board Developer which, due to its constituents, is only available through Marshall's shops and NOT through the postal service. Also available are Ultra Violet light boxes and kits.

The Drillmaster Junior Kit consists of a low voltage mini-drill and a range of accessories for drilling, grinding, polishing, cutting and deburring.

The drill is fitted with a "flexicord" lead and is suitable for battery or transformer operation. A feature of the drill is a detachable chuck finger shield. A chuck with 4 precision cut steel collets is fitted as standard, whilst an automatic 3-jaw chuck may be purchased as an optional extra.

Also available as optional extras are a drill stand with a magnifying glass attachment, a variable speed transformer/rectifier and a flexible drive shaft attachment.

For addresses of nearest stockists and price lists readers should write to Microflame (UK) Ltd., Dept EE, Vincas Road, Diss, Norfolk IP22 3HQ.

New Publications

With UK sales of video recorders forecast to pass the 300,000 mark by the end of the year, Sony has produced a 48-page full-colour handbook containing details not only of the best ways to exploit all the facilities of video recorders, but also how to make home video movies,

the use of sound and lighting and even the creation of professional style, special effects and titling.

Well illustrated and using simple non-technical language *How to Video* is currently on sale at Sony London Showroom, Dept EE, 134 Regent Street, London W1, price 60 pence. It is also available by post from the Showroom for an extra 30p.

The completely revised third edition of the PIL catalogue has just been released and is available from Precision Instrument Laboratories.

Giving specifications for over 400 different instruments, the catalogue is subdivided into 55 different product groups ranging from multimeters to recorders and oscilloscopes to breadboards.

Copies of the PIL catalogue can be obtained from Precision Instrument Laboratories Limited, Dept EE, 727 Old Kent Road, London SE15.

Containing 120 full-colour pages, with photographs, the latest 1981 Catalogue from Toolrange must surely list the largest single source of tools in the UK. From a screwdriver to soldering stations and components cabinets to complete tool kits, you name it and you'll probably find it in the catalogue.

For copies apply to Toolrange Limited, Dept EE, Upton Road, Reading, Berks RG3 4JA.

A new 6-page colour short-form catalogue featuring a fairly comprehensive range of instruments has been produced by Salford Electrical Instruments Limited.

Products covered include multimeters, ammeters, wattmeters, photometers and test sets. One section of the catalogue is devoted to the new SEI range of digital panel meters.

Copies of the short-form catalogue can be obtained from Salford Electrical Instruments Limited, Dept EE, Barton Lane, Eccles, Manchester M30 0HL.



PIL Catalogue



The Drillmaster Junior Kit from Microflame

CONSTRUCTIONAL PROJECTS

This month there should be very few component purchasing problems as most projects use standard off-the-shelf items.

Bench Power Supply

Only a couple of parts could cause readers sourcing problems for the *Bench Power Supply*, this month's major project.

The mains transformer used in the prototype was a Douglas MT79AT. This seems to be only listed in the Home Radio catalogue. Another suitable type is listed in the advertisement from the transformer specialists Baydis, under the 30V section. The optional mains suppressor is available from Maplin.

Although the 1A moving coil meter seems to be generally available, rather surprisingly the 25V d.c. meter would appear to be only listed by Watford Electronics under their type A range.

Treble Boost Unit

The successional action or push-on push-off footswitch is the only item that we could possibly label as a "special" for the *Treble Boost Unit*. This switch is designed to stand up to the rigorous treatment it receives in use and are stocked by Maplin, Watford and Magenta Electronics.

Make sure you are given a logarithmic (log.) potentiometer when ordering VR1, as some suppliers have been known to pass over a linear pot as a matter of course.

Modulated Tone Doorbell

The dual timer i.c. type 556 called for in the *Modulated Tone Doorbell* is now a commonly stocked device and should be available from most suppliers for a very reasonable sum.

The doorbell switch should be available from any of the large electrical or general stores, such as Woolworths.

Mini Siren

All of the components required for this month's *I.C. Uniboard—Mini Siren* project are standard parts stocked by advertisers.

The rotary switch S1 will have to be a 4-pole 3-way type and only one half used. The only other alternative switch is one of the more expensive types with adjustable stops. An investigation of catalogues shows that a 2-pole 3-way rotary switch is unobtainable.

Simple Transistor/Diode Testers

When ordering, components for the *Simple Transistor/Diode Testers* make sure to specify a push-to-make release-to-break switch for S1.

L.E.D. Dice

If any readers experience difficulties in locating the CMOS integrated circuit type CD40174 for the *L.E.D. Dice*, these are stocked by Watford and Maplin Electronics. Apart from the i.c. the rest of the components should not present any difficulties.

Most of the components for the *L.E.D. Flasher* and the *Model Railway Points Controller* should be available from readers existing "parts boxes". Practically any general purpose transistors could be used in the *L.E.D. Flasher*.

TREBLE BOOST

BY E.M. TERRELL



MANY lead guitarists and vocalists in "pop groups" have an insatiable desire for "top" or what is technically called treble boost. This is due to the fact that when they are playing to crowded audiences, the high frequency content of the sound is readily absorbed by the crowd and any soft furnishings that may be present, resulting in a general dulling of the sound and loss of penetration.

Also, the guitarist may wish to add a significant amount of top for a short time, when playing a solo for example. This needs to be instantly switchable in and out, ruling out in most cases resetting of the tone controls on the amplifier and/or guitar.

The Treble Boost to be described here provides these facilities and allows the boosted loudness to be set by the inclusion of a built-in gain control. The unit is powered by a single PP3 battery with current consumption less than 1mA.

CIRCUIT DESCRIPTION

The circuit diagram of the Treble Boost is shown in Fig. 1. The battery is connected to the circuit when the input jack is plugged into the stereo input jack socket. The circuit is made by the shank of the jack plug shorting the rear two contacts of the socket.

A high pass filter is formed by C1 and R2. By the a.c. potential divider effect of C1 and R2 the incoming signal is transmitted with an attenuation inversely proportional to the frequency of the input signal. That is, higher frequencies are attenuated less. These are then amplified by TR1, a simple common emitter amplifier; R1 and R2 are the potential divider bias resistors and C2 increases the a.c. gain.

The amplified signal at the collector is passed to the volume control via d.c. blocking capacitor C3. The required amount of gain is tapped from the wiper of VR1 and available at the

The components are mounted on a small piece of 0.1 inch matrix strip-board size 22 strips x 9 holes as shown in Fig. 2. Not all the strips are used but this size board is necessary if it is to be mounted by means of the guides in the Bimbox.

A hole or cutaway is required as shown at each top corner to allow wires to feed from one end of the case to the other and the lid to seat properly. Only two breaks are required on the underside of the board at locations L5 and K3. Mount the components in any order and attach the flying leads to reach the case mounted components.

The case should be drilled next and the components fitted and wired up as shown in Fig. 3. A small piece of card placed beneath the component board will prevent the possibility of the strips shorting against the case; similarly above the board before the lid is screwed down. A piece of foam sponge placed on top of the battery will prevent it from moving when in use.

The switch used in the prototype is a changeover type and modified with a diagonal link to make it into a s.p.d.t. switch as required, see Fig. 3.

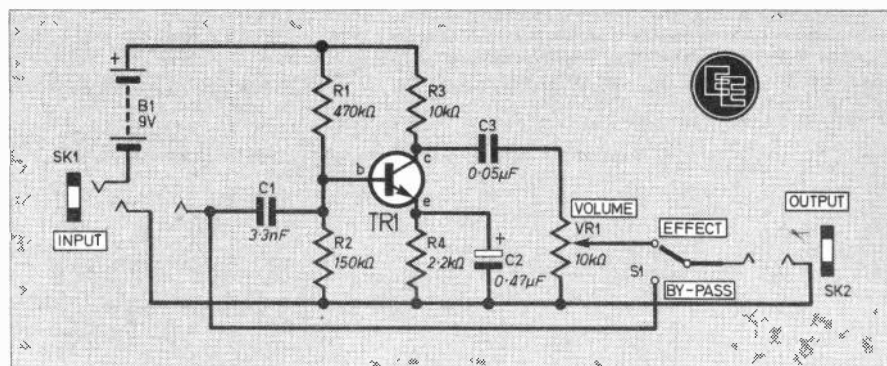

Fig. 1. The complete circuit diagram for the Treble Boost.

output through S1. With S1 in its other position the input signal is fed directly to the output socket and is therefore unmodified.



ASSEMBLY

As the unit is to be floor mounted and operated by foot, a rugged case is called for. A Bimbox type 5003/13 is ideal for this application and can be obtained in a stove finished enamel as was used in the prototype.

IN USE

The unit is intended to be interposed between the musical instrument and the amplifier. Although intended for electric guitar, there is no reason why any other instrument or microphone shouldn't be used. In one position of S1, the signal will be unaffected in sound or volume. In the other, the input signal will have the higher frequency content boosted, the level of boost being controlled by VR1.

The Treble Boost can be made to look "professional" by fixing a label and lettering the controls and sockets with Letraset for example. A coating of clear lacquer or polyurethane should be applied to protect this. Self-adhesive rubber feet can be fitted that will prevent the unit from moving when operated, as well as enhance its appearance. □

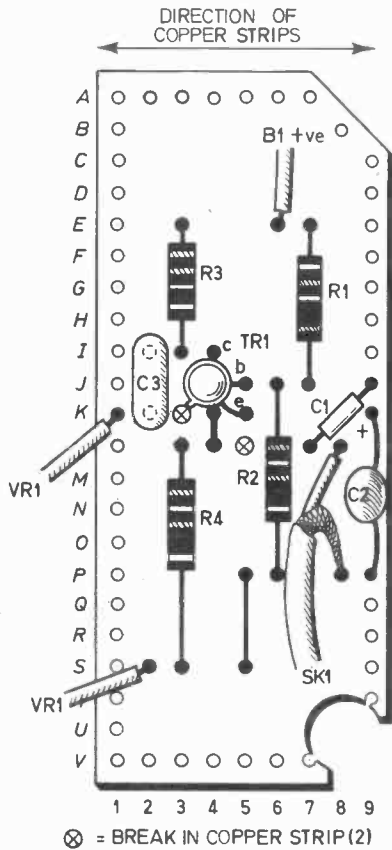

Fig. 2. The component layout on the circuit board shaped to suit the slotted case.

COMPONENTS

Resistors

- R1 470k Ω
- R2 150k Ω
- R3 10k Ω
- R4 2.2k Ω

All carbon $\frac{1}{4}$ W carbon $\pm 5\%$

Capacitors

- C1 3.3nF ceramic plate
- C2 0.47 μ F 10V tantalum (for size only)
- C3 0.05 μ F plastic or ceramic

Semiconductor

- TR1 BC109 *npn* silicon or other low noise type

Miscellaneous

- VR1 10k Ω carbon log. law shafted type
- S1 single-pole changeover successional action foot-switch (see text)
- SK1 standard stereo jack
- SK2 standard mono jack
- B1 9V type PP3

Stripboard: 0.1 inch matrix size 22 strips \times 9 holes; battery connector for B1; case, Bimbox 5003/13 enamelled diecast box; control knob; screened cable.

See **Shop Talk** page 159

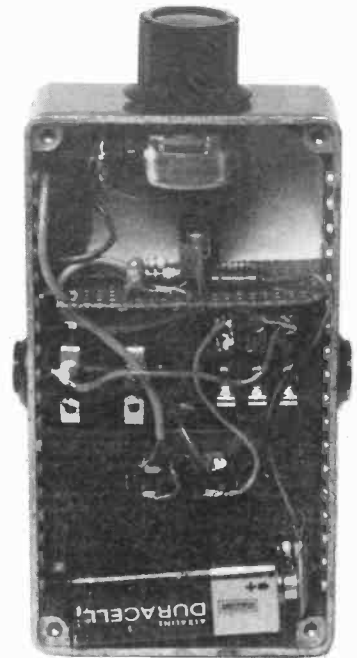

View inside the prototype with base (lid) removed. You can see the card beneath the circuit board which prevents shorting of the board against the case.

COMPONENTS
approximate
cost **£3.50**

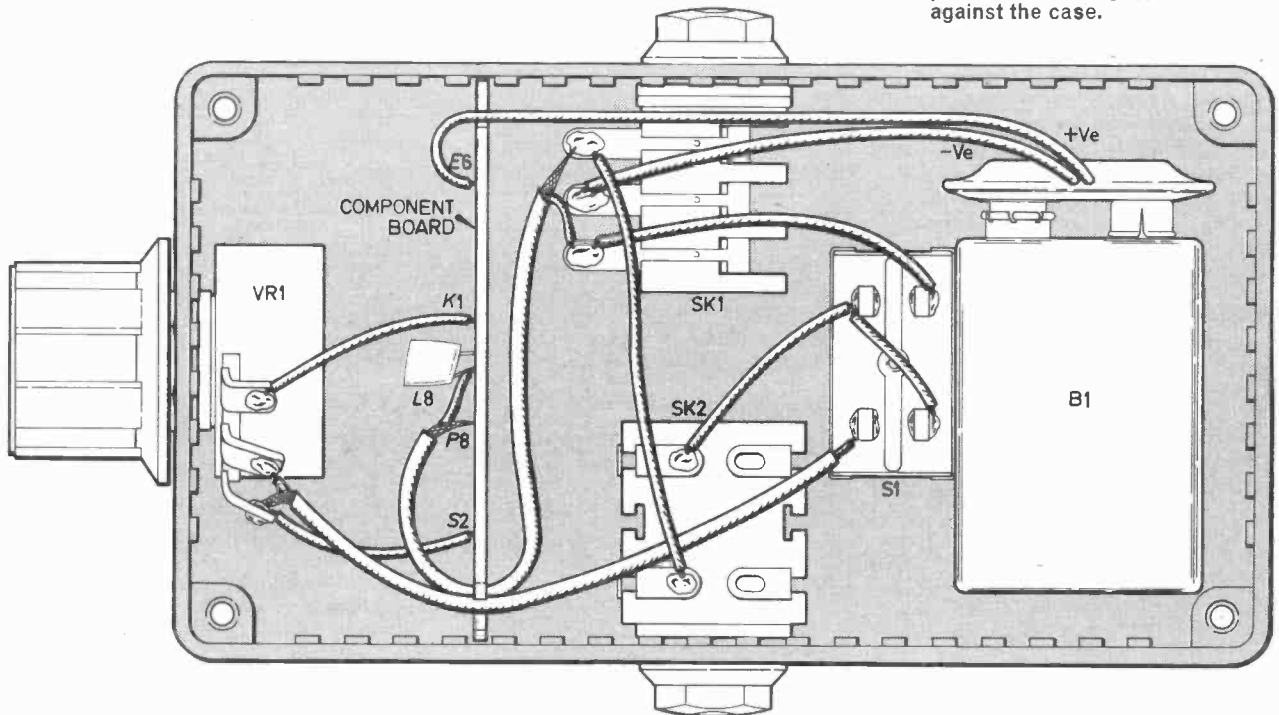

Fig. 3. The positioning of the components within the case and interwiring details.

MODEL RAILWAY POINTS CONTROLLER

BY S. J. SPREADBOROUGH

WHEN points in a model railway are remote from the operating position, it becomes necessary to use a "point motor," usually consisting of two solenoids pulling a bar backwards and forwards to move the track. In a simple system, 16V a.c. is applied momentarily across the coils to operate the motor. These coils, however, have a very low resistance and virtually short circuit the transformer. If operated for a long time possible damage to the motor and/or transformer could result.

Capacitive discharge systems, such as that to be described in this article, provide a large pulse of current to activate the motor, reducing to virtually zero after the initial discharge. This current limit feature results in no risk of damage to the motor. Commercial units are available which will charge up a capacitor, but not all incorporate the current limit facility included in the design here.

CIRCUIT DESCRIPTION

The circuit diagram of the controller is shown in Fig. 1. Transistor TR3 charges up the capacitor, C1, at a

constant current of about 1 ampere. The base current is supplied by R2 and TR2. When the output is connected to a point motor there is a very large initial burst of current as C1 discharges through the motor. TR3 will then attempt to recharge the capacitor, but while the points button is pressed, all the charging current flows through D1 and D2 which develops a voltage of about 1.4 volts across the pair. This is sufficient to switch on TR1 which cuts the base current to TR2 and thus TR3. The short circuit is therefore limited to that value which will develop enough voltage across D1 and D2 to switch on TR1. In the prototype this was about 10mA.

On release of the button, no voltage is developed across D1 and D2, TR2 is turned on and so the full charging current flows and charges up the capacitor.

The charging current is determined by R1 and R2 and the gain of TR1. To increase the current, reduce R2. The limiting current is determined mostly by D1 and D2 but also to a certain extent by R3. Reducing R3 reduces the limiting current.

POWER SUPPLY

The unit should be supplied from a smooth d.c. supply in the range 16 to 20V. The 12V d.c. "uncontrolled" output from many train controllers is suitable but will require smoothing. A suitable circuit for this is shown in Fig. 2. If such an output is not available in the system, then a mains derived supply will need to be made. A suitable circuit for doing this is seen in Fig. 3. See the Component List for full specification for these components.



PRINTED CIRCUIT BOARD

The unit circuitry is constructed on a small piece of fibreglass printed circuit board. The full-size pattern for this is shown in Fig. 4. The black

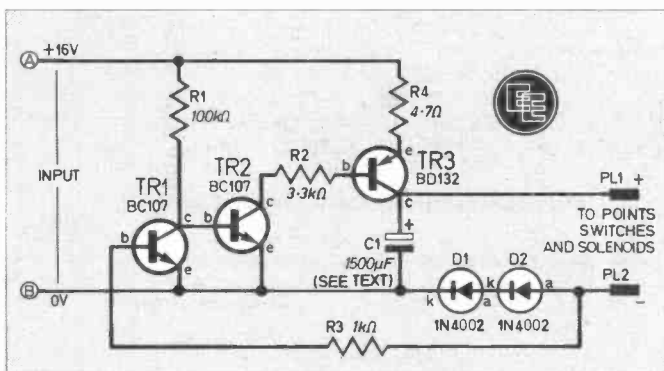

Fig. 1. The circuit diagram of the Points Controller.

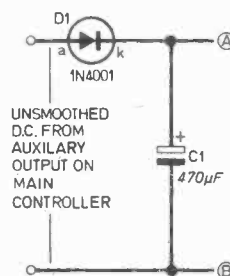

Fig. 2. A suitable smoothing circuit for use with an "uncontrolled" controller output.

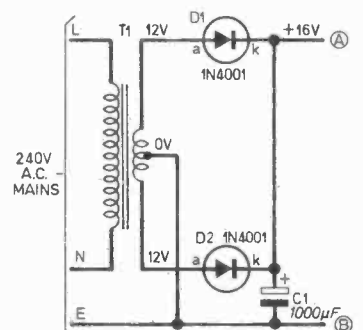

Fig. 3. A self-contained mains derived d.c. supply.

areas are the regions of copper to remain after etching.

The layout of the components on the topside of the board is shown in Fig. 5. Care should be taken when positioning and soldering D1 and D2 as these components form the protection circuitry input.

In the prototype, observant readers will see in the photograph that a double-sided p.c.b. was used, the area remaining on the topside providing a heatsink for TR3. If it is expected that the unit will be charged and discharged at a high rate, then a heat-sink should be fitted. A small piece of 1 or 2mm thick drilled aluminium can be fitted behind the transistor casing.

No provision has been made for mounting the capacitor on the board as this is a very large component compared with the other components and their board area.

ASSEMBLY

The wires for connecting the capacitor to the board should be heavy gauge (flexible 2-core mains cable is suitable) and kept as short as possible. The output wires should be of similar thickness. Good soldering is required here, as any resistance in these leads will derate the performance of the unit.

The basic unit is small enough to be incorporated in most layout control panels, or alternatively could be fitted in its own case as seen in the photograph. Here the "uncontrolled" controller output is assumed to be employed and so the circuit of Fig. 2 is seen wired on a short length of tag-strip. The size of the case will largely be dependent on the capacitor used.

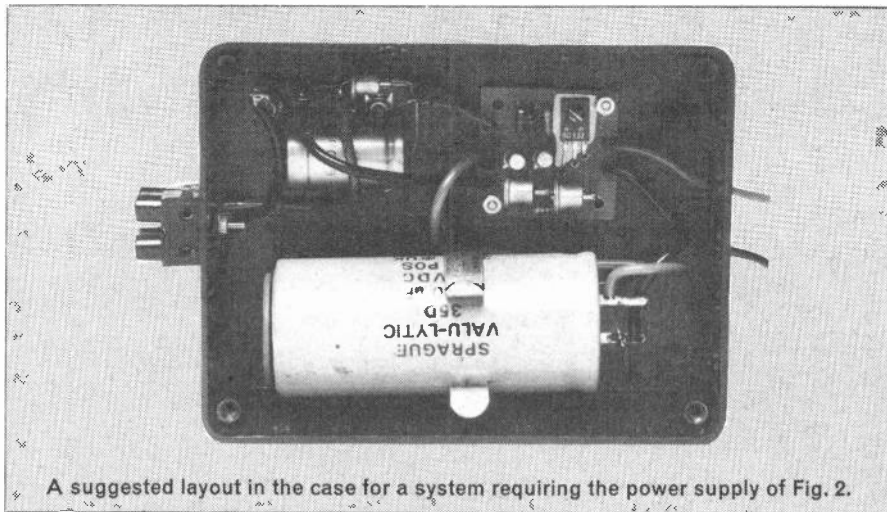

A suggested layout in the case for a system requiring the power supply of Fig. 2.

COMPONENTS

Resistors

- R1 4.7Ω
- R2 3.3kΩ
- All 1/4W carbon ±5%
- R3 1kΩ
- R4 100kΩ

Semiconductors

- D1, D2 1N4002 1A 100V silicon (2 off)
- TR1 BC107 npn silicon
- TR2 BC107 npn silicon
- TR3 BD132 npn silicon

Miscellaneous

- C1 1500μF 20V elect. tag end (see text)
- PL1, 2 4mm banana plugs (1 red, 1 black) (optional)
- Printed circuit board, fibreglass size 35 × 35mm; Terry clip for C1; screw terminal block; heavy duty insulated wiring; 6BA fixings.

See
**Shop
Talk** page 159

COMPONENTS
approximate
cost **£2.50**
excluding
supply and case

D.C. Supply

- | | | | |
|----|-----------------------|--------|--|
| | (Fig. 2) | | (Fig. 3) |
| C1 | 470μF 20V elect. | C1 | 1000μF 20V elect. |
| D1 | 1N4001 1A 50V silicon | D1, D2 | 1N4001 1A 50V silicon |
| | | T1 | mains primary/12-0-12V
0.5A secondary |

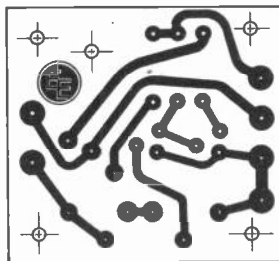

Fig. 4. Full size master of the prototype p.c.b.

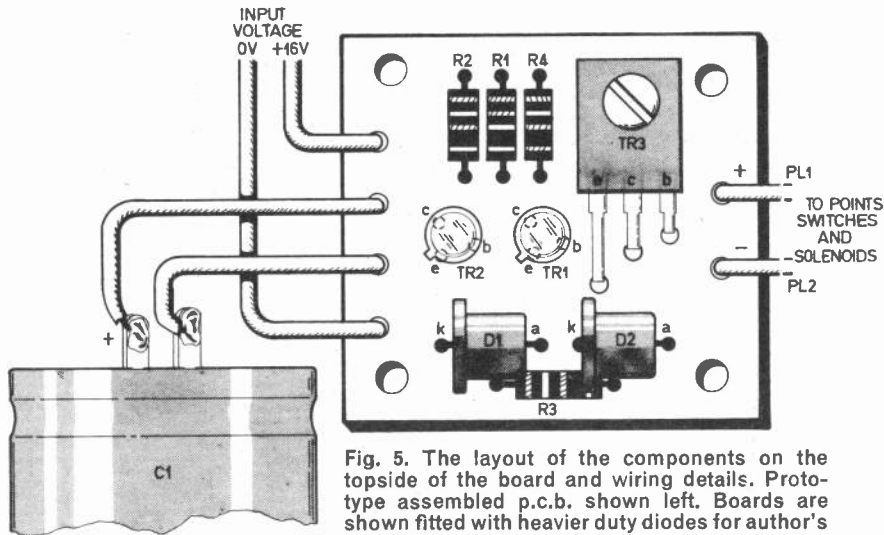
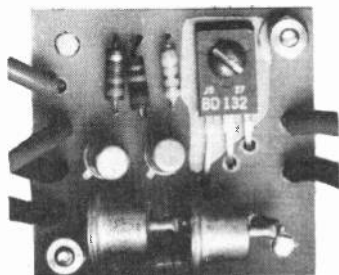

Fig. 5. The layout of the components on the topside of the board and wiring details. Prototype assembled p.c.b. shown left. Boards are shown fitted with heavier duty diodes for author's system.

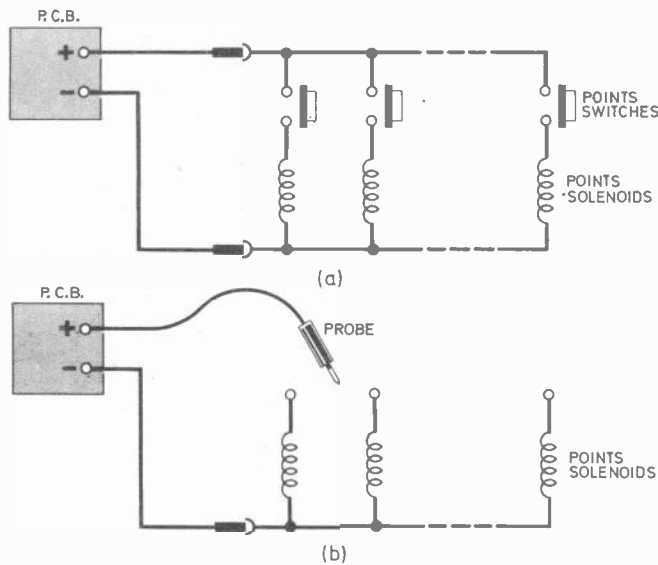

Fig. 6. Showing two methods of using the unit to operate more than one set of points. (a) via a bank of momentary action push button switches and (b) a probe system. The probe contacts or switches could be positioned on a map of the track system for obvious practical purposes.

CONNECTION TO POINTS

The output -ve (PL2) is taken to a common connection of all the point motors, the output +ve (PL1) goes to a probe or a set of push buttons (see Figs. 6a and b).

This unit is ideal for use with diode matrices to operate several points simultaneously. The capacitor value should be increased according to the number of points operated. "Peco" point motors require about 1500 μ F each, "H & M" motors require rather more.

When using push buttons, the button should be pushed firmly to avoid excessive sparking which can drastically reduce switch life.

If a very much larger capacitor is used, it is suggested that D1 and D2 be replaced by types 1N5402.

CONCLUSION

The prototype has been operating well for about two years charging up a 30,000 μ F capacitor which operates up to seven points simultaneously through a diode matrix. Charging time is about 0.5 second which is fast enough to be unnoticeable. ☞



Bright Ideas

"February Fill Dyke". An old country saw! Yes I am aware this is the March issue, but you will all be reading this in February. Anyway, the meaning is fairly clear; it means it rains in February fairly hard.

I expect the Magazines will produce their usual crop of rain warning devices. Last year I adapted one of these to tell me if my storage water tank was overflowing.

As to weather, well I always use a "Donkey Barometer" myself. This consists of a small china donkey with a string tail. It works like this: If the tail is wet, it's raining. If it moves, it's windy. If it is solid, it's freezing. If you can't see it, it's foggy. If it falls out, it's an Earthquake!

I am all for simplicity in design, whether it is mechanical or electronic, but not so the back room boys, bless their hearts. They are not happy unless they can put in a collection of i.c. triacs, flip-flops etc. Take a simple thing like a fuse tester. To my way of thinking all you need is a pair of leads, an l.e.d., a suitable resistor and a

battery. If the l.e.d. lights up the fuse is O.K., if it doesn't, it's dud.

Give it to the Boffins and when they have made it to their liking you finish up with a gadget with flashing red and green lights indicating good or bad, plus an array of buttons and switches. However, we would be lost without them (the technical chaps, not the buttons and switches). Long may they continue to flourish.

Design Register

In a recent article I advised you against going to the expense of taking out a Patent on any idea you had developed. I suggested instead, that you registered the design.

One reader wrote to ask me how you register a design and asked why I didn't write an article on the subject? Well the answer is, this ground has already been well covered by the Patent Office itself.

If you require information on this subject write to: Designs Registry, The Patent Office, 25 Southampton Buildings, London, WC2A 1AY.

They will send you free of charge, a booklet called *Protection of Industrial Designs*, plus an application form.

Hot Stuff

I read with great interest the splendidly illustrated article *Making Printed Circuit Boards* by Mr. Dollin (January issue). If I could add my two bits worth. We put an etching kit on the market a few years ago but before we released it we experimented with Ferric Chloride in various forms. To elaborate, it is available in at least three forms.

The commercial grade which is like pale yellow rock candy, is very hard and very slow to dissolve.

In liquid form sold in bottles at about two pounds (£2) a bottle: very convenient and each bottle will etch about two dozen boards.

Pure Anhydrous Ferric Chloride sold in 1lb bags and double-packed in sealed plastic bags: the pure form and probably the most dangerous, because apart from being toxic and poisonous it produces tremendous heat on contact with water. If you use this, you must always add the crystals to the water, a *fraction* at a time. It is even possible to make the solution too strong, which prevents any etching taking place.

I vividly remember having a pile of this substance in a plastic dish on my desk and without thinking added a dessert spoonful of water. Within seconds the mixture became so hot, it melted the dish and poured on to my desk, completely destroying a pile of unpaid bills.

I was naturally delighted but if you do use this type be *extra* careful and store it in an airtight jar.

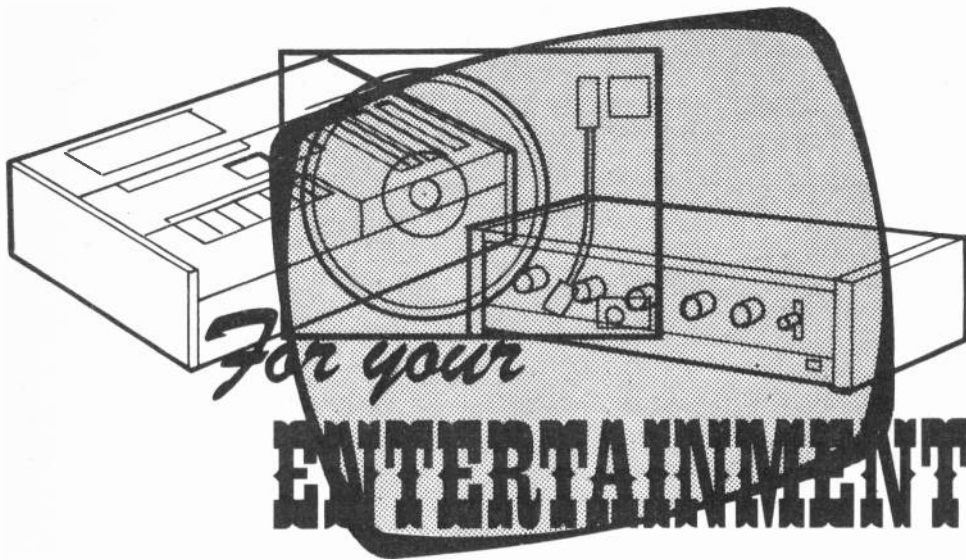

By BARRY FOX

The Spoilers

Here's an opportunity for readers to exercise their brains. Record companies around the world have always clung to the notion that, given enough time and money for research, scientists will eventually come up with an electronic answer to home taping.

The record companies' idea of Heaven is a so-called "spoiler" signal which is recorded on a disc or tape or is broadcast along with the music. This spoiler is inaudible during normal listening but somehow, magically, confuses a tape recorder when an attempt is made to make a copy. Let's look first at what is already well known to be possible but impractical.

The spoiler signal must obviously be too high pitched or too low pitched or of too low a sound level to be heard during normal listening. If a very high pitched signal is recorded on top of the music, then it will be inaudible to most humans and may under certain circumstances beat with a tape recorder bias signal (which is usually at between 80 and 100kHz) to produce a lower pitched and thus audible whistle on tape.

You can make such a system work in a laboratory but not in practice. For example you can't normally transmit ultrasonic signals by radio; the transmitted audio bandwidth is too narrow and the spoiler interferes with the stereo pilot tone. You can't record ultrasonic signals on a Musicassette tape for the simple reason that high speed duplicated Musicassettes seldom offer even a full audio bandwidth, let alone extend to ultrasonics (above 20kHz).

It is possible to cut ultrasonic signals onto an ordinary disc record and this was the basis of at least two of the old quadrasonic "discrete" systems. But cutting ultrasonic signals on to a disc is very difficult because the cutter heads have a nasty habit of burning out under the strain of high energy high frequencies.

When ultrasonic signals are reproduced on domestic systems they can burn out the loudspeaker tweeters and they can also disturb pets and some young people—especially women—whose hearing extends above the normal aural range. More to the point most domestic gramophone pick-ups will not track an ultrasonic signal or it will be filtered off to the connecting leads.

And talking of filtering, it's all too easy to filter off an ultrasonic signal deliberately and so defeat the spoiler system.

Filters

The same proviso extends to low frequency spoilers. The aim here is to saturate the tape with an inaudibly low frequency signal or confuse any automatic gain control by producing a slowly fluctuating low frequency signal.

This can be achieved by cutting a low frequency tone into the disc groove or burying a small permanent magnet under the record label so that as it rotates it produces a pulsed field in a magnetic pick-up. But low frequency signals can easily be filtered off with a simple high pass filter. It's really all only common sense. If a signal is too high or too low to be heard, then it can be filtered out without any audible effect on the music.

If the spoiler signal is in the audible range, e.g. between 30Hz and around 16kHz it will have to be of very low level to remain inaudible. It thus remains impotent as a spoiler and risks being lost in electronic noise created by the reproduction chain. It can also be removed by a noise gate or notch filter without adversely affecting normal reproduction.

The issue of normal reproduction is crucial. It's perfectly possible to issue records which can't easily be copied onto tape.

If a very wide dynamic range of music is recorded, with unlimited peaks, it can be virtually impossible to copy the recording onto a domestic cassette recorder with any degree of fidelity. Quiet passages will recede into ground noise and the unlimited peaks will saturate the tape, causing overload distortion.

However, such records will be unsuitable for most normal domestic use. The low passages will recede into room and system noise and the unlimited peaks will overload the amplifier and loudspeakers causing clipping distortion and bringing complaints from the neighbours.

Distorted Interview

It is sometimes possible to prevent a tape recorder from working properly. Several years ago a BBC reporter went to the Chinese Embassy with a recorder

hidden under his coat. When he returned to the BBC newsroom proudly carrying a candid taped interview he found that although the machine was working perfectly before and after entering the building, the clandestine recording made inside the Embassy was badly distorted.

The mystery was never solved, because you can hardly ask someone to explain how they prevented you making an unauthorised recording. But it's likely that the Embassy rooms are saturated with a heavy magnetic field which in some way upset the bias circuits of the recorder. Alternatively the rooms could have been drenched in very low frequency sound-waves.

Something similar has been proposed to prevent unauthorised concert recording and an optical version is used by some Japanese factories to prevent unauthorised photography. In addition to ordinary illumination there is hidden, invisible, ultraviolet light which fogs every shot taken with a normal camera.

Digital Spoilers

The record industry is staffed by some of the world's best electronic engineers and is wholly dependent on high technology for its daily bread; the gramophone record is arguably the most precision item ever mass produced from plastic. But industry executives seem oblivious of the kind of simple factual breakdown given above. They still talk vaguely about a spoiler signal one day becoming a practical proposition. There is now even talk of digital spoilers.

Naively, record companies believe that digital records will be uncopyable. This may be so; it may prove impractical for the public to copy digital recordings in the digital mode. But because we all hear through ears which operate in analogue fashion, every digital reproduction chain will have to have a digital-to-analogue converter at some stage, probably in the amplifier. It's here, where the signal comes back to analogue, that copying must take place.

Research Guide

Every few months now it seems the record industry talks again of spoilers and the uncritical music press reports such talk enthusiastically. All round the world enthusiastic engineers are unwittingly re-researching the same old spoiler ideas that others already found to be a dead duck.

At the first hint of success they secure some publicity. But when they finally realise that their system is impractical there is no publicity. So someone, somewhere is soon re-researching the whole idea again.

Several years ago the British Phonographic Industry, the trade body which represents the British record companies, commissioned a £10,000 report on spoilers by the Wolfson Unit of Southampton University. Predictably and understandably Wolfson came up with no practical spoiler system. But less understandably the BPI steadfastly refuses to release the report and so steer researchers away from the blind alleys investigated by Wolfson.

It seems that if electronics engineers around the world are to avoid further wasted research they will have to organise their own pool of dead ends.

ALL THE MUSCLE
YOU NEED



BENCH POWER SUPPLY

By A. R. WINSTANLEY

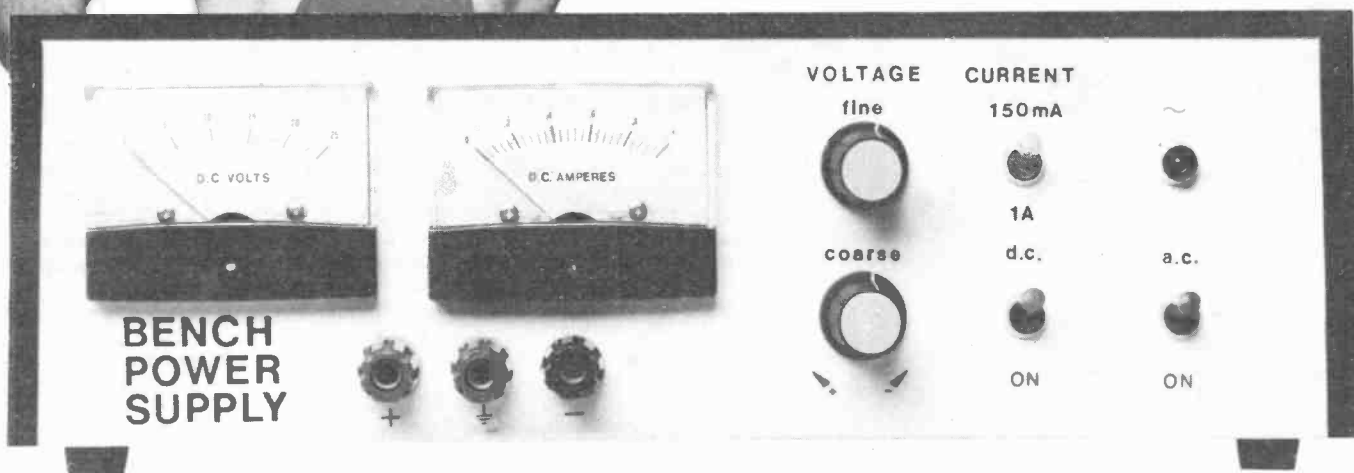

ANY CONSTRUCTOR who intends taking more than a casual interest in electronics will wish to amass a useful selection of test equipment. Certainly a major requirement for any serious enthusiast is a variable power supply.

This would facilitate the operation of projects and circuits under testing from a highly stable mains-powered source, eliminating problems normally associated with the use of dry batteries in such a role.

The Bench Power Supply unit described here should meet the needs of the majority of enthusiasts.

The electronics behind this project is greatly simplified by the utilisation of two modern integrated circuit regulators, type LM317. Construction therefore is quite straightforward and is suitable for the less experienced enthusiast who possibly wishes to build their first item of test gear.

REGULATOR I.C.

The integrated circuits are variable voltage regulator/current limiter i.c.s which are extremely easy to use. They are capable of supplying 1.5

SPECIFICATION

D.C. Range: 1.25 to 25V variable
A.C. Range: six fixed outlets giving
3, 4, 5, 6, 8, 9, 10, 12, 15,
18, 20, 24 or 30V.
Current limit: 1A or 150mA
switched.
Regulation: $\pm 3\%$ on prototype.
Ripple: 4mV peak to peak at full
load.

amps over a voltage range of 1.2 to 37 volts. Within the device there is all the usual overload protection which is only available in i.c.s, including in-built current limiting and thermal overload shutdown.

The device is shown in Fig. 1 in its basic voltage regulator mode. It can be seen that there are only three terminals, namely input, output and "adjustment".

A 240 ohm resistor is usually placed between the output and adjustment pins, and a highly stable 1.2V reference voltage is present across this resistor. The output voltage is deter-

mined by the resistance of R_x and the value of this component is given by:

$$R_x = \frac{(V_o \times R_1)}{1.2} - R_1 \text{ ohms}$$

or with R_1 equal to 240 ohms,

$$R_x = 200V_o - 240 \text{ ohms}$$

In practice it is wise to substitute a preset for R_x so that exact trimming of the output voltage can be achieved.

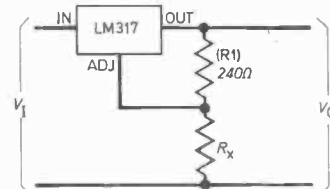

Fig. 1. Voltage regulator circuit.



Fig. 2. Current regulator circuit.

Virtually the only way to destroy the device is to exceed the maximum input-output differential voltage of 40V. Power dissipation however is internally limited by the protection circuitry. Otherwise the i.c. is nearly indestructible.

The LM317 already has a built-in current limiting circuit. This limit level depends mainly on the temperature of the chip and also the input-output differential voltage. A typical value for the LM317K (TO-3 package) is 1.5 to 2.2 amps.

The i.c. can also however be utilised as a precision current-limiting circuit, see Fig. 2. Here the precision reference voltage is placed across a series power resistor, and by altering the value of R , various current-limit values can be obtained. If I_L is the desired limit level, the value of R will equal $1.2/I_L$.

Due consideration must be paid to the power dissipated in this resistor (equal to $1.44/R$). Also, R must not be less than 0.8 ohms or in excess of 120 ohms. Note that the current-limit level does not vary in a linear fashion, and the use of a power potentiometer does not give very good results.

Finally, the i.c. is generally available in three packages. The TO-3 version should be used in this design.

CIRCUIT DESCRIPTION

A block diagram of the Bench Power Supply can be seen in Fig. 3 and the complete circuit diagram appears in Fig. 4.

Mains voltage is applied to the primary of T1, a multi-tapped transformer, via the mains on-off switch S3. The neon indicator LP1 illuminates when the mains is switched on and RV1 is a mains transient suppressor. This is optional and can be omitted if required.

The secondary of T1 has six tapings: 0, 12, 15, 20, 24 and 30V a.c. These are extended to the back panel of the cabinet using SK1-6 as connectors to exterior equipment.

By connecting between different sockets, it is possible to extract all of the fixed a.c. voltages mentioned in the specification. This a.c. facility has proved to be quite useful, but if readers do not consider it necessary to their requirements, then T1 can be substituted by a transformer having simply a 30V a.c. one amp secondary.

The 30V a.c. tapping also provides the main supply rail for the power supply unit proper. This voltage is rectified by D1-4 and smoothed by C4 to give a rough unregulated d.c. voltage of 42V no load, 35V full load.

Transistors TR1 and TR2 form an emitter follower pair of reasonably high gain. Diodes D5 and D6 are Zener diodes which clamp the base of TR1 to about 32V (plus or minus the tolerance on the Zener diodes) and R1

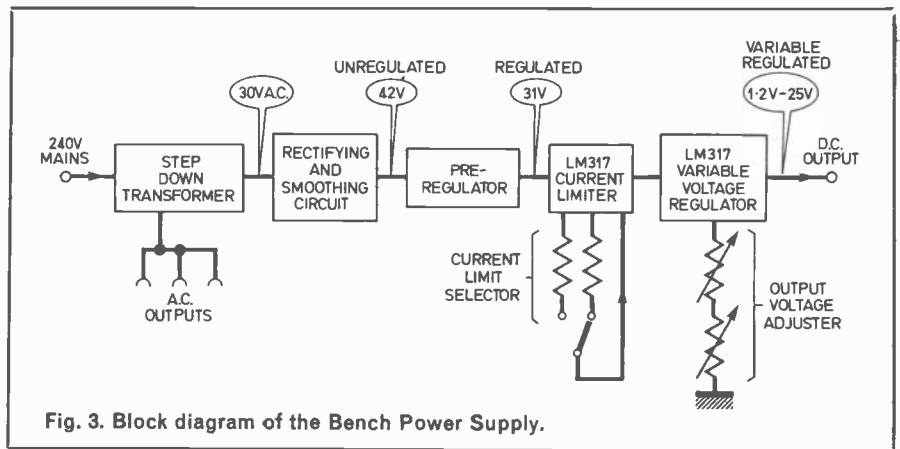

Fig. 3. Block diagram of the Bench Power Supply.

limits the current through the Zeners.

Now, the emitter of TR1 will be 0.6V less than its base, that is about 31.4V. Similarly the emitter of TR2 is 0.6V less than its base, roughly 31V. Capacitor C6 provides local smoothing and reduces any noise across the two Zener diodes.

PRE-REGULATOR

Initial prototypes did not employ this two-transistor circuit but the effects of using a "pre-regulator" are several. For example, nearly all of the ripple present on the supply line is filtered out by the Zener diodes and suppressed at the emitter of TR2. The supply rail is pre-regulated to 31V, no matter what the emitter current of TR2, and after allowing for the toler-

ances of the Zeners a very stable rail is achieved. The smoothing effect of C6 is amplified by the combined effect of the two transistors, its effect being equivalent to using a large smoothing capacitor on the supply line, and, most importantly the maximum input-output differential voltage of the i.c.s will not be exceeded.

The pre-stabilised 31V rail is passed to IC1 which is connected as a current-limiter circuit. The in-built two-amp current-limit level of the i.c.s, was regarded as being too high for Bench Power Supply use and a level of one amp was thought to be satisfactory. Furthermore a glance through some catalogues showed that 2 amp transformers can be very expensive!

The resistor determining the current-limit value is selected by S1.

Fig. 4. Complete circuit diagram of the Bench Power Supply.

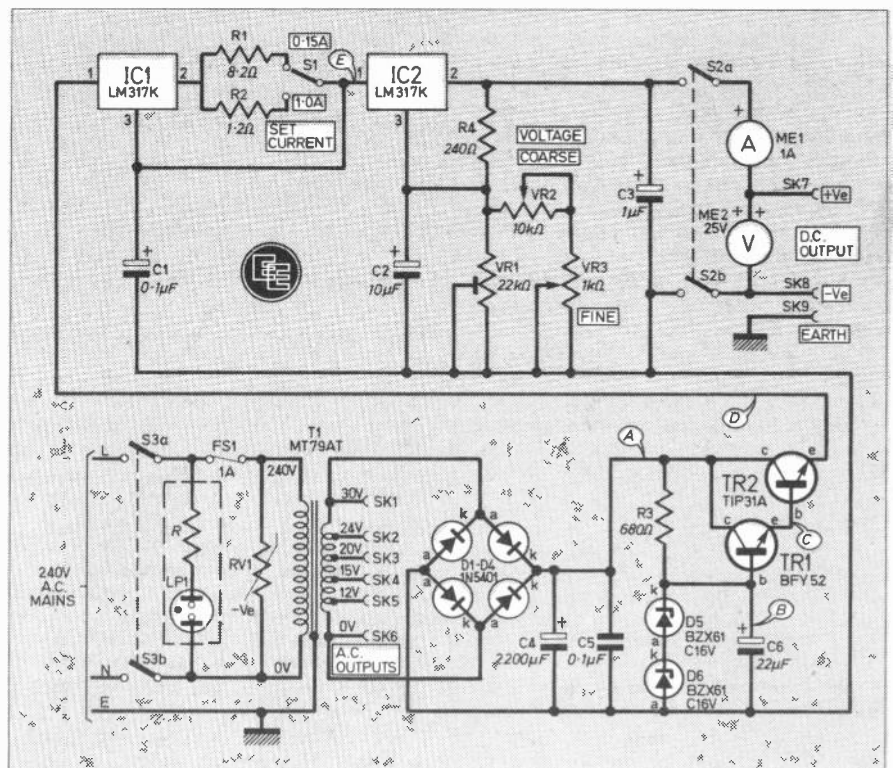

Resistor R1 when selected, limits the current to about 150mA by virtue of IC1. When the switch is in this position, should a fault occur in the load under test, the unit will limit the current through the load to a safe value (that is 150mA) thereby protecting most of the components in the test circuit. When R2 is selected by S2, then the maximum current available is one amp.

FINAL STAGE

After the current limiter comes the regulator itself, IC2 and associated circuitry. Resistor R4 is the standard 240 ohm reference component and VR2 and VR3 are panel-mounted potentiometers which provide coarse and fine adjustment of the output voltage.

The final control has most effect at the lower end of the output range, and as 25V is approached, it begins to have a decreasing effect.

The maximum output voltage is controlled by VR1. This is the voltage that is available when the two potentiometers are set for a full deflection of the voltmeter (ME2). Preset VR1 enables an exact 25V maximum output to be trimmed, so that the voltmeter is not overdriven.

Capacitors C1, C2 and C3 are additional components which decouple the

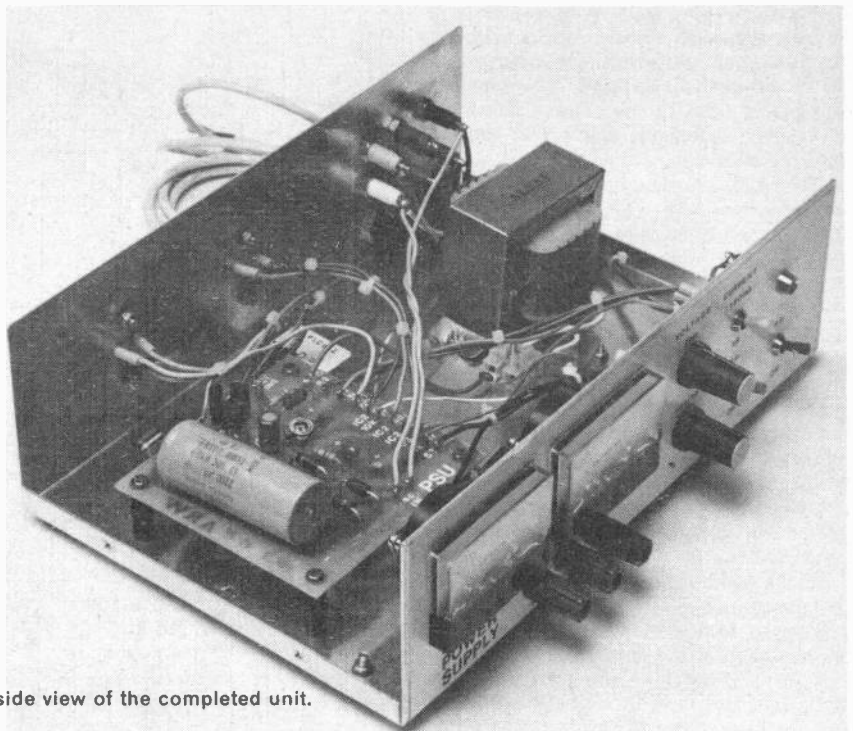

Inside view of the completed unit.

supply rails and also increase the ripple rejection of IC2 to about 80dB.

Direct current switching is provided by S2. This enables the user to immediately isolate the load undergoing

testing and is considerably quicker than using S3 as the on-off switch, because C4 and C3 would tend to retain their charge for many seconds after the unit had been switched "off". Switch S2 compensates for this effect.

Finally, the output current and voltage are together monitored by ME1 and ME2 respectively. The output is connected to SK7 (positive) and SK8 (0V), which are two 4mm binding posts, and also SK9 is a separate earth terminal which enables either the positive or negative line to be earthed if required.

COMPONENTS



Resistors

R1	8.2Ω	R3	680Ω
R2	1.2Ω 3W wire-wound	R4	240Ω

All ½W carbon ± 5% except R2

Potentiometers

VR1	22kΩ lin. miniature horizontal preset
VR2	10kΩ lin. carbon
VR3	1kΩ lin. carbon

Capacitors

C1	0.1μF 35V tantalum bead	C4	2200μF 63V elect.
C2	10μF 35V tantalum bead	C5	0.1μF polyester C280
C3	1μF 35V tantalum bead	C6	22μF 50V elect. p.c.b. mounting

Semiconductors

IC1, 2	LM317K positive variable voltage regulator, TO-3 can (2 off).
TR1	BFY52 npn silicon
TR2	TIP31A npn silicon
DI-D4	1N5401 100V, 3A silicon rectifier diode (4 off)
D5, 6	BZX61C16V 1.3W, 16V Zener diode (2 off)

Miscellaneous

S1	s.p.d.t. miniature toggle
S2, 3	d.p.d.t. miniature toggle (2 off)
T1	mains primary/12, 15, 20, 24, 30V secondary at 1A, Douglas type MT79AT
RV1	mains transient suppressor (see text)
ME1	1A f.s.d. moving coil meter
ME2	25V d.c. f.s.d. moving coil meter
SK1-SK6	4mm sockets, assorted colours (6 off)
SK7-SK9	4mm screw terminals (1 red, 1 black and 1 green)
FS1	20mm 1A fuse and panel mounting holder
LP1	mains panel neon indicator with integral resistor

Printed circuit board, 100 × 100mm; metal case, 280 × 190 × 90mm, Norman type WB5; finned TO-3 heatsink (2 off); finned TO-5 type heatsink; TO-3 type mounting kit (2 off); TO-66 type mounting kit; two knobs; p.c.b. mounting pillars; 3A cable for interior interwiring; 2-way connector block; veropins; nuts and bolts for heatsink and p.c.b. mounting; cabinet feet (4 off).

COMPONENTS
approximate
cost **£48**
complete

See
**Shop
Talk**
page 159

CONSTRUCTION
starts here

PRINTED CIRCUIT BOARD

With the exception of TR2, IC1 and IC2, the circuit is built onto a glass-fibre printed circuit board measuring 100 × 100mm, see Fig. 5.

In designing the p.c.b., due consideration has been given to the current-carrying capabilities of the copper track. Also an adequate air space must be left around most of the components to enable them to dissipate heat efficiently.

Commence construction of the p.c.b. by soldering in the four rectifiers.

These have thick leads which must not be bent close to the rectifier bodies. Furthermore do not mount the rectifiers close to the board but stand them off slightly.

Proceed with the soldering of the Zener diodes. Mount these vertically, observing correct polarity, and again take care when bending the leads.

Transistor TR1 is fitted with a push-on TO-5 heatsink, but this heatsink is not entirely necessary and it has been suggested merely as a precaution. If used, the radiator must be fitted to the transistor can before the transistor is soldered into place.

POWER RESISTOR

The power resistor, R2, is soldered proud of the p.c.b. surface so that it receives adequate ventilation. During maximum output conditions it will get quite warm in operation, assuming of course that the 1A range is in use.

Everything else on the p.c.b. is straightforward. However make quite certain that the electrolytic and tantalum bead capacitors are soldered in correctly.

Finally, Veropins can be used for connecting flying leads to the p.c.b., and although they were not used on the prototype, in retrospect it would be most wise to utilise them. Check the p.c.b. most carefully and then proceed to the casework.

CASE

The case eventually selected for the finalised model was the "Norman" cabinet, type WB5. This measured 280 x 190 x 90mm and comprised a p.v.c.-covered steel cover and folded aluminium chassis.

It is very important that an aluminium chassis is used. If a steel chassis is used, then this can seriously affect the accuracy of the panel-mounting voltmeter. Even the relatively expensive Japanese type used in the prototype was found to be misreading when used in a steel chassis on an earlier model.

Furthermore there is quite extensive metalworking to be performed, and an aluminium chassis will make this very much easier.

General points regarding metalworking are given below, but no details regarding dimensions are given. This will of course mainly depend on the case employed by the individual and also the components and parts used in each instance.

FRONT PANEL

This needs to be prepared to take the following: voltmeter and ammeter, three toggle switches, two potentiometers, pilot lamp and three output terminals.

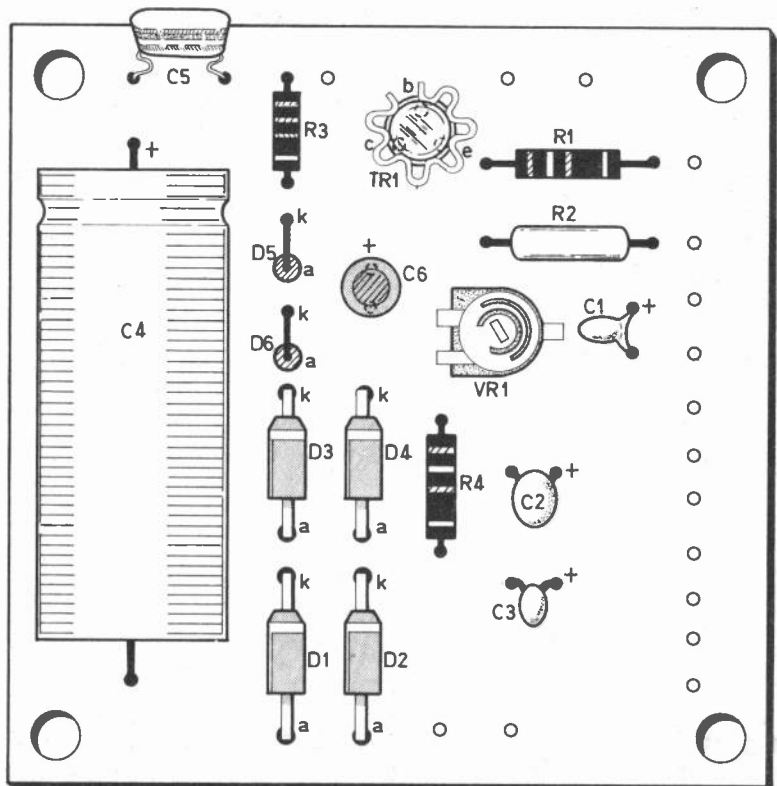
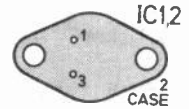
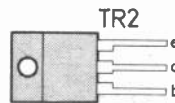
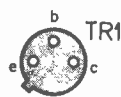
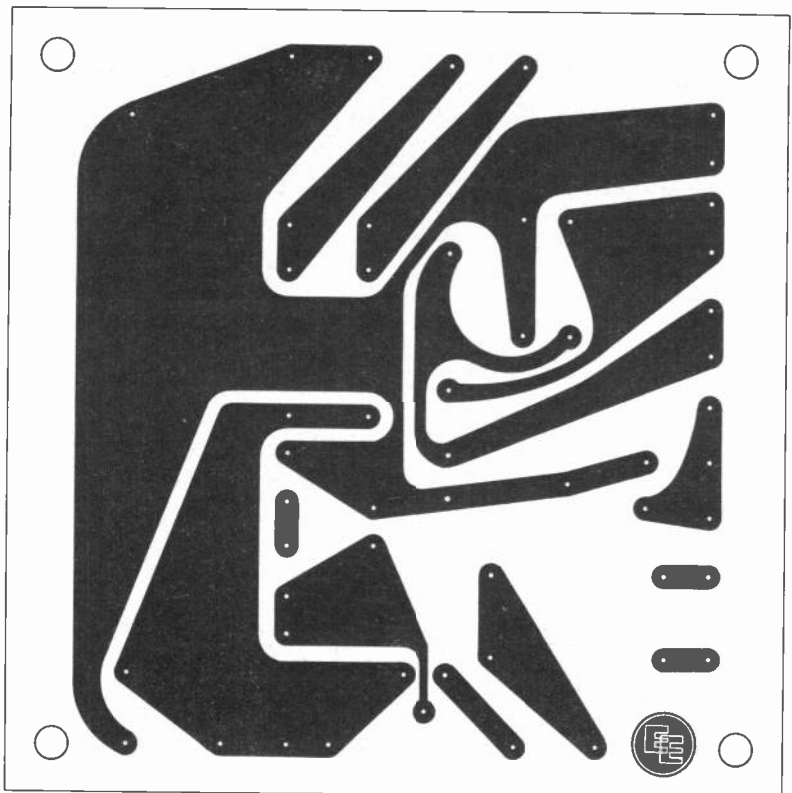
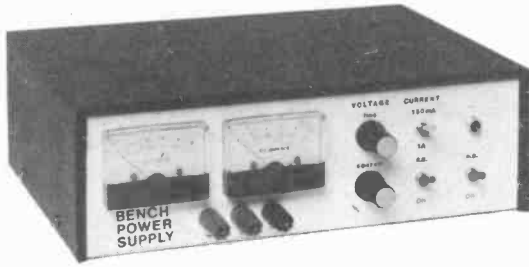

Fig. 5. Foil pattern for the p.c.b. shown actual size. Below this is the component layout and transistor and i.c. outlines. Note that the rectifier diodes D1 to D4 should be mounted clear of the board as should R2.



BENCH POWER SUPPLY

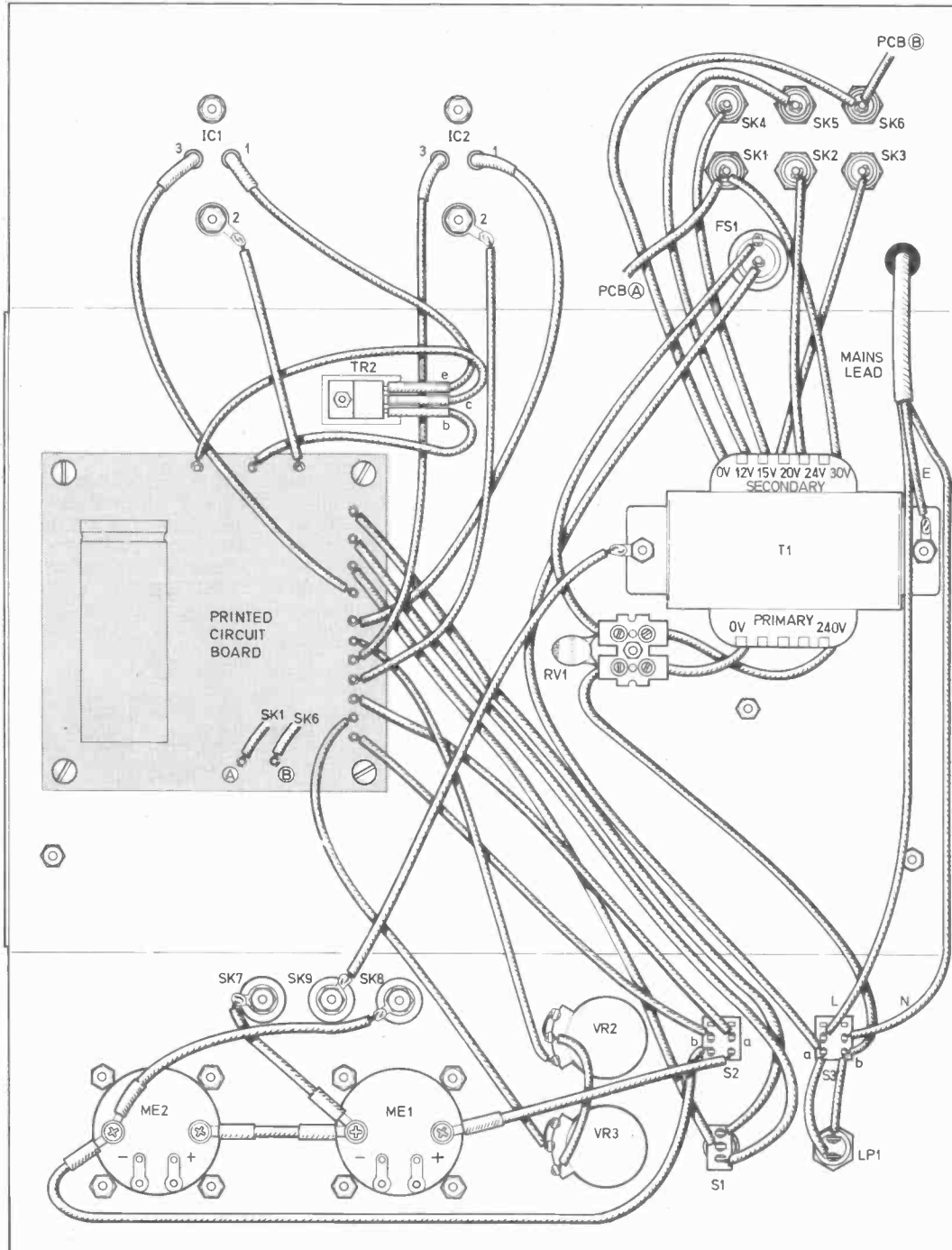
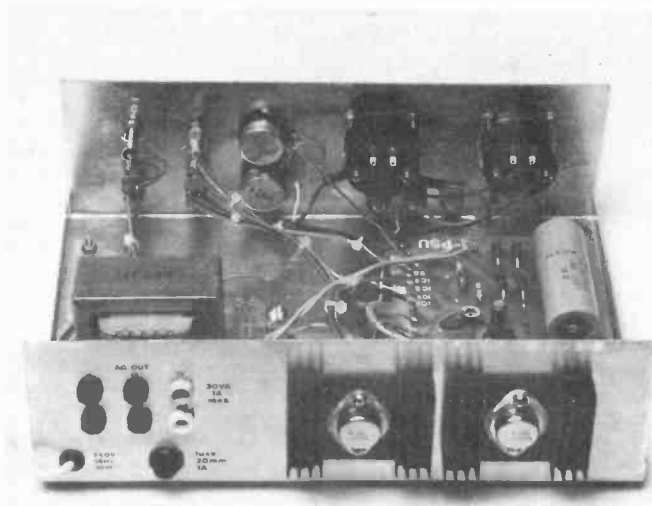
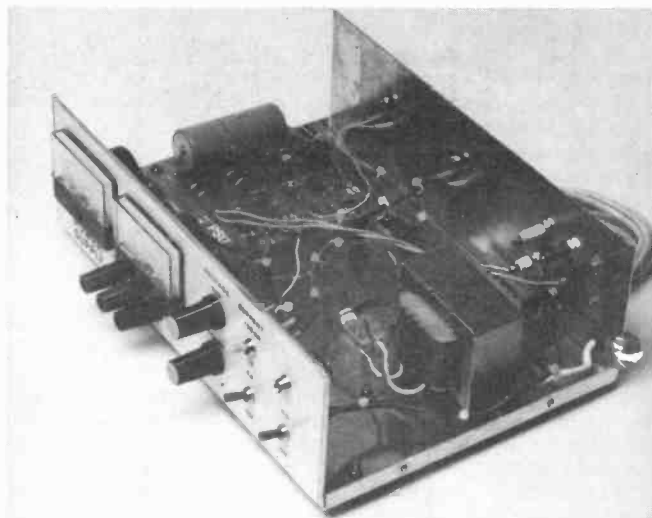

Fig. 6. Wiring diagram of the complete unit. The front and rear panels have been folded down for clarity. The regulator i.c.s, IC1 and IC2, must be mounted on heatsinks using insulating mica washers and plastic bushes.



View from rear showing heatsinks for IC1 and IC2 and rear of front panel.



View from side. Note the output sockets for the a.c. voltage tapplings.

The large cutouts required for the meters can be punched by using a tank cutter or hole saw. Both devices must be fitted to drills running at a slow speed. Alternatively, a ring of small holes could be drilled, the centre punched out and then the edges filed until smooth, but this can be hard work!

The three terminals require a "key-hole" shaped cutout to take the insulating bushes.

CHASSIS

The bottom of the case carries the p.c.b. mounting pillars (four off), the mains transformer, two-way terminal block and also the power transistor, TR2. The transistor can be fixed down with a 6BA bolt and so requires a 6BA clearance hole in the chassis.

The positioning of the transformer is quite important. It should be placed in one corner, away from the output terminals. If it is too close to the output sockets, then there is the possibility that mains hum could be induced on the output. Also it has been known for the magnetic field of the transformer to have an adverse effect on the voltmeter readings.

REAR PANEL

The two TO-3 i.c.s are mounted, with finned heatsinks, on the rear panel next to each other. Each i.c. will require a mica washer for mounting, and this can be used as a marking-out guide prior to drilling. The devices are mounted using two 4BA bolts each.

Note that the holes which are drilled to take the integrated circuits must be filed quite smooth. There must be no burrs on the edges.

A small hole is needed to take the mains cable inlet. This hole must have a rubber grommet and cable clamp

fitted, in order to avoid fracturing or wearing away of the cable insulation on the metal edges.

Six holes may be required for the 4mm sockets if a.c. outlets are incorporated. One final cutout of appropriate diameter carries the chassis-mounting fuseholder.

TOP COVER

If not already ventilated, then several holes should be made, using preferably a metal punch, in order to allow a throughflow of air.

With drilling completed, all necessary lettering should be carried out

at this stage. Use proprietary rub-down lettering and then give the lettered panels several light coats of clear lacquer.

The final part of construction is the interwiring. It is best to start at the mains input and work logically through the circuit. The complete interwiring diagram is shown in Fig. 6.

The earth input is soldered to a tinned tag which is placed under one of the transformer mounting bolts. The mains transient suppressor, if fitted, is connected to the two-way terminal block as shown.

Throughout ensure that interconnecting wire of adequate electrical specification is used. Low tension

Close up view of circuit board. The voltage regulators mounted on finned heatsinks can also be seen and TR2 is shown mounted on the bottom of the case. This must also be insulated from the metal case by using a mica washer and insulating bush. A small amount of silicon grease is smeared between these three items and the metal to aid heat transfer and sleeving is placed over the soldered connections to avoid short circuits.

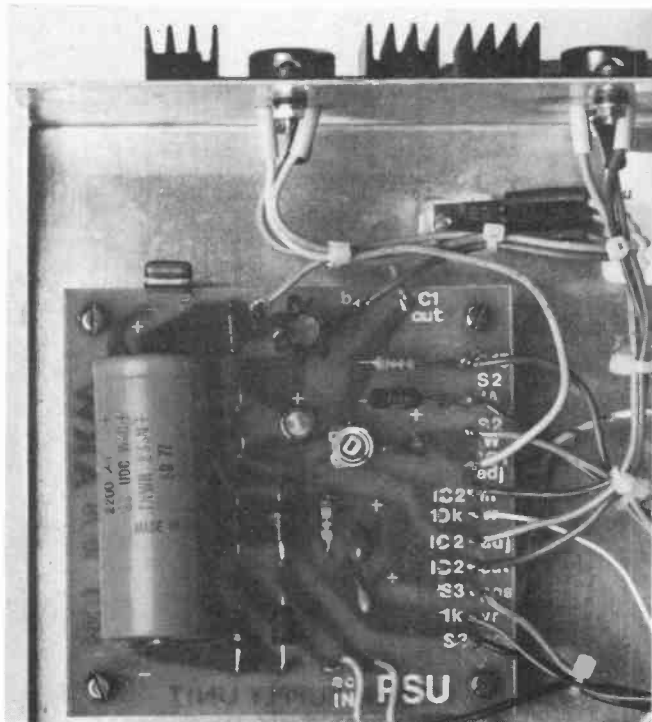

wires should be rated at least one amp, preferably two to three amps.

Wiring should be completed in accordance with Fig. 6 and then the wires can be arranged into small looms using nylon tying-clips. Note that all looms should be as short as possible and also they should be kept away from the mains transformer and mains interwiring.

Finish off the cabinet with four self-adhesive feet on the bottom of the chassis.

FINAL CHECKS

When construction is complete, check all wiring most carefully. Check the p.c.b. once more and also re-check the connections to the power transistor and two i.c.s.

A resistance check between the earth pin of the mains plug and metal chassis should indicate a short circuit (that is, a good earth connection). Similarly check both the resistance between the tab of TR2 and chassis,

Table 1: Test readings for the Bench P.S.U

Location	No load voltage	Full load (25V at 1A)
A	42V	35V
B	33V	32.5V
C	32.4V	31.9V
D	31.8V	31.3V
E	30V	27.5V
F	1.2V	1.2V

and also the cases of the two i.c.s and the chassis.

In both instances the resistances should be infinite, indicating that all three devices are correctly isolated from the chassis. Do not proceed until this aspect is finalised.

If everything appears in order, set VR1 to minimum resistance, and rotate VR2 and VR3 fully clockwise to give maximum voltage output. Switch both S2 and S3 to on. The voltmeter should read approximately 1.2V. Now adjust VR1 to give a maximum reading on the voltmeter of 25V.

Check that rotation of the two potentiometers now give both fine and coarse adjustment of the output.

CURRENT LIMITING

Testing the current-limiting circuit depends on what equipment is available, but could consist of placing dummy wirewound resistors across the output and checking that the current-limit switch is performing correctly. If the one-amp current limit circuit appears to operate prematurely, then this could be due to the tolerance on R2.

The effect is that the power supply limits the maximum output current to less than one amp. The remedy is to replace R2 with a similar resistor until a one-amp output is achieved.

Table 1 gives voltage readings taken on the prototype, and can be used if any faults appear to exist in readers' prototypes. Readings for both no-load and full-load conditions are given. □

DON'T LET THIS HAPPEN...



PLACE A
REGULAR
ORDER
WITH YOUR
NEWSAGENT
FOR

Everyday
ELECTRONICS
EVERY MONTH

SQUARE one

FOR BEGINNERS

THE CIRCUIT DIAGRAM

ALL electronic circuits, from the simplest to the highly complex, use the same standard or conventional symbols to represent components and to indicate certain kinds of wiring and interconnections.

There is international agreement on most of these symbols, but some alternatives exist. For example the long established zig-zag for a resistor is nowadays often replaced by a non-descript rectangle.

EVERYDAY ELECTRONICS continues to use the zig-zag. It is quicker to draw and represents graphically precisely just what a resistor does: it introduces an obstacle to the easy flow of current. All ordinary straight lines on diagrams joining two or more components represent wire (or some other connecting medium) of zero or very low resistance.

LEFT TO RIGHT

Circuit diagrams are intended to be read "left to right". This is borne out by the numbering of components.

Fig. 1. Circuit diagram for a Signal Tracer (from February issue of EE). This is a good example to study, the design is simple and it uses commonplace components. These are resistors (including a variable potentiometer), capacitors (polarised, electrolytic and non-polarised types), two switches, a loudspeaker, and four semiconductor devices: a diode and three transistors. The diagram is drawn in the conventional manner and it will be seen that it has "two dimensions":

(1.) The Signal Path: The signal (high frequency a.c.) proceeds from left to right across the diagram.

(2.) The D.C. Power Supply Circuits: Power to produce the required amplification is supplied by a 9V dry battery. This supplies direct current to each of the three transistors, positive side to the collectors. The supply circuits are completed via the emitters back to the negative side of the battery.

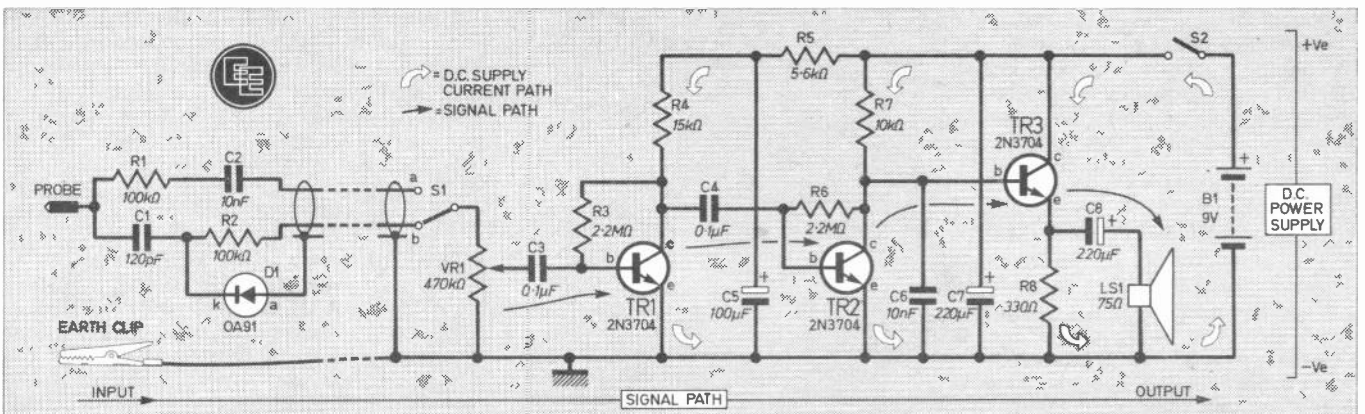

The input signal is applied at the left, and the signal progresses through the circuit, being modified or otherwise affected as required, according to the design. Sometimes two or more signals are involved and they may interact upon one another in the process of passing through the circuit.

The final required result appears at the right hand of the diagram as the "output". This output may be directly coupled to say a loudspeaker, or it may terminate at output sockets or terminals on the diagram.

TOP TO BOTTOM

There is however another dimension to a circuit diagram. What has just been described is the *signal path* of a circuit diagram. In addition there must be a source of electric power to operate the circuit. In its simplest form this can be a dry battery. The battery is usually drawn at the far right of the diagram and its positive side is connected to the top horizontal "h.t." or "+Ve" line. The negative side goes to the bottom horizontal line, which is sometimes earthed.

From this it will be gathered that electronic circuits are drawn with the highest positive voltage points at the top of the diagram.

Any component or combination of components connected between the

upper and lower horizontal lines will have developed across it the full voltage of the battery. In the case of two or more components in series, the total voltage is distributed across the individual components in proportion to their ohmic values. All points connected to the bottom "0V" or "earth" line are at this same zero potential or voltage.

A PRACTICAL EXAMPLE

A circuit diagram of a Signal Tracer (February issue) is reproduced here in Fig. 1 as an example. Study this carefully, noting particularly the symbols used to represent different components, and the "circuit references" given to those components.

POLARISED CAPACITORS

Capacitors C5, C7 and C8 are electrolytic capacitors and are "polarised". The symbol shows one of the plates in outline and this is further identified by a "+" sign, whilst the other plate is blacked in. On the actual component one of the tags, leads or terminals will be marked "+" (positive). This side of an electrolytic capacitor must always be connected in accordance with the circuit diagram.

Other (non-polarised) capacitors are represented by two solid black plates, and may be connected into the circuit either way round—like resistors.

I.C.S

EXPLAINED PART 6

by O.N. BISHOP



LAST MONTH we discussed several types of logic gate, the basic units from which the greater part of all other logic circuits are constructed. Gates have the simplest type of behaviour in that, if we know what their input is now, we can say exactly what their output should be.

The circuits described in this month's article have an additional feature: their output now may depend not only on what their inputs are now but also on what they were in the past. These are sequential circuits that go through a series of states one after another.

There are several kinds of sequential circuit. Those we are dealing with here all have two distinct states. It is possible for the circuit to change or be forced to change from one state to another. We can think of the circuits as changing or vibrating from one state to the other, over and over again—hence their name, *multivibrators*.

BISTABLE MULTIVIBRATORS

The simplest of all multivibrator circuits illustrates the points mentioned above. It can be constructed from just two logic gates. Fig. 6.1 shows two NAND gates connected to form a *bistable* (to save space we will leave out that long word "multivibrator" from now on).

The circuit has two inputs, Set (S) and Reset (R). It has two outputs, Q and \bar{Q} , of which \bar{Q} is normally the inverse of Q . Fig. 6.2 shows how the circuit works. Normally, both inputs are high (or 1), as at (a). The circuit is stable in this state, as you can check by comparing the inputs and output of each gate with the truth table.

What happens if the Set input is made low? In (b) we see one possible result: Q goes high, so both Q and \bar{Q} are high for an instant, but the circuit

immediately goes on to stage (c). This is its other stable state. It remains in this state whether S stays low as in (c) or reverts to high as in (d). The name *bistable* derives from the *two* stable states.

What happens now if S is made low as in (e)? The answer to that question is *nothing!* We can see how the response of the circuit depends on what the inputs were in the past.

Once the circuit has been set, by making S low, further setting has no effect. To reset the circuit to its original state, we must make input R low. We can think of the circuit as having a memory—it remembers which of its inputs was the last one to be made low. This bistable circuit was used last month on the *Who-was-first* monitor. Being a sequential circuit, it told us in which order the two buttons had been pressed.

Building bistables from pairs of gates is easy, but bistables are required so frequently that they are available ready-made in integrated form. In these articles we are considering only CMOS i.c.s, though similar devices are available in TTL.

In CMOS, the 4044 contains four identical and independent circuits each consisting of cross-coupled NAND gates as in the circuit of Fig. 6.1 and performs the same function. They have the additional facility of tri-state outputs, the nature of which

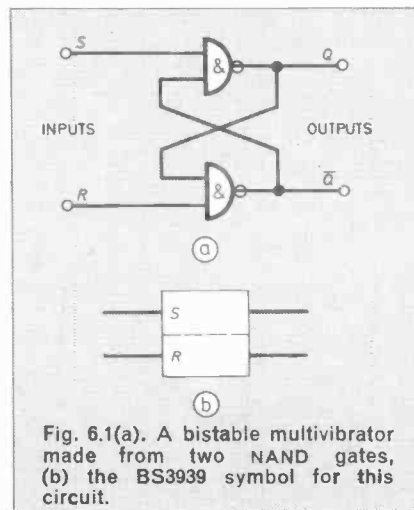

Fig. 6.1(a). A bistable multivibrator made from two NAND gates, (b) the BS3939 symbol for this circuit.

was described in last month's article. Such i.c.s are useful in holding (or "memorising") a four-bit binary number, for example, and transferring it to a data bus when the outputs are enabled.

This circuit is often called a *flip-flop*, for it *flips* to one state when set and then *flops* back again when reset. The 4043 i.c. is similar to the 4044, but its flip-flops are built from NOR gates. Their S and R inputs are normally held low and made high to set or reset the circuit.

D-TYPE FLIP-FLOPS

If we can isolate a flip-flop from its inputs at will, we can "freeze" the output at any instant and hold it unchanged for as long as we wish. This is the function of the D-type flip-flop, or *latch*.

The "D" stands for Data, indicating that we consider the input to be data (1 or 0) which may be changing rapidly, and we wish to be able to hold it or latch it for long enough to look at it, or to do something else with it. D-type flip-flops can be based on simple NAND or NOR gates, as is the rule with TTL, but CMOS circuits generally make use of a different principle.

In Fig. 6.3 a latch is built from four NOR gates and two transmission gates. We will consider the latter in more detail in Part 8 of this series. For the moment, think of the transmission gate (TG) as a switch that can be turned on or off according to the state of a control voltage.

Here the control voltage is applied to the *clock* input. When the clock input is high, TG1 is closed and TG2 is open, as shown in Fig. 6.3. In this state, output Q is the same as input D, since it is D, twice inverted. Output \bar{Q} is D inverted three times, so is the invert of D. Thus the circuit of Fig. 6.3 has a similar action to the more conventional flip-flop of Fig. 6.4, though it operates in a rather different way.

The effect (though not the action) of the clock input is the same in both. When Clock is low, the D input

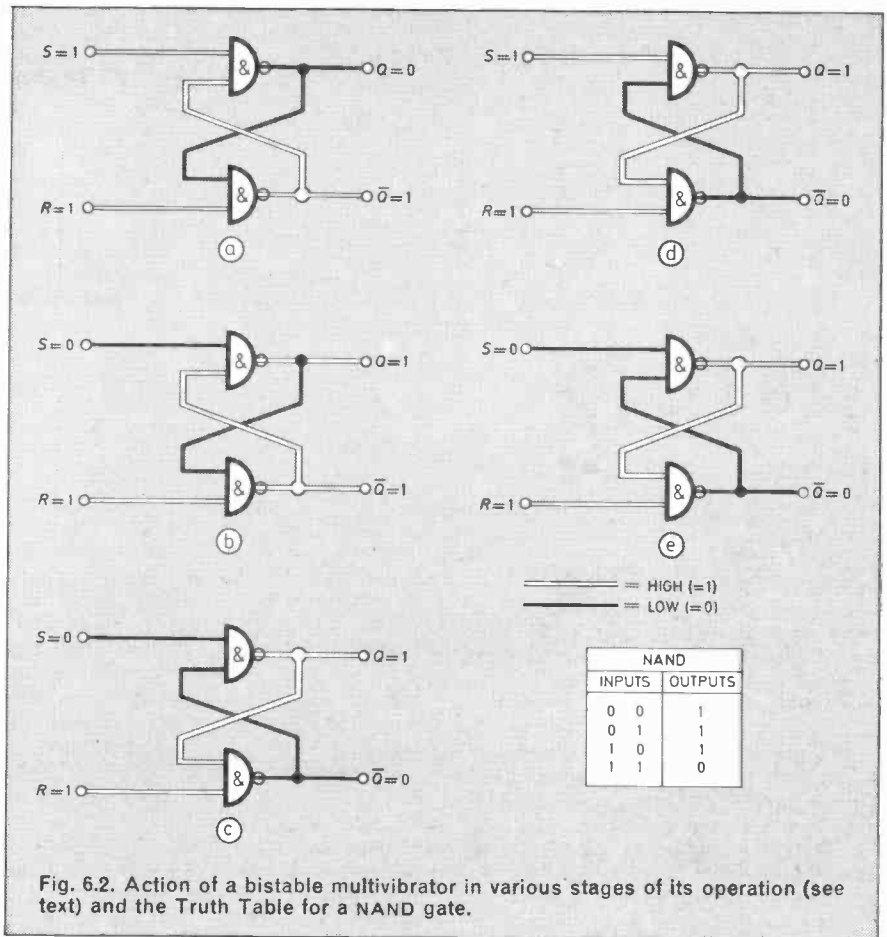

Fig. 6.2. Action of a bistable multivibrator in various stages of its operation (see text) and the Truth Table for a NAND gate.

becomes isolated from the output side of the circuit. In the CMOS circuit (Fig. 6.3) TG1 opens and TG2 closes. The outputs remain latched in the state they were at the instant the clock input was made low. In Fig. 6.4, the low clock input to each NAND gate, ensures that their output remains high whatever the state of D. This being so, the flip-flop can no longer be made to change state.

The 4042 i.c. contains four D-type latches of the kind shown in Fig. 6.3. It also has a "polarity" input which causes the signal at the clock input to be inverted before it goes to the transmission gates. If "polarity" is 0

(low), latching occurs when the clock input is made high. If it is 1 (high) latching occurs when the clock input is made low.

Another i.c., the 4099, has eight latches with Q outputs available, Fig. 6.5. Data input is sent to a selected one of the latches by setting the three address inputs to form a binary number. For example, with A_0 high and A_2 low we get the number "101" (decimal 5) so latch 5 takes whatever value is on line D at that time.

D-type latches are used in many data-manipulating circuits, especially in shift registers (see later).

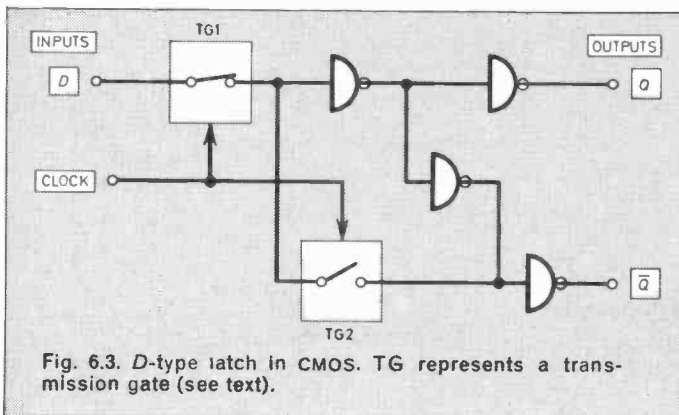

Fig. 6.3. D-type latch in CMOS. TG represents a transmission gate (see text).

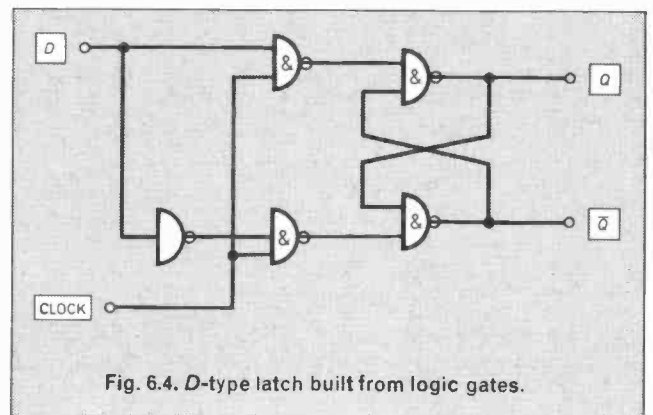

Fig. 6.4. D-type latch built from logic gates.

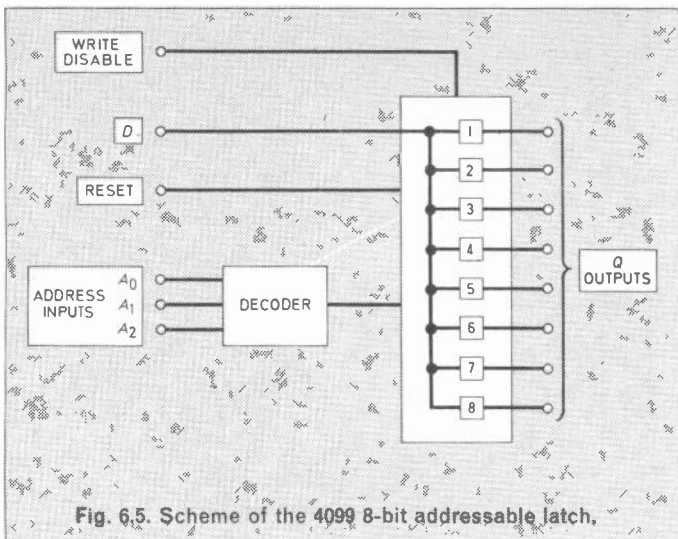

Fig. 6.5. Scheme of the 4099 8-bit addressable latch.

EDGE-TRIGGERED CIRCUITS

A latch such as that described above has many uses but some disadvantages. The chief of these is that its latching action is controlled by the level of its clock input. This may be no problem if we have only one latch in use but, if we have several operating at high speed, it can lead to complications. The clocking gates do not operate at exactly the same rate and this means that some latches and parts of latches become latched or unlatched before others.

When latches are being used to send data on to other latches, the situation becomes even more alarming. The solution is to use pairs of flip-flops so arranged that only one of each pair can change at one time, and both flip-flops are under the control of the same clock. This puts the system under much tighter control.

A D-type latch that has this arrangement is shown in Fig. 6.6. The two flip-flops are known as the master and slave. With clock input low, TG3 is open and the slave is isolated from the master. The slave then acts as an ordinary cross-coupled flip-flop, just like that in Fig.

6.1 except that it is built from NOR gates. The set and reset inputs are normally held low; a high pulse on one or the other input will make the slave change state, independently of the state of the clock. The master flip-flop receives data D via TG1 and its output is the inverse \bar{D} . When the clock starts to go high the transmission gates are switched over. As soon as the change begins, D can no longer have any effect on the master. With TG2 closed, the master becomes an ordinary cross-coupled flip-flop with its output in state \bar{D} . As TG3 closes, the data from the master is transferred to the slave. The slave changes state (if necessary) so that its output at Q is the inverse of \bar{D} , i.e. is the same as D was when the clock began to change state. No further changes can occur because D is disconnected from the system and the master is in a stable state. These changes occurred at clock changed from low to high—at the rising edge of a high pulse.

When clock changes back (from high to low), the master once more begins to follow the data input. But this has no effect on the slave, because TG3 is open again. Output Q remains latched in the former state D until the next rising edge of the clock.

Several flip-flops of this kind are available in CMOS. The 4013 contains two such circuits. The 40175 has four of them, all sharing a common clock input, allowing the four digits of a

binary number (four bits) to be latched simultaneously. The flip-flops also have a common reset line (or "clear"), but no "set" inputs are provided.

The 40174 has as many as six flip-flops, all in a 16-pin package. As might be expected, the limit in the number of pins means that only the Q outputs are provided. The 4077 has four flip-flops with tri-state output, so is useful for holding data ready for transfer to a data bus.

J-K FLIP-FLOP

The J-K flip-flop is another circuit which comprises master and slave flip-flops. The master is controlled by two inputs, known as J and K . At the rising edge of the clock input, the state of the output of the master is transferred to the slave and appears at Q . The inverse appears at \bar{Q} .

The logic circuits produce the following results at the rising clock edge:

- (a) If J and K are both low; Q and \bar{Q} show no change.
- (b) If J is high and K low; Q goes high, \bar{Q} goes low.
- (c) If J is low and K is high; Q goes low and \bar{Q} goes high.
- (d) If J and K are both high; Q and \bar{Q} both change state.

Here we have a device that responds to clocking by "no change", "high", "low", or "change" depending on the J and K inputs. The circuit is also under the control of the Set and Reset inputs, which operate independently of the clock. As will be explained in Part 7, J-K flip-flops are especially useful in building up counters.

The 4027 and 4095 i.c.s both contain two J-K flip-flops. The 4027 has inputs as shown in Fig. 6.7.

The 4095 has three J inputs, which first go to an AND gate. Thus all three J inputs must be high to act as an high J input to the flip-flop. Similarly, there are three ANDed K inputs.

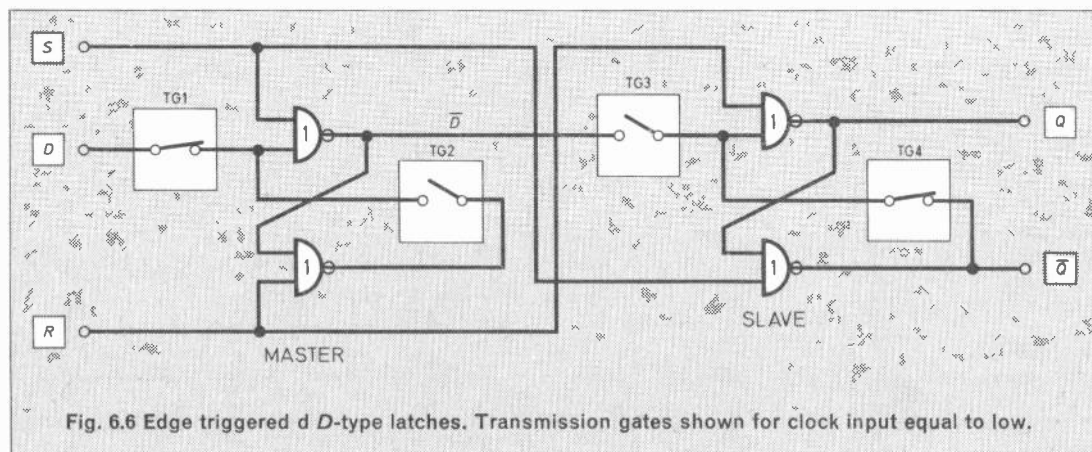

Fig. 6.6 Edge triggered D-type latches. Transmission gates shown for clock input equal to low.

BINARY LOGIC

The greater part of this article has been concerned with bistable multi-vibrators and their close relatives, the latches. This is understandable because such devices play a large part in logic circuits, including computers. The fact that their outputs have two clearly defined states and that they can be switched from one

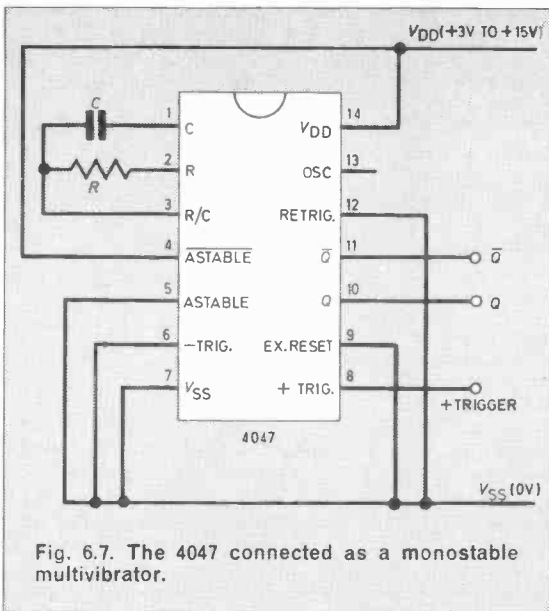

Fig. 6.7. The 4047 connected as a monostable multivibrator.

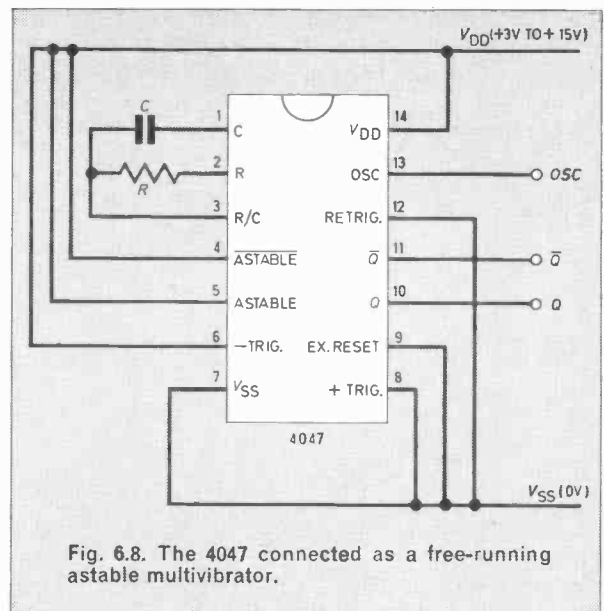

Fig. 6.8. The 4047 connected as a free-running astable multivibrator.

to another by a variety of control inputs means that they are ideal for storing and processing binary data.

Now we move on for a brief look at other types of multivibrator i.c.

MONOSTABLE MULTIVIBRATORS

Like the bistables, monostable multivibrators have two states and change rapidly from one state to another. The difference is that they are stable in only one of these states. When the monostable is put into its unstable state, it remains in that state for a while but invariably it returns to its stable state.

555 TIMER I.C.

An example of a monostable is the 555 timer i.c. described in Part 4 of this series. The time that the circuit spends in its unstable state is determined by the value of the timing capacitor and resistor. Its output is high for the duration of this period. If the timing capacitor and resistor have high values, the circuit remains in the unstable state with high output for periods of several minutes or even hours. This gives it many applications as a process timer.

With smaller values the circuit generates a "high" pulse of precisely fixed length but perhaps only a few milliseconds or microseconds long.

A CMOS version of the 555 is available, generally known as the ICM 7555. It can usually be used as a direct replacement for the 555 and has the advantage of much lower power consumption.

In the CMOS 4000 range there is the 4047 multivibrator i.c. As connected in Fig. 6.7, it is triggered by a rising (positive-going) edge. For negative-edge triggering the trigger pulse is

applied to pin 6 (no longer grounded) with pin 8 connected to V_{DD} . The i.c. requires two external components, the timing resistor and capacitor.

The duration of the output pulse is equal to $2.48 \times RC$. Thus if $R = 1M\Omega$ (the maximum recommended value) and $C = 4700\mu F$, the length of the pulse is $2.48 \times 1 \times 10^6 \times 4700 \times 10^{-6} = 11.656$ seconds or a little over 3 hours. The only reservation is that leakage through the capacitor may prevent it ever charging fully.

At the other extreme if $R = 10k\Omega$ (minimum recommended value) and $C = 1000pF$ (minimum recommended value) the pulse length is $2.48 \times 10^4 \times 1000 \times 10^{-12} = 24.8$ microseconds.

Another CMOS monostable is the 4098, which contains two monostables in one package, see Fig. 6.9.

ASTABLE MULTIVIBRATORS

Finally there is the type of multivibrator that is not stable in either state. It changes back and forth between one state and the other indefinitely. Since it is completely unstable (or astable), it can be used as an oscillator. Its frequency depends on the value of the timing capacitor and resistor. The 555 can be connected as an astable, as described in Part 4.

The 4047 is also designed to be used in this way, as Fig. 6.8 shows. The output period is $4.40 \times RC$. In addition, there is another output, from pin 13, running with half this period. The applications for the 4047 as an astable include clocks for driving logic and counting circuits and tone generators in many kinds of circuit.

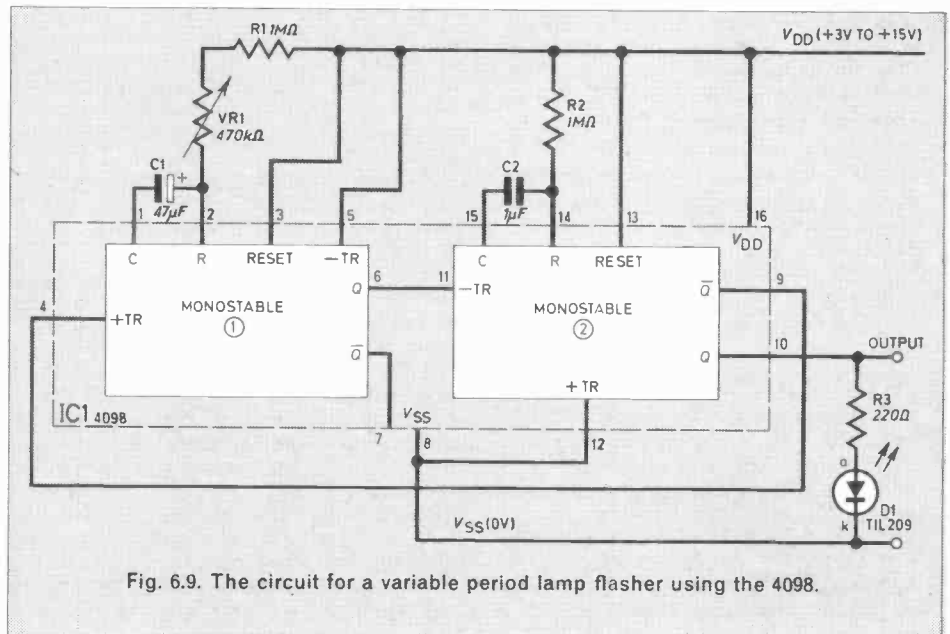

Fig. 6.9. The circuit for a variable period lamp flasher using the 4098.

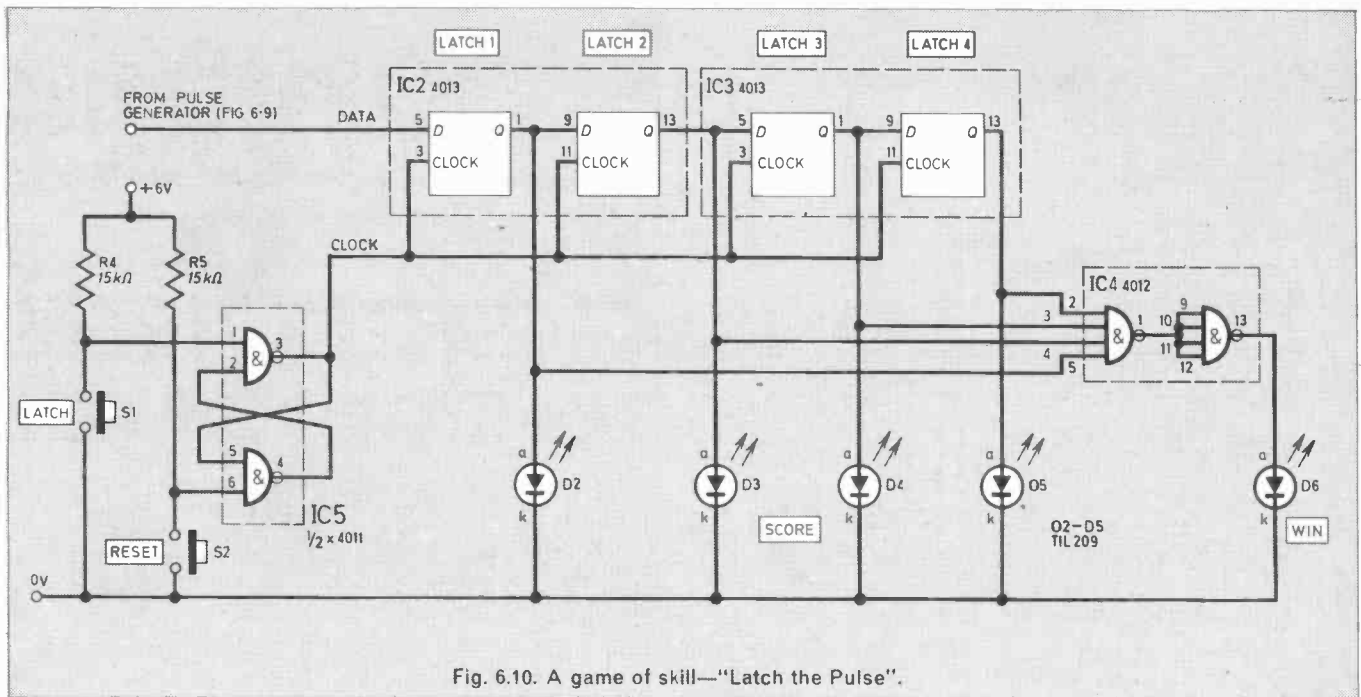

Fig. 6.10. A game of skill—"Latch the Pulse".

The two monostables of the 4098 cannot be used individually as astables since they lack the retriggering inputs required. However, it is possible to connect the two together so that each in turn triggers the other. This requires a capacitor and resistor for each monostable. For many applications the 4047 does the job better and with fewer components.

If an asymmetrical waveform is required (for example 1 second high pulses at intervals of 1 minute) the 4098 is ideal. Fig. 6.9 shows monostable 2 providing the short high pulse. The falling edge of this pulse triggers monostable 1 which, after 1 minute, triggers monostable 2 again, and so the cycle is repeated.

Note the coupling used between the two monostables. Monostable 1 triggers monostable 2 at the end of its long high pulse; as the output at Q falls, the falling edge triggers the TR(-) input of monostable 2. The Q output of monostable 2 then rises to give the 1 second pulse, and its Q output falls. At the end of the period, the Q output rises; its rising edge triggers the TR(+) input of monostable 1.

These monostables also have reset inputs (pins 3 and 13) but these are not used in this application.

TWO TO TRY

The astable based on the 4098 (Fig. 6.9) makes a useful process timer. With the values indicated, the l.e.d. flashes briefly once a minute, which is handy for timing moves in games such as chess. If C1 is reduced to 10µF and R1 to 820kΩ, the l.e.d. flashes every 10 seconds; this could be useful as a darkroom process timer.

In either case, C1 must be a tantalum capacitor, not an aluminium electrolytic type. If the circuit is operated from a 6 volt battery or power-pack or has a supply of lower voltage, R3 may be omitted.

LATCH THE PULSE GAME

The second project (Fig. 6.10) brings together many of the devices mentioned in this article and in the previous article. One second pulses are generated every 10 seconds from the 4098 astable described above. These pulses become the data of a chain of D-type latches.

When the clock input rises, latch 1 registers the state of the astable output. At the same time the data previously held by latch 1 is passed on to latch 2. The data at latch 2 passes on to latch 3 and that at latch 3 passes to latch 4. The data at latch 4 is lost. This array of latches illustrates how a shift-register is built up. It is a most useful device for manipulating binary data.

A 4-stage shift-register such as this can be obtained as a single i.c., the 4015, and several other versions are available.

The aim of the game is to clock the latches at exactly the right instant so as to latch on to the short high pulses from IC1. If four successive attempts are successful, all four l.e.d.s (D2 to D5) will be lit. This event will be detected by the NAND gate of IC4, making its output go low. This output is inverted by the second gate to light the "Win" l.e.d., D6 (or you could make it sound a buzzer).

It is essential to eliminate multiple clocking for, if we use a simple push-button, contact bounce causes the data to be shifted several steps on each

occasion. Bounce-free switching is provided by the bistable flip-flop (IC5). Press S1 to latch a pulse, then press S2 to reset the flip-flop in readiness for the next attempt. ✎

Next Month. Counters and decoders.

Bind it

It's so easy and tidy with the Easibind to file your copies away. Each binder is designed to hold approximately 12 issues and is bound and blocked with the Everyday Electronics logo. Gold letraset supplied for self blocking of volume numbers and years.

Price £4.40 including postage, packing and V.A.T.. Why not place your order now and send the completed coupon below with remittance to: IPC Magazines Ltd, Post Sales Dept, Lavington House, 25 Lavington St, London SE1 0PF

it's easy with **EASIBIND**

Order Form

Everyday ELECTRONICS

I enclose p.o./cheque value for binders. Years required

(BLOCK LETTERS PLEASE)

Name

Address

Date

GOODIES ^{can} become BADDIES



Let the EE FREEZER ALARM watch out for you

A simple design to alert the householder to mains power failure and avert the possibility of ruined food. Can also be used to protect other vulnerable mains powered equipment.

**Also
NEXT
MONTH**

INTERCOM

Mains powered two-station system. Can be used as a doorbell with speech communication to identify unknown visitors.

DIGITAL RULE

Uses ultrasonic pulses to determine distances from a solid object to the instrument. Digital display gives a direct reading in inches.

ELECTRONIC SWITCH FOR MOTORS

A modern triac design to eliminate the troublesome centrifugal starting switch. Suitable for single phase induction motors, reversible or non-reversible.

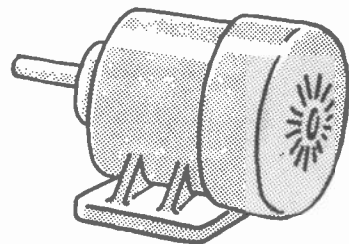

Everyday ELECTRONICS

APRIL 1981
ISSUE ON SALE
FRIDAY, MARCH 20

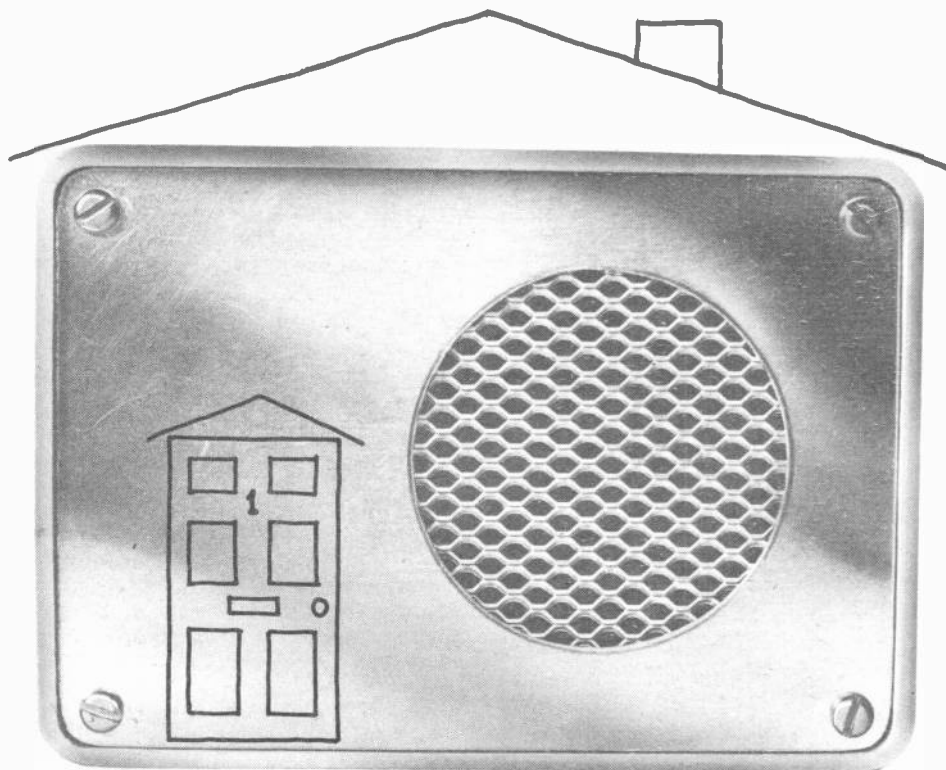

MODULATED TONE DOORBELL

R. A. PENFOLD

THIS ELECTRONIC doorbell design is simple and inexpensive to construct. It has the advantage over most doorbuzzers and bells of very high reliability and, being an electronic device, it is largely unaffected by dust and other environmental conditions.

The only moving part apart from the pushbutton is a loudspeaker, so there is nothing which is likely to wear out. The unit is certainly far more reliable than the unit it has been used to replace.

FREQUENCY MODULATION

It is not advisable to use a straight forward tone generator as a door-buzzer because a single tone is easily masked by other sounds and is thus easily missed. Using a very high volume would overcome this to a large extent, but would make the unit highly objectionable to anyone who happened to be close to it when it sounded.

Better alternatives are to use either a pulsed tone (rapid on and off switching of the signal), or frequency modulation (rapid up and down variations in the pitch of the tone). In either case the varying nature of the signal plus the fact that a fairly wide range of frequencies are generated results in it being very noticeable and not easily masked by other sounds.

CIRCUIT

The unit described here has a frequency modulated tone and the circuit diagram appears in Fig. 1. This is based on an NE556 dual timer i.c. which is capable of producing a very

wide range of pulse and frequency modulated signals. Incidentally, the NE556 i.c. contains two circuits of the type that are used in the popular NE555 single timer i.c.

One section of the 556, IC1b is used to provide the basic audio tone, and this section of the i.c. is wired in the astable or freely oscillating mode. In this configuration C4 will charge up via R4 and R5 until two thirds of the supply rail potential is developed across C4.

The circuit is then triggered into an alternative state where C4 is discharged into pin 13 of the i.c. by way of R5 until one third of the supply voltage is produced across C4.

The circuit then reverts to its original state with C4 charging up to two thirds of the supply voltage once again. The circuit is then triggered once more to its alternative state, and

it continuously oscillates in this manner.

LOUDSPEAKER

A loudspeaker is connected between the output of IC1b (pin 9) and the positive supply rail. Normally the output is at virtually the full positive supply rail voltage with little current being supplied to the speaker in consequence, but during the discharge period of C4 the output goes to a very low voltage and current is fed to the speaker.

It obviously takes C4 longer to charge up through R4 and R5 than it takes to discharge through R5 alone, particularly in view of the fact that R5 has a much lower value than R4.

The time during which the output of the i.c. goes to a low voltage is therefore comparatively short; the

Fig. 1. Full circuit diagram of the Modulated Tone Doorbell.

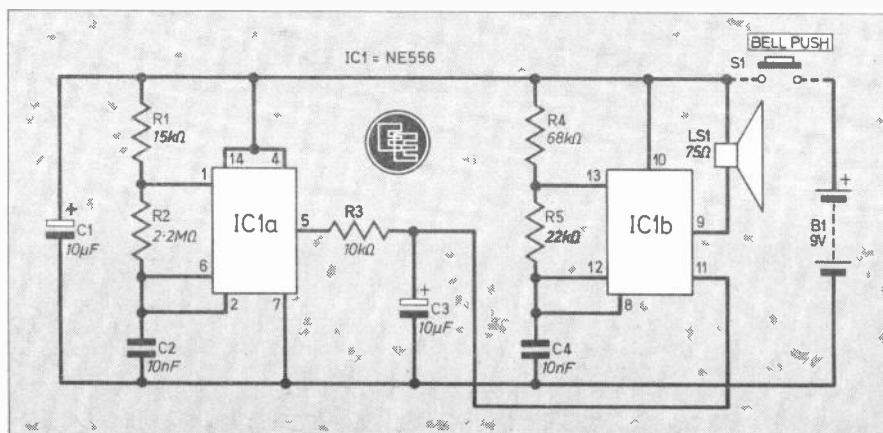

high to low ratio (termed the mark/space ratio) being about four to one. The waveform across the speaker is therefore a series of fairly short pulses, and this type of waveform produces a quite piercing sound from a comparatively low average output power.

THRESHOLD VOLTAGE

The component values have been chosen to provide a nominal operating frequency of 1.4kHz, but this is modulated of course. The obvious way of frequency modulating the oscillator is to vary the threshold voltage at which C4 starts to discharge.

Raising this level would increase both the charge and discharge times of C4 and would reduce the operating frequency. Lowering this voltage would produce an increase in frequency by reducing these times.

This can in fact be achieved as the relevant reference voltage is available at pin 11 of the i.c. and is easily modulated as it is at a fairly high impedance.

The modulating signal is obtained from a second astable circuit which utilises IC1a and is basically the same as the tone generator. However, R1 has been given a value which is very much lower than that of R2 so that the mark space ratio of the output waveform is almost one to one.

The component values have been chosen to produce a comparatively low operating frequency, the actual figure being approximately 27Hz.

If the output at pin 5 of IC1a was to be directly coupled to pin 11 of IC1b this would result in the tone oscillator being rapidly switched between two frequencies. A pleasant and equally effective sound can be produced by a smoother transition between the upper and lower frequency limits of the tone generator.

Therefore, R3 and C3 are used to filter the squarewave modulating signal to produce a roughly triangular waveform which is coupled to pin 11 of IC1b.

The power supply is decoupled by C1, and S1 is the door push-switch which is simply connected to operate

as an on/off switch. The current consumption of the unit is about 30mA or so and this is provided by a small (PP3) 9 volt battery which will have virtually its shelf life under normal circumstances.



STRIPBOARD

Details of the 0.1 inch pitch stripboard layout and wiring of the unit are illustrated in Fig. 2. Start construction by cutting out a board having 17 holes by 17 strips and then make the necessary breaks in the copper strips.

Next drill the two 3.2mm diameter mounting holes and then solder the

COMPONENTS

See
**Shop
Talk**

page 159

Resistors

- R1 15k Ω
- R2 2.2M Ω
- R3 10k Ω
- R4 68k Ω
- R5 22k Ω

All $\frac{1}{4}$ W carbon \pm 5%

Capacitors

- C1 10 μ F 10V elect.
- C2 10nF polyester type C280
- C3 10 μ F 10V elect.
- C4 10nF polyester type C280

Semiconductors

- IC1 NE556 dual timer i.c.

Miscellaneous

- S1 push-to-make, release-to-break door bell push
 - LS1 miniature loudspeaker 50 to 80 ohms impedance.
 - B1 9V battery, PP3 type
- Plastics case, size 110 x 70 x 45mm, Bimbox type BIM4004 or similar; stripboard, 0.1 inch matrix, size 17 holes by 17 strips; battery clip; speaker cloth; bell wire; interconnecting wire; 6BA hardware to mount circuit board.

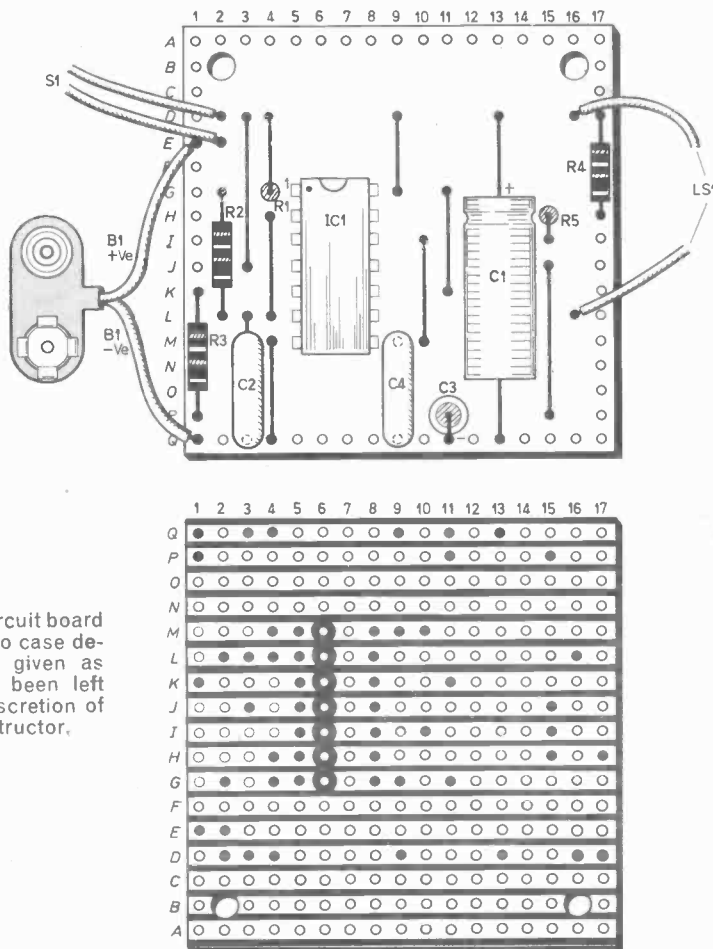

Fig. 2. Circuit board layout. No case details are given as this has been left to the discretion of the constructor.

COMPONENTS
approximate
cost **£8**
excluding case

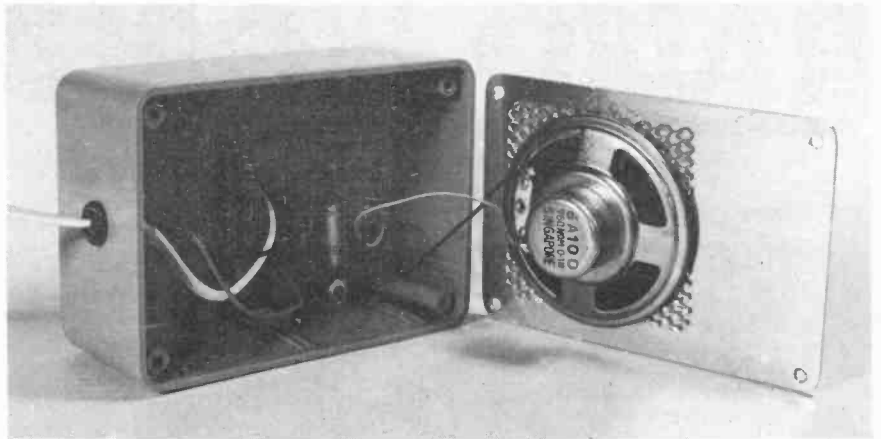
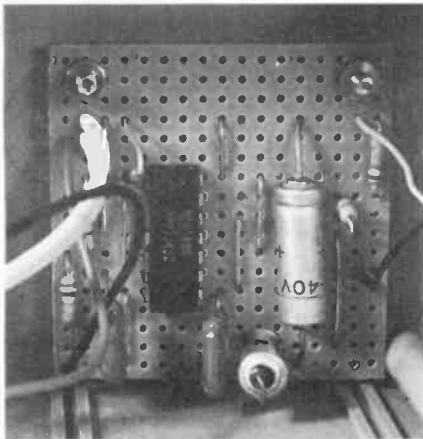

Photo left shows a close-up view of the circuit board. Photograph on the right shows the interior of the case showing the loudspeaker in position on the lid and the circuit board fixed to the base. Note that the lead from the bell-push is hard wired straight to the board.

components and link wires into position. Also connect the battery clip, ensuring that the polarity is correct.

The unit can be housed in any small plastics box of adequate proportions to accommodate all the parts. The prototype is built into a Bimbox type BIM 4004 which has an aluminium front panel and dimensions of about 110 × 70 × 45mm.

LOUDSPEAKER

The loudspeaker is mounted towards the right hand side of the front panel and a circular cutout of slightly smaller diameter than the cone must be made here. This can be made by drilling a series of small holes (about 3 to 4mm in diameter) around the inside of the periphery of the required cutout.

Provided the holes are very closely spaced it will then be possible to push out the material inside the holes. The rough edges of the cutout can then be filed smooth using a large round file.

A piece of speaker cloth or fret is glued in place behind the cutout using a good quality general purpose adhesive. The speaker is then glued in place onto this, but only apply a small amount of adhesive to the very rim of the speaker. When the glue has set, the speaker is wired to the component panel using insulated leads about 100mm long.

BELL PUSH

A hole for the bell-wire must be made in the left hand side of the case. The bell-wire is then threaded

through this and connected to the component panel. It is quite acceptable to use a very long length of bell-wire if this should be necessary.

The component panel is bolted to the rear of the case using short M3 or 6BA bolts which should preferably be countersunk types. It is advisable to use an extra nut over each mounting bolt, between the case and the component panel, as otherwise the panel will probably buckle when the mounting nuts are tightened.

If the unit is to be mounted on a wall this can be accomplished using a couple of screws through the rear of the case, and is done after the component panel has been mounted.

If the unit is working correctly a trill-like sound somewhat like that of a Trimphone should be produced when the bell-push is operated. ☞

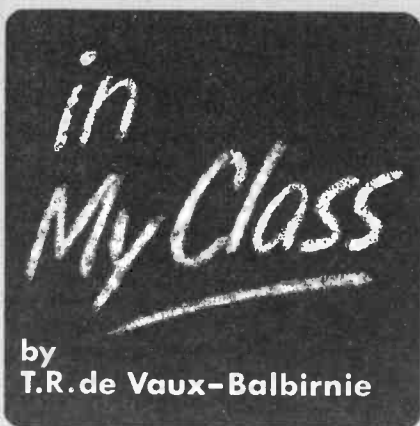

THE class were trying their hands at soldering for the first time. When I toured around to see how they were managing I was horrified—had they learned nothing from the theory lesson?

I had to tell John that it was no good applying solder to his soldering iron then chattering for five minutes before making the joint. The blue smoke was all the flux burning off. As the purpose of flux is to clean and prepare the surfaces to "take" the solder, its purpose was lost. Solder and iron should be applied to the joint together, I told him.

Gerald was next. He was "buttering" the joint with solder, scraping the iron until he had built up a thick layer. This is a sure way to make a bad joint, the solder should melt in one operation. Stephen was caught wiggling the wires around to find out when the solder had hardened. This causes "dry joints", everything should be kept still until the solder has hardened.

Several members of the class were blowing on their joints to cool them. By doing this, the outer skin of solder contracts before the inside causing internal

stresses and cracks. This joint is likely to fail sooner or later.

When they had had their fun, I spent half an hour running through the theory again. I told them that although it was easy to make a soldered joint, a good job was a work of art demanding a good deal of care.

A very common fault is that the solder does not "take" properly to the surfaces and the joint only conducts because of the physical contact between the metals. This will be very unreliable and is likely to alter its resistance with movement.

A good joint will be shiny in appearance, a greyish or cracked joint is always suspect. It is always a good plan to give wires a gentle pull to test the joint, after the solder has hardened.

My final point was that they should not expect the flux to do all the work. Gentle scraping of dirty surfaces with a penknife blade helps.

RADIO WORLD

By Pat Hawker, G3VA

Travel by radio

In some Eastern European countries, amateur radio is officially recognised as a competitive, sporting activity (in Russia a particularly active amateur can become a Master of Sport). In most parts of the world there are now a plethora of "contests", operating awards and certificates . . . too many, some of us feel at times. However they are mostly good fun, at least when they do not bring out an excess of zeal to work rare or new countries by putting out the loudest signal on the band or by butting into other people's contacts.

Fortunately for the hobby, there are many others who succeeded by careful listening rather than brute force. Indeed quite a few British amateurs have made contact with well over 300 different countries, as carefully defined by the American Radio Relay League.

Although at one time quite a keen "DX chaser" I must admit that I largely opted out of this time-consuming race many years ago and my own total is not much over 200. Nevertheless, I still keep a tally and reckon to work between 70 to 100 different countries each year without intensive country chasing.

There are all sorts of ways in which one can enliven such activity. For instance with the coming of 1981, I set myself a small task: to see how many different countries I could work in successive contacts without duplication.

Since there are vastly more active amateurs in some countries than in others, the temptation to work more than one station in a single country soon becomes very powerful. But I was pleasantly surprised to find in the first days of January, with relatively few hours on the air, that 36 solid and pleasant contacts on all bands from 1.8 to 28MHz, yielded a score of 36 countries in 4 continents. Starting off in Italy my journey finished up in French Guiana, South America.

Even using only a simple "long-wire" aerial, it is certainly possible to tour the world rapidly and in comfort on the amateur h.f. bands. Others, such as those who took part in "Operation Drake" still prefer to travel slowly, in person . . .

Travel with radio

The arrival back in the Pool of London of the 150-ton brigantine *Eye of the Wind*—at the conclusion of "Operation Drake" which enabled 404 "Young Explorers" from 27 countries (picked from over 60,000 applications) to take part in some phase of this two-year scientific expedition around the world—gave its leader, Lt-Col J. N. Blashford-Snell, the opportunity to explain how successful and helpful he had found modern single-sideband h.f. radio communication.

The expedition spent a lot of its time away from the ship (which carried standard marine radio equipment supplemented by what proved to be a very

successful amateur-type h.f. transceiver by the American firm appropriately called Drake) and during these periods often relied on a communications link with the Royal Signals at Blandford, Dorset using a Plessey "Clansman" UK/PRC320 h.f. manpack military transceiver. This all-solid-state, frequency-synthesised, compact equipment provides some 30 watts peak envelope power output and can be used with whip, dipole or long-wire aerials.

Although intended primarily for tactical medium-distance voice communication, the pack sets repeatedly showed that they could be relied upon to provide voice links with England at distances up to 11,000 miles. On several occasions they were used under emergency conditions, once to effect a dramatic helicopter rescue of three casualties. On another occasion, when a light aircraft had damaged their aerials in a volcanic crater near Nairobi, East Africa, they were able to warn the airfield that the plane itself had suffered damage, and also to report the incident to Blandford using only make-shift aerials.

Lt-Col Blashford-Snell spoke enthusiastically of the effectiveness of these voice links, when compared with the need on earlier expeditions to depend upon Morse for long-distances, pointing out that single-sideband communication proved possible even under poor propagation conditions—though privately he admitted to me that he had at first been rather dismayed to find very few of his volunteers had any knowledge of Morse, and so was extremely relieved to find the little pack-set performing so well even when using batteries and a hand-generator.

Radio Spectrum Pollution

Viewers and listeners in the UK are fortunate in being able to call upon the free assistance of skilled Post Office engineers in tracing, and often curing, persistent interference from domestic and industrial equipment and the like. This is done by obtaining and filling in a form "Good Radio and Television Reception" available from Post Offices.

However, it should be noted that this free service applies only to interference that affects the reception of broadcast transmissions for that locality. It is also sensible first to try to make sure that the problem really is electrical interference and not due to a faulty receiver or inadequate aerial or from equipment in your own home, and is of a persistent nature. Not even the Post Office teams can be expected to overcome the occasional click.

Twenty years ago or so, the number of people who appealed to the Post Office for help each year was over 100,000. A recent Home Office report shows that in 1979 the number was 35,500. The steady improvement over the past two decades can be ascribed partly to the results of the legislation that regulated the amount of interference from car ignition, electric

motors and refrigerators and partly to the effects of moving television from the v.h.f. bands up to u.h.f.

But unfortunately I suspect that it does not mean that we can claim to have overcome the problem. The amount of spectrum pollution all the way from low frequencies to v.h.f. continues to be very severe, particularly in urban and suburban environments.

This can be shown by the fact that although complaints about TV interference have fallen steadily, radio listeners are reporting more and more interference. In 1971 only about 6500 radio complaints were made; by 1979 the figure had risen to 23,782 (16,568 i.f./m.f., 7214 v.h.f./f.m.) including a staggering 25 per cent increase over the 1978 tally.

Part of this large increase reflects the many complaints about the reception of Droitwich on 200kHz following the re-allocation of this frequency to Radio 4 in November 1978. But another major factor has been the increasing problem, throughout the 1970s, of interference due to defective "contact devices" including faulty switches and especially the thermostats used in hot water and central heating systems. In 1979, some 28 per cent of all complaints (68 per cent of complaints later ascribed to specified sources) were due to contact devices.

As usual, many complaints were found by the Post Office to be due to "conditions at the receiving site" by which is meant inadequate aerials, faulty or maladjusted receivers, or receivers having insufficient "immunity" to strong local signals. This category accounted for 36 per cent of all complaints, with 56 per cent of these due to aerials or feeders and 31 per cent due to receiver design characteristics.

The Post Office do not advise in cases of interference to distant stations, and most radio amateurs could testify to the increasing extent of man-made spectrum pollution on the m.f. and h.f. bands from such causes as the unwelcome timebase and switched-mode power supplies of many colour TV sets. Very few viewers recognise that they themselves are putting out a series of nasty noises every 15kHz or so at frequencies up to about 15MHz or higher.

Here and there

A "télétheque" a museum dedicated to television is to be opened soon at the French television centre at the Palais de Chaillot, Paris. It will include a viewing room where selections of French programmes screened during the past 30 years will be shown daily.

Incidentally, the fascinating IBA's "Broadcasting Gallery" at 70 Brompton Road, London SW3 (opposite Harrods) although not primarily a "museum" does provide an excellent idea of how radio and TV broadcasting has developed and how it is run. There are four free guided tours from Mondays to Fridays, each lasting about 90 minutes. Advance booking is required and there is a minimum stipulated age of 16 years. Phone 01-584 7011 and ask for the Broadcasting Gallery to book a place on a tour.

An American made film *The World of Amateur Radio* has won a gold medal at a National Film and Television Festival in New York. It was judged the best industrial film in a "hobbies and recreational" category.

Everyday News

CREDIT CARD CALLS

Public payphones, using plastic cards instead of coins, will be tried out this year by British Telecom, the telecommunications part of the Post Office.

About 200 of these push-button Cardphones will go on trial in London, Birmingham and Manchester, in busy

places like airports and main line railway stations. In addition to making inland calls, it will be possible to use the

cards for overseas calls to all 101 countries on direct dialling from the UK.

To use the new phones, customers will need to buy special cards which will be the same size and shape as credit cards. These cards contain telephone credit units which are erased by a thermal process when the card is inserted into the cardphone to pay for calls.

The units are priced at 5p and there will be two values of card on sale, one of 40 units costing £2, and a 200 unit card at £10, which is double sided.

The trial cardphones are to be supplied by Landis and Gyr Group. These will use the Sodeco debit card, incorporating holographic technology, based on special patterns of light, to provide a high level of security against fraud or forgery.



Prototype Card Phone made by Landis and Gyr

LICENCE EXEMPTION

Users of model control equipment and metal detectors no longer need official licences to operate their equipment under the Wireless Telegraphy Act 1948.

Announcing this recently the Home Secretary emphasised that exemption of metal detectors would not absolve users in anyway from the need to obtain permission to enter, search and dig land and to keep off protected archaeological and other sites.

At the same time it was announced that an additional frequency band of 35.005MHz to 35.205MHz is to be made available for model aircraft control.

Although metal detectors and model control equipment are exempted from licensing they should conform to the following simple technical conditions in order to avoid interference with other radio users.

Metal Detectors

A metal detector shall be used only with emissions at a fundamental frequency within the frequency band 0Hz to 148.5kHz.

The strength of the electric field of the emissions shall not exceed 3,000 micro volts per metre measured at a distance of 6 metres.

The strength of the electric field of the spurious emissions produced by a metal detector shall not, insofar as those emissions are within the frequency band 148.5kHz to 6.5kHz exceed 100 micro volts per metre when measured at a distance of 6 metres.

The use of a metal detector shall not cause undue interference with any wireless telegraphy.

Model Control Equipment

Model control equipment shall be used only with emissions which are within the 26.96MHz to 27.28MHz band or the 458.5MHz to 459.5MHz band.

With a maximum mean power not exceeding 1.5 watts in the 26.96MHz to 27.28MHz band and 0.5 watts in the 458.5MHz to 459.5MHz band.

Notwithstanding these provisions model control equipment designed solely for the purpose of controlling the movement of a model aircraft may be used with emissions which are within the frequency band 35.005MHz to 35.205MHz and with a maximum mean power of 1.5 watts. This is an additional band not previously available.

The use of model control equipment shall not cause undue interference with any wireless telegraphy.

The use of model control equipment shall be subject to the condition that it is made available for inspection if so required by any person authorised for the purpose by the Secretary of State.

An adaptor costing under £200 that will turn an ordinary TV set into a Prestel terminal is being marketed by Zycor Ltd. To be known as the Teledesk 2000, it uses a hand-held infra red keypad for "page" selection with a range of up to 9 metres (30 feet).

Fluked Again

A major coup is being claimed by Fluke (GB) Ltd with the winning of a large order for handheld digital multimeters from British Telecom, the Post Office telecommunications operation.

The order, which is believed to be one of the largest ever placed for DMMs in the UK, is for nearly 3,000 of Fluke's low cost 3½ digit 8022A handheld models.

Spy-in-the-Sky

Marconi Avionics Heli-Tele helicopter-borne colour TV system has been re-ordered by the Metropolitan Police for a second Bell 222 helicopter.

The airborne camera is in a stabilised mount to eliminate helicopter vibration and includes powerful zoom facilities to read number plates and identify people from the air. The TV pictures are relayed to a ground control post by radio link.

In the Chair

Plessey is sponsoring an industrial professorship at Trent Polytechnic, Nottingham furthering the close links which already exist between the Company and Trent, one of the country's leading institutions of higher education.

Called the Plessey Chair in Computing, support for the professorship reflects the Company's move into computer and software applications as it changes from electro-mechanical to digital, computer controlled products.



ANALYSIS

BREAKTHROUGH

The history of electronics can be compartmented into major advances in technology, each of which crashed through a barrier leading to even greater advance. Examples of such breakthroughs in the first half of the century were Fleming's diode which was the world's first thermionic valve patented in 1904, and de Forest's triode valve patented three years later. These were the great fundamental inventions which were the foundations of all later developments.

In the second half of the century the greatest leap forward was solid state technology, a development even more significant than the thermionic valve and which opened the door to electronics as we know it today. The vintage years were the 1950s and 1960s when breakthroughs of various types were so numerous that the very word became devalued to the extent that today it is almost out of fashion.

The development of microelectronics and its phenomenal success in so many applications has deadened our sense of wonder. Magnificent colour photographs of Saturn, transmitted electronically 900 million miles through space, created less popular interest than the blurred photograph of a footballer transferred for a high fee. The miracle of a home computer cheap enough to be within the reach of all passes almost without comment.

Are we so saturated with technological advance that the idea of a breakthrough has gone forever? Would it be a breakthrough if, for example, we were able to take a very large commercial mainframe computer and shrink it in size to that of a biscuit tin while, at the same time, improve its operating speed by a factor of 20 and reduce its power consumption to a few watts?

Well, scientists are working diligently on superconducting junctions operating at very low temperatures based on a phenomenon discovered by Brian Josephson at Cambridge in 1962. They expect to achieve an entirely new generation of computers which will have the features described above. Where very large memories are needed, typically 10^9 bits upwards, the overall technological and economic advantages of a Josephson computer would easily outweigh the additional cost of the cryogenic cooling equipment.

At least four companies, two in the United States, two in Japan, are known to be active in this exciting new technology and it seems likely that the first Josephson computer will appear towards the middle of this decade.

It should merit the description of breakthrough. It will probably be dismissed as nothing very remarkable.

Brian G. Peck

Leading the Way

The United Kingdom leads Europe in data communications with 117,000 data connections in use, compared with 61,700 in Germany and 54,000 in France.

VIDEO AT HOME

Video at Home is the name of a new company set up within Thorn TV Rentals to supply the group's rental outlets with software for VHS video cassette recorders.

Buying British

Belgium is the sixth country to buy Prestel technology from British Telecom. They are also buying the GEC 4085 computer on which the system is based.

In the UK, Prestel now has 6,700 users of the 170,000 pages of information currently available.

COURSES FOR THE UNION

The electronics union, EEPTU, has set up courses to train members in the new electronics technology which they are now having to face.

The basic courses are of five weeks duration tailored to individual needs from semiconductor theory through to use of MPUs.

Training a PET

Continuing the successful and well-attended series of PET Seminars and Programming Courses, Commodore Business Machines have announced details of their 1981 seminar programme.

Organised and presented by Commodore's own training team, these courses provide participants with theoretical and practical programming and operating experience.

Restricted to small tutorial groups, allocating one Pet computer to every two students, each course contains a high proportion of exercises which participants carry out themselves.

The World Sea Angling Championship staged in Britain was the first angling event, it is claimed, to use a computer and electronic display to provide a running record of catches and competitor placings in all categories during the contest.

Protecting War Relics

Nearly 500 electronic sensors are used in a new fire warning system at the Imperial War Museum.

The system, supplied by AFA-Minerva (EMI), is unique in that automatic extinguishing systems using water or gas cannot be used because of the fragility of many of the exhibits. Instead the fire early-warning system uses a variety of sensors which includes photo-electric smoke detectors, infra-red detectors, fixed temperature and rate-of-rise-of-heat detectors, and flame detectors.

The control system indicates the exact location of any "alarm" condition enabling instant action to be taken.

Business Comsat

A European communications satellite network for business use is planned to be operational in 1983. Companies and organisations will have their own small earth terminals with 4m dishes on or near their premises.

Initial testing will be through the European Space Agency's Orbital Test Satellite (OTS) and the service will use the European Communications Satellite (ECS), which will be modified to include the business service, and the French Telecom 1 system.

Space-Age Armour

The problem of damage to space satellites from high energy electron bombardment is claimed to have been solved by British Aerospace with the development of a new composite sandwich material which dissipates surface charges as soon as they are encountered.

Bookmark

The electrical and electronics library of the IEE has just celebrated its centenary. It was opened 100 years ago with a foundation of 12,000 books on electricity and magnetism from the collection of Sir Francis Ronalds. Today it has 40,000 books, increasing by 2,000 books every year.

Everyday News

AIR SAFETY

One of the hazards of flying is unexpected windshear such as down-draughts which cause an aircraft to sink rapidly, particularly dangerous during take-off and landing. A new laser system, now being test flown, can detect the wind-speed well ahead of the aircraft and warn the pilot of impending windshear.

The system known as LATAS (LAsER True Airspeed System) has been developed by the Royal Aircraft Establishment in collaboration with the Royal Signals and Radar Establishment.

Multi-Part Standards

Three parts of a new British Standard of particular interest to manufacturers and users of visual aids and television for educational, training and similar applications, have recently been published. The BS 5817 *Audio-visual, Video and Television Equipment Systems* is being planned in 12 parts, and is designed as a framework into which further items can be fitted with the advent of new technologies in this field.

The systems covered in the standard range from very simple general purpose devices to highly professional equipment used, for example, for audio-visual distribution systems.

Records and Musicassettes, the way they reach the customer, their future with a view to video—these and other topics will be dealt with at the first "International Music Market Seminar" in Berlin on April 29 and 30, 1981.

Represented will be the music industry as well as experts from the media and the discotheque scene.

Bear Mauls Logger

An unattended automatic data-logger recording meteorological and geological data in the Arctic Circle for a Swedish university scientific project has been attacked by a polar bear. The bear destroyed the tent and the fibre-glass protective case of the logger leaving the equipment exposed and some ten feet from its original position.

The logger, built in the UK by Microdata, was found by the Swedish scientists in perfect mechanical order and still collecting data.

EURO-DEBUT

The first European demonstration of RCA's CED Video Disc system has taken place in Cannes. The Capacitance Electronic Disc (CED) is due for launch in the United States in March.

The US market is expected to attract sales of 200,000 players in the first year plus two million SelectorVision discs. Players are expected to cost under \$500 and the discs at between \$15 and \$25 each.

A date for European marketing has not yet been announced.

Wired City

Milton Keynes has been selected as the first British town to have an experimental fibre-optic communications system, paving the way to the "wired city" of the future.

Twenty houses are to be served with radio and TV through the fibre-optic links. The real-life field trials are the logical next step following work on such systems by British Telecom engineers at the Martlesham Research Laboratories.

SAVINGS IN SPACE

As part of its continuing drive to improve communications, British Telecom has signed an agreement with four Nordic countries to provide mutual access to *Inmarsat* ship-to-shore communication satellites.

The deal will enable British telephone and telex users to link up with the *Inmarsat* Indian Ocean satellite through a new ground aerial at Eik, Norway. At the same time, Scandinavians will have access to the Atlantic Ocean maritime satellite through Telecom's earth station on Goonhilly Downs, Cornwall.

In this way, British Telecom and its counterparts in Denmark, Finland, Norway and Sweden can provide service covering the two ocean regions by constructing only one aerial each, representing a substantial saving in capital and operating costs.

Marconi Space and Defence Systems has signed its largest single export order, worth £50 million, with the Swiss Government via British Aerospace.

The MSDS contract is for the *Blindfire* tracking radar of the *Rapier* anti-aircraft missile system which gives *Rapier* 24-hour all-visibility all-weather operation.

The British Computing Society is holding an international symposium entitled "Computing for National Development" at the University of London Institute of Education on March 23 to 27.

Devoted to the use and application of computers in engineering, the second international conference and exhibition "Engineering Software" is being held at the Imperial College of Science and Technology from March 24 to 26.

Scotland's first Business to Business Exhibition, which will come under the banner of "The Scotsman" newspaper, will be held at the Royal Highland Exhibition Hall, Ingliston, near Edinburgh from April 27 to 30, 1981.

Electronics for Teachers

The Department of Electrical Engineering Science at Essex University will be holding its annual *Electronic Systems Summer Schools for Teachers* during the week commencing July 5, 1981.

This year two newly structured courses are to be run simultaneously, "Feedback and Communications Systems" and "Digital and Computer Systems". The two courses have been designed primarily to complement the "A" level in Electronic Systems. However, the courses should also be of interest to teachers wishing to further their knowledge in the field of electronics.

The Feedback and Communication course covers topics on transistor circuits, operational amplifiers, an audio systems case study, communications and television systems. The Digital and Computer Systems course examines transistor switching circuits, combinational and sequential logic design, introduction to microprocessors and the use of microcomputers in schools.

Each course is supported by formal lectures and an extensive laboratory programme, together with optional evening seminars. Teachers wishing to obtain further details of these courses should contact Mrs J. Mead, Department of Electrical Engineering Science, University of Essex, Wivenhoe Park, Colchester CO4 3SQ.

MICRO-ELECTRONICS COME HOME . .

. . . A PIPE DREAM?

Some of the latest microelectronic products for use in and around the home are available for all to see at the "Micro-Electronics Come Home" exhibition now running at the London Design Centre until March 7, 1981. It will be repeated at the Glasgow Design Centre between March 30 and May 30, 1981.

Women's World

Women will be particularly interested to see the sleek and modern lines of some easy to operate and labour saving devices for use in their homes. For instance, the electronic controlled oven, washing machine, tumble dryer, central heating controllers with digital kitchen clock incorporated and other more personal modern timepieces to be worn.

Sure to be a favourite with many is the "Mole". This is a vacuum cleaner that remembers where you have taken it. Next time its use is required, merely press a button and it does it for you . . . by itself. These have been designed by students at North Staffordshire Polytechnic.

Youngsters (and others) will be entertained by the T.V. Games Centre, the microprocessor controlled model railway system and computer chess.

Two synthesisers, one without a keyboard, and a guitar with not a single string, are the most futuristic looking devices on show. The guitar resembles a painted plastic drainpipe and the synthesiser looks a bit like a hot-air hand-drier. Disappointingly though, they are to be seen and not heard. All are touch sensitive devices (!).

Man's World

For the man-about-the-house (and out-of-doors

types) there is a Navigational Computer, Radio Compass, a Micro Micrometer, an Advanced Car Computer and a ZX80 computer being demonstrated. Perhaps he can use this to work out the best way of paying for all these items. And to protect all your "electronic furniture" there is a Burglar Alarm System.

Business World

Other items on display include a Prestel Business Terminal, Telephone Answering Machine, a Bet Settling Computer (to make life easier for the bookmaker) and various TV sets.



Syntar guitar without strings, designed by Mark Morrison, North Staffordshire Poly.

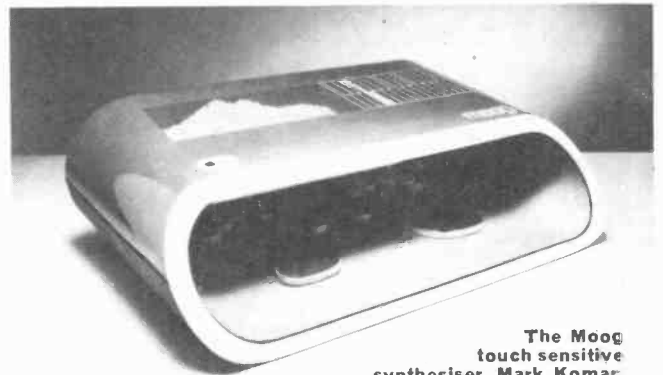

The Moog touch sensitive synthesiser, Mark Komar.



Canon Couture De-Luxe gas oven uses microelectronic control. Zero 1 model railway control console from Hornby Railways. Microprocessor controlled Creda washing machine, claimed to be the world's most sophisticated.



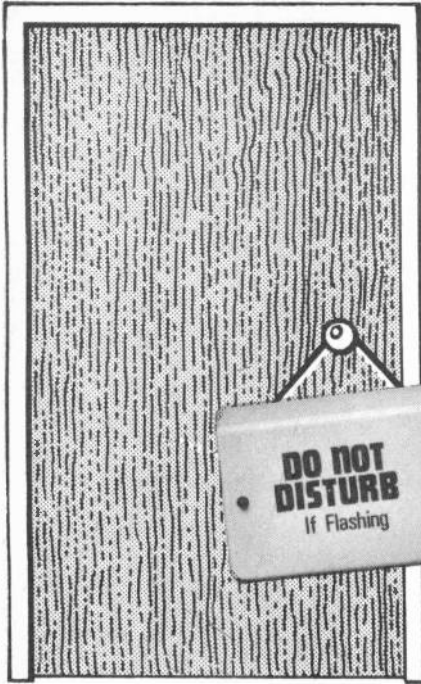

L.E.D. FLASHER

BY K. B. CROFT

A LARGE part of the author's electronic interest lies in various applications to audio; "Jingle" cassettes for disco operators, silly (but incredibly complicated) tapes to friends and relatives abroad, dubbing sound tracks on home movies, effects for theatre productions, and of course good music anywhere in the house at the flick of a switch.

RECORDING HAZARDS

Serious attempts at recording are likely to involve the use of microphones, and here silence is of the essence. Even where mics. are not "open" a great amount of concentration is often needed, especially where dubbing or putting together a composite tape (one film dubbing session involved five cassette recorders, two disc players and two electronic effects!). At times like these, Murphy's law demands that, on the ninth and apparently successful attempt, mum waltzes in with a tray of mugs of tea, trips over a cable and skids across the floor. Even if you have no mics. open and can manage to keep concentrating on the job in hand, the sight of the book shelves toppling over on to the pre-faded play-out disc can be distracting, and ruin a good "take".

Locking the door is really no answer, as the average person seems to try the "Sweeny" approach before accepting that the door cannot be opened, then of course he or she will knock on the door, calling out at the same time.

Some sort of warning, outside the door, could stop such catastrophes and save the tea getting spilt. Such a simple unit is the subject of this article.

CIRCUIT

The circuit diagram of the L.E.D. Flasher is shown in Fig. 1 and is seen to be a basic astable multivibrator using transistors. This circuit may be thought by some to be "old fashioned" in this era of i.c.s but has the advantage that virtually any transistor can be used.

In this application, component values are not critical allowing the circuit to be constructed from components at hand in the "spares" box as was the case with the prototype. With this cross-coupled arrangement of the transistors, an oscillator is produced where TR1 and TR2 alternate with each other to be on and off.

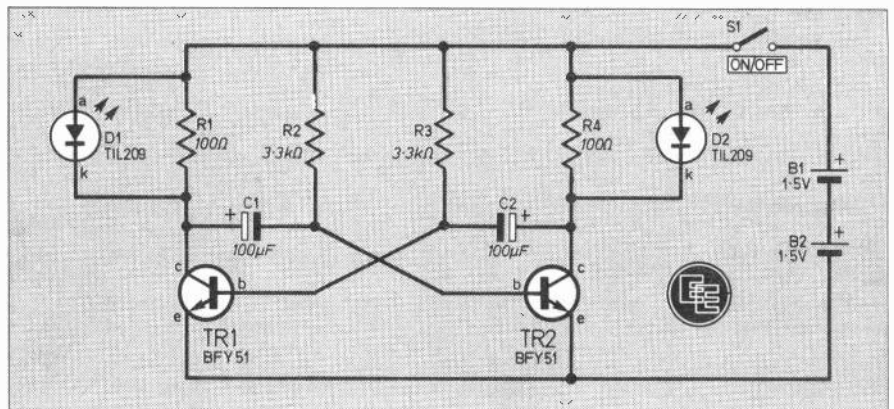

Fig. 1. The full circuit diagram for the L.E.D. Flasher.

As a result, one of the l.e.d.s will be on, the other off, at any one time. With the values of R2 and R3 as shown, the l.e.d.s will each flash for about one-third of a second. Decreasing the resistance of R2 and R3 to about 2 kilohms will give a rapid flash. Increasing the resistor values to about 4.7 kilohms will slow the flash cycle to about 1Hz, that is to say each l.e.d. will glow for about half a second.

Capacitors C1 and C2 could be anything from about 50μF upwards, although 100, 125 or 150μF are the values most likely to be found in the "spares box", all of which would work.

If the resistor of one of the timing circuits, R2 or R3, is of a different value, then the flash rate will be uneven, in other words, one l.e.d. will light for longer than the other.

COMPONENTS

Resistors

R1 100Ω
R2 3.3kΩ
R3 3.3kΩ
R4 100Ω

All ½W carbon ± 5% page 159

See
**Shop
Talk**

Capacitors

C1, C2 100μF 3V elect. (2 off)
(see text)

Semiconductors

TR1, 2 BFY51 or any general purpose silicon npn type with $I_c = 100\text{mA}$ or more
D1, D2 TIL209 light emitting diode (2 off)

Miscellaneous

S1 miniature s.p. on/off toggle.
B1, B2 1.5V size AA cell (2 off).
Stripboard, 0.1 inch matrix, size 11 strips × 28 holes; battery holder for two AA batteries; case, Vero type 202-21025K (2 off) or similar; battery clip.

CONSTRUCTION
starts here

ASSEMBLY

The prototype circuit board layout is shown in Fig. 2. There are no breaks to be made on the underside. Points to watch for when assembling the components are capacitor and l.e.d. polarities. The latter have their cathode (k) marked with a flat on the body, or in some cases a notch.

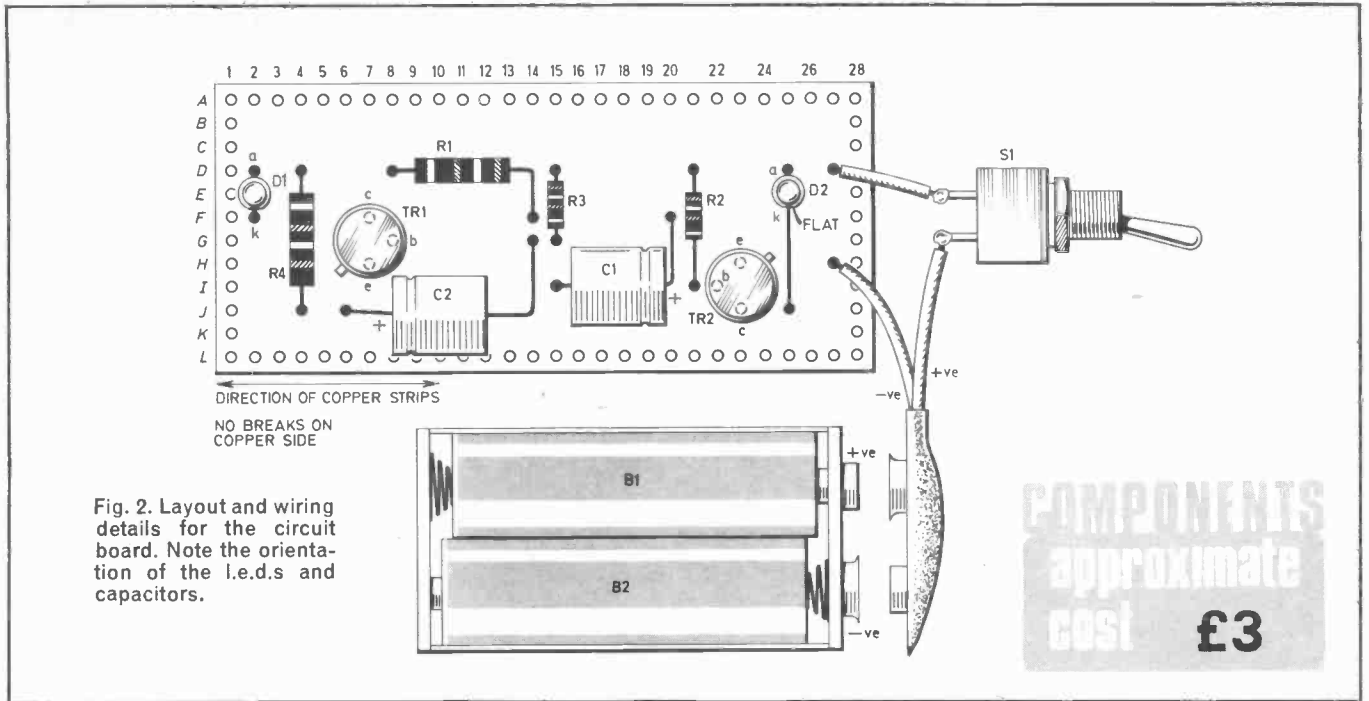
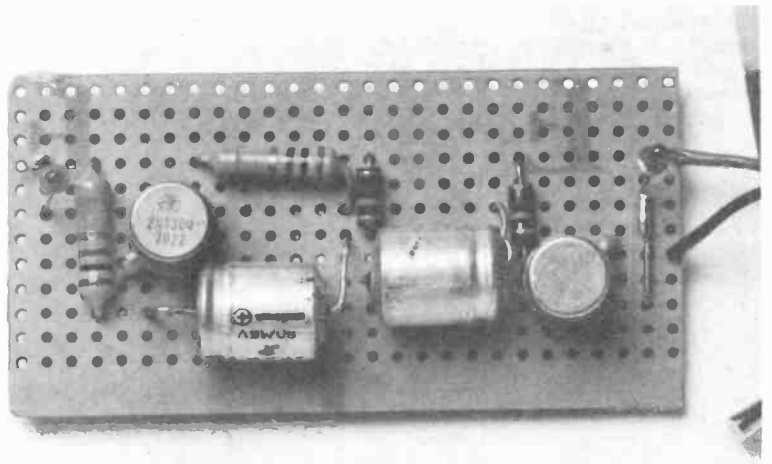

Fig. 2. Layout and wiring details for the circuit board. Note the orientation of the l.e.d.s and capacitors.

The case used and seen in the photograph was two major sections from the Vero General Purpose range. The two sections are held together by nails. The correct size nail produces a very secure connection. The on/off switch and battery holder reside in the case lower section; the battery holder is fixed with self adhesive foam.

The circuit board is tailored to be a close fit lengthwise into the upper case half, and holes are drilled in the case to allow the l.e.d.s on the board to protrude. Blu-Tak satisfactorily held the board in its place. A piece of paper or foam sponge can be sandwiched between the two case sections to eliminate the possibility of shorting the underside of the board with the batteries.



Close up view of the completed circuit board.

IN USE

Letraset was used to label the unit front panel which will be in accordance with its application at the time, RECORDING, MEETING IN PROGRESS, or just, DO NOT DISTURB. Countless other uses will come to mind no doubt. The unit is light enough to be attached to the door or whatever using Blu-Tak or Buddies.

The overall size of the sign and flashing l.e.d.s will be 70x50x40mm and is thus unlikely to annoy the owner of the house. The very fact that the l.e.d.s flash will make even such a small notice catch the attention of a would-be intruder. Whether they act accordingly depends on the people concerned. The important thing is of course to not use the sign too often, or people will learn to ignore the warning!

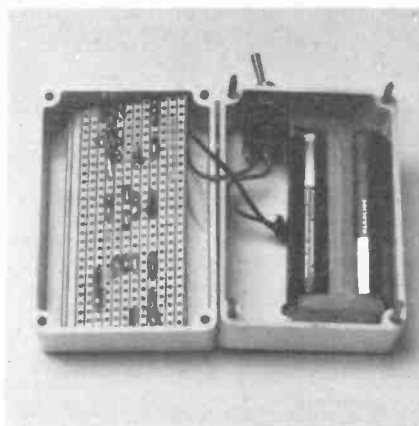

Shows the position of the board, switch and battery holder in the case.

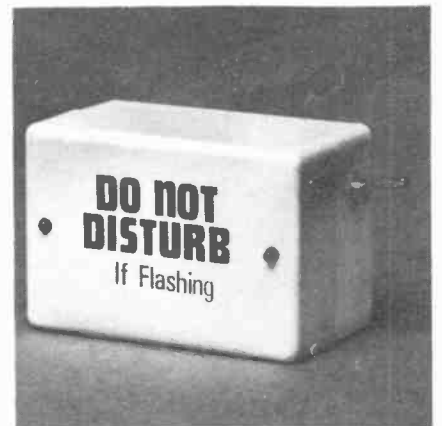

The completed and fully assembled prototype with Letraset varnish protected labels

SIMPLE TRANSISTOR/DIODE TESTERS

BY A.F. OLIVERA

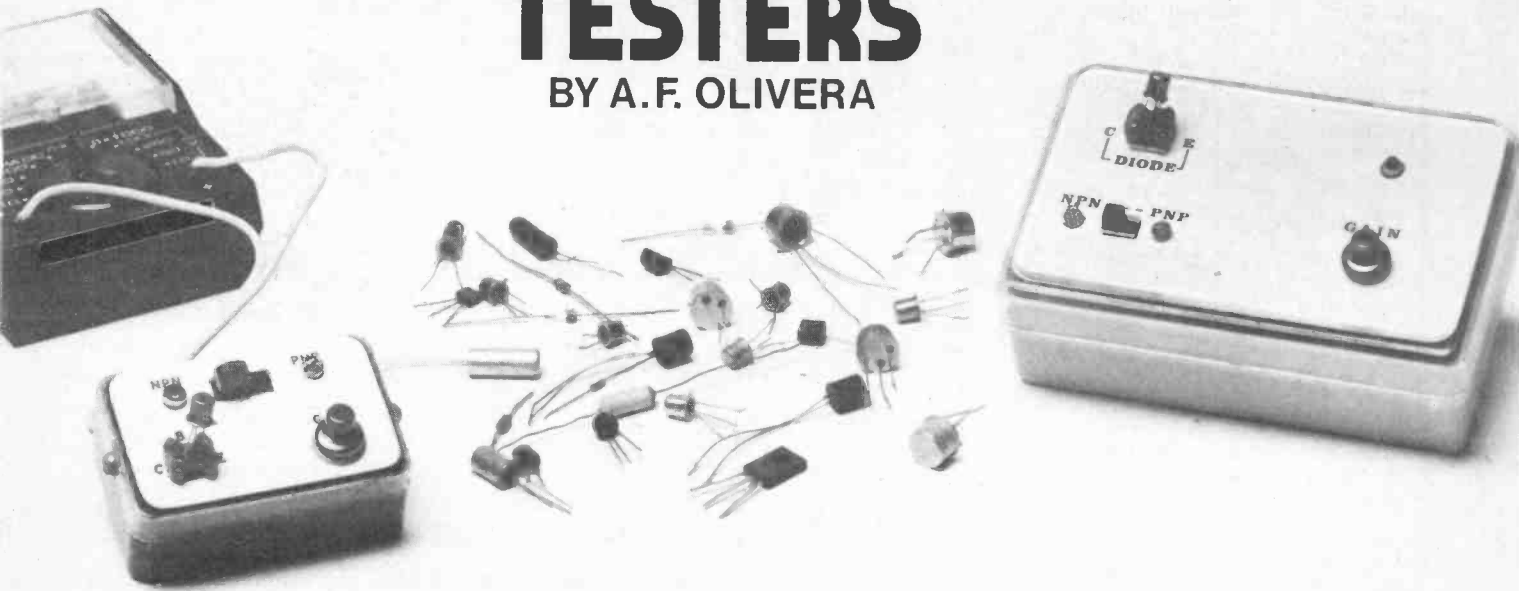

THIS article describes two very simple transistor testers, which can also be used to test diodes and identify their leads. They are of the go/no-go type, but should still prove very useful. Each uses only a handful of components and are thus very simple and inexpensive to build.

OPERATING PRINCIPLE

The testers work by detecting whether or not transistor action takes place. Fig. 1 shows the basic circuit with a *pnp* transistor. With *S1* open no current should flow between point *A* and point *B*. The transistor collector/emitter leakage current is normally so slight that it can be ignored. On closing *S1*, *R1* supplies bias current to the base of the transistor and turns it on if it is a functioning device, thus allowing a relatively large current to flow from *A* to *B*.

If the transistor is faulty, closing *S1* will make no difference to the

current flow measured. It is in the manner that this increase in current is indicated that the two testers described here differ, one using an ohmmeter and the other an l.e.d.

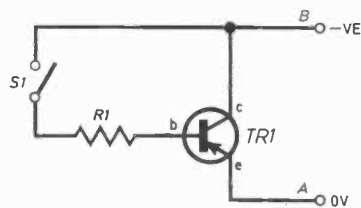

Fig. 1. The basic circuit.

OHMMETER VERSION

The ohmmeter version is marginally more efficient than the other, in that with practice one can "guess-timate" excessive leakage and the approximate gain of the transistor. It can thus be useful in selecting matched pairs. The full circuit diagram is shown in Fig. 2a.

When *S1*, the TEST switch is closed, base bias is applied to the transistor under test via *R1*. *S2* can reverse the supply polarity to allow the testing of both *pnp* and *npn* transistors.

This tester has been designed to be used in conjunction with a multimeter, which in addition to lending its meter also provides power for the tester.

Multimeter resistance ranges are generally connected internally in such a way that the black (negative) socket is at a positive potential relative to the red socket, and the tester leads must therefore be connected to the plugs as shown in Fig. 2a, i.e. PL1 black, PL2 red.

USING OHMMETER VERSION

The red and black plugs are connected to the corresponding sockets on the multimeter, which must be set to a resistance range. The NPN/PNP switch (*S2*) is set as required by

Fig. 2. Circuit diagrams for the Transistor/Diode Testers (a) Ohmmeter version and (b) the l.e.d. (light emitting diode) version.

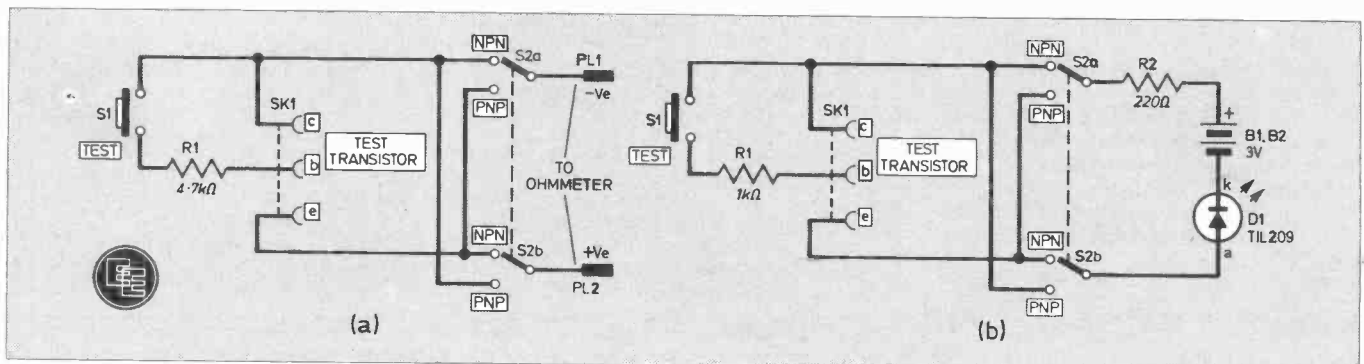

the transistor under test and the transistor inserted in the holder. At this stage the meter will indicate the transistor collector/emitter leakage, which in most cases will be negligible for a "good" device.

The TEST switch (S1) is then pressed and if the transistor is serviceable the meter pointer will be deflected appreciably—the bigger the deflection, the higher the gain of the transistor.

L.E.D. VERSION

The l.e.d. version should be of greater interest to readers who do not own a multimeter, since it is fully self-contained with its own power supply. The circuit diagram is shown in Fig. 2b. A battery and an l.e.d. replace the multimeter in the first version; R2 is a current limiting resistor. The rest of the components perform the same functions as in the first version.

USING THE L.E.D. TESTER

The transistor to be tested is inserted in the holder, and the NPN/PNP switch is set as necessary. If the

l.e.d. lights up at this stage, the transistor probably has a collector to emitter short and is unserviceable. It should be noted, however, that germanium power transistors normally have very high leakage current—enough for an appreciable glow to be seen in the l.e.d. The TEST switch (S1) is then pressed, and if the transistor is serviceable the l.e.d. lights up.

TESTING DIODES

The diode-testing procedure is the same for both versions. The diode to be tested is connected between "c" and "e" of the transistor holder, and the NPN/PNP switch is changed over. If the diode is serviceable the meter pointer or l.e.d., as the case may be, will react in only one of the switch positions.

The position of the switch at which the reaction is seen indicates the polarity of the diode: if the reaction takes place when the switch is moved to the PNP position the anode terminal of the diode is that connected to "e" of the holder. If, however, the reaction takes place when the switch

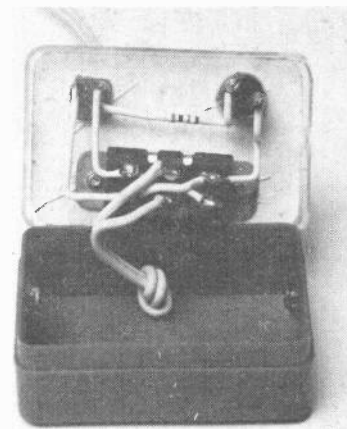

The finished ohmmeter version.

is set to the NPN position, then the anode terminal is that connected to "c".

ASSEMBLY

Assembly details for both units are shown in Fig. 3. The layouts are not critical in any way and may therefore be changed to suit requirements.



COMPONENTS
approximate
cost **£2.00**
each

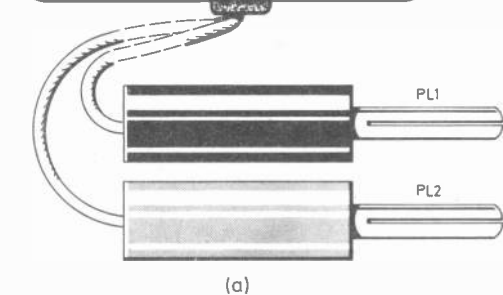
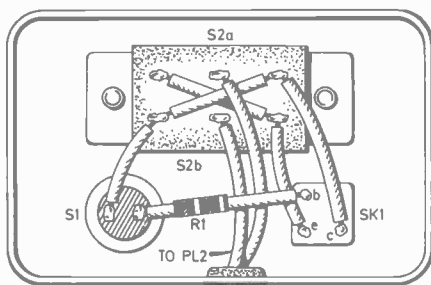

Fig. 3.(a) Component layout and wiring for the ohmmeter version.

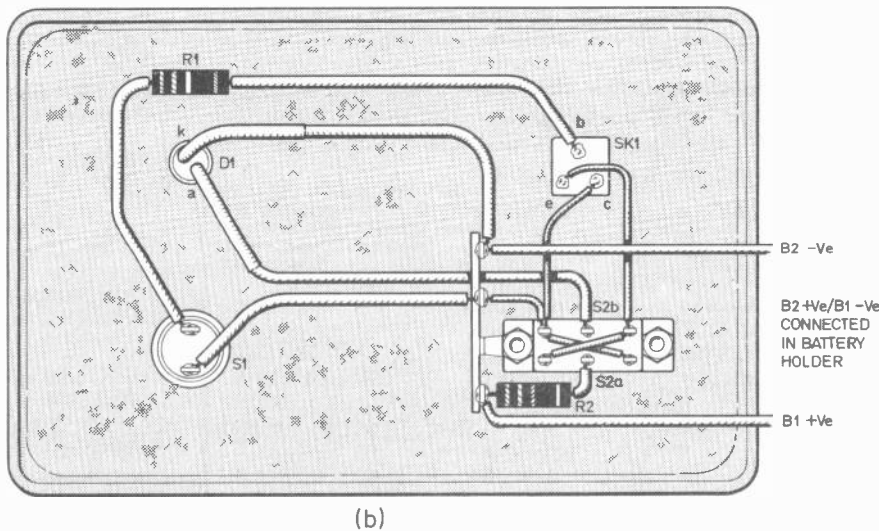

Fig. 3. (b) Layout of components and interwiring for the l.e.d. version. The tag strip is mounted under one of the polarity switch fixing screws.

COMPONENTS

OHMMETER VERSION

R1 4.7kΩ ½W carbon ± 5%
S1 Miniature push-to-make, release-to-break switch
S2 Miniature d.p.d.t. slide switch
SK1 Transistor holder
PL1 4mm banana plug (red)
PL2 4mm banana plug (black)
Plastic case (see text); rubber grommet; connecting wire—extra-flexible type preferred.

L.E.D. VERSION

R1 1kΩ } both ½W carbon ± 5%
R2 220Ω }
D1 TIL209 light emitting diode
S1 miniature push-to-make, release-to-break switch
S2 miniature d.p.d.t. slide switch
SK1 transistor holder
B1, B2 1.5volt cells size AA (2 off)
Battery holder; tag-strip, 4-way with mounting foot; plastic case (see text).



ABSONGLEN LTD.

ANNOUNCE THE

MINIBENCH* II

Special Introductory price!



DO YOU EVER NEED A FEW MORE HANDS?

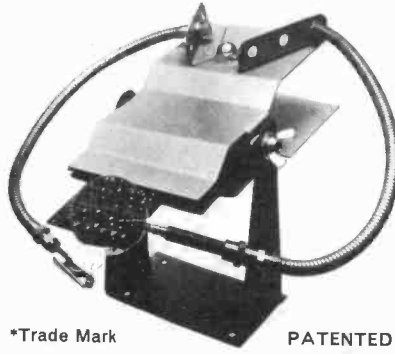

*Trade Mark PATENTED

- ★ Just a squeeze to clamp or release circuit board.
- ★ Adjustable minimum jaw aperture
- ★ Jaws flip over for work on either side of circuit board
- ★ Rubber lined jaws for circuit board protection & maximum grip
- ★ Single wing nut controls jaw attitude and friction setting
- ★ Crocodile clips mounted on flexi-arms hold components exactly where needed
- ★ Crocodile clip can be used as a heat shunt
- ★ Lens similarly mounted is ideal for close work and spotting those solder bridges
- ★ Flexi-arms keep station with circuit board
- ★ A typical configuration would include two Flexi-arms with clip and one with lens
- ★ Attractive stove-enamel two-tone finish
- ★ Built to last a lifetime!

Post Coupon today:

Name

Address

Postal Code

Please supply ONE Minibench II £12.95

Flexible Arms with clips @ £ 4.75†

Flexible Arms with lens @ £ 5.75†

Postage and Packing £2.25

Cheque/Postal Order enclosed for £

†Price applicable to Minibench purchasers only.

Messrs. **ABSONGLEN LIMITED,**
(E.E.3.) THE FORGE, STAPLOW,
LEDBURY, HEREFORDSHIRE HR8
1NP.

AND NOW A DIMMER THAT MAKES TOUCH DIMMERS OBSOLETE

Two years ago TK Electronics launched a touchdimmer kit, the TD300K, which made knob controlled dimmers obsolete. This was such a great success that many magazines and more retailers soon produced similar designs. SO THAT OTHERS MAY FOLLOW, TK have designed a touch dimmer kit with an Infra Red Remote Control, enabling you to switch and control the brightness of your lights from the comfort of your armchair etc. (as well as manually by touching the frontplate or by using the TDE/K extension kit).

As with all our kits, these units come complete with all components, including RFI suppression, frontplate, a neon to help you find the switch in the dark and a neat box for the transmitter. The plastic frontplate has no metal pads to touch, ensuring complete safety and enabling the plate to be covered with a decorative finish to blend with your room decor.



We have designed the light dimmer unit to fit a standard wall box, the transmitter to fit your hand and the price to fit your pocket.

In two years' time everyone will be selling remote control dimmers but you can have your TDRK300K kit NOW for only £14.30 for the dimmer unit and £4.20 for the transmitter. For the more athletic of you, the TD300K is still available at £6.50 and the TDE/K at £2.00.

DON'T FORGET to add 40p P&P and 15% VAT to your total purchase.



NEW REMOTE CONTROL KITS

- MK6 — Simple Infra Red Transmitter—A pulsed infra red source which comes complete with a hand held plastic box. Requires a 9V battery. £4.20
- MK7 — Infra Red Receiver—Single channel, range approximately 20ft. Mains powered with a triac output to switch loads up to 500W ac, can be modified for use with 5-15V dc supplies and transistor or relay outputs. £9.00
- *Special Price* MK6 and MK7 together. Order as RC500K £12.50
- MK8 — Coded Infra Red Transmitter—Based on the SL490, the kit includes two IR LEDs, measures only 6 x 2 x 1.3 cms. Requires a 9V (PP3) battery. £5.90
- MK9 — 4 Way Keyboard—for use with the MK8 kit, to make a 4-channel remote control transmitter. £1.90
- MK10 — 16 Way Keyboard—for use with the MK8 kit, to generate 16 different codes for decoding by the ML926 or ML928 receiver (MK12 kit). £5.40
- MK12 — 16 Channel IR Receiver—for use with the MK8 kit with 16 on/off outputs which with further interface circuitry, such as relays or triacs, will switch up to 16 items of equipment on or off remotely. Outputs may be latched or momentary depending on whether the ML926 or ML928 is specified. Includes its own mains supply. Size 9 x 4 x 2 cms. excluding transformer. £11.95

ALL COMPONENTS ARE BRAND NEW AND TO SPECIFICATION. ADD VAT AT CURRENT RATE TO ABOVE PRICES. 50p P&P MAIL ORDER — CALLERS WELCOME BY APPOINTMENT. *Send SAE with all enquiries.



TK Electronics

(EE), 11 BOSTON ROAD,
LONDON W7 3SJ. TEL. 01-579 9794



24 HOUR CLOCK/APPLIANCE TIMER KIT



Switches any appliance up to 1KW on and off at present times once per day. Kit contains: AY-5-1230 IC, 0.5" LED display, mains supply, display drivers, switches, LEDs, triac, PCBs & full instructions. £14.90

CT1000KB with white box (56/131 x 74mm) £17.40

Ready Built £22.50

D.V.M. THERMOMETER KIT

Based on the ICL 7106. This kit contains a PCB, resistors, presets, capacitors, diodes, IC and 0.5" liquid crystal display. Components are also included to enable the basic DVM kit to be modified to a Digital Thermometer using a single diode as the sensor. Requires a 3mA 9V supply (PP3 battery). £19.50

DISCO LIGHTING KITS

Each unit has 4 channels (rated at 1KW at 240V per channel) which switch lamps to provide sequencing effects, controlled manually or by an optional opto-isolated audio input. £14.60

DL1000K
This kit features a bi-directional sequence, speed of sequence and frequency of direction change being variable by means of potentiometers. Incorporates master dimming control. £14.60

DL21000K
A lower cost version of the above, featuring unidirectional channel sequence with speed variable by means of a preset pot. Outputs switched only at mains zero crossing points to reduce radio interference to minimum. £8.00

Optional Opto Input DLA1 60p

LEDs



- 0.1" Red or 0.2" 9p
- 0.1" Green or 0.2" 12p
- 0.1" Yellow 12p
- 0.2" Yellow 12p
- 0.2" clips 3p
- Rectangular Red 18p
- Rectangular Green 20p
- Rectangular Yellow 21p

MINI TRANSFORMERS



Standard mains primaries 240V a.c. 100mA secondaries

8-0-8V 80p
9-0-9V 85p
12-0-12V 90p

TRADE ENQUIRIES WELCOME

CMOS

4000	17	4019	42	4069	19
4001	18	4023	22	4070	19
4002	18	4025	21	4071	18
4007	17	4026	1-30	4077	26
4011	19	4027	40	4081	20
4012	17	4028	50	4093	54
4013	38	4040	80	4501	24
4015	75	4049	38	4511	90
4016	35	4050	40	4514	1-80
4017	70	4060	1-80	4516	1-80

INTEGRATED CIRCUITS



555 Timer 21u
741 Op. Amp. 19p

- AY-5-1230/2 Clock/Timer £2.60
- AY-5-1224 Clock £4.50
- AY-3-1270 Thermometer £8.20
- ICL7106 DVM (LCD driver) £7.00
- LM377 Dual 2W Amp. £1.45
- LM379S Dual 6W Amp. £3.50
- LM380 2W Audio Amp. 80p
- LM382 Dual low noise Preamp. £1.00
- LM386 250mW low voltage Amp. 75p
- LM1330 Fluid Level Detector £1.50
- LM2917 f-v Converter (14 pin) £1.60
- LM3909 LED Flasher/Oscillator 80p
- LM3911 Thermometer £1.20
- LM3914 Dot/Bar Driver £2.10
- MM74C911 4 digit display controller £6.50
- MM74C915 7 segment-BCD converter £2.90
- MS566B Touchdimmer £4.50
- SL440 AC Power phase control £1.75
- SN76477 Complex Sound Generator £2.52
- TBA800 5W Audio Amp. 68p
- TBA810AS 7W Audio Amp. £1.00
- TDA1024 Zero Voltage Switch £1.20
- TDA2020 20W Audio Amp. £2.85
- ZN1034E Timer £1.80

All ICs supplied with data sheets. Data Sheets only. 10p each device.

TRIACS



- 400V Plastic Case (Texas)
- 3A 49p
- 8A 58p
- 16A 95p
- 6A with trigger 80p
- 8A isolated tab 85p
- Diac 18p

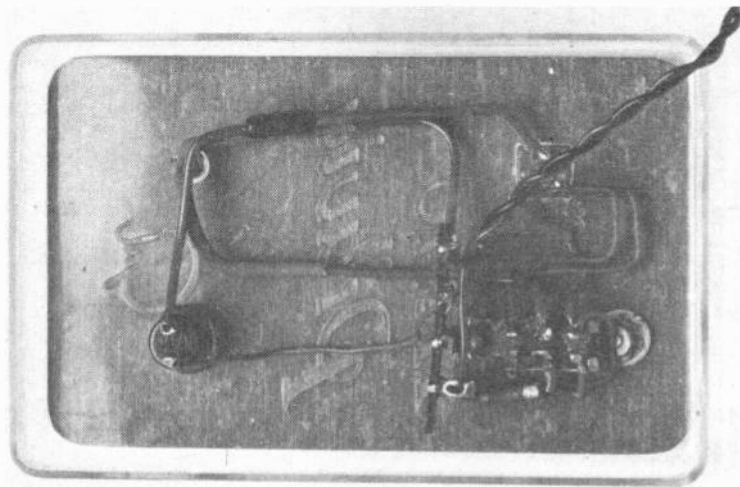

The completed i.e.d. version. The leads from the tagstrip "running off" the photograph at the top right go to the battery holders.

In the prototype ohmmeter version, a plastic box which originally contained a spare set of contact points for the car was used with the components mounted on the lid underside. The measurements were 55×35×20 mm.

A plastic soap dish measuring 95×60×30mm was found to be a suitable container in which to house the i.e.d. version. All the components except the battery were mounted on the lid. The tag strip was fitted to one of the screws holding the polarity switch to

facilitate wiring. A small piece of self adhesive plastic foam will hold the battery container firmly in place on the case lower section.

Construction is straightforward, the only points to watch for being orientation of the i.e.d. and the labelling of the finished units. The transistor sockets are glued in place. Letraset on card fitted beneath thin Perspex for protection, produces a neat and durable finish. This method was used with the i.e.d. version. Alternatively a piece of white laminated with Letraset protected by varnish could be used as was on the other prototype. In both instances, the panels were held to the case rails through the polarity switch fixings. □

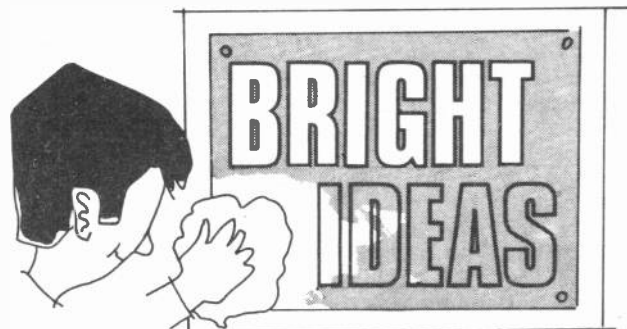
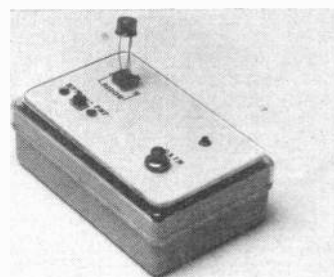

Readers' Bright Ideas; any idea that is published will be awarded payment according to its merit. The ideas have not been proved by us.

FUSE WIRE BIT

I have devised a way of making very fine soldered joints without having to pay a considerable amount of money for a fine soldering iron bit. I use a short piece of 13A or 15A fuse wire. This is cleaned using emery paper. The bit of the iron is also scraped clean to make a good heat-transference interface. The wire is then bound to the bit using Constantan wire. The fuse wire is then cut at a slant at the tip and is about 8mm long.

Kanak Patel,
Fosse Estate, Leicester

PAPER CLIP BIT

When drilling a home-made p.c.b., a straight section cut from a paper clip could be used as a drill bit. The piece is cut and filed to a point. When the bit becomes bent or blunt it can easily be replaced with another inexpensive "bit."

Kevin Lawe (aged 13 years),
Dublin, Eire

NEEDLE DRILLS

Having got rather tired of breaking and buying very small drills which are rather expensive I decided on an alternative. I obtained several darned needles of various sizes, nipped off the tip and the eyes (be careful of these pieces). I then filed the end of the needle four sided as square as I could; these act as the cutting edges, tapering to a point at the tip but not too fine a point

I use a lot of Formica for my projects and these "drills" go through this quite easily, and even 18 s.w.g. aluminium. They are also useful for making pilot holes for larger drills.

E. Vaughan,
High Wycombe, Bucks

MAGNETS IN THE WORKSHOP

I am always losing small nuts, bolts and screws. Putting them in a box helps but this is sometimes knocked over, and I spend a long time looking for them. Placing a magnet in the box keeps all the nuts, bolts and screws together, even if knocked over.

I also keep my small screwdrivers magnetised with magnets from loudspeakers as well because when I had to screw in a screw in a restricted area I could not hold the screw in position. The magnetised screwdriver does this without difficulty.

T. Lee,
Queensborough, Isle of Sheppey

DOUBLE-SIDED FEET

I have found that double-sided self-adhesive foam strips e.g. Sellotape sticky fixers, make good self-adhesive feet for boxes. If one pad is cut in half and the backing of one side is removed then it can be pressed firmly onto a rubber sheet. For this I used an old inner tube. You can carefully cut around the pad with scissors, remove the protective backing of the other side and press firmly onto the case. These have been found to work as well as shop-bought sticky feet.

D. Cockburn,
Middleton, Manchester

I.C. UNIBOARDS

SIMPLE INTEGRATED CIRCUIT DESIGNS

MINI SIREN

No. 4

BY A. R. WINSTANLEY

THIS MONTH'S Uniboard project is a Mini Siren which can produce three distinctive sounds—twin tone, U.S. police-car style siren and a “bleep” alarm signal. The unit makes a good alarm tone generator and perhaps could form a novel toy for a youngster with plenty of imagination.

An integrated circuit type NE556 is used. This i.c. consists of two individual timers similar to the NE555 used in the Uniboard No-Entry Indicator project. In fact the electrical characteristics and method of operation of each timer in the NE556 are identical to those of a normal NE555.

CIRCUIT

The circuit diagram of the Mini Siren is shown in Fig. 1. Integrated circuit IC1 is the NE556 timer chip and this has been shown in the circuit diagram as IC1a and IC1b. Each half of the i.c. can be considered to be just like a standard 555 timer.

One half of the i.c., IC1b, is wired as a slow-running astable multivibrator. It oscillates at approximately 3Hz, and the square wave output from this is obtained at pin 9. More detailed information regarding the function of the astable is given in the “No Entry Indicator”, project No.1.

The other half of the i.c., IC1a, is another astable, this time running at about 220Hz, in fact at an audio frequency. This frequency can naturally be changed as required by altering the timing components R1, R2 and/or C1.

CONTROL VOLTAGE

An electronic alternative to this is to impose a voltage at pin 3 of IC1a. This pin is the control voltage input and provides a means of altering the frequency of operation without having to physically change the value of a timing component.

The slow square wave from IC1b is coupled to the control voltage pin of IC1a through S1a, a rotary switch which selects the function of the Mini Siren: bleep, twin-tone or U.S. siren.

EFFECTS

If S1a is set to “twin-tone”, the output from IC1b is fed straight

through to the control voltage terminal on IC1a. This results in a rapid decrease and then increase in the frequency of oscillation of IC1a. Hence a two-tone effect is created.

By moving the switch to the “U.S. siren” function capacitor C3 is brought into circuit by S1b. In effect this converts the output of IC1b from a square wave into an approximate sawtooth. The sawtooth then passes through to the control voltage terminal of IC1a.

The audio signal from IC1a is then modulated, or varied in sympathy with the sawtooth to produce a characteristic “whooping” tone similar to many American police-car sirens.

With S1 in the “bleep” position, IC1b imposes a 3Hz square wave on pin 4 of IC1a. This is the reset terminal of IC1a. (The reset pin of IC1b has been connected straight to the positive rail, incidentally, because it is not needed.)

By taking pin 4 down to 0V the i.c. is disabled. This means that the astable is prevented from oscillating. When the output from IC1b goes high again, the audio oscillator is enabled again. The overall result is that IC1a is repeatedly prevented from oscillating, producing a “bleeping” tone.

OUTPUT

The audio output from the whole circuit is taken from pin 5 on IC1a and this drives LS1 to generate an audible signal. The alarm tone is quite loud, suitable for burglar alarms and similar applications.

Measurements on the prototype showed that the siren draws about 40mA at 9V, and under 100mA when a 12V rail is used.

A 3.5mm jack socket can be used to connect up an external power supply. You may wish to use the Mini Siren in conjunction with another Uniboard project like the Burglar Alarm

Fig. 1. Complete circuit diagram of the Mini Siren.

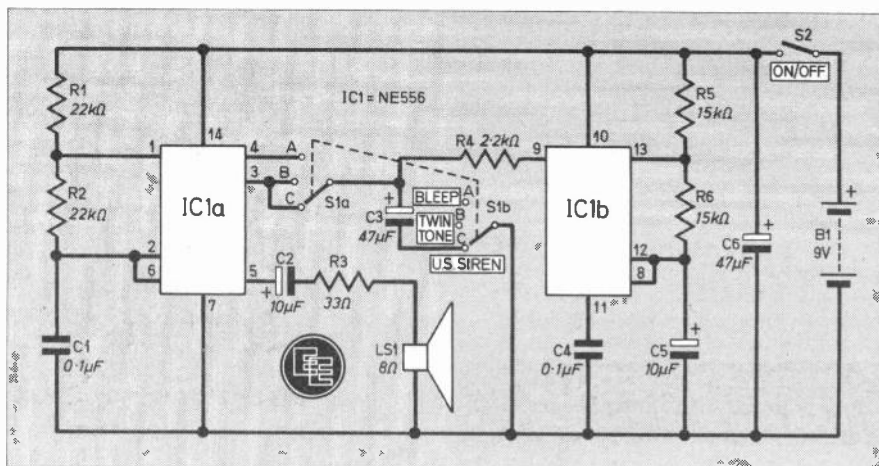

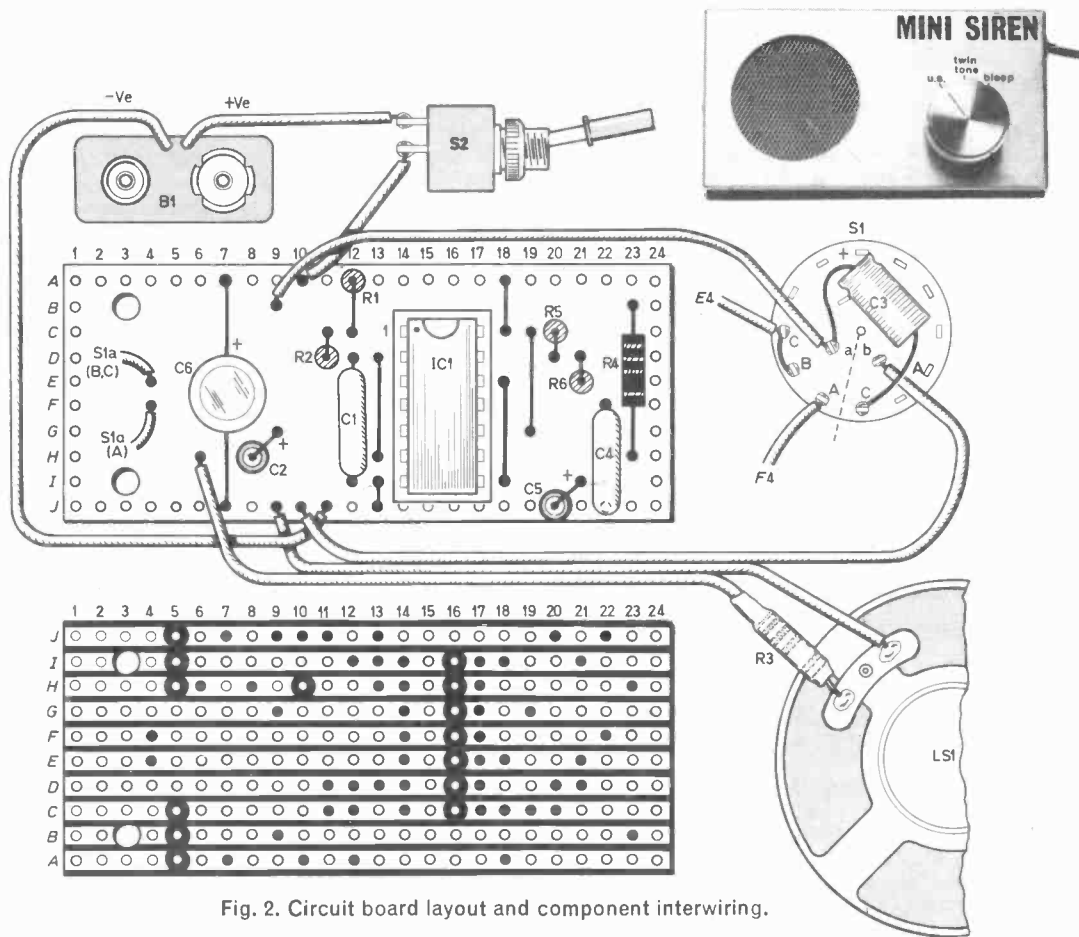

Fig. 2. Circuit board layout and component interwiring.

COMPONENTS

Resistors

R1	22k Ω	R4	2.2k Ω
R2	22k Ω	R5	15k Ω
R3	33 Ω	R6	15k Ω

All $\frac{1}{4}$ W carbon $\pm 5\%$

Capacitors

C1	0.1 μ F C280 polyester
C2	10 μ F 25V elect.
C3	47 μ F 25V elect.
C4	0.1 μ F C280 polyester
C5	10 μ F 25V elect.
C6	47 μ F 25V elect.

Semiconductors

IC1 NE556 dual timer i.c.

Miscellaneous

- S1 2-pole, 3-way rotary
- S2 s.p.s.t. toggle
- LS1 8 ohm miniature loudspeaker
- B1 9V battery, PP3 or PP9 size (see text)

Aluminium case, 130 x 70 x 40mm; 0.1 inch matrix stripboard, 10 strips by 24 holes; 14 pin d.i.l. socket; battery clip; knob; speaker mesh; 6BA nuts, bolts and spacers (for mounting circuit board) (2 off each); connecting wire.

Guidance only
Approx cost
See page 159

£8.00
complete

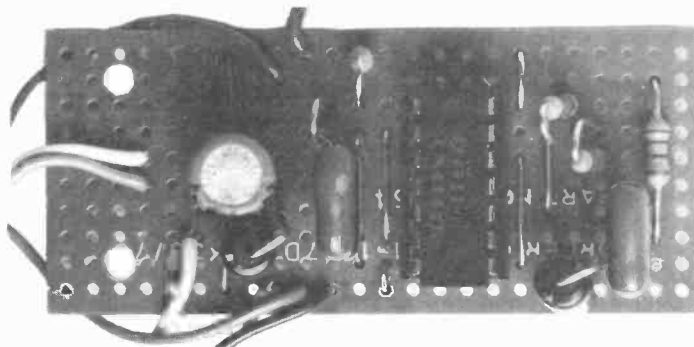

Top view of circuit board.

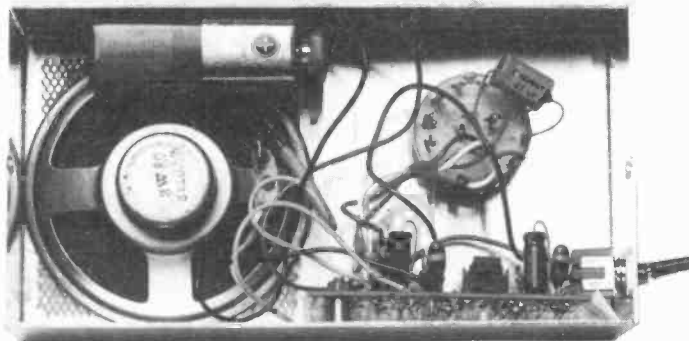

Interior of completed unit.

or the Opto-Alarm. This is easily accomplished. Simply wire the Mini Siren in parallel with the audible warning devices (or in place of them) used in the projects.

Beware when using a battery. Because of the high current consumption a PP9 will probably give the most economical service, although the PP3 size is most compact. A battery clip of the appropriate size will of course be required.

CASE

The Mini Siren can be built into any type of case or box, whether metal, plastic or home-made. The prototype was contained within an aluminium box measuring 130×70×40mm and this was just wide enough to hold the loudspeaker.

The diagram in Fig. 2 illustrates how the various components are arranged on 0.1 inch matrix strip-board measuring 10 strips × 24 holes. It is best to use a 14-pin d.i.l. socket to carry IC1 and this should be soldered in after making the fourteen breaks in the copper strips.

The i.c. is not a CMOS type and no special handling precautions are needed. Insert the i.c. the right way round into its socket after soldering

in all the link wires, resistors and capacitors.

You will see that C3 is mounted on the terminals of the rotary switch and also R3 is soldered onto one of the loudspeaker connectors.

Regarding the rotary switch, a 2-pole 3-way type is not generally available and therefore a 4-pole 3-way version must be used. Half of the switch is disregarded.

LOUDSPEAKER

The loudspeaker used in the author's prototype was an eight ohm 0.5 watt type measuring about 55mm diameter. In the case a large cut-out was made with a tank cutter, and then a piece of aluminium mesh was glued behind the resulting hole.

The speaker was then stuck down with a fairly generous application of glue around the rim. Try not to get any glue onto the loudspeaker cone itself.

If you do not have a tank cutter, you could drill a regular pattern of holes in the front panel. Alternatively, you can make a large cut-out by drilling a ring of holes and then punching out the middle.

The edge of the hole can then be filed with a half round file until a smooth finish is achieved. In practice

it is not easy to achieve a presentable finish with this method.

FINISHING OFF

Dry transfer lettering can be applied as required to the front panel. The prototype was finished off by fixing a large aluminium knob onto the spindle of the rotary switch.

Once construction is finished check all wiring for errors or omissions. Take a look at the stripboard and check for dry joints or whiskers of solder bridging neighbouring strips.

USING THE SIREN

No setting up is needed so connect up a battery and switch on. It is important to wire up the power the right way round. This can come from a 9V Power Pack if a battery is not available.

Then you should hear the appropriate alarm tone depending on the position of S1. If this is satisfactory, then construction is complete and the unit is ready to use.

Readers who like experimenting can try altering timing components R1, R2 or C1; R5, R6 or C5; R4 or C3 to see what effect this has on the sound produced. By doing this you can alter the tone of the alarm, the frequency of the bleeps and so on. ☐

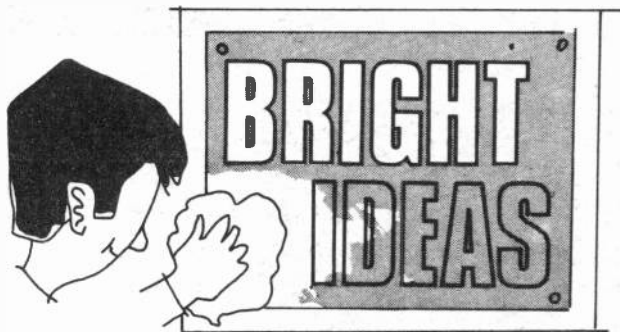

Readers' Bright Ideas; any idea that is published will be awarded payment according to its merit. The ideas have not been proved by us.

PENCIL PROBE

I have discovered an inexpensive way of making probes for equipment. All that is needed to make one probe is a pencil (preferably the HB or B type). Just cut off the wood from the top with a blade or carving knife leaving the lead (graphite) and tie the wire around it. The wire can be secured to it by encapsulating in plastic resin or with a crocodile clip.

I have been using these probes for the *E.E. Continuity Tester* in the January '80 issue and on other pieces of equipment for many months and find its performance excellent! A series resistance of about 5 ohms is introduced with this probe which may need to be accounted for in some measurements.

Pankaj Sharma (aged 15 years),
Perivale,
Middlesex

BOOK REVIEWS

AMATEUR RADIO TECHNIQUES

Author	Pat Hawker G3VA
Price	£5.00 Paperback (£6.08 by post from RSGB worldwide)
Size	246 × 184 368 pages
Publisher	Radio Society of Great Britain
ISBN	0 900612 51 7

As the preface states, this is basically an ideas book and a source book and is intended to supplement standard handbooks. Some 50 new pages are included in this latest edition—the popularity of this publication is indicated by its reissue every two years since the second edition.

The material has largely been collected from the Technical Topics columns in *Radio Communication*, the Journal of the RSGB, and is arranged in nine chapters: Semiconductors, Components and Construction, Receiver Topics, Oscillator Topics, Transmitter Topics, Audio and Modulation, Power Supplies, Aerial Topics, and Fault-finding.

A number of "quick guides" have been incorporated in certain parts of the book to provide concise introductions to more recent devices and techniques. They cover (in Chapter One) topics such as Integrated Circuits, Digital Electronics, VMOS Power f.e.t.s, Microprocessors and (In the Audio and Modulation Chapter) Pulse Modulation, RTTY and SSTV.

There are over 800 diagrams, some 600 of these are circuits. The author's profound practical knowledge of the subject is obvious, and he has interlaced his text with comments on various amateurs' experiences and suggestions as well as references to published information in manufacturers' literature or in periodicals.

F.E.B.

ELECTRONIC GAMES

ATARI

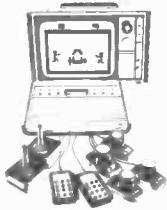

SPECIAL PRICE
£86 + VAT

SPACE INVADERS



HAND HELDS + CARTRIDGES
ATARI - ACETRONIC
PRINZTRONIC
RADIOFIN - DATABASE etc.
We keep a full range!
Send for cartridge lists stating which machine you own.

INTELLIVISION MATTEL



£173.87 + VAT

Available August 1980
This is the most advanced TV game in the world.
Expandable next year into a full microcomputer.
COLOUR CATALOGUE AVAILABLE WITH DETAILS ON ALL THE CARTRIDGES

BRIDGE

COMPUTER



- ★ Plays 1/2/3 or 4 Hands
- ★ Problem Mode
- ★ Audio Feedback
- ★ Instant Response
- ★ Auto scorekeeping

DRAUGHTS

COMPUTER

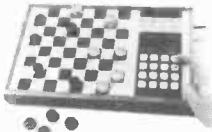

- ★ Solves Problems
- ★ Rejects illegal moves
- 2 level machine £43 + VAT
- 4 level machine £77.78 + VAT

CHESS



Send for further details.

COMPUTERS

NEW RANGE AVAILABLE AUGUST 1980
We specialise in computer chess machines & stock over 13 different models from £20 to £300

BACKGAMMON

COMPUTERS



OMAR 1
OMAR 2
CHALLENGER
GAMMONMASTER

From £38 to £108. Send for further details.

LEISURE

- ★ CHEAP TV GAMES
- ★ TELEPHONE ANSWERING MACHINES
- ★ AUTO DIALLERS
- ★ CALCULATORS
- ★ DIGITAL WATCHES
- ★ PRESTEL
- ★ HAND HELD GAMES

TELETEXT



RADIOFIN
TELETEXT
Add on Adaptor

£173 + VAT

24 TUNE DOOR BELL

£13.65 + VAT



FREE CATALOGUE

For a free copy of our 32 page catalogue, send a 12p stamp to Silica Shop Ltd or Telephone 01-301 1111

MAIL ORDER SERVICE - Free postage & Packing

TELEPHONE & MAIL ORDERS - accepted on:
Access ★ Barclaycard ★ American Express ★ Diners Club

CALLERS WELCOME - at our shop in Welling - Demonstrations daily
Open from 9am-5pm Mon-Sat (9am-1pm Wed)

GUARANTEE - Full 12 months + After Sales Support!

We have comprehensive brochures on all products. Please let us know what you are interested in and we will send you detailed brochures AND our own 32 page catalogue covering most games on the market.

SILICA SHOP LTD

1-4 The Mews Dept. EE3
Hatherley Road
Sldcup, Kent DA14 4DX
Tel: 01-301 1111



5HZ TO 100MHZ

TOMORROW'S TOOLS TODAY

CONTINENTAL SPECIALTIES CORPORATION



C.S.C. (UK) Limited Dept. 4D
Unit 1, Shire Hill Industrial Estate,
Saffron Walden, Essex. CB11 3AQ
Telephone: Saffron Walden (0799) 21682
Telex: 817477

Everyday Electronics, March 1981

Instant frequency indication from 5Hz to 100MHz; no range selection problems; a brilliant 8-digit LED display; mains or battery operation; an accuracy of 4 parts per million ± 1 count; and totally automatic operation - all this for only £77.55* with CSC's new Max-100 frequency counter.

Just take a look at our spec. Where else could you find anything similar at the price?
*Frequency range 5Hz - 100 MHz *Input impedance 1M shunted by 10pF *Sensitivity 30mV from 1KHz up to 50MHz; 120mV r.m.s. over full frequency range *Timebase accuracy ± 4 parts in 10⁶ (from 5 to 45°C) *Maximum aging rate 10 parts in 10⁶ per year *Over-frequency indication *Low-battery-power alarm *Operates from dry or rechargeable cells, an external 7.5 to 10VDC supply, or a car battery (via an adaptor) *Dimensions: 45 x 187 x 143mm *Options: 12V adaptor; battery eliminator; r.f. antenna, low-loss r.f. tap, carrying case.

Fill in the coupon for further details . . .

*price excludes post, packing and VAT

C.S.C. (UK) Limited, Dept. 4D, Unit 1, Shire Hill Industrial Estate, Saffron Walden, Essex CB11 3AQ.

MAX 100	FREQ. COUNTER	Unit price inc P&P 15% VAT	£90.91	Qty Rent	
---------	---------------	----------------------------	--------	-------------	--

Name _____
Address _____

I enclose cheque/P.O. for £ _____ or debit my Barclaycard/Access/
American Express card no. _____ exp. date _____

FOR IMMEDIATE ACTION - The C.S.C. 24 hour, 5 day a week service.
Telephone (0799) 21682 and give us your Barclaycard, Access, American
Express number and your order will be in the post immediately.

For FREE catalogue tick box

BOOK REVIEWS

ROBOTS IN INDUSTRY

Author G. L. Simons
Price £10.00 Limp
Size 210 × 145mm 216 pages
Publisher The National Computing Centre
ISBN 0 85012 236 8

THIS is a good up-to-date introduction to the subject for the general reader. The economic and social consequences of robot developments are discussed. We learn that most advances are being made in the US and Japan, the UK currently possessing 2 per cent of the world's robot population.

Other chapters describe the mechanical features of a robot; sensory systems; programming, software and control; applications and a brief look to the future. There are descriptions of many commercial robots and the kind of tasks they are intended to perform in industry, and problems still to be solved are discussed.

Quite "clever" robots can now be devised with advanced sensory systems, thanks to microprocessors and other electronic techniques. Video cameras provide visual facilities. The touch sense has been greatly improved of late; an interesting system described is a planar matrix artificial skin sensor consisting of a printed circuit on which a series of sensitive points have been isolated. The transversal impedance of a conductive coating on the structure varies according to the pressure exerted and so a variation in current or voltage is obtained.

An extensive bibliography is included and will be valuable for those wishing to pursue their studies of robots.

F.E.B.

THE ART OF ELECTRONICS

Authors Paul Horowitz and Winfield Hill
Price £35.00 Hardcover £12.50 Paperback
Size 250 × 175mm 716 pages
Publisher Cambridge University Press
ISBN 0 521 23151 5 (Hardcover)
0 521 29837 7 (Paperback)

As the title may suggest this is a textbook cum reference book with a difference. It is American, and has been compiled to meet the needs of a one-semester course in laboratory electronics at Harvard, where the enrolment was varied, ranging from undergraduates to post-graduate researchers, all with different skills but all requiring a comparatively simple way into electronics which they realised was an indispensable additional subject to aid their main discipline.

In the view of the authors, existing textbooks were inadequate for such a course, so they have produced this impressive and refreshingly different type of textbook which they suggest could be generally used for a full-year electronics circuit design course at the college level. It

begins at a level suitable for those with no knowledge of electronics, but the mathematical level assumed includes some knowledge of trigonometry, exponential functions and differential calculus.

Semiconductors are treated as working devices without and preliminary discussions of solid state physics. (Perhaps the time is ripe for this to become general practice.)

A radical departure from conventional treatment of circuit design is the dismissal of the hybrid model (equivalent circuit) for a transistor as unsatisfactory, because of the wide variation (in practice) in h_{fe} between individual devices of the same type. Instead, emphasis is placed upon viewing the transistor as a transconductance device, and a modified model is used based on "the respected Ebers-Moll conventions". This, it is claimed, enables first-rate designs to be achieved without the need to do a lot of calculations.

This approach may not be universally applauded nor automatically adopted, but, in any event, teachers of electronics will find, in all, this an inspiring and mind-broadening volume. It is completely up to date, including digital techniques and microprocessors, measurements and signal processing in its formidable range of contents. A novel feature is the inclusion of selections of "Bad Circuits" which demonstrate how *not* to do things!

The second declared function of this volume is to serve as a reference book. The well sign-posted text and the wealth of tabulated data relating to contemporary semiconductor devices of all kinds make this a useful aid to have in the workshop. The price may be daunting, yet this large volume should prove a sound investment for the practising engineer and also for the amateur who has a serious interest in circuit design.

D.D.R.

NEWNES BOOK OF VIDEO

Editor K. G. Jackson
Price £5.95
Size 245 × 185mm 128 pages
Publisher Newnes Technical Books
ISBN 0 408 00475 4

VIDEO is the new area in home entertainment and exciting things are going to happen. So a book that deals with the technicalities involved at a popular level is likely to be a success.

This book has 11 main articles, the work of established authors who are specialists in the areas they write about. The overall content is comprehensive, starting with a scene-setting piece *The Video Centre* which explains how the TV set is likely to become joined by a number of satellites such as tape and disc players, cameras, viewdata, computers and TV games. All these are discussed in following chapters. The history of development, present state of the art and possible future developments in each area are covered, with examples of typical equipment currently available.

The techniques involved are varied and in some instances, such as video recorders, the mechanics are as intriguing as the electronics. The text is well illustrated with diagrams and photographs of representative equipments.

Thankfully, not all video will be passive entertainment. The video camera opens up a new field for artistic creation by the individual and the making of programmes with a single camera forms the subject of one chapter.

Reading this book one realises how underworked our TV sets are at present. Clearly all this is about to change!

F.E.B.

POPULAR KITS AND PARTS

TRANSMITTER SURVEILLANCE

Tiny, easily hidden but which will enable conversation to be picked up with FM radio. Can be made in a matchbox—all electronic parts and circuit. £2-30.

RADIO MIKE

Ideal for discos and garden parties, allows complete freedom of movement. Play through FM radio or tuner amp. £6-90.

SAFE CLOCK

Mains quick connector will save you valuable time. Features include quick spring connectors, heavy plastic case and auto on and off switch. Complete kit £1.95.

LIGHT CHASER

Gives a brilliant display—a psychedelic light show for discos, parties and pop groups. These have three modes of flashing, two chase-patterns and a strobe effect. Total output power 750 watts per channel. Complete kit. Price £16. Ready made up £4 extra.

FISH BITE INDICATOR enables anglers to set up several lines then sit down and read a book. As soon as one has a bite the loudspeakers emit a shrill note. Kit. Price £4-90.

8 WAVEBAND SHORTWAVE RADIO KIT

Bandspread covering 13-5 to 32 metres. Based on circuit which appeared in a recent issue of Radio Constructor. Complete kit. Includes case materials, six transistors, and diodes, condensers, resistors, inductors, switches, etc. Nothing else to buy, if you have an amplifier to connect it to on a pair of high resistance headphones. Price £11-95.

SHORT WAVE CRYSTAL RADIO

All the parts to make up the beginner's model. Price £2-30. Crystal earpiece 85p. High resistance headphones (give best results) £3-75. Kit includes chassis and front but not case.

RADIO STETHOSCOPE

Easy to fault find—start at the aerial and work towards the speaker when signal stops you have found the fault. Complete kit £4-95.

INTERRUPTED BEAM KIT

This kit enables you to make a switch that will trigger when a steady beam of infra-red or ordinary light is broken. Main components—relay, photo transistor, resistors and caps etc. Circuit diagram but no case. Price £2-30.

OUR CAR STARTER AND CHARGER KIT has no doubt saved many motorists from embarrassment in an emergency you can start car off mains or bring your battery up to full charge in a couple of hours. The kit comprises: 250w mains transformer, two 40 amp bridge rectifiers, start/charge switch and full instructions. You can assemble this in the evening, box it up or leave it on the shelf in the garage, whichever suits you best. Price £11-50 + £2-50 post.

G.P.O. HIGH GAIN AMP/SIGNAL TRACER. In case measuring only 5 1/2 in x 3 1/2 in x 1 1/2 in is an extremely high gain (70DB) solid state amplifier designed for use as a signal tracer on GPO cables etc. With a radio it functions very well as a signal tracer. By connecting a simple coil to the input socket a useful mains cable tracer can be made. Runs on standard 45v battery and has input, output sockets and on-off volume control, mounted flush on the top. Many other uses include general purpose amp, cueing amp, etc. An absolute bargain at only £1-85. Suitable 80 ohm earpiece 69p.

VU METER

Edgewise mounting, through hole size 1 1/8" x 1" approx. These are 100 micro amp f.s.d. and fitted with internal 6 volt bulb for scale illumination, also have zero reset. The scale is not calibrated but has very modern appearance. Price £2-89p.

BALANCE METER

Edgewise mounting 100 UA centre zero. Price £2-39p.

1 1/2" SQUARE PANEL METER

Eagle, full vision plastic front, 50 UA. Price £4-60p 1 mA Price £4-69p.

WATERPROOF HEATING WIRE

60 ohms per yard. This is a heating element wound on a fibre glass coil and then covered with p.v.c. Dozens of uses—around water pipes, under grow boxes in gloves and socks. 23p metre.

DIAL INDICATOR

As used in tool making and other precision measuring operations, the famous John Bull accurately shows differences of 0.1mm. A beautifully made precision instrument, price in most tool shops would be £12-15. We have a fair quantity. Price £8-29p.

COMPONENT BOARD REF. W998.

This is a modern fibre glass board which contains a multitude of very useful parts, most important of which are: 35 assorted diodes and rectifiers including four 3 amp 400v types (made up in a bridge) 8 transistors type BC 107 and 2 type BFY 51 electrolytic condensers, SCR ref. 2N 5062 25 0V 100v DC and 100v 25v DC and over 100 other parts including variable, fixed and wire wound resistors, electrolytic and other condensers. A real snip at £1-15.

FRUIT MACHINE HEART. 4 wheels with all fruits, motorised and with solenoids for stopping the wheels with a little ingenuity you can defy your friends getting the "jackpot." £9-95 + £4 carriage.

DESOLDERING PUMP

Ideal for removing components from computer boards as well as for service work generally. Price £6-35.

4-CORE FLEX CABLE

White pvc for telephone extensions, disco lights, etc. 10 metres £2, 100 metres £15. Other multicore cable in stock.

MUGGER DETERRENT

A high-tone bleeper, push latching switch, plastic case and battery connector. Will scare away any villain and bring help. £2-50 complete kit.

HUMIDITY SWITCH

American made by Honeywell. The action of this device depends upon the dampness causing a membrane to stretch and trigger a sensitive microswitch. Very sensitive breathing on it for instance will switch it on. Micro 3 amp at 250V a.c. Only £1-15.

MINI-MULTI TESTER

Deluxe pocket size precision moving coil instrument, jewelled bearings—2000 o.p.v. mirrored scale.

11 instant range measure:
DC volts 10, 50, 250, 1000.
AC volts 10, 50, 250, 1000.
DC amps 0-100 mA.
Continuity and resistance 0-1 meg ohms in two ranges. Complete with Test Prods and Instruction book showing how to measure capacity and inductance as well.
Unbelievable value only £6-75 + 50p post and insurance.

FREE Amps ranges kit to enable you to read DC current from 0-10 amps, directly on the 0-10 scale. It's free if you purchase quickly but if you already own a mini-tester and would like one, send £2-50.

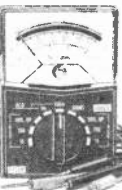

VENNER TIME SWITCH mains operated with 20 amp switch, one on and one off per 24 hrs. repeats daily automatically correcting for the lengthening or shortening day. An expensive time switch but you can have it for only £2-95. These are new but without case, but we can supply plastic cases (base and cover) £1-75 or metal case with window £2-95. Also available is adaptor kit to convert this into a normal 24 hr. time switch but with the added advantage of up to 12 on/off per 24 hrs. This makes an ideal controller for the immersion heater. Price of adaptor kit is £2-30.

MULLARD UNILEX

A mains-operated 4 + 4 stereo system. Rated one of the finest performers in the stereo field this would make a wonderful gift for almost anyone. In easy-to-assemble modular form this should sell at about £30—but due to a special bulk buy and as an incentive for you to buy this month we offer the system complete at only £16 including V.A.T. and postage. **FREE GIFT**—Buy this month and you will receive a pair of Goodman's elliptical 8" x 5" speakers to match this amplifier.

SUPER HI-FI SPEAKER CABINETS.

Our of an expensive Hi-fi outfit—will suit any decor. Resonance free cut-outs for 8" woofer and 4" tweeter. The front material is carved Dacron, which is thick and does not need to be stuck in and the completed unit is most pleasing. Colour black. Supplied in pairs, price £8-90 per pair (this is probably less than the original cost of one cabinet) carriage £3 the pair.

FLOURESCENT TUBE INVERTER

For camping or repairing emergency lighting from a 12v battery you can't beat fluorescent lighting, it will offer plenty of well distributed light and is economical. We offer Phillips inverter for 12" 3 watt miniature tube for only £5-25 with tube and tube holders as well.

WALL MOUNTING THERMOSTAT.

Danfoss, a handsome 2 tone, this is intended for living rooms but is just as efficient in a greenhouse or store. It is suitable for normal air temperature range 32F-90F—price £4-60.

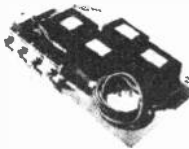

THIS MONTH'S SNIP

Vu METER Approximately 1 1/2" square, suitable for use as a recording level meter, power output indicator or many similar applications. Full vision front cover easily removable if you wish to alter the scale. Special snip price £1-00 or 10 for £9-00, post and VAT paid.



CHASSIS BARGAIN

3 wave band radio with stereo amplifier. Made for incorporation in a high-class radiogram, this has a quality of output which can only be described as superb. It is truly hi-fi. The chassis size is approximately 14". Push buttons select long, medium, short and gram. Control are balance, volume, treble and bass. Mains power supply. The output is 6 + 6 watts. Brand new and in perfect working order. Offered at less than value of stereo amp alone, namely £8-90. Post £2-50.

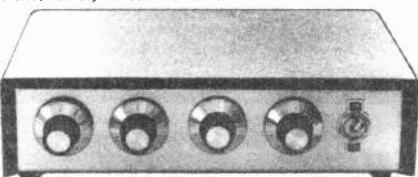

3-CHANNEL SOUND TO LIGHT KIT

Complete kit of parts for a three-channel sound to light unit controlling over 2,000 watts of lighting. Use this at home if you wish but it is plenty rugged enough for Disco work. The unit is housed in an attractive two-tone metal case and has controls for each channel, and a master on/off. The audio input and output are by 1/2" sockets and three panel mounting fuse holders provide thyristor protection. A four-pin plug and socket facilitate ease of connecting lamps. Special snip price is £14-95 in kit form or £19-95 assembled and tested.

TERMS: Cash with order—but orders under £10 must add 50p to offset packing, etc.

BULK ENQUIRIES INVITED. PHONE: 0444-54563.

ACCESS & BARCLAYCARD WELCOMED.

J. Bull [ELECTRICAL] Ltd.

(DEPT. EE1)

34-36 AMERICA LANE,
HAYWARDS HEATH SUSSEX.
RH16 3QU

IT'S FREE

Our monthly Advance Advertising Bargains List gives details of bargains arriving or just arrived—often bargains which sell out before our advertisement can appear—it's an interesting list and it's free—just send S.A.E. Below are a few of the Bargains still available from previous lines.

BURGLAR ALARM CONTROL PANEL Contains labelled connection block, latching relay, test switch and removable key control switch. Simplifies the whole installation, all you have to do is to take wires to pressure pads and to alarm bell. Price £6-90p. With complete diagram.

15-0-15v @ 2 AMP TRANSFORMER Mains transformer, upright mounting primary and secondary wound on separate bobbins with fixing lugs. Price £3-45. Post £1-00.

25-0-25v @ 750 mA MAINS TRANSFORMER Main transformer C core construction, heavily varnished for dead quiet operation. Upright mounting with fixing lugs. Price £3-18. Post £1.

25 WATT MID-RANGE SPEAKER 5 1/2" Made by Goodmans so there's none better. 4 ohm coil. Price £3-95. Post £1-00.

8 OHM TWEETER Made by Goodmans 3 1/2" square, 4" across fixings. Price £1-72. Post 30p.

TELEPHONE PICK-UP coil attaches by suction to phone box, enabling conversation to be recorded, put through amp or headphones. Price £1-15.

TELESCOPIC AERIAL 5 sections, 21" when extended, Nickel plated superior make, one nut fixing, folds over for FM. Price £1-10.

12v SUBMERSIBLE PUMP Our drill pump is useful, but this new one is even more so. Just join it to your car battery, drop it into the liquid to be moved and up it comes, no messing about, no priming etc. and you get a very good head. Suitable for water, paraffin and any non-explosive, non-corrosive liquid. One use if you are a camper, make yourself a shower. Price £6-90. A free gift, first 100 purchasers will get tap with built in switch and length of plastic tubing.

E.H.T. MAINS TRANSFORMER with inductance control, normal primary, secondary output by our equipment, 3-5 kv 3 mA, E.H.T. voltage can be varied by applying a DC voltage to the lower normally unused bobbin. We are not sure how much the voltage may be increased or decreased but using a 9 volt battery we seem to get a rise or fall of about 50 volts. Ex unused P.S.U.'s. Price £2-30. Post £1.

RECHARGEABLE SOLID GEL BATTERY 12v 5 AH new and unused made by or for Epower Corporation of California. Dimensions, 8" long, 3 1/2" high and 2 1/4" wide. Regular price of similar batteries, R.S Components is £26-00. Limited quantity at £15-00.

EXTRACTOR FANS

Ex-Computer made by Woods of Colchester, ideal also as blower; central heating systems, fume extraction etc. Easy fixing through panel, very powerful 2,500 r.p.m. but quiet running. Choice of 2 sizes, 5" £5-50, 6" £6-50; post £1 per fan.



LEDs are used increasingly and are now being recommended for nearly all indicators and for games and novelties. Due to a fortunate purchase, this month we are able to offer 10 red led's for £1. These are the small ones equivalent to the TIL 209. Bulk price £60-00 per 1,000 + V.A.T.

SUPER BREAKDOWN PARCEL with free gift of a desoldering pump, perhaps the most useful break-down parcel we have ever offered. Consists of 50 nearly all different computer panels on which you will find over 300 ICs, over 300 diodes, over 200 transistors and many hundred other parts, resistors, condensers, multi turn pots, rectifiers, SCR etc. etc. for only £8-50, which when you deduct the value of the desoldering pump, works out to just a little over 4p per panel, + £1-27 VAT + £2 post (it's a big parcel).

TIME SWITCH BARGAIN Large clear mains frequency controlled clock, which will always show you the correct time + start and stop switches with dials. Complete with knobs £2-50.

TELEPHONE RINGING MAINS UNIT Another novel unit as it not only reduces mains to 50 volts but also reduces the mains frequency to 25 Hz. This frequency gives correct ringing note for GPO bells. These units were made for the GPO so obviously are first class. Completely enclosed and safe to mount on the wall or stand on a shelf. Price £5-75.

TELEPHONE EXTENSION BELLS in bakelite wall box, these will save you missing calls when you are out in the garden or shed, etc. Price £4-75.

CAR BATTERY POWER UNIT made for Rank Radio. This unit has been designed to operate 6v battery powered equipment from a 12v car battery, it provides a reliable source of stabilised voltage and gives protection to your equipment in case of accidental reversal of connections also against excessive car battery voltage should this occur. The unit is very robust and virtually everlasting if used sensibly. It uses a negative earth circuit but it will operate in a positive earth car providing the instrument being played is not connected to the car chassis. A real bargain at £2-95.

SLIDE SWITCH BARGAIN Double pole changeover standard size with good length of connecting wire soldered to each tag—10 for £1-38.

SIX DIGIT COUNTER Mains operated, 1 pulse moves counter through one digit, not resettable but all you have to do is to make a note of the numbers before the start of each count. Real bargain at £1-15.

CAMBRIDGE LEARNING ENTERPRISES

Self Instruction Courses

Microcomputers are coming - ride the wave! Learn to program.

Millions of jobs are threatened but millions will be created. Learn BASIC - the language of the small computer and the most easy-to-learn computer language in widespread use. Teach yourself with a course which takes you from complete ignorance step-by-step to real proficiency, with a unique style of graded hints. In 60 straightforward lessons you will learn the five essentials of programming: problem definition, flowcharting, coding the program, debugging, and clear documentation

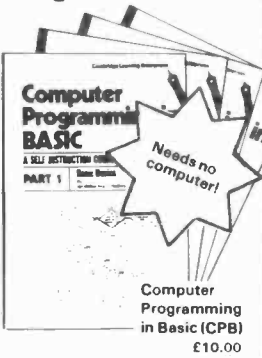

BOOK 1 Computers and what they do well; READ, DATA, PRINT, powers, brackets, variable names; LET, errors; coding simple programs. **BOOK 2** High and low level languages; flowcharting; functions; REM and documentation; INPUT, IF...THEN, GO TO; limitations of computers, problem definition. **BOOK 3** Compilers and interpreters; loops, FOR...NEXT, RESTORE; debugging; arrays; bubble sorting; **TAB BOOK 4** Advanced BASIC; subroutines; strings; files; complex programming; examples; glossary.

Also **THE BASIC HANDBOOK (BHB) £11.50** An encyclopaedic guide to the major BASIC dialects. A must if you use other peoples' programs

and: **ALGORITHM WRITER'S GUIDE (AWG) £4.00** Communicate by flow chart! Learn to use Yes/No questions for: procedures, system design, safety, legislation etc.

Understand Digital Electronics

Written for the student or enthusiast, this course is packed with information, diagrams, and questions designed to lead you step-by-step through number systems and Boolean algebra to memories, counters, and simple arithmetic circuits; and finally to an understanding of the design and operation of calculators and computers



BOOK 1 Decimal, Octal, hexadecimal, and binary number systems and conversion between number systems; negative numbers; complementary systems. **BOOK 2** OR and AND functions; multiple-input gates; truth tables; De Morgan's Laws; canonical forms; logic conventions; Karnaugh mapping; three-state and wired logic. **BOOK 3** Half, full, serial, and parallel adders; subtraction; processors and ALU's; multiplication and division. **BOOK 4** flip flops; shift registers; asynchronous, synchronous, ring, Johnson, and exclusive-OR feedback counters; ROMS and RAMS. **BOOK 5** Structure of calculators; keyboard encoding; decoding display-data; register systems; control unit; PROM; address de-coding. **BOOK 6** CPU, memory organisation character representation; program storage; address modes; input/output systems; program interrupts; interrupt priorities; programming; assemblers; computers; executive programs; operating systems.

DIGITAL COMPUTER LOGIC & ELECTRONICS. (DCL) £7.50
A course covering the material in italics above, but at a slower pace. (4 vols)

GUARANTEE - No risk to you. If you are not completely satisfied your money will be refunded without question, on return of the books in good condition.

CAMBRIDGE LEARNING LTD, UNIT 90, RIVERMILL SITE, FREEPOST, ST. IVES, HUNTINGDON, CAMBS. PE17 4BR ENGLAND.

PLEASE SEND ME: - CPB (£10.00)
BHB (£11.50)
AWG (£4.00)
DDS (£13.50)
DCL (£7.50) Quantity

FOUR WAYS TO PAY:

- 1) A U.K. cheque or a U.K. postal order (Not Eire or overseas)
- 2) A bank draft, in sterling on a London bank (available at any major bank)
- 3) Please charge my Access/M.Ch Barclay/TrustC/Visa Am. Exp. Diners
- 4) Or phone us with these credit card details - 0480 67446 (ansaphone) 24 hour service.

Card No. Signed
THESE PRICES COVER THE COST OF SURFACE MAIL WORLDWIDE. AIRMAIL:
Eur, N.Af, Mid.E. add 1/2 to price of books; Jpn, Aus, N.Z, Pcfc add 1/2; elsewhere add 1/2

Name
Address

Cambridge Learning Limited, Unit 90, Rivermill Site, FREEPOST, St. Ives, Huntingdon, Cambs PE17 4BR England. U.K. Delivery: up to 28 days
Reg. in Eng. No. 1328762

KEELMOOR

**PRESENTS THE LATEST
STATE OF THE ART
in DIGITAL WATCH TECHNOLOGY**

1981 will be known as the year when 'digitals' became slimmer whilst maintaining the trend of increasing number of functions. We now offer YOU this watch - available by mail order for the first time. **THE ULTRA SLIM MUSICAL ALARM CHRONOGRAPH IS YOURS FOR JUST £12.95 + 50p P&P.** It is fully guaranteed for 1 year and comes complete with demonstration battery. Just look at the functions listed below:



**ONLY
£12.95
plus 50p P&P**

- Normal time display of hours, minutes and seconds
- Date
- Melody alarm which plays a complete verse of a well-known tune
- Dual time zone
- Stopwatch with multi-lap times
- Count down timer (sounds alarm when it reaches zero)
- Backlight.

Just complete the form now - in keeping with the Keelmoor promise all goods are despatched by return. We have hundreds of other watches in stock. Send a SAE for our FREE colour brochure and read about all our bargains. Post to:

Keelmoor Ltd, 78 Castle Street, Melbourne, Derby DE7 1DY.

KEELMOOR LTD

78 Castle Street,
Melbourne, Derby
DE7 1DY.

Please rush me the watch. I enclose cheque/PO for £12.95 + 50p P&P.

Name
Address



Money refunded if not delighted. If you wish to buy via Access or Barclaycard write your number here

CIRCUIT EXCHANGE

LOW VOLTAGE ZN414/ULN2283B RADIO

The low operating voltage of the ZN414 makes it ideal for portable use but careful choice of the audio amplifier stage is needed if the low voltage capability is to be exploited. I have designed and tested a circuit running off only 3 volts supply which I thought might interest you.

The circuitry around IC1 is conventional, R1 and R3 forming a potential divider to maintain a supply voltage to IC1 of 1.2 to 1.6 volts.

IC2 is a Sprague ULN2283B audio amplifier. Its high typical voltage gain of 43dB (about 140 times) means that the audio output of IC1 is sufficient to drive IC2 directly without the need for a transistor amplification stage. It can be operated from a supply voltage of 3 to 12.5 volts.

The 100µF capacitor on pin 1 of IC2 decouples an internal bias point and a 3 volt working capacitor can still be used if a higher supply voltage is applied.

To prevent r.f. oscillation of IC2 interfering with radio reception, especially with a low impedance loudspeaker, the output circuit shown should be used. The value of the series inductor is not critical and can be altered to suit what is available.

S. Niewiadomski, Stapleford, Notts.

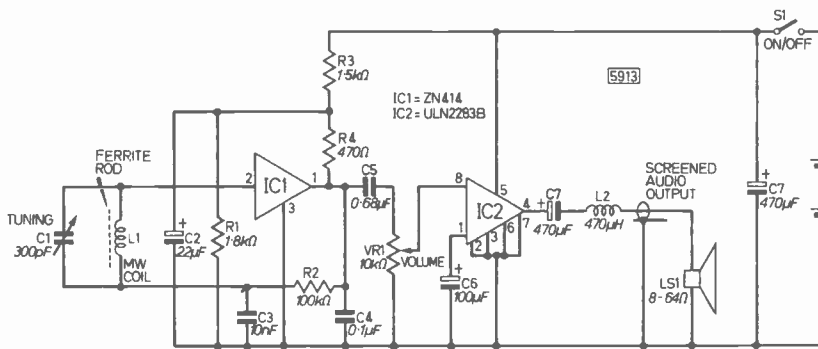

REVERSED SUPPLY PROTECTION

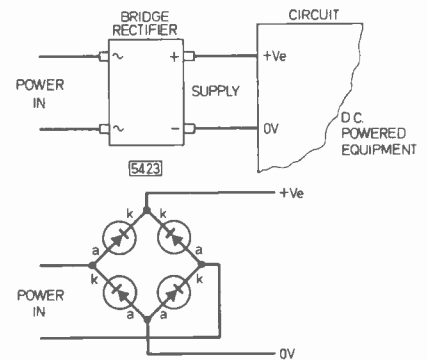

This simple idea ensures that if battery or power supply leads to a d.c. powered circuit are reversed, no damage whatsoever will be entailed; in fact, it does not matter which way round the supply leads are—the circuit will work anyway.

The current and voltage specifications of the bridge rectifier must exceed the voltage and current used by the circuit powered. If a very low power circuit is to be protected, a very cheap bridge rectifier can be made up from small signal diodes, such as 1N4148 or 1N914, as shown below. Whichever way the power goes in, the voltage will always come out the same.

G. Durant, Selby, North Yorkshire

SIGNAL INJECTOR

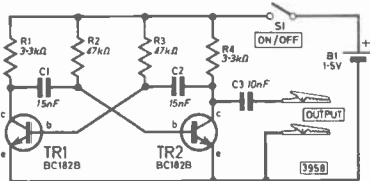

I have built this signal injector into a pocket flashlight, the circuit board occupying the space normally filled by one of the batteries. The values chosen for the timing capacitors and base resistors give a square wave output of approximately 1 kHz ($t = 0.7/CR$, where $C=C1=C2$, $R=R2=R3$) with equal work/space ratio.

D. J. Edwards, St Ann's, Nottingham

TOUCH SWITCH

This is a simple one-contact touch switch (with reset), that can drive an l.e.d., solid state buzzer, low power relay and so on, that uses only one thyristor costing about 50p and one push-to-make reset button, and nothing else.

It could be put under the saddle of a bike, and many other places.

A. Trafford, Milton Common, Oxford

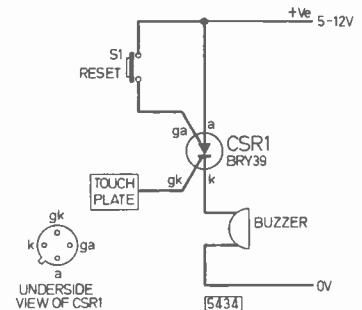

BURGLAR ALARM HANDBAG PROTECTOR

This circuit would be a good thing for the beginner to make because of its simplicity. With a jack plug in the socket SK1 the alarm does not go off, but as soon as it is pulled out the two contacts in the socket join therefore setting off the alarm WD1. The device can be deactivated by S1 if needed. The battery used can be changed to suit the buzzer or vice-versa.

The circuit should be housed in a small case and carried in some secure part on the person. The free end of the string should be firmly attached to the handbag or other object it is intended to protect.

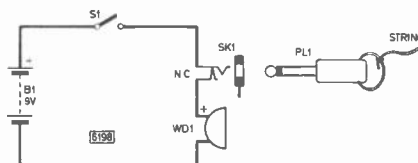

This circuit has many other uses, wherever a string-pulling alarm is needed, trip wires, doors etc.

M. Stevenson, Craigavad, Co. Down

CIRCUIT EXCHANGE

LETTERS

P.C.B. Solution

I have read your informative article on making p.c.b.s and would like to know (1) is there any means of telling when the ferric chloride is nearing the end of its useful life.

(2) When it comes to disposing of the ferric chloride solution is there a neutraliser which can be added first to prevent damage to pipes etc.

J. G. Burch
Southampton, Hants

The process of etching a p.c.b. is basically a chemical reaction in which the ferric chloride reacts with the exposed copper on the board to produce various chemical salts.

As more and more boards, and hence copper, are etched, the quantity of ferric chloride available in the solution to continue the process reduces. Also the quantity of chemical salts produced by the reaction increases and the result is that the etching process slows down.

Therefore the solution has reached the end of its useful life when the speed of etching is so slow as to be unacceptable. In practice you can expect 500ml of solution to etch about 2500cm² before it becomes exhausted.

When disposing of the solution, care must be taken as it is still a dangerous and unpleasant material. Unfortunately there is no commercial neutraliser available on the market so the best way of dealing with the problem is to start by pouring the used solution carefully into a plastic bucket which has been filled with cold water.

Take great care not to splash anyone, especially yourself! Make sure that the resulting solution is thoroughly mixed and then pour it down an outside drain.

On no account should you dispose of the solution undiluted or down an inside drain. [See also Counter Intelligence page 164]

Rule to Follow

Sometimes when in the construction of a p.c.b. one comes across the problem of how to get the holes for an i.c. in line and right distance apart and so on, but the problem can be solved with the use of the EVERYDAY ELECTRONICS constructors ruler presented free in your magazine some months ago. The holes intended for bending the leads of components can be used as a stencil.

Place the ruler on the p.c.b. and apply the etch resist pen to the board via the holes in the ruler, then take the ruler away and you have a perfect set of dots. The same is done for the other side of the i.c.

M. Stevenson,
Craigavad, County Down

Sharp's the word

I wonder if any of your readers could help me. I am the owner of a SHARP RD-708-V reel-to-reel tape recorder, for which I am in desperate need of a service sheet, the company being apparently uninterested in supplying one to one of its own agents. If anyone can help, could they please contact me.

C. P. Bolus,
102 Wellesley Street,
Shelton, Stoke-on-Trent, Staffs

A.C.C. Alive and Kicking

I am pleased to announce that the Amateur Computer Club is now very much alive and kicking following a somewhat dormant period last year. The A.C.C.,

one of the oldest if not the oldest amateur computer club in the world (founded in 1972), is a national organisation to promote interest in amateur computers and computing, to facilitate the exchange of information and ideas to help members with their home computer systems.

Membership is currently £3.50 p.a. (to be raised to £4.50 as of 1st January 1981) and is open to anyone with an interest in computers and computing, further details and membership forms (SAE please) from The Hon. Membership Secretary Jim MacDonald, 1 Carlton Court, Studley Grange Road, London W7 2LU.

Peter Whittle,
Chairman A.C.C.
Manchester M31 1NF.

Save on lighting

Being a fairly regular reader of your magazine, and also running a custom built Disco, I find your projects on lighting, such as Sound-to-Light, Chaser, etc. very good, but in these times when money is in short supply every penny possible must be saved. You always specify the use of Bulgin P550, but as these are very expensive, and when wired to three light boxes, all the light boxes are joined together making it very awkward to move. I have found that the USA two-pin plugs and sockets are ideal, being rated at about 7.5 amps, and no earthing is required if the boxes are made from wood i.e. chipboard.

A. Madden,
Portrack, Stockton-on-Tees

We now specify the Bulgin connector pair P550 as this has been adopted in commercial disco lighting products such as three-channel sound to light units. The P550 is made up from a P551 plug, and P552 panel mounting socket.

You are not obliged to use this connector, and if you have a safe, cheaper alternative, —as Mr. Madden has—then by all means use it.

JACK PLUG & FAMILY...

BY DOUG BAKER



PROJECT PACKS

Pools predictor (79053) An analogue computer that may win you a fortune	£8.15
Talk Funny (80052) A ring modulator circuit that produces very strange results when fed with a human voice	£9.60
Pest Pester (80130) An electronic insect repellent.	£2.35
Steam train sound effects (80019) Simulates the sound of steam and whistle.	£6.50
Electronic Nuisance (80016) Makes an annoying noise, but only in the dark!	£3.85
Cackling Egg timer (9985) An egg timer with a difference, it clucks like a hen.	£8.35
Chorosynth (80060) A cheap mini synthesizer. Send for details.	£57.90
Elektor Vocoder (80060) The first Vocoder designed to be built in kit form. 10 Channel modular construction.	£102.50
Analogue Reverberation Unit (9973) Uses a SAD 1024 which can produce a delay up to 100mS.	£27.70
Guitar Preamp (77020) With three tone controls.	£6.50
Linear Thermometer (80127) Simple but effective meter reading thermometer using a diode as sensor.	£13.45
Precision Power Unit (80514) Produces accurate reference voltages at presettable current limits up to 2 Amps.	£48.65
Top-preamp (80031) Mini, all IC preamplifier for use with most power amplifiers.	£34.40
Programmable Slide Fader (81002) Mixes audio signals on tape with operation of two slide projectors.	£46.50
Stereo dynamic Preamp (80532) A low noise high quality disc preamplifier.	£5.20
STAMP (80543) Super tiny amplifier with up to 1 Watt output.	£3.75
Transistor ignition (80082) The most significant advantages of other systems combined in one.	£20.45
Dipstick Probe (80102) Direct warning of high oil temperature. State long or short dipstick required.	£11.25
Intelligent Wiper Delay (80086) Can be set to produce delayed wipes at any predetermined interval.	£15.85
Fuel Economiser (81013) Audible guide to cheaper driving.	£8.05
Disco Projects.	Send for details
Minimixer (81068) 5 channel high quality stereo mixer.	£37.50
Bath Thermometer (81047) LED display of your bath temperature.	£6.85
Process Timer (81101) Versatile timer circuit.	P.O.A.

Our Project Packs include the electronic components, the PCB, sockets and solder together with assembly instructions. Cases, knobs etc can be supplied as extra items if required. This is only part of our wide range of projects. See our catalogue for details of other projects that we can supply. You can also ring our number between 12.30 p.m. and 1.30 p.m. any weekday for a recorded announcement of any new items we have available.

To order send cheque or postal order + 40p P & P to DORAM ELECTRONICS LTD All prices include VAT
a de boer company Telephone: (0760) 21627 Telex: 817912



Wilmslow Audio

THE firm for speakers!

SEND 50p FOR THE WORLD'S BEST CATALOGUE OF SPEAKERS, DRIVE UNITS, KITS, CROSSOVERS ETC. AND DISCOUNT PRICE LIST

AUDAX ● AUDIOMASTER ● BAKER
BOWERS & WILKINS ● CASTLE
CELESTION ● CHARTWELL ● COLES
DALESFORD ● DECCA ● EAGLE ● ELAC
EMI ● FANE ● GAUSS ● GOODMAN'S
HARBETH ● ISOPHON ● I.M.F. ● JORDAN
JORDAN WATTS ● KEF ● LOWTHER
McKENZIE ● MISSION ● MONITOR AUDIO
MOTOROLA ● PEERLESS ● RADFORD
RAM ● ROGERS ● RICHARD ALLAN
SEAS ● SHACKMAN ● TANNOY
TANGENT ● VIDEOTONE ● WHARFEDALE

WILMSLOW AUDIO LTD. (Dept. EE)

35/39 CHURCH STREET, WILMSLOW,
CHESHIRE SK9 1AS

Tel: 0625-529599 FOR MAIL ORDER & EXPORT OF DRIVE UNITS, KITS ETC.

Tel: 0625-526213 (SWIFT OF WILMSLOW) FOR HI-FI & COMPLETE SPEAKERS

LED'S



·125" & ·2" ROUND		TRIANGULAR	
RED	8p	Large, RED only	8p
YELLOW, GREEN or AMBER	11p	Small, YELLOW or GREEN only	11p
·2" ONLY		DECIMAL POINT	
WHITE illuminated red	8p	RED	8p
RECTANGULAR		YELLOW or GREEN	11p
RED	8p	SEVEN SEGMENT DISPLAYS	
YELLOW or GREEN	11p	RED	83p
Clips for ·125" or ·2"	3p	GREEN	£1-13
Sorry no clips for rectangular and triangular LED's.		State common anode or cathode	

All are top quality LED's—compare price with any other Ad!
P. & P. 60p. Add VAT 15% (carriage free over £5).

ALARM EQUIPMENT

CONTACTS		SIRENS	
Flush 4-wire	70p	12v Rotary	£8-19
Flush 5-screw	85p	12v 2-tone	£9-75
Aluminium (patio)	£1-50	Mains rotary	£25-00
Surface	85p	CONTROL UNITS	
BELL BOXES		Battery operated alarm module, 500µa	
Top quality metal, plastic coated	£6-00	standby current	£5-50
PRESSURE MATS		Mains/battery unit	£29-00
22½" x 6½"	£1-00	CABLE	
29" x 15"	£1-50	4-core	£7-00

Add 15% VAT. Carriage add £2-50 Excess will be refunded. SAE for full list.
Trade enquiries welcome.

WE ARE WARRINGTON'S SUPPLIERS OF CB GEAR!

SHOP HOURS 9.30 - 6PM (5pm Sat.)

WEBB ELECTRONICS

41 WINWICK STREET, WARRINGTON. Tel. 54174



Mains Transformers

SOONER or later everybody gets fed up with buying batteries for domestic equipment and wants to change over to mains power. This calls for power supply units containing mains transformers.

A bewildering variety of types and descriptions are on sale. This article is intended to be a guide through the maze.

The particular reader's enquiry which suggested this *Down to Earth* was from someone who had come across voltage ratings like "6-0-6V" and wanted to know that they meant. It struck me as a very good question, especially when I remembered that an identical transformer might well be described with the term "12V CT". This sort of jargon can be very puzzling until you get used to it so I'll try to put in lots of these technical description terms and explain them as we go along.

Mains transformers of the type used in low voltage power supplies (sometimes called Battery Eliminators, or AC/DC Converters or just P.S.U.s for "power supply units") should have a *PRIMARY* winding for connection to the a.c. mains and a *SECONDARY* winding for connection to the rectifiers which are required to turn the a.c. into d.c. A transformer of this two-winding construction, Fig. 1, is sometimes described as *DOUBLE-WOUND* to distinguish it from another type, the Auto Transformer which has only a single, *TAPPED* winding (Fig. 2).

Isolation

Auto-transformers are often used as mains transformers but for one special job—to convert European mains voltages of 220-240V to American voltages of 110-120V, which enables some American equipment to be operated from European mains. Auto-transformers can be relatively cheap and efficient but they do not provide *ISOLATION* from the mains because one connection is common to both input and output.

In contrast, the secondary winding of a double-wound transformer, if properly insulated, is completely isolated from the mains and there is no chance of getting a mains voltage shock by touching the secondary of any equipment powered from it. This is an important safety point and is the reason why a well insulated double-wound transformer is the only type which should be used to make battery eliminators.

Equipment designed to work off a low-voltage battery may *not* be insulated to mains voltage standards!

Since the primary is completely isolated from the secondary it does not matter which side of the mains ("live" or "neutral") goes to which end of the primary. For the same reason a mains "earth" is not needed, though there is something to be said for earthing exposed metal with a three-core mains flex.

Primaries

Nowadays, the majority of small mains transformers have a plain primary as in Fig. 1, with just two connections for the mains input and no "tappings" to intermediate points on the winding. You may, however, come across primaries which are tapped to make them adjustable to the local mains voltage (which used to differ in different parts of the UK).

The circuit in Fig. 3 shows a rather complicated set of tappings. Forget, for the moment, that the 10V tapping at the bottom is there and connect the "0V tap" to one side of the mains. The other "leg" of the mains can now be connected to whichever of the top end tappings is closer to the local mains voltage. This gives a choice of 220V and 240V, but it is possible to add 10V to either of these by connecting the other side of the mains to the "10V tap". Instead of the 0V point, thereby accommodating 230V and 250V.

A transformer with all these tappings would be described as "Primary 10-0-220-240V". One with only the upper tappings would be "primary 0-220-240V".

This should not be confused with "primary 220-240V", which usually means a plain untapped primary whose design voltage is really 230V but which can be used at 220V and 240V without much error in voltage. Such a transformer will give voltages slightly above the nominal secondary voltage when connected to British 240V a.c. mains and slightly below nominal when used on Continental 220V a.c. mains. Battery operated equipment is usually sufficiently tolerant of voltage variations for this not to matter.

The problem of making a mains transformer adaptable for use on either side of

the Atlantic is sometimes met by winding the mains primary in two separate and equal sections. See circuit diagram Fig. 4.

Each section is rated at 120V. For 240V mains they are connected in series as shown dotted. The letters *S* and *F* refer to the "start" and "finish" of a winding and it is important to connect correctly.

An alternative method of marking is to put dots at points of the same polarity and leave the other ends of the windings unmarked, as shown. For parallel (120V) connection, connect *S* to *S* and *F* to *F* (dot to dot and blank to blank).

Bobbin

Mains primary windings have thousands of turns and these form many layers of wire on the transformer's *BOBBIN*. Old transformers were often made with a sheet of paper insulation between layers, described as "fully interleaved". Modern precision windings and improved *ENAMELS* for insulating the wire make interleaving unnecessary in most cases.

Older transformers generally used a plain bobbin, often just a cardboard tube. The primary was usually wound first, then a layer of insulation, then the secondary.

Some modern transformers use a *SLOTTED* bobbin in the form of a plastics moulding with walls to separate the primary and secondary which are wound side by side.

After assembly some transformers are impregnated with wax to provide extra insulation and moisture-proofing.

Leadouts and Fixings

The leadouts which connect the windings to the outside world may simply be left hanging loose (*FLYING* leads) or may be terminated on tags or pins. These may be attached to the bobbin or be carried on a separate *TAG BOARD* fixed to the *CLAMP* or *YOKE* provided for most transformers to hold the *LAMINATIONS* which form the *CORE* or *STACK* firmly and so discourage vibration which can give rise to *LAMINATION BUZZ*.

In surface mounting transformers the ends of the yoke are often formed into

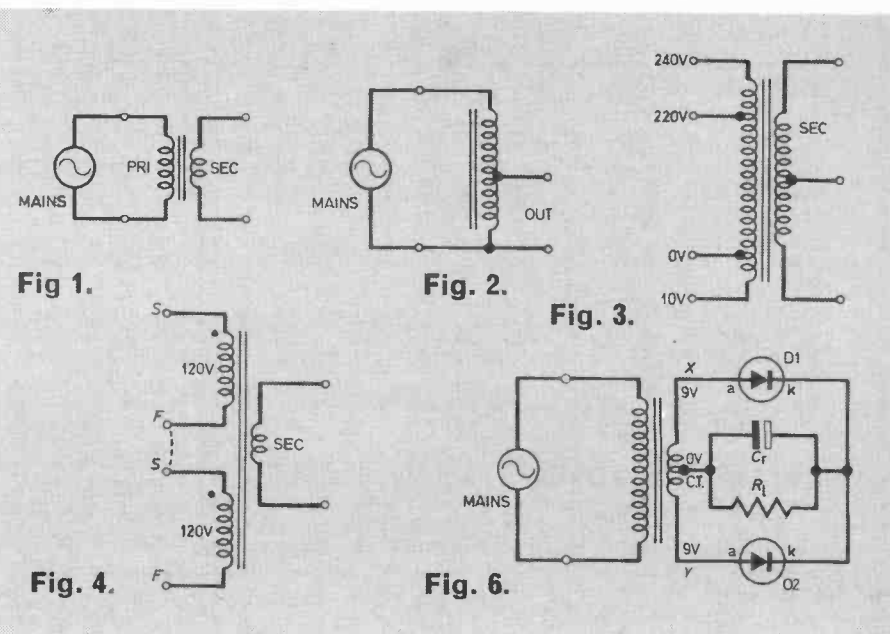

fixing FEET or TAGS for printed-circuit mounting or both. The printed-circuit tags (or LUGS) are straight projections designed to pass through slots in the board and then be twisted to lock the transformer in place.

Feet, on the other hand, have bolt holes which enable the transformer to be bolted or screwed to a baseboard and are therefore more useful to the amateur.

Miniature transformers for printed-circuit board mounting (p.c.b. mounting) may have no fixings on their yokes but rely for support on pins, moulded into their bobbins, which also serve as terminating tags for the windings.

Screen

Despite their solid appearance transformers are easily damaged. For example, a screwdriver carelessly poked into a winding may cause a break or short or both. For this reason some transformers are provided with metal cups or SHROUDS which cover their windings.

Another "extra" is the ELECTRO-STATIC SCREEN or SHIELD. This is a layer of metal foil placed between windings to prevent high-frequency currents from leaking from winding to winding via the insulation.

Each winding acts like the plate of a capacitor and the insulation like the dielectric. The inter-winding capacitance may be a few hundred picofarads. This presents an enormous barrier to mains frequencies but not to radio frequencies.

An earthed shield shorts these high-frequency currents and discourages (for example) the "hash" from the household's electric drill or vacuum cleaner from getting into a radio via the mains connection.

Secondaries

Plain secondaries with untapped windings are suitable for feeding BRIDGE RECTIFIERS. A bridge rectifier, Fig. 5, contains four diodes connected to steer current from the secondary in the correct direction into the RESERVOIR CAPACITOR C_r and therefore provide d.c. for the

LOAD R_l which in practice is the piece of equipment being powered by the p.s.u.

Diodes D1 and D3 conduct on one half cycle and D2, D4 during the next, and so on. The rectifier can be drawn as a bridge, Fig. 5 (a) or as a lattice Fig. 5 (b). These circuits are electrically identical.

If no load is connected C_r usually charges to 1.5-2 times the nominal secondary voltage. So a 10V (nominal) secondary produces about 15-20V off-load. As more and more current is taken by increasing loads (decreasing values of R_l) the output voltage falls until at maximum permitted current it is usually rather less than the nominal r.m.s. voltage of the secondary.

This sagging of the output voltage can be described by a number called the REGULATION:

$$\text{Regulation} = \frac{\text{No-load voltage} - \text{Full-load voltage}}{\text{Full-load voltage}}$$

and it is often expressed as a percentage. Note that this has nothing to do with STABILISATION of voltage which is something that requires extra circuitry.

If you require a substantial amount of current from your power supply unit you may be offered a Battery Charger Transformer. These are frequently designed on the assumption that about 3V will be lost in the rectifiers, so a "6V" charger transformer may deliver 9V and a "12V" type deliver approximately 18V.

Split Secondaries

Another common arrangement is the CENTRE-TAPPED secondary, this is designed to drive a PUSH-PULL rectifier as shown in Fig. 6. Here D1 conducts during one half-cycle, taking current from the upper half of the winding and D2 on the next, taking current from the lower half.

The a.c. voltage between X and Y is twice the nominal voltage. This means that if desired the centre tap may be left unconnected and a bridge rectifier driven by the 18V to give twice the output voltage of the push-pull circuit.

The current rating must then be halved to avoid overloading the transformer. A 9-0-9V winding may equally well be

described as "18V CT" where CT means centre-tapped.

More and more transformers are made with SPLIT SECONDARIES (Fig. 7). The two separate secondary windings can then be connected in series Fig. 7 (a) to give twice the voltage or a centre-tapped secondary or in parallel Fig. 7 (b) to give twice the current of a single winding. Or they can be used separately, of course.

When connecting windings in parallel it is essential to connect S to S and F to F, otherwise you end up with a burned-out transformer.

Current Ratings

A transformer is essentially a voltage changing device. The amount of current it delivers depends on the size of the load and it is up to the user to ensure that this current is within its ratings.

Makers quote the maximum current which may safely be drawn. Thus a transformer described as "220-240V, to 9-0-9V, 100mA" can deliver safely up to 100mA.

Unfortunately, this specification, though typical, is not clear. Does it mean 100mA a.c. or 100mA d.c. after rectification?

If you take 100mA d.c. with the rectifier circuits we've been using then the a.c. drawn is 140mA! It is safest to assume that a.c. is meant in which case the d.c. drawn should not be more than 70 per cent of the rating.

Magnetising Current

Even with no load a small current from the mains flows in the primary. This is called the MAGNETISING CURRENT and it flows because the primary is an inductance and therefore has a finite reactance or impedance.

The mains voltage drives current through this impedance and it is, of course, a wasted current and should be small. For a miniature transformer even 10mA represents a fair proportion of the on-load input current.

A badly-made core or shorted turns on a winding can greatly increase the off-load current and may cause overheating. Check by running off-load for an hour or so to see if the transformer gets hot.

Intermittent Ratings

Transformers for power supplies are normally designed for continuous operation. For other tasks, however, a transformer may be called upon to work flat out for a short time then stand idle.

A typical example is in electric welding where enormous currents are needed but only while the welding electrode is in contact with the work. Between contracts the transformer can cool off.

It is possible to design transformers to cope with large outputs for short periods only. They are then given an INTERMITTENT rating which may be far greater than the CONTINUOUS rating.

The intermittent rating is used in conjunction with a DUTY CYCLE which says for what proportion of the time the transformer may be used. Thus a transformer which can deliver 100A for not more than one minute in every ten minutes could be rated 100A, 10 per cent Duty Cycle.

The electronics enthusiast may come across transformers with intermittent ratings for ringing doorbells or clock chimes or similar short-duration tasks.

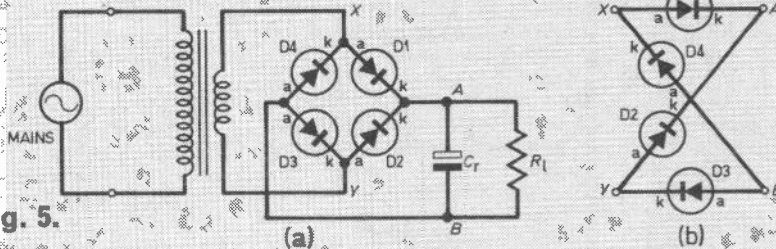

Fig. 5.

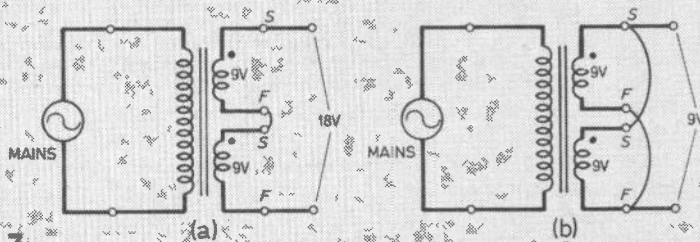

Fig. 7.

All these advantages...

- Instant all-weather starting
- Smoother running
- Continual peak performance
- Longer battery & plug life
- Improved fuel consumption
- Improved acceleration/top speed
- Extended energy storage

..in kit form

SPARKRITE X5 is a high performance, top quality inductive discharge electronic ignition system designed for the electronics D.I.Y. world. It has been tried, tested and proven to be utterly reliable. Assembly only takes 1-2 hours and installation even less due to the patented 'clip-on' easy fitting.

The superb technical design of the Sparkrite circuit eliminates problems of the contact breaker. There is no misfire due to contact breaker bounce which is eliminated electronically by a pulse suppression circuit which prevents the unit firing if the points bounce open at high R.P.M. Contact breaker burn is eliminated by reducing the current by 95% of the normal.

There is also a unique extended dwell circuit which allows the coil a longer period of time to store its energy before discharging to the plugs. The unit includes built-in static timing light systems function light and security changeover switch. Will work all rev counters.

Fits all 12v negative-earth vehicles with coil/distributor ignition up to 8 cylinders.

THE KIT COMPRISESE EVERYTHING NEEDED

Die pressed case. Ready drilled, aluminum extruded base and heat sink, coil mounting clips and accessories. All kit components are guaranteed for a period of 2 years from date of purchase. Fully illustrated assembly and installation instructions are included.

Roger Clark the world famous rally driver says "Sparkrite electronic ignition systems are the best you can buy"



Sparkrite

HIGH PERFORMANCE
ELECTRONIC IGNITION
Electronics Design Assoc.
82 Bath Street, Walsall WS1 3DE

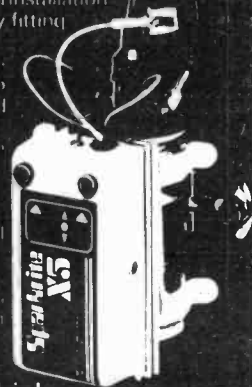

Electronics Design Associates, Dept. EE 3
82 Bath Street, Walsall, WS1 3DE. Phone: (0922) 614791

Name _____

Address _____

Phone your order with Access or Barclaycard

Inc. V.A.T. and P.P.

QUANTITY REQD.

I enclose cheque/PO's for

X5KIT £16.95

£

Cheque No.

ACCESS OR BARCLAY CARD No.

Send SAE if brochure only required.

ELECTRET MICROPHONE INSERTS with FET Pre-Amp @ £1.85.
B9A PLUG AND SOCKET (9 Pin) at 25p pair.
500 Metre of PVC CABLE 13 Strand .019 at £10 Reel. Carr. paid.
PLASTIC TRANSISTORS BC 108 or BC 212 at 6 for 50p.
FERRITE RINGS Orange Ext. Dia. 1/2"; Int. Dia. 3/4" @ 35p.
POWER FETS VK10KM at 40p each.
MINIATURE AIR SPACED VARIABLES 250 + 250 + 20 + 20 + 20pf @ 75p.
SUB-MINIATURE MULLARD DISCS 1000pf 63 v.w. at 25p doz.
MULLARD 808 TYPE TRIMMERS 4pf, 10pf, 20pf, 60pf, all 15p each.
20 WAY LUCAR TAG CONNECTOR at 50p.
3 GANG VARIABLE CAPACITORS 10 + 10 + 10pf at 75p.
VHF WIRE ENDED RF CHOKE 30 U.H. at 25 for 50p.
80 METRE CRYSTALS 10X Type 3642-5 or 3750 KHz at 40p.
50 OC 71 TRANSISTORS untested for 75p.
50 BC 107-8-9 TRANSISTORS assorted untested for 60p.
3/16" COIL FORMERS with core at 6 for 25p.
VERNITRON FM4 10.7 MHz FILTERS at 50p, 3 for £1.
VHF-UHF FETS BF 256C at 4 for 75p, E304 @ 30p, 4 for £1.
2 GANG VARIABLES 250 + 250pf (500pf) @ 85p.
MINIATURE CERAMIC TAG STRIPS 12 Way @ 15p, 21 Way @ 20p.
TTL HOUSE CODED I.C.'s 7400, 7410, 74100, 7453, 7430. All 10p, 6 for 50p.
ELECTROLYTICS 16 + 16uf 450 v.w. @ 25p, 50 + 50uf 450 v.w. @ 40p.
20Hz STRIPLINE NPN TRANSISTORS at £f each.
4500 PIV 2 AMP SILICON DIODES @ £1.50 each.
5 MHz CRYSTALS in 10X Case at 50p each.
POSTAGE STAMP TRIMMERS 10pf, 30pf, 50pf, 500pf, 1000pf. All at 15p each.
CERAMIC TRIMMERS 2-5 to 6pf, 3 to 10pf, 4-5 to 20pf, 6 to 35pf, 10 to 40pf, 10 to 60pf. All at 15p each.
FERRITE BEADS FX1115 @ 15p doz. 1" Long Type 6 for 10p.
R.F. SIGNAL TRANSISTORS BFY 90 @ 50p, 2N 918 @ 25p, 2N 5179 @ 50p, 2N 5180 @ 50p, AF 239 @ 50p.
VERY USEFUL TRANSFORMER 250 Volt Input, Output 43 Volt 50mA, 11 Volt 2-5 Amp, 22-22 Volt 150mA, 16 Volt 120mA, 15 Volt 1-5 Amp, 20 Volt 275mA @ £3.90 (P&P £1.20).
SOLDER-IN FEED THRU's 6-8pf, 27pf, 300pf, 1000pf. All 20p doz.
SPECIAL COMPONENTS Resistor 1K 1% @ 5p, Capacitors 9000pf 2% @ 5p, 12uf 1% @ 5p, .05uf 1% @ 5p, .22uf 1% @ 20p, .39uf 1% @ 20p, 1uf 2% @ 25p.
WIRE WOUND POTENTIOMETERS 2 Watt 2K, 5K, 10K, 4 Watt 100K. All 30p each.
HIGH POWER TRANSISTORS 40 Watt SSB or FM, 28 Volt, Type 587 BLY 27 to 70MHz with data for £3.
MAINS TRANSFORMERS 240 Volt input, 24 Volt Tapped at 14 volt 1 amp @ £1.30 (P&P 25p).

Please add 20p for post and packing, unless otherwise stated, on U.K. orders under £2.

J. BIRKETT

RADIO COMPONENT SUPPLIERS

25 The Strait, Lincoln LN2 1JF Tel. 20767

TRAIN AT HOME

Be an ELECTRONIC ENGINEER

Do something PRACTICAL about your future.

Firms all over Britain are crying out for qualified people. With the right training, you could take your pick of these jobs.

Now, the British Institute of Engineering Technology will train you in your spare time to be an Electrical Engineer.

You risk nothing! We promise to get you through your chosen course—or, refund your fee!

So, join the thousands who have built a new future through home study Engineering courses.

Courses in
C & G Elect. Technicians
C & G Elect. Installations
Telecomms. Technicians Exams
Television Servicing
Radio Maint. & Repairs (BIET)
Pract. Radio & Electronics
Plus over 60 other home study courses.

POST COUPON FOR FREE 44 PAGE GUIDE

BRITISH INSTITUTE OF ENGINEERING TECHNOLOGY

Aldermaston Court, Dept. TEE 59 Reading RG7 4PF.

NAME (Block capitals please) _____

ADDRESS _____

POSTCODE _____

Other Subjects _____ AGE _____

Accredited by CACC

Member of ABCC

Conquer the chip.

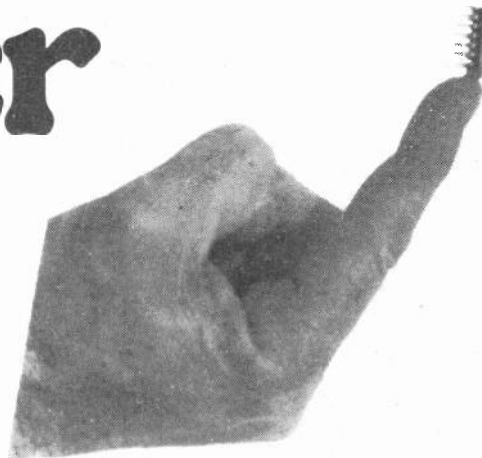

Be it career, hobby or interest, like it or not the Silicon Chip will revolutionise every human activity over the next ten years.

Knowledge of its operation and its use is vital. Knowledge you can attain, through us, in simple, easy to understand stages.

Learn the technology of the future today in your own home.

MASTER ELECTRONICS

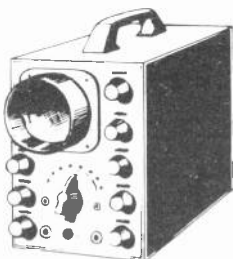

LEARN THE
PRACTICAL WAY BY
SEEING AND DOING

- Building an oscilloscope.
- Recognition of components.
- Understanding circuit diagrams.
- Handling all types Solid State 'Chips'.
- Carry out over 40 experiments on basic circuits and on digital electronics.
- Testing and servicing of Radio, T.V., Hi-Fi and all types of modern computerised equipment.

MASTER COMPUTERS

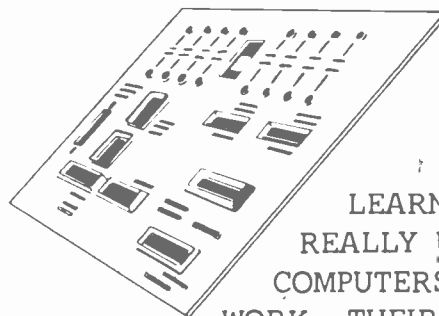

LEARN HOW TO
REALLY UNDERSTAND
COMPUTERS, HOW THEY
WORK - THEIR 'LANGUAGE'
AND HOW TO DO PROGRAMS.

- Complete Home Study library.
- Special educational Mini-Computer supplied ready for use.
- Self Test program exercise.
- Services of skilled tutor available.

MASTER THE REST

- Radio Amateurs Licence.
- Logic/Digital techniques.
- Examination courses (City & Guilds etc.) in electronics.
- Semi-conductor technology.
- Kits for Signal Generators - Digital Meters etc.

BRN

Please send your **FREE** brochure without obligation to:-

Name

Address

BLOCK CAPS PLEASE

I am interested in :-

EE/3/811

PRACTICAL ELECTRONICS

COMPUTER TECHNOLOGY

OTHER SUBJECTS
(please state your interest)

BRITISH NATIONAL RADIO & ELECTRONICS SCHOOL

4 CLEVELAND ROAD, JERSEY, CHANNEL ISLANDS.



SIMPLY AHEAD
and staying there

The range grows bigger... better...

New Profile Amplifiers - Two New Series

MOSFET

CHOOSE AN I.L.P. MOSFET POWER AMP when it is advantageous to have a faster slew rate, lower distortion at higher frequencies, enhanced thermal stability, the ability to work with complex loads without difficulty and complete absence of cross-over distortion. I.L.P.'s exclusive encapsulation technique within fully adequate heatsinks has been taken a stage further with specially developed computer-verified 'New Profile' extrusions. These ensure optimum operating efficiency from our new MOSFETS, and are easier to mount. Connections via five pins on the underside. I.L.P. MOSFETS ARE IDENTICAL IN PERFORMANCE TO THE COSTLIEST AMPLIFIERS IN THIS EXCITING NEW CATEGORY BUT ARE ONLY A FRACTION OF PRICES CHARGED ELSEWHERE.

Model	Output Power RMS	Distortion Typical at 1KHz	Slew Rate	Rise Time	Signal/Noise Ratio DIN AUDIO	Price & VAT
MOS120	60W into 4-8Ω	0.005%	20V/μs	3μs	100dB	£25.88 + £3.88
MOS200	120W into 4-8Ω	0.005%	20V/μs	3μs	100dB	£33.46 + £5.02

BIPOLAR

CHOOSE AN I.L.P. BIPOLAR POWER AMP where power and price are first consideration while maintaining optimum performance with hi-fi quality and wide choice of models. From domestic hi-fi to disco and P.A., for instrument amplification, there is an I.L.P. Bipolar to fill the bill, and as with our new Mosfets, we have encapsulated Bipolars within our New Profile extrusions with their computer-verified thermal efficiency and improved mounting shoulders. Connections are simple, via five pins on the underside and with our newest pre-amps and power supply units, it becomes easier than ever to have a system layout housed the way you want it.

Model	Output Power RMS	Distortion Typical at 1KHz	Slew Rate	Rise Time	Signal/Noise Ratio DIN AUDIO	Price & VAT
HY30	15W into 4-8Ω	0.015%	15V/μs	5μs	100dB	£7.29 + £1.09
HY60	30W into 4-8Ω	0.015%	15V/μs	5μs	100dB	£8.33 + £1.25
HY120	60W into 4-8Ω	0.01%	15V/μs	5μs	100dB	£17.48 + £2.62
HY200	120W into 4-8Ω	0.01%	15V/μs	5μs	100dB	£21.21 + £3.18
HY400	240W into 4Ω	0.01%	15V/μs	5μs	100dB	£31.83 + £4.77

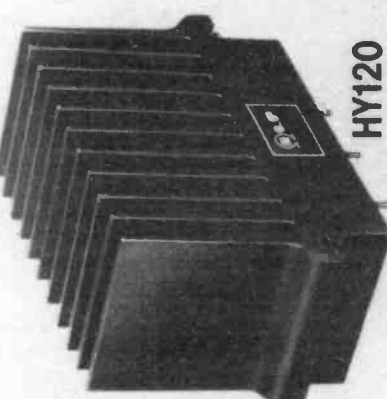

HY120

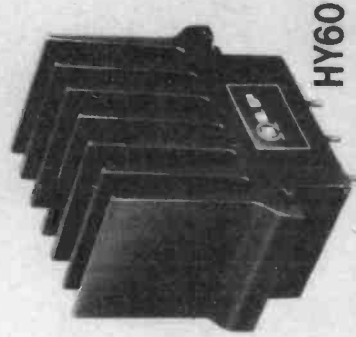

HY60

I.L.P. POWER AMPS ARE ENCAPSULATED FOR THERMAL STABILITY AND LONGER LIFE

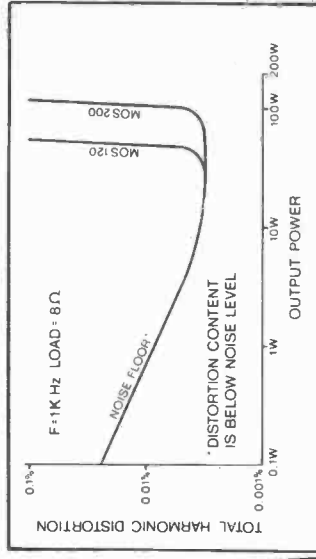

Load impedance both models 4Ω-∞ Input sensitivity both models 500mV
Input impedance both models 100KΩ Frequency response both models 15Hz-100KHz - 3dB

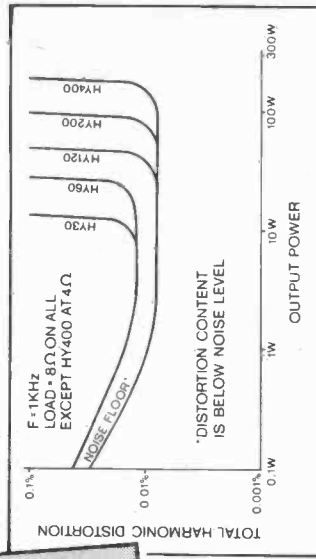

Load impedance all models 4Ω-∞ Input impedance all models 100KΩ
Input sensitivity all models 500mV Frequency response all models 15Hz-50KHz - 3dB

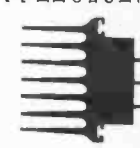

THE NEW PROFILE EXTRUSIONS
The introduction of standard heatsink extrusion for all I.L.P. power amplifiers achieves many advantages: - Research shows they provide optimum thermal dissipation and stability. Slotted shoulders allow easy mounting/standardisation enables us to keep our prices competitive. Surfaces are matt black, anodised for higher thermal conductivity. Extrusions vary in size according to module number.

I.L.P. PRE-AMPS

HY6 (mono) and HY66 (stereo) are new to I.L.P.'s range of advanced audio modules. Their improved characteristics and styling ensure their being compatible with all I.L.P. power-amps both MOSFET and BIPOLAR, giving you a chance to get the best possible reproduction from your equipment. HY6 and HY66 pre-amps are protected against short circuit and wrong polarity. Full assembly instructions are provided. Mounting boards are available as below.

Sizes - HY6 - 45 x 20 x 40 mm. HY66 - 90 x 20 x 40 mm. Active Tone Control circuits provide ± 12 dB cut and boost. Inputs Sensitivity - Mag. PU - 3mV; Mic - selectable 1-12mV. All others 100mV. Tape O/P - 100mV; Main O/P - 500mV; Frequency response - D.C. to 100KHz - 3dB.

HY6 mono £6.44 + 97p VAT Connectors included
 HY66 stereo £12.19 + £1.83 VAT Connectors included
 B6 Mounting Board for one HY6 78p + 12p VAT
 B66 Mounting Board for one HY66 99p + 15p VAT

I.L.P. POWER SUPPLY UNITS

Of the eleven power supply units which comprise our current range, nine have toroidal transformers made in our own factory. Thus these I.L.P. power supply units are space-saving, more efficient and their better overall design helps enormously when assembling building. All models in the range are compatible with all I.L.P. amps and pre-amps with types to match whatever I.L.P. power amps you choose.

- **PSU30** ± 15 V at 100mA to drive up to 12 x HY6 or 6 x HY66 £4.50 + 0.68p VAT
- **THE FOLLOWING WILL ALSO DRIVE I.L.P. PRE-AMPS**
- **PSU36** for use with 1 or 2 HY30's £8.10 + £1.22 VAT
- **ALL THE FOLLOWING USE TOROIDAL TRANSFORMERS**
- **PSU50** for use with 1 or 2 HY60's £10.94 + £1.64 VAT
- **PSU60** for use with 1 HY120 £13.04 + £1.96 VAT
- **PSU65** for use with 1 MOS120 £13.32 + £2.00 VAT
- **PSU70** for use with 1 or 2 HY120's £15.92 + £2.39 VAT
- **PSU75** for use with 1 or 2 MOS120 £16.20 + £2.43 VAT
- **PSU90** for use with 1 HY200 £16.20 + £2.43 VAT
- **PSU95** for use with 1 MOS200 £16.32 + £2.45 VAT
- **PSU180** for use with 1 HY400 or 2 HY200 £21.34 + £3.20 VAT
- **PSU185** for use with 1 or 2 MOS200 £21.46 + £3.22 VAT

★ Freepost facility

When ordering or writing about I.L.P. products, you do not need to stamp the envelope. Mark it FREEPOST, plus the code shown in the address below. We pay the postage for you.

★ **TO ORDER** Send cheque or money order payable to I.L.P. Electronics Ltd and crossed. Or pay by ACCESSOR BARCLAYCARD. Cash payments must be in registered envelope, if C.O.D. payment is wanted, please add £1.00 to TOTAL value of order.

I.L.P. ELECTRONICS LTD.

FREEPOST 3 Graham Bell House, Roper Close, Canterbury, Kent CT2 7EP.
 Telephone (0227) 54778 Technical (0227) 647231 Telex 965780

Available also from MARSHALLS, WATFORD ELECTRONICS and certain other selected retailers

COMPATIBLE WITH ALL I.L.P. MODULES

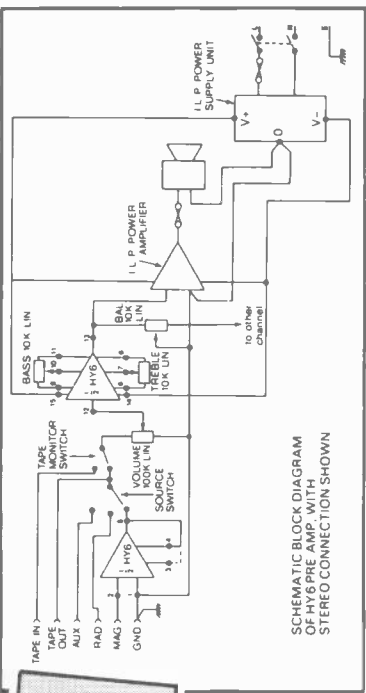

- **DISTORTION TYPICALLY 0.005%**
- **S/N RATIO - 90dB (Mag. P.U. - 68 dB)**
- **38 dB overload margin on Mag. P.U.**
- **LATEST DESIGN HIGH QUALITY CONNECTORS**
- **ONLY POTS, SWITCHES AND PLUGS/SOCKETS NEED ADDING**
- **NEEDS ONLY UNREGULATED POWER SUPPLY ± 15 to ± 60 V**

IN A RANGE OF 11 MODELS USING LATEST TOROIDAL TRANSFORMERS

1971-1980 TEN YEARS OF PLANNED PROGRESS

When in 1971, Ian L. Poits founded his now world-famous company, he saw the need for a different and more rational approach to exploiting to the full, the potential that lay in modular construction. New thinking was badly needed. The result was a range of modules revolutionary in concept. The rightness of this new thinking is shown by the size of the company today. Its vast exports, its acceptance by constructors as the modules to build with. The range grows bigger and better. Exciting new lines (in no way conflicting with existing ones) are well past drawing board stage. This is why I.L.P. are simply ahead and staying there.

BRITAIN'S LEADING QUALITY MODULE SUPPLIERS

To: I.L.P. ELECTRONICS LTD, CANTERBURY CT2 7EP

Please supply
 I enclose Cheque Postal Orders International Money Order
 Please debit my Access/Barclaycard Account No.

Name
 Address
 Signature

ALL U.K. ORDERS DESPATCHED POST FREE

NO QUIBBLE 5 YEAR GUARANTEE
 7-DAY DESPATCH ON ALL ORDERS
 BRITISH DESIGN AND MANUFACTURE
 FREEPOST SERVICE

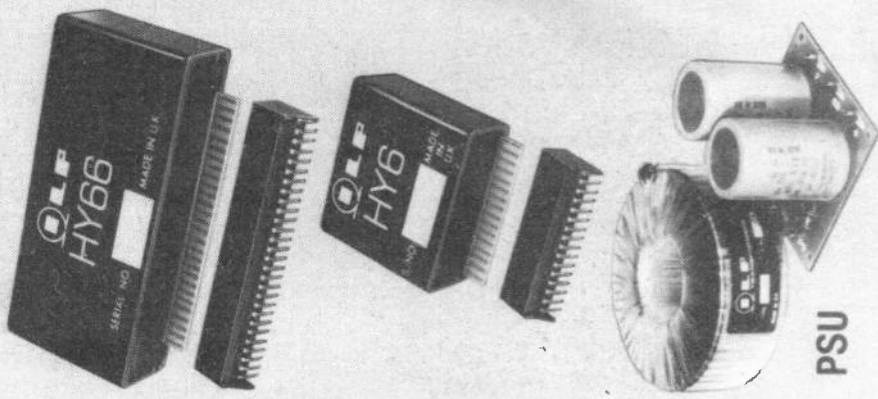

KITS FOR SOUND EFFECTS AND OTHER PROJECTS

PHONOSONICS

DEPT EE2, 22 HIGH STREET,
SIDCUP, KENT DA14 6EH

MAIL ORDER SUPPLIERS OF QUALITY PRINTED
CIRCUIT BOARDS, KITS AND COMPONENTS TO
A WORLD-WIDE MARKET.

P.E. MINISONIC MK2 SYNTHESIZER
A portable mains operated miniature sound synthesiser with keyboard circuits. Although having slightly fewer facilities than the large Formant and P.E. synthesisers the functions offered by this design give it great scope and versatility.
Set of basic component kits (excl. KBD R's & tuning pots—see list for options available) and PCBs (incl. layout charts) KIT 38-25 £80-14
"Sound Design" booklet £1-00

P.E. 128-NOTE SEQUENCER
Enables a voltage controlled synthesiser to automatically play pre-programmed tunes of up to 32 pitches and 128 notes long. Programs are keyboard initiated and note length and rhythmic pattern are externally variable.
Basic comps, PCBs and charts KIT 76-7 £35-55
Text photocopy £1-36

P.E. GUITAR EFFECTS PEDAL
Modulates the attack, decay and filter characteristics of a signal from most audio sources, producing 8 different switchable effects that can be further modified by manual controls.
Basic parts, PCB & chart KIT 42-3 £10-60
Text photocopy £2-28

P.E. GUITAR OVERDRIVE
Sophisticated versatile fuzz unit including variable controls affecting the fuzz quality whilst retaining the attack and decay, and also providing filtering. Can be used with other electronic instruments.
Basic parts, PCB & chart KIT 56-3 £11-22
Text photocopy £6-88

P.E. GUITAR SUSTAIN
Maintains the natural attack whilst extending note duration.
Basic comps, PCB & chart KIT 75-1 £6-99
Text photocopy £3-38

COMPONENT SETS Incl all necessary res., caps, s/cs, pots, t/formers. Hardware such as cases, skts, knobs, kbds, etc, are not incl, but most can be bought separately. Fuller details in lists.

ADD: POST & HANDLING
U.K. orders: under £1 add 35p, under £20 add 70p, over £20 add £1. Recommended insurances against postal mishaps: add

50p for cover up to £50, £1 for £100 cover, etc., pro-rata, must be added to credit card orders. N.B. Eire, C.L., B.F.P.O. and other countries are subject to higher rates.

ADD 15% VAT (or current rate if changed). Must be added to full total of goods, post & handling on all U.K. orders. Does not apply to exports, or to photocopies.

P.E. AUTO-WAH UNIT
Automatic Wah or Swell sounds with each note played.
Basic comps, PCB & chart KIT 58-1 £10-11
Text photocopy £5-88

ELEKTOR CHOROSYNTH
A 21-Octave Chorus synthesiser with an amazing variety of sounds ranging from violin to cello and flute to clarinet, amongst many others. Experienced constructors can readily extend the octave coverage.
Basic comps, PCBs & charts KIT 100-8 £44-39
Text photocopy £7-70

ELEKTOR FUNNY TALKER
Incorporates a ring modulator, chopper and frequency modulator to produce fascinating sounds when used with speech and music signals.
Basic comps, PCB (as publ.) KIT 99-1 £9-60
Text photocopy £4-40

ELEKTOR FREQUENCY DOUBLER
For use with guitars and other electronic instruments to produce an output 1 octave higher than the input. Inputs and outputs may be mixed to give greater depth.
Basic comps, PCB (as publ.) KIT 98-1 £5-48
Text photocopy £2-20

P.E. SPLIT-PHASE TREMOLO
Simple but effective substitute for a rotary cabinet. An internal generator is phase-split and modulated by the music input signal and fed to 1 or 2 amplifiers. Suitable for electronic guitars and other instruments.
Basic comps, PCB & chart KIT 102-3 £17-68
Text photocopy £6-65

P.E. PHASER
An automatic 6-stage phasing unit with integral oscillator.
Set of basic comps, PCB & chart KIT 88-1 £10-91
Text photocopy £6-68



ELEKTOR PHASING & VIBRATO UNIT
Includes manual and automatic control over the rate of phasing & vibrato, and has been slightly modified to also include a 2-input mixer stage.
Set of basic comps, PCB & layout chart KIT 70-2 £21-87
Text photocopy £6-67

P.E. PHASING UNIT
A simple but effective manually controlled phasing unit.
Set of basic comps PCB & chart KIT 25-1 £4-06
Text photocopy £2-28

P.E. SWITCHED TONE TREBLE BOOST
Provides switched selection of 4 preset tonal responses.
Set of basic components, PCB & chart KIT 89-1 £4-34
Text photocopy £7-78

P.E. SMOOTH FUZZ
Set of basic components, PCB & chart KIT 91-1 £6-52
Text photocopy £5-55

P.E. TUNING FORK
Produces 84 switch-selected frequency-accurate tones with an LED monitor clearly displaying beat-note adjustments.
Set of basic comps, PCB & chart KIT 46-3 £23-32
Text photocopy £9-97

P.E. CONSTANT DISPLAY FREQUENCY COUNTER
An improved version of the project published in P.E. Readout does not count visibly or flicker due to blanking.
Set of basic components & PCB KIT 79-4 £31-61
Text photocopy £7-78

DYNAMIC NOISE LIMITER
Effectively reduces tape-recording hiss. Stereo Unit.
Set of basic components, PCB & chart KIT 97-1 £8-07
Text photocopy £7-75

MANY MORE KITS
for synthesizers, Rhythm Generators, Electronic Planos and other projects, big, small, simple or complex, are available, plus a range of keyboards, separate components and accessories. Details in our lists.

LIST: Send stamped addressed envelope with all U.K. requests for free list giving fuller details of our goods. Europe send 35p, other countries send 75p, or equivalent in International reply coupons

TERMS: C.W.O., MAIL ORDER OR COLLECTION BY APPOINTMENT
(TEL: 01-302 6184)

NEW MORE INFORMATIVE LIST NOW AVAILABLE



FM/AM STEREO TUNER AMPLIFIER CHASSIS

Originally designed for installation into a music centre. Supplied as two separate built and tested units which are easily wired together, 240 volts A/C operation. Note Circuit diagram and inter-connecting wiring diagrams supplied.

Rotary Controls Tuning, volume, balance, treble and bass.
Push Button Controls Mono, Tape, Disc, A.F.C., FM(VHF), LW, MW, SW.
Power Output 7 watts RMS per channel into 8 ohms (10 watts music).
Tape Sensitivity output typically 150mv. Input 300mv for rated output.
Disc Sensitivity 100mv (ceramic cartridge).
Stereo Beacon Indicator LED or bulb.
Size Tuner—2 1/4" x 15" x 7 1/4" approx. **Power amp.**—2" x 7 1/4" x 4 1/2" approx.
Price £23.50 + £2.50 Postage and Packing.

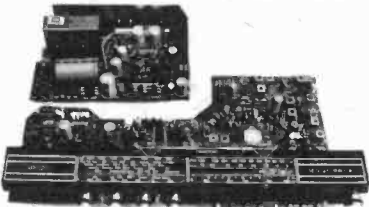

J.V.C. TURNTABLE CHASSIS

J.V.C. Turntable supplied complete with an Audio Technica AT10 stereo magnetic cartridge.
★ 'S' shaped tone arm. ★ Belt driven. ★ Full size 12" platter. ★ Precision calibrated counter balance weight 0-3 grms. ★ Damped cueing lever.
★ Anti-skate (bias) device. Nylon thread weight. ★ Cut out template supplied.
Size—12 1/2" x 15 1/2" (approx).
Price £28.50 + £2.50 Postage and Packing.



Access and
Barclay cards
WELCOME

B. K. ELECTRONICS (Dept. EE)

37, Whitehouse Meadows, Eastwood, Leigh-on-Sea, Essex, S59 5TY.
★ S.A.E. for components list etc. ★ Official orders welcome.
★ All prices include V.A.T. ★ Mail order only.
★ All items packed (where applicable) in special energy absorbing PU foam.

TTC

TITAN TRANSFORMERS AND COMPONENTS
DEPT. EE CENTRAL HALL CHAMBERS
GRIMSBY SOUTH HUMBERSIDE
MAIL ORDER ONLY
PAYMENT C.W.O. CHEQUES, POSTAL ORDERS
ALL PRICES INCLUDE 15% V.A.T.
Please send S.A.E. for complete list of our transformers

TRANSFORMERS

0 100 120 0 120 INPUT 120 220 240
PRIMARY 0 120 OR 240V 50Hz
SECONDARY SERIES OR PARALLEL
P.C.B. OR CHASSIS MOUNTING

PRINTED CIRCUIT BOARD TYPES				
REF	AMPS	PRICE	P/P	
TTP 446	0.5-2	1.79	50	
TTP 447	0.75-2	2.14	60	
TTP 449	1.0-2	2.36	70	
TTP 450	2.08-2	2.99	90	
TTP 451	4.18-2	4.57	125	
TTP 452	8.33-2	5.68	130	

CHASSIS MOUNTING TYPES				
REF	AMPS	PRICE	P/P	
TTC 446	0.5-2	1.85	50	
TTC 447	0.75-2	2.20	60	
TTC 449	1.0-2	2.45	70	
TTC 450	2.08-2	3.10	90	
TTC 451	4.18-2	4.70	125	
TTC 452	8.33-2	5.85	130	

MOUNTING KITS FOR P.C.B. TYPES INCLUDES 4NUTS SCREWS WASHERS + SPACERS				
VA	KIT REF	PRICE	P/P	
12	SK 12	45		
25	SK 25	48		
50	SK 50	52		
100	SK 100	56		

VA=VOLTS * AMPS P/P=PC

MAINS ADAPTORS				
REF	OUTPUT	PRICE	P/P	
TT 100	6-7.5-9V	3.85	40	
TT 101	6-7.5-9V REGULATED	4.70	40	

COMPONENTS				
REF	QTY	PRICE	P/P	
IN 4001	10	45	10	
1000UF 25V	4	95	15	
1000UF 16V	5	105	15	
470UF 16V	5	85	15	



68
LARGE
PAGES

The Catalogue
that means
FREE POSTAGE
IN U.K.

●
ATTRACTIVE
DISCOUNTS

●
GUARANTEED
SATISFACTION
KEEN PRICES

●
GOOD STOCKS
GOOD DELIVERY
we pay postage

Semi-Conductors • I.C.s • Opto-
devices • Rs and Cs in great variety
• Pots • Switches • Knobs •
Accessories • Tools • Materials •
Connectors

ELECTROVALUE

**FREE
FOR THE
ASKING**

ELECTROVALUE LTD., (Dept. EE3) 28 St. Judes Road, Englefield Green, Egham,
Surrey TW20 0HB. Telephone: (STD 0784) (London 87) 33603. Telex: 264475.
Northern (Personal Shoppers only) 680 Burnage Lane, Burnage, M/C, M19 1NA 432 4945.

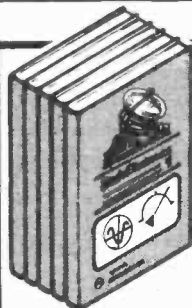

**ANNOUNCING
A NEW SET
OF BASIC
ELECTRONICS**

This 5 volume set contains over 500 pages.
Bound in stiff linen. Cover size 8 1/2" x 5".
Price £10.00 per set (we pay the postage).

- | | |
|---------------------------------|--------------------------------------|
| Book 1. Introducing Electronics | Book 4. Meters/Voltage dividers |
| Book 2. Resistors/Capacitors | Book 5. Transistor Project Circuitry |
| Book 3. Inductors/Diodes | |

The manuals are unquestionably the finest and most up-to-date available and represent exceptional value.

This series has been written in a fascinating, absorbing and exciting way, providing an approach to acquiring knowledge that is a very enjoyable experience. Suitable for industrial trainees, City and Guilds students, DIY enthusiasts and readers of electronic journals.

Each part explains electronics in an easy-to-follow way, and contains numerous diagrams and half tone blocks with construction details and circuit diagrams for making the following transistor projects: Lamp Flasher, Metronome, Wailer, Photographic/Monostable Timer, Metal Locator, Geiger Counter, Radio Receiver, Intercom., Intruder Alarm, Electronic Organ, Battery Eliminator, Anemometer, Sound Switch, Light and Water-operated Switches, Pressure-operated Switches, Light meter, Radio Thermometer, Ice Alarm,

Order now:
Selray Book Company
11, Aspen Copse,
Bromley,
Kent. BR1 2NZ.

OUR 100% GUARANTEE
Should you decide to return the set after 10 days exam-
ination, your money will be refunded by return of post.

Amount enclosed: £

Name:

Address:

EE 4

If you're into
MICROPROCESSORS
then they should be into an
MP UroBreadBoard

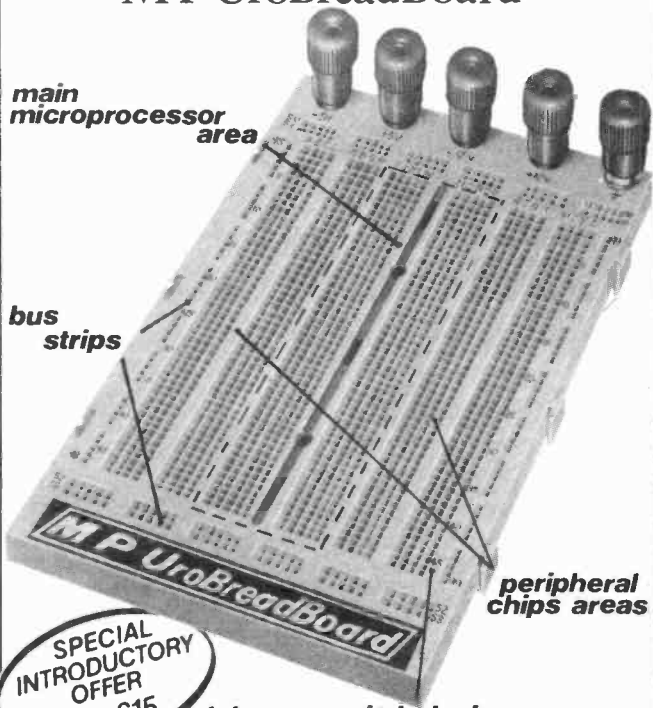

main
microprocessor
area

bus
strips

peripheral
chips areas

**SPECIAL
INTRODUCTORY
OFFER
ONLY £15**

alpha numeric indexing

- * MPU Section accepts 24, 28, 40 & 64 pin DIL microprocessors
- * Auxiliary Areas accept any .3" or .6" RAM, ROM or peripheral chip
- * Power Bus Strips on all sides
- * 5 incoming turret Power Terminals
- * Component Support Bracket included
- * Over 1400 contact points
- * Alpha-Numeric column and row indexing
- * Eurocard size (160mm x 100mm)
- * Slots onto all BIMBOARDS
- * Non-Slip rubber backing
- * Ideal for schools and colleges
- * Long life, < 10m.ohms, nickel silver contacts

The **PROFESSIONALS** breadboard
that **BEGINNERS** can start on

BOSS INDUSTRIAL MOULDINGS LTD

2 Herne Hill Rd, London SE24 0AU, England
Telephone 01-737 2383 Telex 919693
Cables & Telegrams: LITZEN LONDON SE24

Please send me MPUroBreadBoard(s) at the special, limited period, introductory offer price of £15.00. This price includes VAT & PP, is applicable from Sept 1 1980 but please add 15% for Overseas Orders, make cheques/P.O. payable to BOSS Industrial Mouldings Ltd and allow 10 days for order processing and cheque clearance etc.

I enclose a cheque/P.O. to the value of £.....

Name

Company

Address

.....

.....

Telephone Number

EE3

QUALITY DOES NOT HAVE TO COST VERY MUCH!

ALL PRICES INCLUDE VAT

BECKER
Hi-Fi Speakers

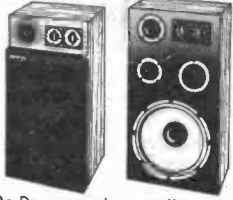

ALL MODELS MULTI-SPEAKER SYSTEMS

With controls, attractive woodgrain finish.

RMS rating for 8 ohm.

- 12.60 12" 4-speaker system 60 watts
26½" x 14½" x 11" £115.95 pair
- 15.90 15" 5-speaker system 90 watts
28" x 17½" x 11½" £135.95 pair
(UK c/p £5.45 pair)

On Demonstration to callers.

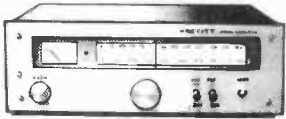

SCOTT T516 STEREO FM/AM TUNER

HIGH QUALITY STEREO FM/AM TUNER BY SCOTT OF USA

Overall size 5" x 14½" x 12". Brand new and fully guaranteed at a special low price.

£38.95

(UK c/p £1.55)

On Demonstration for callers.



JVC BELT DRIVE TURNTABLE

JVC TURNTABLE WITH FREE AUDIO TECHNICA AT 100 STEREO CARTRIDGE

- ★ 'S' shaped tone arm.
- ★ Belt drive.
- ★ 12" Platter. ★ Calibrated counter balance weight.
- ★ Anti-static device.
- Size 12½" x 15½".

£29.95

TV SOUND FROM YOUR HI-FI

High quality TV sound converter plugs into aerial socket of your FM tuner. 9 volt battery operated (battery not supplied). Nothing to look at... but just listen!

£8.50

(UK c/p 50p)

On Demonstration for callers.

(As reviewed in Popular Hi-Fi, July, 1979)

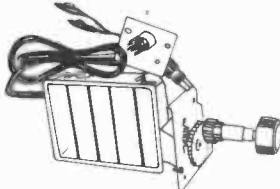

1000's SOLD



SEAS SPEAKER KITS 8 ohm



Professional sound hi-fi speaker kits with high sensitivity (89-92dB). Extended frequency response ('223' 50-20kHz, '253' 35-25kHz). Designed and made in Scandinavia to the highest quality. All supplied with complete cabinet plans, tweeters/crossovers/leads, etc. ★

- ★ Hi-Fi 223. 30/45 watt 3-speaker 8" system £43.50 pair
- ★ Hi-Fi 253. 60/100 watt 3-speaker 8" system £34.50 each
- ★ Hi-Fi 403. 60/100 watt 3-speaker 10" system £44.50 each
- ★ Hi-Fi 603. 80/150 watt 3-speaker 12" system £64.50 each

(UK c/p £2.50)

COMPLETE RANGE OF SEAS CHASSIS SPEAKERS, ETC. ALWAYS IN STOCK

Also stockists for Audax, Goodmans, Kef, Peerless, etc.

PIEZO TWEETERS

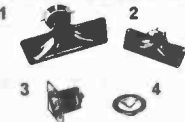

New low prices. Clean sound, very low distortion tweeters. No crossover required. Suitable up to 100 watts—more in series.

- 1 Mid-range horn for disco/pa/groups £6.95
- 2 Tweeter horn for hi-fi/disco/pa £5.50
- 3 Popular hi-fi and disco £4.40
- 4 Flat type hi-fi £3.50

ON DEMONSTRATION TO CALLERS. UK c/p 50p (up to 4 items).

STEREO ACCESSORIES

- ★ 1987 Hi-Fi frequency equaliser £49.95
- ★ APM 200 Peak programme meter (twin scale) £39.95
- ★ MS3219 Twin Scale audio output meter £12.95
- ★ MC350 Tape echo sounder £58.95

FREE CATALOGUE: Large range of speakers / stereophones / microphones/mixers/PA equipment, etc.—and much more! Plus huge range of test equipment. ALL PRICES INCLUDE VAT. SEND LARGE 17p SAE. ALL PRICES CORRECT AT 1-1-81

AUDIO ELECTRONICS

Cubegate Limited

301 EDGWARE ROAD, LONDON, W2 1BN, ENGLAND.

TELEPHONE 01-724 3564 OPEN 9-6 Mon-Sat

ORDER BY POST OR TELEPHONE WITH BARCLAYCARD/ACCESS OR CALL IN AND SEE FOR YOURSELF



MIGHTY NINETY PACKS

SUPER VALUE PACKS ALL AT 90p EACH
POSTAGE 15p PER PACK UP TO FOUR PACKS
FIVE OR MORE POST FREE
BUY SIX PACKS AND GET A SEVENTH PACK FREE!

- | | |
|---|--|
| <p>MN1. 300 ½-watt Resistors pre-formed P&C Mfg.</p> <p>MN2. 200 ¼ AND ½-watt Resistors.</p> <p>MN3. 100 1 & 2-watt Resistors.</p> <p>MN4. 50 Wirewound Resistors.</p> <p>MN5. 100 metal oxide Resistors. 1%, 2% and 5%.</p> <p>MN6. 12 asstd. potentiometers.</p> <p>MN7. 25 asstd. skeleton pre-set Resistors.</p> <p>MN8. 50 asstd. Electrolytic Capacitors.</p> <p>MN9. 100 asstd. Ceramic Capacitors. P1tc, disc, tub and monolytic etc.</p> <p>MN10. 100 mixed capacitors. Polyester. Polystyrene. Metallised, Radial and Axial types.</p> <p>MN11. 20 asstd. Silver Mica Capacitors.</p> <p>MN12. 8 Tantalum Bead Capacitors (useful values).</p> <p>MN13. 20 asstd. Transistors. BC, 2N Series + Power etc.</p> <p>MN14. 40 1N4148 Diodes.</p> <p>MN15. 5 Light Sensitive Devices.</p> <p>MN16. 20 min. wire-ended Neons.</p> <p>MN17. 2 12-volt Relays. Ex nearly new equip.</p> <p>MN18. 3 Encapsulated Reed Relays. 9-12v. coil, d-pole and 1-pole.</p> <p>MN19. 2 24-volt Relays. Ex nearly new equip.</p> <p>MN20. 1 240-110 to 12-volt, 100ma Transformer.</p> <p>MN21. 1 240-110 to 24-volt 100ma Transformer.</p> <p>MN22. 8 2" Led's with clips. 4 red, 2 yellow, 2 green.</p> | <p>MN23. 1lb asstd. screws, nuts, washers, self-tappers etc.</p> <p>MN24. 100 asstd. small springs.</p> <p>MN25. 50 asstd. pop rivets.</p> <p>MN26. 50 asstd. Insulated crimps.</p> <p>MN27. 200 Items, grommets, spacers, cable markers, plastic screws, sleeving, tie wraps etc.</p> <p>MN28. 20 asstd. fuses. 1½" 20mm etc.</p> <p>MN29. 75m equipment wire, asstd. colours and sizes.</p> <p>MN30. 3 x 2m length, 3 core, mains cable.</p> <p>MN31. 12 asstd. trimmer capacitors, compression film. Air-spaced etc.</p> <p>MN32. 15 30pf Beehive trimmers.</p> <p>MN33. 20 coil formers, ceramic, plastic, reel relay etc.</p> <p>MN34. 25 min. glass reed switch.</p> <p>MN35. 10 asstd. switches, toggle, slide, micro, etc.</p> <p>MN36. 10 ex equipment panel lamps (no rubbish).</p> <p>MN37. 10 asstd. audio connectors. Din phono etc.</p> <p>MN38. 1 PCB with triac control IC data inc. components (no data).</p> <p>MN39. 1 oscillator PCB loads of components (no data).</p> <p>MN40. 50 Polyethylene Capacitors.</p> <p>MN41. 10 assorted T.T.L. I/CS.</p> <p>MN42. 10 BC107 Transistors.</p> <p>MN43. 10 BC108 Transistors.</p> <p>MN44. 10 screw fix S.P. C.O. min. slide switch.</p> <p>MN45. 5 1-35V, 1,000 mA/H. Mercury batteries ¼in diameter x ¾in high.</p> |
|---|--|

PLEASE QUOTE NO. OF PACKS WHEN ORDERING

CHORDGATE LTD.

75 FARINGDON ROAD, SWINDON, WILTS.
Tel. Swindon (0793) 33877. Retail shop at above address.

ELECTRONIC IGNITION SAVES PETROL



More and more new cars use electronic ignition to give the best performance and economy. Bring YOUR CAR up to top specification by fitting the latest TOTAL ENERGY DISCHARGE electronic system.

TOTAL ENERGY DISCHARGE gives all the advantages of the best capacitive discharge ignitions;

- ★ Peak Performance—higher output voltage.
- ★ Improved Economy—consistent high ignition performance.
- ★ Better Starting—full spark power even with low battery.
- ★ Accurate Timing—prevents contact wear without 'contactless' errors.
- ★ Smooth Performance—immune to contact bounce effects.

SUPER HIGH POWER SPARK—3½ times the energy of ordinary C.D. systems.

OPTIMUM SPARK DURATION—to get the very best performance and economy with today's lean carburettor settings.

DESIGNED IN RELIABILITY—with the 'ultimate insurance' of a change-over switch to revert instantly to standard ignition.

TECHNICAL DETAILS

HIGH EFFICIENCY INVERTER. A high-power, high efficiency, regulated inverter provides a 400-volt energy source—powerful enough to store twice the energy of other designs and regulated to provide full output even with the battery down to 4 volts.

SUPERB DISCHARGE CIRCUIT. A brand new technique prevents energy being reflected back to the storage capacitor, giving 3½ times the spark energy and 3 times the spark duration of ordinary C.D. systems, generating a spark powerful enough to cause rapid ignition of even the weakest fuel mixtures without the ignition delay associated with lower power 'long burn' inductive systems. In addition this circuit maintains the correct output polarity, thereby preventing unnecessary stress on the H.T. system.

SOPHISTICATED TRIGGER CIRCUIT. This circuit removes all unwanted signals caused by contact volt drop, contact shuffler, contact bounce, and external transients which, in many designs, can cause timing errors or damaging un-timed sparks. Only at the correct and precise contact opening is a spark produced. Contact wear is almost eliminated by reducing the contact breaker current to a low level—just sufficient to keep the contacts clean.

IN MONEY-SAVING KIT FORM at £14.85 Inc. V.A.T. and P. & P.

All you need is a small soldering iron and a few basic tools — everything else is supplied with easy-to-follow instructions.

FITS ALL 6/12 volt NEGATIVE EARTH cars

ELECTRONIZE DESIGN
2 Hillside Road, Four Oaks
Sutton Coldfield, West Midlands, B74 4DQ
Phone 021-308 5877



OVER 10 KITS
IN THE NEW KS RANGE



KS100 MINIATURE V.H.F./A.M./F.M RECEIVER. Varicap tuned, 88-108 MHz earphone output 240mV, sensitivity 1uV, operates from 9V D.C. (PP3) 2.5mA semiconductors EET/E300 & BC205-G. £5.31 inc VAT



KS238 "MICROPHONE OPERATED THREE CHANNEL SOUND TO LIGHT". Complete with microphone, 300 Watts per channel, automatic treble-middle-bass filters. Operates from 240V A.C. £14.34 inc VAT



KS240 3 CHANNEL SOUND TO LIGHT. 1KW per channel, with bass, middle & treble controls, input range 6-70V p.p. with sensitivity control operates from 240V A.C. £13.63 inc VAT



KS260 CHASE LIGHT CONTROL UNIT. 3 x 1KW outputs variable speed -25-2.5 sec. operates from 240V A.C. uses 3 x I.C.'s & 3 x triacs £11.22 inc VAT



LTD
ELECTRONIC KITS

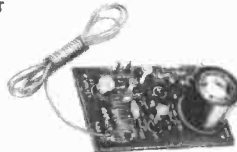

KS200 MINIATURE F.M. TRANSMITTER. 88-108MHz complete with dynamic microphone, operates from 9V D.C. (PP3), semiconductors 2N708 & BC208-B. Not Licenceable in U.K. £7.97 inc VAT



KS450 "MOTOR CYCLE ANTI-THEFT ALARM". Complete with inertia switch. Uses 3 x C Mos I.C. and 2 transistors. Operates from 6V-15V D.C. £11.82 inc VAT

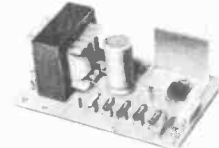

KS490 "NICAD BATTERY CHARGER". Constant current in five ranges, 10-20-45-100-150mA. Max. charge voltage 15V. Operates from 240V A.C. £9.02 inc VAT



KS470 SOUND OPERATED SWITCH. Complete with dynamic microphone, adjustable sensitivity, relay - 1 pole change over contracts rated at 5 amp, operates from 9-12V D.C. semiconductors 2 x BC208 & 1 x I.C. 741. £11.22 inc VAT

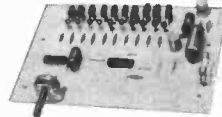

KS262 16 CHANNEL CHASE LIGHT CONTROL UNIT. 350W per channel variable speed, operates from 240V A.C. uses 10 x triacs 10 x BC208-B, 2 x I.C.'s £18.63 inc VAT



KS142 "16 LED V.U. INDICATOR". Sensitivity 3V R.M.S. for first LED to 1.3V R.M.S. for last LED on linear scale. Operates from 5-12V D.C. Max. current 28mA. £9.12 inc VAT

7 HUGHENDEN ROAD, HASTINGS, SUSSEX, TN34 3TG
Telephone: HASTINGS (0424) 436004

Post & Packing 50p per kit.
New Range Of Kits includes: Timers, Transmitters, Receivers, Alarm Devices, Audio Amps, Oscillators, Pre-Amps, Digital Alarm Clocks etc. Plastic Cabinets available for most kits. Send S.A.E. for complete catalogue.
Trade Enquiries Welcomed.

Faster than a scope safer than a voltmeter

LOGIC
MONITOR
LM-1

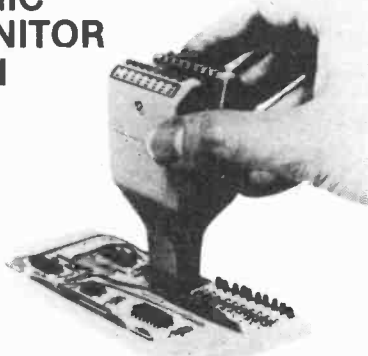

Instant — simultaneous monitoring of the logic state of all IC nodes

Just clip it over your IC

LM-1 Instantly and accurately shows both static and dynamic logic states on a bright 16 LED display.

LM-1 finds its own power.

LM-1 shuts out guesswork, saves time, and eliminates the risk of short circuits.

LM-1 is suitable for all dual-in-line logic ICs LED on = logic state 1 (high), LED off = logic state 0 (low), and each LED is clearly numbered 1 to 16 in the conventional IC pattern.

ONLY £28.70

 (Excluding P&P and VAT)

Total £34.44 including box and instruction manual.

CONTINENTAL SPECIALTIES CORPORATION



C.S.C. (UK) Limited
Dept. 4S, Unit 1, Shire Hill Industrial Estate,
Saffron Walden, Essex CB11 3AQ
Tel: Saffron Walden (0799) 21682
Telex: 817477

C.S.C. (UK) Limited, Dept. 4S, Unit 1, Shire Hill Industrial Estate, Saffron Walden, Essex CB11 3AQ
LM-1 £34.44 (incl. P&P and 15% VAT) Qty. Reqd. For FREE Catalogue tick box

Name Address

I enclose PO/cheque for £..... or debit my
Barclaycard, Access, American Express No.
exp. date

FOR IMMEDIATE ACTION — The C.S.C. 24 hour, 5 day a week service, Telephone: (0799) 21682. and give us your Barclaycard, Access, American Express number and your order will be in the post immediately.



CLASSIFIED

The prepaid rate for classified advertisements is 24 pence per word (minimum 12 words), box number 60p extra. Semi-display setting £6.16 per single column centimetre (minimum 2.5cm). All cheques, postal orders, etc., to be made payable to Everyday Electronics and crossed "Lloyds Bank Ltd." Treasury

notes should always be sent registered post. Advertisements, together with remittance, should be sent to the Classified Advertisement Manager, Everyday Electronics, Room 2337, IPC Magazines Limited, King's Reach Tower, Stamford St., London SE1 9LS. (Telephone 01-261 5942).

When replying to Classified Advertisements please ensure:

- (A) That you have clearly stated your requirements.
- (B) That you have enclosed the right remittance.
- (C) That your name and address is written in block capitals, and
- (D) That your letter is correctly addressed to the advertiser.

This will assist advertisers in processing and despatching orders with the minimum of delay.

Service Sheets

BELL'S TELEVISION SERVICE for service sheets on Radio, TV etc. £1 plus SAE. Colour TV Service Manuals on request. SAE with enquiries to BTS, 190 King's Rd, Harrogate, N. Yorkshire. Tel: 0423 55885.

SERVICE SHEETS from 50p and SAE. Catalogue 25p and SAE, Hamilton Radio, 47 Bohemia Road, St. Leonards, Sussex.

Any single service sheet £1/L.S.A.E. Thousands different Repair/Service Manuals/Sheets in stock. Repair data your named T.V. £6 (with circuits £8). S.A.E. Newsletter, Price Lists. Quotations.

**AUSEE, 76 CHURCHES,
LARKHALL, LANARKSHIRE
(0698 883334).**

Receivers and Components

MIXED. 100 resistors 85p. 100 diodes £1. 100 transistors £5 (new mix). 25 ICs £1.50. 50 C280 £1. 100 components £2.50 (200 £4). 10 Leds £1.25. 10 switches £2. Lists 15p. Pre-war onward valves, wireless, collectors items. SAE. Sole Electronics (EE), 37 Stanley St, Ormskirk, Lancs L39 2DH.

P.C.Bs. PAXOLIN 11 1/2" x 8" 80p. 16" x 11 1/2" £1.40. 1LB WT ASSORTED PIECES 80p. D.S. 10" x 8 1/2" 85p. FIBREGLASS 12" x 8" £1.70. 14" x 6" £1.90. D.S. 10 1/2" x 7" £1.35. 8" x 7" £1.10. PANEL WITH 40 ASSORTED 74 SERIES ICs. £1.00. 20 WIRE ENDED NEONS £1.20. SMALL 3 TRANSISTOR AUDIO AMPS 40p. 3-£1. 300 SMALL COMPONENTS, TRANS. DIODES £1.00. 7LBS ASSORTED COMPONENTS £3.95. 3 ASSORTED M.C. METERS £3. LIST 20p. REFUNDABLE. POST 50p. INSURANCE ADD 20p.

**J. W. B. RADIO
2 BARNFIELD CRESCENT, SALE, CHESHIRE
M33 1NL**

EIGHT-PAGE LIST FREE—thousands of different items, all at cut price. Send SAE to PC Electronics, Thornhill, Romsey Road, Whiteparish, Salisbury.

TURN YOUR SURPLUS capacitors, transistors, etc. into cash. Contact COLES-HARDING & CO., 103 South Brink, Wisbech, Cambs. 0945-4188. Immediate settlement.

Software

THIRTY ZX80 program listings only £4.95, includes a multitude of games, home finance, basic maths, chequebook and more in our publication, ZX80 programs Part I. Also includes hints and tips, from Sussex Software, Wallsend House, Pevensy Bay, Sussex.

Books and Publications

LEARN ELECTRONICS FAST. New, unique, brilliantly simple Tutronik system. Selected by BBC TV. No soldering. Thirty kwikbuild electronics projects and know-how. Identify components, read circuit diagrams, break the colour code and connect circuits that really work. Kit complete with simple-to-follow instructions, circuit plans, components and Tutronik connection system in compact storage wallet. Only £12.95 plus 75p p&p UK (£2.75 p&p elsewhere). Available only from Dept EE, Technocentre Ltd, 140 Norton Road, Stockton-on-Tees TS20 2BG.

WHY NOT START YOUR OWN BUSINESS REWINDING ELECTRIC MOTORS

A genuine opportunity to success. LARGE PROFITS. You can't help but make money if you follow the easy step by step, instructions in our fully illustrated Manual showing how to rewind Electric Motors, Armatures and Field coils as used in Vacuum Cleaners, Electric Drills and Power Tools. NO PREVIOUS KNOWLEDGE IS REQUIRED, as the Manual covers in 13 Chapters, where to obtain all the work you need, materials required, all instructions rewind charts and how to take data etc. A gold mine of information. How to set up your home workshop and how to cost each job to your customer, £4.80 plus 30p P. & P. UK CWO to: 162 Parrswood Rd., Withington, Manchester 20, Dept. EE.

**INDUSTRIAL SUPPLIES, 162 Parrswood Rd.
Withington, Manchester 20, Dept. EE.**

For Sale

NEW BACK ISSUES OF "EVERYDAY ELECTRONICS". Available 85p each Post Free, cheque or uncrossed PO returned if not in stock. **BELL'S TELEVISION SERVICES**, 190 Kings Road, Harrogate, Yorkshire. Tel: (0423) 55885.

ORDER FORM PLEASE WRITE IN BLOCK CAPITALS

Please insert the advertisement below in the next available issue of Everyday Electronics for

insertions. I enclose Cheque/P.O. for £.....

(Cheques and Postal Orders should be crossed Lloyds Bank Ltd. and made payable to Everyday Electronics)

NAME

ADDRESS

.....

Company registered in England. Registered No. 53626. Registered Office: King's Reach Tower, Stamford Street, London SE1 9LS.

Send to: Classified Advertisement Manager

EVERYDAY ELECTRONICS

GMG, Classified Advertisements Dept., Room 2337, King's Reach Tower, Stamford Street, London SE1 9LS. Telephone 01-261 5942

Rate:

24p per word, minimum 12 words. Box No. 60p extra.

For Sale—continued

EVERYDAY ELECTRONICS November 1971 to December 1980 in binders. Offers plus p. & p. Send S.A.E. Box EE11.

Veteran & Vintage

"SOUNDS VINTAGE"

The only magazine for all vintage sound enthusiasts, packed with articles by top writers, covering gramophones, phonographs, 78s, wireless, news, history, reviews, etc.

Bi-monthly. Annual subscription £6.60 (airmail extra). Send 75p for sample copy.
28 Chestwood Close, Billericay, Essex

Miscellaneous

GUITAR/PA/MUSIC AMPLIFIERS

100 watt superb treble/bass overdrive. 12 months guarantee. Unbeatable at £50; 60 watt £44; 200 watt £65; 100 watt twin channel sep. treble/bass per channel £65; 60 watt £52; 200 watt £78; 100 watt four channel sep. treble/bass per channel £75; 200 watt £98; slaves 100 watt £34; 200 watt £60; 250 watt £70; 500 watt £140; fuzz boxes £12.00; Bass fuzz £12.90; overdriver fuzz £22; 100 watt combo superb sound overdrive, sturdy construction, castors, unbeatable £98; twin channel £115; bass combo £118; speakers 15in. 100 watt £36; 12in. 100 watt £24; 60 watt £16; microphone Shure Unidyne B £25; 3-Channel sound/light £26.

Send cheque or P.O. to:

WILLIAMSON AMPLIFICATION
62, Thorncliffe Avenue, Dukinfield, Cheshire.
Tel: 061-308 2064.

DIGITAL WATCH BATTERY REPLACEMENT KIT



These watches all require battery (power cell) replacement at regular intervals. This kit provides the means. We supply eyeglass, non-magnetic tweezers, watch screwdriver, case knife and screwback case opener. Also one doz. assort. push-pieces, full instructions and battery identification chart. We then supply replacement batteries—you fit them. Begin now. Send £9 for complete kit and get into a fast growing business. Prompt despatch.

BOLSTER INSTRUMENT CO. (EE24)
11 Percy Avenue, Ashford, Middx., TW15 2PB

ELECTRONIC KITS. Largest range of kits in the U.K. Everything from stroboscopic lights to transmitters, at unbeatable prices. Send S.A.E. for free catalogue to: Eastling Electronics (Kits), 64B Hawthorn Road, Winton, Bournemouth.

LEARN ELECTRONICS WITHOUT SOLDER

Build electronic circuits without solder on a Roden S-Dec.

This has built-in contacts and holes into which you plug your components. Suitable for all ages. Can be used time after time. Ideal gift for students or experimenters. Full instructions and 2 circuit diagrams with each S-Dec.

Send cheque or P.O. to:-
Roden Products, Dep EE
High March, Daventry,
Northants, NN11 4QE.

£3.85

plus 40p p.&p. each

THE SCIENTIFIC WIRE COMPANY

PO Box 30, London E.4. 01 531 1568.

ENAMELLED COPPER WIRE

SWG	1 lb	8 oz	4 oz	2 oz
8 to 29	2-76	1-50	0-80	0-60
30 to 34	3-20	1-80	0-90	0-70
35 to 39	3-40	2-00	1-10	0-80
40 to 43	4-75	2-60	2-00	1-42
44 to 47	8-37	5-32	3-19	2-50
48 to 49	15-96	9-58	6-38	3-69

SILVER PLATED COPPER WIRE

14 to 30	6-50	3-75	2-20	1-40
----------	------	------	------	------

TINNED COPPER WIRE

14 to 30	3-85	2-36	1-34	0-90
----------	------	------	------	------

Prices include P & P vat and Wire Data. Orders under £2 please add 20p. SAE for List. Dealer enquiries welcome.

BALLARD'S OF TUNBRIDGE WELLS have moved to 54 Grosvenor Road, No lists. SAE. All enquiries phone T/Wells 31803.

MAKE YOUR OWN FIBRE OPTIC LIGHT

Approx 7500 optical fibres mounted in a sheath at the base. Only £10.20 each.

ART AND CRAFTS, Button Bridge Lane, Kinlet, Bewdley, Worcs.

PLEASE MENTION EVERYDAY ELECTRONICS WHEN REPLYING TO ADVERTISEMENTS

INDEX TO ADVERTISERS

Absonglen	192	Electronic Design Assoc. .. .	206	N.I.C.	148
A.J.D. Direct Supplies (Silicon Shop)	197	Electronize Design	212	Phonosonics	210
Amtron	213	Electrovalue	211	Powell T.	Cover iii
Audio Electronics	Cover ii, 212	E.R. Books	216	Radio Component Specialists .. .	216
Bi-Pak	149	Gemini	146	Radio-TV Components	153
Birkett J.	206	Greenweld	152	Science of Cambridge	150-151
B.K. Electronics	210	Home Radio	148	Selray Book	211
B.N.R.E.S.	207	I.L.P. Electronics	208-209	Swanley Electronics	148
Boss Industrial Mouldings Ltd. .. .	211	Intertext (ICS)	146	Tempus	152
Bull J.	199	Litesold	148	Titan Transformers	210
Cambridge Learning Ltd.	200	Keelmoor	200	T.K. Electronics	192
Chordgate	212	Magenta Electronics	147	Watford Electronics	145
Collier-McMillan (B.I.E.T.)	206	Maplin Electronic Supplies Ltd. Cover iv		Webb Electronics	203
C.S.C. (U.K.) Ltd.	197, 213	Marshalls	146	West London Direct Supplies .. .	216
Doram	203			Wilmslow Audio	203

**"SPECIAL PRICES" POST £1.50
BAKER LOUDSPEAKERS**

Model	Ohms	Size Inch	Power Watts	Type	Our Price
Major	4, 8, 16	12	30	Hi-Fi	£14
Deluxe Mk II	8	12	15	Hi-Fi	£20
Superb	8, 16	12	30	Hi-Fi	£20
Auditorium	8, 16	12	45	Hi-Fi	£25
Auditorium	8, 16	15	60	Hi-Fi	£35
Group 45	4, 8, 16	12	45	PA	£15
Group 75	4, 8, 16	12	75	PA	£22
Group 100	8, 16	12	100	PA	£28
Group 100	8, 16	15	100	PA	£28
Disco 100	8, 16	12	100	Disco	£28
Disco 100	8, 16	15	100	Disco	£28

4 CHANNEL MIXERS £8-00
Add musical highlights and sound effects to recordings. With 4 Microphones, records, tapes and tuner with separate controls into single output. 9 volt battery operated with switch for four channel mono or two channel stereo working.

DE-LUXE DISCO MIXER 240V, 4 Stereo Channels plus Mike, 2 Vu meters, Headphone Monitor. £40, Post £1.

MINI MODULE LOUDSPEAKER KIT £10-95
EMI 15 x 8 1/2 in. 3-way Loudspeaker Baffle, 5in. Bass, 5in. Middle, 3in. Tweeter; 3-way Crossover & Ready Cut Baffle. Full assembly instructions supplied. Response 60 to 20,000 c.p.s. 12 watt RMS £10-95 per kit. Two kits £20. Suitable Bookshelf Cabinet £9-50 each. Post £1-50

GARRARD 6-200 SINGLE PLAYER DECK
Brushed Aluminium Arm with stereo ceramic cartridge and Diamond Stylus, Manual and Auto Stop/Start. Large Metal Turntable. Cueing Device and Pause Control. £22, Post £2.

ISKRA SINGLE RECORD PLAYER £8
Fitted with auto stop, stereo cartridge. Baseplate. Size 11 x 8 1/2 in. Turntable size 7in. diameter. a.c. mains 240V 3 speed plays all size records. Post £1.

B.S.R. SINGLE PLAYER P170/2 £21-00
3-speeds 11in. aluminium turntable. "slim" arm, cueing device, stereo ceramic cartridge, silver trim, bias compensator, adjustable stylus pressure, plays all records, spring suspension, 240V A.C. Post £2.

B.S.R. DE-LUXE AUTOCHANGER £20
With stereo cartridge, plays all size records. Post £2

WOODEN PLINTHS CUT FOR B.S.R. £4
Size: 15 x 15 x 3in. Teak effect. Post £1.

BSR DE-LUXE PLINTH Teak Veneered with Hinged Perspex Cover. Size 17 1/2 x 15 x 9in. £10-50, Post £2.

METAL PLINTH CUT FOR GARRARD
Size: 16 x 14 x 3in. £5-00 Silver or Black finish. Post £2.

TINTED PLASTIC COVERS POST £1-50
Size: 14 1/2 x 12 1/2 x 3in. £4, 16 x 14 x 3 1/2 in. £6, 17 1/2 x 9 1/2 x 3 1/2 in. £3, 18 x 13 1/2 x 3in. £8, 18 x 12 1/2 x 3in. £6.

R.C.S. LOW VOLTAGE STABILISED POWER PACK KITS £2-95 Post 45p
All parts and instructions with Zener diode printed circuit, mains transformer 240V a.c. Output 6 or 7 1/2 or 9 or 12V d.c. up to 100mA or less. Please state voltage required.

PP BATTERY ELIMINATOR BRITISH
Mains stabilized power-pack 9 volt 400mA max. with overload cut out. Size 5 x 3 1/2 x 2 1/2 in. £4-50. Post 50p.

MAINS TRANSFORMERS POST 90p

250-0-250V 70mA 6-3V, 2A	£4-50
250-0-250 80mA 6-3V, 3-5A, 6-3V 1A	£5-00
350-0-350V 150mA 6-3V 5A, 5V 2A	£10-50
350-0-350V 250mA 6-3V 5 amp, 5V 2A	£12-50
300-0-300 120mA 2 x 6-3V 2A C.T., 6-3V 2A	£10-00
220V 45mA, 6-3V 2A	£2-50
250V 60mA, 6-3V 2A	£2-75

GENERAL PURPOSE LOW VOLTAGE

2A, 3, 4, 5, 6, 8, 9, 10, 12, 15, 18, 24 and 30V	£6-00
1A, 6, 8, 10, 12, 16, 18, 20, 24, 30, 36, 40, 48, 60	£6-00
2A, 6, 8, 10, 12, 16, 18, 20, 24, 30, 36, 40, 48, 60	£9-50
3A, 6, 8, 10, 12, 16, 18, 20, 24, 30, 36, 40, 48, 60	£12-50
5A, 6, 8, 10, 12, 16, 18, 20, 24, 30, 36, 40, 48, 60	£18-00
5, 8, 10, 18V 1A £2-50 12V 100mA £1-30 12V 300mA £1-50 12V 750mA £2-25 40V 2A tapped 10V or 30V £3-50 10-0-10V 2A £3-50 500mA £2-00 30V 5A + 34V 2A CT £4-2 18V 6A £11, 12-0-12V 2 amp £3-50 25-0-25V 2A £4-50 20-0-20V 1A £3-50 30V 1 1/2A £3-30 20V 1A £3, 9V 3 amp £3-50 60V, 40V, 20V 1A £4, 15/0/15V 2A £3-75 32-0-32V 6 1/2A £11, 9V 250mA £1-50 30V 2A £3-50	

AUTO TRANSFORMERS 115V to 240V 500W £12-00 CHARGER

TRANSF	RECTIFIERS	METERS
6-12v-3A £4-00	6-12v-1A 90p	5amp £2
6-12v-4A £5-50	6-12v-2A £1-10	
6-12v-6A £8-50	6-12v-4A £2-00	

BLANK ALUMINIUM CHASSIS, 18 s.w.g. 2 1/2 in. sides; 8 x 4in. £1-20; 8 x 6in. £1-50; 10 x 7in. £1-90; 14 x 6in. £2-50; 16 x 6in. £2-40; 12 x 3in. £1-50; 16 x 10in. £2-70; 12 x 8in. £2-20. ANGLE BRACKET, 6 x 1 1/2 x 1 1/2 in. 25p.
ALUMINIUM PANELS, 18 s.w.g. 8 x 4in. 36p; 8 x 6in. 60p; 10 x 7in. 80p; 12 x 5in. 60p; 12 x 8in. 90p; 16 x 6in. 90p; 14 x 9in. 1-20; 12 x 12in. £1-30; 16 x 10in. £1-40.
ALUMINIUM BOXES, MANY OTHER SIZES IN STOCK 4 x 2 x 2in. £1-00; 2 x 4in. £1-00; 6 x 4 x 2in. £1-30; 8 x 6 x 3in. £2-10; 9 x 4 x 4in. £2-30; 10 x 7 x 3in. £2-50; 12 x 8 x 3in. £3-00; 12 x 5 x 3in. £2-30.

HIGH VOLTAGE ELECTROLYTICS

8/350V	35p	8+8/450V	75p	50+50/300V	50p
16/350V	45p	8+16/450V	75p	32+32/500V	£1-00
32/500V	75p	20+20/450V	75p	100+100/275V	65p
50/500V	£1-20	32+32/350V	75p	150+200/275V	70p
8/800V	£1-20	16/500V	65p	220/450V	95p

Post 50p Minimum. Callers Welcome. Access-Barclay-Visa. Lists 20p. Closed Wed.

Radio Components Specialists

337 WHITEHORSE ROAD
CROYDON, SURREY, U.K. Tel. 01-684 1665

MAINS INTERCOM



NO BATTERIES NO WIRES ONLY
£37.99
PER PAIR
+ VAT £5-70
+ P & P £1-95

The modern way of instant 2-way communications. Just plug into power socket. Ready to use. Crystal clear communications from room to room. Range 2-mile on the same mains phase. On/off switch. Volume control, with 'buzzer' call and light indicator. Useful as inter-office intercom. between office and warehouse, in surgery and in homes. P. & P. £1-95. Also F.M. 2 channel "touch" model £55-95 per pair + VAT £8-40 + P&P £2-15.

NEW AMERICAN TYPE CRADLE TELEPHONE AMPLIFIER



£18.95
+ VAT £2-85
+ P & P £1-45

Latest transistorised Telephone Amplifier, with detached plug-in speaker. Placing the receiver on to the cradle activates a switch for immediate two-way conversation without holding the handset. Many people can listen at a time. Increase efficiency in office, shop, workshop. Perfect for "confef nice" calls: leaves the user's hands free to make notes, consult files. No long waiting, saves time with long-distance calls. On/off switch, volume control, Conversation recording, model at £20-95 + VAT £3-15. P&P £1-45.

DOOR ENTRY SYSTEM

No house/business/surgery should be without a DOOR ENTRY SYSTEM in this day and age. The modern way to answer the door in safety to unwanted callers. Talk to the caller and admit him only if satisfied by pressing a remote control button which will open the door electronically. A boon for the invalid, the aged, and busy housewife. Supplied complete d.i.y. kit with one internal Telephone, outside Speaker panel, electric door lock release (for Yale type surface latch lock): mains power unit, cable (4 pairs) 50ft and wiring diagram. Price £59-95 + VAT £9-00 + P&P £2-25. Kit with two phones £69-95 + VAT £10-50 + P&P £2-45.

10-day price refund guarantee on all items
Access and Barclaycard welcome.

WEST LONDON DIRECT SUPPLIES (EE3)
169 KENSINGTON HIGH STREET,
LONDON, W8 Tel: 01-937 5548

MAIL ORDER ADVERTISING

British Code of Advertising Practice

Advertisements in this publication are required to conform to the British Code of Advertising Practice. In respect of mail order advertisements where money is paid in advance, the code requires advertisers to fulfil orders within 28 days, unless a longer delivery period is stated. Where goods are returned undamaged within seven days, the purchaser's money must be refunded. Please retain proof of postage/despatch, as this may be needed.

Mail order Protection Scheme

If you order goods from Mail Order advertisements in this magazine and pay by post in advance of delivery, EVERYDAY ELECTRONICS will consider you for compensation if the Advertiser should become insolvent or bankrupt, provided:

- (1) You have not received the goods or had your money returned; and
 - (2) You write to the Publisher of EVERYDAY ELECTRONICS summarising the situation not earlier than 28 days from the date you sent your order and not later than two months from that day.
- Please do not wait until the last moment to inform us. When you write, we will tell you how to make your claims and what evidence of payment is required. We guarantee to meet claims from readers made in accordance with the above procedure as soon as possible after the Advertiser has been declared bankrupt or insolvent.

This guarantee covers only advance payment sent in direct response to an advertisement in this magazine not, for example, payment made in response to catalogues etc. received as a result of answering such advertisements. Classified advertisements are excluded.

ENGINEERING REFERENCE BOOKS

E. R. BOOKS, PO BOX 47, PAIGNTON, DEVON TQ3 1TE

TEXAS INSTRUMENTS SEMICONDUCTOR BOOKS

TTL Data Book	£7-50
Optoelectronics Data Book	£8-50
Opto Theory & Practice	£8-50
9900 Family Systems Design Book	£8-50
Software Design Guide for Microprocessors	£11-50
Linear Control Circuits	£3-50
Interface Circuits Data Book	£3-50
Bipolar Microcomputer Data Book	£4-50
Voltage Regulator Data Book	£4-50
MOS Memory Data Book	£4-50

UNDERSTANDING SERIES

Microprocessors	} £4-00
Digital Electronics	
Solid State Electronics	
Calculator Math	
Communications Systems	

TEXAS INSTRUMENTS CALCULATOR BOOKS

Sourcebook for Programmable Calc.	£9-50
Calculator Analysis Business & Finance	£7-50
Math on Keys	£4-00

RCA

Audio Amplifier Manual	£4-00
C/Mos IC Technical Manual	£4-50
Electro-optic Handbook	£4-50
Solid State Devices Manual	£4-50
Linear Devices Databook	£5-00
Microprocessors Memories and Support Systems Databook	£6-50

NATIONAL

Audio Handbook	£4-50
Fet Handbook	£3-20
Linear Data Catalogue	£7-30

ALL PRICES QUOTED INCLUDE POSTAGE/PACKING.

If you find an ad unacceptable, don't turn the page: turn to us.

The Advertising Standards Authority.
If an advertisement is wrong, we're here to put it right.
A.S.A. Ltd., Brook House, Torrington Place, London WC1E 7HN.

E.E. PROJECT KITS

Audio Effects Unit	ZB122	Oct. 80	£12.25	Signal Level Indicator	ZB36	Oct. 79	£4.50
Phone Call Charge Jogger	ZB121	Oct. 80	£6.00	High Impedance Voltmeter	ZB35	Oct. 79	£14.50
Darkroom Controller	ZB123	Oct. 80	£17.25	Universal Oscillator	ZB37	Oct. 79	£3.50
Bicycle Alarm	ZB124	Oct. 80	£9.25	Chaser Light	ZB4	Sept. 79	£17.50
Precision Parking Pad	ZB73	Sept. 80	£3.50	Low Power Audio Amplifier	ZB3	Sept. 79	£3.75
Lights Failure Monitor	ZB77	Sept. 80	£8.75	Simple Transistor Tester	ZB2	Sept. 79	£5.50
TTL Power Supply Unit	ZB78	Sept. 80	£9.50	Varicap MW Radio	ZB1	Sept. 79	£8.50
Duo-Deci Timer	ZB75	Sept. 80	£8.50	Quiz Referee	ZB12	Aug. 79	£4.75
*TTL Logic Probe	ZB76	Sept. 80	£3.25	Touch-on Pilot Light	ZB10	Aug. 79	£2.00
Bedside Radio	ZB74	Sept. 80	£14.25	Trailer Flasher	ZB9	Aug. 79	£3.00
Auto Lighting-Up Warning	ZB71	Aug. 80	£5.65	Swanee Whistler	ZB8	Aug. 79	£3.50
Audio Millivoltmeter	ZB70	Aug. 80	£17.75	Electronic Tuning Fork	ZB7	Aug. 79	£8.90
Weather Centre (Electronics only)	ZB72	Aug. 80	£47.50	Power Supply 9V	ZB6	Aug. 79	£8.25
Brakesafe Monitor	ZB68	Aug. 80	£7.50	Warbling Timer	ZB5	Aug. 79	£5.80
Cricket Game	ZB69	Aug. 80	£14.95	Water Level Indicator	ZB111	July 79	£4.50
Zener Diode Tester	ZB79	July 80	£5.00	Dolls House Lights Economiser	ZB107	July 79	£4.50
Signal Tracer	ZB80	July 80	£5.00	Darkroom Timer	ZB17	July 79	£2.50
General Purpose Amplifier	ZB81	July 80	£6.00	Soldering Iron Bit Saver	ZB13	July 79	£9.25
Voltage Converter	ZB82	July 80	£4.75	Voltage Splitter	ZB15	July 79	£3.25
Autowaa	ZB83	July 80	£19.25	Conference Timer	ZB14	July 79	£38.00
A.F. Signal Generator	ZB84	July 80	£20.00	Electronic Canary	ZB19	June 79	£4.50
Courtesy Light Delay	ZB85	July 80	£5.25	Tremolo Unit	ZB18	June 79	£10.00
Auto Phase	ZB86	July 80	£19.25	Meter Amplifier	ZB21	June 79	£3.50
Battery Voltage Monitor	ZB64	May 80	£4.80	Quad Simulator	ZB22	June 79	£8.00
Lights Warning System	ZB63	May 80	£3.60	Short Wave Converter	ZB25	May 79	£13.75
Autofade	ZB66	May 80	£10.25	Electronic Dice	ZB24	May 79	£13.50
*Dual Line Game	ZB65	May 80	£25.00	Intruder Alarm	ZB23	May 79	£23.00
Audio Tone Generator	ZB67	May 80	£3.50	Shaver Inverter	ZB26	April 79	£8.00
*Pre-tuned 4-Station Radio	ZB62	May 80	£14.00	Touch Bleeper	ZB27	April 79	£3.25
Gas Sentinel	ZB61	April 80	£27.00	Choke Warning Device	ZB28	April 79	£7.50
Automatic Level Control	ZB60	April 80	£8.00	Transistor Tester	ZB100	April 79	£4.00
Cycle Direction Flasher	ZB59	April 80	£14.50	One Transistor Radio MW/LW	ZB104	March 79	£7.25
Cable and Pipe Locator	ZB54	March 80	£3.75	Time Delay Indicator	ZB98	March 79	£4.00
Stereo Headphone Amplifier	ZB57	March 80	£15.25	Micro Chime	ZB96	Feb. 79	£12.00
Doorbell Register	ZB58	March 80	£3.60	Lights Reminder for Car	ZB32	Jan. 79	£4.50
Five Range Current Limiter	ZB53	March 80	£4.50	Headphone Enhancer	ZB101	Jan. 79	£4.00
Kitchen Timer	ZB55	March 80	£12.75	Solid-State Roulette	ZB95	Jan. 79	£18.25
Touch Switch	ZB56	March 80	£9.00	I'm First	ZB105	Jan. 79	£3.70
Micro Music Box	ZB45	Feb. 80	£17.00	Continuity Tester	ZB115	Jan. 79	£4.30
Simple Short Wave Receiver	ZB44	Feb. 80	£18.00	Fuzz Box	ZB106	Dec. 78	£5.00
Morse Practice Oscillator	ZB43	Feb. 80	£6.00	Vehicle Immobiliser	ZB110	Dec. 78	£5.00
Slide/Tape Synchroniser	ZB42	Feb. 80	£11.50	Audio Effects Oscillator	ZB109	Nov. 78	£3.50
Spring-Line Reverb Unit	ZB49	Jan. 80	£22.50	Tele-Tel	ZB94	Nov. 78	£17.80
Mains on/off Timer	ZB48	Jan. 80	£30.00	Radio MW/LW	ZB116	Oct. 78	£7.00
Power Supply 3-9V	ZB47	Jan. 80	£4.50	Sound to Light	ZB112	Sept. 78	£7.00
Loft Alert	ZB46	Jan. 80	£33.00	R.F. Signal Generator	ZB93	Sept. 78	£20.50
Lightcall	ZB103	Dec. 79	£6.25	Guitar Tone Booster	ZB117	Sept. 78	£5.00
Burglar Alarm	ZB51	Dec. 79	£5.00	A.F. Signal Generator	ZB119	Aug. 78	£10.00
Baby Alarm	ZB40	Nov. 79	£8.50	Quagmire	ZB120	July 78	£9.50
Opto Alarm	ZB41	Nov. 79	£5.00	Tele-Bell	ZB118	June 78	£12.25
Radio Tuner MW/LW	ZB108	Nov. 79	£14.75	Weird Sound Effects Generator	ZB113	March 78	£3.50
3-Function Generator	ZB52	Nov. 79	£25.00	Catch-a-Light	ZB102	March 78	£6.00
One Armed Bandit	ZB33	Oct. 79	£21.00	Chaser Light Display	ZB97	Feb. 78	£22.00
Lights-on Reminder	ZB34	Oct. 79	£4.60	Car System Alarm	ZB92	Feb. 78	£4.50

★ TEACH-IN 80 ★

This popular monthly constructional series started in E.E. in 1979 and is a must for beginners to electronics. The sheer simplicity of the whole project experiments lends itself to be made by any beginner young or old. Basic technical principles and symbols explained in great detail. Start at the beginning with a hobby that could become a worthwhile career, our kit comes complete with all parts as specified by E.E.

List A, B and C £22.50. Monthly reprints from October 1979 available at 40p each per month extra or £4.50 for whole series.

*All E.E. project kits supplied with cases except items marked *. All kits come complete with items as specified plus Texas i.c. sockets where required, also veroboard connecting wire etc.

If you do not have the issue of E.E. which contains the project we can supply a reprint at 40p extra.

Personal callers please ring to check availability of kits.

All prices include post, packing and 15% V.A.T.

LATE EXTRA

MINI I.C. RADIO OCTOBER '80	ZB126	£10.35
DUSK/DAWN RELAY OCTOBER '80	ZB125	£7.45
SOUND TO LIGHT	ZB127 NOV. '80	£19.00
GUITAR PRACTICE AMPLIFIER	ZB128 NOV. '80	£16.85
REACTION TESTER	ZB129 NOV. '80	£10.25
PRECISION TIMER	ZB130 NOV. '80	£21.00
TRANSISTOR TESTER	ZB131 NOV. '80	£8.00
SOIL MOISTURE MONITOR	ZB132 NOV. '80	£5.00
OTHER THAN STATED, PRICES ON APPLICATION.		

Shop Hours Mon-Friday 9-5.30 p.m. Sat. 9-4.30 p.m.
Telephone: 01-226 1489

T. POWELL

306 St. Pauls Road, Highbury Corner, London N.1.



Visa/Access cards accepted

Minimum telephone Orders £5.00

Minimum Mail Order £1.00

Make it for a Song!

198 MOTT



The New Maplin in Matinée

Amazing Value For Only **£299.95** + £99.50 for cabinet if required.

Easy to build. Latest technology — means less cost, less components and 80% less wiring. Comparable with organs selling for up to £1,000.00. Two 49-note manuals. 13-note pedalboard. All organ voices on drawbars. Preset voices: Banjo, Accordion, Harpsichord, Piano, Percussion. Piano sustain Sustain on both manuals, and pedalboard. Electronic rotor, fast and slow. Vibrato and Delayed vibrato. Reverb. Manual and Auto-Wah. Glide (Hawaiian Guitar Sound). Single finger chording plus memory. 30 Rhythms! 8-instrument voicing. Major, Minor and Seventh chords. Unique walking bass lines with each rhythm. Unique countermelody line with each rhythm. Truly amazing value for money. Full construction details start in the March issue of Electronics & Music Maker on sale Feb. 14th.



The complete buyers' guide to electronic components. With over 300 pages, it's a comprehensive guide to electronic components with thousands of photographs and illustrations and page after page of invaluable data. Get a copy now — it's the one catalogue you can't afford to be without.



Post this coupon now for your copy of our 1981 catalogue price £1.

Please send me a copy of your 320 page catalogue. I enclose £1 (Plus 25p p&p). If I am not completely satisfied I may return the catalogue to you and have my money refunded. If you live outside the UK send £1.68 or 12 International Reply Coupons. I enclose £1 25

Name _____

Address _____

EE3/81

MAPLIN

Maplin Electronic Supplies Ltd
All mail to P.O. Box 3, Rayleigh, Essex SS6 8LR
Telephone Southend (0702) 554155 Sales (0702) 552911

Shops
159 161 King Street, Hammersmith, London W6 Telephone (01) 748 0926
284 London Road, Westcliff-on-Sea, Essex Telephone Southend (0702) 554000
Both shops closed Mondays

Catalogue now on sale in all branches of WHSMITH  Price £1.00