

Practical projects to build at home

everyday electronics

MAY 76

30p

FREE! WIRE BENDING GAUGE

EASY
to build...

MAGNETONE

...**EASY**
to play

Starting
THIS MONTH
New series...

**INTEGRATED
CIRCUITS
EXPLAINED**

**LIGHTNING
CHESS BUZZER**

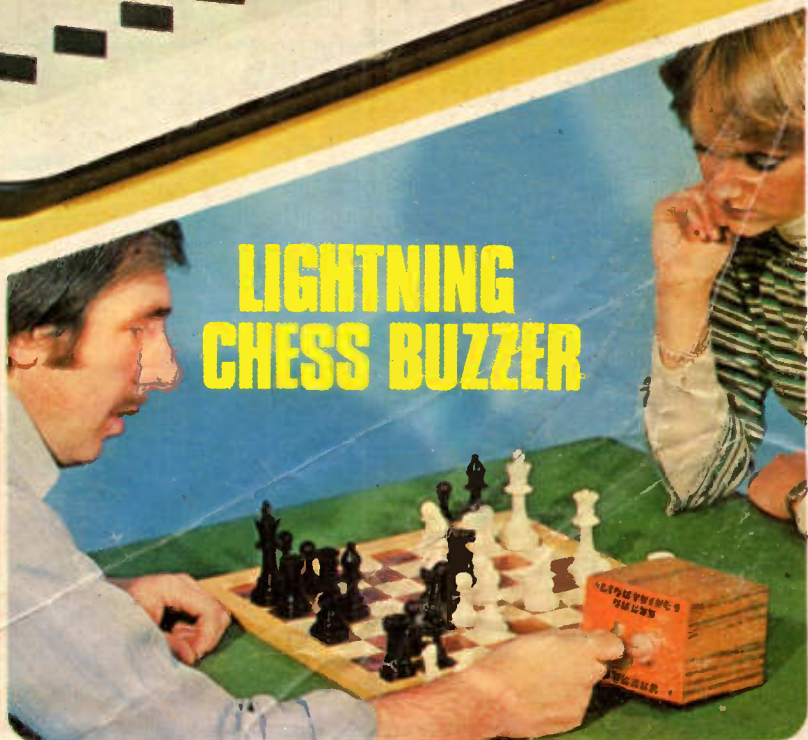

RADIO EXCHANGE LTD.

**ALL PRICES
INCLUDE VAT**

NEW EDU-KIT MAJOR

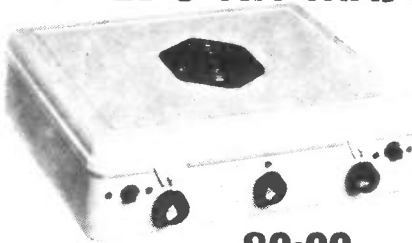

Total Building Costs

£9.99

PP+Ins. 65p. (Overseas Seamail P+P £3.50)

Completely Solderless Electronic Construction Kit. Build these projects without soldering iron or solder

- ★ 4 Transistor Earpiece Radio
- ★ Signal Tracer
- ★ Signal Injector
- ★ Transistor Tester NPN-PNP
- ★ 4 Transistor Push Pull Amplifier
- ★ 5 Transistor Push Pull Amplifier
- ★ 7 Transistor Loudspeaker Radio MW-LW
- ★ 5 Transistor Short Wave Radio
- ★ Electronic Metronome
- ★ Electronic Noise Generator
- ★ Batteryless Crystal Radio
- ★ One Transistor Radio
- ★ 2 Transistor Regenerative Radio
- ★ 3 Transistor Regenerative Radio
- ★ Audible Continuity Tester
- ★ Sensitive Pre-Amplifier

Components include: 24 Resistors ★ 21 Capacitors ★ 10 Transistors
 ★ 3 1/2 in Loudspeaker ★ Earpiece ★ Mica Baseboard ★ 3 12-way connectors
 ★ 2 Volume controls ★ 2 Slider Switches ★ 1 Tuning Condenser ★ 3 Knobs
 ★ Ready Wound MW/LW/SW Coils ★ Ferrite Rod ★ 6 1/2 yards of wire
 ★ 1 Yard of sleeving, etc.
 Complete kit of parts including construction plans

VHF AIR CONVERTER KIT

Build this Converter Kit and receive the Aircraft Band by placing it by the side of a radio tuned to Medium Wave or the Long Wave Band and operating as shown in the instructions supplied free with all parts. Uses a retractable chrome plated telescopic aerial, Gain Control, V.H.F. Tuning Capacitor, Transistor, etc.



All Parts including Case and Plans **£4.35** P & P and Ins. 40p.

NEW Everyday Series

Build this exciting new series of designs.



E.V.5 5 Transistors and 2 diodes. MW/LW. Powered by 4 1/2 volt Battery. Ferrite rod aerial, tuning condenser, volume control, and now with 3" loudspeaker. Attractive case with red speaker grille. Size 9" x 5 1/2" x 2 1/2" approx. All parts including Case and Plans.

Total Building costs **£4.75** P & P + Ins 50p

E.V.6 Case and looks as above. 6 Transistors and 3 diodes. Powered by 9 volt battery. Ferrite rod aerial, 3" loudspeaker, etc., MW/LW coverage. Push Pull output.

All parts including case and plans. Total Building costs **£5.50** P & P + Ins. 55p

E.V.7 Case and looks as above, 7 Transistors and 3 diodes. Six wavebands, MW/LW. Trawler Band SW1, SW2, SW3, powered by 9 volt battery. Push Pull output. Telescopic aerial for short waves. 3" Loudspeaker.

All parts including Case and Plans. Total Building Costs **£7.05** P & P + Ins. 55p

POCKET FIVE

NOW WITH 3" LOUDSPEAKER
 3 Tuneable wavebands. M.W., L.W., and Trawler Band. 7 stages, 5 transistors and 2 diodes. supersensitive ferrite rod aerial, attractive black and gold case. Size 5 1/2" x 1 1/2" x 3 1/2" approx.



Total Building Costs **£3.99**

All Parts including Case and Plans. P&P+Ins. 50p.

ROAMER TEN MARK 2

WITH VHF INCLUDING AIRCRAFT

Now with free earpiece and switched socket. 10 transistors. Latest 5" x 3" loudspeaker. 9 tuneable wavebands, MW1, MW2, LW, SW1, SW2, SW3, trawler band, VHF and local stations, also aircraft band. Built in ferrite rod aerial for MW/LW. Chrome plated. 6 section telescope aerial, can be angled and rotated for peak short wave and VHF listening. Push pull output using 600mW transistors. Car aerial socket, 10 transistors plus 3 diodes. Ganged tuning condenser with VHF section. Separate coil for aircraft band. Volume on/off. Wave change and tone controls. Attractive Case in rich chestnut shade with Gold Blocking. Size: 9" x 7" x 4". Easy to follow instructions and diagrams.



Total building costs **£11.87** P & P + Ins. 65p

ELECTRONIC CONSTRUCTION KITS

ECK 2 Self Contained Multi-Band V.H.F. Receiver Kit. 8 Transistors and 3 Diodes. Push/Pull output. 3" Loudspeaker, Gain Control. Superb 9 section swivel ratchet and retractable chrome plated telescopic aerial. V.H.F. Tuning Capacitor, Resistors, Capacitors, Transistors, etc. Will receive T.V. Sound, Public Service Band, Aircraft, V.H.F. Local Stations, etc. Operates from a 9 Volt PP7 Battery (not supplied with kit). Complete kit of parts including construction plans

£7.95 P & P and Ins. 55p.

ECK 4 7 Transistors, 6 tuneable wavebands, MW, LW, Trawler Band, 3 Short Wave Bands. Receiver Kit. With 5" x 3" Loudspeaker.

Push/Pull output stage, Gain Control, and Rotary Switch. 7 Transistors and 4 Diodes. 6 section chrome-plated telescopic aerial. 8" Sensitive Ready Wound Ferrite Rod Aerial. Tuning Capacitor, Resistors, Capacitors, etc. Operates from a 9 Volt PP7 Battery (not supplied with kit). Complete kit of parts including construction plans. **£7.25** P & P and Ins. 55p

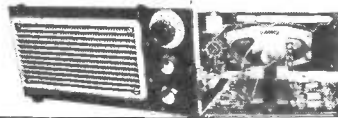
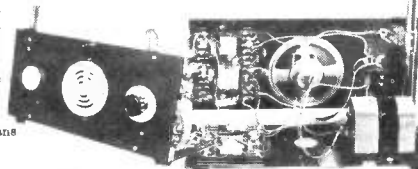

EDU-KIT JUNIOR

Completely Solderless Electronic Construction Kit. Build these projects without Soldering Iron or Solder.

- ★ Crystal Radio Medium Wave Coverage — No Battery necessary.
- ★ One Transistor Radio.
- ★ 2 Transistor Regenerative Radio.
- ★ 3 Transistor Earpiece Radio Medium Wave Coverage.
- ★ 4 Transistor Medium Wave Loudspeaker Radio.
- ★ Electronic Noise Generator
- ★ Electronic Metronome.
- ★ 4 Transistor Push/Pull Amplifier.

All parts including Loudspeaker, Earpiece, MW Ferrite Rod Aerial, Capacitors, Resistors, Transistors, etc. Complete kit of parts including construction plans.

£7.25 P & P + Ins. 55p

EDU-KIT

Build Radios, Amplifiers, etc. from easy stage, diagrams.



Five units including master unit to construct.

Components include: Tuning Condenser: 2 Volume Controls: 2 Slider Switches: Fine tone 3" moving coil Speaker: Terminal Strip: Ferrite Rod Aerial: Latching Clips: 4 Tag Boards: 10 Transistors: 4 Diodes: Resistors: Capacitors: Three 1/2" Knobs. Units once constructed are detachable from Master Unit, enabling them to be stored for future use. Ideal for Schools, Educational Authorities and all those interested in radio construction. All Parts including Case and Plans **£6.99** P & P + Ins. 55p

JIFFY TESTER

Easy to build and operate. Fits in the pocket. A quick checker for continuity of resistors, chokes, diodes, transistors, circuit wiring (not mains) and loudspeakers. Complete with earpiece, jack plug and socket resistors, capacitors, components, etc. Complete kit of parts including construction plans.

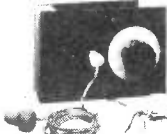

£3.15 P & P + Ins. 30p

TO RADIO EXCHANGE LTD.,
 61A HIGH STREET, BEDFORD MK40 1SA
 Telephone: 0234 52367.

Reg. No. 785372

- ★ Callers side entrance "Lavelis" Shop.
- ★ Open 10-1, 2.30-4.30. Mon-Fri. 9-12 Sat.

I enclose £.....
 for
 Name
 Address

EE576

Why not
DIAL-A-COMPONENT
?

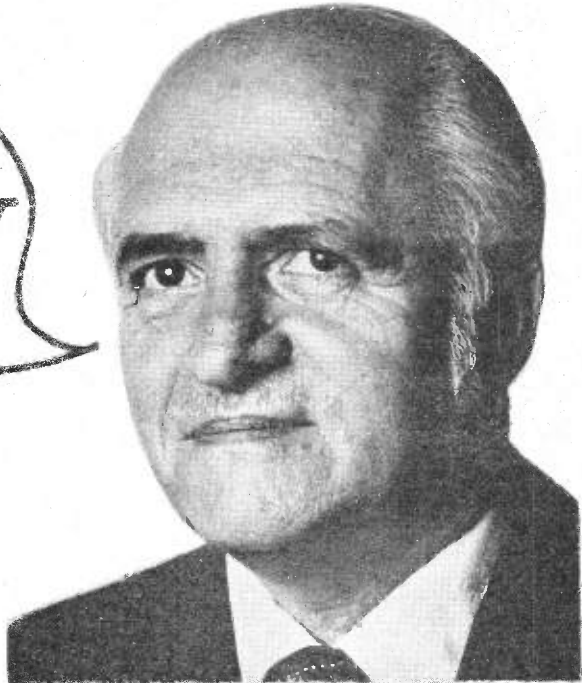

These days you can Dial-a-Van, Dial-a-Recipe, Dial-a-Pop Tune, even Dial-a-Wine. But Home Radio Components Ltd. have been offering such a service for years! Those of you who already own one of the renowned Home Radio Components catalogues already know all about it. For the benefit of those who are still struggling along without one, here is how you set about it.

1. Purchase a Home Radio Components Catalogue. (See details further on).
2. Join the HRC Deposit Account scheme, by simply signing the simple form enclosed in the catalogue.
3. Send it to HRC with your deposit. The deposit is half of whatever credit you require; ie. if you want £10.00 you send £5.00.
4. You will receive back: a copy of your Agreement, special Order Forms, pre-paid envelopes for sending them, a Record Card on which to note your spending, and simple instructions to enable you to use the service to best advantage.

Now you are all set to dial your component orders any hour of the day, any day of the year—including Sundays, holidays, even Christmas day. You have your

own exclusive telephone number, which after business hours is connected direct to an answerphone. Like the idea? Then send for your Home Radio Catalogue straight away. It costs only 54p plus 45p postage and packing, and it contains 6 vouchers each worth 5p when used as directed, so you can soon get back 30p of your investment. Moreover, if you join the Deposit Account scheme you will receive a new catalogue free whenever it is reprinted. It's hardly surprising that over a thousand customers are already using this simple method of buying their components. Try it now—you'll never regret it. Send 99 pence by cheque, Postal Order or Giro with the coupon below, and soon you'll be twirling your telephone dial whenever you urgently want some parts!

Today's finest Components Catalogue
54p plus 45p POST & PACKING

The price of 99p applies only to customers in the U.K. and to BFPO Addresses

Please write your Name and Address in block capitals

NAME.....

ADDRESS.....

.....

.....

HOME RADIO (Components) LTD., Dept. EE. (Regn. No London 912966)
234-240 London Road, Mitcham, Surrey CR4 3HD



POST THIS COUPON with cheque or p.o. for 99p



HOME RADIO (Components) LTD, Dept EE, 234-240 London Road, Mitcham CR4 3HD Phone 01-638-8422

Build it yourself!



Designed by
TEXAS

Featured by **PRACTICAL WIRELESS**
SOLE U.K. DISTRIBUTORS - **HENRY'S**

Build the Texan stereo amplifier, then you can be doubly proud! For a start, you'll own a superb home entertainment unit. And have had all the pleasure of doing it yourself, with the Henry's kit.

Look at the Texan specification

Incorporating fully integrated stereo preamp and power amp, with 6 IC's, 10 transistors, 6 rectifiers and zener diodes. Plus stabilised, protected circuitry, glass fibre pcb. Gardeners low-field low-line mains transformer; all facilities and controls. Slim design, chassis 14 1/2" x 6" x 2" overall, 20 watts per channel RMS, less than 0.1% distortion at 1 kHz.

Can be built in 2 stages by stage.
Ask for leaflet 20.
* Everything necessary supplied. Full after sales service and guarantees.

KIT PRICE
£35.00
inc. VAT = £1 p5p

Built and tested
£45.00 inc. VAT
+ £1.00 p5p.

THE NATURAL FOLLOW-ON - THE TEXAN FM TUNER KIT!

KIT PRICE
£25.95
inc. VAT
50p p5p.

Build the matching Texan stereo tuner! Features advanced varicap tuning. Phase lock loop decoder. Professionally designed circuit. Everything you need is in the kit. From the glass fibre pcb to the cabinet itself. Excellent spec: 2.5 uV aerial sensitivity, 500 mV output (adjustable). Tuning range 87-102 MHz. Mains powered.

Built and tested £30.95 inc. VAT + 50p p5p.

VIDEO SPORT

... all the electronic excitement you could wish for!

OVER 10,000 ALREADY SOLD + IDEAL GIFT!

An up-to-the-minute game. Plugs into your own TV aerial socket. Switch on. And you're away! Choose your game - football, tennis or hole-in-the-wall. Absolutely safe. For you. Your children. And your TV. Mains powered.
List Price £42.50



HENRY'S PRICE - ONLY £29.50
inc. VAT + 50p p5p.

WHATEVER YOU DO, DON'T FORGET YOUR LATEST **HENRY'S CATALOGUE!**



For this new edition, we have made hundreds of changes and additions. It has over 200 pages, containing virtually everything for amateurs and professionals. And you'll have no bother at all finding everything you want, because there's a complete alphabetical index as well as a section index. Together, they put you right on course for the items you need. From Sinclair projects to educational kits. Oscilloscopes to panel meters. Coils to capacitors. Transistors to valves. Loudspeakers to microphones. All at competitive prices. Over 200 pages of vital statistics - just for you! So send now for your copy.

ONLY 50p

20p Carr/Pack

FREE to Educational Establishments when ordered on official headed notepaper.

Over 5000 items inside!
Every copy contains a free 50p voucher.
Many new items.
Over 200 pages.

Henry's

SELF-SERVICE CENTRES 404 and 309 EDGWARE ROAD, LONDON W2
Bargains galore - Call in and see for yourself!

404/6 EDGWARE ROAD, LONDON W2 01-402 8381
LOWER SALES FLOOR, 231, TOTTENHAM CT. RD., LONDON W1 01-636 6681
NEW MIDLANDS STORE 94/96 UPPER PARLIAMENT STREET, NOTTINGHAM. 0602-40403
ALL MAIL TO HENRY'S RADIO, 303 EDGWARE ROAD, LONDON W2

ELECTROVALUE

the good components service

COMPLETE YOUR TEACH-IN WITH E.V.

To ensure success and progress, learn above all to use components you can depend on and buy from a firm that really knows the business
All electronic components for the E.E. Teach In
POST PAID (UK) AND INC. VAT **£14.25 NETT**

CATALOGUE 8 NOW ISSUE No. 2

With our first printing sold out, Cat. 8, No. 2 is now ready, revised and brought up to date on prices, etc. 144 pages. New items. Opto-electronics, Diagrams of Components, applications, I.C. circuits, etc. Post free 40p, including voucher for 40p for spending on order over £5 list value.

DISCOUNTS

On all C.W.O. mail orders, except for some items marked NETT.
5% on orders list value **10%** on orders list value
£10 or more £15 or more

FREE POST & PACKING

On all C.W.O. mail orders in U.K. over £2 list value. If under, add 15p handling charge.

PRICE STABILIZATION POLICY

Prices are held and then reviewed over minimum periods of 3 months—Next price review due July 1st.

QUALITY GUARANTEE

On everything in our Catalogue—No manufacturer's rejects, seconds or sub-standards merchandise.

ELECTROVALUE LTD

All communications to Section 413, 28 ST. JUDES ROAD, ENGLEFIELD GREEN, EGHAM, SURREY TW20 0HB. Telephone Egham 3803, Telex 284475. Shop hours 9-5.30 daily, 9-1 pm Sats.
NORTHERN BRANCH: 680 Burnage Lane, Burnage, Manchester M19 1NA. Telephone (061) 432 4945. Shop hours Daily 9-5.30 pm; 9-1 pm Sats.

ENGINEERS

FREE

YOURSELF FOR A BETTER JOB WITH MORE PAY!



Do you want promotion, a better job, higher pay? "New Opportunities" shows you how to get them through a low-cost home study course. There are no books to buy and you can pay-as-you-learn.

This helpful guide to success should be read by every ambitious engineer. Send for this helpful 44 page FREE book now. No obligation and nobody will call on you. It could be the best thing you ever did.



CUT OUT THIS COUPON
CHOOSE A BRAND NEW FUTURE HERE!

Tick or state subject of interest. Post to the address below.

- | | | | | | |
|-------------------------------------|--------------------------|--|--------------------------|--|--------------------------|
| Electrical Engineering | <input type="checkbox"/> | Colour T.V. Servicing | <input type="checkbox"/> | CITY AND GUILDS Installations and Wiring | <input type="checkbox"/> |
| Electrical Installations and Wiring | <input type="checkbox"/> | C & G Radio, T.V. and Electronic Mechanics | <input type="checkbox"/> | CITY AND GUILDS Electrical Technicians | <input type="checkbox"/> |
| Electrical Draughtsmanship | <input type="checkbox"/> | General Radio and TV Engineering | <input type="checkbox"/> | CITY AND GUILDS Telecommunications | <input type="checkbox"/> |
| Electrical Mathematics | <input type="checkbox"/> | Radio Servicing, Maintenance and Repairs | <input type="checkbox"/> | Radio Amateurs' Exam. etc. etc. | <input type="checkbox"/> |
| Electronic Engineering | <input type="checkbox"/> | Transistor Technology | <input type="checkbox"/> | | |
| Computer Prog | <input type="checkbox"/> | | | | |

To: ALDERMASTON COLLEGE
DEPT. EEV 17 READING RG7 4PF

Also at our London Advisory Office, 4 Fore Street Avenue Moorgate, London EC2Y 5EJ. Tel: 01-628 2721.

EEV 17

NAME (Block Capitals Please)
ADDRESS
POSTCODE

Other subjects Acc
Accredited by C.A.C.C. Member of A.B.C.C.

HOME OF BRITISH INSTITUTE OF ENGINEERING TECHNOLOGY



DRILL CONTROLLER
Electronically changes speed from approximately 10 revs to maximum. Full power at all speeds by finger-tip control. Kit includes all parts, case, everything and full instructions. £2.50 plus 45p post and VAT. Made up model also available.

PERMEABILITY TUNERS



M.W. two stage ideal for use with ZN414 or similar circuit. Price 15p each + post and VAT 15p.

MAINS TRANSISTOR PACK

Designed to operate transistor sets and amplifiers. Adjustable output 6v., 9v., 12 volts for up to 500mA (class B working). Takes the place of any of the following batteries: P11, PP3, PP4, PP6, PP7, PP9 and others. Kit comprises: main transformer rectifier, smoothing and load resistors, condensers and instructions. Real snip at only £1.50. VAT & postage 60p.



NUMICATOR TUBES

For digital instruments, counters, timers, clocks, etc. Hi-vac NX11. Price £1.25 each, 20p Post and VAT.

DC HIGH CURRENT PANEL METERS

3 1/2" wound wide angle 240 movement meters, flush mounting fitted with external shunts, made by Crompton Parkinson, brand new, still in maker's cartons. These are a real bargain at £3.50 each. Reasonable quantities available in the following ranges 0-15 amps, 0-20 amps, 0-30 amps, 0-40 amps, Post and VAT 80p each.



TAPE DECK

In metal case with carrying handle, heavy flywheel and capstan drive. Tape speed 3 1/2. Mains operated on metal platform with tape head and guide. Not new but guaranteed good working order. Price £1.50 plus VAT and Postage £1.50.



SOUND TO LIGHT UNIT

Add colour or white light to your amplifier. Will operate 1, 2 or 3 lamps (maximum 450w). Unit in box all ready to work. £7.95 plus 95 VAT and postage.

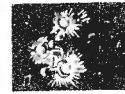

SPIT MOTOR

200-250V Induction motor, driving a Carter gearbox with a 1 1/2" output drive shaft running at 5 revs p.m. for roasting chickens, also for driving models—windmills, coloured disc lighting effects, etc. £2.50 plus 50p post and VAT.



OVEN THERMOSTAT

Made by the famous Diamond H Company, this has a sensor joined by a capillary to a variable control and when fitted with a knob is ideal for many ovens or processes, 50p each + post and VAT 15p



MAINS TRANSFORMERS

All standard 230-250 volt primaries	£	p
1v	1 amp (special)	1.75
2.4v	5 amp	.85
6.3v	2 amp	1.25
6.3v	3 amp	1.75
9v	1 amp	.85
9v	2 amp	1.25
12v	1 1/2 amp	1.50
12v	1 amp	1.00
15v	1 amp	1.50
24v	2 amp	2.25
24v	3 amp	3.00
120-12v	50mA	1.20
6.0-6v	50mA	1.20
8.0-8v	1 amp	1.50
25-0-25v	1 amp	3.50
25v	1 1/2 amp	1.95
50v	2 amp & 6.3v	4.50
60v	5 amp & 5v	7.50
27v	8 amp	4.50
30v	37 amp	22.00
80v tapped 75v & 70v	4 amp	5.50
230v-60mA & 6.3v	3 amp	1.75
275-0-275v at 90mA & 604v 3 amp		2.80
EHT Transformer 5000v 23mA	(intermittent)	5.00
Charger Transformers		
6v and 12v	2 amp	1.50
6v and 12v	3 amp	2.00
6v and 12v	5 amp	3.50

Add 30p per £1 to cover postage and VAT

HONEYWELL PROGRAMMER

This is a drum timing device, the drum being calibrated to equal divisions for switch-setting purposes with trips which are infinitely adjustable for position. They are also arranged to allow 2 operations per switch per rotation. There are 15 changeover micro switches each of 10 amp type operated by the trips, thus 15 circuits may be changed per revolution. Drive motor is mains operated 5 revs per min. Some of the many uses of this timer are Machinery control. Boiler firing. Dispensing and Vending machines. Display Lighting animated and signs. Signalling, etc. Price from makers probably over £20 each. Special snip price £9.95. £1.00 Post and VAT. Don't miss this terrific bargain.

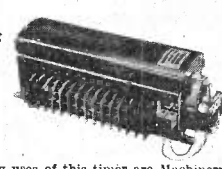

BREAK-DOWN UNIT

Contains hundreds of useful parts some of which are as follows—66 silicon diodes equivalent OA91, 68 resistors, mostly 4 watt 6% covering a wide range of values 4 x 1 mfd 400v mfd condensers, 15 x 0.01 mfd 100v condensers, 2 RF chokes 8 x B9 valve holders, 1 x 4H choke, 1 x 115v transformer, 1 boxed unit containing 4 delay lines also tag panels, trimmer condensers, suppressors, etc., on a useful chassis sized approx 9" x 8" x 7". Only 75p (the 66 diodes would cost at least 10 times this amount). This is a snip not to be missed. Post and VAT 75p.

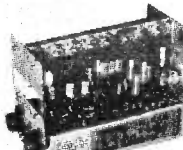

HORSTMANN 24-HOUR TIME SWITCH

With 6 position programmer. When fitted to hot water systems this could programme as follows:

Programme	Hot Water	Central Heating
0	Off	Off
1	Twice Daily	Off
2	All Day	Off
3	Twice Daily	Twice Daily
4	All Day	All Day
5	Continuously	Continuously

Suitable, of course, to programme other than central heating and hot water, for instance, programme upstairs and downstairs electric heating or heating and cooling or taped music and radio. In fact, there is no limit to the versatility of this Programmer. Mains operated. Size 3in x 3in x 2in deep. Price £4.25. 80p Post and VAT. As illustrated but less case.

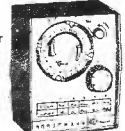

MULLARD UNILEX

A mains operated 4 + 4 stereo system. Rated one of the finest performers in the stereo field this would make a wonderful gift for almost anyone in easy-to-assemble modular form and complete with a pair of Goodmans speakers this should sell at about £30—but due to a special bulk buy and as an incentive for you to buy this month we offer the system complete at only £15.50 including VAT and postage.

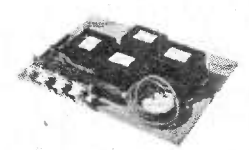

THIS MONTH'S SNIP HIGH POWERED TRANSFORMER

Rated at 250 Watts, upright mounting varnish impregnated. Its primary is for 230/240 volts 50 cycles, it has four secondaries each 10v very high current windings. In a few cases the circuit it can power are: 10-0-10v at up to 15amps; 20-0-20v at up to 6amps; single 10v at 25amps; single 20v at 12 1/2amps; single 30v at 9amps; single 40v at 6.5amps. This can be used for charging or for amplifiers, etc., there being an earth screen between primary and secondaries. A transformer like this to-day would cost at least £15 from the makers; however, we are making a special offer at £3.50 + 25p, post £1 + 8p each. Grab some while you can, our stock may not last long.

TWIN OUTPUT POWER PACKS

These have two separately R.C. smoothed outputs so can operate two battery radios on a stereo amp without cross modulation (they will of course operate one radio-tape-cassette-calculator in fact any battery appliance and will save their cost in a few months). Specs: Full wave rectification, double insulated mains transformer—total enclosed in a hard P.V.C. case—these core mains lead—terminal output—when ordering please state output voltage 4 1/2v, 6v, 7 1/2v, 9v, 12v or 24v. Price £3.95. Post and VAT included.



ONLY £1.50 FOR SEVEN ELECTRIC MOTORS

7 powerful batt. motors as used in racing cars and power models. Output and types vary for use in hundreds of projects—Tools, toys, models, etc. All brand new reversible and for 1 1/2-12v batts. Wiring diag. inc. VAT P Post 40p. FREE plan for min. power station.



BLACK LIGHT

As used in discotheques and for stage effects etc. Virtually no white light appears until the rays impinge on luminous paint or white shirts, etc. We offer 9" 6w tubes complete with starter, choke, lamp holders and starter-holder. Price £2.75 + 30p post. Tubes only £2. Post & VAT 1 30p. 175 Watt model £6.50 + 92p Post and VAT.

MULTIPLE CONTACT PANEL

Size approx. 4 1/2 x 2 1/2" has 200 contacts each across referenced for easy identification. Contacts are spring loaded and gold "pip". Ideal for the circuit breadboarding (resistors, etc., plug straight in) or for working out printed circuits, for electronic novelties, puzzles, combination locks, etc., ex-usable computer panels. Price only £2 + 15p. IE. only 1p per contact, probably less than the value of the gold pip. Post + 11p.

Monthly list available free; send long stamped envelope.

TERMS: Where order is under £5 please add 30p surcharge to offset packing expenses.

J. BULL (ELECTRICAL) LTD.
(Dept. E.E.), 103 TAMWORTH ROAD,
CROYDON CR0 1XX.

G.C.P. 70 photo transistor by Mullard, very popular for circuits such as infra-red burglar alarms, smoke detectors, etc. A big buy enables us to offer at the very favourable price of 25p each + 2p, or 5 for £1 + 8p.

Microswitch bargain, made by Pye, Honeywell, Burgess and similar first class makers originally fitted to the Post Office. Equipment which was never put into use. They are a changeover microswitch with 10 amp contacts offered at the very low price of 20 for £1 + 8p. Post 40p + 3p.

Junction boxes free. We are coming to the time of the year when additional wiring and home alterations are annual carried out and as a special offer to all buying our cable to install immersion heaters, ring main, etc., we are giving free this month six junction boxes with every 100 yard coil of 7/029 (4mm twin and earth cable). Our price for this cable, which is only approximately one half of the regular price anyway, is 23 + 64p. Carriage £2.50 + 20p—don't miss this bargain. Super stick microphone. Japanese made, extremely good quality and performance. Impedance 50 Kohms. The microphone is intended for hand holding but stands as available if required. Price £4.50 + 21.12p. Post 40p + 10p. Tuner Cassette as described in March "Practical Wireless". Please note we can supply the ferrite slab and the Z.N. 414 IC. Price for these two items £2.25 including post and VAT. Copy of the circuit supplied on request.

Burglar Alarms. More and more burglars seem to be thriving on the properties of people who cannot be bothered to install burglar alarms. We can offer the intruder alarm as described in "Everyday Electronics" September issue. This is a good circuit and not too expensive. Price is £23.83 + 31p. Post 40p.

Thermally protected motor. American made 1" stack. This revs. at 2400 RPM, suitable for fan or similar application. Special feature is the trip which cuts off the mains should the motor over-heat. Price £1.80 + 13p. Post 25p + 3p.

Amplifier in case, with speaker, made by British Relay. This is in good quality cabinet with back and elliptical speaker. The amplifier is the Newmarket PC 4 module, together with volume control, size 9 1/2" x 6" x 3 1/2" deep, the amplifier can be powered by an internal 9v battery or from external source. Very useful amplifier for around the home or in the workshop for troubleshooting, or for testing out a quick lash up. Limited quantity of these, offered at bargain prices of £4 + £1. Post 40p + 10p.

Teak veneered double cabinet. We believe that this was made from one of the best sources. Very useful amplifier for around the home or in the workshop for troubleshooting, or for testing out a quick lash up. Limited quantity of these, offered at bargain prices of £4 + £1. Post 40p + 10p.

Disco Dimmers made by Ultra Electronics, this is a variable controller which can be fitted behind a panel or into a standard switch box and it will control by 1250 watts along your similar non-inductive load. Very special price only £3 + 24p + 30p + 3p.

Disco Black Light Lamp 175 watts—230/240v pear-shaped back outer glass which obscures all visible radiation but emits long wave ultra violet (black light). This lamp provides a convenient way of fluorescing a discotheque, club, dance hall, party do, and being direct plug in replacement of a standard lamp it is very convenient for temporary usage anywhere. Price £6.50 + 50p. Post 50p + 4p.

Some more Relay bargains. Miniature plug-in type with perspex dust cover 700 ohm 12v DC working. 4 sets of gold-plated changeover contacts 1 1/2 amps. Normally an expensive relay. Our price £1 + 8p.

Mains Relays 230/240v. AC operated with 10 amp changeover contacts, open type, one screw fixing 3 sets changeover contacts £1 + 8p each. Three Changeover perspex covered plug-in types £1.25 + 10p each, bases for same 30p + 2p each.

4 available in each voltage 12v AC, 50v AC 230/240v AC. Also still available the most versatile type 600 relay which, having a double wound coil, is suitable for working off 6, 12 or 24v. DC or mains through series resistor. This has multiple contacts and the price is 40p + 3p each. Sound Transducers: balanced armature type, 600 ohm imp. in capsule, size diameter 1 1/2" by 1 1/2". Useful in digital equipment or to audio monitoring, or as a microphone or speaker, good quantities available. Basic price 50p + 4p less our usual quality discounts.

Venner Clock Replacements. 24 hour clock motor with threaded driving shaft. Standard replacements in many Venner time switches. Price £1.50 + 12p. Post 30p + 3p. Stereo Pre amplifier, Mullard reference LP1182/2. This is a dual input hi-fi module, has a frequency response of 20 Hz to 50 KHz. Its sensitivity 150mV at input 1 or 320mV at input 2. The bass and treble control ranges are plus or minus 14dB, distortion better than -2%. All components are mounted on printed circuit wiring board, overall size of which is approx. 3" square. Connections are brought out on 4 voltage pins, provide for high and low impedance inputs, stereo outputs, bass and treble lifts, volume and balance controls. We will supply complete with diagram of connections, price £1.50 + 37p. Post 30p + 7p.

Special Instrument offer is a Russian made Galvo, very sensitive precision instrument, suitable for deflection 74-0-74 degrees. This is a bench mounting instrument of extremely high sensitivity (0.5µA per division) size approx. 0 1/4" x 2 1/4" x 2". Price £9.50 each + 75p. Post 50p + 4p.

Photo Multiplier Tubes, U.S. made, I.C.A. type No. 4555. These tubes have a gain of a million, very sensitive precision instrument, suitable for deflection 74-0-74 degrees. This is a bench mounting instrument of extremely high sensitivity (0.5µA per division) size approx. 0 1/4" x 2 1/4" x 2". Price £6.75 + 54p each. Brand new in original maker's cartons.

BI-PAK High quality audio



OUR PRICE ONLY

£19.95

The 450 Tuner provides instant programme selection at the touch of a button ensuring accurate tuning of 4 pre-selected stations, any of which may be altered as often as you choose, by simply changing the settings of the pre-set controls.

Used with your existing audio equipment or with the BI-KITS STEREO 30 or the MK60 Kit etc. Alternatively the PS12 can be used if no suitable supply is available, together with the Transformer T461.

The S450 is supplied fully built, tested and aligned. The unit is easily installed using the simple instructions supplied.

NEW

STEREO FM TUNER

Fitted with Phase Lock-loop Decoder

- ★ FET Input Stage
- ★ VARI-CAP diode tuning
- ★ Switched AFC
- ★ Multi turn pre-sets
- ★ LED Stereo Indicator

Typical Specification:
Sensitivity 3µ volts
Stereo separation 30db
Supply required 20-30v
at 90 Ma max.

STEREO PRE-AMPLIFIER

PA 100



A top quality stereo pre-amplifier and tone control unit. The six push-button selector switch provides a choice of inputs together with two really effective filters for high and low frequencies, plus tape output.

Frequency Response + 1dB
20Hz-20KHz.
Sensitivity of inputs:
1. Tape Input 100mV into 100K ohms
2. Radio Tuner 100mV into 100K ohms
3. Magnetic P.U. 3mV into 50K ohms
P.U. Input equalises to R1AA curve within 1dB from 20Hz to 20KHz. Supply 20-35V at 20mA.
Dimensions—299mm x 89mm x 35mm.

£13.50 p & p 45p

MK60 AUDIO KIT:

Comprising: 2 x AL60's 1 x SPM80, 1 x BTM80, 1 x PA100, 1 front panel and knobs, 1 Kit of parts to include on/off switch, neon indicator, stereo headphone sockets plus instruction booklet. **COMPLETE PRICE £27.55 plus 62p postage.**

TEAK 60 AUDIO KIT:

Comprising: Teak veneered cabinet size 16 1/2" x 11 1/2" x 3 1/2", other parts include aluminium chassis, heatsink and front panel bracket plus back panel and appropriate sockets etc. **KIT PRICE £29.20 plus 62p postage.**

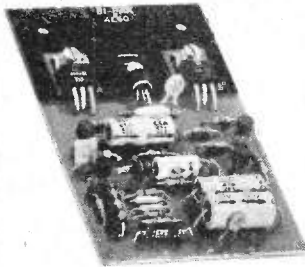

AL 60

25 Watts (RMS)

VAT ADD 25%

- Max Heat Sink temp. 90C. ● Frequency response 20Hz.
- Distortion better than 0.1 at 1kHz. ● Supply voltage 15-50v.
- Thermal Feedback. ● Latest Design Improvements.
- Load—3,4,5, or 16ohms. ● Signal to noise ratio 80db.
- Overall size 63mm. 13mm.

Especially designed to a strict specification. Only the finest components have been used and the latest solid-state circuitry incorporated in this powerful little amplifier which should satisfy the most critical A.F. enthusiast.

ONLY **£3.95**

Stabilised Power Supply Type SPM80

SPM80 is especially designed to power 2 of the AL60 Amplifiers, up to 15 watts (r.m.s.) per channel simultaneously. With the addition of the Mains Transformer BMT80, the unit will provide outputs of up to 1.5A at 35V. Size: 63mm, 105mm, 30mm. Incorporating short circuit protection.

INPUT VOLTAGE 33-40V. A.C.
OUTPUT VOLTAGE 33V. D.C. Nominal
OUTPUT CURRENT 10mA-1.5 amps
OVERLOAD CURRENT 1.7 amps approx.
DIMENSIONS 105mm x 63mm x 30mm
TRANSFORMER BMT80 £2.60 + 62p. postage

£3.00

STEREO 30 COMPLETE AUDIO CHASSIS

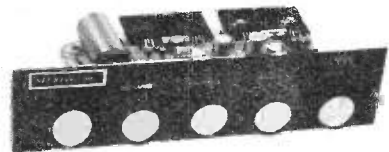

7 + 7 WATTS R.M.S.

The Stereo 30 comprises a complete stereo pre-amplifier, power amplifiers and power supply. This, with only the addition of a transformer or overwind will produce a high quality audio unit suitable for use with a wide range of inputs i.e. high quality ceramic pick-up, stereo tuner, stereo tape deck etc. Simple to install, capable of producing really first class results, this unit is supplied with full instructions, black front panel, knobs, mains switch, fuse and fuse holder and universal mounting brackets enabling it to be installed in a record plinth, cabinets of your own construction or the cabinet FI performance with a minimum of installation difficulty (can be installed in 30 mins.).

TRANSFORMER £2.45 plus 62p p & p

TEAK CASE £3.65 plus 62p p & p.

£15.75

P & P 45p.

equipment mono and other modules for Stereo

IT'S NEW! IT'S POWERFUL IT'S THE AL250

125 watts
R.M.S.

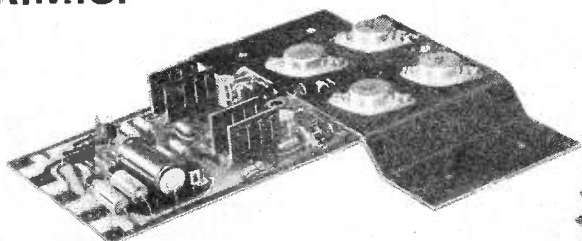

POWER AMPLIFIER

Specially designed for use in—
Disco Units, P.A. Systems, high power
Hi-Fi, Sound reinforcement systems

The module has a sensitivity of 450mV and a frequency response extending from 25Hz to 20KHz whilst distortion levels are typically below .1%. The use of 4, 115w transistors in the output stage makes the unit extremely rugged while damage resulting from incorrect or short-circuit loads is prevented by a four transistor protection circuit.

The unit is intended for use in many applications such as disco units, sound reinforcement systems, background music players, etc.

SPECIFICATION:

Output Power: 125 watt RMS
Continuous
Operating voltage: 50-80
Loads: 4-16 ohms
Frequency response: 25Hz-
20kHz Measured at 100 watts
Sensitivity for 100 watts output
at 1kHz: 450mV
Input impedance: 33Kohms

Total harmonic distortion
50 watts into 4 ohms: 0.1%
50 watts into 8 ohms: 0.06%
S/N ratio: better than 80dBs
Damping factor, 8 ohms: 65
Semiconductor complement: 13
transistors 5 diodes
Overall size: Heatsink width
190mm, length 205mm Height
40mm

ONLY £15.95 +8% VAT

MPA 30

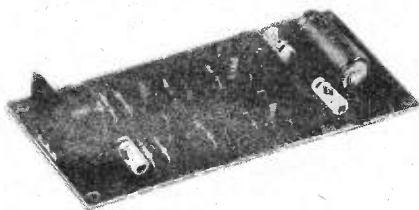

Enjoy the quality of a magnetic cartridge with your existing ceramic equipment using the new Bi-Pak M.P.A. 30 which is a high quality pre-amplifier enabling magnetic cartridges to be used where facilities exist for the use of ceramic cartridges only. Used in conjunction are 4 low noise, high gain silicon transistors. It is provided with a standard DIN input socket for ease of connection. Supplied with full, easy-to-follow instructions.

£2.65



POSTAGE & PACKING
Postage & Packing add 25p unless otherwise shown. Add extra for airmail. Min. £1.00

AL10-20-30

AUDIO AMPLIFIER MODULES

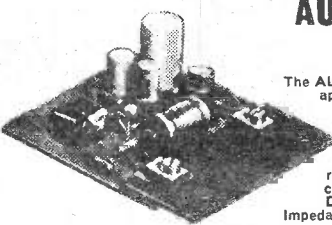

The AL10, AL20 and AL30 units are similar in their appearance and in their general specification. However, careful selection of the plastic power devices has resulted in a range of output powers from 3 to 10 watts R.M.S. The versatility of their design makes them ideal for use in record players, tape recorders, stereo amplifiers and cassette and cartridge tape players in the home. Harmonic Distortion $P_o = 3$ watts $f = 0.25\%$ Load Impedance 8-16ohm

Frequency response $\pm 3dB$ $P_o = 2$ watts 50Hz-25KHz
Sensitivity for Rated O/P— $V_s = 25V$, $R_L = 80ohm$
 $f = 1KHz$ 75mV, R.M.S. Size: 75mm x 63mm x 25mm

AL10 3w R.M.S. **£2.30** AL2: 5w R.M.S. **£2.65** AL30 10w R.M.S. **£2.95**



PA12 £6.50

NEW PA12 Stereo Pre-Amplifier completely redesigned for use with AL10 20 30 Amplifier Modules. Features include on/off volume, Balance, Bass and Treble controls. Complete with tape output.
Frequency Response 20Hz-20KHz (-3dB)
Bass and Treble range $\pm 12dB$
Input Impedance 1 meg ohm
Input Sensitivity 300mV
Supply requirements 24V, 5mA
Size 152mm x 64mm x 33mm

PS12

Power supply for AL10/20/30, PA12, S450 etc. input voltgae 15-20v A.C. Output voltage 22-30v D.C. Output Current 800 mA
Max. Size 60mm x 43mm x 26mm.

Transformer T538 £2.30 **£1.20**

BI-PAK

P.O. BOX 6, WARE, HERTS



"I MADE IT MYSELF"

Imagine the thrill you'll feel! Imagine how impressed people will be when they're hearing a programme on a modern radio you made yourself.

Now! Learn the secrets of radio and electronics by building your own modern transistor radio!

Practical lessons teach you sooner than you would dream possible.

What a wonderful way to learn—and pave the way to a new, better-paid career! No dreary ploughing through page after page of dull facts and figures. With this fascinating Technatron Course, you learn by building!

You build a modern Transistor Radio . . . a Burglar Alarm. You learn Radio and Electronics by doing actual projects you enjoy—making things with your own hands that you'll be proud to own! No wonder it's so fast and easy to learn this way. Because learning becomes a hobby! And what a profitable hobby. Because opportunities in the field of Radio and Electronics are growing faster than they can find people to fill the jobs!

No soldering - yet you learn faster than you ever dreamed possible.

Yes! Faster than you can imagine, you pick up the technical know-how you need. Specially prepared step-by-step lessons show you how to read circuits—assemble components—build things—experiment. You enjoy every minute of it! You get everything you need. Tools. Components. Even a versatile Multimeter that we teach you how to use. All included in the course. **AT NO EXTRA CHARGE!** And this is a course anyone can afford. (You can even pay for it by easy instalments).

So fast, so easy, this personalised course will teach you even if you don't know a thing today!

No matter how little you know now, no matter what your background or education, we'll teach you. Step by step, in simple easy-to-understand language, you pick up the secrets of radio and electronics.

You become somebody who makes things, not just another of the millions, who don't understand. And you could pave the way to a great new career, to add to the thrill and pride you receive when you look at what you have achieved. Within weeks you could hold in your hand your own transistor radio. And after the course you can go on to acquire high-powered technical qualifications, because our famous courses go right up to City & Guilds levels.

Send now for FREE 44 page book - see how easy it is - read what others say!

Find out more now! This is the gateway to a thrilling new career, or a wonderful hobby you'll enjoy for years. Send the coupon now. There's no obligation.

POST TODAY FOR FREE BOOK

**To: ALDERMASTON COLLEGE
DEPT. CEE 17 READING RG7 4PF**

Also at our London Advisory Office, 4 Fore Street Avenue, Moorgate, London EC2Y 5EJ. Tel: 01-628 2721. Yes, I'd like to know more about your course. Please send me free details—plus your big, 44 page book that tells about all your courses.

NAME

ADDRESS

POSTCODE



HOME OF BRITISH INSTITUTE OF ENGINEERING TECHNOLOGY

QUALITY STEREO SOUND

ALMOST **1/2 PRICE OFFER!** SOLENT AUDIO SYSTEM

£5.95 down

MADE TO SELL AT DOUBLE THE PRICE IN CABINET FORM

OUR PRICE **£59.95**



*Stereo Tuner Amplifier chassis with AM/FM radio covering long medium short and Stereo FM wavebands. Separate Base and Treble controls. 30 watts total power output (frequency response 25-20,00 Hz) AFC Switching Tape record and playback facilities. Dimensions 18½" x 9" x 3½". The very latest BSR automatic record deck with cue and pause control. Two matching elliptical speaker units.

Order early limited stocks available cash price £59.95. Credit Sale £5.95 deposit 9 monthly payments of £7.00 (Total Credit price £68.95). P. & P. £3.00. Send £8.95 today.

Chassis only available for cash at £42.00.

Full 12 months Guarantee.

CALLERS WELCOME.

Access and Barclaycard Orders Accepted by Telephone

Stereo headphones supplied with every complete order.

LEWIS radio

EE/5/76 100 CHASE SIDE SOUTHGATE
LONDON N14 5PL Telephones: 01-882-1644

CJL

CJL LTD. P.O. BOX 34, CANTERBURY, CT11 1YT

ALL PRICES INCLUDE P.L.P. AND V.A.T.

ANTEX SOLDERING IRONS

(with slide on & off bits)

15W 'C' miniature irons	£2.30
3/32" 1/8" 3/16" bits—each	£0.45
'C' Elements	£1.10
18W 'G' miniature irons	£2.50
3/32" 1/8" 3/16" bits—each	£0.45
'G' Elements	£1.35
15W 'CCN' Low leakage irons	£2.70
3/32" 1/8" 3/16" bits—each	£0.45
'CCN' Elements	£1.50
25W 'X25' Low leakage irons	£2.30
3/32" 1/8" 3/16" bits—each	£0.47
'X25' Elements	£1.15
'SK1', 'SK2' Soldering Kits	£3.85
ST3 Stands—for all models	£1.10
SOLDER in Bib dispenser	£0.45

WIRE STRIPPER & CUTTER £0.85

HAND DRILLS Leytool precision, compact, 5/16" chuck	£3.99
AERIALS Extend 15-120cm	£1.50
CASSETTE 'Head Demagnetisers'	
Shaped pole-saves time	£3.65
EARPHONES Stethoscope	£1.25
Crystal earphone, lead & plug	£0.65
Headphone, 2,000 n.	£3.20
INTERCOMS 2-station	£6.35
MICROPHONES Dynamic	£2.15
PRINTED CIRCUIT KITS -All items for producing p.c.'s	£3.99
SIGNAL INJECTOR -Audio through video signals, self contained	£4.25
STEREO HEADPHONES 8n	£4.85
SPEAKERS -75mm dia. 8n	£1.00

DENCO (CLACTON) LTD.

Dept. E.E.

**357-8-9 OLD RD., CLACTON-ON-SEA
ESSEX. CO15 3RH**

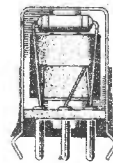

Our components are chosen by technical authors and constructors throughout the world, for their performance and reliability, every coil being inspected twice plus a final test and near spot-on alignment.

General catalogue showing full product range 32p, post paid. Please enclose S.A.E. with all other enquiries.

TRADE ENQUIRIES WELCOME

ELECTRONIC DIGITAL CLOCK

with alarm and snooze features

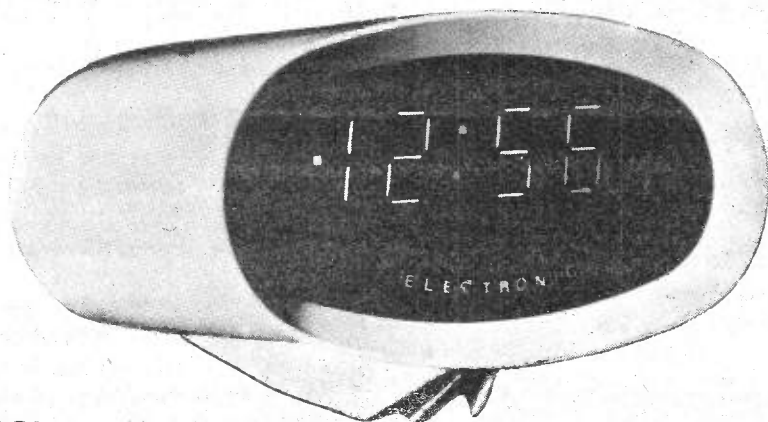

Features:

- 0.7 INCH HIGH DIGITS ● VARIABLE INTENSITY ● 24 HOUR ALARM ● 5 MINUTE REPEATING, SNOOZE ALARM
- ALARM SET INDICATOR ● SNOOZE INDICATOR ● PULSING SECOND INDICATOR
- POWER INTERRUPT INDICATOR ● ALARM CANCEL FEATURES — TILT OPERATION
- ALARM TONE OUTPUT ● A.M. P.M. INDICATOR

Size: 130mm x 90mm x 95mm; Weight: 10oz; Power supply: 110 VAC ± 10% 60Hz, 230 VAC ± 10% 50Hz

Manufactured to high standards by a major American electronics corporation this superbly styled solid-state timepiece is made available to all readers fully guaranteed.

SPECIAL OFFER

£12.48

+ 99 pence VAT

Mail order customers:
Please enclose 55 pence for postage
and packing

TM

TIME MICROELECTRONICS

33, WATERIDGE ROAD, BASINGSTOKE, HANTS, RG21 2RA
PHONE (0256) 66961

FREE TRIAL IN YOUR HOME. TRY OUT THE CLOCK IN YOUR HOME. IF DIGITAL TIME IS NOT FOR YOU RETURN IT IN ORIGINAL CONDITION WITHIN 10 DAYS AND WE'LL REFUND YOUR MONEY WITHOUT QUESTION.

Please send electronic clocks as illustrated

I enclose cheque postal order money order

Name

Address

Signature

The Black Watch kit

£14.95!

* **Practical**—easily built by anyone in an evening's straightforward assembly.

* **Complete**—right down to strap and batteries.

* **Guaranteed.** A correctly-assembled watch is guaranteed for a year. It works as soon as you put the batteries in. On a built watch we guarantee an accuracy within a second a day—but building it yourself you may be able to adjust the trimmer to achieve an accuracy within a second a week.

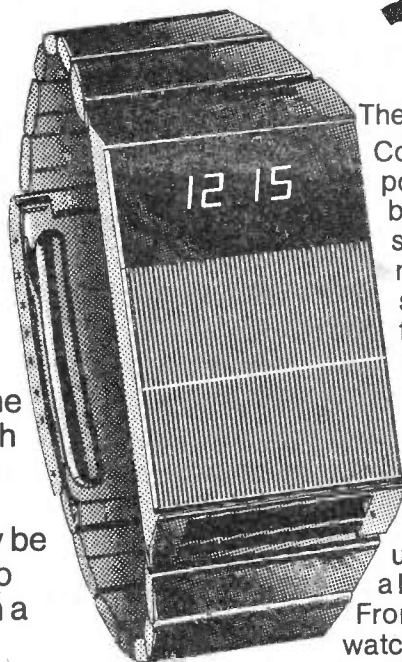

The Black Watch by Sinclair is unique. Controlled by a quartz crystal, and powered by two hearing aid batteries, it uses bright red LEDs to show hours and minutes, and minutes and seconds. And it's styled in the cool prestige Sinclair fashion: no knobs, no buttons, no flash.

The Black Watch kit is unique, too. It's rational—Sinclair have reduced the separate components to just four—and it's simple: anybody who can use a soldering iron can assemble a Black Watch without difficulty. From opening the kit to wearing the watch is a couple of hours' work.

Touch and tell

Press here for hours and minutes... here for minutes and seconds.

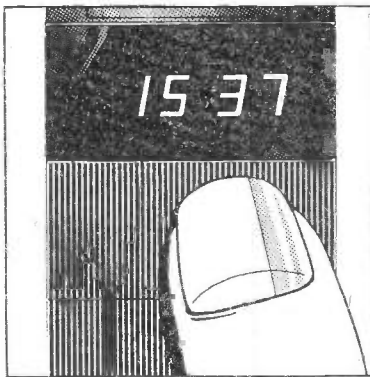
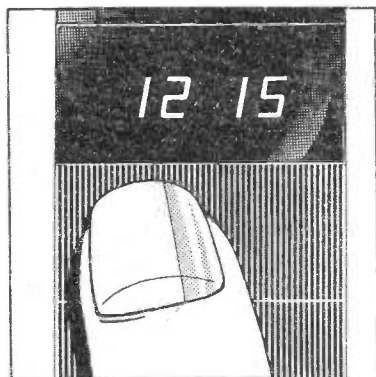

Batteries easily replaced at home.

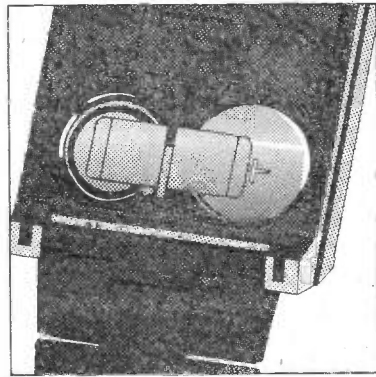

The specialist features of the Black Watch

Smooth, chunky, matt-black case, with black strap. (Black stainless-steel bracelet available as extra—see order form.)

Large, bright, red display—easily read at night. Touch-and-see case—no unprofessional buttons.

Runs on two hearing-aid batteries (supplied). Easily re-set using special button—no expensive jeweller's service.

The Black Watch – using the unique Sinclair-designed state-of-the-art IC.

The chip...

The heart of the Black Watch is a unique IC designed by Sinclair and custom-built for them using state-of-the-art technology – integrated injection logic.

This chip of silicon measures only 3 mm x 3 mm and contains over 2000 transistors. The circuit includes

- a) reference oscillator
- b) divider chain
- c) decoder circuits
- d) display inhibit circuits
- e) display driving circuits.

The chip is totally designed and manufactured in the UK, and is the first design to incorporate all circuitry for a digital watch on a single chip.

...and how it works

A crystal-controlled reference is used to drive a chain of 15 binary dividers which reduce the frequency from 32,768 Hz to 1 Hz. This accurate signal is then counted into units of seconds, minutes, and hours, and on request the stored information is processed by the decoders and display drivers to feed the four 7-segment LED displays. When the display is not in operation, special power-saving circuits on the chip reduce current consumption to only a few microamps.

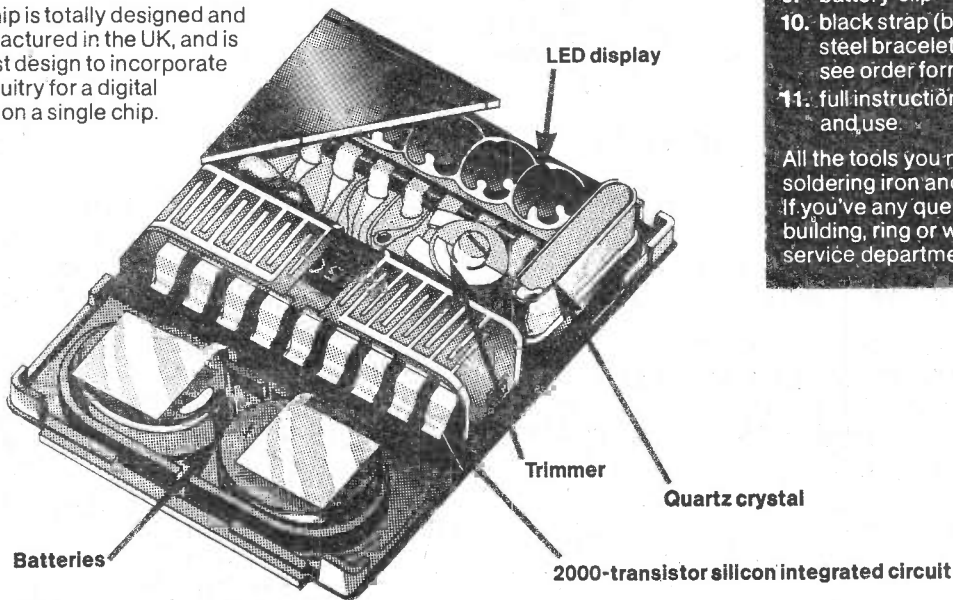

Complete kit £14.95!

The kit contains

1. printed circuit board
2. unique Sinclair-designed IC
3. encapsulated quartz crystal
4. trimmer
5. capacitor
6. LED display
7. 2-part case with window in position
8. batteries
9. battery-clip
10. black strap (black stainless-steel bracelet optional extra – see order form)
11. full instructions for building and use.

All the tools you need are a fine soldering iron and a pair of cutters. If you've any queries or problems in building, ring or write to Sinclair service department for help.

Take advantage of this no-risks, money-back offer today!

The Sinclair Black Watch is fully guaranteed. Return your kit in original condition within 10 days and we'll refund your money without question. All parts are tested and checked before despatch – and correctly-assembled watches are guaranteed for one year. Simply fill in the FREEPOST order form and post it – today!

Price in kit form: £14.95 (inc. black strap, VAT, p & p).

Price in built form: £24.95 (inc. black strap, VAT, p&p).

Sinclair

Sinclair Radionics Ltd,
London Road, St Ives,
Huntingdon, Cambs., PE17 4HJ.
Tel: St Ives (0480) 64646.

Reg. no: 699483 England. VAT Reg. no: 213817088.

To: Sinclair Radionics Ltd, FREEPOST, St Ives, Huntingdon, Cambs., PE17 4BR.

Please send me

Total £

..... (qty) Sinclair Black Watch kit(s) at £14.95 (inc. black strap, VAT, p&p).

* I enclose cheque for £..... made out to Sinclair Radionics Ltd and crossed.

..... (qty) Sinclair Black Watch(es) built at £24.95 (inc. black strap, VAT, p&p).

* Please debit my *Barclaycard/Access/American Express account number

..... (qty) black stainless-steel bracelet(s) at £2.00 (inc. VAT, p&p).

Name (please print) _____

Address _____

Signature _____

EE 5

FREEPOST – no stamp required.

* Delete as required

everyday electronics

PROJECTS
THEORY...

WHOSE BUSINESS?

It seems electronics just can't keep its nose out of anyone's business. Not, at any rate, if our lively readership has its own way. This is patently clear from the response to our invitation to readers to tell us of their particular needs for electronic projects.

Farmers, bird fanciers, photographers, astronomers, brass band players, model enthusiasts, gardeners, and winemakers are among those who have described their particular requirements. And some have really been eye openers! The things folk get up to in their spare time is, it seems, very much EVERYDAY ELECTRONICS' business!

Well, we will rise to the challenge. All requests are being recorded and will be investigated by our designers. So watch these pages!

In the meanwhile, a word to any electronics enthusiast who has of his or her own initiative solved some unusual problem by electronic means: why not get in touch with us? If the design is sound and sufficiently novel for inclusion in our pages, good reward will follow.

A FAMILY AFFAIR

Innovation in electronics is by no means confined to designing circuits. There are always other quite different opportunities for the amateur, yes even for the complete beginner, to ply his or her inventiveness in the practical area of

circuit building. Often it is the beginner who can contribute most effectively in this way since fresh uncommitted eyes may see what escapes those conditioned by habit and practice. This fact is very clearly demonstrated by the EVERYDAY ELECTRONICS Wire Bending Gauge.

This handy and useful tool is based on a reader's *Bright Idea* published some time ago. As the originator explained at the time, he was quite a newcomer to electronics, but he thought up this simple yet clever device in order to facilitate the assembly of components upon circuit boards. And an extremely bright idea it has proved to be—so good in fact that we decided to have this wire bending gauge produced in plastics so that each and every reader could have one this month, entirely free and with our compliments. This means that EVERYDAY ELECTRONICS readers are in an enviable position and have the advantage over other constructors, or professionals for that matter!

And it gives us particular pleasure that this has been entirely a family affair.

So here's the message to each and everyone of our readers. Don't worry if you aren't a circuit design genius; who knows, your particular talent might produce some other winner in the practical construction area. Good thinking!



Our June issue will be published on Friday, May 21

EDITOR F. E. Bennett ● ASSISTANT EDITOR M. Kenward ● TECHNICAL EDITOR B. W. Terrell B.Sc.
ART EDITOR J. D. Pountney ● P. A. Loates ● K. A. Woodruff
ADVERTISEMENT MANAGER D. W. B. Tilleard ● P. Mew

© IPC Magazines Limited 1976. Copyright in all drawings, photographs, and articles published in EVERYDAY ELECTRONICS is fully protected, and reproduction or imitations in whole or part are expressly forbidden.

All reasonable precautions are taken by EVERYDAY ELECTRONICS to ensure that the advice and data given to readers are reliable. We cannot, however, guarantee it, and we cannot accept legal responsibility for it. Prices quoted are those current as we go to press.

Editorial Department: Everyday Electronics, Fleetway House, Farringdon Street, London EC4 4AD. Phone 01-634 4452.

Advertisement Department: Everyday Electronics Advertisements, King's Reach Tower, Stamford Street, London SE1 9LS. Phone 01-261 5148.

...EASY TO CONSTRUCT
...SIMPLY EXPLAINED



VOL. 5 NO. 5

MAY 1976

CONSTRUCTIONAL PROJECTS

MAGNETONE Played by waving a "wand" over the keyboard by Stephen Price	252
LIGHTNING-CHESS BUZZER A novel aid for the chess player by L. Green	258
CARSAFE SYSTEM Protect your car with this easy to install unit by C. J. Allen	274
UNIT BUILT SUPERHET Part 2 Remaining construction details and setting up by F. G. Rayer	280

GENERAL FEATURES

EDITORIAL

COUNTER INTELLIGENCE A retailer comments by Paul Young	256
WIRE BENDING GAUGE How this tool is used	257
PHYSICS IS FUN Faraday and Waltenhofen by Derrick Daines	261
TEACH-IN 76 Part 8, Modes of operation and biasing by A. P. Stephenson	262
FOR YOUR ENTERTAINMENT Budget Movies and Speakers by Adrian Hope	266
YOUR CAREER IN ELECTRONICS Radio and Television Servicing by Peter Verwig	267
I.C.s EXPLAINED Part 1—A new series by Brian Dance	270
JACK PLUG AND FAMILY Cartoon	273
PLEASE TAKE NOTE	278
READERS' LETTERS Your news and views	278
SHOP TALK Component buying for constructional projects by Mike Kenward	284
PROFESSOR ERNEST EVERSURE The Extraordinary Experiments of. by Anthony J. Bassett	285
DOWN TO EARTH Gain, Power and Load Impedance by George Hylton	290

★FREE WITH THIS ISSUE—WIRE BENDING GAUGE

BACK NUMBERS, LETTERS AND BINDERS

We are unable to supply back copies of *Everyday Electronics* or reprints of articles and cannot undertake to answer readers' letters requesting designs, modifications or information on commercial equipment or subjects not published by us. An s.a.e. should be enclosed for a personal reply. Letters concerning published articles should be addressed to: The Editor, those concerning advertisements to: The Advertisement Manager, at the addresses shown opposite.

Binders for volumes 1 to 5 (state which) and indexes for volume 1 and 2 available for £2.10 and 30p respectively, including postage, from Binding Department, Carlton House, Great Queen Street, London, WC2E 9PR.

*How to use your
WIRE BENDING GAUGE
given FREE with this
issue* See page 257 for details

EASY TO BUILD...
magnetone
...EASY TO PLAY

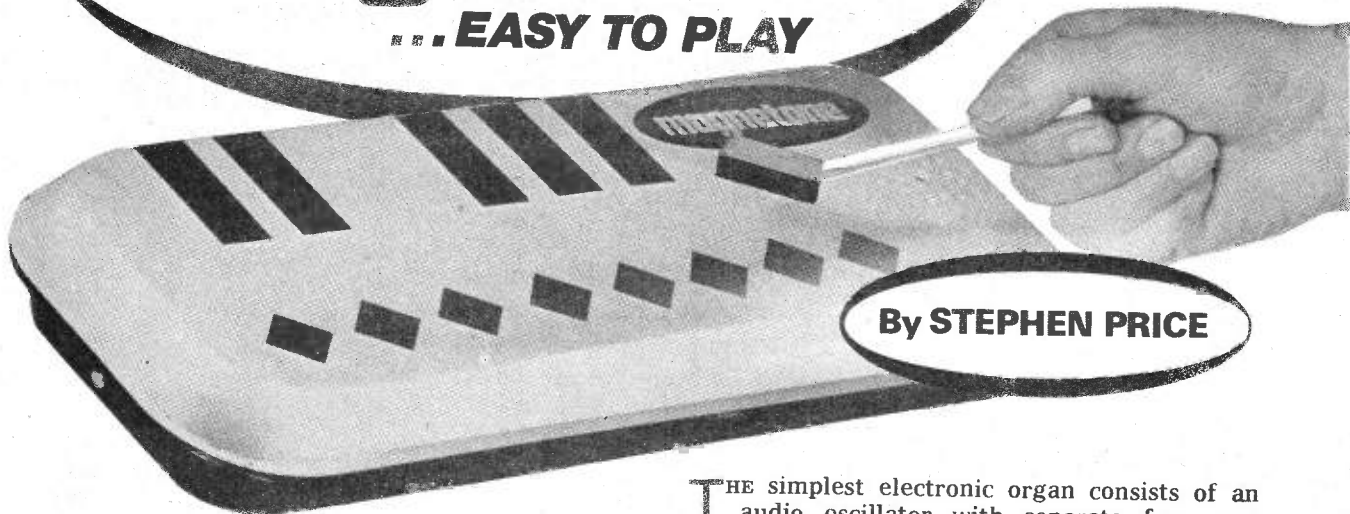

By STEPHEN PRICE

HOW IT WORKS

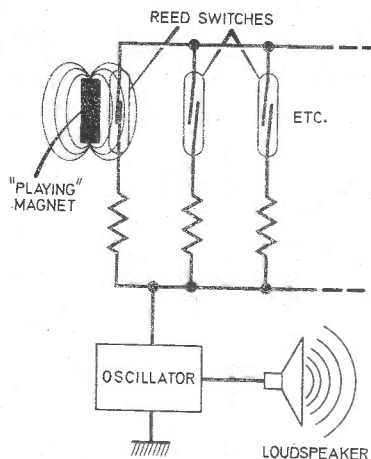

WHEN the magnet on the end of the playing wand is held over a reed switch, two contacts close and a resistor associated with that switch is placed in the timing circuit of an audio oscillator consisting of a unijunction transistor and its associated components.

The lower the value of the resistor connected into the circuit, the higher the pitch of the note heard from the speaker.

THE simplest electronic organ consists of an audio oscillator with separate frequency determining elements for each note of the musical scale.

In the case of an RC oscillator, the output frequency is dependent, either directly or indirectly, on the time constant of the resistor-capacitor network employed. A variation in either one of these elements will shift the oscillator's frequency over a fairly large range and it is common practice for the instrument to be tuned using an individual preset potentiometer for each note.

These variable resistive elements appear in series with single pole switches which form the instrument's keyboard. A toy piano, for instance, may easily be converted into an organ by fixing the necessary switch contacts to its keys.

Another, and perhaps simpler, system involves the use of a printed circuit board which has the keys etched out on its surface. A metal-tipped stylus is provided and this is moved over the "printed keyboard", thus making contact with the keys. This arrangement may be likened to a single pole, multi-way switch; the stylus forming the pole.

FOR GUIDANCE ONLY

ESTIMATED COST* OF COMPONENTS
 excluding V.A.T.

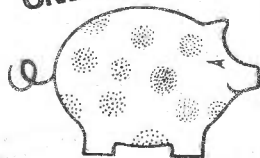

£6.00
 excluding case

*Based on prices prevailing at time of going to press

In the design described here, a rather novel approach has been adopted and the key contacts are replaced by miniature reed switches affixed to the underside of a dummy keyboard.

The instrument is played by passing a small bar magnet over the surface of the keyboard and as the magnet moves near to a particular reed switch, its contacts close, the oscillator becomes operative and a note is sounded!

CIRCUIT

Fortunately, the use of reed switches does not necessitate any specialised circuitry and it can be seen from Fig. 1 that a very simple design has been evolved.

A silicon unijunction transistor TR1 functions as a relaxation oscillator. A unijunction was employed because it has excellent temperature stability and so frequency drift is kept to a minimum.

The circuit works as follows. After a reed switch closes, C1 begins to charge through the series combination of R1 and the respective preset resistance. When the voltage across C1 reaches a certain point the unijunction is "triggered" and becomes conductive. Current now flows into the emitter (e) of TR1 and also between its bases (b1, b2). In consequence, C1 will discharge through TR1's emitter until the voltage drops to a point where TR1 once more turns off.

Capacitor C1 is now free to charge again and so the process repeats itself. This results in a series of negative going pulses which appear at the junction of b2 and R2.

The preset potentiometers control the charging of C1 and thus the regularity with which pulses are generated i.e. as the resistance in

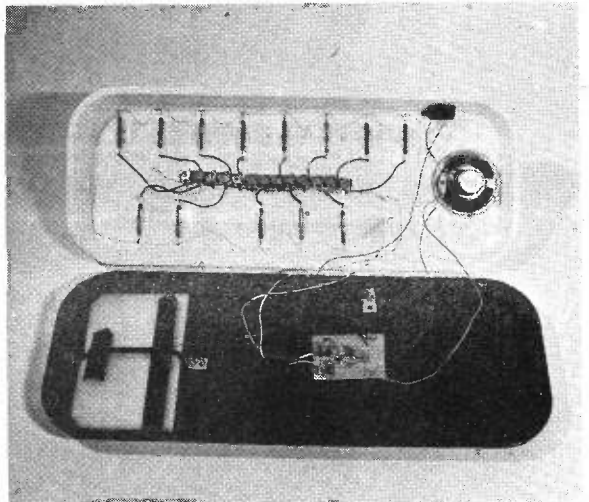

Photograph of the Magnetone case opened to show the layout of components.

series with R1 is decreased, the frequency (or pitch) rises.

Using a value of $47k\Omega$ for R1 and $68k\Omega$ for each preset gives a total range of approximately $1\frac{1}{4}$ octaves. The prototype covers one octave in the key of C and, including the black notes, thirteen reeds (with associated presets) are required. If a greater range is desired, $100k\Omega$ preset potentiometers may be used and R1 reduced to $27k\Omega$.

An amplifier is formed by TR2 and TR3 which serves to raise the output of TR1 to loudspeaker level. The negative going pulses from TR1 base turn on TR2 and thus a voltage is developed across R4. This produces positive going pulses at TR3's base and TR3 also turns on, thus driving the loudspeaker voice coil.

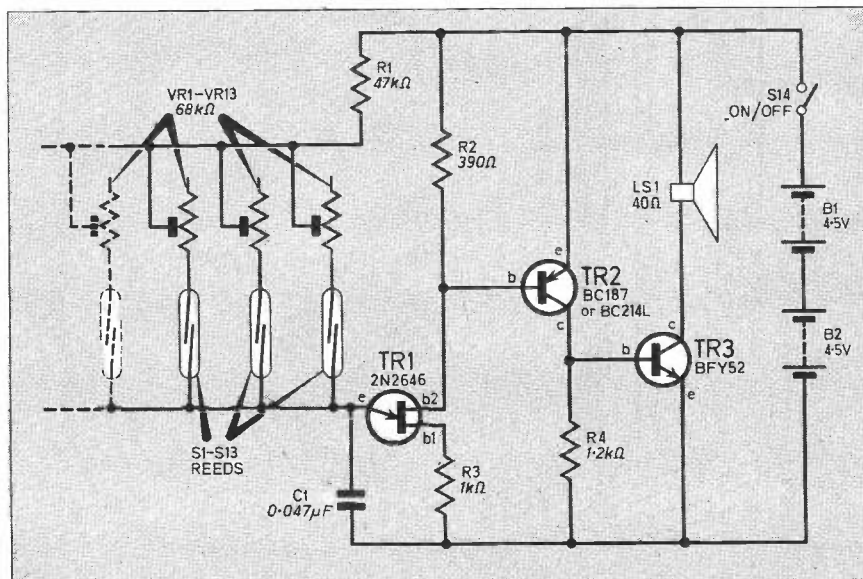
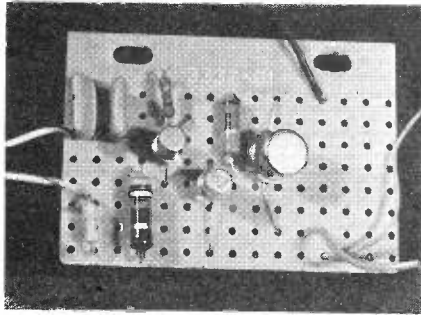

Fig. 1. Circuit diagram of the Magnetone.

magnetone



Photograph of the prototype component board.

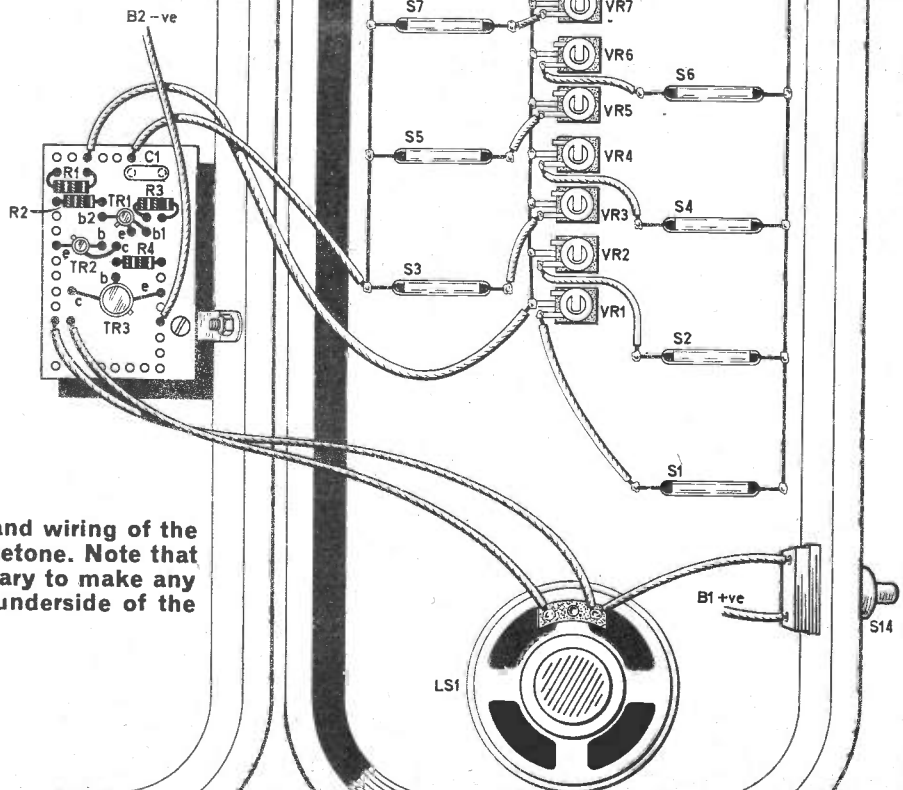

Fig. 2. Layout and wiring of the complete Magnetone. Note that it is not necessary to make any breaks on the underside of the Veroboard.

CONSTRUCTION

It is convenient to mount the three transistors, C1 and the fixed resistors on Veroboard. The author employed a piece of 0.1in matrix board with eight strips. A suitable layout for use with a strip length of ten holes is shown in Fig. 2. The suggested layout uses a larger section of Veroboard than is strictly necessary, but such an approach eliminates the need to cut breaks in the strips and also prevents bunching of components.

A hole of 4 or 6BA clearance should be drilled at the edge of the Veroboard in an uncluttered position. This will allow a small mounting bracket to be attached to the board.

From Fig. 2 can be seen the layout of reeds and presets, which are mounted on the underside of the keyboard. Adjacent reeds are positioned at least 30mm apart and may be fixed in position with Sellotape or glue.

The preset potentiometers are placed at the centre of the keyboard so that a short, direct connection may be made between each reed and its respective preset.

The potentiometers are supported by a single length of tinned copper wire which also serves as their common connection.

The reed positions must, of course, be marked on the topside of the keyboard. The prototype

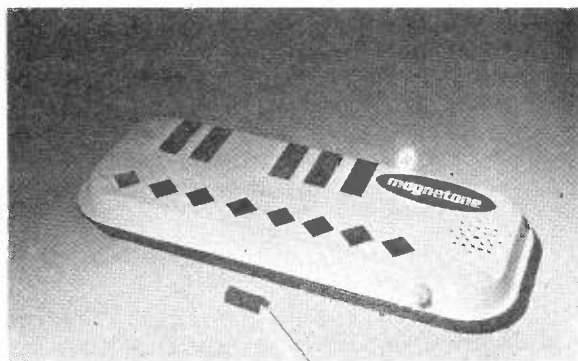

Photograph of the completed Magnetone with the playing wand alongside.

was built into a case formed from two oblong, plastic trays (designed, incidentally, to hold flower pots!). The top of the case is white and the key positions are identified with shapes cut from strips of black, adhesive tape. The case is held together by small self-tapping screws.

Alternatively, a thin sheet of plywood might be used for the case and keyboard, with the keys painted on, but a ferrous metal case must not be used as this would act as a magnetic screen, thus preventing the reeds from closing.

The organ, which requires a nine volt supply, may be powered from two "flat-pack", 4.5 volt dry cells connected in series.

A piece of foam rubber is glued to the bottom of the case so as to provide a cushion for the batteries. Also, a length of elastic or a metal clamp, should be provided in order to hold the batteries in place.

The loudspeaker employed is a miniature unit with a diameter of approximately 50mm. This can be stuck to the case with Araldite. Switch S14 may be any single-pole on/off switch.

As explained earlier, the reed switches are operated by the field of a small bar magnet. Although special reed switch magnets can be

Components

Resistors

- R1 47k Ω (see text)
- R2 390 Ω
- R3 1k Ω
- R4 1.2k Ω
- All 10% $\frac{1}{4}$ or $\frac{1}{2}$ W carbon

**MTAL
JOHS**
SEE

Capacitor

- C1 0.047 μ F polyester

Transistors

- TR1 2N2646 unijunction transistor
- TR2 BC187 or BC214L *pnp* silicon
- TR3 BFY52 *nnp* silicon

Miscellaneous

- VR1-VR13 68k Ω sub-miniature skeleton presets (13 off)
- S1-S13 Miniature reed switches (see text) (13 off)
- LS1 30 to 80 Ω 50 to 65mm diameter speaker
- S14 s.p.s.t. on/off switch
- B1, B2 4.5V 1289 battery (2 off)
- 0.1in matrix Veroboard 10 holes x 8 strips
- 25mm bar magnet, plastic or plywood case, connecting wire, foam rubber, mounting bracket.

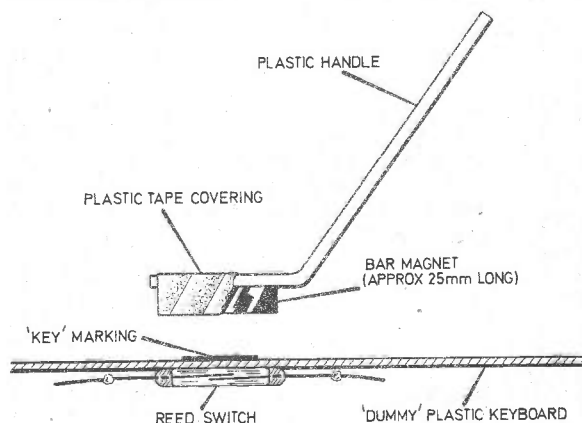

Fig. 3. Mounting the reeds beneath the plastic lid of the case and construction details of the playing wand.

obtained, these tend to be expensive and so the author pressed an ion-trap magnet into service. This was removed from the tube neck of an old television receiver.

A suitable design for the magnetic wand with which the organ is played is shown in Fig. 3. The magnet is placed in line with the axis of the reed switch and each switch should close when the magnet comes to within half an inch of the dummy keyboard.

CONCLUSION

The author has no pretensions as to the value of the reed organ. It is not a professional

musical instrument, but rather, an interesting toy which should prove a source of amusement, even amazement, for young children.

One of the biggest drawbacks in the keyboard design is that it is possible to operate two reed switches simultaneously. This can occur when the magnet is placed between two keys or shifted from one key to another. The closing of two switches does not, of course, result in a chord being sounded. A single high pitch note will be generated, which is not part of the musical scale. In order to overcome this problem, the magnet should be made to "jump" from one key to another when the instrument is played. □

COUNTER INTELLIGENCE

By PAUL YOUNG

It is in two parts, about two-thirds of it is devoted to components both discrete and passive and one-third to hi fi and audio. It is completely international, firms from all over the world taking part.

Next the Birmingham exhibition. I am sure this will be well worth a visit. For those of you who are London based, there will be special fast trains running you right into the exhibition.

I would advise you to visit the Brighton and Leeds exhibition only if you happen to be near either place at the time. They are both excellent in their own way, but on a much smaller scale, and tend to be rather specialised.

Lastly I come to the Amateur Radio Exhibition at Leicester. It has only been going for a relatively short time but it has already become very popular. This year I understand the organisers are taking an adjacent hall which will virtually double the size. I visited it last November for the first time and it reminded me of the old London Radio Hobbies Exhibition. While there are not many well known names (excluding the Navy) all the stands are manned by enthusiasts. Like the old Radio Hobbies Exhibition, you could actually buy things. All the stands were crammed full of assorted components at give away prices.

This is certainly one exhibition I would say is worth making a journey to visit.

Of course, I realise that by the time you read this, the Paris exhibition will be over. Never mind, like the number nine bus, another one will be along shortly.

R.E.C.M.F. Radio and Electronic Component Manufacturers' Association.
I.E.A. International Electronic and Automation.

Everyday Electronics, May 1976

HAVING just received a ticket for the Paris Components Exhibition I thought it might be useful to discuss exhibitions generally. First I will separate them into two main classes, components and audio hi fi. I do not intend to discuss the latter in detail but for the benefit of the hi fi buffs I will give the names, dates and places.

High Fidelity '76—27 April-2 May, Heathrow Hotel.

Audio '76—2-5 September, Harrogate.

Audio Fair—13-19 September, Olympia.

Turning to the component exhibitions, there is the Paris exhibition 5-10 April followed by one to be held at the new Exhibition Centre in Birmingham. May 3-10. In the past we have had component exhibitions at Olympia, one year the R.E.C.M.F. followed the next year by the I.E.A. They have alternated like this for a number of years. Now for the first time they are combining under the title of I.E.A. Electrex for short or International Electrical, Electronics and Instrument Exhibition, to give it its full title, and moving up to Birmingham.

Meanwhile London is not entirely out of the picture, because a new exhibition the All-Electronics Show takes place during

the period 13 to 15 April. This is a new event, though the venue is the same as that of the original London Electronics Show of 16 years ago from which grew the great Olympia shows of more recent years. Yes, it's being held at Grosvenor House, Park Lane.

In July there is the Leeds Exhibition held in the University, followed by Internepcon at Brighton. Finally we have the Amateur Radio Exhibition at Leicester in November. Exact dates for the last three are not yet to hand, but they are usually publicised in the journals well in advance.

Are any of these of interest to the constructor you may wonder? In my opinion, yes and for two reasons. Firstly, many of us try and visit them in the expectation of seeing new technology, and learning new ideas, which we endeavour to pass on to you. Secondly, I think if you can spare the time to visit one or two, I am sure you will find your efforts amply repaid. Over the years I have visited many of them and the ones I think are the most interesting to you are the following.

First I will mention Paris, not that I necessarily think it is the best, although it is a splendid exhibition, but it happens to be first on the list chronologically.

Using your WIRE BENDING GAUGE

Now you have your free EE Wire Bending Gauge all you need to know is how to put it to use. It has been designed mainly for 0.1 inch matrix perforated circuit board and Vero-board. But it can also be usefully employed with 0.15 inch matrix boards.

First look at the component layout diagram and decide how many holes each component should span; next decide if it will lay horizontally or if it must be mounted vertically and then follow the relevant pictures below. It's as easy as that!

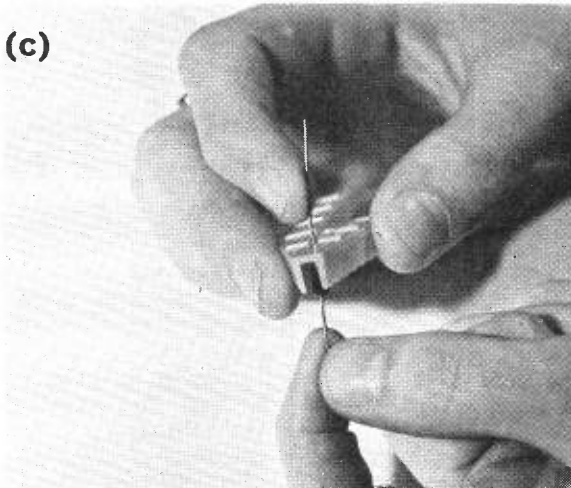
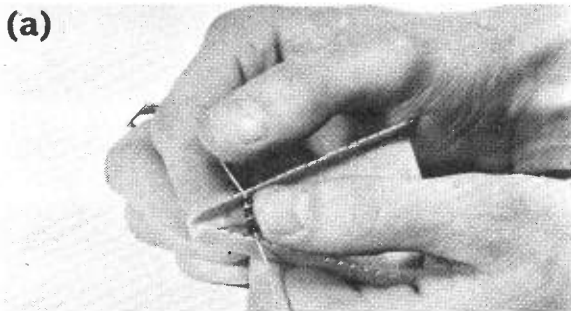
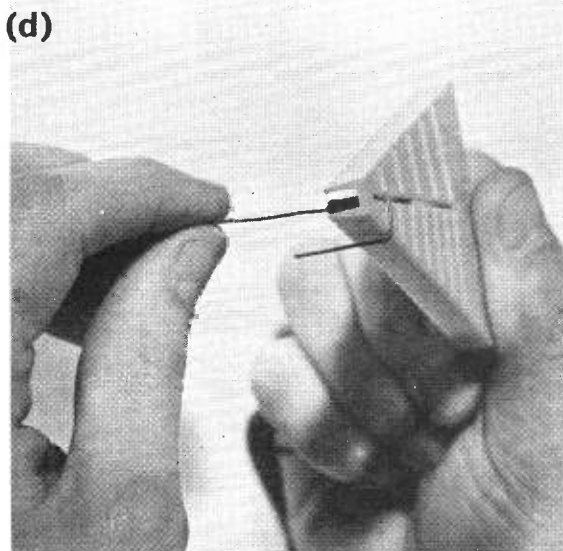
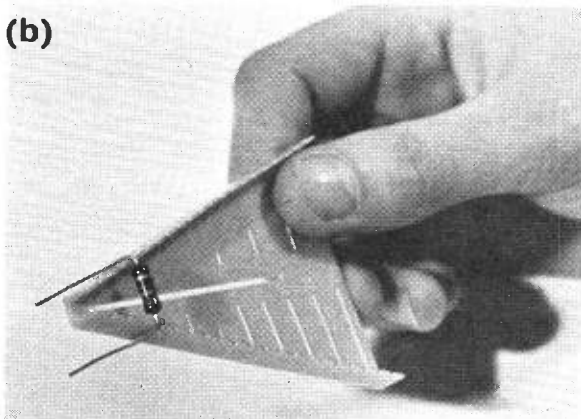

(a) Use this side for horizontally mounted components. The number of holes for 0.1 inch matrix are indicated on the left and for 0.15 inch matrix (only odd numbers can be used) on the right. Before bending, each lead must be straightened with pliers. Place the component in directly opposite notches to the number of holes required.

(b) Bend each lead downwards and check they are parallel. Remove the component and trim the leads to approximately the correct length before inserting the component on the board.

(c) Use the flat side for vertically mounted components. The grooves for 0.1 inch matrix are on the left and those for the 0.15 inch matrix on the right. The numbers indicate the number of holes each component will span. Place one straightened lead of the component up through the slot and align it with required groove.

(d) Holding the top of the component just below the surface of the gauge, bend the wire along the groove and down the side. Make sure the two wires are parallel. Remove the component from the slot. Large diameter components can only be used on bigger hole spans or with more lead length between the component and first bend. Finally trim the leads to the approximate length before inserting the component on the circuit board.

LIGHTNING CHESS Buzzer

By L. GREEN

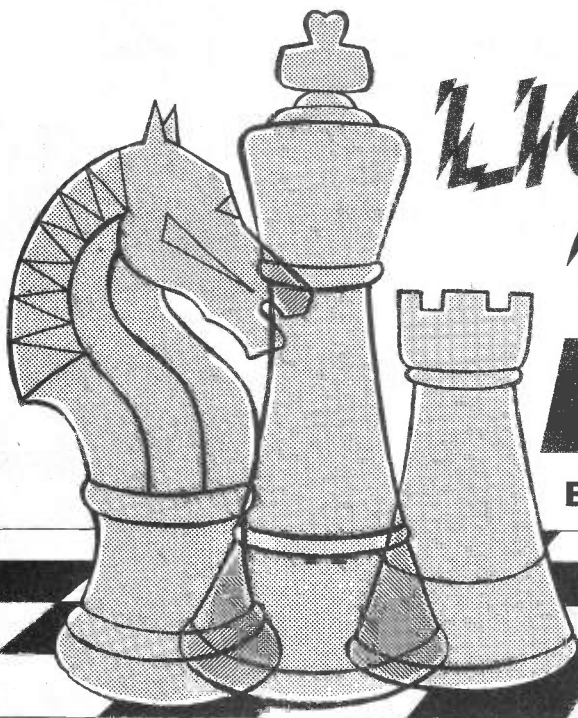

An easy to build unit, which opens the door to a fast and exciting game.

THE game of chess has come a long way since oriental philosophers first shunted pieces of hand carved ivory around checkered boards. Nowadays, in our high speed society, people feel less inclined to play games of an hour or more, so they turn to the fast and exciting game of "lightning chess" where games normally last about ten minutes.

The purpose of the Lightning-Chess Buzzer described here is to produce a buzz of two second duration every five to twenty five seconds, the idea being that every time a buzz is heard a move has to be made.

The extra rules for lightning chess are: (1) you do not have to say "check" and if your opponent fails to move out of check he loses, (2) if a player fails to move during the buzz he loses.

CIRCUIT OPERATION

The complete circuit shown in Fig. 1 is easier to understand when split into its two distinct units, the 0.04 to 0.2Hz astable multivibrator and the audio frequency unijunction oscillator.

The astable multivibrator operates as follows (see Fig. 1). Due to VR1, on switching the potential at A will rise faster than at B. When the potential at A reaches 0.6V TR1 will draw base current and will be turned hard on,

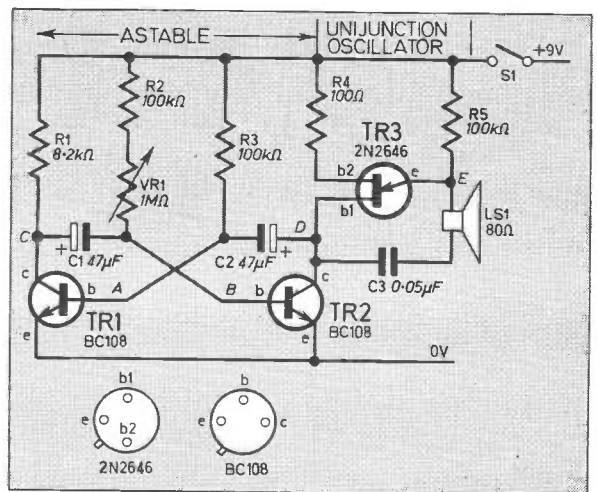
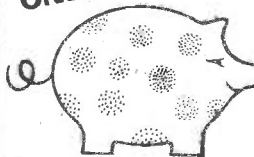

Fig. 1. Circuit diagram of the Lightning Chess Buzzer.

FOR GUIDANCE ONLY

ESTIMATED COST*
OF COMPONENTS
excluding V.A.T.



£2.30
excluding case

*Based on prices prevailing at time of going to press

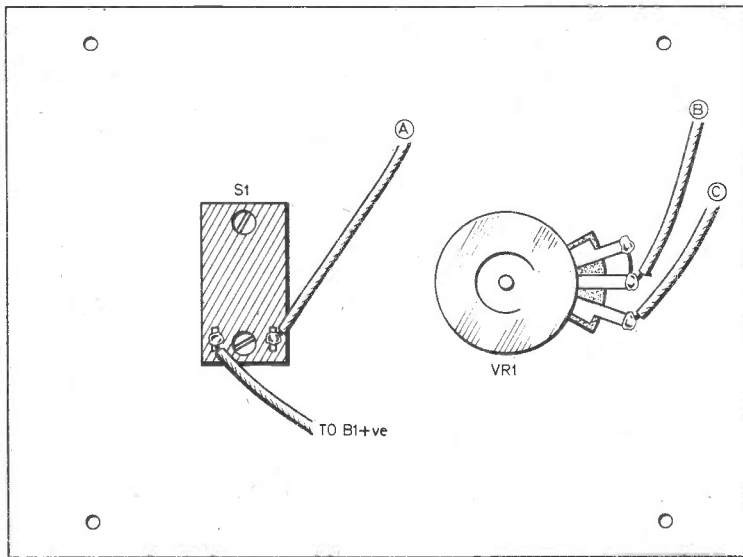
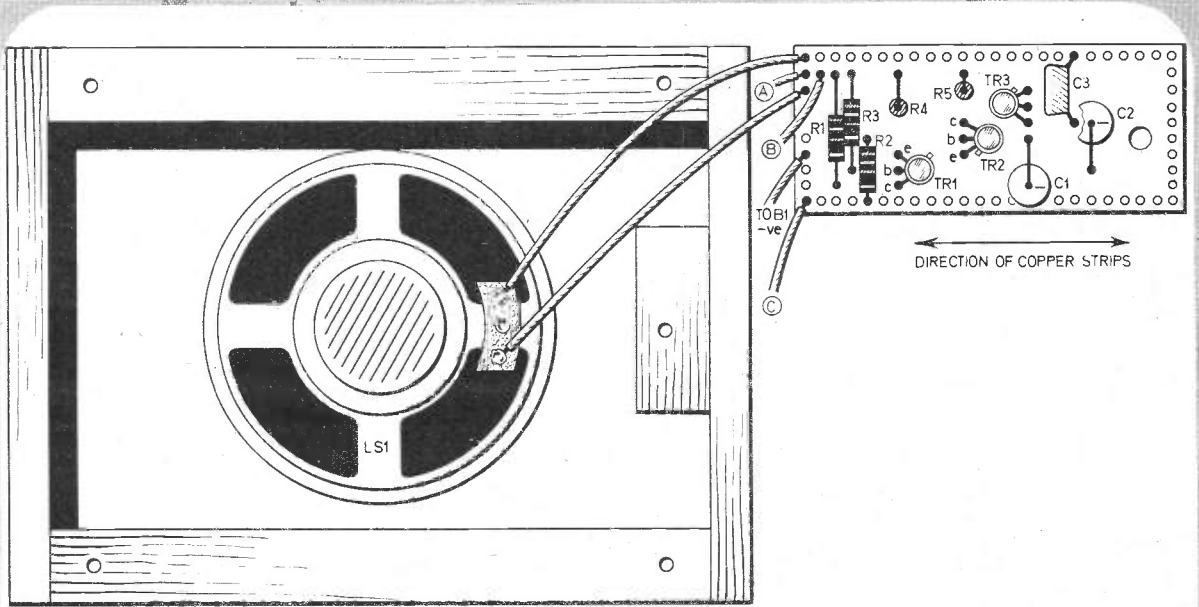
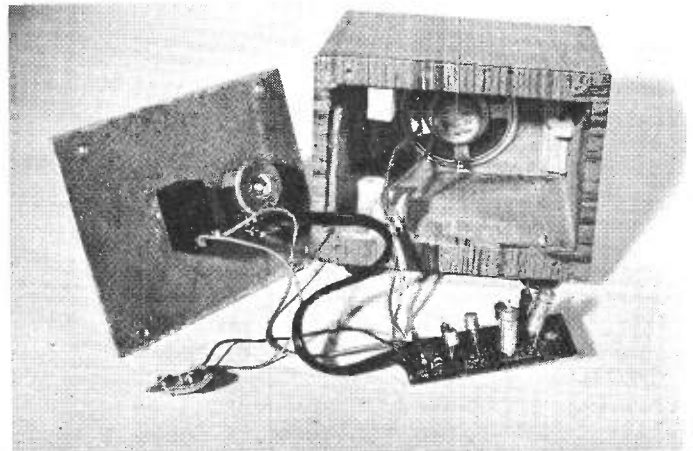
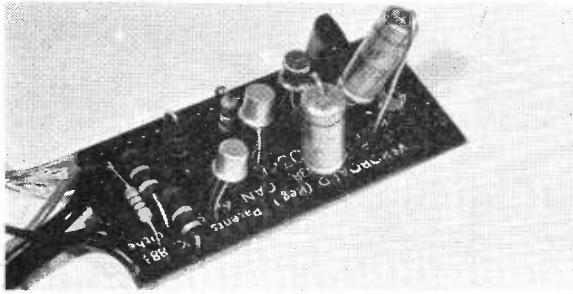

Fig. 2. Layout and wiring of the complete unit. Breaks along the copper strips need to be made in front of the fixing hole so that the fixing screw is unable to short adjacent strips in the vicinity.

LIGHTNING CHESS Buzzer





causing the potential at C to drop from about 9V to almost 0V. A negative pulse will go through C1 turning TR2 hard off; C1 then charges via R2 and VR1 till the potential at B reaches 0.6V. Transistor TR2 will draw base current and will be turned hard on, causing point D to be grounded and a negative pulse to go via C2 thus turning TR1 hard off. Capacitor C2 then charges via R3 till the potential at A reaches 0.6V, causing the cycle to repeat.

The audio frequency unijunction relaxation oscillator operates as follows (Fig. 1). On switching on, C3 charges via R5 and LS1. When the potential at E reaches 0.6V greater than that at b2 of TR3, TR3 conducts heavily, discharging C3 via LS1 very quickly. With insufficient forward bias TR3 stops conducting and the cycle begins again with C3 charging via R5 and LS1.

In the complete circuit the collector load resistor for TR2 has been replaced by the unijunction oscillator so that while TR2 is "on" a buzz is heard from LS1.

For lightning chess the "off" time of TR2 has to be adjustable from five to twenty five seconds and the "on" time should be about two seconds, regardless of the "off" time. By careful selection of the timing components C1, C2, R2, R3 and VR1 the author has been able to achieve this. Adjustment of VR1 changes the "off" time of TR2 without having much effect on the "on" time.

CONSTRUCTION

The components are mounted on a piece of copper clad 0.1 inch matrix Veroboard as in Fig. 2. Contrary to normal procedure the author advises the more experienced constructor to solder the transistors on first so that the resistors and capacitors can be soldered on in a more logical way. The author has found that fewer mistakes are made if the components are soldered on in this way. The case used can be any small type, that for the prototype was constructed from wood and painted to provide a reasonable finish.

Commence construction by cutting the Veroboard to the correct size and drilling the mounting hole. Solder on the components in the order

indicated above, then drill the holes in the control panel and the loudspeaker panel. Solder two six inch wires to the loudspeaker terminals and glue the loudspeaker to the loudspeaker panel with Araldite or similar glue.

Glue a piece of loudspeaker material over the loudspeaker panel and glue small wooden blocks on the side of the case for the battery retainer and the circuit board retainer. Fix S1 and VR1 to the control panel and wire up the battery, LS1, VR1, S1 and the circuit board with reasonably long leads for ease in servicing.

TESTING

Switch S1 "on". If the buzzer is working tie the loose leads in the case together to stop rattling and screw the control panel to the front of the case with four chromium plated, instrument head wood screws. If the buzzer is not working check the Veroboard and all wiring. Finally screw four rubber feet to the bottom of the case.

Although BC108's were used for TR1 and TR2 almost any medium gain *npn* transistors will do e.g. 2N2926, BC107, BC109, BFY51.

Because the peak current drawn by the prototype is a mere 2.2mA the battery life will be considerable and any calibration marks will be reasonably accurate. The lettering on the prototype was done with No. 6 Magic Letters from W. H. Smiths.

A high impedance miniature speaker was used for LS1 because this type was found to be more readily available and generally cheaper. A low impedance speaker will work just as well. □

Components

Resistor

- R1 8.2k Ω
- R2 100k Ω
- R3 100k Ω
- R4 100 Ω
- R5 100k Ω

Capacitors

- C1 47 μ F elect. 12V
- C2 47 μ F elect. 12V
- C3 0.05 μ F

Semiconductors

- TR1 BC108 silicon *npn*
- TR2 BC108 silicon *npn*
- TR3 2N2646 unijunction

Miscellaneous

- VR1 1M Ω lin. potentiometer
 - S1 S.p.s.t. toggle switch.
 - B1 9V battery and clips.
 - LS1 8-100 Ω miniature loudspeaker.
- Veroboard 0.15 inch matrix, 10 strips by 24 holes, connecting wire, materials for case, control knob, fixings.

**WIVAL
SHOP**
SEE

Physics is FUN!

By DERRICK DAINES



An interesting little demonstration piece. Faraday's Disc, will always keep those viewers who are not in the know guessing. A fairly large magnet is required—bar or horseshoe—and a hole is drilled through the centre (Fig. 1). The hole can be tapped for the insertion of a threaded rod, or else the rod can be held by means of two nuts. Mount the rod horizontally in a holder of wood or metal and fashion a cranked handle so that the magnet can be turned. Mecano lends itself very readily to this project.

Now cut a disc of thick aluminium and mount this on a separate rod, but without the crank. The disc should be mounted opposite the magnet and as close as possible without actually touching. Make sure that it can spin freely.

Now for the experiment. Turning the magnet by means of the crank will cause the disc to rotate also but—and here is the crunch—aluminium is not magnetic! So why does the disc rotate? Try picking up the disc with a magnet and nothing happens. So, you tell your viewers, the disc is not being dragged round by the magnet. (This is not entirely true, as we will see.) Someone may suggest that air currents from the rotating magnet drives the disc, so it is as well to have a duplicate

disc handy, made of thick card, which will not respond. So what happens?

A little gadget to get us closer to the answer has been suggested by Mr. Yuen of Bracknell in response to my plea for readers to send in their favourite experiments. It is a duplication of Waltenhofen's pendula. I quote from Mr Yuen's letter:

"A piece of thin copper or aluminium is made into a pendulum which swings freely. The pendulum is put between the poles of two magnets as shown and when an attempt is made to swing it, the movements will quickly be damped. (Fig. 2).

The pendulum is now replaced by a similar one which has slots in it. When this is swung, it swings freely. (Fig. 2).

The experiment shows the eddy currents set up in the first pendulum which, according to Lenz's law, oppose the motion of the pendulum. The slots in the second pendulum prevent the movement of eddy currents and therefore there is no opposition to motion.

The experiment is my favourite because when the first pendulum is swung everyone thinks that nothing will happen because it is non-magnetic, and it is quite surprising when it (quickly) stops swinging."

Thank you, Mr. Yuen. Your

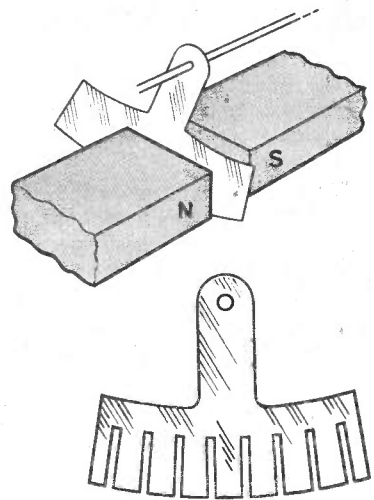

Fig. 2. Waltenhofen's pendula. The second pendulum is shown below the experiment.

letter is my favourite of those received so far.

EDDY CURRENTS

So there we have it—eddy currents in the material of the pendula and in the material of the disc. Remember that magnetic flux, like electrical circuits, must make a completely closed circle?

Although aluminium is not magnetic, the flux does nevertheless flow through it and when the magnet is revolved, the lines of flux also move. However, in the area of disc which is now no longer immediately affected, residual flux remains, jostling about until dissipated. This is an eddy current and it is the eddy current reacting with the new lines of flux that damp the swings of the pendulum or make the non-magnetic disc revolve.

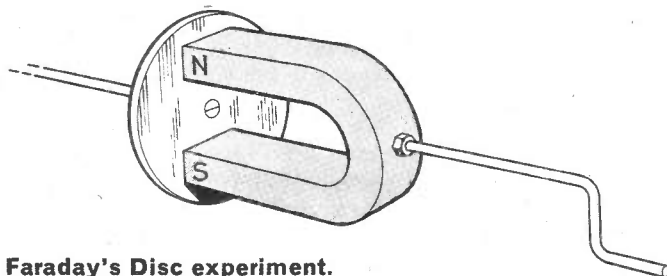

Fig. 1. Faraday's Disc experiment.

TEACH-IN '76

By A.P. STEPHENSON

Part Eight

8.1 THE BLACK BOX AND THE EQUIVALENT CIRCUIT

To avoid unnecessary circuit detail, a dodge called the "black-box" is employed whenever we are interested in *what* a circuit does rather than *how* it does it.

A rectangle is drawn with two input and two output terminals and some symbol or abbreviation is written inside the box which defines its function, (what it does). For example, Fig. 8.1a shows the black box equivalent of a transistor voltage amplifier with a gain A of ten. This means that a change in V_{in} produces ten times larger change in V_{out} .

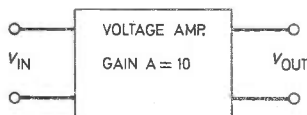

Fig. 8.1a. Black box representation of a voltage amplifier with $\times 10$ gain.

The actual circuit which the box represents may be a maze of transistors and components, some to set the correct bias voltages, others to set the required gain or to ensure protection against temperature changes. Occasionally it is useful to add a little more information inside the box diagram,—not too much—just enough to enable the correct choice of device, gadget, component etc. to drive, or be driven by, the box.

This extra information normally consists of two resistors and perhaps a single signal voltage and when present, raises the status of the black box to an **equivalent circuit**; Fig. 8.1b shows a typical equivalent circuit.

The resistor R_{in} is known as the **equivalent input resistance**. Knowing this value is a great help in say,

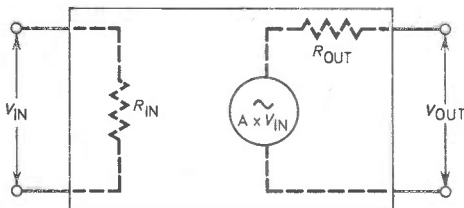

Fig. 8.1b. The equivalent circuit of a voltage amplifier with gain equal to A .



choosing a microphone to drive the amplifier. All sources of e.m.f., microphones included, have some internal resistance which in conjunction with R_{in} will form a voltage divider. Unless R_{in} is much larger than the microphone resistance, only a small fraction of its signal strength will actually reach the black box input.

The resistor R_{out} is in series with the output terminals and appropriately called the **output resistance**. If its value is too high relative to the load resistance, there will again be unwanted voltage division.

The little circle with the squiggle inside is called the equivalent **voltage generator**, its value is A times V_{in} , i.e. the voltage across the black box input multiplied by the gain A .

A word of warning here—don't expect to find these components in the actual circuit. They are simply a set of values mathematically derived from analysis of the actual circuit components. The mathematics is not at all difficult but they could induce an element of nausea at this early stage of our studies. Just trust the eggheads and accept their results, because in a few months you may be one of them.

In Fig. 8.1c a microphone is shown driving an amplifier which in turn is driving a load and provides a typical example of voltage division troubles. Notice the depressing chain of events as we work our way through the circuit from microphone to load.

The microphone e.m.f. starts at 10 millivolts which

Fig. 8.1c. A simple circuit to illustrate the importance of matching input and output stages.

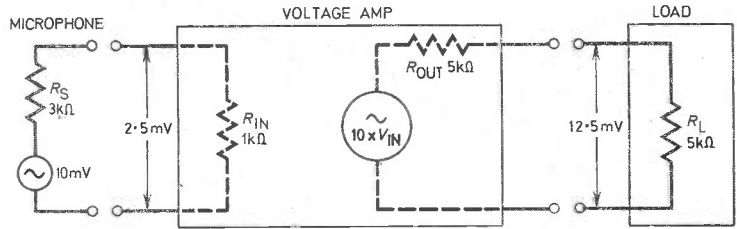

is immediately dropped to 2.5 millivolts before it even enters the black box (this is due to the voltage divider equation $1k\Omega / (1k\Omega + 3k\Omega) = \frac{1}{4}$). Inside the black box, this 2.5 millivolts is amplified to 25 millivolts but only half of this finally arrives across the load because of the output divider, $5k\Omega / (5k\Omega + 5k\Omega) = \frac{1}{2}$.

Thus, because of bad matching, a 10 millivolt microphone output has battered its way through an expensive blackbox only to end up a miserable 12.5 millivolts—not exactly a world shattering achievement.

What was wrong? Take your pick from these suggestions: (a) choose another microphone, one with a lower resistance load, or (b) choose a higher resistance load, or (c) choose another black box with either a high R_{in} a lower R_{out} or both.

This example has been treated in some detail, not only because of the universal problems of input and output resistances but as an introduction to the next section which deals with the three ways of using a transistor.

8.2 THE THREE WAYS OF USING A TRANSISTOR

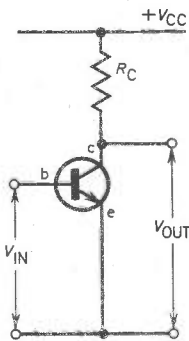

Fig. 8.2a. Common emitter.

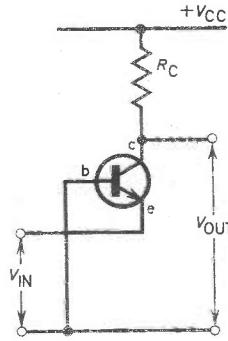

Fig. 8.2b. Common base.

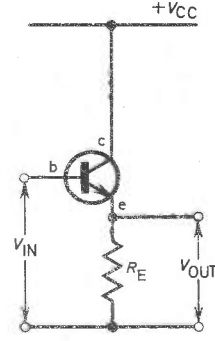

Fig. 8.2c. Common collector.

A transistor has three wires. A blackbox has four terminals so it is necessary to choose one of the transistor wires as the common i.e. one input and one output showing the same wire.

There are three options open to us.

- | | | |
|---|---|---|
| (a) Common emitter
(grounded emitter) | (b) Common base
(grounded base) | (c) Common collector
(grounded collector) |
|---|---|---|

The three basic circuits without bias resistors and other refinements are shown in Figs. 8.2a, b and c. Each of these have their own individual peculiarities.

Common emitter

This is the most popular, general purpose circuit for voltage amplification. It can achieve a very high voltage gain, in fact it could reach a figure of $20 \times V_{cc}$ (Notice the power supply rail has been marked V_{cc} which is modern practice).

The current gain, collector current in output circuit divided by base current is also high. This ratio is called h_{FE} . As a result, the power gain must also be high because power gain equals voltage gain times current gain.

The R_{in} however is not very high, typically 2 to 5 kilohms although this can be increased by an additional resistor in the emitter circuit. The output resistance R_{out} is, for all practical purposes, equal to R_c itself, typical values would be in the range 100 ohms to perhaps 20 kilohms. The phase shift through the circuit is 180 degrees, which is a posh way of saying that as the input signal rises towards the positive rail the output falls towards the common rail, i.e. the output is inverted.

Common base

This is rarely used, the R_{in} is very low, seldom exceeding 200 ohms. The voltage gain can be quite high but the current gain is slightly less than 1, as can be seen by noting that emitter current (the input) is a little greater than collector current (the output).

Unlike the common emitter circuit, there is no phase shift—the output voltage moves in the same direction as the input, which explains an occasional use for it. It is also very stable and efficient when dealing with very high frequencies.

Common collector (often called the emitter follower)

This is a very useful circuit, which is surprising when it is learnt that the voltage gain is *always less than 1*, typically 0.99.

Its claim to fame is the very high R_{in} (hundreds of kilohms or even megohms) and the very low R_{out} which could be as low as a few ohms. The current gain is high, $(h_{FE} + 1)$, and there is no phase shift.

It is used as a **buffer** between a high resistance signal and a low resistance load.

The lever analogy

It may aid comprehension of the three circuits if the analogy of the simple mechanical levers are compared with them. The input signal is the point of applied force; Fig. 8.2d is the equivalent of the common emitter.

The gain for this configuration (which is the output movement over the input movement) is high and would become higher if the fulcrum is moved nearer to the signal end. The phase shift is 180 degrees, i.e. the output moves up as the input moves down.

The common base analogy is shown in Fig. 8.2e. Notice that the gain is high and increases as the signal is moved towards the fulcrum. Also note there is no phase shift.

The common collector seen in Fig. 8.2f, will always have a gain less than unity and without phase shift.

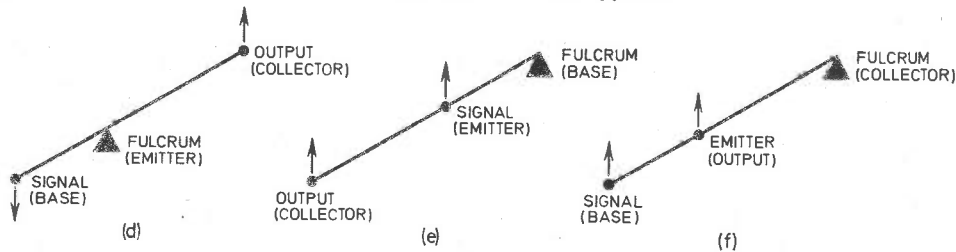

Figs. 8.2d, e and f. Lever analogies for the three transistor configurations.

Table 8.2: Comparison of the three transistor configurations.

Parameter	Common emitter	Common base	Common collector
VOLTAGE GAIN A	High (100)	High (100)	Slightly less than 1
R_{in}	Low (5k Ω)	Very low (100 Ω)	Very high (1M Ω)
R_{out}	Medium (1k Ω)	Medium (1k Ω)	Very low (50 Ω)
CURRENT GAIN	High (100)	Less than 1 (0.99)	High (100)
POWER GAIN	Very high	Medium	Medium
MAIN USE	General purpose amplification	Very high frequency	As a buffer

The above table summarises the properties of the three circuits; the figures given in parenthesis are typical.

8.3 CLASSES OF AMPLIFICATION

In addition to the three ways of using transistor, a further classification is recognised depending on the duration of the collector current relative to the signal.

In defining these classes let us suppose the signal is a smooth variation above and below zero volts.

One complete sequence of variation is called a **cycle** which in turn consists of a positive half cycle and a negative half cycle, see Fig. 8.3a.

Class A amplification

Collector current flows for the whole of the input signal cycle. The collector is therefore an exact replica of the signal waveform—at least it should be—but nothing is perfect.

Nearly all voltage amplifiers are operated in class A.

Class B amplification

Collector current only flows for half the input signal cycle. The terrible distortion which results makes this a "non-starter" as a general purpose

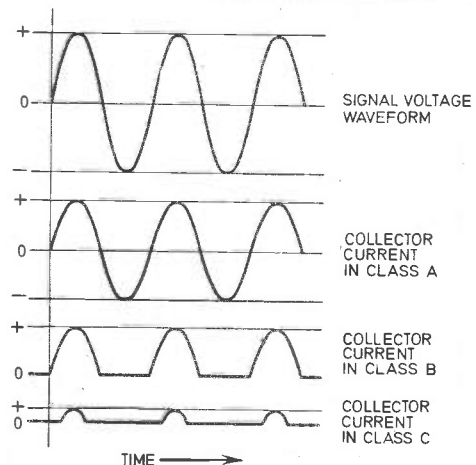

Fig. 8.3a. Comparison of collector current flow for each of the three classes of operation.

class. There is however a neat little trick known as **push-pull**, in which two transistors share each half of the signal. This is used widely in power amplifiers.

Class C amplification

Collector current flows for less than half the input

8.4 CLASS A BIASING METHODS

As mentioned in an earlier part of this series, a transistor must be operated with forward bias on the base/emitter junction. With silicon transistors the value of this bias must be somewhere around 0.6 volts, i.e. the base must be 0.6 volts positive with respect to the emitter. With a *pn*p transistor, the base would of course have to be 0.6 volts negative with respect to the emitter.

With this correct bias applied, the signal voltage will then ride above and below 0.6 volts, causing the collector current to vary in the same manner. Unfortunately for the beginner there are many different ways in which the correct bias can be obtained. The reasons for this lack of standardisation is due to a couple of annoying defects in transistors:

(a) The current gain h_{FE} is, to a large extent,

signal. This is only feasible in **tuned amplifiers** employing a kind of flywheel action which guesses the missing bits. These are discussed in a later section dealing with "Alternating Current Theory".

unpredictable—the manufacturers can only give two limiting figures. For example, the BC107 is stated to be greater than 110 but less than 800. The particular specimen you have could be anywhere within these two figures but more probably it will be somewhere about the middle.

(b) The current gain is dependent on temperature and so also is the current bias voltage. (The correct bias actually reduces at the rate of 2 millivolts for every Centigrade degree rise).

The biasing technique must try to take into account these factors and provide some sort of compensating action. But nature can be most unkind! To cure one defect often means introducing others and so we end up with some sort of compromise and inevitably some additional complication.

8.5 SIMPLE CURRENT BIAS

Design procedure.

The simple current bias arrangement is shown in Fig. 8.5a. Decide on mean collector current I_c and let R_c drop half the supply rail voltage so that output terminal has plenty of room to "move up and down". This makes $R_c = (\frac{1}{2}V_{cc}/I_c)$.

Example. If I_c is chosen as 1 milliamp and a 9 volt battery is used, then $R_c = 4.5V/1mA = 4.5$ kilohms. Next calculate R_b which carries the base current which is I_c/h_{FE} . The volts across R_b must be $(V_{cc} - 0.6)V = (9 - 0.6)V = 8.4$ volts. Assume the h_{FE} is 200, then the base current is equal to $1mA/200 = 5\mu A$ which makes $R_b = 8.4V/5\mu A = 1.68$ megohms.

This method is simple, cheap but virtually useless! We assumed h_{FE} was 200 but supposing it was actually 400? There would be far too much collector current and the output terminal would be resting almost on the floor near the common or ground line.

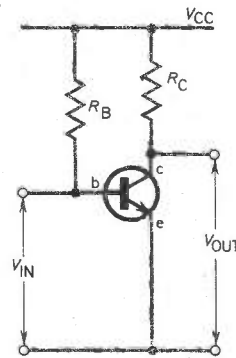

Fig. 8.5a. The circuit shows simple current biasing. The resistor values are chosen such that half the supply is dropped across R_c .

TEACH-IN '76 EXERCISES

8.1. Assume the black box in Fig. 8.1c has been modified such that $R_{in} = 3k\Omega$, $R_{out} = 1k\Omega$, but the remaining components are unchanged. What voltage will now be across the load?

8.2 Why is the common emitter circuit the most popular?

8.3. The forward bias in a silicon transistor is

about 0.6V. What is the forward bias required in germanium?

8.4. If temperature rises, the required forward bias is different—higher or lower?

Answers

8.1 42mV approx. 8.2 High current, and high voltage gain. 8.3 0.2V. 8.4 Lower.

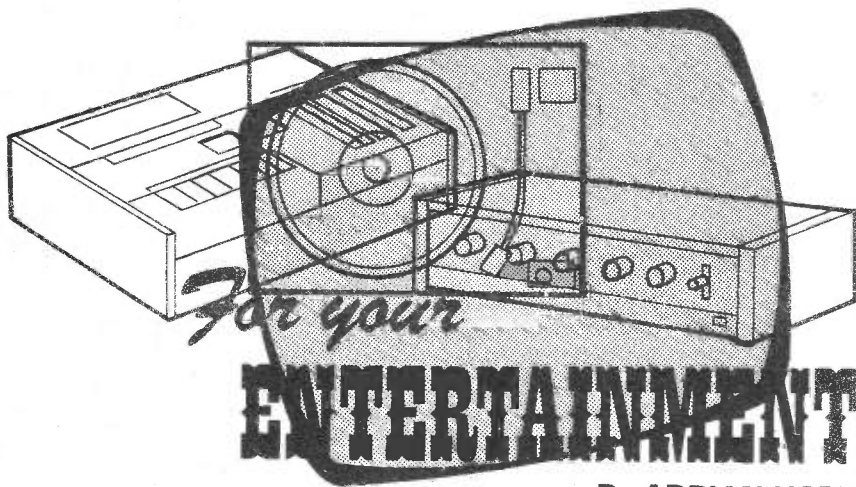

By ADRIAN HOPE

THINK it's fair to assume that readers of EVERYDAY ELECTRONICS are likely to enjoy science fiction films, especially with an electronic slant. Of the most recent, two stand head and shoulders above the rest—Stanley Kubrick's *2001* and (less well known) Douglas Trumbull's *Silent Running*.

Of course, both these films centre round spotlessly clean space-ships which are relying heavily on sophisticated electronics and computers, and are performing important missions in highly efficient manner. Even though the computer, Hal, went wrong in *2001*, it did so efficiently.

A few months ago, I chanced on a one-off screening at the National Film Theatre (in a season devoted to special effects) of a science fiction feature film made on a remarkably low budget by two Californian students, John Carpenter and Dan O'Bannon.

So far the film, *Dark Star*, has no distributor for general release, but sooner or later it is bound to become cult entertainment. In a nutshell, it is everything that other science fiction films are not. A four-man crew of bearded, scruffy screwballs are piloting a dirty, old, badly made space ship on a pointless mission. What is more they have to contend with sophisticated equipment that is continually giving trouble.

The computer, which is supposed to monitor faults, hasn't a clue what is going wrong where and why; the crew have lost interest anyway. Like Hal, the computer talks, but, unlike Hal, it has a sexy, female voice. Also

unlike Hal it keeps playing the crew hillbilly music which they hate, or thanking them for observing all safety precautions, which is the one thing they plainly aren't doing.

When one crew member is trapped in the lift shaft, the computer simply issues the softly spoken warning, "Please get out of the shaft," and starts the lift moving. To the best of my knowledge, this is the first successful feature-length parody of modern electronic technology, and it deserves cinema distribution, or at least a screening on television.

Speakers

Recording studios, especially those working in the pop, rock, and jazz fields, frequently use JBL loudspeakers to monitor their very loud sound. But JBL speakers (from James B. Lansing of Los Angeles) are criticised by audio purists for what has been christened their "warm" sound, and there is no more exciting sight and sound than a pro-JBL studio engineer arguing with a hi-fi pundit, who will accept only the clinical accuracy of Spendor or BBC-designed monitors.

But on one point there is no room for argument. JBL loudspeakers can handle more power, cleanly and without any sound of breakup, than almost any other loudspeakers in the world. This is why they are now virtually a must for some studio work.

Without taking sides I would offer one comment based on personal experience. Next time one of those pundits talks to you

about the need for total accuracy in reproduction, you might like to remind him of the results of a few tests which anyone can carry out for themselves with a sound level meter. For instance, the sound level of a solo, unmuted trumpet from around 5 metres registers about 105dBA on a meter. A Covent Garden soprano notches up the same reading at 1 metre during practice.

When children scream, loudly (as, for instance, they will do during school playtime), the reading at 1 metre is likely to be well over 110dBA and can top 120dBA. The classic definition for hi-fi is still "the closest approach to the original sound" and a JBL loud-speaker is one of the few transducers that can get anywhere near this in terms of clean sound pressure level.

The snag, of course, is that they are expensive, as much as anything due to the inflationary effect of importation from the USA. But the British agents C. E. Hammond & Co. (Lamb House, Church Street, Chiswick, London W4. Tel: 01-995 4551) do now have available a set of detailed blue-print plans for building JBL-design enclosures. Price is still uncertain but should be low enough for anyone with a limited budget, but a hankering for JBL performance, to build their own and save money. One word of warning, however, the project should not be entered into lightly and for success will require care, time, and dedication from someone already reasonably competent as a d.i.y. carpenter.

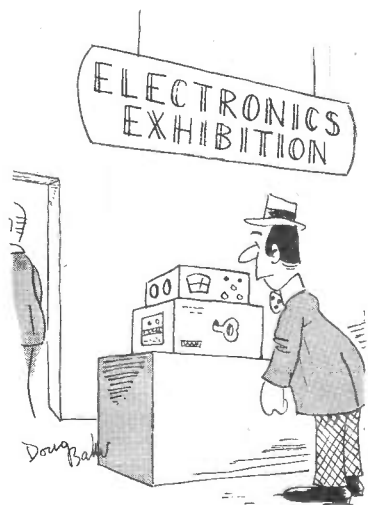

Your Career in **ELECTRONICS**

By Peter Verwig

A career in electronics is an exciting prospect! Month by month our contributor Peter Verwig explains what working in electronics is all about, how to prepare yourself for a rewarding career, and the job opportunities available in the world's fastest growing industry.

RADIO AND TELEVISION SERVICING

ONE of the problems facing people seeking a career in electronics is that over 50 per cent of the professional equipment manufacturing industry and the greater proportion of its research and development work are located in the South East. This imbalance means that those living elsewhere have less opportunity and less choice.

Of course you can always move to the South East, perhaps on a temporary basis to get a start and gain experience. But living away from home is not cheap. Neither is travelling home at weekends with today's petrol costs, or by rail. Even telephoning home for family news can now be an expensive luxury.

Fortunately, wherever there are people there is home entertainment in the shape of radio, TV, and audio equipment, all of which need periodic attention by experts, and so building a career in radio and TV servicing is one way of finding work locally, wherever you are.

GIFTED AMATEUR

In the early days of radio a dabbler was able to cope with most service work. Circuits were generally simple and thermionic valves and point-to-point hand-wired discrete components were standard. You didn't need any academic qualification or much experience to look into the back of a set and see that a valve fila-

ment wasn't lit. It used to be said that a good engineer only needed a screwdriver and a wet finger, the latter to check for presence or absence of the high tension voltage—a procedure not to be recommended!

Many of the faults were very obvious. Failure of a decoupling capacitor generally resulted in severe overheating of the associated resistor and the consequent discolouration of the colour coding was enough to give you a clue. For more obscure faults you would need a multimeter but it didn't need to be all that accurate, and possession of a signal generator was regarded as positively swanky.

Because there were no established technical courses in radio servicing, nearly everyone was self-taught. It was no wonder that the average service engineer was looked down upon by the professionally qualified engineer as little more than a gifted amateur. Nevertheless, there are hundreds of people in executive jobs in electronics today who started professional life as a service engineer and are thankful that servicing gave them a good, if somewhat shaky, start on the professional ladder.

The advent of television and, later, the invention of the transistor and the whole subsequent development of solid state electronics, transformed the status of the service engineer. The newer technologies eliminated

the dabbler. Young engineers of today, confronted with a complex fault on a colour TV set with its hundreds of passive components and dozens of solid state devices need to be very different persons than those who could once get by with an Avominor, a simple tool kit, an elementary knowledge of theory and a lot of luck.

Today's engineer is professionally trained and qualified, needs far more practical and diagnostic skill than in former times, and is likely to have and need far more test equipment to do the job.

QUALIFICATIONS

What qualifications do you need? You should at least try to get the C & G Radio, Television and Electronic Mechanics Certificate. You don't need "O" levels but you will need to satisfy the college that you are science-minded and have some mechanical aptitude. A higher course is the Radio, Television and Electronics Technician's Certificate Parts 1, 2 and 3 for which the entry requirements are "O" level in mathematics and physics, or another subject which includes physics. If you have other academic qualifications you may be able to get exemptions from some or all of the first-year course.

The courses are normally of four or five years on a day-release or block-release basis. If you are on the Mechanic's course and are doing exceptionally well, it is possible to transfer from third year to the second year of the Technician's course. Ask your careers master or the local education authority for details and locations of these courses.

It doesn't matter how good the college is, you won't learn servicing there. You need on-the-job training as well with the college work, generally one day a week, providing the theoretical back-up. So it is preferable to find an employer who has a recognised training or apprenticeship scheme.

EMPLOYERS

There are four main groups of employers. The most numerous are individual retailers of which even small towns may have several. Then there are multiple retailers, household names in retailing who have a whole chain

of shops generally to be found in the High Street or shopping centres of larger towns and cities. Radio and TV rental companies is a third choice and, finally, there are the radio and TV manufacturers' own service organisations.

The individual retailer is most frequently a small family business with a service workshop at the rear of the premises and who may employ only very few, and perhaps only one, engineer and an assistant. The work is necessarily of great variety but obviously the long-term career prospects are limited unless the business expands to a much larger size. Some people, however,

like being a large fish in a small sea, enjoy the intimacy of a small business and are quite happy to stay for years in what may well prove to be very congenial employment.

All the remaining groups are likely to have centralised service facilities with substantial workshops and a number of engineers with a defined career structure for apprentices through junior engineers with the prospect of rising to chief engineers or area managers.

EXAMPLE

As with other careers articles in this series we now look at a

practical example and we chose Combined Electronic Services whose headquarters is at Croydon, from which is run a nationwide spares and service back-up organisation for all products bearing the Philips, Pye, Dynatron and other brand names of associated companies of the Philips Group.

CES is managed by Jim Boyd and he has a total staff of 1,400 people in HQ and 25 branches spread over nine regions throughout the United Kingdom.

In the jargon of the trade there are two main product groups, White Goods and Brown Goods. White goods are refrigerators, freezers, washing machines and other household appliances. Brown goods are radios, TVs, recorders, etc., and these are what really concern us here.

In this division of the business there are some 250 field and workshop service engineers who are located, according to need, at the branches which can vary greatly in size. London, for example, has nearly 60 engineers while Aberdeen needs only a couple to keep the wheels turning. In parallel with the service facilities there is a substantial organisation for the stocking and supply of spare parts.

As a service organisation owned by the manufacturers, CES only handles Philips Group products but the variety is still very wide, unlike some rental organisations

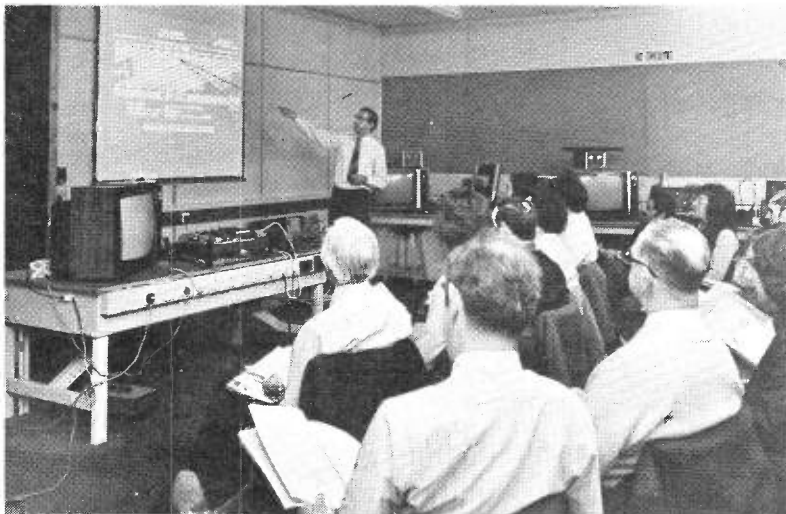

A course in progress for dealer engineers on video cassette recorders.

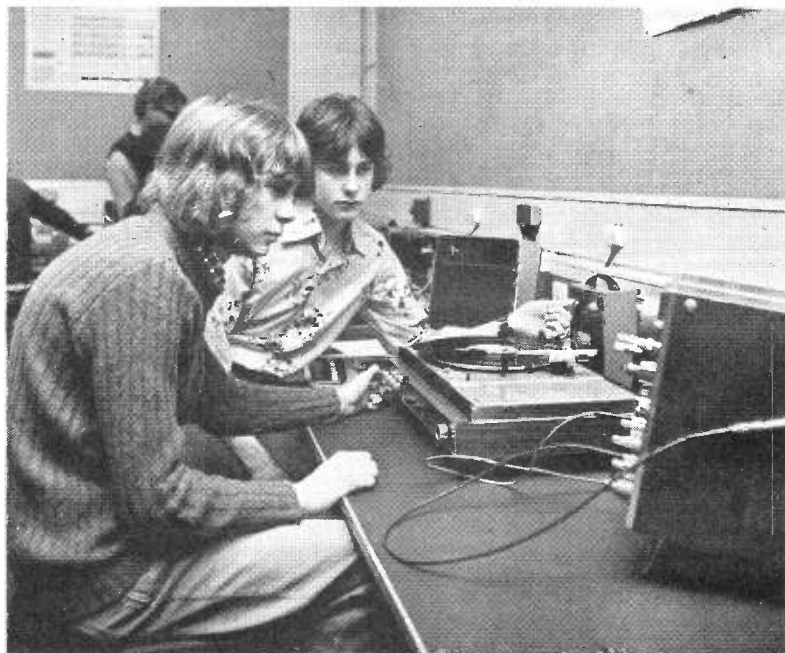

Apprentices undergoing training on audio equipment at the C.E.S. training unit at Wadham.

who only have a very limited product range. About half of CES's service work comes direct from customers and half via radio and TV dealers. The work also breaks down into paid repairs (including some on maintenance contract), repairs under guarantee, and repairs to company stock that is damaged in transit. There is, for example, a cabinet shop at Croydon which includes french polishers.

CES, as a substantial organisation, has a fully-fledged apprenticeship scheme with an intake of 12-15 young people a year so that an average of 40 or so are in training at any one time. But apart from this scheme there is continuous training on new products for CES engineers and dealers' engineers. An example is the Video Cassette Recorder on which CES technical staff have already trained over 1,000 people in theory and maintenance.

FIELD ENGINEERS

Field engineers in CES need to have a good personality and be self-reliant because they deal directly with customers and operate independently from their own homes, keeping in touch by telephone, with perhaps only one call a week at the local branch to collect spare parts and make their reports.

CES preferred procedure is to repair down to circuit board level at the customer's premises, rather than exchange a complete board or module at the customer's premises, and send the faulty one back for workshop repair. Of course, there are cases when an exchange is necessary and field engineers carry replacement boards and modules, but only for use as a last resort.

Customers are often ruffled because their equipment has gone wrong, so the engineer needs to be diplomatic and helpful. Note, too, that the engineer should have good colour vision and good hearing as part of his diagnostic equipment, and be able to drive. And if you are looking for a 9a.m. — 5p.m. job five days a week, forget field service as a career. You will need to be flexible in your hours but there are great compensations in virtually being your own boss and arranging your own work schedules for a great deal of your working time.

Workshop staff have a more regular life but it may still be necessary to work under pressure. If you were to find employment with a company like CES it is almost certain that you will find yourself in workshops for training and working under supervision during the early part of your career.

SALARY

What might you expect to earn? A recent survey conducted by the Society of Electronic and Radio Technicians (SERT) showed that current salary scales are in the £2,500 to £3,500 bracket with the use of a company car for those on field service. Workshop managers might expect to get more. There are frequently some "perks" such as being able to buy electrical goods and accessories at trade price, and having access to high grade instruments which may prove useful for checking out your home-brewed hi-fi or other equipment.

The status of the service engineer has risen tremendously in recent years. There's many an experienced engineer in other specialities who wouldn't dream of servicing his own TV set today because it's now a job for the expert, although a few years ago they would have tackled the job with confidence. And if you

work for a manufacturer's organisation like CES you may even be drawn in by the parent manufacturer as a consultant on new designs with your expert knowledge of component failure rate and your experience of service difficulties in the field.

In fact CES co-operates very closely in the initial design of all new products and supplies very complete failure analyses of components and equipment to development and production colleagues. The feedback of technical information to research and development departments is an important function of the organisation in leading to improved reliability in future products.

The young engineer who starts training now will, by the time he is trained, be coping with further advances in present-day technology such a wider application of thick film hybrid circuits and integrated circuits. Coming along fast are quadrasonic hi-fi equipment and the video disc. Don't forget, too, that the home electronic organ is becoming more popular and that many white goods are now beginning to be fitted with electronic controls. In short, there is more and more work for service engineers trained in electronics and a good engineer will always be in demand and, moreover, demand is nationwide.

Advanced instruction of apprentices in video cassette recorder maintenance.

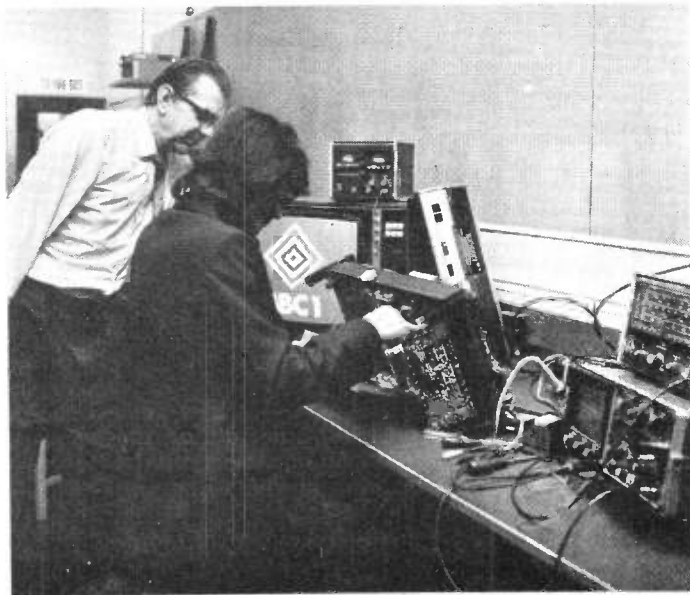

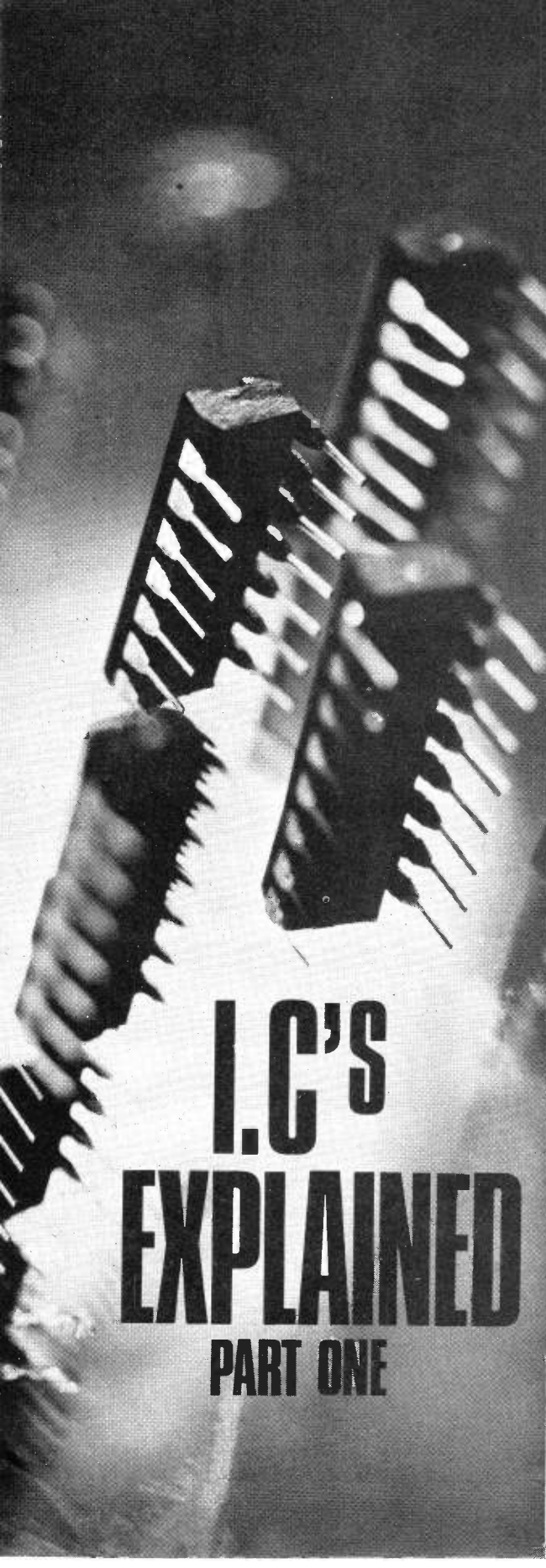

I.C.'S EXPLAINED

PART ONE

ALMOST all electronic equipment which has been designed fairly recently employs integrated circuits in some of its stages. Computers employ very large numbers of integrated circuits, but integrated devices are becoming much more widely used in radio and television receivers, in electronic wrist-watches, in washing machines, in electronic camera shutters, etc.

The motor vehicle industry may appear to have been a little slow in introducing electronics into road vehicles, but much developmental work has been carried out in the past few years and it seems certain that integrated circuits will be widely used in this field before long. Each vehicle will have its own microprocessor unit which will automatically adjust the fuel/air mixture ratio at all values of load, will automatically monitor items such as the oil, water and brake fluid levels, etc. It may even tell the driver how many miles he can cover at his present speed before he runs out of petrol and could apply the brakes in some circumstances to avoid a collision.

In automatic data processing the future for integrated circuits is wide open. Microcomputers can control factory production lines with a minimum of human help. If telephone charges do not continue to rise at their recent rates, it will not be too difficult for electricity, gas and perhaps water meters to be read automatically from a central point without a meter reader having to go from house to house.

The home television screen may be transformed into a private data terminal and eventually it may even be possible to dial for some pages of a book taken from a whole library to be displayed. Indeed, electronic games can already be displayed on a television screen by the use of suitable integrated circuits and it will not be long before the Ceefax system enables a number of pages of information to be displayed on anyone's television screen on demand.

Modern electronic equipment is employing integrated circuits for a wider and wider range of applications. The reasons for this will be seen shortly.

WHAT IS AN I.C.?

An integrated circuit (i.c.) consists of a large number of individual components fabricated and suitably connected together on a single silicon chip. This monolithic chip is itself very small and must be suitably encapsulated so that it is protected from the atmosphere.

The components on a chip can include resistors, capacitors of a small value, transistors, field effect transistors, thyristors and occasionally other components. Devices are now being marketed which contain moderately high power transistors fabricated on the chip, but these components occupy a relatively large fraction of the chip area.

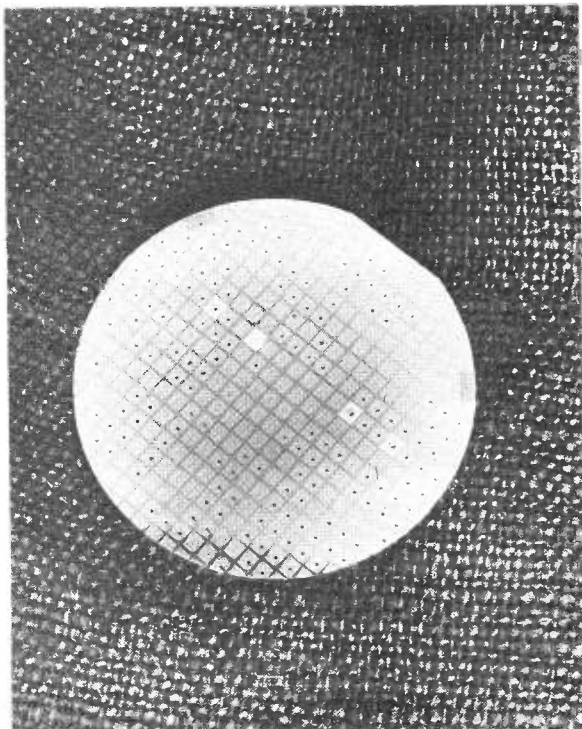

A silicon wafer containing many integrated circuits before it is separated into individual chips. (RCA)

Unfortunately it is not possible to make capacitors of even a moderately large value on a minute silicon chip. If one requires a $0.01\mu\text{F}$ capacitor in a circuit, one must therefore bring out the necessary connections to external pins on the device and employ an external capacitor. Similarly, one cannot fabricate inductors (that is, coils) of any appreciable value on a silicon chip. All the tuned circuits used in a radio receiver are therefore outside the integrated circuits.

A transistor requires a very small area on a silicon chip. For example, a single transistor occupies only about half the area taken up by either a 1 kilohm resistor or by a 5pF capacitor. Thus it makes sound economic sense to include up to about five additional transistors in an integrated circuit if this eliminates the need for just one resistor of moderately high value (perhaps 50 kilohm), since such resistors take up a considerable area.

In general one avoids the use of resistors of values exceeding about 33 kilohm and of capacitors of value above about 300pF fabricated on the chip. In addition, the values of the resistors on the chip usually have much larger tolerances than good quality discrete resistors and they may have a relatively high temperature coefficient; the latter can, for example, impair oscillator frequency stability in certain types of circuit.

The internal circuit employed in an integrated

circuit is usually considerably more complex than the circuit one would use with separate or discrete components for the same application. The cost of adding a few extra components to the internal circuit of a device is extremely small when it is divided out amongst the large numbers of that type of device which are produced over a period of time. Thus it is well worth while adding a reasonable number of additional internal components on the chip if one thereby achieves an improved performance or avoids the necessity of having an additional external component which cannot be fabricated on the chip.

The size of an integrated circuit is almost always determined by the size of the package and the connecting leads, rather than by the complexity of the internal circuit. Devices must be large enough for them to be easily handled.

WHY ARE I.C.s USED?

Integrated circuits offer a number of advantages over the use of separate or discrete components. In many cases these result in an improved performance or enable the equipment to occupy a far smaller volume, but in nearly all cases costs can be greatly reduced by the use of integrated circuits.

The connections inside an integrated circuit are made quite automatically by photographic masking techniques on the device production line. Once this line is in operation, no human time or effort is required to make the numerous internal connections (except, perhaps, the connections to the external pins). Thus one of the main advantages one obtains from the use of integrated circuits instead of discrete devices is the saving in the labour costs of joining up a very large number of connections with a soldering iron.

An additional advantage is that the internal connections in an integrated circuit are far less likely to fail than normal connections made with a soldering iron. Although one still has to make external connections to the integrated circuits, the number of such connections is much lower than in a similar circuit in which only discrete devices are employed.

One can save a great deal of space by the use of integrated circuits. Complex modern computers would occupy a far larger volume if only discrete components were available and their cost would be multiplied many times. Other fields in which the small weight and volume of integrated circuits are absolutely vital are in aerospace applications and in electronic wrist-watches.

COSTS

Many types of integrated circuit cost little more than cheap transistors, although they may contain a hundred or so individual components

on their minute silicon chip. The cost of any device depends more on the estimated volume of sales than on the complexity of the internal circuitry.

Although the design and production of the masks used to make integrated circuits is quite expensive, once the device production line is in operation, the cost of producing each additional device of that particular type is very small. However, the cost of the package used may be appreciable.

In general an integrated circuit is produced only for applications in which it is expected to be sold in large numbers. The cost of a device produced for an application where only a few hundred are likely to be required would be quite prohibitive owing to the cost of setting up the production line. When the sales run into millions of one type of device, the prices fall very rapidly.

It is probable that the cost of integrated circuits (and other semiconductor devices) has fallen more rapidly than that of any other manufactured product during the past few years when most prices have been rising with rapid inflation.

This rapid fall in prices is a result of the fact that the semiconductor industry has become one of the most rapidly growing new industries the world has ever seen. Following the discovery of the transistor at the Bell Telephone Laboratories, Murray Hill, New Jersey in June 1948, annual world semiconductor sales approached 40 million US dollars in 1955 and is expected to exceed 3,800 million US dollars in 1975.

Most integrated circuits are manufactured for a specific application, such as thyristor control, television sound systems, etc., but others consist of a high gain operational amplifier which can be used in a very wide variety of applications. In both cases high volume sales are expected. Some devices are now beginning to

High reliability integrated circuits being bonded at National Semiconductor. (National Semiconductor)

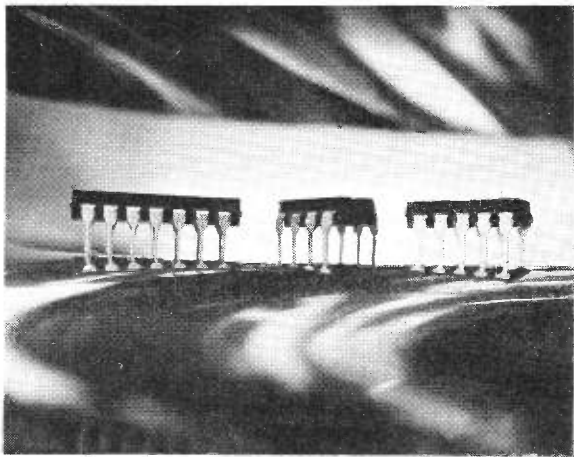

Plastic encapsulated dual-in-line devices.
(National Semiconductor)

come onto the market which appear to have a more limited sales volume; one may, for example, mention the new National Semiconductor LM1812 which is specifically designed for ultrasonic echo depth sounding and fish-finding from a boat.

SOME LIMITATIONS

Some amateur enthusiasts comment that they prefer to use discrete components rather than integrated circuits, since the latter are not so flexible and versatile in circuit design. It is undoubtedly true that one loses much of the versatility of the individual transistors, etc. when one uses complex integrated circuits in which most of the connections have already been made in the factory and which cannot be altered in any way by the user.

However, one must remember that the user of integrated circuits has been saved the work of having to carry out the detailed circuit design calculations; if one regards integrated circuits as the building blocks which one can connect together (possibly with some discrete components) to form a complete working model, one can begin to appreciate how useful these modern devices are.

Any readers who feel that the use of integrated circuits really imposes a severe limit on the possibilities for circuit design would read his electronics magazines much more carefully! Whilst the use of integrated circuits greatly simplifies the task of the circuit designer and enables smaller and more compact pieces of equipment to be made, the writer has no doubt whatsoever that there is still ample scope for ingenuity and inventiveness when taking advantage of the excellent performance of modern devices.

Currently available integrated circuits are not suitable for the highest operating frequencies

(over 1GHz or 1,000MHz). This is not such a severe limitation as it might at first appear. Equipment operating at extremely high frequencies normally has only a very few stages operating at the high frequencies, so the remainder of the equipment can employ integrated circuits for the control of the high frequency circuits.

Integrated devices are now becoming available which can operate at frequencies of well over 100MHz, although the number of these device types is not yet very large.

PACKAGING

One of the first questions a newcomer to electronics will ask is: "What does an integrated circuit look like?". The external appearance is determined entirely by the type of encapsulation employed. The user does not normally cut an integrated circuit open and it is only the package he handles. It is the form of this package which determines how easily the user can employ it in a circuit. The various types of packaging will therefore be discussed in reasonable detail.

Integrated circuits are produced by semiconductor manufacturers; it is therefore only natural that many of the early integrated devices were incorporated into the same type of small circular metal packages which has previously been proved satisfactory for transistors and other devices.

Although a few types of integrated circuit (such as voltage regulators) require only two or three external connections, most types require considerably more. Circular metal packages with 8 or 10 wires coming in from the base of the package are quite common; the leads are arranged in a circle.

An integrated circuit package must incorporate rigidity, provide reasonable thermal dis-

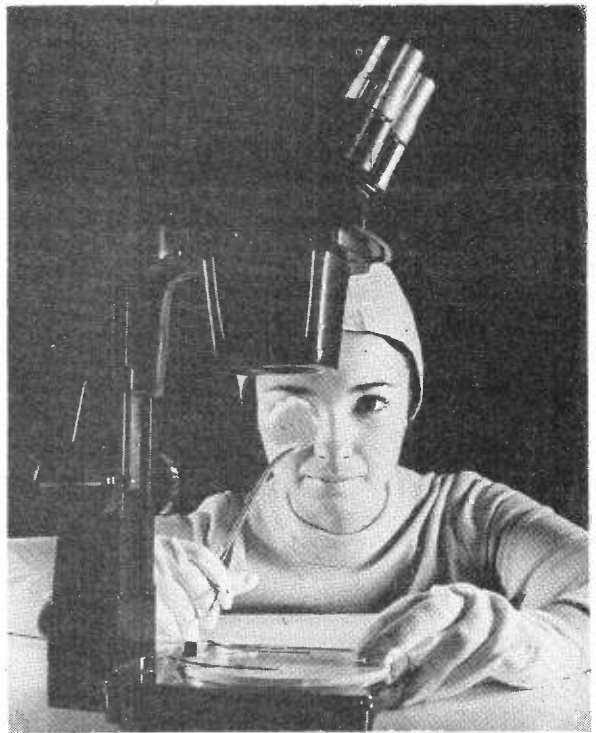

Silicon wafers containing many integrated circuits are prepared for microscopic examination in operating theatre cleanliness at RCA. (RCA)

sipation, provide sealing in defined environments against the entry of any material which could contaminate the silicon chip, have suitable external connections and generally form a convenient interface with other devices in the circuit. In addition, it must be very cheap, since it is almost useless reducing the production costs of a silicon chip to 1p each if the package costs £2.

(Continued next month)





IN these times of rising numbers of car thefts, some form of security is a necessity. Steering locks and the like are a deterrent against "joy riders" but will not stop the thief breaking in to steal radios, tape players, etc. Some form of alarm is required.

The system described here, has so far foiled one would-be thief, and is, in the author's opinion, virtually infallible.

SYSTEM OPERATION

On leaving the vehicle a switch is turned on. The owner then has seven seconds in which to get out and close his door (the other doors being closed first). A warning buzzer will sound until this door is closed.

The next time that a door is opened the buzzer will sound again and after ten seconds, unless the alarm is turned off, the car's horn will be sounded. Once triggered the sequence cannot be stopped by closing the car's door.

CIRCUIT DESCRIPTION

The circuit for negative earth cars is shown in Fig. 1. Since this is the system used by the majority of modern cars, this is the system which will be used to describe the circuit operation.

The alarm is enabled by throwing switch S1 which removes the short circuit across C1 and connects the 12V supply to the circuit; C1 initially has no voltage across it but current flowing through R1 causes this voltage to rise slowly. In fact the voltage across C1 rises towards 12V but Zener diode D1 prevents it from exceeding 6.2V.

If we assume for the moment that TR1 is conducting heavily and therefore its collector to emitter voltage is very low, we can see that TR2 will not begin to conduct until its base reaches a voltage sufficient to overcome the

Carsafe System

By C. J. ALLEN

HOW IT WORKS

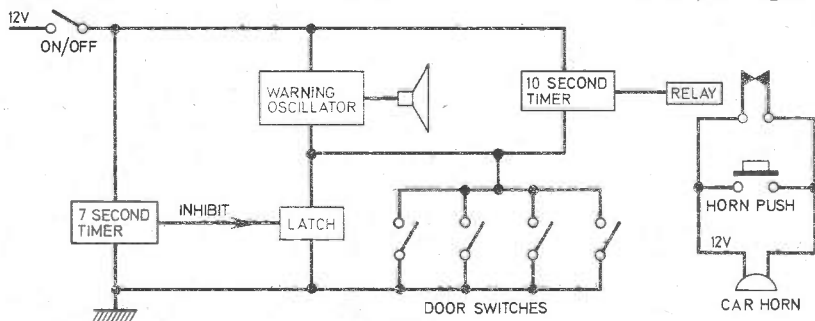

The seven-second timer prevents the latch from being set for seven seconds after the unit is switched on so allowing the driver time to get out.

When any of the doors is opened the latch will be set and remain set even if the

door is then closed. If the unit is not switched off within ten seconds the horn will be sounded.

The warning oscillator gives a warning buzz whenever the unit is on and a door is open.

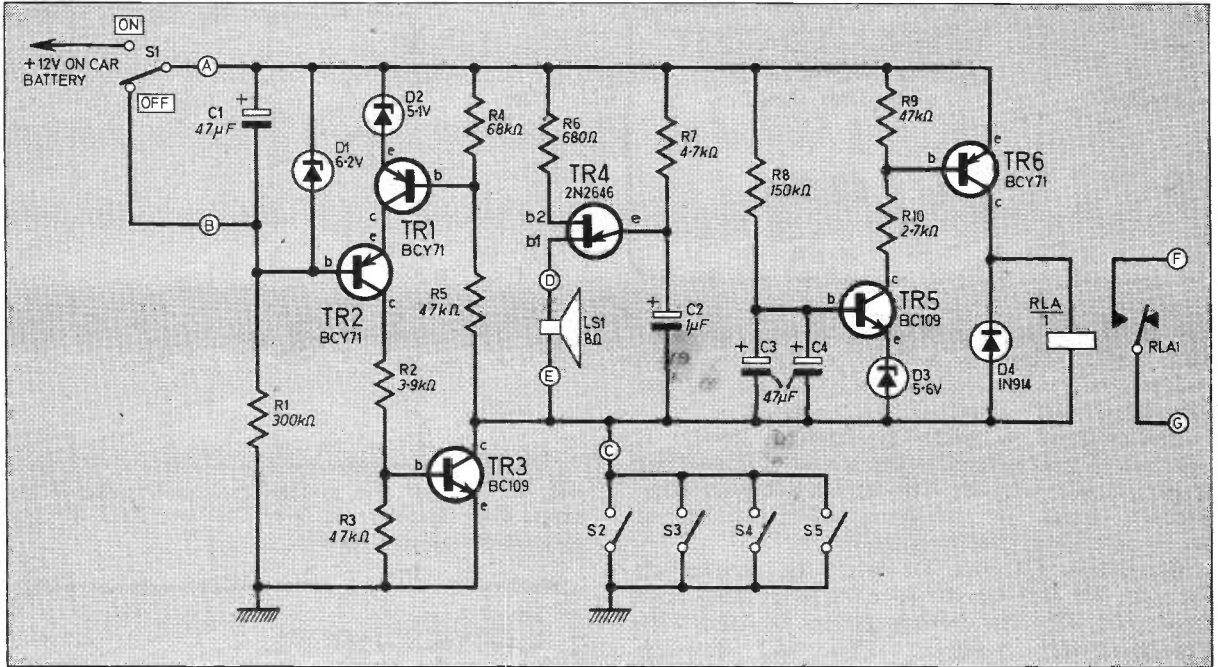

Fig. 1. Circuit diagram of the Carsafe System for cars with negative earth systems.

voltage drop across its base-to-emitter plus the voltage across D2 (5.1V). This voltage (about 6V in total) will be reached when C1 has been charging for about seven seconds.

After this period TR2 conducts heavily and its collector-to-emitter voltage drop becomes very small. To understand the function of TR2 and TR3, this part of the circuit has been re-

drawn in Fig. 3 with TR2 collector-to-emitter shown as a short circuit.

If TR3 is shorted out by one of the door pillar switches (S2 to S5) being closed, R5 will be taken to earth and the voltage drop across R4 will cause TR1 to conduct. Current will flow through R2 and R3 and this will cause current to flow into the base of TR3 so that, even if

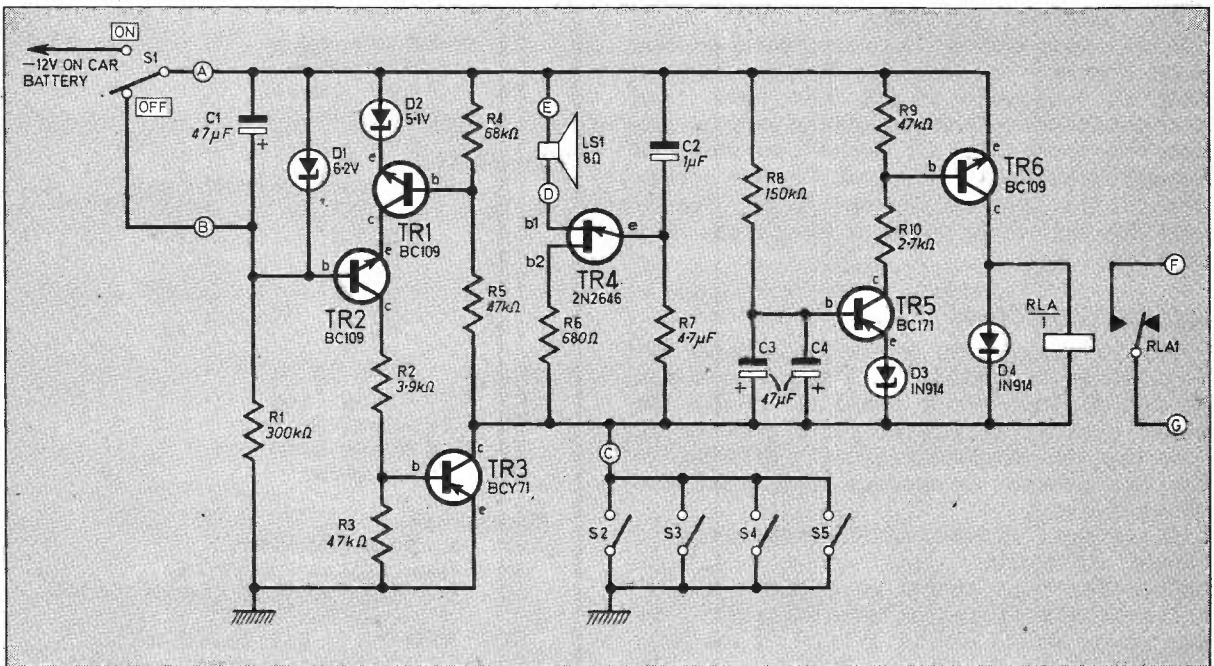
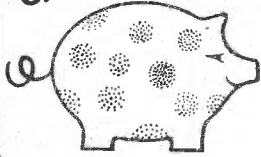

Fig. 2. Circuit diagram of the Carsafe System for cars with positive earth systems.

**FOR
GUIDANCE
ONLY**

ESTIMATED COST*
OF COMPONENTS
excluding V.A.T.



£3.90

*Based on prices prevailing at
time of going to press

the short across it is removed it will still stay conducting. Thus if a door is opened, even momentarily TR3 will "latch" into its conducting state.

Immediately a door is opened power is applied to the circuit to the right of TR3. The unijunction transistor TR4 and associated components form an oscillator which sounds a warning when a door is opened.

Capacitors C3 and C4 begin to charge up through R8 and when the voltage at TR5 base exceeds 6.2V (the voltage across D3 plus TR5 base-to-emitter voltage) TR5 will conduct causing a voltage to be developed across R9 which in turn causes TR6 to conduct and switch on the relay RLA which sounds the vehicle's horn. The time for this to happen is about ten seconds.

Obviously this process will occur when leaving a vehicle having set the alarm, but as long as all doors are closed within the seven seconds that C1 takes to charge to 6V then the circuit will revert to its primed condition and any charge on C3 and C4 will leak away. The buzzer will confirm that the alarm is set.

The preceding description has been for a negative earth system. The circuit for a positive earth system is shown in Fig. 2. It can be seen that all transistors except TR4 have been changed for their complements (i.e. *nnp* for *pnp* and vice versa) and all diodes and polarised capacitors have been inverted. Because a complement for the unijunction is not readily available the whole oscillator circuit has been inverted.

CONSTRUCTION

All the components except the speaker are mounted on a printed circuit board as shown in Fig. 4. This circuit board is suitable for either negative or positive earth systems but note that the component layout is different for the two systems. Component layouts are also shown in Fig. 4.

If the relay specified in the components list cannot be obtained, any similar relay will suffice. The relay should be a 12V type with coil resistance of greater than 100 ohms. Contact rating should be 10A at least. If the relay obtained does not fit the board it can be attached with leads to the appropriate holes.

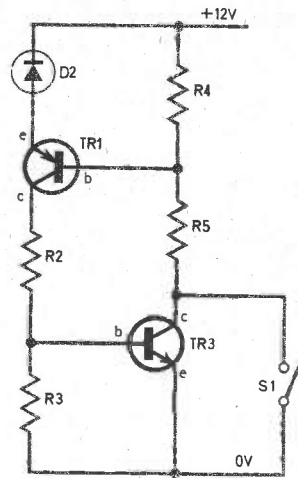

Fig. 3. Part of the circuit diagram redrawn to show the latching action of TR1 and TR3. TR2 is shown on a short circuit.

Components....

Resistors

- R1 300k Ω
- R2 3.9k Ω
- R3 47k Ω
- R4 68k Ω
- R5 47k Ω
- R6 680 Ω
- R7 4.7k Ω
- R8 150k Ω
- R9 47k Ω
- R10 2.7k Ω
- All $\pm 5\%$ $\frac{1}{4}$ W carbon

Capacitors

- C1 47 μ F 6.3V tantalum
- C2 1 μ F 35V tantalum
- C3 47 μ F 6.3V tantalum
- C4 47 μ F 6.3V tantalum

Transistors

	Negative earth	Positive earth
TR1	BCY71	BC109
TR2	BCY71	BC109
TR3	BC109	BCY71
TR4	2N2646	2N2646
TR5	BC109	BCY71
TR6	BCY71	BC109

Diodes

- D1 6.2V 400mW Zener
- D2 5.1V 400mW Zener
- D3 5.6V 400mW Zener
- D4 1N914 or similar

Miscellaneous

- S1 s.p.&t. toggle switch
- S2-S5 Door pillar switches (4 off)
- LS1 8 Ω , 76mm diameter speaker (or telephone speaker insert)
- RLA RSM R15 5A (H.L. Smith) see text.
- Printed circuit board, connecting wire etc.

**SHOP
TALK**
SEE

Carsafe System

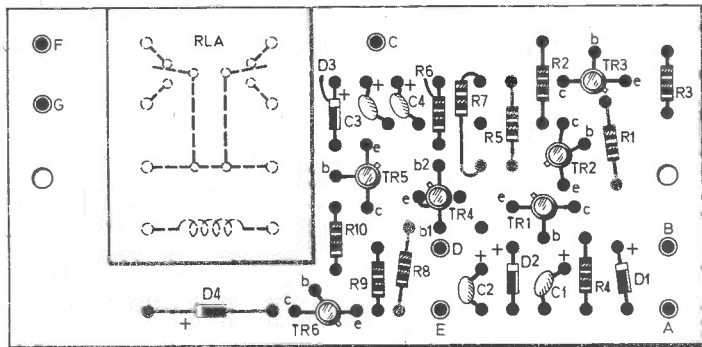

(a)

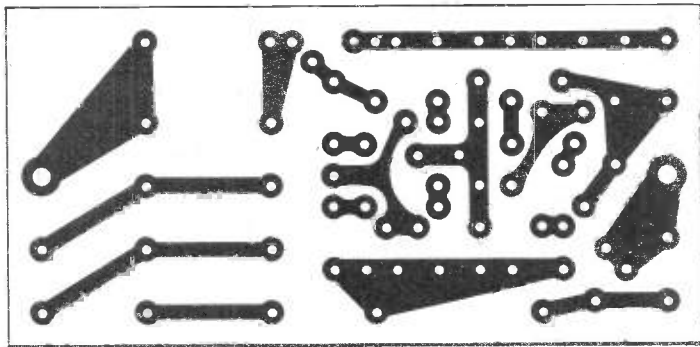

(b)

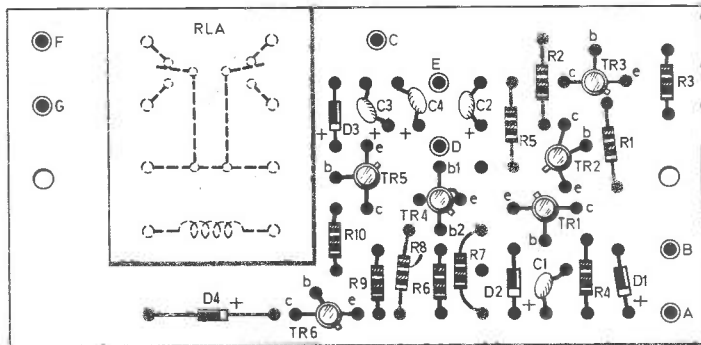

(c)

Fig. 4. Constructional details of the Carsafe System (a) shows the component layout for positive earth systems (b) shows printed circuit board layout twice full size which can be used for either system (c) shows the component layout for negative earth systems.

INSTALLATION

The board is best kept hidden behind the car's fascia. The two fixing holes should have 6BA bolts fitted through them and these should be bolted to a metal part of the car, or a lead taken from one of them to the car's earth.

The speaker can be fixed anywhere—if it cannot be secured by bolts then glue or sticky tape can be used. The switch (S1) is best mounted near the driver's door for speed of operation.

The relay contact terminals on the board (F and G) should be wired across the car's horn push switch using heavy duty (14/0076) cable. On some cars the horn push is merely an earth return in which case terminal G can be connected to a solder tag on one of the board mounting bolts and terminal F only taken to the switched side of the horn push.

Suitable holes should be drilled in all door pillars and the switches held in place with self-tapping screws. They should all be wired in parallel, one side of each being taken to earth and the other taken to point C on the board. The wires should be hidden under the car's trim, carpets, etc, in such a way that they are not broken or worn by being stood on.

It is a good idea to fit a bonnet lock as this will stop the thief disconnecting the battery before he breaks in. □

PLEASE TAKE NOTE

We wish to apologise to our readers for an editorial error which appeared on the contents page of both the March and April 1976 issues of EVERYDAY ELECTRONICS. The matter in question concerns the "Volume Number". It should be 5 and not 6 as printed.

The same error occurred at the foot of these pages under the heading *Back Numbers, Letters and Binders*. With reference to Binders, "... volumes 1 to 6" should read "... volumes 1 to 5".

The author of the article entitled *The Minstrel* (May 1975) has been in correspondence with several readers concerning the heating up of the output transistors, TR3 and TR4. This was not experienced on the prototype. If the transistors are heating up, this can be remedied by replacing D2 by a 68 ohm resistor.

Regarding the *Phone Bell Repeater* article published in the March 1976 issue of EVERYDAY ELECTRONICS there is an error in Fig. 2 on page 144. Transistor TR4 has been incorrectly labelled, "e and c" should be transposed.

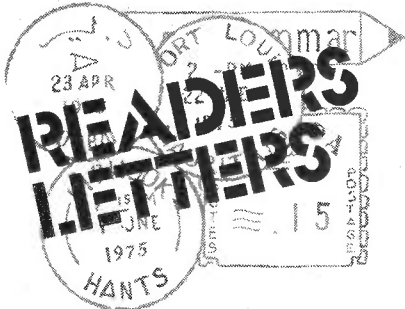

Short Volume!

Having eagerly purchased my regular copy of EVERYDAY ELECTRONICS from my local newsagent this morning, made my way home to read through my magazine whilst eating dinner, my first target was to aim for the contents page and look to see how much binders cost. I went on to read—"Binders for Vol 1 to 6 (state which)", stopping and turning to my bookshelf to see only four volumes of EE magazines, my eyes then fell upon only three copies of EE stacked waiting for their new binder to be ordered, and then panic! 12 copies of EE missing? Jumping up from dinner ripping the house apart for 12 copies of EE "Where's

volume 5?"

A short time later, having calmed down slightly but still shaking at the thought of losing 12 copies I realised there must be a mistake; there it was in Feb. EE—Vol. 5, No 2 and in March EE—Vol. 6, No. 3 (contents page). Sigh of relief!

T. D. Prior.
Kent.

V.A.T. Speak-In

Having read your article in EVERYDAY ELECTRONICS (September '75) concerning V.A.T. and subsequent misunderstandings and your request for V.A.T. funnies (your word, I find V.A.T. far from funny) I feel a moral obligation to submit this bureaucratic gem.

If one should look through the twelve page Sintel catalogue, one may come across the alarm loudspeaker (page seven). So what's that got to do with V.A.T.? Well here's what. The V.A.T. rate is, and I quote "V.A.T. for alarm loudspeaker, add 8 per cent V.A.T. if bought with displays or clock i.c. otherwise add 25 per cent V.A.T."

So according to Darling Denis the humble 80 ohm speaker is a

luxury on its own, but an everyday necessity with other electronic wonders!

I sign off in hope that V.A.T. will go away one day.

S. Lill (age 14),
Northampton.

Double-Talk

I was interested in an article by Adrian Hope with reference to a Monty Python L.P. released under the title of "Matching Tie & Handkerchief". He states that the idea came from an old recording of a horse race, with a different winner for each of several grooves on the same side, and that the idea of the horse race probably came from an Emile Berliner recording made in 1901.

To throw more light on this, that in 1965, Emile Berliner's grandson gave my brother a copy of this record, in turn, was offered to several recording companies. It was turned down as it was not a commercial prospect. The outcome was that it was offered to a leading bookmaker in South Africa, who produced it with some success.

R. Lambert
Lancashire.

next month

waa waa pedal



An easy to build inexpensive popular musical effect whose performance rivals many commercial units. Suitable for guitar and organ.

enlarger meter

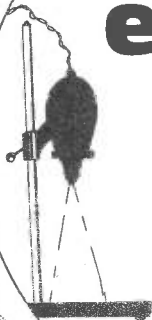

A darkroom aid to help you get your enlargements perfect every time. Very inexpensive yet enables you to get exposure times right.

continuity tester

Using just four components, this useful device gives an audible indication of a short circuit between its test leads. Can be used for checking fuses, tracing wiring, looking for dry joints, etc.

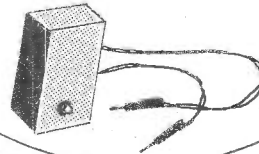

peak level indicator

This device is a fast responding overload indicator and when used together with VU meters can help to produce better tape recordings. Suitable for stereo and mono.

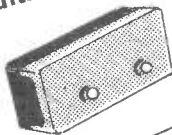

*...another grand selection
of projects!*

everyday electronics

JUNE ISSUE
ON SALE FRIDAY,
MAY 21

IMPORTANT make
sure of your copy,
place an order now

This second and final part gives details of the remaining construction and setting up procedure.

AUDIO BOARD

Both sides of the audio board are shown in Fig. 7, and it is prepared and wired as for the earlier boards. Position the transistor wires so that they cannot touch each other, or put pieces of sleeving on them. Note that C14 and C15 are polarised so must be as shown.

Once again pins provide for external leads, and the bolts MC are means of mounting the board and providing a circuit to the chassis.

CHASSIS AND PANEL

The chassis items listed are ready perforated, including holes for the coil holders. The two plates are bolted to girder shaped rails, as in Fig. 8. Though the correct plate is essential at the left (for the coils) any of the $4 \times 4\frac{1}{2}$ in plates would do for the right.

Optimal holes are present in the rails, and they are bolted to the flanged sides so that the chassis plates are $3\frac{1}{2}$ in from the top of the cabinet.

bracket, centrally between VC2 and VR1, so that the panel can be marked at the correct height for drilling. At the same time mark the panel for VR1, VC2 and output socket.

Controls VR1 and VC2 require holes of 10mm diameter, and the socket a hole about 7mm, with a 19mm hole for the drive. These larger holes can be made with a chassis punch, or with an adjustable washer or tank cutter, or by enlarging a small hole with a tapered reamer, or by filing.

It should be quite possible to use an alternative cabinet, or to assemble the receiver using a chassis and panel only. The chassis should be about $230 \times 127 \times 38$ mm deep, and the panel could be 230×153 mm.

TUNING DRIVE

The tuning drive is secured by two long 6BA bolts as in Fig. 8. It is necessary to use spacing pillars 16mm long on the bolts, or to have extra nuts to lock against the panel and drive lugs.

The drive and capacitor should be correctly in line, for smooth working, and the capacitor bracket can then be bolted to the chassis.

The cursor is attached by two short 8BA bolts to the collar, which is fixed to the drive with set screws, so that its position can be adjusted.

A calibrated dial for the four ranges is shown in Fig. 10, and this can be glued to the panel, and

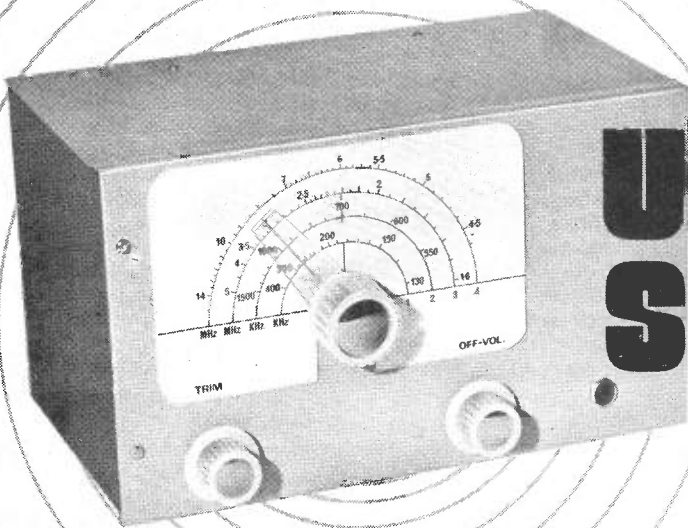

Unit built SUPERHET

By F. G. RAYER

PART 2

A bracket has to be prepared to mount VC1a/VC1b. It is about 50mm wide and 44mm high and can if wished be cut from a small "universal chassis" flanged side. Punch a 13mm or similar hole to clear the spindle, so that the capacitor will be just clear of the chassis.

Holes are then marked and drilled so that three 4BA bolts can pass through the bracket into the tapped holes in the front of the capacitor. It is essential to use short bolts, or to put washers under their heads, so that they do not project through the capacitor and bend or touch the moving or fixed plates.

Temporarily position the capacitor on its

covered with transparent material to avoid fingermarks. Set the cursor so that it is fully clockwise with the capacitor closed.

It may be noted that the maker can supply the same two-speed drive with spacers and a metal dial surrounded with transparent window, which can be mounted on the front of the panel.

L1 HOLDER

Coil L1 holder (SK2) is fitted with tags as in Fig. 9, and soldering tags at the bolts for MC connections. Connect the tags to VC1a and VC2, to MC, and to the insulated aerial socket as

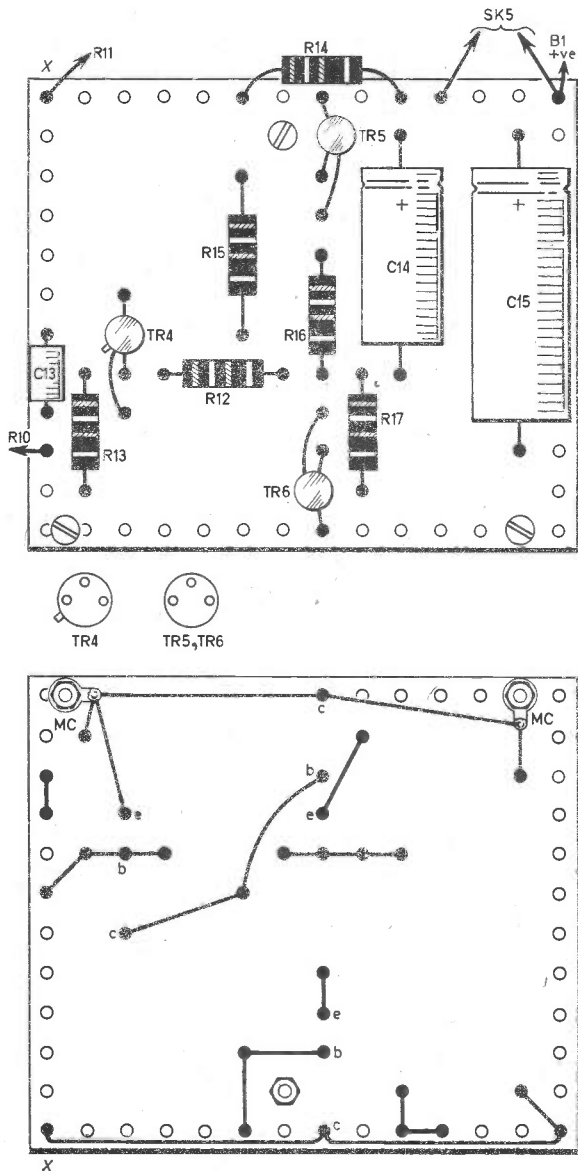

Fig. 7. Layout and wiring up details of the audio board.

shown. The lead from C1 of the mixer board (black) runs to tag 5.

L2 HOLDER

Locate L2 holder (SK4) as in Fig. 9, and connect it as shown. The four padder capacitors C3 to C6 are of different values, and go to different tags, to ensure correct oscillator tuning, as described.

All the connections to the coil holders should be reasonably short and direct.

VOLUME CONTROL

Connect the switch and one outer tag of VR1 to chassis, as in Fig. 9, fitting a soldering tag at

Everyday Electronics, May 1976

one of the nearby bolts for this. Solder R10 to the slider tag, and take a lead from R10 up to C13 on the audio amplifier, Fig. 8. Run a lead from C12 on the IF board to the remaining tag of VR1.

Take a black flexible lead from the remaining tag of S1, and pass it up through the chassis plate, soldering on a negative battery clip. Solder a positive clip to red flex, and take this to the positive pin of the a.f. amplifier. Also connect R11 on the i.f. amplifier to positive, Fig. 8, running the wire under the chassis if preferred.

Two leads run from the output pins of the audio amplifier to the jack socket SK5, Fig. 9. The latter must be of completely insulated type, isolated from the metal.

CABINET FINISHING

The back is fixed by bolts through the holes provided, and the bottom is attached with self-tapping screws. Four small plastic or rubber feet are screwed to the bottom first. Check that the front flange of the bottom member does not touch VR1 or VC2. If it does, the flange should be bent down a little.

The case top passes under the flange of the case front, so cannot be opened on a rear hinge unless it is allowed to rest on top of the flange, or is cut down to suit. In view of this, a top flat aluminium plate 225×120mm in size is preferred for the top. This closes flush when hinged at the back. The hinge is fixed with 6BA bolts and nuts, and it is necessary to cut or file away the flange on the back plate, to accommodate it.

Arranging the top to open in this way allows the battery to be replaced, and coils to be changed when wanted.

AERIAL AND EARTH

An indoor aerial can be made from some 3m to 6m or so of thin insulated wire, running along one or two walls of the room near the

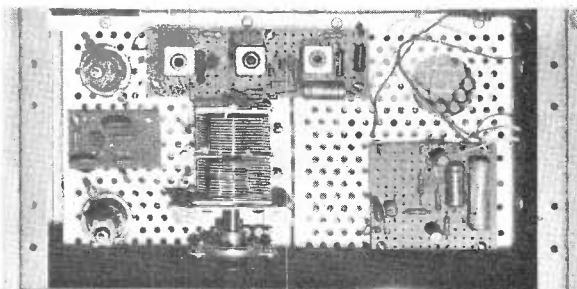

Photograph of the completed prototype showing clearly the positions of the three boards.

Unit built SUPERHET

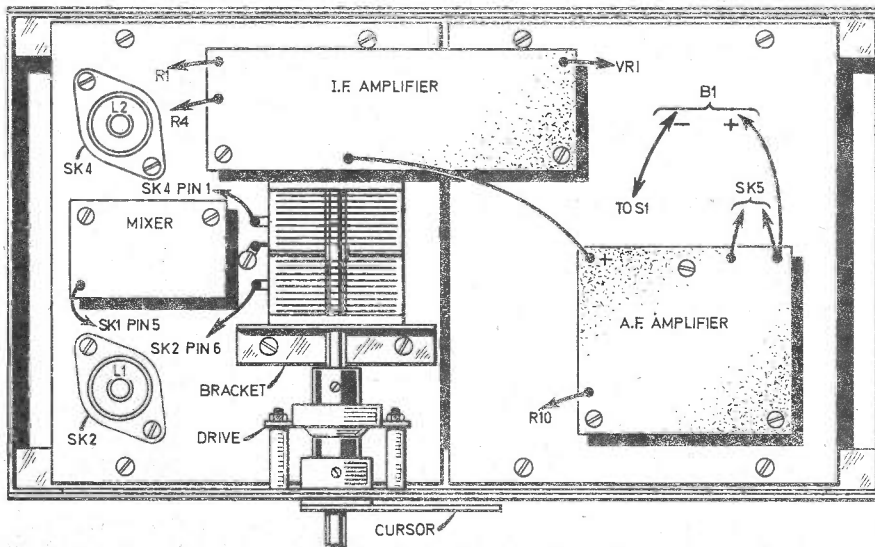

Fig. 8. Positioning of the component boards within the case on the two plates and wiring up details to the other components.

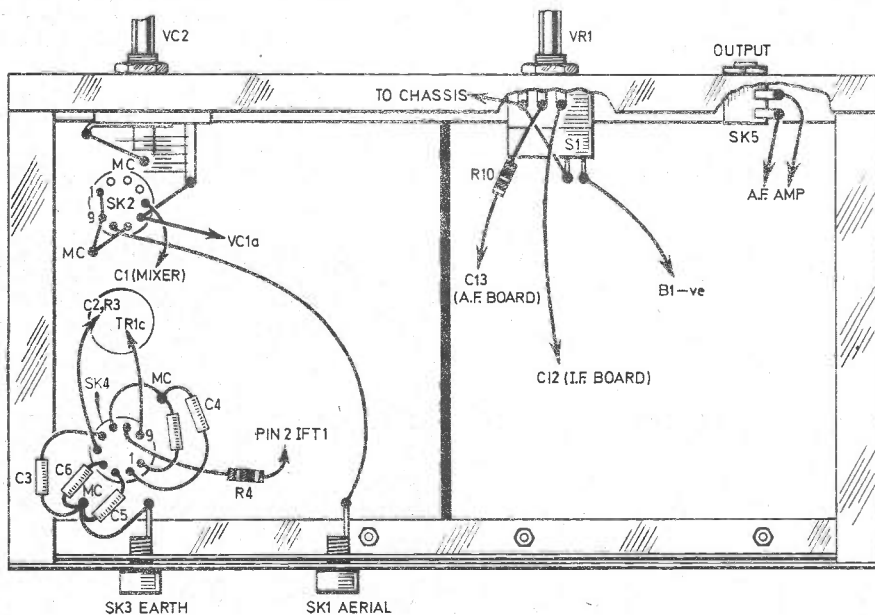

Fig. 9. The wiring on the underside of the plates shown in Fig. 8.

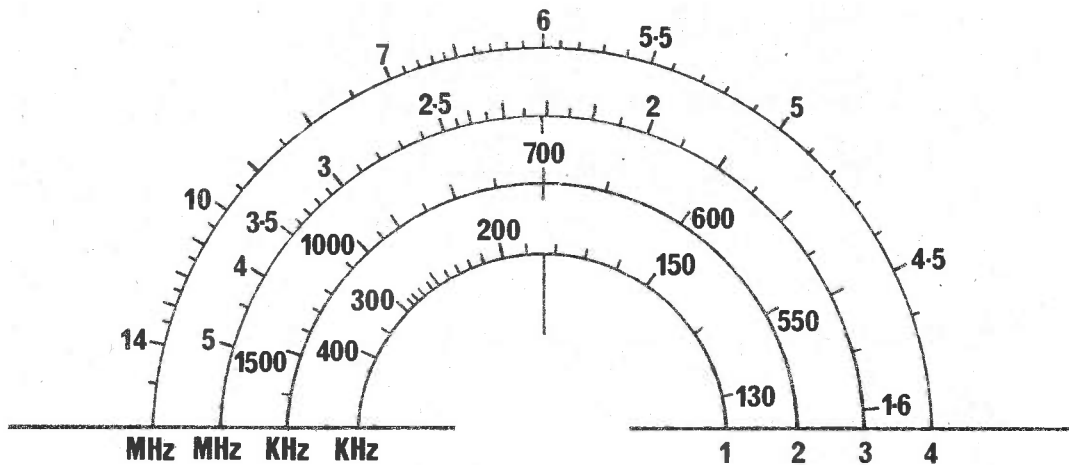

Fig. 10. Full size drawing of the tuning scale used on the prototype unit.

ceiling, and down to the receiver. This is likely to give enough volume for general l.w., and m.w. reception, and for s.w. signals on Range 4.

For Range 3, and particularly amateur signals in the 1.8 to 2.0MHz band and other low-power transmissions, a longer outdoor aerial will greatly improve results. This will usually be perhaps 12m to 30m long, as circumstances allow, and it will give greater range on all bands than a short aerial.

Where an earth connection is available, this generally increases volume. The earth lead can go to an earth spike or other metal object in contact with the ground.

IF ADJUSTMENTS

The five intermediate frequency transformer cores are set by the maker and should not be touched until it has been found that the receiver is in any case working. A weak signal is then tuned in—this can be a local BBC station with only a short piece of wire in use as aerial. Each core is then rotated a little one way or the other, to the setting which gives best volume.

A wedge-shaped blade should not be used. An insulated trimming tool such as the TT5 (available from the coil maker) is most suitable. When the five cores are set for best results, they need no further adjustment.

AERIAL AND OSCILLATOR

Dealing with each range separately, insert the pair of coils for that range. Range 2, m.w., is probably easiest. Set VC2 half closed.

Rotating the top projecting core screw of L2 (Red) coil will cause the tuning point of stations to move on the dial. Correct adjustment of L1 core. (Blue) coil is that giving best volume.

If the scale in Fig. 10 is not used, tune in a signal with VC1a/b nearly closed, and adjust

L1 core for best volume.

However, if the scale is to be used, choose a station of known frequency, and adjust the core of L2 until the dial reading is correct. Then adjust L1 core for best volume. Lock the cores with 6BA nuts. With weak signals at higher frequencies on the same band, it may be necessary to adjust the control VC3 slightly, for best volume. The core of L1 may be set to minimise the need for such adjustment.

The other pairs of coils are dealt with in the same way. To secure agreement with the printed scales it is necessary to know the frequency of some signals tuned in, so that the red coils can be adjusted. Other core settings will result in some modifications to the actual ranges tuned. However, this does not cause any loss of efficiency, provided the blue coil cores are so set that adjustment of VC2 always results in a setting giving best volume, and that VC2 is then not either fully open, or fully closed.

After dealing with the m.w. range as described, it will be found that difficulty with the other ranges is unlikely. □

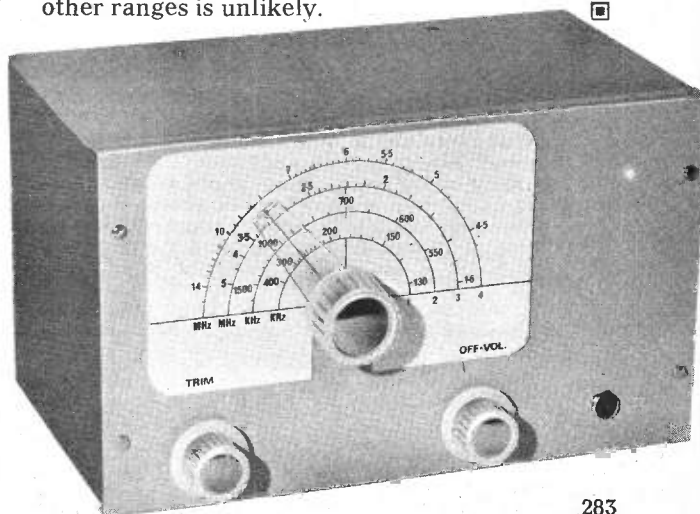

New products and component buying for constructional projects

SHOP TALK

By Mike Kenward

WE note that West Hyde Developments are now supplying an electronic warning buzzer which is said to give "a penetrating but modulated tone". The unit is available in three styles and also three nominal voltages. The example we have seen provides a continuous note—not modulated—and appears to be exactly the same as that which RS (Doram) have been selling for some time in all respects except colour.

The price for the horn type in low quantities is £1.24 including post and packing and V.A.T. but West Hyde, who are at Ryefield Crescent, Northwood, Middlesex HA6 1NN, operate a minimum order charge of £2. The comparable model from Doram costs £1.62 plus the small order surcharge of 40p (orders less than £3) making a total of £2.02 including postage, packing and V.A.T. The West Hyde model is

black for 12V and 24V, and grey for 6V; the RS type is grey. However, West Hyde can also supply an uncased module for £1.03 inclusive, but remember that minimum order charge!

It seems strange that we finish up with roughly the same price for one off from both firms but it is interesting to note the reasons behind the price.

Also this month we have received news of two amplifier kits from a new firm called Chékits, 56, Fortis Green Road, London, N10 3HN. The kits are amplifier modules constructed on glass fibre p.c. board and built around a single i.c. (TBA 801AS for the 7 watt version and TCA940 for the 10 watt version, these outputs being the maximum available).

Basic figures for both types are 0.3 percent distortion at 1kHz over a specified power range into 4 ohm speakers. Both types have thermal limiting and the 10W version is short circuit protected. Prices are £3.99 and £3.19 plus V.A.T. We are told that a suitable preamplifier will soon be available. The kits will be available from a number of stockists, full details of the kits and suppliers can be obtained direct from Chékits.

We have been asked by Bi-Pre-Pak to bring to your attention a V.A.T. mistake in our April issue. The V.A.T. to be added to the "Capacity Discharge Ignition Unit" should be only 8 percent not 25 percent.

Carsafe System

The *Carsafe System* has been built on a printed circuit board so that it is neat and reliable in use. There are a fair number of components used for this project but none of them should cause any real problems. We suggest that you purchase all the components re-

lating to this project before making the board as a different relay or larger components may require slight modification to the board size and layout.

The door pillar switches should be available from most car spare suppliers.

Lightning Chess Buzzer

None of the components used in the *Lightning Chess Buzzer* are specialised and therefore all should be readily available. The author does give alternative transistor types but those quoted are common.

Magnetone

The most expensive items for the *Magnetone* are the reed switches—the problem being that 13 are required. It is possible to find these being sold in ten's at very low prices from time to time so watch the adverts and local suppliers.

The case used for the prototype was formed from two shallow plastic trays, similar ones should be available from various stores, or other designs in wood or aluminium could be employed. No components for this project cause any problems.

Superhet

It has been pointed out that in Shop Talk last month we may have given the impression that the Denco coils used in the *Unit Built Superhet* were only available from Denco. This is, of course, not the case and many retailers throughout the country stock Denco products. However, if you encounter buying problems you can obtain parts direct from Denco.

Create your own EVERYDAY ELECTRONICS Library Bind your magazines in the EASIBINDER

Attractively bound in orange Balacron with the title blocked in black on the spine, the Easibinder is designed to hold 12 copies of EVERYDAY ELECTRONICS.

In addition to the title, the current (or last) Volume No. and date is blocked on the spine, but for any of the previous volumes a set of transfer figures is supplied.

When ordering please indicate which Volume is required.

Price £2.10 including postage and V.A.T.

Send your order with remittance to:

To Post Sales Dept., I.P.C. Magazines Ltd., Carlton House, 66-68 Great Queen Street, London WC2.
I enclose p.o./cheque value..... for binders at £2.10 each for EVERYDAY ELECTRONICS.
Vol. Nos
Name
Address
Date

The Extraordinary Experiments of Professor Ernest Eversure

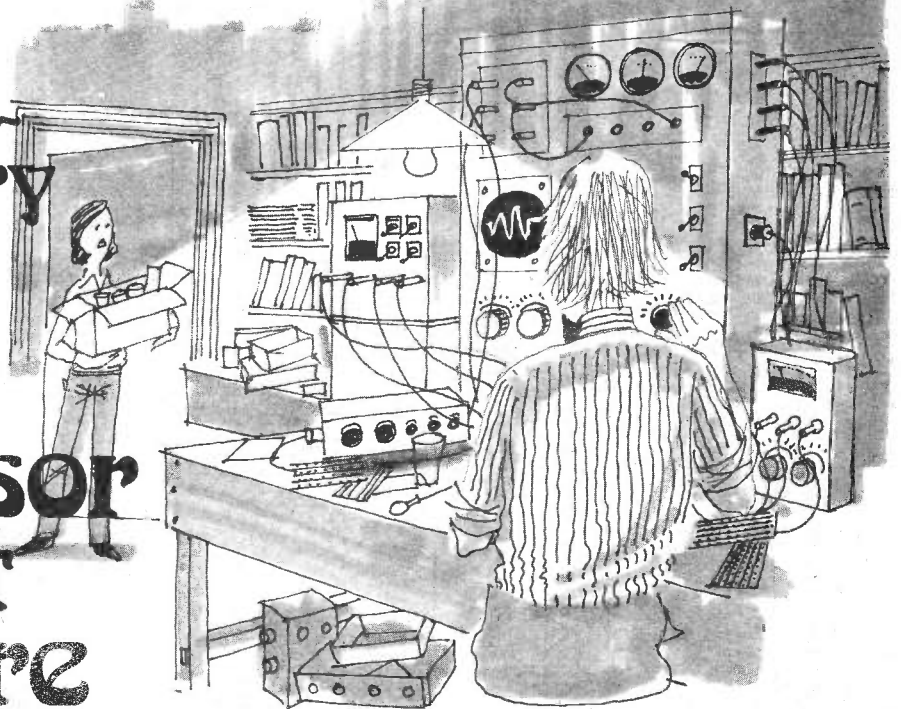

by Anthony John Bassett

A FEW minutes after Bob's arrival at the laboratory, where Bob was using one of the Prof's electronic calculators to double check the results of his homework, the Prof. glanced towards the workbench where Bob should have been working with the calculations. To his surprise he could see that Bob appeared to be in a trance, and the Prof. decided to investigate.

Bob's eyes were open and he seemed to be staring at the numbers on the Prof's calculator but as Bob was neither asleep, nor awake in the conventional sense, the Prof. surmised that he might be experiencing an alternative state of consciousness brought about by the fascinating display of numbers on the calculator.

Bob had given the calculator a task which was beyond its capabilities, and the calculator was now busily engaged in processing and displaying column after column of figures in a mechanical attempt to reach infinity. As Bob's eyes followed the figures on this flashing display he seemed to have become totally oblivious of his surroundings and as if asleep.

The Prof. leaned over and switched off the calculator. As he did so Bob's eyes fell shut. "Best to let him come to naturally," the Prof. thought

leaving Bob to snooze on with the robot standing guard. When Bob was about to wake up the robot's life field monitor would detect changes in Bob's life field and let the Prof. know.

A short while later the robot's signal brought the Prof. along just as Bob opened his eyes with a yawn and a look of amazement. "How did I get here, Prof.?" he asked, "I thought I was in your lounge; but that must have been part of the dream. I've had a fantastic dream," he informed the Prof. in some confusion.

Then Bob told the Prof. about the dream, about Sir Rockwell Orbitor, the International Electronic Games Symposium, King Moggi and the psycho computers and the amazing Mogadorian electronic wish fulfilment game of I-Chingo.

The Prof. listened very attentively to this strange tale Bob had to tell "How remarkable!" he commented from time to time. "How fascinating. I happen to know Rockwell Orbitor quite well and he isn't a Sir yet but he may well be under consideration for the honours list. As for the International Electronic Games Symposium, I think that, too, is planned to happen some years hence! Bob, I do believe that your dream may be a view into the future! With hypnosis people

appear to be able to remember events from past dates even years before their own birth, and the flashing numbers on the overloaded calculator may have induced an alternative state of consciousness enabling you to experience the future before it happens. We'll have to wait to find out the significance of your dream.

My own view of the future is that science and an ever-increasing understanding of its fascinating complexities will play an increasing role in our lives and that electronics will be there to an increasing extent to help us control the powerful practical technologies which science will uncover. "Yes," said Bob, pensively thinking still of the I-Chingo wish fulfilment game of his futuristic vision, "electronics will be there!"

EXPERIMENTS

"To prepare for the future we must have a balance between theory and practice," hinted the Prof. gently. "Oh! Great!" remarked Bob, happily taking the hint. "This means we can continue with a few more practical experiments with the breakdown voltage tester! Those experiments with neon bulbs were really interesting but now I'd like to con-

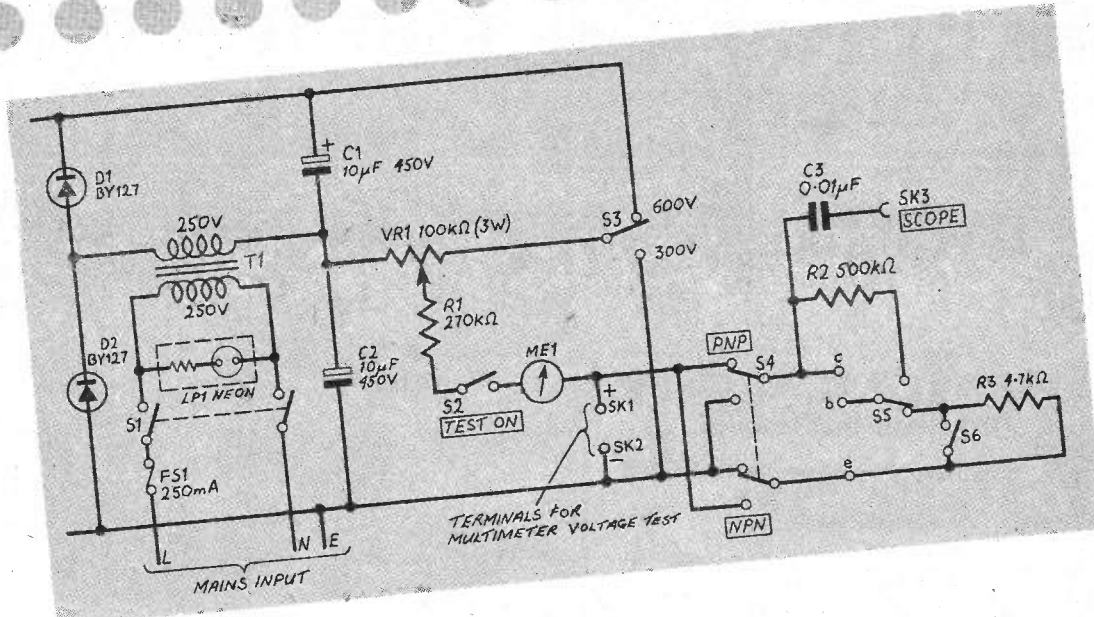

This section of a page torn from the Prof's old notebook shows the Breakdown Voltage Tester first described back in December 1975.

tinue with the experiments we were intending to do with light emitting diodes and other diodes."

Bob and the Prof. made their way over to the other laboratory workbench where the breakdown voltage tester had been set up in readiness for experiments on l.e.d.'s and Zener diodes. Bob had earlier connected the oscilloscope terminal of the tester to a crystal earpiece, so that he could hear random noise generated by components under test. Now, however this terminal was connected, by way of a 470 kilohm resistor, to the input of an audio amplifier and loudspeaker and to an oscilloscope so that the results could be seen and heard by more than one person at a time.

"One very obvious difference between these diodes, and the symmetrical wire ended neons which we used is that the diodes have two different terminals, an anode and a cathode," remarked the Prof.

"But Prof. don't some neon tubes also have an anode and a cathode?" queried Bob.

"Yes," replied the Prof. "This is so, and for various reasons. Some have a cathode which is

bigger than the anode and specially shaped to give out more light or to display a pattern or numeral, others have electrodes constructed of different metals, which may result in a different breakdown voltage according to the direction of the applied voltage and this results in a 'gas diode' with rectifying properties! But they are very large, delicate, cumbersome and inefficient."

The Prof. picked up a red l.e.d. type LED4 and examined it for a moment. "This is the cathode and here is the anode," he said pointing out the different electrodes to Bob (see Fig. 1). The Prof. handed the l.e.d. to Bob who then inserted it into the transistor socket of the breakdown voltage tester with the anode in the "e" socket and the cathode in the "c" socket, the "b" socket not being used. The tester was switched to the *pnp* test position, which would cause the voltage to bias the diode in a forward direction.

VOLTAGE DROP

As Bob very slowly increased the test voltage by carefully

rotating VR1 a slight hum could be heard from the speaker and a shallow trace could be seen on the oscilloscope. At a particular voltage (about 1.9 volts) the hum disappeared, the trace flattened to a horizontal line and the l.e.d. began to glow faintly with a red light. As Bob continued to rotate VR1 the voltage did not change very much but the glow became brighter as the multimeter indicated a greater flow of current.

"By this test you can easily see," pointed out the Prof., "how at a certain forward voltage the l.e.d. begins to conduct and glow

Fig. 1 Basic construction of an l.e.d. together with its circuit symbol.

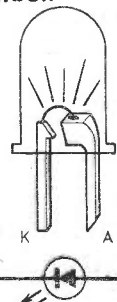

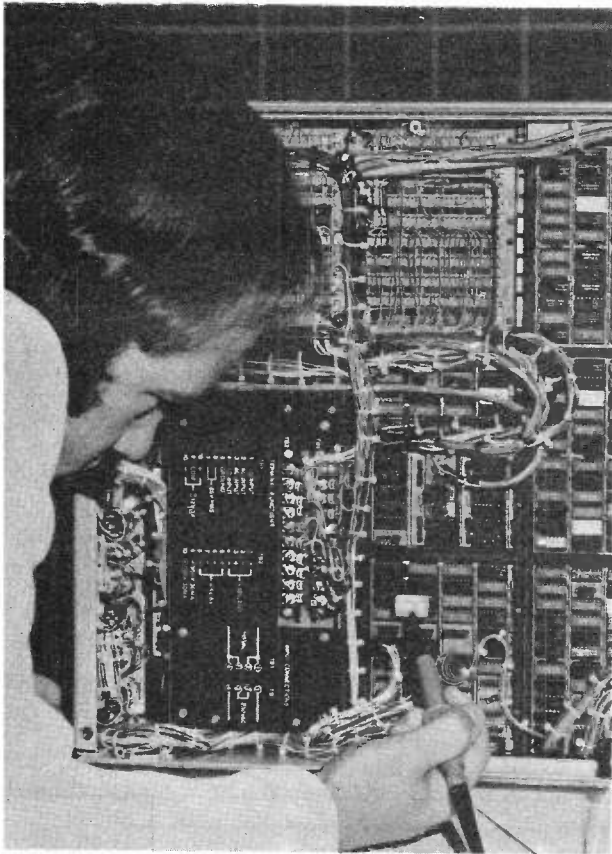

This hobby brings big rewards.

A soldering iron and a screwdriver. If you know how to use them, or at least know one end from the other, you know enough to enrol in our unique home electronics course.

This new style course will enable anyone to have a real understanding of electronics by a modern, practical and visual method. No previous knowledge is required, no maths, and an absolute minimum of theory.

You build, see and learn as, step by step, we take you through all the fundamentals of electronics and show you how easily the subject can be mastered and add a new dimension not only to your hobby but also to your earning capacity.

All the training can be carried out in the comfort of your own home and at your own pace. A tutor is available to whom you can write, at any time, for advice or help during your work. A Certificate is given at the end of every course.

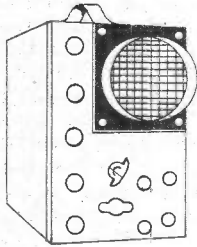

1 Build an oscilloscope.

As the first stage of your training, you actually build your own Cathode ray oscilloscope! This is no toy, but a test instrument that you will need not only for the course's practical experiments, but also later if you decide to develop your knowledge and enter the profession. It remains your property and represents a very large saving over buying a similar piece of essential equipment.

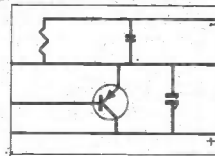

2 Read, draw and understand circuit diagrams.

In a short time you will be able to read and draw circuit diagrams, understand the very fundamentals of television, radio, computers and countless other electronic devices and their servicing procedures.

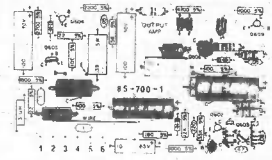

3 Carry out over 40 experiments on basic circuits.

We show you how to conduct experiments on a wide variety of different circuits and turn the information gained into a working knowledge of testing, servicing and maintaining all types of electronic equipment, radio, t.v. etc.

To find out more about how to learn electronics in a new, exciting and absorbing way, just clip the coupon for a free colour brochure and full details of enrolment.

PLUS FREE GIFT!

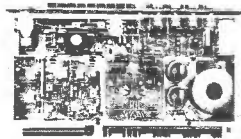

ALL STUDENTS ENROLLING IN OUR COURSES RECEIVE A FREE CIRCUIT BOARD ORIGINATING FROM A COMPUTER AND CONTAINING MANY DIFFERENT COMPONENTS THAT CAN BE USED IN EXPERIMENTS AND PROVIDE AN EXCELLENT EXAMPLE OF CURRENT ELECTRONIC PRACTICE

Brochure without obligation to:

**BRITISH NATIONAL RADIO EEL 56
& ELECTRONICS SCHOOL, Dept
P.O. Box 156, Jersey, Channel Islands.**

NAME _____

ADDRESS _____

(Block caps please)

SINCLAIR IC20

IC20 10W+10W stereo IC amplifier kit with free booklet and printed circuit £8.95.
 PS20 Power supply kit for the above £4.95.
 VP20 Volume, tone-control and preamp kit £7.95.
 SP20 10W 4 ohm speaker for IC20 £2.95.
 Send sae for free leaflet.

JC12 AMPLIFIER

6W IC audio amp with free data and printed circuit £1.95*

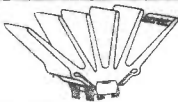

DELUXE KIT FOR JC12

Includes extra parts for the pcb and vol, bass and treble controls for mono version £2.29. Stereo model with balance control £4.95.

JC12 POWER KIT

Supplies 25V 1 Amp £2.95.

JC12 PREAMP KITS

Type 1 for magnetic pickups, mics and tuners. Mono £1.55. Stereo £3.10. Type 2 for ceramic or crystal pickups. Mono 85p. Stereo £1.70.

LOUDSPEAKERS FOR JC12

8in x 5in 8 ohms 5W £2.50.

SEND SAE FOR FREE LEAFLET ON KITS.

SINCLAIR PROJECT 80

FM tuner £13.25. PZ5 £3.95. Q16 £10.95. PZ6 £8.70. PZ8 £9.10. Trans for PZ8 £5.40. Z40 £5.75. Stereo 80 £11.95. Project 805Q £18.95. Quad decoder £14.95. Z60 discontinued but we stock 30W equivalent amp £10.30

PRINTED CIRCUIT KIT £3.95*

Make your own printed circuits. Contains etching dish, 200 sq ins of copper clad board, 1lb ferric chloride, etch resist pen, small drill bit, laminate cutter and instructions.

MAINS TRANSFORMERS

6-0-6V 100mA 95p. 9-0-9V 100mA 95p. 18V 1A £1.65*. 0, 12, 15, 20, 24, 30V 1A £2.95*. 12-0-12V 1A £1.95* 0, 12, 15, 20, 24, 30V 2A £4.20*. 20V 2½A £2.20 6 and 9V trans are DC rated, others are AC volts.

SINCLAIR BLACK WATCH

Fully assembled with black leather strap £20.95*. Bracelet £2*.



SINCLAIR CALCULATORS*

Cambridge £7.95. Cambridge Memory £11.20. Scientific £11.95. Oxford 100 £8.95. Cam. Sci. £14.95. Oxford 300 £16.95. Programmable scientific £25.95. Mains adaptor for programmable and Oxfords £3.19. Mains adaptor for Cambridge and Scientific £3.15.

CBM CALCULATORS*

796MD £6.45. 897D £7.69. SR1800 £23.25. 776MD 7 digit/mem/£5.95. SR7919D 8 digit/mem/trig/log/pi/powers/scientific notation £13.20. SR148R with mains unit £34.95. Mains unit for other machines £2.95.

CASIO CALCULATORS*

Personal mini 6+6 digits £5.95. Pocket 8S 8 digits/%/const £3.25. Memory 8R 8 digits/%/memory/const £3.25. FX20 £19.95. Mains adaptor for all models £3.95.

24 HR DIGITAL CLOCK KIT*

Includes pcb, mains power supply, attractive case 0-5in jumbo green display, clock chip, and all other parts. Displays hours and minutes separated by a pulsating colon. Kit £12.50. Built £13.50. Send sae for free leaflet.

S-DECS AND T-DECS*

Special Offer: 25p or 50p off orders accompanied by 25p or 50p PB Electronics adverts.

S-DeC £2.24

T-DeC £4.95

u-DeC A £4.45

u-DeC B £7.85

IC carriers:-

16 dil: plain £1.07

with socket £2.21

10TOS: plain 99p.

With socket £1.95.

SST1 60p. SSU1 60p. SSN1 80p.

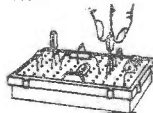

BATTERY ELIMINATOR BARGAINS

55 WAY SUPER

New switched model. 3 to 30V in ½V steps. Fully stabilized. 1A output. Kit £7.95. Assembled £10.95. 2 Amp model. Kit £9.95. Built £12.95.

6 WAY SPECIAL

Switched output of 3/4/6/7½/9/12V at 500mA with 4-way multi-jack plug and free matching socket £5.80.



6-WAY DOUBLE RADIO MODEL £6.80

Similar to above, but with press-stud battery connectors. 3+3/4+4½/6+6/7½+7½/9+9/12+12V at 250mA. Also gives 15/18/24V single.

3-WAY MODEL

Switched output of 6/7½/9V at 250mA with 4-way multi-jack plug and free matching socket £2.95*.

RADIO MODELS

50mA with press-stud battery connectors for radios etc. 6V £2.95. 9V £2.95. 4½+4½V £4.45 6+6V £4.45. 9+9V £4.45.

CASSETTE MAINS UNITS

7½V output to run cassette recorders from the mains. Complete with 5 pin DIN plug £3.45.

CAR CONVERTERS

Input 12V DC. Output 6/7½/9V DC 1A regulated £3.95*.

BATTERY ELIMINATOR KITS

Send sae for free leaflet on kits.

100mA radio type with press stud battery terminals. 4½V £1.95. 6V £1.95. 9V £1.95.

50mA double radio type with press stud terminals. 4½V+4½V £2.75. 6V+6V £2.75. 9V+9V £2.75.

100mA cassette type with 5 pin DIN plug. 7½V £1.95.

Stabilized 8 way type with voltage stabilizer to give low hum. 3/4/6/7½/9/12/15/18V 50mA £2.95.

Heavy duty 12 way types 4½/6/7½/9/11/13/14/17/21/28/34/42V. 1 Amp £3.95. 2 Amp £5.95.

SWANLEY ELECTRONICS

Dept. EE, PO BOX 68,
 SWANLEY, KENT.

Post 30p on orders under £2, otherwise free. Prices include VAT. (Overseas customers deduct 7% on items marked*, otherwise 20%). Official orders from schools, government labs. etc. welcome.

SPRING MADNESS BARGAIN SALE

F.M. Tuners. 8-transistor chassis with Stereo-decoder and L.E.D. indicator
 Aircraft-band receiver. Just place near any radio
 Echo-chamber. (Endless tape). Variable delay
 Field-strength indicators. 1-250 MHz
 Stereo Amplifiers complete. 3-watt. 8-ohm
 10-watt Amplifiers. 12 volt D.C. 3/8/15-ohm.
 Cartridges. Acos GP 104. Ceramic/Diamond
 Cartridges. Acos GP 101. Crystal/Sapphire/Compatible
 Speakers. 2½"-8-ohm
 Speakers. Car Stereo. 8-ohm. 5-watt. in cabinets
 Dynamic Tape Mikes with remote-control facility
 Crystal Tape Recorder Mikes
 Crystal Mike inserts with bracket
 Indicators. 12-volt L.E.D. in Chrome Bezel
 "Bargain Bags" 4lbs Caps/Resistors/Transistors/Diodes
 Components. Volume/Pre-set (Rotary & Slider) Assorted 100
 Transistors. 20 NPN/PNP. All new and marked
 Transistors. 100 NPN untested.
 Diodes. 100 Germanium untested
 Diodes. 100 Silicon untested
 Diodes. 100 Zener untested
 "Pack 1" 100 resistors, 100 ceramics, 100 diodes
 "Pack 2" 100 resistors, 100 ceramics, 100 polystyrene
 "Pack 3" 100 resistors, 100 S/Mica/Ceramic. 100 Polyester

NORMAL PRICE

£16.60 £10.90
 £5.97 £3.90
 £52.00 £34.50
 £5.00 £3.30
 £4.00 £2.75
 £5.90 £3.90
 £2.32 £1.50
 £1.00 £0.50
 £0.50 £0.35
 £2.90 £2.50
 £1.80 £0.90
 £1.30 £0.60
 £0.30 £0.20
 £0.48 £0.35
 £5.00 £4.00
 £2.50
 £1.00
 £1.00
 £0.50
 £0.50
 £0.50
 £1.00
 £1.00
 £1.00

ALL ABOVE ITEMS PLUS 25% VAT

Fluorescent 12-volt Camping Lights. 21" 13-watt £8.00 £4.90
 12" 8-watt £7.00 £3.90
 "Disco type 3-Channel flashing light units. Built-in mike. No connection needed to amp £19.95 £17.50
 Multimeters. AC 0-1000V. DC 0-1000V. 0-100 ma. 0-150kohm £3.80 £3.50
 Multimeters. AC 0-500V. (10 ranges) DC 0-500V. (12 ranges) DC Current 0-25ua to 0-10 amps (10 ranges) Resistance 0-100ohms to 0-16Mohms. (4 ranges) £15.95 £11.30
 Panel Meters. 0-50ua. 2½" x 1½" £3.30 £2.50
 Soldering Irons. 15-watt. Pencil Bit. £1.58 £1.20
 Servisol Switch Cleaner (with Snorkel) £0.62 £0.50
 Copper-clad Fibre Glass Board. Single-sided. Square foot £1.25 £1.00
 Double-sided £1.25 £1.00
 "Fotolok" Light sensitive spray for printed circuit making Developer for same £1.30 £0.30
 Ferric Chloride for etching £0.40

ALL ABOVE ITEMS PLUS 8% VAT

G. F. MILWARD, 369 Alum Rock Road,
 Tel. 021-327 2339 Birmingham B8 3DR.

POSTAGE: Below £10 50p
 Above £10 Free

VALVE BARGAINS

Any 5 64p, 10 £1-10, 50 £5. Your choice from the following list:
 ECH84, ECC82, EF80, EF183, EF184, PC86, PC88, PCF80, PCF802, PCL82, PCL84, PCL85, PCL80S, PFL200, PL36, PL504, PY81, PY800, PY88, EH90, 30PL14, 6F28.

Colour Valves 30p each PL508. PL 509, PY500/A.

Small Plastic Boxes (white) made out of high impact plastic with flick on lids. Ideal for most projects. All three types one price. Prices 15p each. Ten £1.30. Size (approx.): Type 1—3½ins x 2½ins x 1in deep. Type 2—3½ins x 2½ins x 2ins deep. Type 3—3½ins x 3½ins x 1½ins deep.

Prices include V.A.T. P. & P. under £1/15p, £1 to £3/20p above £3/30p. Overseas at cost. Money back guarantee on all orders.

ELECTRONIC MAIL ORDER

62 BRIDGE ST., RAMSBOTTOM, BURY, LANCS. Tel. Rams. 3036

AERIAL BOOSTERS

We make three types of Aerial Boosters all for set top fitting, with Co-ax Plugs and Sockets.

B11—For Stereo and Standard VHF Radio.

B12—For the older VHF Television, please state BBC1 and ITV Channels.

B45—For mon. or colour this covers the complete UHF band.

All Boosters are complete with Battery and take only minutes to fit. Price £3.90 each.

LOUDSPEAKER KITS—8 OHMS

2 way, 8" Bass, 2½" Tweeter, 15 watts £12.25
 3 way, 8" Bass, 2½" Midrange, 2" Tweeter, 20 watts £17.25

STEREO HEADPHONES—8 OHMS

with Stereo/Mono switch £10.35
 without switch £8.25

TELEPHONE AMPLIFIER:—

STEREO 4 CHANNEL MIXER:— £10.95

STEREO 4 CHANNEL MIXER:—

2 L.H. Channel 2 R.H. Channel £12.25

REGULATED POWER SUPPLY:—

O/P 6, 7.5, 9, 12, Volts D.C. Max. 1 Amp £18.25

PRINTED CIRCUIT KIT:—

Contains everything to produce printed circuits £2.65

RESISTORS:—

¼, ½, watt 5% 1p each., 10/9p; 100/80p. BC107/8/9—9p; 555 timer—57p; 741—25p.

C.W.O. VAT included. 20p P & P. Send stamp for lists or enquiries.

CLEVELAND SUPPLIES (EE)
 P.O. BOX 20, REDCAR, CLEVELAND.

and once the diode is conducting the voltage across it does not seem to vary much, although the brightness varies according to the current passed. So this type of diode may be used not only to give light, but also as a voltage regulator in the same way as a Zener diode. In some projects an l.e.d. can be used simultaneously for both purposes. Whilst the glow acts as an on/off indicator lamp, the l.e.d. is being used as a voltage regulator or limiter in the circuit. Here try a few more." The Prof. handed Bob an assortment of l.e.d.'s of various shapes, sizes and colours.

Bob repeated the tests and soon found that when forward biased all the l.e.d.'s gave similar results with conduction beginning at voltages in the region of 1.5V to 2V. With slight differences between diodes of different types or colours.

"These l.e.d.'s all seem to act like low voltage Zener diodes, Prof. But I know that Zener diodes are normally operated with reverse bias. I wonder what will happen if I apply reverse bias to an l.e.d.? Can I try it, Prof.?"

"Yes, Bob. Although the manufacturers state that l.e.d.s are easily damaged by current passed in the reverse direction the small test current from the breakdown voltage tester should not do any harm."

Bob rotated VR1 to bring the test voltage to zero. Then he reversed the polarity using the pnp/npn switch S4, and with the red LED4 in position as before, began to slowly rotate VR1 so that an increase in voltage was produced. A hum came from the loudspeaker and a triangular waveform appeared on the oscilloscope as before but as Bob turned up the voltage the amplitude increased so that it was quite a lot higher than for the forward bias test.

RANDOM NOISE

Suddenly at about 16½ volts reverse bias, the hum from the loudspeaker was replaced by a very loud hiss, and a broad pattern of random noise display was shown by the oscilloscope. "That's interesting remarked the Prof., examining the oscilloscope trace, and comparing it against the graticule calibrations. The random noise output from that l.e.d.

has a peak-to-peak amplitude greater than 1.5 volts.

"This is a very high output voltage. The current consumption is very low, let's see, it's less than 5µA! Try a higher current, Bob." As Bob rotated VR1 this gave both a higher current and a slightly higher voltage, but the noise almost disappeared. The trace on the oscilloscope became almost flat, but was slightly disturbed by what little noise remained. "This is because at higher currents the impedance of the diode becomes lower and shunts the signal away," explained the Prof.

Bob tried several other l.e.d.s and found that the reverse breakdown voltage varied considerably, with type LED3 giving breakdown together with plenty of noise at a voltage in the region of 30V to over 40V, and with interesting variations in the noise produced at various currents of up to 1mA. The most interesting, however, was the green type as this produced a good noise output when reverse biased at only 13½ volts.

"Zener diodes are often used for the purpose of random noise generation but these l.e.d.'s seem to generate much more noise with lower power-consumption," observed the Prof. drawing out a circuit diagram on his notepad, "and the effects of variation of current on the noise produced are very interesting and could be useful for sound effects. This type of circuit he said, indicating his sketch to Bob (Fig. 2) could take advantage of this property to produce a handy portable random noise generator."

"That looks interesting, I'd like to build one and try it out," said Bob viewing the circuit with interest. "It could easily be built in a small metal box fitted with an audio output socket and would provide a handy noise generator which is independent of mains-power."

MYSTERY BOXES

"Go ahead," suggested the Prof. "I think this would be a useful little item of equipment. You could use this to build it in." The Prof. handed Bob a small metal box, just big enough to contain two PP3 batteries, the potentiometer on/off switch and other components. Bob had just collected together the necessary

components and made holes in the box ready to begin construction when, under instructions given to it by the Prof. in a mysterious code of clicks and whistles, the experimental robot arrived.

The robot was carrying a number of large metal boxes which looked to Bob rather like large biscuit tins. As Bob worked on the noise generator, he observed the activities of the Prof. and the robot with these mysterious boxes. There was a small hole in one side of each box, and through a rubber grommet, protruded two wires a few inches long, one red, one black.

Removing the green l.e.d. from the tester, the Prof. handed it to Bob for use in his random noise generator. Then he connected the wires from one of the metal boxes to the tester and began to increase the voltage with careful steady adjustments of VR1. However, the voltage indicated on the meter did not rise steadily. It seemed to rise and fall in jerks. The Prof. let the robot take over and went off to the other side of the laboratory.

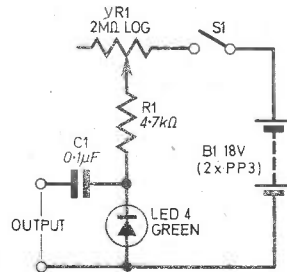

Fig. 2. The random noise generator designed by the Prof.

Puzzled, Bob watched as the robot connected the mysterious boxes to the breakdown voltage tester one at a time in succession. Bob noticed that the robot connected each box several times, and seemed to be testing them repeatedly. What could be in the mysterious boxes? He wondered. He could not ask the robot, and he did not want to interfere by opening one of the boxes.

With his attention torn between the random noise generator which he was constructing and the puzzling activities of the robot, Bob waited for the Prof. to return in order that he might ask about the mysterious boxes.

Continued next month.

DOWN TO EARTH

By GEORGE HYLTON

GAIN, POWER AND LOAD IMPEDANCE

A YOUNG friend who built a simple radio receiver complained that he couldn't get much volume from the loudspeaker. Should he add an audio amplifier, he asked, producing a circuit for one.

An easy question, you might think. For greater audio volume, add more audio gain. However, I knew all about this particular receiver, and I had grave doubts about the usefulness of the amplifier he wished to add.

The receiver used a "direct drive" amplifier, with the speaker connected as the load for the output transistor (Fig. 1). With this type of circuit, there is direct current through the speaker. (This is not a good thing. It displaces the diaphragm and heats the voice coil. However, it is usually all right so long as the power is small compared with whatever audio power the speaker is designed to handle.)

In this particular amplifier about 100mA flows through the speaker. This enables the d.c. power in the speaker to be calculated. For example, a 10 ohm speaker, with 100mA (0.1A) through it will drop 1V. Power = amps \times volts = 0.1A \times 1V = 0.1W.

So far, so good. Now let's think about *audio* in the speaker. The static, d.c. conditions are that TR2's collector current of 100mA flows in the voice coil, displacing it slightly. Transistor TR2 must operate in class A, being a single transistor, not part of a push-pull pair. It must therefore always pass some collector current, and not be "cut off", otherwise severe distortion would occur. Thus the collector current can only fall from 100mA to near zero, a decrease of about 100mA.

If the driving signal is a sine-wave, this down-swing of 100mA on one half-cycle will be followed by an up-swing of 100mA on the next. The "sine-wave power" is therefore whatever you get when

the peak-to-peak current swing is 200mA (down to zero, up to 200mA) and the load is 10 ohms. The books tell you that this is 0.05W, or 50mW. It is no coincidence that this audio sine-wave power is just *half* the d.c. power. With this type of circuit it is always half.

In passing, it's as well to note that the circuit as a whole is very inefficient. The battery has to supply 100mA at 6V, which is 600mW. The undistorted audio power can't exceed 50mW. So only 50/600 or 1/12 of the d.c. input power is converted to audio power. The moral is, don't use this sort of circuit in dry-battery operated equipment.

To get back into the main stream of the subject, the situation is that the amplifier can't deliver more than 50mW. Not a lot, but still quite useful. But now we come to the crunch. The output was less than this, the obvious remedy was to find out why, and correct the trouble.

POSSIBILITIES

I hope all my readers will see one simple possibility. An amplifier will only produce its maximum *output* if it receives enough *input*. In the case in question, the input came from a radio "front end". If the "front end", that is, the r.f. amplifier and detector wasn't delivering enough audio signal to drive the amplifier to full power this would explain the low volume. Well, all right. But the radio did produce *some* audio, so why not add the amplifier and boost it? You could. But you'd also boost any *noise* from the radio.

One way of boosting the signal was to use a longer aerial, because the set used a wire aerial, not a ferrite rod. Another trick, much resorted to by builders of simple radios with inadequate radio-frequency amplification, is to apply "reaction", that is, to feed radio signals back from the

output to the input of an r.f. amplifier. This, properly done, increases the sensitivity and improves the selectivity at the same time. The price you pay is an extra, and possibly tricky adjustment.

EFFICIENCY

Some of you will have thought of another way of increasing volume—by increasing the *efficiency* of the amplifier. This is easier said than done. With a direct-drive circuit, the only way to do it is to pass more current through the speaker. Ideally, the speaker resistance should drop the same voltage as the transistor. In the present case, about 1V of the 6V supply is lost in the emitter resistance of the BFY51, leaving 5V. If half of this (2.5V) is to be dropped by the 10 ohm speaker the collector current must be increased to 250mA. This calls for a re-design of the circuit and also increases the power dissipated by the transistor to 625mW, which is getting a bit near the limit for an uncooled BFY51—not to mention the loudspeaker. But the efficiency *does* increase.

The audio power (remember it's half the d.c. power in the load) is about 312mW. The total supply power to the BFY51 is 6V \times 250mA = 1500mW. So the ratio of audio to d.c. power is 312/1500 or just over 1/5, which is a lot better than the 1/12 we got earlier.

A better, though expensive way of increasing the output is to use a transformer. But that is a subject for another article.

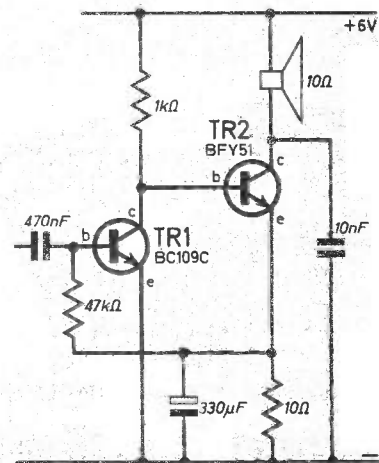

Fig. 1. Circuit diagram of the amplifier.

BI-PRE-PAK

Bargains in Semi-Conductors, components, modules & equipment.

B-P-P Packs

Originated in 1959 by managing director Bernard Davis, his were the first semi-conductor and component packs to be marketed in this country, and indeed, the company's name grew out of "British Industrial Pre-Packed Components". Today, BI-Pre-Pak continues to occupy a position of pre-eminence in the supply of packs as well as a vastly extended range of products detailed in our latest 24 page A.4 size free catalogue. Send 10p stamped large addressed envelope for your copy by return.

IT'S ALL IN OUR FREE CATALOGUE

Component Packs

- CP1 150 Capacitors, mixed bag of paper, silver mica, electrolytics, etc. Approx. quantity, counted by weight. (post & packing) 60p
- CP2 200 Resistors, mixed bag of different types, values, wattages, etc. Approx. quantity, counted by weight. 60p
- CP3 40 Wirewound resistors, mixed types, values and wattages. 60p*
- CP4 12 Potentiometers, pre-sets, w/wound, carbon, etc. Mixed types and values. 60p
- CP5 5 Earphones, single low impedance for transistor radios, cassettes etc. Less plugs, for suitable plugs see PAKS CP9 and CP10. 60p
- CP6 50 TO-5 mounting pads, fits between transistor and board, for that pro. finish. 60p
- CP8 500 Cable clips for G.P.O. 1/4" dia. cable. Nylon with hardened steel pin (probably tungsten) per sealed box of 500. 60p*
- CP9 5 3.5mm plugs, miniature jack, to fit earphones in PAK CP5. 60p*
- CP10 5 2.5mm sub miniature jack plugs, to fit earphones in PAK CP5. 60p*
- CP11 6 Screwdrivers, 1 x mains neon tester, 5 x grub screwdrivers. 60p*
- CP12 10 Reed relay inserts, 1" long 1/4" dia. These will operate from an external magnet or coil. For magnets see PAK CP13. 60p*
- CP13 10 Magnets of various sizes for operating reed switches in PAK CP12. Ideal for burglar alarms on doors and windows etc. 60p*
- CP14 40 Potentiometers, pre-sets, wirewounds, carbons, dual gangs, with and without switches etc. Mixed values and wattages £1-20
- CP15 12 Standard crocodile clips, screw fixing, good quality. 60p*
- CP16 5 P.C. boards each containing a BF180 UHF amplifier transistor. A good basis for building a T.V. aerial pre-amp as various parts inc. 60p
- CP17 25 Electrolytic Capacitors, various values and voltages, many useful types, from T.V. to transistor radio & Hi-Fi (post & packing 23p) 60p
- CP18 1 Light activated SCR. 50 volts 1.6 amps type 9A9F. Ready mounted on PC board with gate resistor and leads fitted. Full data and circuit diagrams for 14 projects, includes: slave photo flash unit, burglar alarm etc. 60p*
- CP19 3 Micro switches 1 pole change over, standard model 1 1/2" x 1/2". 60p*

Semi-Conductors

- Tested and guaranteed
- TP4 3 SN7490 integrated circuits, 14 pin dual in line TTL type. Decade counter. Get one FREE these are 60p each in singles. £1-20p*
- ALL THE FOLLOWING ARE AT 60p EACH PACK
- TP9* 5 SN7400 integrated circuits, 14 pin dual in line TTL type. Quad 2-input NAND gate. Get one FREE, these are 15p each.
- TP10 2 Light dependant resistors. 400 ohms light, 1 megohm dark. 1/2" dia.
- TP11 10 Transistors XB102 and XB112 equivalent to AC126, AC156, OC812, OC72 etc.
- TP12* 4 BY127 Silicon rectifiers 1000 piv 1 amp. Plastic T.V. rectifier.
- TP13* 5 OC71 Light sensitive transistors.
- TP14 20 OC71 germanium PNP audio pre amp transistor, black glass type.
- TP15 20 OC81 germanium PNP audio output transistor, white glass type.
- TP16 20 OC200/1/2/3 transistors, PNP silicon TO-5, unmarked.
- TP17 20 1 watt zener diodes, mixed voltages, 6-8 to 43 volts
- TP18 20 2N3707/9/10 transistors, NPN silicon plastic, unmarked.
- TP19 100 Diodes, mixture of germanium, gold bonded, silicon, etc., a useful selection of many types, marked and unmarked.
- TP20 10 Mullard OC45 transistors, I.F. amp. PNP germanium.
- TP23 20 BFY50/1/2, 2N656/7, 2N1613, etc. NPN silicon IO-5 uncod. COMPLEMENTARY TO PAK TP24.
- TP24 20 BFY64, 2N2904/5, etc., PNP silicon TO-5 uncod. COMPLEMENTARY TO PAK TP23.
- TP30 20 NPN silicon planar transistors, TO-18 similar to BC108 etc. uncod.
- TP31 20 PNP silicon planar transistors. TO-18 similar to BC178 etc. uncod.

- Untested Packs—60p each
- Specialty for keen bargain hunters
- UT1 50 PNP germanium transistors, AF and RF. Very good yield.
- UT2 150 Germanium diodes, miniature glass type.
- UT5 40 Zener diodes, 250 mW OAZ240 range, average 50% good.
- UT6 25 Zener diodes, 1-1 1/2 watt top hat type, mixed voltages.
- UT9 40 NPN silicon planar transistors, of the 2N3707-11 range, low noise amp.
- UT10 15 Power transistors, PNP germanium and NPN silicon, mostly TO-3 but some plastic and some marked.
- UT13 15 Integrated circuits, experimenters pak, dual in line, TO-5, TTL, DTL, marked and unmarked, some definitely good but old types.

FOR FULL RANGES—SEE CATALOGUE

- Singles
- BRIDGE RECTIFIERS Plastic encapsulated
- P.1.V. 100v 400v
- 1 amp 25p* 35p* 45p*
- 2 amp 35p* 45p* 55p*
- 4 amp 45p* 50p* 80p*
- 6 amp 50p* 60p* 90p*
- BY164 equiv. SKB2/02 400v 1.5 amp. 45p*

- FETs
- 2N3919 18p
- 2N4416 20p

- MOS F.E.T.s
- 3N141/MEM616 50p

- UNI-JUNCTION TRANSISTORS
- 2N2160 65p*
- 2N2646 48p*
- T1S43 31p*

- P.U.T.s
- 2N26027 50p

- LEDs
- T1L209—Red 18p*
- T1L211—Green 33p*

Also Power Diodes, Thyristors, Triacs, Diac Zener Diodes, Opto-Electronics, etc.

POWER TRANSISTORS

	V _{ce}	Watts	1c Amps	Price
40P1	15	20	3	20p*
40P2	40	40	4	30p*
40P2	40	40	4	30p*
90N1	15	45	4	25p*
90P1	15	45	4	25p*
90N2	40	90	8	35p*
90P2	40	90	8	35p*

Many other types available from 3 to 115 watts

INTEGRATED CIRCUITS

LM555/1 Dual in line clock chip £3*
LM5580/SL60745 Dual in line 2w. audio amp. with data, etc. 75p
Dual in line I.C. sockets 8 pin 14p; 14 pin 15p*; 16 pin 16p*

Sundry

SIGNAL GENERATOR

For MW and IF Covers 550 KHz to 1.6 MHz for MW and 400 to 550KHz for IF. Fully portable. (p/p 40p) £4-25

POCKET SIGNAL INJECTOR

Fountain-pen type. invaluable for finding faults £2-00*

EX-G.P.O. 5" SIDECUTTERS

Not new, but in perfect order, per pair 50p*

EX-G.P.O. 6" LONG NOSE PLIERS

Not new, but in perfect order, per pair 60p*

MAINS TRANSFORMERS

	MT6	MT12	SST9/1	SST12/1	SST18/1	SST25/2	SST30/2	SST35/4	Price
	6v 0.6v 100mA	12v 0.12v 50mA	9v 1amp	12v 1amp	18v 1amp	25v 2amp	30v 2amp	35v 4amp	£1-22*
									£1-22*
									£1-67*
									£2-05*
									£2-50*
									£3-00*
									£4-25*
									£5-50*

PC EDGE CONNECTORS

Type	Sizes	Pitch	Price
SSEC 6 way	1 1/2"	156"	32p
SSEC 10 "	1 1/2"	156"	60p
SSEC 12 "	2"	156"	50p
SSEC 16 "	2 1/2"	156"	75p
SSEC 18 "	3"	156"	85p
SSEC 22 "	3 1/2"	156"	1-00

BOOKS

All free of V.A.T. We carry very large stocks of technical books by Babani & Bernard Publishers, by Newnes and Butterworth as well as reference books from the Common Market in English/German/Italian. All detailed in our catalogue.

MONEY SAVERS FOR MOTORISTS

Our new "Super Spark" Capacity Discharge Ignition unit is instantly adaptable for pos. or neg. earth; can be switched back to conventional ignition instantly and incorporates anti-burglar immobilising switching, Rev. controlling adjustment. In totally enclosed strong metal box (p/p—50p) (S.A.E. for leaflet)

KIT—£7.95* READY BUILT £10.50*

NEXT MONTH LOOK OUT FOR SOME EXCITING NEW

Stirling Sounds Audio Modules £10-50

B-P-P SECURITY CHECK POINT

Write your own name and address clearly in block capital letters. **MAKE SURE YOU GET OUR NAME AND ADDRESS RIGHT WHEN ORDERING** Cash, (cheque, money or postal order) with your order, please. **Mention this journal when ordering if you don't want to cut out the coupon.**

TERMS OF BUSINESS:

VAT at 25% must be added to total value of order, except for items marked * or (8%), when V.A.T. is to be added at 8%. No VAT on overseas orders. **POST & PACKING** Add 30p for UK orders except where shown otherwise. Minimum mail order acceptable—£1. Overseas orders, add £1 for postage. Any difference will be credited or charged. **PRICES** Subject to alteration without notice. **AVAILABILITY** All items available at time of going to press when every effort is made to ensure correctness of information.



BI-PRE-PAK LTD

222-224 WEST ROAD, WESTCLIFF-ON-SEA, ESSEX SSO 9DF.
TELEPHONE: SOUTHEND (0702) 46344.

WRITE ORDER SEPARATELY AND ATTACH COUPON IF REQUIRED

To BI-PRE-PAK, 224-226 WEST RD., WESTCLIFF-ON-SEA, ESSEX

Please send _____

for which I enclose _____ inc. V.A.T.

Name _____

Address _____

EE 3

Marshall's

A. Marshall (London) Ltd Dept:EE
 42 Cricklewood Broadway London NW2 3ET Tel: 01-452 0161/2
 Telex: 21492
 & 85 West Regent St Glasgow G2 2OD Tel: 041-332 4133
 & 1 Straits Parade Fishponds Bristol BS16 2LX
 Tel: 0272 654201/2
 & 27 Rue Danton Issy Les Moulineaux Paris 92 Tel: 644 2356
 Catalogue price 25p Trade and export enquiries welcome

Our range covers over 7,000 items. The largest selection in Britain

Top 200 IC's TTL, CMOS & Linears			
CA3020A	£1.80	CD4049	45p
CA3028A	79p	CD4050	45p
CA3035	£1.37	CD4510	£1.25
CA3046	70p	CD4511	£1.94
CA3048	£2.11	CD4516	£1.25
CA3052	£1.62	DC4518	£1.87
CA3089E	£1.96	CD4520	£1.87
CA3090Q	£4.23	LM301A	48p
CA3130	88p	LM308	£1.17
CD4000	18p	LM309K	£1.88
CD4001	18p	LM380	98p
CD4002	18p	LM381	£2.07
CD4006	99p	LM702C	75p
CD4007	18p	LM709	75p
CD4008	82p	T099	38p
CD4009	52p	8D1L	45p
CD4010	52p	14D1L	38p
CD4011	18p	LM710	47p
CD4012	18p	LM723C	66p
CD4013	18p	LM741C	40p
CD4014	89p	8D1L	40p
CD4015	89p	14D1L	38p
CD4016	45p	LM747	£1.05
CD4017	88p	LM748	£1.05
CD4018	88p	8D1L	44p
CD4019	32p	14D1L	41p
CD4020	98p	LM3900	61p
CD4021	88p	LM7805	£1.88
CD4022	85p	LM7812	£1.99
CD4023	18p	LM7815	£1.99
CD4024	72p	LM7824	£1.99
CD4025	19p	MC1301	50p
CD4027	43p	MC1310P	£2.50
CD4028	83p	MC6330P	90p
CD4029	£1.06	MC1351P	80p
DC4030	52p	MC14553	£4.07
DC4031	98p	MC1466L	£3.50
DC4037	88p	MC1469R	£2.75
DC4041	70p	NE55V	70p
NE556	£1.30	SN7446	84p
NE560	£4.48	SN7447	80p
NE565	£4.48	SN7448	90p
SL414	£2.35	SN7450	16p
SL610C	£2.35	SN7451	16p
SL611C	£2.35	SN7453	16p
SL612C	£2.35	SN7454	16p
SL620C	£3.50	SN7460	16p
SL621C	£3.50	SN7470	20p
SL623C	£5.24	SN7472	21p
SL640C	£4.00	SN7473	31p
SN7400	16p	SN7474	31p
SN7401	16p	SN7475	45p
SN7401AN	20p	SN7476	30p
SN7402	16p	SN7480	42p
SN7403	16p	SN7481	£1.00
SN7404	19p	SN7482	65p
SN7405	19p	SN7483	82p
SN7406	36p	SN7484	95p
SN7407	36p	SN7485	£1.00
SN7408	19p	SN7486	29p
SN7409	18p	SN7490	42p
SN7410	16p	SN7491	75p
SN7411	20p	SN7492	45p
SN7412	22p	SN7493	45p
SN7413	25p	SN7494	75p
SN7416	28p	SN7495	68p
SN7417	28p	SN7496	68p
SN7418	23p	SN74100	£1.10
SN7418	85p	TAA300	£1.84
SN7419	£1.75	TAA350A	£1.96
SN7423	23p	TAA550	32p
SN7425	23p	TAA611C	£2.18
SN7427	23p	TAA621	£2.03
SN7422	42p	TAA661B	£1.03
SN7423	65p	TAA661B	£2.25
SN7414	75p	TBA651	£1.69
SN7415	72p	TBA800	99p
SN74150	£1.20	TBA810	98p
SN74151	68p	TBA820	80p

LONDON GLASGOW PARIS AND NOW

BRISTOL

IT'S OUR SERVICE THAT MAKES US GROW

POPULAR SEMICONDUCTORS

2N696	22p	2N3906	19p	AF139	65p	BD139	71p	MPSA56	31p
2N697	16p	2N4037	42p	AF239	65p	BD140	87p	OC28	£1.48
2N698	82p	2N4036	67p	AF240	90p	BF115	29p	OC35	£1.16
2N699	59p	2N4037	18p	AF279	70p	BF117	35p	OC42	50p
2N706	14p	2N4062	55p	AF280	79p	BF154	20p	OC45	39p
2N708	17p	2N4289	34p	AL102	£1.00	BF159	27p	TIP29A	40p
2N916	28p	2N4920	£1.10	BC107	14p	BF180	35p	TIP29C	80p
2N918	32p	2N4921	83p	BC108	14p	BF181	36p	TIP31A	62p
2N1302	18p	2N4923	£1.00	BC109	14p	BF184	30p	TIP32A	74p
2N1304	28p	2N5245	29p	BC147B	10p	BF194	12p	TIP33A	£1.01
2N1306	31p	2N5246	46p	BC148	99p	BF195	12p	TIP34A	£1.81
2N1308	47p	2N5296	48p	BC149B	11p	BF196	13p	TIP35A	£2.90
2N1711	27p	2N5457	29p	BC157A	16p	BF197	13p	TIP36A	£3.70
2N2102	60p	2N5458	26p	BC158A	16p	BF198	18p	TIP41A	79p
2N2147	78p	2N5459	29p	BC167B	15p	BF244	21p	TIP42A	£0.90
2N2148	94p	2N6027	45p	BC168B	15p	BF257	47p	TIP2955	98p
2N2218A	47p	3N128	73p	BC169B	15p	BF258	53p	TIP3055	90p
2N2219A	52p	3N140	£1.00	BC182	12p	BF259	55p	TIS43	28p
2N2220	25p	3N141	81p	BC182L	12p	BF561	27p	ZTX300	13p
2N2221	18p	3N200	£2.49	BC183	12p	BF598	25p	ZTX301	13p
2N2222	20p	40361	40p	BC183L	12p	BF939	24p	ZTX500	13p
2N2369	20p	40362	45p	BC184	13p	BF979	24p	ZTX501	13p
2N2646	55p	40406	44p	BC184L	13p	BF929	32p	ZTX502	15p
2N2994	40p	40407	35p	BC182A	13p	BF930	34p	AI119	8p
2N2905	47p	40408	50p	BC212LA	16p	BF984	30p	IN375A	18p
2N2906	33p	40409	52p	BC213LA	15p	BF985	35p	IN4007	10p
2N2907	22p	40410	52p	BC214LB	18p	BF988	30p	IN4148	4p
2N2924	20p	40411	£2.00	BC237B	16p	BF950	30p	IN5404	22p
2N2926G	12p	40515	74p	BC238C	15p	BF951	28p	IN5408	30p
2N3053	25p	40595	89p	BC239C	15p	BF952	28p	OA91	6p
2N3054	60p	40636	£1.10	BC257A	16p	BR939	48p	BA102	25p
2N3055	65p	40673	73p	BC258B	16p	ME0402	20p	BA145	18p
2N3391	28p	AC162	20p	BC259B	17p	ME0412	18p	BA154	12p
2N3392	15p	AC127	40p	BC301	34p	ME4102	11p	BA155	12p
2N3393	15p	AC128	35p	BC307B	17p	MJ480	95p	BB103B	23p
2N3440	15p	AC161	27p	BC121	£1.00	MJ481	£1.20	BB104B	48p
2N3442	£1.40	AC132	49p	BC309C	20p	MJ490	£1.05	BY126	12p
2N3638	15p	AC153	35p	BC327	23p	MJ491	£1.45	BY127	15p
2N3702	12p	AC176	41p	BC328	22p	MJ2955	£1.00	BY211	51p
2N3703	13p	AC187K	35p	BCV70	17p	MJ340	48p	BY212	51p
2N3704	15p	AC188K	40p	BCY71	22p	MJ370	65p	OA47	6p
2N3706	15p	AD143	68p	BCY72	18p	MJ371	75p	OA81	18p
2N3709	14p	AD161	69p	BD121	£1.00	MJ372	60p	OA90	6p
2N3714	£1.38	AD162	89p	BD123	82p	MJ521	70p	OA91	6p
2N3716	£1.80	AF106	40p	BD124	67p	MJ2955	£1.20	OA200	8p
2N3771	£2.20	AF109	40p	BD131	40p	MJ3055	75p	BY164	37p
2N3773	£2.65	AF115	35p	BD132	50p	MP8113	47p	ST2diac	20p
2N3789	£2.06	AF116	35p	BD135	21p	MPF102	39p	40669	47p
2N3819	37p	AF117	35p	BD136	22p	MPSA05	25p	TIC44	29p
2N3921	29p	AF118	35p	BD137	24p	MPSA06	31p	CI06D	65p
2N3904	19p	AF124	30p	BD138	26p	MPSA55	21p	ORP12	60p

Prices correct at April 1976, but all exclusive of VAT. P. & P. 25p

EVERYDAY ELECTRONICS Easybuild DIGITAL CLOCK

We are offering kits for this attractive clock, featured in January E.E., at special prices. Anyone with a little experience of soldering should be able to build a fully working clock.

No moving parts—4 digit 0.5" green display—flashing or fixed colon—12 or 24 hour display—slim attractive white case—full instructions included.

COMPLETE EE CLOCK KIT £15.70

All components necessary except mains lead and plug to complete fully working clock: AY51202 clock IC, 5LTO1, display, PCB, miniature transformer, resistors, capacitors, diodes, switches, verocase, green perspex panel, nuts, screws, washers, wire, grommet.

Complete kit as above, but with lead and plug £16.20

EE CLOCK MODULE KIT £12.04

This kit comprises all components as in the clock kit except verocase, perspex panel, nuts, screws, washers, wire, grommet, mains lead and plug.

AVAILABLE SEPERATELY AY51202 £4.76

5LTO1 Transformer £1.80 5LTO1 £5.80

Verocase J and green perspex £2.94 PCB £1.40

"25p P & P"—ADD VAT (now 8%)
to ALL PRICES ABOVE

SINTEL

53E Aston Street, Oxford. Tel. 0865 49791

A hobby that pays big salaries.

Enrol in the BNR & E School and you'll have an entertaining and fascinating hobby. Stick with it and the opportunities and the big money await you, if qualified, in every field of Electronics today. We offer the finest home study training for all subjects in radio, television, etc., especially for the CITY AND GUILDS EXAMS (Technicians' Certificates); the Grad. Brit. I.E.R. Exam; the RADIO AMATEUR'S LICENCE; P.M.G. Certificates; the R.T.E.B. Servicing Certificates; etc. Also courses in Television; Transistors; Radar; Computers; Servo-mechanisms; Mathematics and Practical Transistor Radio course with equipment. We have OVER 20 YEARS' experience in teaching radio subjects and an unbroken record of exam successes. We are the only privately run British home study College specialising in electronics subjects only. Full details will be gladly sent without any obligation.

BRITISH NATIONAL RADIO & ELECTRONICS SCHOOL, Dept EEC 56

P.O. Box 156, Jersey, Channel Islands.

NAME _____

ADDRESS _____

(Block caps please)

constructors guides

This exciting new series, under the general Editorship of **Morris COLWELL**, provides clear and easily understood descriptions, advice and general help for amateur constructors, students and technicians aimed at breaking down the barriers that often deter beginners in electronics.

Available Now...

ELECTRONIC DIAGRAMS

M. A. Colwell

One of the first things that newcomers to radio and electronics need to come to terms with is the language used. This book, which is aimed primarily at beginners, attempts to break down the barriers which so often deter students from taking up the subject. It takes the reader through the logical steps of building up circuit diagrams from elementary circuit symbols to complex systems.

112 pages 216 x 138mm Illustrated
0 408 00201 8 £1.80

PRINTED CIRCUIT ASSEMBLY

M. J. Hughes, MA, AMIERE and M. A. Colwell

This book takes the mystery out of techniques used in printed circuit assembly and encourages constructors to make their own printed circuit boards. The book describes the characteristics of the various bases used and guides the reader through the stages of translating circuit diagrams into printed circuit layouts.

96 pages 216 x 138mm Illustrated
0 408 00203 4 £1.80

ELECTRONIC COMPONENTS

M. A. Colwell

This Guide describes the characteristics of the various bases used in printed circuit systems and guides the reader through the stages of translating circuit diagrams into printed circuit layouts. Image transference, etching, milling and trimming methods are described. Some special techniques such as through-hole plating,

edge connector tabs and multi-layer assembly are also outlined, and reliability and maintenance procedures are discussed. The merits of alternative ready-made proprietary assembly systems are reviewed and tabular comparisons made.

112 pages 216 x 138mm Illustrated
0 408 00202 6 £1.80

Available June...

PROJECT PLANNING AND BUILDING

Morris A. Colwell

This guide will help the constructor to plan, design and lay out his electronic projects. The book explains planning, use of tools, component board layout, the design and layout of chassis and cases, and assembly and wiring. There is also an extremely useful Appendix.

SIMPLE CIRCUIT BUILDING

Morris A. Colwell

This Guide provides a logical introduction to general purpose circuits for the home constructor and to converting theoretical circuits into practical layouts. The book covers a wide range of easy to assemble circuits, including switching and logic circuits and their layouts, operational amplifiers, a.c. amplifiers and d.c. power supplies.

PRACTICAL ELECTRONIC PROJECT BUILDING

Alan Ainslie and Morris A. Colwell

A concise but informative guide to some of the current popular methods of construction and techniques employed in home construction. Contains hints on finishing and fault-finding methods.

For details of all Newnes Technical Books please write for a free catalogue and watch for announcements in following issues of *Everyday Electronics*.



Newnes Technical Books



BOROUGH GREEN, SEVENOAKS, KENT TN15 8PH

Everyday Electronics Classified Advertisements

RATES: 12p per word (minimum 12 words). Box No. 35p. extra. Semi-display—£8.00 per single column inch. Advertisements must be prepaid and addressed to GMG Classified Advertisement Department, "EVERYDAY ELECTRONICS," I.P.C. Magazines Ltd., Room 2337 King's Reach Tower, Stamford Street, London. SE1 9LS. (01-261 5918)

EDUCATIONAL

TRAIN FOR SUCCESS

An ICS home study course will give you the qualifications to improve your career prospects in electronics.

C & G Exams

Course for Certificates in Telecoms Technicians, Electrical Installations, Radio, T.V. and Electronics Technicians & Radio Amateurs.

Practical Radio

Courses include FREE construction kits.

Colour TV Servicing

Covers principles, practice and alignment with numerous illustrations and diagrams. Other courses for Radio & Audio Servicing.

Technical Training

Courses include Electronic Technicians, Computer Technicians, Radio and Television Technicians and many more.

Write for full details TODAY.

ICS School of Electronics,
Dept. 711S, Intertec House,
London SW8 4UJ.
Telephone 01-822 9911 (all hours).

TAPETALK

THE CLEVER WAY TO LEARN

TWO C60 Cassettes entitled

INTRODUCING ELECTRONICS
£5.44 plus 55p VAT/P. & P.

TAPETALK, P.O. Box 99 (EE)
Milton Keynes MK3 5BR
Tel.: Milton Keynes (0908) 77710

RECEIVERS and COMPONENTS

500 COMPONENTS. Resistors, Capacitors, Diodes, Transistors, Pots, Coils, etc. Identified, formed leads, fall-out, & surplus. Good value at £1.60. All inclusive. (UK postal rates only). CWO please to L. PENSENEY, E. Bankhead Farm, South Queensferry, West Lothian.

FOUR PANELS EX F.M. STEREO AMP. 14 Transistors, 3 Stereo Pots, 7-Way Push Button Assembly, Coils and IFS, etc. £1.75 (50p). BANK OF 20 NEONS 75p (15p) 3 Ass. M.C. Meter. 3-£1.50 (50p). T.V. CONVERGENCE PANELS 2XA128, 3 slugged coils, 3 slide switches, 11 W.W. pots, 3 carbon presets, 2 ferrite chokes etc. £1.30p.p. TALKING PAGE PANEL 2 pots, 12 silicon trans. and SCR. 8 nice electrolytics 80p (15p). THREE TRANSISTOR AUDIO AMP Trans. equiv. to AC128, OC72, 40p (10p) 3-£1 p.p. COPPER CLAD FAX PANELS 53 x 51 p.p. 12 x 12" 75p. 123 x 9" 55p. 81 x 91" 3-£1.25. All C.P. 74 SERIES IC's ON PANELS (10-85p (10p)). STABILISED POWER SUPPLY PANEL 2 x 2N3702, 2 x AC153 Bridge rectifier 2 x 10"50V and 1000, 250 MFD 35V electrolytics 45p (10p). VALUPAKS 10 Silicon diodes 650V 11A on tagboard 50p (10p). 100 S/MICA caps 55p (10p) 100 C280 polyester caps £1 (15p) Lists 15p. Refund on purchase. 400 Small Comps. inc. Trans. £2.00 p.p. 7lbs Assorted Components £2.50 p.p.

J. W. B. Radio, 2 Barnfield Crescent Sale
Cheshire M33 1NL.
Postage in brackets Mail order only.

COMPONENTS GALORE, pack of 500 assorted radio, TV and electronic components a real bargain at a realistic price, send only £1.50 C.W.O. This applies only to United Kingdom and Ireland. Overseas prices by arrangement. Caledonian Components. P. O. Box 3, Glenrothes, Fife, Scotland.

Polyester Caps C280 -1 250V 4 for 5p. 5 Yards Connecting Wire Ass'd Colours 10p. Enamelled Copper Wire 32, 34, 36 S.W.G. 1p ft. Large Red I.E.D.s 25p. 5 for £1.00. Loudspeakers 2 1/2" 8 ohm 75p. 2 1/2" 80 ohm 75p. Microswitch 5 amp c/o 10p. BC 107/8/9 15p. Burglar Alarm 1 1/2 V DC 75p. Reed Switch Large/Small 10p. 3 Digit Counters 15p. Capacitors or Resistors Ass'd Pkt 25p. Jack Plugs 2.5mm/3.5mm 12p. Sockets 10p. Loud 6V DC Sirens £1.28. Miniature Push to Test Switches 20p. 90V Neons 8p. Crystal Mikes and Plug 59p. Inserts 32p. Croc Clips Red/Black 7p. Solder 5p yd. Veroboard 4" x 3" 25p. Bank of 6 Reed Switches 38p. Waster Plugs Ass'd colours 7p. Tuning Capacitors 15pF 45p. 500 + 500 75p. 8 ohm Earphones and Plug 18p. 100mA Mains Transformers 6-0-6V 95p. 9-0-9V £1.10. Pots LIN 10k, 25k 1M 14p. Prices include VAT. Add 12p post. 1976 list 9p.

GRIMSBY ELECTRONICS

64 TENNYSON ROAD, CLEETHORPES, HUMBERSIDE

Ferric Chloride, Alum Boxes, Components, etc. at our LAMBERT ROAD SHOP (open Saturdays)

BOOKS and PUBLICATIONS

Start your own business printing pound notes

Printing pound notes? Well not quite—but 'start your own business rewinding electric motors' could easily be your licence to make money in 1976.

Lavishly illustrated, this unique instruction manual shows step by step how to rewind motors working part or full time, without experience. Everything you need to know easily explained, including where to obtain materials, how to get all the work you need, etc, etc. A goldmine of information and knowledge. Only £3.65 plus 25p P&P. From:—

Magnum Publications Dept. EE5, Brinksway Trading Estate, Brinksway, Stockport MK3 0BZ

LOGIC. Reliable step-by-step design techniques for the non-specialist are described in a new Oxford book 'Problems and Solutions in Logic Design' by D. Zissos (1976). Over 50 problems with fully worked out solutions demonstrate the design steps. Obtainable from booksellers £3.50, paper covers £1.75.

FOR SALE

MICROPHONES: AKG D202E1, £45.00; AKG D190C or 'E' £20.00; AKG D224, £60.00; Sennheiser MD211N, £45.00. All brand new and boxed. Please add 25% for VAT. All other AKG and Sennheiser mikes. SAE for quote to J. J. Francis (Wood Green), Ltd., Manwood House, Matching Green, Harlow, Essex. Tel: Matching 476.

TAPES

TAPETALK THE NATURAL WAY TO LEARN

Two C60 cassettes entitled

THE SCIENCE OF SOLDERING

£5.44 plus 55p VAT/P. & P.

TAPETALK, P.O. Box 99 (EE)

Milton Keynes MK3 5BR

Tel.: Milton Keynes (0908) 77710

SERVICE SHEETS

SERVICE SHEETS for Radio, TV, Tape Recorders, Stereo, etc., with free fault-finding guide, 50p and SAE. Hamilton Radio, 47 Bohemia Road, St. Leonards, Sussex.

BELL'S TELEVISION SERVICES for service sheets, manuals & books on radio/TV etc. Service sheets 50p plus SAE. Service sheet catalogue 25p. Back issues of magazines from April '74 onwards cover price plus 12p post. Free booklists on request. SAE with enquiries please to:— B. T. S. 190, Kings Road, Harrogate, Yorkshire. Telephone Harrogate (Code 0423) 55885.

MISCELLANEOUS

HOME SCIENTISTS

Get the key to a FANTASTIC WORLD of previously UNHEARD-OF-PROJECTS. The NEW Boffin catalogue lists LOTS of HIGHLY UNUSUAL, LOW-COST BARGAINS, READY-BUILT MODULES. Here are just a few examples, there are stacks more!

Dazzling MINI-STROBE (pocket size) £3.50

PEOPLE DETECTOR £4.20

Big-Ear SOUND-CATCHER £4.20

Mini DREAM LABORATORY £4.20

Don't take our word for it though! GET A COPY & SEE! SEND ONLY 20p, and we'll RUSH YOU A COPY (YOU'LL GET THE GOODIES' JUST AS QUICKLY TOO!)

BOFFIN PROJECTS

4 Cunliffe Road, Stoneleigh, Ewell, Surrey (Mail Order U.K. Only)

NICKEL CADMIUM, fully sealed, rechargeable batteries. Equivalent dry cell sizes. Discount. S.a.e. brings full details by return.—Sandwell Plant Ltd., 1 Denholm Road, Sutton Coldfield, West Midlands B73 6PP. 021-354 9764.

ENAMELLED COPPER WIRE

SWG	1lb	4oz	2oz
14-19	2.40	.60	.50
20-29	2.45	.82	.59
30-34	2.60	.89	.64
35-40	2.85	1.04	.75

inclusive of P. & P. and VAT

S.A.E. brings Catalogue of copper and resistance wires in all coverings.

THE SCIENTIFIC WIRE COMPANY

P.O. Box 30 London E.4. 9BW.

LOWEST COST IC SOCKETS. Use Soldercon IC socket pins for 8 to 40 pin DIL's. 50p for strip of 100 pins, £1.50 for 3 strips of 100, £4 for 1000. 10p p&p for orders under £2. Add 8% VAT. Instructions supplied—send sae for sample. SINTEL, 53e Aston Street, Oxford. Tel: 0865 43203.

MINI ACCUMULATORS

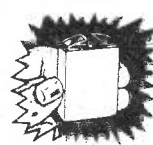

2 volt MULTI-USE Sealed Lead Acid Rechargeable Cells.
Size L450—1.4" x 1.1" x 0.44", 3 for £2.15 inc. P. & P.
Size GA2—1.7" x 1.3" x 0.5", 3 for £2.65 inc. P. & P.
Suits Fi-Cord
GARFIELDS, 295 Rye Lane, London SE15



MULTIMETER

Type C7081
Overload protected, 50,000 ohms/volt, 15uA movement. 12 DC Voltage ranges from 0-25V-1000V; 10 AC voltage ranges from 1-5V-1000V; 10 DC current ranges from 25uA-10A, 4 resistance ranges, dB scales. Size 160 x 120 x 63mm. Only £15-20. Send 10p for illustrated brochure of meters.

71b BARGAIN PARCELS

Contains hundreds of resistors, pots, capacitors, switches, transistors, PC Boards and loads of odds and ends. Only £3-25.

CAPACITOR PACKS

200 mica ceramic poly caps £1-15; 100 polyester caps 0.01 to 1uF £1-30; 200 mainly unmarked miniature electrolytics. Only £1-35. One of each pack £3-30.

Mains TRANSFORMERS

12-0-12V 50mA 80p; 6-0-6V 100mA 80p; 0-0-9V 100mA 95p; 12-0-12V 100mA £1; 6-0-6V 1A £1-85; 12-0-12V 1A £2-20; 30-0-30V 1A £3-30; 30V 1A tapped to give 3, 4, 5, 6, 8, 9, 10, 12, 15, 18, 20, 24 or 30V, or 12-0-12 or 15-0-15V £3-15. 2A version £4-45.

PC ETCHING KIT Mk II

Contains 1lb Ferric Chloride, DALO Etch resist pen, 100 sq ins copper clad board, etching dish, abrasive cleaner, instructions and now 2 miniature drill bits as well. Only £3-65.

GREENWELD ELECTRONICS (EE3)

443 Millbrook Road, Southampton SO1 0HX
All prices include VAT and Postage In UK
SAE List. Callers welcome 9-5 Mon-Sat
Telephone (0703) 772501.

SUPERB INSTRUMENT CASES by Bazelli, manufactured from heavy duty PVC faced steel. Hundreds of people and industrial users are choosing the cases they require from our vast range, competitive prices start at a low 75p. Over 400 Models to choose from, Prompt despatch, Free literature, (stamp would be appreciated). Bazelli, Department No. 24, St. Wilfreds, Foundry Lane, Halton, Lancaster LA2 6LT.

LOUDSPEAKERS



Speakers, kits and cabinets for D.I.Y., HiFi, P.A., Disco, etc. by EMI, Fane, Goodmans, Baker, Kef, Elac, Richard Allan, Wharfedale, etc. Send stamp for free booklet "Choosing a speaker"

WILMSLOW AUDIO

Dept. EE, Swan Works, Bank Square, Wilmslow, Cheshire, SK9 1HF
Tel. Wilmslow 29599

STYLI & CARTRIDGES. For the best at keenest prices send SAE for free illus. list to FELSTEAD ELECTRONICS (EE), Longley Lane, Gatley, Ches. SK8 4EE.

TREASURE TRACER MK III Metal Locator

- Varicap tuning
- Britain's best selling metal locator kit; 4,000 sold
- Weights only 22oz. Fitted with Faraday shield
- Speaker and earphone operation
- Knocks down to only 17in
- Prebuilt search coil assembly
- Thoroughly professional finish
- As seen on BBC1 and BBC2 TV
- You only need soldering iron, screwdriver, pliers and snips
- Five transistor circuit

Send stamped addressed envelope for leaflet

Complete Kit **£12-50** Built & tested **£17-50**
Post 85p-£1.00 VAT (8%) Post 85p-£1.90 VAT (8%)

MINIKIT'S ELECTRONICS
6b CLEVELAND ROAD,
LONDON, E18 2AN (Mail order only)

PRACTICAL WIRELESS

FREE DOUBLE-SIDED RADIO SERVICING CHART

for tracing the trouble to its cause!
Weak, distorted or intermittent sound? You name the trouble. The chart helps you find the cause. You simply look for the description of the fault you want to cure.

THE PW RHYTHM GENERATOR

—a versatile rhythm section at your command!

pragress with PRACTICAL WIRELESS

May issue out now 35p

GIRO NO. 331 7056. Access and Barclaycard accepted.
C.W.O. only. Terms of business as in our catalogue.
Export Order enquiries welcome (£5 min.)
Official Orders accepted from Educational & Government Departments
ALL PRICES INCLUDE VAT AND P & P
E. & O.E.
SHOP HOURS—9-12.30, 1.30-5 pm 5 DAYS EXCEPT WEDNESDAY

66 Pages—3000 Items Fully illustrated
★20p Credit Vouchers★All New Stock
1976 Issue ★Satisfaction Guarantee
★Discounts
★New Price S.A.E. FOR CAT. 5

Resistors - Capacitors - Semiconductors - Boxes - Cases - Kits - PC materials - Tools - Test Meters - Books - Pots - Coils - Hardware - Audio Accessories - Connectors - Veroboard - Transformers - Screws - Knobs - Calculators - Audio - Modules - Audio Leads - Batteries - Heatsinks - 5 Dec Storage Units etc. etc.

SPECIAL RESISTOR KITS (CARBON FILM 5%) (Prices include post & packing)
10E12 \pm W or \pm W KIT: 10 of each £12 value, 22 ohms—1M, a total of 570 £5-29 net
25E12 \pm W or \pm W KIT: 25 of each £12 value, 22 ohms—1M, a total of 1425 £12-64 net

SPECIAL CAPACITOR KITS
C280 Kit—PC Mounting polyester 250V 5 or each value: 0-01, 0-022, 0-047, 0-1, 0-22uF, 2 of 0-47, 1uF £1-98
C295 Kit—Tubular polyester, 400V 5 of each value: 0-01, 0-022, 0-047, 0-1, 0-22uF, 2 of 0-47uF £2-67
Ceramic Kit—square plaque 50V 5 of each value: 22, 33, 47, 100, 220, 330, 470, 1000pF, 2200, 4700pF, 0-1uF £1-86
250V Paper Kit—Tubular metal case 3 of each value: 0-05, 0-1, 0-25, 0-5, 1uF £1-48 net
600V Paper Kit—Tubular metal case 3 of each value: 0-025, 0-05, 0-1, 0-25, 0-5uF £1-41 net
1000V Paper Kit—Tubular metal case 3 of each value: 0-01, 0-025, 0-05, 0-1uF £1-63 net

B. H. COMPONENT FACTORS LTD.

MULTIMETER U4323
22 Ranges plus AF/IF Oscillator
20,000 Ω /Volt
Vdc—0-5-1000V in 7 ranges.
Vac—2-5-1000V in 6 ranges.
Idc—0-05-500mA in 5 ranges.
Resistance—5 Ω -1M Ω in 4 ranges.
Accuracy—5% of F.S.D.
OSCILLATOR—1 KHz and 465KHz (A. M.) at approx. 1 Volt
Size—160 x 97 x 40mm.
Supplied complete with carrying case, test leads and battery.
PRICE £29-95 net P. & P. 75p U4323

MULTIMETER U4324
34 Ranges. High Sensitivity.
20,000 Ω /Volt.
Vdc—0-5-1200V in 9 ranges.
Vac—2-900V in 8 ranges.
Idc—0-05-3A in 6 ranges.
Iac—0-3-3A in 5 ranges.
Resistance—25 Ω -5M Ω in 5 ranges.
Accuracy—dc and R—2 1/2% of F.S.D.
ac and db—4% of F.S.D.
Size—167 x 98 x 63mm.
Supplied complete with storage case, test leads, spare diode and battery.
PRICE £11-72 net P. & P. 75p U4324

TEACH-IN SERIES COMPONENT KIT
KIT No. T12
ALL COMPONENTS AS SPECIFIED BY E.E. FULLY GUARANTEED AND NEW STOCK (INCLUDES BATTERIES) **£15-50 NET** + 60p p&p

WOOD KIT
Includes all wood as specified by E.E., cut to size, ready to assemble and includes adhesive and screws. (Not drilled).
£3 NET + 75p p. & p.
FULL LIST AVAILABLE. S.A.E. PLEASE OR FREE WITH CATALOGUE

(E. E.) LEIGHTON ELECTRONICS CENTRE,
59 NORTH STREET, LEIGHTON BUZZARD,
LUT 7EG. Tel: Leighton Buzzard 2916 (St. Code 05253).

Sparkrite mk2

Capacitive discharge electronic ignition

VOTED BEST OF 8 SYSTEMS TESTED BY 'POPULAR MOTORING' MAGAZINE



- * Smoother running
- * Instant all-weather starting
- * Continual peak performance
- * Longer coil/battery/plug life
- * Improved acceleration/top speeds
- * Up to 20% better fuel consumption

Sparkrite Mk. 2 is a high performance, high quality capacitive discharge, electronic ignition system in kit form. Tried, tested, proven, reliable and complete. It can be assembled in two or three hours and fitted in 15/30 mins.

Because of the superb design of the Sparkrite circuit it completely eliminates problems of the contact breaker. There is no misfire due to contact breaker bounce which is eliminated electronically by a pulse suppression circuit which prevents the unit firing if the points bounce open at high R.P.M. Contact breaker burn is eliminated by reducing the current to about 1/50th of the norm. It will perform equally well with new, old, or even badly pitted points and is not dependent upon the dwell time of the contact breakers for recharging the system. Sparkrite incorporates a short circuit protected inverter which eliminates the problems of SCR lock on and, therefore, eliminates the possibility of blowing the transistors or the SCR. (Most capacitive discharge ignitions are not completely foolproof in this respect). All kits fit vehicles with coil/distributor ignition up to 8 cylinders.

THE KIT COMPRISES EVERYTHING NEEDED

Ready drilled pressed steel case coated in matt black epoxy resin, ready drilled base and heat-sink, top quality 5 year guaranteed transformer and components, cables, coil connectors, printed circuit board, nuts, bolts, silicon grease, full instructions to make the kit negative or positive earth, and 10 page installation instructions.

OPTIONAL EXTRAS

Electronic/conventional ignition switch. Gives instant changeover from "Sparkrite" ignition to conventional ignition for performance comparisons, static timing etc., and will also switch the ignition off completely as a security device, includes: switch connectors, mounting bracket and instructions. Cables excluded. Also available RPM limiting control for dashboard mounting (fitted in case on ready built unit).

CALLERS WELCOME. For Crypton tuning and fitting service - phone (0922) 33008

PRICES INCLUDE VAT, POST AND PACKING.

Improve performance & economy NOW

POST TODAY!

Quick installation
No engine modification required

Electronics Design Associates, Dept.,
82 Bath Street, Walsall, WS1 3DE. Phone: (0922) 33652

Name
Address
EE/5

Mk. 2 DIY Ass. Kit @ £11.80

Mk. 2 Ready Built Negative Earth @ £14.97

Mk. 2 Ready Built Positive Earth @ £14.97

Ignition Changeover switches @ £4.30

R.P.M. Limit systems in above units @ £2.42

I enclose cheque/PO's for £

Cheque No.

Send SAE if brochure only required.

orchard electronics

TRANSISTORS		RESISTORS		INTEGRATED CIRCUITS	
p	p	1p	1 watt	TTL	DIGITAL
AC125 20	ASY26 30	BC132* 11	BC178B 18	BC261A 16	BC559* 9
AC126 20	ASY27 34	BC136* 12	BC179B 19	BC262A 15	BCY70 15
AC127 20	ASY28 30	BC137* 16	BC182B* 10	BC266A 18	BCY71 18
AC128 20	ASY29 34	BC138 15	BC183B* 10	BC267A 14	BCY72 14
AC132 35	ASY67 70	BC139 35	BC183L* 10	BC268B 13	BD115 60
AC141 20	BA145* 15	BC142 22	BC184* 11	BC269 13	BD121 90
AC142 17	BA154 10	BC143 24	BC184L* 11	BC287 20	BD123 90
AC151 24	BA155 12	BC147A* 9	BC186 25	BC300 26	BD132 36
AC153 27	BAX12 10	BC147B* 10	BC187 28	BC302 24	BD132 38
AC176 20	BAX13 4	BC148* 9	BC204A* 16	BC303 30	BD133 65
AC188 20	BAX16 6	BC148B* 10	BC205A* 15	BC304 27	BD135* 37
AD161 42	BC107 11	BC149B 11	BC209A* 15	BC307A* 16	BD136* 39
AD162 42	BC107A 12	BC149C* 12	BC209A* 11	BC308A* 14	BD137* 44
AF114 24	BC108 10	BC153* 18	BC208A* 11	BC309B* 16	BD138* 47
AF115 24	BC108B 11	BC154* 18	BC209B* 13	BC317A* 12	BD139* 54
AF116 24	BC109 11	BC157B* 12	BC212A* 13	BC319B* 12	BD155* 75
AF117 24	BC109B 12	BC158A* 12	BC212L* 15	BC322B* 15	BD165* 34
AF118 47	BC109C 13	BC159A* 12	BC213B* 12	BC327* 20	BD232* 70
AF124 30	BC115* 15	BC167A* 11	BC219L* 14	BC328* 18	BDY20 80
AF125 30	BC116* 15	BC168B* 14	BC214* 15	BC337* 18	BF115 22
AF126 28	BC117* 18	BC171A* 14	BC214L* 17	BC338* 16	BF154* 20
AF139 34	BC118* 10	BC172A* 15	BC237A* 16	BC461 35	BF158* 20
AF186 50	BC119 28	BC173B* 18	BC238A* 15	BC557* 9	BF159* 26
AF239 37	BC125* 14	BC177 17	BC2895* 12	BC558* 9	BF160* 20

SILICON RECTIFIERS	RESISTORS	INTEGRATED CIRCUITS	"S.A.E. for full list of components"
50V 3A 15p	1p each	TTL	"Same day despatch to Mail Order Customers"
100V 3A 15p	range	DIGITAL	"Min order £11" "p. & p. 25p" Callers Mon-Sat. incl.
200V 3A 18p	1Ω-10mΩ	7400 18p	
		7401 20p	
		7402 18p	
		7403 18p	
		7404 23p	

INTEGRATED CIRCUITS	ZENERS (400HW)	VOLTAGE REGULATORS	LED
LINEAR	BZX83/BZY88	(TO3)	125R Red 80p
709 (8 pin Dtl) 40p	3V9, 5V6, 4V7, 5V1, 5V6, 6V2, 6V5, 7V5, 8V2, 9V1, 10V, 12V, 13V, 15V, 18V, 30V.	5V 1A 175p	125A Amber 27p
741 (8 pin Dtl) 33p	All at 12p each	12V 1A 175p	125Y Yellow 27p
NE555 60p		15V 1A 175p	TIL209 Red 25p

VAT—Items marked * add 25%. Rest at 8%
Flint House, High Street, Wallingford, Oxon OX10 0DE
Tel. Wallingford (0491) 35529 Telex 4SPWALFRD 849349

TECHNICAL TRAINING IN ELECTRONICS AND TELECOMMUNICATIONS

ICS can provide the technical knowledge that is so essential to your success; knowledge that will enable you to take advantage of the many opportunities open to the trained man. You study in your own home, in your own time and at your own pace and if you are studying for an examination ICS guarantee coaching until you are successful.

- City & Guilds Certificates:**
Telecommunications Technicians
Radio, TV, Electronics Technicians
Technical Communications
Radio Servicing Theory
Radio Amateurs
Electrical Installation Work
MPT Radio Communications Certificate

- Diploma Courses:**
Colour TV Servicing
Electronic Engineering and Maintenance
Computer Engineering and Programming
Radio, TV, Audio Engineering and Servicing
Electrical Engineering, Installation and Contracting

POST OR PHONE TODAY FOR FREE BOOKLET

To: International Correspondence Schools

ICS Dept. 710S Intertext House, London SW8 4UJ or telephone 622 9911

Subject of Interest.....
Name

Address

Tel:

Veroboards are available with 0.1" x 0.1" or 0.15" x 0.15" matrix with holes, in 15 sizes. A new catalogue describing Verostrip, DIP boards, Plastic x Metal cases, Veroboxes etc is available (price 10p + S.A.E.)

VERO

VARIABLE EASY TO USE RELIABLE ORIGINAL...

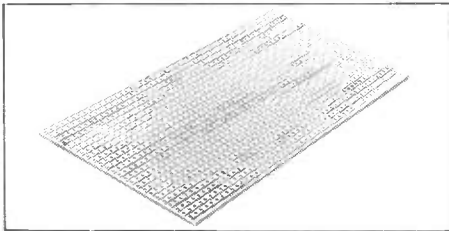

Vero Electronics Limited, Retail Dept., Industrial Estate, Chandler's Ford, Hants., SO5 3ZR Telephone: Chandler's Ford 2956 (STD 04125)

ENGINEERS

FREE



YOURSELF FOR A BETTER JOB WITH MORE PAY!

Do you want promotion, a better job, higher pay? "New opportunities" shows you how to get them through a low-cost, Home Study Course. There are no books to buy and you can pay as you learn.

This easy to follow GUIDE TO SUCCESS should be read by every ambitious engineer. Send for this helpful 44 page free book NOW! No obligation, nobody will call on you. It could be the best thing you ever did.

CHOOSE A BRAND NEW FUTURE HERE



- ELECTRICAL and ELECTRONICS
- Practical Radio & Electronics (with KIT)
- Electronic Engineering Certificate
- General Elect. Eng. Certificate
- C. & G. Elect. Installations
- Elect. Install. & Work
- C. & G. Elect. Technicians
- AUTO and AERO Motor Mechanics
- C. & G. Motor V. Mechanics
- General Auto Engineering
- A.M.I.M.I.
- Air Registration Board Certs.
- M.A.A./I.M.I. Dip.
- MECHANICAL A.M.S.E. (Mech.)
- General Mech. Eng.
- Inst. Engineers & Technicians
- Maintenance Engineering
- Welding
- MANAGEMENT and PRODUCTION Computer Programming
- Inst. of Cost & Managements Accis.
- CONSTRUCTIONAL Heating, Ventilating & Air Conditioning
- Architectural Draughtsmanship & Design
- L.I.O.B.
- Carpentry & Joinery
- Plumbing Technology
- General Building
- Painting & Decorating
- DRAGHTS-MANSHIP and DESIGN General Draughtsmanship
- A.M.I.E.D.
- Electrical Draughtsmanship



G.C.E.
—58 'O' & 'A' Level Subjects
—over 10,000 Group Passes!

Aldermaston College

Dept. TEE16 Reading RG7 4PF.
also at our London Advisory Office, 4 Fore Street Avenue, Moorgate, London EC2Y 5EJ. Tel. 01-628 2721.

NAME (Block Capitals)

ADDRESS

..... Postcode

Other subjects of interest Age

Accredited by C.A.C.C. Member of A.B.C.C.

HOME OF BRITISH INSTITUTE OF ENGINEERING TECHNOLOGY

CRESCENT RADIO Ltd.

11-15 & 17 MAYES ROAD, LONDON N22 6TL
(also) 13 SOUTH MALL, Edmonton, N.9
MAIL ORDER DEPT. 1 St Michaels Terrace Wood Green
London N22 4SJ Phone 888 3206 & MAIL ORDER 888-4474

POWER PACKS

PP1 Switched 3, 4, 6, 7, 9 and 12 volt @ 500 m/a, with on/off switch and pilot light.
Size = 130 mm x 55 mm x 75 mm
ONLY = £4.00
PP3 Car converter. From 12v Pos. or Neg to = 6-7.5-9 volt. Easy to fit and transistor regulated.
£3.90 each.
Plus 8% VAT

SCOOP PURCHASE AM—FM STEREO TUNER

We supply an AM. FM. Stereo tuner fully wired and aligned on a 6" x 4" x 1 1/4" Printed board, plus the ferrite aerial and a switch which you connect following our complete instructions. Now you only need a 9/12 Volt DC supply and you can feed this tuner into any stereo amplifier.
Fantastic Value at £7.00 + 25% VAT.

ALUMINIUM BOXES

Metal Project Boxes give your work a professional finish.

AB7	L	W	H	Price
AB7	2 1/2	5 1/2	1 1/2	54p
AB8	4	4	1 1/2	63p
AB9	4	2 1/2	1 1/2	54p
AB10	4	3 1/2	1 1/2	63p
AB11	4	2 1/2	2	54p
AB12	3	2	1	43p
AB13	6	4	2	89p
AB14	7	5	2 1/2	94p
AB15	8	6	3	99p
AB16	10	7	3	£1.35
AB17	10	4 1/2	3	£1.02
AB18	12	5	3	£1.20
AB19	12	8	3	£1.50

All size are approx and in inches.
Plus 8% VAT

P.C. ETCHING KIT

This kit contains all that the constructor will need to etch the circuits of his own design.
Contents—Plastic etching dish. Sample copper clad board. Laminate Cutter. 1 lb Ferric Chloride. Large Plastic Spoon. Etch Resist Pen. Full Etching Instructions.
Complete and Big Kit Value at £3.75p + 8% VAT.

FERRIC CHLORIDE

Anhydrous ferric chloride in double sealed one pound pld packs.
OUR PRICE — 65p + PP + 8% per lb.

2in. PANEL METERS

Size 59mm x 46mm

0.50µA —ME6	0.100mA—ME13
0.100µA —ME7	0.500mA—ME14
0.500µA —ME8	0.1A —ME15
0.1mA —ME9	0.50V —ME16
0.5mA —ME10	0.300V a.c.—ME17
0.10mA —ME11	8 meter —ME18
0.50mA —ME12	V.U. meter—ME19

£3 each. + 8%.

MINI LOUSPEAKERS

2 1/2" 80 ohm	80p
2 1/2" 40 ohm	80p
2 1/2" 8 ohm	80p
+ 25%	
I.C. SOCKETS + 8%	
D.I.L.	
8 pin—13p	24 pin—24p
14 pin—14p	28 pin—28p
16 pin—14p	36 pin—36p

U.K. CARR. 50p unless otherwise stated
All prices are excluding VAT. Please add to each item the VAT rate indicated to all orders

FANTASTIC VALUE! ONLY 40p

132 PAGES INCLUDING PROJECTS FOR YOU TO BUILD. PLUS HUNDREDS OF ILLUSTRATIONS OF COMPONENTS.

PRICES GUARANTEED FOR TWO MONTH PERIODS

FULL DETAILS AND PICTURES OF A WIDE RANGE OF COMPONENTS

SAME-DAY MAILING SERVICE!

PAGES OF TRANSISTOR AND I.C. DATA

THOUSANDS OF COMPONENTS

A BEAUTIFULLY PRODUCED BOOK!

VALUABLE DISCOUNT VOUCHERS

MAPLIN ELECTRONIC SUPPLIES

GET THIS! BOOK NOW

FROM: MAPLIN ELECTRONIC SUPPLIES
P.O. Box 3, Rayleigh, Essex.
SS6 8LR

SPECIAL! SPECIAL! SPECIAL! £8.60 INC. V.A.T. & P/P
READY MADE *ALARM CLOCK MODULE*

This is a fully constructed and tested electronic clock module as illustrated. Data sheet supplied with module shows how simple it is to connect an audible alarm, and your battery or mains radio. A smart case will be available shortly. Data sheet available separately. Please send s.a.e.

- BRIGHT 4 DIGIT 0.5 INCH DISPLAY
- FLASHING COLON (1Hz)
- SWITCH FOR DISPLAY SECONDS
- AUTOMATIC DISPLAY BRIGHTNESS (NEEDS Cds CELL)
- TIME CAN BE SET ACCURATELY TO WITHIN ONE SECOND
- LEADING ZERO BLANKING

- ALARM SET INDICATOR
- P.M. INDICATOR
- POWER FAILURE INDICATION
- SLEEP TIMER
- SNOOZE TIMER

