

Practical projects to build at home

JAN. 76
30p

everyday electronics

Time marches on!

EASY TO BUILD **DIGITAL CLOCK**



**ALL IN
THIS
ISSUE!**

**4 EXCITING DESIGNS for
HOME CONSTRUCTORS**
PLUS MANY FEATURES TO INTEREST THE BEGINNER



**RADIO CONTROL
TRANSMITTER**

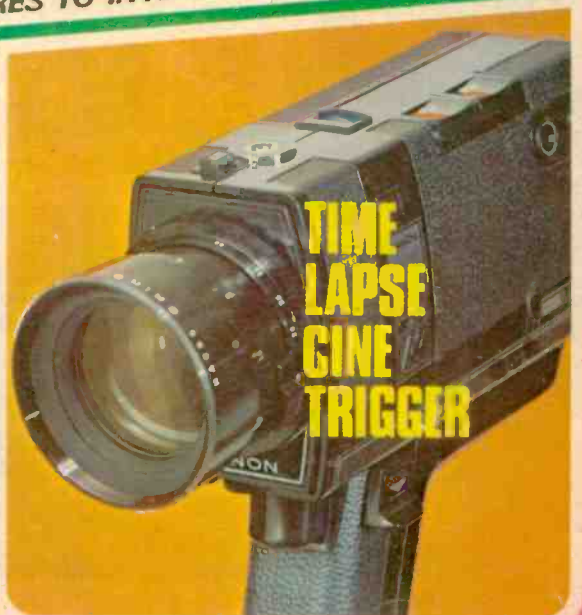

RADIO EXCHANGE LTD.

ALL PRICES INCLUDE VAT
We regret we cannot for the time being accept Overseas Orders. Open to U.K. and Ireland residents only.

NEW EDU-KIT MAJOR

Completely Solderless Construction Kit. Build these projects without soldering iron or solder

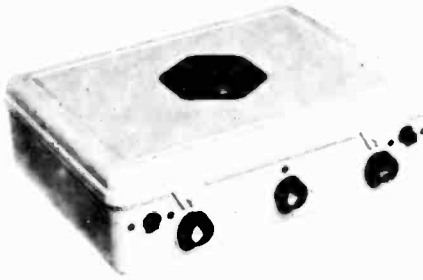

- ★ 4 Transistor Earpiece Radio.
- ★ Signal Tracer.
- ★ Signal Injector.
- ★ Transistor Tester NPN-PNP.
- ★ 4 Transistor Push Pull Amplifier.
- ★ 5 Transistor Push Pull Amplifier.
- ★ 7 Transistor Loudspeaker Radio MW/LW.
- ★ 5 Transistor Short Wave Radio.
- ★ Electronic Metronome
- ★ Electronic Noise Generator.
- ★ Batteryless Crystal Radio.
- ★ One Transistor Radio.
- ★ 2 Transistor Regenerative Radio.
- ★ 3 Transistor Regenerative Radio.
- ★ Audible Continuity Tester.
- ★ Sensitive Pre-Amplifier.

Components Include: 24 Resistors ● 21 Capacitors ● 10 Transistors ● 31" Loudspeaker ● Earpiece ● Mica Baseboard ● 3 1/2 way connectors ● 2 Volume controls ● 2 Slider Switches ● 1 Tuning Condenser ● 3 Knobs ● Ready Wound MW/LW/SW Coils ● Ferrite Rod ● 6 1/2 yards of wire ● 1 Yard of sleeving etc. ● Complete kit of parts including construction plans.

Total Building Costs **£9.99** P & P 65p

ELECTRONIC CONSTRUCTION KITS

ECK 1

3 Transistor Easy Stage Earpiece Receiver Kit. Full Medium Wave Coverage. Complete with Ready Wound Ferrite Rod Aerial. High Efficiency Air Spaced Tuning Capacitor. Sensitive Crystal Earpiece and Gain Control. Operates from a 9 Volt P.P.7 Battery (not supplied with kit). This Electronic Construction Kit is a good starter for those interested in kit building and soldering. Complete kit of parts including construction plans. **£4.50** P.P. and Ins. 45p.

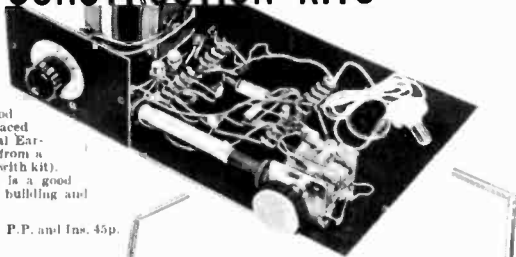

ECK 2

Self Contained Multi-Band V.H.F. Receiver Kit. 8 Transistors and 3 Diodes. Push/Pull output. 3" Loudspeaker. Gain Control. Superb 9 section swivel ratchet and retractable chrome plated telescopic aerial. V.H.F. Tuning Capacitor. Resistors, Capacitors, Transistors, etc. Will receive T.V. Sound, Public Service Band, Aircraft, V.H.F. Local Stations, etc. Operates from a 9 Volt P.P.7 Battery (not supplied with kit). Complete kit of parts including construction plans. **£7.95** P.P. and Ins. 55p.

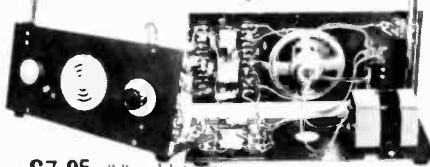

ECK 3

5 Transistor Medium Wave Receiver Kit. Class "A" Output with 3 1/2" Loudspeaker. Simple to operate with full Medium Wave Coverage. Ready Wound 8" Ferrite Rod Aerial. No external Aerial required. 7 stages, 5 Transistors and 2 Diodes, Tuning Capacitor, Gain Control, etc. Operates from a 4 1/2 Volt Battery (not supplied). Complete kit of parts including construction plans. **£5.40** P.P. and Ins. 45p.



ECK 4

7 Transistors, 6 tuneable wavebands, MW, LW, Trawler Band, 3 Short Wave Bands. Receiver Kit. With 5" x 3" Loudspeaker. Push/Pull output stage. Gain Control, and Rotary Switch. 7 Transistors and 4 Diodes. 8 section chrome-plated telescopic aerial. 8" Sensitive Ready Wound Ferrite Rod Aerial. Tuning Capacitor, Resistors, Capacitors, etc. Operates from a 9 Volt P.P.7 Battery (not supplied with kit). Complete kit of parts including construction plans. **£7.25** P.P. and Ins. 55p.

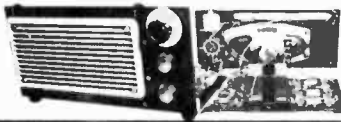

EDU-KIT JUNIOR

Completely Solderless Electronic Construction Kit. Build these projects without Soldering Iron or Solder.

- *Crystal Radio Medium Wave Coverage—No Battery necessary.
- *One Transistor Radio.
- *2 Transistor Regenerative Radio.
- *3 Transistor Earpiece Radio Medium Wave Coverage.
- *4 Transistor Medium Wave Loudspeaker Radio.
- *Electronic Noise Generator.
- *Electronic Metronome.
- *4 Transistor Push/Pull Amplifier.

All parts including Loudspeaker, Earpiece, MW Ferrite Rod Aerial, Capacitors, Resistors, Transistors, etc. Complete kit of parts including construction plans

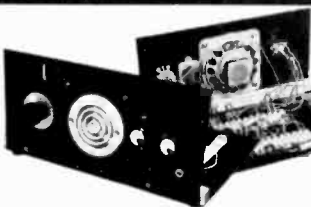

£7.50 P.P. and Ins. 45p

VHF AIR CONVERTOR KIT

Build this Converter Kit and receive the Aircraft Band by placing it by the side of a radio tuned to Medium Wave or the Long Wave Band and operating as shown in the instructions supplied free with all parts. Uses a retractable chrome plated telescopic aerial, Gain Control, V. H. F. Tuning Capacitor, Transistor, etc.



All Parts Including Case and Plans. **£4.35** P.P. and Ins. 40p

ROAMER TEN MARK 2

With VHF including aircraft

Now with free earpiece and switched socket. 10 Transistors. Latest 4" 2 watt Ferrite Magnet Loudspeaker. 9 Tuneable Wavebands, MW1, MW2, LW, SW1, SW2, SW3, Trawler Band, VHF and Local Stations also Aircraft Band. Built in Ferrite Rod Aerial for MW/LW. Chrome plated 4 section Telescopic Aerial can be angled and rotated for peak short wave and VHF listening. Push/Pull output using 600mW Transistors. Car Aerial and Tape Record Sockets. 10 Transistors plus 3 Diodes, Ganged Tuning Condenser with VHF section. Separate coil for Aircraft Band. Volume on/off. Wave Change and tone Controls. Attractive Case in black with silver blocking. Size 9" x 7" x 4". Easy to follow instructions and diagrams. Parts price list and plans 50p free with parts.

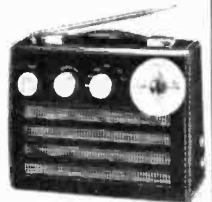

Total building costs **£11.87** P.P. and Ins. 65p

RADIO EXCHANGE LTD.

TO RADIO EXCHANGE LTD., 61A HIGH STREET, BEDFORD MK40 1SA. Tel: 0234 52367, REG NO. 788372

- * Callers side entrance "Lavells" Shop.
- * Open 10-1, 2.30-4.30. Mon-Fri. 9-12 Sat.

I enclose £..... for
Name
Address

EE 1



I can just imagine the old chap bawling at Rudolph "Here's another nice mess you've landed us in!" And there's Rudolph smirking all over his face, fondly imagining he's another Biggles. They've certainly a lot of ground to cover to deliver all those toys, not to mention all those gorgeous Home Radio Components Catalogues!

Don't worry . . . they'll soon carry out some make-shift repairs and your catalogue will arrive on time. That is, assuming you have ordered one! You *have* ordered one . . . haven't you? If not, please order right away. It certainly is the most useful present you could give the electronics enthusiast. So, if you have a son, grandson or nephew who's

been bitten by the electronics bug, just send them one, and then every time they use it (which will be often) they'll think "what a clever feller you are!"

Of course, you already own one yourself? No? Then treat yourself right away . . . you deserve it! The catalogue has 240 pages listing about 6,000 items, of which nearly 2,000 are illustrated. The cost for that little lot is 85p plus 45p postage and packing, but the catalogue has 14 vouchers, which when used as directed enable you to claim back 70 pence. Send the coupon below, with your cheque or P.O. for £1.30 today.

I showed this advert to my grand-daughter and she asked "Is a victory roll something you eat?" It therefore occurred to me that the point of the cartoon might escape our younger readers, so here is the explanation. During World War Two, if one of our fighter pilots shot down an enemy aircraft, when he returned to base he did a slow roll over the aerodrome before landing; hence the term "Victory Roll."



**A Happy
Christmas
to all our
readers.**

Please write your Name and Address in block capitals

NAME

ADDRESS



HOME RADIO (Components) LTD., Dept. EE,
234-240 London Road, Mitcham, Surrey CR4 3HD

(Regn. No
London 912966)

HOME RADIO (Components) LTD, Dept EE, 234-240 London Road, Mitcham, CR4 3HD Phone 01-648 8422

Sparkrite mk2

The tried, tested, proven, reliable, complete, professional, capacitive discharge,

Electronic Ignition Kit

Sparkrite was voted best of 8 systems tested by Popular Motoring Magazine



Sparkrite MK2 is a high performance, high quality, capacitive discharge electronic ignition system. Because of the superb design of the Sparkrite circuit it completely eliminates problems of the contact breaker. There is no misfire because contact breaker bounce is eliminated electronically by a pulse suppression circuit which prevents the unit firing if the points bounce open at high R.P.M. Contact breaker burn is eliminated by reducing the current to about 1/50th of the norm. It will perform equally well with new, old, or even badly pitted points and is not dependent upon the dwell time of the contact breakers for recharging the system. Sparkrite incorporates a short circuit protected inverter which eliminates the problems of SCR lock on and therefore eliminates the possibility of blowing the transistors or the SCR. (Many capacitive discharge ignitions are not completely foolproof in this respect.) Sparkrite can therefore give you: up to 20% better fuel consumption, instant all weather starting, cleaner plugs—they last up to 5 times longer without attention, faster acceleration, higher top speeds, longer coil and battery life, efficient fuel burning and less air pollution, smoother running, continual peak performance. **THE KIT COMPRISES EVERYTHING NEEDED.** Ready drilled pressed steel case coated in matt black epoxy resin, ready drilled base and heatsink,

top quality 5 year guaranteed transformer and components, cables, coil connectors, printed circuit board, nuts, bolts, silicon grease, full instructions to make the kit negative or positive earth, and 10 page installation instructions.

OPTIONAL EXTRAS

Electronic R.P.M. limitation. This can be included in the unit to prevent over revving, an advantage to most companies, hire firms, high performance drivers etc.

Electronic/conventional ignition switch. Gives instant changeover from "Sparkrite" ignition to conventional ignition for performance comparisons, static timing etc., and will also switch the ignition off completely as a security device. Includes: switch, connectors, mounting bracket and instructions. Cables excluded.

PRICES

D.I.Y. assembly kit £10-93 incl. V.A.T. post and packing. Ready built unit £13-86 incl. V.A.T. post and packing. (Both to fit all vehicles with coil/distributor ignition up to 8 cylinders.)

Switch for instant changeover from "Sparkrite" ignition to conventional ignition £2-79 incl. V.A.T. post and packing. R.P.M. limiting control £2-42 incl. V.A.T. post and packing. (Fitted in case on ready built unit, dashboard mounting on kit.)

CALLERS WELCOME

ORDER NOW

To ELECTRONICS DESIGN ASSOCIATES DEPT EE1
82 Bath Street, Walsall, WS1 3DE.
Phone 33652.

From Name

Address

Qty.

Sparkrite Mk 2 DIY Ass. kits @ £10-93

Sparkrite Mk 2 Ready Built Negative earth @ £13-86

Sparkrite Mk 2 Ready Built Positive earth @ £13-86

Ignition changeover switches @ £2-79

R.P.M. Limit systems in the above units @ £2-42

I enclose cheque/P.O.s for £.....

Cheque No.

(Send SAE if brochure only required)

ELECTROVALUE

The good components service

In relatively few years, Electrovalue has risen to a position of pre-eminence as mail-order (and industrial) suppliers of semi-conductors, components, accessories, etc. There are wide ranges and large stocks to choose from as well as many worthwhile advantages to enjoy when you order from Electrovalue.

CATALOGUE 8 NOW READY

Enlarged to 144 pages. New Items. Opto-electronics. Diagram of components, applications, I.C. circuits, etc. Better than even No. 7. Post free 40p, including voucher for 40p for use on order over £5 list value.

DISCOUNTS

On all C.W.O. mail orders, except for some items marked NETT.
5% on orders list value 10% on orders list value
£10 or more £15 or more

FREE POST & PACKING

On all C.W.O. mail orders in U.K. over £2 list value. If under, add 10p handling charge.

PRICE STABILIZATION POLICY

Prices are held and then reviewed over minimum periods of 3 months—With effect from Feb 1st 1975.

QUALITY GUARANTEE

On everything in our Catalogue—No manufacturer's rejects, seconds or sub-standards merchandise.

ELECTROVALUE LTD

All communications to Dept. 3/1, 28, ST. JUDES ROAD, ENGLEFIELD GREEN, EGHAM, SURREY TW20 0HB, Telephone Egham 3603, Telex 284475. Shop hours 9-5.30 daily, 9-1 pm Sats.

NORTHERN BRANCH: 680, Burnage Lane, Burnage, Manchester M19 1NA, Telephone (061) 432 4945. Shop hours Daily 9-5.30 pm, 9-1pm Sats.

ENGINEERS

FREE

YOURSELF FOR A

BETTER JOB WITH MORE PAY!

Do you want Promotion, a better job, higher pay? "New Opportunities" shows you how to get them through a low-cost home study course. There are no books to buy and you can pay-as-you-learn.

This helpful guide to success should be read by every ambitious engineer. Send for this helpful 76 page FREE book now. No obligation and nobody will call on you. It could be the best thing you ever did.



This 76 page FREE book shows how!



CUT OUT THIS COUPON

CHOOSE A BRAND NEW FUTURE HERE!

Tick or state subject of interest. Post to the address below.

- | | | |
|--|---|---|
| <input type="checkbox"/> Electrical Engineering | <input type="checkbox"/> Colour T.V. Servicing | <input type="checkbox"/> CITY AND GUILDS Installations and Wiring |
| <input type="checkbox"/> Electrical Installations and Wiring | <input type="checkbox"/> C & G Radio, T.V. and Electronic Mechanics | <input type="checkbox"/> CITY AND GUILDS Electrical Technicians |
| <input type="checkbox"/> Electrical Draughtsmanship | <input type="checkbox"/> General Radio and TV Engineering | <input type="checkbox"/> CITY AND GUILDS Telecommunications |
| <input type="checkbox"/> Electrical Mathematics | <input type="checkbox"/> Radio Servicing, Maintenance and Repairs | <input type="checkbox"/> Radio Amateurs' Exam. etc. etc. |
| <input type="checkbox"/> Electronic Engineering | <input type="checkbox"/> Transistor Technology | |
| <input type="checkbox"/> Computer Prog | | |

To: ALDERMASTON COLLEGE
DEPT. EEV 13 READING RG7 4PF

Also at our London Advisory Office, 4 Fore Street Avenue
Moorgate, London EC2Y 5EJ. Tel: 01-628 2721.

NAME (Block Capitals Please)

ADDRESS

POSTCODE

Other subjects

Accredited by C.A.C.O.

Member of A.B.C.C.

HOME OF BRITISH INSTITUTE OF ENGINEERING TECHNOLOGY

BI-PRE-PAK

The people for component bargains



Makers of Stirling Sound audio equipment

ORIGINATORS OF PRE-PACKED COMPONENTS IN BRITAIN — AND STILL LEADING!

GREAT XMAS OFFER!

BATT/MAINS STEREO F.M. TUNER/AMPLIFIER

£18 TO SHOW YOU A SAVING OF £12

if you buy all 4 units together. Bought singly you still save 33% off regular advertised price of each unit

A Bi-Pre-Pak Super Special!

- ★ TOTAL VALUE £30 —YOU PAY £18.00
- ★ PRICES INCLUDE V.A.T. AND POSTAGE AND PACKING IN U.K.
- ★ SATISFACTION GUARANTEED
- ★ ORDER NOW—DELIVERY BY RETURN

1 F.M. TUNER FRONT-END

Ganged tuning; A.F.C. facility. Reduction-g geared drive, 88-108 MHZ. Usual price inc. VAT £8.01

£5.34

2 I.F. BOARD

Using I.C. Designed for use with above front-end.

Usual price inc. VAT £6.76

£4.50

3 STEREO DECODER, using I.C.

Designed for use with the above modules, can also be used with other mono F.M. tuners. Ready aligned. (L.E.D. for stereo beacon available at 20p) usual price inc. VAT £7.22

£4.82

4 5+5 WATT MUSIC POWER I.C. AMP

Useful stereo power amplifier with good performance, at economy price. Usual price inc. VAT £8.01

£5.34

TOTAL VALUE AT REGULAR ADVERTISED PRICE £30.00

SPECIAL OFFERS

LM 380 AUDIO IC (Marked SL60745). Brand new and to spec. 3 watts R.M.S. out. With data, 75p

Three **SN7490**. Brand new I.C. to spec. decade counters only £1.20*

Five **SN7400** Quad 2 input NAND gate ICs. Only 60p*

SUNDRY

P.I PAK—Approx. 170 short-lead semi-conductors and components. PNP, NPN, diodes, rectifiers, etc. on PCBs. At least 30% factory marked. Some data supplied. 50p*
UHF 625 line tuner, rotary. £2.50
Rev Counter (for cars) (8%). £1.99*
Books by Bernard's Publications, Newnes-Butterworth's etc. No VAT.

THE FREE CATALOGUE

New edition better than ever. It's yours for free and well worth getting—only please send large S.A.E. with 10p stamp if we have to post it to you.

NOW READY

TERMS OF BUSINESS:

VAT at 25% must be added to total value of order except for items marked * or (%), when VAT is to be added at 8%. No VAT on overseas orders. POST & PACKING add 25p for UK orders unless marked otherwise. Minimum mail order acceptable—£1. Overseas orders, add £1 for postage. Any difference will be credited or charged. PRICES subject to alteration without notice. AVAILABILITY All items available at time of going to press when every effort is made to ensure correctness of information.

NEW RANGE B-P-P TRANSISTOR & COMPONENT PACKS

TP SELECTION

TP19 100 diodes, mixed Germanium, Gold-bonded, etc. Marked/Unmarked.

TP21 30 short lead (6mm approx.) transistors, NPN silicon planar types. Ex-radio mfrs, all good, but production line changes.

TP23 Twenty NPN Silicon uncoated TO5. Similar to BFY50/2, 2N696, 2N1613, etc. Complementary to TP24.

TP24 Twenty PNP Silicon, uncoated TO5. Similar to BFY64, 2N2904/5

TP29 8 power diodes 400V, 1-25A Silicon FST 3/4.

UT SELECTION

UT1 50 PNP's Germanium, AF & RF.
UT2 150 Germanium diodes, min. glass.

UT4 100 Silicon diodes, min. glass, similar to IN914, IN916.

UT5 40 250mW Zener diodes OAZ24 range; average 50% good.

UT7 30 Silicon rectifiers 750mA, mixed voltages, Top Hats, etc.

UT9 40 NPN Silicon planars. Similar to 2N3707-11 range. Low noise amps.

UT12 25 2N3702/3 Transistors, PNP Silicon, Plastic to 92.

CP SELECTION

CP1 Mixed bag of capacitors—Electrolytic, Paper, Silver Mica (Approx. 150—sold by weight).

CP2 200 (approx.) Resistors, various types, values, watts. (Sold by weight.)

CP3 40 Wire wound resistors, mixed.

CP4 12 pots—pre-set, w/wound; carbon, dual, with/without switches—all mixed.

CP7 Heat sinks, assorted. To fit SO-Z (OC72) TO-1 (AC128), etc.

ALL ABOVE PACKS—60p EACH.

TP Tested & Guaranteed; UT Untested, unmarked; CP Components.

CAPACITOR DISCHARGE IGNITION KIT

Simple to assemble and fit. Improves car performance, saves on fuel. P&P 50p. £7.50*

BI-PRE-PAK X-HATCH GENERATOR MK.2



Four-pattern selector switch
3" x 5 1/2" x 3"
Ready-built
and tested
in kit form
Please add 50p for postage and packing

is invaluable to industrial and home user alike. Improved circuitry assures reliability and still better accuracy. Very compact, self-contained. Robustly built. Widely used by TV rental and other engineers. With reinforced fibreglass case, instructions, but less batteries. (Three U2 type required.)

TV SIGNAL STRENGTH METER

Complete kit as described in "Television" £19.50 plus 40p* for P&P

SS300 POWER SUPPLY STABILISER

Add this to your unregulated supply to obtain a steady working voltage from 12 to 50V for your audio system, workbench etc. Meters can be easily added. £3.25*

PLASTIC POWER TRANSISTORS

40 WATT SILICON*			
Type	Polarity	Gain	VCE Price
40N1	NPN	15	15 20p
40N2	NPN	40	40 30p
40P1	PNP	15	15 20p
40P2	PNP	40	40 30p

90 WATT SILICON*			
Type	Polarity	Gain	VCE Price
90N1	NPN	15	15 25p
90N2	NPN	40	40 35p
90P1	PNP	15	15 25p
90P2	PNP	40	40 35p

★ PHONE · WRITE · CALL WITHOUT DELAY

GIVE US YOUR ACCESS NO. and we will do the rest!

If you prefer not to cut coupon out, please mention EE16 when writing

To BI-PRE-PAK, 224-226 WEST RD., WESTCLIFF-ON-SEA, ESSEX

Please send

for which I enclose inc. V.A.T.

Name

Address

EE16

BI-PRE-PAK LTD

Reg. No. 1057114

222, 224 WEST ROAD, WESTCLIFF-ON-SEA, ESSEX SSO 0DF.

TELEPHONE: SOUTHEND (0702) 46344.

GET THE NAME AND ADDRESS RIGHT WHEN ORDERING

Everyday Electronics, January 1976

CRESCENT RADIO LTD.

11-15 & 17 MAYES ROAD, LONDON N22 6TL
(also) 13 SOUTH MALL, EDMONTON, N.9

MAIL ORDER DEPT.

1 St Michaels Terrace Wood Green London N22 4SJ
Phone 888 3206 & MAIL ORDER 888-4474

ABS PLASTIC BOXES

Handy boxes for construction projects. Moulded extrusion rails for P.C. or ohmastic panels. Fitted with 1mm front panels.

1006-105mm x 73mm x 46mm - 85p.
1006-150mm x 74mm x 47mm - 75p.
1007-135mm x 124mm x 60mm - 81.55
1021-106mm x 74mm x 45mm - 65p.
(sloping front) Plus 8% VAT

CLEAR PLASTIC PANEL METERS

Size 50mm x 46mm x 35mm these meters require a 38mm hole for mounting.

ME6 - 0 to 50 micro amp Full Scale
ME7 - 0 to 100 micro amp
ME8 - 0 to 500 micro amp
ME9 - 0 to 1mA
ME10 - 0 to 5mA
ME11 - 0 to 10mA
ME12 - 0 to 50mA
ME13 - 0 to 100mA
ME14 - 0 to 500mA
ME15 - 0 to 1 amp
ME16 - 0 to 50 volts
ME17 - 0 to 300 volts A.C. Full Scale
ME18 - "8" Meter



"VU" Meter
OUR PRICE
88.00
Plus 8% VAT

LOW VOLTAGE AMPLIFIER

5 transistor amplifier complete with volume control, is suitable for 9V d.c. and a.o. supplies. Will give about 1W at 8 ohm output. With high IMP input this amplifier will work as a record player, baby alarm, etc., amplifier. Plus 25% VAT £2.00



P.C. ETCHING KIT

This kit contains all that the constructor will need to etch the circuits of his own design.

Contents—Plastic etching dish. Sample copper clad board. Laminate Cutter. 1 lb Ferric Chloride. Large Plastic Spoon. Etch Resist Pen. Full Etching Instructions.

Complete and Big Kit Value at £3.75p + 8% VAT.

FERRIC CHLORIDE

Anhydrous ferric chloride in double sealed one pound pld packs.
OUR PRICE - 65p + PP + 8% per lb.

3 KILOWATTS PSYCHEDELIC LIGHT CONTROL UNIT

Three Channel: Haas—Middle—Trebble. Each channel has its own sensitivity control. Just connect the input of this unit to the loudspeaker terminals of an amplifier, and connect three 250V up to 1000W lamps to the output terminals of the unit, and you produce a fascinating sound-light display. (All guaranteed.)

£18.50 plus 75p P. & P.
Plus 8% VAT

POWER PACKS

PP1 Switched 3, 4, 6, 7, 9 and 12 volt @ 500 mA, with on/off switch and pilot light.
Size - 130 mm x 85 mm x 75 mm
ONLY - 84.00

PP2 Switched 6-7.5-9 volt Battery Eliminator. Approx size 2 1/2" x 2 1/2" x 3 1/2". Ideal for cassette recorders. £8.55 each.

PP3 Car converter. From 12v Pos. or Neg to - 6v-7.5-9 volt. Easy to fit and transistor regulated.
£8.90 each.
Plus 8% VAT

U.K. CARR. Send 30p for a 50p unless otherwise stated CRESCENT CATALOGUE

LOW PRICE TRANSISTORS

BF305B-15p TIP42A-75p
AC142K-25p OC75-25p
BC149B-15p AA129-6p

Plus 25% VAT

IC EXTRACTION TOOL

Saves damage to valuable ICs.
Only 40p + 8% VAT

ANTEX SOLDERING IRONS AND SPARES

X25 25 watt. £2.45
X25 Spare Element £1.80
X25 Spare Bits No. 50, 51, 32 44p each
C240/2 15 watt. £2.45
C240/2 Spare Element £1.10
C240/2 Spare Bits No. 2, 3, 6 33p each
873. Soldering Iron Stand suitable for all models. £1.10
Plus 8% VAT

ALUMINIUM BOXES

Metal Project Boxes give your work a professional finish.

	L	W	H	Price
AB7	2 1/2	5 1/2	1 1/2	64p
AB8	4	4	1 1/2	68p
AB9	4	2 1/2	1 1/2	64p
AB10	4	5 1/2	1 1/2	68p
AB11	4	2 1/2	2	64p
AB12	3	2	1	45p
AB13	6	4	2	68p
AB14	7	5	2 1/2	84p
AB15	8	6	3	89p
AB16	10	7	3	£1.85
AB17	10	4 1/2	3	£1.95
AB18	12	5	3	£1.20
AB19	12	8	3	£1.50

All size are approx and in inches.

Plus 8% VAT

SCOOP PURCHASE AM-FM STEREO TUNER

We supply an AM, FM, Stereo tuner fully wired and aligned on a 6" x 4" x 1 1/2" Printed board, plus the ferrite aerial and a switch which you connect following our complete instructions. Now you only need a 9/12 Volt DC supply and you can feed this tuner into any stereo amplifier.

Fantastic Value at £7.00 + 25% VAT.

TELESCOPIC AERIAL

Nine section fully swivelling telescopic aerial with 4BA single bolt fixing or two hole fixing bracket. Fully extended - 43". Fully closed - 7".
Our Price - 50p + P/P + VAT @ 8%

CABLELESS SOLDERING IRON WAHL "ISO-TIP"

★ Completely Portable
★ Solders up to 150 joints per charge
★ Re-charges in its own stand
★ Fine tip for all types of soldering
★ Only 9" long and weighs just 6 ozs.
Our Price £9.75. Plus 8% VAT
(Spare bits are available)

12-0-12 VOLT 500mA/240 VOLT PRIMARY TRANSFORMER

approx. size - 60mm x 40mm x 50mm. Fixing centres - 75mm.
A REAL BARGAIN AT £1.80 each.
Plus 8% VAT

LOW NOISE LOW PRICE CASSETTES

Good quality tape in well made screw type cassettes. Presented in single plastic cases.
C80-81p
C90-85p
C120-83p
10% discount on ten or more cassettes of one type Plus 8% VAT

All prices are excluding VAT. Please add to each item the VAT rate indicated to all orders

CJL

CJL LTD. P.O. BOX 34, CANTERBURY, CT1 1YT

ALL PRICES INCLUDE P&P AND V.A.T.

AERIALS Telescopic, 15-120 cm £1.50
KEYNECTORS Rapid connect to mains. Built-in piano switches, neon & 13A fuse £3.55
MULTIMETERS Vdc/ac-10, 50, 250, 1,000, Idc-0.1A, R-150k £4.95
PRINTED CIRCUIT KITS Contain all items necessary to produce printed circuits £3.99
SIGNAL INJECTORS Audio through video signals, ideal servicing amplifiers, radio and tv £4.25
TEST SWITCHES 5 miniature push to test switches £1.00

AUDIO LEADS
5p din plug to 5p din plug, 1.5m £1.20
2p din plug to 2p din skt, 10m £1.45
5 pin din plug to 2 phono plugs £1.20

BIB HI-FI ACCESSORIES
Groov-Kleens /42 £1.95
1/2" Tape Editing Kits /23 £1.50
Cassette Editing Kits /24 £1.65
Cassette Head Cleaners /31 £0.65
Hi-Fi Stereo Test Cassette £2.15
Cassette Wallets (hold 6) £0.90

CASSETTE HEAD DEMAGNETISER
Shaped pole piece-saves time £3.65

EARPHONES Stethoscope style, 8 ohm dynamic £1.20
Crystal earphone-lead & plug £0.65

INTERCOMS 2-station, ideal for the home-baby alarm, office, with cable and staples £6.35

MICROPHONES Dynamic, remote start/stop, 200 ohms, 100-10kHz 6mV output £2.15

STEREO HEADPHONES Supero stereo listening in comfort and privacy. 30-15kHz, 8 ohms £4.85
STEREO HEADPHONE JUNCTION BOXES 3 way unit selects phones only, speakers only or both £2.30

STEREO PRE-AMPLIFIERS
3-30mV, RIAA, Out: 200-800mV flat, 20-20kHz. Supply: PP3 £7.30

SPEAKERS Miniature, 75mm dia, 8 ohms £0.95

SOLDERING IRONS (ANTEX)
15W, 'C' miniature irons, slide on & off 3/32" bit £2.30
3/32", 1/8", 3/16", bits-each £0.45
'C' Elements £1.10

25W, X25 irons, low leakage, slide on & off 1/8" bit £2.30
3/32", 1/8", 3/16", bits-each £0.40
X25 Elements £1.15

Soldering Kits, SK1, 'C' Iron, 2 spare bits 3/32" & 5/32", heat sink, solder, base, booklet £3.85
Stands, ST3, High grade base, spring, sponges, accommodation-spare bits £1.10

SOLDER -in handy Bib dispenser £0.43

TRY SQUARES
10 tools in one-ideal-marking out Cabinets, Chassis, PCB's £2.50

WIRE STRIPPERS & CUTTERS
Bib 8B, 8 gauge selector, automatic opening, easy grip handles £0.85

FOOT SWITCHES
Push on/off, Anti skid £2.70

A hobby that pays big salaries.

Enrol in the BNR & E School and you'll have an entertaining and fascinating hobby. Stick with it and the opportunities and the big money await the qualified man in every field of Electronics today. We offer the finest home study training for all subjects in radio, television, etc., especially for the CITY AND GUILDS EXAMS (Technicians' Certificates); the Grad. Brit. I.E.R. Exam; the RADIO AMATEUR'S LICENCE; P.M.G. Certificates; the R.T.E.B. Servicing Certificates; etc Also courses in Television; Transistors; Radar; Computers; Servo-mechanisms; Mathematics and Practical Transistor Radio course with equipment. We have OVER 20 YEARS' experience in teaching radio subjects and an unbroken record of exam successes. We are the only privately run British home study College specialising in electronics subjects only. Fullset details will be gladly sent without any obligation.

BRITISH NATIONAL RADIO & ELECTRONICS SCHOOL, Dept EEC 16

P.O.Box 156, Jersey, Channel Islands.

NAME _____

ADDRESS _____

(Block caps please)

HIGH POWER BATTERY MOTOR

12v operated strong enough to power a go-cart or similar. Speed easily variable. These motors can also be used as a brake for any rotating machine simply by coupling the spin due to the machine and short-circuiting the windings by a variable resistance. Price £2-50 + post and VAT. 74p. *D1770* but 6/12v even more powerful as it is larger and is series wound £2-50 + 85p post and VAT.

PERMEABILITY TUNERS

M.W. two stage ideal for use with ZN414 or similar circuit. Price 15p each + post and VAT 15p.

MAINS TRANSISTOR PACK

Designed to operate transistor sets and amplifiers. Adjustable output 6v, 9v, 12v volts for up to 500mA (class B working). Takes the place of any of the following batteries: PP1, PP3, PP4, PP6, PP7, PP9 and others. Kit comprises: main transformer rectifier, smoothing and load resistor, condensers and instructions. Real snip at only £1-50. VAT + postage 60p.

NUMICATOR TUBES

For digital instruments, counters, timers, clocks, etc. Hi-vac XN11 Price 80p each, 20p Post and VAT.

DC HIGH CURRENT PANEL METERS

3 1/2" round wide angle 240 movement meters, flush mounting fitted with external shunts, made by Crompton Parkinson, brand new, still in maker's cartons. These are a real bargain at £2-50 each. Reasonable quantities available in the following ranges 0-10 amps, 0-20 amps, 0-30 amps, 0-40 amps, 0-50 amps. Post and VAT 80p each.

CONTROL DRILL SPEEDS

DRILL CONTROLLER
Electronically changes speed from approximately 10 revs. to maximum. Pull power at all speeds by finger-tip control. Kit includes all parts, case, everything and full instructions. £2-50 plus 45p post + VAT. Add 10p model also available.



TAPE DECK

In metal case with carrying handle, heavy flywheel and capstan drive. Tape speed 3 1/2. Mains operated on metal platform with tape head and guide. Not new but guaranteed good working order. Price £1-50 plus VAT and Postage £1-50.

SOUND TO LIGHT UNIT

Add colour or white light to your amplifier. Will operate 1, 2 or 3 lamps (maximum 450w). Unit in box all ready to work. £7-95 plus 95 VAT and postage.

OVEN THERMOSTAT

Made by the famous Diamond H Company, this has a sensor joined by a capillary to a variable control and when fitted with a knob is ideal for many ovens or processes, 60p each + post and VAT 15p.

MAINS TRANSFORMERS

All standard 230-250 volt primaries	amp	£ p
1v	1 amp (special)	1-78
2-4v	5 amp	0-85
6-3v	2 amp	1-25
6-3v	3 amp	1-75
9v	1 amp	0-95
9v	3-5 amp	2-50
12v	1 1/2 amp	1-50
12v	1 amp	1-00
6-5v-0-6-5v	1 amp	1-50
18v	1 amp	1-50
24v	2 amp	2-25
24v	3 amp	2-60
12-0-12v	50mA	1-20
6-0-6v	50mA	1-20
6-0-8v	1 amp	1-50
18-0-18v	2 amp	3-30
25v	1 1/2 amp	1-95
0-5v 2 amp & 0-5v	1 amp	4-50
6-0v 5 amp & 8v	1 amp	7-50
27v	8 amp	4-50
30v	37 amp	23-00
80v tapped 75v & 70v	4 amp	5-80
230v-80mA & 8-3v	1-5 amp	1-75
27-0-27-5v at 50mA & 60v	3 amp	2-25
EHT Transformer 5000v		
23mA	(intermittent)	5-00
Charger Transformers		
6v and 12v	2 amp	1-50
6v and 12v	3 amp	2-25
6v and 12v	5 amp	3-50

Add 30p per £ to cover postage and VAT 25%.

HONEYWELL PROGRAMMER

This is a drum timing device, the drum being calibrated to equal divisions for switch-setting purposes with trips which are infinitely adjustable for position. They are also arranged to allow 2 operations per switch per rotation. There are 15 changeover micro switches each of 10 amp type operated by the trips, thus 15 circuits may be changed per revolution. Drive motor is mains operated 5 revs per min. Some of the many uses of this timer are Machinery control, Boiler firing, Dispensing and Vending machines, Display lighting animated and signs, Signalling, etc. Price from makers probably over £20 each. Special snip price £9-95. £11-00 Post and VAT. Don't miss this terrific bargain.

BREAK-DOWN UNIT

Contains hundreds of useful parts some of which are as follows—66 silicon diode equivalent OA81, 68 resistors, mostly 4 watt 5%, covering a wide range of values 4 x 1 mfd 400v mid condensers, 15 x 0.1 mfd 100v condensers, 2 RF chokes 8 x B9 valve holders, 1 x 4H choke, 1 x 115v transformer, 1 boxed unit containing 4 delay lines also tag panels, trimmer condensers, suppressors, etc., on a useful chassis sized approx 9" x 5" x 7". Only 75p (the 66 diodes would cost at least 10 times this amount). This is a snip not to be missed. Post and VAT 75p.

HORSTMANN 24-HOUR TIME SWITCH

With 6 position programmer. When fitted to hot water systems this could programme as follows:

Programme	Hot Water	Central Heating
0	Off	Off
1	Twice Daily	Off
2	All Day	Off
3	Twice Daily	Twice Daily
4	All Day	All Day
5	Continuously	Continuously

Suitable, of course, to programme other than central heating and hot water; for instance, programme upstairs and downstairs electric heating or heating and cooling of taped music and radio. In fact, there is no limit to the versatility of this Programmer. Mains operated. Size 3 1/2 x 3 1/2 x 2 1/2 deep. Price £5-50. 80p Post and VAT. As illustrated but less case.

THIS MONTH'S SNIP

MULLARD UNILEX

A mains operated 4 + 4 stereo system. Rated one of the finest performers in the stereo field this would make a wonderful gift for almost anyone in easy-to-assemble modular form and complete with a pair of Goodmans speakers this should sell at about £30—but due to a special bulk buy and as an incentive for you to buy this month we offer the system complete with speakers at only £15-50 including VAT and postage.

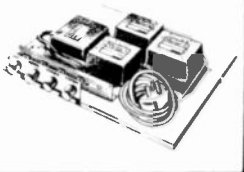

GPO PUSH BUTTON DIALLING UNIT

Will take the place of the normal rotating dial has 10 numbered keys, so suitable for other digital systems. A neat mounting unit with rubber feet, this is a very intricate and expensive piece of apparatus. New and unused—our price only £9 each + £1-38 post and VAT.

TWIN OUTPUT POWER PACKS

These have two separately R.C. smoothed outputs so can operate two battery radios on a stereo amp without cross modulation (they will of course operate one radio-tape-cassette-recorder in fact any battery appliance and will save their cost in a few months.) Specs: Full wave rectification, double insulated mains transformer—total enclosed in hard P.V.C. case—three core mains lead—terminal output—when ordering please state output voltage 1 1/2v, 6v, 7 1/2v, 9v, 12v or 24v—price £2-55 post and VAT included.

ONLY £1-50 FOR SEVEN ELECTRIC MOTORS

7 powerful batt. motors as used in racing cars and power models. Output and types vary for use in hundreds of projects—Toys, models, etc. All brand new reversible and for 1 1/2v batts. Wiring diag. inc. VAT + Post 40p. FREE plan for min. power station.

BLACK LIGHT

As used in discotheques and for stage effects etc. Virtually no white light appears until the rays impinge on luminous paint or white shirts, etc. We offer 9" 6w tubes complete with starter, choke, lamp holders and starter-holder. Price £2-75 + 30p post. Tubes only £2. Post + VAT 50p. 175 Watt model £2-50 + 92p Post and VAT.

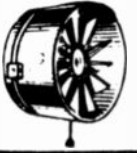

EXTRACTOR FAN

Cleans the air at the rate of 10,000 cubic feet per hour. Suitable for kitchens, bathrooms, factories, changing rooms, etc. It's so quiet it can hardly be heard. Compact, 6 1/2" casing comprises motor, fan blades sheet steel casing, pull switch, mains connector and fixing brackets £4-25 VAT + Postage £1-50.

Monthly list available free; send long stamped envelope.

TERMS: Where order is under £5 please add 30p surcharge to offset packing expenses.

J. BULL (ELECTRICAL) LTD.

(Dept. E.E.), 103 TAMWORTH ROAD, CROYDON CRO 1XX.

NEW ITEMS THIS MONTH

NOTE: PLUS SIGN AFTER THE PRICES INDICATES VAT.

Ferrite pot core (Vinkor) made by Mullard, maker's ref. No. LA 14107402K, circular, size approx. 1 1/2" x 1/2", a size which is the same as the one specified for the Scropio car ignition system. Price £1-50 + 40p pair. Post 15p + 1p.
12v DC motor made by Smiths, powerful, ideal for car blower; motor size 4" long x 3" diameter, 1" spindle, 1 1/2" long. £2 + 66p. Post 40p + 3p.
Plinth and cover for BEE plinth in teal colour and cover is smoky. Special offer £4 + £1. Post £1 + 25p. Covers available separately price £2 + 60p. Post £1 + 25p.

Plinth and cover for BF25. This is a deeper, rather nicer plinth, unfortunately more expensive. Price £5-50 + £1-37. Post £1 + 25p.
Central heating controller, the Randall Mark 3, as fitted to Trianco and many other central heating systems. Has a two on/off per 24 hour clock switch and a 7 position selector switch. Price £2-50 + 52p. Postage 50p + 4p.
Light for growing. Putting back the clock makes us realise how short daylight is during the months of November, December, January and February. As plants cannot grow without light, short days represent a loss of growing time which can be supplemented by using fluorescent lighting, especially important now that heating represents such an expensive item. We can offer a very cheap form of fluorescent lighting, (we do not think any other firm can beat our price), 50' of fluorescent light £10 + 80p if you can collect, or £13 + £1-04 if we have to despatch by British Road Services. For this you get 10 x 6" tubes, 50 tube ends, 10 chokes, 10 starters and holders and 20 terry clips for mounting the tubes. You only have to supply the wooden battens and wiring up wire. Do not miss this offer—only 60 parcels now remain.

Crossing wire. Suitable for joining up these fluorescent lights is available, price £5 + 40p per 100 metres. This is a good quality flat, twin with heavy duty insulation. Post £1 + 8p per reel. 70 stranded very heavy duty wire rated at 15 amps but will carry considerably more than this. 500 metre drums only £10 + 80p per drum. Carriage £2 + 15p.

Multi-range test meter. 11 ranges all selected by central switch, first-class two jewel movement, Japanese made. The right size to put in your pocket, always carry one with you to save your legs and earn your money. Ranges as follows: AC 10, 50, 250, 1000; DC 10, 50, 250, 1000. Resistance 0-150,000 ohms. Current 0-1-0-100. A big purchase of these enables us to offer at £4-55 + 36p (post 40p + 3p), which is very little more than we originally sold these for, 6 years ago.

8v Battery operated record player motors, on plate with turntable and mat. Price £4 + £1. Post 50p + 15p.

Instrument motor, mains operated, makes 1 rev in 4 hours, made by the famous Smiths Company. Price £1-50 + 12p. Post 10p + 1p.

BARGAINS FOR CALLERS. We always have bargains for callers and now that the post charges are so high it is even more worthwhile for you to call. One item which we are offering at a very silly price this month is a wooden cabinet intended originally to be used for a music centre and offered at only a fraction of the cost of the wood alone, namely 50p each.

We have other cabinets including large stereogram types from £2 upwards, depending on condition, cabinets for portable players and radios from 60p upwards.

Key chain radio (microscopic). Whilst clearing out our Park Street store we came across a box of these, brand new, just as they left the factory, some in transit and some in store but we tested them all and quite a lot are in working order. You might know someone who would like one for Christmas. We have not got many but are offering at £2 each. Post 40p + 10p. Please note this is just for the radio in its zipped around carrying case. The re-chargeable batteries have depreciated beyond reclaiming and so we are not including these.

Thermostat with capillary with sensor joined by approx. 1 metre of capillary covering the temperature range 0-170°C capable of switching 16 amps at 250v. Made by the famous Ranco Company with screwed threads and spindle rather like a volume control—has dozens of applications. Offered at only 75p + 6p. Post 12p + 1p.

Aerials. For medium and long wave, wound and fitted on ferrite rod, 5" long by 1" diameter. Price 60p + 15p. Post 10p + 5p.

Smoke, fire and gas alarm (BAGA Mark II). Winter is the worst time for fires because more heaters are used. Even all electric homes are now becoming an increasing fire risk. Colour television, blower heaters, electric blankets have all been the cause of tragic and disastrous fires, so the need for protection in the home becomes greater every day. Do not leave it until it is too late! The money invested in our BAGA Mark II spread over its useful life is negligible compared to the life of one of your dear ones. The BAGA will trigger off when the level of smoke, gas or heat exceeds normal. Price £15 + £1-20. Post 75p + 6p.

Blower/fan by Smiths maker's ref. FEB 071-092. This is a mains operated blower, the special feature being that the motor is mounted inside the impeller, so making this very compact. Fan housing size approx. 7 1/2" x 8 1/2", outlet size 3" x 3 1/4". Price £5-75 + 46p. Post 80p + 6p.

Dial thermometer by Rohotherm, indicates from 50F to 250F, dial size 3 1/2", chrome and glass front, 75p + 6p. Post 10p + 1p.
Rocker switch 13 amp 250v, white, small snapfin fixing into oblong hole, size approx. 1 1/2" x 1" engraved on/off. 85p + 2p. Post 1p.

Now...the most exciting Sinclair kit ever

The Black Watch kit

At £17.95, it's

★ **practical** – easily built by anyone in an evening's straightforward assembly.

★ **complete** – right down to strap and batteries.

★ **guaranteed.** A correctly-assembled watch is guaranteed for a year. It works as soon as you put the batteries in. On a built watch we guarantee an accuracy within a second a day – but building it yourself you may be able to adjust the trimmer to achieve an accuracy within a second a week.

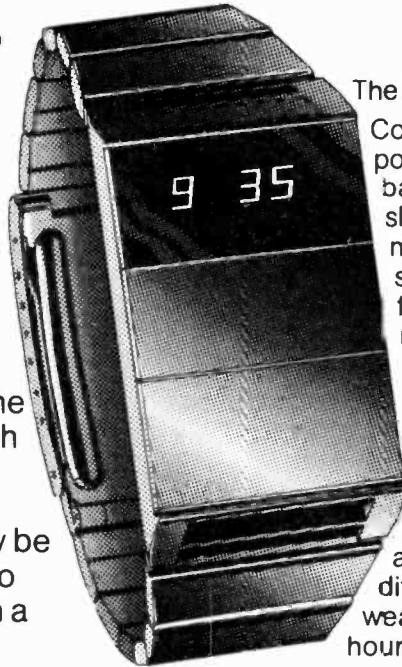

The Black Watch by Sinclair is unique. Controlled by a quartz crystal... powered by two hearing aid batteries... using bright red LEDs to show hours and minutes and minutes and seconds... it's also styled in the cool prestige Sinclair fashion: no knobs, no buttons, no flash.

The Black Watch kit is unique, too. It's rational – Sinclair have reduced the separate components to just four.

It's simple – anybody who can use a soldering iron can assemble a Black Watch without difficulty. From opening the kit to wearing the watch is a couple of hours' work.

The special features of The Black Watch

Smooth, chunky, matt-black case, with black strap. (Black stainless-steel bracelet available as extra – see order form.)

Large, bright, red display – easily read at night.

Touch-and-see case – no unprofessional buttons.

Runs on two hearing-aid batteries (supplied). Change your batteries yourself – no expensive jeweller's service.

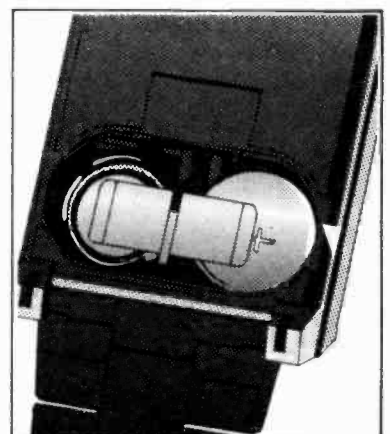
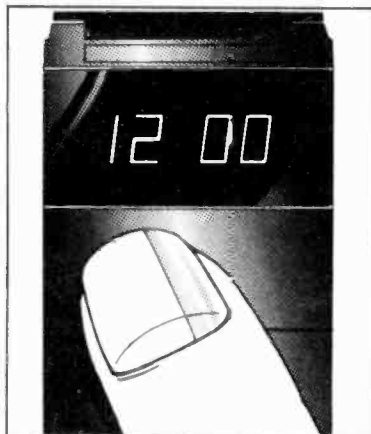
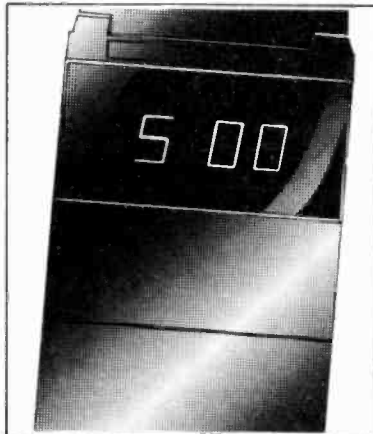

The Black Watch – using the unique Sinclair-designed state-of-the-art IC.

The chip...

The heart of the Black Watch is a unique IC designed by Sinclair and custom-built for them using state-of-the-art technology – integrated injection logic.

This chip of silicon measures only 3 mm x 3 mm and contains over 2000 transistors. The circuit includes

- a) reference oscillator
- b) divider chain
- c) decoder circuits
- d) display inhibit circuits
- e) display driving circuits.

The chip is totally designed and manufactured in the UK, and is the first design to incorporate all circuitry for a digital watch on a single chip.

...and how it works

A crystal-controlled reference is used to drive a chain of 15 binary dividers which reduce the frequency from 32,768 Hz to 1 Hz. This accurate signal is then counted into units of seconds, minutes, and hours, and on request the stored information is processed by the decoders and display drivers to feed the four 7-segment LED displays. When the display is not in operation, special power-saving circuits on the chip reduce current consumption to only a few microamps.

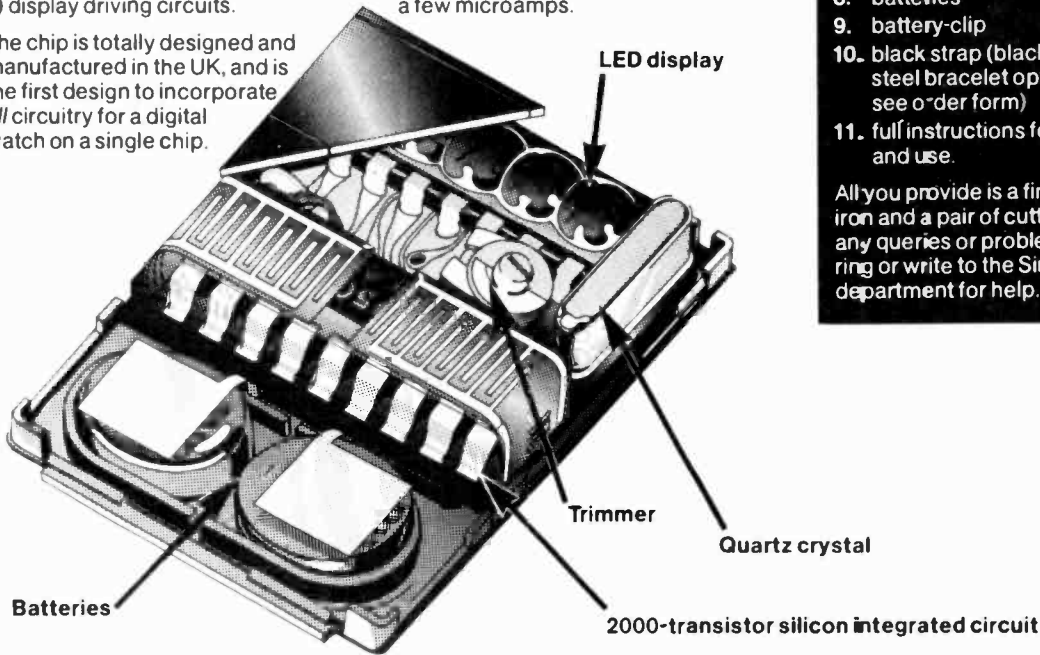

Complete kit £17.95!

The kit contains

1. printed circuit board
2. unique Sinclair-designed IC
3. encapsulated quartz crystal
4. trimmer
5. capacitor
6. LED display
7. 2-part case with window in position
8. batteries
9. battery-clip
10. black strap (black stainless-steel bracelet optional extra – see order form)
11. full instructions for building and use.

All you provide is a fine soldering iron and a pair of cutters. If you've any queries or problems in building, ring or write to the Sinclair service department for help.

Take advantage of this no-risks, money-back offer today!

The Sinclair Black Watch is fully guaranteed. Return your kit within 10 days and we'll refund your money without question. All parts are tested and checked before despatch – and correctly-assembled watches are guaranteed for one year. Simply fill in the FREEPOST order form and post it – today!

Price in kit form: £17.95 (inc. black strap, VAT, p&p).

To: Sinclair Radionics Ltd, FREEPOST, St Ives, Huntingdon, Cambs., PE17 4BR.

Please send me

Total £

..... (qty) Sinclair Black Watch kit(s) at £17.95 (inc. black strap, VAT, p&p).

* I enclose cheque for £..... made out to Sinclair Radionics Ltd and crossed.

..... (qty) black stainless-steel bracelet(s) at £2.00 (inc. VAT, p&p).

* Please debit my *Barclaycard/Access/American Express account number

Name _____

Address _____

EE/1/76

Please print. FREEPOST – no stamp required.

*Delete as required

sinclair

Sinclair Radionics Ltd,
London Road, St Ives,
Huntingdon, Cambs., PE17 4HJ.
Tel: St Ives (0480) 64646.

Reg. no: 699483 England. VAT Reg. no: 213 8170 88.

everyday electronics

PROJECTS.
THEORY....

A TRICK OR TWO

We are now fast approaching the period when involved or prolonged constructional activities probably have to be suspended for a while on account of more pressing seasonal activities and preparations. But if the Lights Flasher has been completed and installed satisfactorily, the soldering iron can be put away for a while with good conscience.

But we are not advocating a total abstinence from this hobby for the duration of the holiday, not in the least! For example, good use can be made of the magnetic effect to devise a few simple toys, as shown in this month's *Physics Is Fun*. All the materials required are likely to be found around the home and little time or effort has to be expended in making up these items.

Having a few such tricks "up the sleeve" could prove very handy. One way to keep youngsters occupied and amused during the holiday when, with time on their little hands, they might become a threat to their parents' peace of mind. So keep this issue of EE close at hand. It could suggest a simple way to alleviate periods of boredom amongst the children, or even their elders!

NORMAL SERVICE . . .

After the holiday interlude . . . back to more serious matters. The major project this month is a digital clock, a desirable acquisition for any home, we might suggest. At first it may appear

to be a somewhat formidable task—but upon closer investigation will be found perfectly straightforward and quite easy to build. The secret (though it's not so much of a secret nowadays) lies within the i.c. (integrated circuit) which embodies the heart of the electronics. These tiny nondescript objects really do make life easy for the electronics constructor. The digital clock is a useful and highly appropriate project to start the New Year with.

ANOTHER YEAR

And as we go forward into 1976 a small but important request to our readers. Your letters will be welcome throughout the coming year—just as in the past. We always endeavour to help with problems and enquiries relating directly to the contents of the magazine. But economic facts of life compel us to ask that a stamped addressed envelope be enclosed with any letter requiring a personal reply. Thank you.

All of us at EE send greetings to our readers and to our advertisers, also to those in the trade who distribute and sell our magazine. It's been a rather depressing 12 months in many respects and here's hoping things are on the mend and brighter prospects will illuminate 1976.

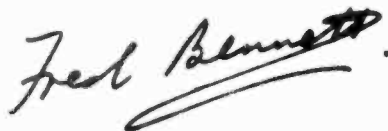

Our February issue will be published on Friday, January 16

EDITOR F. E. Bennett ● ASSISTANT EDITOR M. Kenward ● TECHNICAL EDITOR B. W. Terrell B.Sc.
ART EDITOR J. D. Pountney ● P. A. Loates ● K. A. Woodruff
ADVERTISEMENT MANAGER D. W. B. Tilleard

© IPC Magazines Limited 1976. Copyright in all drawings, photographs, and articles published in EVERYDAY ELECTRONICS is fully protected, and reproduction or imitations in whole or part are expressly forbidden.

All reasonable precautions are taken by EVERYDAY ELECTRONICS to ensure that the advice and data given to readers are reliable. We cannot, however, guarantee it, and we cannot accept legal responsibility for it. Prices quoted are those current as we go to press. Everyday Electronics Fleetway House, Farringdon Street, London, E.C.4. Phone: Editorial 01-634 4452; Advertisements 01-634 4202.

EASY TO CONSTRUCT SIMPLY EXPLAINED



VOL. 5 NO. 1

JANUARY 1976

CONSTRUCTIONAL PROJECTS

DIGITAL CLOCK <i>An easy to build electronic clock</i> by P. J. Fischer	10
RADIO CONTROL TRANSMITTER <i>Simple single channel design</i> by R. A. Penfold	18
TIME LAPSE CINE TRIGGER <i>Single shot delay</i> by P. W. Alley	32
STABILISED POWER SUPPLY UNIT <i>5 to 20V at 1amp</i> by C. F. Terrell	46

GENERAL FEATURES

EDITORIAL	8
SHOP TALK <i>Component buying and new products</i> by Mike Kenward	17
FOR YOUR ENTERTAINMENT <i>Radio Frequency Allocations</i> by Adrian Hope	23
TEACH-IN 76 <i>Part 4 Capacitors</i> by A. P. Stephenson	24
COUNTER INTELLIGENCE <i>A retailer's comments</i> by Paul Young	28
TEACH-IN 76 MATTERS ARISING	29
PHYSICS IS FUN <i>Magnetic Toys</i> by Derrick Daines	30
JACK PLUG AND FAMILY <i>Cartoon</i>	36
CALCULATORS GALORE by Adrian Hope	38
YOUR CAREER IN ELECTRONICS <i>1975—A Year of Opportunity</i> by Peter Verwig	43
BRIGHT IDEAS <i>Reader's Constructional Hints</i>	45
READERS' LETTERS	50, 55
PROFESSOR ERNEST EVERSURE <i>The Extraordinary Experiments of.</i> by Anthony J. Bassett	52
DOWN TO EARTH <i>Milli, Micro, Mega and their Relations</i> by George Hylton	56

LETTERS AND BINDERS

We are unable to supply back copies of *Everyday Electronics* or reprints of articles and cannot undertake to answer readers' letters requesting designs, modifications or information on commercial equipment or subjects not published by us. An s.a.e. should be enclosed for a personal reply. Letters concerning published articles should be addressed to: The Editor, those concerning advertisements to: The Advertisement Manager, both at the address shown opposite.

Binders for volumes 1 to 5 (state which) and indexes for volume 1 and 2 available for £1.85 and 30p respectively, including postage, from Binding Department, Carlton House, Great Queen Street, London, WC2E 9PR.



Easy to build

DIGITAL CLOCK



By P. J. Fischer

OVER the past few years electronic calculators have found their way into many high street stores. More recently the manufacturers have started to produce electronic digital clocks on the same lines. Using the most up-to-date technology to produce the two main components required—the large scale integrated circuit, which contains most of the complex circuitry; and the numeric display which makes the information available, one can now make a clock without the use of tens of discrete i.c.s and hundreds of other components.

This article describes the design and construction of a very attractive four digit clock for the living-room, kitchen or study, displaying tens of hours, hours, tens of minutes, minutes. It uses a 24 pin i.c. for the production of the appropriate timing pulses in conjunction with a 12mm high green fluorescent display manufactured by Futaba. The only other components required to build the clock are 18 resistors, 6 diodes, 5 capacitors, 2 switches, 1 transformer, a mains plug, mains lead and a case. In this article we assumed

the use of the smallest of the new range of very attractive Verocases, thus making a slim and elegant clock.

The only controls in the clock are two push-button switches—one for setting the hours and the other for setting the minutes. Thus, even the wife can set the clock if she accidentally switches it off!

BASIC ELEMENTS OF CLOCK

The clock centres around the AY-1202, a metal-oxide-semiconductor (m.o.s.) large scale integrated circuit (l.s.i.) which contains hundreds of f.e.t.s and diodes inside its 24 pin dual-in-line (d.i.l.) plastic package, manufactured by General Instruments Microelectronics.

Care is needed when handling all m.o.s. or complementary m.o.s. (c.m.o.s.) devices since these have inputs which can be damaged by excessive voltage applied to them (usually static). See below for handling details before you buy or handle any of these devices.

The AY-1202 does most of the work in the circuit (see Fig. 1). It has a half-wave rectified 50Hz supply (through a filter to remove mains spikes) which provides the chip with the basic timing pulses. The i.c. divides the 50Hz down to 1Hz and so on down to one pulse every hour. From the output of the divider stages it produces the waveforms needed to display the time.

The AY-1202's outputs go to the 4 digit display, which works in a multiplexed mode. This means that the clock chip feeds the information to only one digit of the display at a time and all the

FOR GUIDANCE ONLY

ESTIMATED COST* OF COMPONENTS
excluding V.A.T.

£14.30
excluding case

*Based on prices prevailing at time of going to press



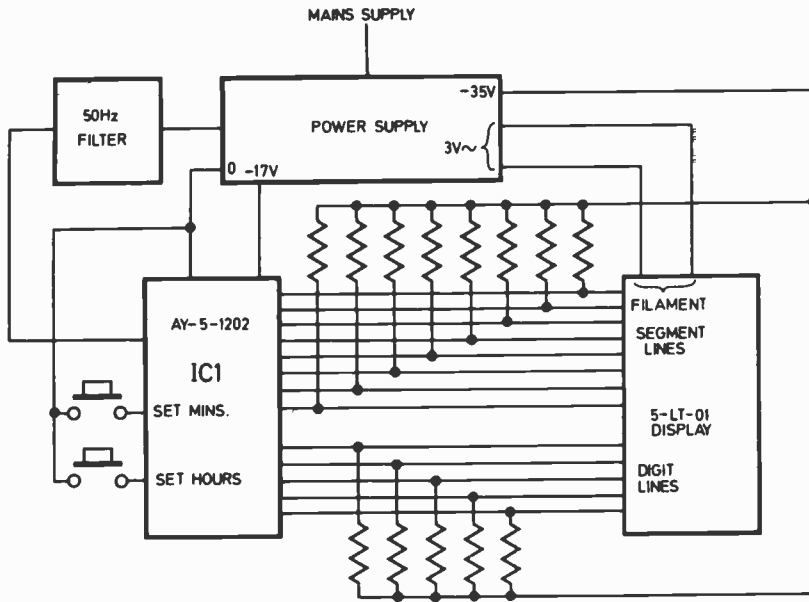

Fig. 1. Block diagram of the Digital Clock.

digits use a set of common lines to receive, each in turn, the necessary information to light-up the appropriate segments to display the correct number.

CIRCUIT DESCRIPTION

The complete circuit diagram of the clock is shown in Fig. 2. It might look somewhat daunting, but once one has sorted out all the wires the circuit is not that involved. The 12-0-12V transformer and the diodes D1, D2, D3 and D4 supply the -17V full-wave rectified supply for the AY-1202 and the -35V supply for the 5LT-01 display.

Diode D6 is a reverse protection diode for the i.c. whilst C1 and R13 form the low-pass filter to remove spikes from the 50Hz input to the AY-1202 (pin 24); D5 ensures that pin 24 (50Hz input) does not become more negative than the negative supply to the i.c. If it tries to go more negative D5 conducts to pin 2 and is clamped at -17V. Capacitor C2 provides the external capacitor needed for the internal oscillator of the i.c.

This internal oscillator is needed to provide the multiplexing between the displays (see discussion on multiplexing). The 1.5-0-1.5V winding of the transformer provides the current for the heater filament of the display. Resistor R18 and C4 provide the smoothed biasing voltage for the filament with respect to the -35V line. Pins 3, 4, 5 and 6 on the AY-1202 go to the grids of digits 4, 3, 2 and 1 respectively. When the appropriate digit is to be on, the output from AY-1202 will rise to 0V (from -17V) thus making the grid of that digit positive. The other grids are held negative by the so-called "pull-down" resistors R1 to R12 and those digits will be off at that instant in time.

The segment lines from the AY-1202 (pins 13 to 19) go to the segment pins of the display. Here again the segments which are to be lighted will have positive voltages applied to them while those which are to remain off at that instant in time will be "pulled-down" by the 100 kilohm resistors to -35V. Pin 7 of the AY-1202 goes to the colon on the display which flashes at a 1Hz rate. Finally there are two switches S1 and S2 between pins 21, 22 and 0V. These switches are depressed to increment the hours and minutes.

MULTIPLEXING

The idea of "multiplexing" arose out of the need to reduce the number of wires in a system in which an i.c. or i.c.s feed a numeric display. Take for example a calculator with a nine digit display (see the discussion elsewhere on displays). If you did not use a multiplexed system, each digit would have to have 11 wires going to it. That makes a total of 99 wires going to the display which is quite a hefty bundle (see Fig. 3)!

In a multiplexed system, this would be reduced to 19 wires which is much more manageable. This is achieved by using a set of common lines through which all the information flows from the i.c. to the display. The common lines in the above example would be the segment lines (a, b, . . . g) and the decimal point (d.p.) line (see Fig. 4). As well as these, one needs a set of control lines (1, 2 . . . n) from the i.c. to the display to determine which of the n digits will receive the information which is at that time present on the common lines a, b, . . . g.

In the case of phosphor-diode displays the control lines go to the grids of the digits (see discussion on phosphor-diode displays). The control lines will then each be activated in

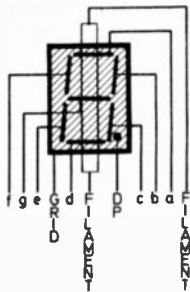

Fig. 5. Diagram illustrating the basic construction of the phosphor diode display.

Each segment has a connection to it which makes a total of 7 plus one for the decimal point (d.p.) and then there is a "common" connection which in the phosphor diode display goes to a grid inside the display (like the grid of a triode) covering all the segments (see Fig. 5). There are also 2 connections to a filament inside the display.

The principle of operation is fairly straightforward. The heated filament wire emits electrons into the evacuated tube. If a positive potential is applied to one or more of the segments and the grid the electrons will be accelerated towards them, will pass through the grid and will be absorbed by the appropriate segment(s). On collision with the segments, the latter, being coated with a phosphor compound (hence the name), emit(s) a green light which appears as a bar or a number.

If, however, the grid is held negative, the electrons will be repelled from it and thus will not strike any of the segments, even if any of them are held positive, as these lie behind the grid and so the digit will not light-up. This last point, concerning the fact that the grid is "in control" of the digit, is vital in the operation of a multiplexed display which is discussed above.

M.O.S. HANDLING

Although most m.o.s. devices on the market today have protection circuits on all their input pins it is still advisable to handle them in such a way so as not to apply any voltages above about 14V to their inputs. In practice this means guarding against electrostatically charged surfaces, mains earth and mains neutral supply lines. This is why all m.o.s. devices are shipped and packaged in so-called "conductive foam" or in metal tubes to ensure that all the pins of the i.c. are shorted together. The following simple rules eliminate any danger of damage to the i.c.

Keep the i.c. in its "conductive foam" until ready to put it in its socket. Layout a strip of aluminium foil such as used in the kitchen or a metal tray large enough to work on. Clip or solder a wire between it and the "earth pin" on the board (see Fig. 3). Do all the handling of the chip whilst working on this surface. Always switch off the supply before inserting or removing the i.c. Always use a socket for the m.o.s.

device. This means that you can remove it from the circuit later on if you have to do any soldering and it also eliminates the need to solder directly onto the pins of the i.c.

Place the i.c., still in the conductive foam, on the metal tray, making sure that the conductive foam touches the metal surface. Rest one of your arms or elbows with your shirt sleeve rolled up on the metal surface thus ensuring that your body (which is a good conductor) is at the same potential as the circuit.

It is now safe to handle the i.c.—you can touch the pins, insert it into the socket, etc, you must not let the pins of the i.c. touch anything other than yourself, the metal surface, the circuit board, or anything metallic such as a pair of long-nosed pliers (without insulated handles) that you are holding. Before inserting the i.c. into its socket, you will most probably have to bend the rows of pins a little as they tend to get splayed-out during manufacture. This you can safely do by placing the i.c. with one row of its pins on the metal surface and pushing down on them carefully. Do the same with the other side. Some trial and error is needed to get the correct positioning of the rows (see Fig. 6).

Should you want to do any soldering, desoldering, etc, later on, remember always to remove the i.c. beforehand and remember to always have an elbow or arm resting on the metal surface before and whilst handling the i.c.

CONSTRUCTION

Insert and solder all the resistors, pins, diodes, links, fuse links, i.c. socket and capacitors on the printed circuit board as detailed in Fig. 3, taking note of the following points:

Not all holes drilled in the board are used. This is because the holes which are not used now,

Photograph showing the construction of the complete clock.

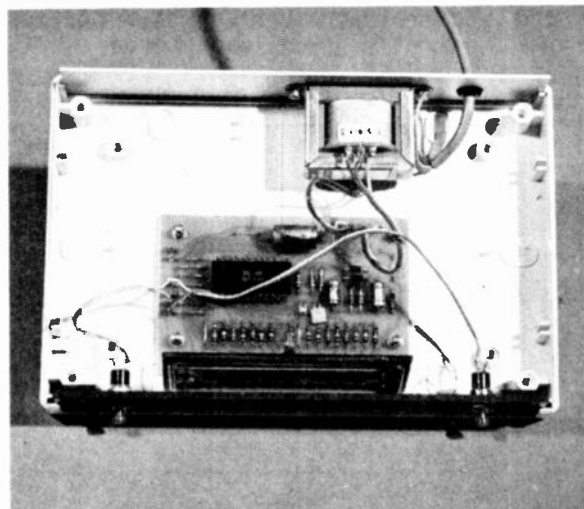

facilitate the use of the clock in other circuits—such as feeding the AY-1202 with a crystal controlled frequency for portable use. Link L2 should be inserted if you want the colon to be permanently on. If you want the colon to flash at a 1 second rate you should not insert this link. Link L3 should be inserted if you want the clock to work in a 12 hour format. If you want the clock to work in a 24 hour format you should leave this link out.

The fuse wire for links F can be any very thin wire—for instance a single strand taken from a length of multi-strand insulated wire. Carefully check the polarity of electrolytics and diodes.

Drill two 6BA clearance holes (3mm drill) and a 6mm hole in the back panel as shown in Fig. 8. Drill two holes to suit the pushbuttons in the Perspex as shown in Fig. 8, being careful not to scratch or splinter the Perspex. (It is suggested that you leave the protective paper on the Perspex until you have finished drilling, etc.) Mount a pushbutton at either end of the Perspex panel and solder the insulated wires to them as shown in Fig. 7.

Mount the transformer and the grommet on the back panel as shown in Fig. 7 using two 6mm 6BA screws.

Very carefully bend the leads of the display so that when mounted the display will lean backwards slightly and solder to the circuit board on tags provided. In the finished clock, the leads of the display will be resting against the bottom of the clock; to minimise the overall height of the display the leads should be bent so as to be very close to the bottom of the display. This is done so that the clock will fit in the Verocase suggested. Drill four 6BA clearance holes (3mm drill) in the bottom of the Vero-case using the board as a template. Cut the vertical pillars at their bases in the bottom of the case to allow room for the display to be mounted in place. Mount the board in the case using four 6BA 10mm screws.

Bend back the display slightly to allow the top of the case to fit on properly. Solder the cable

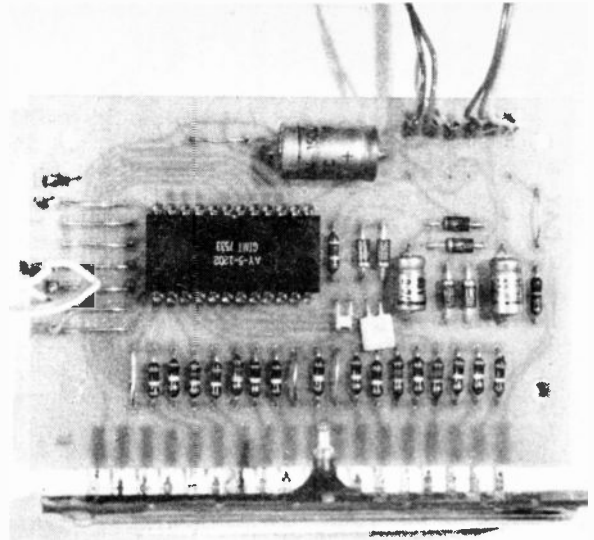

Photograph showing layout of the circuit board.

from the transformer 12-0-12V and 1.5-0-1.5V supplies to their respective pins on the board as shown in Fig. 7.

Solder the mains lead on to transformer and mount this in the case ensuring that the mains side of the transformer faces the bottom of the box. Fix the earth lead (green/yellow) of the mains cable to a tag under one of the screws holding the transformer on the back panel.

Fit the Perspex front panel into the slots in the bottom half of the case. Use two off-cuts

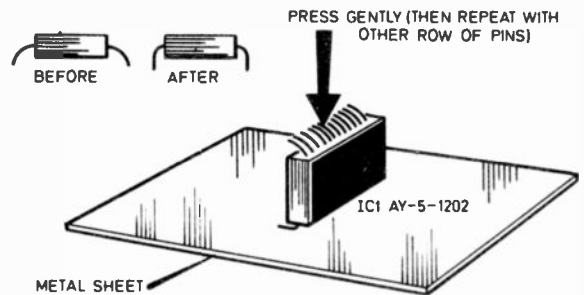

Fig. 6 (above). Method of bending the i.c. pins to fit the socket.

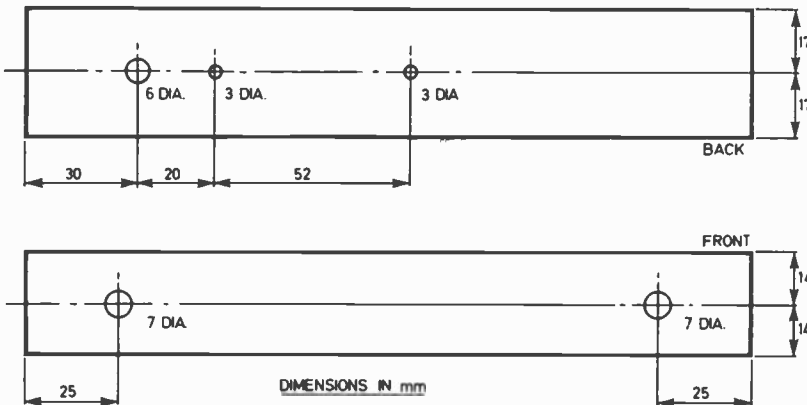

Fig. 8 (left). Back panel—aluminium, and front panel—green perspex, drilling details.

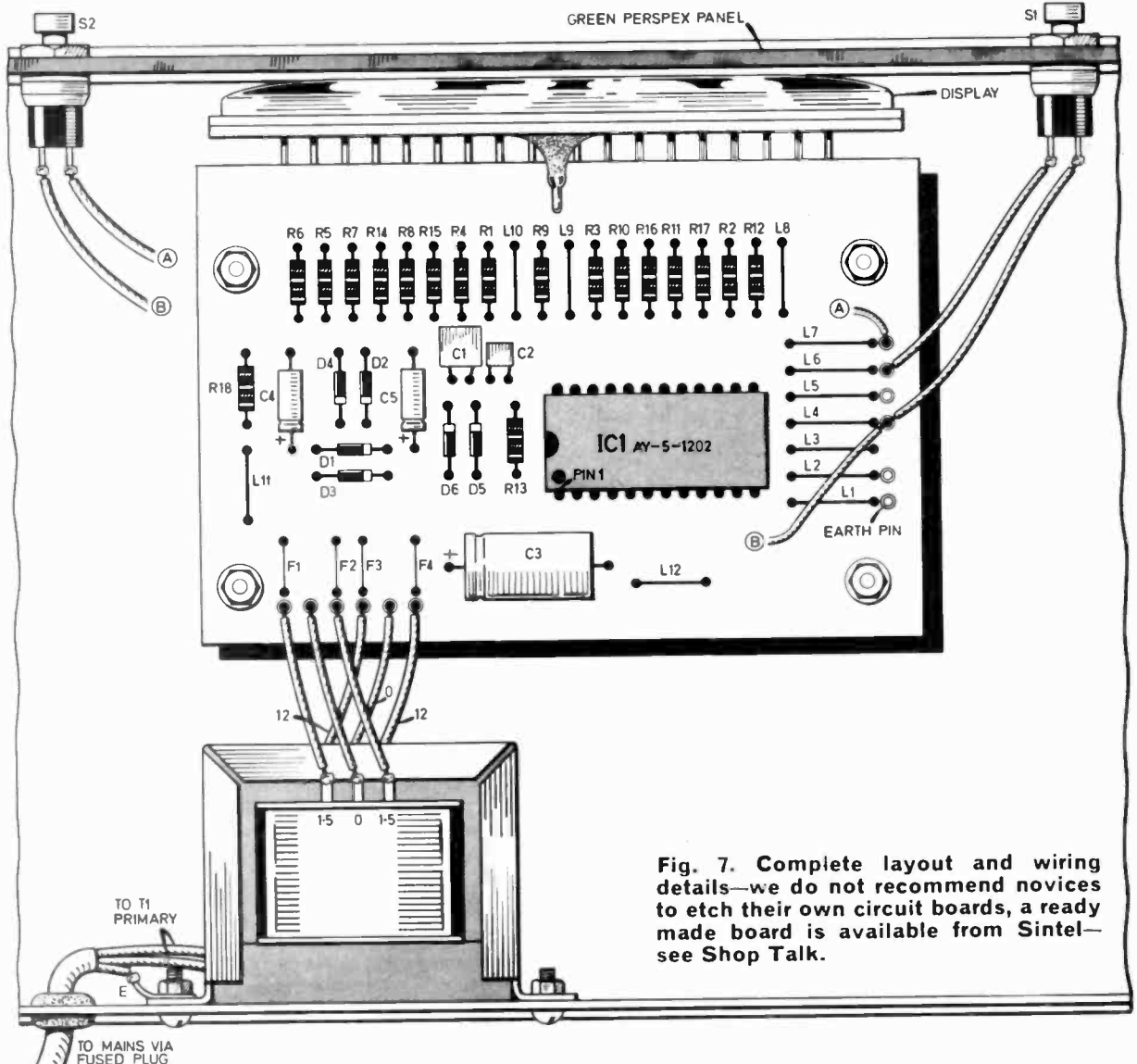
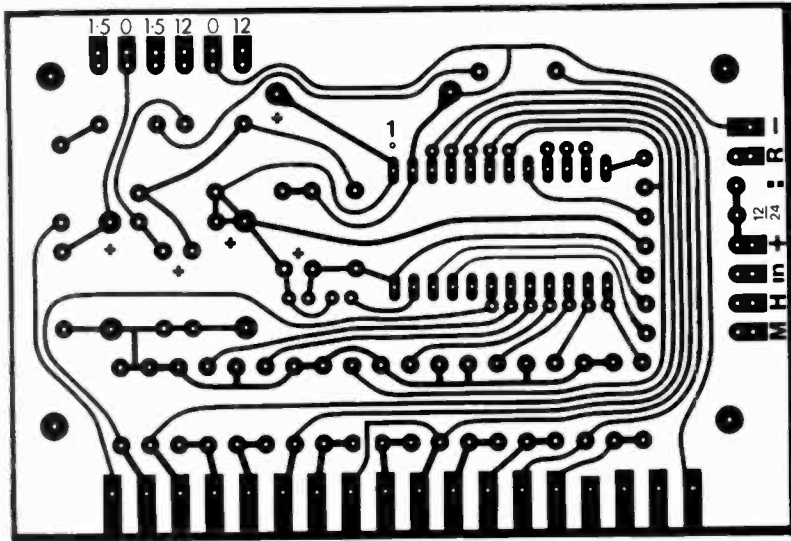

Fig. 7. Complete layout and wiring details—we do not recommend novices to etch their own circuit boards, a ready made board is available from Sintel—see Shop Talk.

of Perspex to wedge the front panel in place so that it does not move when one presses the setting switches.

TESTING AND SETTING-UP

All testing should be done at this stage, before the AY-1202 is plugged in. Double-check polarity of all diodes and capacitors (see Fig. 7). Switch the power on without the AY-1202 plugged in.

Test the voltage between pin 1 and pin 2 of the i.c. socket, pin 1 is identifiable by being by a lone hole drilled in the board. Pin 1 should be about 15-20V positive with respect to pin 2. Switch power off.

Insert the i.c. into its socket taking the precautions suggested under the section headed m.o.s. handling. Make sure that the i.c. is inserted the right way around i.e. pin 1 of the i.c., which has a little black dot by it, goes into pin 1 of the socket. Switch on the clock.

The clock should now read 00:00 with the colon in the centre flashing (if selected—see above) to indicate that the clock is counting. Press the right-hand button to set the minutes and the tens of minutes digits. Press the left-hand button to set the hours and tens of hours digits. The clock should now run and show the correct time of day.

FINISH

There is no reason why the clock should not be housed in any other type of case provided it is earthed if metal. It is possible that some readers would prefer to make their own case or to alter the layout shown by putting S1 and S2 on the back panel—this of course should present no problems. ▣

Photograph of the completed working digital clock.



Components

Resistors

R1-R12 100k Ω (12 off)
R13 470k Ω
R14-R17 12k Ω (4 off)
R18 1.8k Ω
All $\frac{1}{4}$ W \pm 10% carbon

**WAVEL
JOHS**
EES

Capacitors

C1 3.3nF miniature ceramic
C2 1nF miniature ceramic
C3 150 μ F elect. 25V
C4 22 μ F elect. 25V
C5 2.2 μ F elect. 63V

Semiconductors

IC1 AY-5-1202G I.M. Clock chip
D1-D6 1N4001 (6 off)
5LT-01 Futaba phosphor diode display

Miscellaneous

T1 Mains primary 12-0-12V at 50mA and 1.5-0-1.5V at 250mA secondaries
S1, S2 miniature s.p.s.t. push to make push-buttons.
Printed circuit board single sided—101mm x 67mm (see text).
Veropins; Verocase 75-1410J; 28mm x 189mm x 3mm green perspex; mains lead; 6, 6BA fixings; 6mm grommet; earth tag; connecting wire.

EE SUBSCRIPTION SERVICE

Copies of EVERYDAY ELECTRONICS can no longer be supplied on direct subscription. The publishers have found it necessary to close the subscription service chiefly on account of escalating costs on packing and postage. No new subscriptions will be accepted. Existing annual subscriptions will continue to be serviced until expiry.

This action is very much regretted, but it should not mean any reader being deprived of his regular copy of the magazine.

Present subscribers should make arrangements with their local newsagent or bookseller for EVERYDAY ELECTRONICS to be delivered to their home address or to be reserved for collection each month, immediately their current subscription has expired.

Any readers outside the United Kingdom who have difficulty in locating a supplier should write direct to the editor who will be pleased to advise them of the local agent for IPC Magazines.

**New products and
component buying
for constructional
projects**

SHOP TALK

By Mike Kerward

SOME readers will have noticed that the "see Shop Talk" notices in the component boxes have appeared upside down last month and again this month. This is deliberate and is intended to get people to read this page; we know people have noticed it, since everyone not "in the know" has pointed it out to us.

Why do we want more people to read this page? Quite simply because it will save them letters and phone calls to us; about 50 per cent of the component supply queries we get have been dealt with in this page and readers have simply not read it. Time will tell if the inversion has made any difference.

We had hoped to bring you a brief review of a new entirely British product this month—the Black Watch kit from Sinclair. However we have not yet been able to get our hands on a kit, but with luck the review will appear next month. We hope to be able to show you exactly what is involved

An internal view of the Sinclair Black Watch

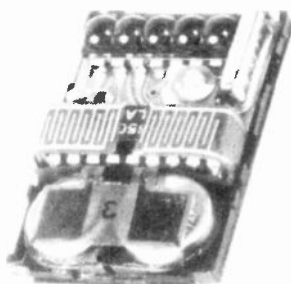

in constructing the watch so you can decide if you are capable of successfully completing the kit.

The dimensions of the watch are 50 x 28 x 8mm it weighs only 30 grams and uses integrated injection logic technology—the only watch in production that uses this technology. The case is specially designed and is not just a "copy" of a "normal watch". The kit price is £17.95 including strap, V.A.T. and postage, the complete watch is sold for £24.95 so the kit saving of £7 appears to be well worth while.

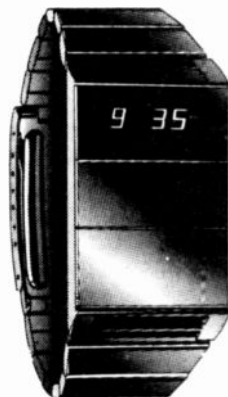

The Black Watch showing display of time

On a more general basis we note that Marshalls of Cricklewood have recently signed up with National Semiconductors to handle their customer product range. This new line will include semiconductors and integrated circuits. Marshalls have also recently acquired franchise with ITT and Mullard. Branches in London, Glasgow and Bristol will stock the range.

Digital Clock

Some of the parts for the *Digital Clock* are obviously very special and the clock chip (AY-5-1202) needs special handling, read the article before you buy. The chip is available from Sintel, 53 Aston Street, Oxford, and SCS Components, Wellington Road, London Colney, St. Albans, Herts, AL2 1EZ. The display is available from Sintel and Imtech Products Ltd., Imp House, Ashford Road, Ashford, Middlesex.

The transformer has been specially wound for this application and is available from Sintel. We doubt if you will be able to get a suitable one elsewhere; if you can, make sure the current ratings are adequate otherwise it

could get hot after a long period of use.

Most of the remaining parts should be readily available. The Verocases are now widely stocked and although expensive do provide a professional finish to the unit Perspex should be available through a hardware or d.i.y. store, if not try a local sign manufacturer for an off-cut.

Radio Control Transmitter

All the components for the *Radio Control Transmitter* should be readily available. If your local stockists does not have them then one of the larger mail order companies that advertise in our pages should be able to supply. It is important to use the Mullard C280 type capacitors to fit the layout given, most suppliers stock this type of capacitor these days.

Power Supply Unit

The *Stabilised Power Supply Unit* could work out expensive if the meters are not bought at the right price—about £3.00 each (including V.A.T.) is reasonable—various firms stock various makes, any of the correct rating will do but make sure they will fit in the case.

If the case is made bigger, thinner material can be used but the important point is that enough heat sink must be provided for the AD142 transistor.

Time Lapse Cine

The *Time Lapse Cine Trigger* parts list may provide some problems but these should be mainly restricted to the mechanical parts and the motor. The important thing when getting these parts is that the gears and motor case should be metal to provide an electrical connection and that the gears should provide a reduction of about 64/1.

Mecano worm and wheel type gears could be used if the reduction is correct, but these may be rather too heavy for this application, depending on the motor used. Alternatively gears could be salvaged from an old clockwork toy.

The reed relay specified is an RS type and is available from Doram, P.O. Box TR8, Wellington Road Industrial Estate, Wellington Bridge, Leeds, LS12 2UF.

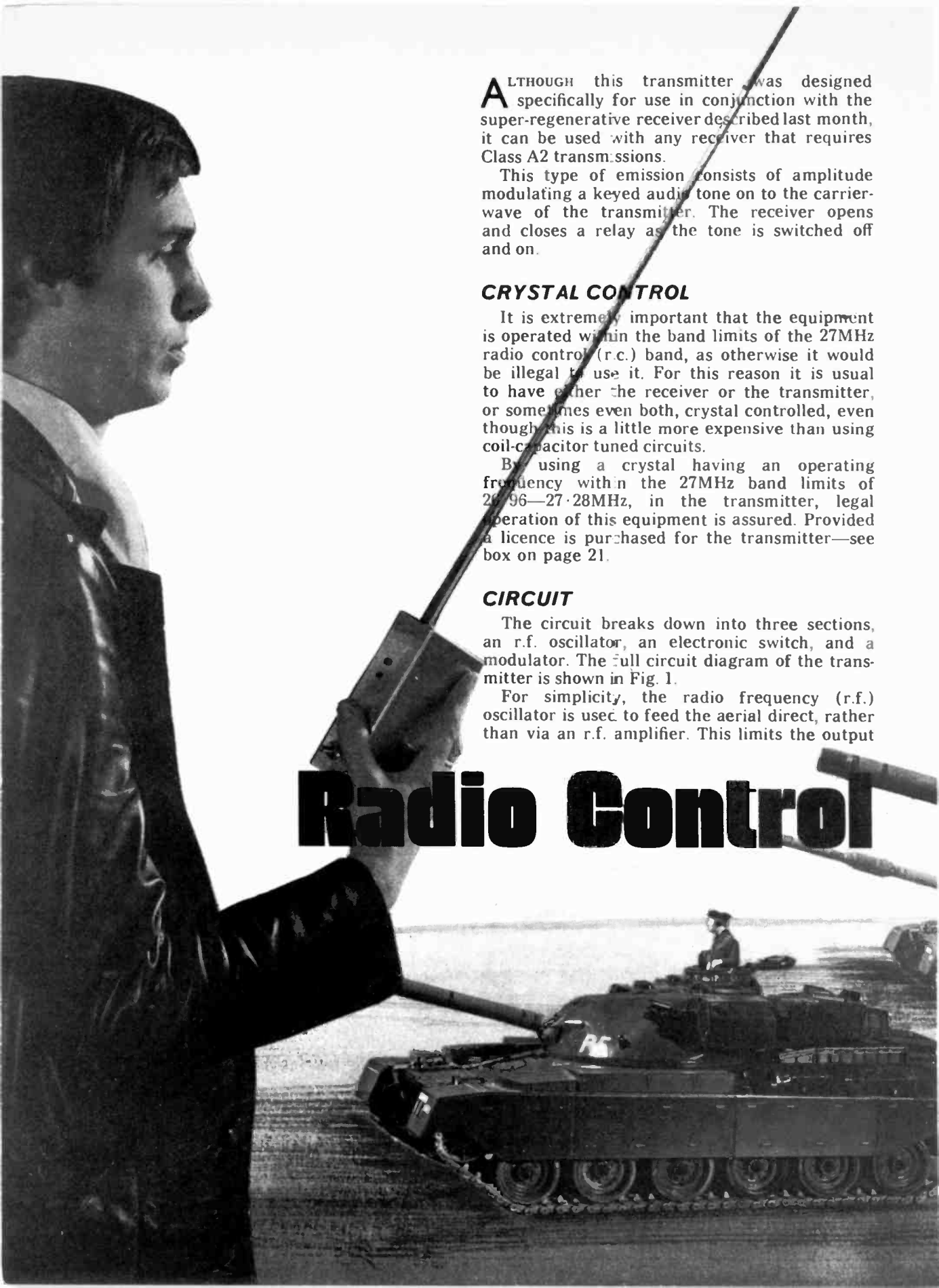

ALTHOUGH this transmitter was designed specifically for use in conjunction with the super-regenerative receiver described last month, it can be used with any receiver that requires Class A2 transmissions.

This type of emission consists of amplitude modulating a keyed audio tone on to the carrier-wave of the transmitter. The receiver opens and closes a relay as the tone is switched off and on.

CRYSTAL CONTROL

It is extremely important that the equipment is operated within the band limits of the 27MHz radio control (r.c.) band, as otherwise it would be illegal to use it. For this reason it is usual to have either the receiver or the transmitter, or sometimes even both, crystal controlled, even though this is a little more expensive than using coil-capacitor tuned circuits.

By using a crystal having an operating frequency within the 27MHz band limits of 26.96—27.28MHz, in the transmitter, legal operation of this equipment is assured. Provided a licence is purchased for the transmitter—see box on page 21.

CIRCUIT

The circuit breaks down into three sections, an r.f. oscillator, an electronic switch, and a modulator. The full circuit diagram of the transmitter is shown in Fig. 1.

For simplicity, the radio frequency (r.f.) oscillator is used to feed the aerial direct, rather than via an r.f. amplifier. This limits the output

Radio Control

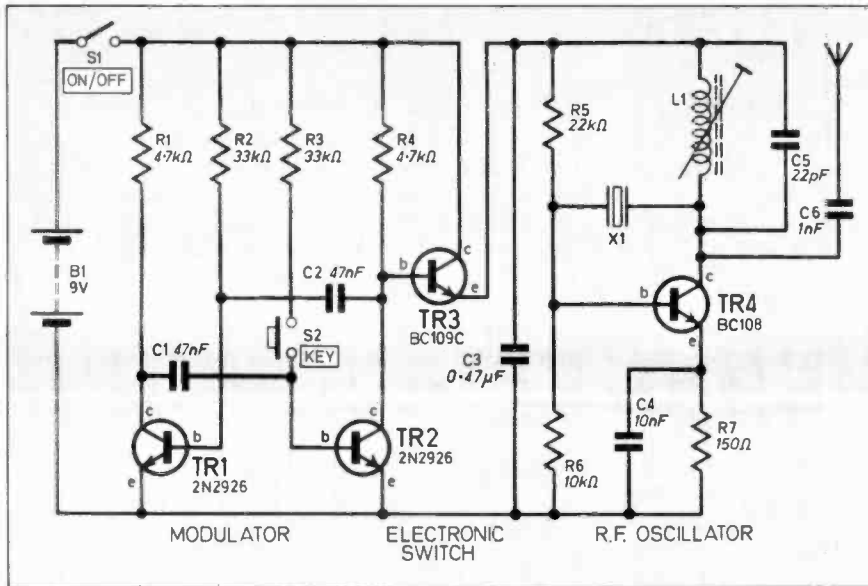

Fig. 1. Complete circuit diagram of the Radio Control Transmitter.

power of the transmitter, and thus also the attainable range, but with a reasonably sensitive receiver a range of up to about 100 metres can be obtained.

The oscillator configuration used here is frequently employed in r.c. transmitters because it is very reliable and has a large drive capability. The last factor is very important, since no r.f. amplifier is used.

Capacitor C5 and L1 form a tuned circuit collector load for TR4, and the core of L1 is adjusted for maximum output from the transmitter. This is of course, tuned to the crystal

frequency, and this fact helps to minimise spurious emissions, such as harmonics.

FOR
GUIDANCE
ONLY

ESTIMATED COST*
OF COMPONENTS
excluding V.A.T.

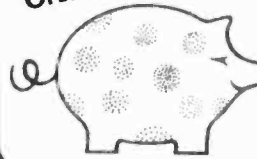

£3.00

excluding case

*Based on prices prevailing at time of going to press

TRANSMITTER

By R. A. PENFOLD

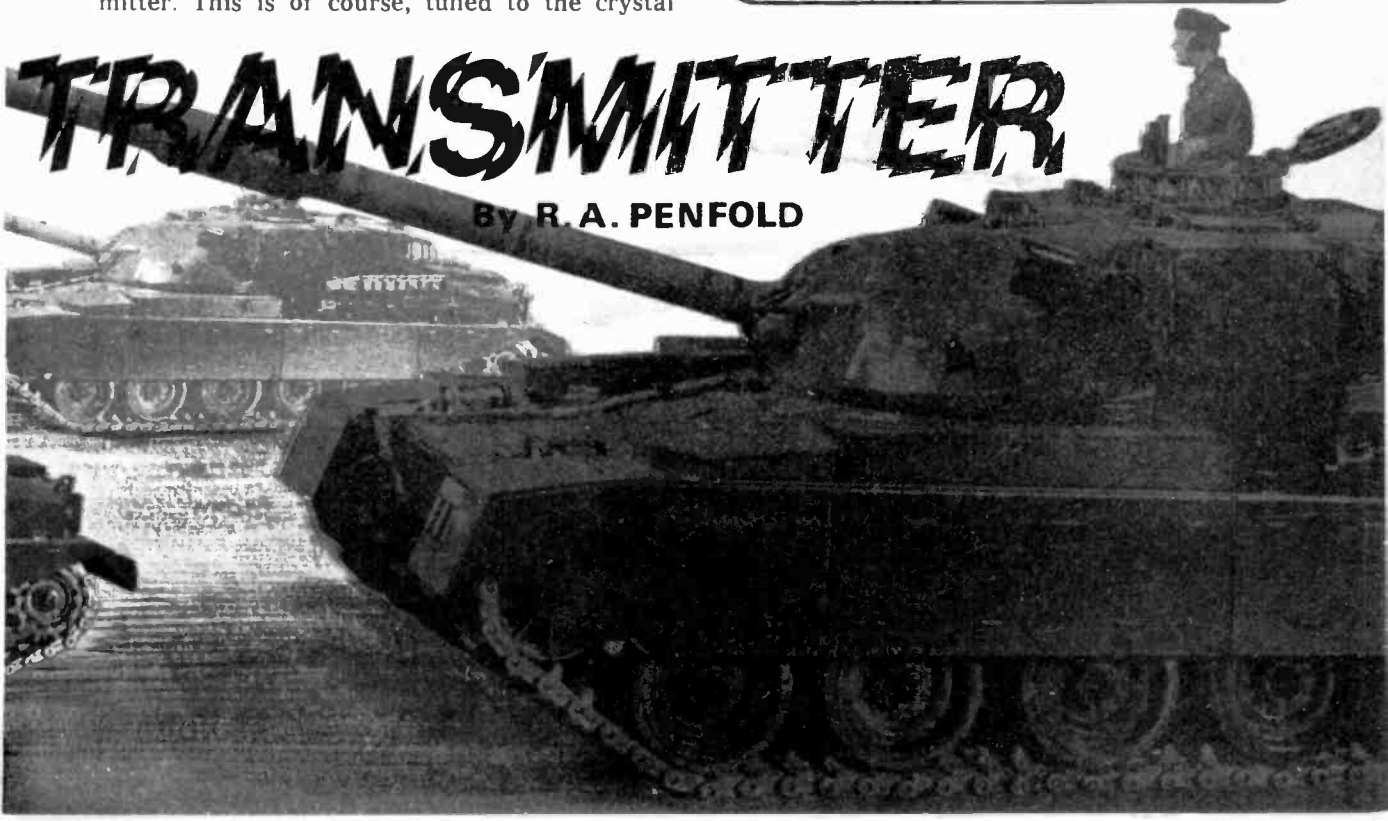

The modulator uses an astable or free running multivibrator. This consists basically of a two stage common emitter amplifier using TR1 and TR2, with positive feedback supplied via C2. Interstage coupling is via C1; R1 and R4 are the collector load resistors and R2 and R3 are the base bias resistors.

When TR1 is conducting, TR2 is turned off, and vice versa. When S2 is depressed and the circuit is operating, these transistors continually turn on and off at a rate of several hundred times per second.

Transistor TR3 is used as a switch, and is used in the emitter follower mode. It thus has almost unity voltage gain between its base and emitter terminals, but has a very large current gain.

When TR2 is turned on, the base of TR3 will be at virtually the same potential as the negative supply rail, and no current will be supplied to the r.f. oscillator from its emitter. When TR2 is turned off, TR3 is biased hard on by R4 and virtually the full battery potential is supplied to the r.f. oscillator.

When S2 is closed, the r.f. oscillator is switched on and off several hundred times per second, providing a crude but effective form of modulation. Capacitor C3 is the bypass capacitor for the r.f. oscillator and this has a rather large value, as it is also required to filter out the high frequency harmonics on the virtually squarewave output of the modulator. If these were not filtered out they could produce emissions outside the r.c. band.

When S2 is released, the modulator will cease to oscillate as the base bias to TR2 is cut off. Therefore TR2 does not conduct, and R4 biases TR3 hard on. This brings the r.f. oscillator into operation, but without any modulation. S1 is the ordinary on/off switch.

CIRCUIT BOARD

Most of the components, including the coil and the crystal, are wired up on a plain 0.15inch matrix Veroboard panel. The component layout and underside wiring of this panel are shown in Fig. 2.

Start by cutting out a panel of the correct size (16 x 14 holes). Then drill the two 6BA mounting holes for the panel (No. 31 twist drill) and the two for the coil former. These will probably need to be drilled for 8BA clearance using a No. 42 drill.

Now mount the components in the appropriate positions, and bend the leadout wires flat against the underside of the panel. Solder them together in the arrangement shown in the underside panel view of Fig. 2. Insulate the leads with pieces of p.v.c. sleeving in places where they pass close to each other, so as to avoid the possibility of short circuits. Use about 20 s.w.g. tinned copper extension wires in any places where the leads are too short to reach one another.

Construction will be more straight forward if a miniature wire ended crystal is used, but with a little ingenuity it should be possible to wire any miniature crystal into circuit.

To wind the coil, first mount the coil former, and then take a length of about 30cm of 24s.w.g. enamelled copper wire. Prepare and connect one end of the wire, and then wind 12 turns around the former in a single layer with closely spaced turns, keeping the winding as tight as possible.

Finally, cut the wire to length and connect the free end, still keeping the winding as tight as possible so that there is no tendency for it to spring apart. The former is fitted with a tuning slug.

CASE LAYOUT

A ready made aluminium box type AB7 makes a very practical and inexpensive housing for the transmitter. Alternatives can be used if preferred, but do not attempt to use a case which is significantly smaller than the AB7 (133 x 70 x 38mm) as this would probably not be large enough to take all the parts.

The layout and other wiring used on the prototype unit is also shown in Fig. 2.

Components

Resistors

R1	4.7k Ω	R5	22k Ω
R2	33k Ω	R6	10k Ω
R3	33k Ω	R7	150 Ω
R4	4.7k Ω		

All $\frac{1}{2}$ watt carbon $\pm 5\%$ types.

Capacitors

C1	47nF type C280
C2	47nF type C280
C3	0.47 μ F type C280
C4	10nF type C280
C5	22pf ceramic or polystyrene

Semiconductors

TR1 and TR2	2N2926 silicon <i>n</i> p <i>n</i> (2 off)
TR3	BC109C silicon <i>n</i> p <i>n</i>
TR4	BC108 silicon <i>n</i> p <i>n</i>

Miscellaneous

B1 PP6 battery and battery clips to suit.
 S1 Small s.p.s.t. toggle switch.
 S2 Miniature push button switch.
 L1 7mm screw fixing coil former with tuning slug, 24s.w.g. enamelled copper wire for coil.
 X1 Miniature wire ended 27MHz radio control crystal.
 Approximately 117cm long telescopic aerial.
 Aluminium case type AB7 or similar—see text.
 0.15in matrix plain perforated board, 14x16 holes; 20s.w.g. aluminium for aerial mounting bracket; two grommets and other hardware; connecting wire.

**WVW
TALK
SHOP**
SES

DON'T BREAK THE LAW !

The operation of this transmitter requires a licence. An application form for this is available from the Home Office, Radio Regulatory Dept., Waterloo Bridge House, Waterloo Road, London, SE1. A licence for 5 years costs £1 50.

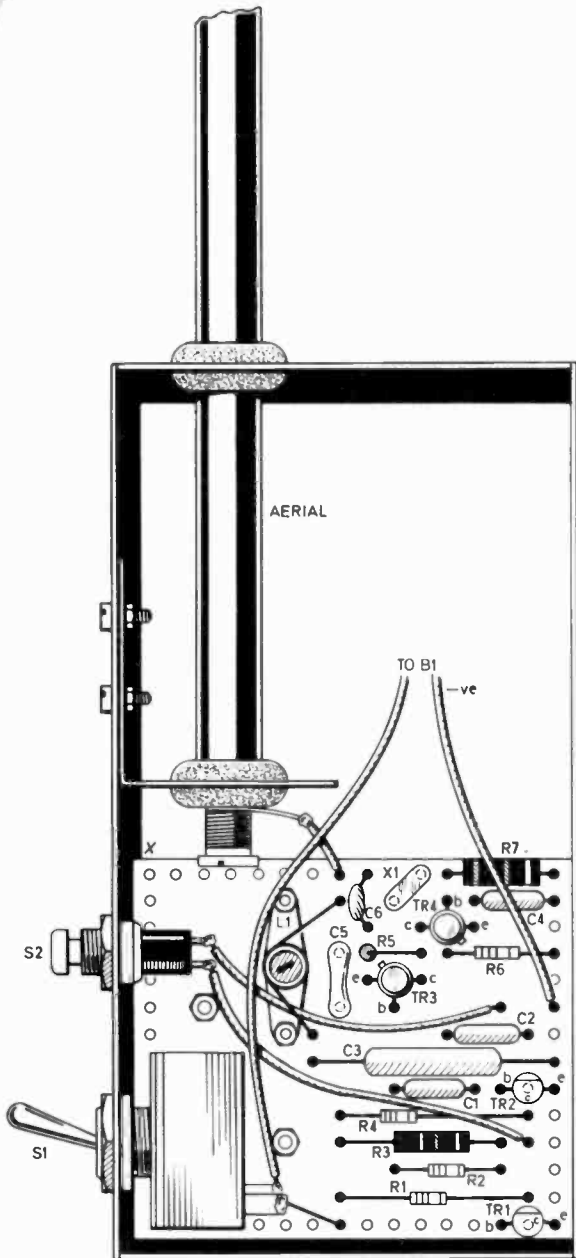
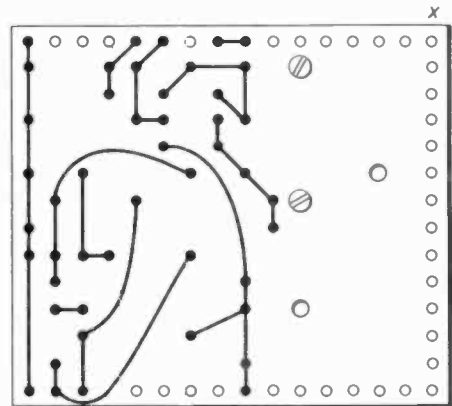
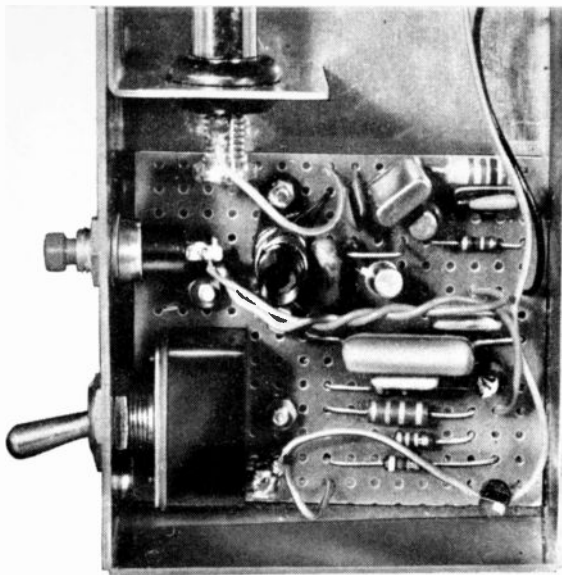

Fig. 2. Layout and wiring of the Radio Control Transmitter.



Radio Control TRANSMITTER



Before mounting the component panel, connect the negative battery clip lead, and short insulated leads where connections are eventually to be taken to the aerial, S2, and S1. Use 6BA 6mm spacers or a couple of extra nuts over each mounting bolt, between the panel and the case, to hold the underside wiring of the panel clear of the metal case. If it is felt that there is still a risk of a short circuit through the case, a couple of layers of insulation tape can be applied to the interior of the case beneath the panel.

Also drill the mounting holes for the aerial, S2 and S1 before finally mounting the component panel; S2 and S1 must be reasonably small types if they are to fit into the available space. Place their mounting holes sensibly, so that they do not foul either the lid of the case, or the component panel.

AERIAL BRACKET

A 64mm x 24mm piece of 24s.w.g. aluminium is formed into a mounting bracket for the aerial. This is folded in the middle at right angles (across its width). One section of the bracket is drilled to take a grommet into which the aerial fits, and the other is drilled to enable the bracket to be mounted on the side of the case using short 6BA screws.

A second hole for the aerial is drilled in the top of the case, and this is also fitted with a grommet. Be sure to drill the hole in the correct position so that the aerial fits in reasonably straight. Provided that the inside diameter of the grommets is correct for the diameter of the telescopic aerial used, they will provide a firm mounting for the aerial as well as insulating it from the case.

When all the components have been mounted, the last few connections can be made. There is a space for a PP6 battery beside the aerial. A couple of strips of foam rubber can be fixed on the inside of the base lid opposite the battery, so that the battery is held firmly in place when the lid is screwed into position.

Current consumption is about 12mA without modulation and 8mA with modulation. This gives very good battery economy.

ADJUSTMENT

Only one adjustment is required to the finished transmitter, and that is to adjust the core of L1 for maximum output. A field strength monitor is really required for this (details of this next month).

Start with the core screwed well down into the coil, and then with the telescopic aerial fully extended, unscrew the core whilst monitoring the output from the unit on a field strength monitor.

Unscrewing the core should result in increasing output until a peak point is reached, and unscrewing the core beyond this point will give a very rapid decline in output power.

An alternative method is to connect a multi-meter in the positive supply lead, and with this set to read 25mA f.s.d., turn the unit on and adjust the core of L1 for minimum deflection of the meter. No modulation should be used while making this adjustment.

When using the transmitter, the aerial must be in a vertical or nearly vertical position. The unit is quite small and light, and is easily held and operated by one hand. □

We wish to thank Beatties of London for kindly loaning the model tank shown in the heading and front cover photographs.

Technician and Student Apprenticeships in Engineering or Electronics

If you are leaving school in 1976 and are interested in starting a worthwhile career, we can provide you with the training and education to fulfil your ambitions.

We are one of Britain's major electronics companies whose products include communications systems, T.V. cameras, telephone switching systems and mobile radio equipment.

Apprentices study for City and Guilds, National Certificate or Degree Courses.

All training is undertaken at Chelmsford in Essex and accommodation is available during the first year of the apprenticeships.

There is an active Apprentice Association, together with a wide range of sports and social activities.

For further details, please write to:—Mr. J. A. Poole, Senior Training Officer, Marconi Communication Systems Ltd., New Street, Chelmsford, Essex, CMI IPL.

**Marconi
Communication
Systems**
A GEC-Marconi
Electronics Company

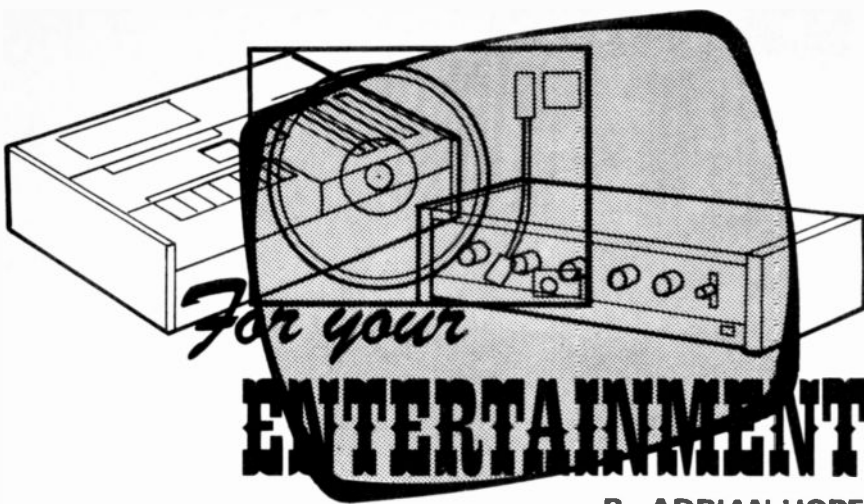

By ADRIAN HOPE

As anyone who owns a radio or television knows only too well, the wireless bands of the Earth's electromagnetic spectrum are bursting at the seams. Far too many transmissions (both legitimate and otherwise) are competing for far too few discrete spots on the dial. One result is mutual interference between different stations.

Allocations

In Copenhagen in 1948 the medium and long waveband frequency bands were carefully analysed and set frequencies allocated to radio stations round Europe. Provision was made for 400 transmitters on the medium waveband, with a total transmitting power between them of 20 million watts. No single transmitter was to be permitted a power greater than 150kW, and separate channels would be spaced apart by 9kHz. But the Convention has been almost universally ignored, and there are now 1500 transmitters operating in the medium waveband in Europe, with a total transmission power of 60 million watts and some individuals operating on powers of up to 1,500kW!

Currently the International Telecommunication Union is looking at ways of sorting out the mess. One suggestion is that the 9kHz channel spacing should be reduced to 8kHz, to make room for 16 extra channels on the a.m. bands. But realistically, the a.m. bands must now be regarded as irrevocably cluttered and virtually a write-off for anything other than casual listening on a portable set. And of course, as previously reported, the medium and

long waves are becoming increasingly polluted with thyristor generated interference.

The problems of medium and long wave a.m. transmission clutter are global, because these frequencies can easily travel long distances. On the other hand, v.h.f. transmissions (f.m. radio and television) normally travel only short distances and are thus far less susceptible to mutual interference. Except under unusual atmospheric conditions, when the signals travel farther than usual by bouncing off upper layers of the atmosphere and down to Earth again, legitimate transmitters operating on the same frequency seldom encroach on each other's territory. This is why different stations as close together as Swansea and Glasgow can easily share the same v.h.f. frequency, even while transmitting 4kW of power.

Stockholm Plan

The v.h.f. radio and TV bands were allocated in Stockholm in 1961, and it is probably not generally realised that the so-called Stockholm plan made only the frequencies 88MHz to 100MHz available for entertainment broadcasting in Europe. But virtually every v.h.f. f.m. receiver sold in this country will tune over the much wider range of 86 to 109MHz, and in so doing will pick up a wide range of police, fire engine and ambulance transmissions—which it is in fact illegal for the public to receive.

Sets are sold with the unnecessary ability to receive illegal transmissions in the U.K., because the spot on the 86 to 109MHz dial occupied by legal transmissions

varies round the world, and it is obviously not cost-effective to design a set for U.K. use only.

It has required the very careful allocation of shared wavelengths and restricted transmission powers to squeeze all the current and planned BBC and Independent Local Radio stations into the small space left in the 88 to 100MHz range by the BBC national stations. To make matters worse some public services still encroach on these frequencies.

In this respect, we are paying a penalty for being a pioneer of public service broadcasting. As far back as 1939, the police and fire engines in this country were using two-way radio, and their frequencies were allocated long before serious thought had been given to the transmission of entertainment on the v.h.f. bands; and some service allocations in the entertainment band still persist. But the Home Office confirm that a project to clear the 88-100MHz band of all public service transmissions is already well under way.

Citizens Band

Although bad news for those who like to dabble with gadgetry, it is also probably good news for hi-fi enthusiasts that the Home Office plans to continue its present policy of refusing to allow Citizen-Band transmissions in the frequencies around 27MHz. For many years in the U.S.A., and more recently in France, Germany, Holland, Switzerland and Denmark, it has been legal for the public to use walkie-talkies on these frequencies.

In the U.K. these frequencies are still legally available only for non-speech transmissions, such as very low-power transmitters for radio-controlled models and hospital and other radio paging and bleep systems. Also industrial r.f. generators operate in this area.

The Home Office say that C.B. equipment is notorious (especially if cheap, faulty or with its power illegally over 5 watts) for producing second and other harmonic interference. And this breaks through onto domestic v.h.f. radio and TV receivers. According to the Home Office the U.S.A. authorities regret ever having allocated the Citizens Band, and the European countries who have followed suit are also becoming sadder but wiser.

TEACH-IN '76

By A.P. STEPHENSON

Part Four

4.1 CAPACITORS

Capacitors are nearly as common as resistors and consist of two conducting plates separated by an insulator (such as air), see Fig. 4.1a. Superficially, capacitors might appear to be useless because no current can pass through them. They can however be used to (a) store energy, (b) delay a change of voltage.

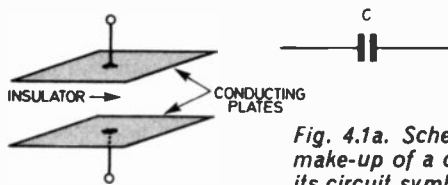

Fig. 4.1a. Schematic of the make-up of a capacitor and its circuit symbol.

Beginning with the ability to store energy, consider the circuit shown in Fig. 4.1b.

The plates are made of a conducting material so there are plenty of free electrons on both of them. When the switch S1 is closed, the positive terminal of the battery attracts electrons away from the top plate and the negative terminal pushes electrons on to the bottom plate, i.e. the battery sweeps electrons from the top to the bottom.

The action is virtually instantaneous and ends with the capacitor being "charged" to 10 volts, the same as the battery.

If the battery is now isolated, (switch S1 open) the capacitor is left in this charged state i.e. top plate

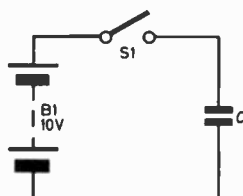

Fig. 4.1b. A circuit to illustrate the ability of a capacitor to store energy.

starved of electrons and the bottom plate is left with a surplus. Since air is almost a perfect insulator, the excess electrons are trapped and ten volts remain "stored" in the capacitor for as long as we choose.

4.2 CAPACITANCE

Capacitors, like resistors, are manufactured with a wide variety of values but the property is in terms of capacitance instead of resistance. Capacitance is the charge needed to raise the plates to a given voltage difference. The symbol for capacitance is C, the unit is the farad (F) and the equation for the above definition is given below.

$$\text{Capacitance} = \frac{\text{Charge}}{\text{Voltage}} \text{ or in symbols } C = \frac{Q}{V}$$

Example

If a certain capacitor requires 5 coulombs to raise

2.5 volts difference across the plates, its capacitance is

$$C = \frac{5 \text{ coulombs}}{2.5 \text{ volts}} = 2 \text{ farads}$$

The farad is an enormous unit, so the following sub-multiples are used:

The microfarad (abbreviation μF) = 1 millionth of a farad 10^{-6}F .

The nanofarad (abbreviation nF) = 1 thousand millionth 10^{-9}F . The picofarad (abbreviation pF) = 1 million millionth of a farad = 10^{-12}F (A picofarad is usually called a "puff".)

To make a large capacitance we can increase the area of the plates, or decrease the distance between

the plates, or we can use insulation material other than air.

This insulation is called a **dielectric** and depending on the material, has a property called the **dielectric constant**, which is simply a measure of comparison with air.

Mica for instance has a value of about 7 which means the capacitance would be increased seven times if we replaced the air by mica. Unfortunately

4.3 STORED ENERGY

An isolated charged capacitor stores energy (W). To calculate the amount of energy in joules we use the equation below.

Stored energy = $\frac{\text{Capacitance} \times (\text{Voltage})^2}{2}$

or in symbols $W = \frac{CV^2}{2}$

4.4 WORKING VOLTAGE AND LEAKAGE

Besides the capacitance value, a capacitor is normally marked with its **working voltage**, which tells you the maximum safe voltage allowed across the plates. If for example, the marking is "6 volts working", a higher voltage may puncture the dielectric causing the plates to short together.

All capacitors will gradually lose charge due to leakage which may be thought of as a high resistance permanently in parallel across the plates. With the

these materials are not as perfect as air, so they tend to slowly leak away the stored charge. Capacitors of one microfarad or greater are considered large and are normally the **electrolytic** type, meaning the dielectric has been formed by chemical action. These types leak badly and are sensitive to polarity, i.e. the end coloured red or marked (+) is the positive end and the capacitor must be operated this way round.

Example

A 2 farad capacitor charged to 10 volts will store an amount of energy equal to $\frac{1}{2} \times 2 \times 100 = 100$ joules.

For instance, if we discharge a capacitor by placing a resistance across its plates, current will flow until all the surplus electrons on the negative plate return to the positive plate via the resistor. The final result will be zero stored energy and a warm resistor (energy has been converted to heat).

4.5 TIME CONSTANTS

A battery connected suddenly across a capacitor will charge it up almost instantly. The action can be slowed down by connecting a resistor in series with the charging path, see Fig. 4.5a.

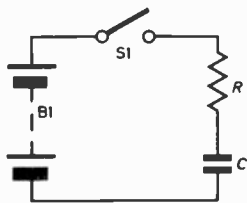

Fig. 4.5a. The resistor in series with the charging capacitor, increases the charging up time.

Since the resistor (R) limits the current, the capacitor will now take some time for sufficient electrons to flow from top to bottom plates, i.e. it takes time to charge up C to the battery voltage. Rather complex mathematics will reveal that the time taken to complete the charging action is $5 \times C \times R$ seconds

(approximately). The product $C \times R$ is called the **time constant** which is defined as the time taken for the capacitor voltage to reach approximately two thirds of the supply (applied) voltage.

Electrolytics have relatively high leakage (lower leakage resistance) and in general it increases with capacitance and the working voltage.

For a given manufacturing type, the physical size is increased in proportion to the capacitance and working voltage. Electrolytics have the advantage of small physical size in spite of large capacitance.

Examples

(a) A 2 farad capacitor charging via a 4 ohm resistor has a time constant equal to $2 \times 4 = 8$ seconds. This means it will take 8 seconds to charge the capacitor to two thirds the battery voltage and $5 \times 8 = 40$ seconds to be equal to the battery voltage.

Since microfarads and megohms balance, we can use this to save noughts in practical calculations.

(b) A $2\mu\text{F}$ capacitor and a 6 megohm resistor has a time constant of 12 seconds and will take 60 seconds to charge up fully. We now see how we can delay a voltage. Close the switch $S1$ and volts across C will appear later. By choice of CR values, delays of microseconds or hours can easily be obtained.

4.6 CHARGING ACTION

To illustrate the charging action in more detail consider the graph shown in Fig. 4.6a.

On closing the switch $S1$, charging current starts to flow. This current is large to start with and becomes

progressively less as time passes. The voltage across C therefore rises rapidly at first but quickly slows down. The reason for this behaviour is explained by remembering Khirchoff's law of voltages which for this particular example can be as below.

At all times during the charging action
 $V_R + V_C = V_B$

At the instant of closing switch $S1$, the capacitor has not yet had time to acquire any charge so V_C is still zero. This means that all the battery voltage is across R .

The initial charging current must therefore be

$$I = \frac{V_B}{R}$$

As time progresses, V_C rises, so the *nett* voltage driving the current is no longer V_R but $(V_R - V_C)$. The current at all times will be $I = (V_B - V_C)/R$ and will obviously become smaller and smaller as V_C climbs nearer towards its final value of V_B .

In fact V_C will never quite reach V_B but this is hair-splitting. At the end of $5CR$ seconds it had reached

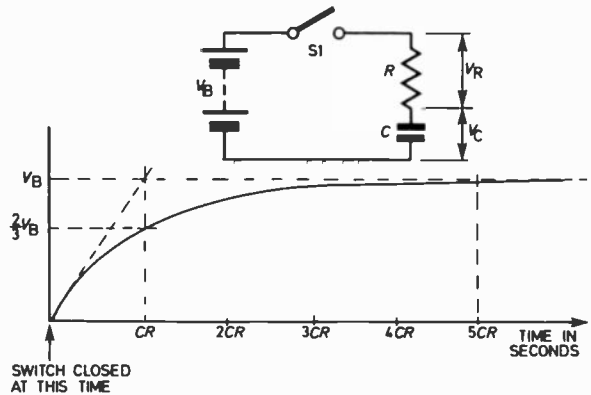

Fig. 4.6a. The circuit diagram for charging up a capacitor via a series resistor, and a graph showing the voltage across the capacitor as a function of time.

99.3262 per cent of V_B which is near enough for most people. Whilst on the subject of accuracy, at the end of one time constant (CR seconds), V_C actually rises to 63.212 per cent of V_B although it is customary to round this up to two thirds for most practical purposes.

4.7 DISCHARGE ACTION

The discharging of a capacitor via a resistor is basically the same as the charging action but in reverse.

Fig. 4.7a. On closing the switch, the capacitor discharges exponentially through the resistor.

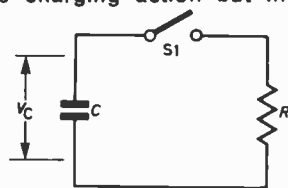

Assume the capacitor in Fig. 4.7a has been previously charged to a voltage V_C . On closing the switch $S1$, a large discharge current flows at first, but as the voltage gradually falls, the current becomes smaller. At the end of one time constant (CR seconds) the voltage falls to about one third of the original voltage (which is actually two thirds of the discharge range). At the end of $5CR$ seconds, the capacitor is considered discharged.

4.8 CAPACITORS IN SERIES AND PARALLEL

Capacitors are said to be connected in series when connected as shown in Fig. 4.8a. The total capacitance across the terminals AB given by

$$\frac{1}{C_{total}} = \frac{1}{C_1} + \frac{1}{C_2} + \frac{1}{C_3}$$

If there are only two capacitors connected, the product over sum equation can be used as shown below

$$C_{total} = \frac{C_1 \times C_2}{C_1 + C_2}$$

Note that these formulae are the same as those for resistors connected in *parallel*.

Capacitors are said to be connected in parallel when they are connected as shown in Fig. 4.8b. The total capacity across AB is given by

$$C_{total} = C_1 + C_2$$

which is the same kind of formula as used for resistors in series.

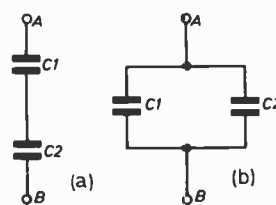
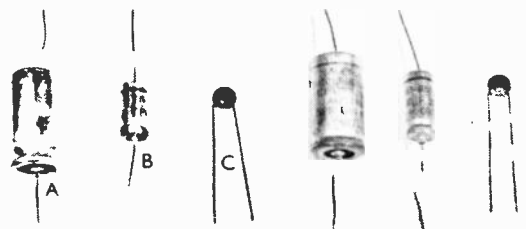

Fig. 4.8 (a) and (b) shows series (a) and parallel (b) connection of capacitors



Photograph of the capacitors used in the Teach-in series: (a) $1000\mu F$ (b) $100\mu F$ both electrolytics and (c) $0.1\mu F$ ceramic.

TEACH-IN '76 EXPERIMENTS AND EXERCISES

EXPERIMENT 4A

To show that a capacitor can "store" voltage and to show that a meter can quickly discharge it.

PROCEDURE

1. Assemble the 100 microfarad capacitor on the Circuit Deck and wire up to the switch and 9 volt battery terminals as shown in Fig. 4A.1. Using the meter on the 10 volt range, fix the meter probes to the terminals as shown. Make sure that the capacitor polarity is correct and check out your wiring up.
2. Switch on and confirm that the meter almost instantly reads the same voltage as the battery.
3. Isolate the battery by switching off and confirm that the meter is still reading 9 volts, indicating that a capacitor can "store" a voltage. The meter reading will fall away (decrease) towards zero volts as the seconds pass, due partly to the internal leakage of the capacitor, but mainly due to the meter itself behaving as a parallel resistance of value 200 kilohms.
4. Switch on again to recharge the capacitor, and then off if you want a repeat performance.
5. To prove the meter is mainly responsible for the leakage, disconnect the meter, switch on and then off, and leave for a few minutes. The voltage across the capacitor will still be high if you momentarily take a measurement again.

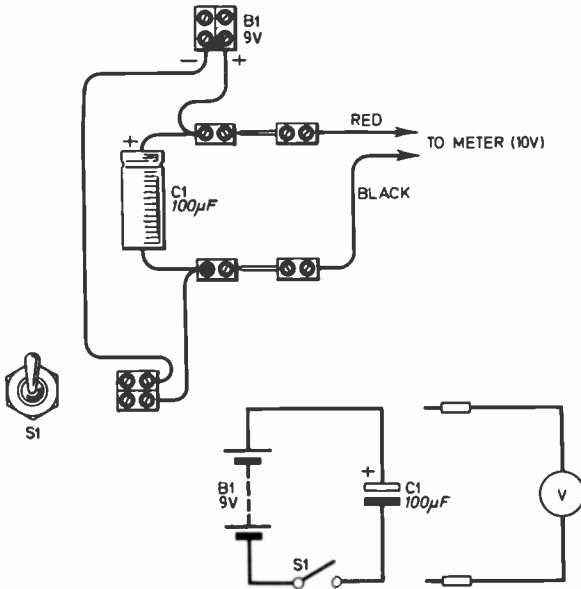

Fig. 4A.1. The layout of the components on the Circuit Deck for experiment 4A together with the circuit diagram.

EXPERIMENT 4B

To verify the CR time constant.

PROCEDURE

1. Assemble the 1000 microfarad capacitor, the 4.7 kilohm resistor and then wire up the 9 volt battery and switch as shown in Fig. 4B.1.

2. With the switch turned off, connect the meter probes (plugged for 10 volts) to the terminals as shown.
3. Switch on and confirm that the meter takes nearly 5 seconds to climb to 6 volts and about 25 seconds to reach 9 volts. [Theory: $CR = 1000\mu\text{F} \times 4.7\text{k}\Omega = 4.7$ seconds (time to reach 2/3 of the battery voltage); $5CR = 23.5$ seconds.]
4. Switch off and change the 4.7 kilohm resistor to 47 kilohms. It is necessary to completely discharge the capacitor before proceeding. To do this, hold a 100 ohm resistor across the capacitor terminals for a few seconds.
5. Switch on and confirm that the meter now takes much longer to reach the final value (CR is now increased by a factor of 10 times). Remember now however that the meter resistance is 200 kilohms on the 10 volt range and will have more effect when the 47 kilohm resistor is used.
6. Perform all these experiments again, but fix the meter probes across the resistor instead of the capacitor. You will find that meter readings will now start at 9 volts and fall away to zero volts.

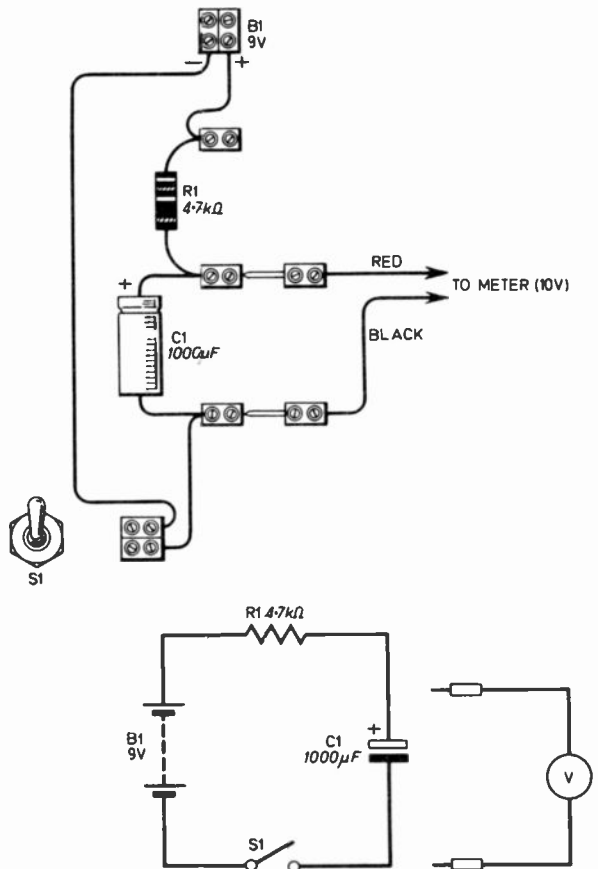

Fig. 4B.1. Shows the layout and wiring up of the components on the Circuit Deck for experiment 4B. Also shown is the theoretical circuit diagram.

EXERCISES

- 4.1. Calculate the time constant of the following:
 - (a) $C=2$ microfarads, $R=5$ megohms
 - (b) $C=0.1$ microfarads, $R=20$ kilohms
 - (c) $C=100$ microfarads, $R=1$ megohm
- 4.2. How long would it take a 0.5 microfarad capacitor to charge up to the full battery voltage via a 100 kilohm resistor?
- 4.3. A 1000 microfarad electrolytic capacitor has an internal leakage resistance of 200 kilohms. How long would it take to dis-

charge itself to about one-third of its original voltage?

- 4.4. Calculate the total capacity if a 2 microfarad and an 8 microfarad capacitor were connected in (a) parallel (b) series.
- 4.5. When using an electrolytic capacitor, what is the special precaution to be taken?

Answers

- 4.1. (a) 10 seconds (b) 2 milliseconds (c) 100 seconds
- 4.2. 0.25 seconds (approx).
- 4.3. 200 seconds.
- 4.4. (a) 10 microfarads (b) 1.6 microfarads.
- 4.5. Ensure correct polarity when connecting.

COUNTER INTELLIGENCE

By PAUL YOUNG

HAVE you ever read a description of a day in the life of the Prime Minister or the President of the United States, for that matter? If you have you will know that it goes something like this. "He is at his desk at 7 a.m. sharp every morning. He works till 1 p.m. and then has a working lunch".

In case it was true I refused both jobs, and decided selling electronic components was less tiring. Should any of my younger readers think it might be preferable to engine driving or window cleaning, I thought it might be advisable to describe my working day. Not that I would wish to deter them from their ambition, far from it, there are too few of us, and we cannot last for ever.

I am not at my desk at 7 a.m. it is in fact nearer 9.45, but unless the weather is particularly unkind, I go for a mile walk each morning before I start work. My first job is to deal with the post. Usually it is a mixed bag. Here is one from Sri Lanka, or Ceylon that was, and the writer says he is not allowed to send money out of the country, but if I send the goods he will send me some tea. I like it, I am always advising barter.

My next letter is from a customer in Kent who is very lavish in his praise of our catalogue. "Somehow you have even managed to improve on the last one, a seemingly impossible feat." Oh! I like this man, I could read his letters all day! My third one raises a smile, as it is an indignant letter from a customer, wanting to know why we have sent him a $0.0005\mu\text{F}$ variable capacitor when he asked for a 500pF ! My fourth letter is from the state department of the Channel Islands asking why we are robbing the poor inhabitants by asking them to pay V.A.T.!! It is hard to write a sympathetic reply to that one.

I quickly draft out replies to all my mail and gulp down a working cup of tea. By now several people have telephoned and some orders have been placed on my desk, each one short of one or two things. They have been put there in the hope that I can suggest substitutions, and frequently I can.

I am about to make my customary walk around the establishment, when one of the girls rushes in, looking like an over-worked sweep, caught by a shower of rain, "Oh! Mr. Young the

machine's gone wrong, its blacking all the paper". So I roll up my sleeves, put on my printing coat and investigate the trouble.

Crisis number two quickly follows, and turns out to be a shortage of the 100 microamp meters, wanted for the *Teach-In 76* series. To overcome this, entails several phone calls, to say nothing of frustration.

I get back to my desk and start to tidy it up, something I should have tackled weeks ago, when the phone rings, and it is the advertising agency wanting the copy for the next advertisement and telling me it should have been in yesterday. I sit down and try to think of something startling, original and clever that will bring the customers rolling in.

The phone rings again, it is a friend of mine in St. Vincent, West Indies, wanting a few bits and pieces. It is so clear I immediately say "Oh are you home Barrv?" When he tells me "no", I rather lamely say, "Oh! What's the weather like?"

Now it is time for a quick lunch and when I return, I see the girls are rather pushed, so I serve a few customers. Of course the afternoon brings in dramas, the post machine runs out of money and when we get our mail half way down in the hoist the mains fail. We can neither get it up nor down and the mail van has to leave without it.

Usually I have some electronic project on the go and each day I hope I can sneak an odd five minutes for some actual constructional work but it seldom happens, and all too soon I see the hands of the clock point to 6.15 and it is time to depart.

You have been warned.

TEACH-IN 76 *Matters Arising*

METER

On reading the *Teach-in 76* series E.E. October 1975, I noticed that a 100 microamp meter was called for. I have at home a 50 microamp meter and wondered if this could be used with the changes shown below.

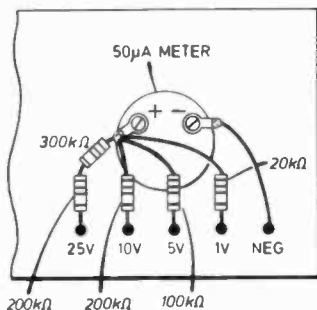

As the meter is only going to be used to monitor voltage, it is quite in order to use the 50 microamp meter as detailed above. You will in fact have a better voltmeter than with the 100 microamp meter as its sensitivity will be increased to 20 kilohms per volt.

LOUDSPEAKER

I have recently purchased a kit of components for the *Teach-in 76* series (which incidentally cost £21.18 from Home Radio).

How should the loudspeaker be attached to the top panel. In the illustration I see four screws and speaker cloth is used. Should there be a special fixing attachment on the loudspeaker.

Elizabeth McFadzen
Ayr, Scotland.

There are many small speakers that have no fixing holes and it appears that you have one of these. You have several choices of fixing, such as glueing the speaker cloth in place with an adhesive such as Araldite and then glueing the speaker to the cloth. Alternatively, wooden or metal brackets can be made to clamp the speaker (and cloth) to the top panel at the corners or edges of the loudspeaker.

MATHS

Unlike many, I suggest, of your readers, I really am a complete novice and as such am following your *Teach-In 76*. I am also taking through the course a number of boys aged 11 to 13 and shall be very interested to see how they can cope with the mathematical side of it. I realise that it is difficult to simplify far enough, and so I have in fact re-written some of your material in simpler words for their benefit. I should be interested to know if there are

any other readers of this age and what their opinions are.

Like many schools, I have a multimeter and so it would seem that the meter that you have said will be made at the end of the course would duplicate what I have already. Would it however be possible for one of your staff to design a pH meter with the parts being used? I feel that this would be a valuable addition to a school's equipment.

J. P. Bailey,
Camberley, Surrey.

We will look at alternative construction ideas for the meter.

PARALLEL RESISTORS

May I heartily congratulate you on such a fine—informative light-hearted series *Teach-In 76* that is currently being written in EVERYDAY ELECTRONICS. This is by far the best series I have seen—and the easiest to understand that I have yet seen.

However, it does in one sense fall into the same category as others—which is always a bit misleading regarding resistances in parallel, when more than two are involved, and it is dismissed as

$R = \frac{1}{\frac{1}{R_1} + \frac{1}{R_2} + \frac{1}{R_3}}$. Then it is explained and helpful

tips given for two in parallel—but rarely explanation for three. So that three 9Ω resistors in parallel is

often confusing as we get $\frac{1}{9} + \frac{1}{9} + \frac{1}{9} = \frac{3}{9}$ which many

think is the finish as nothing else is explained—I've

even known $\frac{3}{27}$ for above. No book ever tells people

that the result of above should be turned upside down or that the lowest common denominator

should be found making the result $= \frac{9}{3} = 3\Omega$. In

addition a useful tip arrives out of this: if three resistors of the same value are in parallel then the result is the value of one divided by the number of resistors.

Hoping for some clarification in the future—meanwhile carry on Mr. A. P. Stephenson—a fine series.

P. D. Cheel
Clacton, Essex

The formula for resistors in parallel is actually

$$\frac{1}{R_{total}} = \frac{1}{R_1} + \frac{1}{R_2} + \frac{1}{R_3} \text{ (see section 2.1, page 580)}$$

so the inversion is shown by $\frac{1}{R_{total}}$. The rest is simply

the application of maths to get the answer.

Physics is FUN!

By DERRICK DAINES



CHRISTMAS TOYS

As they used to say, A Merry Christmas to all our readers! And, while you're digesting that pudding and want something to keep the kids from bouncing on your stomach, show them how to make an electromagnet. It is a cute little gadget that any child can make and have fun with, yet has an astronomical number of applications that reach out over every branch of technology.

All that is needed to keep the kids happy is a nail, a length of wire and a battery—and that's all! The nail can be of any size—15mm is useful—and in any condition. The wire can be salvaged from a discarded transformer, while even the battery can be virtually discharged. Take about a metre of the wire and wrap it round the nail; bare the two ends and that's it! What could be simpler? If the battery is the single-cell type, anyone may hold the battery in one hand, nipping the wires between the top and the bottom (Fig. 1). Tightening and slackening the grip will cause the electromagnet to switch on and off. Anybody can have fun picking up and dropping several pins and paper clips.

Some readers may worry that the coil of wire is short-circuiting the battery, but we cannot agree or disagree without knowing their concept of a short-circuit. The internal resistance of the coil is very small, but is present nevertheless and will cause the coil to get quite warm after a few minutes. So if readers think of a short-circuit as nil resistance, they may set their minds at rest. However, since the resistance is so small the battery will be fairly quickly discharged, but then you can press that controller from the train set into use!

If you slip the coil off the nail, you will find that you can no

longer pick up pins, which is rather odd; what has happened? Whatever happened to that magnetism we discovered last month? Don't worry—it's still there, but it is now so weak that it is not strong enough to be demonstrated by a chunk of iron as big as a pin.

Clearly, the iron has the effect of increasing the magnetism. Consider Fig. 2; each millimetre of the wire contained in the coil still contributes its mite, a sheath of magnetism along its length, but the overall effect is for a North seeking pole to be created at one end and a South-seeking pole at the other. As mentioned last month, each line of flux makes a complete circuit.

This time it goes down the centre of the coil, out into space and round to the other end. The geometry of the arrangement means that there are more lines of flux per square centimetre of cross-sectional area inside the coil than there are on the outside. In other words, more magnetism. Now, the resistance of air to the passage of flux is immeasurably greater than the resistance of iron, so when we place iron inside the coil, the flux is enormously increased, manifesting itself at the ends of the iron.

If you change the polarity of supply, the North and South poles will change ends, as you would expect. This can be proved by means of a compass or another magnet, remembering that like poles repel and opposite poles attract; Fig. 3 shows the polarity that an electromagnet will adopt when a current is passed through it. If the current is passing clockwise when viewed from the end, the end nearest the observer will be the South-seeking pole. In other words, when turning an imaginary screwdriver with the current, the forefinger points to the North-seeking pole.

If your children have a Meccano set among their gifts, make a model crane with their electromagnet in place of the hook and you will then be able to snooze until teatime! Of course, this is one use to which it is put in industry. Other uses are legion and include the separation of metals, removal of impurities during food preparation, circuit breakers, meters and so on, as well as the enormous family of relays.

MAGNETIC SWING

A wooden frame can make the basis of a magnetic swing (Fig. 4). The swing itself is made of wire bent into a U-shape with hooks formed at each end. One side has a leg continuing upwards for 2 to 3cm above the hook. Small pieces of wire or panel pins pushed through the wood form pivots for the swing and an extra pin is pushed through on one side and the wire leg adjusted so that it just touches when the swing is at rest. Place a horseshoe magnet so that the swing is between the poles. Now when the battery is connected at the points shown, the swing will continually swing backwards and forwards.

Lastly, another little toy that always causes amusement; see Fig. 5. A pair of stiff wires are bent so as to form bridges about 8cm apart. They can be held in place by piercing a piece of card and bending the wires at the back, securing with Sellotape.

A horseshoe magnet is stood as shown and a 'snake' cut out of baking foil. When this is placed on the bare wires of the bridges and a battery connected, the snake will wriggle in an amusing way. For the best results the snake should not be flat but it should make good contact with the wires—Have fun!

Physics is FUN!

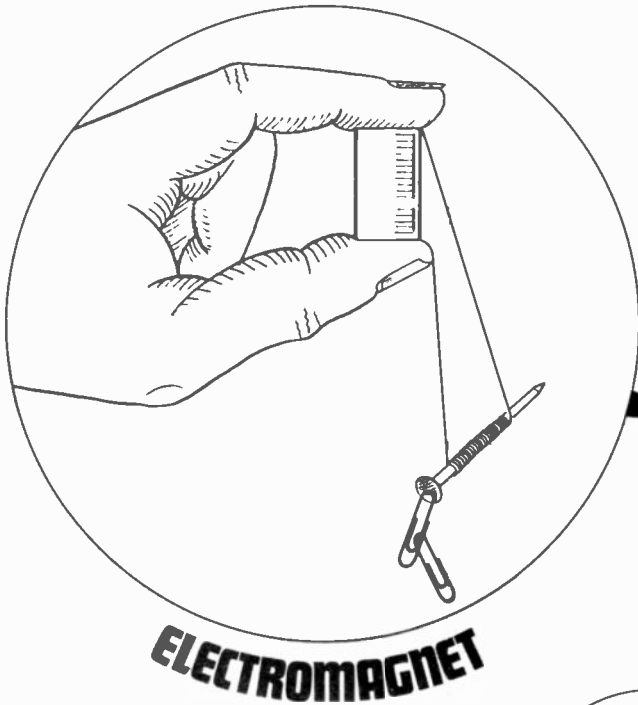

ELECTROMAGNET

Fig. 1. Use of a battery, nail and wire to make an electromagnet.

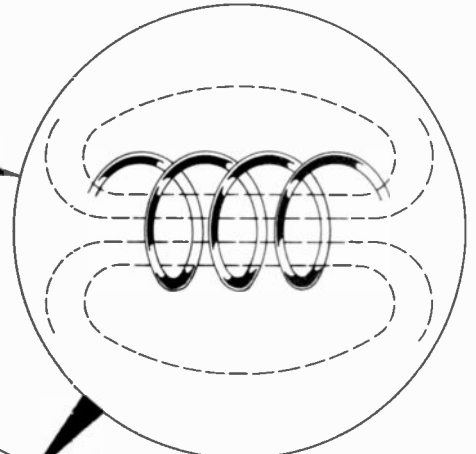

Fig. 2 (above). The magnetic field around a current carrying coil.

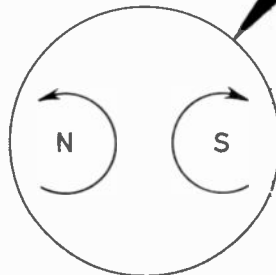
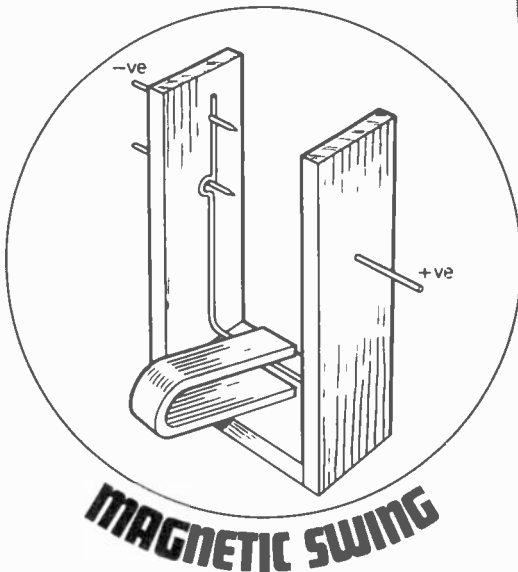

Fig. 3 (left). Polarity and current direction.



MAGNETIC SWING

Fig. 4 (above). Construction details of the magnetic swing.

MAGNETIC SNAKE

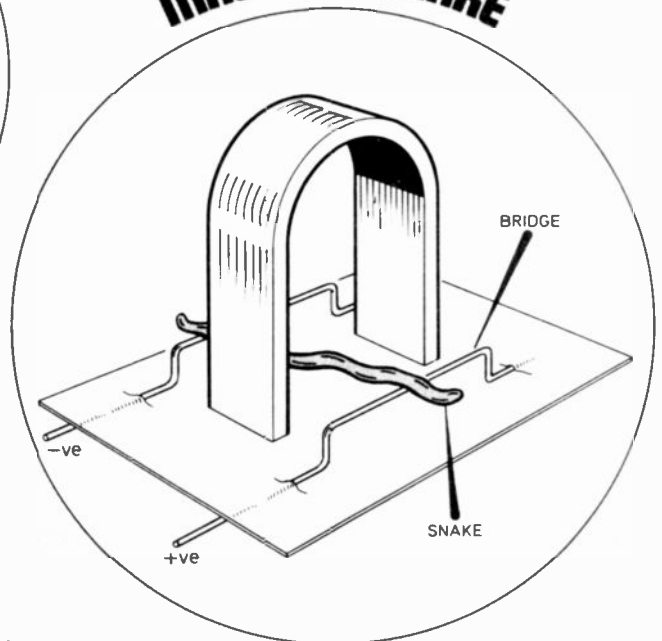
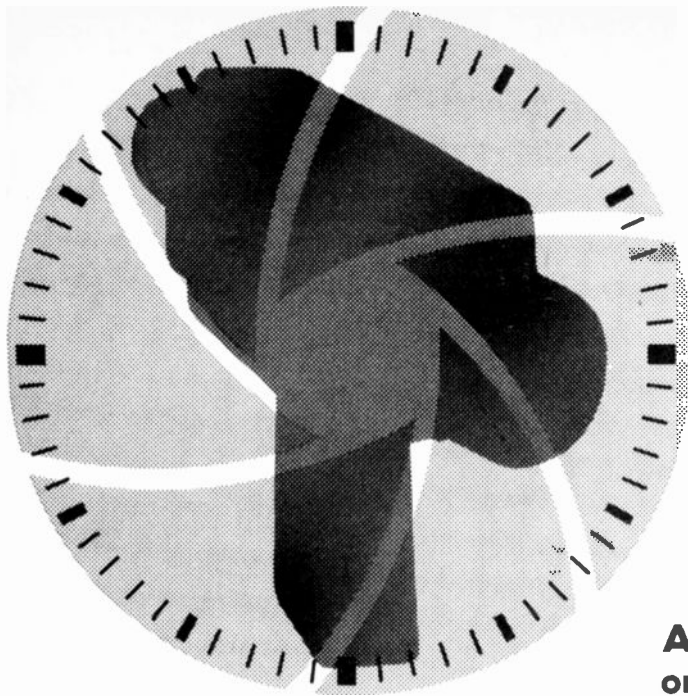

Fig. 5 (right). The 'snake' will wriggle when the battery is connected.



TIME LAPSE CINE TRIGGER

By P.H. ALLEY

Automatically fires a cine camera on single shot at set intervals.

DRIVE your car along the M1, or even a less auspicious road, at over 1000 m.p.h. and later produce the proof of this fact, for the benefit of any disbeliever, in the form of a movie film. The secret, if you haven't already guessed, is to set the movie camera up on a tripod in the car and press the single shot release at regular intervals. When subsequently projected onto a screen at the normal speed of 16 f.p.s. (or 24 f.p.s. if sound is recorded) the apparent motion will be increased by a factor dependent on projected speed divided by the filming speed.

For example, assume the actual speed of the car is 30 m.p.h., filming one frame every three seconds and then projecting the processed film at 16 f.p.s. will give an apparent speed on the screen of $(30 \times 16) \times \frac{1}{3} = 1440$ m.p.h.

For the filming sequence to last on the screen for 30 seconds will entail $30 \times 16 = 480$ frames which will take $(480 \times 3 \text{ secs}) = 24$ minutes to actually film.

Similar novelty films are only limited by the imagination and can be anything from filming a flower bulb opening over a period of hours to the tortoise skipping across the lawn.

The problem is the boredom for the photographer having to operate the cable release at intervals of a few seconds for several minutes. The answer is a remotely operated cable release which will do it automatically. This article describes how one can be made.

CIRCUIT DESCRIPTION

The circuit diagram of the Time Lapse Cine Trigger is shown in Fig. 1 and has been designed with minimal quiescent current so as to conserve the battery power which is important when set for long delay times and operating over long hours.

Transistor TR1 is a unijunction transistor connected up as a relaxation oscillator. This produces a pulse at regular intervals depending on the values of VR1, R1 and C1. The values have been chosen so that the minimum delay is 3 seconds when VR1 is set for minimum resistance and a maximum delay of about 3 minutes with VR1 set for maximum resistance.

The output from the unijunction is a very short duration pulse (in the order of a few microseconds) across R3. Each pulse causes TR2 to switch on hard and allows C2 to charge up very quickly to 6 volts before switching off. With TR2 off, C2 discharges through the base of TR3 at a rate principally determined by the value of R4. The value of the latter has been chosen so that the discharge time is about half a second and during this period the relay is energised and causes the motor to begin turning.

The electric motor, through the gearing, drives a shaft with cams at each end. One cam operates the cable release mechanism.

The other cam, which is electrically connected to the negative side of the motor power terminal through the case of the motor (and metal gearing), rotates sufficiently during the period the relay is energised to make contact with the contactor connected to the negative battery rail.

**FOR
GUIDANCE
ONLY**

**ESTIMATED COST*
OF COMPONENTS**
excluding V.A.T.

**£3.50 excluding
motor, gearing
and case**

*Based on prices prevailing at
time of going to press

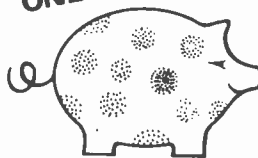

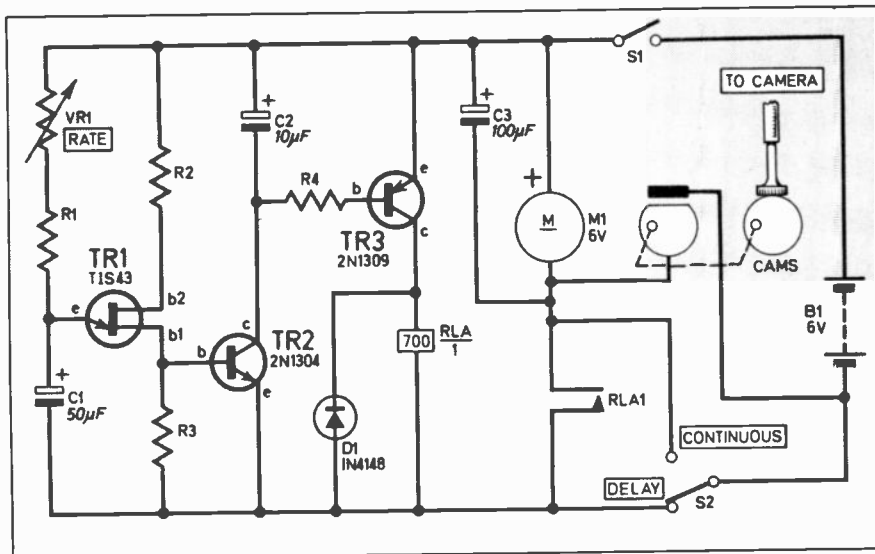

Fig. 1. The complete circuit diagram of the Time Lapse Cine Trigger.

When this happens the motor is caused to make a complete revolution and stops when the contactor/cam contact is broken by the cam flat. The motor is then ready to accept another pulse from the oscillator and the cycle is repeated for as long as S2 is in the "delay" position.

With S2 on "continuous", the relay contacts are bypassed and S2 provides a continuous circuit to the motor resulting in the operation of the cable release mechanism about once every second depending on the gearing.

Note that D1 is a small catching diode to prevent high inductive voltage across TR3 collector junction when the relay operates; C3 absorbs the nuisance pulse from operating TR3 and the relay when the motor stops.

The quiescent current for the circuit is about 1 milliamp being that of the unijunction oscillator. The cam motor consumes 100 milliamps when operating.

In one test carried out using four 1.5 volt pen-light batteries for the cam motor S2 was set for continuous run to see how long the batteries would last. After 35 minutes and 2000 exposed frames the batteries showed no signs of exhaustion. If S2 is set to "delay" it is estimated the batteries would last for days.

If less than a minimum 3 second delay is required, reduce C1 proportionally in which case the maximum delay period will be reduced in proportion.

COMPONENT BOARD

The prototype component board was 0.1 inch matrix Veroboard; the layout of the components on the topside of the board and the breaks to be made along the copper strips on the underside are shown in Fig. 2.

Begin by making the necessary breaks and drilling the fixing holes. Next mount the capacitors, resistors and relay coil followed by the transistors and diodes using a heatshunt on the

latter items to avoid thermal damage from the soldering iron. Attach suitable lengths of flying lead to the board so that they will comfortably reach the other components.

Components....

Resistors

- R1 33k Ω
- R2 120 Ω
- R3 20 Ω
- R4 10k Ω
- All $\frac{1}{4}$ W carbon \pm 10%

Potentiometer

- VR1 1M Ω carbon lin.

Capacitors

- C1 50 μ F 10V elect.
- C2 10 μ F 10V elect.
- C3 100 μ F 10V elect.

Semiconductors

- TR1 TIS43 unijunction
- TR2 2N1304 germanium *npn* or similar switching transistor
- TR3 2N1309 germanium *pnp* or similar switching transistor
- D1 1N4148 or similar silicon diode

Miscellaneous

- S1 on/off slide or toggle
 - S2 s.p.d.t. slide or toggle
 - RLA 6 vclt reed relay coil resistance 700 ohms (Doram)
 - M1 6 volt model motor
 - B1 6 volts (HP7, 4 off)
- Veroboard: 0.1 inch matrix, 37 holes by 22 strips; holder for B1; battery connectors for B1; knob; case to suit; metal gearing (see text); aluminium for brackets; solder tag.

**TALK
SHOP**
 SEE

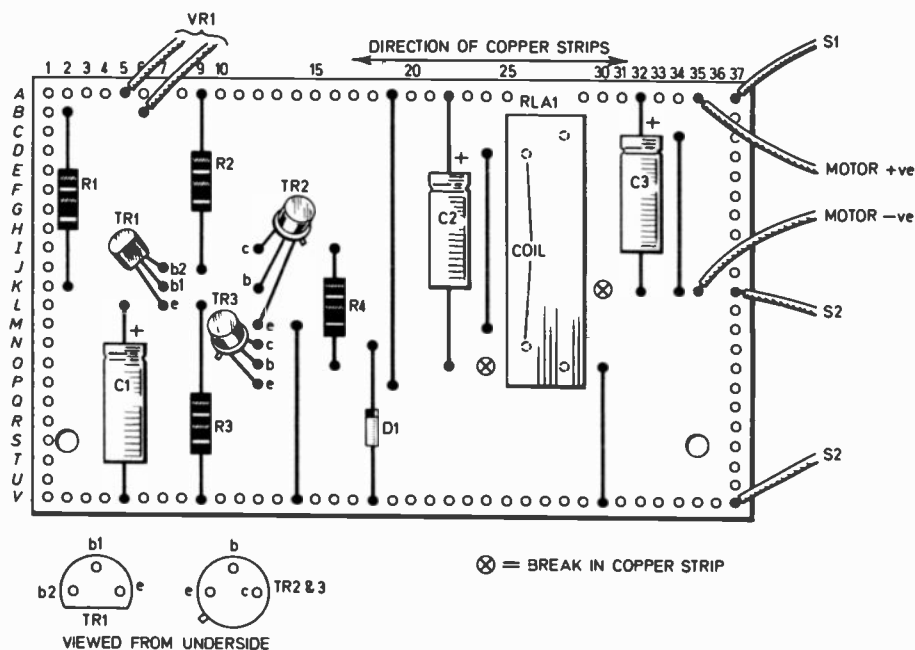

Fig. 2. The layout of the components on the veroboard. Note that there are two breaks to be made on the underside of the board at locations K30 and O24.

MOTOR DRIVE AND GEARING

The single shot release "pressure" on many ciné cameras can be quite high, some apparently needing $1\frac{1}{2}$ lb force.

Few solenoids are made which operate on less than 12 volt and inherently consume high instantaneous current necessitating high capacity and therefore bulky batteries. To keep the weight down the answer was found in an electric motor driven cam arrangement.

The 6 volt motor used in the prototype unit measured 35mm diameter and 38mm long and consumed 100 milliamps when used to operate the cam, thus four ordinary penlight HP7 batteries can provide the requisite battery power.

The gearing used in the prototype was rescued from a discarded child's electric motor driven toy, the ratio from motor input shaft to output shaft being 64:1. Most low voltage motor spindles are of similar dimensions and the original 1.5 volt toy motor complete with spindle was removed from the first gear boss and replaced by the 6 volt motor, the spindle being soldered inside the gear boss, lightly filing the motor spindle beforehand to give a good "key" for the solder. Suitable electric motors and gearing should be available from most good hobby stores.

A small copper wheel of 19mm diameter was drilled 3mm off centre and then soldered to the output shaft of the gear so as to form a cam.

Should the reader's gear ratio be significantly lower than 64:1, torque compensation can be obtained by proportionately increasing the diameter of the cam e.g. for a gear ratio 32:1, diameter of cam should be 38mm.

A second copper wheel 19mm diameter should be prepared with a "flat" filed on the circumference 13mm long, then drilled concentrically and soldered to the other end of the output shaft, see Fig. 3.

A standard cable release can be gripped by two small metal bracelets and bolted into position so that the cam, bearing up against the head of the cable push rod, causes it to reciprocate as the cam rotates, the stroke of the cable release plunger being equal to the lift of the cam (see Fig. 3). The point of contact between cam and push rod should be well lubricated.

The stroke of the cable release has been deliberately designed slightly on the high side. When the unit is completed and the cable release screwed fully home into the camera shaft, the cable should be flexing, coincident with the high side of the cam; unscrew the cable release sufficiently to prevent any undue strain on the cam motor and mechanical parts.

Some cable releases have accentuated conical threads allowing insufficient adjustment of this nature. In this case adjust the cable release position between its metal brackets so as to tailor the stroke to the camera's release mechanism.

CAMERA MECHANISM

With electric motor driven cameras the initial depression of the cable release closes a lightly sprung switch which starts the camera motor off-load. Further depression connects the motor to the shutter system through a clutch mechanism allowing the inertial torque of the motor to operate the system quickly, thereby

TIME LAPSE CINE TRIGGER

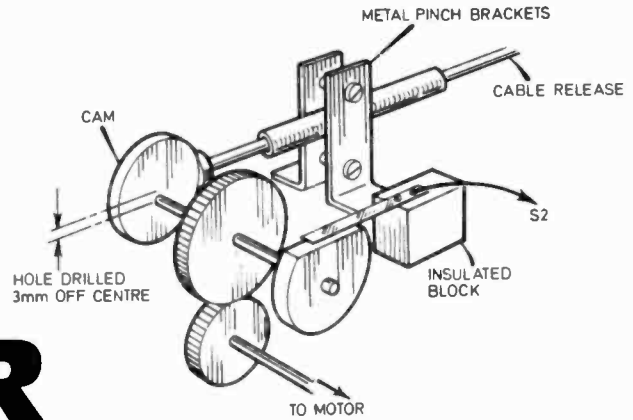
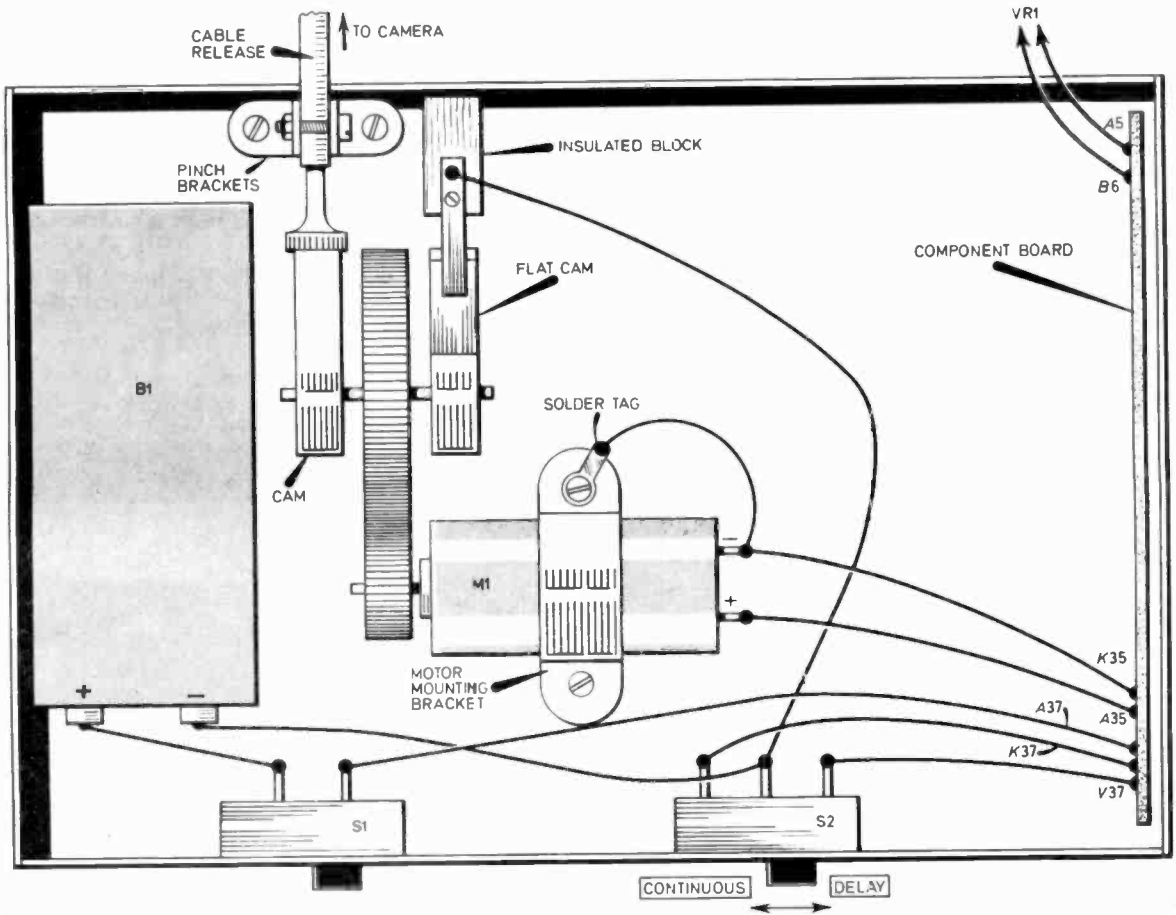

Fig. 3. Details of the pinch brackets, gearing and cam arrangement. For simplicity, only a two cog gear system is shown.

Fig. 4. The layout of the components in the case and complete wiring up details.



avoiding an overexposed frame. A typical 6 volt camera motor will only consume 100 milliamps when on continuous run but will consume up to 1 amp for the time the cable release is operated on single shot, the current flow starting from the time the lightly sprung switch is closed and ceases when it is opened. Therefore it is important to ensure that after every single shot the cable release is fully retracted and when in this quiescent position is not contacting the operating plate inside the camera thus preventing any possibility of the lightly sprung switch not being allowed to open. Thus, not only will battery life be conserved but will also prevent unnecessary heat being generated in the camera motor.

This goal is achieved initially by ensuring that the stroke of the cable release is more than sufficient to leave it fully retracted in the quiescent condition.

We now have to ensure that during the quiescent stage between each single shot, the low side of the cam is in contact with the cable release pushrod, thus ensuring maximum retraction. This is achieved by the metal contactor connected to one side of the battery, but insulated from the main gearing, resting on the rim of the "flat" cam wheel such that the flat portion of the wheel rim is co-incident with the position of the cam which leaves the cable release fully retracted.

ASSEMBLY

When the motor, gearing and cam mechanism have been completed the unit can be assembled. The prototype unit was housed in an empty plastic cigarette box size 106×95×55mm although the size and shape of the case will depend on the dimensions and configuration of the motor and gearing used.

The layout of the components in the case is shown in Fig. 4. This is not critical in any way and may be changed to suit. Begin by preparing the case to accept all the components and component board; secure them all in position in-

cluding the release cable and pinch brackets.

Note that the gearing and cams need to be metallic as should the motor body and fixing bracket. A solder tag is connected to one side of the motor bracket to enable the mechanism to be connected to the negative supply terminal.

The contactor for the "flat" cam should be mounted on a block of insulating material such as wood. Finally, wire up the components and board as detailed in Fig. 4.

ADJUSTMENT

The relay operating time is a function of C2, R4, TR3 and relay operating current. The operating time has a very wide tolerance necessitating only that the metal contactor reaches the rim of the copper wheel (flat cam) and lasts no more than one complete revolution of the output cam.

Should the time be too short, increase the value of R4 and when the maximum adjustment is reached here, indicated by erratic relay contact closure, increase the value of C2. If the time is too long, start adjustment by reducing C2 to 5 microfarads.

It is suggested that the case be screwed or glued onto a small plate which is drilled at one end for attaching the camera with a normal camera screw, or the whole mounted on a tripod.

With no film in the camera, connect the cable release to the camera with S2 set to "delay" and VR1 set for minimum resistance and switch on at S1. The cam will rotate once about every three seconds. Check, that as the cable release is operated by the cam, the shutter is functioning satisfactorily. With S2 in the "continuous" position, the camera shutter should operate about once every second.

If all is functioning correctly, mark the positions of the potentiometer knob that correspond to the required timing positions. □

We would like to thank Dixons for the loan of the cine camera shown on the front cover.

JACK PLUG & FAMILY...

I CAN'T MAKE UP MY MIND WHAT TO CONSTRUCT — THE HAWAIIAN GUITAR, THE STEREO AMPLIFIER, AUTOMATIC GARAGE DOORS.



WHAT WOULD YOU SUGGEST I DO FIRST, HARRY?



SINCE YOU ASK, I'D SUGGEST THE FIRST THING YOU DO IS GET YOUR PRIORITIES SORTED OUT.



NEXT MONTH

Prevention is better than cure!

Boiling Liquid Alarm

Prevent that mess on your hob, the waste of milk and the smell with this simple alarm. Inexpensive, easy to build.



AND Electronic Watchdog

Guard your home and possessions, build this inexpensive electronic alarm system to prevent stealing.



PLUS

**FIELD STRENGTH
METER**

**TWO TONE
OSCILLATOR**

everyday electronics

**FEBRUARY ISSUE
ON SALE FRIDAY,
JANUARY 16**



CALCULATORS GALORE

By ADRIAN HOPE



A COUPLE of years ago I wrote a consumer article about domestic calculators, and rounded it off with what I thought at the time was a very brave prediction. When domestic calculators first came onto the market, they fetched several hundreds of pounds each. But there were, even by the time when I wrote that article, plenty of good domestic machines at around £60, and even a couple at around half that. So I stuck my neck out and suggested that the price would continue dropping, even as far as the then unimaginably low figure of £15.

Well, you can't be right all the time! Despite the miserable state of our economy and the pathetic exchange rate for the pound, this country can still import foreign-made components or ready-made calculators and sell them for only a little above a fiver a time. And the "below a fiver" calculator must soon be with us. In fact, to be strictly accurate, it has already been with us—albeit temporarily. A domestic calculator for £4.99 or thereabouts recently appeared briefly, but it has since disappeared.

Although there is no doubt that the downward spiral of calculator prices is decelerating, there is also no doubt that before long below-a-fiver calculators will be readily available (*As we go to press we note that Laskys are selling the Casio Personal Mini for £4.95*). So how and why has all this happened?

MINIATURISATION

Man has always tried to automate the chore of arithmetic and as long ago as the seventeenth century inventors used wheels and drums to add and subtract. And, of course, the slide rule and

The calculators shown above are: Bowmar MX90, Bowmar MX120, Bowmar Mathmate, CBM 9140D and CBM SR 6120R.

abacus are hardly new. With electricity came realisation that the future of automatic calculating lay with electronics, and after the last war massive room-sized, valve-powered gadgetry was designed. Then came the transistor, and with it the possibility of a reasonably small, cheap and cool (remember valves run very hot!) calculator. But by modern standards the original transistor devices were very bulky and the modern trend towards smaller and cheaper follows from the advent of new techniques in sub-miniaturisation and integration.

The real watershed in the history of the calculator was the commercial production of an integrated circuit or "chip" which, as a single unit, replaced virtually all the discrete components hitherto needed.

COST SPIRAL

Although chips cost a considerable amount of money to design and put into production, they cost very little to actually produce. Thus it makes sense to sell them very cheaply and in vast quantities, to recoup their original development costs. In the world of calculators, there is a routine which has now become standard.

One of the large manufacturers, such as Texas, Rockwell, Hewlett-Packard or Novus, develops a chip for their own use and incorporates it in their own calculators. Soon they sell, at a reasonably high price (but still ludicrously low in real terms), a batch of identical chips to other, rival manufacturers. The rivals then build the chips into their own machines.

It is for this reason that any major new calculator development is usually found first in the expensive machines of a few, large firms and then, a few months later, in the cheaper



The chip shown contains 120 components—this picture was taken in 1969, before things really got small.

machines of slightly less well known but equally reputable firms. Finally, once everyone at the top end of the bracket has had all the chips they need, and there is a new chip on the way (either improved in some respect or offering even more facilities), the remaining stocks of the old chip are sold off cheap in massive job-lots to other electronic firms, usually in the East.

These firms then build the perfectly sound, but in some respects obsolete, chips into their own calculators and export them around the world at what now seems a ridiculously low cost. This is why we can buy today a machine offering all the facilities that a top maker's machine was offering a few months ago, but at only a fraction of the price asked for the original machine. And this is how the below-a-fiver calculator can be possible. But of course there must come a time when prices can drop no further.

However cheaply a manufacturer can buy his chips, he must still spend money on a casing, power supply and digital readout, to produce a saleable calculator. All these extra items cost money and they are not getting any cheaper. Also, the materials and labour involved in chip production is costing more all the time, and this must limit the eventual rock bottom price of a chip.

RPN CHIPS

Perhaps the best example of how an obsolete chip finds its way onto various markets at ever decreasing prices is that of the Reverse Polish Notation chip. In the beginning (which, remember, for calculators was only a few years ago), most chips and thus calculator designs used RPN (or post-fixed operator logic). According to this logic or notation, the user or operator must add and subtract in a manner which, although mathematically more correct, does not tally with the way most people's mental processes work.

Take, for example, the simple sum: $4-3$. When we do this sum in our head, we think first of 4, then minus, then 3, and come up with the result: 1. But to do this sum on an RPN machine, it is necessary to enter first the figure 4; then enter a plus/equals sign; then enter the 3; and then enter a minus/equals sign. This gives the correct result. On the other hand, if you use an RPN machine in the mental manner (enter 4; enter minus/equals; enter 3; enter plus/equals) it will give the incorrect answer: -1 .

Some scientific calculators (for instance those made by Hewlett-Packard) still use RPN because the scientists and mathematicians who use them prefer this reverse logic, but for domestic use, an RPN machine (however mathematically correct, etc.) really is a pest. It makes far more domestic sense to use normal, algebraic or free-flow logic, as is now incorporated in the chip of virtually every domestic and even semi-scientific machine.

With algebraic logic, the simple sum $4-3=1$ is entered exactly as you read it (enter 4, enter $-$, enter 3, enter $=$, and read off the result: 1).

Of course once algebraic chips had become available no one in the trade would pay more than a pittance for a domestic RPN chip. So the remaining RPN chips were sold off at ever decreasing prices, in job lots round the world. Thus machines were still appearing on the market with RPN logic long after the major manufacturers had abandoned it for domestic use. Incidentally, you can tell an RPN machine at a glance, because it will have two $=$ keys, one $+ =$ and one $- =$. But there are few, if any, still on sale now as domestic machines.

The Sinclair Executive—at one time the world's smallest calculator—now they come in watches.



RETAIL SALES

Over recent months I have noticed that as the hi-fi boom has cooled so the calculator section of the Lasky's catalogue and price list has swollen. I asked their Oxford Street store to give me the lowdown from the other side of the counter. After all, if you stock and sell a large number of calculators, you soon find out not only what is reliable and what the public wants, but what also is unreliable and what the public don't want.

In fact although Lasky's have what seems like a very large range, they apparently don't touch the job-lot, cheaper sort of unrepeatable offers with a barge pole. It just isn't worth the trouble. Because calculator servicing (by the retailer, at least) is just not cost-effective, the retailer is duty bound simply to replace any calculator that is faulty on purchase or that develops a fault within the guarantee period. Provided that the retailer (through his wholesaler) has been dealing with an established firm, this system works well. Just as a record retailer sends back a batch of faulty discs and is either credited or receives an equal number of replacements in return, so the shop selling calculators simply bundles off every faulty machine back to the manufacturer and takes either a credit or an equal number in replacements. You can't work this way with a vanishing supply source!

The failure rate from some established calculator firms is high and from others low. For instance one British firm is particularly poor in this respect, but their products are still universally stocked for a variety of reasons. The machines look good, perform well (when working properly), are remarkably cheap and sell like hot cakes.

The range of CBM Business Machines scientific calculators.

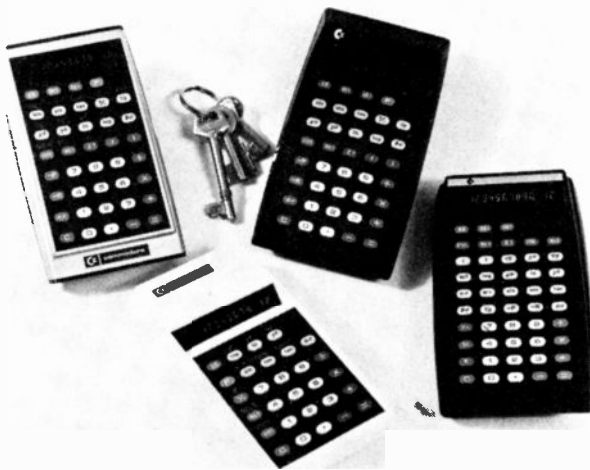

Equally important, the firm never quibbles over crediting or replacing anything faulty that is returned. Perhaps they work on the assumption that it is cheaper to churn out large quantities of machines which have a high fault rate and replace them as a routine, than it is to tighten on quality control.

EXTRA FACILITIES

Now algebraic logic is the norm for all domestic calculators, the most important facilities to watch for [over and above the basic four (+/-/×/÷) functions] are probably a green display of eight digits minimum, a live per cent key, a CE key, a reciprocal key and a constant. Although scientific calculators tend to have red l.e.d. displays and use re-chargeable batteries, a green display (usually with disposable batteries) is generally more legible for domestic use. And it can be irritating to have anything less than eight digits on the display. Whereas on a scientific calculator any number of digits over and above the display capacity can automatically convert into scientific notation, with most domestic calculators the display will simply not hold any overload—and a six digit display is easily overloaded.

The live per cent key is extremely useful in these days of mixed VAT rate because it automatically gives a VAT inclusive result; a constant facility makes it easier to repeat a similar calculation several times. A CE (clear entry) key enables the user to wipe out the last entry of a calculation without obliterating all the previous steps. This can be very useful, because without such a facility it is necessary to clear a whole calculation and go back to the beginning if you make just one mistake in any entry.

There are probably two golden rules for calculator buyers. First, think not so much of what you fancy in a calculator but what you are going to use it for. If, for instance, you are going to use it for shopping or accounting, then a live per cent key is an essential. If, on the other hand, you are going to use it mostly for mathematical work, then a log and anti-log key may be invaluable. And curiously, I have never yet seen one calculator that offers both functions.

Also, a reciprocal, although at first seeming rather superfluous, can be very useful for anyone involved in currency conversions. Imagine, for instance, the dollar rate is (as at the time of writing) 2.03. Using the reciprocal key ($1/\times$) produces the result: 0.49, which you then simply multiply by the number of dollars to provide a direct readout of pounds sterling equivalent. This calculation can, of course, be done without a reciprocal key, but it takes longer.

The second golden rule is to read the instruction book for whatever calculator you buy. You



The Decimo Super VATMAN, similar to the VATMAN but with more facilities.

can in fact do the reciprocal calculation easily without a reciprocal key if you have got to know your machine well by reading the instruction book. Many modern machines now have an automatic constant facility (whereas earlier models had it as a switchable function) and if you take the 2.03, press the \div key and then the = key, you will get the obvious answer: 1. But pressing the = key again (if the machine has automatic constant or is switched to constant) will give you the reciprocal as a result. This of course is then simply multiplied by the number of dollars to give a direct readout as sterling. It would be easy to go a lifetime with a machine and never know this kind of thing, if you do not bother to read the instruction book. And you may get the wrong answer by not reverting to clear before multiplying.

VAT CALCULATIONS

Take, for instance, the popular Decimo Vatman, which has a live per cent key and, as its name implies, is intended primarily as a VAT percentage calculator. The steps for working out a ten per cent increase on 200 are as follows:

Enter 200, enter \times , enter 10, enter $\%$. This gives the intermediate result of 20 as the percentage figure. Then enter $+$ and then $=$, to give the total result of original figure plus percentage increase, which in this case is 220. But miss out the last = sign and the machine continues to display 20. Miss out instead the $+$ sign and the machine displays 4,000. Replace the first \times sign by $+$, and the machine always gives the answer 210. Whereas the first two incorrect answers (20 and 4,000) are unlikely to pass unnoticed, the third (210) might well do so.

Now try the same strings of calculations on

Table 1 Percentage Results

To show how different calculators produce different results from the same entries. Three machines were used, in each case, the problem was the same—what is 200, increased by 10 per cent?

	Enter	Enter	Enter	Enter	Enter	Enter	Answer or Wrong (\checkmark or \times)
Casio Personal 8	200	\times	10	$\%$	$+$	$-$	440 \checkmark
	200	\times	10	$\%$	$+$	$=$	220 \checkmark
	200	\times	10	$\%$	$+$	$=$	20 \times
	200	$+$	10	$\%$	$+$	$-$	420 \times
	200	$+$	10	$\%$	$+$	$=$	210 \times
	200	$+$	10	$\%$	$=$	$=$	210 \times
Rockwell 20R	200	\times	10	$\%$	$+$	$=$	40 \times
	200	\times	10	$\%$	$+$	$=$	20 \times
	200	\times	10	$\%$	$+$	$-$	200 \times
	200	$+$	10	$\%$	$+$	$=$	240 \times
	200	$+$	10	$\%$	$+$	$=$	220 \checkmark
	200	$+$	10	$\%$	$-$	$=$	220 \times
Decimo VATman	200	\times	10	$\%$	$+$	$-$	220 \checkmark
	200	\times	10	$\%$	$+$	$=$	20 \times
	200	\times	10	$\%$	$+$	$=$	4000 \times
	200	$+$	10	$\%$	$+$	$=$	210 \times
	200	$+$	10	$\%$	$+$	$=$	210 \times
	200	$+$	10	$\%$	$=$	$=$	210 \times

But — still with the Vatman —

$$100 + 10 \% + = 110 \checkmark$$

This may be the numerically correct answer for the calculation performed but it is only by coincidence! As the table shows the same sequence will give incorrect answers for other sets of figures.

different machines, and as the table dramatically shows you may well only get the correct answer from a different sequence. No one machine is good or bad in this respect. They all simply need to be used in their own particular way, and it is the fault of the operator if his use of a wrong procedure produces the wrong result. It is the people who work computers and calculators that produce the wrong results, not the machines themselves; they can only feed out junk, if junk is fed into them.

It defeats the whole object of using a calculator if you check the results continually for errors. Instead, check the procedure carefully, and then, within reason, leave the results to look after themselves.

When checking procedure, it is a good idea to run through the machine at least two simple test calculations, with simple, known answers. Beware of running only one test calculation, because it may, by sheer coincidence, give the correct result with an incorrect sequence. For instance, as the table also shows, on the Vatman *incorrectly* using $+$ rather than \times for the first entry gives the *numerically correct* result for a calculation which seeks to establish a percentage increase on 100.

Readers with inquiring minds, a little time to kill and a calculator to hand, might like to amuse themselves looking for other, and less obvious pitfalls where the wrong entry sequence happens to give the right result for just one set

of figures. Other, less active, readers can muse on a sobering thought—how many small, and even large, company decisions on financial matters have been taken on the strength of an incorrect answer given by a calculator fed with the correct figures but in a sequence which is wrong for that particular machine's logic?

CASH BOOM?

Contrary to what one would imagine, there is not really a calculator cash boom at the moment. Figures for the last three years show that the total number of hand-held calculators sold has been increasing (from 650,000 to 1,000,000, to 1.5 million per year), but set against that is the fact that in those three years the average price has dropped from £45 to £30 to £18. So the turnover has gone from £30,000,000 to £30,000,000 to £27,000,000. In other words, astonishing as it may sound, there is now less money being spent on calculators than there was last year or the year before.

What of the future? The answer, in a word, is time. Calculators are already being built to incorporate time recording components and thus can be used as a stopwatch. So far the calculator circuitry and the time circuitry share, and are switched between, the same display. But inevitably future calculators will have a separate permanent time display. And the cross-fertilisation between calculators and clocks is two-way. There is already a watch with a digital time readout that incorporates calculator circuitry. In the future there will be more wristwatches that can be used both as a watch and a calculator.

PROGRAMMABLE CALCULATORS

Another area of future interest is the programmable calculator. It makes sense to be able to program a calculator to work for you. If you are doing the same calculation over and over again, but with different entry figures, it can be a real time saver simply to punch in the differing figures in a set sequence and let the machine's memory cope with entering the various intermediate functions to be applied to them (such as +, -, X, ÷, log, etc.).

Already, and indeed for some time now, there have been programmable machines (such as those offered by Hewlett Packard) whereby a tiny magnetic strip carrying a program is pushed into the machine and read by its internal electronics to define what function steps the calculator should carry out on any figures entered into it. Machines like this do, however, tend to be expensive, largely because the mechanics and electronics necessary for reading the program from the card must be both small and reliable. It is after all more difficult to miniaturise mechanics than electronics.

The answer now is to make the machine pro-



The Bowmar MX90 Brainmaster and MX100 Brainwave

grammable via its keyboard. At the time of writing, Sinclair are just launching a new machine with keyboard programming for around £30. But doubtless by the time this appears in print its cost will have fallen well below this figure. Because the same chips as are used in the Sinclair must very soon become available to other firms, it is a safe bet that the next year will see a flood of keyboard program calculators on the market.

Perhaps after that there will be a combined wristwatch with calendar and programmable calculator. There is already in production a watch with a calendar programmed to account for month length and year length for the next 200 years, and it seems reasonable to assume that if a watch is to incorporate a keyboard operated calculator then the calculator might as well be programmable and the program controllable by the keyboard.

BAD RESULTS

Personally, what bothers me more than where we are taking the technology, is where the technology is taking us. Recently my eleven-year-old son came home from school with a batch of long multiplication and division sums that had been set for his homework. He was worried about how to do them and couldn't remember the steps that his teacher had explained to him. Now this is a shameful admission, but I had considerable difficulty in remembering them myself, and when I had remembered and had a go at the sums I had to check that the results were correct with my calculator. What any thinking person must now ask themselves is, how many parents will be able to help their children with written arithmetic in the years to come?

The present adult generation is safe, in that it has once had to do its sums the hard way and could, if necessary, and with a little self-discipline, go back to first principles again. But if children in the future never have the need of those first principles, how are they going to fare in everyday life? There are already enough shopkeepers giving wrong change (always in favour of themselves, it seems) to make the future decidedly bleak for anyone who can't do his own simple mathematics. □

Your Career in **ELECTRONICS**

By Peter Verwig

1976—A YEAR OF OPPORTUNITY

AFTER some months of planning, the first article in the series Your Career in Electronics appeared in the April 1975 issue. The series will continue on a regular monthly basis throughout 1976 but as we enter the New Year the Editor thought it might be a good idea to interrupt the flow of information on career opportunities available in specific areas of the world of electronics in order to "recap" on some of the earlier articles for the benefit of new readers, and also to review the present state of the industry.

First, how has the series been received and is it doing its job? Feedback from readers indicates that they find the articles both interesting and useful. **EVERYDAY ELECTRONICS** has enjoyed from the start the active co-operation of companies in the electronics industry and from the learned societies and institutions. Two commercial companies ordered reprints of articles which described openings for apprentices and young engineers and these will be used by the companies as introductory literature for potential new recruits.

We know that one company had more than a hundred enquiries from readers. So it might be said with some justification that in just a few short months the series has become well established, is popular with readers and has earned the respect of employers.

Let us now look at the other side of the coin. **EVERYDAY ELECTRONICS** is not an employment bureau and we cannot undertake to answer correspondence on career opportunities or advise readers on an individual basis. Your Career in Electronics sets out to explain the structure of professional electronics, and give guidance on the types of careers available and how to obtain the necessary qualifications and experience to equip yourself for a professional career.

Electronics is volatile. It is the fastest moving of all technologies and what it needs is a constant supply of vigorous "self-starters". By this is meant people with initiative and self-reliance. We can give guidelines and some hints and tips but we can't get a job for you. It is up to you to demonstrate to a prospective employer that you are keen, have the character and determination he is looking for, and have the right qualifications or are studying to get them.

QUALIFICATIONS

The past two years have seen a world recession in trade and rising unemployment in a number of industries. Electronics has suffered less than most, and some companies have bucked the trend and done better than ever before during this period. But with more people available for fewer jobs it automatically follows that employers have been able to be more selective in choosing from those in the job queue.

All other things being equal, the person with paper qualifications will score over those who are unqualified. The person who is an obvious self-starter but may as yet be unqualified might score over the person who is qualified but has an unattractive personality and lack of ambition. A keen self-starter with qualifications will always get a good hearing.

A good technical qualification will always be of value. While studying or when you have acquired qualifications, get elected

A European Space Agency ground station under construction in Germany to receive weather pictures transmitted from the "Meteosat" satellite due to be operational in mid-1977. (Photo by courtesy of Siemens)

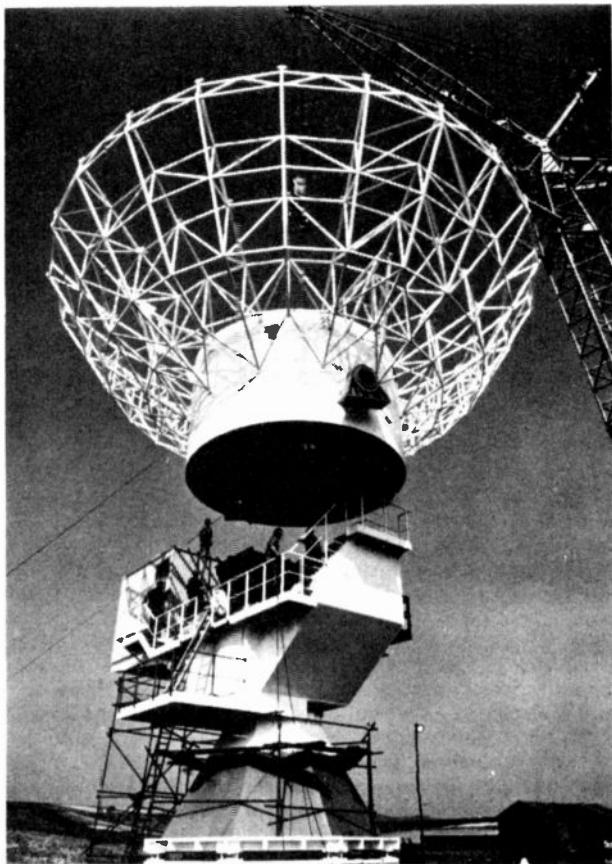

to one of the technician or chartered engineer professional institutions and get yourself listed on the register of the Engineers Registration Board.

At present you can only become registered if you are a member of one of the recognised professional institutions within the Council of Engineering Institutions. There is some talk of widening the register to embrace members of "non-recognised" institutions but this has not yet happened. But whatever the outcome, it is worth getting on the register because there is more than just a mere possibility that at some future date it may be necessary to be on the register before you are allowed to practice your profession.

Keeping abreast of a fast-moving technology is always a problem. Every aspiring engineer will have his own favourite areas which he finds especially appealing once he has learnt the fundamentals of electronics. But whatever you do, don't neglect digital techniques. The engineer who is well informed on digital circuits and logic has infinitely greater career opportunities today that his colleague who is knowledgeable only in analogue techniques.

REWARD

Is there really a future in electronics? Is all the study and struggle worth it? Aren't there easier ways of making a living? The answer is yes to all three questions.

Let's take the last one first. And let's take the simple test of income. Apprentices today earn a little over £1,000 per annum while training, rising to perhaps £2,000 by the time they are trained. Qualified engineers in electronics earn in the range £2,500 to £3,500; senior design and development engineers get up to £4,500. These are the sort of incomes now regarded as typical for semi-skilled male manual workers in an egalitarian society. Pay differentials have narrowed over the years so that the premium once available for special skills has been effectively eroded.

To be perfectly honest, we have to admit that it is possible to earn as much, or more, on a building site, in the docks, down a mine or even on the road as a long-distance truck driver. The

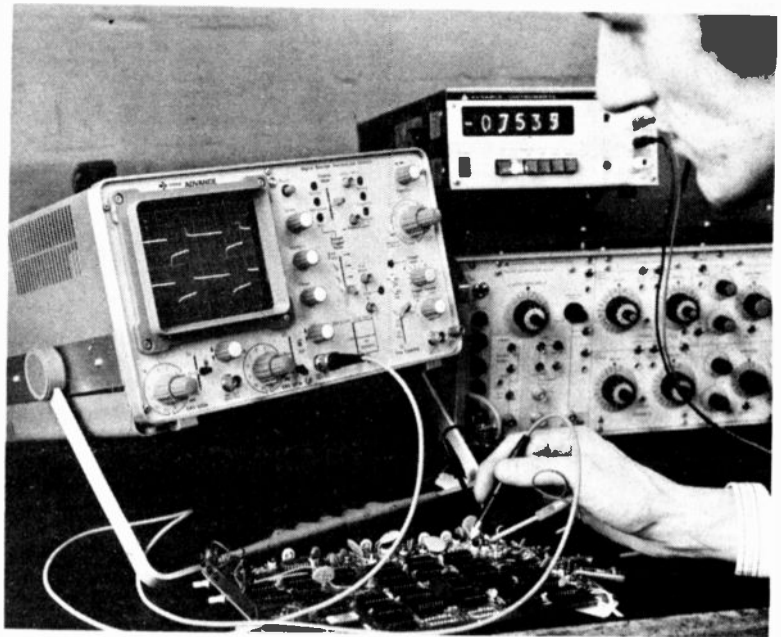

The Gould Advance digital storage oscilloscope type OS 4000 in laboratory use. Announced last October it is the first British oscilloscope to use a random access memory to store information.

choice is yours and if the income is equal then the choice is between a job and a career, working just to earn a living or participating in a creative activity which is interesting as well as rewarding.

Of course the incomes quoted above are for average people with average talent. They are not the top salaries. A percentage of engineers graduate to management posts. Chief engineers and technical directors sit on the boards of companies with salaries and privileges to match. Many practising engineers switch to sales at some stage in their careers and may expect to earn £5,000 to £7,500. And plenty of bright engineers, having gained experience in commercial firms, spin off and start their own businesses, many with considerable success.

BROAD RANGE

One of the fascinations of the electronics industry is the broad range of specialities open to the technically qualified. In manufacture, for example, the openings are in research; design; product development and planning; production; quality control; testing; sales and marketing; installation and commissioning; and after-sales service.

A young engineer starting his career might serve in more than

one, and perhaps several, of these areas of activity before finding his true niche and then building his career in the occupation which suits him best. None of his experience is wasted, all is valuable. Truck drivers do not have this variety of choice open to them.

Is all the study and struggle worth it? This question, I believe, has already been answered. The person who studies for his qualifications will certainly not be doing it for hard cash but out of interest, even passion, for the subject and because it enriches the mentality and broadens opportunity.

FUTURE

But what of the future? Let it be understood right away that electronics is an un-stoppable growth industry. You will read scare stories in the newspapers of redundancies. Five hundred laid off here, a thousand there. But look closer and you will find that nearly all these stories are from the cyclical consumer sector (e.g. domestic radio and TV) or from telecommunication equipment manufacturers temporarily affected by Post Office cut-backs in orders.

Which workers are being laid off? In all cases the great bulk are line assembly workers, many of

them part-time semi-skilled female operators. In the case of Post Office cut-backs it is the old electro-mechanical Strowger exchange equipment that is affected, not the new generation electronic exchanges.

The great capital goods sector of the industry is prospering, even through bad times. There are several product areas where business has never been better. Communications equipment for North Sea oil rigs is a topical example. Huge contracts have been obtained from the Middle East and not only for defence equipment. A giant new market is opening up in China and trade is increasing with Eastern Bloc countries. And the much-discussed programme for the regeneration of British industry will create enormous demand for electronic-based automation.

Technology is still on the move. The microprocessor is gaining hold commercially and will add its own impetus to electronics. The demand for good electronic engineers is as high as ever and this when times are bad. By the end of 1976 and beyond there could be a critical shortage and this might well provide the leverage to restore the salary differential which exclusive skills merit.



Charles Cookson started his career in 1962 as a student apprentice with GEC Telecommunications. Since then he has been a commissioning engineer, a production foreman, and went to Australia in 1974 as a sales engineer for English Electric Valve Co. products. He was awarded an Honours Degree in 1967 and received a Diploma in Management Studies in 1973.



Readers' Bright Ideas; any idea that is published will be awarded payment according to its merit. The ideas have not been proved by us.

I thought this hint might be worthwhile publishing in your Bright Ideas section.

When mounting finished component boards into their cases, one has the problem of how to stand off and insulate the component board. My tip is to

buy a length of plastic petrol piping and cut this to the required stand off length.

The piping acts as a stand off insulator as well as a good shock absorber.

Mr. P. Hart,
Nottingham.

Making one's own printed circuit boards is in the long run cheaper than using Veroboard, but it is a time-consuming process. The quickest method for one-off production is to draw the circuit layout directly on to the copper using a pen specially designed for the purpose, containing an etch-resistant ink. Such pens are quite expensive.

Ordinary fibre-tip pens are not a satisfactory alternative; the ink does not dry on non-absorbent surfaces, and is not resistant to the etching solution. A suitable pen however is the type designed for writing garden labels, available for about 15p from Woolworths and gardening shops. These pens have a tip which is suitable for all but the most intricate work, the ink dries instantly on all surfaces and does not come off in the etching bath. After etching, the ink can be easily removed by rubbing lightly with fine steel wool (Brillo pad).

M. McKay,
Londonderry.

Provides a variable voltage output from 5 to 20 volts and current up to 1 amp.

THE need for a power supply unit is essential when one is concerned with building and testing transistorised equipment. With the high cost of batteries nowadays, it will not be too long before the unit pays for itself.

Besides the cost point of view, it is far more convenient and helpful to have a power supply unit capable of giving a continuously variable voltage output with monitored current consumption such as the unit described in this article.

OUTPUT DETAILS

The Stabilised Power Supply Unit detailed here has a variable output voltage from 5 to 20 volts and can supply a current of up to one ampere. This should cover the needs for a wide range of constructional projects. The unit employs two meters so that voltage and current can be monitored simultaneously.

The a.c. ripple at any voltage between 5 and 20 volts, and for all current demands up to one ampere, is less than one millivolt. Regulation (the amount by which the output voltage changes with varying load currents) is in the order of 2.5 per cent as measured on the prototype.

A switch has been incorporated that allows the voltmeter to become completely isolated from the unit, so that voltage measurements may be taken on the equipment under test.

CIRCUIT DESCRIPTION

The complete circuit diagram of the Stabilised Power Supply Unit is shown in Fig. 1.

Mains voltage is applied via fuse FS1 and on/off switch S1 to the primary of T1 where it is stepped down to approximately 18 volts r.m.s. This is full-wave rectified by diode bridge D1-D4 and smoothed by capacitor C1 producing a d.c. level of approximately 25 volts across C1.

The emitter of TR2 is clamped at approximately -20 volts with respect to the 0V line by means of Zener diode D5 and associated series resistor R1.

The output voltage is that developed across the collector load of TR3; this load is composed of R7 in parallel with the voltage monitoring network, R5 and R6 in series with the voltage control potentiometer VR1. Capacitor C2 gives additional smoothing.

CLOSED LOOP

The output voltage is seen to be directly proportional to the collector current of TR3. Now the setting of VR1 determines the base current for TR2, thus setting the collector current of TR2. The latter constitutes the base current for TR1, whose collector current determines how far TR3 is driven on. Thus we have a closed loop which stabilises the output voltage at a value determined by the setting of VR1.



STABILISED POWER SUPPLY UNIT

By C. F. TERRELL

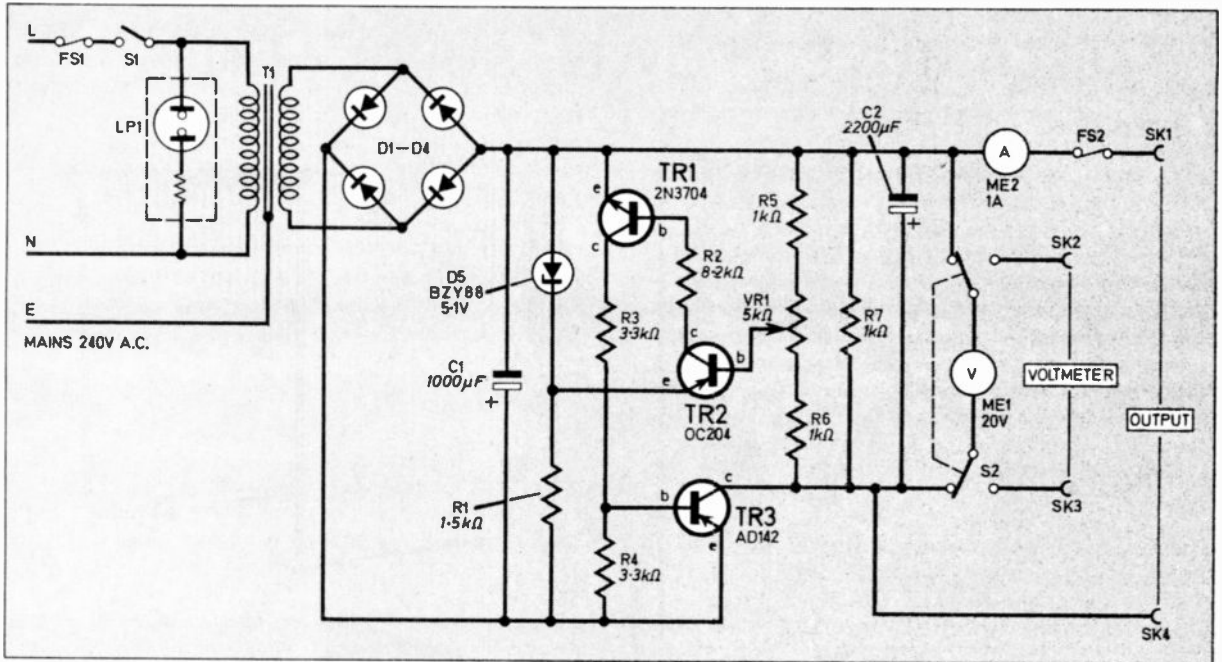

Fig. 1. The complete circuit diagram of the Stabilised Power Supply Unit.

ACTION

The action of the unit when an external load is connected is best described with the following example.

Assume VR1 is set to give a 10 volt output, then the current flowing through TR3 will be about 10 milliamps. If now a heavy load is connected, say 10 ohms, before the sensing loop readjusts, the effective load for TR3 is just less than 10 ohms and 10 milliamps is flowing. This produces a voltage drop of only 0.1 volt; therefore the potential on the base of TR2 is at almost -25 volts. Consequently, TR2 base current is increased, and through the loop causes TR3 collector current to increase. As the latter increases the potential on the base of TR2 increases (TR2 current decreases).

This process, which is virtually instantaneous, continues until equilibrium is reached. At this point, the current through the 10 ohm load will be 1 ampere.

METERS

Output voltage levels are monitored by ME1, a 20 volt d.c. voltmeter connected across the output terminals. Current flow is monitored by ME2, a 1 amp d.c. ammeter connected in series with one output terminal. A fuse FS2 is included in series with ME2 to give protection to the latter and the unit in the event of the output being shorted. This fuse should be a quick-blow type.

The voltmeter, ME1, serves a dual purpose. When the device under test has been connected and the voltage level selected, switch S2 can

disconnect the meter from the output and connect it to terminals SK2 and SK3 enabling probes to be inserted to take voltage readings on various parts of the equipment under test. The sensitivity of the meter specified is only 1,000kΩ/V.

COMPONENT BOARD

Some of the components are mounted on a piece of 0.15 inch matrix Veroboard, size 12 strips by 22 holes. Begin by cutting the board to size and drilling the two 6BA fixing holes and making the breaks along the copper strips on the underside of the board as detailed in Fig. 2.

Now position and solder the components to the board as shown paying attention to capacitor polarities. The transistors and Zener diode should be soldered in last of all and a heatsink used on their leads to prevent thermal damage.

Next attach the flying leads to the board using coloured insulated multistrand wire.

THE CASE

The prototype unit was housed in a home-made aluminium case in the form of two U-

FOR GUIDANCE ONLY

ESTIMATED COST* OF COMPONENTS

excluding V.A.T.

£8.00

excluding case

*Based on prices prevailing at time of going to press



STABILISED POWER SUPPLY UNIT

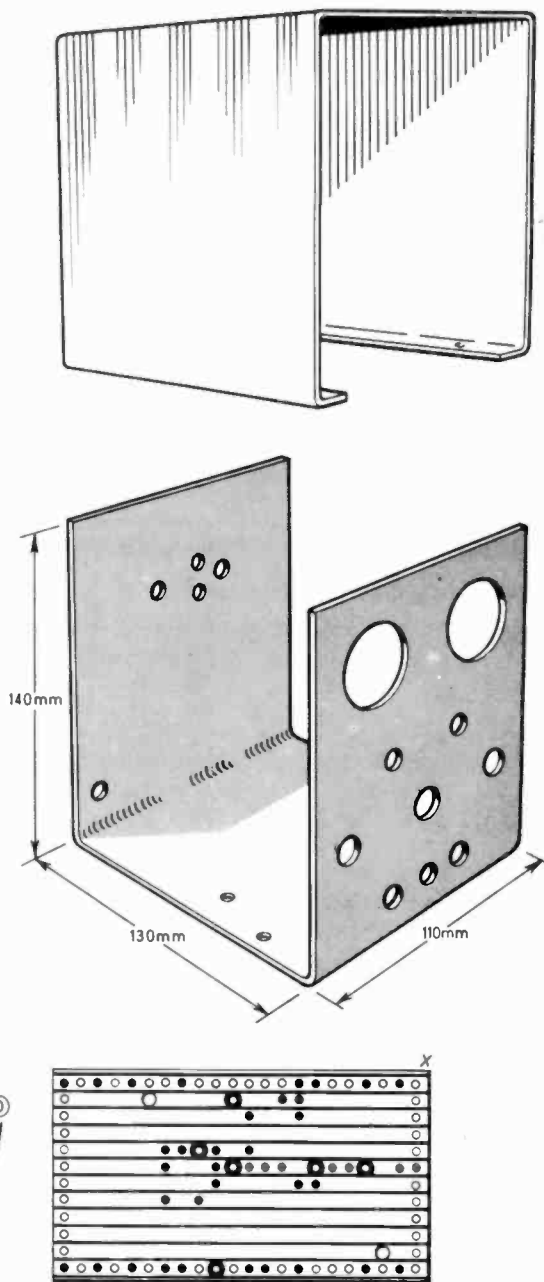
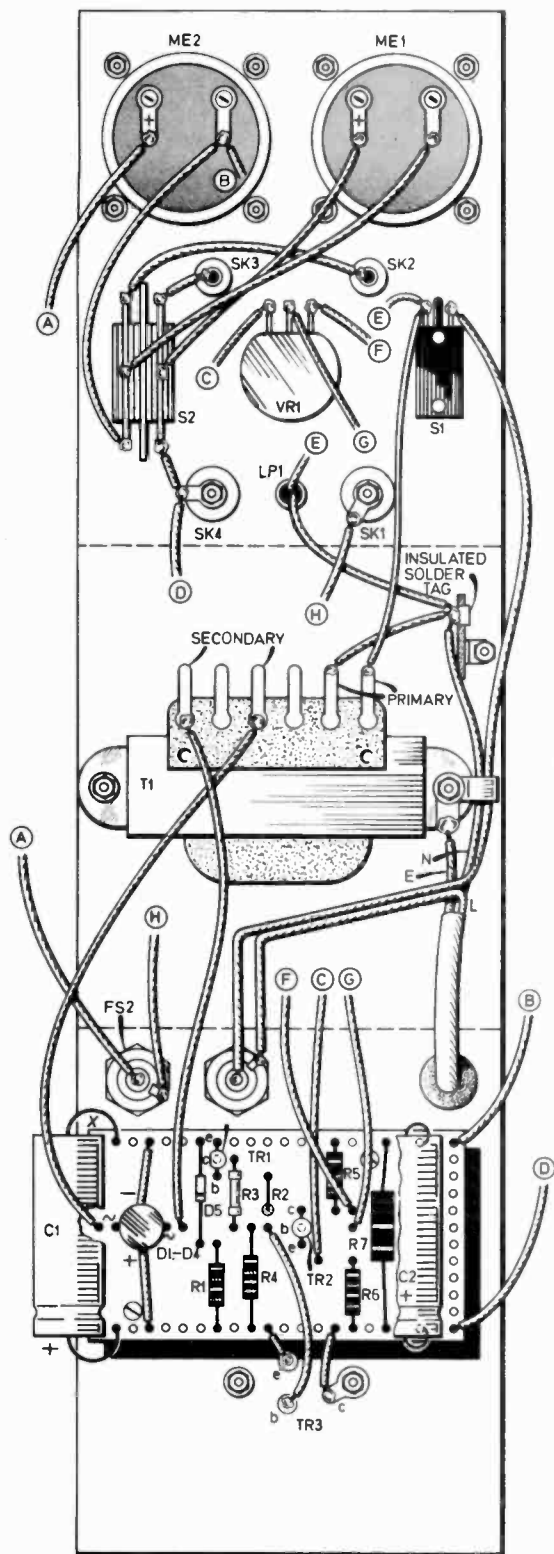

Fig. 2 (left). The layout of the components within the case, the components on the board and complete wiring up details. Also shown above are details of the case and lid. Note that the component board fixings must be of insulating material such as nylon.

sections. The lower portion takes all the components and is 3mm thick and acts as the heat-sink for TR3. Additional heat sinking is afforded by means of a U-shaped bracket, mounted under TR3; this is also used for winding the main cable on when not in use.

It is not essential that this design of case is used as any metal case of adequate size will do. It may be necessary to mount TR3 on a suitable heatsink if an alternate case is used.

If making your own case, all the holes and cut-outs should be made before bending to shape. Also, it is a good idea to have all the larger components to hand before making the case, as component sizes can differ from those used in the prototype to which the dimensions refer.

To make the cut-outs for the meters, scribe a circle of slightly larger diameter than that of the meter barrel and drill a string of holes around the inside circumference of the scribe so that the centre portion can be easily knocked out. The edges should then be cleaned up using a half-round file.

Components

Resistors

- R1 1.5k Ω
- R2 8.2k Ω
- R3 3.3k Ω
- R4 3.3k Ω
- R5 1k Ω
- R6 1k Ω
- R7 1k Ω 2W

All $\frac{1}{2}$ W carbon $\pm 10\%$ except where stated

Potentiometer

- VR1 5k Ω carbon lin.

Capacitors

- C1 1000 μ F 30V elect.
- C2 2200 μ F 30V elect.

Semiconductors

- D1-D4 bridge rectifier, 1A 50 p.i.v.
- D5 BZY88C5V1 5.1 volt Zener diode
- TR1 2N3704 silicon *npn*
- TR2 OC204 silicon *pnp*
- TR3 AD142 germanium *pnp*

Miscellaneous

- T1 mains/18volt 1A secondary transformer
- LP1 mains panel neon with built in resistor
- FS1 100mA fuse and panel holder
- FS2 1A quick-blow type fuse and panel holder
- S1 mains on/off toggle switch
- S2 d.p.d.t. toggle switch
- SK1, 4 screw terminals one red, one black (2 off)
- SK2, 3 wander sockets, one red, one black (2 off)
- ME1 20 volt d.c. voltmeter type SEW MR45P
- ME2 1A d.c. ammeter type SEW MR45P
- Veroboard: 0.15in. matrix size 12 strips x 22 holes; TO3 type mica washer and insulating bushes; insulated solder tag; control knob; materials for case; length of mains lead (3-core).

SEE
TALK
SHOP

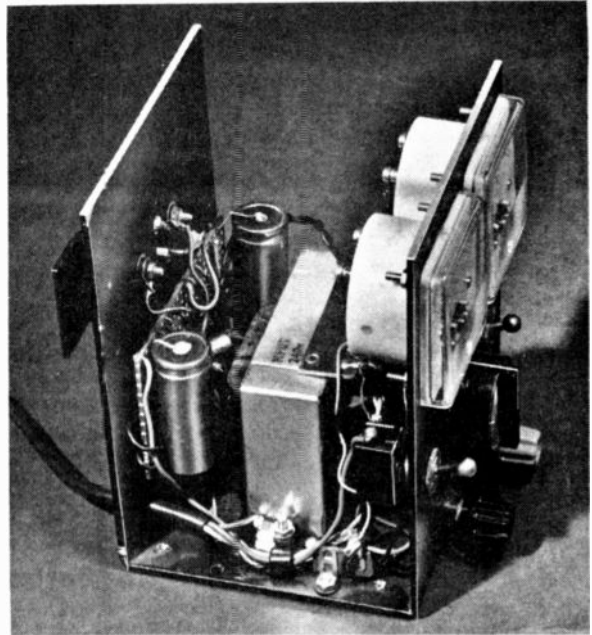

Photograph of the completed prototype with top half of case removed.

CONSTRUCTION

When the case has been made ready to accept all the components, they should be mounted and secured in position according to Fig. 2. Ensure that no components are touching each other or will be shorted against the case when the lid is fixed in place.

It is imperative that TR3 is electrically isolated from the case. This is accomplished by using a mica washer and insulating bushes. For good thermal contact a heatsink compound is recommended. All the components and component board should now be wired up as shown in Fig. 2 and when complete the component board screwed in place using *nylon* nuts, bolts, washers and spacers.

Try and keep the wiring as neat as possible and use as many different wire colours as possible. This will make it easier to check out when the wiring is complete.

When you are completely satisfied that the wiring is correct, the two fuses should be inserted in their holders and the lid fixed in position by means of the fixings on the rubber feet.

TESTING

Set switch S2 in the upward position and turn VR1 fully anti-clockwise. With no load connected switch on at S1. Meter ME1 should read 5 volts and ME2 zero. If this does not happen switch off and check all connections again.

Rotating VR1 in a clockwise direction should cause ME1 reading to advance to 20 volts; ME2 should still read zero since no current is being drawn.

Now turn VR1 fully anticlockwise and switch off at S1. Some sort of load is required such as radio, amplifier, car bulb, etc., that takes less than 1 ampere. In the case of a 12 volt car bulb, the rating must be less than 12 watts.

The unit should now be switched on, voltage selected and the load connected. On connecting the load, ME2 should show a reading. The voltmeter reading should remain constant as originally selected even though the current may be varying.

Switch S2 downwards and the voltmeter reading should drop to zero. With probes in sockets SK2 and SK3 check that ME1 is now functioning as a simple voltmeter, by means of a battery and potentiometer, for example, or by measuring the set voltage output at terminals SK1 and SK4. □

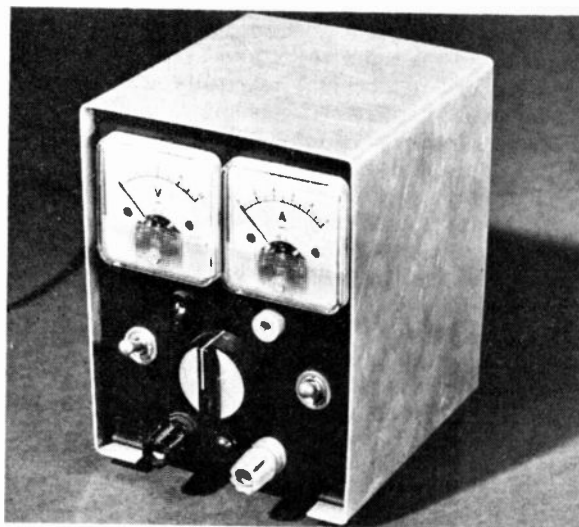

READERS' LETTERS

Finding the Pole

I have read your article—*Physics is Fun, A Pole-finding Paper*—and I am writing to inform you that it is the Standard Electrode Potential (S.E.P.) and not the atomic number that determines which metal is the cathode. The metal with the more negative S.E.P. will be the cathode.

Furthermore the potential difference between the two metals will be equal to the difference of the two S.E.P.'s

The values of some S.E.P.'s are as follows.

Metal	S.E.P. (Volts)	Atomic No.
Aluminium	-1.66	13
Zinc	-0.76	30
Iron	-0.44	26
Nickel	-0.23	28
Tin	-0.14	50
Lead	-0.13	82
Copper	+0.34	29
Silver	+0.80	47

So in your examples, the copper will be the anode, with a p.d. of 0.78V with the iron.

I hope this is useful for you.

G. A. Lay,
London.

The element which forms positive ions (atoms with a smaller number of electrons than usual) the most readily will form the cathode. The elements in Group I of the periodic table, which have only one electron in their "outer shell" of electrons will form ions with an "empty" outer shell more easily than Group II elements, which contain 2 electrons in this shell, both of which will be removed in the formation of the ion. Hence, the fewer the number of electrons in this shell, the more likely is the element to be the cathode.

Group I	Group II
Sodium A.N. = 11 2.8.1	Magnesium A.N. = 12 2.8.2
Potassium A.N. = 19 2.8.8.1.	Calcium A.N. = 20 2.8.8.2

A.N. = Atomic Number. The number below the atomic number represents the electronic structure.

Also the metals in Group I will have an increasing tendency to form the cathode as the atomic number increases (probably where your error occurred) as the positive nucleus has a gradually

decreasing influence on the outer electrons, as they are further away.

From the information shown on the small section of the periodic table above, we can deduce the information shown in Table 1.

Also in your article, you state "sodium combines with oxygen to form a precipitate". Unfortunately, sodium oxide is almost non-existent, as it reacts with water immediately to form sodium hydroxide. Here, a more plausible explanation is that the sodium ions travel to the cathode, where they receive an extra electron to form (momentarily) sodium metal. This will react instantaneously with the water, to give hydrogen gas and sodium hydroxide.

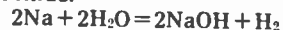

D. Howes,
Kent.

My thanks go to all who helped to clear up the mystery. We have managed to quote only two of the many letters sent.

May I also take this opportunity to thank all of those people who have written to me over the past eighteen months about one item in the series or another.

D. R. Daines.

TABLE 1

Electrodes	Cathode
Sodium and Magnesium	Sodium
Sodium and Calcium	Sodium
Sodium and Potassium	Potassium
Magnesium and Calcium	Magnesium
Potassium and Magnesium	Potassium
Potassium and Calcium	Potassium

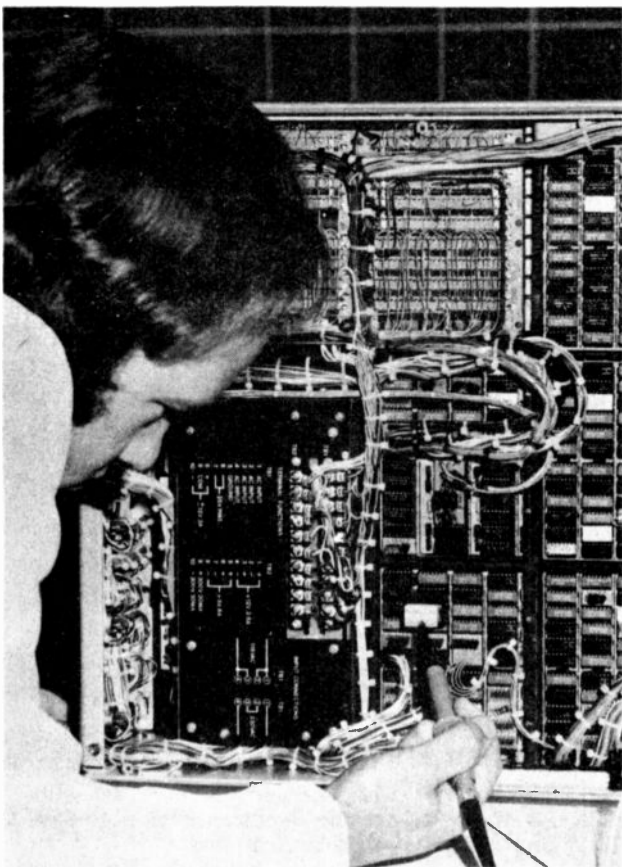

This hobby brings big rewards.

A soldering iron and a screwdriver. If you know how to use them, or at least know one end from the other, you know enough to enrol in our unique home electronics course.

This new style course will enable anyone to have a real understanding of electronics by a modern, practical and visual method. No previous knowledge is required, no maths, and an absolute minimum of theory.

You build, see and learn as, step by step, we take you through all the fundamentals of electronics and show you how easily the subject can be mastered and add a new dimension not only to your hobby but also to your earning capacity.

All the training is planned to be carried out in the comfort of your own home and work in your own time. You send them in when you are ready and not before. These culminate in a final test and a certificate of success.

1

Build an oscilloscope.

As the first stage of your training, you actually build your own Cathode ray oscilloscope! This is no toy, but a test instrument that you will need not only for the course's practical experiments, but also later if you decide to develop your knowledge and enter the profession. It remains your property and represents a very large saving over buying a similar piece of essential equipment

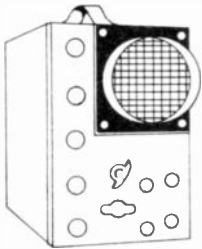

2

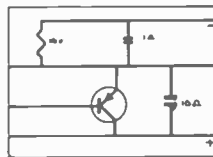

Read, draw and understand circuit diagrams.

In a short time you will be able to read and draw circuit diagrams, understand the very fundamentals of television, radio, computers and countless other electronic devices and their servicing procedures

3



Carry out over 40 experiments on basic circuits.

We show you how to conduct experiments on a wide variety of different circuits and turn the information gained into a working knowledge of testing, servicing and maintaining all types of electronic equipment, radio, t.v. etc

To find out more about how to learn electronics in a new, exciting and absorbing way, just clip the coupon for a free colour brochure and full details of enrolment.

PLUS FREE GIFT!

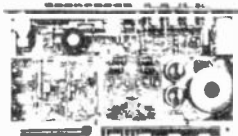

ALL STUDENTS ENROLLING IN OUR COURSES RECEIVE A FREE CIRCUIT BOARD ORIGINATING FROM A COMPUTER AND CONTAINING MANY DIFFERENT COMPONENTS THAT CAN BE USED IN EXPERIMENTS AND PROVIDE AN EXCELLENT EXAMPLE OF CURRENT ELECTRONIC PRACTICE

Brochure without obligation to:
**BRITISH NATIONAL RADIO
 & ELECTRONICS SCHOOL, Dept
 P.O. Box 156, Jersey, Channel Islands.**

NAME _____

ADDRESS _____

EEL 16 (Block caps please)

The Extraordinary Experiments of Professor Ernest Eversure

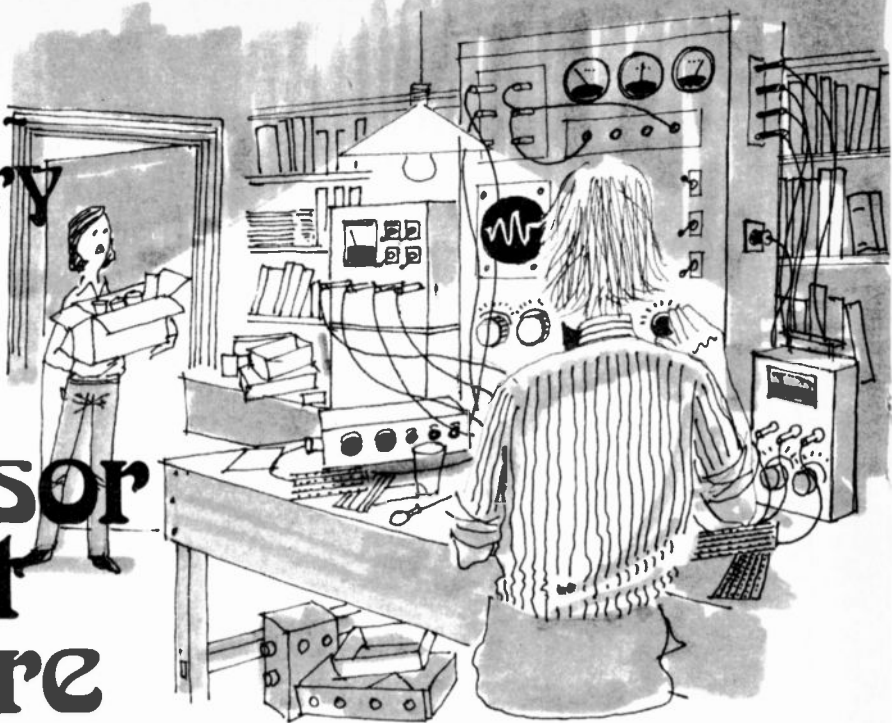

by Anthony John Bassett

THERE are a number of reasons why the transistor manufacturers allow such a large margin. They must consider the technicalities of transistor production, transistor selection and other factors affecting the performance and price of the product.

This was the Prof's reply to Bob's query.

VARIATIONS

The Prof. had in the laboratory stores samples of BC109 transistors produced by a number of different manufacturers, and as Bob proceeded to repeat the test on a few more of these, he found wide differences between the results. Whereas some of the transistors would block voltages only as high as 25 volts or so, there were others which appeared to work even as high as 120 volts.

"This is amazing, Prof.! Does it really mean that some of these BC109 transistors can be used with collector voltages as high as 100 volts or more, even though the makers specify a maximum of only 30 volts?"

"Because the tester actually shows the transistor practically working at over 100 volts, one might easily presume that the transistor could really be used at such a voltage," the Prof. observed, "but it is not wise to attempt to use a component under conditions which exceed the

manufacturer's specification, as there are a number of limitations which should be recognised."

"One of these is reliability. If you attempt to make use of the component under these conditions it becomes more likely to fail in use, and from a number of causes. For instance, the transistor may be unable to meet its rated power-dissipation, and this could cause failure due to breakdown of the junction at its weakest point. The voltage-breakdown test is carried out at low current level in order to avoid device failure, if a high current is used problems may arise from this. Another likely cause of variation is change of temperature."

The Prof. used a generous squirt from a can of freezer spray to demonstrate this. First he connected an OC71 transistor to the tester by means of wires several inches long. This was to avoid freezing Bob's tester. He operated the polarity reversal switch S4 to the *pnp* position, and with S5 at the zero-bias position, closed S6. Now he began to use VR1 to turn up the test voltage. Although the OC71, being a germanium transistor, showed a lot more leakage than the silicon type BC109, the voltage nonetheless continued to rise as he turned the control, until a level of about 70 volts was reached.

At this point a current of about

200 micro-amps was shown on the meter ME1, and if the Prof. turned VR1 much further clockwise, the current increased without any significant increase in the voltage measurement.

However, after the Prof. had used the freezer to such an extent that the transistor was covered in hoar frost, he was able to increase the voltage reading to over 80 volts!

As the frost melted the voltage reading began to decrease, and the Prof. switched off the test voltage for a few moments by means of S2, in order to wipe moisture from the transistor. He stuck a small piece of wax onto the case of the transistor, then switched S2 back on in order to resume testing.

He warmed the transistor carefully by means of a soldering iron placed near to it. The voltage continued to decrease until as the wax began to melt, the voltage across the transistor was observed to be less than 5 volts. With just a little more heat the wax melted completely and the voltage was down almost to zero. At this point the Prof. removed the hot iron.

"If I let it become much hotter," he informed Bob, "the properties of the transistor junctions would be destroyed. However, as the transistor cools, I think we will find that this one has not become hot enough for damage to occur,

TO ALL CONSTRUCTORS OF THIS MONTH'S CLOCK ARTICLE. PLEASE NOTE:

WE STOCK ALL COMPONENTS NEEDED TO BUILD THE CLOCK AS FEATURED IN THE ARTICLE.

WE WILL OFFER A SPECIAL DISCOUNT PRICE IF YOU ORDER THE COMPLETE KIT (WHICH WILL INCLUDE EVERYTHING DOWN TO THE LAST WASHER).

PLEASE SEND LARGE S.A.E. OR PHONE US FOR MORE DETAILS AND PRICES AND IMMEDIATE DESPATCH TO GET TO YOU BEFORE CHRISTMAS:

AS PART OF OUR RANGE OF COMPONENTS, WE STOCK THE FOLLOWING:

CLOCK CHIPS		DISPLAYS		VEROBOXES		CLOCK TRANSFORMERS	
MK50253	£5.60	DL704	£0.85	751410J	£2.64	AY51202/5LT01 TRF.	£1.70
MM5314	£4.44	FND500	£1.50	751411D	£3.04	AY51224/LED. TRF.	£1.70
AY51224	£3.66	5LT-01	£5.80	751412K	£4.00		
AY51202	£4.76						

ADD VAT at 8% to above prices
15p P & P on orders under £3

SINTEL

53E, ASTON STREET, OXFORD. TEL: 0865 43203

Don't miss your copy of
**HENRY'S
NEW 1975
CATALOGUE**

only
50p
Plus 15p
P&P



- ★ OVER 5,000 ITEMS – largest UK range of electronic components for home constructors.
- ★ 200 PAGES – every aspect of electronics and components for amateurs and hobbyists – kits, projects, test gear.
- ★ DOZENS of new lines and new ranges.
- ★ MANY price reductions throughout the new Catalogue.
- ★ A Discount Voucher with every copy, worth 50p.

FREE TO EDUCATIONAL ESTABLISHMENTS when ordered on official notepaper

Write now for your copy, enclosing 65p remittance

Now Open Supermarket,
Browse Round The New
Supermarket at 404 Edgware
Road.
ALL PRICES INCLUSIVE OF VAT

**Henry's
RADIO**

ELECTRONIC FOOTBALL & TENNIS WITH THE FABULOUS VIDEO SPORT

ON YOUR OWN TV

Play three exciting electronic ball games FOOTBALL, TENNIS, HOLE IN THE WALL on your own TV! Just plug Video Sport into the aerial socket of your TV and away you go. Completely safe for you, your children and your TV. Mains operated.

OUR INCREDIBLE PRICE £35.00 DEMONSTRATIONS NOW IN ALL HI FI CENTRES!

NEW SPECIAL PURCHASE

Mullard type LP1179 and LP1171 AM/FM tuner modules

These two modules together form a high quality AM/FM tuner covering the long, medium and VHF broadcast bands. Requires only 18 resistors and capacitors and a switch to complete. Supplied with circuits and spec. data.

LP1179
FM Coverage 87-108 MHz;
Bandwidth 300 KHz;
Audio output 70mV
with built in tuning gang

LP1171
AM Coverage mW-1W
Supply 6V negative earth
LP1179 and LP1171 £4.60 each or £8.40 pr.
Suitable Ferrite aerial £4.60 ea. or £8.40 pr.

UHF TV TUNERS

625 line receiver UHF transistorised tuners UK operation

Brand new. (Post:packing 25p each)
TYPE A var. tun. slow motion drive £3.50.
TYPE C variable tuning £2.90.
TYPE B 4-button push button (adj.) £3.60.
TYPE D 6-button UHF/VHF tuner £3.15.

You can build the Texan and Stereo FM Tuner
TUNER 20 – 20 WATT IC STEREO AMPLIFIERS

Features glass fibre PC board, Gardners low field transformer 6-IC's, 10-transistors plus diodes etc. Designed by Texas Instruments engineers for Henry's and P.W.1972. Overall size 151" x 21" x 61" mains operated. Free leak sleeve with every kit.
£38.75 (CARRIAGE 50p)
(also built and tested £46.87)

HENELEC STEREO FM TUNER

Features capacity diode tuning, lead and tuning meter indicators, mains operated. High performance and sensitivity.
Overall size in leak sleeve 8" x 21" x 61". Complete kit with leak sleeve.
£26.25 (Carriage 50p)
(also built and tested £31.20)

JOIN THE LARGE BAND OF CONSTRUCTORS!

FREE:

SEND NOW FOR OUR FREE LIST NO. 36 FOR OUR COMPLETE RANGE OF OVER 10,000 SEMI-CONDUCTOR DEVICES AT NEW LOW PRICES.



EXTRA DISCOUNTS

Semiconductors—Any one type or mixed SN74 Series '1C', 12-extra 10%; 25-extra 15%; 100-extra 20%.

TRANSISTORS & INTEGRATED I/C's

TTL "7400 series" IC's from 18p each
Cosmos "4000 series" IC's from 28p each
Linear Op-Amps from 43p each
Signetics Phase Lock IC's; RCA Linear IC's; TO3 Power Devices in PNP and NPN; BC107 and "BC range" from 13p each
Range of OC Types 28p
Plastic Power Devices, Rectifiers, Zener, Power Regulator IC's and many others.
Diodes up to 10 watts.

LONDON
EDGWARE ROAD LONDON W2
40/46 Electronics Centre & Supermarket 01 402 8381
303 Bagen Centre
308 Electronics Supermarket
TOTTENHAM COURT ROAD W1
231 Electronics Centre & Supermarket 01 580 3450

YOUR NEAREST STORE

OUT OF TOWN

NOTTINGHAM

94/9 Electronics Centre Nottingham 42966

ALL MAIL ORDERS TO 303 EDGWARE ROAD W2

Prices correct at time of preparation

Subject to change without notice E & OE

Barclaycard & Access welcome
ALL PRICES INCLUDE VAT

Enough books are written about crime, this one stops it.

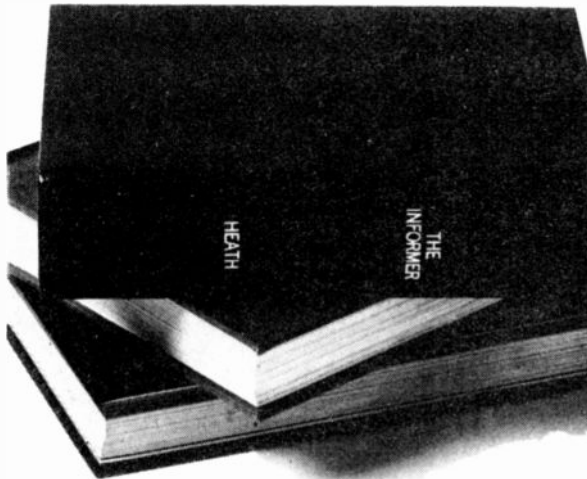

Outside it's a book. Inside it's an ingenious ultrasonic burglar alarm from Heathkit. The GD-39. A complete kit that can be assembled in only a few enjoyable hours, with the help of a very easy to follow instruction manual.

The GD-39 works by transmitting a silent, ultrasonic signal throughout the room. And continuously monitoring it. Any movement made by an intruder in the room will then automatically produce a change in the signal. Which triggers off a lamp and, thirty seconds later, a remote buzzer, that just you hear, or a loud bell.

Enough to scare the living daylights out of a burglar. For more details, and a bookful of other ideas, just post the coupon now for your Heathkit catalogue.

Or, if you're in London or Gloucester, call in and see us. The London Heathkit Centre is at 233 Tottenham Court Road. The Gloucester showroom is next to our factory in Bristol Road.

Heath (Gloucester) Limited,
Dept. EE-16 Bristol Road,
Gloucester GL2 6EE.
Tel: (0452) 29451.



The GD-39 Ultrasonic Burglar Alarm

To: Heath (Gloucester) Limited, Dept. EE-16 Gloucester GL2 6EE. Please send me a Heathkit catalogue. I enclose a 10p stamp for postage.



Name _____
Address _____
Postcode _____



Monthly budget plan available



"I MADE IT MYSELF"

Imagine the thrill you'll feel! Imagine how impressed people will be when they're hearing a programme on a modern radio you made yourself.

Now! Learn the secrets of radio and electronics by building your own modern transistor radio!

Practical lessons teach you sooner than you would dream possible.

What a wonderful way to learn—and pave the way to a new, better-paid career! No dreary ploughing through page after page of dull facts and figures. With this fascinating Technatron Course, you learn by building!

You build a modern Transistor Radio . . . a Burglar Alarm. You learn Radio and Electronics by doing actual projects you enjoy—making things with your own hands that you'll be proud to own! No wonder it's so fast and easy to learn this way. Because learning becomes a hobby! And what a profitable hobby. Because opportunities in the field of Radio and Electronics are growing faster than they can find people to fill the jobs!

No soldering – yet you learn faster than you ever dreamed possible.

Yes! Faster than you can imagine, you pick up the technical know how you need. Specially prepared step-by-step lessons show you how to read circuits—assemble components — build things — experiment. You enjoy every minute of it! You get everything you need. Tools. Components. Even a versatile Multimeter that we teach you how to use. All included in the course. AT NO EXTRA CHARGE! And this is a course anyone can afford. (You can even pay for it by easy instalments).

So fast, so easy, this personalised course will teach you even if you don't know a thing today!

No matter how little you know now, no matter what your background or education, we'll teach you. Step by step, in simple easy-to-understand language, you pick up the secrets of radio and electronics.

You become a man who makes things, not just another of the millions, who don't understand. And you could pave the way to a great new career, to add to the thrill and pride you receive when you look at what you have achieved. Within weeks you could hold in your hand your own transistor radio. And after the course you can go on to acquire high-powered technical qualifications, because our famous courses go right up to City & Guilds levels.

Send now for FREE 76 page book – see how easy it is – read what others say!

Find out more now! This is the gateway to a thrilling new career, or a wonderful hobby you'll enjoy for years. Send the coupon now. There's no obligation.

POST TODAY FOR FREE BOOK



To: ALDERMASTON COLLEGE CEE 13
DEPT. CEE 13, READING RG7 4PF
Also at our London Advisory Office, 4 Fore Street Avenue, Moorgate, London EC2Y 5EJ. Tel: 01-828 2721.
Yes, I'd like to know more about your course. Please send me free details—plus your big, 76-page book that tells about all your courses.

NAME _____
ADDRESS _____
POSTCODE _____



HOME OF BRITISH INSTITUTE OF ENGINEERING TECHNOLOGY

and it should soon regain its original room-temperature properties."

As the Prof. spoke, the transistor was cooling down and the multimeter needle began to move across the scale to indicate that once more the transistor was beginning to block a higher and higher voltage as the temperature decreased, until when the transistor reached room temperature the voltage was once again at 70 volts. The Prof. switched off the tester.

"It is obvious from the alteration in breakdown voltage with variation of temperature, that a 'safety margin' is necessary, especially with germanium transistors. You will find that if you try a silicon transistor, the same test will show less dependence upon temperature than germanium, and this is a big advantage for silicon semiconductors.

NOISE

Another factor which makes the margin between the manufacturer's stated maximum voltage, and the actual measured breakdown voltage, even more necessary, is the need to avoid excessive noise generation. This is especially necessary with preamplifier transistors such as type BC109.

Because noise generation begins to reach high levels, in most transistors and diodes, at a voltage somewhat below breakdown, and may manifest in undesirable ways if the component is used in equipment under these conditions, it is advisable to operate the component well clear of the breakdown voltage."

"I can understand, Prof., how

noise generation can affect audio amplifiers by producing a hissing, rumbling or crackling sound, but what about its effects on other types of equipment if, for instance, a 'noisy' component is used in equipment intended for purposes other than straightforward audio amplification?"

"That is an interesting question," replied the Prof., "and noise-generation can be quite a big problem in many sorts of electronic equipment, especially where highly sensitive circuits are used.

With T.V. reception, noise may manifest as speckles on the screen whenever reception is difficult.

With computers and calculators, if electrical 'noise' is allowed to upset the system, a wrong computation may result. It is easy to imagine how a computer-calculated bank transaction could go badly wrong due to a false signal. Or a computer-guided missile might steer for the wrong target or even the wrong Continent; a computer-guided spaceship might head for the wrong planet!

So elaborate and costly precautions have to be taken, in designing such important computers, to safeguard their operation against noise.

With oscillators and timers, incorrect timing, and oscillator 'jitter' are likely to result. For instance with a photographic timer, this could result in wrong exposure, and with an electronic organ or synthesiser, or other electronic tone-generator, a true, clear note would not be produced, and the result can sound quite unpleasant."

"I can see even more clearly, now, Prof., why it is important to

avoid noise generation if we require steady, clear and reliable results from electronic equipment. Can the breakdown voltage tester be of much help with the problems of noise, and assist by helping us to avoid it when we choose components?"

"Yes, Bob, but only to a limited extent. As we use the tester to measure the breakdown voltages of components, it is also quite easy to observe the generation of electrical noise. There are several ways in which we can observe this noise, for example, with an oscilloscope, or by use of an audio amplifier, or even, in some instances, directly by use of a crystal earpiece.

Although the breakdown voltage tester is not equipped for the measurement of noise, we can readily, by observation and comparison, obtain comparative evaluations of noise generation from various components and, for instance, compare the noise levels produced by each of a number of components and use this as a rough guide to their use in a circuit.

Another observation we may make with the aid of the tester is the type of noise produced.

One component may produce a steady output of noise observed as a steady hiss. Another component may, under similar conditions, put out less energy in the form of noise—and yet the potential nuisance from the second component may be the greater due to the nature of the noise produced. This could be of an impulsive, crackly, unsteady nature, and this could easily be more upsetting than the constant steady hiss."

READERS' LETTERS

Passed It?

I am only in partial agreement with what you said in *Your Career in Electronics* in E.E. October '75.

I agree that transistors and
Everyday Electronics, January 1976

i.c.s are smaller and use lower voltages but please don't look down too critically at the valve.

Old televisions provide a number of my components including some valves. From my variety of three televisions I made a valve amplifier. The valve may be "passed it" but an amplifier from a few old televisions isn't bad.

P. Hawkins
Epsom.

Response

I am writing to thank you for your article on the British Amateur Electronics Club in the August issue of *EVERYDAY ELEC-*

TRONICS. The response was really amazing, as we now have over 50 new members as a direct result of your article.

All the members should now have received their Newsletters and all enquiries received have been replied to.

I am pleased to say that at the B.A.E.C. meetings in Penarth we are using your series *Teach-In 76* which is proving very popular with our members, so congratulations again!

C. Bogod,
26 Forrest Road,
Penarth,
Glamorgan.

DOWN TO EARTH

By GEORGE HYLTON

MILLI, MICRO, MEGA AND THEIR RELATIONS

THIS month's Down to Earth is a brief excursion among the multiples and sub-multiples which we all come across when dealing with electrical units. Pico, nano, micro, milli, kilo, mega, giga, to name but a few, as they say. Several readers are bothered by these in working out resistances and so on, and new readers will have to come to grips with them.

These things jump up by the thousand(!). Each member of the list is a thousand times bigger than the previous one. One nanofarad is a thousand picofarads, one kilovolt a thousand volts.

You may have heard the one about Helen of Troy, reputed to be the most beautiful woman of all time. As the poet said, her's was the face that launched a thousand ships. So the unit of beauty might reasonably be called the helen (with a small "h", because that's the usual practice with units named after people, like the henry, the watt, or the ohm).

However, since one helen is a large amount of beauty, a more convenient one is the millihelen, that is, the amount of beauty which would launch one ship.

To get back to reality, the problem is that real, electrical units come all mixed up. If you have 200 microamps flowing through five megohms, what's the voltage?

Well, $E=I \times R$, so in this case $I=200 \times 5=1000$. But 1000 *what*? Volts, megavolts, kilovolts, picovolts...?

One way to find out is to cheat, by using the table on this page. It's used like a map with a reference grid. In the example above, we need to know what units microamps \times megohms ($\mu A \times M\Omega$) come out in. That is, we want $\mu \times M$.

Find μ on the top edge, (A) and M on the left-hand edge (B). Look along the corresponding columns to the point where they intersect. There, you'll find a "U"

for units. So $200\mu A \times 5M\Omega = 1000$ volts, or if you prefer, one kilovolt. (These things go by thousands.)

UNUSUAL UNITS

Now, some of the boxes are left empty. This doesn't mean that the relevant units are non-existent, but merely that you are unlikely to come across them in electronics at the moment. Even "f" for femto, meaning a thousand-millionth of a millionth is still fairly new. It's used in some transistor data to give the feed-

back capacitance of a high-frequency transistor as so many fF (femtofarads). (Sometimes you find mpF, for milli-picofarads instead, which is another way of expressing the same thing.) Similarly, at the high end, you may come across frequencies of light waves in THz, tera-hertz, 1THz being 1000GHz or a million megahertz.

A word about spelling. Usually the prefix is just added to the unit proper. So, 3GV is three gigavolts. (The "g's" are pronounced hard, as in gun.) But if the electrical unit's name begins with a vowel, as in ohms, the vowel at the end of the prefix is sometimes dropped. Thus "kilo-ohms" becomes kilohms, which is easier to say.

What if you have to divide one quantity by another; e.g., $I=10kV/2M\Omega$? For this you use sides A and C, and the crossing point of the A column and C row gives the result for A/C. So 10 kilovolts divided by 2 megohms would be 5 milliams.

		A										
		p	n	μ	m	U	k	M	G	T		
B	p				f	p	n	μ	m	U	k	T
	n			f	p	n	μ	m	U	k	M	G
	μ		f	p	n	μ	m	U	k	M	G	T
	m	f	p	n	μ	m	U	k	M	G	T	U
	U	p	n	μ	m	U	k	M	G	T	U	M
	k	n	μ	m	U	k	M	G	T	U	M	k
	M	μ	m	U	k	M	G	T	U	M	k	μ
G	m	U	k	M	G	T	U	M	k	μ	n	
T	U	k	M	G	T	U	M	k	μ	n	p	

Map for finding $A \times B$ or A/C

f = femto, p = pico, n = nano, μ = micro, m = milli, U = units, k = kilo, M = mega, G = giga, T = tera

Units and Symbols

Quantity	Unit Symbol	Unit Name
Resistance	Ω	ohm
Capacitance	F	farad
Inductance	H	henry
Voltage	V	volt
Current	I	ampere
Power	W	watt
Energy	J	joule
Charge	C	coulomb

ENTER
* THE

BI-PAK

GREAT
CHRISTMAS
COMPETITION!

WIN A 22" COLOUR T.V. FREE!



2nd Prize: A complete HI-FI outfit comprising a Legions Amplifier, Record Deck and EMI Speaker Kits.

3rd Prize: Black and White mains/battery Television.

4th Prize: An Electronic Calculator.

Plus: 49 runner-up prizes of Electronic Slide Rules.

HOW TO ENTER

You are allowed one line for every £1.00 spent with BI-Pak. Facing you will find illustrated, 20 electronic symbols. Just choose the correct descriptions for these from the 30 alternatives shown and enter the numbers of the descriptions in the entry coupon alongside the letter indicating the symbol—should you need more columns you will find a coupon in every electronic publication. Then write a slogan of not more than 10 words but including the name BI-PAK.

RULES

There is no entry fee but one line is allowed for every £1.00 spent with BI-PAK (SEE OUR ADVERTISEMENT ON PAGE 734). Every entry must be made on a proper entry coupon and must bear the entrant's full name and address.

All accepted entries will be examined and the Adjudicating Committee will award the FIRST PRIZE of a COLOUR TELEVISION to the competitor they consider to show the correct answers and who submits the best slogan. The remaining prizes will be awarded for the next best entries in order of merit.

Closing date February 29th. Entries arriving after the closing date will be disqualified, as will any received incomplete, illegible, mutilated or altered or not complying with the instructions and rules exactly. No responsibility can be taken for entries lost or delayed in the post or otherwise. Proof of posting will not be accepted as proof of receipt. All decisions of the adjudicating Committee will be final and legally binding. No correspondence will be entered into. Winners will be notified and the result published in the earliest possible issues of this magazine.

The competition is open to all except employees (and their families) of BI-Pak Semiconductors. We regret that this competition is restricted to U.K. residents only. Entrants must agree to abide by the rules of the competition.

All entries become the property of BI-Pak Semiconductors and any slogan submitted may be used at the discretion of the company.

1. Unijunction Transistor
2. Electrolytic Capacitor
3. Thermistor
4. Hexode Valve
5. Diac
6. Light Dependent Resistor
7. Gas Filled Discharge Tube
8. Field Effect Transistors
9. NPN Transistor
10. Capacitor
11. L.F. Choke
12. Microphone
13. Thermo-couple
14. Aerial (General)
15. Earth
16. Neon
17. Zener Diode
18. Tetrode Valve
19. PNP Transistor
20. Resistor (Variable)
21. Selenium Cell
22. Aerial (Transmitting)
23. Preset Resistor
24. Electro Magnet
25. Plug and Socket
26. Fuse
27. Silicon Controlled Rectifier
28. Rectifier
29. Spark Gap
30. Coaxial Plug & Socket

A	B	C	D	E	F	G	H	I	J										
K	L	M	N	O	P	Q	R	S	T										
A	B	C	D	E	F	G	H	I	J	K	L	M	N	O	P	Q	R	S	T

SLOGAN

Name

Address EE

Send to: BI-PAK, P.O. BOX 6, WARE, HERTS.

PLEASE MENTION
EVERYDAY
ELECTRONICS
WHEN REPLYING TO
ADVERTISEMENTS

DENCO (CLACTON) LTD.

Dept. E.E.

357-8-9 OLD RD., CLACTON-ON-SEA
ESSEX. CO15 3RH



Our components are chosen by technical authors and constructors throughout the world, for their performance and reliability, every coil being inspected twice plus a final test and near spot-on alignment.

General catalogue showing full product range 32p, post paid. Please enclose S.A.E. with all other enquiries.

TRADE ENQUIRIES WELCOME

BI-PAK

SEMICONDUCTORS



TRANSISTORS

BRAND NEW FULLY GUARANTEED

Type	Price	Type	Price	Type	Price	Type	Price	Type	Price
AC107	0-06	BC183L	0-15	2N2193	0-36	ORP61	0-41	EC173	0-15
AC113	0-10	BC184	0-30	2N2194	0-26	P20	0-41	BF167	0-23
AC115	0-30	BC184L	0-30	2N2217	0-36	P345A	0-36	BF173	0-23
AC117K	0-30	BC186	0-30	2N2218	0-30	PS97	0-43	BF176	0-26
AO122	0-12	BC187	0-30	2N2219	0-30	ST140	0-43	BF177	0-26
AO125	0-12	BC207	0-11	2N2220	0-23	ST141	0-43	BF178	0-21
AC126	0-12	BC208	0-11	2N2221	0-30	TIP29	0-46	BF179	0-21
AC127	0-12	BC209	0-12	2N2222	0-30	TIP29G	0-58	BF180	0-21
AC128	0-12	BC212L	0-12	2N2268	0-12	TIP31A	0-58	BF181	0-21
AC132	0-15	BC213L	0-12	2N2269	0-12	TIP32A	0-60	BF182	0-21
AC134	0-15	BC214L	0-17	2N2309A	0-12	TIP41A	0-60	BF183	0-21
AC137	0-15	BC225	0-26	2N2411	0-25	TIP42A	0-61	BF184	0-20
AC141	0-19	BC226	0-26	2N2412	0-25	TI843	0-21	BF185	0-21
AC141K	0-30	BC291	0-23	2N2446	0-43	UT46	0-28	BF187	0-23
AC142	0-19	BC292	0-23	2N2711	0-21	2N3011	0-11	BF188	0-21
AC142K	0-30	BC303	0-21	2N2712	0-21	2N3011	0-11	BF194	0-18
AC181	0-18	BC304	0-27	2N2714	0-21	2G302	0-18	BF195	0-18
AC184	0-30	BC400	0-21	2N2904	0-18	2G303	0-19	BF196	0-18
AC185	0-30	BC400	0-27	2N2904A	0-21	2G304	0-26	BF197	0-15
AC186	0-30	BCY30	0-25	2N2905	0-21	2G306	0-41	BF200	0-46
AC187	0-30	BCY31	0-27	2N2906	0-21	2G308	0-36	BF222	0-23
AC188	0-30	BCY32	0-23	2N2906A	0-18	2N2926 G	0-18	BF227	0-23
AC189	0-30	BCY33	0-23	2N2906A	0-18	2N2926 Y	0-11	BF228	0-21
AC189K	0-30	BCY34	0-23	2N2907	0-23	2N2926 E	0-10	BF229	0-21
AC189	0-15	BCY71	0-30	2N2923	0-15	2N2926 R	0-10	BF263	0-56
AC178	0-30	BCY72	0-15	2N2924	0-18	2N3010	0-17	BF270	0-26
AC177	0-30	BCY73	0-15	2N2925	0-18	2N3011	0-21	BF271	0-21
AC178	0-30	BCY74	0-15	2N2926	0-18	2N3011	0-21	BF272	0-21
AC179	0-30	BCZ12	0-26	BC108	0-06	2N3054	0-47	BF273	0-26
AC180	0-30	BD115	0-23	BC109	0-06	2N3055	0-43	BF274	0-26
AC180K	0-30	BD116	0-21	BD136	0-41	2N3219	0-15	BF275	0-21
AC181	0-30	BD121	0-21	BD137	0-46	2N3291 A	0-17	BFX29	0-23
AC181K	0-30	BD122	0-21	BD138	0-41	2N3392	0-15	BFX34	0-23
AC187	0-30	BD124	0-21	BD139	0-46	2N3393	0-15	BFX35	0-23
AC187K	0-30	BD131	0-21	BD140	0-61	2N3394	0-15	BFX36	0-23
AC188	0-30	BD132	0-21	BD155	0-21	2N3395	0-18	BFX37	0-23
AC188K	0-30	BD133	0-21	BD175	0-21	2N3402	0-21	BFX38	0-23
ACT17	0-30	BD135	0-41	BD176	0-21	2N3403	0-21	BFY50	0-20
ACT18	0-30	BFY53	0-12	BD177	0-21	2N3404	0-21	BFY51	0-20
ACT19	0-30	BD139	0-18	BD178	0-21	2N3405	0-43	BFY52	0-20
ACT20	0-30	BD140	0-18	BD179	0-21	2N3414	0-18	PG309	0-27
ACT21	0-30	BD141	0-18	BD180	0-21	2N3415	0-18	PG339	0-27
ACT22	0-17	BD142	0-18	BD181	0-21	2N3416	0-20	PG339A	0-17
ACT27	0-19	BD143	0-18	BD182	0-21	2N3417	0-20	PG344	0-19
ACT28	0-19	BD144	0-18	BD183	0-21	2N3425	0-27	PG345	0-17
ACT29	0-30	BD145	0-18	BD184	0-21	2N3614	0-20	PG371B	0-17
ACT30	0-30	BD146	0-18	BD185	0-21	2N3615	0-20	PG373	0-18
ACT31	0-30	BD147	0-18	BD186	0-21	2N3616	0-20	PG374	0-18
ACT32	0-30	BD148	0-18	BD187	0-21	2N3617	0-20	PG375	0-18
ACT33	0-30	BD149	0-18	BD188	0-21	2N3618	0-20	PG376	0-17
ACT34	0-30	BD150	0-18	BD189	0-21	2N3619	0-20	PG381	0-17
ACT35	0-30	BD151	0-18	BD190	0-21	2N3620	0-20	PG401	0-21
ACT36	0-30	BD152	0-18	BD191	0-21	2N3621	0-20	PG414	0-21
ACT37	0-30	BD153	0-18	BD192	0-21	2N3622	0-20	PG417	0-21
ACT38	0-30	BD154	0-18	BD193	0-21	2N3623	0-20	PG418	0-21
ACT39	0-30	BD155	0-18	BD194	0-21	2N3624	0-20	PG419	0-21
ACT40	0-18	BD156	0-18	BD195	0-21	2N3625	0-20	PG420	0-21
ACT41	0-18	BD157	0-18	BD196	0-21	2N3626	0-20	PG421	0-21
ACT42	0-18	BD158	0-18	BD197	0-21	2N3627	0-20	PG422	0-21
ACT43	0-18	BD159	0-18	BD198	0-21	2N3628	0-20	PG423	0-21
ACT44	0-30	BD160	0-18	BD199	0-21	2N3629	0-20	PG424	0-21
AD130	0-30	BD161	0-18	BD200	0-21	2N3630	0-20	PG425	0-21
AD140	0-40	BD162	0-18	BD201	0-21	2N3631	0-20	PG426	0-21
AD142	0-43	BD163	0-18	BD202	0-21	2N3632	0-20	PG427	0-21
AD143	0-43	BD164	0-18	BD203	0-21	2N3633	0-20	PG428	0-21
AD144	0-43	BD165	0-18	BD204	0-21	2N3634	0-20	PG429	0-21
AD145	0-43	BD166	0-18	BD205	0-21	2N3635	0-20	PG430	0-21
AD161	0-30	BD167	0-18	BD206	0-21	2N3636	0-20	PG431	0-21
AD162	0-30	BD168	0-18	BD207	0-21	2N3637	0-20	PG432	0-21
AD161 & AD162 (MP)	0-30	BD169	0-18	BD208	0-21	2N3638	0-20	PG433	0-21
ADT140	0-30	BD170	0-18	BD209	0-21	2N3639	0-20	PG434	0-21
AF114	0-25	BD171	0-18	BD210	0-21	2N3640	0-20	PG435	0-21
AF115	0-25	BD172	0-18	BD211	0-21	2N3641	0-20	PG436	0-21
AF116	0-25	BD173	0-18	BD212	0-21	2N3642	0-20	PG437	0-21
AF117	0-25	BD174	0-18	BD213	0-21	2N3643	0-20	PG438	0-21
AF118	0-25	BD175	0-18	BD214	0-21	2N3644	0-20	PG439	0-21
AF134	0-21	BD176	0-18	BD215	0-21	2N3645	0-20	PG440	0-21
AF135	0-21	BD177	0-18	BD216	0-21	2N3646	0-20	PG441	0-21
AF126	0-21	BD178	0-18	BD217	0-21	2N3647	0-20	PG442	0-21
AF127	0-21	BD179	0-18	BD218	0-21	2N3648	0-20	PG443	0-21
AF128	0-21	BD180	0-18	BD219	0-21	2N3649	0-20	PG444	0-21
AF129	0-21	BD181	0-18	BD220	0-21	2N3650	0-20	PG445	0-21
AF178	0-21	BD182	0-18	BD221	0-21	2N3651	0-20	PG446	0-21
AF179	0-21	BD183	0-18	BD222	0-21	2N3652	0-20	PG447	0-21
AF180	0-21	BD184	0-18	BD223	0-21	2N3653	0-20	PG448	0-21
AF181	0-21	BD185	0-18	BD224	0-21	2N3654	0-20	PG449	0-21
AF182	0-21	BD186	0-18	BD225	0-21	2N3655	0-20	PG450	0-21
AF183	0-21	BD187	0-18	BD226	0-21	2N3656	0-20	PG451	0-21
AF184	0-21	BD188	0-18	BD227	0-21	2N3657	0-20	PG452	0-21
AF185	0-21	BD189	0-18	BD228	0-21	2N3658	0-20	PG453	0-21
AF186	0-21	BD190	0-18	BD229	0-21	2N3659	0-20	PG454	0-21
AF187	0-21	BD191	0-18	BD230	0-21	2N3660	0-20	PG455	0-21
AF188	0-21	BD192	0-18	BD231	0-21	2N3661	0-20	PG456	0-21
AF189	0-21	BD193	0-18	BD232	0-21	2N3662	0-20	PG457	0-21
AF190	0-21	BD194	0-18	BD233	0-21	2N3663	0-20	PG458	0-21
AF191	0-21	BD195	0-18	BD234	0-21	2N3664	0-20	PG459	0-21
AF192	0-21	BD196	0-18	BD235	0-21	2N3665	0-20	PG460	0-21
AF193	0-21	BD197	0-18	BD236	0-21	2N3666	0-20	PG461	0-21
AF194	0-21	BD198	0-18	BD237	0-21	2N3667	0-20	PG462	0-21
AF195	0-21	BD199	0-18	BD238	0-21	2N3668	0-20	PG463	0-21
AF196	0-21	BD200	0-18	BD239	0-21	2N3669	0-20	PG464	0-21
AF197	0-21	BD201	0-18	BD240	0-21	2N3670	0-20	PG465	0-21
AF198	0-21	BD202	0-18	BD241	0-21	2N3671	0-20	PG466	0-21
AF199	0-21	BD203	0-18	BD242	0-21	2N3672	0-20	PG467	0-21
AF200	0-21	BD204	0-18	BD243	0-21	2N3673	0-20	PG468	0-21
AF201	0-21	BD205	0-18	BD244	0-21	2N3674	0-20	PG469	0-21
AF202	0-21	BD206	0-18	BD245	0-21	2N3675	0-20	PG470	0-21
AF203	0-21	BD207	0-18	BD246	0-21	2N3676	0-20	PG471	0-21
AF204	0-21	BD208	0-18	BD247	0-21	2N3677	0-20	PG472	0-21
AF205	0-21	BD209	0-18	BD248	0-21	2N3678	0-20	PG473	0-21
AF206	0-21	BD210	0-18	BD249	0-21	2N3679	0-20	PG474	0-21
AF207	0-21	BD211	0-18	BD250	0-21	2N3680	0-20	PG475	0-21
AF208	0-21	BD212	0-18	BD251	0-21	2N3681	0-20	PG476	0-21
AF209	0-21	BD213	0-18	BD252	0-21	2N3682	0-20	PG477	0-21
AF210	0-21	BD214	0-18	BD253	0-21	2N3683	0-20	PG478	0-21
AF211	0-21	BD215	0-18	BD254	0-21	2N3684	0-20	PG479	0-21
AF212	0-21	BD216	0-18	BD255	0-21	2N3685	0-20	PG480	0-21
AF213	0-21	BD217	0-18	BD256	0-21	2N3686	0-20	PG481	0-21
AF214	0-21	BD218	0-18	BD257	0-21	2N3687	0-20	PG482	0-21
AF215	0-21	BD219	0-18	BD258	0-21	2N3688	0-20	PG483	0-21
AF216	0-21	BD220	0-18	BD259	0-21	2N3689	0-20	PG484	0-21
AF217	0-21	BD221	0-18	BD260	0-21	2N3690	0-20	PG485	0-21
AF218	0-21	BD222	0-18	BD261	0-21	2N3691	0-20	PG486	0-21
AF219	0-21	BD223	0-18	BD262	0-21	2N3692	0-20	PG487	

PO BOX 6 WARE HERTS

SUPER UNTESTED PAKS

Pak No.	Description	Price
U 1	120 Glass Sub-min. General purpose Germ. diodes	£0.60
U 2	50 Mixed Germanium transistors AF/RF	£0.60
U 3	75 Germanium gold bonded sub-min. like OA5, OA47	£0.60
U 4	30 Germanium transistors like OC81, AC128	£0.60
U 5	60 200mA sub-min. silicon diodes	£0.60
U 6	30 8H. Planar trans. NPN like B8Y95A, 2N704	£0.60
U 7	16 8H. rect. TOP-HAT 750mA VLTG. RANGE up to 100	£0.60
U 8	80 8H. planar diodes DO-7 glass 250mA like OA200/202	£0.60
U 9	20 Mixed voltages, 1 Watt Zener Diodes	£0.60
U10	20 BAY90 charge storage diodes DO-7 glass	£0.60
U11	20 PNP 8H. planar trans. TO-5 like 2N1192, 2N2904	£0.60
U13	30 PNP-NPN 8H. transistors OC200 & 28104	£0.60
U14	150 Mixed silicon and germanium diodes	£0.60
U15	20 NPN 8H. planar trans. TO-5 like 2N696, 2N697	£0.60
U16	10 3Amp sil. rectifiers stud type up to 1000 PIV	£0.60
U17	30 Germanium PNP AF transistors TO-5 like ACY 17-22	£0.60
U18	8 6 Amp sil. rectifiers BYZ13 type up to 600 PIV	£0.60
U19	20 Silicon NPN transistors like BC 108	£0.60
U20	12 1.5 Amp sil. rectifiers top hat up to 1000 PIV	£0.60
U21	30 AF. Germ. alloy transistors 2G300 series & OC71	£0.60
U22	25 MADT's like MHz series PNP transistors	£0.60
U24	20 Germ. 1 Amp rectifiers GJM series up to 300 PIV	£0.60
U25	25 300 MHz NPN silicon transistors 2N708, B8Y27	£0.60
U26	30 Fast switching silicon diodes like IN914 Micro-Min	£0.60
U29	10 1 Amp SCR's TO-5 can. up to 600 PIV CR81/25-600	£1.90
U32	25 Zener diodes 400 mw DO-7 case 3-33 volts mixed	£0.60
U33	15 Plastic case 1 Amp sil. rectifiers IN4000 series	£0.60
U34	30 silicon PNP alloy trans. TO-5 BCY26 28302/4	£0.60
U35	25 Silicon planar transistors PNP TO-18 2N2906	£0.60
U36	20 Silicon planar NPN transistors TO-5 BFY50/51/52	£0.60
U37	30 Silicon alloy transistors 80-2 PNP OC200, 82322	£0.60
U38	20 Fast switching silicon trans. NPN 400 MHz 2N3011	£0.60
U39	30 RF. Ger. PNP transistors 2N1303/5 TO-5	£0.60
U40	10 Dual transistors 6 lead TO-5 2N2904	£0.60
U43	25 Silicon trans. plastic TO-18 A.F. BC113/114	£0.60
U44	20 Silicon trans. plastic TO-5 BC115	£0.60
U45	7 3A SCR. TO66 up to 600 PIV	£1.90
U46	20 Unijunction transistors similar to T1843	£0.60
U47	10 TO220AB plastic triacs 50V 6A	£1.90
U48	9 NPN 8H. power transistors like 2N3055	£1.90
U49	12 NPN 8H. plastic power trans. 60W like 2N5294/5296	£1.90

Code No's mentioned above are given as a guide, to the type of device in the pak. The devices themselves are normally unmarked.

QUALITY TESTED PAKS

Pak No.	Quality Tested Paks	Price
Q 1	20 Red spot transistors PNP	£0.60
Q 2	16 White spot R.F. transistors PNP	£0.60
Q 3	4 OC 77 type transistors	£0.60
Q 4	6 Matched transistors OC44/45/81/81L	£0.60
Q 5	4 OC 75 transistors	£0.60
Q 6	5 OC 72 transistors	£0.60
Q 7	4 AC 128 transistors PNP high gain	£0.60
Q 8	4 AC 126 transistors PNP	£0.60
Q 9	7 OC 81 type transistors	£0.60
Q10	7 OC 71 type transistors	£0.60
Q11	2 AC 127/128 Complementary pairs PNP/NPN	£0.60
Q12	3 AF 116 type transistors	£0.60
Q13	3 AF 117 type transistors	£0.60
Q14	3 OC 171 H.F. type transistors	£0.60
Q15	7 2N2926 8H. Epoxy transistors mixed colours	£0.60
Q17	5 NPN 2x8T.141, & 3x8T.140	£0.60
Q18	4 MADT'S 2xMAT 100 & 2xMAT 120	£0.60
Q19	3 MADT'S 2xMAT 101 & 1xMAT 121	£0.60
Q20	4 OC 64 Germanium transistors A.F.	£0.60
Q21	4 AC 127 NPN Germanium transistors	£0.60
Q22	20 NKT transistors A.P. R.F. coded	£0.60
Q23	10 OA 202 Silicon diodes sub-min	£0.60
Q24	8 OA 81 diodes	£0.60
Q25	15 IN 914 Silicon diodes 75PIV 75mA	£0.60
Q26	8 OA95 Germanium diodes sub-min.	£0.60
Q27	2 10A 400 PIV Silicon rectifiers 18A425B	£0.60
Q28	2 Silicon power rectifiers BYZ 13	£0.60
Q29	4 8H. transistors 2x2N696, 1x2N697, 1x2N698	£0.60
Q30	7 Silicon switch transistors 2N706 NPN	£0.60
Q31	6 Silicon switch transistors 2N708 NPN	£0.60
Q32	3 PNP 8H. trans. 2x2N1151, 1x2N1152	£0.60
Q33	3 Silicon NPN transistors 2N1711	£0.60
Q34	7 8H. NPN trans. 2N2369, 500MHz (code P597)	£0.60
Q35	3 Silicon PNP TO-5 2x2N2904 & 1x2N2095	£0.60
Q36	7 2N3646 TO-18 plastic 300 MHz NPN	£0.60
Q37	3 2N3053 NPN Silicon transistors	£0.60
Q38	5 PNP transistors 3x2N3703, 2x2N3072	£0.60
Q39	5 NPN transistors 3x2N3704, 2x2N3705	£0.60
Q40	5 NPN transistors 3x2N3707, 2x2N3708	£0.60
Q41	3 Plastic NPN TO18 2N3904	£0.60
Q43	5 BC 107 NPN transistors	£0.60
Q44	5 NPN transistors 3x BC 108, 2x BC 109	£0.60
Q45	3 BC 113 NPN TO-18 transistors	£0.60
Q46	3 BC 115 NPN TO-5 transistors	£0.60
Q47	4 NPN high gain transistors 2x BC 167, 2x BC 168	£0.60
Q48	3 BCY 70 PNP transistors TO-18	£0.60
Q49	3 PNP transistors 2x BFY 51, 1x BFY 52	£0.60
Q50	7 B8Y 28 NPN switch transistors TO-18	£0.60
Q51	7 B8Y 95A NPN transistors 300MHz	£0.60
Q52	8 BY 100 type silicon rectifiers	£1.90
Q53	25 8H. & Germ. trans. mixed all marked new	£1.90
Q54	6 TIL 209 Red LED	£1.90

VISIT OUR COMPONENT SHOP
18 BALDOCK ST., WARE, Herts. (A10)
Open Mon.-Sat. 9-5.30 p.m. Tel. 61593

MAMMOTH I.C. PAK

APPROX 200 PIECES
Assorted full-out integrated circuits, including: Logic, 74 series, Linear, Audio and D.T.L. Many coded devices but some unmarked—you to identify.
OUR SPECIAL PRICE £1.90p

WORLD SCOOP

JUMBO SEMICONDUCTOR PAK
Transistors—Germ. and Silicon. Rectifiers—Diodes—Triacs—Thyristors—I.C.'s and Zeners. ALL NEW AND CODED

APPROX 100 PIECES
Offering the amateur a fantastic bargain PAK and an enormous saving—identification and data sheet in every pak.
ONLY £1.95p

UNTESTED LIN PAKS

Manufacturers—'Fall Outs' which include Functional and part Functional Units. These are classed as 'out-of-spec' from the makers' very rigid specifications, but are ideal for learning about I.C.'s and experimental work.

Pak No.	Contents	Price
ULIC709	— 10 x 709	£0.60
ULIC710	— 7 x 710	£0.60
ULIC741	— 7 x 741	£0.60
ULIC747	— 5 x 747	£0.60
ULIC748	— 7 x 748	£0.60

C280 CAPACITOR PAK

Containing 75 of the C280 range of capacitors assorted in values ranging from .01uF to 2.2uF. Complete with identification chart.
FANTASTIC VALUE
ONLY £1.90p

SIL. G.P. DIODES

300 mw 40 PIV (min) SUB-MIN FULLY TESTED
Ideal for Organ builders
20 for 50p, 100 for £1.50, 500 for £5, £1000 for 9.

G.P. SWITCHING TRANS

TO18 8H. TO 2N706/8 B8Y27/88/95A
All usable devices. No open and shorts. ALSO AVAILABLE IN PNP similar to 2N2906, BCY 70 20 for 50p, 50 for £1, 100 for £1.90, 500 for £5, 1000 for £14.
When ordering please state NPN or PNP

G.P. 300

115 WATT SILICON TO3 METAL CASE
V_{ceo} 100V, V_{ceo} 60V, IC 16A, Hts. 20-100 suitable replacement for 2N3055, BDY11 or BDY20

1-24 50p	25-99 48p	100+ 46p
----------	-----------	----------

INDICATORS

3015F MiniTron 7 Segment Indicator £1.11**
MAN 3M L.E.D. 7 SEGMENT DISPLAY
0.127" High Characters £1.79**

ZENER DIODES

FULL RANGE IN STOCK
VOLTAGE RANGE 2-33V

400 mw 8p	1.5 w 17p	10 w** 80p
-----------	-----------	------------

V.A.T. STOP PRESS TRANSISTORS

Transistors, metal or plastic, over 3A + 8% V.A.T. All others + 25%.

EXCLUDE VAT
AT 25% TO ALL

*** ADD 8%**
NO VAT
add 25p Overseas
Minimum order 75p

VOLTAGE REGULATORS

TO-3 Plastic Encapsulation

ua.7805/L129 5V	(Equiv. to MVR5V) £1.95p
ua.7812/L130 12V	(Equiv. to MVR12V) £1.95p
ua.7815/L131 15V	(Equiv. to MVR15V) £1.95p
ua.7818 18V	(Equiv. to MVR18V) £1.95p

THYRISTORS

PIV	0-6A	0-8A	1A	3A	5A	5A	7A	10A	16A	30A
	TO18	TO92	TO5	TO66	TO66	TO64	TO48	TO48	TO48	TO48
10	0-18	0-18	—	—	—	—	—	—	—	—
30	0-15	0-18	—	—	—	—	—	—	—	—
30	0-19	0-18	—	—	—	—	—	—	—	—
100	0-22	0-22	0-30	0-25	0-30	0-36	0-48	0-51	0-54	£1-18
100	0-25	0-30	0-25	0-25	0-48	0-48	0-51	0-57	0-58	£1-48
150	0-21	0-28	—	—	—	—	—	—	—	—
900	0-38	0-44	0-26	0-30	0-50	0-50	0-57	0-63	0-62	£1-81
400	—	—	0-30	0-30	0-55	0-57	0-58	0-71	0-77	£1-75
600	—	—	0-33	0-48	0-50	0-59	0-73	0-99	0-90	—
800	—	—	0-38	0-45	0-51	0-58	0-73	0-99	0-90	—

DIODES

Type	Price	Type	Price	Type	Price	Type	Price
AA119	0-08	BY101	0-18	BYZ16	0-41	OA85	0-09
AA120	0-08	BY105	0-18	BYZ17	0-36	OA90	0-07
AA129	0-08	BY114	0-18	BYZ18	0-36	OA91	0-07
AA230	0-08	BY124	0-18	BYZ19	0-36	OA95	0-07
AA213	0-10	BY126	0-18	CG82	0-44	OA200	0-07
BA100	0-10	BY127	0-18	(OA91Eq)	0-08	OA202	0-07
BA116	0-11	BY128	0-18	CG85 (OA70)	0-07	8D10	0-08
BA128	0-28	BY130	0-17	OA79)	0-07	8D19	0-08
BA148	0-18	BY133	0-21	OA8 Short	—	1N34	0-07
BA154	0-18	BY164	0-51	Leads	0-21	1N34A	0-07
BA155	0-18	BYX38/306-48	0-40	OA10	0-14	1N814	0-08
BA156	0-14	BYZ10	0-26	OA47	0-07	1N816	0-08
BA178	0-18	BYZ11	0-21	OA70	0-07	1N4148	0-08
BB104	0-18	BYZ12	0-21	OA79	0-07	18021	0-10
BY100	0-16	BYZ13	0-26	OA81	0-07	18981	0-07

UNTESTED T.T.L. PAKS

Manufacturers—'Fall Outs' which include Functional and part Functional Units. These are classed as 'out-of-spec' from the makers' very rigid specifications but are ideal for learning about I.C.'s and experimental work.

Pak No.	Contents	Price	Pak No.	Contents	Price
UIC00	— 12 x 7400	£0.60	UIC72	— 8 x 7472	£0.60
UIC01	— 12 x 7401	£0.60	UIC73	— 8 x 7473	£0.60
UIC02	— 12 x 7402	£0.60	UIC74	— 8 x 7474	£0.60
UIC03	— 12 x 7403	£0.60	UIC75	— 8 x 7475	£0.60
UIC04	— 12 x 7404	£0.60	UIC76	— 8 x 7476	£0.60
UIC05	— 12 x 7405	£0.60	UIC80	— 5 x 7480	£0.60
UIC06	— 8 x 7406	£0.60	UIC81	— 5 x 7481	£0.60
UIC07	— 8 x 7407	£0.60	UIC82	— 5 x 7482	£0.60
UIC10	— 12 x 7410	£0.60	UIC83	— 5 x 7483	£0.60
UIC13	— 8 x 7413	£0.60	UIC86	— 5 x 7486	£0.60
UIC20	— 12 x 7420	£0.60	UIC90	— 5 x 7490	£0.60
UIC30	— 12 x 7430	£0.60	UIC91	— 5 x 7491	£0.60
UIC40	— 12 x 7440	£0.60	UIC92	— 5 x 7492	£0.60
UIC41	— 5 x 7441	£0.60	UIC93	— 5 x 7493	£0.60
UIC42	— 5 x 7442	£0.60	UIC94	— 5 x 7494	£0.60
UIC43	— 5 x 7443	£0.60	UIC95	— 5 x 7495	£0.60
UIC44	— 5 x 7444	£0.60	UIC96	— 5 x 7496	£0.60
UIC45	— 5 x 7445	£0.60	UIC100	— 5 x 74100	£0.60
UIC46	— 5 x 7446	£0.60	UIC121	— 5 x 74121	£0.60
UIC47	— 5 x 7447	£0.60	UIC141	— 5 x 74141	£0.60
UIC48	— 5 x 7448	£0.60	UIC151	— 5 x 74151	£0.60
UIC60	— 12 x 7460	£0.60	UIC154	— 5 x 74154	£0.60
UIC61	— 12 x 7461	£0.60	UIC193	— 5 x 74193	£0.60
UIC63	— 12 x 7463	£0.60	UIC199	— 5 x 74199	£0.60
UIC64	— 12 x 7464	£0.60	UIC X125	Assorted 74's	£1.90
UIC65	— 12 x 7465	£0.60			
UIC70	— 8 x 7470	£0.60			

TELEVISIONS AND SPARES TO THE TRADE

MONOCHROME TELEVISIONS

BBC2 Dual Standard TVs (19in, 23in) in batches of 10—£5-90 each (makes include Bush, Thorn, Philips, Pye/Ekco, Baird). Many with transistorised tuners. GEC 2000, Thorn 950 series, Bush 141, Philips Style 70, Baird 600 and 700 series all at £7-50 each.
 Thorn 1400, Bush 160/170 series, Philips 210, Pye-Ekco Olympic, etc., Baird 673. Push Button—all at £12-50 each.
 20in and 24in square screen Dual Standard sets—Thorn, GEC, etc, 20in—£17-50, 24in—£22-00.
 20in and 24in Single Standard Thorn 1500, GEC, Bush Acoustic, 20in—£22-00, 24—£26-00.

(1) Discounts for quantities. (2) All monochrome spares supplied free of charge. (3) All tubes guaranteed. (4) All cabinets very good. (5) All sets "walk and talk". (6) All sets guaranteed complete inside and out. (7) Delivery and VAT extra.

COLOUR TELEVISIONS

Colour TVs 19in and 25in. Makes include Thorn 2000, Bush CTV25, Decca CTV 19/25in, Pye-Ekco, Baird 700 and 710 series, Philips G6, GEC 2028. All sets guaranteed complete inside and out—cabinets first class and tubes guaranteed, complete inside and out—cabinets first class and tubes guaranteed. From £65 each.

20in and 22in Colour Televisions are always available in varying quantities—please telephone for availability and cost.

Please Note: (1) We deliver anywhere by our own transport. (2) All goods are blanket wrapped in our vans. (3) All orders with half deposit, balance on delivery after inspection. (4) Cheques most welcome. (5) Any quantity supplied. (6) We do not sell rubbish, and we stand by our guarantees. (7) We aim to please. (8) All spares supplied free of charge (mono only).

N.B. Special arrangement for delivery to North and South Ireland and world-wide exports orders welcomed.

TEST BENCH FACILITIES ALWAYS AVAILABLE
 WORLD WIDE DELIVERIES OF TV's, SPARES
 WE EXPORT TO ANY COUNTRY.

MISCELLANEOUS ITEMS

Large quantities of stereograms, fridges, deep freezers, Hoovermatics, radios, etc., always at hand—prices on request.

Colour **SCAN COILS** Mono
 All dual standard £5 plus £1 P. & P. All makes £2 inclusive.

VALVES
 All colour valves 40p each plus 5p All mono valves 10p each plus 2p P. & P. per valve. each P. & P.

TUBES
 19in—£15, 22in—£22, 25in—£26 (post, 19in £4, 20in—£5-50, 23in—£5, 24in—£6 (post), insurance, packing £3-50)

CABINETS
 19in—£12, 22in—£16, 25in—£14 (post, All cabinets—£5 including post, insurance, packing £5).

LOPTs
 All dual standard colour £5-50 plus £1 P. & P. All makes available. All dual standard mono £2-20 plus £1 P. & P. All makes available.

PANELS Mono
 Colour IF, Decoder and Convergence—frame IF, Line timebase £3 plus £1 P. & P. output for all dual standard models All dual standard models in stock. from £7-50 plus £1-50 P. & P. All models available.

SLOT METERS
 10p meters—£1-50 each including postage and packing.

SPEAKERS
 6in x 4in Round, 8in x 2in 30p each plus 10p P. & P.

MAIL ORDER SERVICES

BLACK/WHITE TELEVISIONS
 Working: 19in—£12-50, 23in—£15-00, 20in—£25, 24in—£20-50.
 Untested (but guaranteed complete with good tubes): 19in—£4, 23in—£5, 20in—£15, 24in—£19.

(Postage, packing and insurance £4-50 each, prices include VAT.)
 N.B. All tubes guaranteed.

COLOUR TELEVISIONS
 Working: 19in—£25, 22in—£125, 25in—£130.
 Untested (but guaranteed complete with good tubes): 19in—£70, 22in—£80, 25in—£95.

(Postage, packing and insurance £9 each, prices include VAT.)
 Thorn 2000, Bush CTV25, Philips G6, GEC2028, Baird 700, Decca CTV25

MAIL ORDER SPARES. Special Offer
 BRC 2000 panels, video, convergence and regulator—only £12-50 plus £1-50 P. & P.

Bush CTV 25 Line timebase-tower unit including LOPT and valves Mk. 1 and II only—£18 plus £3 P. & P.

BRC single standard colour 4 button tuners colour and mono—£7-50 plus £1 P. & P.

UHF Vari-cap tuner units—£6-50 plus £1 P. & P.

VHF Vari-cap tuner units—£7-50 plus £1 P. & P.

Pye-Ekco CTV Tripler units—£6-25 plus 75p P. & P.

Philips G6 Tripler units—£7-50 plus 75p P. & P.

KB VC Series LOPT £2-50 including P. & P.

Bush 125 and 135 IF PANELS—£3-50 plus 75p P. & P.

Thorn 850 IF Panels—£2-50 plus £1 P. & P.

GEC 2000 IF Panels—£3-50 plus £1 P. & P.

EX-EQUIPMENT TUNERS:

Colour:
 All dual standard colour push button—rotary and integrated models in stock from £4-50 plus £1 P. & P.

Mono:
 All VHF tuners available from £2 plus £1 P. & P.
 All UHF tuners for dual standard models in stock. Push button—£4-50 plus £1-50 P. & P.

Rotary—£2-50 plus £1 P. & P.
 Integrated (UHF and VHF) £4-50 plus £1-50 P. & P.
 Comprehensive list of capacitors, resistors, etc., too numerous to mention. Prices on request.

PLEASE ALLOW 2 WEEKS DELIVERY. S.A.E. PLEASE FOR ENQUIRIES. ALL STOCK EX-EQUIPMENT
 BARCLAYCARD, ACCESS AND PROVIDENT WELCOME

TRADE DISTRIBUTORS

EMPIRE BUILDINGS, CHELTENHAM PARADE, HARGATE, YORKSHIRE

Telephone: (STD 0423) 3498 and 62347

Create your own EVERYDAY ELECTRONICS Library Bind your magazines in the EASIBINDER

Attractively bound in orange Balacron with the title blocked in black on the spine, the Easibinder is designed to hold 12 copies of EVERYDAY ELECTRONICS.

In addition to the title, the current (or last) Volume No. and date is blocked on the spine, but for any of the previous volumes a set of transfer figures is supplied.

When ordering please indicate which Volume is required.

Price £1.85 including postage and V.A.T.

Send your order with remittance to:

To Post Sales Dept., I.P.C. Magazines Ltd., Carlton House, 66-68 Great Queen Street, London WC2.
 I enclose p.o./cheque value..... for binders at £1.85 each for EVERYDAY ELECTRONICS.
 Vol. Nos
 Name
 Address
 Date



GIRO NO. 331 7056 Access & Barclay Cards accepted. C.W.O. only, p. & p. 75p Discounts: £15-10% (except net items) Export Order enquiries welcome (£5 min. order)

Official Orders accepted from Educational & Government Departments
ALL PRICES INCLUDE VAT

LEIGHTON ELECTRONICS CENTRE

MULTIMETER U4323

22 Ranges plus AF/IF Oscillator 20,000 Ω/Volt.
Vdc—0.5—1000V in 7 ranges
Vac—2.5—1000V in 6 ranges
Idc—0.05—500mA in 5 ranges
Resistance—5 Ω—1M Ω in 4 ranges.



Accuracy—5% of F.S.D.
OSCILLATOR—1 KHz and 465 KHz (A.M.) at approx. 1 volt.
Size—160 x 97 x 40mm.
Supplied complete with carrying case, test leads and battery.
PRICE £8.64 net p & p 75p.

U4323

MULTIMETER U4324

34 Ranges. High sensitivity. 20,000 Ω/Volt. Overload protected.
Vdc—0.6—1200V in 9 ranges.
Vac—3—900V in 8 ranges.
Idc—0.06—3A in 6 ranges.
Iac—0.3—3A in 5 ranges.
Resistance—25 Ω—5M Ω in 5 ranges.
Accuracy—dc and R—2 1/2% of F.S.D.
ac and db—4% of F.S.D.



Size—157 x 98 x 63mm.
Supplied complete with storage case, test leads, spare diode, and battery.
PRICE £10.64 net p & p 75p.

U4324

TEACH-IN SERIES COMPONENT KIT

KIT No. T12

ALL COMPONENTS AS SPECIFIED BY E.E.
FULLY GUARANTEED AND NEW STOCK

£15.50 + 60p p & p
NET.

INCLUDING VAT

WOOD KIT

Includes all wood as specified by E.E., cut to size, ready to assemble and includes adhesive and screws

£3 NET + 75p p. & p.

FULL LIST AVAILABLE. S.A.E. PLEASE
OR FREE WITH CATALOGUE

E. & O.E.

ALL STOCK SUBJECT TO AVAILABILITY

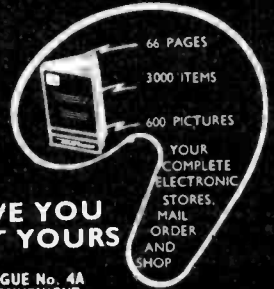

HAVE YOU GOT YOURS

CATALOGUE No. 4A
NEW CONVENIENT SIZE, AND FULLY ILLUSTRATED

CONTAINS MANY HARD TO GET ITEMS

20p

PAYS FOR ITSELF WITH DISCOUNT VOUCHERS WORTH 20p

*DISCOUNTS

*ALL NEW STOCK

*SATISFACTION GUARANTEE

*DEPENDABLE SERVICE

S.A.E. FOR SUPPLEMENT NO. 1

B. H. COMPONENT FACTORS LTD.

(E.E.) LEIGHTON ELECTRONICS CENTRE, 59 NORTH ST., LEIGHTON BUZZARD, BEDS. Tel. LEIGHTON BUZZARD 2316 (STD. Code 05253)

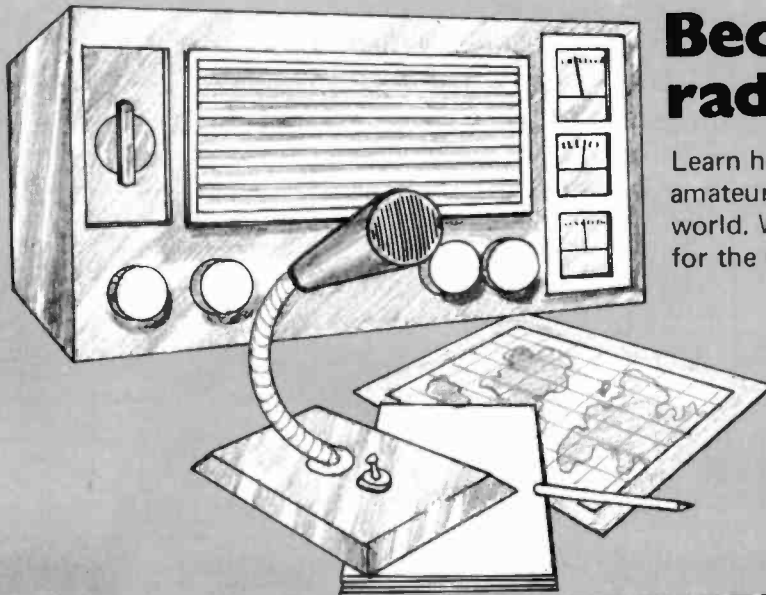

Become a radio amateur.

Learn how to become a radio-amateur in contact with the whole world. We give skilled preparation for the G.P.O. licence.

Free!

Brochure, without obligation to:

To: **BRITISH NATIONAL RADIO & ELECTRONICS SCHOOL**, Dept. EEB 16, P.O. Box 156, Jersey, Channel Islands.

NAME _____

ADDRESS _____

Block caps please

New Motorcycling Monthly RIDES THE STORM



And so will you if you're wearing the right kind of protective clothing. This exciting new-look mag has roped in the military no less, to test a selection of bikers' gear . . . in a rainmaking machine and an arctic cold room specially rigged up to put armoured cars and tanks through their paces.

See New Motorcycling Monthly's straight-from-the-shoulder "Which"-style report on the kind of gear that'll get you through any storm

Also ALL-TIME GREATS TT GAME - unique Xmas pull-out novelty 10,000 KM ROAD TEST on a Jawa 350
 BATTERIES - treat 'em well, and they'll take care of you
 WORKS RACER'S WEEKEND - the stresses and strains on a teamster . . . and the triumphs too! ROAD IMPRESSIONS - Suzuki 550 and 750 'triples'

RIDE IN STYLE EVERY MONTH WITH

FREE ENTRY COMPETITION!

Win a Sporting Motorcycle Holiday. We're giving away 3 trips (each for 2 people) to a selection of major European sporting events.

NEW Motorcycling Monthly

No. 3
(January issue)
OUT NOW 30p

Marshall's

A. Marshall (London) Ltd Dept: EE
42 Cricklewood Broadway London NW2 3ET Tel: 01-452 0161/2
Telex: 21492

& 85 West Regent St Glasgow G2 2OD Tel: 041-332 4133

& 1 Straits Parade Fishponds Bristol BS16 2LX

Tel: 0272 654201/2

& 27 Rue Danton Issy Les Moulineaux Paris 92 Tel: 644 2356

Catalogue price 25p Trade and export enquiries welcome

Our range covers over 7,000 items. The largest selection in Britain
Top 200 IC's TTL, CMOS & Linear

CA3020A	£1.80	CD4050	66p	NE556	£1.30	SN7446	95p	SN74153	85p
CA3028A	79p	CD3130	80p	NE560	£4.48	SN7447	89p	SN74154	£1.50
CA3035	£1.37	CD4510	£1.25	NE565	£4.48	SN7448	90p	SN74157	95p
CA3046	70p	CD4511	£1.94	SL414	£1.80	SN7450	16p	SN74160	£1.10
CA3048	£2.11	CD4516	£1.25	SL610C	£1.70	SN7451	16p	SN74161	£1.10
CA3052	£1.62	CD4518	£1.87	SL611C	£1.70	SN7453	16p	SN74162	£1.10
CA3089E	£1.96	CD4520	£1.87	SL612C	£1.70	SN7454	16p	SN74163	£1.10
CA3090Q	£4.23	LM301A	48p	SK620C	£2.60	SN7460	16p	SN74164	£2.01
CD4000	36p	LM308	£2.50	SL621C	£2.60	SN7470	33p	SN74165	£2.01
CD4001	36p	LM057L	£1.50	SL623C	£4.39	SN7472	26p	SN74167	£4.10
CD4002	36p	LM380	£1.10	SL640C	£3.10	SN7473	36p	SN74174	£1.25
CD4006	£1.58	LM381	£2.20	SN7400	16p	SN7474	36p	SN74175	90p
CD4007	36p	LM705C	75p	SN7401	16p	SN7475	30p	SN74176	£1.44
CD4008	£1.63	LM709	75p	SN7401AN	38p	SN7476	35p	SN74180	£1.40
CD4009	£1.18	T099	38p	SN7402	16p	SN7480	50p	SN74181	£1.95
CD4010	£1.18	8DIL	45p	SN7403	16p	SN7481	£1.25	SN74190	£2.30
CD4011	36p	14DIL	38p	SN7404	19p	SN7482	75p	SN74191	£2.30
CD4012	36p	LM710	47p	SN7405	19p	SN7483	95p	SN74192	£1.10
CD4013	66p	LM723C	90p	SN7406	45p	SN7486	95p	SN74193	£1.15
CD4014	£1.72	M741C	40p	SN7407	48p	SN7485	£1.25	SN74196	£1.60
CD4015	£1.72	8DIL	40p	SN7408	19p	SN7486	32p	SN74197	£1.58
CD4016	66p	14DIL	38p	SN7409	22p	SN7490	45p	SN74198	£2.25
CD4017	£1.72	LM747	£1.05	SN7410	16p	SN7491	85p	SN74199	£2.25
CD4018	£2.55	LM748	SN7411	25p	SN7492	45p	SN76003N	£2.92	
CD4019	86p	8DIL	73p	SN7412	28p	SN7493	45p	SN76013N	£1.95
CD4020	£1.91	14DIL	73p	SN7413	35p	SN7494	32p	SN76023N	£1.60
CD4021	£1.72	LM3900	70p	SN7416	35p	SN7495	72p	SN76033N	£2.92
CD4022	£1.66	LM7805	£2.00	SN7417	35p	SN7496	75p	TAA263	£1.10
CD4023	36p	LM7812	£2.30	SN7420	16p	SN74100	£1.25	TAA300	£1.80
CD4024	£1.24	LM7815	£2.30	SN7423	29p	SN74107	36p	TAA350A	£2.10
CD4025	32p	LM7824	£2.50	SN7425	29p	SN74118	£1.00	TAA550	60p
CD4027	43p	MC1303L	£1.50	SN7427	29p	SN74119	£1.92	TAA611C	£2.18
CD4028	£1.50	MC1310P	£2.59	SN7430	16p	SN74131	37p	TAA621	£2.03
CD4029	£3.50	MC6330P	90p	SN7432	28p	SN74122	30p	TAA661B	£1.25
CD4030	87p	MC1351P	80p	SN7437	35p	SN74123	60p	TBA641B	£2.32
CD4031	£5.19	MC14553	£4.07	SN7438	35p	SN74141	85p	TBA651	£1.69
CD4037	£1.93	MC1466L	£3.30	SN7440	16p	SN74145	90p	TBA800	£1.40
CD4041	£1.86	MC1469R	£2.75	SN7441AN	85p	SN74150	£1.50	TBA810	£1.40
CD4049	81p	NE555V	70p	SN7442	65p	SN74151	85p	TBA820	£1.15

LONDON GLASGOW PARIS AND NOW

BRISTOL

IT'S OUR SERVICE THAT MAKES US GROW

POPULAR SEMICONDUCTORS

2N696	22p	2N3906	27p	AF139	65p	BD139	71p	MPSA56	31p
2N697	16p	2N4037	42p	AF239	65p	BD140	87p	OC28	76p
2N698	82p	2N4036	67p	AF240	90p	BF115	36p	OC35	60p
2N699	59p	2N4037	67p	AF279	70p	BF117	55p	OC42	50p
2N706	14p	2N4062	15p	AF280	79p	BF154	20p	OC45	32p
2N708	17p	2N4289	34p	AL102	£1.00	BF159	27p	PIP29A	49p
2N916	28p	2N4920	£1.10	BC107	14p	BF180	35p	PIP29C	58p
2N918	32p	2N4921	83p	BC108	14p	BF181	36p	TIP31A	62p
2N1302	181p	2N4923	£1.00	BC109	14p	BF184	30p	TIP32A	74p
2N1304	26p	2N5294	48p	BC147B	14p	BF194	12p	TIP33A	£1.01
2N1306	31p	2N5294	48p	BC148B	15p	BF195	12p	TIP34A	£1.31
2N1308	47p	2N5296	48p	BC149B	15p	BF196	13p	TIP35A	£2.90
2N1711	45p	2N5457	49p	BC157A	16p	BF197	15p	TIP36A	£3.70
2N2102	60p	2N5458	46p	BC158A	16p	BF198	18p	TIP41A	74p
2N2147	78p	2N5459	49p	BC167B	15p	BF244	21p	TIP42A	£0.90
2N2148	94p	2N6037	47p	BC168B	15p	BF257	47p	TIP295S	90p
2N2218A	22p	3N128	73p	BC169B	15p	BF258	53p	TIP305S	50p
2N2219A	26p	3N140	100p	BC182	12p	BF259	58p	TIS43	28p
2N2220	25p	3N141	81p	BC182L	12p	BF561	27p	ZTX300	13p
2N2221	18p	3N200	£2.49	BC183	12p	BF598	25p	ZTX301	13p
2N2222	20p	40361	40p	BC183L	12p	BF839	14p	ZTX500	15p
2N2369	20p	40362	45p	BC184	13p	BF879	24p	ZTX501	13p
2N2646	35p	40406	44p	BC184L	13p	BFX29	90p	ZTX502	15p
2N2904	22p	40407	35p	BC212A	16p	BFX30	27p	IN914	7p
2N2905	25p	40408	30p	BC212LA	16p	BFX84	24p	IN3754	15p
2N2906	19p	40409	32p	BC213LA	15p	BFX85	30p	IN4007	10p
2N2907	22p	40410	52p	BC214LB	18p	BFX88	25p	IN4148	7p
2N2924	20p	40411	£2.00	BC237B	16p	BFY50	21p	IN5404	22p
2N2926	15p	40594	74p	BC238C	15p	BFY51	20p	IN5406	30p
2N3053	25p	40595	84p	BC239C	15p	BFY52	20p	AA119	8p
2N3054	60p	40636	£1.10	BC257A	16p	BRY39	48p	BA102	25p
2N3055	75p	40673	73p	BC258B	16p	ME0402	20p	BA145	18p
2N3391	28p	AC162	20p	BC259B	17p	ME0412	18p	BA154	12p
2N3392	15p	AC127	20p	BC301	34p	ME4102	11p	BA155	12p
2N3393	15p	AC128	20p	BC307B	17p	M480	95p	BB103B	23p
2N3440	59p	AC151	27p	BC308A	15p	MJ481	£1.20	BB104B	45p
2N3442	£1.40	AC152	49p	BC309C	20p	MJ490	£1.05	BY126	12p
2N3638	15p	AC153	35p	BC327	23p	MJ491	£1.45	BY127	15p
2N3702	12p	AC176	30p	BC328	22p	MJ2955	£1.00	BY211	51p
2N3703	13p	AC187K	35p	BCY70	17p	MJE340	48p	BY212	51p
2N3704	15p	AC188K	40p	BCY71	22p	MJE370	65p	OA47	6p
2N3705	15p	AD114	68p	BCY72	15p	MPF102	39p	OA81	18p
2N3708	14p	AD161	50p	BD121	£1.00	MJES20	60p	OA90	6p
2N3714	£1.38	AD162	50p	BD123	82p	ME521	70p	OA91	6p
2N3716	£1.80	AF106	40p	BD124	67p	MJE2955	£1.20	OA200	8p
2N3771	£2.20	AF109	40p	BD131	40p	MJE3055	75p	BY164	57p
2N3773	£2.65	AF115	35p	BD132	50p	MPB113	47p	ST2diac	20p
2N3789	£2.06	AF116	35p	BD135	45p	MPB102	39p	40669	£1.00
2N3819	37p	AF117	35p	BD136	47p	MPSA05	35p	TIC44	29p
2N3820	64p	AF118	35p	BD137	55p	MPSA06	31p	CI06D	65p
2N3904	27p	AF124	30p	BD138	63p	MPSA55	31p	ORP12	60p

Prices correct at December 1975, but all exclusive of VAT. P. & P. 25p

ENGINEERS

FREE



YOURSELF FOR A

BETTER JOB WITH MORE PAY!

Do you want promotion, a better job, higher pay? "New opportunities" shows you how to get them through a low-cost, Home Study Course. There are no books to buy and you can pay as you learn.

This easy to follow GUIDE TO SUCCESS should be read by every ambitious engineer. Send for this helpful 76-page free book NOW! No obligation, nobody will call on you. It could be the best thing you ever did.

CHOOSE A BRAND NEW FUTURE HERE

CUT OUT THIS COUPON

<input type="checkbox"/> ELECTRICAL and ELECTRONICS	<input type="checkbox"/> AUTO and AERO Motor Mechanics	<input type="checkbox"/> MECHANICAL A.M.S.E. (Mech.)
<input type="checkbox"/> Practical Radio & Electronics (with KIT)	<input type="checkbox"/> C. & G. Motor V. Mechanics	<input type="checkbox"/> General Mech. Eng.
<input type="checkbox"/> Electronic Engineering Certificate	<input type="checkbox"/> General Auto Engineering	<input type="checkbox"/> Inst. Engineers & Technicians
<input type="checkbox"/> General Elect. Eng. Certificate	<input type="checkbox"/> A.M.I.M.I.	<input type="checkbox"/> Maintenance Engineering
<input type="checkbox"/> C. & G. Elect. Installations	<input type="checkbox"/> Air Registration Board Certs.	<input type="checkbox"/> Welding
<input type="checkbox"/> Elect. Install. & Work	<input type="checkbox"/> M.A.A. I.M.I. Dip.	<input type="checkbox"/>
<input type="checkbox"/> C. & G. Elect. Technicians	<input type="checkbox"/>	<input type="checkbox"/>
<input type="checkbox"/> RADIO and TELECOMMUNICATIONS	<input type="checkbox"/> Heating, Ventilating & Air Conditioning	<input type="checkbox"/> CONSTRUCTIONAL
<input type="checkbox"/> Colour TV Servicing	<input type="checkbox"/> Architectural Draughtsmanship & Design	<input type="checkbox"/> Computer Programming
<input type="checkbox"/> C. & G. Telecoms. Technician's Cert.	<input type="checkbox"/> L.I.O.B.	<input type="checkbox"/> Inst. of Cost & Managements Accts.
<input type="checkbox"/> C. & G. Radio, TV & Electronics Mech. Cert.	<input type="checkbox"/> Carpentry & Joinery	<input type="checkbox"/> DRAUGHTSMANSHIP and DESIGN
<input type="checkbox"/> Radio & TV Engineering Course	<input type="checkbox"/> Plumbing Technology	<input type="checkbox"/> General Draughtsmanship
<input type="checkbox"/> Radio, Servicing & Repairs	<input type="checkbox"/> General Building	<input type="checkbox"/> A.M.I.E.D.C.
<input type="checkbox"/> Radio Amateur's Exam.	<input type="checkbox"/> Painting & Decorating	<input type="checkbox"/> Electrical Draughtsmanship



G.C.E.
—58 'O' & 'A' Level Subjects
—over 10,000 Group Passes!

Aldermaston College
Dept. TEE13 Reading RG7 4PF.
also at our London Advisory Office, 4 Fore Street Avenue, Moorgate, London EC2Y 5EJ. Tel. 01-628 2721.

NAME (Block Capitals)

ADDRESS

..... Postcode.....

Other subjects of interest..... Age.....

Accredited by C.A.C.C. Member of A.B.C.C.

HOME OF BRITISH INSTITUTE OF ENGINEERING TECHNOLOGY

FANTASTIC VALUE! ONLY 40p

132 PAGES INCLUDING PROJECTS FOR YOU TO BUILD. PLUS HUNDREDS OF ILLUSTRATIONS OF COMPONENTS.

PRICES GUARANTEED FOR TWO MONTH PERIODS

FULL DETAILS AND PICTURES OF A WIDE RANGE OF COMPONENTS

SAME-DAY MAILING SERVICE!

PAGES OF TRANSISTOR AND I.C. DATA

THOUSANDS OF COMPONENTS

A BEAUTIFULLY PRODUCED BOOK!

VALUABLE DISCOUNT VOUCHERS

MAPLIN ELECTRONIC SUPPLIES

GET THIS! BOOK NOW AND TAKE OFF TODAY WITH MAPLIN SUPERSERVICE

EASY TO ORDER LAYOUT

Clear pictures and full description of every component makes ordering simple—you'll know exactly what you're buying.

I enclose Cheque/P.O. value (EE)
For copy/copies of your Catalogue
NAME
ADDRESS

MAPLIN ELECTRONIC SUPPLIES P.O. Box 3, Rayleigh Essex S56 6LR.