

PARETTI

Construction and theory for everyone

# everyday electronics

MAR.75

25p

WALL CHART  
**FREE!**  
INSIDE  
CONSTRUCTION  
TECHNIQUES

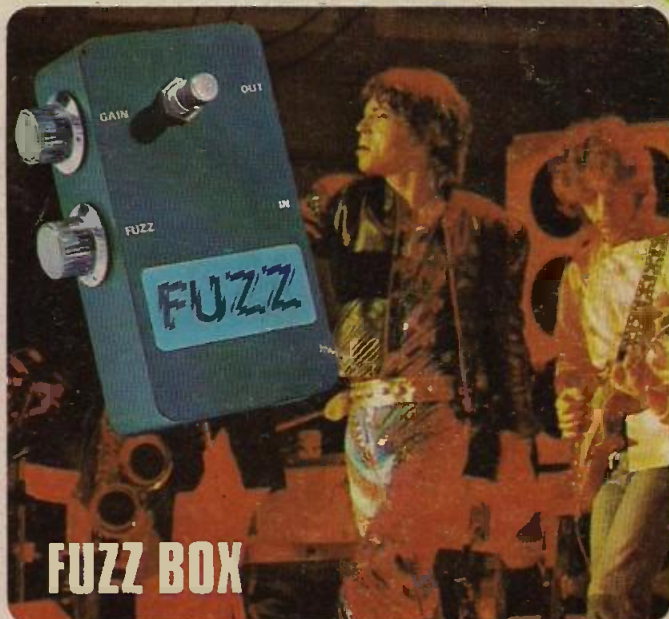

**FUZZ BOX**

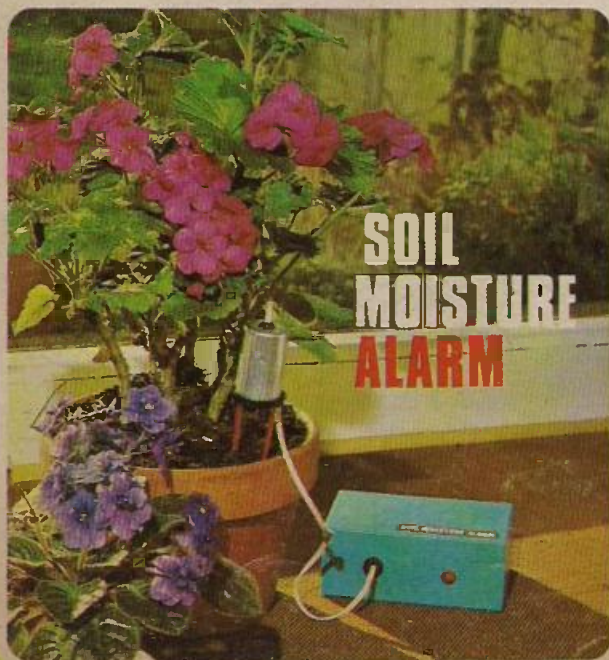

**SOIL  
MOISTURE  
ALARM**



**AMATEUR SHORT WAVE  
RECEIVER**

# NEW EDU-KIT MAJOR

Completely Solderless Electronic Construction Kit  
Build these projects without soldering iron or solder

- ★ 4 Transistor Earpiece Radio.
- ★ Signal Tracer.
- ★ Signal Injector.
- ★ Transistor Tester NPN-PNP.
- ★ 4 Transistor Push Pull Amplifier.
- ★ 5 Transistor Push Pull Amplifier.
- ★ 7 Transistor Loudspeaker Radio MW/LW.
- ★ 8 Transistor Short Wave Radio.
- ★ Electronic Metronome.
- ★ Electronic Noise Generator.
- ★ Batteryless Crystal Radio.
- ★ One Transistor Radio.
- ★ 2 Transistor Regenerative Radio.
- ★ 3 Transistor Regenerative Radio.
- ★ Audible Continuity Tester.
- ★ Sensitive Pre-Amplifier.

**Total Building Costs**  
**£7-23** P P & Ins. 44p  
(Overseas Seamail P & P £2-35)  
(+ 8% VAT 57p)

Components Include: 24 Resistors • 21 Capacitors • 10 Transistors • 3 1/2" Loudspeaker • Earpiece • Mica Baseboard • 3 12-way connectors • 2 Volume controls • 2 Slider Switches • 1 Tuning Condenser • 3 Knobs • Ready Wound MW/LW/SW Coils • Ferrite Rod • 6 1/2 yards of wire • 1 Yard of sleeving etc. • Parts Price List and Plans 55p free with parts.

## NEW ROAMER NINE

WITH V.H.F. INCLUDING AIRCRAFT

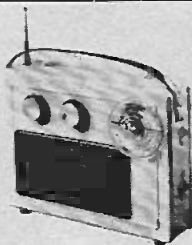

Nine Transistors, 9 Tunable wavebands as Roamer Ten. Built in ferrite rod aerial for MW/LW. Retractable chrome-plated telescopic aerial for VHF and SW. Push Pull output using 600 mW transistors, 3 Transistors and 3 diodes, tuning condenser with V.H.F. section, separate coil for aircraft, moving coil loudspeaker, volume ON/OFF and wavechange controls. Attractive all white case with red grille and carrying strap. Size 9 1/2" x 7" x 2 1/2" approx. Parts Price List and Plans free with parts.

**Total Building Costs** **£6-95** P P & Ins. 44p  
(Overseas Seamail P & P £3-35)  
(+ 8% VAT 35p)

## POCKET FIVE

NOW WITH 3" LOUI-SPEAKER



3 Tunable wavebands, M.W. L.W. and Trawler Band, 7 stages, 7 transistors and 2 diodes, super-sensitive ferrite rod aerial, attractive black and gold case. Size 5 1/2" x 1 1/2" x 3 1/4" approx. Plans and Parts Price List 26p free with parts.

**Total Building Costs** **£2-50** P P & Ins. 38p  
(Overseas Seamail P & P £1-70)  
(+ 8% VAT 20p)



## TRANSONA FIVE NOW WITH 3" LOU-SPEAKER

Wavebands, transistors and speaker as Pocket Five. Larger Case with Red Speaker Grille and Tuning Dial. Plans and Parts Price List free with parts.

**Total Building Costs** **£2-75** P P & Ins. 36p  
(+ 8% VAT 21p)

## TRANS EIGHT 8 TRANSISTORS and 3 DIODES

5 Tunable Wavebands: MW, LW, SW1, SW2, SW3 and Trawler Band. Sensitive ferrite rod aerial for M.W. and L.W. Telescopic aerial for Short Waves. 3in. Speaker. 8 Improved type transistors plus 3 diodes. Attractive case in black with red grille, dial and black knobs with polished metal inserts. Size 9 x 5 1/2 x 2 1/2 in. approx. Push pull output. Battery economiser switch for extended battery life. Ample power to drive a larger speaker. Parts price list and plans free with parts.

**Total building costs** **£4-48** P P & Ins. 40p  
(+ 8% VAT 36p)  
(Overseas Seamail P & P £2-00)

## ROAMER SIX

Trawler band plus an extra Medium waveband for easier tuning of Luxembourg, etc. Sensitive ferrite rod aerial and telescopic aerial for Short Waves. 3in. Speaker. 5 stages - 6 transistors and 2 diodes. Attractive black case with red grille, dial and black knobs with polished metal inserts. Size 9 x 5 1/2 x 2 1/2 in. approx. Plans and parts price list free with parts.

**CASE AND LOOKS AS TRANS-EIGHT**  
**Total building costs** **£3-98** P P & Ins. 40p  
(+ 8% VAT 32p) P & P £2-00

## NEW Everyday Series

Build this exciting New series of designs

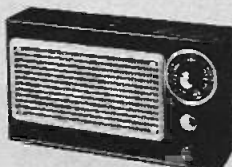

E.V.5. 5 Transistors and 2 diodes. MW/LW. Powered by 4 1/2 volt battery. Ferrite rod aerial, tuning condenser, volume control, and now with 3" loudspeaker. Attractive case with red speaker grille. Size 9" x 5 1/2" x 2 1/2" approx. Parts Price List and Plans free with parts.

**Total Building Costs** **£2-95** P P & Ins. 36p  
(Overseas Seamail P & P £1-70)  
(+ 8% VAT 23p)

E.V.6. Case and looks as above. 6 Transistors and 3 diodes. Powered by 9 volt battery. Ferrite rod aerial, 3" loudspeaker, etc., MW/LW coverage. Push Pull output. Parts Price List and Plans free with parts.

**Total Building Costs** **£3-60** P P & Ins. 36p  
(Overseas Seamail P & P £1-70)  
(+ 8% VAT 29p)

E.V.7. Case and looks as above. 7 Transistors and 3 diodes. Six wavebands. MW/LW. Trawler Band. SW1, SW2, SW3, powered by 9 volt battery. Push Pull output. Telescopic aerial for short waves. 3" Loudspeaker. Parts Price List and Easy Build Plans free with parts.

**Total Building Costs** **£4-08** P P & Ins. 38p  
(Overseas Seamail P & P £2-00)  
(+ 8% VAT 32p)

## ROAMER EIGHT Mk I

NOW WITH VARIABLE TONE CONTROL



7 Tunable Wavebands: MW1, MW2, LW, SW1, SW2, SW3 and Trawler Band. Built in Ferrite Rod Aerial for MW and LW. Chrome plated Telescopic aerial can be angled and rotated for peak short wave listening. Push pull output using 600mW transistors. Car aerial and Tape record sockets. Selectivity switch. 8 transistors plus 3 diodes. Latest 4" 2 watt ferrite magnet loudspeaker. Air spaced ganged tuning condenser. Volume/on/off, tuning, wave change and tone controls. Attractive case in rich chestnut shade with gold blocking. Size 9 x 7 x 4 1/2 in. approx. Easy to follow instructions and diagrams. Parts price list and plans free with parts.

**Total building costs** **£6-98** P P & Ins. 47p  
(Overseas Seamail P & P £2-50)  
(+ 8% VAT 56p)

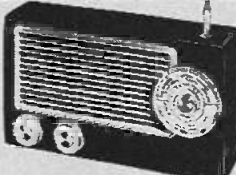

## ROAMER TEN Mk 2

WITH VHF INCLUDING AIRCRAFT

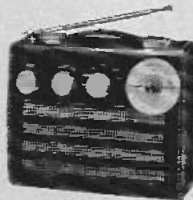

Now with free earpiece and switched socket. 10 Transistors. Latest 4" 2 watt Ferrite Magnet Loudspeaker.

9 Tunable Wavebands. MW1, MW2, LW, SW1, SW2, SW3, Trawler Band, VHF and Local Stations also Aircraft Band. Built in Ferrite Rod Aerial for MW/LW. Chrome plated 7 section Telescopic Aerial, can be angled and rotated for peak short wave and VHF listening. Push Pull output using 600mW Transistors. Car Aerial and Tape Record Sockets. 10 Transistors plus 3 Diodes. Ganged Tuning Condenser with VHF section. Separate coil for Aircraft Band. Volume on/off. Wave Change and tone Control. Attractive Case in black with silver blocking. Size 9" x 7" x 4". Easy to follow instructions and diagrams. Parts price list and plans 50p free with parts.

**Total building costs** **£9-50** P P & Ins. 52p  
(Overseas Seamail P & P £3-50)  
(+ 8% VAT 76p)

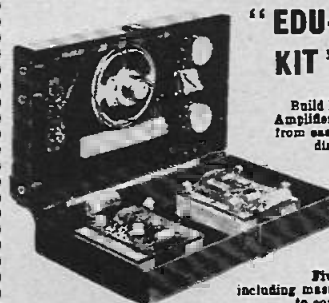

"EDU-KIT"  
Build Radios, Amplifiers, etc. from easy stage diagrams.

Five units including master unit to construct.

Components include:

Tuning Condenser; 2 Volume Controls; 2 Slider Switches; Fine Tune 3" Moving Coil Speaker; Truncated Strip; Ferrite Rod Aerial; Battery Clips; 4 Tag Boards; 10 Transistors; 4 Diodes; Resistors; Capacitors; Three 1" Knobs. Units once constructed are detachable from Master Unit, enabling them to be stored for future use. Ideal for Schools, Educational Authorities and all those interested in radio construction. Parts price list and plans free with parts.

**Total building costs** **£5-50** P P & Ins. 40p  
(Overseas Seamail P & P £2-35)  
(+ 8% VAT 44p)

## RADIO EXCHANGE LTD

★ Callers side entrance "Lavells" shop.  
★ Open 10-1, 2.30-4.30, Mon.-Fri. 9-12 Sat.

To RADIO EXCHANGE CO., 61a HIGH STREET, BEDFORD, MK40 1SA  
Tel.: 0234 52367. Reg. No. 788372.

I enclose £..... for.....  
Name.....  
Address.....  
(Dept. EE3.)

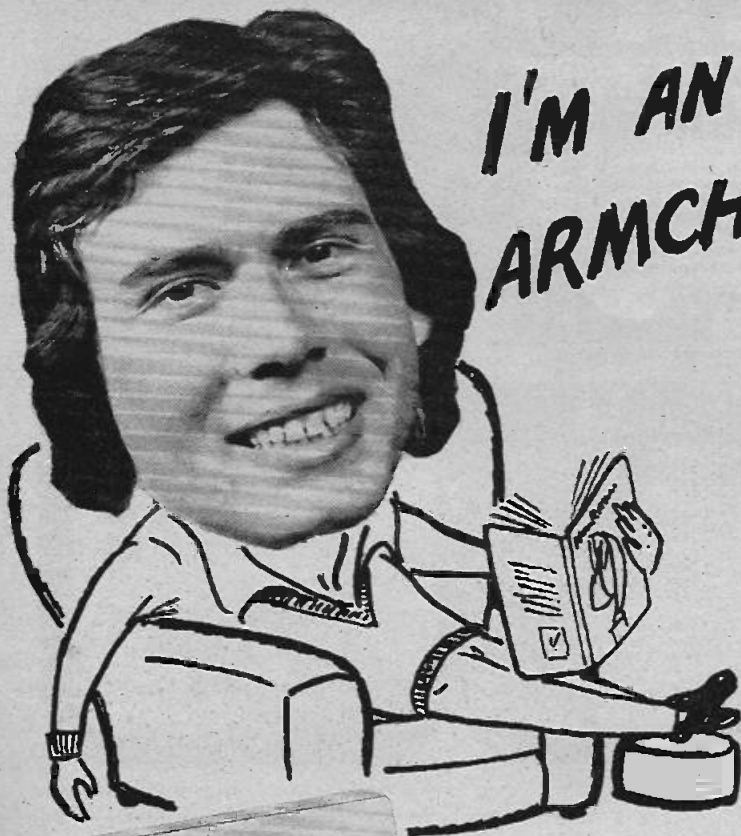

# I'M AN ARMCHAIR SHOPPER!

On a cold dark winter's evening, with the rain lashing down and the wind howling around, there's nothing I like better than to curl up in front of a fire, with tea and toasted scones at my side . . . and my catalogue on my lap. I then start choosing the bits and pieces for my next project. Home Radio Components had sent me one of their special order packs, so I had six order forms and six pre-paid addressed envelopes to simplify my job. I've now gone even one better. When I've written out my order, I pick up the phone and order direct. This was another thoughtful idea of Home Radio. They've made it easy for anyone to open a Credit Account without the delay and formality of references and all that fiddle faddle. Once you have an account, you can order anything, any time during the 24 hours! Just think what a boon that is, if you run out of wire or solder late at night.



**65p. plus 33p POST AND PACKING**

**Send off the coupon today. It's your first step to solving your component buying problems.**

The price of 98p applies only to customers in the U.K. and to BFPO Addresses.

## HOW ABOUT YOU?

I expect by now you're itching to know how to get in on this. It's really quite easy; but for a start you need the fabulous Home Radio Components Catalogue. It costs 65 pence, plus 33p post and packing; but with the catalogue you get 14 vouchers, each worth 5 pence when used as directed, so you can recover 70 pence of your investment. Why hesitate any longer? *Post off the coupon below today, with your cheque or PO for 98p, and join the merry band of Armchair Shoppers!*

Please write your Name and Address in block capitals

NAME.....

ADDRESS.....



HOME RADIO (Components) LTD., Dept. EE,  
234-240 London Road, Mitcham, Surrey CR4 3HD

(Regn. No.  
London 912966)

# SPARKRITE MK 2

## CAPACITIVE DISCHARGE ELECTRONIC IGNITION KIT

"Sparkrite MK 2" is a high performance, high quality, capacitive discharge, electronic ignition system. Sparkrite completely eliminates problems of the contact breaker. Misfire due to contact breaker bounce is electronically eliminated, contact breaker burn is eliminated, the condition of the contacts is not relevant to the performance of the ignition, and the system is no longer dependant on the dwell period for recharging.

Sparkrite will give you: Up to 20% better fuel consumption, instant all weather starting, cleaner plugs, faster acceleration, higher top speed, longer coil and battery life, efficient fuel burning and less air pollution, smoother running, continual peak performance.

The Kit comprises everything needed. Already drilled and guaranteed components and parts.

Prices: D.J.V. assembly kit £10.93\*. Ready built unit £13.86\*. (Both to fit all vehicles with coil/distributor ignition up to 8 cylinders.) Switch for instant changeover from "Sparkrite" ignition to conventional ignition £2.79\*. R.P.M. limiting control £2.42\*. Details of more specialised units on request.

CALL IN AND SEE US FOR A DEMONSTRATION.



## ORDER NOW

TO Electronics Design Associates Dept  
82 Bath Street, Walsall, WS1 3DE.  
Phone 33652.

FROM Name

Address

QTY

Please Supply  
SPARKRITE MK 2 DIY Assembly kits  
@ £10.93  
SPARKRITE MK 2 Ready Built  
Negative earth @ £13.86  
SPARKRITE MK 2 Ready Built  
Positive earth @ £13.86  
Ignition changeover switches @ £2.79  
R.P.M. Limit systems in the above  
units @ £2.42  
Fluorescent light assembly kits  
@ £3.19  
Fluorescent light built units @ £3.78  
Diffusers for the above @ 59p  
of number alum. boxes @  
of number alum. boxes @  
of number alum. boxes @

I enclose cheque/P.O.s for £.....

Cheque No. ....  
(Send SAE if brochure only required)

## ELECTRONICS DESIGN ASSOCIATES of WALSALL

### ALUMINIUM BOXES

Prices include lids, screws and V.A.T. (@ 8%). Add 18p to the total order value for postage and packing.

No. 7	5 1/2"	2 1/2"	x 1 1/2"	high	47p
No. 8	4"	4"	x 1 1/2"	high	48p
No. 9	4"	2 1/2"	x 1 1/2"	high	46p
No. 10	5 1/2"	4"	x 1 1/2"	high	49p
No. 11	4"	2 1/2"	x 2"	high	46p
No. 12	3"	2 1/2"	x 1"	high	38p
No. 13	6"	4"	x 2"	high	58p
No. 14	7"	5"	x 2 1/2"	high	75p
No. 15	8"	6"	x 3"	high	93p
No. 16	10"	7"	x 3"	high	£1.14

### FLOURESCENT LIGHT KIT

You can build this reverse polarity protected 12v, 8 w. fluorescent light. Everything needed is supplied: white enamelled ready drilled metalwork, ready drilled heatsink, printed circuit board, high quality components and transformer, end caps, cable, the fluorescent tube, nuts bolts washers, and simple assembly and operating instructions. Prices: Assembly kit £3.19\*. Ready built £3.78\*. Diffuser £59p.  
\*inc. V.A.T. p. and p.



4 1/2 in x 3 1/2 in METER. 30µA.  
50µA or 100µA, £3.85. P. & P. 11p.

TAPE  
RECORDER  
LEVEL  
METER

500µA. 70p  
P. & P. 5p.

CARDIOID  
DYNAMIC  
MICROPHONE

Model UD-130. Frequency response 50-15,000c/s. Impedance Dual 50K and 600 ohms.  
£6.55. P. & P. 11p.

42 x 42mm METERS 100µA,  
500µA, 1mA, 500mA £2.76, 11p  
P. & P.

60 x 45mm METERS 50µA,  
100µA, 500µA and 1mA VU  
METER £2.92, 11p P. & P.

EDGEWISE METERS, 90mm x  
34mm, 1mA £3.40, 11p P. & P.

MULTI-  
METER

Model D62  
20,000 ohm/  
volt, £7.65.  
P. & P. 15p.

3 WATT STEREO  
AMPLIFIER

£4.30. P. & P. 10p.

All above prices include 8% V.A.T. LARGE S.A.E. for List No. 11.  
Special prices for quantity quoted on request.

M. DZIUBAS

168 Bradshawgate · Bolton · Lancs. BL2 1BA

## YOUR CAREER in RADIO & ELECTRONICS ?

Big opportunities and big money await the qualified man in every field of Electronics today—both in the U.K. and throughout the world. We offer the finest home study training for all subjects in radio, television, etc., especially for the CITY & GUILDS EXAMS (Technicians' Certificates); the Grad. Brit. I.E.R. Exam.; the RADIO AMATEUR'S LICENCE; P.M.G. Certificates; the R.T.E.B. Servicing Certificates; etc. Also courses in Television; Transistors; Radar; Computers; Servo-mechanisms; Mathematics and Practical Transistor Radio course with equipment. We have OVER 20 YEARS' experience in teaching radio subjects and an unbroken record of exam. successes. We are the only privately run British home study College specialising in electronics subjects only. Fulllest details will be gladly sent without any obligation.

To: British National Radio & Electronics School, Dept E.E.C. 35  
P.O. Box 156, Jersey, C.I.

Please send FREE BROCHURE to

NAME ..... Block

ADDRESS ..... Caps.

..... Please

BRITISH NATIONAL RADIO  
AND ELECTRONICS SCHOOL

# Now Radionic solves your quest for further knowledge about practical electronics

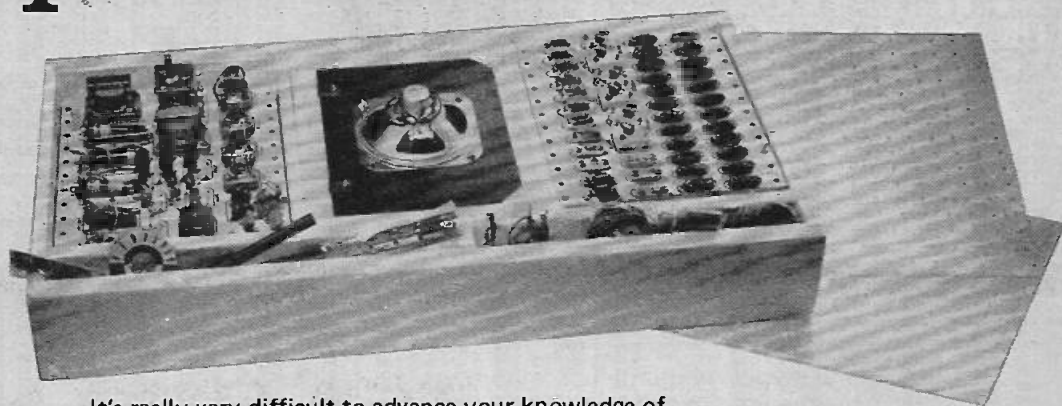

It's really very difficult to advance your knowledge of practical electronics once you've mastered the basics isn't it? So many so-called straightforward kits prove to be highly complex when you examine them closely — indeed, they often cause difficulties even for the 'professional'. Others are so basic that they simply don't contribute anything to your practical knowledge whatsoever.

You'll be interested to know that Radionic have devised a practical and educational — yet sophisticated — electronic kit which provides an ideal method of furthering electronic knowledge for those who wish to re-inforce their basic ability. This special kit — called the Radio and Electronic Kit No. 4 — comes with a detailed 148-page handbook containing theoretical and practical diagrams for all the circuits together with full descriptions of their functions and a variety of other useful technical information. And each kit contains all the components needed to assemble twenty-three radio circuits and seventeen additional electronic circuits.

If you want to make more headway with your knowledge of electronics the Radionic Kit No. 4 is tailor-made for you. Take the first step straightaway by clipping the coupon and mailing it to us today.

## RADIONIC PRODUCTS LIMITED

Registered Office:  
St. Lawrence House,  
29-31 Broad Street,  
Bristol BS1 2HF.

I would like to advance my knowledge of practical electronics. Please send me the leaflet describing the No. 4 Kit.

Name.....

Address.....

EE375



**RADIONIC PRODUCTS LIMITED**  
Registered Office:  
St. Lawrence House, 29-31 Broad Street,  
Bristol BS1 2HF.









# BI-PRE-PAK

Bargains in Semi-Conductors, components, modules & equipment.

## Bargains from our FREE Catalogue

20 large pages, filled with real bargains in transistors, I.C.s, components, equipment, etc. Send large S.A.E. with 6p stamp for your FREE copy of 6th Edition by return. Meanwhile, for prompt delivery order from this month's ad. NOW.

### BPP TRANSISTOR PACKS ALL AT 50p EACH TESTED & GUARANTEED

<b>B78</b>	<b>4</b>	IN4007 Sil. Rec. diodes. 1,000PIV 1 amp. plastic	<b>H39</b>	<b>6</b>	Integrated circuits 4 gates BMC 982, 2 flip flops BMC 945 BD131/BD132
<b>B81</b>	<b>10</b>	Reed Switches, 1" long 1/4" dia. High-speed P.O. type	<b>H41</b>	<b>2</b>	Complementary Plastic Transistors
<b>H35</b>	<b>100</b>	Mixed Diodes, Germ. Gold bonded, etc. Marked and Unmarked	<b>H65</b>	<b>4</b>	40361 Type NPN Sil. Transistors TO-5 can comp. to H65
<b>H38</b>	<b>30</b>	Short lead Transistors, NPN Silicon Planar types	<b>H66</b>	<b>4</b>	40382 Type PNP Sil. Transistors TO-5 can comp. to H65

### UNMARKED & UNTESTED

<b>B1</b>	<b>50</b>	Germanium Transistors PNP, AF and RF	<b>B86</b>	<b>100</b>	Sil. Diodes sub. min. IN914 and IN918 types
<b>B66</b>	<b>150</b>	Germanium Diodes Min. glass type	<b>H20</b>	<b>20</b>	BY126/7 Type Silicon Rectifiers 1 amp. plastic. Mixed volts
<b>B83</b>	<b>200</b>	Transistors, manufacturers' rejects. AF, RF, Sil. and Germ.	<b>H34</b>	<b>15</b>	Power Transistors, PNP. Germ. NPN Silicon TO-3 Can
<b>B84</b>	<b>100</b>	Silicon Diodes DO-7 glass equiv. to OA200, OA202	<b>H67</b>	<b>10</b>	3819N Channel FET's plastic case type

### PLASTIC POWER TRANSISTORS—2 ranges

In NPN or PNP at shattering low prices sold to you under our Tested and Guaranteed terms.  
Range 1. VCE Min 15. HFE Min 15 Range 2. VCE Min. 40. HFE Min 40  
1-12 13-25 26-50 1-12 13-25 26-50  
40 Watt 26p 18p 15p 40 Watt 30p 25p 25p  
90 Watt 24p 22p 20p 90 Watt 35p 33p 30p  
Please state NPN or PNP on order.

### NEW X-HATCH GENERATOR Mk.2



Essential for Colour T.V. alignment of 4 patterns. Featuring plug in IC's and a more sensitive sync. pick-up circuit. The case is virtually unbreakable—ideal for the engineer's toolbox—only measures 3" x 5 1/2" x 3". Operates from 3 U.2 type batteries (extra).

Complete kit **£7-93** Ready built unit only **£9-93**

### OVER 1,000,000 TRANSISTORS

of all most needed types in stocks including power, diode, rectifier, etc., etc., marked, tested and guaranteed. Hundreds of worthwhile bargains will be found in our FREE CATALOGUE (6th edition). Also Zener diodes, I.C.s, etc.

### SUNDRY

Metrication Pocket Charts 12p. 8 assorted relays £1-00. Rev. counter device (for cars) £1-00. U.H.F./TV Tuner Units £2-50. L.M.380 Audio I.C. £1-00 and technical books of all kinds.

### TERMS OF BUSINESS

V.A.T. Prices shown do not include V.A.T. Please add 8% to total value of your order including postage. No. V.A.T. on overseas orders.

POSTAGE Except where stated, add 15p for postage & packing in U.K. Overseas—add £1, any difference being charged or refunded.

PAYMENT Cash with order, Cheque or money order. Minimum value—50p. You can also pay by ACCESS.

IMPORTANT—Every effort is made to ensure accuracy of prices and description at time of preparing this advertisement and going to press. Prices are subject to alteration without notice.

## BI-PRE-PAK LTD

Ch. Reg. 1401209/19

222 224 WEST ROAD, WESTCLIFF-ON-SEA, ESSEX SS0 9DF.

TELEPHONE: SOUTHEND (0702) 46344.

WRITE ORDER SEPARATELY AND ATTACH COUPON IF REQUIRED



challenging values!

## Stirling Sound

STIRLING SOUND AUDIO MODULES come to you as basic units assembled on P.C.B.s enabling you to add required components in layouts of your own choice. Modules are tested and boxed before despatched and include well printed instructions.

### AMPLIFIER MODULES

Pre-amplifiers; tone control  
**SS.100** Active tone control unit to provide bass, treble, balance and volume controls **£1-60**  
**SS.101** Pre-amp for ceramic cartridge, tape and radio **£1-60**  
**SS.102** Pre-amp for low output magnetic cartridge, tape and radio. With R.I.A.A. correction  $\pm 1$ dB at 1K **£2-25**

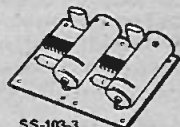

SS-103-3

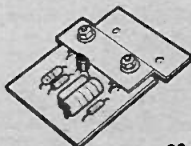

SS-105

### POWER AMPLIFIERS

**SS.103** Compact I.C. amp. with 3 watts R.M.S. output. Operating voltage 6 to 22. Size 3" x 2" **£1-75**  
**SS.103-3** Stereo version of above using one I.C. on each channel **£3-25**  
**SS.106** A compact and useful all-purpose amplifier which will run excellently on a 12V supply. With 5 watt output, two make a good stereo amp. Size 3 1/2" x 1 1/2" **£1-95**  
**SS.110** Similar in size to SS.103 but with a 10 watt output. Ideal for many domestic and small-size P.A. applications. Operates from 26 to 32V. **£2-40**  
**SS.140** Excellently designed 40 watt R.M.S. (Into 4 ohms) hi-fi amplifier. S/N ratio better than 75dB. THD better than 0.2%. Power requirements—45V. d.c. With 0.15" centre edge connections. Two can be bridged to give 80 watts R.M.S. into 4 ohms **£3-60**

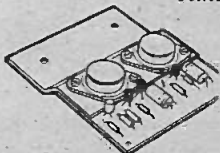

SS-140

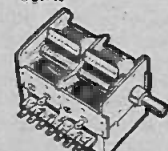

SS-201

### TUNER MODULES

**SS.201** Ganged tuning condenser with accurately engineered slow-motion drive in rugged housing. Excellent sensitivity. Tunes 88-108MHz. With A.F.C. facility. Operates from 6V—16V **£4-25**  
**SS.202** I.F. stage (with I.C.) Pre-tuned. A.F.C. connection. Operates from 4.5 to 14V **£5-25**  
**SS.203** Stereo Decoder. Designed essentially for use with SS.201 and 2. This module can also be used in most mono FM tuners. A LED may be attached. Operating voltage 9-16V. d.c. **£5-62**

### POWER SUPPLY STABILIZER

**SS.300** Add this to an unregulated supply (say typically 45V output) to obtain a steady powerful working output adjustable from 12 to 60V. Essential to your audio and special systems. Money saving and very reliable **£3-25**

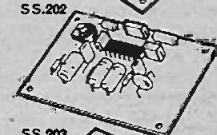

SS-202

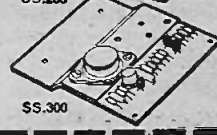

SS-300

### ● ALL MODULES TESTED AND GUARANTEED

### ● WITH WELL PRINTED INSTRUCTIONS

### ● FULL RANGES OF ANCILLARY COMPONENTS AVAILABLE—SEE CATALOGUE

To BI-PRE-PAK, 222-224 WEST RD., WESTCLIFF-ON-SEA, ESSEX

Please send .....

for which I enclose ..... Inc. V.A.T.

Name .....

Address .....

EE 3

# NEW LOW PRICES!

## Sinclair Scientific kit

(Was £19.95 - save £5!)

**£14.95**

(INC. VAT)

### Britain's most original calculator now in kit form

The Sinclair Scientific is an altogether remarkable calculator.

It offers logs, trig, and true scientific notation over a 200-decade range — features normally found only on calculators costing around £100 or more.

Yet even ready-built, the Sinclair Scientific costs a mere £21.55 (including VAT).

And as a kit it costs under £15!

### Forget slide rules and four-figure tables!

With the functions available on the Scientific keyboard, you can handle directly

sin and arcsin,  
cos and arccos,  
tan and arctan,  
automatic squaring and doubling,  
 $\log_{10}$ ,  $\text{anti}\log_{10}$ , giving quick access to  $x^y$  (including square and other roots).

plus, of course, addition, subtraction, multiplication, division, and any calculations based on them.

In fact, virtually all complex scientific or mathematical calculations can be handled with ease.

### So is the Scientific difficult to assemble?

No. Powerful though it is, the Sinclair Scientific is a model of tidy engineering.

All parts are supplied — all you need provide is a soldering iron and a pair of cutters. Complete step-by-step instructions are provided, and our Service Department will back you throughout if you've any queries or problems.

Of course, we'll happily supply the Scientific or the Cambridge already built, if you prefer — they're still exceptional value. Use the order form.

### Components for Scientific Kit (illustrated)

1. Coil
2. LSI chip
3. Interface chips
4. Case mouldings, with buttons, windows and light-up display in position
5. Printed circuit board
6. Keyboard panel
7. Electronic components pack (diodes, resistors, capacitors, etc)
8. Battery assembly and on/off switch
9. Soft carrying wallet
10. Comprehensive instructions for use

Assembly time is about 3 hours.

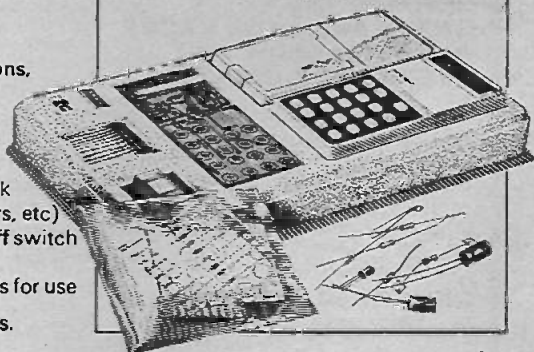

## Features of the Sinclair Scientific

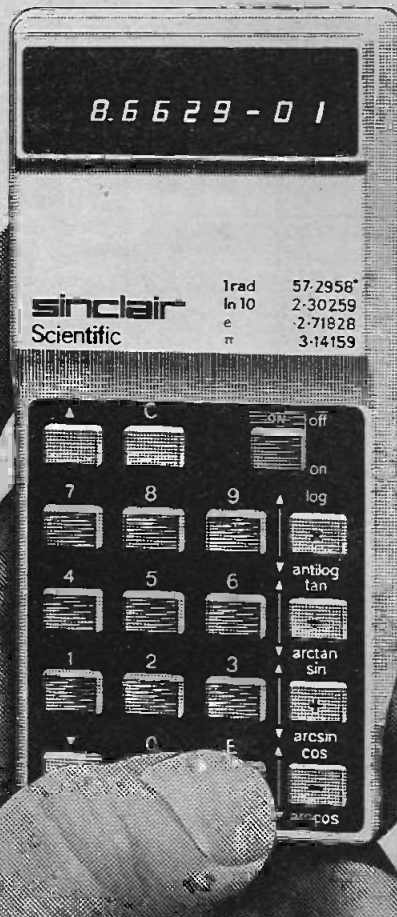

● 12 functions on simple keyboard  
Basic logs and trig functions (and their inverses), all from a keyboard as simple as a normal arithmetic calculator's. 'Upper and lower case' operation means basic arithmetic keys each have two extra functions.

● Scientific notation  
Display shows 5-digit mantissa, 2-digit exponent, both signable.

● 200-decade range  
 $10^{-99}$  to  $10^{+99}$ .

● Reverse Polish logic  
Post-fixed operators allow chain calculations of unlimited length — eliminate need for an = button.

● 25-hour battery life  
4 AAA manganese alkaline batteries (e.g. MN2400) give 25 hours continuous use. Complete independence from external power.

● Genuinely pocketable  
 $4\frac{1}{3}'' \times 2'' \times 1\frac{1}{16}''$ .  
Weight 4 oz. Attractively styled in grey, blue and white.

# NEW LOW PRICES!

## Sinclair Cambridge kit

(Was £14.95—save £5!)

Now only  
**£9.95**  
(INC. VAT)

At its new low price, the original Sinclair Cambridge kit remains unbeatable value.

In less than a year, the Cambridge has become Britain's most popular pocket calculator.

It's not surprising. Check the features below — then ask yourself what other pocket calculator offers such a powerful package at such a reasonable price.

### Components for Cambridge Kit

1. Coil
2. LSI chip
3. Interface chip
4. Thick film resistor pack
5. Case mouldings, with buttons, window and light-up display in position
6. Printed circuit board
7. Keyboard panel
8. Electronic components pack (diodes, resistors, capacitors, transistor)
9. Battery clips and on/off switch
10. Soft wallet

Assembly time is about 3 hours.

### Take advantage of this

**money-back, no-risk offer today**

The Sinclair Cambridge and Scientific kits are fully guaranteed. Return either kit within 10 days, and we'll refund your money without question.

All parts are tested and checked before despatch — and we guarantee any correctly-assembled calculator for one year. (This guarantee also applies to calculators supplied in built form.)

Simply fill in the preferential order form below and slip it in the post today.

### Scientific

Price in kit form £14.95 inc. VAT

Price built £21.55 inc. VAT.

### Cambridge

Price in kit form £9.95 inc. VAT.

Price built £13.99 inc. VAT.

## Features of the Sinclair Cambridge



- Uniquely handy package. 4 1/3" x 2" x 1 1/16", weight 3 1/2 oz.
- Standard keyboard. All you need for complex calculations.
- Clear-last-entry feature.
- Fully-floating decimal point.
- Algebraic logic.
- Four operators (+, -, x, ÷), with constant on all four.
- Powerful constant with separate 'K' button.
- Constant and algebraic logic combine to act as a limited memory, allowing complex calculations on a calculator costing less than £10.
- Calculates to 8 significant digits.
- Clear, bright 8-digit display.
- Operates for weeks on four AAA batteries.

To: Sinclair Radionics Ltd,  
FREEPOST St Ives,  
Huntingdon, Cambs. PE17 4BR

Please send me

- Sinclair Scientific kit at £14.95  
 Sinclair Scientific built at £21.55  
 Sinclair Cambridge kit at £9.95  
 Sinclair Cambridge built at £13.99

All prices include 8% VAT.

\*I enclose a cheque for £.....  
made out to Sinclair Radionics Ltd,  
and crossed.

\*Please debit my \*Barclaycard/  
Access account. Account number

--	--	--	--	--	--	--	--	--	--	--	--

\*Delete as required.

Signed

Name

Address

E.E. 3/75.

Please print. FREEPOST — no stamp  
needed.

# sinclair

Sinclair Radionics Ltd,  
FREEPOST St. Ives,  
Huntingdon, Cambs. PE17 4BR.

Reg. No: 699483 England. VAT Reg. No: 213 8170 88.

# everyday electronics

PROJECTS  
THEORY....

## STRICTLY FOR THE BROWSERS

What sparks off a personal interest in a subject? A chance remark overheard, a casual glance at an item in a newspaper or book, perhaps something in a radio or television programme? Certainly these are some of the seemingly insignificant incidents by which "doors are opened" and subjects first revealed in a new and unsuspected light.

As we all are well aware, some new-found interests prove but passing fancies and are abandoned after a brief courtship. But others hold their attraction indefinitely and may, indeed, have profound influence on the pattern of a person's life.

It is true that after some time spent enjoying a favourite pursuit its original selection probably seems all too obvious and natural. Yet, upon looking back, it all may have started with a chance encounter, of one sort or another. An encounter made, possibly, when browsing through magazines in a newsagent's or bookstore.

Just browsing—perhaps this is what you are doing right now. If so, it's an even bet of course that electronics is not really *your* scene, and you are about to pass on to other pastures. But do stay awhile. Who knows, this may be the big opportunity you've been looking for.

We don't claim that we will necessarily change your way of life (though that's a possibility) but we will show you how to put some of your spare time to profitable use.

Not that monetary gain is the only or the most important reward we offer. There is fun to be enjoyed in the process of building electronic circuits. Sometimes there is fun to be derived from the end product itself—games and musical instruments, for example. In any event there is the sheer satisfaction to be obtained from creating something worthwhile with one's own hands.

But, you know absolutely *nothing* of electronics? Don't worry on that account. EVERYDAY ELECTRONICS makes the learning of both theory and practice an enjoyable entertainment. Why not give it a whirl?

*Fred Bennett*

Our April issue will be published on Friday, March 21

EDITOR F. E. Bennett • ASSISTANT EDITOR M. Kenward • TECHNICAL EDITOR B. W. Terrell B.Sc.  
ART EDITOR J. D. Pountney • P. A. Loates • K. A. Woodruff  
ADVERTISEMENT MANAGER D. W. B. Tilleard

© IPC Magazines Limited 1975. Copyright in all drawings, photographs, and articles published in EVERYDAY ELECTRONICS is fully protected, and reproduction or imitations in whole or part are expressly forbidden.

All reasonable precautions are taken by EVERYDAY ELECTRONICS to ensure that the advice and data given to readers are reliable. We cannot, however, guarantee it, and we cannot accept legal responsibility for it. Prices quoted are those current as we go to press. Everyday Electronics Fleetway House, Farringdon Street, London, E.C.4. Phone: Editorial 01-634-4452; Advertisements 01-634-4202.

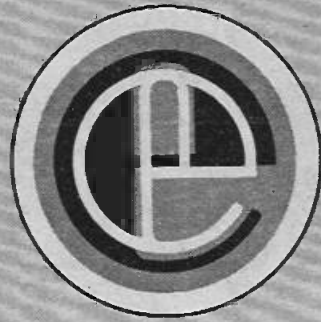

# EASY TO CONSTRUCT SIMPLY EXPLAINED

VOL. 4 NO. 3

MARCH 1975

**FREE INSIDE CONSTRUCTION TECHNIQUES** Wall Chart

## CONSTRUCTIONAL PROJECTS

<b>SOIL MOISTURE ALARM</b> Indicates soil moisture at root depth by R. A. Penfold	124
<b>MODULA 3 STEREO AMPLIFIER</b> Part 2 A hifi amplifier by Mike Kenward	128
<b>AMATEUR SHORT WAVE RECEIVER</b> For amateur and many other transmissions by F. G. Royer	138
<b>FUZZ BOX</b> Sound effect for electronic instruments and guitars by C. F. Terrell	148

## GENERAL FEATURES

<b>EDITORIAL</b>	122
<b>COUNTER INTELLIGENCE</b> A retailer comments by Paul Young	126
<b>PHYSICS IS FUN</b> Faraday's Ice Pail Experiment by Derrick Daines	127
<b>SHOP TALK</b> Component buying for constructional projects by Mike Kenward	134
<b>BEGIN HERE—4</b> Testing and Construction Techniques by Donald Maynard	135
<b>RUMINATIONS</b> by Sensor	137
<b>QUAD</b> And Other Multichannel Systems. Part 2 by Adrian Hope	144
<b>PLEASE TAKE NOTE</b>	147
<b>HELP!</b> Some questions answered	152
<b>PROFESSOR ERNEST EVERSURE</b> The Extraordinary Experiments of. by Anthony J. Bassett	153
<b>DOWN TO EARTH</b> Capacitors by George Hylton	159
<b>READERS' LETTERS</b> From you to us	160

Publisher's Annual Subscription Rate, including postage Inland £3.55, Overseas £3.60, USA/Canada \$10. International Giro facilities Account No. 5122007. State reason for payment "message to payee". Address to Everyday Electronics, Subscription Department, Carlton House, Great Queen Street, London, WC2E 9PR. Binders for volumes 1 to 4 (state which) and indexes for volume 1 and 2 available for £1.25 and 30p respectively, including postage, from Binding Department, at the above address.

We are unable to supply back copies of Everyday Electronics or reprints of articles and cannot undertake to answer readers' letters requesting designs, modifications or information on commercial equipment or subjects not published by us. An s.a.e. should be enclosed for a personal reply. Letters concerning published articles should be addressed to: The Editor, those concerning advertisements to: The Advertisement Manager, both at the address shown opposite.

## DON'T MISS OUT!

Starting next month—two new series

- ★ CAREERS IN ELECTRONICS
- ★ WORKSHOP PRACTICE

See page 143 for more details

# SOIL MOISTURE ALARM

By R.A. PENFOLD

Gives an electronic indication when your plants need water.

**M**ANY types of potted plants are easily harmed by either an excess or a deficiency of moisture in the soil. It is not always easy, or even possible to determine by examination of the surface of the soil, whether the soil around the roots of the plant has the correct moisture content, and the first sign that it does not may well be a wilting or dying plant.

A device which enables some indication of the soil moisture at root depth to be obtained would obviously be a great help in such circumstances. Such devices can be obtained commercially, but it is a simple matter to construct ones own soil moisture indicator, and at a very low cost compared with a commercial unit. The operation and construction of such a device forms the subject of this article.

## CIRCUIT OPERATION

A circuit diagram of the soil moisture indicator is shown in Fig. 1. The operation of the device relies on the fact that the resistance of soil varies according to its moisture content, the more moist the soil, the less its resistance. There are of course other factors governing the resistance between two probes in a sample of soil, but for all practical purposes these can be ignored here.

Referring to Fig. 1, TR1 is operated as an emitter follower, and it has R2 and D1 as its emitter load; D1 is a light emitting diode (l.e.d.), and is protected against excesses of voltage and current by the inclusion of R2. The probes are connected between the base and collector of TR1, and when these are placed in a sample of soil, the soil resistance will supply TR1 with a small base current. This will cause a much larger current to flow in the emitter circuit of TR1, and through the l.e.d.

The amount of emitter current that flows, and therefore the intensity of the light from the l.e.d., is dependent upon the resistance of the soil, which is in turn dependent upon its moisture content. The greater the moisture con-

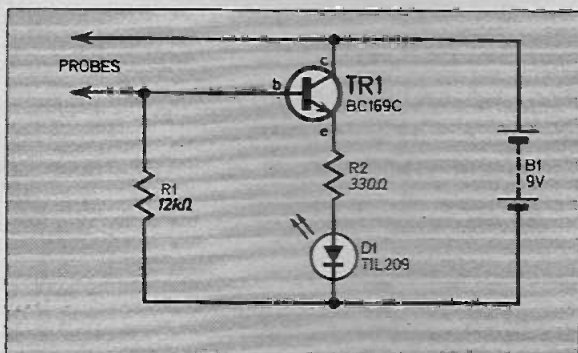

Fig. 1. The complete circuit diagram of the Soil Moisture Alarm.

tent of the soil, the greater will be the light emission from the l.e.d.

Thus an idea of the wetness of the soil between the two probes can be judged from the intensity of the light emission from D1, ranging from very dry soil when it fails to, or only just lights up, to very wet soil when it is very brightly illuminated.

No on/off switch is required since when the unit is not in use, only minute leakage currents can flow through TR1, and these are too low to be of significance. Resistor R1 is necessary in order to reduce the input impedance and sensitivity of the device to a suitable level for its intended purpose.

FOR  
GUIDANCE  
ONLY

ESTIMATED COST\*  
OF COMPONENTS  
including V.A.T.

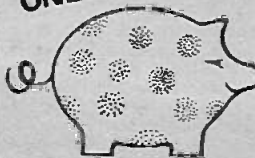

£0.70

excluding case

\*Based on prices prevailing at  
time of going to press

## PROBES

Construction of the probes is illustrated in Fig. 2. These should not be completely separate, but must be contained as a single unit so that they are held apart at a more or less constant distance.

The probes are very simple and as can be seen, they merely consist of two lengths of 14 s.w.g. tinned copper wire contained in two lengths of p.v.c. sleeving. These are glued to a wooden grip which has two grooves cut lengthwise down opposite sides (one each side) into which the probes are slotted. Insulated leads are then connected to the probes, and the unit is finished by winding a couple of layers of p.v.c. insulation tape around the grip.

To improve the appearance of the probe assembly, it can be mounted in an empty film can as shown on the front cover.

It is important that only about 3mm of the wire at the tip of each probe is left exposed, as otherwise the correct sensitivity will not be obtained. The probes can be made more substantial if suitable materials are to hand, but the exposed area at the tip of each probe must be kept about the same as on the originals, and for obvious reasons the probes must be reasonably thin.

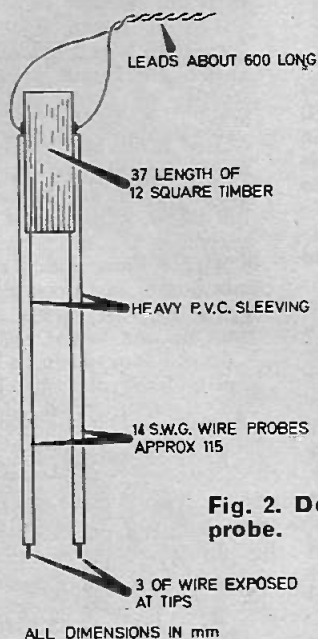

Fig. 2. Details of the probe.

## COMPONENT PANEL

The components are all mounted on a small Veroboard panel which can be either 0.1 inch or 0.15 inch matrix, measuring 5 holes by 9 strips. This is shown diagrammatically in Fig. 3. There are no breaks in the copper strips.

Solder the two resistors and the probe and battery clip leads into position first, and then TR1 and the l.e.d. using a heatsunt on their leads to prevent damage through overheating.

Everyday Electronics, March 1975

## Components....

### Resistors

R1 12 k $\Omega$   
R2 330 $\Omega$   
Both  $\frac{1}{4}$  W  $\pm$  10% carbon

SEE

**SHOP  
TALK**

### Semiconductors

TR1 BC169C silicon npn  
D1 TIL209 l.e.d. or similar with panel holder

### Miscellaneous

B1 9V PP3 battery and connector. Veroboard 5 holes by 9 strips 0.1 or 0.15 inch matrix, 14 s.w.g. copper wire and sleeving for probes (see text), small case, grommet, connecting wire, wood and insulation tape for probes (see text).

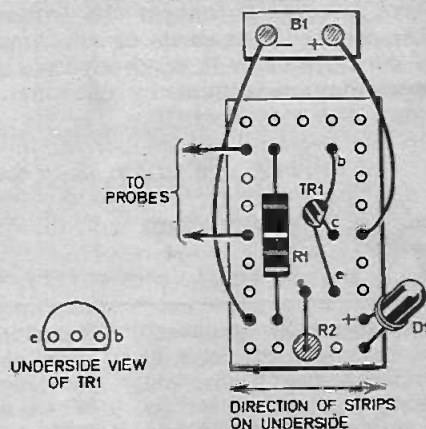
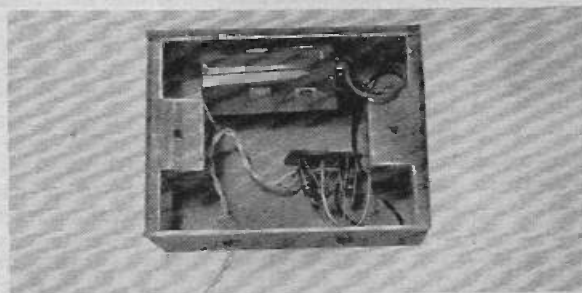

Fig. 3. The layout of the components on the Veroboard.



Photograph of the prototype unit assembled in home made case.

## CASE

Any small case can be used as a suitable housing for the unit. The author used a simple home made aluminium/plywood case measuring approx. 90x60x35 mm. There are available several commercially suitable cases of about this size. As can be seen from the photographs, the front panel is drilled with two holes, the one on the right being for D1, which is mounted in a plastic holder, the other is fitted with a

small grommet and the leads from the probes are taken to the inside of the case through this. A knot is tied in these leads on the inside of the case, and then they are connected to the Veroboard component panel.

If D1 is now pushed into its holder it will be found that as the component panel is so small it will need no further mounting, and will be adequately supported by the leadouts of D1. The case for the prototype was designed such that no battery mounting bracket was required, but should one be found necessary it can be easily fabricated from a piece of thin aluminium sheet.

## TESTING

Before connecting a battery, check the wiring, paying particular attention to the connections to the transistor and the l.e.d. Once satisfied that the wiring is correct, connect the battery and insert the probes into a series of soil samples of varying moisture content, to check that the device is operating correctly.

In the unlikely event that the sensitivity of the unit needs some slight adjustment, this can be achieved by very slightly shortening the metal tips of the probes to reduce sensitivity, or removing a small amount of the p.v.c. sleeving from the tips of the probes to increase sensitivity. □



## ...Counter Intelligence

BY PAUL YOUNG

*A retailer discusses component supply matters.*

I AM sure that none of us will deny that inflation hits all things including our hobby, and consequently the cost of our requirements goes up and up and if our expenditure is fixed, we will get less and less for our money. In this respect electronics as a hobby suffers no worse than other hobbies, in some ways it actually comes off better. You have always the chance to hunt round and find bargains that are denied to others.

Let us examine the possibilities of saving pennies. For a start, why not pal up with one of your local radio and television dealers. When you know him well enough ask if he has any old chassis he wants to dispose of, either television, radio or amplifiers. My guess is, he will be glad for you to take them away. Now, you can spend an evening stripping one of them down, cleaning the solder off the ends of the wires and sorting out the resistors, various capacitors, pots and (if you are lucky) transformers and speakers.

Your next job will be to check each one for value, and to see it is not faulty. For this you will need a reasonably good multi-meter, preferably one that reads voltage and current both a.c. and

d.c. It should also, ideally have a wide ohms coverage. A small resistance/capacity bridge would be an advantage, and a simple transistor checker. Circuits to build these last two have appeared in EVERYDAY and PRACTICAL ELECTRONICS from time to time.

When you have checked your salvaged parts, mark them. In the case of the small things (resistors and capacitors), if they are not already marked or colour coded, bag them up with a label enclosed, giving the required information. When this is all done, put them away in your storage boxes ready for use when required. In this way, you should be able to save money, to buy the specialised things, that will not be found on the "junk heap". There are of course other sources of supply of bargains.

There are shops that sell Government and manufacturers' surplus, but these are becoming harder to find, because the sources of supply are diminishing, but they are worth searching for. In London, we have several streets which are still worth exploring, Lisle Street, Tottenham Court Road, Edgware Road, New Oxford Street. Lisle Street is

probably still the best of them.

If any readers think inflation is a new phenomena or started with the Weimar Republic let me enlighten them. Even Emperor Diocletian was troubled with it in AD300. He found prices rose so steeply he could not equip his army. Although he himself caused it all, by debasing the currency, he blamed the poor old shopkeepers, and issued a list of 700 items, stating that if anyone exceeded the price he had laid down for these goods, the penalty was death. But even that did not work. Lots of heads rolled and then no one would sell anything.

So if I look down in the dumps and you ask me why, I shall say "I've got a touch of the Diocletians"



"This computer I made has a fantastic memory storage capacity—trouble is, I can't remember how to get the darned thing started!"



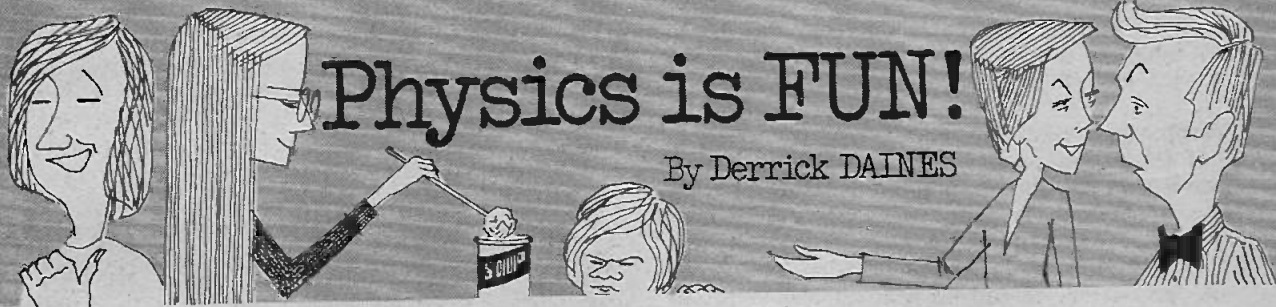

# Physics is FUN!

By Derrick DAINES

## FARADAY'S ICE-PAIL EXPERIMENT

**T**HIS experiment is so-called because Faraday, who first thought of it, was in the Royal Institute at the time and looking around for a suitable container; he found an ice-pail.

The experiment arises from the previous experiments with a static charge on a plastic film; if we form the film into a bucket-shape, can we hold more charge in it, as water in a bucket?

First make a proof-sphere by taking aluminium foil and forming it into a hollow ball. Glue it carefully onto an insulating handle such as a plastic or wooden rod. It is now ready for use and can be tested by transferring charge from a charged plastic film to the electroscope.

All that needs to be done is to touch the charged film lightly with the proof-sphere and transfer it to the wire point of the electroscope. Between transfers, lightly touch an earthed object such as a water tap, to discharge the sphere completely. see Fig. 1.

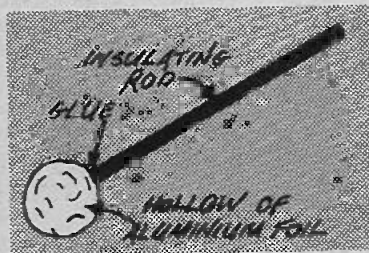

Fig. 1. Details of the proof-sphere.

Now obtain any empty tin, such as a soup tin, clean it well and remove any sharp edges for safety's sake. To "fill" the tin with charge, stand it on an insulating plastic film, then rub another film with wool and stroke the top of the tin several times with the charged film.

If we like, we can imagine

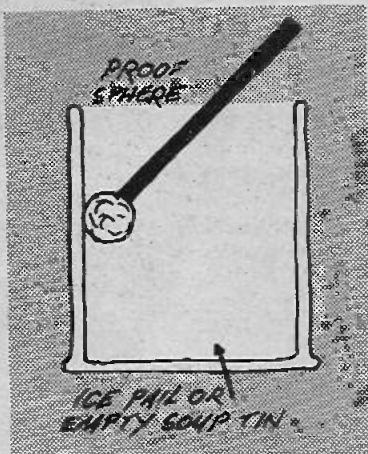

Fig. 2. The experiment with the proof-sphere and charged empty tin.

charge being scraped off the film into the tin. Repeat the process several times, then check with the proof-sphere.

A surprise awaits us—the inside of the tin contains no charge at all! (see Fig. 2). On the other hand, the outside of the tin is found to hold a static charge!

Charge is distributed over the surface of a conductor

Try collecting the charge from the top edge of the tin and you will find that it is stronger here than anywhere else. You may have found that sometimes your electroscope leaves have remained deflected even after the applied charge has been removed—it is as if the point had absorbed charge and indeed, the phenomenon is called the absorption effect of a point.

Faraday's ice-pail experiment shows that edges and points collect the charge more readily than flat surfaces. It also shows why lightning strikes the point of a lightning conductor and also illustrates why all experi-

ments and equipment that utilise static electricity must avoid sharp edges and points, since a concentration of charge is more easily lost into the air.

It will have occurred to some readers that there might be some connection between Faraday's ice-pail experiment and the capacitor, which for some purposes might be likened to a "bucket" capable of storing electric charge. There is more than a passing connection and the unit of charge which we use, the Farad, is named after Faraday.

Originally the charge unit was a centimetre, implying the total charge that could be contained on the surface of a metal sphere, one centimetre radius, but the unit was changed in Faraday's honour and to prevent confusion. For most purposes, a charge of one Farad is far too big, so we use the fractional units of microfarad ( $1\mu\text{F}$ ) and picofarad ( $1\text{pF}$ ).

1 million pF =  $1\mu\text{F}$   
1 million  $\mu\text{F}$  = 1 Farad

Next month we will make our own capacitors and conduct some experiments with them.

The photograph below shows various types of commercial capacitors—our home-made one will do exactly the same job.

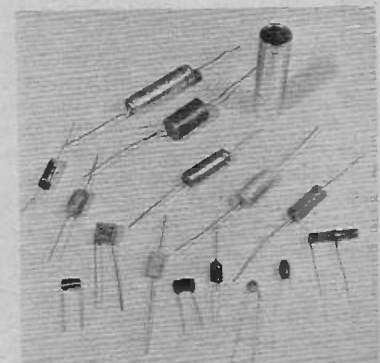

A selection of some commercially available capacitors.

# modula 3

## STEREO AMPLIFIER

By MIKE KENWARD

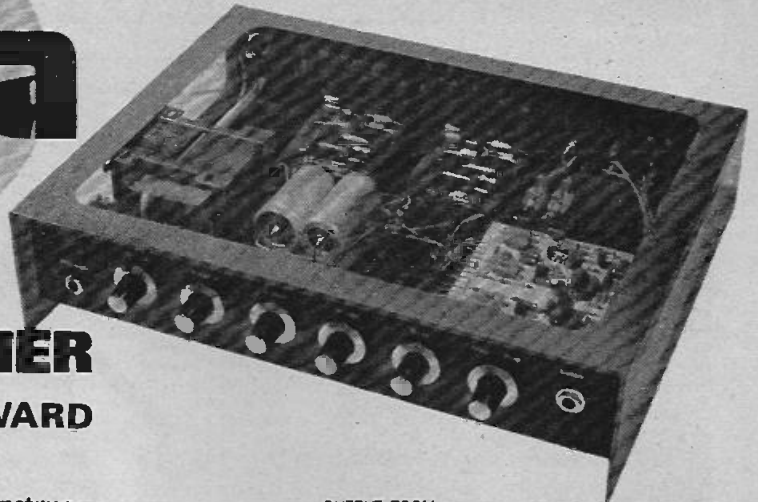

HAVING completed the mechanical construction of the amplifier—excepting the case which is detailed later—we now come to the actual wiring up of all the parts.

### COMPONENT BOARDS

The first task is to complete the two identical Veroboards which hold the components for the power amplifier equalisation. One board layout and wiring is shown in Fig. 9, two are required.

Commence by cutting the boards to size, cutting the breaks in the copper strips and cleaning up the edges. Next mount all the components except IC1, IC101 and check their positions carefully against Fig. 9. A number of strips are linked on the underside to provide a large earth area on the board.

Solder the components in place and affix the flying lead connections. The earthing wire must be of heavy gauge (14 strand) and must be soldered to the board as shown. Do not connect the screen of the input lead as this will later be earthed at the other end. A length of 150mm is sufficient for connections except the input and output to one board, these should be left 50mm longer. The use of different colour leads will help with identification, use corresponding colours for both boards so that they are exactly the same.

After checking the boards once again, bend the tags of IC1 and IC101 over at right angles about 3mm from the ends and solder the i.c.'s in position. It may be necessary to slightly reduce the space between the ends of the tags so that they line up with the Veroboard strips.

This method of fixing is recommended rather than inserting the pins in the Veroboard holes because the later method makes it very difficult to remove the i.c. should the occasion ever arise. The need to make these boards exactly as shown cannot be over emphasized, alteration could

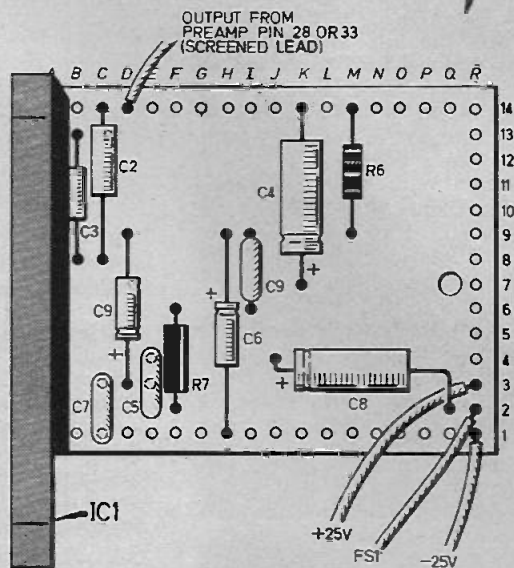
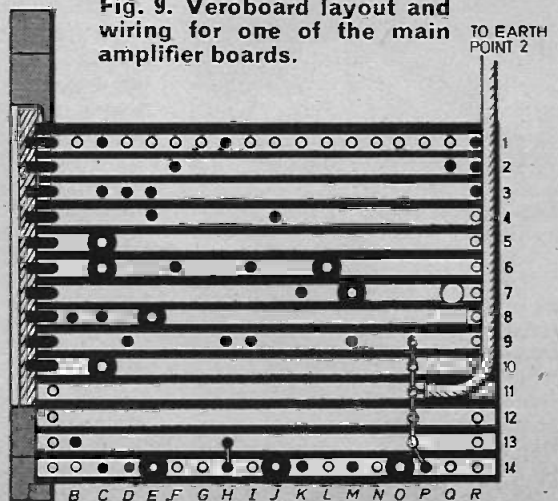

Fig. 9. Veroboard layout and wiring for one of the main amplifier boards.



cause instability; also check carefully that all the components are in the correct positions with the electrolytic capacitors round the right way.

Do not mount the amplifiers and boards in the chassis at this stage.

### POWER SUPPLY WIRING

The wiring of the power supply is shown in Fig. 10. Mount the tag strip and two large electrolytic capacitors in place using Terry clips or plastic strip to hold the capacitors in place. Mount the bridge rectifier ensuring that the connections fall in the right places (Fig. 10) and complete the wiring as shown.

A clip should be used inside the mains cable grommet to prevent the lead being pulled out. The connections to the fuse should be as shown—mains line input to the end tag not the body tag.

Tags 30/31 on the preamplifier are connected together and then to the components of the power supply circuit.

Earthing, as mentioned before, is important. Connect a thick wire (14 strand) to the earth junction of the components, cut it to a suitable length to reach earth point 2 and solder on a 4BA solder tag. The soldered joints to all earths must be of good quality.

### PREAMPLIFIER WIRING

Before wiring the preamplifier two capacitors must be disconnected from it. These are one in each channel in the first stage feedback circuit and are designed to limit the high frequency performance to about 16kHz at the -3dB point. The capacitors are shown in the photograph, they are the very small flat ceramic type located near pins 1 and 22. Disconnect them by cutting through one wire of each one using sidecutters.

Wiring to all pins of the preamplifier module (except supply pins) is carried out using twin screened lead which in some cases is split so that only single lead is used. Before any wiring is carried out bend down pins 11 and 12 and solder a length of 16 s.w.g. tinned copper wire to them to form an earth bar running the length of the module. A similar earth bar is mounted by a 6BA tag to earth point 1 and is bent to run along just under the input and tape sockets (Fig. 11), make sure that the tag makes good contact with the metal chassis.

Commence wiring of the preamplifier module and associated components at the input and tape sockets. Wire the two channels of the tape input (SK4 and SK104) to pins 6 and 7 respectively and connect the outer screen of both wires to the earth bar at the socket end. The screens of this lead are not connected at the other end.

Next connect the radio input sockets to a screened pair with the screens connected to the earth bar at the sockets. Take this lead under the side of the preamp to the guitar socket via R2 and R102 also connect the screens to this

socket. Connect R2 to the tag furthest from the front panel and R102 to the centre tag. Resistors R3 and R103 complete the circuit to S1a and S101a as shown. If an auxiliary input is required wire this to the third set of tags on S1a and S101a via two 1.8 megohm resistors. Do not connect the screens at the switch end.

The magnetic input wiring provides the earthing for the preamplifier and wiring of this input is carried out to S1a and S101a, the screens being connected to the screens of the wires from the wipers to the input tags 9/14 on the module. These wires also have their screens connected to the earth bar on the preamplifier, thus forming a circuit between that earth bar and earth point 1 on the chassis. This forms the only connection to earth of the preamplifier.

Continue wiring of S1b and S101b as shown connecting the screens to the preamplifier earth bar only, Fig. 11.

Having completed wiring to all the inputs and the switch connect up the twin volume control using two lengths of twin screened wire as shown. In this case the screens form one of the connections. Use three short lengths of ordinary insulated wire to connect the balance control. Keep this wiring close to the front panel.

Photograph showing the two preamplifier capacitors that must be disconnected.

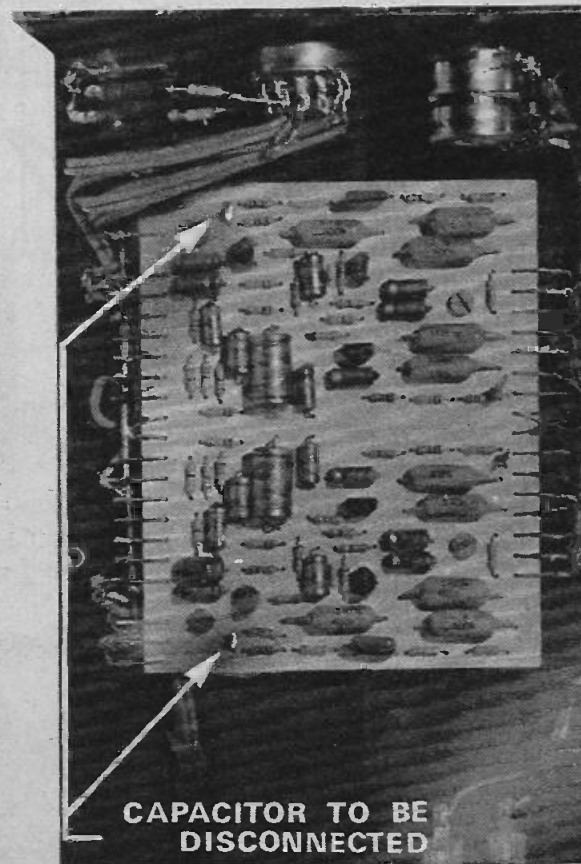

# modula 3

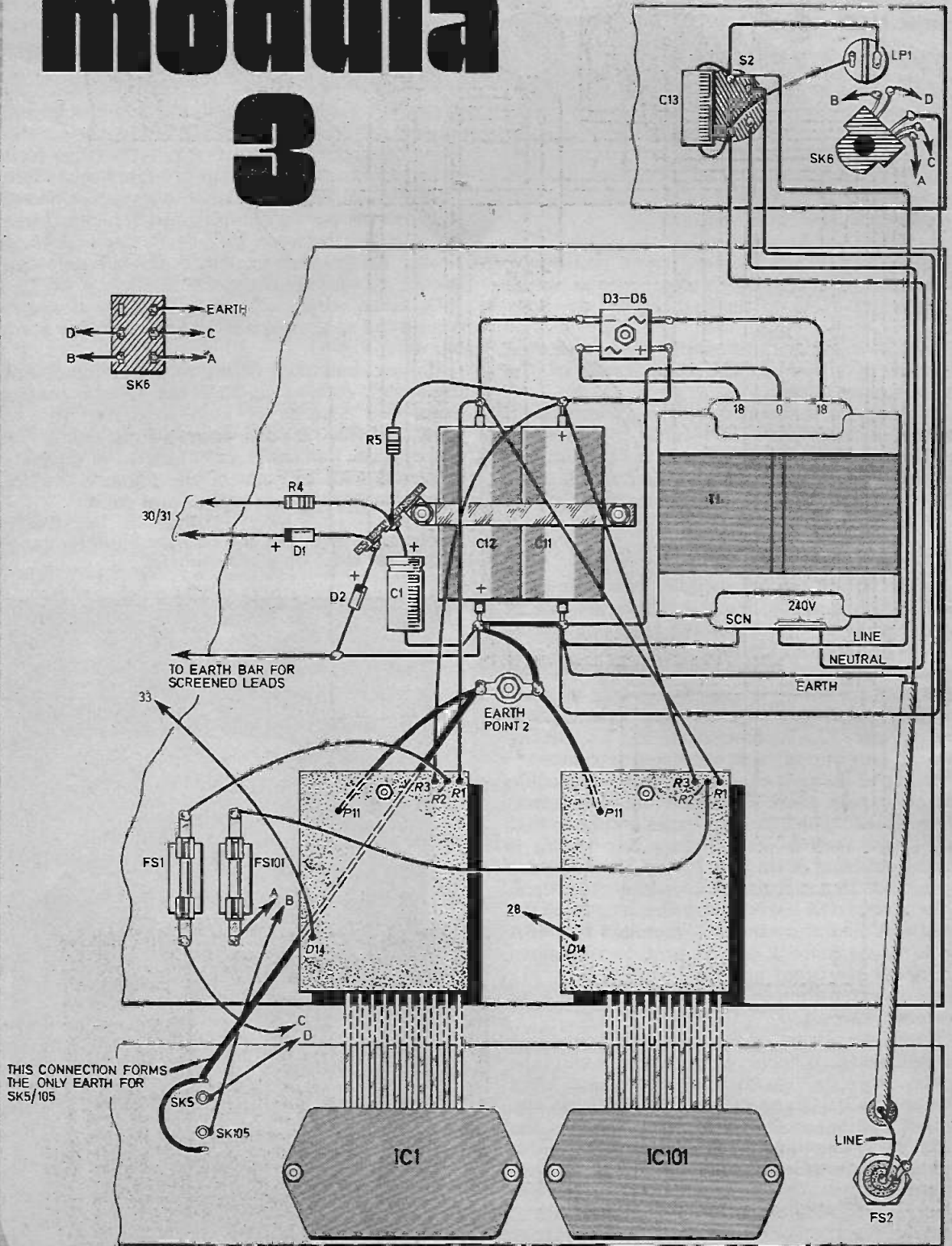

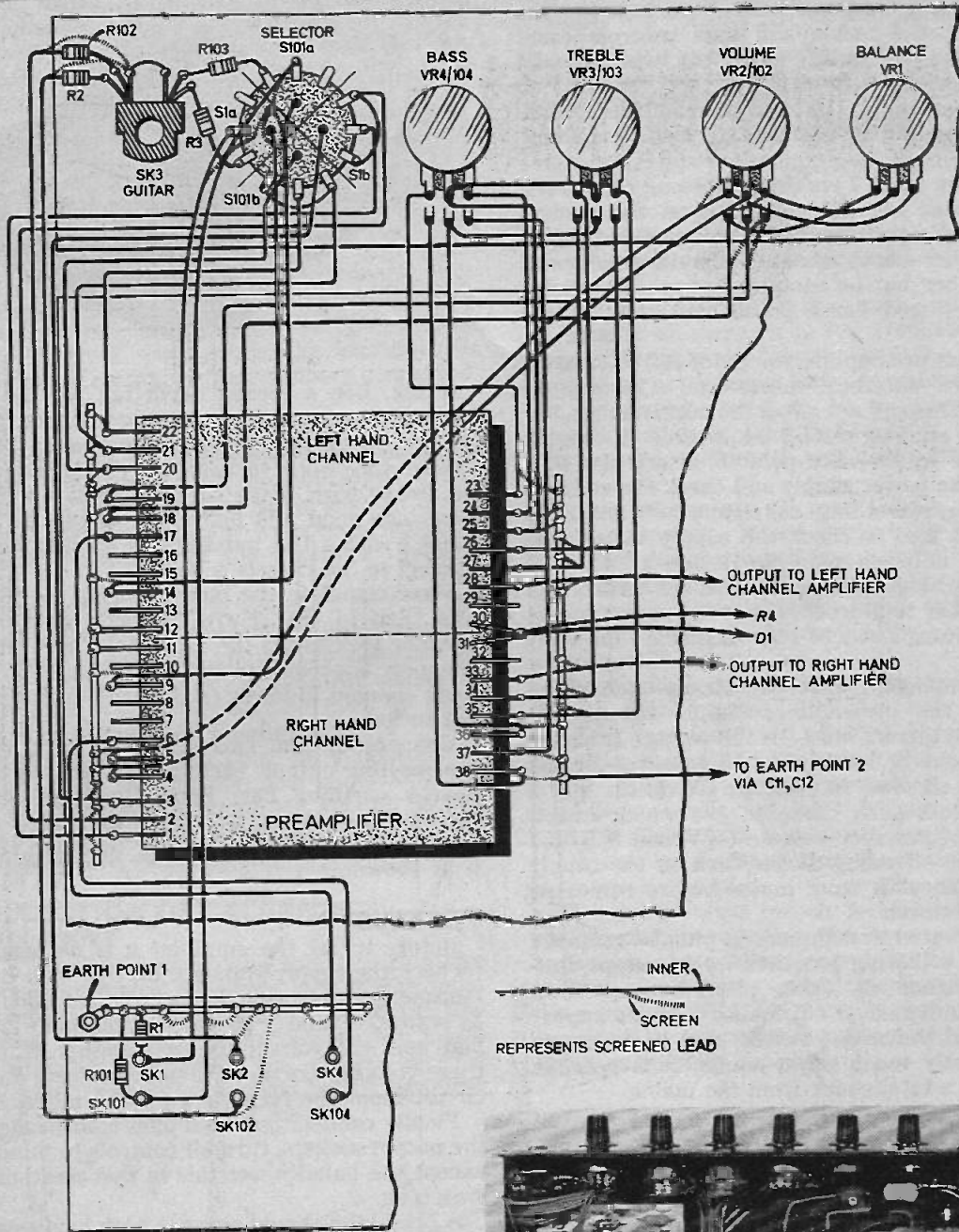
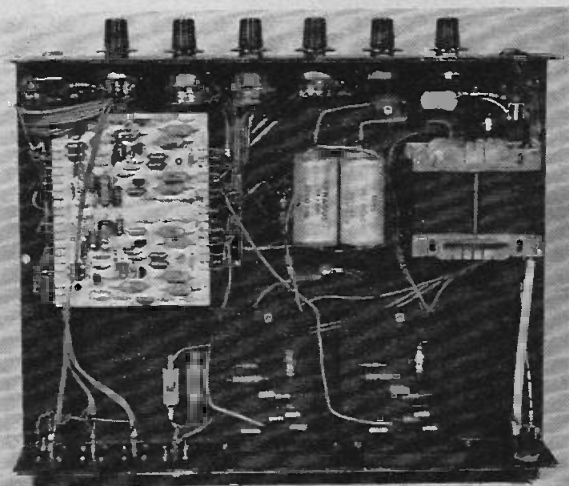

Fig. 11. Preamplifier wiring. See text concerning connection of screened leads and earthing. Right: Photograph of the prototype amplifier.



Next make the two connections between the wipers of the treble and bass controls using unscreened wire and then use the twin screened lead to connect the tags on these controls to the relevant pins. The screens from these wires are connected to an earthing bar that runs alongside the pins of the preamplifier and is connected to earthing point 2 via the smoothing capacitors. The screens are not connected at the control end. Check carefully all the connections to the preamplifier—each channel should correspond to the other but be completely separate except for supply and earth points and the balance control.

On some preamplifier modules  $R_{14}$ ,  $R_{15}$  and  $C_{18}$  may have different values and  $C_{19}$  may be omitted. This will not affect the performance.

At this stage it should be possible to connect the earth tag to earth point 2, insert fuse FS2, turn on the power supply and check the voltages across the smoothing capacitors (+ and -26 volts) and also to check the supply to the preamplifier between pins 30/31 and 11/12. This should be 19 volts. If these voltages are correct it is in order to proceed, if not the power supply and earthing should be checked for any mistakes.

It is important that the Zener diodes are reducing the preamplifier supply to approximately the correct level—if the voltage is higher than 20 volts or lower than 18 volts the Zeners should be checked for voltage. To do this put a meter across each diode to see which one is giving the incorrect voltage (10V and 9V) and change the offending diode. Turn off the supply and disconnect it from mains before removing any components.

It is essential that the mains plug be removed whenever soldering or other work, except voltage measurements, takes place because even with the unit turned off, mains voltages appear at FS2 and the mains switch, and it is easy to inadvertently touch these points. It is possible to receive a fatal shock from the mains.

### FINAL CONSTRUCTION

With wiring of all the individual parts and supply to the preamplifier completed and checked the final stage is to fit the two main amplifiers with associated boards and complete the wiring. The board with longer input and output leads forms the left hand amplifier. The amplifiers should be given a slight smear of silicon grease on their metal back panels and bolted in place. Make sure that the surface under each amplifier is flat and that the module cases make good contact, with the fixing screws well tightened. Insert the supporting spacers and 6BA bolts for each Veroboard and finally tighten up all mounting screws.

Remove the earthing tag from earthing point 2 and solder the earth lead from the left hand channel to it leaving just enough length to refix

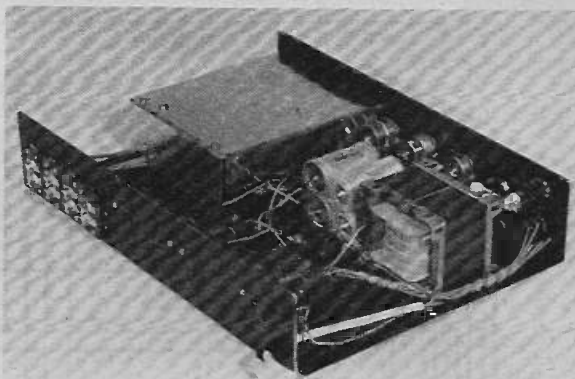

the tag. Use a second earth tag for the right hand channel amplifier and also connect the tag to the earth tag on the loudspeaker sockets (make sure both sockets are connected) using 14 strand wire. Make sure the soldered connections are good and bolt the two tags to earth point 2 with a 4BA nut and bolt making sure the contact to the chassis is good.

Next complete the output wiring to FS1/101 and then to the centre contacts of the loudspeaker sockets via the SK6. Make sure the two channels are wired to the correct sockets, right hand channel to lower (right hand channel) output socket.

Connect up the two screened leads to the preamplifier output, earthing the screens to the nearby earthing bar. Finally connect up the power supply leads as shown and once again check all wiring and earthing to make sure it is as shown.

### TESTING

Before trying the amplifier it is necessary to recheck the supply voltages. Do this without any loudspeakers connected. The voltages should be as before, + and -26 volts to the main amplifiers and +19 volts to the preamplifier. If any of these voltages are more than 10 per cent out the circuit should be rechecked for any mistakes.

Finally connect up two 8 ohm loudspeakers to the output sockets, turn all controls to minimum except the balance, set this to mid position and switch on.

A brief hum should occur in both loudspeakers while the smoothing capacitors charge, after that slight noise only. If this is the case slowly turn up the volume, this should increase the noise to an audible level. Now try varying the treble and bass controls over their entire range making sure that they affect the noise in the correct way.

Should any of these items not work correctly switch off, disconnect the mains and check the wiring to that part, making sure there are no dry joints or shorts caused by the screening of the leads.

Once all is correct, and if you have carefully followed the diagrams, that should be the first

time, a suitable input can be connected and the unit tried out. Before fitting a case the pre-amplifier screen should be attached using 4BA mounting pillars approx 40mm long. This screen is earthed to the chassis by its two mountings. make sure it does not touch the tags of SK6.

### HEADPHONE ATTENUATOR

Wiring of an an attenuator for use with high impedance headphones is shown in Fig. 12. This will be necessary with some headphones. It is suggested that the resistors be mounted inside a film can mounted on the headphone jack socket. This will ensure that the loudspeakers remain out of circuit with headphones connected.

### CASE

The case can be made from wood, metal or Perspex, the latter is not recommended if the amplifier is to be used at high volume levels for long periods as it may then be affected by the heat generated by the amplifier modules and T1.

A simple case design is shown in Fig. 13. The corner strengthening pieces will not be required if the case is made of metal. The case can be finished with stick on fabric, paint or veneer as required and is very easy to make even for those not skilled in metal or woodwork.

The amplifier chassis must be supported off the surface so that air can flow under it to aid heat dissipation. The amplifier should not be stood on top of or just above any source of heat e.g. radio tuner, radiator, etc.

### CONNECTION OF EXTERNAL EQUIPMENT

It is possible when connecting the amplifier to other equipment to induce hum at the input by completing an earth loop. To avoid this the amplifier only should be earthed to the mains and all other equipment e.g. record deck or radio tuner, should be earthed to the amplifier only, via the input screened lead.

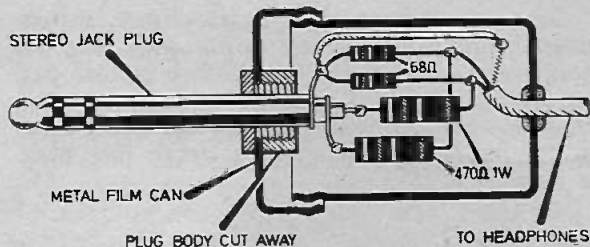

Fig. 12. Wiring of a headphone attenuator for use with high impedance 'phones.

A hum loop will make itself immediately obvious by an increase in low frequency (50Hz) hum in both loudspeakers when the offending equipment is plugged into the mains—it does not necessarily need to be switched on. To prevent this disconnect the earth in the mains plug on the equipment and earth as described above.

The amplifier can be used with a variety of other equipment, record decks with both magnetic and ceramic cartridges can be inputted—the ceramic type into the radio input (or auxiliary if fitted). Most radio tuners, tape recorders and tape players can be used via the radio socket.

The amplifier can be used with crystal microphones again plugged into the radio socket or medium impedance (50 kilohm) dynamic microphones plugged into the guitar socket.

The tape output will provide a signal for recording, unaffected by the tone or volume controls. Tape A/B monitoring can be provided if desired by disconnecting the volume control connections to pins 18/5 on the preamplifier with a push button switch or a switched stereo socket and connecting the tape preamplifier outputs to the volume control at this point.

Thus a recording signal is provided at the tape output (SK4/104) and a replay input is provided to the volume control—the two now being completely separate.

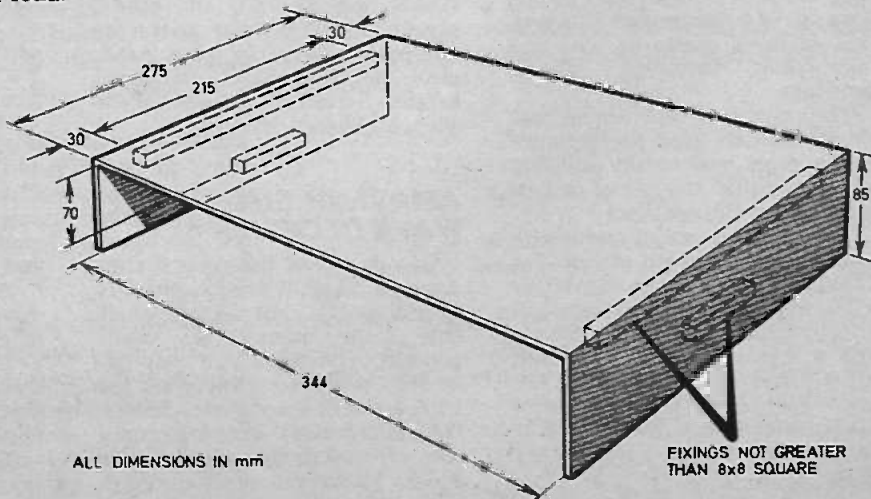

Fig. 13. A simple case for the amplifier. The corner strengthening pieces are not necessary if the case is metal.

Other equipment such as electronic instruments (organs, etc) and synthesisers can be plugged into the radio socket. Two guitars can be played through the amplifier—one on each channel—but the tone controls will affect both in the same way and a single stereo jack plug is needed at the input.

### ANCILLARY EQUIPMENT

It is not possible to recommend record decks, tape recorders and loudspeakers for use with this design, since the range and difference in price for various items is considerable.

Most medium priced hi fi equipment will be suitable but we do recommend the use of good quality speakers and magnetic cartridges, since

these are probably the weakest links. A two-way speaker system capable of handling 20 watts r.m.s. (40 watts DIN or music rating) or more would be adequate for most domestic set-ups. If the amplifier is to be used at high volume levels, say for guitar or disco work, the speakers should be rated at 30 watts r.m.s. (60 watts DIN or music rating) each; 8 ohm or 4-8 ohm speakers should be used.

Magnetic cartridges are now reasonably priced and a Goldring G800, Empire 999 RE/X, Shure M44 or similar would be suitable. Higher priced, better quality cartridges can of course be used to advantage, provided the record deck and arm are of good quality. □

*New products and  
component buying  
for constructional  
projects*

# SHOP TALK

By Mike Kenward

WE have recently received information on a range of Scandinavian loudspeaker kits that are new in this country. The Seas Hi Fi Loudspeaker Kits contain speakers, crossover, wire and instructions including cabinet drawings.

The kits are not cheap but should provide good performance at the price, and would probably be cheaper than the cost of equivalent commercial speakers.

The available range starts with a two way 10 watt system for £7.35 each and rises to £34.95 for a 70 watt four way system—all prices exclude V.A.T. Baffle boards and a frame with speaker cloth are available as extras for all the kits. For more details contact Macel Electronics Ltd, PO Box 64, 14 High Street, Ipswich, IP1 3LR.

### MODULA 3

Having mentioned the speaker kits—and some of these would be suitable for use with the Modula 3—we will move on to other cabinets. The only parts required to complete the amplifier are the materials for the cabinet. As stated in the text this can be made from almost any material, but wood or metal is preferable because the amplifier may get too warm for a Perspex case if it is used at high output levels for long periods.

A veneered plywood or similar material would provide an excellent finish and would be easy to work. We do suggest that the material used is not thicker than about 6 or 7 mm or the case will look "too chunky." If you want Perspex a local hardware shop or a local sign maker should be able to help—they should also be able to provide suitable glue.

Since publication of part 1 last month we have been informed that S.C.S. Components can also supply the Mullard LP 1184/2 pre-amplifier module, they are offering it at a special price. S.C.S. are at Northfield Industrial Estate, Beresford Avenue, Wembley, Middlesex, HA10 1YY.

### AMATEUR SHORT WAVE RECEIVER

One or two of the parts for the *Amateur Short Wave Receiver* are rather special, but all are available from Home Radio Components. The parts you may not be able to get everywhere are the trimmer with spindle attachment, the coil formers and dust cores, the universal chassis parts and the Bulgin knobs and dials, although

the latter should be available from other sources.

Thus although some parts for this project are not generally available, they are all easy to get and an order to Home Radio, who advertise regularly in our pages, should bring results.

### MOISTURE ALARM

Basically no buying problems for the *Soil Moisture Alarm*, all the parts should be readily available and almost any small case can be employed.

Just one point worth mentioning, the unit shown on the front cover employed a metal film can as protection for the end of the probes. This finishes the probe neatly and is easily removed should something go wrong.

### FUZZ BOX

One or two points concerning buying for the *Fuzz Box* need amplification. The jack socket used in the prototype is available from Re-An products, (type R26/1) or a switched stereo jack socket can be employed. Re-An are at Burnham Road, Dartford, Kent. The type FB1 case used on the prototype is a glassfibre type and is available from E. R. Nicholls, at 46 Lowfield Road, Stockport, Cheshire. The case costs 50p (a special price for this project) including post and packing, V.A.T., and rubber feet.

The footswitch may also prove difficult to get but a suitable type is available for £1.05 including post and packing from Express Components, 17 Albert Square, Stratford, London E15 1HJ. Order type 81158/9.

All the other parts should be readily available.



# BEGIN HERE

## PART FOUR CONSTRUCTION TECHNIQUES

By DONALD MAYNARD

In the last part of this series for the beginner we deal with the problems of testing and construction. As time goes on, the purchase of more sophisticated test equipment may be contemplated. Initially, however, all we need is a multimeter. This is an instrument capable of measuring alternating and direct currents and voltages together with resistance.

### TESTING

All resistors should be checked by first determining their value from the colour code to make sure that the correct one has been purchased. Sometimes red and orange or brown can look very similar on a small resistor. Check the value again by measuring on the most convenient ohms range of the multimeter.

The value of capacitors written on their sides should be checked against the circuit diagram. Large valued capacitors produce a little kick if the ohms range of the multimeter is used and the leads are first connected one way and then reversed. Otherwise they appear to be open circuit i.e. very high resistance. Inductors on the other hand will appear as a short circuit or very low resistance as will the windings of a transformer.

Potentiometers may be checked by connecting the multimeter set to the ohms range between the central connector and one end. Look for the variation in resistance as the spindle is turned.

### SEMICONDUCTORS

The resistance ranges are also used for testing semiconductors. For diodes, the red, positive, lead of the multimeter connected to the positive marked (sometimes just a ring round the diode) end of the diode and the black or negative lead to the other end should give a low reading of resistance. Reversing the leads gives a high



reading. Voltage reference diodes (Zeners) produce the same result. The reference voltage can only be checked when the diode is in circuit.

Thyristors should give a high reading between anode and cathode whichever way the leads are connected. For a p-gate thyristor a low reading should be obtained with the positive lead on the cathode and negative lead on the gate.

Bipolar transistors can be tested with a multimeter although a proper transistor tester has many advantages. Table 4.1. shows the readings that should be obtained on a multimeter set to the ohms range. The actual values will depend on the type of transistor being tested. Remember that on most multimeters the low values of resistance are near full scale deflection, the opposite of the voltage and current ranges. It is not usually possible for the home constructor to test integrated circuits before making up the circuit.

Table 4.1

Resistance readings for testing transistors			
red lead	black lead	reading	
		pnp	npn
base	emitter	low	high
base	collector	low	high
emitter	base	high	low
collector	base	high	low
collector	emitter	high*	high*
emitter	collector	high*	high*

\* Depends on transistor leakage currents

## ASSEMBLY OF COMPONENTS

Never bend leads close to the component, and always use a small diameter rod or large nail to bend the leads around. Make sure that the leads are clean and then "tin" them by applying heat with the soldering iron and feeding a small quantity of solder on to the lead at the same time. Never leave the iron in contact with the components for longer than is absolutely necessary.

The solder should be a good quality multi-core type needing no additional flux. The iron should be an electric one of between 15 and 30 watts. If trouble is experienced the most likely causes are a dirty bit on the iron or a dirty lead on the component. A file on the former or fine grade emery paper on the latter should cure the problem.

If possible use pliers, adjacent to the junction of the component and lead-out, to conduct heat away. Make sure that the final joint is sound and is not "dry". Try not to move a lead until the solder has cooled as this can cause dry or fractured joints. Finally trim the leads on the soldered side with a pair of side-cutters.

The handling of semiconductor devices is especially important. They should always be mounted last, and the soldering iron applied for a minimum period while ensuring a good joint. The pliers should always be used to dissipate heat and great care should be taken to avoid breaking the leads. Soldering really requires three hands which leaves most of us one short. The best arrangement is to fix the board vertically so providing access to both sides simultaneously.

## COMPONENT LAYOUT

It is advisable to obtain all the components for a circuit before thinking about layout. In general most circuits can be laid out in a similar fashion to the theoretical circuit. If miniturisation is required, careful adjustment of the components' positions will be necessary. Jig-saw enthusiasts can have a field day.

It is however important to keep the output components and connections away from the input or the circuit may oscillate. In an audio amplifier this is denoted by a continuous whistle from the loudspeaker even with no input.

A simple theoretical circuit is shown in Fig. 4.1. We will use this as an example. Usually batteries, switches, lamps and other large components will be mounted separately. Flying leads connect them to the circuit board. Fig. 4.2. shows a component layout that is suitable for all three types of construction that we will look at. This makes it easier for working out the cutting of the Veroboard and for designing the printed circuit.

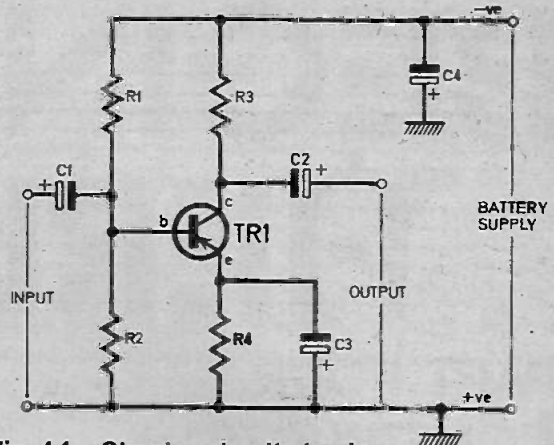
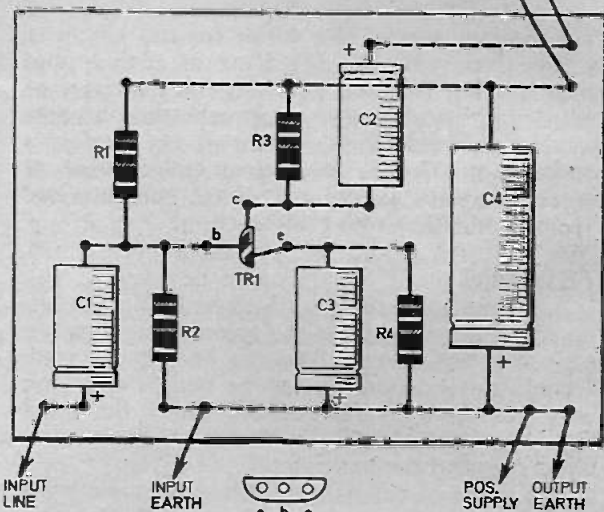

Fig. 4.1. Simple circuit to be constructed.

Fig. 4.2. Layout of the circuit of Fig. 4.1. X



## TYPES OF BOARD

The simplest type of mounting board is plain Paxolin drilled (or it can be purchased ready-drilled) with small holes. The component leads are passed through the holes and soldered to each other on the reverse side. This does not provide a very neat finish but it is useful if the circuit is liable to be changed, Fig. 4.2. shows this construction, the dotted lines indicating component leads soldered together.

Veroboard provides a much neater alternative. This consists of a piece of Paxolin or glass fibre board in which is drilled a matrix of holes. The diagram of Fig. 4.3 shows how the holes are connected by thin strips of copper laminated to one side of the board. All the constructor has to do is to break the copper strips where necessary using a twist drill or cutter that can be bought with the board.

Making your own printed circuits is not as difficult as it sounds. Having decided on the layout of the components, they have to be

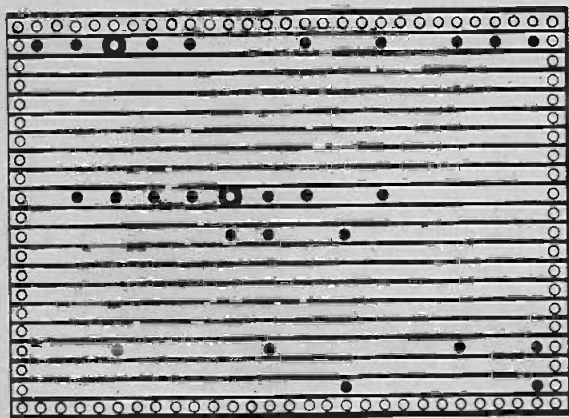

X  
Fig. 4.3. Underside view of the Veroboard layout of Fig. 4.2.

joined up like the circuit diagram. The black areas in Fig. 4.4 show the connections required. The pattern then has to be traced onto a clean grease-free blank printed board (Paxolin or fibre glass with one side laminated with copper). The areas which are to remain copper are painted with an enamel such as the "Humbrol" model paints, nail varnish or shaded in with a printed circuit resist pen.

When this is dry the board is immersed in ferric chloride solution. This can be obtained from chemists, but make sure that it is strong. The solution should be put in a plastic container such as a photographic developing dish

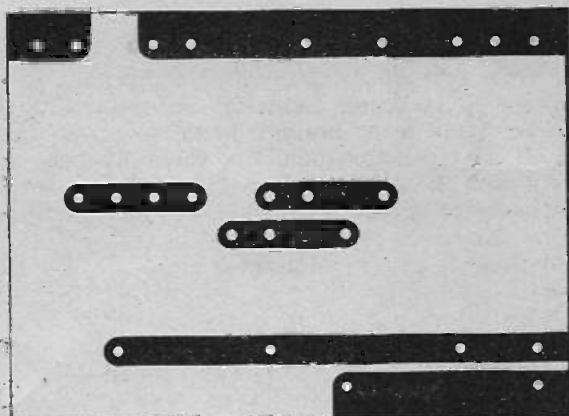

X  
Fig. 4.4. Printed circuit design for Fig. 4.2.

and contact with clothes and skin should be avoided. Wash off splashes immediately.

When it is clear that the copper has been eaten away from the unprotected areas, remove the board and wash it. The paint must then be taken off by using a suitable solvent. It is a good idea to then give each copper area or "land" a thin film of solder by the tinning process already described. This stops the copper tarnishing which could make soldering difficult later on. Holes then have to be drilled for the components.

Although other methods exist for the production of printed circuits, the one outlined is the simplest. □

## Ruminations By Sensor

### A Second Look

There must be many inventions from the past that would be worth looking at again with our advanced knowledge of materials and construction.

For example, Babbage's computing engine was not completed in his lifetime because mechanical engineering at the time was just not equal to the task. It was not until electronic digital techniques became available that the digital computing engine became a reality.

Leonardo da Vinci had many ideas that were incapable of realization during his day. Although sound in design, the necessary materials and methods for the constructions were unknown to the artisans of the time.

There have, of course, been

many developments and variations of very old inventions, such as the Archimedian screw which was originally used for raising water—the modern version, powered by electric motor, is universally used for moving grain.

With the increasing cost of fuel, we should look carefully at older sources of power, the water wheel and the horse. Hydro-electric schemes could perhaps be extended and the high capital cost of these would be justified when viewed in relation to the cost of other fuels.

### Horse Power

At least one brewery has re-discovered the horse and finds that it is more economic to use a horse-drawn dray for local deliveries than a motor lorry. The bi-products of the horse have important uses unlike those of the motor car which are entirely pollutant. I wonder if it would be possible to control a horse by electronic methods.

Having recently myself, discovered how difficult it is to learn

the traditional methods of control, I visualise a system of transducers distributed around the horse to replace the reins, whip and leg-aids of the rider.

The transducers would be operated from a small control panel, perhaps built into a kind of howdah where the rider would sit in comfort. Each transducer could be caused to administer a mild "tickle" to guide the horse in the required direction. I don't know how the horse would like this but in my limited experience I should think the trial runs would be alarming in the extreme.

My daughter objects very strongly, on behalf of the horses, to any form of shock treatment (cruelty, her word) while still prepared to use reins, bit boots (and whip?) to achieve the same results.

However, I feel the special relationship between horse and master ought to be respected for the good and benefit of both. There would be little pleasure for the rider in sitting, pushing buttons,—no better than a motor boat on the park lake.

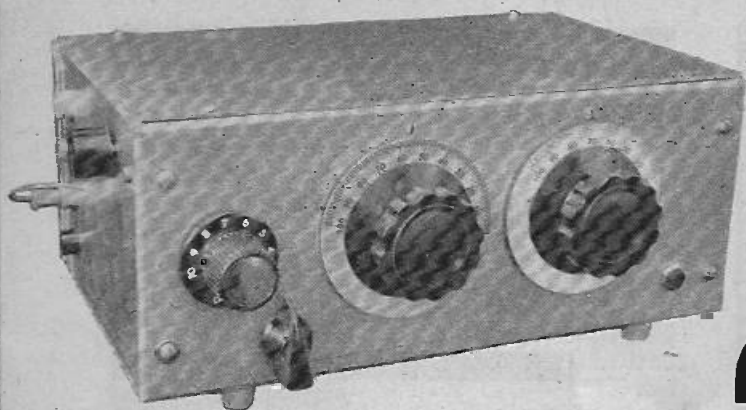

# AMATEUR SHORT WAVE RECEIVER

BY F.G. RAYER

A simple regenerative receiver for reception of amateur and other short wave transmissions.

**T**HIS receiver has a simple circuit and is easy to construct, but will bring in a great number of broadcasts, amateur, ship to shore, and other transmissions, over a frequency range of approximately 15MHz to 1.76MHz, or 20 to 170 metres. You do not even need to use a high, long outdoor aerial, and it is possible to receive c.w. morse signals, and amateur single-sideband transmissions, as well as the usual amplitude modulated programmes on these frequencies.

Bandspread tuning eases operation on the congested short wavebands. The whole receiver is enclosed in a quite strong but economical case.

## BANDSWITCHING

Two frequency ranges are provided, with a 3 way rotary switch. The third or central switch position is "off." In Fig. 1, pole S1a of the switch selects either coil L1, or coil L2. Pole S1b at the same time transfers the aerial connection SK2 to a tapping B, on L1 or L2. Switch section S1c transfers the circuit from the source (s) of the f.e.t. TR1, to either of the tappings C, on L1 or L2, according to the band required.

This allows selection of either the band tuned by L1, or that tuned by L2. Coil L1 covers approximately 1.76MHz to 4.9MHz, and L2 approximately 5.6MHz to 15MHz. This leaves a gap of about 4.9MHz to 5.6MHz, but it is felt that this small range of frequencies is not of particular interest. If wished, the adjustable core of L2 can be positioned so that this coil tunes 2.0MHz to 5.6MHz, but this means that amateur, shipping and other signals in the 1.8MHz to 2.0MHz band cannot be received.

The remaining section of the switch S1d, disconnects battery negative in the central position.

## AERIAL COUPLING

The results obtained with a receiver of this kind can be influenced by the loading of the aerial on the tuned circuit. To secure best operating conditions with any aerial, there are three optional aerial connections SK1, 2 and 3 and a pre-set capacitor C1.

An extremely short aerial, such as a telescopic rod or few feet of wire, can be taken to SK3. With longer aerials (say over about 6ft) this can load the receiver too heavily, so connection SK2 is used. With a long aerial (say over 30ft or so) the aerial lead is connected to SK1, and the plug from C1 is generally placed in SK2.

Capacitor C1 is situated with a small control knob on the side of the case, so that it is readily adjustable.

Too heavy loading on the tuned circuit will cause flat tuning, and may also prevent regeneration, upon which the high sensitivity of this kind of circuit depends.

## REGENERATION

Regeneration is obtained by taking the source of TR1 to the tappings C, and is controlled by the potentiometer VR1, which adjusts the voltage reaching the drain of TR1 through R3.

For reception of a.m. signals (speech, music, etc.) VR1 is placed so that TR1 is not quite oscillating, as this gives maximum sensitivity. For

FOR  
GUIDANCE  
ONLY

**ESTIMATED COST\***  
OF COMPONENTS  
including V.A.T.

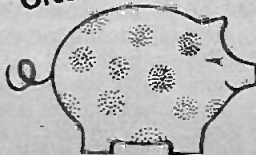

**£4.50** excluding  
case and headset

\*Based on prices prevailing at  
time of going to press

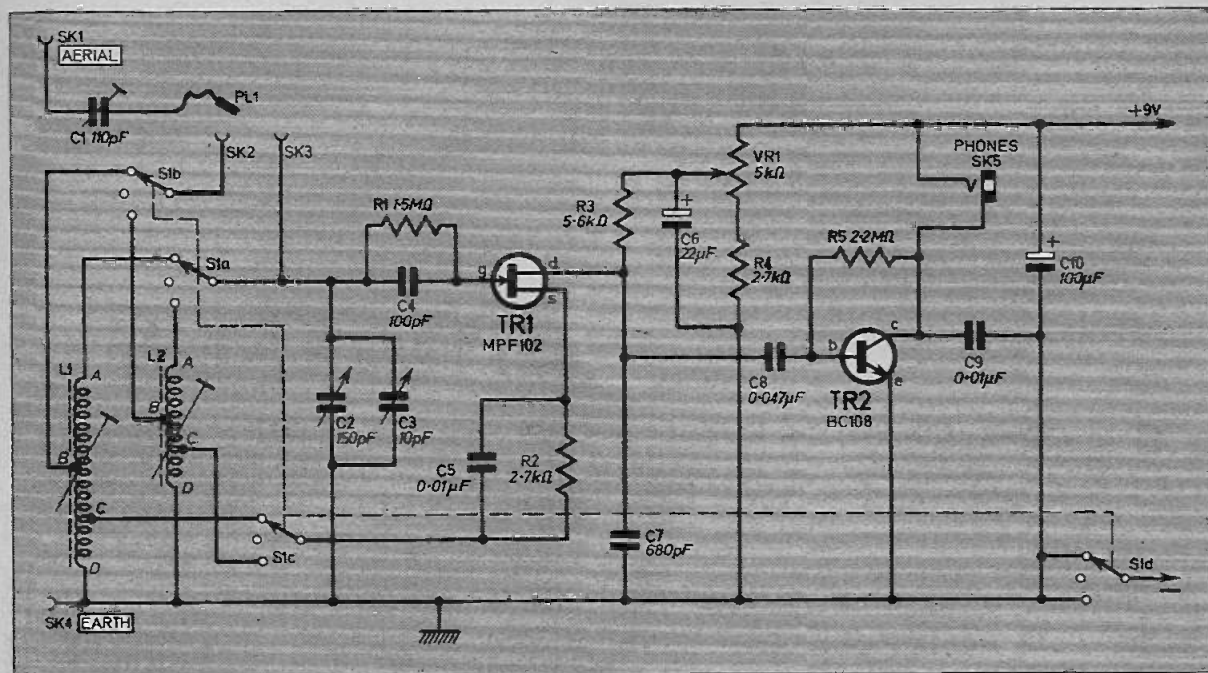

Fig. 1. Complete circuit diagram of the Amateur Short Wave Receiver.

c.w. signals (morse code) VR1 is turned a little further and an audio heterodyne is produced. This advance in regeneration is also required for the reception of s.s.b. (single sideband) signals but the oscillation of TR1 then replaces the carrier which is suppressed before the transmission.

### BANDSPREAD TUNING

Capacitor C2 is the main tuning capacitor, and is 150pF. Capacitor C3 is the bandspread capacitor, and is 10pF. As a result, the full 180 degree rotation of C3 covers about the same frequency range as one-fifteenth of the rotation of C2, and has the effect of breaking up the band covered by C2 into a large number of small bands, tuned by C3.

This method costs less than a high quality reduction drive and allows easy tuning and searching over a narrow band of frequencies.

### AUDIO AMPLIFIER

Audio signals developed across R3 reach TR2 via C8, and this single audio stage contributes a large degree of amplification, so that good head phone volume is obtained. High impedance phones, such as 2,000 ohms, should be used. A comfortable, good quality headset is recommended, not a single earpiece or miniature phone.

### COIL WINDING

Each coil is wound as in Fig. 2, except that L1 has more turns. L1 is wound with 34 s.w.g.

enamelled wire, turns side by side. The winding begins at A. When 55 turns have been put on, the small loop B is made. After a further 15 turns, loop C is made. A further three turns are then wound on, and the wire cut off, leaving end D.

Coil L2 is wound with 32s.w.g. enamelled wire, turns side by side, and has 10 turns from A to B, three turns from B to C, and one turn from C to D.

In each case begin as near the top of the former as practicable. The wire can be secured with a turn or two of cotton, with a little adhesive to prevent any movement. Taps B and C are scraped clean of enamel so that leads can be soldered on. End D is fixed as when beginning the winding.

### CASE

The front and back are 255×100mm flanged universal chassis members, and the sides are 150×100mm flanged members. The top and bottom are 255×150mm flat plates.

As the case front is also the receiver panel, this should be drilled or punched as in Fig. 3. The small hole for SK5 should be checked to suit the actual socket.

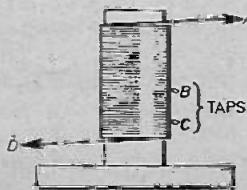

Fig. 2. Details for winding L1 and L2.

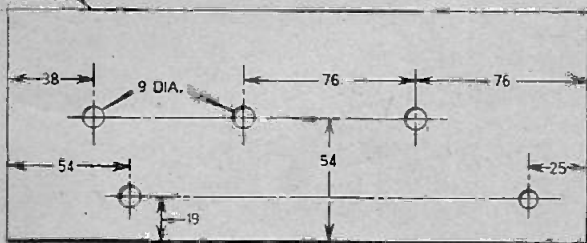

Fig. 3. Front panel drilling details.

Capacitors C2 and C3 are fitted with 0-100 dials, and marks can be made vertically on the panel above these, or they can be read against the vertical slots of 6BA round-headed screws. The slots may be filled with black or white paint.

The 150×100mm members are placed inside the 255×100mm members, and held by 4BA bolts through the holes present in these items. Check that the box is square, place the bottom in position, and drill both it and the flanges. The bottom can be held with 6BA bolts, or self-tapping screws. Four rubber feet are put on the screws. The top is similarly drilled, to be fixed by self-tapping screws.

The left-hand side is drilled for the four sockets SK1, 2 and 3 with SK4 (for earth). Sockets SK1, 2 and 3, must of course be of the type giving isolation from the metal. Socket SK4 is joined to the metal by a lead to the earthing tag.

The bracket shown in Fig. 4 is cut, and supports C1. C1 must also be the type of capacitor which has both sets of plates isolated from its mounting bush (to prevent the aerial circuit being shorted). The screw is taken out, and replaced by the extension spindle, which passes through a clearance hole, and is fitted with a knob.

To simplify work, the back and right side of the case are removed.

### CIRCUIT BOARD

Veroboard could be used for the circuit board, but as there are only a few holes needed, plain 1.5mm thick paxolin sheet is suitable. The board is 150×75mm. Position it as in Fig. 4 and drill board and case bottom for the three 6BA bolts. These bolts are 12mm long. Each has extra nuts, so that wiring under the board is held clear of the metal. A tag is locked under the front nut (Fig. 5) to serve as a connecting point to the metal chassis.

Mark and drill holes for bolts to hold L1 and L2. The other holes can all be made with a 1.5mm drill.

Place the resistors and capacitors as in Fig. 5, noting that C6 and C10 have positive and negative ends. Turn the board over and commence to wire it as in Fig. 5. In many places the wire ends of components will be long enough to

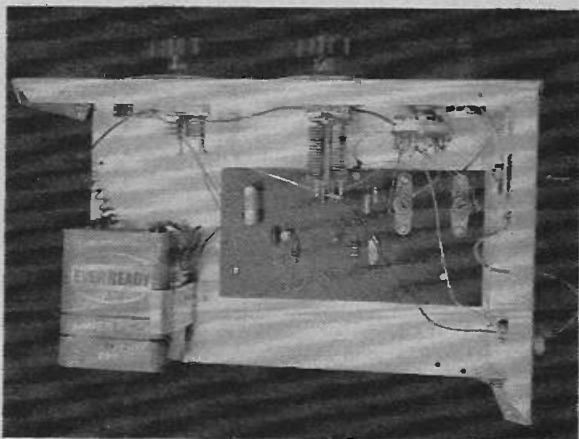

## Components . . . .

### Resistors

- R1 1.5M $\Omega$
- R2 2.7k $\Omega$
- R3 5.6k $\Omega$
- R4 2.7k $\Omega$
- R5 2.2M $\Omega$
- All  $\frac{1}{4}$ W  $\pm 5$  per cent

SEE  
**SHOP  
TALK**

### Potentiometer

- VR1 5k $\Omega$  lin.

### Capacitors

- C1 10-110pF compression trimmer with spindle attachment
- C2 150pF Jackson C804 variable
- C3 10pF Jackson C804 variable
- C4 100pF silver mica or tubular ceramic
- C5 0.01 $\mu$ F disc ceramic
- C6 22 $\mu$ F elect. 10V
- C7 680pF tubular ceramic
- C8 0.047 $\mu$ F
- C9 0.01 $\mu$ F
- C10 100 $\mu$ F elect. 10V

### Semiconductors

- TR1 MPF102 f.e.t.
- TR2 BC108 silicon *npn*

### Miscellaneous

- SK1-4 single insulated sockets (4 off) with plugs to match
- SK5 3.5mm insulated jack socket
- S1 4 pole 3 way rotary switch
- L1, 2 coil formers CR9 29 x 10mm with CR10 dust cores (2 off each from Home Radio) 32 s.w.g. and 34 s.w.g. enamelled copper wire.

Case, universal chassis 255 x 150 x 100mm with extra 255 x 150mm flat plate. Paxolin panel 150 x 75mm. 2,000 ohm headset. Bulgin 70mm dia. silver dials with skirts and knobs (2 off). Small pointer knobs (2 off). Knob with numbered skirt for VR1. Rubber feet (4 off), connecting wire, 6BA fixings, wire for aerial and earth—see text. 9V PP9 battery and clips.

# AMATEUR SHORT WAVE RECEIVER

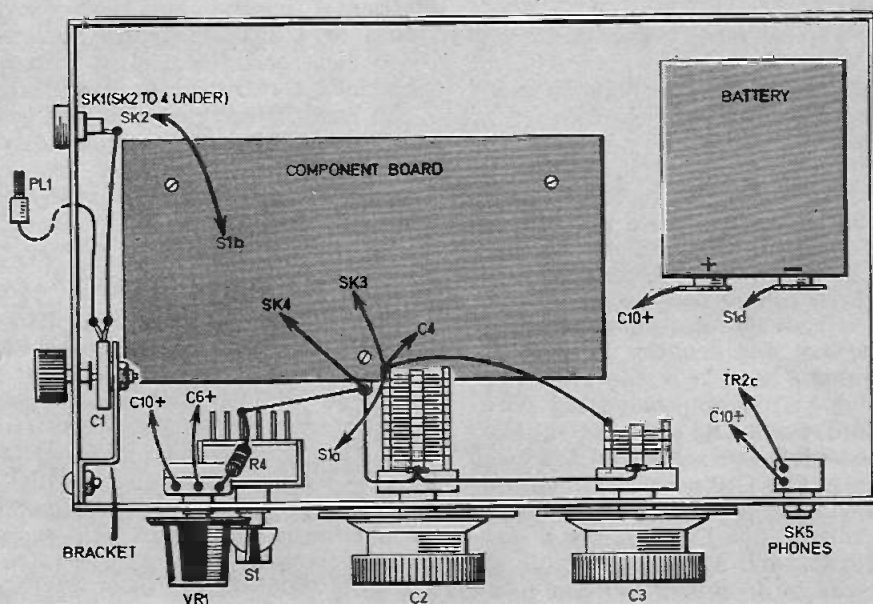

Fig. 4. Layout and wiring of the components mounted in their relative positions inside the case.

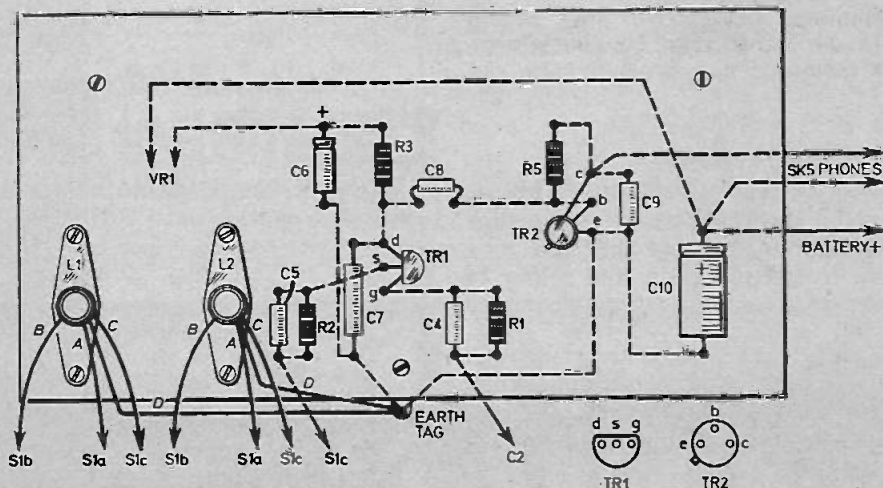

Fig. 5. Layout and wiring of the component mounting board. Connections shown by broken lines are made on the underside of the board.

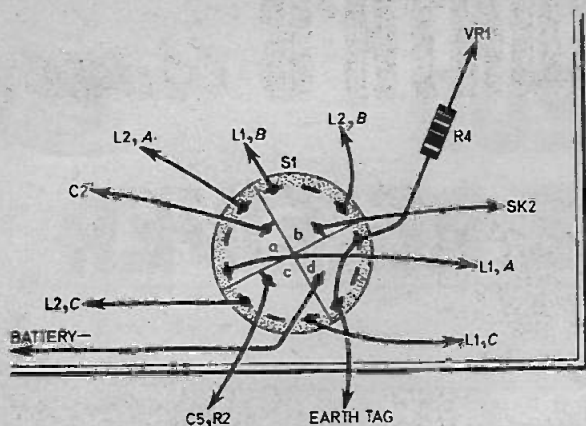

Fig. 6. Wiring of S1. The inner tags of each section are the wipers.

reach other points. Cut off excess wire, and place insulated sleeving on the leads which cross other wires.

The positions of the leads for TR1 and TR2 are shown in Fig. 5. Arrange the drain, source and gate leads of TR1, and collector, base and emitter leads of TR2, as shown, and solder them, avoiding unnecessary and lengthy heating of the joints while doing so.

Solder two lengths of thin connecting wire or flex to C10 positive and TR2 collector, to take to the headphone outlet. Also solder red flex with a positive battery clip to C10 positive. Solder on two leads which will run to VR1—that from C10 positive can be red to identify it. Leave a projecting wire from C4, and another from C5, as in Fig. 5. These can be identified by their positions.

Place the board as in Fig. 4 and lock it with nuts underneath the case. Assure no bare leads or joints can touch the metal.

The lead from C4 is cut and soldered to C2. Also join the moving plates tag of C2 to the earth tag, and solder the leads to VR1 and to SK5. Note that the latter must be of the type which is fully insulated and isolated from the metal panel.

### SWITCH CONNECTIONS

The switch connections are shown in Fig. 6. It is best to make the connections to the four inner tags first. Cut leads A of the coils to a suitable length, scrape the ends, and solder to the tags shown. In the same way, take ends D to the earth tag.

Connections to the taps C and D are made with insulated wire. All wires to the coils and switch should be reasonably short and direct.

### AERIAL

As mentioned, the receiver will perform well with a wide range of aerials. A reasonably effective indoor aerial can be made by arranging a

few yards of thin insulated wire, along one wall of the room near the ceiling, part of the wire descending to form the down-lead to the receiver.

An outdoor wire gives better reception, especially if clear of the house walls. It can be semi-vertical, Fig. 7, consisting of 6 to 9 metres or so of wire. The upper end is supported at the eaves or top of a bedroom window. The bottom is secured by a cord to a stake some distance from the house. The wire is one uncut length to the receiver.

There is also the popular inverted "L" aerial, which may be 9 to 30 metres or more long, the horizontal portion being stretched from the house to a distant support such as a pole. A fairly long aerial is helpful with weak signals, especially for the lower frequencies.

An earth is not essential, but is helpful. Run an insulated lead to a spike driven into the ground. A connection to a hot or cold water pipe, gas pipe, or mains earth should not be used.

### USING THE RECEIVER

The aerial is probably best plugged into SK1, and the plug from C1 inserted in SK2. Screw C1 about half down. Advance VR1 slowly from minimum until oscillation just arises when tuning through a signal. Back off VR1 very slightly from this position for a.m. reception. If VR1 is turned too far, sensitivity falls and proper reception is impossible. The adjustment of VR1 is extremely important for tuning in weak signals.

Fig. 7. Arrangement for an outdoor aerial

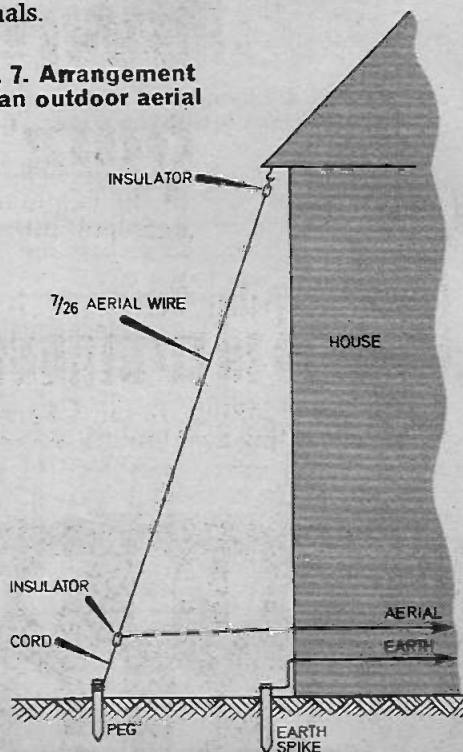

continued on page 156



*All in* **NEXT MONTH'S** *issue...*

## **CAR RALLY INTERCOM SYSTEM**

An easy to build inexpensive intercom system for driver and navigator. Requires no special helmets or headphone attachments. Also suitable for motorcyclists.

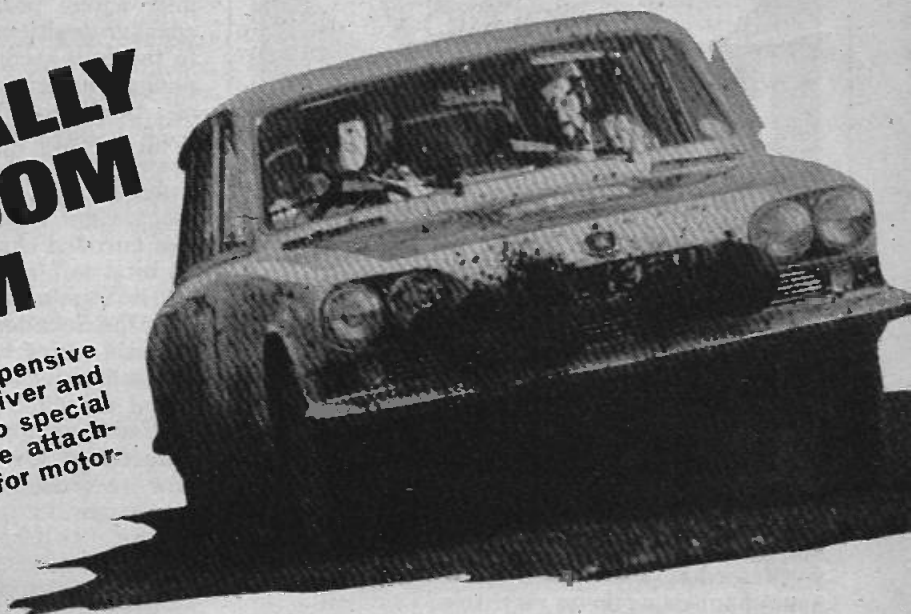

A switch operated by body resistance rather than pressure. Simple, inexpensive with a relay for power switching.

## **QUIZ MASTER**

For panel games—make sure of the sequence with the Quizmaster. This article also provides an excellent introduction to simple logic.

**PLUS**

New Regular Feature...

### **CAREERS in ELECTRONICS**

If you are thinking about a career in electronics, this new feature is for you!

### **STARTING NEXT MONTH WORKSHOP PRACTICE**

A look at the mechanics of electronics, for the beginner and all constructors.

# everyday electronics

APRIL ISSUE  
ON SALE MARCH 21

## NEW DIMENSIONS IN SOUND

## AND OTHER MULTICHANNEL SYSTEMS

PART 2

By ADRIAN HOPE

It was in the late 'sixties that the search really hotbed up for a matrixing system which would encode four channels of sound into two channels for recording with accurate decoding back into four channels again on playback.

Much of the incentive came from the record companies, who saw how four channel experiments relying on tape with four separate tracks running in one direction (rather than in oppositely directed pairs as in conventional tape recording) were catching the public interest and could well erode disc sales. For whereas most people at that time (and even now, for that matter) preferred discs to tape, there was no guarantee that they would not stop buying discs and start buying tapes if the latter could offer four-channel sound when discs could not.

### SCHEIBER'S TECHNIQUE

Probably the first man to achieve any real success with matrixing four channels into two and from there back into four again, (thereby making the record companies dream of a four channel disc come true) was Peter Scheiber, a New York musician.

Scheiber's technique has never been adopted in its own right but it has been used as a jumping off point for other techniques. Thus much modern matrixing owes a considerable debt to Scheiber's original work.

Scheiber's British Patents Nos. 1328141 and 1328142 show a matrix system using four microphones and four loudspeakers. The loudspeakers are arranged in a square either at front, left, right and rear of the listener or (now more conventional) left front, right front, left rear and right rear.

The position chosen for the loudspeakers must of course depend on the position chosen for the microphones with which the original recording was made.

Because, from a matrixing point of view, it doesn't matter how the microphones and loudspeakers are arranged (so long as the original microphone positions correspond to the loudspeaker positions) it is probably easier to refer to the four incoming channels (from the microphones) as original channels 1, 2, 3 and 4. These can then be coded down to channels A and B from which decoding produces playback channels 1, 2, 3 and 4 again. In most cases the channels 1, 2, 3 and 4 will be respectively left front, right front, left rear and right rear; the two encoded channels A and B can be regarded as total left and total right channels and they will be usable as an ordinary stereo pair.

In the Scheiber system the sum of channels 1, 3 and 4 is fed to channel A, with the channels 3 and 4 reduced in level (attenuated). Channel 2 and the difference between channels 3 and 4 are fed to channel B, with channels 3 and 4 again reduced in level. The channels A and B are now recorded or transmitted as an ordinary stereo pair.

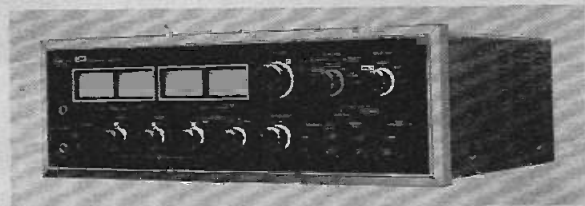

The Sansui QA7000 quadrasonic amplifier. Also suitable for other systems including discrete.

### DECODING

For decoding on playback the A signal alone is fed to one loudspeaker (the left front), and the B signal alone fed to another loudspeaker (the right front). The sum of the A and B signals is fed to a third speaker (left rear) after reduction in volume, and the difference between the A and B signals is fed to the fourth speaker (right rear) also after similar reduction. This technique of adding and subtracting the signals means that sound fed to one microphone alone will be reproduced at the corresponding loudspeaker, with the adjacent two loudspeakers producing a similar but reduced sound.

No sound at all will issue from the fourth loudspeaker. Thus a sound at the left front will emerge loudest from the left front loudspeaker and at reduced volume from the left rear and right front loudspeakers. No sound at all will issue from the opposite (right rear) loudspeaker.

An important point to bear in mind is that when we talk of *summing* signals we mean combining them so that they add together. To take the *difference* between signals we shift one of them in phase so that in combination it will subtract rather than add.

Scheiber shifted half his channel number 4 (right rear) through a full 180 degrees to produce replicas of opposite polarity in the two matrixed channels A and B.

All manner of exotic sounding modifications to the basic Scheiber system were proposed (names like New Orleans matrix, 45 Degree Rotation matrix, 90 Degrees Rotation matrix, and so on) but commercially the most important to emerge so far have been the Sansui QS matrix and the CBS SQ matrix.

## SANSUI QS

At the time of writing no patents on the Sansui system (used by Pye Records in this country) have come to hand, but the technical details released by the company explain the system as follows.

The encoder of Fig. 7 receives the four input signals 1, 2, 3 and 4 and feeds 1 and 2 direct into the channels A and B. Signals 3 and 4 are mixed together by the matrix circuit represented as a simple resistor and are each subjected to a 90 degree phase shift in an opposite direction. This puts them into the channels A and B with 180 degrees phase shift between them (like Scheiber but without phase-shifting of either by the full 180 degrees).

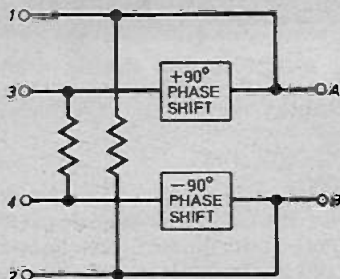

Fig. 7. Schematic of the QS encoder adopted by Sansui.

To decode the two channels A and B the decoder of Fig. 8 is used. This is virtually a mirror image of the encoder. The inputs and outputs 1, 2, 3 and 4 are usually left front, right front, left back and right back and like all matrix systems it suffers from some irreversible loss of separation between channels. In other words some sounds present in one input channel will appear not only in the corresponding output channel, but also in some adjacent channels.

This means loss of directional accuracy in the final result and Sansui tackle the problem by making the matrix circuit of the coders (represented in Figs. 7 and 8 by simple resistors, but in fact much more complex) variable under the control of the signals that they are handling.

In other words the Sansui QS decoder matrix is active rather than passive and what it does is vary in such a way as to accentuate the directionality of the loudest signal.

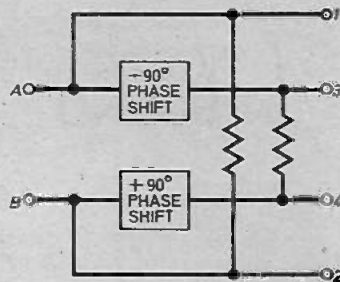
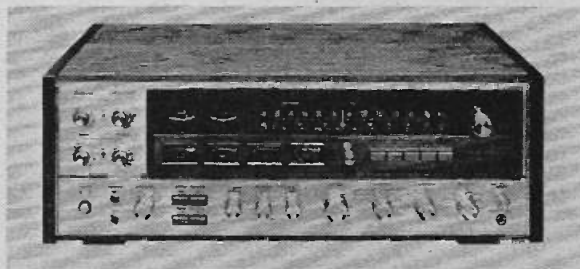

Fig. 8. Schematic details of the QS decoder.

Now CBS have proposed different ways of tackling the same problem which involves using a logic system to actuate automatic gain control amplifiers and push up the level of which ever channel contains the prominent signal. It is also interesting to note that a similar technique, using automatic gain control amplifiers, was also suggested by Peter Scheiber. Thus both CBS and Scheiber artificially enhance the directionality of their results in a manner quite different from that used by Sansui. Sansui have christened their enhancing circuitry a "vario matrix" and CBS refer to their enhancing circuitry as "logic control". The simplest Sansui (QS) and CBS (SQ) decoders often incorporate no vario matrix or logic circuitry and work with only the basic matrix essentials.

There are in fact fairly substantial differences between the basic essentials of the Sansui and CBS matrixing techniques. Whereas Sansui (like Scheiber) rely mainly on differences in level the CBS system relies more heavily on differences in phase.



The Sansui QRX5500 quadrasonic receiver. Can also be used for discrete quadrasonic.

## CBS SQ MATRIX

The basic working of the CBS matrix system is shown in Fig. 9. Of the usual four inputs to the encoder (1, 2, 3 and 4) signals 1 and 2 are each phase shifted by 45 degrees. Signals 3 and 4 are each split into two equal halves and one half of each split signal is phase shifted by 90 degrees. Signal 1 (which has been shifted by 45 degrees), the unshifted half of signal 3 and the shifted half of signal 4 are all fed to a first adding circuit.

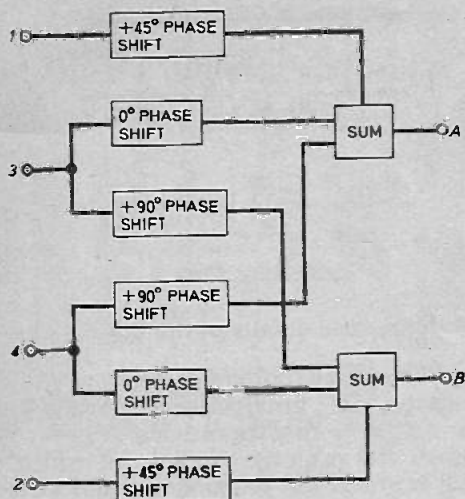

Fig. 9. The basic details of the CBS matrix (SQ encoder).

The signal 2 (which has been shifted by 45 degrees), the unshifted half of signal 4 and the shifted half of signal 3 are all fed to another adding circuit. Some of the signals are reduced in level before adding.

One adder produces channel A and the other adder produces channel B. Channels A and B are used as an ordinary stereo pair for transmission or recording and are split into four signals again by a decoder, as shown in Fig. 10.

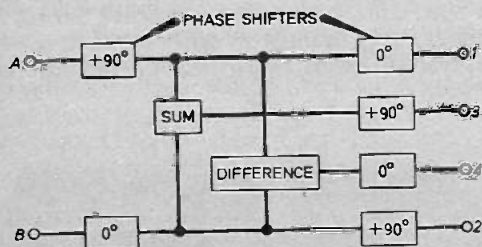

Fig. 10. The SQ decoder basics.

The signal from channel A is phase shifted by 90 degrees and the signal from channel B is left untouched at this stage. The two signals are then added and subtracted to produce a sum signal and a difference signal.

The sum signal is shifted by 90 degrees, amplified and fed to a loudspeaker as channel 3. The difference signal is amplified and fed without any change (i.e. unshifted) to another loudspeaker as channel 4. Simultaneously the signal from channel A is fed direct to an amplifier and loudspeaker as channel 1 and the signal from channel B is phase shifted through 90 degrees and fed via another amplifier to a loudspeaker as channel 2.

As we have already seen, it is usual to make signal 1 the left front signal, signal 3 the left back, signal 4 the right back and signal 2 the right front.

Although there is no need to follow and understand too clearly the exact phase shifting involved, the important point to grasp is that the signals have all been given various relative phase shifts so that when mixed together they have boosted or cancelled each other out in varying amounts. Remember what we established right at the beginning of Part 1, namely that similar signals which are in phase boost each other and similar signals which out of phase cancel each other out, with in between circumstances producing in between results. This guiding principle applies to both the Sansui and CBS systems, albeit somewhat differently.



The Sony SQD2020 SQ matrix 4-channel decoder. Also handles CD4, regular matrix and stereo.

## PHASE SHIFTS

We have seen now how the major systems currently on the market function. Although the systems differ, they have in common a reliance on artificial phase shifts to enable the decoder to unscramble what was coded. We have seen that the four input signals 1, 2, 3 and 4 are usually respectively left front, right front, left back and right back and this choice is not purely random.

For the encoded signals A and B to be stereo and mono compatible, one must have the left front (1) as its dominant component and the other must have the right front (2) as its dominant component. For proper stereo reproduction these must also be predominantly in phase and thus most of the relative phase shifting is carried out on the rear channels (3 and 4).

On mono or stereo playback the out of phase signals either get swamped or cancel each other out, or appear at low level from the front loudspeakers. But, and this is a very important point, those out of phase signals are always there in the stereo pair (A and B). What's more, they can very easily be extracted from the stereo pair and fed to a pair of rear speakers by anyone with an ordinary stereo set up who is willing

to buy an extra pair of loudspeakers and a length of speaker wire.

## HAFLER'S PROPOSAL

The trick is to go back to that original proposal made by David Hafler for producing difference signals. He suggested that this could be done by connecting an extra loudspeaker across the positive output terminals of the left and right channels of an ordinary stereo amplifier. What the extra loudspeaker produces is sound corresponding to the difference between the left and right channels.

Usually the major part of this difference signal which is reproduced comes from out of phase signals, i.e. signals which are present in both the left and right outputs but are out of phase with each other. Out of phase signals of this type may be present for several reasons.

They may for instance be there because the original recording microphones have picked up echo or ambience from the recording studio or concert hall. Echo or ambience signals are those which have reached the microphones by indirect routes (reflected from the walls, ceiling and back of the hall) slightly after similar sounds which have reached the microphones direct from the orchestra. An extra speaker connected in Hafler fashion will thus tend to reproduce any such ambience signals which are present on a record.

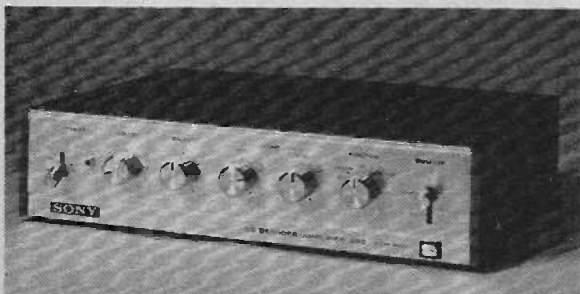

The Sony SQA200 decoder/amplifier 4 x 8 watts.

## EFFECTS OF OUT-OF-PHASE

In practice there is a very startling result. Many stereo recordings are made in large halls and contain, under the in-phase signals, a significant amount of out-of-phase ambience signals, which on an ordinary stereo rig (two front speakers) are just not heard because they are swamped by the direct sounds. But when such sounds are fed to an extra loudspeaker at the rear of the room, they emerge to reproduce the original ambience of the concert hall.

Likewise in some pop recordings, out of phase signals are used for trick effects. Often electric guitars are recorded out-of-phase and thus an electric guitar will sometimes emerge from the Hafler connected extra speaker. This can pro-

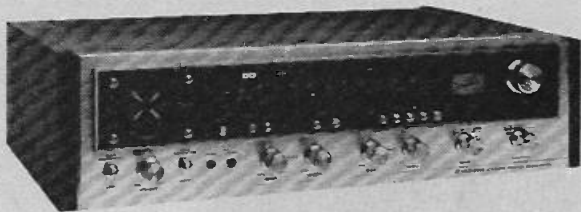

The Pioneer GX747 quadraphonic receiver. Suitable for SQ, Regular matrix, CD4 (discrete) and stereo.

duce an unreal surround-sound effect which can make for exciting listening.

Perhaps most important of all, because the matrix systems described all rely on the technique of putting the rear channel signals *artificially* out of phase into channels A and B (which are what anyone with an ordinary stereo amplifier will be using as their left and right signals) it follows that a Hafler-connected extra speaker will reproduce whatever matrixed signals are out of phase. If the extra loudspeaker is placed at the rear of the room, then it will be producing sounds which were intended to come from the rear. In other words, a Hafler-connected extra speaker will in many respects produce a good pseudo-quadraphonic effect.

In practice there are only a few guiding principles for connecting up an extra speaker and although simply connecting it across the amplifier positive output terminals will do the job well, there are easy ways of doing the job even better. Next month we will look at them.

To be continued

## PLEASE TAKE NOTE

We wish to apologise for a mistake made in the article *Delayed Action Switch* in our February 1975 issue. The operating switch S1 should be a 2-pole push-to-make type and the other contacts wired across the normally open set of relay contacts.

In the article entitled *Quad* in the February 1975 issue, there is an error in Fig. 5. The connection from the wiper of the potentiometer should be to the connection between right-front and left-front loudspeakers such that it is in parallel with the centre loudspeaker.

### CALLING SHEFFIELD AND LOWESTOFT! BRIGHT IDEAS—JULY 1974 ISSUE

Will the undermentioned readers please forward their full address to the Editor so that payment can be made in respect of their contributions to this feature.

M. Renshaw, Sheffield.  
P. Stokes, Lowestoft.



## An effects unit designed for use with electric musical instruments.

**S**TILL one of the most used effects units in the world of "pop music" is the fuzz box. Although this "effect" was one of the first used, its popularity has not waned.

The fuzz box is used most by the lead guitarist but has on occasion been found useful for the bass guitar and organ to produce an exciting and dramatic sound.

The Fuzz Box to be described in this article is simple to build, is inexpensive (compared with commercially available units) and incorporates a footswitch that enables "fuzz" or "straight-through" operation. It is powered by a single PP3 9 volt battery, and since current drain is in the order of 1 milliamp, the battery should last a long time.

### CIRCUIT DESCRIPTION

The complete circuit diagram of the Fuzz Box is shown in Fig. 1, and is seen to be a simple two-stage amplifier incorporating negative feedback between the stages.

Transistors TR1 and TR2 are wired in a d.c. feedback pair configuration giving high gain which is virtually independent of individual transistor gains. Base bias for TR1 is derived from the emitter of TR2 via feedback resistor R2. The biasing has been arranged such that TR1 is biased close to saturation level.

Input is via coupling capacitor C1. For ease of explanation it will be assumed that a small sinusoidal signal of peak amplitude greater than about 10 millivolts is being inputted, see Fig. 2(a).

The positive half cycles of the input waveform cause the transistor TR1 to move further towards saturation and to become saturated on the peaks. The point at which saturation is reached is determined by the amplitude of the

input and the setting of the fuzz control—but more about this later. The result of this is to produce severely clipped sine wave as seen in Fig. 2(b).

The negative excursions of the input waveform may also produce a clipped output if the input signal is of sufficient amplitude, in which case a waveform of that shown in Fig. 2(c) would be obtained.

Note that the signal appears inverted. This is due to the property of a single-stage common emitter amplifier producing a phase shift of 180 degrees.

The single or double-clipped waveform is then directly coupled to the base of TR2 where it is further amplified to produce a double-clipped waveform with very short rise time. The output is approximately a square wave, Fig. 2(d).

The output at the collector of TR2 swings by 9 volts, peak-to-peak. This is too high to be inputted into an amplifier and is attenuated by using a split collector load and taking the output from the junction of R3 and R4. This arrangement attenuates by a factor  $R3/(R3+R4)$  to give a peak-to-peak swing of approximately 600 millivolts which is coupled to the volume control VR2 by C2, functioning as a d.c. blocking capacitor.

The circuit formed by C2 and VR2 is that of a differentiator whose time constant has been designed to produce "spiking" at low frequencies. This enhances the sharpness of the fuzz effect at low frequencies.

**FOR  
GUIDANCE  
ONLY**



**ESTIMATED COST\***  
**OF COMPONENTS**  
including V.A.T.

**£3.00**  
**including case**

\*Based on prices prevailing at  
time of going to press

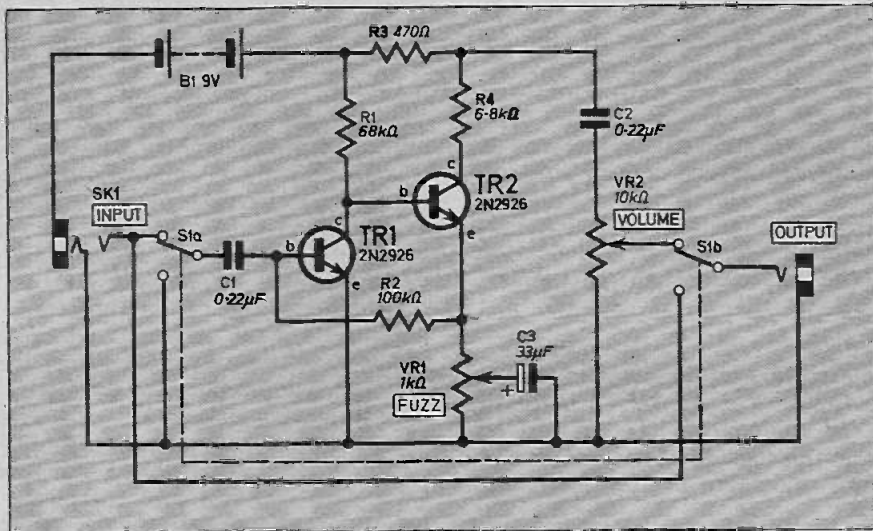

Fig. 1. The complete circuit diagram of the Fuzz Box with built-in footswitch.

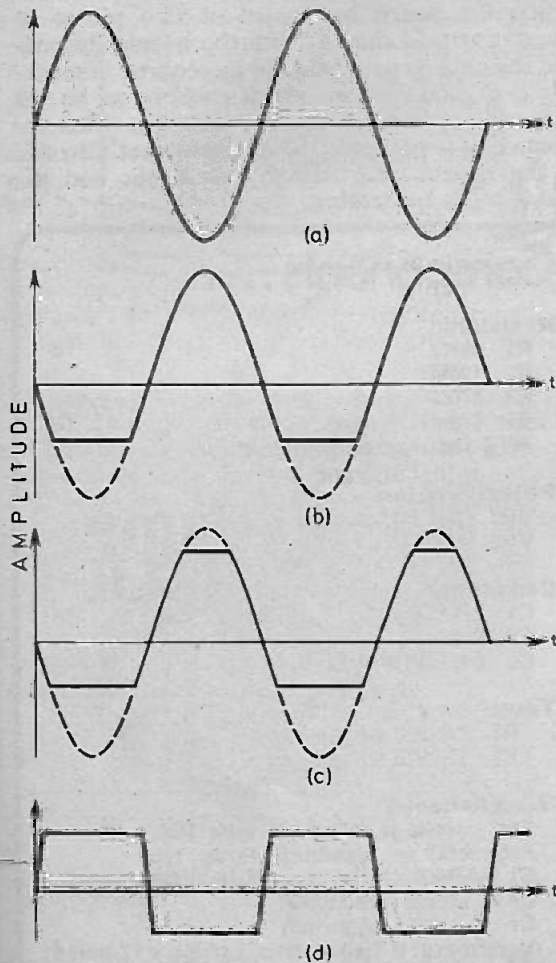

Fig. 2. (a) The input waveform; (b) waveform at collector of TR1; (c) at collector of TR1 if input signal amplitude is increased; (d) output waveform at collector of TR2.

### FUZZ CONTROL

A control over the "quality" or "quantity" of fuzz is afforded by VR1.

Now the a.c. gain of the feedback pair is dependent on the ratio of feedback resistor R2 to the a.c. resistance (impedance) in the emitter leg of TR2.

It can be easily verified that the reactance of C3 is approximately equal to  $5000/f$  ohms where  $f$  is frequency of the input signal.

For  $f=100\text{Hz}$  and  $10\text{kHz}$ , the reactance of C3 is approximately 50 ohms and 0.5 ohm respectively. Therefore, the effect of shunting VR1 or portion of VR1 can dramatically affect the gain of the amplifier. It can also be seen that the higher the frequency, the higher the gain for the same setting of VR1.

As VR1 is turned up, so as more of VR1 is shunted by C3, it has been shown that the gain of the two-stage amplifier is increased, but since limiting (clipping) is evident from the beginning of turning VR1, it is difficult to see how this control further affects the tone of the fuzz. So how does it work?

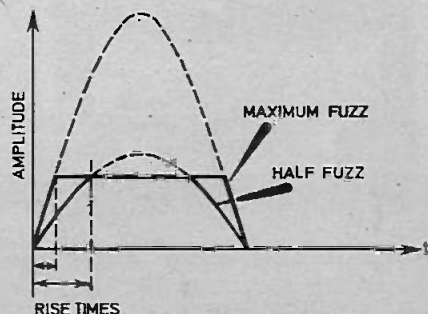

Fig. 3. Shows how the gain of the amplifier pair is proportional to the harmonic content.

Well, when the control VR1 is set for maximum effect, (total shunt), the onset of clipping occurs at a much shorter time (measured from when the signal starts to rise or fall) than when the control is set, say halfway, see Fig. 3. The important observation is that the waveform at the collector of TR2 is much more "square" than when set at say, the halfway position, indicating the presence of higher order harmonics (see *Help E.E. Feb. 74*). It is the latter that determines the harshness of the fuzz effect.

## CONSTRUCTION

The prototype Fuzz Box used a piece of 0.15in matrix Veroboard size 7 strips by 17 holes to secure the smaller components. The layout of the components on the topside of the board, and the breaks on the underside of the board are shown in Fig. 4.

In the prototype, no component board fixing holes were needed, since the commercially available fibreglass case used had slots to accommodate the board. If this type of fixing is not available, the board should be extended to allow a fixing hole to be made.

Begin by making the necessary breaks along the copper strips and then position and solder the resistors and capacitors according to Fig. 4. The transistors should be mounted last of all and a heatsink used to avoid thermal damage.

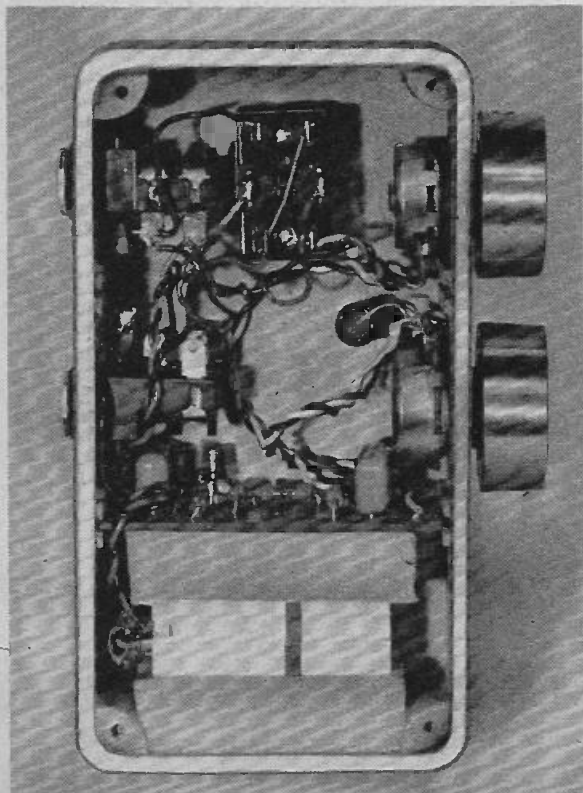

Photograph of the inside of the completed prototype Fuzz Box.

Now attach the five flying leads using adequate lengths to reach the other components.

It is now necessary to prepare the case to mount SK1, SK2, VR1, VR2 and S1. Secure these components to the case and wire up to each other and the component board as in Fig. 4.

Note that there is no battery on/off switch; the battery circuit is made on the negative side by use of an extra earth tag on the input jack socket SK1, the connection between the two earth contacts being made by the earth shank on the jack plug. It is therefore, essential to remove the input jack plug when the unit is not in use so as to prolong the life of the battery.

If the type used in the prototype is not available, a stereo jack socket can be used. In this case, the two rear contacts should be used so that the input jack plug earth shank connects these two contacts and completes the battery circuit on the negative side. Alternatively, an on/off switch can be wired in series with the battery.

The battery is held in position behind the component board by means of two pieces of sponge foam as shown. With the battery in position the bottom panel should be secured in place.

It is a good idea to attach rubber feet to the underside to prevent the unit slipping when the footswitch is operated. The rubber feet also add to the appearance. Attach two knobs and the unit is ready for testing.

## Components . . . .

### Resistors

- R1 68k $\Omega$
- R2 100k $\Omega$
- R3 470 $\Omega$
- R4 6.8k $\Omega$
- All  $\frac{1}{4}$  watt carbon  $\pm 10\%$

### Potentiometers

- VR1 1k $\Omega$  lin. carbon
- VR2 10k $\Omega$  log. carbon

### Capacitors

- C1 0.22 $\mu$ F
- C2 0.22 $\mu$ F
- C3 33 $\mu$ F 10V elect.

### Transistors

- TR1 2N2926 silicon npn
- TR2 2N2926 silicon npn

### Miscellaneous

- SK1 mono jack socket type R26/1 (Re-An Products) or standard stereo type
- B1 9V PP3
- SK2 mono jack socket
- S1 d.p.d.t. foot switch
- Veroboard: 0.15in. matrix 7 strips x 17 holes;
- battery clips to suit B1; knobs (2 off); case (type FB1 E. R. Nicholls); rubber feet (4 off); foam sponge; connecting wire.

SEE  
**SHOP  
TALK**



# FUZZ BOX

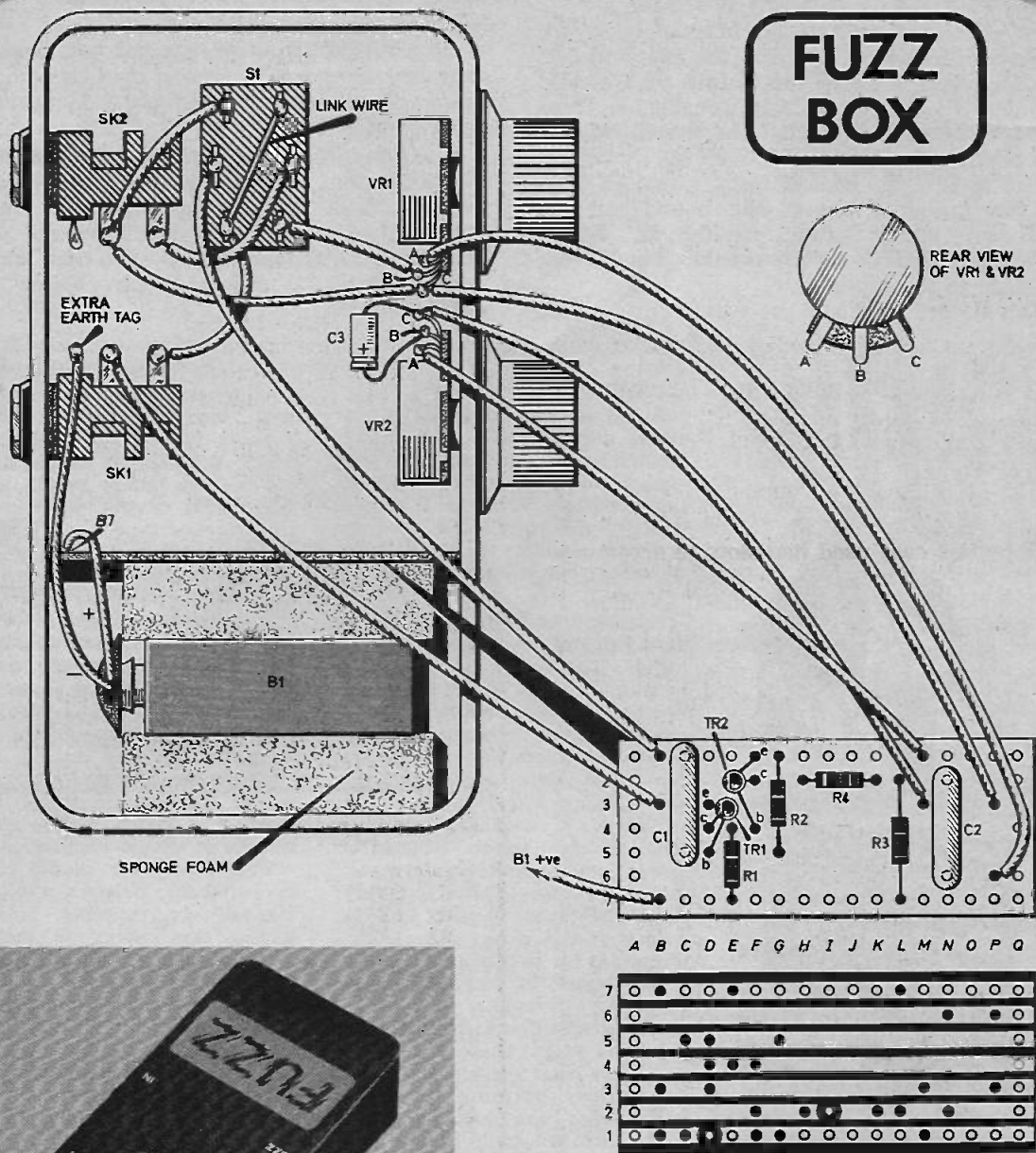

Photograph of the completed unit.

Shown right is a photograph of the component board.

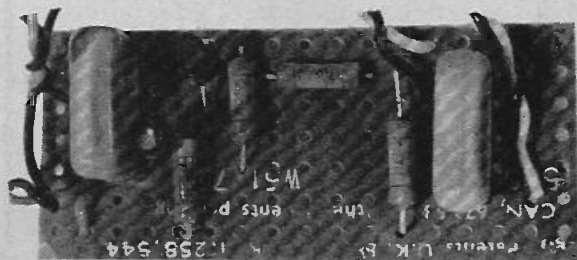

Fig. 4 (above). The layout of the components on the Veroboard and wiring up details to case mounted components.

## IN USE

The electric guitar or other instrument should be plugged in at SK1 and with the gain and fuzz controls turned low; the fuzz output, SK2, should be plugged into an amplifier using a length of screened cable, both ends terminated with a jack plug.

Turn up the gain control slightly, and on playing the guitar a slight fuzz sound, or the unaffected guitar sound should be heard. Depressing the foot switch should change from one state to the other.

With S1 set for fuzz, the fuzz control, VR2,

should be turned clockwise, resulting in a more harsh fuzz.

With VR2 set for the required fuzz tone, the gain control should be set so that the required balance between "straight-through" and "fuzz" is obtained.

When the prototype unit was thoroughly tested to satisfaction, the component assembly was removed from the case and the case cleaned and sprayed with a matt black aerosol paint. The controls and jack sockets were then labelled using Letraset, as shown, to give a neat, professional finish. □



## 'Scope

I am contemplating buying a cheap oscilloscope — possibly secondhand or surplus. Could you advise me as to what would be the minimum features I should look for if it was to be used on projects similar to those published in your magazine?

Advising someone on what is desirable in an oscilloscope is rather like trying to advise a woman about a dress! Everyone has his own opinions. However if one is limited in price (we assume the range £25 to £40) we can be of some help. Invariably you will find that the older type of 'scope is cheaper—the type with circular screen format as opposed to the more modern rectangular shape. Quite honestly the appearance of the unit is irrelevant and screen shape is unimportant for simple applications.

One might be tempted to go for an impressive looking machine with dozens of knobs on the front panel; these are fine if you know what you are doing but can be very confusing to operate unless you have some previous experience. We would suggest you look for a simple unit which has sophistication built into its electronics rather than into its appearance—apart from being easier to use it will probably be more reliable.

Considering the self imposed price restriction we must talk in terms of a SINGLE BEAM 'scope; it should be of medium persistence and should have controls for beam brightness and focus (some surplus types may offer an astigmatism control which is an extension of the focus to get a really sharp spot). The two most important parameters to select on are the range of X-timebase speeds or frequencies and the

sensitivity of the Y-amplifier. A good general purpose instrument will have X-timebase speeds ranging from 100mS per cm to about 1μS per cm with a five or six position range switch and a fine speed control which makes the switched ranges overlap. Such an instrument will cover most circumstances that involve frequencies up to about 1MHz.

The timebase ought to be triggerable. Cheaper instruments will have automatic trigger control but we feel that an overriding manual trigger level control is a very useful feature—even though it makes the unit a little more complex to operate. Having an option for external triggering is a bit of a luxury and is seldom needed in simple applications.

The Y-amplifier should ideally be switchable between a.c. coupling and d.c. coupling, however, having the facility to measure d.c. voltages on an oscilloscope usually puts its price up. Whatever you decide on the latter point you should aim to go for as high an input impedance as possible (greater than 1 megohm) and its sensitivity should give you vertical beam deflections of from 10mV per cm to about 5V per cm at its least sensitive end.

There should be a fine control on this sensitivity which can be switched to a calibrated position—so that you know where you stand. In the absence of a calibrated amplifier there should be an internally generated calibration signal available on the front panel for checking purposes. There should also be vertical and horizontal beam shift controls. The above points are usually embodied in most instruments called "service scopes" as well as many other niceties but we suggest that you consider the above as being MINIMUM requirements—your pocket sets the MAXIMUM!

## Speaker impedance

I have been given a record deck and I have a suitable amplifier which uses two 16 ohm loudspeakers. I only have two 8 ohm loudspeakers. Is there any way of coupling these to the amplifier without causing damage.

Although not an ideal solution you can put each loudspeaker in series with an 8 ohm resistor of suitable power rating to increase their effective impedance. The problem with this approach is that you will half the effective power output into the loudspeaker. Nevertheless if your amplifier provides an output in the range of 5 to 10 watts this should present no major problem for domestic applications.

The resistors you use should have a power rating approximately equal to the channel output power that is quoted for your amplifier and you should remember that they might get warm.

# The Extraordinary Experiments of Professor Ernest Eversure

by Anthony John Bassett

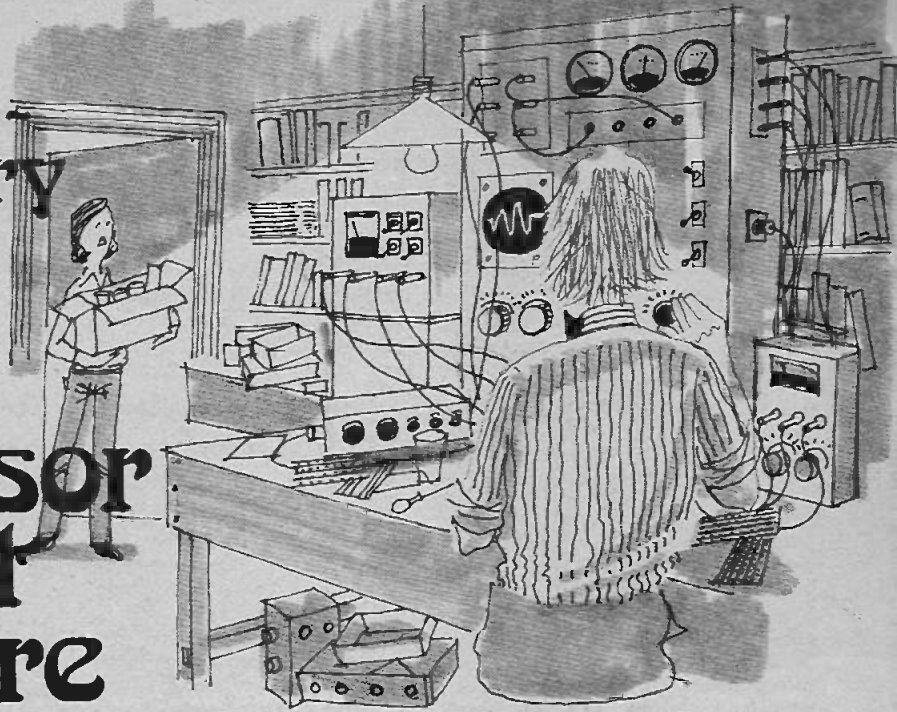

Professor Ernest Eversure, or the Prof. as his friends call him, has been experimenting in electronics for more years than anyone can remember and we thought that you might like to hear of, and perhaps repeat, some of his extraordinary experiments. Anthony J. Bassett recounts some of these experiments every month so why not follow the Prof's work and learn along with young Bob, his friend.

"Would the robot really have harmed us?" asked Bob, back in the laboratory.

"No Bob", replied the Prof, "he has a very comprehensive built-in safety programme to prevent any action which could be harmful to a human being. The programme makes the likelihood of beneficial action many millions of times greater than the likelihood of any harmful action. This means that the actions of the robot are far more likely to save us from danger, than to bring us any harm!"

"Wow!" exclaimed Bob in amazement, "This is fantastic! I did not know that robots could be so good to have around! With his tough metal body, fantastic strength, and all sorts of other mechanical and electronic advantages to help us too!" He looked at the robot with new awe and respect, and as he cast his eye over his mechanical frame, an amazing thought came to him.

"What a pity, Prof," said Bob, "That the robot looks so bulky and mechanical. Would it not be

possible to make him look more like a human being. Then I could take him out for a walk without causing people to be afraid."

"Not yet, Bob," replied the Prof. "There are so many more experiments and improvements yet to be made before we could fit the robot into a human-size body, and replace his code of clicks and whistles with human sounding speech."

"We cannot let him go far out of the laboratory yet, and whilst we are doing our other experiments here in the laboratory, I am able to observe the robot in action, and think about these improvements. So let us carry on with the next experiment!"

Bob already had most of the necessary materials on the laboratory workbench, ready to make an experimental mono gramophone pick-up using a vibration-sensitive graphite line.

"The first prototype we will make will only play in mono," said Bob, "because a stereophonic pick-up is somewhat more complicated to build."

"Yes," agreed the Prof, "But if we use a stereo-compatible stylus, we will be able to play both mono and stereo records quite readily, and maybe we could make a stereo pick-up later."

"Most commercial pick-ups," explained the Prof., "Consist of a thin strip of a special crystalline material, or of a special polarised ceramic, which is sensitive to twisting or bending. The vibrations from sound waves which pass from the stylus into the crystal or ceramic strip when a record is played, are converted into corresponding electrical signals by a special property of the material called "piezoelectricity". This property does not concern us greatly in this experiment as we are going to replace the special material with a strip of plastic which carries a vibration-sensitive graphite line."

Bob had already, in his ardent quest for knowledge, taken apart a number of faulty gramophone cartridges to examine them, and attempt, often unsuccessfully, to effect repairs. He had seen inside them the thin slices of crystal or ceramic.

"To make a pick-up of the size used inside most cartridges is quite a delicate job", remarked the Prof., "so I would suggest you start by making a prototype of somewhat larger size."

The strips inside gramophone

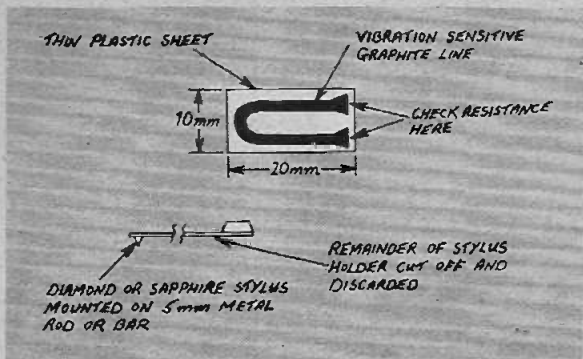

Fig. 1. The Prof's design for a simple mono record pick-up.

cartridges are often less than 3mm wide by 12mm long. The Prof. quickly sketched a design for a vibration-sensitive plastic strip (see Fig. 1). This uses a piece of plastic film considerably thicker than the foil used for microphones in the previous experiment, though still less than 1/2mm. thick. A suitable material is sold at hobby shops, and at some motorcycle stores, for making windows for model vehicles, or for motorcycle sidecars.

### MAKING THE EXPERIMENTAL PICK-UP

Bob carefully cut out a piece of the plastic sheet 10x20mm, and roughened the surface using medium emery or sandpaper all over one side. Then, with a soft graphite pencil (5B or softer) he drew a pencil line near to one edge, and, drawing a U-turn near one end, brought the pencil line back to the other end.

He made sure that the ends of the pencil line did not come too close together. By means of a multimeter, he measured the electrical resistance of the pencil line from end to end by laying the probes of the multimeter close to, but not touching each other, on the ends of the pencil line.

Like the first microphone which he had made during the previous series of experiments, Bob decided to aim for a resistance of about 10 kilohms. At first the measurement was above 10 kilohms, but as Bob rubbed more graphite onto the line, the resistance gradually fell.

Next Bob took a replacement gramophone stylus with a single point. The stylus point, which is made of sapphire or diamond, is

mounted in a short length of thin metal rod or bar whose function is to support it, and to carry the sound vibrations to the sensitive part of the pick-up. Bob decided to cut off most of this metal, to leave a piece about 5mm long with the stylus mounted on it.

With a strong pair of side-snips Bob prepared to cut the metal to length and, as he made the cut—with a snap! the precious stylus flew away across the laboratory. "Oh no!" wailed Bob, "That stylus cost me 40p! I'll have to wait until next week before I can afford another!"

However a few moments later the Prof. came across and presented Bob with the lost stylus. "The robot recovered this for you," he told Bob, I have examined it with a microscope and can see that it has not been cracked or chipped. You should be a bit more careful when using those cutters, as even small pieces of cut metal can be dangerous, especially if they get inside the equipment!"

"Sorry, Prof!" apologised Bob ruefully, "I'll try to see that it doesn't happen again."

Using a tiny blob of quick-setting epoxy adhesive, he fastened the stylus to the edge of the plastic film, together with the short piece of metal, as shown in Fig. 2. Whilst waiting for the epoxy to set, the stylus was held in place by means of a small U-shaped piece of Plasticine or Bostik Blu-Tack, which could be easily removed when the epoxy had set hard.

A further quantity of adhesive was used to fasten the plastic film to a mounting block in order to mount it in the pick-up arm.

The mounting block can be a small piece of wood or insulating material cut to fit in the pick-up arm in place of the usual cartridge, or else the plastic body of an old cartridge can be used. Only a small portion of the length of the film was glued, about 5mm, as shown in Fig. 2, leaving most of the film free to pick up vibrations.

When the epoxy adhesive had set hard, Bob attached the mounting block to the arm of the record player deck and made certain that the stylus was located at the correct angle (Fig. 2). With conducting cement, he connected the pick-up to two thin flexible wires which ran through the pick-up arm to a tag-strip below the turntable.

From this tagstrip he connected the pick-up to the same energiser circuit as he used in the microphone experiments, and from there to the high-gain input of an audio amplifier. (The energiser circuit will be shown again

Fig. 2. Construction of the pick-up made by Bob.

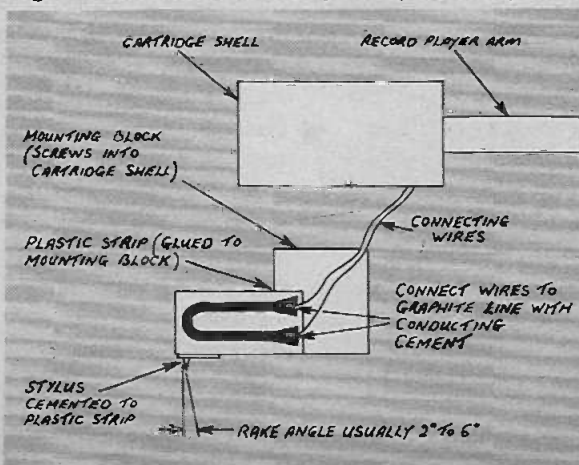



# Now there's Doram, you need never wait for electronic components.

## 7-day service.

Buy the new Doram catalogue and you could have your components within 7 days of our receipt of your order.

If you don't, you'll have your money back and no questions asked.

What you won't get is a tedious wait. Which goes on. And on. And on. And on. You know just where you are with Doram.

## Millions of components.

Doram is a brand-new deal for serious amateurs. It's a complete door-to-door components service operated by mail order.

You buy the Doram catalogue for 25p (that's a yearly reference book for the price of a pint) and then you order from it.

We're big enough to offer you stocks of millions of components on over 4,000 product lines.

And so confident of our service that if we can't supply the part you want within 7 days of receiving your order, we'll give you your money back. Immediately.

## No-quibble guarantee.

It's just about impossible to buy a defective part from us. Because our checking is so pains-taking.

But even if the unthinkable does happen—and you're unlucky—then we'll still make you happy quickly.

Because we offer a no-quibble replacement part service.

And our guarantee is guaranteed by the fact that we belong to the biggest electronics distribution Group in Britain.

## All branded goods.

All goods supplied are branded goods. Made by big-name manufacturers like RS, Mullard, SGS-ATES, Ferranti, Siemens etc.

Doram brings the amateur the sort of service only professionals have enjoyed before.

So don't delay. Use the coupon. Send today for your first Doram catalogue. It can make your life a whole lot easier.

For 25p that can't be bad, can it?

**I ENCLOSE 25p.\* PLEASE  
SEND ME THE NEW DORAM  
CATALOGUE.**

Name \_\_\_\_\_

Address \_\_\_\_\_  
\_\_\_\_\_  
\_\_\_\_\_

**Doram Electronics Limited,**  
PO Box TR8,  
Wellington Road Industrial Estate,  
Wellington Bridge, Leeds LS12 2UF.

\*This will be refunded on orders of £5 (less VAT) or more received by us before March 31st, 1975.

**DORAM**  
E.E. 3/75.

next month in connection with the electronic kazoo experiment).

Before attempting to play a record, Bob set the stylus pressure to about 6 grams, and, with the turntable stationary, carefully set the stylus down on a sheet of flat plastic. He examined it as he did this, to ensure that the plastic pick-up-strip did not bend unduly, which might cause the stylus to dig in and damage the record.

He then reduced the pressure to about 4 grams. Making sure that the amplifier volume control was at minimum setting, he switched on the energiser and amplifier circuits, put a record on to the turntable, lowered the stylus carefully onto it and gradually turned up the volume until the sound of the record could be heard from the loudspeaker.

"It sounds a little 'honky' to me," remarked the Prof., examining the pick-up. He suggested a remedy, which was to smear the plastic film with a small quantity of high-viscosity grease, such as R.S. core-locking compound, Rocol Kilopoise high viscosity grease or similar material.

"To increase the viscosity still further, this material may be mixed to a paste with Aerosil silica powder, which makes it even more effective. The 'honky' sound is caused by resonance, and the high-viscosity material will damp this down considerably."

(Aerosil powder can be obtained from car-body and fibre-glass specialists. It is a very fine powder, and the dust from it should not be breathed into the lungs).

He carefully mixed a small amount of high-viscosity grease with some Aerosil powder, being careful not to raise a dust of Aerosil powder into the air, and applied a thin smear of this paste to the surface of the film opposite the graphite. Then he tried the record again.

"I see," said Bob enthusiastically, "It sounds a lot better now!" He adjusted the volume and tone controls to give the best sound.

"Some of my friends at school have old gramophone turntables," he remarked, listening to the sound of the record, "and they will be very interested in this type of pick-up to help get them going again! It's ideal for listening to pop records."

(For this experiment, the reader should ensure that the amplifier used is isolated from the mains by a transformer, and is properly earthed for safety. Most amplifiers have the necessary transformer built in, but some of the cheaper record-players do not, so it is unsafe to attempt to use the amplifier from one of these.)

Just then the turntable slowed right down, went into reverse and began to play the record

backwards, faster and faster. Both the Prof. and Bob goggled in amazement. Then they noticed that other strange things were happening in the laboratory. The clocks were running rapidly backwards, electricity power cables were writhing about the floor, walls and ceiling like snakes, as strange convulsions passed through them. Solid steel rods and pipes began to bend crazily, and a length of railing suddenly wrapped itself several times around the Prof's waist and lifted him high into the air!

It seemed that the Prof's experimental robot was powerless to help, as he had fallen into a heap on the laboratory floor, and appeared to be busily attempting to tie his metal limbs and body into knots.

Suddenly the laboratory door burst open, and in strode a strange figure. On his head was an enormous helmet of metal and plastic, covered in a variety of strange shapes, bent and coiled in all conceivable ways and directions. Between the aeriels danced and crackled a continuously changing series of fat electric sparks, discharges, and balls of fiery energy.

"Oh, no!" groaned the Prof., viewing the grotesque apparition from his uncomfortable vantage point near the ceiling, "I can see our visitor is desperately in need of assistance!"

Continued next month.

continued from page 142

If regeneration cannot be obtained, C1 may need to be unscrewed further. Regeneration, as well as band coverage, is influenced by the positions of the coil cores, though these can probably be about level with the top of the formers. Should TR1 have relatively poor efficiency, an extra half turn or turn might be necessary between C and D, although no modification here should prove necessary.

A little experiment will soon show how the regeneration control VR1 functions, and the best aerial socket and setting for C1 for the aerial in use.

Many amateur transmissions should be heard on 80m, in particular at week-ends. The amateur bands which the receiver can tune are 1.8-2.0MHz (commonly called top band, or 160 metres); 3.5-3.8MHz (or 80 metres); 7.7-1MHz (or 40 metres) and 14.14-35MHz (or 20 metres). For c.w. reception, adjust VR1 and C3 for the best heterodyne tone. For s.s.b. signals, have VR1 in a similar position for that required for

c.w., and adjust C3 carefully to resolve the transmission. If it is too strong, unscrew C3.

Very many ordinary short-wave broadcasts can be heard on the 25, 31m and other bands. The best frequencies depend on the time of day and other factors, and will soon be found. □

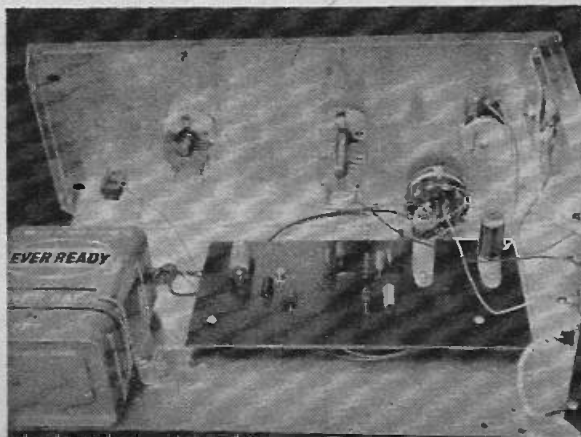

# look! electronics really mastered

... practical  
... visual  
... exciting!

no previous knowledge  
no unnecessary theory  
no "maths"

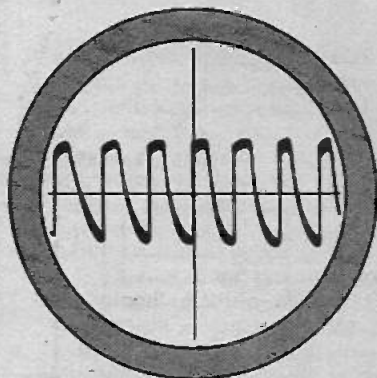
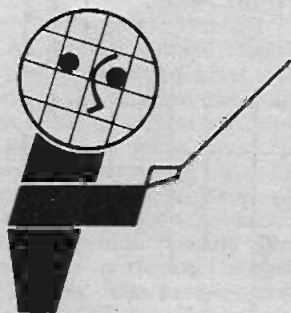

RAPY

## BUILD, SEE AND LEARN

step by step, we take you through all the fundamentals of electronics and show how easily the subject can be mastered. Write for the free brochure now which explains our system.

### 1/ BUILD AN OSCILLOSCOPE

You learn how to build an oscilloscope which remains your property. With it, you will become familiar with all the components used in electronics.

### 2/ READ, DRAW AND UNDERSTAND CIRCUIT DIAGRAMS

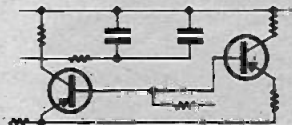

as used currently in the various fields of electronics.

### 3/ CARRY OUT OVER 40 EXPERIMENTS ON BASIC ELECTRONIC CIRCUITS & SEE HOW THEY WORK, including:

valve experiments, transistor experiments amplifiers, oscillators, signal tracer, photo electric circuit, computer circuit, basic radio receiver, electronic switch, simple transmitter, a.c. experiments, d.c. experiments, simple counter, time delay circuit, servicing procedures.

This new style course will enable anyone to really understand electronics by a modern, practical and visual method—no maths, and a minimum of theory—no previous knowledge required. It will also enable anyone to understand how to test, service and maintain all types of electronic equipment, radio and TV receivers, etc.

**FREE** POST NOW for BROCHURE

or write if you prefer not to cut page

To: **BRITISH NATIONAL RADIO & ELECTRONICS SCHOOL**, Dept. EEL 35, P.O. Box 156, JERSEY. Please send your free brochure, without obligation, to:

we do not employ representatives

NAME

**BLOCK CAPS**

ADDRESS

PLEASE

**special free gift also to all our students**



I.L.P. (Electronics) Ltd

# SHEER SIMPLICITY!

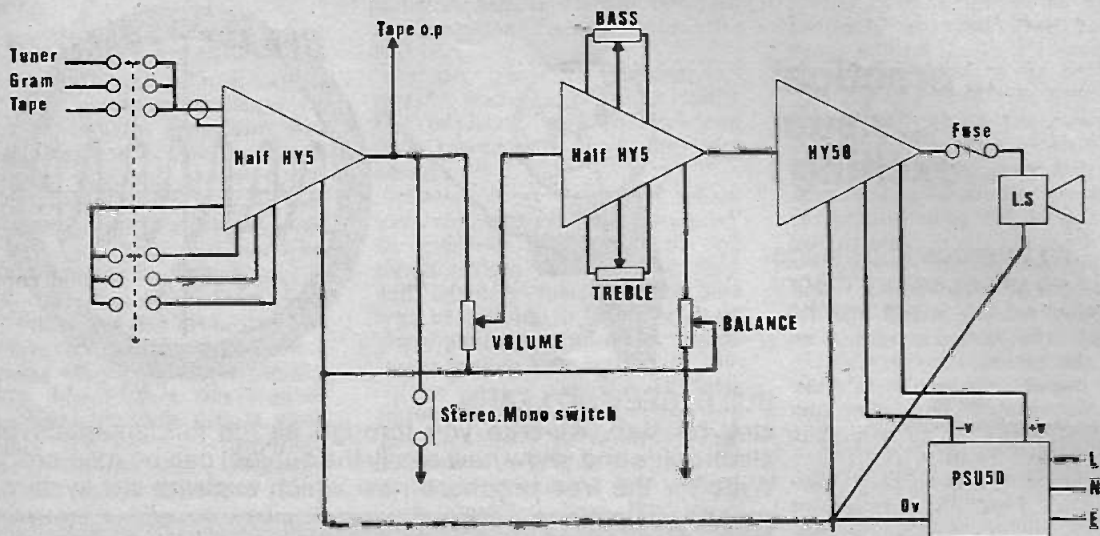

MONO ELECTRICAL CIRCUIT DIAGRAM WITH INTERCONNECTIONS FOR STEREO SHOWN  
POWER CONNECTIONS FROM PSU50 TO HY5 NOT SHOWN FOR CLARITY OF DIAGRAM

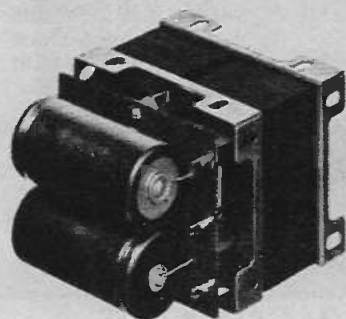
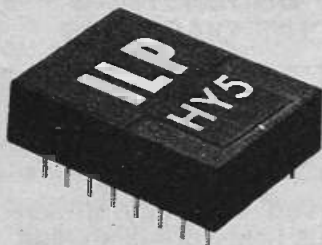

The HY5 is a complete mono hybrid preamplifier, ideally suited for both mono and stereo applications. Internally the device consists of two high quality amplifiers—the first contains frequency equalisation and gain correction, while the second caters for tone control and balance.

#### TECHNICAL SPECIFICATION

Inputs: Magnetic Pick-up 3mV RIAA; Ceramic Pick-up 30mV; Microphone 10mV; Tuner 100mV; Auxiliary 3-100mV; Input Impedance 47kΩ. Outputs: Tape 100mV; Main output 0db (0.775V RMS). Active Tone Controls: Treble ± 12db at 10kHz; Bass ± 12db at 100Hz. Distortion: 0.5% at 1kHz. Signal/Noise Ratio: 68db. Overload Capability: 40db on most sensitive input. Supply Voltage: ± 16-25V.

**PRICE £4.50 + 36p VAT**  
P. & P. free

The HY50 is a complete solid state hybrid HI-FI amplifier incorporating its own high conductivity heatsink hermetically sealed in black epoxy resin. Only five connections are provided, input, output, power lines and earth.

#### TECHNICAL SPECIFICATION

Output Power: 25W RMS into 8Ω. Load Impedance: 4-16Ω. Input Sensitivity 0db (0.775V RMS). Input Impedance: 47kΩ. Distortion: Less than 0.1% at 25W typically 0.05%. Signal/Noise Ratio: Better than 75db. Frequency Response: 10Hz-50kHz ± 3db. Supply Voltage: ± 25V. Size: 105 x 50 x 25mm.

**PRICE £5.98 + 48p VAT**  
P. & P. free

The PSU50 incorporates a specially designed transformer and can be used for either mono or stereo systems.

#### TECHNICAL SPECIFICATIONS

Output voltage: 50V (25-0-25V). Input Voltage: 210-240V. Size: L.70. D.90. H.60mm.

**PRICE £6 + 48p VAT**  
P. & P. free

## TWO YEARS' GUARANTEE ON ALL OUR PRODUCTS

I.L.P. Electronics Ltd.  
Crossland House,  
Nackington, Canterbury  
Kent CT4 7AD

Tel (0227) 63218

Please supply, .....

Total Purchase price .....

I Enclose, Cheque  Postal Orders  Money Order

Please debit my Access account  Barclaycard account  EE1

Account number .....

Name & Address .....

Signature .....



# DOWN TO EARTH

By GEORGE HYLTON

"An audio amplifier circuit I want to build specifies a 10 $\mu$ F, 12V capacitor. Can I substitute a 15 $\mu$ F, 10V one?"

The answer depends on the way in which this particular capacitor is used in the circuit. Sometimes the capacitance is the critical factor, sometimes the voltage rating must be above a certain level. The 10 $\mu$ F, 12V capacitor of the amplifier circuit is probably an "electrolytic" and with this type other considerations such as leakage and a.c. current may enter the picture.

The amplifier circuit on this page illustrates some of the typical situations. Let's take a look at the capacitors in it.

The job of C1 is to block d.c. If it wasn't there, plugging a low-resistance device (such as a magnetic pickup) into the input socket (now connected directly to the base of TR1) would short out R3 and so remove the bias voltage for TR1, preventing it from working. Capacitor C1 avoids this, but of course it has to allow audio signal currents to pass freely into the amplifier, and this fixes its capacitance, because too low a capacitance causes bass cut.

## LEAKAGE

Actually C1 is a much more tricky component than you might

think. As the d.c. voltage "flags" on the diagram shown, C1 has only 1.7V across it. A capacitor with a rated working voltage of 2.5V would seem to be quite adequate. Yet some designers might specify a component with a working voltage of 12V or more. Why? Because "electrolytics" leak. That is, they allow a certain amount of d.c. to flow. This leakage current increases with voltage, temperature and age.

A component with an initial leakage of say 1 $\mu$ A may, when old and warm, have a leakage of 20 $\mu$ A. Thus as much as 20 $\mu$ A might flow when a magnetic pickup is plugged in. This could easily upset the biasing of TR1.

Fortunately the leakage falls very sharply as the voltage is reduced. So by using a capacitor with a much higher rated voltage than the actual voltage in the circuit it is possible to avoid trouble.

You can see that it's probably all right to substitute a 10V for a 12V capacitor here, so long as it's a new component, since the voltage rating is still well above the actual circuit voltage. As for the capacitance, it's nearly always permissible, with electrolytics, to substitute a near value. This is because the tolerance on the

cheaper sorts of electrolytic is so wide anyway that they are never used in positions where the capacitance is critical. (This may not apply to tantalum capacitors, whose capacitance is often specified to close tolerances such as plus or minus 10 per cent.) Assuming C1 to be the usual cheap miniature aluminium electrolytic, it would be safe to substitute 15 $\mu$ F, 10V for 10 $\mu$ F, 12V.

## BYPASS CAPACITOR

Emitter bypass capacitor C2 is a simpler proposition. A typical value would be 100 $\mu$ F, 6V. Leakage is relatively unimportant since R1 is low and probably passing 1mA of collector current anyway, which is large compared with even say 100 $\mu$ A of leakage. A rating of 2.5V is good enough here, since there's only 1V in the circuit and no leakage problem.

Interstage coupler C3 presents a more interesting case because, by now, the audio signal, having been amplified by TR1, may add significantly to the d.c. voltage. The actual d.c. voltage is only 3.5V, since the 5V on one plate is offset by the 1.5V on the other. Many designers, to be on the safe side, would specify a rating equal to the supply voltage (here 12V). This takes care of any leakage problem too.

Decoupling capacitor C4 has 8V across it, but if something goes wrong with the circuit it may get the full voltage supply of 12V, so a rating of at least 12V is advisable. Any rating above this will do, of course.

Our first non-electrolytic, C5, typical value 10nF (0.01 $\mu$ F), is in a circuit position where it could have a significant high frequency cut effect, so it is advisable not to depart much from the specified value. What is not obvious is that this capacitor should have a high voltage rating. If the amplifier is overloaded by large audio signals or hum, TR2 may be suddenly cut off from time to time. The inductance of the output transformer then behaves rather like a shocking coil or ignition coil and generates large voltage impulses which C5 must withstand. The designer might specify a 250V d.c. working metallised polyester capacitor, of 20 per cent tolerance.

continued on next page

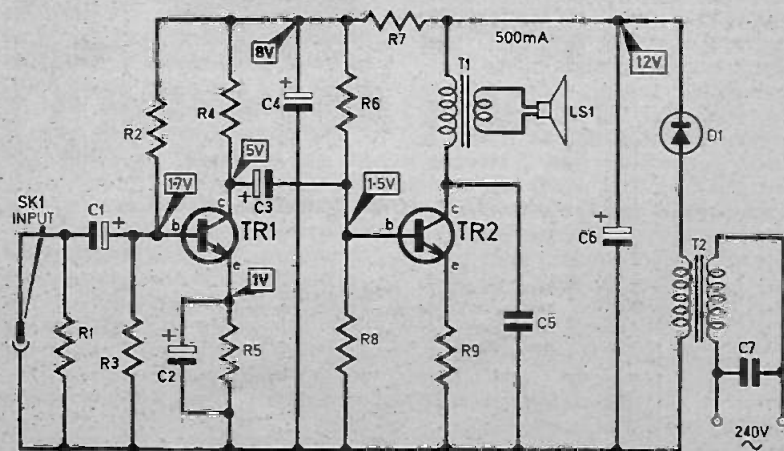

Fig. 1. A typical mains-powered amplifier.

## SMOOTHING

Smoothing capacitor C6 (typical value 3300 $\mu$ F) must be rated at 1.5 times the supply voltage (i.e. 18V) or more, in case of voltage surges. Using a low-voltage component here may result in an explosion! It must also be a large component because it has to pass a lot of mains frequency ripple current and miniature capacitors may not be adequately rated for

this. (Assume the ripple current is the same as the d.c., in this case 500mA). Substituting a smaller electrical capacitance such as 2200 $\mu$ F may increase the mains hum: a larger value such as 4700 $\mu$ F may be an improvement.

Mains r.f. interference suppressor C7 must be a special type for the job, rated at 270V or 300V a.c. 50-60Hz. Never take chances with the mains.

You can see from all this that

Britain and there are numerous solvents that will serve its purpose in domestic use that are far less dangerous to the user.

Benzine is one of these, its greatest risk in ordinary use being from skin irritation, and care in use will avoid this—if it is to be handled for long wear rubber gloves.

I do endorse Mr. Hartley's recommendation of lighter fluid as a general solvent and cleaner; I have been a railway modeller for some 25 years and have always used it for cleaning the small mechanisms of model locomotives and the like. It does not quickly attack motor winding varnish or various plastic parts and does remove oils, greases and dirt with swift efficiency, especially from parts not readily accessible to manual cleaning.

I have also used it for cleaning switch contacts, wipers, potentiometer tracks and the like without any detriment at all.

Not least of all it is low in cost and obtainable from the tobacconist round the corner whilst some of the proprietary "Switch Cleaners" need a journey to the radio components shop if there is one within miles. Moreover when trying these on railway models that include polystyrene I found that some popular ones dissolve the plastic and that rules them out for my main hobby!

Another solvent which should be avoided if at all possible is carbon tetrachloride as if this is used in a warm room it removes oxygen from the air. It was once thus popular as a fire extinguisher but Manchester Fire Service told me some years ago that appliances using CTC are no longer allowed.

If readers are not sure whether they have benzene or benzine, smell the fluid briefly. Benzene has an almost sickly sweet odour whereas benzine in lighter fluid has a markedly pungent odour.

there's more to capacitor ratings than meets the eye. Three general hints on capacitor substitution apply to most audio circuits:

1. At least the stated voltage. Higher is always safe.

2. For electrolytics, at least the stated capacitance. Higher is usually suitable.

3. For non-electrolytics, get the capacitance right, and use your common sense about the voltage rating.

Benzene was not long ago retailed as "Hasyco P F" but so far as I know was withdrawn from the market owing to its dangers; however, if any is found or a reader has purchased any in the past, get rid of it promptly.

R. C. Ormiston-Chant,  
Manchester,  
Lancs.

## Communicator Oscillation

After constructing the 2 Way In-House Communicator I find that on switching on the set, I am getting oscillation at the same frequency or almost the same as that caused when the "CALL" button is pressed.

I have checked the set over and find it as in your drawing in the Sept. '74 issue.

Could you please advise me as to the possible cause.

A. R. Leng,  
Cleveland,  
Yorks.

The oscillations you (and others) are experiencing is most likely due to feedback through the power supply line as a result of the battery internal resistance causing a significant voltage drop under load.

It was assumed that reservoir capacitor C6 was of sufficient capacity to eliminate this effect by holding the supply voltage constant. This value was found satisfactory in the prototype.

The oscillations should cease if C6 is increased to about 500 microfarads.

Alternatively, the gain of the first stage can be reduced by inserting a preset potentiometer (value about 100 ohms or greater) wired as a variable resistor in the line connecting the emitter of TR1 to S3b. This will reduce the volume and should be adjusted for maximum volume without oscillation.

Everyday Electronics, March 1975

# READERS' LETTERS

## I Before The E

Mr. Manning's strictures on the use of lighter fluid (*Readers' Letters Jan. '75*) as a cleaner and degreasant rest on a spelling error in the letter from Mr. Hartley (*Bright Ideas, Oct. '74*).

Whilst Mr. Manning is quite right about the danger from benzene (benzol, benzoline) and it is certainly carcinogenic, I am advised by a well known manufacturer of lighter fluid that benzine is the petroleum spirit used in that.

Benzene is an aromatic spirit commonly obtained by distilling coal tar. Benzine is an aliphatic spirit occurring during the breakdown of petroleum and is closely related to toluene and ortho-xylene both of which are commonly used as solvents in adhesives and similar.

Benzene is not merely carcinogenic in the long term, often so long term that the cause of the carcinoma is not suspected, but it is very toxic when inhaled as a vapour and highly toxic (i.e. more so) when absorbed by the skin. A concentration of only 10 mg per litre can cause serious illness after little more than one hour in many people. Headache and nausea is followed by paralysis and congestion of the lungs given long enough exposure.

I am told by my local pharmacist that for these reasons benzene is no longer sold to the ordinary person by most pharmacies in

## QUALITY STEREO SOUND.

ALMOST **1/2 PRICE OFFER!** SOLENT AUDIO SYSTEM

MADE TO SELL AT  
DOUBLE THE PRICE  
IN CABINET FORM  
OUR PRICE **£49.95**

**£5  
down**

\*Stereo Tuner Amplifier chassis with AM/FM radio covering long medium short and Stereo FM wavebands. Separate Base and Treble controls. 30 watts total power output (frequency response 25-20,000 Hz) Tape record and playback facilities. Dimensions 18" x 8 1/2" x 3 1/2". The very latest BSR automatic record deck with cue and pause control. Two matching elliptical speaker units.

Order early limited stocks available cash price £49.95. Credit Sale £5.00 deposit 9 monthly payments of £5.75 (Total Credit price £56.75). P. & P. £3.00 Send £8.00 today.

Chassis only available for cash at £35.00.

Full 12 months Guarantee.

CALLERS WELCOME.

Stereo headphones supplied with every complete order.

**LEWIS radio**

EE/375 100 CHASE SIDE SOUTHGATE  
LONDON N14 5PL Telephones: 01-882-1644

# Enough books are written about crime, this one stops it.

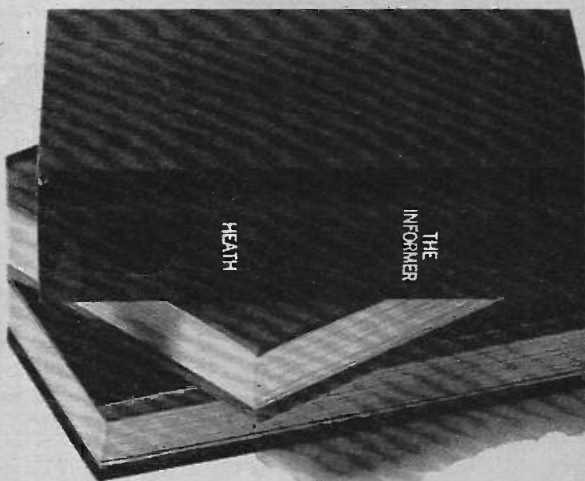

Outside it's a book. Inside it's an ingenious ultrasonic burglar alarm from Heathkit. The GD-39.

A complete kit that can be assembled in only a few enjoyable hours, with the help of a very easy to follow instruction manual.

The GD-39 works by transmitting a silent, ultrasonic signal throughout the room. And continuously monitoring it. Any movement made by an intruder in the room will then automatically produce a change in the signal. Which triggers off a lamp and, thirty seconds later, a remote buzzer that just you hear, or a loud bell.

Enough to scare the living daylights out of a burglar.

For more details, and a bookful of other ideas, just post the coupon now for your free Heathkit catalogue.

Or, if you're in London or Gloucester, call in and see us. The London Heathkit Centre is at 233 Tottenham Court Road. The Gloucester showroom is next to our factory in Bristol Road.

Heath (Gloucester) Limited,  
Dept. EE35, Bristol Road,  
Gloucester GL2 6EE.  
Tel: (0452) 29451.

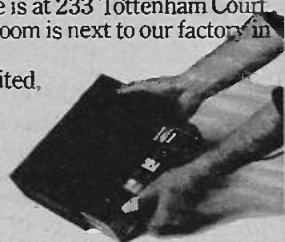

### The GD-39 Ultrasonic Burglar Alarm

To: Heath (Gloucester) Limited, Dept. EE35, Gloucester GL2 6EE. Please send me a free Heathkit catalogue.



Name \_\_\_\_\_  
Address \_\_\_\_\_  
Postcode \_\_\_\_\_  
Dept. EE-35,

Remember easy terms are available with the Heathkit Monthly Budget Plan.

HEATH  
Schlumberger



## become a RADIO-AMATEUR!

learn how to become a radio-amateur in contact with the whole world. We give skilled preparation for the G.P.O. licence

**free!**

Brochure, without obligation to:

**BRITISH NATIONAL RADIO & ELECTRONICS  
SCHOOL**

Dept EEB 35 P.O. Box 156, JERSEY

NAME: \_\_\_\_\_

ADDRESS: \_\_\_\_\_

BLOCK CAPS please



## AUTOMATIC EMERGENCY LIGHTING

Power out days will soon be upon us. Our simple kit makes any light a fail-safe light. Kit containing relay and rectifiers and data, only 55p each. 10 or more 80p each. Suitable case 40p extra.

## PORTABLE CABINET OFFER

A nicely made portable cabinet, soft padded black finish intended for portable stereo system. Dimensions as sketch. With motor board cut out for Garrard SP 25. This was obviously a very costly cabinet originally made for a de-luxe record player. Offered at £1.95 plus £1 carriage free if bought with the Garrard or BSR record decks. £1.95 and £2.95 each respectively.

## LIGHT DIMMER KIT

For dimming up to 250w without heat sink or 750w with heat sink. This comprises, quadric, variable control potentiometer, condenser, resistors, tag strip for mounting and data. Price £1.50. 5 amp Industrial Model £3.30.

## RELAY BARGAIN

Type 600 relay, 2 changeover one open and one closed contact. Twin 500 ohm coils make this suitable for closing off DC 6v, DC 12v, DC 24v or AC mains using resistor and rectifier. £2p each. Resistor and rectifier 20p extra.

## MAINS MOTOR

Precision made—as used in record decks and tape recorders—ideal also for extractor fans, blower, heaters, etc. New and perfect. Snip at 75p. Postaru 20p for first one then 10p for each one ordered. 1" stack motor £1.04. 1 1/2" stack motor £1.20.

## TIME SWITCH

Smith's mains driven clock with 15 amp switch, also notes showing how you can wake up with music playing, kettle boiling or come home to a warm house. Warn of burglars, keep pets warm, halve your heating bills, etc. £2.45.

## MACLAREN THERMOSTAT

Makes and breaks 20A a.c. with the sensor probe coupled by a 2 feet capillary covering range of 10-100°C—complete with large engraved control knob. Price 88p.

## WINDSCREEN WIPER CONTROL

Vary speed of your wiper to suit conditions. All parts and instructions to make. £2.75.

## 6 DIGIT COUNTER

Rectifiable. 440 ohm coil up to 25 impulses per second. Ex-equipment but guaranteed! Best. £2.85 each. 4 digit counter as specified in telephone charge calculator 85p.

## PRESSURE SWITCH

Containing a 15 amp change over switch operated by a diaphragm which in turn is operated by air pressure through a small metal tube. The operating pressure is adjustable and is set to operate in approx. 10 in. of water. These are quite low pressure devices and can in fact be operated simply by blowing into the inlet tube. Original use was for washing machines to turn off water when tub has reached correct level but no doubt has many other applications. £1.72, each.

## NUMERIC TUBES

For digital instruments, counters, timers, clocks, etc. 11 types. £1.3. Price 90p each, 10 for £9. Other types list on request.

## MULLARD AUDIO AMPLIFIERS

All in module form, each ready built complete with heat sinks and connection tags, data supplied.  
Model 1153 500mW power output 90p  
Model 1172 760mW power output £1.07  
Model EP9000 4 watt power output £2.00  
EP 9001 twin channel or stereo pre amp. £1.41

## EXTRACTOR FAN

Extracts the air at the rate of 10,000 cubic ft. per hour. Suitable for kitchens, bathrooms, bedrooms, changing rooms, etc. It's quiet and hardly to be heard. Compact, 5 1/2" casing with 6 1/2" fan blades. Kit comprises motor, fan blades, sheet steel casing, pull switch, mains connector, and fixing brackets. £2.75 + 20p P. & P.



## CENTRIFUGAL BLOWER

Miniature mains driven blower centrifugal type blower unit by Woods. Powerful but specially built for quick running—driven by cushioned induction motor with specially built low noise bearings. Overall size 4 1/2" x 4 1/2" x 4". When mounted by flange, air is blown into the equipment but to suck air out, mount it from centre using clamp. Ideal for cooling electrical equipment or fitting into a cooker hood, film drying cabinet or for removing flux smoke when soldering, etc. A real bargain at £2.50p.

## TANGENTIAL HEATER UNIT

This heater unit is the very latest type, most efficient, and quiet running. Is as fitted in Hoover and blower heaters. Comprises motor, impeller, 2kW element allowing switching 1, 2kW, and with thermal safety cut-out. Can be fitted into any metal lined case or cabinet. Only needs control switch. £2.75. Don't miss this. Control Switch, 55p. P. & P. 50p.



## SHORTWAVE CRYSTAL SET

Although this uses no battery it gives really amazing results. You will receive an amazing assortment of stations over the 19.25-31.39 metre bands—Kit contains chassis front panel and all the parts. £1.25—crystal ear-phone 50p.

## DRILL CONTROLLER

NEW IKW MODEL  
Electronically changes speed from approximately 10 revs. to maximum. Full power at all speeds by finger-tip control. Kit includes all parts, case, everything and full instructions. £2.95 plus 25p post and insurance. Made up model also available. £3.25 plus 50p post & p.

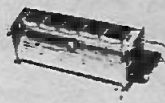

CONTROL  
DRILL  
SPEEDS

## THIS MONTH'S SNIP

High compliance 8" round speakers suitable for 8-12 ohm outputs, these speakers have rubber mounted diaphragms and will handle up to 12.5 watts. Made originally for an expensive Decca hi-8 outfit, we offer at £2.25 each or £6.00 a pair plus 40p each postage.

## SMITHS CENTRAL HEATING CONTROLLER

Push button gives 10 variations as follows—(1) continuous hot water and continuous central heating (2) continuous hot water but central heating off at night (3) continuous hot water but central heating on only for 2 periods during the day (4) hot water and central heating both on but day time only (5) hot water all day but central heating only for 2 periods during the day (6) hot water and central heating on for 2 periods during the day time only—then for summer time (9) hot water twice daily (10) everything off. A handsome looking unit with 24 hour movement and the switches and other parts necessary to select the desired programme of heating. Supplied complete with wiring diagram. Originally sold, we believe, at over £15—we offer these, while stocks last, at 25 95p each, post 30p.

## TAPE DECK

In metal case with carrying handle, heavy fly wheel and capstan drive. Tape speed 3 1/2. Mains operated on metal platform with tape head and guide. Not new but guaranteed good working order. Price £1.95 plus £1 post and insurance.



## GENERAL PURPOSE SWITCH

Responds to moisture, heat, light, touch, time delays, etc. etc. Basic kit comprising relay, transistors, diodes, condensers, resistors, etc. and data—only £1.50 + 30p post.



## AMMETERS

—moving iron no AC/DC—ideal for chargers etc. 2" sq. full vision 4-8 amp 85p. 1 1/2" round 0-2 amp 55p. 0-3 amp 65p. 0-4 amp 75p.

## DISTRIBUTION PANELS

Just what you need for work bench or lab. 4 x 13 amp sockets in metal box to take standard 13 amp fuses and on/off switch with neon warning light. Supplied complete with 6 feet of flex cable. Wired up ready to work. £2.75 plus 25p P. & P.

## SOIL HEATER

Or could be used on bench for seed trays. Comprising 9 mains transformer to reduce to safe voltage also heater wire. £2.00 plus 20p p. & p.

## SPIT MOTOR

200-250V induction motor, driving a Carter gearbox with a 1 1/2" output drive shaft running at 3 revs p.m. Intended for roasting chickens, also for driving models—windmills, coloured disc lighting effects, etc. £2.50 plus 20p post and ins.

## TERMS—

ADD 8% V.A.T.  
Send postage where quoted—other items, post free if order for these items is £6.00, otherwise add 30p.

## NEW ITEMS THIS MONTH

The bargains in this column are just some of the items which appeared in the December supplement to our catalogue. You can receive this catalogue and the next 12 supplements by sending £1.

Room Thermostat. Mercury Switch type with thermometer for low voltage gas central heating systems etc. Made by a famous American Company, these are of very neat appearance, in plastic case, easily mounted but the most important feature is that they cut in and out quickly, thus maintaining a very steady temperature. Price £1.95.

12V Sealed Plug-In Relay with two sets changeover contacts 10 amp rating. Fit into a standard octal valve base. Limited quantity. £1 each. Constant voltage step down transformer. American made 600w rating. Input voltage can be either 115 v or — 20% or 230 v or — 20%. For 50 c.p.s. mains output 115v 60 c.p.s. real quality transformer, probably cost well over £100. Not new but guaranteed perfect. Our price £45. Ditto 750w £60. Carriage paid.

Mercury Batteries. Rank of 7 mercury cells Type No. 625 which measure approx. 1 1/2" diameter by 1 1/2" thick in plastic tube with positive and negative ends marked giving a total of 10.7v. Only 5p per bank or £1 per carton of 25. With simple holder these will replace the PFS and similar, or can be quite easily separated for operating simple pocket radios and instruments, etc. £1.50.

2-wire circuit micro-switch. Famous American Icon, maker's ref. 16-40411. Size approx. 1" long 1/2" wide 1/2" thick. Two electrically separate circuits, one makes the other breaks when nylon push rod is depressed. Circuit rating we estimate at 5 amps 250v, 12p each. Sound to light unit for exciting your audio either with the addition of coloured lighting or white light responding to the music. Our unit, which will work up to three 150w lamps, is available as a kit of parts at £2.95 or made up ready to work £7.95.

Emergency lights. It would seem that once again there is a possibility of power cuts and black-outs. We hope it won't be as bad as last year, but the possibility of having to work off batteries is definitely with us. We can still offer 12v battery fluorescent. 24" uses the standard 24 tube and gives an excellent light. Price £4.50 + 50p post and insurance. Also the 40", which uses the 40w tube, is now available. Price £7 + 75p post and insurance. We also still have stocks of big inverters, ref. YB. This is a 500w 24v operated inverter, unfortunately not 50 c.p.s. Its frequency, we believe, is 400 c.p.s. which means that whilst fluorescent lighting could be worked off it, special chokes would have to be used. Normal incandescent lamps can of course be used without any bother. The price of this unit is £19.50 + carriage at cost.

Luminous rocker switch, suitable for 13 amps at mains voltage, these are fused with an on through amber panel, main in fixing into hole size 1 1/4" x 1 1/4". Special bargain, 22p each.

Chrome plated metal legs, heavy duty, really good quality, made originally for an expensive Decca outfit, height 12", £1.60 per set of 4 plus post 30p.  
Experimenters Relay Parcel. 10 type 600 relays all different coil values covering most experimenters needs. Also one mounting bracket. Total retail value £3.50—yours for £3 plus 30p post.  
Motor with fan blade—If you want something to cool a cabinet or if you are making a cooker hood, a blower heater, this may be the answer. 1" stack induction motor with a set of Smith's fan blades, approx. 5" diameter. £1.50 + 30p post.  
Microswitch bargain—Honeywell, brand new 10 amp 250v gold on silver contacts, standard fixing, normal operation. Price 10p each.  
Cooling fans—Heavy duty for T06 type semi-conductors, extruded aluminium, size 4 1/2" x 3". Price 50p each.

Full wave rectifiers 4 x 1N3208 which we understand are rated at 25 amps mounted on cooling fins, these were intended for computers but were never installed. Price £3 each.  
Insulated terminals. These are the popular type which will take a wire under the head or a 4mm plus in the top, fully insulated for mounting with metal panels, available in several popular colours—price 12p each.

Delay Switch. Depending on the amount of voltage applied, this switch will delay making the circuit (of up to 15 amps at normal mains voltage) for up to 10 seconds, delay may be fixed or made variable with a suitable potentiometer. These can also be used as thermal relays as suitably connected a low current relay can switch up to 100 amperes or more across air class tubes plus a 4 pin base with base 75p each.  
Smiths 24 hr. timer heart, really the "Autosec" without its plastic case. This is a 24 hr. twice on, twice off, clock switch which will repeat until re-programmed. Switches rated at 15 amps. Limited supplies—£2.70 each.

Smiths colour stat. Customers will remember that we had a supply of these wall mounting thermostats last year. We were able to supply these at £1.65. A new batch has just arrived but like most other things these days they have gone up in price and we must now charge £2.25 each. However, this is still a very low price for such a thoroughly reliable wall thermostat.  
Panel meter with trip. American made. These are flash mounting, full vision, moving coil meters, face size 1 1/2" x 2 1/2" with two front settings which enable an external circuit to be tripped, a light lit or an alarm sounded. All pre-set voltages within the range of the meter. We have meters covering the following DC voltages: 0 to 6; 0 to 15; 0 to 25; 0 to 25; 0 to 25; 0 to 150. All £4.75 each.

## J. BULL (ELECTRICAL) LTD.

(Dept. EE), 102/103 TAMWORTH RD.

CROYDON CRO IXX



### "I MADE IT MYSELF"

Imagine the thrill you'll feel! Imagine how impressed people will be when they're hearing a programme on a modern radio you made yourself.

## Now! Learn the secrets of radio and electronics by building your own modern transistor radio!

Practical lessons teach you sooner than you would dream possible.

What a wonderful way to learn—and pave the way to a new, better-paid career! No dreary ploughing through page after page of dull facts and figures. With this fascinating Technatron Course, you learn by building!

You build a modern Transistor Radio... a Burglar Alarm. You learn Radio and Electronics by doing actual projects you enjoy—making things with your own hands that you'll be proud to own! No wonder it's so fast and easy to learn this way. Because learning becomes a hobby! And what a profitable hobby. Because opportunities in the field of Radio and Electronics are growing faster than they can find people to fill the jobs!

### No soldering - yet you learn faster than you ever dreamed possible.

Yes! Faster than you can imagine, you pick up the technical know how you need. Specially prepared step-by-step lessons show you how to read circuits—assemble components—build things—experiment. You enjoy every minute of it! You get everything you need. Tools. Components. Even a versatile Multimeter that we teach you how to use. All included in the course. AT NO EXTRA CHARGE! And this is a course anyone can afford. (You can even pay for it by easy instalments).

### So fast, so easy, this personalised course will teach you even if you don't know a thing today!

No matter how little you know now, no matter what your background or education, we'll teach you. Step by step, in simple easy-to-understand language, you pick up the secrets of radio and electronics.

You become a man who makes things, not just another of the millions, who don't understand. And you could pave the way to a great new career, to add to the thrill and pride you receive when you look at what you have achieved. Within weeks you could hold in your hand your own transistor radio. And after the course you can go on to acquire high-powered technical qualifications, because our famous courses go right up to City & Guilds levels.

### Send now for FREE 76 page book - see how easy it is - read what others say!

Find out more now! This is the gateway to a thrilling new career, or a wonderful hobby you'll enjoy for years. Send the coupon now. There's no obligation.

**POST TODAY FOR FREE BOOK**

To: **ALDERMASTON COLLEGE**  
DEPT. CEE 03  
READING RG7 4PF

CEE 03

Yes, I'd like to know more about your course. Please send me free details—plus your big, 76-page book that tells about all your courses.

NAME

ADDRESS

POSTCODE



HOME OF BRITISH INSTITUTE OF ENGINEERING TECHNOLOGY

# PE SCORPIO Mk 2 ignition system kit new from ELECTRO SPARES

\* 6 OR 12 VOLT  
\* + VE AND - VE GROUND

Here's the new, improved version of the original Scorpio Electronic Ignition System — with a big plus over all the other kits — the Electro Spares Kit is designed for *both* positive and negative ground automotive electrical systems. Not just +ve ground. Nor just —ve ground. But both! So if you change cars, you can be almost certain that you can change over your Scorpio Mk. 2 as well.

Containing all the components you need, this Electro Spares Scorpio Mk. 2 Kit is simply built, using our easy-to-follow instructions. Each component is a branded unit by a reputable manufacturer and carries the manufacturer's guarantee. Ready drilled for fast assembly. Quickly fitted to any car or motor cycle.

When your Scorpio Mk. 2 is installed, you instantly benefit from all these Scorpio Mk. 2 advantages:

- ★ Easier starting from cold
- ★ Firing even with wet or oiled-up plugs
- ★ Smoother running at high speed
- ★ Fuel saving
- ★ More power from your engine
- ★ Longer spark plug life
- ★ No more contact-breaker burn.

### Electro Spares prices:

De luxe Kit only **£10.85** inc. VAT and p & p.  
Ready Made Unit **£13.65** inc. VAT and p & p.  
State 6V or 12V system.

Send SAE now for details and free list.

### PE FM VARICAP STEREO TUNER

As featured in the May 1973 issue of 'Practical Electronics'. Superb Hi-Fi tuner Kit now available from Electro Spares. Including cabinet and all components — pre-set Mullard modules for R.F. and I.F. circuits. Motorola I.C. Phase Lock Loop Decoder for perfect stereo reception. No alignment needed. Guaranteed first time results — or send it back, and we'll return it in perfect order (for a nominal handling charge). Electro Spares price only **£28.50** inc. VAT and p & p.

### PE GEMINI STEREO AMPLIFIER

A superb unit with a guaranteed output of 30 watts RMS per channel into 8 ohms. Full power THD is a mere 0.02%, and frequency response is —3 dB from 20 Hz to 100 kHz into 8 or 15 ohms. Electro Spares have already sold 100s and 100s of these Kits. Get yours now! Depending on your choice of certain components, the price can vary from **£50** to **£60** inc. VAT and p & p.

- ★ All components as specified by original authors, and sold separately if you wish.
- ★ Full constructional data book with specification graphs, fault finding guides, etc. 55p plus 9p postage.
- ★ Price List only. Please send S.A.E. (preferably 9 x 4 minimum) for full details.

# ELECTRO SPARES



The Component Centre of the North  
288 ECCLESALL RD., SHEFFIELD S11 8PE(B)  
Tel: Sheffield (0742) 668888

# ELECTROVALUE

Present

a price-stabilizing policy for 1975

new revised catalogue · attractive discounts · free postage & packing (U.K.)

## A 100 OF THE BEST out of our latest catalogue

2N1307	47p	AF200U	70p	BD135	37p
2N2646	51p	AF230	60p	BD136	36p
2N3053	39p	BI906	36p	BDY20	83p
2N3054	60p	BA138	31p	BF194	15p
2N3055	70p	BB103	24p	BF399	23p
2N3702	11p	BB105	34p	BFR70	33p
2N3703	10p	BB109	18p	BFX29	33p
2N3704	11p	BC10/A	16p	BFX84	27p
2N3705	16p	BC107B	16p	BFY51	23p
2N3794	18p	BC108B	15p	BRY39	50p
2N3819	28p	BC108C	15p	BY164	51p
2N4082	11p	BC108B	18p	C10611	42p
2N4443	93p	BC109C	18p	C108D1	47p
2N5052	42p	BC147A	12p	C1406	78p
2N5163	20p	BC147B	15p	MJ481	£1.20
2N5459	32p	BC148B	12p	MJ491	£1.35
40361	48p	BC149C	14p	MJ2955	80p
40362	44p	BC158B	15p	MJE371	89p
40602	46p	BC159	15p	MJE391	81p
40636	£1.36	BC167B	13p	MJE2955	£1.12
40669	£1.10	BC188B	12p	MJE3055	68p
AC128	17p	BC169B	12p	OAP1	60p
AC151R	35p	BC189C	13p	SD4	8p
AC153	27p	BC179B	26p	TIP31A	70p
AC153K	37p	BC182L	10p	TIP32A	80p
AC176	24p	BC184L	10p	TIP41A	80p
AC176K	38p	BC212L	12p	TIP42A	£1.10
AC176K	31p	BC214L	14p	W02	30p
AC188K	29p	BC257A	14p	W02	30p
AD133	£1.92	BC259B	14p	ZTX300	14p
AD136	£1.11	BCY58	30p	ZTX304	23p
AD146SL	65p	BD130	70p	ZTX500	14p
AD161	42p	BD131	43p	ZTX504	45p
AD162	40p	BD132	52p		

## ELECTROLYTIC CAPACITORS

Axial Lead	3V	6.3V	10V	16V	25V	40V	63V	100V
0-47	—	—	—	—	—	—	—	8p
1-0	—	—	—	—	11p	—	—	8p
2-2	—	—	—	11p	—	—	—	8p
4-7	—	—	—	11p	—	—	—	8p
10	—	—	—	—	—	—	—	8p
22	—	—	—	—	—	—	—	8p
47	8p	—	—	—	—	—	—	10p
100	8p	8p	—	—	—	—	—	13p
220	8p	8p	8p	—	—	—	—	19p
470	9p	10p	10p	11p	13p	17p	24p	45p
1,000	11p	13p	13p	17p	20p	25p	41p	—
2,200	15p	—	—	—	—	—	—	—
4,700	—	—	39p	44p	58p	—	—	—
10,000	42p	46p	—	—	—	—	—	—

## RESISTORS

Code	Watts	Ohms	1 to 9	10 to 99	100 up
C	1/3	4.7-470K	1-3	(see note below)	
C	1/2	4.7-10M	1-3	1-1	0-9 nett
C	3/4	4.7-10M	1-5	1-2	0-97 nett
C	1	4.7-10M	1-2	2-5	1-92 nett
MO	1/2	10-1M	4	3-3	2-3 nett
WW	1	0.22-0.47 Ω	16	14	11 nett
WW	1	0.36-9 Ω	12	10	8 nett
WW	3	1-10K	9	10	8 nett
WW	7	1-10K	11	10	8 nett

Codes:  
C-carbon film, high stability, low noise.  
MO-metal oxide. Electroall TR5 ultra low noise.  
WW-wire wound, Pleasay.  
Values: All E12 except C 1/3, C 3/4 and MO 1/2.  
E12: 10, 12, 15, 18, 22, 27, 33, 39, 47, 56, 68, 82, and their decades.  
E24: as E12 plus 11, 13, 16, 20, 24, 30, 36, 43, 51, 62, 75, 91 and their decades.  
Tolerances:  
5% except WW 10% -0.05Ω below 10Ω and 1/3 MO 2%  
Prices are in pence each for quantities of the same ohmic value and power rating. NOT mixed values. (Ignore fractions of one penny on total value of resistor order.) Prices for 100 up in units of 100 only.

1975 is the year of challenge. Rather than sit back and wait for things to happen, we have produced our own policy to help stabilize price structure and maintain the services for which ELECTROVALUE are pre-eminent.

### PRICES

as shown in our latest catalogue (No. 7, issue 3) will be maintained at least until March 31st next (except in cases of severe market fluctuation) and then held after review for further three-month periods instead of making day to day price change.

### CATALOGUE 7 ISSUE 3

is now ready with 108 pages of bargains and information. Price—30p post paid including 25p refund voucher for use on orders list value for £5 or more

### DISCOUNTS

apply on all items except the few where prices are shown NETT. 5% on orders from £5 to £14.99; 10% on orders value £15 or more.

**FREE POSTAGE & PACKING**  
In U.K. for pre-paid mail orders over £2 (except Baxandall cabinets). If under, there is an additional handling charge of 10p.

### QUALITY GUARANTEE

All goods are sold on the understanding that they conform to makers specifications. No rejects, seconds or sub-standard merchandise.

**V.A.T. @ 8% must be added to total value of orders.** Every effort is made to ensure correctness of information at time of preparing and putting this advertisement to press.

## CAPACITORS

**DALY ELECTROLYTIC** In cans, plastic sleeved  
1000mF/25V 34p 2200/50 £1.91  
5000/100 £3.56 1000/50 50p  
5000/25V 75p 2000/50 70p  
2000/50 70p 5000/50 £1.44  
1000/100 £1.00

## POLYESTER TYPE C.280. Radial leads for P.C.B.

mounting. Working voltage 250V d.c.  
0-01, 0-015, 0-022, 0-033, 0-047 ea. 3p  
0-068, 0-1, 0-15 ea. 4p  
0-22 5p; 0-33 7p; 0-47 8p; 0-68 11p; 1-0 14p; 1-5 21p; 2-2 24p

**SILVERED MICA.** Working voltage 500V d.c. Tolerance 1% or 0.5pF  
Values in PFs—2 to 250 in 26, stages ea. 6p  
270-820 in 9 stages, ea. 7p

1000, 1500, 1800 9p; 2200 10p; 2703, 3600, 4700, 5000 11p; 6800, 8200, 10,000 25p

**TANTALUM BEAD**  
0-1, 0-22, 0-47, 1-0 mF/35V, 1-5/20V, 3-5/16V ea. 16p  
0-0047, 0-0068, 0-01, 0-15, 0-22 ea. 18p  
2-2/16V, 2-2/35V, 4-7/16V, 10-6-3V ea. 21p  
4-7/35V, 10/16V, 22/6-3V ea. 21p  
10/25V, 22/16V, 27/6-3V, 100/3V, 6-8/25V, 15/25V ea. 23p

**POLYCARBONATE**  
Type B42540 Working Voltage—250V Values in mF:  
0-0047, 0-0068, 0-01, 0-15, 0-22 ea. 4p  
0-018, 0-027, 0-033, 0-039, 0-047, 0-068, 0-082, 0-1, 100/0-1 ea. 5p  
0-18, 0-22 7p; 0-27, 0-33 9p; 0-39, 0-47 11p; 0-56, 0-68 16p

**CERAMIC PLATE**  
Working voltage 50V, d.c.  
In 26 values from 22p to 8800pF, ea. 2p

**POTENTIOMETERS**  
ROTARY, CARBON TRACK.  
Double wipers for good contact and long working life

P.20 SINGLE linear 100 ohms to 4.7 meg ohms, each 14p  
P.30 SINGLE log 4-7 Kohms to 2-2 megohms, each 14p  
JP.20 DUAL GANG tin. 4-7 Kohms to 2-2 megohms, each 48p  
JP.20 DUAL GANG log. 4-7 Kohms to 2-2 megohms, each 48p

JP.20 DUAL GANG Log/antilog 10K, 22K, 47K, 1 megohm only, each 48p  
JP.20 DUAL GANG antilog 10K only, each 48p  
2A DP mains switch for any of above 14p extra.  
Decades of 10, 22 and 47 only available in ranges above.  
Skeleton Carbon Presets, Type PR, horizontal or vertical 5p each.

**SLIDER**  
Linear or log mono 4-7K to 1 meg. In all popular values, each 38p  
STEREO, matched tracks, 1in. or log in all popular values from 4-7K to 1 meg. 60p  
Eucytecon plates, mono, black or grey, each 10p  
Control knobs, blk/wht/red/yel/grn/blu/dk. grey/lt. grey, each 7p

**MINITRON DIGITAL INDICATORS.**  
3015F Seven segment filament compatible with standard logic modules. 0-9 and decimal point: 9mm characters in 16 lead DIL £1.20  
Suitable BCD decoder driver 7447 £1.15  
3015S showing + or - & 1 & dec. pt. £1.29

**LEDS (Light Emitting Diodes)**  
Photo Cells, cadmium sulphide each 25p  
48p

**ANTEX Soldering Irons**  
C240 £2.25 Spare bits 32p  
CCN240 £2.65 Spare bits 42p

## WAVECHANGE SWITCHES

1 pole 12 way; 2 pole 6 way; 3 pole 4 way;  
4 pole 3 way each 33p  
TAG STRIP 28 way 11p

## NUTS, SCREWS, etc.

in lots of 100 each  
4BA NUTS 31p 6BA NUTS 22p  
4BA SCREWS 30p 1 6BA SCREWS 24p  
Threaded pillars 6BA, 1/4" hexagonal £1.35  
Plain spacers 1/4" round £1.32  
Other sizes available

# ELECTROVALUE LTD

28, ST. JUDES ROAD, ENGLEFIELD GREEN, EGHAM, SURREY TW20 0HB  
Telephone Egham 3603 Telex 264475 Shop hours 9-5.30 daily; Sat. 9-1 p.m.

**NORTHERN BRANCH:** 680, Burnage Lane, Burnage, Manchester M19 1NA  
Telephone (061) 432 4945 Shop hours 9-5.30 daily; Sat. 9-1 p.m.

**U.S.A. CUSTOMERS** are invited to contact ELECTROVALUE AMERICA, P.O. Box 27, Swarthmore PA 19081.

# Everyday Electronics Classified Advertisements

**RATES:** 11p per word (minimum 12 words). Box No. 30p. extra. Semi-display—£7.50 per single column inch. Advertisements must be prepaid and addressed to Classified Advertisement Department, "EVERYDAY ELECTRONICS," I.P.C. Magazines Ltd., Fleetway House, Farringdon Street, London EC4 4AD.

## EDUCATIONAL

**HOLIDAY FOR BOYS.** 14-16 years, August 1975. Tuition and practical work in electronics, radio production and tape recording, engineering (Karting) and photography. 11 days in Norfolk—£25. Write for free brochure: Inter-School Christian Fellowship, c/o 1 Hubbard Road, London SE27 9PJ.

## C AND G EXAMS

Make sure you succeed with an ICS home study course for C and G Electrical Installation Work & Technicians Radio/TV/Electronics Technicians, Telecommunications Technicians and Radio Amateurs.

## COLOUR TV SERVICING

Make the most of the current boom! Learn the techniques of servicing Colour and Mono TV sets through new home study courses, approved by leading manufacturers.

## TECHNICAL TRAINING

Home study courses in Electronics and Electrical Engineering, Maintenance, Radio, TV, Audio, Computer Engineering and Programming. Also self-build radio kits. Get the qualifications you need to succeed.

Free details from:

### INTERNATIONAL

### CORRESPONDENCE SCHOOLS,

Dept 731, Intertext House, London SW8 4UJ.  
Or Phone 01-622 9911 (all hours)

## FOR SALE

**MICROPHONES:** AKG D109, £12.65; AKG D202E1, £43.45; AKG D190C, £18.70; AKG D190E, £20; AKG D224, £55; Sennheiser MD211N, £49.50; Sennheiser MD413N, £29.70. All brand new and boxed. Send CWO to J. J. Francis (Wood Green) Ltd., Manwood House, Matching Green, Harlow, Essex. Tel: Matching 476.

**EVERYDAY ELECTRONICS.** Volumes 1-2 bound, Volume 3, complete, mint offers? M. George, Christ's College, Cambridge.

**THREE VOLUMES** Everyday Electronics. Offers to G. May, 4 Genoa Road, Leeds 12, Yorks.

## RECEIVERS and COMPONENTS

**LOWEST COST IC SOCKETS.** Use Soldercon IC socket pins for 80 to 40 pin DIL's. 70p for strip of 100 pins, £1.50 for 3 strips of 100, £4 for 1000. 10p p&p for orders under £2. Add 8% VAT. Instructions supplied—send sae for sample. SINTEL, 53e Aston Street, Oxford. Tel: 0865 43203.

**TUNBRIDGE WELLS.** Components from Ballard's, 108, Camden Road, Tunbridge Wells. Tel: Tunbridge Wells 31803. S.a.e. for all enquiries.

**COMPONENTS GALORE.** Pack of 500 mixed components manufacturers surplus plus once used. Pack includes Resistors, carbon and W.W., capacitors various, transistors, diodes, trimmers, potentiometers etc. Send £1+10p p. and p. c.w.o. to CALEDONIAN COMPONENTS, Strathore Road, Thornton, Fife.

**VALVES, TRANSISTORS, STYLI.** Valves 1930 to 1975, 1,500 types. Many obsolete. List 15p. Transistor list 15p. Diamond styli list 10p. SAE for quotation. Cox Radio (Sussex) Ltd., The Parade, East Wittering, Sussex. West Wittering 2025.

**LED's.** Red Green Yellow. Sizes, .1", .125", .16", .2". Mixed bags all sizes and colours. 50—25, 100—£9 including postage, VAT. C.W.O. Individual types and larger quantities by negotiation. Industrial Electronic Supplies (Stockport) Ltd., 181a Bramhall Lane, Davenport, Stockport, Cheshire.

**3 Ass. M.C. meters £1.30 (40p).** Large Computer Panels. 35-50 Transistors, Long Leads 85p (40p). Copper Clad Pax Panels 6" x 6" 6—60p c.p. 7" x 9", 6—£1.20 c.p. Silicon Diodes 550V 11A. 10 on Tagboard 50p c.p. T.V. Convergence Panels 2 x AC128 3 Slugged Coils, 3 Slide Switches, 11 W.W. Pots, 3 Carbon Presets, 2 Ferrite Chokes etc. £1.20 c.p. Valupaks. P9 100 SiMica Caps 87p c.p. send 10p for Lists of others plus Panels etc. Refund on purchase. 7 lbs Assorted Components £2 c.p.  
J.W.B. RADIO  
2 Barnfield Crescent, Sale, Cheshire M33 1NL  
Postage in brackets Mail Order only

**GREENBANK ELECTRONICS.** New components. Digital Clock chip AY-5-1224+data £3.66, data alone 16p (refundable on order). DL747 0.6in "Jumbo" LED display now only £2.04. 1/2 W Carbon Film Resistors 4.7 ohm to 4.7 Meg 1p each. Triac TAG 250-400 8A, 69p. D32 diac 23p. IN914/4148 3p. 2N3702/3704 9p. Post free, add standard VAT. 94 New Chester Road, Wirral Merseyside L62 5AG.

## SERVICE SHEETS

**SERVICE SHEETS** for over 6,000 models of Television, Radios, Transistors, Stereo, Tape Recorders, Record Players, etc., at only 30p plus S.A.E. with free Fault-Finding Guide. Over 50,000 sheets in stock for 10,000 models. S.A.E. enquiries. Catalogue 20p plus S.A.E. Hamilton Radio, 47 Bohemia Road, St. Leonards, Sussex. Telephone Hastings 429066.

**BELL'S TELEVISION SERVICES** for Service Sheets, Manuals, Books on Radio's TV's etc. Service Sheets 40p plus S.a.e. Free book lists on request. Back issues of PW, PE, EE, TV available 25p + 7p post. S.a.e. with enquiries—B. T. S. (Mail Order Dept.) 190, Kings Road, Harrogate, Yorks. Telephone (0423) 55885.

## MISCELLANEOUS

**AERIAL BOOSTERS £3.30**  
We make three types of aerial boosters B45-UHF-TV, B12-VHF-TV, B17-VHF-Radio.  
**VALVES BARGAINS**  
ANY 5-30, 10-75p, 50-83.30  
ECC82, EF80, EF183, EF184, PCC189, PCF80, PCF802, PCL82, PCL84, PCL85/805, PFL200, PL36, PL504, PY800, PY88.  
**COLOUR TV VALVES—PL508, PL509, PY500** 25p each.  
Prices includes VAT, P&P 10p, SAE—leaflet  
Electronic Mail Order Ltd, 62 Bridge Street, Ramsbottom, Bury, Lancs. Tel RAMS 3038.

**SUPERB** instrument cases by Bazelli, manufactured from heavy duty P.V.C. faced steel. Hundreds of Radio, Electronic and Hi-Fi enthusiasts are choosing the case they require from our range of over 200 models. Generous trade discount, prompt dispatch. Free literature, Bazelli, Department No. 24, St. Wilfrids, Foundry Lane, Halton, Lancaster, LA2 6LT.

**TRANSISTOR TESTER.** Ideal for beginners. Measures gain directly. Can be used to test diodes and unmarked transistors. SAE details. Money-back assurance. £6.50 (P&P 15p). Viking, Oak Lodge, Tansley, Derbyshire.

**TREASURE TRACER MK III Metal Locator**



- Varicap tuning
- Britain's best selling metal locator kit
- Weighs only 22oz.
- Speaker and earphone operation
- Knocks down to only 17in.
- Prebuilt search coil assembly
- Thoroughly professional finish
- As seen on BBC1 and BBC2 TV
- You only need soldering iron, screwdriver, pliers and snips
- Five transistor circuit

Send s.a.e. for leaflet

Complete Kit P&P 60p **£9.80** Built, tested and guaranteed P&P 60p. + £1.75 VAT **£13.75**

**MINIKITS ELECTRONICS,**  
6a CLEVELAND ROAD,  
LONDON, E18 2AN (Mail order only)

**LOUD 6V SIRENS** for burglar alarms, etc. (new and boxed). £1.20, add 10p P.P. List 6p. Grimby Electronics, 64 Tennyson Road, Cleethorpes, South Humberside (callers to Lambert Road, Saturdays only).

## GADGETS GALORE!!

★ READY BUILT + TESTED ★

Signal Injector £1.95 Signal Tracer £2.95  
Logic Probe £4.45 Noise Generator £8.95  
Metronome £3.50 Continuity Tester £3.95  
Automatic Transistor Checker £15.25

Prices include U.K. Postage and Ba taxes  
—Mail Order Only— S.A.E. list to.

### G.K. SERVICES.

83 Westdale Road, London SE18 8BQ

**CONSTRUCTION AIDS.** Screws, nuts, spacers, etc., in small quantities. Aluminium panels punched to spec. or plain sheet supplied. Fascia panels etched aluminium to individual requirements. Printed circuit boards—masters, negatives and boards, one-off or small numbers. Send 6p for list. **RAMAR CONSTRUCTOR SERVICES,** 29 Shelbourne Road, Stratford-on-Avon, Warks.

**MULTIMETER**  
Type U424  
20,000 Ω/V. Overload protected. Ranges: 0.5, 1, 2, 3, 12, 30, 60, 120, 200, 1200V DC; 3, 6, 15, 30, 60, 150, 300, 600V AC; 0.06, 0.6, 6, 60, 600mA, 3A DC; 0.3, 3, 30, 300mA, 3A AC; 5 resistance ranges to 5M Ω, dBs, —10 to +12. Size 167 x 28 x 63mm. Supplied complete with test leads, clips, spare diode and instructions. ONLY £10.00.

**PC ETCHING KIT**  
Contains 1lb Ferric chloride, DALO etch-resist pen, 100 sq in copper clad board, etching dish, abrasive cleaner and instructions. £3.30

**FERRIC CHLORIDE**  
Anhydrous to Mill-spec in double-sealed 1lb packs. 1lb 80p; 3lb £1.85; 10lb £4.40.

**VEROBOARD**  
100 sq in 0.1, 0.15 & 0.2" good-size offcuts (About 8 pieces) £1.10

**TRANSFORMERS**  
Miniature type, mains primary, 100mA sec. 0-0-8V 85p; 0-0-8V 90p; 12-0-12V 85p. 18-0-16V with 9V tap @ 11A 82c

**COMPUTER PANELS**  
3lbs asstd £1.40; 7lb £2.60; 35lb £16; 12 high quality panels with trim pots, power transistors, IC's etc. £2.50. Pack of boards with 500 components inc. at least 50 transistors 90p.

**GREENWELD ELECTRONICS [EE10]**  
51 SHIRLEY PARK ROAD,  
SOUTHAMPTON SO1 4FX  
Tel (0703) 772501. Also at 38 Lower Addiscombe Rd, Croydon & 21 Deptford Bdy SE8.  
ALL PRICES INCLUDE 8% VAT AND UK POSTAGE. SAE LIST, ENQUIRIES, CALLERS WELCOME.



**HOME SCIENTISTS**  
Get the key to a FANTASTIC WORLD of previously UNHEARD-OF PROJECTS. The NEW Boffin catalogue lists DOZENS of HIGHLY UNUSUAL, LOW-COST BARGAINS, READY-BUILT MODULES. Here are just a few examples, there are stocks more!

- Dazzling MINI-STROBE (pocket size) £2.90
- PEOPLE DETECTOR £3.20
- Big-Ear SOUND-CATCHER £3.20
- Mini DREAM LABORATORY £3.20

Don't take our word for it thought GET A COPY & SEE! SEND ONLY 20p, and we'll RUSH YOU A COPY (YOU'LL GET THE GOODIES' JUST AS QUICKLY TOO!)

**BOFFIN PROJECTS**

4 Cunliffe Road, Stoneleigh, Ewell, Surrey  
(Mail Order U.K. Only)

**LOUDSPEAKERS**

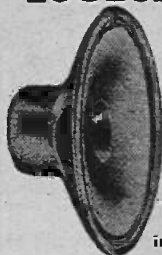

Speakers, kits and cabinets for D.I.Y., Hi Fi, P.A., Disco, etc. by EMI, Fane, Goodmans, Baker, Kef, Elac, Richard Allan, Wharfedale, etc. Send stamp for free booklet "Choosing a speaker"

**WILMSLOW AUDIO**

Dept. EE, Swan Works, Bank Square, Wilmslow, Cheshire, SK9 1HF  
Tel. Wilmslow 29599

**INSTRUMENTAL  
AUDIO  
EFFECTS**

**SUPER "FUZZ" UNIT KIT. CONNECTS BETWEEN GUITAR & AMPLIFIER. OPERATES FROM 9v BATTERY (not supplied). ALL COMPONENTS AND PRINTED CIRCUIT BOARD WITH FULL INSTRUCTIONS. KIT PRICE: £3.00 post paid.**

**CREATE "PHASE" EFFECT ON YOUR RECORDS, TAPES ETC., UNIQUE CIRCUITRY ENABLES YOU TO CREATE PHASE EFFECT AT THE TURN OF A KNOB. OPERATES FROM 9v BATTERY (not supplied) COMPLETE KIT OF COMPONENTS WITH PRINTED CIRCUIT BOARD & FULL INSTRUCTIONS. KIT PRICE: £3.00 post paid.**

**MAIL ORDER ONLY.**

**S.A.E. ALL ENQUIRIES.**

**PLEASE ADD V.A.T. TO ALL ORDERS**

**DABAR  
ELECTRONIC  
PRODUCTS**

98, LICHFIELD STREET, WALSHALL, STAFFS. WS1 1UZ

**ELECTRONIC-KIT**

**Electronic fun for all ages**

The most versatile electronics kits. All components are beautifully encapsulated in unbreakable transparent plastic blocks. Perfect connections are made WITHOUT SOLDERING, SCREWING OR WIRING. **INCREDIBLE VALUE.** Build, dismantle and rebuild projects any number of times and invent your own experiments too.

**COMPLETELY SAFE.** Instructive and FUN—all kits operate from 9v. battery only.

**VALUABLE MANUALS** included with every kit. No previous knowledge is required, even with the largest kits.

**KIT 2A**—30 projects £10.45. Radios, amplifiers, alarms, microphones, Morse, etc. **KIT 3A**—100 projects £20.45. As 2A plus electronic birds, cats, sirens, organs, metronome, guns, light and sound, burglar alarms, etc.

**3AD3**—105 projects £25.25. As 3A plus solar cell experiments and complete sophisticated control panel, etc.

**4AD3**—150 projects £33.95. As 3AD3 plus Relay and Meter experiments; ion concentration—, volume—, out-put—, field intensity—, volt—, resistance meters, ammeter, illuminometer, etc. and many, many more. **ADD-ON parts** and manuals available as required.

The three larger kits include Electrical experiments too.

All prices include **Battery, Manual, VAT & p. & p.** Cheque/P.O. (or 6p for literature) to:

Satisfaction guaranteed  
**ELECTRONIC-KIT LTD.** 408 St John's Street, London, EC1. [01-278 4579]

**CF** GIRO NO. 331 7056 ACCESS ACCEPTED C.W.O. only. P. & P. 10p on orders below £5 Discount: £10-10%, £20-15% (except net items) Export Order enquiries welcome (VAT free) Official Orders accepted from Educational & Government Departments  
**ALL PRICES INCLUDE VAT**

**SPECIAL RESISTOR KITS** (Prices include post & packing)

**10E12 1W KIT:** 10 of each E12 value, 22 ohms—1M, a total of 570 (CARBON FILM 5%), £3.65 net  
**10E12 1/2W KIT:** 10 of each E12 value, 22 ohms—1M, a total of 570 (CARBON FILM 5%), £3.85 net  
**25E12 1W KIT:** 25 of each E12 value, 22 ohms—1M, a total of 1425 (CARBON FILM 5%), £8.35 net  
**25E12 1/2W KIT:** 25 of each E12 value, 22 ohms—1M, a total of 1425 (CARBON FILM 5%), £8.45 net  
**5 1/4W KIT:** 5 of each E12 value, 10 ohms—1M, a total of 305 (METAL FILM 5%), £2.85 net  
DUE TO CURRENT WORLD SHORTAGES, RESISTOR KITS MAY TEMPORARILY CONTAIN WATTAGE OR VALUE SUBSTITUTIONS.

**MULLARD POLYESTER CAPACITORS C280 SERIES**  
250V P.C. Mounting: 0.01µF, 0.015µF, 0.022µF, 0.033µF, 0.047µF, 3p. 0.068µF, 0.1µF, 4p. 0.15µF, 5p. 0.22µF, 5p. 0.33µF, 8p. 0.47µF, 9p. 0.68µF, 12p. 1µF, 15p. 1.5µF, 23p. 2.2µF, 26p.

**MULLARD POLYESTER CAPACITORS C296 SERIES**  
400V: 0.001µF, 0.0015µF, 0.0022µF, 0.0033µF, 0.0047µF, 2p. 0.0068µF, 0.01µF, 0.015µF, 0.022µF, 0.033µF, 3p. 0.047µF, 0.068µF, 0.1µF, 4p. 0.15µF, 6p. 0.22µF, 8p. 0.33µF, 12p. 0.47µF, 14p.  
160V: 0.01µF, 0.015µF, 0.022µF, 3p. 0.047µF, 0.068µF, 3p. 0.1µF, 4p. 0.15µF, 5p. 0.22µF, 5p. 0.33µF, 8p. 0.47µF, 8p. 0.68µF, 12p. 1µF, 14p.

**MINIATURE CERAMIC PLATE CAPACITORS**  
50V: (pF) 22, 27, 33, 39, 47, 56, 68, 82, 100, 120, 150, 180, 220, 270, 330, 390, 470, 560, 680, 820, 1K, 1K5, 2K2, 3K3, 4K7, 6K8, (µF) 0.01, 0.015, 0.022, 0.033, 0.047, 2p. each. 0.1, 1, 30V, 5p.

**POLYSTYRENE CAPACITORS 160V 5%**  
(pF) 10, 15, 22, 33, 47, 68, 100, 150, 220, 330, 470, 680, 1000, 1500, 2200, 3300, 4700, 6800, 10,000, 4p.

**RESISTORS**  
CF—High Stab Carbon Film, 5%, MF—High Stab Metal Film, 5%.

W. Type Range	1-99	100-999	500-999	1000+	Size mm
↑ CF 22-1M	1	0.75	0.60	0.55	2.4 x 7.5
↑ CF 22-1M	1	0.75	0.60	0.55	3.9 x 10.5
↑ CF 22-1M	2	0.75	0.60	0.55	5 x 16
↑ MF 10-247	2	1.54	1.32	1.1	3 x 7
↑ MF 10-247	2	1.43	1.21	1.09	4.2 x 10.8
↑ MF 10-10M	3	1.98	1.81	1.65	6.6 x 13
↑ MF 10-10M	4.5	3.52	3.08	2.75	8.1 x 15

For value mixing prices, please refer to our catalogue. (Price in pence each)  
VALUES AVAILABLE—E12 Series only. (Net prices above 100.)

**PRESET SKELETON POTENTIOMETERS**

MINIATURE 0.25W Vertical or horizontal 6p each 1K, 2K2, 4K7, 10K, etc. up to 1M Ω  
SUB-MIN 0.05W Vertical, 100 Ω to 220K Ω 5p each

**LEIGHTON ELECTRONICS CENTRE**  
(E.E.) 59 North St, LEIGHTON BUZZARD, Beds.  
Tel. Leighton Buzzard 2316  
(Std Code 05253) CATALOGUE No. 4—20p

**B. H. COMPONENT FACTORS LTD.**

**Miniature Mullard Electrolytics**

1.0µF 63V 6p	68µF 63V 12p
1.5µF 63V 6p	100µF 10V 6p
2.2µF 63V 6p	100µF 25V 6p
3.3µF 63V 6p	100µF 63V 14p
4.7µF 63V 6p	150µF 16V 6p
6.8µF 63V 6p	150µF 63V 15p
10µF 25V 6p	220µF 6.4V 6p
10µF 63V 6p	220µF 10V 6p
15µF 16V 6p	220µF 16V 8p
15µF 63V 6p	220µF 63V 21p
22µF 40V 6p	330µF 16V 12p
22µF 25V 6p	330µF 63V 25p
32µF 63V 6p	470µF 6.4V 9p
32µF 10V 6p	470µF 40V 20p
33µF 16V 6p	680µF 16V 15p
33µF 40V 6p	680µF 40V 25p
32µF 63V 6p	1000µF 16V 20p
47µF 10V 6p	1000µF 25V 25p
47µF 25V 6p	1500µF 6.4V 15p
47µF 63V 8p	1500µF 16V 25p
68µF 16V 6p	3300µF 6.4V 26p

**VEROBOARD 0.1-0.15**

2 1/2 x 5"	36p 36p
2 1/2 x 3 1/2"	33p 25p
3 1/2 x 5"	42p 46p
3 1/2 x 3 1/2"	36p 36p
2 1/2 x 5"	7p 9p
2 1/2 x 3 1/2" (Plain)	— 16p
2 1/2 x 3 1/2" (Plain)	— 29p
5 x 3 1/2" (Plain)	73p 73p
Insertion tool	56p 56p
Track Cutter	22p 22p
Pins, Pack. 50	

**TRANSISTORS**

AC127 16p	BC212L 12p
AC128 22p	BC213L 12p
BC107 11p	BC214L 17p
BC108 12p	OC44 18p
BC109 13p	OC71 13p
BC148 12p	OC81 12p
BC149 12p	OC170 23p
BC182L 12p	TS143 33p
BC183L 12p	2N2926 11p
BC184L 13p	2N3702 11p

**POTENTIOMETERS**

Carbon Track 5K Ω to 2M Ω, log or lin. Single, 16p Dual Gang 46p. Log Single with switch 26p  
Slider Pos. 10K, 100K, 500K, 30mm, 34p, 45mm, 47p, 60mm, 55p.

**DIODES**

IN4001 6p	DIN 2 Pin 12p
IN4002 7p	3 Pin 13p
IN4003 9p	5 Pin 18p
IN4004 9p	5 Pin 18p
IN4005 12p	2.5mm Jack 13p
IN4006 14p	Phone 6p
IN914 7p	
IN916 7p	
BA100 10p	
OA3 42p	
OA47 9p	
OA81 11p	
OA200 8p	

**PLUGS**

DIN 2 Pin 12p	(µF/V): 1/25, 2/25, 4/25, 4-7/10, 5/25, 8/25, 10/10, 10/50, 16/25
3 Pin 13p	22/63, 25/25, 25/50, 32/25, 50/25, 100/10, 100/25, 6p, 50/50, 8p,
5 Pin 18p	100/50, 200/25, 11p, 250/50, 15p, 500/10, 11p, 500/25, 15p,
5 Pin 18p	500/50, 18p, 1000/10, 15p, 1000/25, 22p, 1000/50, 40p, 2000/10,
2.5mm Jack 13p	20p, 1000/100 90p, 2000/25, 30p, 2000/100, 95p, 2500/25, 38p,
Phone 6p	2500/50, 62p, 3000/50, 80p, 5000/25, 66p, 5000/50, £1.10

**SOCKETS**

HI-VOLT: 8/350, 15p, 16/350 22p, 32/350, 33p, 50/250, 20p  
DIN 2 Pin 10p 100/100, 20p, 100/250, 30p, 32/500, 40p, 16 + 32 = 32/350, 40p

**METALLISED PAPER CAPACITORS**

5 Pin 180° 12p 250V: 0.05µF, 0.1µF, 6p, 0.25, 6p, 0.5µF, 7p, 1µF, 9p, 500V: 0.025, 0.05, 6p, 0.1, 6p, 0.25, 7p, 0.5, 9p, 1000V: 0.01, 11p

PLEASE NOTE OUR NEW ADDRESS. OUR NEW ELECTRONICS CENTRE IS NOW OPEN IN LEIGHTON BUZZARD AND ALL CALLERS ARE WELCOME. AS WELL AS OUR NORMAL STOCK OF OVER 2000 PRODUCTS, WE HAVE A LARGE RANGE OF SURPLUS EQUIPMENT, BARGAINS AND CALCULATORS, ETC. ETC. OPEN 6 DAYS. 9 to 12.30 — 1.30 to 5.00.

**5E12 5W METAL FILM. 1µ each Value 10Ω-1M. Total of 305 £3.25.**

# At Last... A Perfect Hi-Fi Match!



**our comprehensive matching hi-fi guide will start you assembling a quality system of your own choice to suit your needs and your pocket – and with no dud buys!**

Now at last you can see at a glance what components will match up mechanically, electrically – and financially – to produce the best possible sound for your money.

Basic specifications, recommended retail prices, generous discounts and the simplest classification will combine to help you make the best selection from the wide range of different makes available.

This authoritative 'map' of the hi-fi jungle will appear regularly as an updated section in Practical Hi-Fi and Audio every month, starting in the March issue with what makes a perfect match for setups costing less than £150.

**NO GUESSWORK! NO MISMATCHING!  
NO FRUSTRATION!**

**Plus our regular coverage of hi-fi developments and commonsense advice on hi-fi problems**

**PRACTICAL  
HI-FI & AUDIO**

March issue

**OUT NOW 30p**



# FREE!

## Over 150 ways to engineer a better future

**HIGHER PAY**      **A BETTER JOB**  
**SECURITY**

### find out how in just 2 minutes

That's how long it will take you to fill in the coupon. Mail it today and we'll send you full details and a free book. We have successfully trained thousands of men at home—equipped them for higher pay and better, more interesting jobs. We can do as much for YOU. A low-cost home study course gets results fast—makes learning easier and something to look forward to. There are no books to buy and you can pay-as-you-learn.

Why not do the thing that really interests you? Without losing a day's pay, you could quietly turn yourself into something of an expert. Complete the coupon (or write if you prefer not to cut the page). No obligation and nobody will call in on you . . . but it could be the best thing you ever did.

Others have done it, so can you

"Yesterday I received a letter from the Institution informing that my application for Associate Membership had been approved. I can honestly say that this has been the best value for money I have ever obtained, a view echoed by two colleagues who recently commenced the course".  
 Student D.I.B., Yorks.

"Completing your course, meant going from a job I detested to a job that I love, with unlimited prospects"—Student J.A.O. Dublin.

"My training quickly changed my earning capacity and, in the next few years, my earnings increased fourfold". Student C.C.P., Bucks.

#### FIND OUT FOR YOURSELF

These letters and there are many more on file at Aldermaston College, speak of the rewards that come to the man who has given himself the specialised know-how employers seek. There's no surer way of getting ahead or of opening up new opportunities for yourself. It will cost you a stamp to find out how we can help you. Write to

### ALDERMASTON COLLEGE

Dept. TEE03 Reading RG7 4PF.

HOME OF BRITISH INSTITUTE OF ENGINEERING TECHNOLOGY



This FREE 76 page book can put you on the road to success through a B.I.E.T Home Study Course. Choose your subject now!

Practical Radio & Electronics Certificate course includes a learn while you build **3 transistor radio kit.** Everything you need to know about **Radio & Electronics** maintenance and repairs for a **spare time income** and a **career** for a better future.

**CUT OUT THIS COUPON**  
 Tick or state subject of interest. Post to address below.

<b>MECHANICAL</b>	<input type="checkbox"/>	<b>DRAUGHTSMANSHIP</b>	<input type="checkbox"/>
Society of Engineers—		Institute of Engineers	
A.M.S.E. (Mech)	<input type="checkbox"/>	Designers (A.M.I.E.D.)	<input type="checkbox"/>
Institute of Engineers & Technicians (A.M.I.E.)	<input type="checkbox"/>	General Draughtsmanship	<input type="checkbox"/>
<b>CITY &amp; GUILDS</b>	<input type="checkbox"/>	Elec. Draughtsmanship	<input type="checkbox"/>
Gen. Mech. Eng. Maintenance Eng.	<input type="checkbox"/>	Architectural Draughtsmanship	<input type="checkbox"/>
Welding (Gen. Diesel Eng.	<input type="checkbox"/>	Technical Drawing	<input type="checkbox"/>
Sheet Metal Work Eng. Inspection Eng. Metallurgy	<input type="checkbox"/>		
<b>ELECTRICAL &amp; ELECTRONIC CITY &amp; GUILDS</b>	<input type="checkbox"/>	<b>RADIO &amp; TELECOMMUNICATIONS</b>	<input type="checkbox"/>
Gen. Electrical Engineering	<input type="checkbox"/>	City & Guilds Telecoms.	<input type="checkbox"/>
Electrical Installations	<input type="checkbox"/>	Gen. Radio & TV Eng.	<input type="checkbox"/>
Electrical Maths	<input type="checkbox"/>	Radio Amateurs Exam	<input type="checkbox"/>
Computer Electronics	<input type="checkbox"/>	Radio Servicing	<input type="checkbox"/>
Electronic Eng. Practical Radio & Electronics (with kit)	<input type="checkbox"/>		
<b>MANAGEMENT &amp; PRODUCTION</b>	<input type="checkbox"/>	<b>AUTOMOBILE &amp; AERONAUTICAL</b>	<input type="checkbox"/>
Institute of Cost & Management Acctns.	<input type="checkbox"/>	Institute of the Motor Industry A.M.I.I.	<input type="checkbox"/>
Computer Programming	<input type="checkbox"/>	MAA/TMI City & Guilds	<input type="checkbox"/>
Works M'nt Work Study	<input type="checkbox"/>	Auto Eng. Motor Mechanics	<input type="checkbox"/>
Gen. Production Eng. Estimating & Planning	<input type="checkbox"/>	Auto Diesel Eng. Garage M'nt	<input type="checkbox"/>
Storekeeping	<input type="checkbox"/>	AEC Aero Engineering Exams	<input type="checkbox"/>
Management Skills	<input type="checkbox"/>	Gen. Aero Eng.	<input type="checkbox"/>
Quality Control	<input type="checkbox"/>		
		<b>CONSTRUCTIONAL</b>	<input type="checkbox"/>
		Institute of Building L.T.O.B.	<input type="checkbox"/>
		A.L.O. Clerk of Works	<input type="checkbox"/>

**G.C.E.**  
 —choose from 58 'O' & 'A' level subjects

Coaching for many exams, including C & G

## POST TODAY FOR A BETTER TOMORROW

To Aldermaston College, Dept. TEE03 Reading RG7 4PF.

NAME.....  
 Block capitals please  
 ADDRESS.....  
 POSTCODE.....  
 OTHER SUBJECTS.....  
 AGE.....

Accredited by C.A.C.C. Member of A.B.C.C.

Published approximately the third Friday of each month by IPC Magazines Ltd., Fleetway House, Farringdon Street, London E.C.4 4AD. Printed in England by Index Printers Ltd. Dunstable, Beds. Sole Agents for Australia and New Zealand—Gordon and Gotch (A/As) Ltd. South Africa—Central News Agency Ltd. Publisher's Subscription Rate including postage for one year, inland £3.35. Overseas £3.60. USA/Canada \$10.00. International Giro facilities Account No. 5122007. Please state reason for payment, message to payee. Everyday Electronics is sold subject to the following conditions, namely that it shall not, without the written consent of the Publishers first given, be lent, resold, hired out or otherwise disposed of by way of Trade at more than the recommended selling price shown on cover, excluding Hire where the selling price is subject to V.A.T., and that it shall not be lent, resold, or hired out or otherwise disposed of in a mutilated condition or in any unauthorised cover by way of Trade, or affixed to or as part of any publication or advertising, literary or pictorial matter whatsoever.

