

Inexpensive, easy to build projects

everyday electronics

FEB. 75
20p

Morse Practice Unit

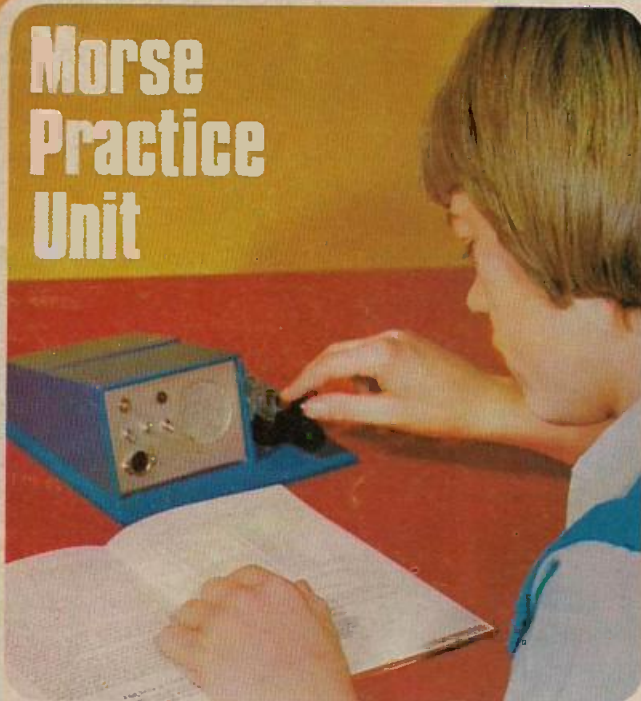

Lighting-up Warning

FOR THE MOTORIST

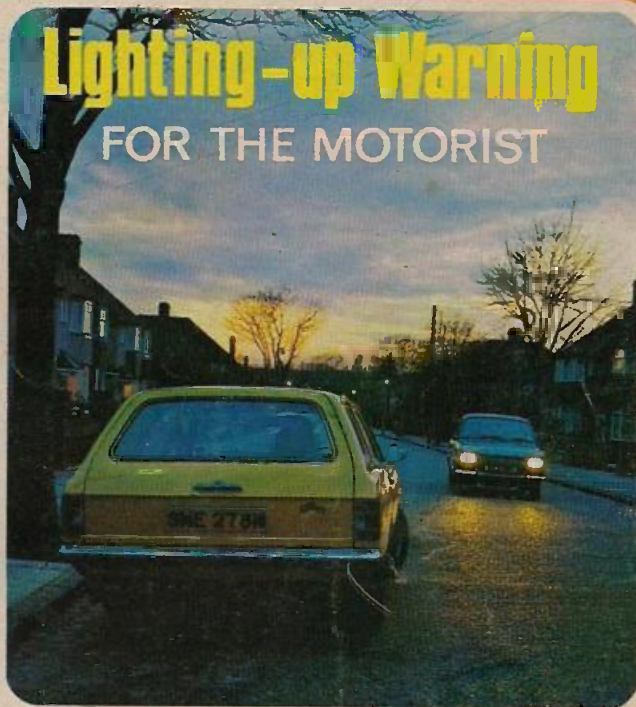

PLUS !

**THEORY • PRACTICE
POPULAR FEATURES**

*Electronics
made easy!*



**MODULA 3
STEREO AMPLIFIER**

NEW EDU-KIT MAJOR

Completely Solderless Electronic Construction Kit
Build these projects without soldering iron or solder

- ★ 4 Transistor Earpiece Radio.
- ★ 5 Transistor Push Pull Amplifier.
- ★ Batteryless Crystal Radio.
- ★ Signal Tracer.
- ★ 7 Transistor Loudspeaker Radio MW/LW.
- ★ 2 Transistor Regenerative Radio.
- ★ Signal Injector.
- ★ 5 Transistor Short Wave Radio.
- ★ 3 Transistor Regenerative Radio.
- ★ Transistor Tester NPN-PNP.
- ★ Electronic Metronome.
- ★ Audible Continuity Tester.
- ★ 4 Transistor Push Pull Amplifier.
- ★ Electronic Noise Generator.
- ★ Sensitive Pre-Amplifier.

Total Building Costs
£7-23
P P & Ins. 44p
(Overseas P & P £1-85)
(+ 8% VAT 57p)

Components Include: 24 Resistors • 21 Capacitors • 10 Transistors • 3 1/2" Loudspeaker • Earpiece • Mica Baseboard • 3 12-way connectors • 2 Volume controls • 2 Slider Switches • 1 Tuning Condenser • 3 Knobs • Ready Wound MW/LW/SW Coils • Ferrite Rod • 6 1/2 yards of wire • 1 Yard of sleeving etc. • Parts Price List and Plans 50p. (Free with parts).

NEW ROAMER NINE

WITH V.H.F. INCLUDING AIRCRAFT

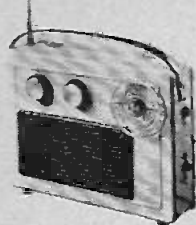

Five Transistors, 9 Tunable wavebands as Roamer Ten. Built in ferrite rod aerial for MW/LW. Retractable chrome-plated telescopic aerial for VHF and SW. Push Pull output using 600mW transistors, 9 Transistors and 3 diodes, tuning condenser with V.H.F. section, separate coil for aircraft, moving coil loudspeaker, volume ON/OFF and warchange controls. Attractive all white case with grille and carrying strap. Size 9 1/2" x 7" x 2 1/2" approx. Parts Price List and Plans 40p (Free with parts).

Total Building Costs **£6-95**
P P & Ins. 44p
(Overseas P & P £1-85)
(+ 8% VAT 53p)

NEW Everyday Series

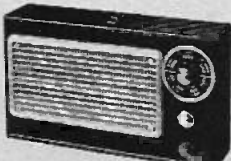

Build this exciting New series of designs

E.V.5. 5 Transistors and 2 diodes. MW/LW. Powered by 41 volt Battery. Ferrite rod aerial, tuning condenser, volume control, and now with 8" loudspeaker. Attractive case with red speaker grille. Size 9" x 5 1/2" x 2 1/2" approx. Parts Price List and Plans 20p. Free with parts.

Total Building Costs **£2-95**
P P & Ins. 36p
(+ 8% VAT 23p)
(Overseas P & P £1-25)

E.V.9. Case and looks as above. 6 Transistors and 3 diodes. Powered by 9 volt battery. Ferrite rod aerial, 5" loudspeaker, etc. MW/LW coverage. Push Pull output. Parts Price List and Plans 30p. Free with parts.

Total Building Costs **£3-60**
P P & Ins. 30p
(+ 8% VAT 26p)
(Overseas P & P £1-25)

E.V.7. Case and looks as above. 7 Transistors and 3 diodes. Six wavebands. MW/LW, Trarler Band, SW1, SW2, SW3, powered by 9 volt battery. Push Pull output. Telescopic aerial for short waves. 3" Loudspeaker. Parts Price List and Easy Build Plans 35p. Free with parts. Overseas P & P £1-05.

Total Building Costs **£4-08**
P P & Ins. 31p
(Overseas P & P £1-85)
(+ 8% VAT 32p)

ROAMER TEN

WITH VHF INCLUDING AIRCRAFT

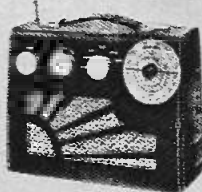

10 Transistors. Latest 4" 2 watt Ferrite Magnet Loudspeakers. 9 Tunable Wavebands. MW1, MW2, LW, SW1, SW2, SW3, Trarler Band, VHF and Local Stations also Aircraft Band.

On some cases the grill pattern will be horizontal bars and not as illustrated

Built in Ferrite Rod Aerial for MW/LW. Chrome plated, 7 section Telescopic Aerial, can be angled and rotated for peak short wave and VHF listening. Push Pull output using 600mW Transistors. Car Aerial and Tape Record Sockets. 10 Transistors plus 3 Diodes. Ganged Tuning Condenser with VHF section. Separate coil for Aircraft Band. Volume on/off. Wave Change and tone controls. Attractive Case in black with silver blocking. Size 9" x 7" x 2 1/2". Easy to follow instructions and diagrams. Parts price list and plans 50p (FREE with parts).

Total building costs **£8-50**
(Overseas P & P £1-85) P P & Ins. 82p
(+ 8% VAT 68p)

POCKET FIVE

NOW WITH 3" LOUD-SPEAKER

3 Tunable wavebands, M.W. L.W. and Trarler Band, 7 stages, 5 transistors and 2 diodes, supersensitive ferrite rod aerial, attractive black and gold case. Size 5 1/2" x 4 1/2" x 3 1/2" approx. Plans and Parts Price List 20p (Free with parts). (+ 8% VAT 20p)



Total Building Costs **£2-50**
P P & Ins. 26p
(Overseas P & P £1-25)



TRANSONA FIVE NOW WITH 3" LOUDSPEAKER

Wavebands, transistors and speaker as Pocket Five. Larger Case with Red Speaker Grille and Tuning Dial. Plans and Parts Price List 20p (Free with parts). (+ 8% VAT 25p)

Total Building Costs **£2-75**
P P & Ins. 28p
(+ 8% VAT 21p)

ROAMER EIGHT Mk I

NOW WITH VARIABLE TONE CONTROL

7 Tunable Wavebands: MW1, MW2, LW, SW1, SW2, SW3 and Trarler Band. Built in Ferrite Rod Aerial for MW and LW. Chrome plated Telescopic aerial can be angled and rotated for peak short wave listening. Push pull output using 600mW transistors. Car aerial and Tape record sockets. Selectivity switch. 8 transistors plus 3 diodes. Latest 4" 2 watt ferrite magnet loudspeaker. Air spaced ganged tuning condenser. Volume/on/off, tuning, wave change and tone controls. Attractive case in rich chestnut shade with gold blocking. Size 9 x 7 x 2 1/2 in. approx. Easy to follow instructions and diagrams. Parts price list and plans 50p (FREE with parts).



Total building costs **£6-98**
(Overseas P & P £1-85) P P & Ins. 47p
(+ 8% VAT 56p)

TRANS EIGHT

8 TRANSISTORS and 3 DIODES

8 Tunable Wavebands: MW, LW, SW1, SW2, SW3 and Trarler Band. Sensitive ferrite rod aerial for M.W. and L.W. Telescopic aerial for Short Waves. 3in. Speaker. 8 improved type transistors plus 3 diodes. Attractive case in black with red grille, dial and black knobs with polished metal inserts. Size 9 x 5 1/2 x 2 1/2 in. approx. Push pull output. Battery economiser switch for extended battery life. Ample power to drive a larger speaker. Parts price list and plans 35p (FREE with parts).

Total building costs **£4-48**
P P & Ins. 33p
(+ 8% VAT 36p)
(Overseas P & P £1-25)

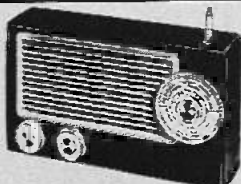

"EDU-KIT"

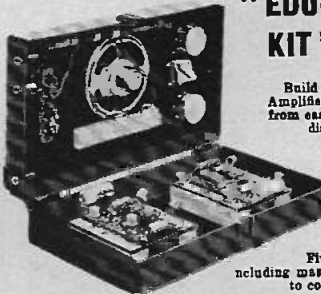

Build Radios, Amplifiers, etc. from easy stage diagrams.

Five units including master unit to construct.

Components include:
Tuning Condenser: 2 Volume Controls: 2 Slider Switches: Fine Tone 3" Moving Coil Speaker: Terminal Strip: Ferrite Rod Aerial: Battery Clips: 4 Taps Boards: 10 Transistors: 4 Diodes: Resistors: Capacitors: Three 1/2" Knobs. Units once constructed are detachable from Master Unit, enabling them to be stored for future use. Ideal for Schools, Educational Authorities and all those interested in radio construction. Parts price list and plans 40p (FREE with parts).

Total building costs **£5-50**
P P & Ins. 33p
(Overseas P & P £1-85)
(+ 8% VAT 44p)

RADIO EXCHANGE LTD

★ Callers side entrance "Lavelis" shop.
★ Open 10-1, 2.30-4.30, Mon.-Fri. 9-12 Sat.

To RADIO EXCHANGE CO., 61a HIGH STREET, BEDFORD, MK40 1SA
Tel.: 0234 52387. Reg. No. 788372.

I enclose £..... for

Name

Address

(Dept. E.E.2.)

ROAMER SIX

CASE AND LOOKS AS TRANS-EIGHT

6 Tunable Wavebands: MW, LW, SW1, SW2. Sensitive ferrite rod aerial and telescopic aerial for Short Waves. 3in. Speaker. 8 stages—5 transistors and 2 diodes. Attractive black case with red grille, dial and black knobs with polished metal inserts. Total P P & Ins. 31p
Size 9 x 5 1/2 x 2 1/2 in. approx. Plans and building costs **£3-98**
parts price list 35p (FREE with parts). (+ 8% VAT 32p) (Overseas P & P £1-85)



*COME AND JOIN THE ELECTRONIC ENTHUSIASTS CLUB!

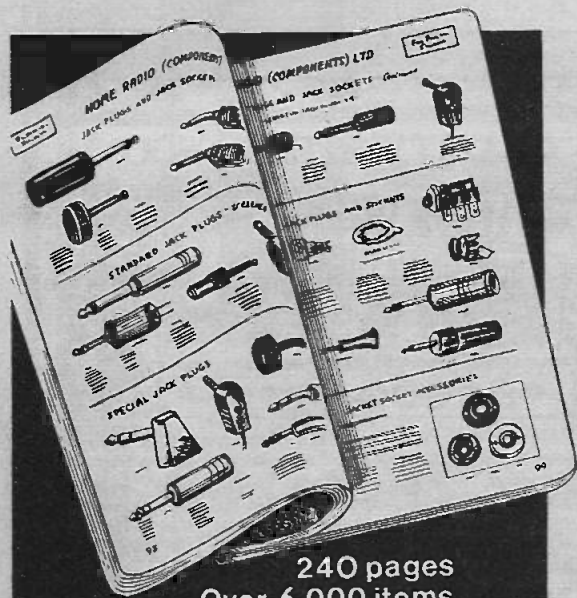

240 pages
Over 6,000 items
Nearly 2,000 pictures

I've been dealing with Home Radio Components for a number of years and I've never felt I was a *customer*; rather that I'd joined a bunch of enthusiasts who were out to help me every way they could. This shows itself in many ways. Take their catalogue for instance. Several pages are taken up with information such as useful formulae, how to choose a microphone, the meaning of conventional signs, resistor and capacitor codes. Every page in that catalogue must cost them a great deal of money, and these things can't show them a direct return. On the other hand it does show that they care!! There is a whole page telling you the best way to order, plus carefully worked out order forms, and two pages showing how you can open a credit account. Then there is their philosophy with the catalogue. They are anxious that the good customer will get it for the minimum price, so they include 14 coupons each worth 5p if used as directed. Don't take my word for it, try it for yourself, join the merry band! Membership is automatic, once you buy a catalogue. Send off for it today. It costs 65p plus 33p postage and packing but with the coupons you can get back 70p—the whole cost of the catalogue plus 5p towards the postage. Complete the coupon below and send it to the address shown, with your cheque or p.o. for 98p.

65p. plus 33p POST AND PACKING

Send off the coupon today. It's your first step to solving your component buying problems.

The price of 98p applies only to customers in the U.K. and to BFPO Addresses.

Please write your Name and Address in block capitals

NAME

ADDRESS



HOME RADIO (Components) LTD., Dept. EE,
234-240 London Road, Mitcham, Surrey CR4 3HD

(Regn. No.
London 912966)

CRESCENT RADIO LTD.

11-15 & 17 MAYES ROAD, LONDON N22 6TL
(also) 13 SOUTH MALL, EDMONTON, N.9

MAIL ORDER DEPT.
11 MAYES ROAD, LONDON N22 6TL
Phone 888 3206 & (EDM). 803 1685

ABS PLASTIC BOXES

Ready made for construction projects.
Standard entrance hole for P.C. or
change panel. Filled with foam front
panel.

11" x 11" x 45mm - 53p.
11" x 11" x 67mm - 66p.
11" x 11" x 90mm - 82p.
11" x 11" x 113mm - 100p.

Shipping Costs

CLEAR PLASTIC PANEL METERS

Size 50mm x 48mm x 35mm these
meters require a 38mm hole for
mounting.

ME2 - 0 to 50 micro amp Full Scale
ME7 - 0 to 100 micro amp
ME8 - 0 to 500 micro amp
ME9 - 0 to 1mA
ME10 - 0 to 5mA
ME11 - 0 to 10mA
ME12 - 0 to 50mA
ME13 - 0 to 100mA
ME14 - 0 to 500mA
ME15 - 0 to 1 amp
ME16 - 0 to 50 volts A.C. Full Scale
ME17 - 0 to 300 volts A.C. Full Scale
ME18 - "8" Meter
ME19 - "40" Meter
OUR PRICE
£3.00



LOW VOLTAGE AMPLIFIER

5 transistor amplifier complete with volume control, suitable for 9V d.c. and a.c. supplies. Will give about 1W at 8 ohm output. With high I.M.P. input this amplifier will work as a record player, baby alarm, etc., amplifier. £2.00



LIGHT EMITTING DIODES

TL 209 (Red) with Chip 22p each
TL 209 (Green) with Chip 85p each
TL 209 (Yellow) with Chip 90p each
Med 609 T092 Type .. 16p each

LED READOUTS

Litronix
DL707 - 3 Character 14 Pin DIL 88.00
DL701 As above but ±1 .. 82.00
DL747 - 6 Character 82.82
Mintron
3015 7 Segment 16 Pin DIL .. 81.18
9015G As above but ±1 .. 81.18

CLOCK CHIP

CT7001 MOS/LSI Digital Clock/
Calendar Chip plus full Circuits and
Information Leaflet 88.95
Circuits and Information Sheet 16p
L14704 Led Display for above 81.35
Or 4 for 25.25

3 KILOWATTS PSYCHEDELIC LIGHT CONTROL UNIT



Three Channel: Base-Middle-Treble.
Each channel has its own sensitivity
control. Just connect the input of this
unit to the loudspeaker terminals of an
amplifier, and connect three 250V up to
1000W lamps to the output terminals
of the unit, and you produce a fascinating
sound-light display. (All guaranteed.)
£18.50 plus 36p P. & P.

U.K. CARR.
15p unless otherwise
stated

V.A.T.
8% V.A.T. to be added
to all orders

Send 20p for a
CRESCENT
CATALOGUE

VEROBOARD

	-1	-15	Plain -16
21 x 31	85p	24p	15p
21 x 5	34p	34p	18p
21 x 31	34p	34p	..
31 x 5	85p	45p	..
17 x 21	1.08p	77p	60p
17 x 31	1.45p	1.18p	76p
17 x 5	1.85p	..	1.10p

Pin insertion tool 63p
Spot face Cutter 45p
Pkt 36 pins (state -1 or -15) 25p

LOUDSPEAKERS

2 1/2" 8 ohm 50p
2 1/2" 40 ohm 50p
2 1/2" 80 ohm 50p
6" 8 ohm ceramic £1.25
6" 8 ohm Dual cone ceramic £2.50
7" x 4" 8 ohm ceramic £1.60
8" x 8" 8 ohm Permanent Magnet £1.80
EMI 13 x 8" 450 Kit 3-8-15 ohm £4.70
EMI 12 x 8" 350 Kit 8 ohm £7.50
Fane Ultra high power loudspeakers
*Pop 25/2 30 watt 15ohm 12" £8.29
*Pop 55 60 Watt 8/15ohm 12" £14.60
*Pop 50 50 Watt 15ohm 12" £11.99
*Pop 60 60 Watt 8/15ohm 15" £15.70
*Pop 100 100 Watt 8/15ohm 18" £23.70
*Car 20 L/S over 13 x 8" and 12" 60p
per L/S.

S. G. BROWN "DIPLOMAT" HEADSET

Finest quality British made Light-
weight Headphones.
Incorporates ceramic piezo electric
transducers.
Specification:-
Frequency - 20-17,500 CPS.
Impedance - Predominantly capacitive,
at -001MFD per piece can be re-
garded as 150K at 1kcs.
Weight - 3.5oz. (98 grams).
A Bargain at £1.25 each set

TWO WAY STEREO ADAPTOR

Stereo jack plug to two stereo line
sockets complete with 110 mm of cable.
For plugging two stereo inputs into one.
A Bargain at 65p.

STEREO/MONO HEADPHONE VOLUME CONTROL BOX

Plug Stereo phones into this control
box and you then incorporate a right
and left hand volume control and a
stereo/mono switch. Complete with
stereo jack plug and 2 m cable.
A Bargain at £1.

12-0-12 VOLT 500m/A 240 VOLT PRIMARY TRANSFORMER

approx. size - 60mm x 40mm
x 50mm. Fixing centres - 75mm.
A REAL BARGAIN AT £1.20 each.

DECON-DALO

33 PC ETCH RESIST PEN
The Decon-Dalo 33PC is a unique
instrument for the professional and
amateur electronics engineer. Enabling
him to prepare in minutes a perfect
printed circuit board.

OUR PRICE 80p + VAT

POWER PACKS

PP1 Switched 3-6-7.9volt 400M/A
Transistor & Zener Stabilised On/
Off switch & Polarity Reversal
switch, in a black metal case
£5.25 each
PP2 Switched 6-7.9 volt Battery
Eliminator. Approx size 2 1/2" x
2 1/2" x 3 1/2". Ideal for cassette re-
corders. £3.25 each.
PP3 Car converter. From 12v Pos. or
Neg to - 6-7.9 volt. Easy to fit
and transistor regulated.
£3.90 each.



become a RADIO-AMATEUR!

learn how to become a radio-amateur
in contact with the whole world. We give
skilled preparation for the G.P.O. licence

free! Brochure, without obligation to:

**BRITISH NATIONAL RADIO & ELECTRONICS
SCHOOL** Dept EEB 25 P.O. Box 156, JERSEY

NAME: _____

ADDRESS: _____

BLOCK CAPS please

QUALITY STEREO SOUND

SOLENT AUDIO SYSTEM

ALMOST 1/2 PRICE OFFER!

£5
down



*Stereo Tuner Amplifier chassis with AM/FM radio covering long medium short and Stereo FM wavebands. Separate Base and Treble controls. Power output 7 watts R.M.S. per channel (frequency response 25-20,000 Hz) Tape record and playback facilities. Dimensions 18" x 8 1/2" x 3 1/4". The very latest BSR automatic record deck with cue and pause control. Two matching elliptical speaker units.

Order early limited stocks available cash price £49.95.
Credit Sale £5.00 deposit 9 monthly payments of £5.75
(Total Credit price £56.75). P. & P. £2.50. Send £7.50
today.

Chassis only available for cash at £35.00.

Full 12 months Guarantee.

CALLERS WELCOME.

Stereo headphones supplied with every complete order.

LEWIS radio E.E. 2/75. 100 CHASE SIDE SOUTHGATE
LONDON N14 5PL Telephone: 01-882-1644

ELECTROVALUE

APPOINTED STOCKISTS FOR SIEMENS QUALITY PRODUCTS

Present

top quality electronic components for price-minded buyers

112 p. CATALOGUE · FREE POSTAGE (U.K.) · ATTRACTIVE DISCOUNTS · SPECS. GUARANTEED

A 100 OF THE BEST

From our transistor stock.

2N1307	47p	BC149C	14p
2N2646	51p	BC158B	15p
2N3053	26p	BC159	16p
2N3054	66p	BC187B	13p
2N3055	70p	BC188B	12p
2N3702	11p	BC189C	13p
2N3703	10p	BC189C	13p
2N3704	11p	BC179B	26p
2N3705	10p	BC182L	28p
2N3784	18p	BC184L	26p
2N3819	25p	BC212L	12p
2N4082	11p	BC214L	14p
2N4443	83p	BC257A	14p
2N5062	42p	BC259B	14p
2N5163	26p	BCY58	36p
2N5459	35p	BD130	70p
40391	48p	BD131	48p
40362	48p	BD132	52p
40602	48p	BD135	37p
40636	£1-36	BD136	38p
40669	£1-10	BDY20	83p
AC128	17p	BF194	15p
AC151R	36p	BF839	23p
AC183	27p	BF879	23p
AC153K	37p	BFX29	33p
AC176	24p	BFX84	27p
AC176K	38p	BFY51	23p
AC187K	31p	BRV39	45p
AC188K	26p	BY164	81p
AD133	£1-92	C108B1	42p
AD136	£1-11	C108D1	62p
AD149	63p	C1408	78p
AD161	42p	MJ481	£1-20
AD162	46p	MJ491	£1-35
AF200J	70p	MJ295	89p
AF238	50p	MJE371	89p
B1906	38p	MJE521	91p
BA138	31p	MJE2955	£1-12
BB103	24p	MJE3055	69p
BB105	34p	QA91	8p
BB109	18p	SD4	8p
BC107A	18p	TIP1A	78p
BC107B	18p	TIP32A	80p
BC108B	15p	TIP41A	80p
BC108C	15p	TIP42A	£1-00
BC109B	18p	W02	39p
BC109C	18p	ZTX300	14p
BC147A	12p	ZTX304	22p
BC147B	13p	ZTX500	14p
BC148B	12p	ZTX504	45p

100s MORE IN CATALOGUE 7

BAXANDALL SPEAKER KIT

As designed by P. J. Baxandall and described originally in "Wireless World." Simple to assemble, fantastically good results and a greater money saver. Carries 10 watts RMS, 15 ohms impedance. Size 18in x 12in x 10in. Complete kit, including pack-flat cabinet, £18-90. The size and weight of this product obliges us to charge 70p part cost of carr. in U.K. Equaliser Assembly, £2-60. Loudspeaker Unit 50RM109, £2-85. Cabinet Kit to Baxandall design, £10-45. Cross-over choke for additional woofer to above, £1-50.

DISCOUNTS

Available on all items except those shown with NETT PRICES 5% on orders from £5 to £14-99. 10% on orders £15 and over.

FREE POSTAGE

In U.K. for pre-paid mail orders. For mail orders for £2 list value and under there is an additional handling charge of 10p. Overseas orders - carriage charged at cost. 6/ro A/C No.

38/871/4062

RESISTORS

Code	Watts	Ohms	1 to 9	10 to 99	100 up
(see note below)					
C	1/3	4-7-470K	1-3	1-1	9-9 nett
C	1/2	4-7-10M	1-3	1-1	9-9 nett
C	3/4	4-7-10M	1-3	1-2	9-97 nett
C	1	4-7-10M	3-2	2-3	1-92 nett
MO	1/2	10-1M	4	3-3	2-3 nett
WW	1	0-27-0-47Ω	18	14	11 nett
WW	1	0-22-3-9Ω	12	19	8 nett
WW	3	1-10K	9	8	9 nett
WW	7	1-10K	11	10	9 nett

Codes:

C = carbon film, high stability, low noise.
MO = metal oxide. Electroslit TR5 ultra low noise.
WW = wire wound, Plessey.

Values: All E12 except C 1/3W, C 1/2W and MO 1/2W.
E12: 10, 12, 15, 18, 22, 27, 33, 39, 47, 56, 68, 82 and their decades.
E24: as E12 plus 11, 13, 16, 20, 24, 30, 36, 43, 51, 62, 75, 81 and their decades.

Tolerances:

5% except WW 10% ± 0-05Ω below 10Ω and MO 1/2W 2%.
Prices are in pence each for quantities of the same ohmic value and power rating. NOT mixed values. (Ignore fractions of one penny on total value of resistor order): Prices for 100 up in units of 100 only

POTENTIOMETERS

ROTARY, CARBON TRACK, Double wipers for good contact and long working life

P.20 SINGLE linear 100 ohms to 4-7 megohms, each 14p
P.20 SINGLE log. 4-7 Kohms to 2-2 megohms, each 14p
JP.20 DUAL GANG 1in. 4-7 Kohms to 2-2 megohms, each 46p
JP.20 DUAL GANG log. 4-7 Kohms to 2-2 megohms, each 46p
JP.20 DUAL GANG Log/antilog 10K, 22K, 47K, 1 megohm only, each 46p
JP.20 DUAL GANG antilog 10K only 48p

2A DP mains switch for any of above 14p extra.

Decades of 10, 22 and 47 only available in ranges above.

Skeleton Carbon Presets, Type PR, horizontal or vertical, each 6p

SLIDER

Linear or log mono 4-7K to 1 meg. In all popular values, each 39p

STEREO, matched tracks, lin. or log in all popular values from 4-7K to 1 meg. 66p

Ecutcheon plates, mono, black, white or light grey, each 16p

Control knobs, blk/wht/red/yel/grn/blue/dk. grey/lt. grey, each 7p

CAPACITORS

DAILY ELECTROLYTIC in cans, plastic sleeved 2200/100 £1-91

1000mF/25V 34p	1000/50 50p
5000/100 £3-56	2000/50 78p
5000/25V 75p	5000/50 £1-44
POLYESTER TYPE C.226. Radial leads for P.C.B. mounting. Working voltage 250V d.c.	
0-01, 0-015, 0-022, 0-033, 0-047, ea. 3p	
0-068, 0-1, 0-15 ea. 4p	
0-22 5p; 0-33 7p; 0-47 8p; 0-68 11p;	
1-014p; 1-5, 21p; 2-2 24p	
SILVERED MICA. Working voltage 500V d.c. Tolerance 1% or 5p F ea. 6p. 270-820 in 9 sizes.	
Values in pF's—2-2 to 250 in 26 stages ea. 6p	

1000, 1500 pF; 1800 pF; 2200 10p; 2700; 3800 15p; 4700, 5000 18p; 6800 20p; 8200, 10,000 25p

TANTALUM BEAD 0-1, 0-22, 0-47, 1-0 mF/35V, 1-5/20V, 3-5/16V ea. 15p

2-2/16V, 2-2/35V, 4-7/16V, 10/5-3V ea. 16p

4-7/35V, 10/16V, 22/8-3V ea. 20p

10/25V, 22/16V, 27/6-3V, 100/3V, 6-8/25V, 15/25V ea. 20p

POLYCARBONATE Type B42540 Working Voltage—250V

Values in mF: 0-0047; 0-0068; 0-0082; 0-01; 0-012; 0-015

0-018; 0-022; 0-027; 0-033; 0-039; 0-047; 0-056; 0-068; 0-082; 0-1 ea. 4p

CERAMIC PLATE Working voltage 50V, d.c. In 26 values from 22pF to 6800pF, ea. 2p

ELECTROLYTIC CAPACITORS

Axial Lead	3V	6-3V	10V	16V	25V	40V	63V	100V
0-47	—	—	—	—	—	—	11p	8p
1-0	—	—	—	—	—	—	—	8p
2-2	—	—	—	—	11p	—	—	8p
4-7	—	—	—	—	—	8p	8p	8p
10	—	—	—	—	—	—	8p	8p
22	—	—	—	—	—	—	8p	8p
47	8p	—	—	—	—	—	8p	8p
100	8p	8p	8p	8p	8p	8p	8p	8p
220	8p	8p	8p	10p	10p	11p	17p	24p
470	8p	10p	10p	10p	13p	17p	24p	28p
1,000	11p	13p	13p	17p	20p	25p	41p	—
2,200	15p	18p	23p	26p	37p	41p	—	—
4,700	20p	30p	39p	44p	—	—	—	—
10,000	42p	44p	—	—	—	—	—	—

MINITRON DIGITAL INDICATORS

3015F Seven segment filament compatible with standard logic modules. 0-9 and decimal point: 9mm characters in 16 lead DIL £1-20
Suitable BCD decoder driver 7447 £1-15
3015G showing + or - & 1 & dec. pt. £1-20

LEDS (Light Emitting Diodes)

Photo Cells, each 25p

ANTEX Soldering Irons

C-240 £1-95 Spare bits 32p
CCN240 £2-85 Spare bits 48p

DESOLDER BRAID

6 ft strip 78p

WAVECHANGE SWITCHES

1 pole 12 way; 2 pole 5 way each 33p
3 pole 4 way; 4 pole 3 way each 33p

TAG STRIP 28 way 11p

NUTS, SCREWS, etc.

In lots of 100 each
4BA NUTS 28p; 6BA NUTS 28p
1/4" 4B Screws 28p; 1/4" 6BA Screws 24p
Threaded pillars 6BA, 1/4" hexagonal £2-10
£1-32

Plain spacers 1/4" round

Other sizes available

ENAMEL COPPER

WIRE in 2 ounce reels

16, 18, 20, 22 SWG 34p
24, 26, 28, 30 SWG 44p
32, 34 44p; 36, 38, 40 44p

DIN CONNECTORS

1 way loudspeaker	Socket Plug 10p
3 way audio	16p
5 way audio 180	12p
5 way audio 240	12p
6 way audio	13p

EV CATALOGUE 7

2nd printing—Green and yellow Cover

112 pages, thousands of items; illustrations, diagrams; much useful technical information. The 2nd printing has been updated as much as possible on prices. It costs only 30p post free including refund voucher for 25p for spending when ordering goods list value £5 or more.

QUALITY GUARANTEE

All goods are sold on the understanding that they conform to manufacturers' specifications and satisfaction is guaranteed as such—no rejects, 'seconds' or sub-standard merchandise is offered for sale.

Prices quoted do not include V.A.T. for which 8% must be added to total net value of order. Every effort is made to ensure the correctness of information and prices at time of going to press. Prices subject to alteration without notice.

ELECTROVALUE LTD

28, ST. JUDES ROAD, ENGLEFIELD GREEN, EGHAM, SURREY TW20 0HB
Telephone Egham 3603 Telex 264475 Shop hours 9-5.30 daily: Sat. 9-1 p.m.

NORTHERN BRANCH: 680, Burnage Lane, Burnage, Manchester M19 1NA
Telephone (061) 432 4945 Shop hours 9-5.30 daily: Sat. 9-1 p.m.

U.S.A. CUSTOMERS are invited to contact ELECTROVALUE AMERICA, P.O. Box 27, Swarthmore PA 19081.

All postal communications, mail orders etc. to Head Office at Egham address, Dept. EE2. S.A.E. with enquiries requiring answers.

The largest selection

BRAND NEW FULLY GUARANTEED DEVICES

AC107 0.22	162(MF) 0.75	BC152 0.19	BD135 0.44	BF187 0.80	MJE2955 0.95	ZN414 11.20	2N2192 0.39	2N3391 0.16	2N4060 0.13
AC113 0.20	ADT140 0.55	BC153 0.31	BD136 0.44	BF188 0.44	MJE3055 0.82	2G301 0.21	2N2193 0.39	2N3391A 0.19	2N4061 0.13
AC115 0.22	ADT14 0.55	BC154 0.31	BD137 0.50	BF194 0.18	MJE2440 0.55	2G302 0.21	2N2194 0.39	2N3392 0.18	2N4062 0.13
AC117K 0.22	AF115 0.27	BC157 0.20	BD138 0.55	BF195 0.18	MFF102 0.45	2G303 0.21	2N2217 0.24	2N3393 0.18	2N4284 0.19
AC122 0.18	AF116 0.27	BC158 0.13	BD139 0.61	BF196 0.18	MFF104 0.41	2G304 0.27	2N2218 0.22	2N3394 0.18	2N4285 0.19
AC125 0.19	AF117 0.27	BC159 0.13	BD140 0.66	BF197 0.16	MFF105 0.41	2G306 0.48	2N2219 0.22	2N3395 0.18	2N4286 0.19
AC126 0.18	AF118 0.39	BC160 0.50	BD155 0.58	BF200 0.50	OC19 0.38	2G345 0.18	2N2220 0.22	2N3402 0.23	2N4288 0.19
AC127 0.20	AF124 0.33	BC161 0.55	BD175 0.66	BF222 0.15	OC20 0.38	2G471 0.18	2N2221 0.22	2N3403 0.18	2N4289 0.19
AC128 0.20	AF126 0.33	BC162 0.13	BD176 0.66	BF225 0.50	OC22 0.38	2G371B 0.18	2N2222 0.22	2N3404 0.18	2N4290 0.19
AC132 0.18	AF126 0.33	BC168 0.13	BD177 0.72	BF258 0.66	OC23 0.48	2G373 0.19	2N2268 0.19	2N3405 0.46	2N4291 0.19
AC134 0.18	AF126 0.33	BC169 0.13	BD178 0.72	BF259 0.94	OC24 0.48	2G374 0.19	2N2269 0.19	2N3414 0.17	2N4292 0.19
AC137 0.16	AF129 0.51	BC170 0.13	BD179 0.77	BF274 0.39	OC25 0.48	2G377 0.33	2N2269A 0.16	2N3415 0.17	2N4293 0.19
AC141 0.20	AF178 0.55	BC171 0.18	BD180 0.77	BF283 0.61	OC26 0.48	2G378 0.18	2N2241 0.27	2N3417 0.31	2N4294 0.19
AC141K 0.22	AF179 0.55	BC172 0.16	BD185 0.72	BF290 0.39	OC28 0.55	2G381 0.18	2N2242 0.27	2N3425 0.33	2N4295 0.19
AC142 0.20	AF180 0.55	BC173 0.18	BD198 0.72	BF271 0.38	OC29 0.55	2G382 0.18	2N2246 0.42	2N3425 0.33	2N4296 0.19
AC142K 0.22	AF181 0.55	BC174 0.18	BD187 0.77	BF272 0.88	OC33 0.48	2G401 0.33	2N2271 0.23	2N3414 0.17	2N4297 0.19
AC154 0.22	AF186 0.55	BC175 0.24	BD198 0.77	BF273 0.39	OC36 0.46	2G414 0.33	2N2272 0.23	2N3415 0.17	2N4299 0.19
AC154 0.22	AF189 0.41	BC177 0.23	BD189 0.88	BF274 0.39	OC41 0.23	2G417 0.33	2N2304 0.18	2N3416 0.17	2N4300 0.19
AC155 0.22	AL102 0.72	BC178 0.21	BD190 0.88	BF283 0.61	OC42 0.32	2G418 0.33	2N2304A 0.23	2N3416 0.17	2N4301 0.19
AC156 0.22	AL103 0.72	BC179 0.21	BD195 0.94	BF290 0.39	OC43 0.32	2G419 0.33	2N2304A 0.23	2N3417 0.31	2N4302 0.19
AC157 0.27	AS226 0.28	BC180 0.27	BD196 0.94	BF292 0.50	OC45 0.14	2N404 0.22	2N2305 0.23	2N3403 0.18	2N4302A 0.46
AC185 0.22	AS227 0.28	BC181 0.27	BD197 0.99	BF285 0.33	OC70 0.11	2N404A 0.22	2N2306A 0.23	2N3704 0.14	2N4302 0.46
AC186 0.22	AS228 0.28	BC182 0.18	BD198 0.99	BF286 0.24	OC71 0.11	2N404 0.22	2N2306A 0.23	2N3705 0.14	2N4303 0.46
AC187 0.22	AS229 0.28	BC183 0.18	BD199 0.99	BF287 0.24	OC72 0.16	2N404 0.22	2N2306A 0.23	2N3706 0.14	2N4304 0.72
AC188 0.27	AS230 0.28	BC184 0.18	BD200 0.15	BF288 0.24	OC73 0.16	2N404 0.22	2N2307 0.22	2N3707 0.14	2N4305 0.86
AC189 0.14	AS231 0.28	BC185 0.18	BD205 0.88	BF290 0.22	OC75 0.17	2N404 0.22	2N2307A 0.24	2N3708 0.18	2N4306 0.86
AC186 0.22	AS232 0.28	BC186 0.22	BD206 0.88	BF291 0.22	OC76 0.17	2N404 0.22	2N2308 0.14	2N3709 0.10	2N4307 0.86
AC177 0.27	AS233 0.28	BC187 0.22	BD207 0.15	BF292 0.22	OC77 0.28	2N404 0.22	2N2309 0.14	2N3710 0.10	2N4308 0.86
AC178 0.21	AS234 0.28	BC188 0.22	BD208 0.15	BF293 0.19	OC81 0.17	2N404 0.22	2N2310 0.14	2N3711 0.10	2N4309 0.86
AC179 0.21	AS235 0.28	BC189 0.22	BD209 0.15	BF294 0.19	OC83 0.17	2N404 0.22	2N2311 0.14	2N3712 0.10	2N4310 0.86
AC180 0.22	AS236 0.28	BC190 0.12	BD210 0.15	BF295 0.17	OC85 0.22	2N404 0.22	2N2312 0.14	2N3713 0.10	2N4311 0.86
AC180K 0.22	AS237 0.28	BC191 0.12	BD211 0.15	BF296 0.17	OC87 0.22	2N404 0.22	2N2313 0.14	2N3714 0.10	2N4312 0.86
AC181 0.22	AS238 0.28	BC192 0.13	BD212 0.15	BF297 0.17	OC89 0.22	2N404 0.22	2N2314 0.14	2N3715 0.10	2N4313 0.86
AC181K 0.22	AS239 0.28	BC193 0.13	BD213 0.15	BF298 0.17	OC91 0.22	2N404 0.22	2N2315 0.14	2N3716 0.10	2N4314 0.86
AC182 0.22	AS240 0.28	BC194 0.13	BD214 0.15	BF299 0.17	OC93 0.22	2N404 0.22	2N2316 0.14	2N3717 0.10	2N4315 0.86
AC183 0.22	AS241 0.28	BC195 0.13	BD215 0.15	BF300 0.17	OC95 0.22	2N404 0.22	2N2317 0.14	2N3718 0.10	2N4316 0.86
AC184 0.22	AS242 0.28	BC196 0.13	BD216 0.15	BF301 0.17	OC97 0.22	2N404 0.22	2N2318 0.14	2N3719 0.10	2N4317 0.86
AC185 0.22	AS243 0.28	BC197 0.13	BD217 0.15	BF302 0.17	OC99 0.22	2N404 0.22	2N2319 0.14	2N3720 0.10	2N4318 0.86
AC186 0.22	AS244 0.28	BC198 0.13	BD218 0.15	BF303 0.17	OC101 0.22	2N404 0.22	2N2320 0.14	2N3721 0.10	2N4319 0.86
AC187 0.22	AS245 0.28	BC199 0.13	BD219 0.15	BF304 0.17	OC103 0.22	2N404 0.22	2N2321 0.14	2N3722 0.10	2N4320 0.86
AC188 0.22	AS246 0.28	BC200 0.13	BD220 0.15	BF305 0.17	OC105 0.22	2N404 0.22	2N2322 0.14	2N3723 0.10	2N4321 0.86
AC189 0.22	AS247 0.28	BC201 0.13	BD221 0.15	BF306 0.17	OC107 0.22	2N404 0.22	2N2323 0.14	2N3724 0.10	2N4322 0.86
AC180K 0.22	AS248 0.28	BC202 0.13	BD222 0.15	BF307 0.17	OC109 0.22	2N404 0.22	2N2324 0.14	2N3725 0.10	2N4323 0.86
AC181 0.22	AS249 0.28	BC203 0.13	BD223 0.15	BF308 0.17	OC111 0.22	2N404 0.22	2N2325 0.14	2N3726 0.10	2N4324 0.86
AC181K 0.22	AS250 0.28	BC204 0.13	BD224 0.15	BF309 0.17	OC113 0.22	2N404 0.22	2N2326 0.14	2N3727 0.10	2N4325 0.86
AC182 0.22	AS251 0.28	BC205 0.13	BD225 0.15	BF310 0.17	OC115 0.22	2N404 0.22	2N2327 0.14	2N3728 0.10	2N4326 0.86
AC183 0.22	AS252 0.28	BC206 0.13	BD226 0.15	BF311 0.17	OC117 0.22	2N404 0.22	2N2328 0.14	2N3729 0.10	2N4327 0.86
AC184 0.22	AS253 0.28	BC207 0.13	BD227 0.15	BF312 0.17	OC119 0.22	2N404 0.22	2N2329 0.14	2N3730 0.10	2N4328 0.86
AC185 0.22	AS254 0.28	BC208 0.13	BD228 0.15	BF313 0.17	OC121 0.22	2N404 0.22	2N2330 0.14	2N3731 0.10	2N4329 0.86
AC186 0.22	AS255 0.28	BC209 0.13	BD229 0.15	BF314 0.17	OC123 0.22	2N404 0.22	2N2331 0.14	2N3732 0.10	2N4330 0.86
AC187 0.22	AS256 0.28	BC210 0.13	BD230 0.15	BF315 0.17	OC125 0.22	2N404 0.22	2N2332 0.14	2N3733 0.10	2N4331 0.86
AC188 0.22	AS257 0.28	BC211 0.13	BD231 0.15	BF316 0.17	OC127 0.22	2N404 0.22	2N2333 0.14	2N3734 0.10	2N4332 0.86
AC189 0.22	AS258 0.28	BC212 0.13	BD232 0.15	BF317 0.17	OC129 0.22	2N404 0.22	2N2334 0.14	2N3735 0.10	2N4333 0.86
AC180K 0.22	AS259 0.28	BC213 0.13	BD233 0.15	BF318 0.17	OC131 0.22	2N404 0.22	2N2335 0.14	2N3736 0.10	2N4334 0.86
AC181 0.22	AS260 0.28	BC214 0.13	BD234 0.15	BF319 0.17	OC133 0.22	2N404 0.22	2N2336 0.14	2N3737 0.10	2N4335 0.86
AC181K 0.22	AS261 0.28	BC215 0.13	BD235 0.15	BF320 0.17	OC135 0.22	2N404 0.22	2N2337 0.14	2N3738 0.10	2N4336 0.86
AC182 0.22	AS262 0.28	BC216 0.13	BD236 0.15	BF321 0.17	OC137 0.22	2N404 0.22	2N2338 0.14	2N3739 0.10	2N4337 0.86
AC183 0.22	AS263 0.28	BC217 0.13	BD237 0.15	BF322 0.17	OC139 0.22	2N404 0.22	2N2339 0.14	2N3740 0.10	2N4338 0.86
AC184 0.22	AS264 0.28	BC218 0.13	BD238 0.15	BF323 0.17	OC141 0.22	2N404 0.22	2N2340 0.14	2N3741 0.10	2N4339 0.86
AC185 0.22	AS265 0.28	BC219 0.13	BD239 0.15	BF324 0.17	OC143 0.22	2N404 0.22	2N2341 0.14	2N3742 0.10	2N4340 0.86
AC186 0.22	AS266 0.28	BC220 0.13	BD240 0.15	BF325 0.17	OC145 0.22	2N404 0.22	2N2342 0.14	2N3743 0.10	2N4341 0.86
AC187 0.22	AS267 0.28	BC221 0.13	BD241 0.15	BF326 0.17	OC147 0.22	2N404 0.22	2N2343 0.14	2N3744 0.10	2N4342 0.86
AC188 0.22	AS268 0.28	BC222 0.13	BD242 0.15	BF327 0.17	OC149 0.22	2N404 0.22	2N2344 0.14	2N3745 0.10	2N4343 0.86
AC189 0.22	AS269 0.28	BC223 0.13	BD243 0.15	BF328 0.17	OC151 0.22	2N404 0.22	2N2345 0.14	2N3746 0.10	2N4344 0.86
AC180K 0.22	AS270 0.28	BC224 0.13	BD244 0.15	BF329 0.17	OC153 0.22	2N404 0.22	2N2346 0.14	2N3747 0.10	2N4345 0.86
AC181 0.22	AS271 0.28	BC225 0.13	BD245 0.15	BF330 0.17	OC155 0.22	2N404 0.22	2N2347 0.14	2N3748 0.10	2N4346 0.86
AC181K 0.22	AS272 0.28	BC226 0.13	BD246 0.15	BF331 0.17	OC157 0.22	2N404 0.22	2N2348 0.14	2N3749 0.10	2N4347 0.86
AC182 0.22	AS273 0.28	BC227 0.13	BD247 0.15	BF332 0.17	OC159 0.22	2N404 0.22	2N2349 0.14	2N3750 0.10	2N4348 0.86
AC183 0.22	AS274 0.28	BC228 0.13	BD248 0.15	BF333 0.17	OC161 0.22	2N404 0.22	2N2350 0.14	2N3751 0.10	2N4349 0.86
AC184 0.22	AS275 0.28	BC229 0.13	BD249 0.15	BF334 0.17	OC163 0.22	2N404 0.22	2N2351 0.14	2N3752 0.10	2N4350 0.86
AC185 0.22	AS276 0.28	BC230 0.13	BD250 0.15	BF335 0.17	OC165 0.22	2N404 0.22	2N2352 0.14	2N3753 0.10	2N4351 0.86
AC186 0.22	AS277 0.28	BC231 0.13	BD251 0.15	BF336 0.17	OC167 0.22	2N404 0.22	2N2353 0.14	2N3754 0.10	2N4352 0.86
AC187 0.22	AS278 0.28	BC232 0.13	BD252 0.15	BF337 0.17	OC169 0.22	2N404 0.22	2N2354 0.14	2N3755 0.10	2N4353 0.86
AC188 0.22	AS279 0.28	BC233 0.13	BD253 0.15	BF338 0.17	OC171 0.22	2N404 0.22	2N2355 0.14	2N3756 0.10	2N4354 0.86
AC189 0.22	AS280 0.28	BC234 0.13	BD254 0.15	BF339 0.17	OC173 0.22	2N404 0.22	2N2356 0.14		

-the lowest prices!

BRAND NEW TEXAS GERM. TRANSISTORS
 Coded and Guaranteed
 Pak No. EQVT
 T1 8 2G3718 OC71
 T2 8 D1374 OC76
 T3 D1216 OC81D
 T4 8 2G381T OC81
 T5 8 2G382T OC82
 T6 8 2G344B OC44
 T7 8 2G345B OC45
 T8 8 2G375 OC78
 T9 8 2G389A 2N1802
 T10 2G417 AF117
 All 55p each pak

WD 150 ELKIE DRIVER TRANSISTOR.
 Suitable replacement for
 BX21, C 407, 2N 1893
 120vrb.
 1 25 100+
 0-19 0-17 0-16

SIL trans. suitable for
 P.E. Organ Metal TO-18
 Eqvt. ZTX300 p each.
 Any Qty.

GP 100 TOS METAL CASE GERMANIUM
 Vbeo=80V. Vceo=60V.
 I.C.=10 amps. Ptot=50W.
 hfe=30-170.
 Replaces the majority of Germanium power transistors in the OC, AD and NKT range.
 1 25 100+
 0-47 0-44 0-40

GP 300 TOS METAL CASE SILICON
 Vbeo=100V. Vceo=60V.
 I.C.=15 amps. Ptot=115W.
 hfe=20, 100T.
 1MHz. Suitable replacement for 2N 3056, BDY 11 or BDY 20.
 1 25 100+
 0-55 0-53 0-51

NEW 8th EDITION 250 pages
TRANSISTOR EQUIVALENTS BOOK. A complete cross reference and equivalents book for European, American and Japanese Transistors. Exclusive to BI-PAK. £1.85 each.

A LARGE RANGE OF TECHNICAL AND DATA BOOKS ARE NOW AVAILABLE EX STOCK. SEND FOR FREE LIST.

GENERAL PURPOSE NPN SILICON SWITCHING TRANS. TO-18
 SILM TO 2N708/8. BSY-27/28/90A. All usable devices no open or short circuits. AL80 AVAILABLE in PNP Sim. to 2N2906, BCY70. When ordering please state preference NPN or PNP.
 20 For 0-15
 50 For 1-10
 100 For 1-92
 500 For 8-25
 1000 For 14-30

SIL. G.P. DIODES 55 300mW 30 0-55 40P(V)Min. 100 1-85 Sub-Min. 500 5-90 Fully Tested 1,000 9-90 Ideal for Organ Builders.

ADI61/162
 M/P COMP GERM. TRANS. TO-18
 EST. PRICE OF 75p
 PER PAIR.

LOOK FOR OUR AUDIO & ELECTRONIC COMPONENTS ADVERTISEMENTS PRACTICAL WIRELESS EVERYDAY

ELECTRONICS AND RADIO CONSTRUCTOR
 FULL RANGE OF ZENER DIODES
 VOLTAGE RANGE 2-33V. 400mW (DO-7 Case) 9p ea. 1W (Top-Hat) 18p ea. 10W (SO-10 Stud) 32p ea.

QUALITY TESTED SEMICONDUCTORS

Pak No.	Description	Price
Q 1	20 Red spot transistor PNP	0-64
Q 2	10 White spot R.F. transistors GNF	0-54
Q 3	4 OC77 type transistors	0-54
Q 4	6 Matched transistors OC44/45/81/81D	0-54
Q 5	4 OC78 transistors	0-54
Q 6	5 OC79 transistors	0-54
Q 7	4 AC128 transistors PNP high gain	0-54
Q 8	4 AC128 transistors PNP	0-64
Q 9	7 OC81 type transistors	0-54
Q10	7 OC71 type transistors	0-54
Q11	2 AC127/128 Complementary pairs NPN/NPN	0-54
Q12	3 AF116 type transistors	0-54
Q13	3 AF117 type transistors	0-54
Q14	3 OC117 H.F. type transistors	0-54
Q15	7 2N2926 SIL Epoxy transistors mixed colours	0-64
Q17	5 NPN 2xST.141 & 3xST.140	0-54
Q18	4 MADT'S 3xMAT 100 & 2xMAT 120	0-54
Q19	3 MADT'S 2xMAT 101 & 1xMAT 121	0-54
Q20	4 OC44 Germanium transistors A.F.	0-54
Q21	4 AC127 NFN Germanium transistors	0-54
Q22	20 NKT transistors A.F. R.F. coded.	0-54
Q23	10 OA202 Silicon diodes sub-min.	0-54
Q24	8 OA1 diodes	0-54
Q25	16 IN914 Silicon diodes 75PIV 75mA	0-54
Q26	8 OA95 Germanium diodes sub-min IN69	0-54
Q27	2 10A PIV Silicon rectifiers 1B425R	0-54
Q28	2 Silicon power rectifiers BYZ13	0-54
Q29	4 Silicon transistors 2x2N696, 1x 2N697, 1x 2N698	0-54
Q30	7 Silicon switch transistors 8N706 NPN	0-54
Q31	8 Silicon switch transistors 2N708, NPN	0-54
Q32	3 NPN Silicon transistors 2x2N1181, 1x 2N1182	0-54
Q33	3 Silicon NFN transistors 2N1711	0-54
Q34	7 Silicon NFN transistors 2N2369, 500MHz (code P597)	0-54
Q35	3 Silicon PNP TO-5, 2x2N2904 & 1x 2N2905	0-54
Q36	7 2N3646 TO-18 plastic 300MHz NPN	0-54
Q37	3 2N3053 NFN Silicon transistors	0-54
Q38	7 PNP transistors 3 x 2N3703, 2x 2N3702	0-54

555 I.C. 65p each

MAMMOTH I.C. PACK

APPROXIMATELY 200 PIECES ASSORTED MANUFACTURERS FALL OUT INTEGRATED CIRCUITS INCLUDING LOGIC 74 SERIES LINEAR and AUDIO AMPLIFIERS
 MANY CODED also some UNKNOWN TYPES - YOU TO IDENTIFY
PAK NO. M.I.C. 200
 PRICE £1.25 per PAK including p & p & V.A.T.

INTEGRATED CIRCUIT PAKS

Manufacturers "Fall Outs" which include Functional and Part-Functional Units. These are classed as "out-of-spec" from the maker's very rigid specifications, but are ideal for learning about I.C.s and experimental work.

Pak No. Contents Price	Pak No. Contents Price	Pak No. Contents Price
UIC00=12x7400 0-54	UIC46=5x7446 0-54	UIC90=5x7490 0-54
UIC01=12x7401 0-54	UIC48=5x7448 0-54	UIC91=5x7491 0-54
UIC02=12x7402 0-54	UIC50=12x7450 0-54	UIC92=5x7492 0-54
UIC03=12x7403 0-54	UIC51=12x7451 0-54	UIC93=5x7493 0-54
UIC04=12x7404 0-54	UIC53=12x7453 0-54	UIC94=5x7494 0-54
UIC05=12x7405 0-54	UIC54=12x7454 0-54	UIC95=5x7495 0-54
UIC06=5x7406 0-54	UIC60=12x7460 0-54	UIC96=5x7496 0-54
UIC07=8x7407 0-54	UIC70=5x7470 0-54	UIC100=5x74100 0-54
UIC10=12x7410 0-54	UIC72=5x7472 0-54	UIC121=5x74121 0-54
UIC20=12x7420 0-54	UIC73=8x7473 0-54	UIC141=5x74141 0-54
UIC30=12x7430 0-54	UIC74=8x7474 0-54	UIC151=5x74151 0-54
UIC40=12x7440 0-54	UIC76=8x7476 0-54	UIC154=5x74154 0-54
UIC41=5x7441 0-54	UIC80=5x7480 0-54	UIC193=5x74193 0-54
UIC42=5x7442 0-54	UIC81=5x7481 0-54	UIC199=5x74199 0-54
UIC43=5x7443 0-54	UIC82=5x7482 0-54	
UIC44=5x7444 0-54	UIC83=5x7483 0-54	
UIC45=5x7445 0-54	UIC86=5x7486 0-54	

Packs cannot be split, but 25 assorted pieces (one mix) is available as PAK UICX1.

1975 CATALOGUE NOW READY 10p

NEW LOW PRICED TESTED S.C.R.'s

TO5 TO66 TO66T TO64 TO48 TO48T TO43 TO48
60 0-26 0-28 0-39 0-29 0-82 0-55 0-99 1-27
100 0-28 0-37 0-52 0-52 0-85 0-84 0-70 1-54
200 0-39 0-41 0-54 0-54 0-63 0-67 0-83 1-76
400 0-48 0-53 0-62 0-62 0-74 0-83 1-03 1-93
600 0-59 0-63 0-75 0-75 0-85 1-07 1-38
800 0-70 0-77 0-88 0-88 0-99 1-32 1-65 4-40

2N3055
 115 WATT SIL POWER M/N
 45p EACH

KING OF THE PAKS Unequaled Value and Quality

SUPER PAKS NEW BI-PAK UNTESTED SEMICONDUCTORS

Money back refund if not satisfied

Pak No.	Description	Price
U 1	120 Glass Sub-Min. General Purpose Germanium Diodes	0-54
U 2	50 Mixed Germanium Transistors AF/BF	0-54
U 3	75 Germanium Gold Bonded Sub-Min. like OA5, OA47	0-54
U 4	30 Germanium Transistors like OC81, AC128	0-54
U 5	60 200mA Sub-Min. Silicon Diodes	0-54
U 6	30 SIL Planar Trans. NFN like BSY2A, 2N706	0-54
U 7	16 SIL Rectifiers TOP-HAT 750mA VLTG. RANGE up to 1000V	0-54
U 8	50 SIL Planar Diodes DO-7 Glass 250mA like OA200/202	0-54
U 9	20 Mixed Voltages, 1 Watt Zener Diodes	0-54
U10	20 BAY50 charge storage Diodes DO-7 Glass	0-54
U11	20 PNP SIL Planar Trans. TO-5 like 2N1182, 2N2904	0-54
U13	30 PNP-NFN SIL Transistors OC200 & 2S 104	0-54
U14	150 Mixed Silicon and Germanium Diodes	0-54
U16	20 NFN SIL Planar Trans. TO-5 like BFY91, 2N697	0-54
U17	10 3 Amp Silicon Rectifiers Stud Type up to 1000V	0-54
U18	30 Germanium PNP AP Transistors TO-5 like AOY 17-22	0-54
U19	8 6 Amp Silicon Rectifiers BYZ13 Type up to 600 PIV	0-54
U19	20 Silicon NPN Transistors like BC108	0-54
U20	12 1.5 Amp Silicon Rectifiers Top Hat up to 1000 PIV	0-54
U21	30 AF. Germanium Alloy Transistors 2G300 Series & OC71	0-54
U22	25 MADT's like MIL Series ENP Transistors	0-54
U24	20 Germanium PNP Rectifiers GJM Series up to 300PIV	0-54
U25	25 300MHz NPN Silicon Transistors 2N1305, BS727	0-54
U26	30 Fast Switching Silicon Diodes like IN914 Micro-Min.	0-54
U29	10 1 Amp SCR's TO-5 can. up to 600PIV GEB1/25-600	1-08
U32	25 Zener Diodes 400mW DO-7 case 3-18 volts mixed	0-54
U33	15 Plastic Case 1 Amp Silicon Rectifiers 1N4000 Series	0-54
U34	30 Silicon PNP Alloy Trans. TO-5 BCY26 2N302/4	0-54
U35	25 Silicon Planar Transistors PNP TO-18 2N2906	0-54
U36	20 Silicon Planar NPN Transistors TO-5 BFY50/51/52	0-54
U37	30 Silicon Alloy Transistors 80-2 PNP OC200, 28327	0-54
U38	20 Fast Switching Silicon Trans. NPN 400MHz 2N3011	0-54
U39	30 RF. Germ. PNP Transistors 2N1303/STO-5	0-54
U40	10 Dual Transistors 6 Lead TO-5 1N2090	0-54
U42	26 SIL Trans. Plastic TO-18 A.F. BC118/114	0-54
U44	30 SIL Trans. Plastic TO-5 BC115/116	0-54
U45	7 5A SCR TO66 up to 600PIV	1-08
U46	20 Unijunction transistors similar to T1843	0-54
U47	10 TO220AB plastic triacs 50V 8A	1-08
U48	9 NPN SIL power transistors like 2N3055	1-08
U49	12 NPN SIL plastic power trans. 60W like 2N8294/8296	1-08

Code No's. mentioned above are given as a guide to the type of device in the pak. The devices themselves are normally unmarked.

FREE
 One 55p Pak of your own choice free with orders valued \$4 or over

SIL RECTS. TESTED

One 55p Pak of your own choice free with orders valued \$4 or over	PIV 300mA 750mA 1A	1.5A 3A	10A 30A
50 0-05 0-06	1N4001-0-05	0-08 0-15 0-21 0-60	
100 0-05 0-07	1N4002-0-08	0-10 0-17 0-23 0-75	
200 0-06 0-10	1N4003-0-07	0-12 0-22 0-25 1-00	
400 0-08 0-15	1N4004-0-08	0-15 0-30 0-38 1-35	
600 0-09 0-17	1N4005-0-10	0-18 0-38 0-45 1-90	
800 0-12 0-19	1N4006-0-11	0-20 0-38 0-55 2-10	
1000 0-14 0-30	1N4007-0-12	0-25 0-48 0-85 2-50	
1200	0-35	0-30 0-58 0-75 3-00	

CADMIUM CELLS
 ORP12 48p

DIACS FOR USE WITH TRIACS.
 BR100 (D32) 25p each

10 amp POTTED BRIDGE RECTIFIER on heat sink (MPP19 99p each)	TRIACS
	VDOM 5A 6A 10A TO-5 TO-66 TO-48
	P P 4p
	200 23 55 83
	100 25 68 99
	400 77 83 1-21

Giro No. 388-7006
 Please send all orders direct to warehouse and despatch department

BI-PAK
 P.O. BOX 6, WARE, HERTS
 Postage and packing add 15p. Overseas add extra for airmail.
 Minimum order 55p. Cash with order please.
 Guaranteed Satisfaction or Money Back



GIRO NO. 331 7056 ACCESS ACCEPTED
C.W.O. only. P. & P. 10p on orders below £5
Discount: £10-10%, £20-15% (except net items)
Export Order enquiries welcome (VAT free)
Official Orders accepted from
Educational & Government Departments.
ALL PRICES INCLUDE VAT

SPECIAL RESISTOR KITS (Prices include post & packing)
10E12 \pm W KIT: 10 of each E12 value, 22 ohms—1M, a total of 570 (CARBON FILM 5%), £3-65 net
10E12 \pm W KIT: 10 of each E12 value, 22 ohms—1M, a total of 570 (CARBON FILM 5%), £3-85 net
25E12 \pm W KIT: 25 of each E12 value, 22 ohms—1M, a total of 1425 (CARBON FILM 5%), £8-35 net
25E12 \pm W KIT: 25 of each E12 value, 22 ohms—1M, a total of 1425 (CARBON FILM 5%), £8-45 net
5 \pm W KIT: 5 of each E12 value, 10 ohms—1M, a total of 305 (METAL FILM 5%), £2-85 net
DUE TO CURRENT WORLD SHORTAGES, RESISTOR KITS MAY TEMPORARILY CONTAIN
WATTAGE OR VALUE SUBSTITUTIONS.

MULLARD POLYESTER CAPACITORS C280 SERIES
250V P.C. Mounting: 0-01 μ F, 0-015 μ F, 0-022 μ F, 0-033 μ F, 0-047 μ F, 3 μ F, 0-068 μ F,
0-1 μ F, 4 μ F, 0-15 μ F, 4 μ F, 0-22 μ F, 5 μ F, 0-33 μ F, 8 μ F, 0-47 μ F, 9 μ F, 0-68 μ F, 12 μ F, 1 μ F,
15 μ F, 1-5 μ F, 2 μ F, 2-2 μ F, 2 μ F.

MULLARD POLYESTER CAPACITORS C296 SERIES
400V: 0-001 μ F, 0-0015 μ F, 0-0022 μ F, 0-0033 μ F, 0-0047 μ F, 2 μ F, 0-0068 μ F, 0-01 μ F,
0-015 μ F, 0-022 μ F, 0-033 μ F, 3 μ F, 0-047 μ F, 0-068 μ F, 0-1 μ F, 4 μ F, 0-15 μ F, 4 μ F,
0-22 μ F, 5 μ F, 0-33 μ F, 12 μ F, 0-47 μ F, 14 μ F.
160V: 0-01 μ F, 0-015 μ F, 0-022 μ F, 3 μ F, 0-047 μ F, 0-068 μ F, 3 μ F, 0-1 μ F, 4 μ F, 0-15 μ F,
5 μ F, 0-22 μ F, 5 μ F, 0-33 μ F, 6 μ F, 0-47 μ F, 8 μ F, 0-68 μ F, 12 μ F, 1 μ F, 14 μ F.

MINIATURE CERAMIC PLATE CAPACITORS
50V: (pF) 22, 27, 33, 39, 47, 56, 68, 82, 100, 150, 180, 220, 270, 330, 390, 470,
560, 680, 820, 1K, 1K5, 2K2, 3K3, 4K7, 6K8, (μ F) 0-01, 0-015, 0-022, 0-033, 0-047,
2 μ F, each, 0-1, 30V, 5 μ F.

POLYSTYRENE CAPACITORS 160V 5%
(pF) 10, 15, 22, 33, 47, 68, 100, 150, 220, 330, 470, 680, 1000, 1500, 2200, 3300,
4700, 6800, 10,000, 4 μ F.

RESISTORS
CF—High Stab Carbon Film, 5% MF—High Stab Metal Film, 5%.

W. Type Range	1-99	100-499	500-999	1000+	Size mm
CF 22-1M	1	0-75	0-60	0-55	2-4x7-5
CF 22-2M2	1	0-75	0-60	0-55	3-9x10-5
CF 22-1M	1	0-75	0-60	0-55	5-5x16
MF 10-2M7	2	1-54	1-32	1-1	3x7
MF 10-2M2	2	1-43	1-21	0-99	4-2x10-8
MF 10-10M	3	1-98	1-81	1-65	6-6x13
2 MF 10-10M	4-5	3-52	3-08	2-75	8x17-5

For value mixing prices, please refer to our catalogue. (price in pence each)
VALUES AVAILABLE—E12 Series only. (Net prices above 100.)

PRESET SKELETON POTENTIOMETERS
MINIATURE 0-25V Vertical or horizontal 6p each 1K, 2K2, 4K7, 10K, etc.
SUB-MIN 0-05V Vertical, 100 Ω to 220K Ω 5p each

B. H. COMPONENT FACTORS LTD. (E.E.) 61 CHEDDINGTON ROAD, PITSTONE, NR. LEIGHTON BUZZARD, BEDS, LU7 9AQ
Tel.: Cheddington 668446 (Std. Code 0296)
CATALOGUE No. 3-70p

Miniature Mullard Electrolytics

1-0 μ F 63V 4 μ F	68 μ F 63V 12 μ F
1-5 μ F 63V 4 μ F	100 μ F 10V 6 μ F
2-2 μ F 63V 4 μ F	100 μ F 25V 6 μ F
3-3 μ F 63V 4 μ F	100 μ F 63V 14 μ F
4-7 μ F 63V 4 μ F	150 μ F 16V 6 μ F
6-8 μ F 63V 4 μ F	150 μ F 63V 15 μ F
10 μ F 25V 6 μ F	210 μ F 6-4V 6 μ F
10 μ F 63V 6 μ F	220 μ F 10V 8 μ F
15 μ F 16V 4 μ F	220 μ F 16V 8 μ F
15 μ F 63V 6 μ F	220 μ F 63V 21 μ F
16 μ F 40V 6 μ F	330 μ F 16V 20 μ F
22 μ F 25V 6 μ F	330 μ F 33V 25 μ F
22 μ F 63V 6 μ F	470 μ F 6-4V 9 μ F
32 μ F 10V 6 μ F	470 μ F 40V 20 μ F
33 μ F 16V 6 μ F	680 μ F 16V 15 μ F
33 μ F 40V 6 μ F	680 μ F 40V 25 μ F
32 μ F 63V 6 μ F	1000 μ F 16V 20 μ F
47 μ F 10V 6 μ F	1000 μ F 25V 25 μ F
47 μ F 25V 6 μ F	1500 μ F 6-4V 15 μ F
47 μ F 63V 8 μ F	1500 μ F 16V 25 μ F
68 μ F 16V 6 μ F	2200 μ F 10V 25 μ F
	3300 μ F 6-4V 26 μ F

VEROBOARD 0-1 0-15

2 $\frac{1}{2}$ x 5"	36p 36p
2 $\frac{1}{2}$ x 3 $\frac{1}{2}$ "	33p 25p
3 $\frac{1}{2}$ x 3 $\frac{1}{2}$ "	42p 46p
3 $\frac{1}{2}$ x 3 $\frac{1}{2}$ "	36p 36p
2 $\frac{1}{2}$ x 1 $\frac{1}{2}$ "	9p 9p
2 $\frac{1}{2}$ x 5" (Plain)	— 19p
2 $\frac{1}{2}$ x 3 $\frac{1}{2}$ " (Plain)	— 16p
5 x 3 $\frac{1}{2}$ " (Plain)	— 29p
Insertion tool	73p 73p
Track Cutter	56p 56p
Pins: Pkt. 50	23p 22p

TRANSISTORS

AC127 16 μ p	BC212L 12p
AC128 22p	BC213L 12p
BC107 11p	BC214L 17p
BC108 12p	OC44 18p
BC109 13p	OC71 13p
BC148 12p	OC81 16p
BC149 12p	OC170 23p
BC182L 12p	T1543 33p
BC183L 12p	2N2926 11p
BC184L 13p	2N3702 11p

POTENTIOMETERS
Carbon Track 5K Ω to 2M Ω , log or lin. Single, 16 μ p Dual Gang 46p. Log Single with switch 26p
Slider Pots: 10K, 100K, 500K, 30mm, 34p, 45mm, 47p, 60mm, 53p.

DIODES

IN4001 6 μ p	DIN 2 Pin 12p
IN4002 7 μ p	3 Pin 13p
IN4003 7 μ p	5 Pin 18 μ 16p
IN4004 9 μ p	Std. Jack 20p
IN4005 12 μ p	2.5mm Jack 13p
IN4006 14 μ p	Phone 6p
IN914 7p	
IN916 7p	
BA100 10p	
OA5 42p	
OA47 9p	
OA81 11p	
OA200 8p	

STOP PRESS
Our Retail Shop should now be open in North St., Leighton Buzzard

ELECTROLYTIC CAPACITORS. Tubular & Large Cans
(μ F/V): 1/25, 2/25, 4/25, 4-7/10, 5/25, 8/25, 10/10, 10/50, 16/25, 22/63, 25/25, 25/50, 32/25, 50/25, 100/10, 100/25, 61p, 50/50, 8p, 100/50, 200/25, 11p, 250/50, 18p, 500/10, 11p, 500/25, 15p, 500/50, 18p, 1000/10, 15p, 1000/25, 22p, 1000/50, 40p, 2000/10, 20p, 1000/100, 90p, 2000/25, 30p, 200/100, 95p, 2500/25, 38p, 2500/50, 62p, 3000/50, 80p, 5000/25, 66p, 5000/50, £1-10.

HI-VOLT: 8/350, 19p, 16/350 22p, 32/350, 33p, 50/250, 20p, 100/100, 20p, 100/150, 30p, 32/500, 40p, 16 + 32 + 32/350, 60p.

METALLISED PAPER CAPACITORS
250V: 0-05 μ F, 0-1 μ F, 6p, 0-25 μ F, 6p, 0-5 μ F, 7 μ F, 1 μ F, 9p, 500V:
0-025, 0-05, 6p, 0-1 μ F, 6p, 0-25 μ F, 7 μ F, 0-5 μ F, 1000V: 0-01, 11p,
0-022, 13p, 0-047, 0-1, 15p, 0-22, 23p, 0-47, 28p.

5E12 \pm W METAL FILM, 5 each Value 10 Ω -1M. Total of 305 £3-25.

SOCKETS
DIN 2 Pin 10p
3 Pin 10p
5 Pin 18 μ 12p
Std. Jack 15p
2.5mm Jack 13p
Phone 6p

Screwed Wire, Metre 61p
Twin Screwed Wire, Metre 12p
Screened Wire, Metre 12p
Staro Screened Wire, Metre 21p
Connecting Wire, All colours, Metre 21p
Neon Bulb, 90V Wire Ended 5 for 24p
Panel Neon, 240V Red, Amber, Clear, 20p

SPARKRITE Mk II

Electronic Ignition...

Better on all points
Because you keep your points!

The SPARKRITE MK.2 is a full capacitive discharge electronic system. Specifically designed to retain the points assembly — with all the advantages and none of the disadvantages. No misfire because contact breaker bounce is eliminated electronically by a pulse suppression circuit which prevents the unit firing if the points bounce open at high rpm. Contact breaker burn is eliminated by reducing the current to about 1/50th of norm, thus avoiding arcing. But you can still revert to normal ignition if need be. In seconds. If points go (very unlikely) you can get replacements anywhere. All these advantages.

- Fitted in 15 minutes. ● Up to 20% better fuel consumption. ● Instant all weather starting. ● Cleaner plugs — they last 5 times longer without attention.
- Faster acceleration. ● Faster top speeds.
- Coil and battery last longer. ● Efficient fuel burning with less air pollution.

The kit comprises everything needed
Ready drilled scratch and rust resistant case, metalwork, cables, coil connectors, printed circuit board, top quality 5 year guaranteed transformer and components, full instructions to make positive of negative earth system, and 6 page installation instruction leaflet.

WE SAY IT IS THE BEST SYSTEM AT ANY PRICE!

PRICES
D.I.Y. Kit only £10'93 incl. VAT and P & P
Ready Built Unit £13'66 incl. VAT and P & P
(Both to fit all cars with distributor ignition up to 8 cylinders).

We can supply units for any petrol-engined vehicle (boat, motorcycle etc) with coil/contact breaker ignition. Details on request. Call in and see us for a demonstration.

ELECTRONICS DESIGN ASSOCIATES
(Dept. E.E.2.) 82 Bath Street, Walsall WS1 3DE Phone 33652

Order NOW direct from: =

YOUR CAREER in RADIO & ELECTRONICS ?

Big opportunities and big money await the qualified man in every field of Electronics today—both in the U.K. and throughout the world. We offer the finest home study training for all subjects in radio, television, etc., especially for the CITY & GUILDS EXAMS (Technicians' Certificates); the Grad. Brit. I.E.R. Exam.; the RADIO AMATEUR'S LICENCE; P.M.G. Certificates; the R.T.E.B. Servicing Certificates; etc. Also courses in Television; Transistors; Radar; Computers; Servo-mechanisms; Mathematics and Practical Transistor Radio course with equipment. We have OVER 20 YEARS' experience in teaching radio subjects and an unbroken record of exam. successes. We are the only privately run British home study College specialising in electronics subjects only. Fullest details will be gladly sent without any obligation.

To: British National Radio & Electronics School, Dept E.E.C. 25 P.O. Box 156, Jarney, C.I.

Please send FREE BROCHURE to

NAME Block
ADDRESS Caps.
..... Please

BRITISH NATIONAL RADIO AND ELECTRONICS SCHOOL

Complete the coupon and we'll send you our new catalogue. Completely free.

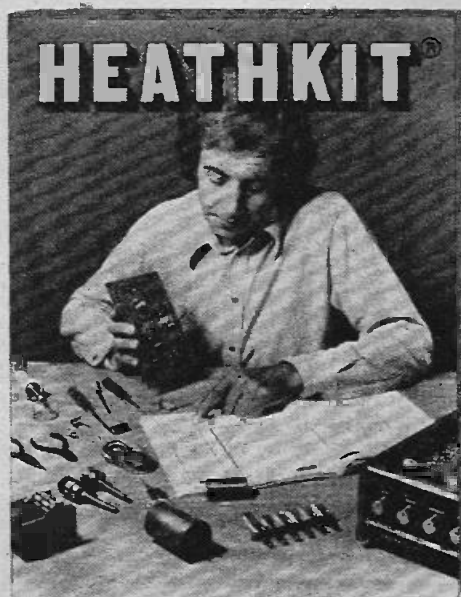

The new Heathkit catalogue is now out. Full as ever with exciting, new models. To make building a Heathkit even more interesting and satisfying.

And, naturally, being Heathkit, every kit is absolutely complete. Right down to the last nut and bolt. So you won't find yourself embarrassingly short of a vital component on a Saturday evening—when the shops are shut.

You'll also get a very easy to understand instruction manual that takes you step by step through the assembly.

Clip the coupon now and we'll send you your free copy to browse through.

With the world's largest range of electronic kits to choose from, there really is something for everyone.

Including our full range of test equipment, amateur radio gear, hi-fi equipment and many general interest kits.

So, when you receive your catalogue you should have hours of pleasant reading.

And, if you happen to be in London or Gloucester, call in and see us. The London Heathkit Centre is at 233 Tottenham Court Road. The Gloucester showroom is next to our factory in Bristol Road.

At either one you'll be able to see for yourself the one thing the catalogue can't show you.

Namely, how well a completed Heathkit performs.

Heath (Gloucester) Limited, Dept. EE-25, Bristol Road, Gloucester, GL2 6EE. Tel: Gloucester (0452) 29451.

AM/FM digital electronic clock-radio.

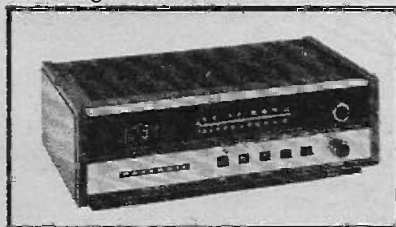

An oscilloscope from the Heathkit range.



Digital electronic car clock/elapsed timer.



The new Heathkit catalogue. Out now. FREE.

To: Heath (Gloucester) Limited, Dept. EE-25, Gloucester, GL2 6EE. Please send me my free Heathkit catalogue.

Name _____ Address _____

Postcode _____

Remember easy terms are available with the Heathkit Monthly Budget Plan.

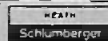

everyday electronics

PROJECTS
THEORY....

GETTING BIG IDEAS

From time to time we receive requests for projects that would be too complex to include in this magazine if we are to remain true to our declared policy. Our advice, generally, is that those interested in more advanced and more complicated electronic designs should consult our companion PRACTICAL ELECTRONICS—long ago christened "Big Brother" (but with only friendly implications, we are sure) by some correspondents.

However, rules can sometimes be "bent", if not actually broken, to some advantage. So just once in a while we may bow to popular demand, forget Big Brother, and allow something rather more ambitious than would be strictly in accord with our general policy to enter our pages. Only once in a while, though. That's a promise.

MODULES MAKE IT EASY

A hifi stereo amplifier seems to be high on many an enquirer's list. So here now in this issue is our first reckless venture, embarked upon regardless of all cost—well not entirely!

Certainly by any previous standards, the Modula 3 is a large and unusual project for EE. Yet things aren't always quite what they appear to be. In this case, the actual constructional work involved is far less than one might expect. The secret lies in the use of circuit modules—factory assembled units containing the more complex parts of the whole design.

Even so, this is not a project for the absolute beginner. But those with some modest experience in building electronic circuits need not shrink from the task involved here.

AMAZE YOUR FRIENDS

The cost of the Modula 3 is, necessarily, high in comparison with our usual run of projects. But it represents good value, since the modules ensure a top class performance that will compare favourably with commercial amplifiers costing rather more to buy.

A good quality audio system is nowadays regarded as a vital piece of furniture for the home. What better way to show off one's abilities in electronics than to build an amplifier that could form the heart of a home entertainment system. An excellent way to amaze friends. After all, one doesn't have to let them into the full secret, does one?

VERY SORRY, BUT—

As from next month the price of EVERYDAY ELECTRONICS will be 25p. We regret the need for this increase, but believe our readers will agree that our contents represent good value at this new price.

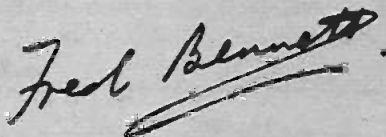

Our March issue will be published on Friday, February 21

EDITOR F. E. Bennett ● ASSISTANT EDITOR M. Kenward ● B. W. Terrell B.Sc.
ART EDITOR J. D. Pountney ● P. A. Loates ● K. A. Woodruff
ADVERTISEMENT MANAGER D. W. B. Tilleard

© IPC Magazines Limited 1975. Copyright in all drawings, photographs, and articles published in EVERYDAY ELECTRONICS is fully protected, and reproduction or imitations in whole or part are expressly forbidden.

All reasonable precautions are taken by EVERYDAY ELECTRONICS to ensure that the advice and data given to readers are reliable. We cannot, however, guarantee it, and we cannot accept legal responsibility for it. Prices quoted are those current as we go to press. Everyday Electronics Fleetway House, Farringdon Street, London, E.C.4. Phone: Editorial 01-634-4452; Advertisements 01-634-4202.

EASY TO CONSTRUCT SIMPLY EXPLAINED

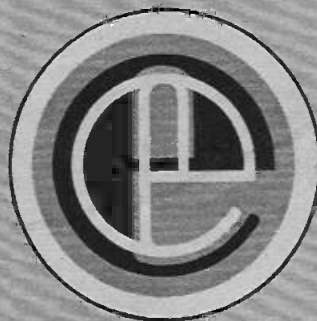

VOL. 4 NO. 2

FEBRUARY 1975

CONSTRUCTIONAL PROJECTS

- MODULA 3 STEREO AMPLIFIER** A hi fi amplifier designed for ease of construction by Mike Kenward 66
DELAYED ACTION SWITCH A simple device to delay the switch off of a lamp by J. B. Dance 74
MORSE PRACTICE UNIT An aid to learning visual or audible Morse by Mike Hughes 82
LIGHTING-UP WARNING For the Motorist. Provides an audible alarm as darkness falls by David Smith 96

GENERAL FEATURES

- EDITORIAL** 64
PHYSICS IS FUN Magnetism by Derrick Daines 73
QUAD And Other Multichannel Systems. Part 1—New dimensions in sound by Adrian Hope 77
READERS' LETTERS Your news 86
SHOP TALK Component buying for constructional projects by Mike Kenward 87
BEGIN HERE—3 Integrated Circuits by Donald Maynard 88
COUNTER INTELLIGENCE A retailer comments by Paul Young 90
PROFESSOR ERNEST EVERSURE The Extraordinary Experiments of. by Anthony J. Bassett 92
HELP! Common queries answered 100
JACK PLUG AND FAMILY Cartoon 100
FOR YOUR ENTERTAINMENT Computers by Adrian Hope 103
DOWN TO EARTH Loudspeaker impedance by George Hylton 104

Publisher's Annual Subscription Rate, including postage Inland £2.95, Overseas £3.00. International Giro facilities Account No. 5122007. State reason for payment "message to payee". Address to Everyday Electronics, Subscription Department, Carlton House, Great Queen Street, London, WC2E 9PR. Binders for volumes 1 to 3 (state which) and indexes for volume 1 and 2 available for £1.25 and 30p respectively, including postage, from Binding Department, at the above address.

We are unable to supply back copies of Everyday Electronics or reprints of articles and cannot undertake to answer readers' letters requesting designs, modifications or information on commercial equipment or subjects not published by us. An s.a.e. should be enclosed for a personal reply. Letters concerning published articles should be addressed to: The Editor, those concerning advertisements to: The Advertisement Manager, both at the address shown opposite.

LOOK TO THE FUTURE!

Our younger readers will learn something greatly to their advantage in a new unique series starting soon. Further details next month.

modula 3

STEREO AMPLIFIER

By MIKE KENWARD

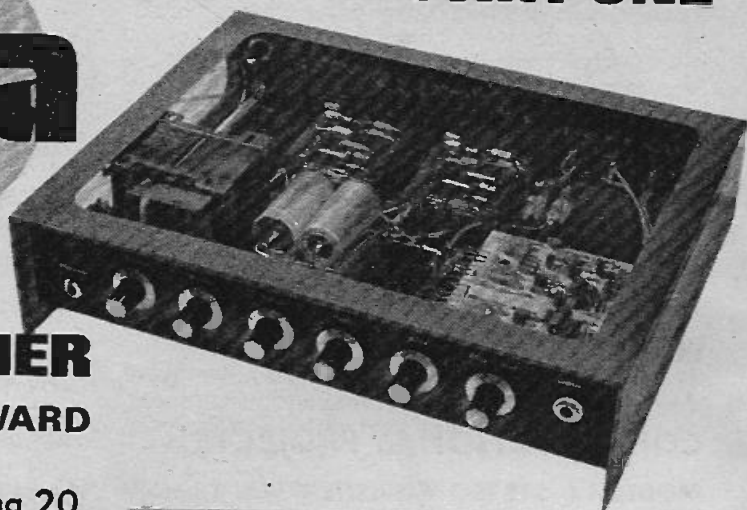

A hi fi stereo amplifier providing 20 watts output per channel at low cost

THE construction of a high power stereo amplifier of the quality of this design is normally a complex and substantial undertaking; however, with the use of some of the many audio modules now available this task has been drastically reduced. The use of modules also helps to guarantee "first time" results, however this does not imply that this project is a suitable first construction for the novice.

We do not advise any reader who has not constructed electronic units previously, to undertake this design. A reasonably high standard of soldering and mechanical workmanship is required to successfully complete the amplifier. However, if the design is carefully followed and the correct materials used, an amplifier can be produced that compares very favourably with similar commercial units costing considerably more. The design employs two Sanyo thick-film power amplifiers and a printed circuit Mullard preamplifier module.

PERFORMANCE

The basic specification of the Modula 3 is given in Table 1 this, together with the graphs if Figs. 1 and 2 show the typical performance that can be expected from the completed unit.

The output has been conservatively rated at 20 watts per channel and the amplifier will provide this output on both channels (continuous r.m.s.) without trouble. The modules are in fact rated by Sanyo at 25 watts each into 8 ohms.

However, at the higher power levels, above 20 watts, the distortion rises, at 28 watts it is approximately 0.8 per cent. Thus, although the amplifier is capable of providing a maximum total output of 56 watts, this increase is at the expense of the distortion figure.

TABLE 1

MODULA 3 PERFORMANCE

OUTPUT POWER

35W continuous one channel driven
28W continuous per channel, both channels driven

POWER BANDWIDTH

-3dB at 20Hz and 20 kHz

FREQUENCY RESPONSE

-1dB at 30Hz and 20kHz } see Fig. 1
-3dB at 15Hz and 27kHz }

TONE CONTROLS

Bass \pm 14dB at 20Hz } see Fig. 2
Treble \pm 15dB at 20kHz }

INPUTS

For 20W r.m.s. per channel output
Magnetic 2.5mV at 40k Ω RIAA equalised (within \pm 1dB between 20Hz and 20kHz) Dynamic range 30dB
Radio 80mV at 1.2M Ω flat response
Guitar 12mV at 50k Ω flat response

TAPE OUTPUT

80mV at 5.6k Ω

SIGNAL TO NOISE RATIOS

Measured at an output of 20W. Unweighted figures
Magnetic -52dB
Radio and Guitar -60dB

INTERCHANNEL CROSSTALK

-43dB measured with one channel driven at 20W

DISTORTION

Total harmonic distortion.
Less than 0.2% up to 20W
Less than 0.8% up to 28W.

FOR
GUIDANCE
ONLY

ESTIMATED COST*
OF COMPONENTS
including V.A.T.

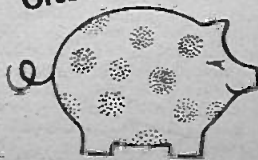

£28 excluding case

*Based on prices prevailing at time of going to press

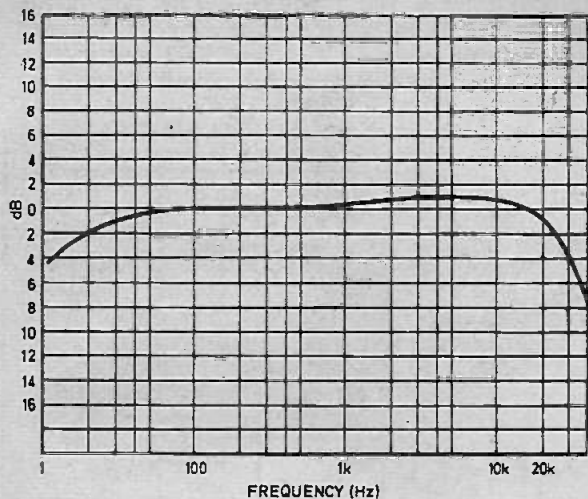

Fig. 1. Graph showing frequency response of complete amplifier.

The frequency response curve shown in Fig. 1 shows that the output of the amplifier is almost flat from 30Hz to 20kHz. This covers the whole of the audible range and shows that any audio signal fed to the input will be reproduced at the correct level compared to any other signals.

Action of the tone controls is shown in Fig. 2 the alteration of the frequency response with treble and bass cut and lift is clearly indicated. The square wave output at 1kHz is shown in Fig. 3 this shows a good overall frequency response since a square wave is made up of a number of sine waves at the harmonics of the square wave. The slight roll-off at the leading edge of the square wave shows that the response falls at high frequency and this is confirmed by Fig. 1. However, it does not start to fall within the audible range.

The signal to noise ratio indicated in Table 1 shows that the difference between the signal output and the noise generated in the amplifier is reasonably large. The figure compares with that quoted for many medium price range commercial audio amplifiers.

The Sanyo power modules are protected by fuses in the output from short circuit damage. The output stage of those modules is class AB, d.c. coupled, and no damage will result from an open circuit output.

PREAMPLIFIER

The preamplifier module is a Mullard type LP1184/2 which has only recently been produced by Mullard and was not available to the home constructor before the publication of this design. The circuit of the complete preamplifier with its power supply components is shown in Fig. 4. Only the right hand channel is shown, component numbers in the other channel are

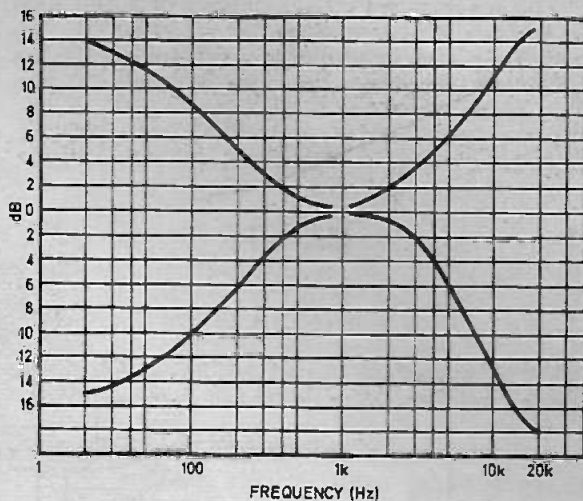

Fig. 2. Graph showing frequency response with the controls in their maximum positions.

the corresponding numbers plus 100. The tinted areas are the module and the untinted areas show the external components and wiring that the constructor must complete.

Inputs have been provided for magnetic cartridge, radio and guitar, an additional auxiliary input can be provided if required—sensitivity 80mV. Input and equalisation switching is accomplished by S1a and S1b respectively. For guitar input the switch must be in the radio, position, and a stereo jack socket inserted in SK3 then disconnects the radio socket SK2.

The amplifier can be used on both channels with a guitar simply by shorting the two "tips" on the stereo jack plug together, this provides a 40 watt output. To simplify switching some of the input connections on the module have not been used and the associated resistors are replaced by R1, R2 and R3.

Fig. 3. The square wave input and output (below) at 1kHz into 8 ohms.

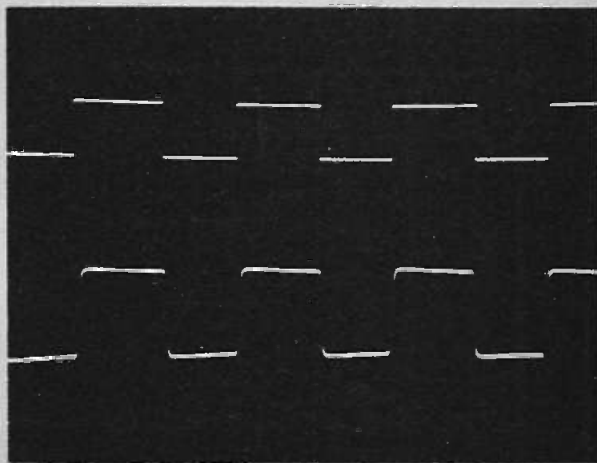

The preamplifier circuit consists of a high gain amplifier with equalisation provided by TR₁, TR₂ and their associated components (to obtain the specified frequency response C₁ and C₁₀₄ are

removed from the module—details are given later). This is followed by the external balance and volume controls VR1 and VR2 and a standard Baxandall tone control circuit formed by

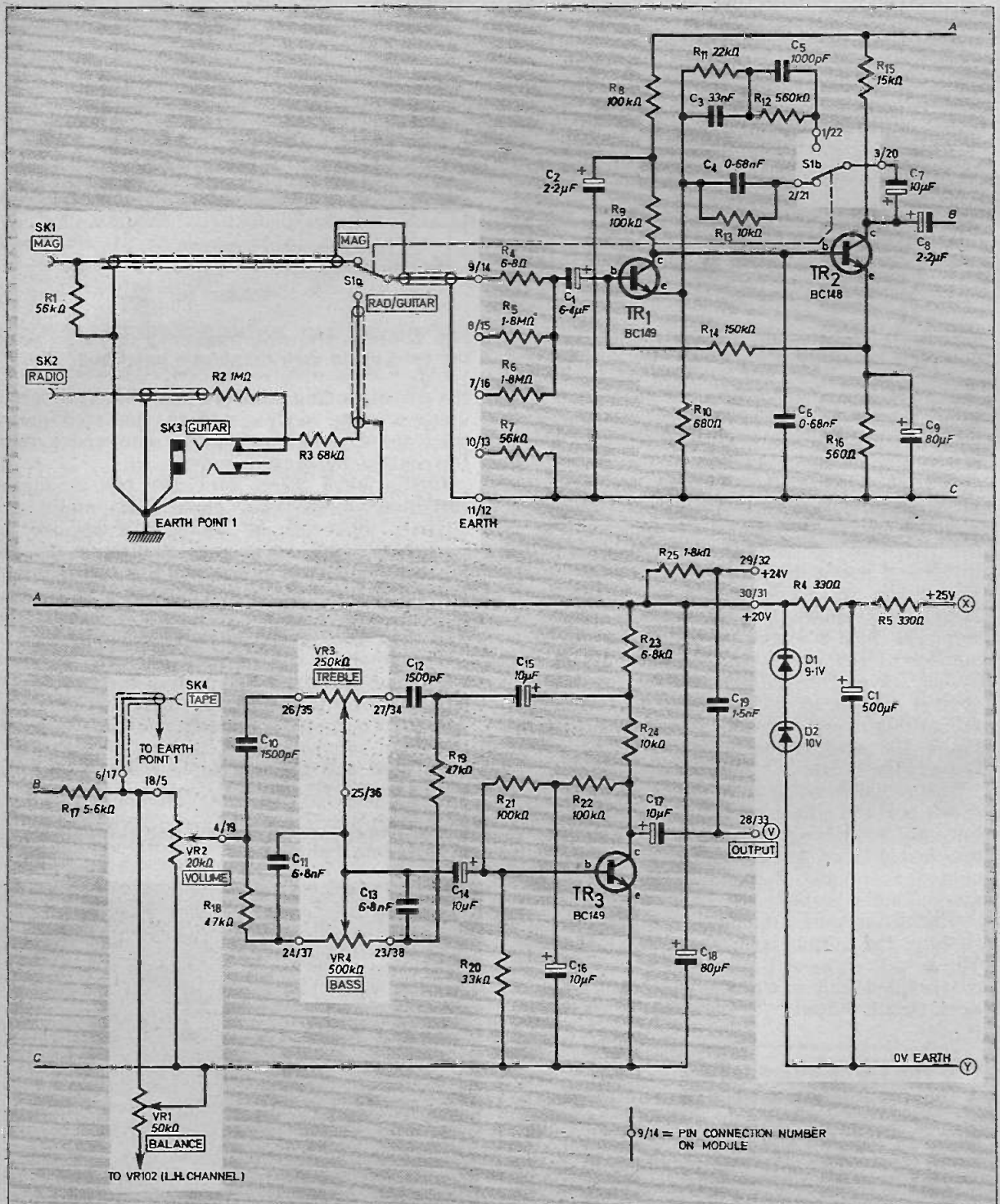

Fig. 4. Preamplifier circuit diagram, the tinted areas represent components mounted on the module.

VR3, VR4 and the associated components on the module. This control stage forms the feedback of a second amplifier (TR₂).

An output for a tape recorder is provided at SK4. This output comes before the volume and tone controls and is thus unaffected by them. It is, however, affected by the balance control.

The preamplifier supply is initially taken from the smoothed d.c. provided for the main amplifiers. This voltage is dropped by R5 and additionally smoothed by C1 and then dropped further to 20V and stabilised with Zener diodes at this voltage. Further smoothing capacitors C18 and C118 are provided on the module.

The supply components in the lower right hand untinted area and the balance control are not repeated for the second channel. A 9V and a 10V Zener diode are used, wired in series, to provide the 20V supply. This arrangement is used in preference to a single 20V Zener due to the oscillation problems that have arisen with some 20V types.

EARTHING

The earthing of the amplifier in general is important and only two earthing points must be used, one for the preamplifier and one for the main amplifiers. It is important to follow carefully the details to be given later in the text for connecting earthing lines.

The correct earthing is shown on the preamp circuit with the module being earthed to the chassis at the input sockets via the magnetic input screened lead. A second earth is provided for the screened leads to the tone controls (screens not shown on circuit) but these are not connected to the module in any way, they are simply taken to earth point 2 (see later) because it is physically most convenient.

It is worth mentioning at this stage that the push button switch originally used for S1/S101 (shown on the cover photograph) has been replaced by a rotary switch due to the difficulty in obtaining a suitable make-before-break push button. This alteration actually enhances the appearance of the finished unit—compare the heading and cover photographs.

POWER AMPLIFIER

A circuit diagram of the power amplifier modules has not been provided simply because the circuit available gives very little information about the operation of this device and no component values. The circuit is available from the suppliers of the modules and should be included with the general information on the modules at the time of purchase.

The modules require some equalisation and decoupling components in addition to the $\pm 25V$ supply and input and load (loudspeaker), these components are shown as C3 to C10, R6 and R7 in Fig. 5. Capacitor C3 is provided to prevent any tendency to high frequency oscillation. Resistor R6 has been reduced in value from that quoted in the Sanyo literature to increase the gain of the amplifier since the output available from the preamplifier is only 150mV. This resistor should be a close tolerance type to ensure equal gain from both channels.

The output from pin 2 of the module is fed via a short circuit protection fuse (FS1) to the headphone output socket and to the loudspeaker socket (SK5). As shown the headphone output is suitable for low impedance type headphones or phones with built-in attenuators. On insertion of the headphone jack plug the speakers are automatically disconnected.

Attenuator details will be provided later.

Fig. 5. The circuit diagram of the power amplifier, refer to Figs. 4 and 6 for connections.

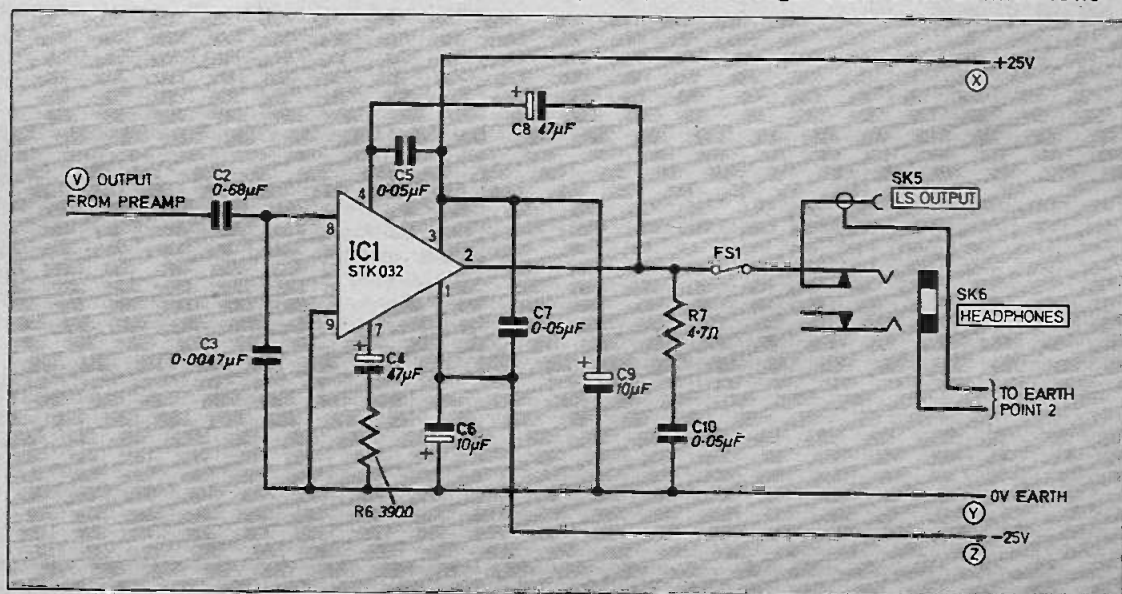

POWER SUPPLY

The supply required by the output modules is $\pm 25V$ at a maximum current of 1.8 amps (28 watts per channel), this is provided by the circuit shown in Fig. 6. This circuit provides power for both channels.

Transformer T1 provides 18-0-18V r.m.s. from the mains and this is rectified by the bridge rectifier D3-D6 to provide 25-0-25V d.c. Capacitors C11 and C12 provide smoothing to remove most of the ripple voltage. The value of these capacitors could be reduced slightly but only at the expense of increased hum.

Switch S2 is the mains on/off switch and neon LP1 provides visual indication that the amplifier is switched on. Capacitor C13 prevents switch on and switch off noise spikes which would other-

wise cause noise at the amplifier output. The amplifier is protected by a 1 amp slow-blow fuse FS2. A slow-blow fuse is required because of the large initial current taken by C11 and C12.

In the prototype amplifier C11 and C12 were each made up from two 2,500 μF , 50V capacitors wired in parallel—see photographs. There is however, room for single 5,000 μF capacitors and since these are cheaper to buy they have been specified.

CHASSIS CONSTRUCTION

The chassis for the prototype unit was made from one piece of 12 s.w.g. aluminium; however, this material is difficult to bend without a proper bending machine. If readers are unable to get the metal bent by a local workshop it is

Components

Resistors

- R1, 101 56k Ω
 - R2, 102 1M Ω
 - R3, 103 68k Ω
 - R4, 330 Ω
 - R5, 330 Ω
 - R6, 106 390 Ω $\pm 2\%$
 - R7, 107 4.7 Ω 1W wirewound
- 2 off each except R4 and R5, all $\frac{1}{4}W \pm 10\%$ carbon except where stated

SEE
**SHOP
TALK**

Capacitors

- C1 500 μF elect. 30V
 - C2, 102 0.68 μF
 - C3, 103 0.0047 μF
 - C4, 104 47 μF elect. 16V
 - C5, 105 0.05 μF
 - C6, 106 10 μF elect. 35V
 - C7, 107 0.05 μF
 - C8, 108 47 μF elect. 25V
 - C9, 109 10 μF elect. 35V
 - C10, 110 0.05 μF
 - C11 5,000 μF elect. 35V
 - C12 5,000 μF elect. 35V
 - C13 0.1 μF , 400V
- 2 off each except C1 and C11 to C13.
Values marked 0.05 μF can be 0.047 μF

Semiconductors

- D1, D2 10V and 9.1V 400mW Zener diodes (1 off each)
- D3-D6 2A, 100V bridge rectifier

Modules

- IC1, 101 STK032 Sanyo amplifier (2 off)
- Preamplifier LP1184/2 Mullard stereo pre-amplifier module

Potentiometers

- VR1 50k Ω lin. carbon
- VR2, 102 20k Ω log. carbon dual gang (25k Ω or 22k Ω may be used)
- VR3, 103 250k Ω lin. carbon dual gang
- VR4, 104 500k Ω lin. carbon dual gang

Switches

- S1, 101 4pole 3-way make before break rotary switch (two poles for each channel—only 2 ways used—see text)
- S2 d.p.d.t. rotary mains switch

Sockets

- SK1, 101 stereo phono
- SK2, 102 stereo phono
- SK3 stereo switched jack
- SK4, 104 stereo phono
- SK5, 105 stereo phono
- SK6 stereo switched jack

Miscellaneous

- FS1, 101 skeleton fuse holders and 2 amp fuses (2 off)
- FS2 panel mounting fuse holder and 1 amp slow blow fuse
- T1 mains, 18-0-18V, 2 amp secondary transformer not higher than 65mm (Type 1024 Zeta Windings)
- LP1 panel mounting mains neon indicator with built-in resistor. Two-way chassis mounting tag strip, 4BA earth tags (2 off), 6BA earth tag, 4BA and 6BA fixings, 4BA and 6BA spacers (10mm), 16 s.w.g. tinned copper wire approx. 350mm, stereo screened lead (miniature) approx. 2.5m. 7-strand connecting wire—various colours, 14-strand connecting wire, fixing or clips for C11 and C12, mains cable 3 core length as required with 3-pin plug, cable clip for mains lead, Letraset or similar material, paint. Knobs type R62 black with chrome top cap and skirt with indicator 6 off (Re-An products). Veroboard 0.15inch matrix 14 strips by 18 holes (2 off), grommet for mains cable.

Aluminium for chassis 1 piece, 12 s.w.g. approx. 400mm by 344mm. Alternatively 1 piece, 12 s.w.g. 344mm by 250mm, 2 pieces 344mm x 70mm, angle aluminium—3mm material thickness, 10mm x 10mm cross section, 688mm length. 1 piece 200 x 200mm x 20 s.w.g. for preamplifier screen.

Materials for case—see text.

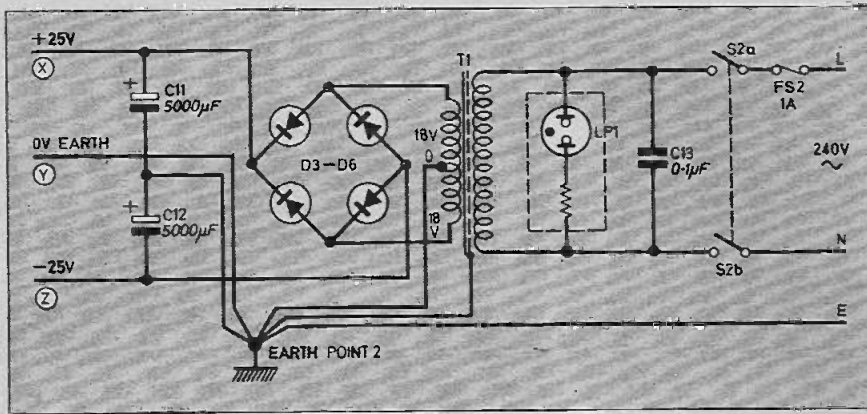
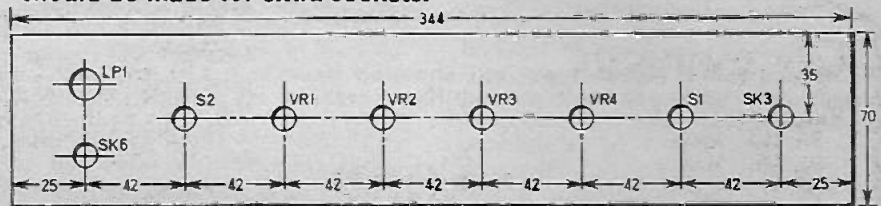
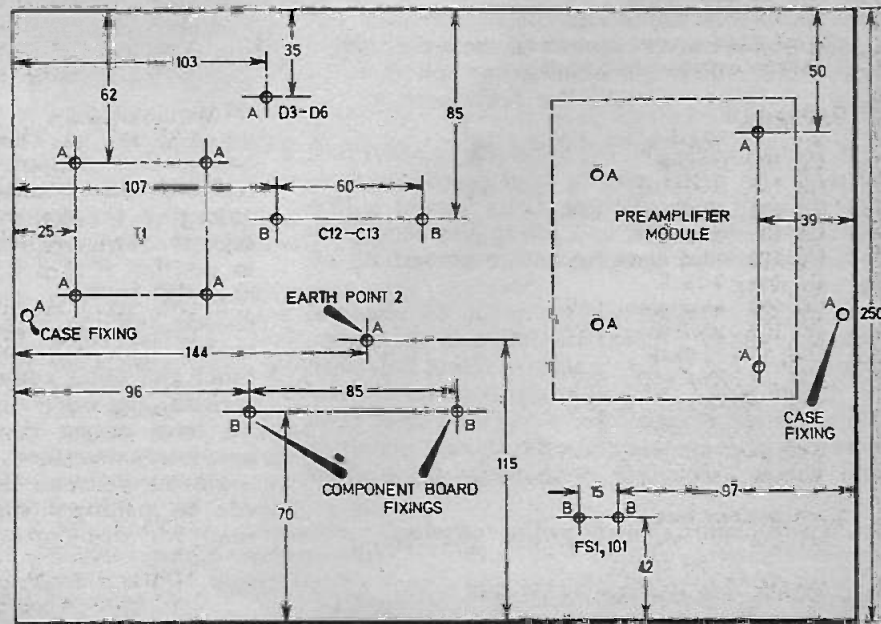

Fig. 6. The power supply circuit — see text concerning earthing.

Fig. 7. Chassis drilling details, some measurements may vary slightly depending on individual components. Viewed looking from the underside with panels "bent down". If an extra auxiliary input is required provision should be made for extra sockets.



FRONT PANEL



BASE

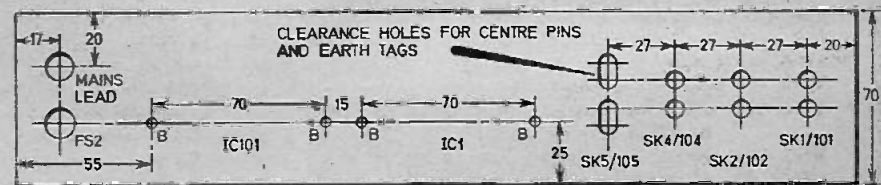

BACK PANEL

A=4BA CLEARANCE
B=6BA CLEARANCE

FIXING HOLES FOR THESE SOCKETS NOT SHOWN

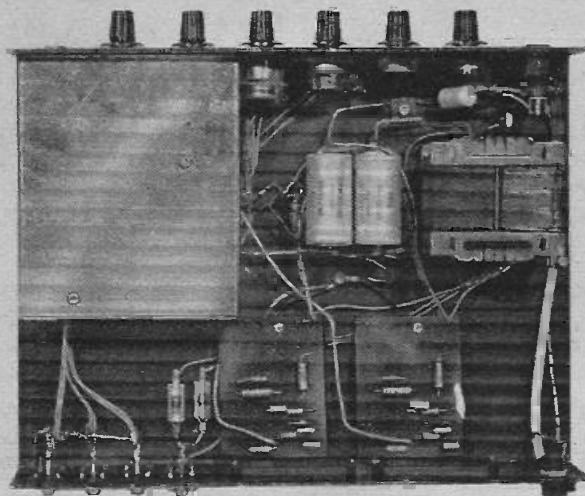

Photograph of the prototype unit showing the component positions, the preamplifier screen is shown fitted.

suggested that the chassis be made from three separate pieces of aluminium joined by angle aluminium bolted at the corners. It is not permissible to use thinner material as the chassis provides a heat sink for the power modules. For this reason it is also essential to use a reasonably heavy piece of angle aluminium, bolted at, at least six points, to join the rear panel to the chassis floor.

If three panels are used the neat appearance of the front panel may be kept by countersinking the bolt heads (three bolts should suffice here) into the metal and filling the remaining indentation with Araldite before smoothing off and painting.

Once the chassis has been cut to size and bolted together or bent as shown in the photographs and Fig. 7, the necessary fixing holes can be drilled using the actual components as templates wherever possible, since individual components vary in some respects. Having done this and checked that all components fit in their

Front and back panels showing lettering.

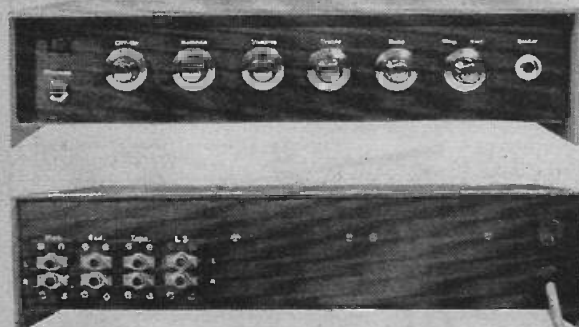

positions the chassis can be rubbed down inside and out with fine wet and dry paper—used wet—before painting.

It is recommended that the inside and outside of the amplifier excepting the front panel, be painted matt black using a car type aerosol paint. This will help the heat dissipation. The front panel may be painted any required colour—matt black was used on the prototype and this, together with the specified knobs, gives a good finished appearance.

When painting the inside of the chassis it is necessary to draw around the power modules whilst they are mounted and then mask the area under each one with masking tape. The lack of paint between the modules and chassis helps thermal conduction.

It was found that one can of spray paint was just enough to complete the whole chassis, giving a reasonable coating. Once the painting is complete the lettering can be applied, using Letraset or similar materials, as shown in the photographs of the unit. Use the knobs to decide the position of the lettering on the front panel.

Having completed the chassis the components can be mounted in position as shown in the photographs and indicated in Fig. 7. Do not at this stage mount the two power amplifier modules or the earth tags for the two earthing points.

When mounting the input and tape sockets the earthing tags for these parts can be flattened against the body of the socket and paint scraped off the chassis in the relevant positions to ensure an earth contact. **This must not be done with the loudspeaker output sockets which must be isolated with Paxolin under the socket or by enlarging the holes to accommodate the earth tags as shown.** With all the components mounted in position it is a good idea to check with an ohmmeter for any shorts between sockets and chassis and the tags of other components and chassis. This is particularly important with the inner and outer connections of the loudspeaker sockets. The other "back panel" sockets should all have outers connected to the chassis as previously described.

Having done all this the preamplifier screen can be made up (Fig. 8) and then the unit is ready for wiring up. *Continued next month.*

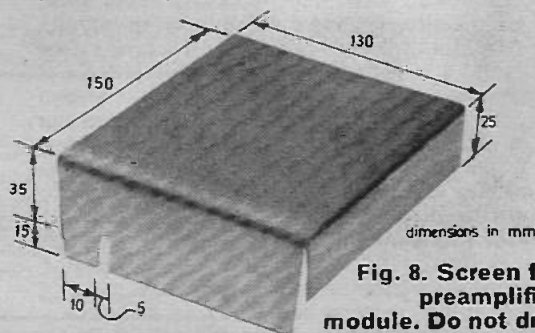

Fig. 8. Screen for preamplifier module. Do not drill mounting holes.

Physics is FUN!

By Derrick DAINES

MAKING SMALL MAGNETS

Take a discarded razor blade and stroke it many times with one pole of a permanent magnet (see also August issue), thereby magnetising it. If you remember that like poles repel and opposite poles attract, you will be able to determine which end of the razor-blade is North seeking; mark it with a scratch, or dab of paint.

Now break the blade lengthwise into two halves and test each half—each is equally magnetised and as might be expected, the North-seeking poles are at the same end. What might happen if we break one of the halves across into quarters? The same rule applies—we create two smaller magnets, see Fig. 1.

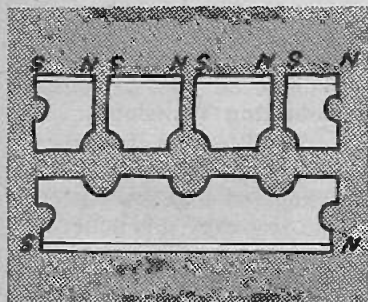

Fig. 1. Breaking a magnet creates more magnets.

With a little thought, we could see that the process could be continued indefinitely, creating smaller and smaller magnets, until—in imagination, at least—we reached individual molecules.

Every molecule of iron has its own magnetic field.

We can now see why the centre of a magnet does not attract iron filings; a North- and South-seeking pole cancel each other out.

One of my readers queried the process of magnetisation and others have put the query another way—what happens when we de-magnetise a metal, such as a screwdriver? How is it done? Well here is a method in which you can actually see it.

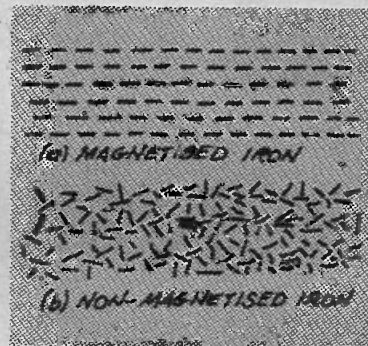

Fig. 2. The effect of a strong magnet on iron filings in a phial.

Fill a small glass phial with iron filings and hold it near a strong magnet. Now repeated tapping will slowly turn the phial into a magnet. If you examine the filings through a strong magnifying glass, you will observe that the majority of the filings have aligned themselves along the length of the phial. Now shake the phial and re-examine. The filings are now randomly-aligned and the total magnetism has disappeared.

As you know, the smallest piece of iron-filing is as big as many thousands of molecules, so we are not actually seeing the realignment of molecules, but the method is a very good analogy of what really happens, Fig. 2.

As a boy, I remember there was an iron fence near my home which was appreciably magnetic. Since it lay in a North-South direction, it was aligned with the earth's magnetic field. Repeated

vibration and taps from a multitude of sources had gradually aligned the molecules and it had become magnetic.

The same thing frequently happens to tools. By their nature they are frequently banged and tapped and if they happen to be in a magnetic field they become magnetised. A magnetic screwdriver can be very useful for inserting tiny screws into inaccessible crevices, but often we do not want the magnetism—what then?

Shaking a spanner is not going to realign the molecules as it did the iron-filings in the phial. One way to demagnetise is by heating, which makes the molecules vibrate more vigorously. Another is to utilise a strong magnetic field to align the molecules across the tool so that the end of the tool is effectively the side of the magnet as in Fig. 3. This is the principle adopted in bulk tape erasers.

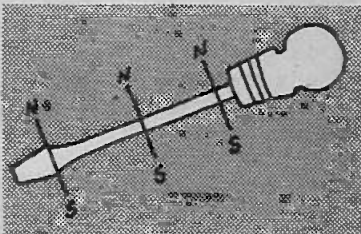
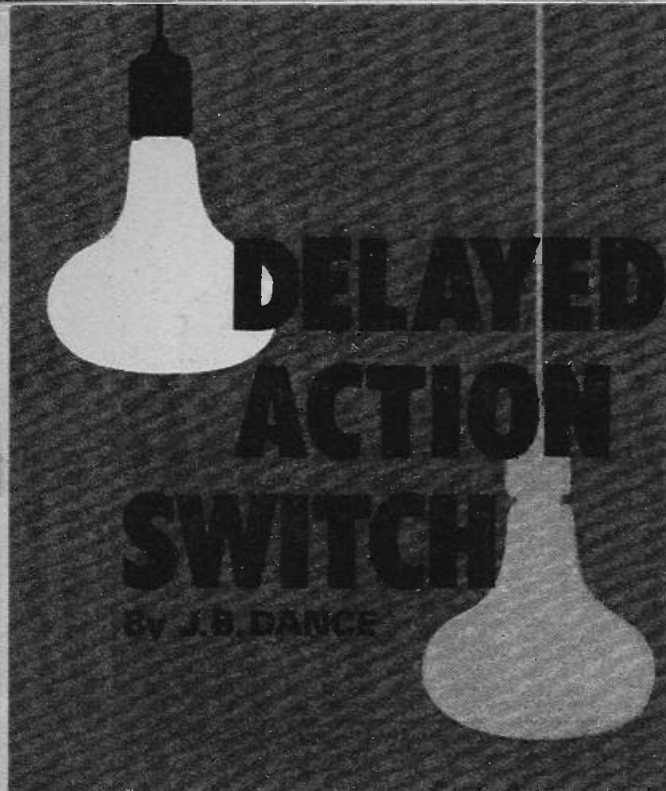

Fig. 3. Laterally magnetised tool will not pick up objects.

Steel is more difficult to magnetise than iron, but it will also hold its magnetism longer. This is because steel contains molecules of carbon that act rather like a film of glue, holding the iron molecules firmly in whatever position they are placed.

Permanent magnets are therefore made of steel, but transformer cores, which are required to accept and lose magnetism quickly, are made of soft iron.



Enables a lamp or other device to be switched off after a predetermined delay

IT is often convenient to have a facility which enables a lamp to be extinguished after a certain delay. For example, a light outside a garden shed which will switch itself off after about a minute, may be used to enable one to return to the house whilst the path is illuminated.

Another use occurs when one has a light which enables visitors to leave a house with the path outside illuminated. A circuit which automatically switches the lamp off after a preset time will avoid the necessity of anyone having to remember to switch off the light when the visitors have left the path.

The circuit to be described may also be fitted in a car so that when one arrives home one can leave the headlamps operating with the car in one's drive. One can then find the key-holes to lock the car and to unlock the house door with ease; this is especially convenient if one is carrying large articles from the car to the house. It is illegal to leave a car stationary in a street with the headlamps switched on and therefore this device should only be used when the car is off the road.

The unit is also suitable for switching off the interior light in a car a certain time after the car door is closed. This helps people who have just entered the car. It is also an aid to anyone who has just locked the car before leaving his garage.

The very simple circuit to be described automatically switches off the controlled light(s) and isolates itself from the power supply. It can be employed for controlling lamps supplied from a battery or from the mains; if a small power supply is constructed the whole unit may be operated from the mains.

The basic circuit itself can be used in many other applications for which a short delay is required. Although the delay period is not intended to be highly accurate and cannot be very long, the circuit is much simpler than those normally used in timing circuits.

DARLINGTON CIRCUIT

A Darlington amplifier consists of two transistors connected as shown in Fig. 1(a). The input to the base of the first transistor is amplified and the resulting current is fed to the base of the second transistor where it is amplified again.

This results in the Darlington pair behaving like a single transistor of extremely high current gain. The base, emitter and collector electrodes of the equivalent transistor are marked in Fig. 1(a).

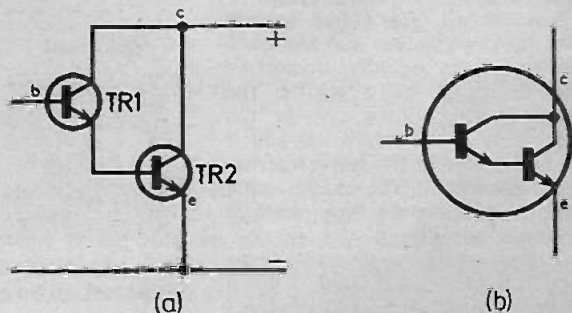

Fig. 1. Details of a Darlington Transistor.

A Darlington circuit can be made from two separate transistors connected together externally as shown in Fig. 1(a). However, it is generally more convenient to employ a device containing both transistors in a single encapsulation. The equivalent circuit is shown in Fig. 1(b).

One such family of Darlington amplifiers is the silicon D40C group of devices manufactured by the International General Electric Company. The various devices in this range have a further

FOR GUIDANCE ONLY

ESTIMATED COST* OF COMPONENTS including V.A.T.

£1.90

*Based on prices prevailing at time of going to press



digit added at the end of the device coding to specify the different voltage ratings and current amplification factors. The cheapest device in the range, the D40C1, is quite suitable for use in the circuit to be described, since it has a 30V collector rating and a d.c. current gain of between 10,000 and 60,000.

THE DEVICE

The D40C1 has the type of construction shown in Fig. 2. It is not necessary to connect the tab of the device to a heat sink in this application, since the power dissipation of the device itself is 1.25W at an ambient temperature of 25 degrees C. (The use of a heat sink can raise the maximum permissible dissipation to 6W if the metal tab of the device is kept at 25 degrees C or less.)

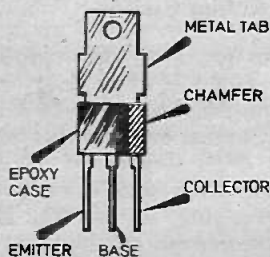

Fig. 2. Physical details of the transistor used in the prototype.

The circuit used is shown in Fig. 3. It has been designed to operate from a 12V supply, but the supply voltage is not at all critical provided that it is suitable for the operation of the relay.

When S1 is pressed, C1 charges to the full power supply voltage. The current flowing through R1 can be estimated in the following way.

The base to emitter voltage of each of the silicon transistors in the D40C1 is about 0.5V when forward biased. Thus there is about 1V between the base and emitter of the whole device. As there is about 12V across C1, approximately 11V will appear across R1. The current through this resistor is therefore about $11/180,000 = 0.061\text{mA}$.

If the gain of the Darlington device is the minimum of the tolerance range, namely 10,000, one might expect its collector current to be $10,000 \times 0.061\text{mA} = 0.61\text{A}$. However, the resistance of the relay will limit the current to less than this figure. The D40C1 therefore operates in the "saturated" condition; in other words, most of the 12V supply appears across the relay coil and only a very small voltage between the collector and the emitter of the D40C1.

OPERATION

A push-to-make switch is used for S1, this automatically opens when released. When this

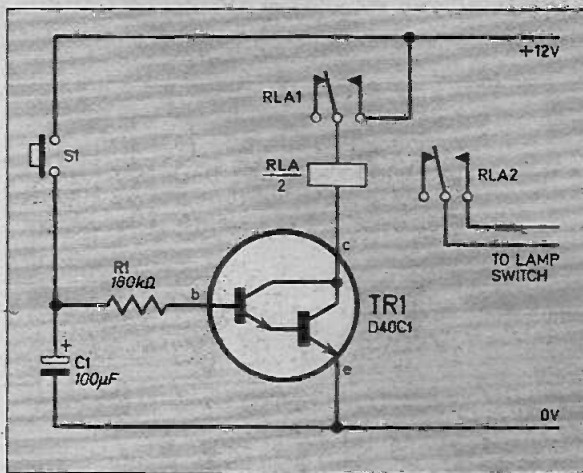

Fig. 3. The circuit diagram of the Delayed Action Switch.

switch opens, the capacitor C1 slowly discharges into the base-emitter junction of TR1. Thus this capacitor provides a base current to the device and the relay remains closed.

As C1 discharges, the potential across it falls and this results in the base current being reduced. However, the device remains in the saturated condition for about a minute, since enough current is still flowing into the base to ensure that the collector current is limited only by the relay resistance. After about a minute, however, the base current becomes so small that the collector current commences to fall. Shortly afterwards the relay opens.

The opening of the relay causes the contacts RLA1 to open and this isolates the circuit from the supply. This isolation should not really be necessary, since the circuit should not pass any appreciable current in its quiescent state. However, a spare set of contacts are available on the relay and constructors are advised to use them in this way to avoid the possibility of the battery being discharged if a fault should occur in the device.

LAMP CONTROL

The other pair of relay contacts, marked RLA2 in Fig. 3, are used to switch the controlled lamps off at the instant the relay opens. These contacts are merely connected to the existing switch contacts for the lamp concerned and do not interfere with the normal operation of the lamp in any way.

One might expect that a transient voltage would be generated across the relay coil as the current through the latter is switched off. However, in this circuit the current falls fairly slowly in the relay coil and no appreciable transient is generated. This avoids the need for a transient suppressing diode across the relay to prevent damage to TR1.

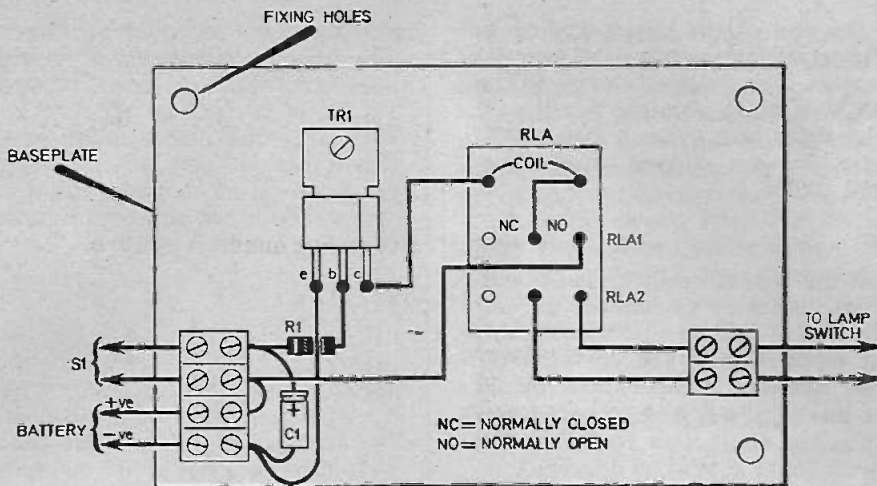

Fig. 4. Construction and wiring of the Delayed Action Switch.

Components SEE

- R1** 180k Ω $\frac{1}{4}$ W carbon $\pm 10\%$
- C1** 100 μ F 20V elect.
- TR1** D40C1 Darlington transistor silicon *n*p*n*
- RLA** Any 12V relay with coil resistance greater than about 100 ohms and two pairs of normally open contacts (see text)
- S1** Push-to-make release-to-break s.p.s.t. switch

Paxolin size 150 x 100mm; terminal block 6-way; battery connectors; 6BA fixings.

**SHOP
TALK**

CONSTRUCTION

In the prototype, a piece of Paxolin was used as the baseplate although any other insulator material such as Perspex, plain matrix board, Formica etc. will do just as well, see Fig. 4.

Begin construction by making a suitable bracket to hold the relay securely to the baseplate. The four fixing holes, one near each corner should now be made, and holes drilled to accommodate TR1, relay bracket and terminal blocks. When the components have been secured they should be wired up as detailed in Fig. 4, and mounted in a case most suitable to the application of the device.

OTHER DELAY VALUES

It has been found that the circuit shown provides a delay of rather over one minute before the lights are switched off. This time is approx-

imately proportional to the product of the values of R1 and C1. If a delay of about 30 seconds is required, the value of R1 may be reduced to 100 kilohms or the value of C1 reduced to 50 μ F.

Times longer than one minute may be obtained by increasing R1 or C1. However, R1 should not be increased much above 500 kilohms or the relay may not close if TR1 has a gain near to the minimum tolerance value for this type of device. No damage can be done by trying a higher value of R1, however.

THE RELAY

The relay used in the prototype was the microswitch relay type MS2B which is available (through retailers) from Keyswitch Relays Ltd. This will operate with supplies in the recommended range 9.6 to 14.4V if the coil has a nominal operating voltage of 12V (although it was found that one of these relays would operate with less than 7V across the coil). The coil resistance is about 465 ohm in the case of the 12V relay, so the operating current is about 26mA.

The MS2B is designed to switch up to 2A at each set of contacts at voltages up to 250V in a.c. circuits, but the maximum recommended contact current is smaller in d.c. circuits. (In a.c. circuits the voltage across the contacts falls to zero between alternate half cycles and this helps to break any arc.) The maximum recommended contact currents are 2A in a 24V d.c. circuit, 0.25A in a 100V d.c. circuit and 0.2A in a 250V d.c. circuit.

The MS2B should not be employed to switch car headlamps; a relay which can switch larger currents should be used for this application. For example, the Keyswitch Relays type KMK2P or the R. S. type 1A can switch up to 10A and are suitable for this application. They have 12V coils and an operating coil current of about 100mA. □

NEW DIMENSIONS IN SOUND

AND OTHER MULTICHANNEL SYSTEMS

PART 1

By ADRIAN HOPE

IF THEY gave away prizes for confusion, the last few years of surround-sound, quadraphonics and four-channel reproduction would win hands down. I do not think that any other topic in the history of the world can have been so widely discussed and so little understood.

Over the past few years I have been lucky (or perhaps unlucky) enough to attend demonstrations of different surround-sound systems and have heard all manner of experts pontificate on how wonderful one system is in comparison with all the others. I have also read the technical literature put out by those with a commercial axe to grind and have understood very little of it.

Where so-called "easy to understand" literature has been given to me, it has been so oversimplified as to convey no real meaning.

Reluctantly, I have come to the conclusion that most of the wizards involved in the research and development of surround-sound systems are incapable of describing them intelligibly to anyone other than another wizard, and that the more down to earth people involved in selling the hardware (such as amplifiers and equipment) and the software (such as records) have not the faintest idea how what they are selling actually works.

In between these two schools falls a large number of interested enthusiasts who would dearly like to get to grips with the basic essentials of the various surround-sound systems.

Certainly I have felt frustration in this respect and have tried hard to get something clear in my mind. Being no mathematician I don't feel I have yet achieved an all round understanding, but I have (I hope) started in the right direction. The knowledge I have gained is imparted in this series of articles.

MULTI-CHANNEL SYSTEMS

All surround-sound or multi-channel systems

Everyday Electronics, February 1975

have one thing in common. They seek to cram more than two channels of information into a two-channel (stereo) recording medium. Usually an attempt is made to cram four channels into two and for this reason the term "quadraphonic" is often used to describe a multi-channel system. But there is no reason why a multi-channel system should not reproduce three channels or five or five hundred and five.

TWO WAYS

There are two basic ways of tackling the problem. On the one hand there is the matrix approach, and on the other there is the multiplex approach. The latter technique is used in many fields of electronics, including radio transmission, where the two stereo channels are multiplexed for transmission as a single channel and separated on reception to produce the two channels of stereo radio.

The JVC-Nivico CD4 discrete four-channel disc system involves a process akin to radio multiplexing and is out of place in the context of the present articles which concentrate on the matrixing approach as being that most immediately relevant to the audio man in the street who wants to know about four channel for entertainment now.

Although the discrete approach has much to offer from a technological point of view (incidentally discrete recording by multiplex techniques dates back to at least 1954) there is still very little discrete software (records) available.

MATRIX SYSTEM

"Matrixing" is really nothing more than a fancy term for mixing. In a four-channel matrix system the four original channels are mixed

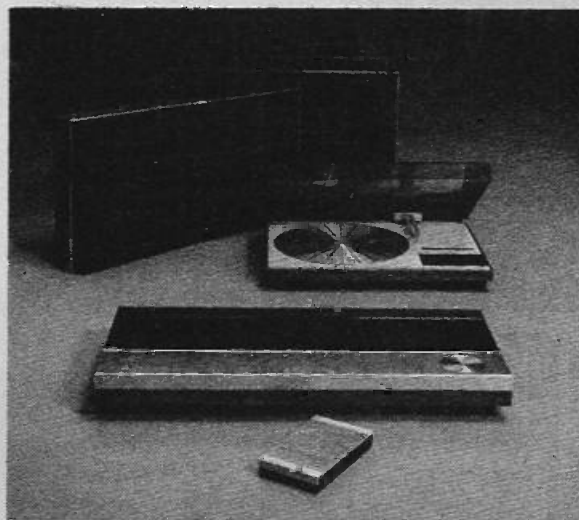

The Beosystem 6000 (4 x 40 watts) with f.m. receiver. Plays mono, stereo, amblo, quad SQ matrix, quad CD4. Shown in foreground is remote control box.

(Bang & Olufsen)

together into two for recording or transmission in stereo fashion, and then unmixed again on playback or reception.

In practice the unmixing is only partial, which means that although four channels are retrieved, they are not as independent of each other as the original four channels were before mixing. In other words the separation between the unmixed (decoded) channels is not as clean as the separation between the original channels before they were mixed (encoded).

In even simpler terms this means that four totally separate sounds which existed, one in each of the original four channels, will spread over between channels after encoding and decoding.

Most of the technical literature which purports to describe matrixing techniques is replete with phase diagrams, circles and heart-shaped polar diagrams. But in many respects these technical excesses are totally unnecessary. There is only one basic electronic concept that must be grasped to understand matrixing, and that is the manner in which in-phase and out-of-phase signals behave when combined.

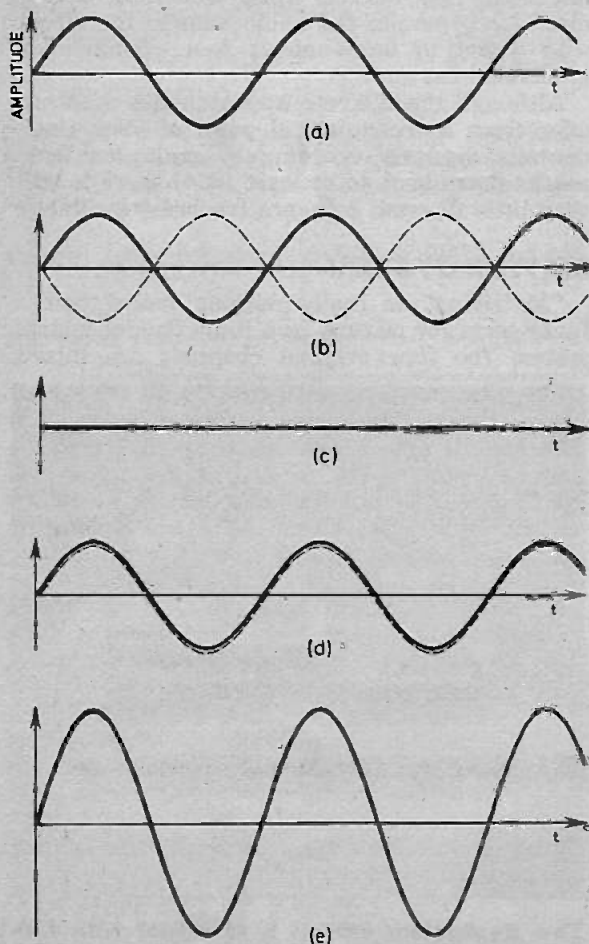

Fig. 1. The results of mixing in and out of phase identical signals.



The JVC Nivico 4VR-5456 f.m./a.m. CD4 discrete four channel stereo receiver. Also handles all other matrix systems. JVC (U.K.) Ltd.

SIGNAL MIXING

In Fig. 1(a) a simple audio signal is shown. It does not matter what frequency (pitch) or what amplitude (volume) it is. What does matter is that if a second identical signal is added to it, the result will depend on whether the two signals are in or out of phase with each other.

In Fig. 1(b) two exactly similar signals are shown, one in full lines and one in broken lines, and one signal is exactly 180 degrees out of phase with the other. In other words, when one signal is peaking, the other is dipping, or when one is pushing the other is pulling. The result, as shown in Fig. 1(c) is absolutely nothing. The one signal has completely cancelled out the other to leave no signal.

If on the other hand, as shown in Fig. 1(d), the two signals are exactly in phase with each other, so that the peaks and the dips correspond, then the result as shown in Fig. 1(e) will be a greatly increased final signal, with the energy of the two signals added together.

Thus just as the two signals of Fig. 1(b) were pushing and pulling against each other, so the two signals of Fig. 1(d) were pushing and pulling together. And whereas the competing signals of Fig. 1(b) cancelled out, the co-operating signals of Fig. 1(d) boosted each other to produce a final signal which is larger than either one alone. In-between circumstances produce in-between results.

All the matrixing systems for surround-sound rely on this fact by using one signal to boost or reduce another during encoding and decoding. Of course the actual signals involved are infinitely complex, being usually music or speech, but the same basic principle applies however complicated the signals involved.

PATENTS

With this effect (hopefully) clear in our minds, we can look at how matrixing systems apply the principle in practice. Often the clearest descriptions are obtainable from patent specifications and as all patent specifications are open to the public for inspection free of charge at various libraries (such as that attached to

the British Patent Office in Southampton Buildings, Chancery Lane, London WC2), relevant patent numbers will be given where applicable for reference.

Matrixing history started in 1931 when Alan Dower Blumlein of EMI filed a patent application (BP 394 325) which laid down the principles not only for most modern stereo recording and microphone techniques but also for matrixing.

Blumlein explained how the relative loudness of sounds emitted from loudspeakers could be made dependent upon the relative phasing of the original signals. He also explained techniques for converting phase differences into amplitude or volume differences.

There is no need in the present context to look closely at what Blumlein wrote, but it would be unfair not to at least acknowledge the existence of this pioneer work.

Further work in this area was carried out around twenty years ago (e.g. Telefunken, German patent No. 1077710) but it was not until the sixties that interest in matrixing as a means for cramming more than two channels into a stereo recording gained momentum.

It is easy to forget how long it took for stereo to take over from mono and there was little or no incentive to devise extra channel systems until stereo had become a domestic way of life.

Some of the earliest discussions of simple matrixing came from Ben Bauer, of CBS, and David Hafler, of Dynaco, in the first half of the sixties. We shall meet both these names again as the plot thickens, but for the moment Bauer and Hafler enter the picture as men who both suggested simple techniques for encoding an extra centre front channel and an extra rear channel into stereo recordings. But even before looking at what Bauer and Hafler were proposing a decade ago, it is best to digress for a while and consider how the so-called "ordinary" stereo record is made.

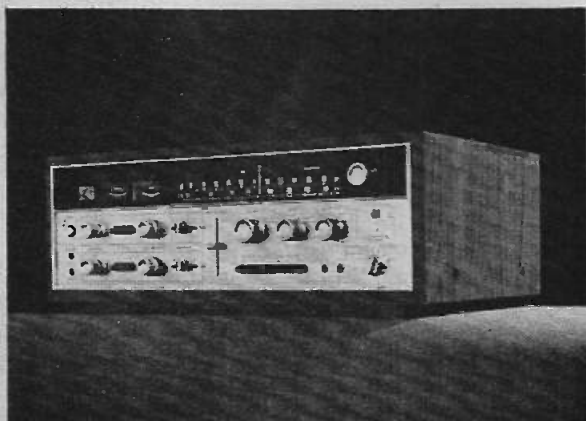

The Sansui QRX 6500 four channel receiver.
(Ventron Ltd.)

Everyday Electronics, February 1975

RECORDING

Recording began in 1877 when Thomas Edison suggested (USA Patent No. 200521) that sound waves could be captured in grooves cut in wax by a vibrating needle. The grooves could then be made to release their captured sound by tracking them with a needle attached to a diaphragm which then vibrated in a manner which corresponded to the original vibrations which had cut the groove.

The grooves were cut in either up and down (hill and dale) or sideways (lateral cut) manner. As most people realise, hill and dale recording eventually fell by the wayside and mono records as we played them on our old 78 gramophones, and for that matter on our old mono 33 $\frac{1}{3}$ players, were lateral cut.

Stereo recording became a reality when the technique was evolved of cutting the two sides of the groove differently.

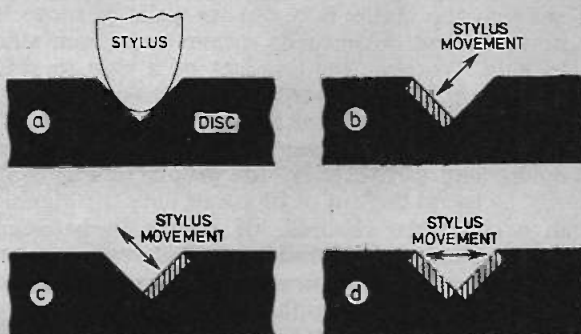

Fig. 2. Details of stylus movement in the groove of a disc.

In Fig. 2(a) the record groove has two walls which are at right angles to each other and at 45 degrees to the record surface. The playback stylus runs in the groove and touches both of its sides. If one side is cut away (as shown by the hatching in Fig. 2(b) then the stylus will move to that side. If the other side of the groove is cut away, as shown by the hatching in Fig. 2(c), then the stylus will move to that side.

Thus in Fig. 2(b) the left hand wall of the groove only is cut with a simple sound and the stylus will move up and down, towards and away from that groove wall, as indicated by the arrow. The pick-up is so constructed that this movement will produce sound in one channel only.

If on the other hand only the other wall of the groove is cut, as shown in Fig. 2(c), then the stylus will move up and down, towards and away from the cut wall, as again shown by the arrow. The pick-up will in this case produce sound only in the other loudspeaker.

If the walls of the grooves are both cut, Fig. 2(d) in matching snake-like fashion the stylus will move only from side to side (not up and down) and will produce the same sound in both

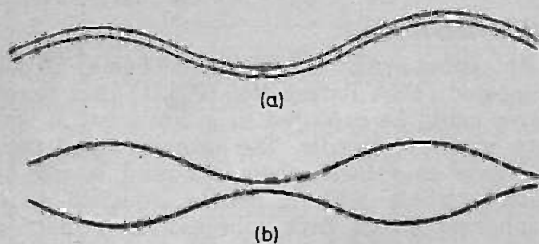

Fig. 3. A plan view of a disc groove for (a) in phase (b) out of phase signals.

loudspeakers; Fig. 3(a) shows the walls of the groove moving ganged together in snake-like fashion or "in phase" with each other.

Once in a while, however, either intentionally or otherwise, the groove will be cut so that the wall movements are opposed to each other or "out of phase". Thus the result then will be a bulbous shaped groove, as shown in Fig. 3(b).

This bulbous shaped groove will tend to squeeze the stylus between its walls to move it upwards and downwards rather than from side to side. Whereas the product of a side to side movement, as produced by the groove of Fig. 3(a), will be equal and in phase signals in each stereo channel, the result of an up and down movement, as caused by the groove of Fig. 3(b), will be equal but out of phase or opposite signals in each stereo channel. Of course in between circumstances will produce in between results.

On an ordinary stereo (two speaker) record playing set-up, the in-phase signals produced by the groove of Fig. 3(a) will produce equal sounds from both loudspeakers which will seem to come from a point in space half way between the loudspeakers (this is a psycho-acoustic effect which is best taken for granted in the present context or we shall be off on another digression).

The equal but out-of-phase or opposite signals produced by the groove of Fig. 3(b) will also be reproduced by both loudspeakers but (because of another of those psycho-acoustic effects) will tend to be lost to the ear or confuse it. This is one reason why most recording and cutting engineers try and keep their records as relatively free of out-of-phase sounds as possible.

But there are occasions when out of phase sounds are deliberately or accidentally present and we shall see later how this can be of interest and importance.

THIRD SPEAKER

But to return now to those simple methods of matrixing proposed by Bauer and Hafler. We have already seen how an illusion of a centre channel is created between left and right speakers if the same signal is present on both left and right channels.

This can be achieved either by recording with two microphones spaced equally apart from the instrument or voice that is to be in the centre,

or it can be achieved artificially by taking a sound intended for the centre and applying that sound to each of the left and right channels as a simple addition.

In 1965 David Hafler patented (USA patent 3417203) a system of going one better than having the centre channel appear in space between the left and right loudspeakers. What he suggested was a method of deriving power for a third loudspeaker which would be physically located between the left and right loudspeakers in an ordinary stereo set up.

There was nothing new in suggesting the use of a third speaker to fill the "hole in the middle" between the left and right loudspeakers, but previous proposals had tended to be rather complicated and require an extra amplifier.

The Hafler circuit, as shown in Fig. 4(a), is simple and requires no extra amplification. Similar and in-phase signals feeding the left and right channel speakers will tend to cancel each other out and so produce reduced signal levels in the left and right speakers, while the centre, extra speaker will be driven by the sum of such signals. Thus a centre sound will tend to appear from the centre loudspeaker rather than from the left and right loudspeakers.

In practice there will be some loss of the left-right separation and in the patent Hafler explains various ways of overcoming this problem. For instance a simple blend resistor across the amplifier inputs may suffice.

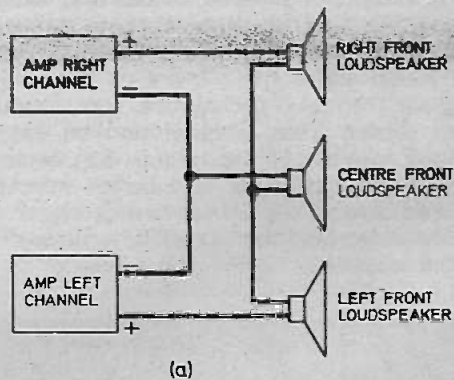

(a)

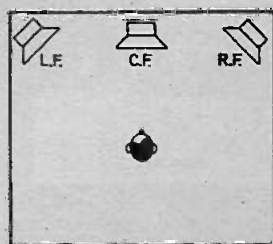

(b)

Fig. 4(a). The Hafler circuit for producing a signal, from in-phase signals, in a front central speaker; (b) shows domestic arrangement of speakers and listener.

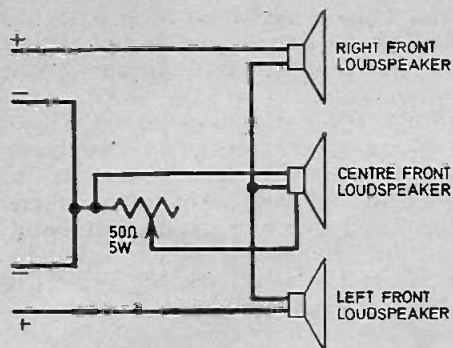

Fig. 5. Circuit to give a degree of volume control for the centre speaker.

For a degree of volume control for the centre speaker, all that is necessary, as shown in Fig. 5, is a 50 ohm, 5 watt potentiometer as a variable shunt across the centre loudspeaker, to by-pass it to a controllable degree.

So here we have a simple way of imposing an extra (third) channel on an ordinary stereo recording and recovering it on playback.

REAR SPEAKER

It is also relatively simple to impose a fourth channel and this is achieved by deliberately putting out of phase signals onto the left and right channels so that the stylus will be confronted with a groove like that of Fig. 3(b), and will move in an up and down fashion to produce out of phase signals on the left and right loudspeaker channels.

Just as the in phase centre signals can be extracted by the simple summing technique just described, so the out of phase signals can be likewise extracted by a simple subtraction technique.

Much of the inspiration in this direction also comes from David Hafler and it was in fact his suggestions for deriving a rear channel in simple manner (in an article in August 1970) that has made his name something of a household word. We shall come back to Hafler's suggestions for deriving a rear channel when we have finished looking at the whole question of matrixing.

In the meantime, suffice it to say that there are simple techniques for imposing a fourth channel on to a recording in out of phase fashion.

Most straightforward, the fourth channel signal is divided into two equal parts and these applied in phase opposition to the left and right channels. This produces similar but opposite components in the two stereo channels (left and right) and these can be most simply extracted by the simple subtraction circuit shown in Fig. 6(a).

The right and left channels feed the left and right speakers in conventional fashion, but the

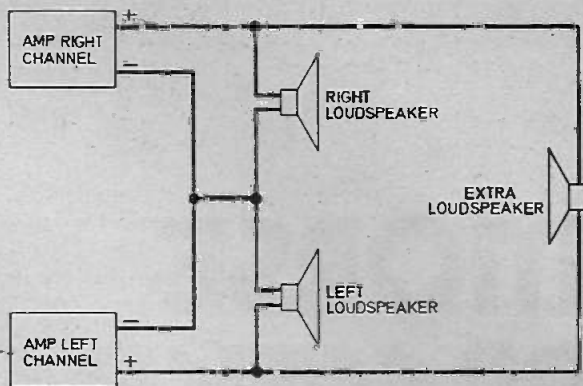

(a)

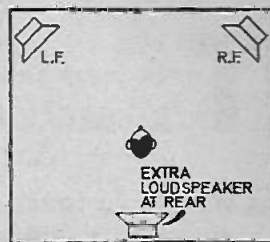

(b)

Fig. 6 (a) The Hafler circuit for producing signals in a rear speaker from out of phase signals in left and right channels; (b) shows the domestic arrangement.

positive output terminals of each channel are connected together via the extra loudspeaker, which is thus fed by whatever currents flow from the positive terminal of one amplifier to the positive terminal of the other. Such currents will flow when there is any difference between the output of the two amplifiers; maximum current will flow when the signals of each channel are similar and out of phase with the other; minimum current will flow when the two channels are in phase. In simple terms, a peak in one channel and a dip in the other channel will cause a current flow between channels through the extra loudspeaker.

ANOMALOUS RESULTS

It would seem that by now we have enough to provide four channels. This is true, but the problem is that the separation between those channels is not particularly good and all manner of anomalous results will occur in practice, with some wanted signals being lost and other signals appearing from the wrong loudspeaker or from too many loudspeakers at the same time.

All in all the techniques described so far cannot achieve the ultimate aim of recorded sounds cleanly separated into their four original channels on playback. In other words, these matrixing techniques provide only partial decoding.

To be continued

dah-dah dah-dah-dah di-dah-dit di-di-dit dit
di-dah-dah-dit di-dah-dit di-dah
dah-di-dah-dit dah di-dit dah-di-dah-dit dit
di-di-dah dah-dit di-dit dah

MORSE PRACTICE UNIT

By MIKE HUGHES

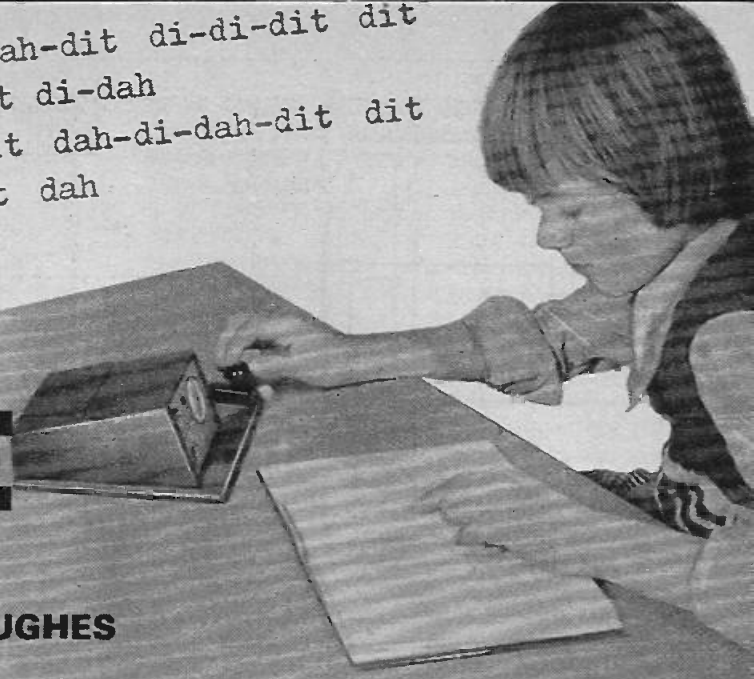

An ingenious device to teach visual Morse. Can be used for record/playback with tape recorder

THIS design arose from the request of a friend who was attempting to obtain his maritime "Master's" certificate. He had to learn to send and read visual Morse code, and as he wanted to learn quickly, was hoping it might be possible to use ready made Morse gramophone records to operate a flashing light. This gadget was quickly hooked up and it worked very successfully.

Thinking more about this simple project the author felt that there might be a more general application for an instrument that will enable one to record morse and play it back either aurally or visually; potential users range from sailors to boy scouts and radio amateur clubs to sailing clubs.

The design requirements were that it should be very simple to operate, not require a lot of power, be simple to construct and plug directly into a cassette recorder.

CIRCUIT DESCRIPTION

The complete circuit is shown in Fig. 1; TR1 is a transistor operating as a class C amplifier and is the first stage of the playback circuitry. Any signals greater than a certain value (about 50 millivolts) that are fed to its base through C1 will produce negative going signals (heavily distorted as far as conventional audio is concerned) at the collector. If S1 is in the "play" position these signals are fed through C2 to the base of TR3.

In the absence of a signal, the base of TR3 is returned to ground through R3 and the tran-

sistor is cut off. However, when the large amplitude signals from TR1 collector are present (these exceed a volt—provided the tape has been correctly recorded) TR3 is driven into conduction as they rise in a positive direction. When this happens the light emitting diode, D1, glows brightly.

In practice the signal will be pulses of a high frequency tone and the effect is that D1 glows for the duration of the pulse. It is essential to use an l.e.d. because an ordinary tungsten filament bulb has too great a thermal inertia and the filament does not respond to high speed Morse.

The large amplitude signals at the collector of TR3 are fed, via C4, to TR2 which is normally biased heavily into conduction by R4 (thus keeping its collector at near zero volts), however, when a signal is present it is forced out of conduction during the negative excursions and this resulting signal is fed via an emitter follower (TR4) to loudspeaker LS1.

PLAYBACK

When a pre-recorded morse tape is played back, the light emitting diode flashes in the same rhythm as the dots and dashes giving visual stimulus and at the same time the tone is heard in the loudspeaker. If desired the loud-

FOR
GUIDANCE
ONLY

ESTIMATED COST*
OF COMPONENTS
including V.A.T.

£5.00

excluding case

*Based on prices prevailing at
time of going to press

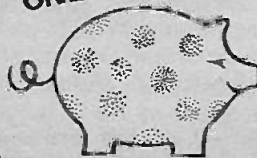

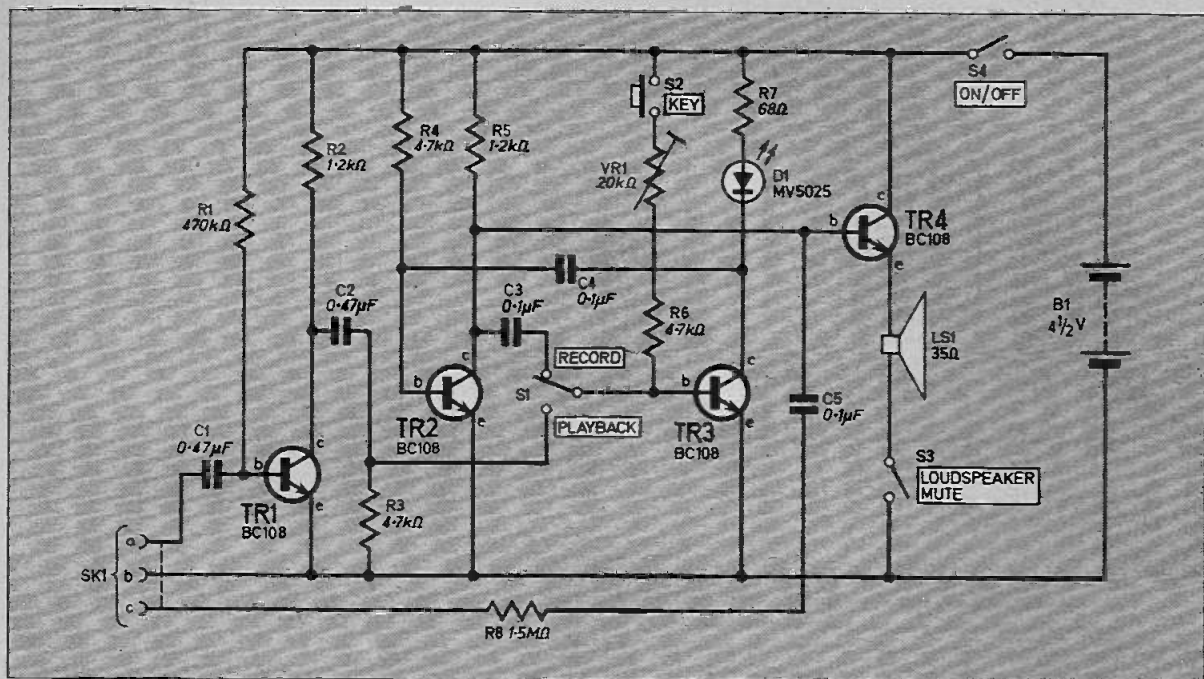

Fig. 1. The circuit diagram of the Morse Practice Unit.

speaker can be muted by means of S3 but the light will continue to follow the input signals.

Notice that we assumed—during the playback operation—that the Morse key (S2) played no role; it should be open circuit i.e. not depressed, during the playback cycle. No harm will come if it is pressed but it might produce a slight parasitic glow in the l.e.d. which would be distracting.

MULTIVIBRATOR

For normal practice, use of the key, and for recording a signal onto tape, S1 should be put in the "record" position. This removes C2 from the base of TR3 and instead switches to C3. This action turns TR2 and TR3 into a simple cross coupled astable multivibrator whose time constants are set by C4 with R4, and C3 with R6 and VR1.

The astable will only work when the Morse key is depressed. Its pitch is controllable by VR1 and the l.e.d. glows each time the key is pressed; likewise the loudspeaker will continue to give an audible tone (provided it is switched in with S3).

The signal at the collector of TR2 is taken via C5 and R8 to the recording input lead of the cassette tape recorder. When recording a signal it is important that the level be set correctly to ensure that there is sufficient signal level on playback.

RECORDER CONNECTION

An advantage with using the Philips recorder is that the input and output terminate at the

Components

Resistors

R1 470kΩ	R5 1.2kΩ
R2 1.2kΩ	R6 4.7kΩ
R3 4.7kΩ	R7 68Ω
R4 4.7kΩ	R8 1.5MΩ

All $\frac{1}{4}$ watt carbon $\pm 10\%$

Capacitors

C1 0.47μF
C2 0.47μF
C3 0.1μF
C4 0.1μF
C5 0.1μF

SEE

**SHOP
TALK**

Semiconductors

TR1 BC108 silicon npn
TR2 BC108 silicon npn
TR3 BC108 silicon npn
TR4 BC108 silicon npn
D1 MV5025 (or similar) light emitting diode

Miscellaneous

S1 miniature single pole two-way toggle
S2 Morse key
S3 miniature on/off toggle
S4 miniature on/off toggle
VR1 20kΩ linear carbon (22kΩ or 25kΩ are suitable)
LS1 35mm dia. loudspeaker
SK1 5-pin 180 degree DIN socket
PL1, PL2 5 pin 180 degree DIN plug (2 off)
B1 $4\frac{1}{2}$ volt bell battery with screw terminals
Veroboard: 0.1in. matrix-size 15 strips x 25 holes; aluminium for front panel; expanded aluminium (loudspeaker grille); twin-screened cable (connection to recorder); plywood for case and base.

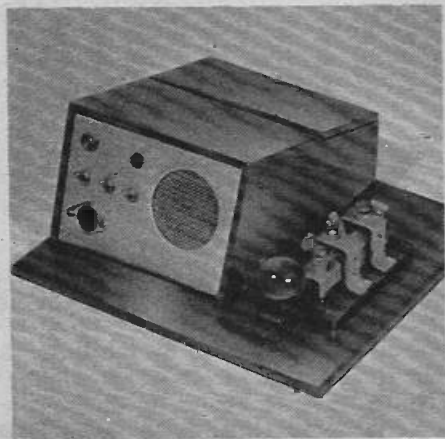
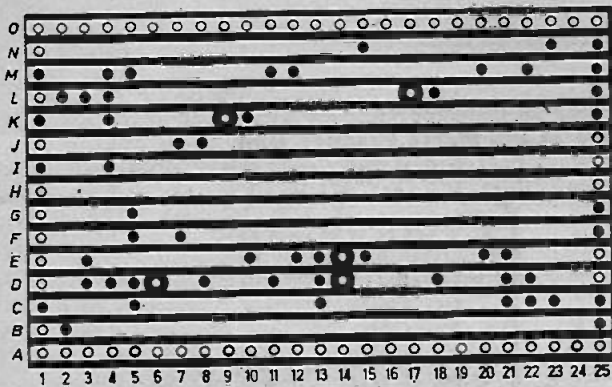
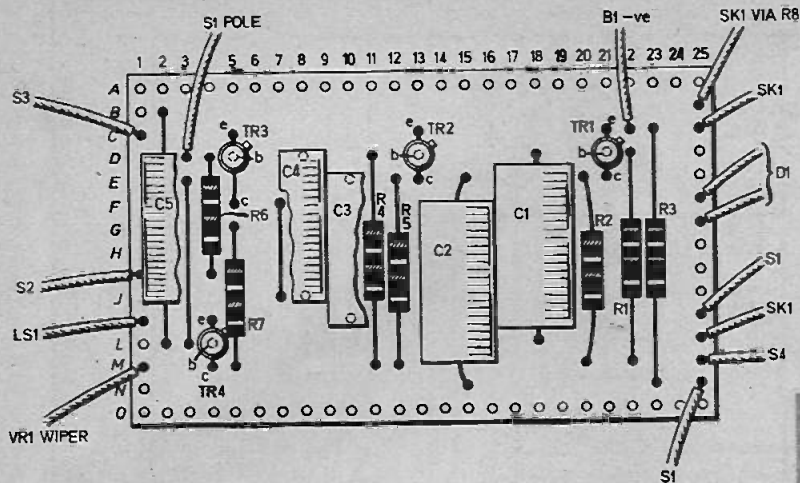

Fig. 2. The layout of the components on the topside of the Veroboard and the region of copper strip to be removed.

same DIN plug, hence interconnection is simplicity itself with a single piece of twin screened lead. The fact that the playback signal is taken from this connection instead of, as was first considered, the loudspeaker means that the volume control of the recorder can be set to zero without interfering with playback.

We recommend you make up your own lead for coupling to the recorder because some standard leads have resistors within the DIN plugs and these can cause the equipment to malfunction.

CONSTRUCTION

The circuitry for the prototype was made up on a piece of 0.1in matrix Veroboard size 40 x 65mm approximately. The layout of the components on the topside of the board and the areas of copper strip to be removed on the underside are shown in Fig. 2. The components are rather closely grouped so be careful about solder blobs bridging conductors.

Begin assembly by soldering in the two link wires followed by the resistors and capacitors. The transistors should be soldered in last of all

and a heat shunt used to prevent thermal damage from the soldering iron. Finally solder suitable lengths of lead to the board as indicated in Fig. 2.

In the prototype, two small aluminium lugs, with mounting holes, were next Araldited to either end of the board (on the unclad side), see photograph.

The remainder of the components are to be mounted on the aluminium front panel, dimensions and layout shown in Fig. 3. The panel size has been chosen to suit the sub-miniature

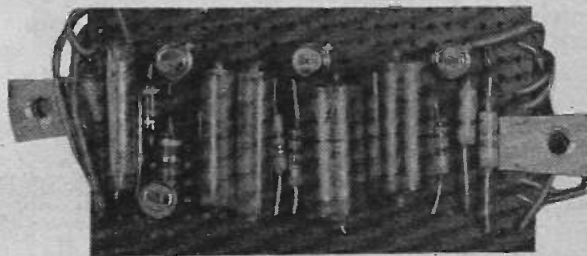

Photograph of the prototype component board showing boxing lugs glued in place.

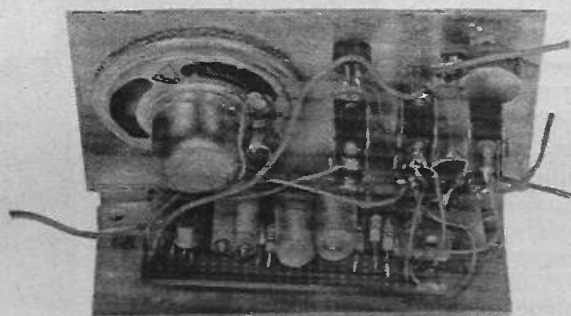
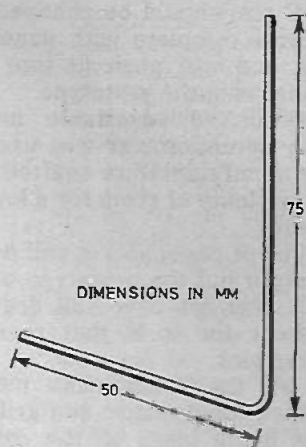
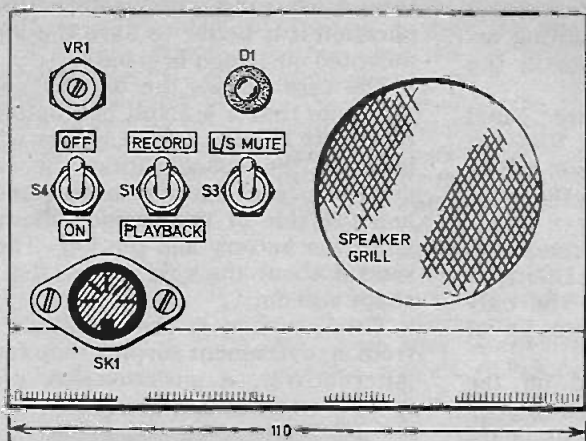

Fig. 3 (above and top left). Details of the front panel layout and construction.

Left. Photograph of the prototype wiring.

MORSE PRACTICE UNIT

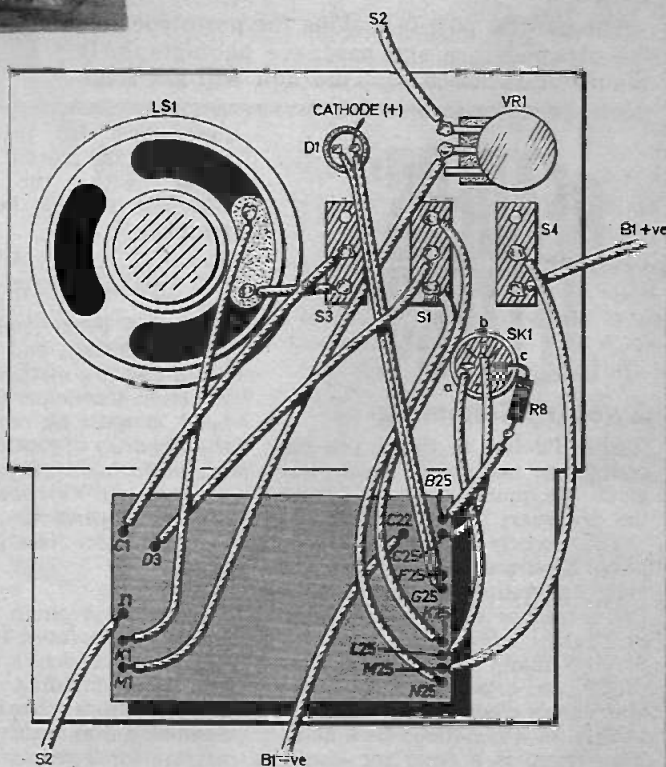

Fig. 4. Complete wiring up details of the front panel components to the component board.

switches used. If the larger switches are used, the panel size should be changed to suit. Some l.e.d.'s come complete with panel mounting accessories and will push fit into a hole in the front panel as in the prototype.

A screwdriver adjustable miniature panel mounting potentiometer was used for VR1 but a conventional miniature shafted pot will suffice as there is plenty of room for a knob on the front of the unit.

Any type of panel socket will do for the signal input/output but the prototype used a DIN type having 5 pins set over 180 degrees. The only requirement for it is that there must be at least three pins.

With all the components mounted on the front panel, loudspeaker and grill glued in position, the flying leads on the component board should be wired up to the panel mounted components as shown in Fig. 4.

The component board should now be secured to the angled base of the front panel by means of two small nuts, bolts, washers and spacers through the aluminium lugs. The two wires to switch S2 should be wrapped together and taken to the morse key S2. Similarly, the other two leads to B1.

CASE

The hardest part in making the prototype was the plywood case and base, see photograph. It should be foreseen that the unit will get some

pretty heavy treatment so it should be made from fairly substantial material and for the application it is better to have the Morse key (S2) mounted on a good firm base.

The case houses the battery under a hinged top. Note that a 4.5 volt bell battery with screw terminals is used and it is this which takes up most of the space within the cabinet. Holes drilled in the internal compartment separator and the side of the cabinet allow the wires to go to the battery and the key. There is nothing special about the case shape, and any size and shape will do.

The key used in the prototype was obtained from a government surplus shop for a few pence. Alternatively, a push-to-make, release-to-break switch can be used. □

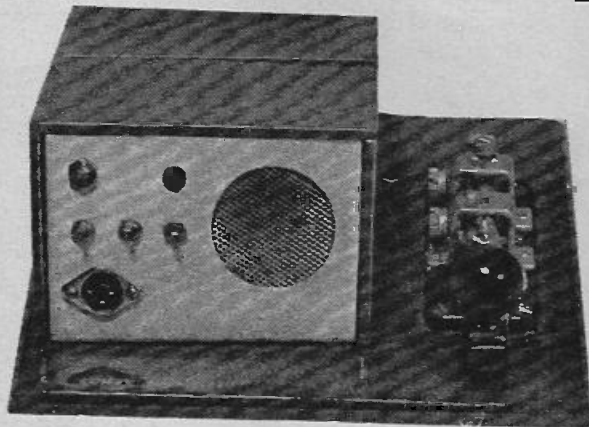

READERS' LETTERS

Swedish Schooling

First I'd like to thank you for your nice magazine, which has given me much pleasure during the few years I've known it.

Your article in the November issue *Electronics At School* was very interesting to me, because I'm a teacher at a Swedish comprehensive school. My school, as well as many others, give their pupils an opportunity to learn elementary electronics as a hobby, mainly on a non-theoretical basis. Thus there is a need for simple building projects, where E.E. comes in very handy. Many pupils, however, need much help, and plenty of prepared material.

Therefore, if E.E. had full-size

suggestions for printed-circuits, e.g. like the recent mini-organ, along with the Veroboard sketches, it would be even more useful.

Hans Nyström,
Sandviken,
Sweden.

We note your point regarding printed circuits, and we do sometimes use this method in our constructional articles. On the other hand, it must be recognised that the majority of readers appear to prefer to build on such standard products as Veroboard. We will of course continue to use both methods from time to time.

Delta

I enclose a photo of my Delta Guitar, as featured in your October issue, which I have had a lot of fun building and playing. It is quite a change from my Spanish guitar which I have been playing for 2 years!

The body was made from plywood and chipboard joined with Resin W. The neck was beech stained "mahogany", the fretboard, 3/8 inch plywood. I got the

pickups for my 13th birthday and they give a high output. I found that the pickups were about the same price as the transformer and the magnets. I tried making the tailplate out of aluminium but I found it was too weak so I made a steel one.

All I have to do now is make an amplifier so dad can have his hifi back!

Arthur Lowery,
Yorkshire.



This month we start publication of the largest and most expensive project we have ever tackled, the *Modula 3 Stereo Amplifier*. Readers should take note of the advice given at the start of the article before attempting construction. Although some warnings are needed, the amplifier should work properly if the construction is carefully followed.

New products and component buying for constructional projects

SHOP TALK

By Mike Kenward

Being a large, specialised project, there are a few buying problems that need some comment. First of all, the two Sanyo power amplifier modules are available from Guest International Ltd, who are offering the modules, when purchased together for this project, at a specially reduced price of £8.86, inclusive of V.A.T. and postage—this is a saving of a few pounds on previously advertised prices. To get the modules, write to Guest Distribution Division, Redlands, Coudon, Surrey, CR3 2HT quoting reference EE1 on the envelope and order, enclosing a cheque or P.O. for the above amount and an order for two STK 032 Sanyo power amplifier modules.

The transformer for this project has been specially designed for a low external field, good regulation and to be the correct physical size and electrical specification. It is therefore recommended that this transformer be used. It is available from Zeta Windings, who are advertising in this issue, the cost being £4.75 including postage, packing and V.A.T. The

transformer is adequately rated for the amplifier and incorporates a screen to help prevent hum pickup by the sensitive pre-amplifier circuitry.

The third module, the Mullard LP 1184/2 preamplifier, is available from Home Radio Components who are regular advertisers in our pages or Electrospares, 288 Ecclesall Road, Sheffield S11 8PE (D). Prices had not been finalised at the time of going to press. One point concerning all the parts mentioned above—they may all take some time to reach you if demand is high. Obviously suppliers cannot afford to stock large quantities of expensive single items until they have some gauge of the demand—if it is high they will have to re-stock and that will take a few weeks, however, there is plenty of metalwork to be getting on with!

All other parts for this project should be readily available and in fact we bought them all from various suppliers in the London area with no trouble. The knobs used on the prototype give it an excellent finished appearance and are available from Re-An Products Ltd., Burnham Road, Dartford, Kent. The total cost including V.A.T., post and packing for the 6 knobs is £1.84.

When ordering please ask for "6 knobs for the EE *Modula 3 Stereo Amplifier*" and enclose a cheque or P.O. for the above amount.

Lighting-up Warning

No doubt most drivers have at some time or other been "flashed" for not having lights on after dark, and many of us have been stopped by the police for a "friendly" warning. The *Lighting-up Warning* should prevent this ever happening again.

There should be no problems in buying for this project, the only point that may need clarification is that we have not provided a type number for the miniature transistor output transformer. This can be any small type—if the retailer has a number, buy the cheapest. It does not need to be a push-pull type or anything sophisticated, simply a cheap miniature one.

Make sure you order the correct transistors for the polarity you require; check if your car is negative or positive earth before buying for this project.

Morse Practice Oscillator

Just a couple of parts need special mention for the *Morse Practice Oscillator*, they are the morse key and the l.e.d.—the old and the new? The Morse key is available from various suppliers new, however they are not cheap and many army surplus stores will be able to provide a good secondhand one for much less, so have a look around.

The l.e.d. used can be almost any small type but make sure you know which lead is which—ask when you buy it if you are not sure. The case used for the prototype unit was made from three-ply and painted to provide a neat appearance.

Delayed Action Switch

The active device used in the *Delayed Action Switch* is rather special and is not generally available. However, Jermyn are able to supply for a total cost of 58p including postage and V.A.T. Send your cheque or P.O. to Jermyn, Cash Sales Dept, Vestry Trading Estate, Sevenoaks, Kent.

Most 12V relays with the required contacts will operate in this device, the minimum coil resistance is given. The main point is to make sure the contacts are capable of switching the required current, e.g. for a 200W 240V bulb use 1 amp contacts, for car headlights use 10 amp d.c. rated contacts.

The case for this device can be any small plastic box that will hold the relay, and a power supply if mains operation is required.



"Your self-controlled electronic lawn mower has just been spotted on the M1 heading for Birmingham at 70 m.p.h."

BEGIN HERE

PART THREE INTEGRATED CIRCUITS

By DONALD MAYNARD



EVERY week, it seems, designers find more and more uses and applications for integrated circuits. As their name implies, integrated circuits (i.c.s) are devices that contain within one package, a large number of active and passive components. In fact, with the latest large scale integration, many thousands of components can be accommodated on one chip a few millimetres square. The problem then becomes, not "how much can you cram into such a small space?", but rather "how do you obtain access to all the points in the circuit that you require?". There are three main divisions of i.c.s that we will look at—digital, linear and hybrid types.

DIGITAL I.C.s

Digital i.c.s operate on the presence or absence of certain voltages, usually in the form of pulses. While many different conventions are possible when considering the states of conduction and non-conduction of the circuits, the following (positive logic) is the arrangement that a lot of i.c.s use. All positive voltages above about 2 volts are called logic "1", and voltages below about 0.8 volt, including all negative voltages, are logic "0". The operation of the circuits is then described in terms 1s and 0s. When interfacing with other circuits, care should be taken that the voltages present are suitable for the i.c.s used. In some cases, for example, a "1" may be a negative voltage while a "0" is around zero volts and any positive voltage (negative logic).

The circuit within the integrated package can take many forms. The early digital integrated circuits used direct coupled transistor logic

(DCTL) which had the disadvantage that, within the package, one of the transistors could tend to "hog" most of the current. Later, integrated circuits were produced that were based on discrete component arrangements in early computers. They used diode-transistor logic (DTL). Its immunity to faulty operation due to noise was good although they were rather slow in operation.

Today, by far the most common type of i.c. in the digital field is the family of transistor-transistor logic (TTL). This is the best compromise for high noise immunity, large feeding capability (fan out), small propagation delay (time taken to transfer information from input to output), and cost. This last, the cost, makes the TTL family of i.c.s ideal for the home

Some Motorola 14-pin dual in line i.c.s.

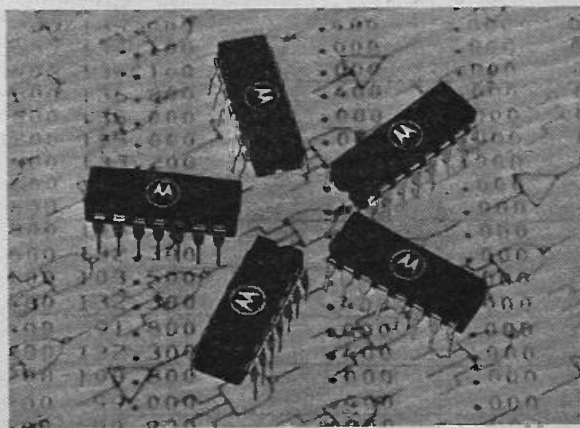

constructor. In addition, for the low outlay, you get a circuit that is small, reliable and capable of high circuit complexity with high performance to go with it. Often these i.c.s are called the 7400 series because this series of numbers is common to many manufacturers' designations.

When very fast operation is required a different sort of circuit is used, called either emitter coupled logic (ECL) or current mode logic (CML). In this arrangement the transistors do not saturate (i.e. they do not switch hard on). The time taken to go from the "on" state to the "off" state is therefore much less. Propagation delays down to 1nS (one nanosecond) are possible.

In recent years devices employing large scale integration (LSI) have come onto the market. They use metal oxide semiconductor (MOS) material as their basis. Typically this enables 5,000 component devices to be accommodated on one chip 4mm square. The LSI of these i.c.s makes them ideal for data handling, computer memories, delay lines, calculators and display system applications.

LINEAR I.C.s

Linear i.c.s are available for carrying out a number of different functions. Let us first look at the operational amplifier. This is a circuit having very high gain, high input impedance, low output impedance and wide bandwidth. It usually has two inputs, one the non-inverting

A much enlarged photograph of an i.c., the Signetics 10125 which employs ECL.

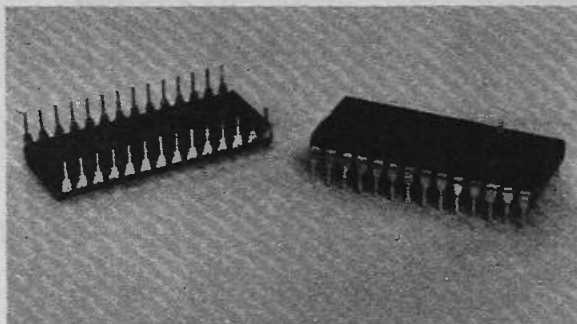
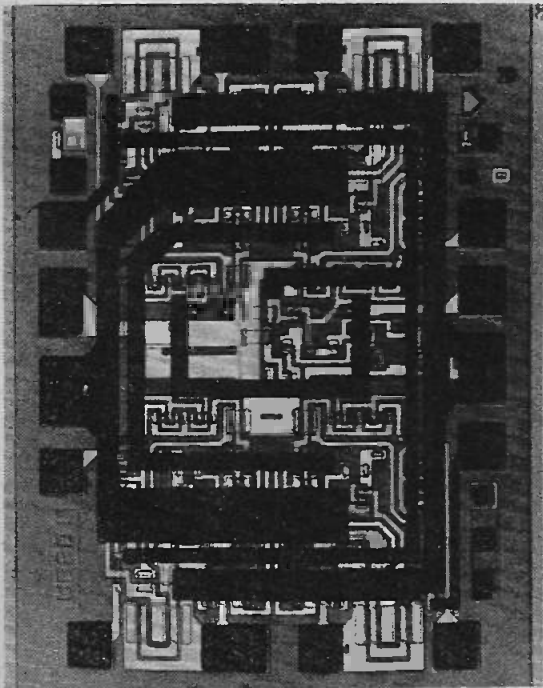

Examples of LSI. The Texas TMS0017 "number cruncher"—a sort of mini computer.

input, the other the inverting input, designated "+" and "-" respectively. The device amplifies the voltage between these two inputs. While the open circuit gain of the op. amp. may be as high as 200,000 operation in this mode would be highly unstable. The gain and frequency response of the final circuit is determined by external components. Operational amplifiers can be used for straightforward amplification or they may be used to carry out mathematical functions including differentiation and integration.

COMPARATORS

Comparators are also circuits which have two inputs. The output switches to one of two states depending on the relationship between the two input voltages. It is similar to the operational amplifier in that it has gain. Differences of less than a millivolt at the inputs are translated into a change of volts at the output.

Then we have the many integrated circuits that are made for specific applications. There are audio amplifiers, intermediate frequency and radio frequency (i.f. and r.f.) amplifiers, video circuits and many others. It is not possible in this article to include details of i.c.s, but information is available in many magazines, books and manufacturers' data sheets.

HYBRID I.C.s

Hybrid microcircuits use a combination of conventional i.c. manufacturing techniques together with thin-film and thick-film deposition. Deposition allows passive components with relatively high values of resistance, inductance and capacitance to be incorporated in the package. With conventional manufacture, only semiconductors and resistors are easy to produce. The Japanese seem to be well to the fore in offering hybrid circuits for audio applications. The Modula 3 audio amplifier featured in this issue uses two Japanese hybrid amplifiers for its main amplifiers.

Some manufacturers will even undertake to produce a custom design for a particular

requirement. The packaging of hybrids takes many different forms and it is best to consult manufacturers' data sheets for pin allocations and heat sink requirements etc.

I.C. PACKAGING

There are three main types of integrated circuit packaging. Fig. 3.1b shows a 14-pin dual-in-line package but this is also available in 8, 16 and 24 pin configurations. Pin numbering is always anticlockwise when looking down on top of the i.c. The first pin, anticlockwise from the inlet semicircle is number 1. The flat-pack numbering (Fig. 3.1c) is also anticlockwise from on top, starting from the T-shaped pin or the spot.

Finally there is the TO-5 type of encapsulation shown in Fig. 3.1a. This looks like a transistor except that it has 8 or 10 leadouts coming from it. Pin numbering is clockwise looking at the bottom with pin number 8 or 10 nearest the pip on the can, depending on whether it is an eight or ten-lead package.

Sometimes i.c.s, especially the linear ones, are manufactured in both 8 pin and 14 pin dual-in-

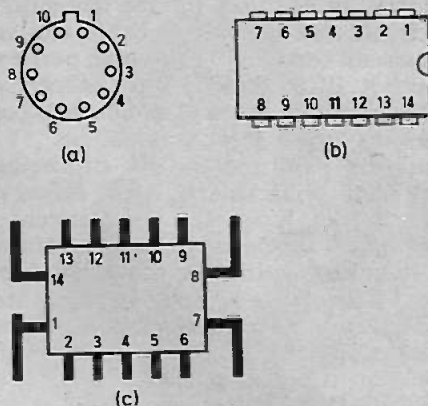

Fig. 3.1. The three most common types of i.c. packages.

line packages. The 8 pin version can then be put physically onto a printed circuit board designed for the 14 pin type. Pin holes 3 to 6 and 9 to 12 (of the 14 pin design) will be the only ones occupied by the 8 pin package.

Next month: circuit construction.



...Counter Intelligence

BY PAUL YOUNG

A retailer discusses component supply matters.

THE other day a customer came into our shop, clutching a small pocket portable. He wanted a small earphone to plug into his radio. As he had no idea what impedance was required, I tried my entire stock from 10 ohms to one kilohm. The difference between them was negligible.

What goes for earphones would also apply to speakers excluding perhaps hi fi and those handling large wattages. If speaker and earphone impedances are not critical, when it comes to potentiometer, resistors and capacitors the tolerances can be even greater.

MESSAGE

This is the message I have been hammering home ever since the inception of this column in the hope that the designers of the articles would give wider parameters, and you, the constructor would make substitutions if necessary.

Sometimes I think the designers are responding; I did the other day, when I saw among the list of

components "Speaker 30 to 100 ohms", but alas it was just a flash in the pan! In the end I think it will be you the experimenter who will solve the problem, and by way of a start let me suggest you try the following.

OLD PROJECT

Take one of your finished projects, preferably one that you have no further use for and do not mind spoiling, and change the value of the components and observe the effect. Something in the nature of a radio circuit would offer the best scope. Concentrate on the resistors first. Using the well known Ohm's law formula, work out the wattage dissipated by each one. In most cases it will be negligible.

If you have in your junk box a few spare potentiometers, select one of a slightly higher resistance than a particular resistor in the unit, and provided the wattage dissipated across it is less than $\frac{1}{2}$ watt, replace it with the pot and you will be able to judge how far the results are affected by changing the value.

If you have no potentiometers, use a few fixed resistors, first increasing the value by 25 per cent, 50 per cent, 75 per cent and then decreasing it by the same amounts.

The same treatment can be applied to the capacitors as long as you make sure that the ones you are using are of sufficient voltage.

Next try different value potentiometers in place of the existing ones, but do not substitute log. for lin. types or vice versa or you will get some odd results.

Finally if you have a few speakers of different impedances, try them to see what difference they make. I think having carried this out you may be astonished at how little the results are changed by these alterations.

VALUE

The value of this experiment, is, that it will give you far greater confidence and next time you need a 100 kilohm resistor and have run out, instead of tearing down to the shops you will simply select an 82 kilohms or a 120 kilohms knowing that nineteen times out of twenty it will work just as well. Just think of the possible frustration you will avoid in the future.

FREE! NEXT MONTH

this WALL CHART on CONSTRUCTION TECHNIQUES



AMATEUR SHORT WAVE RECEIVER

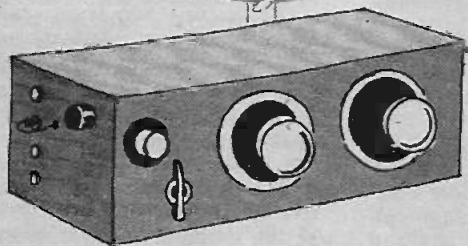

Scan the wavebands with our 15MHz to 1.76MHz receiver. Will bring in a great number of broadcasts, amateur, ship to shore and other transmissions. Receives c.w. morse, single sideband and a.m. transmissions.

SOIL MOISTURE ALARM

Keep your plants in good condition with the aid of this unit. Provides a visual indication of moisture at root level.

FUZZ BOX

Add the fuzz effect to your guitar or other electronic instrument. Complete, easy to build unit, with built in footswitch, fuzz and volume controls.

everyday electronics

MARCH ISSUE
ON SALE FRIDAY
FEBRUARY 21

The Extraordinary Experiments of Professor Ernest Eversure

by Anthony John Bassett

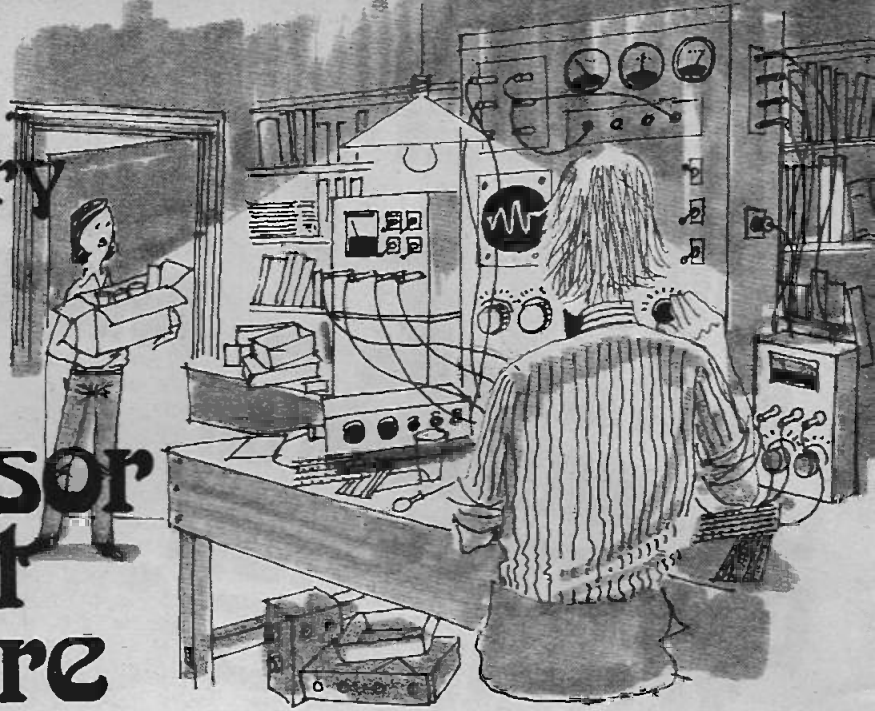

Professor Ernest Eversure, or the Prof. as his friends call him, has been experimenting in electronics for more years than anyone can remember and we thought that you might like to hear of, and perhaps repeat, some of his extraordinary experiments. Anthony J. Bassett will be recounting some of the experiments every month so why not follow the Prof's work and learn along with young Bob, his friend.

THE Prof. was seated before a huge panel covered in meters, oscilloscope displays, controls and coloured flashing lights. On each side of him were more panels covered with an amazing variety of gadgets. The robot fussed around in the background, making alterations and connections to some of the equipment, and occasionally communicating with the Prof. in a code of clicks and whistles as results and measurements were obtained.

This fantastic scene was the setting for one of the Prof's remarkably complex, and fascinating experiments, but when one particular lamp began to flash, the Prof. left his robot assistant to continue the preparations. The Prof. knew that he had a visitor, and he could see on his monitor screen that it was his young friend Bob, just arriving to do some experiments in the laboratory. He and the Prof. were hoping to make some experimental microphones, a gramophone pickup, and maybe some other types of vibration pickups.

"Hi, Prof." Bob greeted the Prof. as he entered, and proceeded to deposit a strange collection of oddments on the nearest available workbench.

"Hallo there, Bob," replied the Prof., "I'm glad to see that you were able to bring all the parts we'll need."

He examined the things which Bob had brought. Most of them did not look like electronic components at all, but a strange collection of bottles, plastic jars and beakers, and a variety of thin sheets of paper and plastic wrapping-foil. With these were a few resistors and capacitors, and a 9 volt battery.

"How on earth do we make microphones from these things, Prof.?" asked young Bob in puzzlement.

"The microphones which we will attempt to make," explained the Prof., "consist basically of thin, lightweight sheets of paper or plastic foil, which vibrate whenever sound waves strike them. Each thin sheet is stretched across the mouth of a container. A line

is drawn across the sheet using either a soft graphite pencil, or a fluid graphite composition, and this makes it sensitive to sound waves. Each graphite line is attached at both ends to wires, and sounds can be picked up, amplified and either recorded on a tape-recorder or heard directly from a loudspeaker."

The Prof. drew a sketch showing how a simple microphone can be constructed, his drawing is shown in Fig. 1. A thin piece of paper is pasted carefully across the mouth of a plastic container. A graphite line drawn across the paper acts as a conductor of electric current, as described by the Prof. in earlier experiments, and it is this line which is sensitive to vibrations. The resistance of the graphite line varies as the paper is vibrated by sound waves.

A SIMPLE EXPERIMENTAL MICROPHONE

Young Bob decided to start right away and make his first trial model. He selected a plastic beaker, placed it open end down on a piece of thin paper, and marked the circular outline of the beaker on the paper. Then he drew a slightly larger circle to give a border of about 8mm round the first. With a sharp pair of scissors, he cut out the larger circle, and cut out a number of

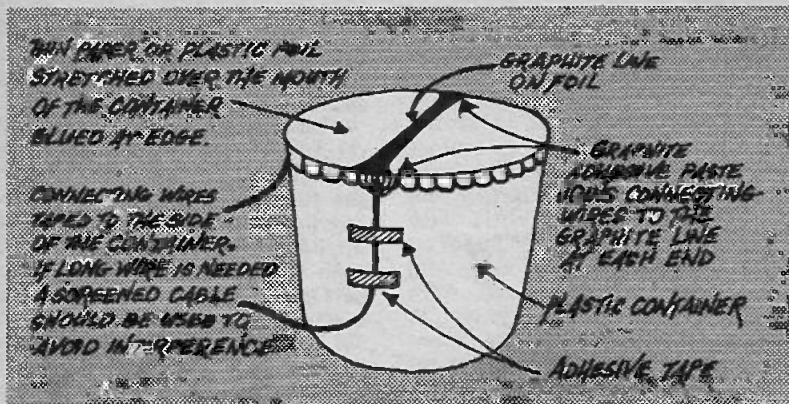

Fig. 1. The basic microphone arrangement

V-shaped notches from the larger to the smaller circle at intervals of about 8 mm to give a piece of paper shaped like Fig. 2.

"What resistance should this microphone have, Prof.?" he asked.

"Almost any value could be used," replied the Prof., "But very high or low values could be troublesome. To start with, I suggest you try about 10 kilohms."

Using a soft graphite pencil (about 5B), Bob carefully rubbed graphite onto the paper to produce a wide, dense line right across the paper disc. He used a multi-meter to measure the resistance of the pencil line by laying the probes of the multi-meter onto the ends of the pencil line.

The resistance was higher than 10 kilohms, so Bob rubbed some more graphite onto the paper until the resistance was about right.

Turning the paper disc over, so that the graphite was on the underside, Bob placed a small smear of contact adhesive on each of the tabs round the edge of the disc, and also round the outer edge of the beaker. He also glued a ball of cotton wool to the inside of the beaker (Fig. 3).

When the adhesive became tacky, Bob carefully glued the paper disc to the top of the beaker, folding down the tabs at the edge of the disc so that the disc was slightly taut, and firmly fastened to the beaker. Then he taped two flexible insulated wires a few inches long to the sides of the beaker. The wires were bared near the ends, and he glued the bared ends to the ends of the graphite line on the paper, using a thick paste of glue and graphite.

This paste can be made by mixing powdered graphite with adhesive gum or thin varnish, and serves both to attach the wire to

the graphite line, and to form an electrical connection.

Whilst waiting for the paste to dry on the first microphone, Bob cut out a further quantity of discs to suit some of the other containers which he had brought. Some of the discs were made from thin paper, and for others he tried using thin plastic wrapping-foil, see-through cooking foil, and similar sheet materials such as polythene, and thin rubber cut from a balloon.

He attached these discs to the various containers, and soon had a row of experimental microphones of many shapes and sizes waiting to be tested. Some of these used straight graphite lines, and others were zig-zag (Fig. 4). For some, the lines were made with a soft graphite pencil or a lump of pure Artist's graphite, and for others, the graphite lines were painted on using a composition of graphite and varnish.

Bob then consulted the Prof. about the connection between the microphone and the amplifier.

"This type of microphone can easily be connected to most types of audio amplifier, and either

Fig. 2. Disc shape used for Fig. 1

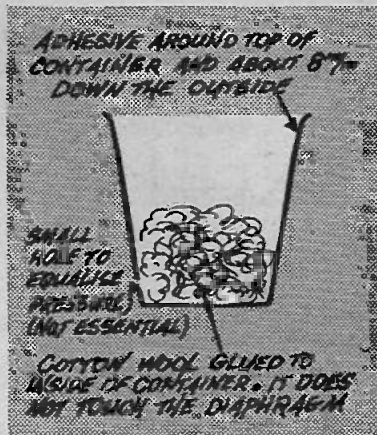
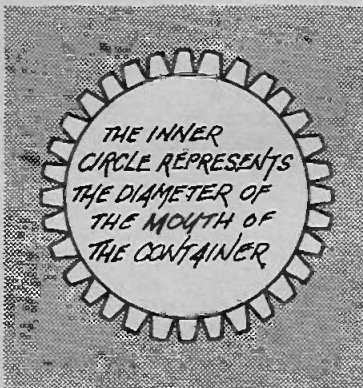

Fig. 3. Container arrangement

valve or transistor amplifiers can be used. With some amplifiers a pre-amplifier might be needed," said the Prof., "However, a carbon microphone like this needs to be activated in use by means of a small electric current, and for this purpose it is convenient to use a simple energiser circuit."

ENERGISER CIRCUIT

The Prof. drew the circuit diagram (Fig. 5) for a simple energiser consisting of a battery, two resistors, and one capacitor together with an on/off switch.

Fig. 4. Zig-zag graphite lines

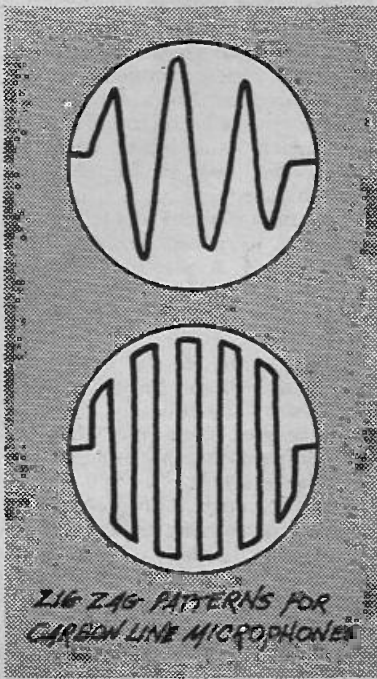

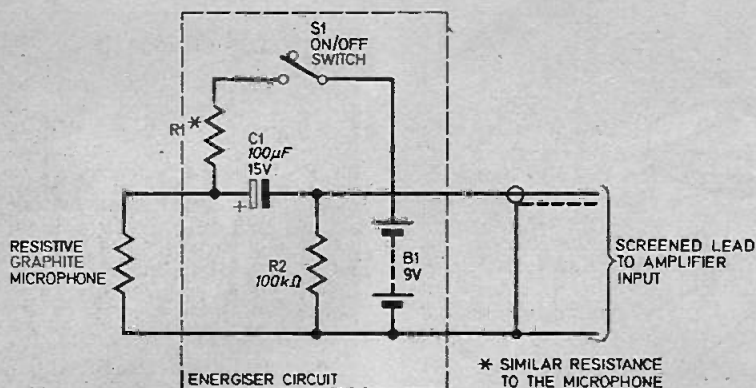

Fig. 5. The circuit diagram of the energiser used for the experimental microphones.

Using a piece of miniature tag-board, Bob soon built the energiser circuit and connected the microphone. Then by way of a length of screened audio cable, he prepared to connect the output of the microphone to the high gain input of an audio amplifier.

"Before you switch the microphone on," said the Prof., "Turn down the volume control on the amplifier, so that the switch-on does not produce a loud noise from the loudspeaker."

Bob connected the screened cable from the output of the energiser to the amplifier, switched on, then gradually turned up the volume.

Meanwhile the Prof. had also been busily making experimental microphones similar to, but not identical with those made by Bob. The microphones which the Prof. produced were somewhat more elaborate than Bob's simple prototype, and some of the materials used, such as graphite emulsion type 568C, had to be specially ordered.

The microphones made by the Prof. are, like those made by Bob, based upon a plastic container such as a tumbler or small jar. The container should not be of plastic which is very soft or thin, as this might easily bend and cause the diaphragm to wrinkle and distort. Fortunately, suitable containers of more rigid material are readily obtainable from household goods stores.

The Prof. used a fine saw to cut out and remove the middle section of a plastic tumbler, as shown in Fig. 6, so that the bottom section could slip through the top section. He smoothed the cut edges using an file and some sandpaper, and glued a strip of tissue paper about

25 x 12 mm over the edge of the bottom section. Then he used electrically-conducting graphite emulsion paint type 568C to paint inside both top, and bottom sections of the tumbler to provide an electrically-conducting screen over the inside of each. He also painted over the tissue-paper strip to form a connecting tab on the outside. (With some types of plastic it may be necessary to sandpaper the surface or to apply a primer paint before using type 568C conducting paint).

The conducting paint dried very rapidly, and the Prof. then glued a layer of sound-absorbing material (thick felt or BAF wadding is suitable) to the bottom of the tumbler. He cut out, very carefully, so as not to damage or wrinkle the delicate material, a disc of thin plastic film (100-gauge polythene, thin see-through cooking-foil or wrapping foil are suitable), and cut a series of V-slots in the edge as shown in Fig. 2. After making a small hole in the side of the container, the

Prof. glued the disc over the mouth of the lower section in just the same way Bob had glued his paper version earlier.

The Prof. glued two further pieces of tissue paper, each about 10 x 20mm to opposite sides of the tumbler, so that one of them overlapped the larger strip he had applied earlier, and one end of each strip projected over the top surface of the plastic disc for a distance of about 3mm (see Fig. 7). He used a small paintbrush to cover these strips with 568C graphite paint to form conducting tabs, so that one of these contacted the tab of tissue which connected to the inside screen. He then painted a line of graphite from one tab, across the diaphragm, to the opposite tab. This line forms the sensitive graphite pickup.

If the 568C paint does not adhere to the plastic film directly, it may in some cases be necessary to key it on. This may be done by rubbing the surface very gently with a grease-removing solvent or some acetone, or by roughening it slightly with fine scouring powder or other very fine abrasive. Then apply a very thin smear of gum adhesive before using the 568C paint.

Now it only remained to attach the connecting wires to the microphone before fitting the top grille and surround. The Prof. bared the end of a length of single-screened miniature audio cable for a distance of about 10 mm, and soldered a length of stranded flexible wire to the outer braid, sufficient to run a half way around the outer edge of the container.

He attached the screened cable to the side of the container, near to one of the tissue-paper tabs (not the one which connects

Fig. 6. The Prof's more complex microphone. The top section of the beaker is cut to fit over the lower section.

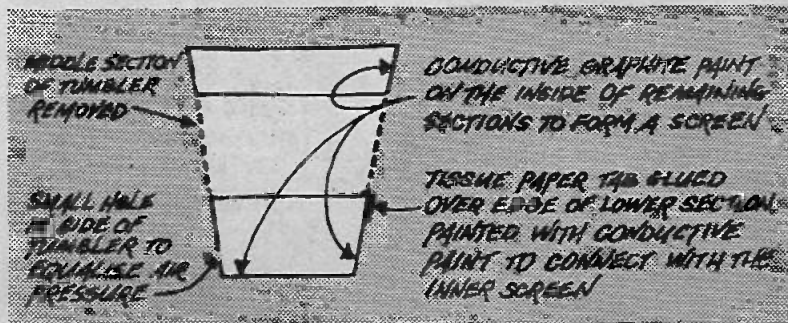

directly to the inner screen) using quick-set epoxy or contact adhesive, and further securing it with P.V.C. plastic adhesive tape. Next he ran the length of stranded wire round to the screen tab to connect both the inner screen, and one end of the graphite line, to the outer braid of the audio cable. The stranded wire was held in position around the edge of the container using contact adhesive, and connected to the tab by a dab of 568C paint. The inner wire of the audio cable was similarly connected to the other end of the graphite line by a dab of 568C paint.

GRILLE AND SURROUND

The grille consists of a disc of wire mesh (obtainable from engineers suppliers for use as oil filters and similar purposes) cut to size which will just fit inside the mouth of the top section of the tumbler. The edge may be bent under, with care, to give a good appearance and freedom from sharp projections. A piece of dark-coloured cloth or thin felt is glued to the underside of the mesh, using only a small amount of adhesive around the edge and a few small dabs elsewhere to prevent sagging.

In order to fit the grille and surround, the surround (which consists of the top half of the tumbler) is first passed over the screened lead, then over the lower section and into position as shown in Fig. 7. It is wedged into place by means of a number of small pieces of Balsa wood or similar material. These are painted with 568C paint to connect the screen on the surround to the outer braid

of the screened lead, and to the stranded flexible wire around the edge of the inner section.

Before applying the 568C paint, the Prof. carefully adjusted the wedges so that the surround was concentric with the remainder of the microphone. He popped the wire grille into the top of the surround and sealed it carefully into place with a neat bead of white flexible sealing compound or silicone rubber sealant (this can be obtained from d.i.y. shops for sealing around baths, etc.).

Then to put the finishing touch, he applied a further quantity of white sealant to fill in beneath the lower edge of the surround.

While the Prof. had been constructing his microphone Bob was getting ready to test some of his. He placed one of the microphones he had made a near to a ticking clock, and the sound of the clock could be heard quietly through the loudspeaker. As Bob altered the volume control, the ticking became louder, and it was obvious that the microphone was picking up the sound of the clock very effectively.

Turning down the volume-control on the amplifier, he then disconnected the energiser from the amplifier, and substituted another of the microphones. As Bob tried a few of the microphones, in some cases changing R1 to match the resistance of the microphone, he noticed that the tone quality of each microphone was different. Some made the ticking of the clock sound deep and boomy, others made it sound light and sharp. Even though the same amplifier and clock were being used, the tone was different.

Bob looked around for the Prof., but could not see where he was.

He picked up the microphone and shouted: "Prof., where are you?"

"Over here came the Prof's reply in a loud, rather strange-sounding voice. Unknown to Bob, the Prof. had taken his microphone and rigged it up with another energiser circuit, amplifier and loudspeaker at the other end of the laboratory. Now they communicated with each other from one end of the lab. to the other, by way of the microphones!

"Why is it," asked Bob, "that each of these microphones has a different tonal sound?"

"This is because of the differences between the sizes of the cavities associated with the microphones due to the different containers you have used," the Prof. replied, "and also there are differences in the diaphragms. I notice that you have "damped" some of the the microphones by the use of sound-absorbing materials such as cotton-wool or felt, and these tend to sound more natural."

While the Prof. was speaking, the Robot came into view, and began to communicate with him in its strange code of clicks and whistles. Bob began to experiment with the controls of the amplifier and a moment later the peaceful atmosphere of the laboratory was shattered by a series of loud crackling noises and ear-splitting shrieks of acoustic feedback!

He quickly turned the amplifier down, and as he did so, he saw the Prof. come running across the laboratory towards him, pursued by the Robot, which was carrying the speaker cabinet which the Prof. had been using with his microphone. On its way, the Robot paused to pick up the speaker used by Bob.

"Quickly, Bob, come with me," said the Prof. as he sped up to Bob's workbench, "Those noises you just made overloaded the Robot's communicator circuits, and I cannot communicate with him! He thinks that those speaker cabinets are our voice-boxes, and is coming to put them in their 'proper' places!"

"What!" exclaimed Bob in horror, "Does the Robot intend to cram those speaker cabinets down our throats?"

He put on an extra spurt of speed as he and the Prof. passed rapidly through the laboratory exit, followed closely by the Robot carrying two wooden cabinets!

Continued next month.

Fig. 7. The complete microphone as constructed by the Prof.

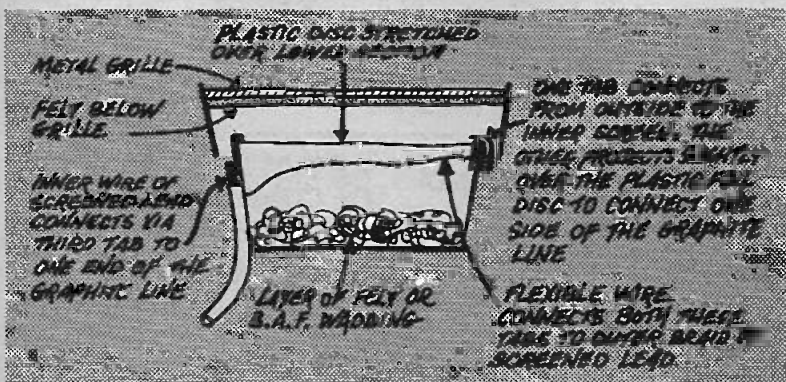

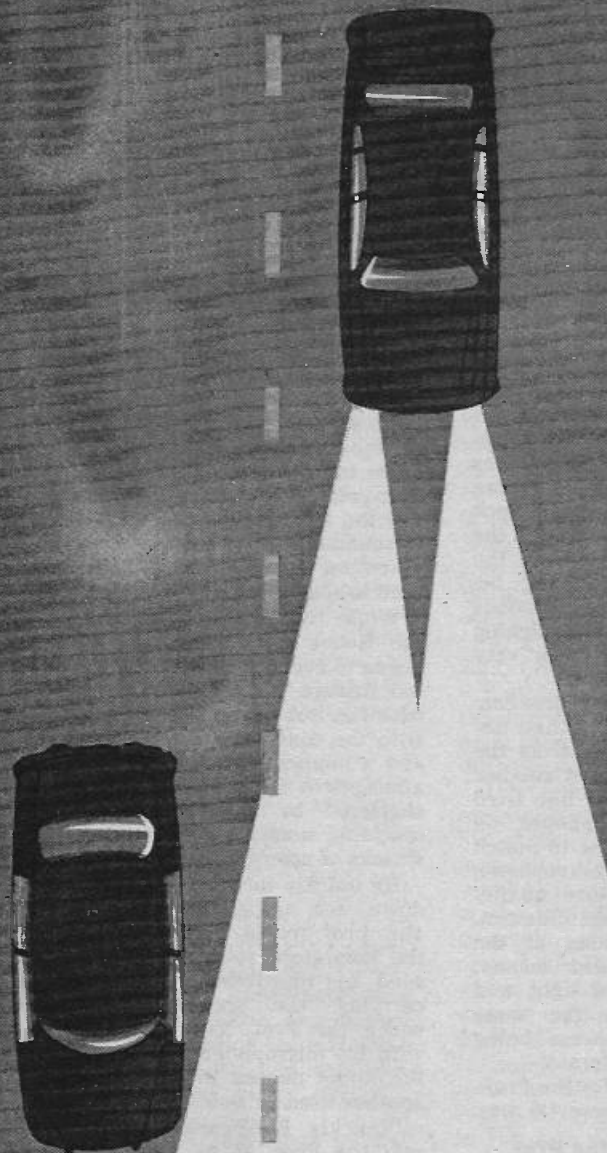

Lighting-up Warning

FOR THE MOTORIST

By DAVID SMITH

Audible warning is sounded as lighting-up time approaches.

EVERY year, motorists find themselves in court being charged with the offence of driving without lights. Even so, such a simple, absentminded mistake can confront the motorist with a heavy fine, even an endorsement. What is required is somebody to keep an eye open for signs of dusk and then to warn the driver to switch on his lights.

This is done for you electronically with the device described here. It's a simple device which produces an audible warning as dusk approaches; this alerts the driver that it's lighting up time and when he switches on his lights he automatically switches off the audible warning.

A built-in refinement stops the device operating under dark bridges etc. The driver may if he wishes delay the device from operating for up to 10 seconds, which would get him well past an average bridge.

CIRCUIT DIAGRAM

The circuit diagram for the Lighting Up Warning is shown in Fig. 1. The heart of the unit is composed of TR1, PCC1, VR1 and R1. For the moment ignore the presence of PCC1, whose ohmic value varies from about 100 ohms to about one megohm in bright and dark conditions respectively.

As the ignition is switched on, with S1 on, current flows through R1 and VR1 charging up capacitor C1. The time taken to charge up C1 is controlled by the setting of VR1. It is seen from Fig. 1 that PCC1 is in parallel with C1 and under "light" conditions the capacitor discharges through this parallel low resistance and TR1 does not turn on. As darkness approaches, the ohmic value of PCC1 rises until ambient conditions (lighting-up time) allow the capacitor to charge up sufficiently to turn on TR1.

Transistors TR2 and TR3 and associated components form a simple astable multivibrator producing an audible frequency that is coupled via transformer T1 to the loudspeaker LS1.

When TR1 is switched on, its collector, and hence the emitters of TR2 and TR3 are at approximately 12 volts.

FOR
GUIDANCE
ONLY

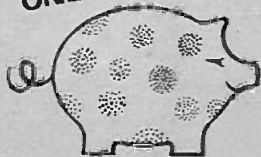

ESTIMATED COST*
OF COMPONENTS
including V.A.T.

£2.70

excluding case

*Based on prices prevailing at
time of going to press

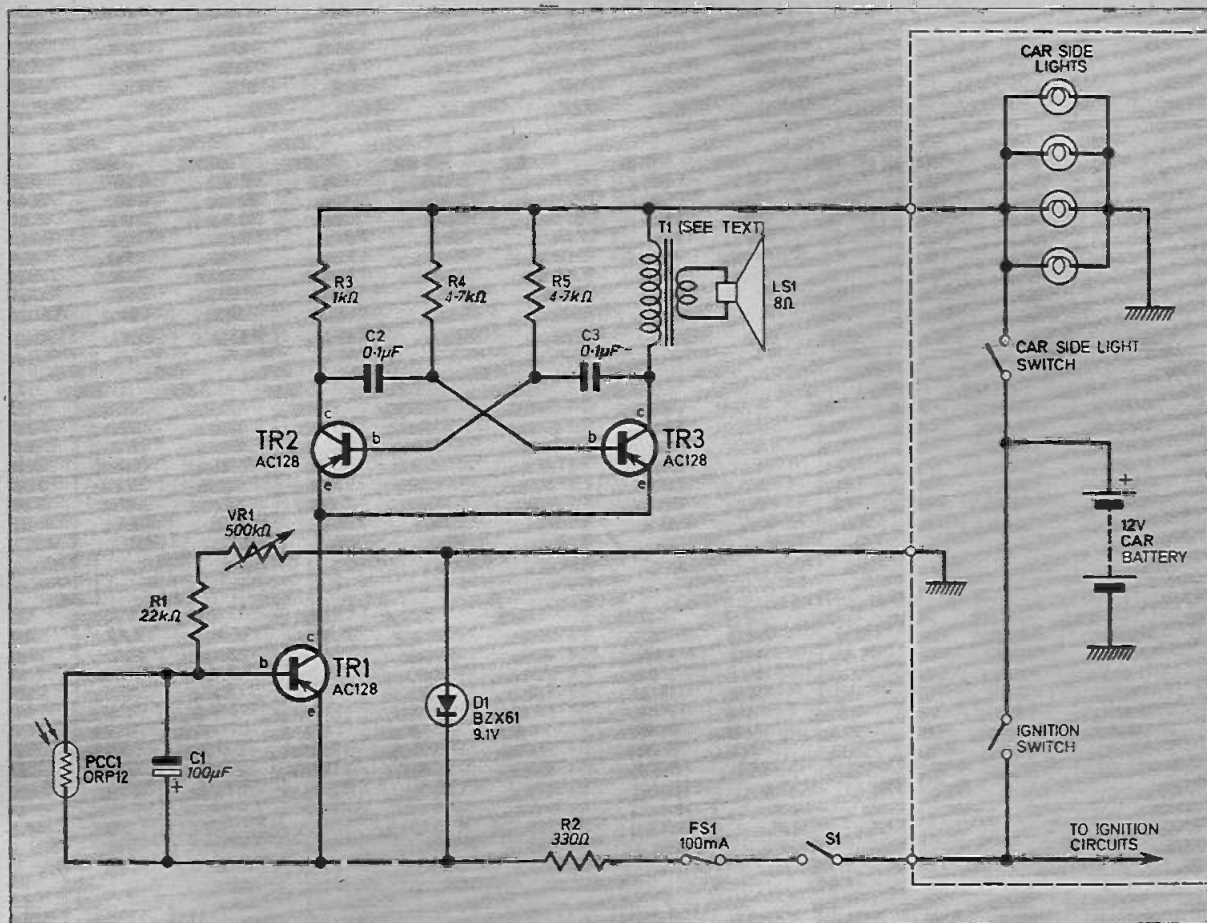

Fig. 1. The circuit diagram of the Lighting-up Warning device showing wiring to car electrical system.

The negative supply rail is derived through the car side lights to chassis while the lights are switched off; when the latter are switched on, a positive voltage is applied to the negative supply rail to the multivibrator of the same magnitude as that on the emitters of TR2 and TR3. Consequently the oscillations cease.

Potentiometer VR1 controls the charging up time of capacitor C1 so that bridges and other obstacles can be negotiated without the audible alarm being triggered.

Resistor R2 and Zener diode D1 provide voltage stabilisation to the circuit. The unit may be switched off at S1 if required; a fuse has been added for safety.

The circuit components shown in Fig. 1. are for negative earth systems only. For positive earth systems, change all the transistors to type AC127 and reverse the polarity of C1 and D1.

CONSTRUCTION

The prototype unit was housed in a commercially available fibreglass case approximate dimensions 130×70×40mm. The front panel

should be removeable and prepared to accommodate the potentiometer VR1, the on/off switch, S1, and the loudspeaker LS1.

In the prototype holes were drilled and brass eyelets inserted where the speaker was to be glued in position with Bostik. This is to enable the speaker to be heard easily and gives a neat appearance.

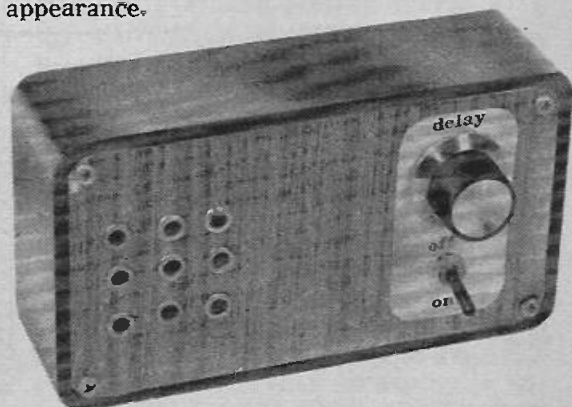

The completed prototype showing details of front panel.

Lighting-up Warning

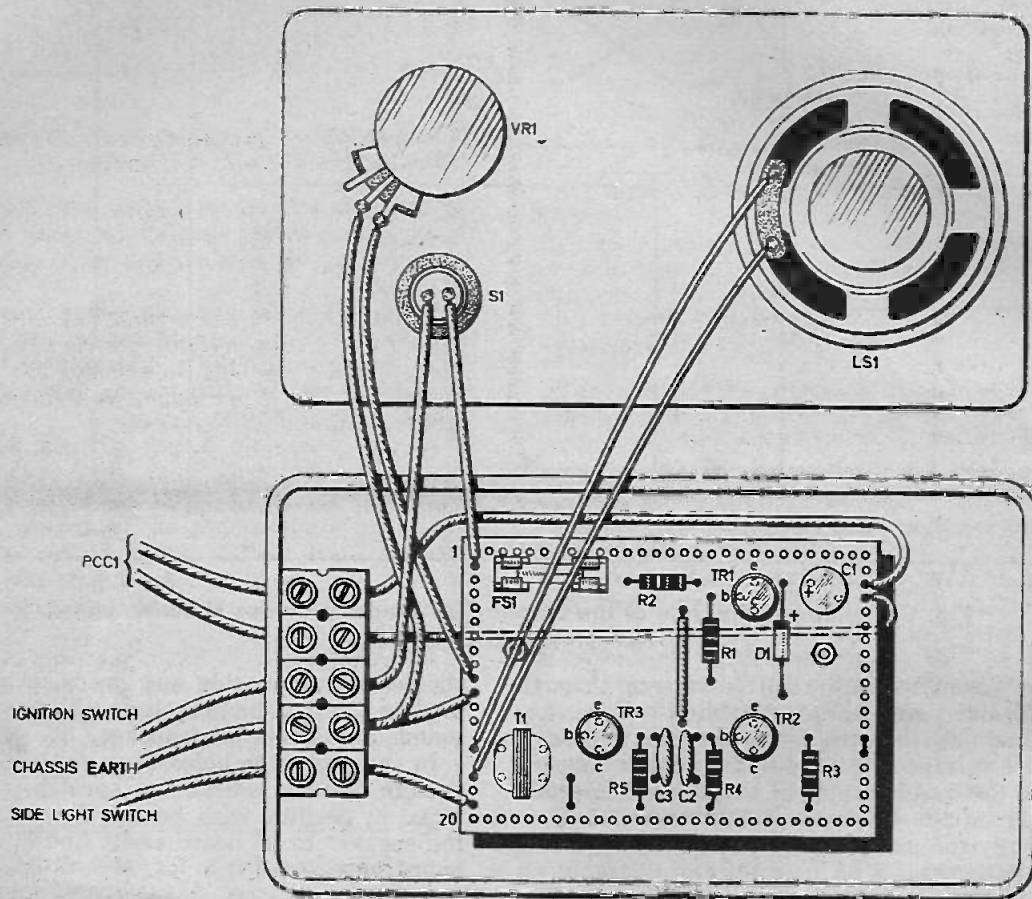
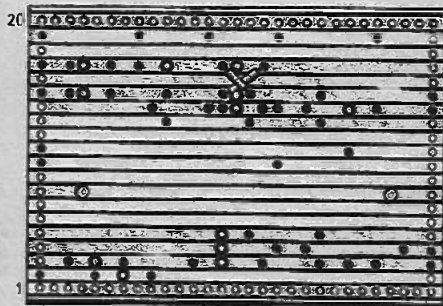

Fig. 2. The layout of the components within the case and full wiring up details. Also shown is layout of components on topside of Veroboard and breaks in copper strips on the underside.



Components....

Resistors

- R1 22k Ω
- R2 330 Ω
- R3 1k Ω
- R4 4.7k Ω
- R5 4.7k Ω
- All $\frac{1}{2}$ watt carbon $\pm 10\%$

SEE
**SHOP
TALK**

Capacitors

- C1 100 μ F 12V elect.
- C2 0.1 μ F
- C3 0.1 μ F

Semiconductors

- TR1 AC128 germanium pnp
 - TR2 AC128 germanium pnp
 - TR3 AC128 germanium pnp
 - D1 BZX61 9.1 volt 400mW Zener diode
 - PCC1 ORP12 light dependent resistor
- } see text

Miscellaneous

- VR1 500k Ω lin. carbon
 - S1 on/off toggle switch
 - FS1 100mA fuse with p.c. type holder
 - T1 miniature transistor radio output transformer
- Veroboard: 0.1in. matrix, size 30 holes by 20 strips; 5-way terminal block; knob; case; brass eyelets; twin flex and wire.

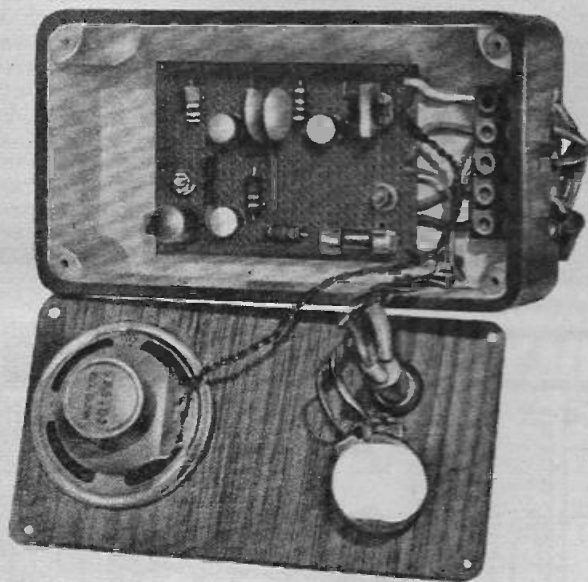

A view of the prototype unit with lid removed.

The remainder of the components are mounted on a piece of 0.1in. matrix Veroboard, the layout and cut-outs to be made are shown in Fig. 2. Make the cut-outs and assemble and solder the components as indicated.

Five holes should now be drilled in the end

Everyday Electronics, February 1975

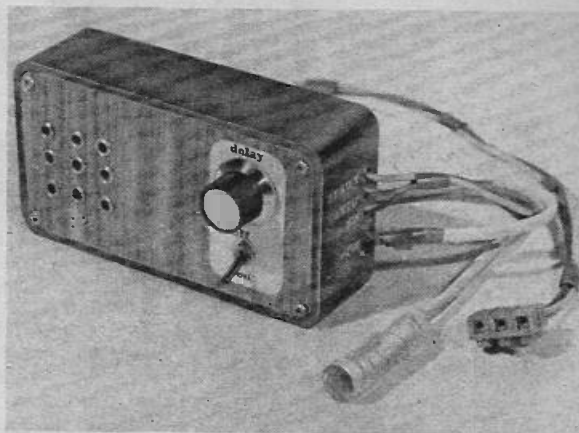

The completed prototype ready for installation showing sensor and connector.

of the case so that they align with the terminal block glued to the base of the case. Wiring up should now be carried out with reference to Fig. 2.

When complete, the component board should be secured to the base of the case by means of some small nuts, bolts and shakeproof washers; next label the front panel as indicated in the photograph and fit the knob.

Solder a suitable length of twin flex to the l.d.r. and wrap the joints and device with a couple of layers of insulating tape. Do not obscure the front window of the device. The l.d.r. can be glued in the corner of the windscreen using a thin smear of clear Bostix over its front face. This was found not to impede the passage of light.

All that remains is to connect the l.d.r. flex to the terminal block in the unit and wire in to the car ignition and side light switch and a good earth point on the chassis. Secure the lid and place the unit in a convenient position within the car. □

PROTECT YOUR HOME WITH THE P.E. ULTRASONIC INTRUDER ALARM

Protect a whole room and its contents with a complete security system using the principle of Doppler Shift to detect moving objects in an ultrasonic field

REMEMBER—PREVENTION IS BETTER THAN CURE
Also

Identify your integrated circuits with the FREE I.C. IDENTICHART with the March Issue. This chart provides types and descriptions of over 400 i.c.s.

PRACTICAL
ELECTRONICS

MARCH ISSUE ON SALE FEBRUARY 14, 1975
ORDER YOUR COPY FROM YOUR NEWS-AGENT—NOW!



Harmonics

I am told that square waves are made up of several sinewaves.

If one makes a multivibrator one generates square waves but where do the sinewaves come from?

This is a terribly difficult question to answer in a short space and in simple terms, however we appreciate your problem and will try to give a simple explanation. We have to refer back to a man named Fourier who proved that any repeating waveform of a cyclic nature could be synthesised by adding together the voltages of individual sinewaves at identical points of time. The stipulation of his theory was that the individual sinewaves had to have a precise harmonic relationship and be of known phase.

Provided the waveform that needed to be synthesised was perfectly cyclic (i.e. after a certain period of time it repeated itself in an identical fashion) then it did not matter what the shape of the wave was within one basic cycle—it could still be generated from a set of sinewaves. By looking at a complex cyclic wave on an oscilloscope one can usually see the period of the basic repeating cycle; this is called the *fundamental frequency*. To generate the complex signal synthetically we would have to start with a sinewave having this fundamental frequency and then it is only necessary to add to it carefully calculated levels of sinewaves that are twice, three times, four times etc., etc., the frequency of the fundamental. These latter signals are all harmonics of the fundamental.

We have mentioned three orders of harmonics in the above list (which is called a *series*) but in actual fact there is no upper limit; however, in practice if one was to try and carry out a genuine synthesis of, say, a musical instrument one only has to consider the first 8 harmonics. The higher order harmonics tend to define the very small detail of the waveform. The magnitude of each harmonic that is added depends on the shape of the final waveform and relative to the fundamental these can range from zero to many times the amplitude of the fundamental. The factor that gives the relative amplitude of each harmonic is called the *coefficient*.

The major problem in synthesising a waveform is knowing what these coefficients, or har-

monic relationships, are. It requires considerably complex mathematics to do what is called Fourier analysis of a wave to work out its components but nevertheless this can be done. For example we now know that a square, or rectangular wave is made up of a fundamental sinewave having identical frequency to the square wave and to this has to be added proportions of the third (times three), fifth (times five), seventh and all further odd harmonics. Even harmonics have zero coefficient and so play no part in a square wave. On the other hand a sawtooth wave contains all the odd and all the even harmonics in controlled proportions.

If one looks at a square wave on an oscilloscope one can cast a critical eye at what we call its rise time (this is the time taken for the leading edge of the wave to get from zero volts to its maximum excursion). The sharpness, or speed, of this risetime is controlled by the higher order harmonic content; if the higher orders are missing the square wave has a curving or slow rise time.

The harmonic content of a square wave is exploited in simple test oscillators in which a multivibrator is made to oscillate at an audio frequency—thus giving out an audio tone for testing amplifiers but the same oscillator can also be used for injecting signals into the radio frequency stages of a radio. In the latter case the radio's tuned circuits are responding to the harmonics of the fundamental audio tone and these must be odd order harmonics.

JACK PLUG & FAMILY...

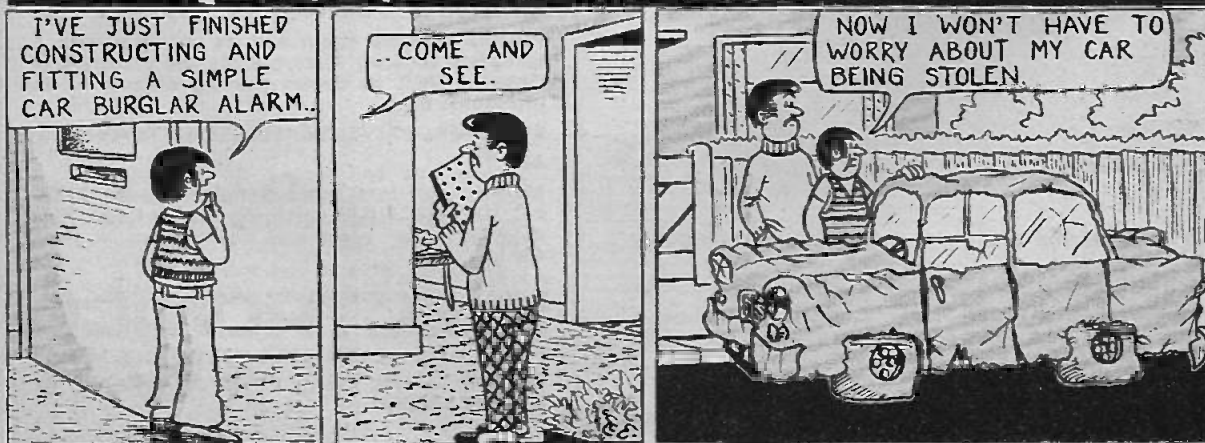



With the Doram catalogue, even the guarantee is guaranteed.

Doram is an entirely new way of buying electronic components.

So, to succeed, it's got to have something going for it, right?

We agree with you. And where Doram scores is in the security it gives the amateur buyer.

We'll give you peace of mind three ways.

No-quibble guarantee.

Firstly, we guarantee to replace any component which arrives faulty. Absolutely free of charge.

And secondly, our guarantee is backed by the biggest electronics distribution Group in Britain.

7-day service.

Thirdly, we guarantee you'll have your components within 7 days from our receipt of your orders.

We're so confident of our service that if we can't supply

the part you want within 7 days we'll give you an immediate refund.

So you'll never get a tedious wait.

You know just where you stand with Doram.

All branded goods.

All goods supplied by Doram are made by big-name manufacturers. And they're all to manufacturer's specifications. They're the best money can buy.

In fact, Doram gives the amateur the sort of service only professionals have enjoyed before.

Millions of components.

All in all, we're big enough to offer you stocks of millions of components, on over 4,000 product lines.

All you do is buy the Doram catalogue for 25p (that's a yearly reference book for the price of a pint of lager) and then take your pick from it.

Use the coupon now. Send today for the first-ever Doram catalogue. It can take a lot of worry out of amateur components buying.

And for 25p that's not bad, is it?

I ENCLOSE 25p* PLEASE SEND ME THE NEW DORAM CATALOGUE.

Name.....

Address.....

Doram Electronics Limited,
PO Box TR8,
Wellington Road Industrial Estate,
Wellington Bridge, Leeds LS12 2UF.

*This will be refunded on orders of £5 (less VAT) or more received by us before March 31st, 1975.

DORAM

EE12/75

PE SCORPIO Mk 2 ignition system kit new from ELECTRO SPARES

- * 6 OR 12 VOLT
- * +VE AND - VE GROUND

Here's the new, improved version of the original Scorpio Electronic Ignition System - with a big plus over all the other kits - the Electro Spares Kit is designed for both positive and negative ground automotive electrical systems. Not just +ve ground. Nor just -ve ground. But both! So if you change cars, you can be almost certain that you can change over your Scorpio Mk. 2 as well.

Containing all the components you need, this Electro Spares Scorpio Mk. 2 Kit is simply built, using our easy-to-follow instructions. Each component is a branded unit by a reputable manufacturer and carries the manufacturer's guarantee. Ready drilled for fast assembly. Quickly fitted to any car or motor cycle.

When your Scorpio Mk. 2 is installed, you instantly benefit from all these Scorpio Mk. 2 advantages:

- ★ Easier starting from cold
- ★ Firing even with wet or oiled-up plugs
- ★ Smoother running at high speed
- ★ Fuel saving
- ★ More power from your engine
- ★ Longer spark plug life
- ★ No more contact-breaker burn.

Electro Spares prices:

De luxe Kit only £11.50 inc. VAT and p & p.
Ready Made Unit £14.75 inc. VAT and p & p.
State 6V or 12V system.

Send SAE now for details and free list.

PE FM VARICAP STEREO TUNER

As featured in the May 1973 issue of 'Practical Electronics'. Superb Hi-Fi tuner Kit now available from Electro Spares. Including cabinet and all components - pre-set Mullard modules for R.F. and I.F. circuits. Motorola I.C. Phase Lock Loop Decoder for perfect stereo reception. No alignment needed. Guaranteed first time results - or send it back, and we'll return it in perfect order (for a nominal handling charge). Electro Spares price only £28.50 inc. VAT and p & p.

PE GEMINI STEREO AMPLIFIER

A superb unit with a guaranteed output of 30 watts RMS per channel into 8 ohms. Full power THD is a mere 0.02%, and frequency response is -3 dB from 20 Hz to 100 kHz into 8 or 15 ohms. Electro Spares have already sold 100s and 100s of these Kits. Get yours now! Depending on your choice of certain components, the price can vary from £50 to £60 inc. VAT and p & p.

- ★ All components as specified by original authors, and sold separately if you wish.
- ★ Full constructional data book with specification graphs, fault finding guides, etc. 55p plus 4p postage.
- ★ Price List only. Please send S.A.E. (preferably 9 x 4 minimum) for full details.

ELECTRO SPARES



The Component Centre of the North
288 ECCLESALL RD., SHEFFIELD S11 8PE(B)
Tel: Sheffield (0742) 668888

TECHNICAL TRAINING

*in radio television
and electronics*

Whether you are a newcomer to radio and electronics, or are already engaged in the industry, ICS can help you. We can further your technical knowledge and provide the specialised training so essential to success, or prepare you for a recognised examination. ICS have helped thousands of ambitious men to move up into higher paid jobs - we can do the same for you. *Take one of these courses.*

CITY & GUILD CERTIFICATES:-
Telecommunications Technicians
Radio, TV and Electronics Technicians
Electrical Installations Technicians
Electrical Installation Work
Technical Communication
Radio Amateur

MPT General Radio Communications Cert.

DIPLOMA COURSES:-
Electronic Engineering, Maintenance
Radio, TV, Audio Engineering and
Servicing (inc. Colour TV)
Electrical Engineering, Installations
Computer Engineering & Programming
New Self-Build Radio Courses

QUALIFY FOR A NEW CAREER

Home study courses for leading professional examinations and diploma courses for business and technical subjects:-

G.C.E. 60 subjects at 'O' and 'A' levels	Accountancy	Engineering	Motor
	Administration	Farming	Personnel
	Advertising	Heating	Purchasing
	Air Conditioning	Industrial	Sales
	Building	Management	Secretarial
	Construction	Marketing	Storekeeping
	Catering	Mechanical	Work Study

POST THIS COUPON TODAY

To: INTERNATIONAL CORRESPONDENCE SCHOOLS

Dept. 231C, Intertext House, LONDON
SW8 4UJ or telephone 01-622 9911

Please send me full details of your courses for:-

(State Subject)

Name

Address

Occupation..... Age.....

Accredited by the Council for the Accreditation of Correspondence Colleges

for your Entertainment...

By Adrian Hope

THE machine that takes over is by now a science fiction cliché; Stanley Kubrick's film "2001" said it all with HAL, the soft spoken computer that developed a mind of its (his) own. Unfortunately, science fiction clichés have a nasty habit of becoming science fact.

Some electronic intrusions into human life are of course very welcome. Self-seeking car radios (which automatically scan the wave bands and tune in only to good strong signals) leave the driver's hands where they should be—on the steering wheel. And it was the much maligned computer that made possible the design of zoom lenses for cameras and projectors which are so cheap that almost every photographer can now afford them.

Likewise computer techniques made the production of cheap plastic Fresnel lenses a possibility. These flat sheets have a myriad of concentric prism rings cut in their surface, the computer-calculated angling of the rings making the disc either a magnifying (positive) lens or a reducing (negative) lens for wide angle viewing.

COMPUTER WRITES OWN PROGRAMME!

But some recent developments are rather disturbing. A few months ago IBM patented a computer which effectively writes its own programme! The dividing line between computers and humans has so far been fairly clear. Whereas we can programme computers to perform tedious tasks which are so time-consuming that they would be impossible or take a lifetime for us to perform, some tasks are so complicated that we cannot programme

a computer to do the job as well as we can.

For instance, computers usually lose at chess because of the programming problems involved. What IBM said in their patent was that although a human can learn to make machine-like decisions, it is difficult to build a machine to make a human-like decision. So the IBM line of approach is now to build a machine which imitates a person who is imitating a machine.

NUMBER PLEASE

If you feel confident that this is all still only theory or science fiction, let me tell you what happened when I tried to phone Washington DC in the USA recently. I was calling a private number in the Georgetown area which for present purposes we will call 338 1234.

Each time I dialled the number I was answered by a female voice which asked "What number are you calling". After putting the question the voice remained silent until I had recited the number. The voice then answered "the number you have called, 338 1234, is a working number. Will you dial 338 1234 again please. This is a recording".

I recorded the voice and a colleague and I are satisfied that although the first query "what number are you calling" may be a human voice, the remaining words are definitely uttered by a machine.

I checked with the London International Exchange and they are only familiar with operator intercepts where the local operator abroad butts in live to say that a number is no longer in service. But "working number" is telephone jargon for a number that is in service so there seems no point

in butting in. And sure enough later that night I did get through to the Georgetown number, thereby proving that it was indeed working.

Anyone with an electronically inquiring mind is likely to get shivers down their spine if they think this one through. The only reasonable conclusion is that the Washington exchange now has equipment which can listen to the voice of a caller and then accurately repeat to him the number that he has asked for (probably by reconstituting the number from a bank of pre-recorded digits). The questions to be answered are not only how, but why, this is being done.

COMPUTER TERMINAL

By coincidence at around the same time, I visited an exhibition where the National Development Programme in Computer Assisted Learning was showing how computers could be used to help teachers in schools. The idea is to use a terminal in the classroom linked by telephone lines to a central computer, perhaps miles away.

The exhibition was just drawing to a close and although the computer was due to close down the terminal was still switched through. Sympathetically the exhibitors allowed a passing child to try his wits against the computer.

"Who are you?" typed the child. "Syntax error in command", flashed up the automatic computer response on the TV display above the keyboard. "Are you Santa Claus?" asked the child. "Syntax error in command" flashed the reply. "And the same to you", typed the child angrily. But of course up came "Syntax error in command" again. "It is my birthday today" typed the child in a last desperate attempt at getting through to the machine.

At this moment an odd thing happened. Presumably the computer operator all those miles down the wire was just about to close the machine down and saw what was coming up on the monitor screen at his end. One can only assume that he quickly sat down at his keyboard and switched the computer off automatic response, for up on the screen to the child's delight came back the message "Happy Birthday to you".

DOWN TO EARTH

By GEORGE HYLTON

"My amplifier is designed for a 5 ohm speaker but I have only speakers of 3 ohms and 8 ohms impedance. Can I use one of these?"

You can almost certainly use the 8 ohm loudspeaker, but the amplifier will not deliver full power. Using the 3 ohm speaker might be dangerous.

First, what is it about an amplifier that determines what is the correct load impedance (the speaker is the load in the present instance)? Not the gain, or the supply voltage, or whether it's valve or transistor, but the design of the output stage in the amplifier and the ratings of the valves or transistors in it—that is, how much power and current they can deliver safely, without overheating, or breaking down, or causing severe distortion.

AUDIO GENERATOR

As far as the load is concerned, the amplifier is just a generator of audio power. It might just as well be some other kind of generator, such as an alternator, if all we want to do is explore the effects of different loads. The entire circuit might then, for this restricted purpose, be simplified to Fig. 1.

Here the amplifier is shown as a voltage generator V_s whose internal resistance is R_s . The load (speaker) is R_L . This circuit is a reasonable equivalent, for our purposes, of a class B amplifier.

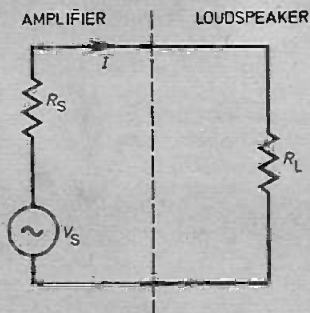

Fig. 1. Equivalent circuit of a class B amplifier.

This crude, oversimplified circuit, plus Ohm's law, tells you that the output current depends on both R_s and R_L .

In practice, of course, you can't reduce R_s because it's inside the amplifier. You can only alter R_L , the external load—the speaker impedance.

It's possible to argue, wrongly, that R_L should be the same as R_s . A well-known theorem of electrical engineering says that if R_L equals R_s you get maximum power. There's nothing wrong with the theorem, but when I tell you that in practical transistor power amplifiers R_s is in the region of one ohm I hope you'll smell a rat. Nobody makes one ohm speakers!

PRACTICAL CASE

What's wrong, then? Simply this: in practical amplifiers, reducing R_L to the same size as R_s causes the output current I to rise far too high for the output transistors. They may be destroyed in the process. So in practice R_L has to be a lot more than R_s . This is no bad thing. It increases the electrical "damping" of the speaker, making it perform better on transients. Less obviously, it increases the efficiency of the circuit.

Look at it this way. If R_L equals R_s , half the power is developed in each resistance. In other words, only half the power reaches the load. The rest is wasted in warming up the output transistors. On the other hand, if R_L is bigger than R_s , a greater proportion of the power is spent in R_L . If R_L equals $9R_s$, only one-tenth of the power is lost in R_s .

It sounds from this as if the original notion that you get maximum output power when R_L equals R_s must be wrong, but it isn't. You see, when R_L is bigger than R_s , the total amount of power is reduced. The increasing

proportion which gets to R_L isn't enough to compensate for the fall in total power.

SPEAKERS

Anyway, you can now see why it's usually safe to use a speaker of higher impedance than specified. The power output is reduced, which is safe from the amplifier's point of view. However the volume may go down.

If both speakers were equally efficient, the one with the correct impedance would produce more volume than the one whose impedance is too high. But in practice speaker efficiencies vary enormously so the reverse of this may be what actually happens.

In any case, so long as the too-high impedance isn't enormously too high, the audible effect shouldn't be all that great. Doubling the impedance reduces the power by less than 3dB, which is a just easily noticeable drop in volume.

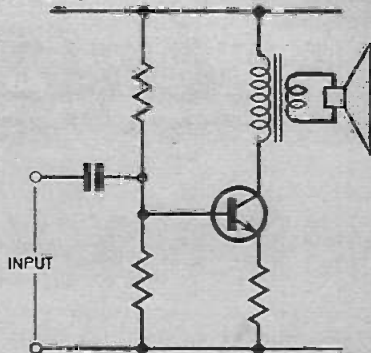

Fig. 2. A transformer driven output stage.

I should now point out that there is one type of amplifier to which the above reasoning does not apply. This is the kind with a very high internal resistance R_s , and is chiefly encountered, these days, as the single-transistor class A output stage of the older types of car radio.

The essential circuit (Fig. 2) shows that the load is driven (via a transformer) by the collector current of the output transistor. Transistor data shows that the impedance, looking back into the collector, is high. The transistor, in effect, pushes a current through the load. This would seem to favour a high load impedance, but a limit is soon reached where the current cannot develop enough voltage across the load. The voltage is limited by the supply.



"I MADE IT MYSELF"

Imagine the thrill you'll feel! Imagine how impressed people will be when they're hearing a programme on a modern radio you made yourself.

Now! Learn the secrets of radio and electronics by building your own modern transistor radio!

Practical lessons teach you sooner than you would dream possible.

What a wonderful way to learn—and pave the way to a new, better-paid career! No dreary ploughing through page after page of dull facts and figures. With this fascinating Technatron Course, you learn by building!

You build a modern Transistor Radio... a Burglar Alarm. You learn Radio and Electronics by doing actual projects you enjoy—making things with your own hands that you'll be proud to own! No wonder it's so fast and easy to learn this way. Because learning becomes a hobby! And what a profitable hobby. Because opportunities in the field of Radio and Electronics are growing faster than they can find people to fill the jobs!

No soldering - yet you learn faster than you ever dreamed possible.

Yes! Faster than you can imagine, you pick up the technical know how you need. Specially prepared step-by-step lessons show you how to read circuits—assemble components—build things—experiment. You enjoy every minute of it! You get everything you need. Tools. Components. Even a versatile Multimeter that we teach you how to use. All included in the course. **AT NO EXTRA CHARGE!** And this is a course anyone can afford. (You can even pay for it by easy instalments).

So fast, so easy, this personalised course will teach you even if you don't know a thing today!

No matter how little you know now, no matter what your background or education, we'll teach you. Step by step, in simple easy-to-understand language, you pick up the secrets of radio and electronics. You become a man who makes things, not just another of the millions, who don't understand. And you could pave the way to a great new career, to add to the thrill and pride you receive when you look at what you have achieved. Within weeks you could hold in your hand your own transistor radio. And after the course you can go on to acquire high-powered technical qualifications, because our famous courses go right up to City & Guilds levels.

Send now for FREE 76 page book - see how easy it is - read what others say!

Find out more now! This is the gateway to a thrilling new career, or a wonderful hobby you'll enjoy for years. Send the coupon now. There's no obligation.

BI-PRE-PAK

INTRODUCE

Sterling Sound Audio Modules



- SS.203 Stereo Decoder **£5.62**
- SS.202 I.F. Stage (Pre-tuned) **£5.25**
- SS.201 Front end (Variable tuned) **£6.25**

Stereo Decoder, ready for connecting to the IF stages of existing FM Radio or Tuner. The very latest 2nd Generation coil-less integrated circuit design, operating on this phase locked loop system, offering even better stereo separation. LED stereo indicator lights available.

SS.103 3W R.M.S. I.C. AMP

- on P.C. Board with all components built and tested **£1.75**
- SS.103-3 Two I.C. stereo version **£3.25**

These amps. are supplied with a free booklet on connecting up, specifications and easy to build projects.

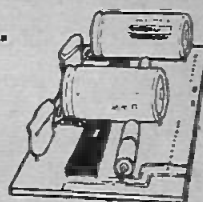

5W & 10W POWER AMPS

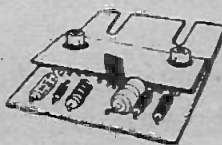

- SS.105 5W **£1.95**
- SS.110 10W **£2.40**

These matchbox size amplifiers have an exceptionally good tone and quality for the price. They are only 2 1/4" x 1 1/4". The 5W amp will run from a 12V car battery making it very suitable for portable voice reinforcement such as public functions. Two amplifiers are ideal for stereo. Complete connection details and treble, bass, volume and balance control circuit diagrams are supplied with each unit. Discounts available for quantity orders.

Other Sterling Sound Modules

Pre-assembled printed circuit boards 2" x 3" available in stereo only, will fit .15 edge connector.
Stereo Pre-Amp SS.101 is for use with crystal or ceramic cartridges. **£1.60**
Stereo Pre-Amp SS.102 for use with low output magnetic cartridges. **£2.25**
Stereo Tone Control SS.10C active tone control board will give bass and treble boost and cut. Pots. extra. **£1.60**
 Instruction leaflet supplied with all units. **VAT at 8%** must be added to total value of order. **Postage and packing—add 15p (U.K. orders)**

POST TODAY FOR FREE BOOK



To: ALDERMASTON COLLEGE DEPT. CEE 01 READING RG7 4PF CEE 01

Yes, I'd like to know more about your course. Please send me free details—plus your big, 76-page book that tells about all your courses.

NAME

ADDRESS

POSTCODE



HOME OF BRITISH INSTITUTE OF ENGINEERING TECHNOLOGY

Everyday Electronics, February 1975

To BI-PRE-PAK LTD., 224 West Road Westcliff-on-sea Essex SS0 9DF.

Please send SS Modules

I enclose £..... Inc. V.A.T.

Name

Address

RECORD PLAYBACK HEADS (TRUVOX)

Individual prices of these are:
 2 track record playback heads 55p each.
 4 track record playback heads 80p each.
 Erase heads are also available separately—
 2 track 40p—4 track 65p.

NEED A SPECIAL SWITCH

Double Leaf Contact. Very airtight pressure closes both contacts. Sp each, 10 for 74p. Plastic pushrod suitable for operating. 7p each, 10 for 63p.

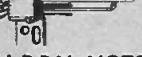

I.R.P.M. MOTOR & GEAR BOX

Made by the famous Chamberlain & Hookham Ltd. These can be made to drive clock or similar. Really robust reliable unit. Price £1.25 each.

AUTO-ELECTRICAL CAR AERIAL

with dashboard control switch—fully extendable to 40ft or fully retractable. Suitable for 12V positive or negative earth. Supplied complete with fitting instructions and ready wired dashboard switch. £6.95 plus 25p post and insurance.



MAINS TRANSISTOR POWER PACK

Designed to operate transistor sets and amplifiers. Adjustable output 6v, 9v, 12 volts for up to 500mA (class B working). Takes the place of any of the following batteries: PP1, PP3, PP4, PP6, PP7, PP9 and others. Kit comprises: mains transformer, rectifier, smoothing and load resistor, condensers and instructions. Real snip at only £1.50.

MINIATURE WAFER SWITCHES

2 pole, 2 way—4 pole, 2 way—3 pole, 3 way—4 pole, 3 way—2 pole, 4 way—3 pole, 4 way—2 pole 6 way—1 pole, 12 way. All at 30p each.



MULTI-SPEED MOTOR.

Six speeds are available 500, 850 and 1,100 r.p.m. and 8,000, 12,000 and 15,000 r.p.m. Shaft is 1/8 in. diameter and approximately 1 in. long. 230/240v. Its speed may be further controlled with the use of our Thyristor controller. Very powerful and useful motor size approx. 2 in. dia. x 5 in. long. Price £1.00 plus 25p postage and insurance.



SLIDE SWITCHES

Slide Switch, 2-pole changeover panel mounting by two 63A screws. Size approx. 1 1/2 x 1/2 in. rated 250V lamp, 10p each. 10 for 90p. Ditto as above but for printed circuit 8p each 10 for 72p. Sub Miniature Slide Switch, DPDT 19mm (1/2 in. approx.) between fixing centres. 20p each or 10 for £1.90. 5P Change over spring return 250V 1 amp. 15p.



ISA ELECTRICAL PROGRAMMER

Learn in your sleep! Have radio playing and kettle boiling as you awake—switch on lights to ward off intruders—have a warm house to come home to. All these and many other things you can do if you invest in an electrical programmer. Clock by famous maker with 15 amp. on/off switch. Switch-on time can be set anywhere to stay on up to 6 hours. Independent 60 minute memory logger. A beautiful unit. Price £2.30 + 20p p. & p. or with glass front, chrome bezel, £1.00 extra.



All these and many other things you can do if you invest in an electrical programmer. Clock by famous maker with 15 amp. on/off switch. Switch-on time can be set anywhere to stay on up to 6 hours. Independent 60 minute memory logger. A beautiful unit. Price £2.30 + 20p p. & p. or with glass front, chrome bezel, £1.00 extra.

BALANCED ARMATURE UNIT

500 ohm, operates as speaker or microphone, so useful in intercom or similar circuits. 37p each.



12 VOLT 1 1/2 AMP. POWER PACK

This comprises double-wound 230/240V mains transformer with full wave rectifier and 2000 mF smoothing. Price £2.50 plus 20p post & packing. Heavy Duty Mains Power Pack. Output voltage adjustable from 15-40V in steps—maximum load 250W—draws its from 6 amp at 40V to 16 amp at 15V. This really is a high power heavy duty unit with dozens of workshop uses. Output voltage adjustment is very quick—simply interchange push on leads. Silicon rectifiers and smoothing by 3,000mF. Price £6.95 plus £1.00 post.

PC BOARD MARKER

Valve action fibre tipped marking pen filled with black etch resist—it's easy with this to make a perfect PC board, just draw straight bit to the copper—allow 15 minutes to dry, then immerse in ferric chloride or other etchant on removal the circuit stands in high relief. 95p.

HONEYWELL PROGRAMMER

This is a drum type timing device, the drum being calibrated in equal divisions for switch setting purposes with trips which are infinitely adjustable for position. They are also arranged to allow 9 operations per switch per rotation. There are 15 changeover micro switches each of 10 amp type operated by the trips thus 15 circuits may be changed per revolution. Drive motor is mains operated 5 revs. per min. Some of the many uses of this timer are Machinery control, Boiler firing, Dispensing and Vending machines. Display lighting animated and signs, Signalling, etc. Price from makers probably over £20 each. Special snip price £7.50 plus 25p post and insurance. Don't miss this terrific bargain.

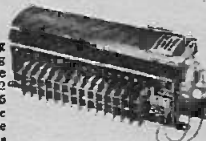

TANGENTIAL HEATER UNIT

This heater unit is the very latest type, most efficient, and quiet running. It is fitted in Hoover and blower beaters. Comprises motor, Impeller, 2kW, element allowing switching 1, 2kW, and with thermal safety cut-out. Can be fitted into any metal line case or cabinet. Only needs control switch, £2.75. Don't miss this. Control Switch, 42p. P. & P. 40p.

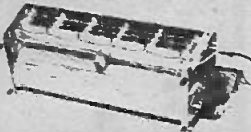

STEREO RADIO CABINET

Long, Low and Modern. Teak veneered with alding front and tapered legs. Speaker spaces each end. Size approx. 4ft. 2in x 15in x 16in. Probably cost over £20 to make. Our Price £8.10 each.

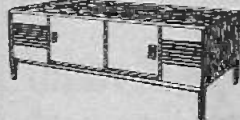

TWENTYLITE

Fluorescent lighting units with polyester chokes and finished white enamel 40 ins. model. Ideal kitchen, bedroom, hallway, porch, lift, etc., with tube. Assembled ready to install. Price £2.20 + 40p p. & p.



THIS MONTH'S SNIP

SOUND TO LIGHT UNIT

Add colour or white light to your amplifier. Will operate 1, 2 or 3 lamps (maximum 45W) Unit in Box all ready to work. £7.95 plus 95p VAT and postage.



HORSTMANN 24-HOUR TIME SWITCH

With 6 position programmer. When fitted to hot water systems this could programme as follows:—

Programme	Hot Water	Central Heating
0	Off	Off
1	Twice Daily	Off
2	All Day	Off
3	Twice Daily	Twice Daily
4	All Day	All Day
5	Continuously	Continuously



Suitable of course, to programme other than central heating and hot water, for instance, programme upstairs and downstairs electric heating or heating and cooling or taped music and radio. In fact there is no limit to the versatility of this Programmer. Mains operated. Size 3in. x 3in. x 2in. deep. Price £4.35 as illustrated but less case.

SHORTWAVE CRYSTAL SET

Although this uses no battery it gives really amazing results. You will receive an amazing assortment of stations over the 19.25.31.39 and 49 metre bands—Kit contains chassis front panel and all the parts. £1.25—crystal carphone 50p.



MULLARD UNILEX STEREO SYSTEM

There is no doubt that it is a good system, we believe that for the money it is without comparison. We demonstrate gladly at our Tamworth Road depot. Prices of the individual items for this:—

1 Unilex Amplifier	Ref. EP.9090	£1.60
1 Unilex Amplifier	Ref. EP.9090	£1.60
1 Unilex Pre-Amp	Ref. EP.9001	£1.88
1 Unilex Power Unit	Ref. EP.9002	£2.53
1 Control panel kit with spun aluminium faced knobs		£3.20

Or the complete outfit—£11.30 post paid. Pair of 15 ohm speakers made by Goodmans are also available if required, price £3.30 the pair. No extra postage if ordered with the above, otherwise add 25p.

SPECIAL PRICES TO COLLEGES AND INSTITUTION ENGINEERING: THIS KIT IN THEIR CURRICULUM

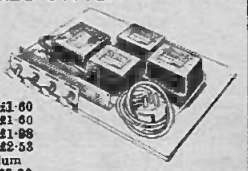

SWITCH TRIGGER MATS

So thin is undetectable under carpet but will switch on with slightest pressure. For burglar alarms, shop doors, etc. 24in x 18in £1.90
 13in x 9in £1.50

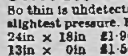

HORSTMANN "TIME AND SET" SWITCH

(A 30 amp switch). Just the thing if you want to come home to a warm house without it costing you a fortune. You can delay the switch on time of your electric fires, etc., up to 14 hours from setting time or you can use the switch to give a boost on period of up to 3 hours. Equally suitable to control processing. Two models 15 amp £2.18, 30 amp £3.35. P. & P. 25p each.



TERMS:—

ADD 8% V.A.T.

Send postage where quoted—other items, post free if order for these items is £6.00, otherwise add 30p.

AM/FM TUNER

Unit made by the American GEC company, 8 transistor, all-transistors ready to work. Complete with tuner condenser, needs only scale and pointer. Tunes AM range 540 to 1620 KHz, FM range 88 to 108 MHz. Switches for on-off and AFC. Output for MXP or direct. Special snip price £5 plus 30p post. Three or more post free.

7 WATT STEREO AMPLIFIER

Again by the American GEC company. This has exceptionally good tone quality. Is complete with pre-amp and treble base, volume and balance controls. Also has mains smoothing circuit and rectifiers so requires only mains transformer. Output for 15 ohm speakers. Inputs for tuner, pick-up, mike, etc. Special snip price £8 plus 30p post. Three or more post free.

COMPLETE SYSTEM

AM/FM and MPX Tuner Decoder and stereo amplifier. Specifications of tuner and amplifier are approximately as given above. This is ready built and tested system complete with scale and pointer, ready to install into suitable cabinet. (Our big stereo cabinet should be added for this.) Limited quantity, £15 each.

AMPLIFIER PANELS



Very nice looking, polished black presspan with fixing holes. 6 phono sockets and changeover slide switch and is printed as sketch. Price is 30p.

BATTERY CHARGERS

Famous Atlas in metal case with meter, output leads terminated by crocodile clips. For 6 or 12 charging simply by changing plug on front panel. Ready built new and still in maker's original packing. Two models: 15 amp £1.99 and 3-4 amp £2.85. Please add 40p postage for one and 75p postage for two.



ONLY
 £1
 FOR
 7

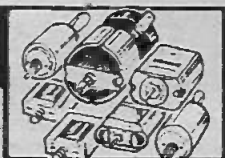

ELECTRIC MOTORS

7 powerful battery motors as used in racing cars and power models. Output and types vary to make them suitable for hundreds of different projects—tools, toys, models, etc. All brand new reversible and for 10 to 12v. Bats., wiring diagrams included. Post and VAT 80p.

FREE Details on how to make miniature power station.

NEW ITEMS THIS MONTH

Car Cassette Power Kit. With a stabilised output of 6v, 9v or 12v. The kit comprises transformer, zener diode, resistors and condensers. Price £2.10. Suitable plastic case 40p extra.

Black Light as used in discotheques and for stage effects, etc. Virtually no white light appears until the rays impinge on luminous paint or white shirts, etc. We offer 12" 9w tubes complete with starter, choke, lamp holders and starter holder. Price £2.75 + 20p post. Tubes only £2 + 50p post. 8 KV Rectifiers. For replacements in colour TVs or for experimenting with really high voltage for doublers and triplers, etc. Famous maker. 45p each. Quantity prices available.

Meters. All Rust mounting with chrome-plated surround. 0-2 amp 40p, 0-3 amp 45p, 0-4 amp 55p, 0-10 amp 85p.

Rectifiers. All 24v full wave (bridge) with cooling fins. 1-2 amp 25p, 3-4 amp 36p, 5-7 amp £1.25. 15 way Screen Cable. Suitable for equipment wiring, multi-way telephone installations, etc. Each core has seven strands copper, PVC insulated and colour coded differently from every other core. These are then laid together encased first by a metal screen and then grey PVC. Price 30p metre or 10 metres £2.60.

Touch Switch. This switch suitable for up to 10 amps mains voltage. Stands up approximately 1" rather like a joy stick and no matter which direction it is pushed, it makes contact. Base size approximately 2 1/2" x 2". Price 25p each.

Light Switch. Automatically switches on lights at dusk and off at dawn. Can also be used where light and dark is a convenient way to stop and start an operation. Requires only a pair of wires to the normal switch. In bakelite box normal switch plate size. 1 amp model: £2.85.

J. BULL (ELECTRICAL) LTD.

(Dept. E.E.), 102/3 TAMWORTH RD., CROYDON CRO IX.

Everyday Electronics, February 1975

look! electronics really mastered

... practical
... visual
... exciting!

no previous knowledge
no unnecessary theory
no "maths"

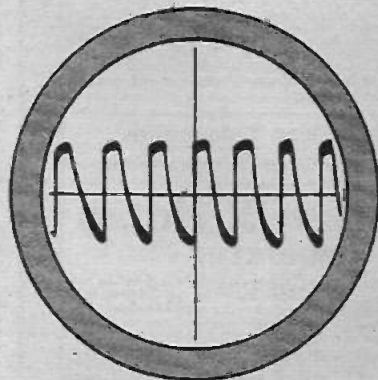

RAPY

BUILD, SEE AND LEARN

step by step, we take you through all the fundamentals of electronics and show how easily the subject can be mastered. Write for the free brochure now which explains our system.

1/ BUILD AN OSCILLOSCOPE

You learn how to build an oscilloscope which remains your property. With it, you will become familiar with all the components used in electronics.

2/ READ, DRAW AND UNDERSTAND CIRCUIT DIAGRAMS

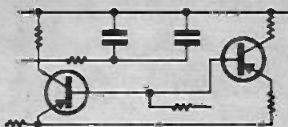

as used currently in the various fields of electronics.

3/ CARRY OUT OVER 40 EXPERIMENTS ON BASIC ELECTRONIC CIRCUITS & SEE HOW THEY WORK, including:

valve experiments, transistor experiments amplifiers, oscillators, signal tracer, photo electric circuit, computer circuit, basic radio receiver, electronic switch, simple transmitter, a.c. experiments, d.c. experiments, simple counter, time delay circuit, servicing procedures.

This new style course will enable anyone to really understand electronics by a modern, practical and visual method—no maths, and a minimum of theory—no previous knowledge required. It will also enable anyone to understand how to test, service and maintain all types of electronic equipment, radio and TV receivers, etc.

FREE POST NOW for BROCHURE

or write if you prefer not to cut page

To: **BRITISH NATIONAL RADIO & ELECTRONICS SCHOOL**, Dept. EEL 25, P.O. Box 156, JERSEY. Please send your free brochure, without obligation, to:

we do not employ representatives

NAME

BLOCK CAPS

ADDRESS

PLEASE

special free gift also to all our students

BI-PRE-PAK

Bargains in Semi-Conductors, Components Modules and Equipment

Electronic Transistor Ignition £6'00

Complete kit p. & p. 11p

Now in kit form, we offer this "up-to-the-minute" electronic ignition system. Simple to make, full instructions supplied with these outstanding features. Transistor and conventional switchability, burglar proof lock-up and automatic alarm, negative and positive compatibility.

Extension Telephones

Ideal for toys 70p each P. & P. 25p.

New X Hatch Generator Mk.2

Essential for alignment of colour guns on all colour T.V. receivers. Featuring plug in IC's and a more sensitive sync, pick-up circuit. The case is virtually unbreakable—ideal for the engineer's toolbox—only measures 3" x 3 1/2" x 3".

Ready built unit only **£9.95** Complete kit **£17.95**

(Includes p. & p. but no batteries)



LM380 AUDIO IC

We have just received a large consignment of LM380 IC's. These are specially selected to a higher grade and are marked with the number SL60745.

This fantastic little 3 watt audio IC only requires two capacitors and two potentiometers to make an amplifier with volume and tone control. The quality is good and has to be heard to be believed.

Our special price **£1.00** ea. complete with data and projects book

Over 1,000,000 Transistors in stock

We hold a very large range of fully marked, tested and guaranteed transistors, power transistors, diodes and rectifiers at very competitive prices. Please send for free catalogue.

Our very popular 4p transistors

TYPE "A" PNP Silicon alloy, TO-5 can
TYPE "B" PNP Silicon, plastic encapsulation
TYPE "E" PNP Germanium AF or RF
TYPE "F" NPN Silicon plastic encapsulation
TYPE "G" NPN silicon similar ZTX 300 range

8 RELAYS various types p & p 27p **£1.00p**

UHF TV Tuner Units

Brand new by a famous

manufacturer Data supplied **£2'50**

B.P.P. CATALOGUE

20 pages packed with bargains. Size 11 1/2" x 8". Send large S.A.E. with 6p stamp.

Plastic Power Transistors

IN TWO RANGES

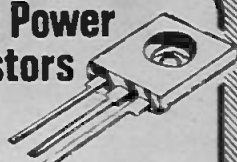

These are 40W and 90W Silicon Plastic Power Transistors of the very latest design, available in NPN or PNP at the most shatteringly low prices of all time. We have been selling these successfully in quantity to all parts of the world and we are proud to offer them under our Tested and Guaranteed terms.

Range 1. VCE. Min 15. HFE Min 15.
1-12 13-25 26-50
40 Watt 20p 18p 18p
90 Watt 24p 22p 20p

Range 2. VCE. Min. 40. HFE Min 40
1-12 13-25 26-50
40 Watt 30p 25p 24p
90 Watt 35p 33p 30p
Please state NPN or PNP on order.

High Speed Magnetic Counters 4 digit (non-reset) 24V or 48V 4 x 1 x 1 in 33p p & p 5p.

INTEGRATED CIRCUITS

We stock a large range of IC's at very competitive prices (from 10p each). These are all listed in our FREE Catalogue, see coupon below.

METRICATION CHARTS now available. This fantastically detailed conversion calculator carries thousands of classified references between metric and British (and U.S.A.) measurements of length, area, volume, liquid measure, weights etc.

Pocket Size 12p Wall Chart 18p

LOW COST DUEL IN LINE IC. SOCKETS
14 pin type at 15p each 1. Now new low profile
16 pin type at 17p each 2 type

BOOKS

We have a large selection of Reference and Technical Books in stock. Dates are in our latest Catalogue. Send for it TODAY, using the coupon below. N.B. Books are void of V.A.T.

Send for lists of publications

Our famous P1 Pak is still leading in value

Full of Short Lead Semiconductors & Electronic Components, approx. 170. We guarantee at least 30 really high quality factory marked Transistors PNP & NPN, and a host of Diodes & Rectifiers mounted on Printed Circuit Panels. Identification Chart supplied to give some information on the Transistors.

Pak P.1. 50p

TERMS OF BUSINESS

V.A.T. Prices shown do not include V.A.T. Please add 8% to total value of your order including postage. No V.A.T. on overseas orders.

POSTAGE Except where stated, add 15p for postage & packing in U.K. Overseas—add £1., any difference being charged or refunded.

PAYMENT Cash with order, Cheque or money order. Minimum value—50p. You can also pay by ACCESS.

IMPORTANT—Every effort is made to ensure accuracy of prices and description at time of preparing this advertisement and going to press. Prices are subject to alteration without notice.

SPECIAL BPP PAKS Tested & Guaranteed



all at **50p** each

B79 4 IN4007 Sil. Rec. diodes. 1,000 PIV 1 amp. plastic

B81 10 Reed Switches, 1" long 1/8" dia. Highspeed P.O. type

H35 100 Mixed Diodes, Germ. Gold bonded, etc. Marked and Unmarked

H38 30 Short lead Transistors. NPN Silicon Planar types

H39 6 Integrated circuits 4 gates BMC 902, 2 flip flops BMC 945

H41 2 BD131/BD132 Complementary Plastic Transistors

H65 4 40361 Type NPN Sil. transistors TO-5 can comp. to H66

H66 4 40362 Type PNP Sil. transistors TO-5 can comp. to H65

Special Bargain Paks (unmarked, untested)



all at **50p** each

B1 50 Germanium Transistors PNP, AF and RF

B66 150 Germanium Diodes Min. glass type

B43 200 Transistors, manufacturers' rejects, AF, RF, Sil. and Germ.

B84 100 Silicon Diodes DO-7 glass equiv. to OA200, OA202

B86 100 Sil. Diodes sub. min. IN 914 and IN 915 types

H29 20 BY126/7 Type Silicon Rectifiers 1 amp. plastic. Mixed volts

H34 15 Power Transistors. PNP, Germ. NPN Silicon TO-3 Can

H67 10 3B19N Channel FET's plastic case type.

Sterling Sound Audio Modules

A new development by BI-PRE-PAK for enthusiasts who like building at keen prices.

SEE OUR SPECIAL AD. PAGE 954

A rev. counter for your car

The "Tacho Block" enables you to turn any 0.1 mA meter into an accurate linear rev. counter. The block is encapsulated and easily fitted into any car with conventional coil ignition. Each **£1.00**

To BI-PRE-PAK 222 West Rd., Westcliff-on-Sea, Essex

Please send latest B.P.P. Catalogue. (I enclose large S.A.E. envelope with 6p stamp.)

Please send

Enclosed £..... inc. V.A.T. cheque/money order (Write on more paper if necessary)

NAME

ADDRESS

BI-PRE-PAK LTD

Co. Reg. No 820919

Dept. D. 222-224 WEST ROAD, WESTCLIFF-ON-SEA, ESSEX.

TELEPHONE: SOUTHEND (0702) 46344.

A
TECHNOLOGICAL
MIRACLE
DEVELOPED
BY U.S. SPACE
SCIENTISTS!

NOW YOU CAN
JUDGE FOR YOURSELF
WHETHER OR NOT THIS

**MAKES VIRTUALLY
EVERY OTHER TYPE OF WATCH
IN THE WORLD OBSOLETE!**

THE GREATEST
HOROLOGICAL
ADVANCE SINCE
THE INVENTION OF
THE CHRONOMETER

THE SYSTEM
EXCELLED
IN ACCURACY
ONLY BY THE
ATOMIC FREQUENCY
STANDARD!



The space-age system

**LIQUID
CRYSTAL
QUARTZ**

WRIST WATCH
WITH CONTINUOUS
'COMPUTER
DIGITAL READ OUT'

OUR WORLD
SHATTERING PRICE ONLY

£57.95

REGISTERED POST PACK ETC. 50p

**SAVE
UP TO £140!**

ELSEWHERE YOU COULD
PAY UP TO £200 OR
MORE FOR THIS INCREDIBLE
NEW SPACE-AGE TYPE
OF WATCH!

FROM WORLD FAMOUS MAKERS! The greatest Watch offer since time began! Everyone who sees it is fascinated by it! It's unbelievable! Continuous digital reading—hours and minutes AND Second Pulsator miraculously transmits before your very eyes like a continuously changing TV Picture! A new "dimension" in time! Now YOU can join the elite few—the proud owners of a watch that is utterly different from any other timepiece you've ever known! **THEY'RE NEWS! THE WATCH OF TOMORROW—TODAY!** And you buy at a price that's just a fraction of what you could have paid! But remember—you can only buy at this amazing price from Shopertunities. **★UNBELIEVABLY ACCURATE TO WITHIN SECONDS A YEAR!** The system excelled in accuracy only by the Atomic frequency standard! Now TIM can phone you for a time check! **★NO MOVING PARTS! ★NO MAINTENANCE! ★ABSOLUTELY SILENT! ★BUILT TO GIVE A LIFETIME OF SERVICE! ★18CT GOLD PLATED CASE! ★BRAND SPANKING NEW ADVANCE 1975 MODEL! WRITTEN GUARANTEE.** Developed from the fantastic "space-age" techniques that first put men on the moon, this incredible watch is based on the natural action of Quartz Crystal, that vibrates approx. 32,768 times per second! A veritable miracle of micro-circuitry! An "electronic brain" with 1500 Transistors! You could even spend £400 or more for a Quartz Crystal watch! OUR fantastic cash price for this masterpiece is **ONLY £57.95**, registered post, pack, etc. 50p ex, including expensive matching adjustable safety bracelet and presentation casket. Send quickly & test for yourself on 7 days' mail order approval from receipt of goods. **REFUND IF NOT DELIGHTED.** Or send only £12.50 deposit, balance by 6 monthly payments of £9.47 (total credit price £69.32 plus post). Please hurry! Limited quantity! **THIS is the greatest investment you'll EVER make!** Or call at either store and see this fabulous watch for yourself! At this price you just can't lose!

Order by post to Uxbridge Road, or call at either store
Callers: ACCESS & BARCLAY CARDS ACCEPTED
Bargains galore at both stores.—COMMERCIAL
TRAVELLERS NOTE: Merchandising office at Holborn.

Send
or
call

SHOPERTUNITIES LTD.

Dept. EE/31, 164 UXBRIDGE ROAD (facing Shepherds Bush Green),
LONDON W12 8AG. (Thurs. 1, Fri. 7). Also at 37/39 HIGH
HOLBORN (opposite Chancery Lane), LONDON, W.C.1 (Thurs.
7 p.m.) BOTH OPEN MON. TO SAT. 9 A.M. TILL 6 P.M.



MULTIMETER Model C-7081
GN Range Doubler 50,000 ohm/
volt High Sensitivity Meter
£14.40.

**TAPE
RECORDER
LEVEL
METER**
500µA, 70p



**CARDIOID
DYNAMIC
MICROPHONE**

Model UD-130. Fre-
quency response 50-
15,000c/s. Impedance
Dual 50K and 600 ohms,
£6.55.



4 1/2 in x 3 1/2 in METER. 30µA,
50µA or 100µA, £3.85

**MULTI-
METER**

Model D62
20,000 ohm/
volt, £7.65



**3 WATT STEREO
AMPLIFIER**
£4.30

All above prices include 8% V.A.T. Please add 10p for P. & P. on
orders under £5. LARGE S.A.E. for List No. 11 Special prices for
quantity quoted on request.

M. DZIUBAS

158 Bradshawgate • Bolton • Lancs. BL2 1BA

ENGINEERS

FREE

**YOURSELF FOR A
BETTER JOB WITH MORE PAY!**

Do you want promotion, a better job,
higher pay? "New Opportunities" shows
you how to get them through a low-cost
home study course. There are no books to
buy and you can pay-as-you-learn.

This helpful guide to success should be
read by every ambitious engineer.
Send for this helpful 76 page FREE book
now. No obligation and nobody will call
on you. It could be the best thing you
ever did.



CUT OUT THIS COUPON
CHOOSE A BRAND NEW FUTURE HERE!
Tick or state subject of interest. Post to the address below.

- | | | |
|--|---|---|
| Electrical Engineering <input type="checkbox"/> | General Radio and TV Engineering <input type="checkbox"/> | CITY AND GUILDS Electrical Technicians <input type="checkbox"/> |
| Electrical Installations and Wiring <input type="checkbox"/> | Radio Servicing, Maintenance and Repairs <input type="checkbox"/> | CITY AND GUILDS Telecommunications <input type="checkbox"/> |
| Electrical Draughtsmanship <input type="checkbox"/> | Transistor Technology <input type="checkbox"/> | Radio Amateurs' Exam. <input type="checkbox"/> |
| Electrical Mathematics <input type="checkbox"/> | CITY AND GUILDS Installations and Wiring <input type="checkbox"/> | etc. etc. <input type="checkbox"/> |
| Electronic Engineering <input type="checkbox"/> | | |
| Computer Programming <input type="checkbox"/> | | |

ALDERMASTON COLLEGE
Dept EEV01 Reading RG7 4PF

EEV 01

NAME (Block Capitals Please)

ADDRESS

POSTCODE

Other subjects _____ Age _____
Accredited by C.A.C.C.

Member of A.B.C.C.

HOME OF BRITISH INSTITUTE OF ENGINEERING TECHNOLOGY

Everyday Electronics Classified Advertisements

RATES: 11p per word (minimum 12 words). Box No. 30p. extra. Semi-display—£7.50 per single column inch. Advertisements must be prepaid and addressed to Classified Advertisement Department, "EVERYDAY ELECTRONICS," I.P.C. Magazines Ltd., Fleetway House, Farringdon Street, London EC4A 4AD.

EDUCATIONAL

C AND G EXAMS

Make sure you succeed with an ICS home study course for C and G Electrical Installation Work & Technicians Radio/TV/Electronics Technicians. Telecomm Technicians and Radio Amateurs.

COLOUR TV SERVICING

Make the most of the current boom! Learn the techniques of servicing Colour and Mono TV sets through new home study courses, approved by leading manufacturers.

TECHNICAL TRAINING

Home study courses in Electronics and Electrical Engineering, Maintenance, Radio, TV, Audio, Computer Engineering and Programming. Also self-build radio kits. Get the qualifications you need to succeed.

Free details from:

INTERNATIONAL CORRESPONDENCE SCHOOLS.

Dept 771, Intertech House, London SW8 4UJ. Or Phone 01-422 9911 (all hours)

HOLIDAY FOR BOYS. 14-16 years, August 1975. Tuition and practical work in electronics, radio production and tape recording, engineering (Karting) and photography. 11 days in Norfolk—£23. Write for free brochure: Inter-School Christian Fellowship, c/o 1 Hubbard Road, London SE27 9PJ.

FOR SALE

MICROPHONES: AKG D109, £12.65; AKG D202E1, £43.45; AKG D190C, £18.70; AKG D190E, £20; AKG D224, £55; Sennheiser MD211N, £49.50; Sennheiser MD413N, £29.70. All brand new and boxed. Send CWO to J. J. Francis (Wood Green) Ltd., Manwood House, Matching Green, Harlow, Essex. Tel: Matching 476.

RECEIVERS AND COMPONENTS

LOWEST COST IC SOCKETS. Use Soldercon IC socket pins for 8 to 40 pin DIL's. 70p for strip of 100 pins, £1.50 for 3 strips of 100, £4 for 1000. 10p p&p for orders under £2. Add 8% VAT. Instructions supplied—send sae for sample. SINTEL, 53c Aston Street, Oxford. Tel: 0865 43203.

3 Ass. M.C. meters £1.15 (40p). Large Computer Panels. 35-50 Transistors, Long Leads 85p (40p). Copper Clad Pax Panels 5" x 5" 6-85p c.p. 7" x 9", 6-£1.30 c.p. Silicon Diodes 450V 1A. 10 on Tagboard 50p c.p. T.V. Convergence Panels 2 x AC128 3 Slugged Coils, 3 Slide Switches, 11 W.W. Pots, 3 Carbon Presets, 2 Ferrite Chokes etc. £1.10 c.p. Valupaks, P9 100 5/16c Caps 47p c.p. send 10p for Lists of others plus Panels etc. Refund on purchase. 7 lbs Assorted Components £2 c.p.

J.W.B. RADIO

2 Barnfield Crescent, Sale, Cheshire M33 1NL. Postage in brackets. Mail Order only

RADIO, TV and other valves. Large stocks 1930 to 1974. Many obsolete types. SAE for quotation. Price List 15p. Also available a large range of Transistor and Still. Cox Radio, The Parade, East Wittering, Sussex. West Wittering 2023.

COMPONENTS GALORE. Pack of 500 mixed components manufacturers surplus plus once used. Pack includes Resistors, carbon and W.W., capacitors various, transistors, diodes, trimmers, potentiometers etc. Send £1+10p p. and p. c.w.o. to CALEDONIAN COMPONENTS, Strathore Road, Thornton, Fife.

TUNBRIDGE WELLS. Components from Ballard's, 105, Camden Road, Tunbridge Wells. Tel: Tunbridge Wells 31803. S.a.e. for all enquiries!

SERVICE SHEETS

SERVICE SHEETS—for over 6,000 models of Television, Radios, Transistors, Stereo, Tape Recorders, Record Players, etc., at only 30p plus S.A.E. with free Fault-Finding Guide. Over 50,000 sheets in stock for 10,000 models. S.A.E. enquiries, Catalogue 20p plus S.A.E. Hamilton Radio, 47 Bohemia Road, St. Leonards, Sussex. Telephone Hastings 428066.

BELL'S TELEVISION SERVICES for Service Sheets, Manuals, Books on Radio's TVs etc. Service Sheets 40p plus S.a.e. Free book lists on request. Back issues of PW, PE, EE, TV available 25p + 7p post. S.a.e. with enquiries—B. T. S. (Mail Order Dept.) 130, Kings Road, Harrogate, Yorks. Telephone (0423) 55885.

MISCELLANEOUS

LED	S dia.	0-125	0-2	D I L SOCKET	
RED		15p	19p	8 pin	
GREEN		27p	33p	12 pin	
YELLOW		27p	33p	14 pin	
				13p	
AC127	15p	2N3055	41p	NES55V	60p
AC128	15p	2N3702	12p	ZN414	£1.10
AF117	20p	2N3704	12p	7400	18p
BC107	10p	TIS43	25p	BHA 0002 15w	7p
BC108	10p	MPF102	40p	IC AMP £2.50	
BC108C	14p	2N3818	25p	IN914	3p
BCY70	15p	2N3823	30p	IN4001	5p
BCY71	22p	OP. AMPS		IN4002	6p
BCY72	12p	709 all	29p	IN4004	7p
BFY80/81	18p	741 B pin	30p	IN4148	4p
OC71	19p	748 D.I.L.	38p	OA47	6p
2N708	10p	7805 Reg. £1.50		OA81	7p
2N2904	18p	Plastic		OA91	5p
2N2906	16p	1.5 Amp		OA95	5p
2N2926(R)	7p	used OC84		OA200	6p
2N2928(R)	12p	10 for 50p		OA202	7p
2N3033	15p				

PRICES INCLUSIVE + 10p P. & P. (1st class)
ISLAND DEVICES, P.O. Box 11, Margate, Kent

SUPERB instrument cases by Bazelli, manufactured from heavy duty P.V.C. faced steel. Hundreds of Radio, Electronic and Hi-Fi enthusiasts are choosing the case they require from our range of over 200 models. Generous trade discount, prompt dispatch. Free literature, Bazelli, Department No. 24, St. Wilfrids, Foundry Lane, Halton, Lancaster, LA2 6LT.

LOUDSPEAKERS

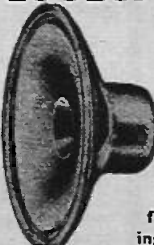

Speakers, kits and cabinets for D.I.Y., Hi Fi, P.A., Disco, etc. by EMI, Fane, etc. by EMI, Fane, Goodmans, Baker, Elac, Richard Allan, Wharfedale, etc. Send stamp for free booklet "Choosing a speaker"

WILMSLOW AUDIO

Dept. H. Swan Works, Bank Square, Wilmslow, Cheshire SK9 1HF. Tel. Wilmslow 29599

AUTUMN BONANZA!

B.B. SUPPLIES offers:

LEVER key switch, 4-pole, lock-off-lock, in black plastic stackable case app. 120mm x 120mm x 25mm. Brand new
PUSH button switching unit, 3 two-pole c/o units, one cancels others, room for one more unit. App. 75mm x 60mm x 35mm. Brand new (wired and numbered) 50p
RELAY, 24 volt, 3800 ohms, 4 c/o contacts, size: 40mm x 33mm x 15mm (wired and covered). Brand new 50p
LAMP fitting, 8 volt—contained in hammar finished, grey steel box on wood plinth. Ideal case for small projects. Size app. 75mm x 75mm x 70mm. Brand new 80p
SPECIAL price until 28.2.75 for all 4 above
 4T Silverplating amples (salvaged) £2.99
 All prices include VAT and p. & p. Man. other Govt. surplus, new and s/band items at bargain prices. S.A.E. for Autumn Catalogue of electronic parts to:
 38 HEATHWOOD GARDENS, SWANLEY KENT BR8 7HN

TRANSISTOR TESTER. Ideal for beginners. Measures gain directly. Can be used to test diodes and unmarked transistors. SAE details. Money-back assurance, £6.50 (P&P 15p). Viking, Oak Lodge, Tansley, Derbyshire.

MULTIMETER
Type U4324
20,000Ω/V, Overload protected, Ranges: 0.6, 1.2, 3, 12, 30, 60, 120, 600, 1200V DC; 3, 6, 15, 60, 150, 300, 600, 900V AC; 0.06, 0.6, 6, 60, 600mA, 3A DC; 0.3, 3, 30, 300mA, 3A AC; 5 resistance ranges to 5MΩ, dBs, -10 to +12. Size 167 x 83 x 63mm. Supplied complete with test leads, clips spare diode and instructions.
 ONLY £10.00.

PC ETCHING KIT
Contains 1lb Ferric chloride, DALO etch-resist pen, 100 sq ins copper clad board, etching dish, abrasive cleaner and instructions. £3.30

FERRIC CHLORIDE
Anhydrous to Mill-spec in double-sealed 1lb packs. 1lb 80p; 3lb £1.65; 10lb £4.40.

VEROBARD
100 sq ins 0.1, 0.15 & 0.2" good-size offcuts (About 8 pieces) £1.10.

TRANSFORMERS
Miniature type, mains primary, 100mA sec. 6.0-8V 85p; 9.0-9V 90p; 12-12V 95p. 16.0-16V with 9V tap @ 11s, £2.

COMPUTER PANELS
3lbs assd £1.40; 7lb £2.99; 56lb £16; 12 high quality panels with trimpois, power transistors, IC's etc. £2.50. Pack of boards with 500 components inc. at least 50 transistors 90p.

GREENWELD ELECTRONICS [EE9]
51 SHIRLEY PARK ROAD, SOUTHAMPTON SO1 4FX
Tel (0703) 772501. Also at 38 Lower Addiscombe Rd, Croydon & 21 Deptford Bay SE2.
ALL PRICES INCLUDE 8% VAT AND UK POSTAGE. SAE LIST, ENQUIRIES, CALLERS WELCOME.

HOME SCIENTISTS

Get the key to a FANTASTIC WORLD of previously UNHEARD-OF PROJECTS. The NEW Boffin catalogue lists DOZENS of HIGHLY UNUSUAL, LOW-COST BARGAINS. READY-BUILT MODULES. Here are just a few examples, there are stocks more!

Dazzling MINI-STROBE (pocket size) £2.90
 PEOPLE DETECTOR £3.20
 Big-Ear SOUND-CATCHER £3.20
 Mini DREAM LABORATORY £3.20
 Don't take our word for it though! GET A COPY & SEE!
 SEND ONLY 20p, and we'll RUSH YOU A COPY (YOU'LL GET THE GOODIES' JUST AS QUICKLY TOO!)
BOFFIN PROJECTS
 4 Cunliffe Road, Stoneleigh, Ewell, Surrey
 (Mail Order U.K. Only)



ONE OF
EUROPE'S
LEADING
ELECTRONIC
KITS

POST FREE MAIL ORDER
S.A.E. FOR CATALOGUE

TELEVIEW

414, CATCOTE ROAD,
HARTLEPOOL,
CLEVELAND.



TREASURE TRACER MK III Metal Locator

- Varicap tuning
- Britain's best selling metal locator kit
- Weighs only 22oz.
- Speaker and earphone operation
- Knocks down to only 17in.
- Prebuilt search coil assembly
- Thoroughly professional finish
- As seen on BBC1 and BBC2 TV
- You only need soldering iron, screwdriver, pliers and snips
- Five-transistor circuit

Send s.a.e. for leaflet

Complete Kit P&P 45p. **£9.80** Built, tested and guaranteed P&P 45p. **£13.75** £1.10 VAT

MINKITS ELECTRONICS,
156 LANGLEY DRIVE, WANSTEAD
LONDON. E11 2LN (Mail order only)

CONSTRUCTION AIDS. Screws, nuts, spacers, etc., in small quantities. Aluminium panels punched to spec. or plain sheet supplied. Fascia panels etched aluminium to individual requirements. Printed circuit boardmasters, negatives and boards, one-off or small numbers. Send 6p for list. **RAMAR CONSTRUCTOR SERVICES**, 29 Shelbourne Road, Stratford-on-Avon, Warks.

FLUORESCENT LIGHT KIT

12 v
8 w

You can build this reverse polarity proof light for use in homes, garages, caravans, for camping, or emergency lighting. Everything is supplied: the tube, white enameled metalwork, first quality components, P.C.B., instructions, etc.

Price only **£3-19**
Ready built **£3-78**
Diffuser only 69p extra

inc. VAT
post &
packing

ALUMINIUM BOXES

Prices include 84, screws, and V.A.T.
Post and packing 10p extra on all orders.

7	3 1/2"	by	3 1/2"	by	1 1/2"	high	28p
8	4"	by	4"	by	1 1/2"	high	30p
9	4 1/2"	by	4 1/2"	by	1 1/2"	high	32p
10	5"	by	5"	by	1 1/2"	high	34p
11	5 1/2"	by	5 1/2"	by	1 1/2"	high	36p
12	6"	by	6"	by	1 1/2"	high	38p
13	6 1/2"	by	6 1/2"	by	1 1/2"	high	40p
14	7"	by	7"	by	1 1/2"	high	42p
15	7 1/2"	by	7 1/2"	by	1 1/2"	high	44p
16	8"	by	8"	by	1 1/2"	high	46p

Order now to—

ELECTRONICS DESIGN ASSOCIATES
DEPT EE,
82 Bath St. Walsall, WS1 3DE. Phone 33652

AERIAL BOOSTERS-£3.38
We make three types of aerial boosters B45-UHF-TV, B12-VHF-TV, B11-VHF-Radio.
VALVES BARGAINS
ANY 5-50p, 10-75p, 50-£3.38.
ECC82, EF80, EF183, EF184, PC189, PCF60, PCF802, PCL32, PCL34, PCL85/80S, PFL200, PL38, PL504, PY800, PY88.
COLOUR TV VALVES-PL508, PL509, PY500-25p each.
Prices include VAT, P&P 10p, SAE—leaflet
Electronic Mail Order Ltd, 62 Bridge Street, Ramsgate, Bury, Lancs. Tel RAMS 3436.

ZETA WINDINGS LTD.

26 All Saints Road,
London W.11

Transformer No. M218
"Delta Guitar Project" **£1.85**

Transformer No. 1069 "P.E. Bench
Power Supply Project" **£3.85**

Transformer No. 1040 "P.E. Power
Inverter Project" **£8.00**

Inductor No. 1028 "P.E. Power
Inverter Project" **£8.30**

Transformer No. 1024 "Modular
3 Stereo Amplifier Project" **£4.75**

All prices include Postage and VAT

We design and manufacture trans-
formers to any specification in
large or small quantities.

4-STATION INTERCOM



£15.05

Solve your communication problems with this 4-Station Transistor Intercom system (1 master and 3 Subs), in robust plastic cabinets for desk or wall mounting. Call/talk/listen from Master to Subs and Subs to Master. Ideally suitable for Business, Surgery, Schools, Hospital, Office and Home. Operates on one 9V battery. On/off switch. Volume control. Complete with 3 connecting wires each 66ft. and other accessories. P. & P. 50p

MAINS INTERCOM NEW MODEL
No batteries—no wires. Just plug in the mains for instant two-way, loud and clear communication. On off switch and volume control. Price **£23.75** per pair P. & P. 40p

INTERCOM BABY ALARM



OUR
PRICE
ONLY
£8.50

Same as 4-Station Intercom for two-way instant communication. Ideal as Baby Alarm and Door Phone. Complete with 66ft. connecting wire and Battery. P. & P. 40p

TELEPHONE AMPLIFIER



£6.45

Why not boost your business efficiency with this incredible Telephone Amplifier. Take down long telephone messages or converse without holding the handset. A useful office aid. On/off switch. Volume Control. Complete with Battery. P. & P. 30p. Full price refunded if not satisfied in 7 days.

WEST LONDON DIRECT SUPPLIES (E/E)
169 KENSINGTON HIGH STREET, LONDON, W.8.

ELECTRONIC-KIT

Electronic fun for all ages

The most versatile electronics kits. All components are beautifully encapsulated in unbreakable transparent plastic blocks. Perfect connections are made WITHOUT SOLDERING, SCREWING OR WIRING

INCREDIBLE VALUE. Build, dismantle and rebuild projects any number of times and invent your own experiments too.

COMPLETELY SAFE. Instructive and FUN—all kits operate from 9v. battery only.

VALUABLE MANUALS included with every kit. No previous knowledge is required, even with the largest kits.

KIT 2A-30 projects £10.45. Radios, amplifiers, alarms, microphones, Morse, etc.
KIT 3A-100 projects £20.45. As 2A plus electronic birds, cats, sirens, organs, metronome, guns, light and sound, burglar alarms, etc.

3ADX-105 projects £25.25. As 3A plus solar cell experiments and complete sophisticated control panel, etc.

4ADX-150 projects £33.95. As 3ADX plus Relay and Meter experiments; ion concentration, volume, out-put, field intensity, volt-, resistance meters, ammeter, illuminometer, etc. and many, many more.

ADD-ON parts and manuals available as required.

The three larger kits include Electrical experiments too.

All prices include Battery, Manual, VAT & p. & p.

Cheque/P.O. (or 6p for literature) to:

Satisfaction guaranteed
ELECTRONIC-KIT LTD, 408 St. John's Street, London, EC1. (01-278 4579)

INSTRUMENTAL AUDIO EFFECTS

SUPER "FUZZ" UNIT KIT. CONNECTS BETWEEN GUITAR & AMPLIFIER. OPERATES FROM 9v BATTERY (not supplied). ALL COMPONENTS AND PRINTED CIRCUIT BOARD WITH FULL INSTRUCTIONS. KIT PRICE: **£3.00** post paid.

CREATE "PHASE" EFFECT ON YOUR RECORDS, TAPES ETC.. UNIQUE CIRCUITRY ENABLES YOU TO CREATE PHASE EFFECT AT THE TURN OF A KNOB. OPERATES FROM 9v BATTERY (not supplied) COMPLETE KIT OF COMPONENTS WITH PRINTED CIRCUIT BOARD & FULL INSTRUCTIONS. KIT PRICE: **£3.00** post paid.

MAIL ORDER ONLY.
S.A.E. ALL ENQUIRIES.
PLEASE ADD V.A.T. TO ALL ORDERS

DABAR ELECTRONIC PRODUCTS

98, LICHFIELD STREET,
WALSALL, STAFFS. WS1 1UZ

Marshall's

Everything you need in our
New Catalogue
available now price 20p
(100 pages of prices and data)

A. Marshall (London) Ltd. Dept. EE
42 Cricklewood Broadway London NW2 3HD Telephone 01-452 0161/2 Telex 21492
& 85 West Regent Street Glasgow G2 2QD Telephone 041-332 4133

Call in and see us 9-5.30 Mon-Fri
9-5.00 Sat
Trade and export enquiries welcome

Popular Semiconductors

2N456	0-75	2N2647	1-12	2N3905	0-24	ACV28	0-20	BC169B	0-13	BD132	0-50	BFY19	0-62	MJ490	0-98
2N456A	0-75	2N2904	0-22	2N3906	0-27	ACV30	0-58	BC169C	0-13	BD135	0-43	BFY20	0-50	MJ491	1-38
2N457A	1-35	2N2904A	0-22	2N4036	0-63	AD142	0-59	BC170	0-11	BD136	0-49	BFY29	0-40	MJE340	0-45
2N490	3-16	0-24	2N4037	0-42	AD143	0-45	BC171	0-11	BD137	0-55	BFY50	0-23	MJE2955	1-12	
2N491	3-58	2N2905	0-24	2N4058	0-16	AD149V	0-06	BC172	0-11	BD138	0-63	BFY51	0-23	MJE3055	0-68
2N492	3-99	2N2905A	0-24	2N4059	0-09	AD150	0-63	BC182	0-12	BD139	0-71	BFY52	0-21	MF611	1-11
2N493	4-20	0-26	2N4060	0-11	AD161	0-45	BC183	0-12	BDY20	1-05	BFY90	0-75	MP8113	0-40	
2N496	0-22	2N2906	0-19	2N4062	0-11	AD161 pr	0-05	BC183L	0-12	BF115	0-25	BRY39	0-48	MPF102	0-30
2N497	0-16	2N2906A	0-21	2N4126	0-20	AD162	1-05	BC184	0-13	BF116	0-23	BU104	2-00	MPSA05	0-25
2N498	0-40	0-22	2N4289	0-84	AF109R	0-40	BC184L	0-13	BF117	0-43	BU105	2-25	MPSA06	0-26	
2N499	0-45	2N2907	0-22	2N4289	0-84	AF115	0-24	BC186	0-23	BF119	0-58	CI06A	0-46	MPSA55	0-26
2N506	0-14	2N2907A	0-24	2N4292	0-99	AF116	0-25	BC187	0-27	BF121	0-25	CI06B	0-58	MPSA56	0-27
2N706A	0-16	2N2974	0-24	2N4292	0-99	AF117	0-26	BC208	0-11	BF123	0-27	CI06D	0-43	NE555V	0-78
2N708	0-17	2N2976	0-24	2N4292	0-84	AF118	0-25	BC208	0-11	BF125	0-25	CI06E	0-43	NE560	4-40
2N709	0-17	2N2976	0-24	2N4292	0-84	AF118	0-25	BC208	0-11	BF125	0-25	CI06E	0-43	NE560	4-40
2N711	0-50	2N3053	0-25	2N4923	0-83	AF124	-0-30	BC212K	0-16	BF152	0-20	CA3020A	1-80	NE565A	4-48
2N718	0-23	2N3054	0-60	2N5172	0-12	AF125	-0-30	BC212L	0-16	BF153	0-21	CA3046	0-70	OC23	1-35
2N718A	0-28	2N3055	0-75	2N5174	0-22	AF127	-0-28	BC214	0-11	BF154	0-16	CA3048	2-11	OC26	0-76
2N720	0-50	2N3390	0-26	2N5175	0-26	AF127	-0-28	BC237	0-13	BF159	0-27	CA3089E	1-96	OC35	0-60
2N721	0-45	2N3391	0-27	2N5176	0-32	AF139	0-39	BC238	0-13	BF160	0-23	CA3090C	1-96	OC42	0-50
2N914	0-32	2N3391A	0-29	2N5190	0-92	AF170	-0-25	BC239	0-13	BF160	0-23	CA3090C	1-96	OC45	0-32
2N916	0-20	2N3392	0-13	2N5191	0-92	AF172	-0-25	BC251	0-20	BF161	0-42	CD4000	0-51	OC71	0-17
2N918	0-32	2N3392	0-13	2N5192	1-24	AF178	-0-55	BC252	0-18	BF163	0-32	CD4001	0-51	OC72	0-25
2N929	0-30	2N3393	0-13	2N5195	1-46	AF179	-0-65	BC253	0-23	BF166	0-32	CD4002	0-51	OC80	0-46
2N1302	0-19	2N3394	0-13	2N5245	0-43	AF180	-0-58	BC257	0-14	BF167	0-24	CD4009	1-07	OC83	0-24
2N1303	0-19	2N3402	0-18	2N5457	0-49	AF186	-0-46	BC258	0-14	BF172	0-29	CD4010	1-07	ORP12	0-85
2N1304	0-24	2N3403	0-19	2N5458	0-43	AF200	-0-35	BC259	0-14	BF177	0-24	CD4011	0-51	R53	1-20
2N1305	0-21	2N3440	0-59	2N5459	0-49	AF239	-0-51	BC261	0-20	BF178	0-35	CD4011	0-51	R53	1-20
2N1306	0-31	2N3441	0-97	40361	-0-48	AF240	0-72	BC262	0-18	BF179	0-43	CD4015	2-66	R154	0-15
2N1307	0-22	2N3442	1-69	40362	-0-50	AF279	0-54	BC263	0-23	BF180	0-35	CD4016	1-02	SC350	1-68
2N1308	0-25	2N3414	1-10	40363	-0-88	AF280	0-54	BC300	0-36	BF181	0-21	CD4020	2-96	SC40D	1-46
2N1309	0-36	2N3415	1-10	40389	-0-46	AL102	0-75	BC301	0-34	BF182	0-40	CD4020	2-96	SC40D	1-46
2N1671	1-44	2N3416	0-15	40394	-0-56	AL103	0-70	BC302	0-29	BF183	0-40	CD4023	0-51	SC41D	1-32
2N1671A	1-54	2N3417	0-21	40395	-0-65	BC107	0-16	BC303	0-54	BF184	0-30	CD4024	1-90	SC45D	1-89
2N1671B	1-72	2N3638A	0-15	40406	-0-44	BC108	0-15	BC307	0-11	BF185	0-30	CD4027	1-56	SC46D	1-96
2N1671C	1-72	2N3638A	0-15	40407	-0-33	CC109	0-19	BC307A	0-10	BF194	0-12	CD4028	2-34	SC50D	2-60
2N1711	0-45	2N3641	0-17	40409	-0-52	BC113	0-15	BC308	0-12	BF195	0-12	CD4029	2-79	SC51D	2-39
2N1907	0-12	2N3702	0-11	40411	-2-25	BC116	0-17	BC308A	0-12	BF196	0-13	CD4041	2-11	SL41-4A	1-80
2N2102	0-50	2N3703	0-12	40414	-3-55	BC117	0-21	BC309	0-10	BF197	0-15	CD4044	2-11	SL41-4A	1-80
2N2147	0-78	2N3704	0-14	40430	-0-85	BC118	0-11	BC309B	0-10	BF199	0-18	CD4047	1-65	TAA263	1-10
2N2148	0-94	2N3705	0-12	40433	-0-23	BC119	0-19	BC309A	0-10	BF199	0-18	CD4049	0-90	TAA350	2-00
2N2160	0-60	2N3706	0-09	40601	-0-67	BC121	-0-23	BC309B	0-10	BF200	0-40	CD4050	0-90	TAA621	2-03
2N2192	0-40	2N3707	0-13	40602	-0-53	BC122	-0-23	BC309B	0-10	BF200	0-40	CD4050	0-90	TAA621	2-03
2N2192A	0-40	2N3708	0-70	40603	-0-53	BC126	-0-23	BC309B	0-10	BF200	0-40	CD4050	0-90	TAA621	2-03
2N2913	0-40	2N3709	0-11	40604	-0-56	BC132	-0-30	BCY30	0-64	BF245	0-58	CD4050	0-90	TAA621	2-03
2N2913A	0-40	2N3710	0-12	40636	-1-10	BC134	-0-13	BCY31	0-64	BF246	0-58	CD4050	0-90	TAA621	2-03
2N2913B	0-40	2N3711	0-11	40669	-1-00	BC135	-0-13	BCY32	0-15	BF247	0-23	BD1C	0-38	TBA800	1-50
2N2913C	0-61	2N3712	0-96	40673	0-70	BC136	-0-17	BCY33	0-45	BF248	0-16	BD1C	0-38	TBA800	1-50
2N2914	0-73	2N3713	1-20	40673	0-70	BC137	-0-17	BCY34	0-49	BF253	0-17	BD1C	0-38	TBA800	1-50
2N2914A	0-30	2N3715	1-50	40673	0-70	BC138	-0-24	BCY38	0-58	BF257	0-46	BD1C	0-38	TBA800	1-50
2N2218A	0-22	2N3716	1-80	40673	0-70	BC140	-0-34	BCY39	1-50	BF258	0-59	BD1C	0-38	TBA800	1-50
2N2219	0-24	2N3717	2-20	40673	0-70	BC141	-0-29	BCY40	0-87	BF259	0-55	BD1C	0-38	TBA800	1-50
2N2219A	0-24	2N3718	2-65	40673	0-70	BC142	-0-23	BCY42	0-80	BF259	0-55	BD1C	0-38	TBA800	1-50
2N2219B	0-26	2N3719	2-65	40673	0-70	BC143	-0-25	BCY58	0-21	BF258	0-55	BD1C	0-38	TBA800	1-50
2N2220	0-25	2N3720	2-65	40673	0-70	BC144	-0-25	BCY59	0-21	BF258	0-55	BD1C	0-38	TBA800	1-50
2N2221	0-18	2N3721	2-35	40673	0-70	BC145	-0-13	BCY70	0-17	BF258	0-55	BD1C	0-38	TBA800	1-50
2N2221A	0-21	2N3722	2-69	40673	0-70	BC149	-0-12	BCY72	0-12	BFX29	0-30	BD1C	0-38	TBA800	1-50
2N2222	0-20	2N3723	2-69	40673	0-70	BC153	-0-18	BCY87	3-54	BFX44	0-23	BD1C	0-38	TBA800	1-50
2N2222A	0-20	2N3724	2-69	40673	0-70	BC154	-0-18	BCY88	2-42	BFX63	0-28	BD1C	0-38	TBA800	1-50
2N2222B	0-25	2N3725	2-69	40673	0-70	BC157	-0-14	BCY89	2-42	BFX63	0-28	BD1C	0-38	TBA800	1-50
2N2368	0-25	2N3900	0-21	ACV178	0-24	BC159	-0-14	BD116	1-00	BFX84	0-24	BD1C	0-38	TBA800	1-50
2N2369	0-41	2N3901	0-32	ACV19	0-27	BD121	-0-15	BD116	1-00	BFX85	0-30	BD1C	0-38	TBA800	1-50
2N2369A	0-41	2N3902	0-24	ACV20	0-22	BD123	-0-32	BD121	-0-15	BFX87	0-28	BD1C	0-38	TBA800	1-50
2N2646	0-55	2N3904	0-27	ACV21	0-26	BD124	-0-67	BD123	-0-32	BFX88	0-25	BD1C	0-38	TBA800	1-50
				ACV21	0-26	BD124	-0-67	BD123	-0-32	BFX88	0-25	BD1C	0-38	TBA800	1-50
				ACV21	0-26	BD124	-0-67	BD123	-0-32	BFX88	0-25	BD1C	0-38	TBA800	1-50

PW TELE TENNIS KIT
As featured on BBC Nationwide and in the Daily Mail 2 Oct '74. Ideal game for whole family. No need to modify your TV set, just plugs in to aerial socket.
Parts list as follows: A Resistor Pack £1-00 p & p 20p; B Potentiometer Pack £1-25 p & p 20p; C Capacitor Pack £3-10 p & p 20p; D Semiconductor Pack £14-50 p & p 20p; E IC Sockets £4-00 p & p 20p; F Transformer £1-15 p & p 25p; G PCB's £7-50 p & p 20p; H Switches £4-50 p & p 20p; I UHF Modular Kit £7-50 p & p 20p.

Special Prices—complete kit excluding case £42-00 p & p 50p. Sections A-F incl. £23-50 p & p 30p. Assembly instructions with complete kit or 75p on request.

P.C. Marker Pen Dalo 33pc Price 87p. Zeners 400V 2W 7V-3V 11p. 1W 3-3V-120V 17p. IC Sockets 8D1L-16p, 14D1L-17p, 16D1L-20p.

Liquid Crystals—£13-00.
Ex stock S.A.E. for details of CMOS battery operated clock kit using LCD's.
Scorpion Car Ignition Kit—£11-50 + VAT IMF 440V £1-30
BSTB0246 £1-05 Transformer £2-75
Minitor £1-55
DL7 07 £2-35 or 4 for £8-00

W	Tol	Price	Tant Beads Value
1/4	5%	1p	1/35 14p
1/2	5%	1-5p	22/35 14p
1	5%	2p	47/35 14p
1	10%	2-5p	2-2/35 14p
2	10%	6p	4-7/35 18p
2 1/2	5%	7p	10/16V 18p
5	5%	9p	47/6-3V 10p
10	5%	10p	100/3V 20p

Veroboard	Copper	Plain
2 1/2 x 3 1/2	1	15
2 1/2 x 5	36p	26p
2 1/2 x 5	40p	40p
3 1/2 x 3 1/2	40p	40p
3 1/2 x 5	45p	47p
3 1/2 x 7	£1-61	£1-26
Pins x 36	24p	24p
x 200	89p	92p

Trade and Retail Supplied

Integrated Circuits TTL (SN 7400 Series)

SN7400	16p	SN7410	16p	SN7
--------	-----	--------	-----	-----

FREE!

Over 150 ways to engineer a better future

HIGHER PAY **A BETTER JOB**

SECURITY

find out how in just 2 minutes

That's how long it will take you to fill in the coupon. Mail it today and we'll send you full details and a free book. We have successfully trained thousands of men at home—equipped them for higher pay and better, more interesting jobs. We can do as much for YOU. A low-cost home study course gets results fast—makes learning easier and something to look forward to. There are no books to buy and you can pay-as-you-learn.

Why not do the thing that really interests you? Without losing a day's pay, you could quietly turn yourself into something of an expert. Complete the coupon (or write if you prefer not to cut the page). No obligation and nobody will call in on you . . . but it could be the best thing you ever did.

Others have done it, so can you

"Yesterday I received a letter from the Institution informing that my application for Associate Membership had been approved. I can honestly say that this has been the best value for money I have ever obtained, a view echoed by two colleagues who recently commenced the course".
Student D.I.B., Yorks.

"Completing your course, meant going from a job I detested to a job that I love, with unlimited prospects"—Student J.A.O. Dublin.

"My training quickly changed my earning capacity and, in the next few years, my earnings increased fourfold". Student C.C.P., Bucks.

FIND OUT FOR YOURSELF

These letters and there are many more on file at Aldermaston College, speak of the rewards that come to the man who has given himself the specialised know-how employers seek. There's no surer way of getting ahead or of opening up new opportunities for yourself. It will cost you a stamp to find out how we can help you. Write to Aldermaston College, Dept. TEE01, Reading RG7 4PF.

ALDERMASTON COLLEGE

Dept. TEE02 Reading RG7 4PF.

HOME OF BRITISH INSTITUTE OF ENGINEERING TECHNOLOGY

Practical Radio & Electronics Certificate course includes a learn while you build **3 transistor radio kit.**

Everything you need to know about **Radio & Electronics** maintenance and repairs for a **spare time income** and a **career** for a better future.



This FREE 76 page book can put you on the road to success through a B.I.E.T. Home Study Course. Choose your subject now!

CUT OUT THIS COUPON

Tick or state subject of interest. Post to address below.

MECHANICAL	DRAUGHTSMANSHIP	Construction
Society of Engineers	Institute of Engineers	Surveyors Institute
A.M.S.E. (Mech)	Designers (A.M.I.E.D.)	L.C.S.I.
Institute of Engineer & Technicians (A.M.I.E.)	General Draughtsmanship	City & Guilds
CITY & GUILDS	Architectural Draughtsmanship	General Building (all branches)
Gen. Mech. Eng.	Technical Drawing	Heating & Vent.
Maintenance Eng.		Inst. Clerk of Works
Welding		Site Surveying
Gen. Diesel Eng.		Health Engineering
Sheet Metal Work		Road Construction
Eng. Inspection		Quantity Surveying
Eng. Metallurgy		Estimates
		Hydraulics
		Structural Eng.
ELECTRICAL & ELECTRONIC	RADIO & TELECOMMUNICATIONS	GENERAL
CITY & GUILDS	City & Guilds	Agricultural Eng.
Gen. Electrical Engineering	Telecoms.	Council of Eng. Institutions
Electrical Installations	Gen. Radio & TV Eng.	Farm Science
Electrical Maths	Radio Amateur Exam	Plastics
Computer Electronics	Radio Servicing	Supplementary courses for Nat. Certificates.
Electronic Eng.		
Practical Radio & Electronics (with kit)	AUTOMOBILE & AERONAUTICAL	
	Institute of the Motor Industry	
MANAGEMENT & PRODUCTION	A.M.I.	
Institute of Cost & Management Accnts.	M.A./I.D.I.	
Computer Programming	City & Guilds	
Works M'nt	Auto Eng.	
Work Study	Gen. Auto Eng.	
Gen. Production Eng.	Motor Mechanics	
Estimating & Planning	Auto Diesel Eng.	
Storekeeping	Garage M'nt	
Management Skills	AEC Aero Engineering Exams	
Quality Control	Gen. Aero Eng.	
	CONSTRUCTIONAL	
	Institute of Building	
	L.I.O.B.	
	A.B.T. Clerk of Works	

G.C.E.
—choose from 58 'O' & 'A' level subjects

Coaching for many exams, including C.A.G.

POST TODAY FOR A BETTER TOMORROW

To Aldermaston College, Dept. TEE02, Reading

NAME.....
Block capitals please
ADDRESS.....
.....
POST CODE.....
OTHER SUBJECTS.....
.....
AGE.....
Accredited by C.A.C.C. Member of A.B.C.C.

Henry's

LARGEST SELECTION OF ELECTRONIC COMPONENTS AND EQUIPMENT. LOW PRICES—MEAN LESS VAT.

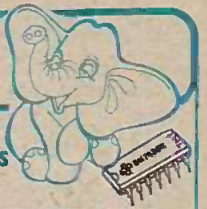

You can build the Texan and Stereo FM Tuner

TEXAN 20 — 20 WATT IC STEREO AMPLIFIERS

Features glass fibre PC board, Gardners low field transformer, 6-IC's, 10-transistors plus diodes, etc. Designed by Texas Instruments engineers for Henry's and, P.W. 1972. Supplied with full chassis work, detailed construction handbook and all necessary parts. Full input and control facilities. Stabilised supply. Overall size 15½" x 2½" x 6½" mains operated. Free teak sleeve with every kit.



£31.00 (GB post paid) (also built and tested £37.50)



STEREO FM TUNER Features capacity diode tuning, lead and tuning meter indicators stabilised power supply—mains operated. High performance and sensitivity with unique station indication IC stereo decoder. Overall size in teak sleeve 8" x 2½" x 6½". Complete kit with teak sleeve **£21.00 (GB post paid)** (also built and tested £24.95)

JOIN THE LARGE BAND OF HAPPY CONSTRUCTORS!

TRANSISTORISED MODULES

Tuners - Power Supplies - Amplifiers

AMPLIFIERS (All single channel unless stated)

Code	Specs	Price
4-300	9 volt 300 mW	1-75
2004	9 volt 250 mW	1-00
104	9 volt 1 watt	3-10
304	9 volt 3 watt	3-95
555	12 volt 3 watt	4-10
555ST	12 volt 1½ + 1½ watt	5-95
E1208	12 volt 5 watt	5-10
608	24 volt 10 watt	4-95
410	28 volt 10 watt	4-95
620	45 volt 30 watt	9-95
Z60	30/35 volt 15 watt	5-45
Z40	45/50 volt 25 watt	6-95
SA8817	24 volt 6 + 6	10-20

Amplifiers with controls

Code	Specs	Price
E1210	12 volt 2½ + 2½ watts 8 ohms	8-25
R500	Mains 5 watts 4-16 ohms	6-30
SAC14	Mains 7 + 7 watts 8 ohms	11-75
SAC30	Mains 15 + 15 watts 8 ohms	14-95
CA038	9 volt 1½ + 1½ watts 8 ohms	6-95
CA068	12 volt 3 + 3 watts 8 ohms	10-50

FM Modules

Code	Specs	Price
Mullard LP 1186 FM tuner (front end) with data 10-7 MHz O/P		4-85
Mullard LP 1185 10-7 MHz IF unit with data		4-50
Gorler Permeability FM tuner (front end) 10-7 MHz O/P		4-20

FM and AM Tuners and Decoders

Code	Specs	Price
FM5231 (to 2) 6 volt FM tuner		7-95
TU3 12 volt version (FM use with Decoder)		7-95
SD4912 Stereo Decoder for Tu 3-12 volt		7-95
SP82H 5 volt stereo FM tuner		4-80
A1067 9 volt MW-AM		11-95
Sinclair 12/45 volt FM tuner stereo recorder for above		7-45
A1018 9 volt FM tuner in cabinet		13-95
A1005M (S) 9-12 volt Stereo decoder FM for above		7-50
106Z 12 volt Stereo decoder general purpose		6-50

Preamplifiers

Code	Specs	Price
Sinclair Stereo 60 Preamplifier		6-75
E1300 Cart/Tape Mic inputs 9 volt		2-85
E1310 Stereo 3-30 mV mal cart 9 volt		4-75
FF3 Stereo 3 mV tape head 9 volt		4-95
3042 Stereo 5-20 mV Map. cart. mains		5-95
EQ25 Mono 3-250 mV Tape/Cart/Play 9 volt		5-95

Power Supplies Mains Input (Chassis-rest cased)

Code	Specs	Price
470C 6 1/2 19V 300 MA with ad'rs		2-25
P500 9 volt 500 MA		3-25
HC244R 3 6/17 19V. 400 MA stabilised		5-50
*P1 24v. 4 amp. 3-30		3-30
*P15 28v. 1 amp		3-30
*PI080 12V 1A 4-70		7-80
*PI081 45V 0-9A		7-80
PI2 4 1/2 12V. 0-4-1 amp		7-15
SE101A 3 1/2 19V. 1 amp stabilised		12-75
PI076 3 1/4 1/2 17 1/2 V. 1 amp		4-20
SE800A 1-15 VOLT 0-1 A stabilised		17-50

EMI SPEAKERS SPECIAL PURCHASE



13 in. x 8 in. chassis speakers (Carr.packing 30 each or 50p)

*150 TC 10 watts £2-20

*450 10 watts 4, 8, 15 ohm with twin tweeters and crossover £3-85 each

EW 15 watt 3 ohms with tweeter £5-25

350 20 watt 8, 15 ohm with tweeter £7-80 each

*Polished wood cabinet £4-30 carr. etc. 35p each or 50p pair.

UHF TV TUNERS

625 line receiver UHF UK operation. Brand new. (Post/packing 25p. each).

TYPE C variable tuning £2-50

TYPE B 4-button push-button (adjustable) £3-50

PA-DISCOTHEQUE LIGHTING EQUIPMENT



Without doubt U.K.'s best range of modular and complete equipment. Lighting, mixing, microphones, accessories, speakers, amplifiers, lenses, etc., etc.

FREE stock lists (Ref. No. 18) on request CALL IN AND SEE FOR YOURSELF at HENRY'S DISCO CENTRE, 309 EDGWARE ROAD, TEL. 01-723 6963

1250-WATT LIGHT DIMMER £3-50 pp 20p

Manufactured by Ultra Ltd. Supplied with plate knob & inst.

DENSHI BOARD KITS

Code	Specs	Price
SR-2A 16 Projects		£7-70
SR-3A 100 Projects		£14-95
SR-45 45 Projects		£10-50
ST-100 100 Projects		£13-20

TURNER KITS

Code	Specs	Price
10 in 1 1/0 Projects		£6-80
50 in 1 50 Projects		£15-45
150 in 1 150 Projects		£23-85

RADIONIC KITS

Code	Specs	Price
X20 20 Projects		£6-20
X40 40 Projects		£13-85
X40A ADD-ON		£11-35

TEST EQUIPMENT MULTIMETERS

Code	Specs	Price
Carr/packing 35p		
J4324 20kΩ/V		10-50
with case 9-25		
J43520kΩ/V with steel case 8-75		
J431320kΩ/V with steel case 12-50		
J4317 20kΩ/V with case 16-50		
J4341 33kΩ/V plus transistor steel case		10-50
A4323 20kΩ/V plus 1kHz OSC with case		7-70
ITT 2 20kΩ/V slim type		5-95
TR435D (L3SDX) 2kΩ/V		7-50
Robust		8-25
TP10S 2kΩ/V		6-25
TW20S 20kΩ/V		10-00
TW50K 50kΩ/V		11-25
EPT0KM 10kΩ/V		5-95
W195 50kΩ/V Deluxe (case £1-90)		12-50
S100TR 100kΩ/V plus transistor tester		22-50



INTEGRATED CIRCUITS 74 SERIES & LINEAR

EXTRA DISCOUNTS Semiconductor—Any one type or mixed SN74 Series 'IC' 12—extra 10%; 25—extra 15%; 100—extra 20%.

Code	Price	Code	Price	Code	Price
SN7400N	0-16	SN7485N	1-63	SN74191N	2-00
SN7401N	0-16	SN7486N	1-47	SN74192N	2-00
SN7402N	0-16	SN7489N	3-87	SN74193N	2-00
SN7403N	0-16	SN7490N	0-70	SN74194N	1-10
SN7404N	0-16	SN7491A N	1-00	SN74195N	1-10
SN7405N	0-16	SN7492N	0-70	SN74196N	1-10
SN7406N	0-42	SN7493N	0-70	SN74197N	1-10
SN7407N	0-42	SN7494N	0-90	SN74198N	2-70
SN7408N	0-28	SN7495N	0-90	SN74199N	2-32
SN7409N	0-28	SN7496N	0-95	RCA	
SN7410N	0-16	SN7497N	3-87	CA3012	1-32
SN7411N	0-25	SN74100N	1-89	CA3014	1-80
SN7412N	0-30	SN74104N	0-58	CA3018	1-82
SN7413N	0-36	SN74105N	0-53	CA3019	1-12
SN7414N	0-72	SN74107N	0-45	CA3020	1-80
SN7416N	0-36	SN74110N	0-58	CA3022	1-93
SN7417N	0-36	SN74111N	0-88	CA3028A	1-03
SN7420N	0-16	SN74116N	1-89	CA3036	1-08
SN7421N	0-33	SN74118N	0-90	CA3046	1-03
SN7422N	0-25	SN74119N	1-66	CA3048	2-76
SN7423N	0-37	SN74120N	0-55	CA3049	1-03
SN7425N	0-37	SN74121N	0-50	CA3081	1-80
SN7426N	0-32	SN74122N	0-70	CA3089E	2-94
SN7427N	0-37	SN74123N	1-00	CA30900	5-40
SN7428N	0-40	SN77125N	0-85	Signetics	
SN7430N	0-16	SN74132N	0-72	NE555	0-85
SN7431N	0-37	SN74141N	1-90	LS560B	5-00
SN7433N	0-37	SN74145N	1-26	NE561B	5-00
SN7437N	0-37	SN74150N	1-75	NE562B	5-00
SN7438N	0-37	SN74151N	1-00	NE567B	3-50
SN7440N	0-22	SN74153N	0-95	Motrola	
SN7441A N	0-92	SN74154N	2-00	MC1303L	1-42
SN7442N	0-79	SN74160N	1-00	MC1304P	1-79
SN7443N	1-27	SN74156N	1-00	MC1310P	2-91
SN7444N	1-27	SN74157N	0-95	MC1458CF	0-77
SN7445N	1-60	SN74160N	1-38	MC1710CC	0-80
SN7446N	1-39	SN74161N	1-38	MFC4000P	0-45
SN7447A N	1-60	SN74162N	1-38	MFC4010P	0-55
SN7448N	1-27	SN74163N	1-38	MFC5040P	1-00
SN7450N	1-16	SN74164N	1-76	Others	
SN7451N	0-16	SN74165N	1-76	TBA800	1-50
SN7453N	0-16	SN74166N	1-60	SN76003N	1-50
SN7454N	0-16	SN74167N	3-00	SN74274P	0-60
SN7456N	0-16	SN74170N	2-52	SN72748P	0-81
SN7457N	0-36	SN74171N	3-95	74BC0	0-61
SN7472N	0-38	SN74174N	1-57	709C	0-39
SN7473N	0-41	SN74175N	1-10	723C	0-90
SN7474N	0-42	SN74176N	1-26	728C	0-45
SN7475N	0-59	SN74177N	1-26	741C	0-50
SN7476N	0-45	SN74180N	1-26	747C	1-00
SN7478N	0-50	SN74181N	1-26	748C	1-00
SN74781N	1-10	SN74182N	1-26	LM309K	2-00
SN7482N	0-87	SN74184N	1-80	TAA980	1-75
SN7483N	1-10	SN74185N	1-80	Sinclair IC12,	
SN7484N	1-00	SN74190N	2-00	6w amp	2-20

Cosmos Integrated Circuits. Full Range in Stock

Code	Price	Code	Price	Code	Price
AAZ13	0-12	BLY36	6-00	TIP42A	0-90
AC107	0-51	BSX20	0-13	TIS43	0-23
AC128	0-15	BU105	2-20	V405A	0-22
AC187	0-21	BY100	0-27	ZTX108	0-08
ACY17	0-40	BY127	0-12	ZTX300	0-13
ACY39	0-78	BYZ13	0-42	ZTX302	0-18
AD149	0-90	CD4000	0-50	ZX500	0-13
AD161	0-44	GET111	0-72	2N697	0-16
AD162	0-44	GET115	0-90	2N706	0-12
AF117	0-24	GET880	0-60	2N930	0-18
AF118	0-57	LM309K	2-00	2N987	0-42
AF139	0-41	MAT121	0-25	2N1132	0-24
AF196	0-48	MC1304	1-80	2N1304	0-28
AF239	0-44	MJES20	0-63	2N1613	0-21
ASV27	0-33	MJES3055	1-77	2N1617	0-20
BA115	0-10	MJES2855	0-27	2N2147	0-78
BAX13	0-05	MPF105	0-36	2N2160	0-78
BC107	0-14	NKT404	0-66	2N2926	0-12
BC108	0-13	OA5	0-72	2N3553	0-18
BC109	0-14	OA31	0-18	2N3054	0-48
BC109C	0-16	OA200	0-08	2N3055	0-45
BC113	0-15	OA202	0-06	2N3440	0-58
BC147	0-10	OC28	0-66	2N3442	1-39
BC148	0-08	OC35	0-55	2N3525	0-91
BC169	0-15	OC36	0-63	2N3614	0-65
BC182	0-12	OC45	0-20	2N3702	0-11
BCY32	0-85	OC71	0-18	2N3771	1-77
BCY39	1-50	OC72	0-28	2N3773	2-40
BCY35	2-84	OC77	0-54	2N3790	2-10
BCV70	3-01	OC81	0-29	2N3819	0-38
BCV71	0-22	OC83	0-27	2N3836	0-72
BCV72	0-12	OC84	0-14	2N3903	0-15
BD124	0-65	OC170	0-30	2N4002	0-14
BD131	0-42	OC200	0-54	2N4126	0-15
BF115	0-20	OC202	0-90	2N4871	0-34
BF180	0-36	OCPT1	1-20	2N5457	0-30
BF194	0-36	OP12	0-90	2N5530	0