

electronics today international

JANUARY 1975

25p

**TWO
OFFERS
INSIDE**

**SURVEY OF
ELECTRONIC
KITS**



BUILD THE ETI

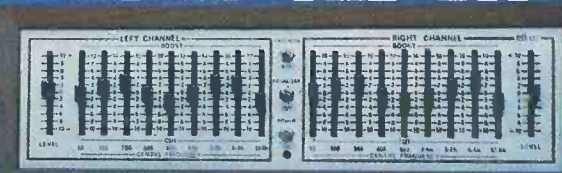

GRAPHIC EQUALISER

**MATRIX TV
RADIO ASTRONOMY
MOTOR SPEED CONTROL
RUMBLE FILTER PROJECT
YAMAHA AMP REVIEW**

HI-FI... CONSTRUCTION... COMMUNICATIONS... DEVELOPMENTS

FREE!

Over 150 ways to engineer a better future

HIGHER PAY **A BETTER JOB**

SECURITY

find out how in just 2 minutes

That's how long it will take you to fill in the coupon. Mail it today and we'll send you full details and a free book. We have successfully trained thousands of men at home - equipped them for higher pay and better, more interesting jobs. We can do as much for YOU. A low-cost home study course gets results fast - makes learning easier and something to look forward to. There are no books to buy and you can pay-as-you-learn.

Why not do the thing that really interests you? Without losing a day's pay, you could quietly turn yourself into something of an expert. Complete the coupon (or write if you prefer not to cut the page). No obligation and nobody will call on you . . . but it could be the best thing you ever did.

Others have done it, so can you

"Yesterday I received a letter from the institution informing that my application for Associate Membership had been approved. I can honestly say that this has been the best value for money I have ever obtained, a view echoed by two colleagues who recently commenced the course". — Student D.I.B., Yorks.

"Completing your course, meant going from a job I detested to a job that I love, with unlimited prospects". — Student J.A.O. Dublin.

"My training quickly changed my earning capacity and, in the next few years, my earnings increased fourfold". — Student C.C.P., Bucks.

FIND OUT FOR YOURSELF

These letters, and there are many more on file at Aldermaston College, speak of the rewards that come to the man who has given himself the specialised know-how employers seek. There's no surer way of getting ahead or of opening up new opportunities for yourself. It will cost you a stamp to find out how we can help you. Write to Aldermaston College, Dept. BE180, Reading RG7 4PF, Home of B.I.E.T.

Practical Radio & Electronics Certificate course includes a learn while you build **3 transistor radio kit.**

Everything you need to know about **Radio & Electronics** maintenance and repairs for a **spare time income** and a **career** for a better future.

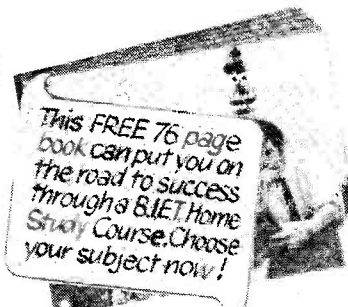

CUT OUT THIS COUPON

Tick or state subject of interest. Post to address below.

MECHANICAL Society of Engineers- A.M.S.E. (Mech) Institute of Engineer & Technicians (A.M.I.E.) CITY & GUILDS Gen Mech. Eng. Maintenance Eng. Welding Gen. Diesel Eng. Sheet Metal Work Eng. Inspection Eng. Metallurgy	Man. Prod.—cont. Storekeeping Management <input type="checkbox"/> Skills Quality Control <input type="checkbox"/> DRAUGHTSMANSHIP <input type="checkbox"/> Institute of <input type="checkbox"/> Engineering <input type="checkbox"/> Designers <input type="checkbox"/> (A.M.I.E.D.) <input type="checkbox"/> General <input type="checkbox"/> Draughtsmanship <input type="checkbox"/> Elec. Draughtsmanship Architectural Draughtsmanship Technical Drawing	<input type="checkbox"/> Motor Mechanics <input type="checkbox"/> Auto Diesel Eng. <input type="checkbox"/> Garage M'nt. <input type="checkbox"/> AEC Aero Eng. <input type="checkbox"/> Ineering Exams Gen. Aero Eng.
ELECTRICAL & ELECTRONIC CITY & GUILDS Gen. Electrical Engineering Electrical Installations Electrical Maths Computer Electronics Electronic Eng. Practical Radio & Electronics (with kit)	<input type="checkbox"/> RADIO & TELE-COMMUNICATIONS <input type="checkbox"/> CITY & GUILDS <input type="checkbox"/> Telecoms. Gen. Radio & TV Eng. <input type="checkbox"/> Radio Amateur Exam Radio Servicing	CONSTRUCTIONAL Institute of Building L.I.O.B. A.B.T. Clerk of Works Construction Surveyors Institute L.C.S.I. <input type="checkbox"/> CITY & GUILDS General Building (all branches) <input type="checkbox"/> Heating & Vent. <input type="checkbox"/> Inst. Clerk of Works Site Surveying Health Engineering Road Construction Quantities Estimates Hydraulics <input type="checkbox"/> Structural Eng.
MANAGEMENT & PRODUCTION Institute of Cost & management Accnts. Computer Programming Works M'nt. Work Study Gen. Production Eng. Estimating & Planning	<input type="checkbox"/> AUTOMOBILE & AERONAUTICAL <input type="checkbox"/> Institute of the <input type="checkbox"/> Motor Industry <input type="checkbox"/> A.M.I.I. <input type="checkbox"/> MAA/IMI <input type="checkbox"/> CITY & GUILDS <input type="checkbox"/> Auto Eng. <input type="checkbox"/> Gen. Auto Eng.	GENERAL <input type="checkbox"/> Agricultural Eng. <input type="checkbox"/> Council of Eng. Institutions Farm Science Plastics

Coaching for many major exams. including O.N.C., C & G, etc.

G.C.E.

58 'O' & 'A' LEVELS SUBJECTS Over 10,000 group passes

POST TODAY FOR A BETTER TOMORROW

To Aldermaston College, Dept. BE180, Reading RG7 4PF. QN BE180

NAME.....
Block Capitals Please
ADDRESS.....

OTHER SUBJECTS..... AGE.....

Accredited by C.A.C.C. Member of A.B.C.C.

BRITISH INSTITUTE OF ENGINEERING TECHNOLOGY

electronics today international

JANUARY 1975

Vol. 4, No. 1.

main features

MATRIX TV	10
<i>Solid-state picture transmission is progressing</i>	
RADIO ASTRONOMY	18
<i>Where do extra-terrestrial signals come from?</i>	
SURVEY OF ELECTRONIC KITS	35
<i>A directory of kits available to the amateur</i>	
ELECTRONIC SPEED CONTROL FOR MOTORS	48
<i>Circuits to control different types of motor</i>	
ELECTRONICS - IT'S EASY	60
<i>Designing amplifier stages</i>	

projects

GRAPHIC ROOM EQUALISER	23
<i>Control the frequency response of your stereo system at nine octave points</i>	
RUMBLE FILTER	52
<i>24dB/octave filter gets rid of sub-audible signals and improves hi-fi sound.</i>	

product tests

YAMAHA CA800 AMPLIFIER	44
<i>An amp that can be switched to either Class A or Class B</i>	

news & information

NEWS DIGEST	6
PREVIEW OF FEBRUARY'S ETI	32
ELECTRONICS TOMORROW	64
TECH-TIPS	66
DX MONITOR	69

ETI READER OFFERS	31
<i>15 BC108 transistors for £1.00</i>	
<i>36 Electrolytics for £2.50</i>	

Cover: A selection of kits available on the U.K. market — details of these and many more in our Kits Survey starting on page 35.

EDITORIAL & ADVERTISEMENT OFFICE
36, Ebury Street, London SW1W 0LW.
Tel. 01-730 8282.

HALVOR W. MOORSHEAD

Editor

ROBERT C. EVANS

Advertisement Manager

STEVE BRAIDWOOD

Assistant Editor

JEAN BELL

Production

HELEN COHEN

Administration

International Editions

COLLYN RIVERS

Editorial Director

Australia

BRIAN CHAPMAN

Technical Editor

BARRY WILKINSON

Engineering Manager

France

DENIS JACOB

Editor-in-chief

CHRISTIAN DARTEVELLE

Editor

Published by: Modern Magazines (Holdings) Ltd
36, Ebury Street, London SW1W 0LW.

Electronics Today International is published on the third Friday in the month prior to the cover date.

Distributed by: Argus Distribution Ltd.

Printed by: Alabaster Passmore & Sons Ltd.
London and Maidstone.

International Associates:

Australia: Modern Magazines (Holdings) Ltd,
Ryrie House, 15 Boundary Street, Rushcutters
Bay 2011, Sydney, Australia.

France: Electroniques Pour Vous International,
17 Rue de Buci, Paris, France.

USA: ACP, Room 401, 150,1 Broadway, New
York, USA.

European News Bureau: H. Dvoretzky, Manager,
107 Fleet Street, London EC4.

CORRESPONDENCE: Readers queries can only be answered if they relate to recent articles published in the magazine and must be accompanied by a stamped, self-addressed envelope. We are rarely able to provide information in addition to that published. Answers may be subject to delays at certain times due to the production schedule of the magazine.

BACK NUMBERS: Back numbers of many issues are available for 30p each plus 10p postage.

SUBSCRIPTIONS: Great Britain, £3.60 per year, Overseas, £4.00 per year.

COPYRIGHT: All material is subject to World-wide Copyright protection. All reasonable care is taken in the preparation of the magazine to ensure accuracy but ETI cannot be held responsible for it legally. Where errors do occur, a correction will be printed as soon as possible afterwards in the magazine.

Now - two fascinating ways to enjoy saving money!

NEW! Sinclair Scientific kit **£19.95** (INC. VAT)

Britain's most original calculator now in kit form

The Sinclair Scientific is an altogether remarkable calculator.

It offers logs, trig, and true scientific notation over a 200-decade range - features normally found only on calculators costing around £100 or more.

Yet even ready-built, the Sinclair Scientific costs a mere £32.35 (including VAT).

And as a kit it costs under £20!

Forget slide rules and four-figure tables!

With the functions available on the Scientific keyboard, you can handle directly

sin and arcsin,
cos and arccos,
tan and arctan,
automatic squaring and doubling,

log₁₀, antilog₁₀, giving quick access to x^y (including square and other roots),

plus, of course, addition, subtraction, multiplication, division, and any calculations based on them.

In fact, virtually all complex scientific or mathematical calculations can be handled with ease.

So is the Scientific difficult to assemble?

No. Powerful though it is, the Sinclair Scientific is a model of tidy engineering.

All parts are supplied - all you need provide is a soldering iron and a pair of cutters. Complete step-by-step instructions are provided, and our Service Department will back you throughout if you've any queries or problems.

Of course, we'll happily supply the Scientific or the Cambridge already built, if you prefer - they're still exceptional value.

Components for Scientific kit (illustrated)

1. Coil
2. LSI chip
3. Interface chips
4. Case mouldings, with buttons, windows and light-up display in position
5. Printed circuit board
6. Keyboard panel
7. Electronic components pack (diodes, resistors, capacitors, etc.)
8. Battery assembly and on/off switch
9. Soft carrying wallet
10. Comprehensive instructions for use

Assembly time is about 3 hours.

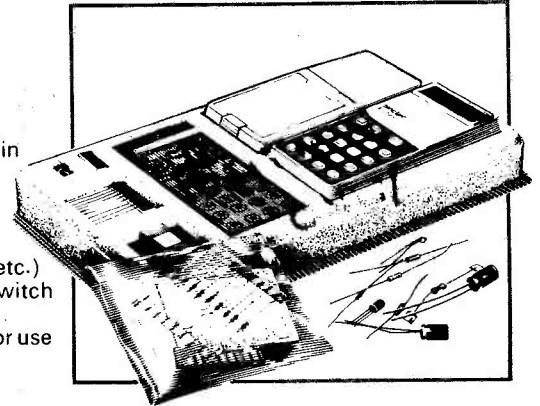

Features of the Sinclair Scientific

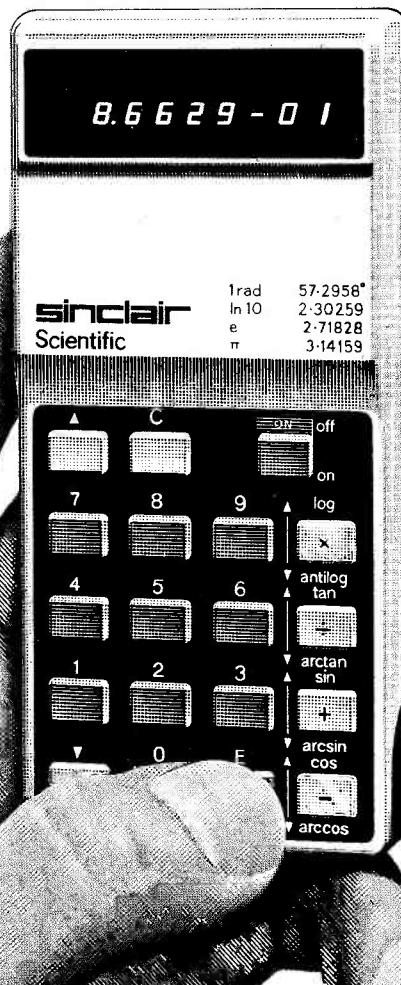

- **12 functions on simple keyboard**
Basic logs and trig functions (and their inverses), all from a keyboard as simple as a normal arithmetic calculator's. 'Upper and lower case' operation means basic arithmetic keys each have two extra functions.

- **Scientific notation**
Display shows 5-digit mantissa, 2-digit exponent, both signable.

- **200-decade range**
10⁻⁹⁹ to 10⁺⁹⁹

- **Reverse Polish logic**
Post-fixed operators allow chain calculations of unlimited length - eliminate need for an = button.

- **25-hour battery life**
4 AAA manganese alkaline batteries (e.g. MN 2400) give 25 hours continuous use. Complete independence from external power.

- **Genuinely pocketable**
4 1/3" x 2" x 11/16". Weight 4 oz. Attractively styled in grey, blue and white.

Sinclair Cambridge kit

Now only
£14.95
 (INC. VAT)

At its new low price, the original Sinclair Cambridge kit remains unbeatable value

In less than a year, the Cambridge has become Britain's most popular pocket calculator.

It's not surprising. Check the features below - then ask yourself what other pocket calculator offers such a powerful package at such a reasonable price.

Components for Cambridge kit

1. Coil
2. LSI chip
3. Interface chip
4. Thick film resistor pack
5. Case mouldings, with buttons, window and light-up display in position
6. Printed circuit board
7. Keyboard panel
8. Electronic components pack (diodes, resistors, capacitors, transistor)
9. Battery clips and on/off switch
10. Soft wallet

Assembly time is about 3 hours.

Take advantage of this money-back, no-risk offer today

The Sinclair Cambridge and Scientific kits are fully guaranteed. Return either kit within 10 days, and we'll refund your money without question.

All parts are tested and checked before despatch - and we guarantee any correctly-assembled calculator for one year. (This guarantee also applies to calculators supplied in built form.)

Simply fill in the preferential order form below and slip it in the post today.

Scientific

Price in kit form £19.95 inc. VAT.

Price built £32.35 inc. VAT.

Cambridge

Price in kit form £14.95 inc. VAT.

Price built £21.55 inc. VAT.

Features of the Sinclair Cambridge

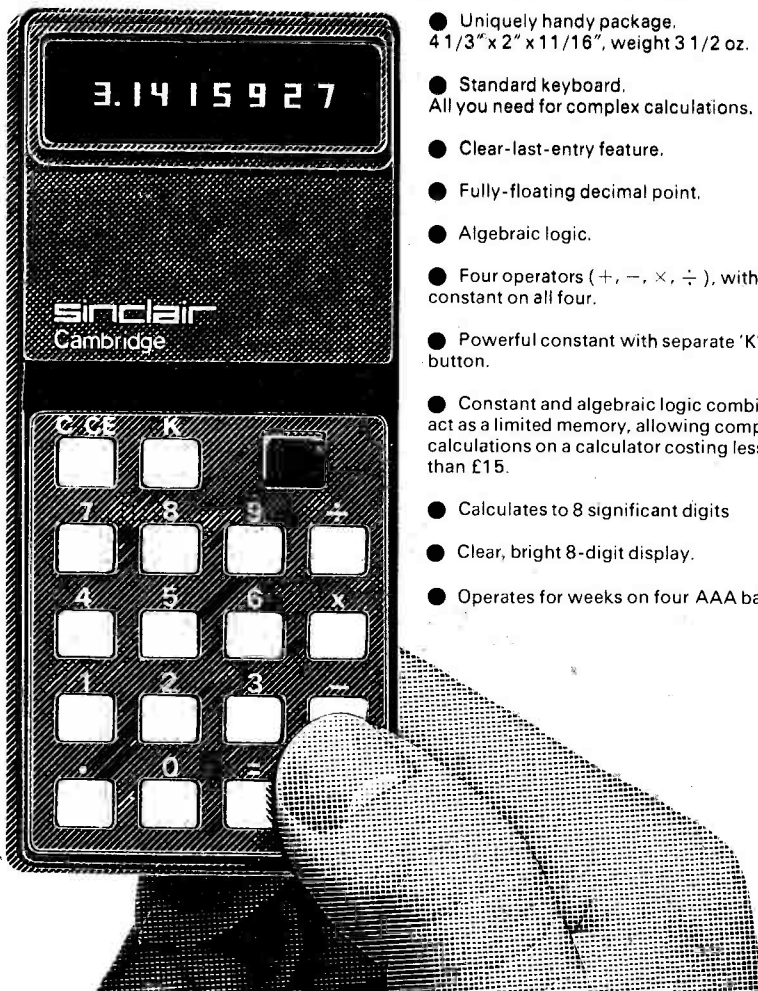

- Uniquely handy package. 4 1/3" x 2" x 11/16", weight 3 1/2 oz.
- Standard keyboard. All you need for complex calculations.
- Clear-last-entry feature.
- Fully-floating decimal point.
- Algebraic logic.
- Four operators (+, -, x, ÷), with constant on all four.
- Powerful constant with separate 'K' button.
- Constant and algebraic logic combine to act as a limited memory, allowing complex calculations on a calculator costing less than £15.
- Calculates to 8 significant digits
- Clear, bright 8-digit display.
- Operates for weeks on four AAA batteries.

To: Sinclair Radionics Ltd,
 FREEPOST, St Ives,
 Huntingdon, Cambs. PE17 4BR

Please send me

- Sinclair Scientific kit at £19.95
- Sinclair Scientific built at £32.35
- Sinclair Cambridge kit at £14.95
- Sinclair Cambridge built at £21.55

All prices include 8% VAT.

*I enclose a cheque for £
 made out to Sinclair Radionics Ltd,
 and crossed.

*Please debit my *Barclaycard/
 Access account. Account number

--	--	--	--	--	--	--	--	--	--

*Delete as required.

Signed _____

Name _____

Address _____

Please print. FREEPOST - no stamp
 needed.

ETI/1/75

sinclair

Sinclair Radionics Ltd,
 FREEPOST, St Ives,
 Huntingdon, Cambs. PE17 4BR.

Reg. No. 699483 England. VAT Reg. No. 213 8170 88.

news digest

NEW DIGITAL MULTIMETER FROM SINCLAIR

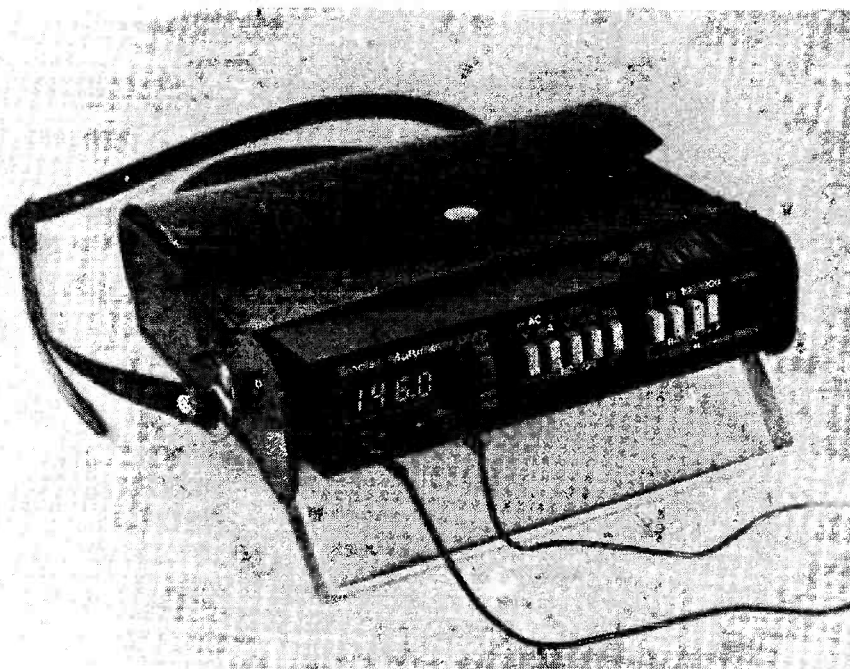

Replacing the DM1, one of the first digital multimeters, Sinclair have introduced the DM2, a much improved model for £59 plus VAT.

The designers have carefully thought out the needs of the user. Multimeters are dropped; we know they shouldn't be but that's life so they have gone for a thick aluminium case, not plastic. The unit is powered by an integral PP9 battery for portable use (60 hours life) but an external mains power supply is also available. For normal overloads, built-in protection is provided but for gross overload there is fuse protection.

Input impedance, even on low voltage ranges is $10M\Omega$. The actual ranges can be seen clearly on the photograph. Basic accuracy is 0.4% - very much better than even excellent analogue meters.

The display is large, made up from 0.3" 7-segment displays. Designed around a custom-designed MOS I.C., the DM2 utilises dual scope integration and features high operational repeatability and reliability.

A chain of high stability resistors are used in preference to presets: this improves stability and reduces setting-up costs. Optional extras are a carrying case (£5.00 + VAT) and mains converter (£1.85 + VAT). The DM2 weighs 1kg and measures 9" x 6" x 2" plus handle.

Sinclair Radionics, St. Ives, Huntingdon, Cambridgeshire.

PERSONAL ALARM SYSTEM

All Americans may soon carry a wristwatch-sized personal security alarm!

The US Law Enforcement Assistance Administration has commissioned the Aerospace Corporation to launch a massive field test next year of a prototype system that may eventually become nation-wide.

The system is based on thick-film hybrid UHF modulated transmitters which may eventually be built into standard electronic watches.

To generate an alarm, the wearer presses two buttons simultaneously. This causes an internal shift register to generate a digital code which in turn frequency modulates the transmitter.

The alarm signal is then picked up by the nearest of a vast number of

local receivers which retransmits the signal together with data identifying the transmitter's location to a central processing computer in the local police headquarters.

In the forthcoming field trials, some 5000 alarm units will be used.

SCHOOLS' LINK TO INDUSTRY

We received an interesting newsletter from the organisers of the "Link Scheme". They are a service for school teachers complimentary to that of the National Centre for School Technology. Help is offered regarding technical data, component distributors or technical advice, by means of a "Hot Line" phone number. The scheme's newsletter prints comments on recent issues of electronics magazines and provides additional information for school teachers. Also there is an evaluation of magazine

projects which have been built up by grammar school pupils. Their scheme has a contact man who will be arranging to visit schools to see what assistance a contact in industry can be to a school teacher.

If you are an interested teacher we suggest you get more details from Peter Noakes at the University of Essex Department of Engineering and Science, Wivenhoe Park, Colchester, CO4 3SQ.

200 MILLION DEGREES!

An important advance in work on nuclear fusion is reported by scientists at the University of Texas, Austin. Dr. William E. Drummond, director of the university's fusion research centre, says that a temperature of more than 200 million degrees Centigrade has been attained for some 50 micro-seconds in the centre's Tokamak-type unit by turbulent heating of the plasma, a new technique developed at Texas and in the U.K.

PCB MOUNTING PILLARS

The Ilex pillars are designed to insulate printed circuit boards from the chassis and at the same time to support them. One PCB can be stacked on another (either vertically or horizontally).

Now the experimenter can easily mount a PCB to a chassis, a PCB to a PCB, or a screen to a PCB using Ilex, completely dispensing with nuts or screws.

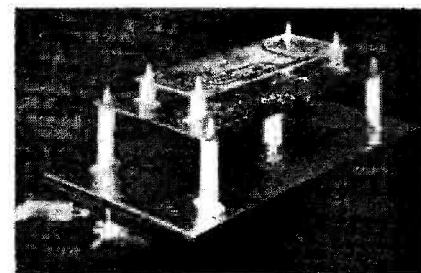

The pillars are made in moulded nylon, and have a rigid girder-shaped supporting section, a spring-in fastening at the top and at the base constant bending springs together with a push-in clip (giving a wide thickness tolerance which ensures an equally tight fit to any thickness from 1/32" to 1/8"). A firm grip by the Ilex into the upper board can be obtained with a 4 mm hole, and because it is insulating, it can quite safely be close to the conductors. At the base a 4.8 mm hole is needed.

Ilex come in heights of 1/4", 1/2", 3/4", 1" and 1 1/2". The half inch size costs 3p each for 10 off, dropping to 1.2p each in lots of 10,000 off. From West Hyde Developments Limited, Rye field Crescent, Northwood Hills, Middlesex, HA6 1NN.

STATIC 4k MEMORY

For some time now, efforts have been made to increase the integration density of static memories. In the Siemens Research Laboratories a static MOS memory has been produced accommodating 4000 bits on 14.7mm².

The memory is an integrated circuit in aluminium gate ESFI technology. This step forward was made possible by integrating the switching elements on an insulating substrate and employing a non-crossing conductor layout between the transistors and resistors in a memory cell.

An initial breakthrough on the way towards static ESFI MOS memory cells (ESFI = epitaxial silicon film on insulators) of high packing density was the development of a complementary MOS cell with five transistors and an area of 4000µm². The second measure was to combine two complementary transistors and two load transistors in one cell in a non-crossing layout to obtain a flip-flop. In this way, the cell area was reduced to 2000µm². The final step was to replace the select transistor by a diode and to use the power supply lines. It was thus possible to reduce the memory cell area again to 1500µm². This is even less than the area required by MOS memories and bipolar memory cells.

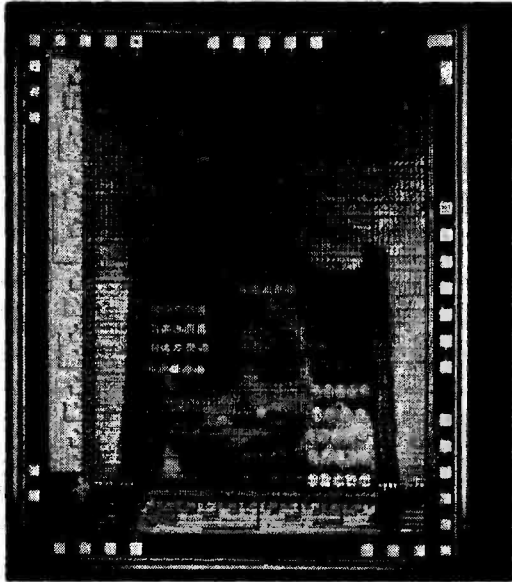

The chip measuring 4.2mm x 3.5mm contains the actual memory matrix, the word line decoder (on the left), the bit line decoder (at the bottom) and the read-out circuit (bottom left-hand corner).

Such memory cells have already been integrated in a configuration with 4096 bits. The chip area is then 14.7mm²: the actual memory matrix, the word and bit line decoders and the read-out circuit are accommodated in an area measuring 4.2mm x 3.5mm. The results of tests allow us to predict an access time of around 120nS and a cycle time of about 170nS for the production module. The power dissipation is 100mW.

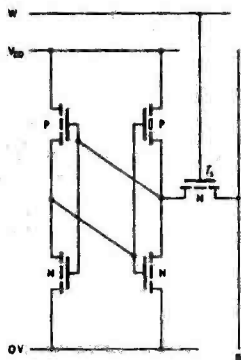

4000µm² (6.4 mil²): circuit of a conventional flip-flop memory cell with two p-channel and two n-channel transistors and a select transistor T_S in ESFI MOS technology.

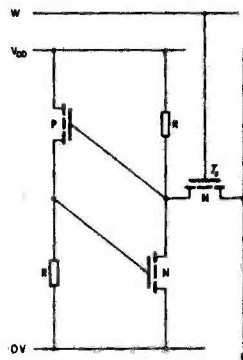

2000µm² (3.2 mil²): circuit of the new memory cell made in the Siemens Research Laboratories. One of the p-channel and one of the n-channel resistors was replaced by a high-valued resistor R. The size of this flip-flop in non-crossing conductor layout has been halved.

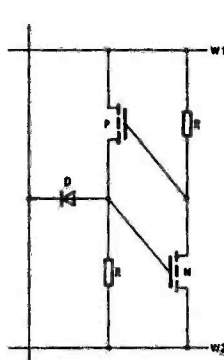

1500µm² (2.4 mil²): This further reduction in area has been obtained by replacing the select transistor T_S by diode D.

Supply Voltage: V_{DD}
word lines: W & W_1 & W_2
bit lines: B
chassis ground: 0 V

QUAD OP-AMP: LM324

SDS Components Ltd have available an interesting quad op-amp which is unusual in that the input common mode voltage range includes ground even when the amplifier is operated from a single supply rail. In addition, also under single-rail supply conditions, the output voltage swing includes ground. The device is the Signetics LM324. The current drain (800µA) is essentially independent of supply voltage over the range 3 to 30V or ± 1.5 to ± 15 V. Power consumption works out at about 1mW per op-amp when a 5V supply is used.

The devices feature internal frequency and temperature compensation, and each op-amp has a unity gain bandwidth of 1MHz, a common mode rejection ratio (d.c.) of 85dB and a power supply rejection ratio of 100dB. Open loop gain at d.c. is 100dB while coupling between amplifiers is -120dB.

Differential input voltages equal in value to the power supply voltage can be applied without fear of damage. Bias current and input offset voltage and current are all very low at 45nA, 2mV and 5nA respectively. The input bias current is temperature compensated. At the 100 up rate, the cost is £1 (25p per dual-in-line package). Designed for operation over the industrial temperature range of 0 to 70°C, the LM324 is a general-purpose quad operational amplifier of good performance for use in industrial, automotive and other similar applications.

SDS Components Ltd, Hilsea Trading Estate, Portsmouth, Hants, PO3 5JW.

PUSHBUTTON POTENTIOMETER

Bourns new Model 3680 KNOBPOT Digital Potentiometer combines a precision incremental decade potentiometer with an easy-to-read digital display, and fast, pushbutton resistance selection all in one integral package, with snap-in-mounting.

This device is ideal for use where Panel designs involve data entry or set-point controls. Bourns' unique design combines precision laser-trimmed cermet resistor technology with a pushbutton detent action. Resolution of the output is 1 in 1000 discrete steps, and repeatability of $\pm 0.1\%$. Each decade has a rated life of 100,000 operations. The specification gives a power rating of 2W, a standard resistance range of 3-decade units (5KΩ to 1MΩ), and a resistance tolerance of $\pm 1.0\%$.

Bourns (Trimpot) Ltd., Hodford House, High Street, Hounslow, Middlesex TW3 1TE.

DIL PCB SWITCH

Ten new types of dual-in-line PCB programming switches are now available. Contact arrangements include 1 pole 8 way and 4 independent changeover contacts with bbm action. The gold on nickel contact surfaces give in excess of 20,000 switching

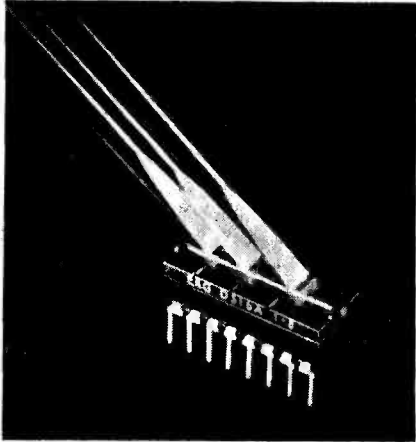

steps at the full rated load of 30VDC 250mA. Applications include BCD setting, select on test, range attenuation and cross point switching.

From ERG Limited, Luton Road, Dunstable, Beds.

GRAVITY WAVE DATA TRANSMISSIONS?

Future communications systems could well utilize modulated gravity waves propagating directly through the centre of the earth — according to a report given recently to the British Association by Dr. Drever of the Dept of Natural Philosophy, Glasgow University.

The notion is very much on the border-line between physics and science fiction as great controversy still continues as to whether gravity waves exist or not, however modern theory increasingly supports the idea of energy waves flowing across the universe in the way that light energy flows from the gigantic energetic disturbances in stars and galaxies.

MAGNETIC-ELECTRIC INTERCONVERSION

Philips Research Laboratories in Eindhoven have developed a composite piezo-magnetic/piezo-electric material that inter-converts magnetic and electrical fields.

The actual material is composed of a molten eutectic mixture of barium titanate and cobalt ferrite which is solidified uni-directionally.

Conversion is brought about by mechanical deformation hence optimum efficiency occurs at the mechanical resonant frequency.

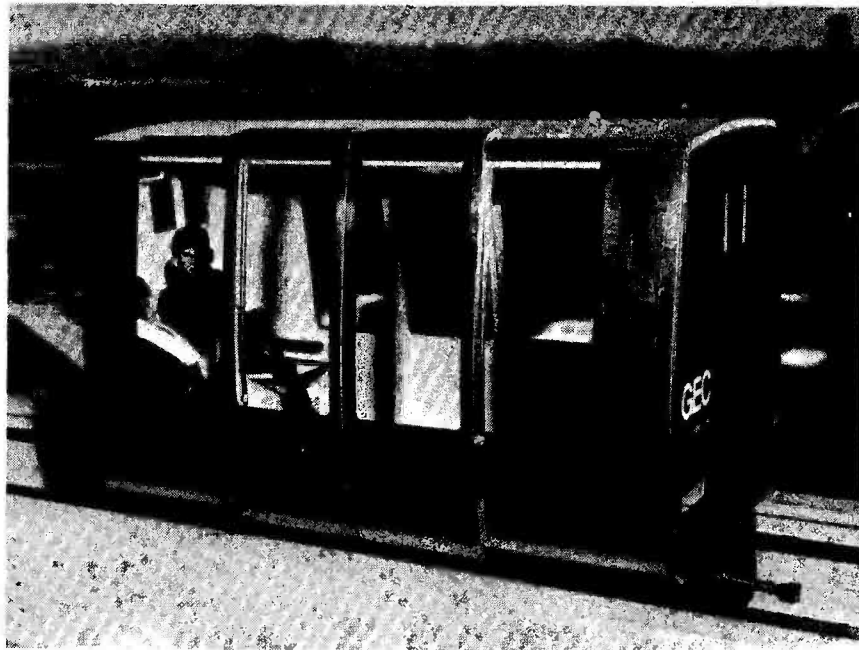

The photo shows a model of the GEC-Marconi Minitram which was produced as a result of work on a competitive contract for the Transport and Road Research Laboratory to define the development necessary for a proposed system in Sheffield. The work included the design of the vehicle itself, the track on which it would run and the control system for its operation.

There is of course nothing new in magnetic and electrical inter-conversion. It is achieved for instance in a solenoid. What is unique about Philips' new material is that conversion takes place without a flow of current.

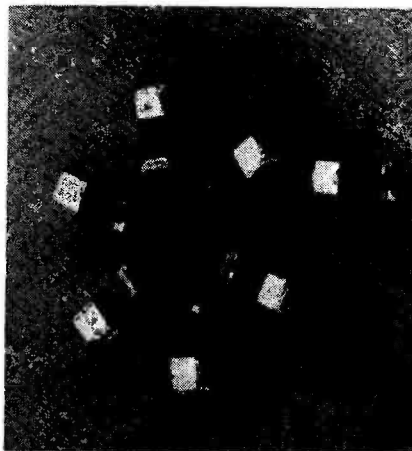

They might look like date stamps but in fact they are new aluminium electrolytic capacitors.

They are made by AEG-Telefunken and coded EFT. The capacitors feature low dissipation, low impedance and good temperature characteristics. Intended for AC operation without polarized voltage DC, these components are especially suitable for the audio-frequency load in dividing networks of loudspeaker-cabinets. They come in ratings from 2.2 μ F to 100 μ F and voltages of 40V and 63V DC as well as 15V and 23V AC.

ELECTRONIC BALANCE

This first product from Shinko Denshi of Tokyo launched on the British market is the Digipet top-loading automatic electronic weighing machine with digital display. This is a compact precision weighing machine with measuring ranges of 0-19.99gm and 0-199.9gm; the required range is set automatically to provide an accuracy of two decimal places for weights under 20gm and one decimal place for objects over 20gm. Overload is set at 250gm.



The electromagnetic weighing mechanism automatically resets to zero within 0.15 sec and the digital meter can be switched to give a read-out within either 0.5 or 1.5 sec. Facilities are provided for automatic tare compensation, and BCD, TTL-compatible digital outputs or 5-V analogue outputs are provided for recorders, printers, comparators and computers. Supplied by Transducers (CEL) Limited, Trafford Road, Reading, R61 BJH.

MK50250N Alarm Clock IC £6.90
 CT7001 Alarm/Date IC £9.80

We have developed some new circuits for using these I.C.'s with various displays.

MK50250N plus 4xDL704 £10.20
 plus 6xDL704 £12.10

You can now build a high quality 0.3" LED alarm clock at a reasonable price.

High Quality 0.3" LED's. Common Cath. 95p
 These LED's are manufacturer's prime units, better than the special offer LED's; in a 14-pin package.

SOLDERCON IC PINS — Affordable Technology

Reduce wastage - if you buy 1000 pins you can make an 8-pin socket for about 3½p, a 14-pin socket for about 6p - Reuse your IC's, DISPLAYS, LM380's etc. Ideal for LED digits and clock chips, anything from 8-pin to 40-pin.

Prices per 100 pins

100+ 70p
 300+ 50p
 1000+ 40p
 3000+ 35p

or send s.a.e. for sample and instructions

HEAT SHRINK TUBING

1/16", 1/4", 3/8", 12 p per 20 cm (any diameter).

COMING SOON: 3 digit LED (0.12" high in DIL package for £1.35 (45p per digit)

DIGITAL WATCH KIT: £55. Send for details
 ADD 8% VAT.....10p p&p for orders under £2.

SINTEL, 53a Aston St., Oxford. Tel: 0865 43203

SPECIAL XMAS OFFER!!

FOR THIS MONTH ONLY: CALCULATORS
 SINCLAIR TEXAS

Cambridge	£17.25	TI-1500	£26.25
Cambridge Memory	£24.95	TI-2000	£13.95
Scientific	£24.95	TI-2500	£19.95
Executive	£24.95	TI-2550	£29.95
Executive Memory	£28.95	SR-10	£32.00

BC107	10	BC212	12	TIP29A	50	709 8pn DIL	36
BC108	10	BC213	12	TIP30A	55	709 TO99	36
BC109	10	BC214	12	TIP41A	85	711 TO99	50
BC177	22	BC212L	12	TIP42A	90	741 TO99	38
BC178	24	BC213L	12	TIP2955	90	741 8pn DIL	37
BC179	24	BC214L	12	TIP3055	56	741 14pnDIL	39
BC182	10	BCY70	15	TIS43	25	747 14pnDIL	96
BC183	10	BCY71	16	TIS74	65	748 8pn DIL	39
BC184	10	BCY72	17	ZTX304	26	S301B	75
BC182L	10	BFV50	18	ZTX504	34	IC SOCKETS	
BC183L	10	BFV51	18	2N3055	16	8 pin DIL	15
BC184L	10	BFV52	19	2N3055	49	14 pin DIL	15

7400/5	20	7490	66	2N3819	20		
7410	20	7492	70	2N3820	39	Diecast Boxes	
7413	38	7493	66	2N4442	70	4½x2½x1 50p	
7420	20	74107	55	OA10	22	4½x2½x2 70p	
7430	20	74121	55	OA47	7	7½x4½x2 150p	
7440	20	74141	1.00	OA70	7		
7442	86	74150	2.10	OA81	7		
7447	1.30	702	45	OA91	6	RESISTORS	
7470	34	710 14pn	37	OA200	6	TR5 2%	
7472	34	709 14pn	37	OA202	9	All values	
7473	45	OC23	50	1N914	5	2.5p	
7474	42	OC24	50	1N916	5		
7475	60	OC28	60	1N4001	6	WIREWOUND	
7476	42	OC29	60	1N4002	6	2.5W	10
7483	1.25	OC35	55	1N4003	7	6W	10
7486	46	OC44	25	1N4006	9	9W	12
				1N4148	5	15W	15

SOLDER	CA3046	80			
18 s.w.g.	CA3028	99	Disc Ceramics	ZENERS	
£1.80/½ kilo	CA3026	75	All values	3p	400mW 12p

P.E.C.

49-51 St. Mary's Road,
 Oatlands Village,
 Weybridge, Surrey
 KT13 9PX.
 Tel. Walton 21324 or
 Weybridge 51907 (evenings)

**ALL PRICES INCLUDE VAT
 CWO. MAIL ORDER ONLY**



Telephone Orders
 accepted from
 ACCESS holders

P & P 15p — FREE over £3.00

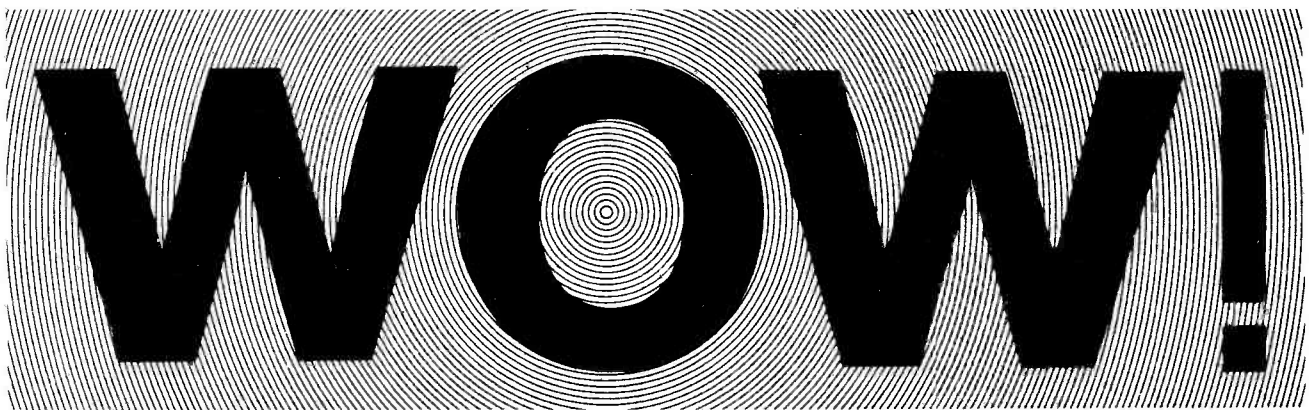

We thought the fantastic offer with 7 segment LED displays would be popular. But the response was shattering. Our apologies to those of you who didn't get the devices as quickly as you, or we, would have liked - but we were slightly overwhelmed. Anyway, we have still got devices available, so if you want some DL704, 5 for £3.25 inc. VAT & pp - please send the coupon from September ETI. Otherwise, they will cost you £5.00 for five, After all, special offers have to be special - nonetheless, this is still terrific value.

Don't forget we do things like TTL, PLL, TOKO coils and filters, lots of linears. And don't forget we know more about using our devices than any other enthusiast orientated supplier. Try us, and see.

First step is to get our catalogue — 25p, refundable with £5 worth of goods. Here's a very brief selection:

NE560/1/2B	£3.19	ICL8038CC	£3.10	LM381N	£1.85	TOKO EF5603 Tuner	£8.40	CFS10,7 (sim FM4)	40p
NE565A	£2.75	CA3089E	£1.90	MC1310P	£2.80	CFT AM ceramic filters	45p		
NE566V	£2.55	CA3123E	£1.40	CT7001	£10.00	MFH mechanical filters	£1.35		
NE567V	£2.75	LM380	£1.00			TIP3055/2955 pair	£1.50	7447	£1.45

VAT EXTRA POST AND PACKING 15p ACCESS WELCOME

All goods are brand new marked and tested, and available in quantity. Manufacturer enquiries welcome.

ambit INTERNATIONAL

37 HIGH STREET, BRENTWOOD, ESSEX CM14 4RH

Tel: (0277) 216029

Telex: 995194

SAE All enquiries please

MATRIX TV - a solid-state picture transmission system

by Dr. Sydenham

WHEN MAN learned of ways to produce an optical image — probably when he found that a pin-hole in a screen produced a reduced size picture — he took a great step forward in both understanding and enjoying life.

In 1859 Dionysius Lardner of University College, London wrote in his encyclopaedic "Museum of Science and Art"

"The image of visible objects produced by reflection from smooth or polished surfaces, natural and artificial, and by looking through transparent media, bounded by surfaces having certain curved shapes, play a part so important in the effects of vision, that it must be regarded as highly interesting to explain the optical principles upon which the production of such images depends, so far at least as may be

necessary to render intelligible the natural appearances and effects which are familiar to every eye, and innumerable contrivances, from which we derive essential benefit, either in repairing defects of vision, or extending the range of that sense to objects removed beyond its natural limits, either because of their minuteness or remoteness or in fine in producing phenomena affording at once amusement and instruction."

SAMUEL WHITFORD,

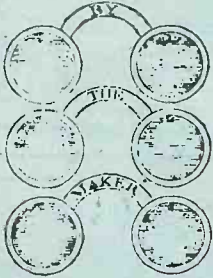
OPTICAL,  MATHEMATICAL-
PHILOSOPHICAL, INSTRUMENT-
AND MAKER,

(THE ORIGINAL SHOP.)

At the **THREE SPECTACLES, N^o 27,**
Ludgate-Street, near St. Paul's, LONDON,

MAKES and sells Spectacles of Glass or Pebble, in neat and light Frames, of the newest and best Construction, and in the most convenient Manner for avoiding Pressure on the Nose or Temples.

Concaves for very short-sighted Persons; and Glasses for reading, magnifying, and burning.

Reflecting Telescopes, of all Kinds, and with the latest Improvements.

Refracting Telescopes of all Sorts; with one of a New Invention (useful for Sea or Land) that will not warp in any Weather; and a Sort to use at sea in the Night.

Double, Single, Solar, Opaque, or Aquatic Microscopes.

Camera Obscuras, to delineate Landscapes and Prospects (and which serve to view Perspective Prints) made truly parallel; Sky-Optic Balls; Prisms, to demonstrate the Theory of Light and Colours; Concave, Convex, and Cylindrical Speculums; Magical Lanthorns; Opera Glasses; Optical Machines for Perspective Prints; Cylinders and Cylindrical Pictures.

Air-Pumps and Air-Fountains of various Kinds; Glass-Pumps; Portable Apparatus for Electrical Experiments, which is allowed by the Curious to be the best of the Kind.

Barometers, Diagonal, Standard, or Portable.

Thermometers, Hydrostatical Balances, and Hydrometers.

Hadley's Quadrant, after the most exact Method, with Glasses truly parallel; Davis's Quadrant; Globes of all Sizes; Compasses, Azimuths, Steering, and Plain; Loadstones; Nocturnal and Sun-dials of all Sorts.

Scales; Cases of Drawing-Instruments; Parallel Rulers; Proportional Compasses, and Drawing Pens.

Theodolites, Semicircles, Circumferencers, Measuring Wheels, Spirit Levels, Rules, and all Sorts of the best Black Lead Pencils, and all other Sorts of Instruments of the newest and most approved Invention.

* * * L A N D S accurately surveyed.

Fig. 1. Trade card of Samuel Whitford shows evidence of early links between optical and electrical crafts.

All manner of devices were indeed devised. The microscope, the telescope, the camera obscura, the camera lucida and the magic lantern have been handed down to us.

The science of optical imaging was well developed by the start of the 19th century. For many a decade before this, firms had been proudly advertising their optical wares and expertise in handbooks such as that shown in Fig. 1.

Optical instrument-makers excelled at the crafting of mechanical contrivances so it was natural for them also to take on the manufacture of the then emerging electrical machines.

There were very few of these to begin with — Whitford's sheet mentions "portable apparatus for electrical experiments". But by the mid-19th century, the electrical "curiosities" had expanded in number from simple electrostatic devices to include magnetic ones as well. The feeble oil-lamp powered magic lantern gave way to arc-lamp versions — like that of Mr. Duboscq of Paris (illustrated in Fig. 2).

A new science, that of electro-optics, came into being. But it could not advance much in the 19th century, for hardware capable of converting light into electrical signals was not developed until the 1880's. If an experimenter wished to relay or record images before this time then they had to be copied and conveyed by hand. If several people wished to view the same image they had to take turns, use elementary photographs or manage with a multiple instrument such as Nachet's multiple microscope (shown in Fig. 3.)

In 1895 Becquerel observed that certain substances used as electrolytes in a primary battery cell generated differing voltages if the two plates

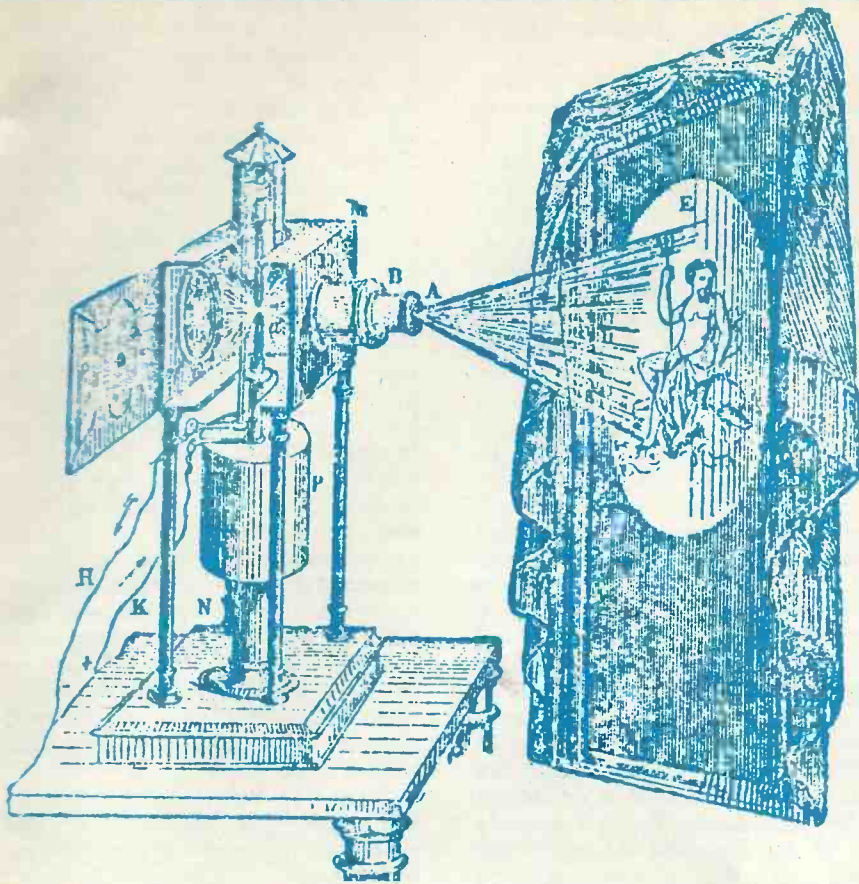

Fig. 2. This magic lantern, made about 1855, uses electrics and optics. In those days electric photo diodes did not exist: opto-electronics was a simple discipline.

were exposed to different light intensities.

A little later, in 1887, Arrherrius found that the resistance of silver halides increases with increasing light level.

In 1905 a photo-electric theory of vision was published and photo-detectors (of cumbersome form) became a more or less routine component available to designers.

By 1920 one could purchase a potassium-hydride photocell complete with a thermionic valve amplifier. Glazebrook, in his 'Dictionary of Applied Physics' (1922) remarked on this package —

"Used in this way the photo-electric cell may well prove its usefulness not only in photometry but in signalling without wires and as a means of scientific investigation."

He was so right*

He also said he was pleased to see that such an obscure phenomenon was finding increasing use of technical importance.

Single-cell detectors were continually improved, and far greater sensitivity was achieved by devices such as the photo multiplier. A solid-state

photo-diode was eventually developed which was not only small but retained a good measure of detectivity.

Single-cell detectors, however, can only measure and transduce the intensity of radiation occurring in a single-point area. They cannot produce an electrical equivalent signal of two-dimensional images unless some mechanical system is used to enable

them to scan an area, or a matrix of such photo cells is used.

The first photo cells were bulky so early inventors of two-dimensional image transducing systems were obliged to use mechanical scanning to effectively move the photo cell across the image.

Nipkow devised his spinning disc method of television in 1884; with it successive elements of the picture were viewed one at a time in a sequential pattern.

His work was further developed by Baird, in the 1920's — who pioneered our present-day television systems.

The Nipkow disc, however, was incapable of producing really acceptable picture definition, it was soon replaced by thermionic camera tubes in which an electron beam is systematically deflected across a photo-sensitive target on which the image is formed.

Zworykin's "Iconoscope", one of the earliest camera tubes, used a photo sensitive area of fine mica flakes — called the mosaic. These minute cells formed small capacitors that became charged to a level decided by the intensity of the radiation falling on them. The many "cells" were interrogated at regular time intervals by an electron beam scanned across them, monitoring the change in beam current occurring at each cell as they discharged.

As the cells were not being read out continuously it was possible to integrate (or average-out) the charge produced over a period of time, thereby increasing the sensitivity to light. This process is now known as charge-integration.

Today's television picture-tubes are still similar to the Iconoscope, the differences being in simplification of

* (A future issue of ETI will feature modern electro-optic communication links.)



Fig. 3. Before closed-circuit television was invented, multiple viewing had to be undertaken with devices such as Nachet's multiple microscope.

MATRIX TV

the mica mosaic to give us the relatively inexpensive Vidicon and its derivatives and sometimes to make use of secondary emission which enhances sensitivity in tubes such as the image-orthicon.

Thermionic picture tubes have long provided adequate resolution and linearity for most purposes, and production costs have been reduced to the point where amateur video recording is an increasingly popular hobby.

Nevertheless, thermionic tubes are bulky and thirsty for power compared with the potential capability of the latest solid-state integrated circuit technology. The days of thermionic picture tubes are numbered. Solid-state detection will undoubtedly replace them in the not too distant future — indeed in a few special cases this has already happened.

MATRIX SOLID-STATE DETECTORS

Early photo detectors needed several square centimetres of radiation to produce a useable signal change. Consequently a multiple array used to transduce line or plane optical information was rather large in size. Scanning was much easier to implement in a reasonable space.

Selenium was found to be a photo-electric substance. Willoughby Smith made resistors of it (in 1873) only to find its ohmic value varied with light intensity — thus adding

another important transducer effect to the growing list!

The existence of relatively sensitive selenium detectors enabled Ruhmer to study the practicality of matrix array techniques which were connected to a similar array of lights with paralleled wires. In the period 1901-1912 he tried many ways of producing television by such means. He failed miserably. Selenium cells have a quite long time-constant (many milliseconds) so they were unable to follow transients of moving images.

Experimenters tried to reduce wiring connections by scanning the cells using mechanical switches. A scheme was proposed that needed a 32-contact wiper switch rotating at 960 rpm; it was dropped because it would also demand lamps that could be flashed at 640 000 times a second "which was manifestly impossible" says the author of the report.

In 1929, a popular-science technical writer (Ellison Hawks), summed up the situation by these remarks:—"Although there are immense difficulties, however, one would like to suggest that the method should not be finally discarded for it is the only one so far suggested by which the whole of the picture can be transmitted at one time".

When semiconductor technology exploded in the 'fifties and 'sixties it became possible to make highly reliable and inexpensive solid-state photo-diodes that were of only pinhead size. Eventually the problems of placing a large number of these side

by side to form a matrix were overcome and we saw the successful development of lines of detector elements using large-scale integrated circuit production methods.

Some of the "immense difficulties" have been overcome, some still remain.

It is now about ten years since satisfactory integrated detector arrays were first made. Line arrays have been used in military optical missile trackers, and in a few industrial applications. Their widespread use was, however, restricted by cost and by the lack of an adequate density of photo-diodes. Today the diodes can be formed 75 μm apart (less than half the size of a full stop on this page) with a 64 by 64 array being comparatively easy to accomplish.

Such achievement may well seem surprising but the resolution needed for many purposes is already routinely obtained with the 625 line television system — about 3 000 000 picture elements in the picture area.

The massive IBM array still does not compete on a size basis with a good vidicon tube!

To illustrate the technology used, we now take a look at some manufacturing methods and circuit techniques.

THE MATRIX

Basically light-detecting photo-diodes are paired with semiconducting solid-state switches — shown diagrammatically in Fig. 4a. They are made by sequentially depositing metal conducting and semiconducting films on a supporting insulator substrate. This technique gives the designer a high degree of confidence as the majority of devices made in an array will work as expected. It also enables a variety of components — both active and passive to be produced by the same basic process of depositing films through carefully made screening masks.

The most generally used mode of operation for the photo diode is that of charge-integration.

Using the self-capacitance of the diode, (which is created by the separated metal films), the diode is first charged up with an externally applied voltage source. The associated switch is used firstly to connect the diode to the source — and then to isolate it by effectively opening one connection of the photo diode. Charge in the diode then commences to leak away due to electron leakage within the diode structure and, more dominantly, by electron carriers that are formed by the photons falling on the photo-diode. The charge loss is

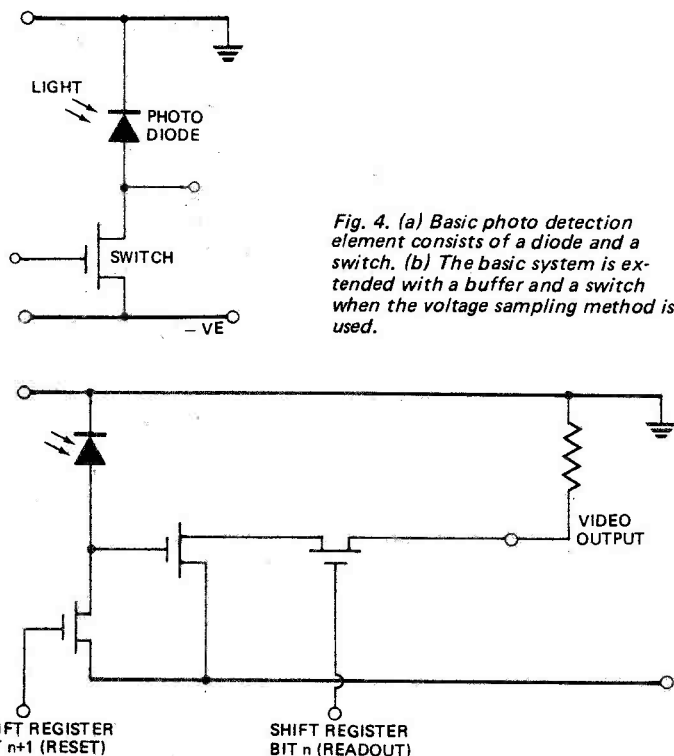

Fig. 4. (a) Basic photo detection element consists of a diode and a switch. (b) The basic system is extended with a buffer and a switch when the voltage sampling method is used.

then measured, as will be explained later.

The amounts of energy involved are minute. The voltage across the diode decays through 2.5 V (that is, the charge is lost and, therefore, so is the voltage) in an integration period of 10 ms when the incident light level falling on the diode is 0.1 W/m². This process, due to the tiny area of the diode, involves only 1-10 pC of charge (pC — pico coulombs; the charge of a single electron is roughly 10⁻¹⁹ C and 1 C flowing per second is a current of one ampere). Direct sunlight provides a radiation intensity of around 100 W/m². The energy involved to "drive" the detector through the 2.5 V swing is of the order of 10⁻¹⁰ W!

Having devised a scheme to charge the diode and isolate it ready for radiation detection, the next state is to measure the loss of charge. This can be achieved by measuring the voltage across the diode, in which case a second MOS switch is used to connect the external circuit to the diode. A third MOS component is used to buffer the photo-diode from the load imposed by the sampling switches. This is necessary for without it, the sampling switch will present too low a resistance to the diode, leaking charge before the correct voltage level can be decided.

This method of measurement is known as voltage sampling. It is portrayed diagrammatically in Fig. 4b. The sampling rate for this mode of readout is around 200-500 kHz and it suffers from a somewhat large noise level.

An alternative way to interrogate the diode is by what is known as the recharge-sampling mode. In this the criteria of light-level used is that related to the amount of recharge needed to fully re-establish the voltage across the diode, (Fig. 5). This method needs only the first-mentioned charging switch at the diode location, thus reducing the number of elements needed in the full detector component, but it does require more analogue voltages. But having added this extra circuitry, it then becomes possible to read at 5 MHz multiplexing rates — and the noise level is much less than with the above described voltage sampling.

The actual manufacturing method used to make an element of the array is typified by the drawing of one such element that is given in Fig. 6. Simplicity of contacts and junctions is had at the expense of adding more electronic components elsewhere in the data processing. When the array is made as a single line only it is possible to pack the photo-detecting elements at one third of the spacing, that is at only 25 μm centres.

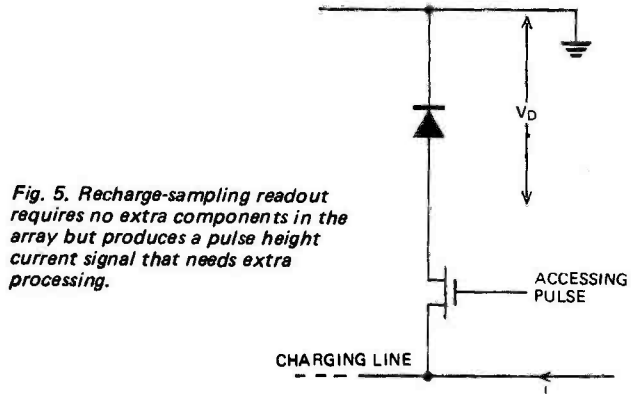
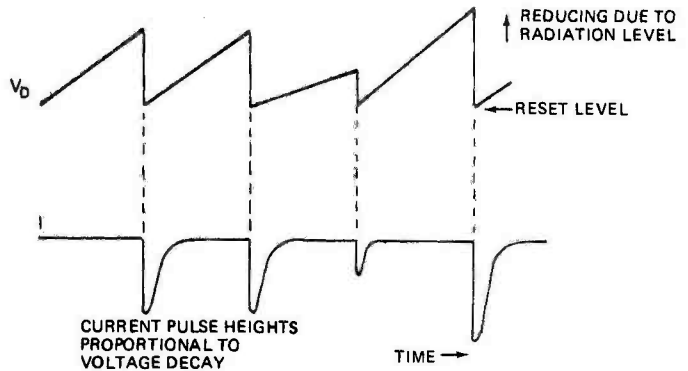

Fig. 5. Recharge-sampling readout requires no extra components in the array but produces a pulse height current signal that needs extra processing.



OBTAINING ACCESS TO THE DIODES OF THE ARRAY

Each element has its input and output "terminals" permanently connected to X and Y conducting lines — made with deposited metal film strips.

The arrangement used for the faster recharge-sampling processing method is shown in Fig. 7. The ends of each X and Y line are connected such that each can be connected to a single common line as needed, this happening sequentially. This is achieved by using a continuously operating pulse generator that "clocks" a solid-state scanning switch — the register — along in steps. This causes a string of charge pulses to appear on

the output line ready for height processing.

Special consideration has to be given to driving these lines, for several effects, such as large line capacitance, tend to limit the useable scan rate unless used in special ways. IPL, for example, have developed a system whereby the flyback time is eliminated thus utilizing the total time more efficiently.

The shift register scanning switches for the X and Y drives, are also formed on the same chip, placing them around the edges. Figure 7 shows an enlarged view of the top of the 64 x 64 IC which includes both the photo-diode array with its recharge switches and the shift registers. (Most users of such a chip would not wish to have to build

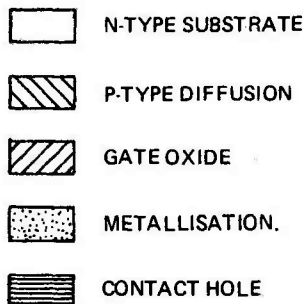

R IS THE RATIO OF PHOTO-DIODE AREA TO TOTAL ELEMENT AREA

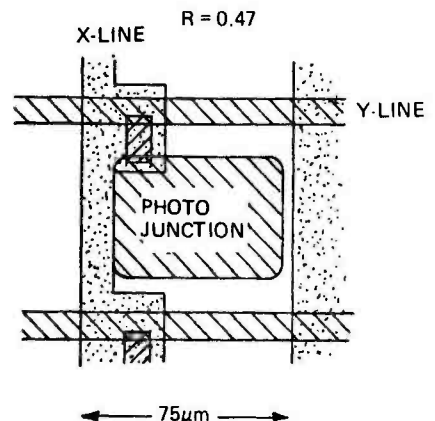
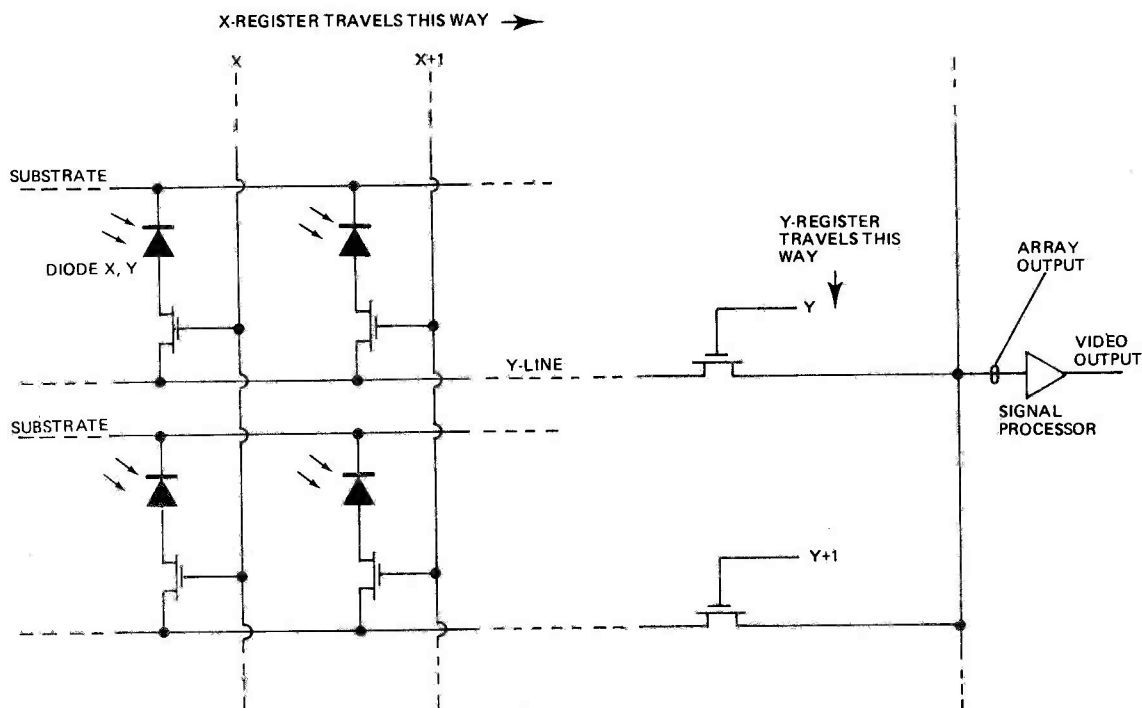

Fig. 6. Photo-diode and switch is manufactured by appropriate diffusion and metallisation on a substrate.

MATRIX TV

Fig. 7. Typical section of a two-dimensional array using recharge-sampling.



their own processing circuits, so a complete system is offered shown in Fig. 9. In this are housed the clock pulse generator, signal processing circuits and a means to physically mount the appropriate optical element to produce the right size image.)

After preamplification, the recharge pulses appearing on the output line are integrated (rather than peak detected) and applied to a circuit that samples them and holds their level for outputting. as a closely analogue-varying signal.

APPLICATIONS OF MATRIX ARRAYS

Arrays containing only 4096 picture points ("pixels" is a term sometimes used) cannot compete with vidicon television picture tubes on a resolution basis.

Nevertheless, there are many applications where an array is superior and/or where the full resolution capability of the thermionic camera tube is not required.

Flaw detection — unwanted pin holes in, say, tape or films can be easily detected using a single photo detector to look for light coming through from a source mounted below. This basic method, however, is limited by non-uniformity of the background

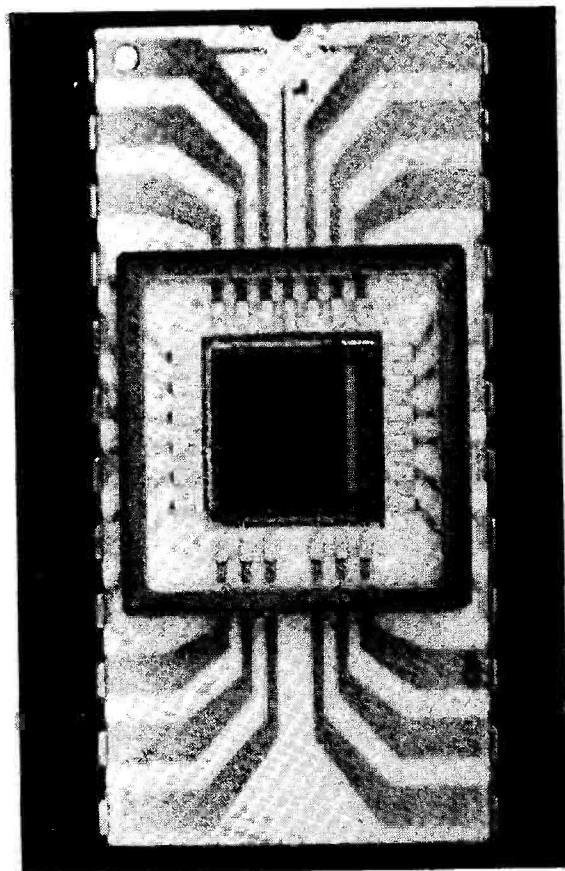
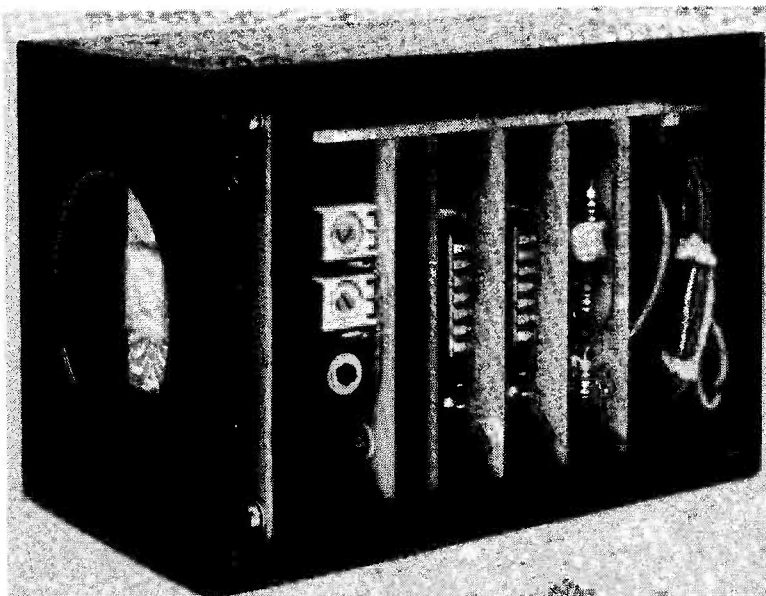

Fig. 8. Integrated Photomatrix Ltd.'s 64 x 64 photo-diode array. The central chip is barely 6 mm square.

Fig. 9. At present the processing circuits of the complete matrix camera require more room than the array (lower centre) but this is largely due to the need to custom build this part of the system.



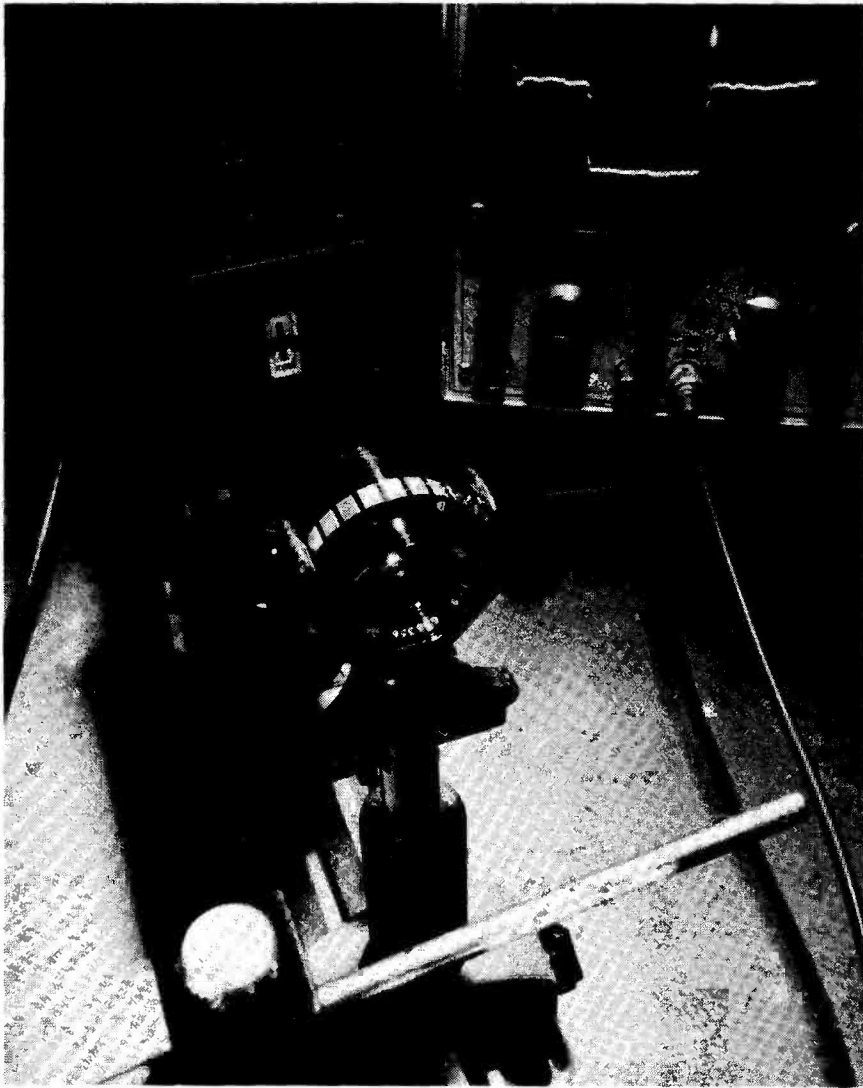

Fig. 10. In this demonstration a linear array is used to produce an electrical signal which has pulse-width proportional to the diameter of the rod seen in the foreground.

illumination coming through the tape or film and cannot provide information about flaw distribution. In looking for small flaws in a wide area the area is actually directed up into smaller fields — that of each element in the array — to increase the signal to background ratio and to define the location of flaws. For this purpose a linear array of 100 photo-diodes is adequate. The actual size of the film and the detector array matter little as the appropriate power lenses will provide the magnification needed. The possibilities for using the data obtained are numerous and depend only on the needs of the task.

Gauging size — if the width and range to be gauged lies within the full range of a linear array, the array can be used to measure rod size without physical contact and at great speed. Figure 10 demonstrates this principle. Back lighting passing the rod throws a shadow on the linear array. This, in turn, produces the gauging signal seen on the CRO screen. As the diodes

resolve measurements in discrete dimensionally stable increments, these arrays can provide greater accuracy and long-term stability than a vidicon method.

If the measurement task is one needing only width change monitoring it is better to use two separate arrays

set apart as shown in Fig. 11. This technique increases the relative resolution obtained, and by this method it is possible to monitor the width of sheets, stripes and even railway lines. The block schematic of a hot rod gauging system using two arrays is given in Fig. 12.

Optical character recognition and data digitizing — linear arrays for scanning documents, such as cheques, have been in use for several years. Current developments involve automatic post-code recognition and for the processing of football-pools entry forms.

Linear arrays have been used in an instrument for measuring pipe straightness. This device consists of a flexible tube containing two fixed-end units. Mounted in one fixed unit is a fine light source that radiates across the flexible section to the other side which houses a linear array. The unit is blown by compressed air down the pipe to be tested, bending as the pipe bends. If and when the unit bends, the light scans across the array, thus yielding straightness data.

Television — this is an extension of one-dimensional array methods to two dimensions. Arrays with only 64 x 64 elements, although somewhat limited, are capable of many useful tasks.

Obvious applications include blood count and cell analysis, more complex character recognition situations and area gauging. There is also a large potential market for the arrays as sensors for reading cost and inventory labels in the so-called "point-of-scale" checkout systems recently introduced into some supermarkets.

Here the label on the item is "read" as the checkout girl scans it with a special head. The data is then used to prepare the total cost and to inform the computing storage about the latest stock totals.

To demonstrate the capabilities of their self-scanned matrix array, IPL have developed a complete C.C.T.V. system based on the 64 x 64 array

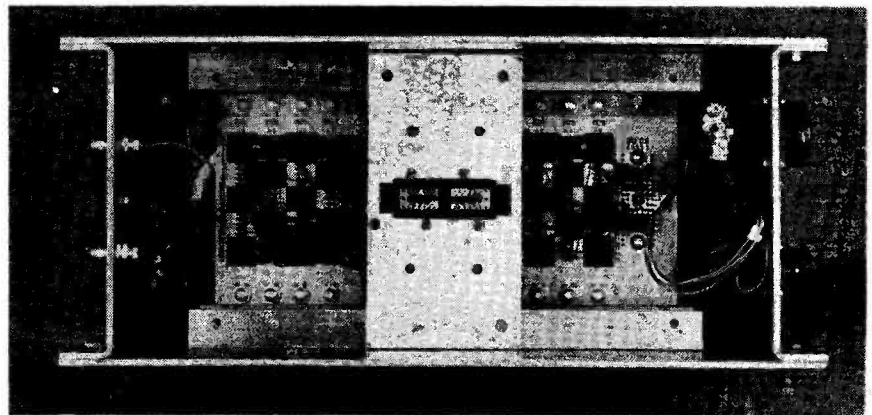

Fig. 11. Width gauging using two linear arrays.

MATRIX TV

element. Figure 13 shows the system using a cathode-ray tube to reconstruct the image.

It is clear that the basic technology exists for designers seriously to consider matrix television techniques.

As integrated circuit manufacture advances toward finer detail and more extensive LSI systems resolution will be improved and price reduced. Currently, it is more difficult to find

applications that *need* the fast rate of data obtainable than with its procurement.

We have come a long way since electricity and optics first came together in the instrument makers workshops.

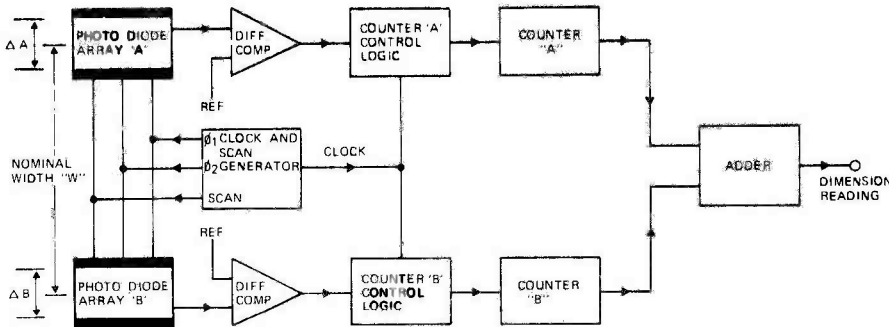

Fig. 12. Block schematic showing how two arrays are combined electronically to provide width variations.



Fig. 13. Although not primarily intended to rival conventional C.C.T.V. (at this stage of development) a useable picture can be formed with a 64 x 64 array. The reconstruction is made on a C.R. Tube.

BUILD THE TREASURE TRACER MK III



METAL
LOCATOR

AS SEEN
ON BBC-1
& BBC-2
TV

- Genuine 5-silicon transistor circuit, does not need a transistor radio to operate.
- Incorporates unique varicap tuning for extra stability.
- Search head fitted with Faraday screen to eliminate capacitive effects.
- Loudspeaker or earphone operation (both supplied).
- Britain's best selling metal locator kit.
- Kit can be built in two hours using only soldering iron, screw-driver, pliers and side-cutters.
- Excellent sensitivity and stability.
- Kit absolutely complete including drilled, tinned, fibreglass p.c. board with components siting printed on.
- Complete after sales service.
- Weighs only 22oz; handle knocks down to 17" for transport.

Send stamped, self-addressed envelope for literature.

Complete kit
with pre-built
search coil

£9.80

Plus 78p VAT
Plus 45p P&P

Built, tested
and
Guaranteed

£13.75

Plus £1.10 VAT
Plus 45p P&P

South Africa, Rhodesia etc:
Send £13.00 for kit, £16.95
built, both include Air Mail.

MINIKITS ELECTRONICS,
35d Langley Drive, Wanstead,
LONDON E11 2LN
(Mail order only)

BI-PRE-PAK

SUPPLIERS OF SEMI-CONDUCTORS TO THE WORLD



12 Watt stereo amp

Only 45p Special offer
£10 p. p. Limited quantity

This excellent little amplifier is of the latest integrated circuit design, and will work into 4, 8 or 16 ohm speakers. The reproduction is excellent for an amplifier of this size, only 8"x3"x2". The case is made of chromed metal.

Tested and Guaranteed Paks



B79	4	1N4007 Sil. Rec. diodes, 1,000 PV lamp plastic	50p
B81	10	Reed Switches 1" long 1/4" dia. High speed P.O. type	50p
H35	100	Mixed Diodes, Germ. Gold bonded etc. Marked and Unmarked	50p
.38	30	Short lead Transistors, NPN Silicon Planar types	50p
H41	2	Power Transistors Comp. Pair BD 131/132	50p
H63	4	2N3055 Type NPN Sil. power transistors. Below spec. devices	50p
H65	4	40361 Type NPN Sil. transistors TO-5 can comp. to H66	50p
H66	4	40362 Type PNP Sil. transistors TO-5 can comp. to H65	50p
H69	8	Integrated Circuits DTL data supplied Mixed types, Flip Flops, Gates, Hex Inverters etc.	50p



Unmarked Untested Paks

B1	50	Germanium Transistors PNP, AF and RF.	50p
B66	150	Germanium Diodes Min. glass type	50p
B84	100	Silicon Diodes DO-7 glass Equiv. to OA200, OA202	50p
B86	100	Sil. Diodes sub. min. IN914 and IN918 types	50p
B83	200	Transistors, manufacturers, rejects, AF, RF, sil and germ.	50p
H34	15	Power Transistors, PNP, Germ. NPN Silicon TO-3 Can. P & P Sp extra.	50p
H67	10	3B19 N Channel FET's plastic case type	50p
H68	10	Experimenters Pak of Integrated Circuits Data supplied DTL & TTL, some marked	50p

Make a rev counter for your car

The TACHO BLOCK. This encapsulated block will turn any 0-1mA meter into a linear and accurate rev. counter for any car with normal coil ignition system.

£1-00 each

Telephone dials

Standard Post Office type
Guaranteed in working order only **25p**

Electronic Transistor Ignition £6.00

Now in kit form, we offer this "up to the minute" electronic ignition system. Simple to make, full instructions supplied with these outstanding features:- Transistor and conventional switch-ability, burglar proof lock up and automatic alarm, negative and positive compatibility.

New X-Hatch

Our new, vastly improved Mark Two Cross-Hatch Generator is now available. Essential for alignment of colour guns on all TV receivers. Featuring plug-in ICs and a more sensitive sync. pick-up circuit. The case is virtually unbreakable—ideal for the engineer's toolbox—and only measures 3" x 5 1/2" x 3".

Ready built kit only **£9.95** Complete kit **£7.95**
(includes P & P, but no batteries)



LM 380 AUDIO IC

We have just received a large consignment of LM380 ICs. These are specially selected to a higher grade and are marked with the number SL80745. This fantastic little 3 watt audio IC only requires two capacitors and two potentiometers to make an amplifier with volume and tone control. The quality is good and has to be heard to be believed.

Our special price **£1-00** complete with data and projects book

Over 1,000,000 Transistors in stock

We hold a very large range of fully marked, tested and guaranteed Transistors, Diodes and Rectifiers at very competitive prices. Please send for Free Catalogue.

Our very popular 4p Transistors

FULLY TESTED & GUARANTEED
TYPE "A": PNP Silicon alloy, TO-5 can.
TYPE "B": PNP Silicon, plastic encapsulation.
TYPE "E": PNP Germanium AF or RF.
TYPE "F": NPN Silicon plastic encapsulation.
TYPE "G": NPN Silicon, similar ZTX300 range.

8 RELAYS FOR £1-00 P & P 27p.
Various Types

UHF TV Tuner Units

for 625 line channels 21 to 65

Brand new by a famous

manufacturer

Data supplied **£2.50**

Plastic Power Transistors



40 WATT SILICON

Type No	Gain	VCE	Polarity	Price
40N1	15	15	NPN	20p
40N2	40	40	NPN	30p
40P1	15	15	PNP	20p
40P2	40	40	PNP	30p

90 WATT SILICON

Type No	Gain	VCE	Polarity	Price
90N1	15	15	NPN	25p
90N2	40	40	NPN	35p
90P1	15	15	PNP	25p
90P2	40	40	PNP	35p

L.E.D.'s complete with mounting grommet
Red 25p Green 40p

INTEGRATED CIRCUITS

We stock a large range of I.C.s at very competitive prices. These are all listed in our FREE Catalogue. See coupon below.

METRICATION CHARTS now available

This fantastically detailed conversion calculator carries thousands of classified references between metric and British (and U.S.A.) measurements of length, area, volume, liquid measure, weights etc. Pocket Size 12p. Wall Chart 18p.

LOW COST DUAL IN LINE I.C. SOCKETS

14 pin type at 15p each }
18 pin type at 17p each } Now new low profile type.

BOOKS

We have a large selection of Reference and Technical Books in stock.

BUMPER BUNDLES

These parcels contain all types of surplus electronic components, printed panels, switches, potentiometers, transistors and diodes, etc.

2 LBS in weight for £1-00

Post and Packing 27p.

Our famous P1 Pak is still leading in value

Full of Short Lead Semiconductors & Electronic Components, approx. 170. We guarantee at least 30 really high quality factory marked Transistors PNP & NPN and a host of Diodes & Rectifiers mounted on Printed Circuit Panels. Identification Chart supplied to give some information on the Transistors.

Please ask for Pak P.1. only **50p**

Please send me the FREE BI-Pre-Pak catalogue. I enclose large s.a.e. with 5p stamp. Please add VAT at current rate.

NAME
ADDRESS

MINIMUM ORDER 50p. CASH WITH ORDER PLEASE. Add 15p post and packing per order. OVERSEAS ADD EXTRA FOR POSTAGE.

Buy these goods with Access.

BI-PRE-PAK LTD

Co. Reg. No. 820919

Dept. H. 222-224 WEST ROAD, WESTCLIFF-ON-SEA, ESSEX.

TELEPHONE: SOUTHEND (0702) 46344.

RADIO

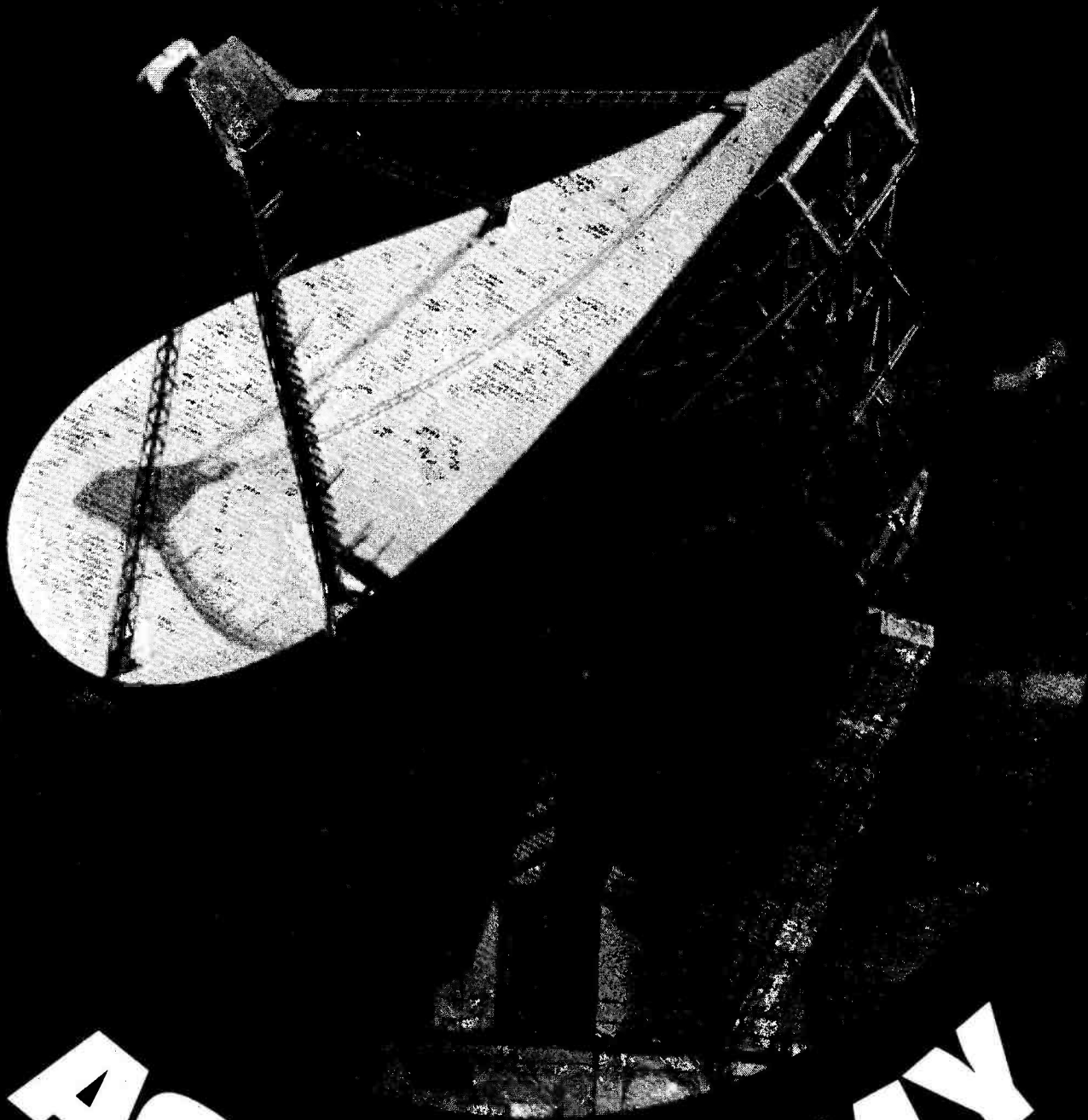

ASTRONOMY

By C. Bruce Sibley

During recent years, our concept of the Universe and of our own place in it has been turned completely upside-down by the discoveries of the radio astronomer. Radio signals radiated by our Sun and Planets; from the debris of exploding stars and fast moving galaxies; from vast clouds of gaseous material; and lastly, from the most distant objects of all - the Quasars and Pulsars, have presented mankind with a valuable tool to probe the innermost secrets of energy, time and space.

Radio Astronomers have taken over the helm in charting the maps of the heavens. Their investigations have probed deeply into our own galaxy, the Milky Way, revealing that our own Sun with its tiny system of nine planets travels some 180×10^{15} miles from the galaxy's centre - we live at the edge of the Milky Way, an enormous spiral system of stars, planets and moons - we are a mere dot amongst millions of millions.

COSMIC RADIO EMISSION was first discovered in 1932 by a young American radio engineer, Karl Jansky, an employee of Bell Telephone Laboratories, USA. Jansky has been assigned to investigate the sources of radio static which disrupt short-wave radio traffic. Some of the static appeared to have no earthly origin and further observations suggested that the 'noise' was coming from outer space - from the centre of the Milky Way to be exact! Although Jansky published his discovery in the Proceedings I.R.E. (now I.E.E.E., USA), scientists paid little attention. Radio was a young science and there was much to do by way of improving telecommunications without diverting effort elsewhere.

However, one man did take note of Jansky's report and became highly intrigued by the thought of tuning into radio signals from the depths of galactic space. This was Grote Reber who spent nearly 11 years (1934-1945) recording and plotting the 'noises' of space. He can truly lay claim of the title of 'first' radio astronomer.

Reber's equipment was years ahead of its time, anticipating most of Radar and Microwave techniques used in the Second World War. He designed and constructed all of his equipment, including a 30ft dish antenna - the first radio telescope! He experimented with various new radio valves and modified them to meet his requirements in the quest for perfecting very

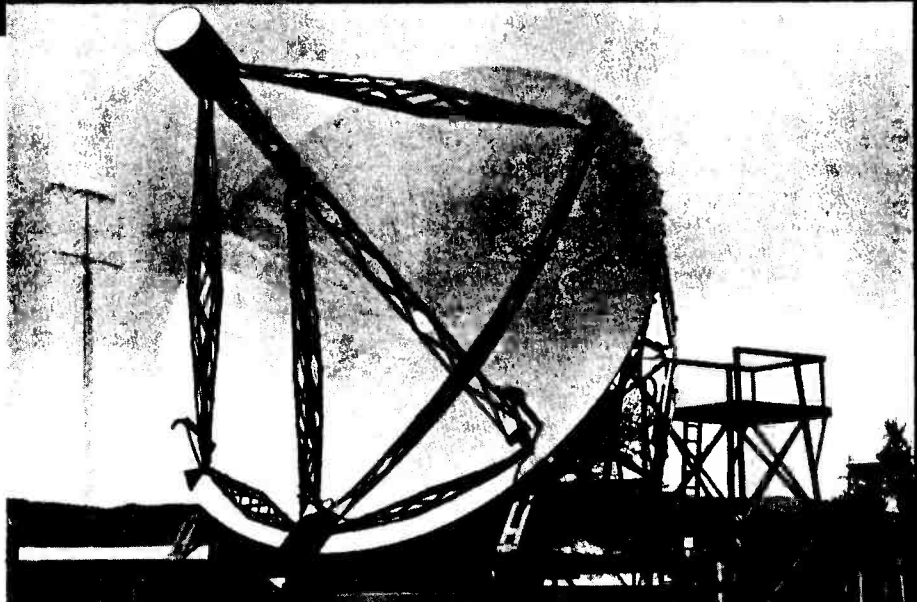

Grote Reber's home-made dish antenna - years ahead of its time.

low noise amplifiers; the noise from space was exceedingly weak and Reber quickly realised that extremely low noise techniques were necessary. He published several papers and articles on his findings in the Proc. I.R.E. (now I.E.E.E. (USA)), giving details of his equipment. His early maps plotting the noise distribution of space parallels the work done in later years by others.

During the war, the radar networks of both sides began to experience severe forms of interference. Experts spent a great deal of time eliminating the possible causes of this annoying 'snow storm' on the radar screens. Both sides had learnt various games of subterfuge, like dropping long and short pieces of metallic strip from attacking aircraft and confusing the radar plotters as to how many raiders were actually approaching the target areas. However, investigations soon showed that another source was responsible the interference was coming from the Sun!

From time to time, the Sun becomes extremely active; about every 11 years. At these cyclic moments, the solar surface becomes pock-marked with markings called 'sun-spots'. Sun-spots are areas of intense nuclear activity and also giant whirlpools of magnetic force. The reaction between these two agencies releases enormous amounts of radiant energy in the form of 'ionized' particles and a wide spectrum of electro-magnetic radiation. The latter form of radiation reaches the vicinity of the Earth in 8 minutes, travelling at the speed of light. Meantime the 'ionized' portion of the ejected solar radiation takes much longer to travel the 93 million miles distance between the Sun and the Earth - between 24 and 36 hours - travelling at speeds of between 1077 and 718 miles per second.

When this solar radiation hits the earth's upper atmosphere and magnetic field, enormous ionic storms occur and the entire 'ionosphere' becomes disturbed and short-wave radio transmissions become much weakened and distorted. Simultaneously with the commencement of these 'storms', radio receivers detect a considerable increase in noise level, heralded on radar screens as 'snow' patterns and as hissing in the loudspeaker.

After the war, scientists returned to peaceful research and many turned their attention to radio astronomy. The huge advances made in the field of telecommunications and electronics were now channelled to meet the needs of radio astronomy. Wartime equipment was quickly converted into low noise receivers, various antennas (including several 'captured' German microwave dishes) were re-assembled and pointed skywards. Britain and Australia led the way in this new enterprise with Holland and the USA close behind. Today, most advanced nations participate in this field of research and the science has sprouted a veritable mountain of data leading down many corridors of scientific investigation; even biology has been influenced by the discoveries of radio astronomers!

THROUGH THE WINDOW

The power intensity of cosmic radio noise is extremely weak, one value for a very distant source quotes 0.000, 000,000,000,001 watt! Thus radio telescopes and their receiving equipment must push the current engineering techniques to their absolute perimeter of performance. Radio telescopes vary in size depending on the task required of them. Small aerials a few feet across will usually serve the requirements involving the recep-

tion of solar radio noise - with one or two important exceptions. Larger telescopes are usually constructed for the task of probing deep into galactic space. Some telescopes are built to stand on supporting structures that can tilt or rotate the antenna into any required direction, like the 250 foot dish at Jodrell Bank, UK. Alternatively the size of the collecting bowl may prohibit motorised movement such as the huge 1000 foot dish at Arecibo, Puerto Rico. This telescope is sculptured from the ground itself; surrounding mountain tops act as part of the pillar supports for the enormous gantry that hangs at the point of focus 500 feet above the centre of the reflector. This gantry is the site of the 'pick-up' antenna (or transmitting antenna when used for sending Radar signals to the planets). The entire structure scans the sky by using the rotation of the earth.

Other radio telescopes consist of miles of dipole antennas supported on short poles and switched into circuit as required.

One important advantage that radio astronomy exercises over optical astronomy lies in its ability to operate regardless of weather conditions.

The atmosphere is a complicated mixture of gases and varying amounts of water vapour. These constituents combine together and act as a powerful screen to all life on the earth - without this protection all plants and animals would die of intense solar irradiation. Equally miraculously the atmosphere does permit 'necessary' radiation to pass through a series of 'natural' windows. Ordinary sunlight, heat rays, some weak Ultra-Violet light and radio waves find access to the ground through these atmospheric windows. Astronomers utilise these windows to study the radiation beyond.

THE CAUSES OF COSMIC RADIO NOISE

Cosmic radio noise is generated by a variety of strange phenomena, many of these are as yet not fully understood, but noise is produced by interstellar gases, free electrons and magnetism, thermal processes, atmospheric forces and gravitational forces.

GAS NOISES

Throughout the Universe there exist copious quantities of gaseous debris, the fragments of cosmic collisions and explosions. Much of this debris consists of fine clouds of hydrogen which, as a result of changes within the energy level of individual atoms, radiates a precise radio signal at 1420.4057MHz. Astronomers can use the 'radio fingerprint' to track these

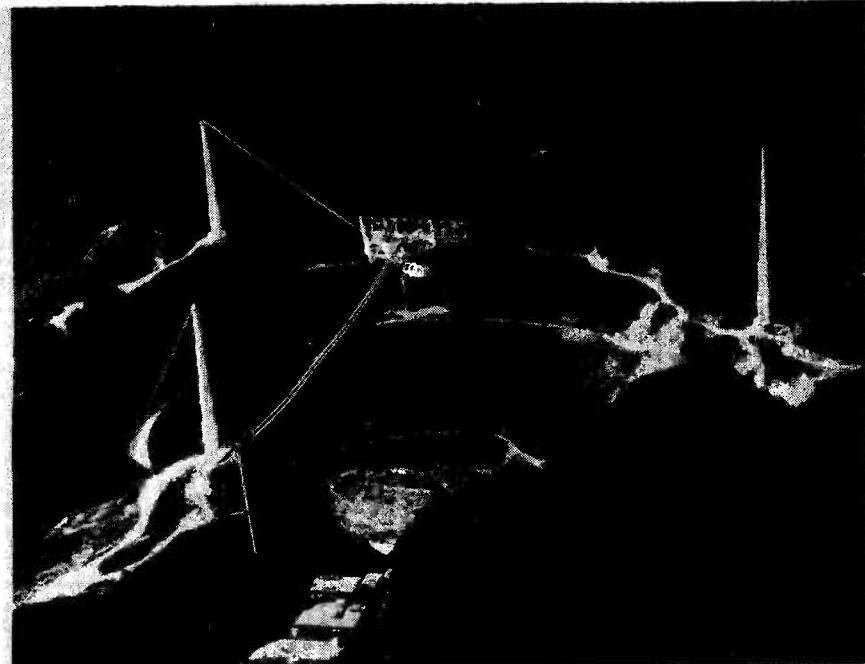

The largest non-steerable radio telescope in the world at Arecibo, Puerto Rico - 1000 foot in diameter.

clouds and their speed of travel throughout the Universe.

The Dutch astronomer, Van De Hulst, suggested the existence of a Hydrogen 'line-emission', in 1943, but it was not until 1951 that his prediction was proved correct! Since then, several 'emission-lines' have been observed among which molecules of Hydroxyl, Ammonia, Water, and Formaldehyde have featured - each a constituent of the basic building blocks of life itself.

FREE ELECTRON NOISE

Free electrons (escapes from nuclear reactions), travel at various speeds throughout space. In the course of these wanderings they encounter several areas of strong magnetic influence. When electrons travel along lines of magnetic force they move in a spiral motion. As they spiral around and around they emit radiation over a wide band of frequencies, much of this in the radio spectrum. Receivers on earth are able to detect this radio noise and thus examine not only the probable electron density of a particular area under observation, but also establish other factors such as the level of magnetic intensity, temperature, and distance, etc, etc. Noise from spiraling free electrons is called *synchrotron* radiation after the self-same effect logged in the earth-bound laboratories of nuclear research. Atom smashers produce similar results!

THERMALLY GENERATED RADIO NOISE

Like other stars, our Sun 'burns'

nuclear energy. The temperature of this seemingly eternal furnace reaches unimaginable heights - perhaps more than a million degrees inside its fiery atmosphere. The 'stripped' nuclear particles of this atmosphere whirl about in frenzied motion generating huge amounts of dangerous radiation and prodigious radio noise. The amount and spectrum range of star's radiation depends directly on its evolutionary state. A less active body will generate correspondingly less noise. Our Sun generates a considerable amount of radiation and radio noise which tends to increase dramatically in level every 11 years, called the 'sun-spot' cycle. At these times, the last peak was 1968/69, very high radio noise levels were recorded throughout the radio spectrum. Most experts believe that there are longer cyclic variations in solar activity and that the 11 year one is only part of the story. All the planets of the solar system 'bathe' in the 'solar-wind', it blows continuously across interplanetary space enveloping all in its path.

The planets themselves exhibit a personal temperature regardless of solar absorbed heat. Bodies radiate their own temperature data by means of 'infra-red' radiation. This radiation lies at the top of the radio wavelength spectrum. Measurement of the 'noise temperature' of any radiating object (including icebergs) can be accomplished using specially designed equipment. Volcanic 'hot-spots' can be detected by these methods.

NOISE FROM ATMOSPHERIC SOURCES

Radio scanning of the Moon and

planets has revealed self-generated 'thermal' noise. But in one particular instance another type of noise making phenomenon has been discovered. When the early radio astronomers turned their attention to the huge planet of Jupiter they were amazed to discover that Jupiter was generating powerful pulses of radio noise around 22MHz. This noise consists of short sharp bursts of static, rather similar in character to that of terrestrial storm static. Hence one of the theories put forward to explain this strange Jovian noise relies heavily on the concept of Jovian thunderstorms, though of course the magnitude of such storms would be considerably larger in relation with the size of Jupiter. Another theory points at the idea of Jupiter's radiation belts interacting with the planets magnetic field and producing noise. Lastly, there is another hypothesis that the red spot, a feature plainly seen on the surface of Jupiter, triggers the discharge of naturally generated electricity residing in the atmosphere. We may be witnessing the very same events that began life upon Earth.

NOISE GENERATED BY GRAVITATIONAL COLLAPSE

Pulsars are thought to be the product of stars of a particular type and in a unique gravitational state. The term 'gravitational collapse' really explains itself - a body collapsing under its own gravitational force. With Pulsars we have a situation that tests our concept of normal experience - when a body

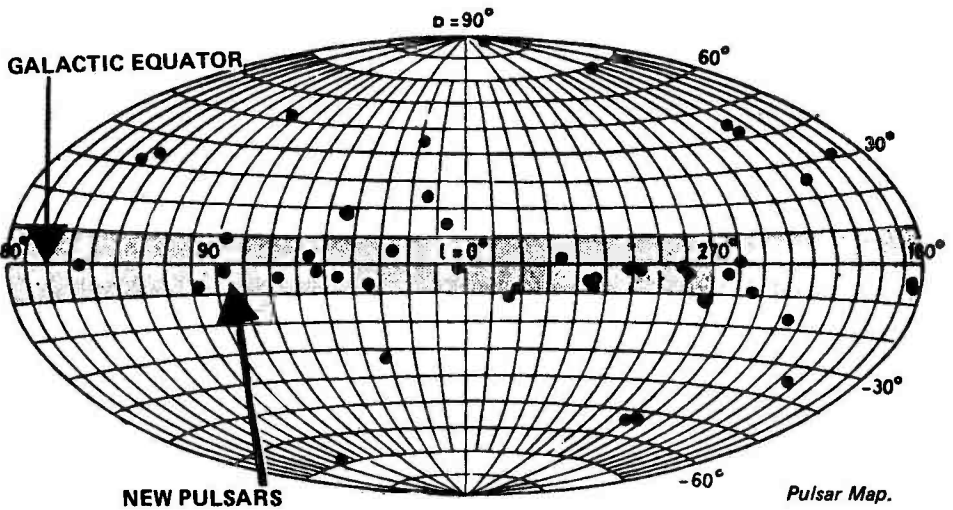

gets smaller and smaller, and the material within gets packed more tightly together, curious and entirely new rules of physics begin to reveal themselves. Strange and quite bizarre things occur. One of these new and difficult to understand phenomena takes the form of pulsed radio noise - but quite fantastic and beyond the normal everyday measurement of radio astronomers. The radio pulse emitted by collapsing stars (called neutron stars) takes the form of precision pulses and not only that, their radiating power is enormous.

If we take the evolution of a neutron star to its logical conclusion, we finally reach a point where *no* radiation escapes because the force of gravitation is so great - we get a

'black hole' in space - our pulsar stops sending and collapses into "something" we can only speculate about!

RESOLVING POWER - SEEING CLEARLY

Next time you go for a walk at night, look up at that nearby office block. Notice that you are so close to the windows that you can perceive the light streaming from each and every window. Your eyes are capable of 'resolving' this image. Now get into your car and travel to some distant point where you can again observe the same building. The further and further away you travel from the block the harder it will become for your eyes to perceive the individual points of light. Finally you will be at such a distance from the image that all the illuminated windows merge as one splash of light.

This is a simple demonstration of what is termed 'resolving power'. Most of us are familiar with the inability of resolving distant objects - though we know that what we see cannot be!

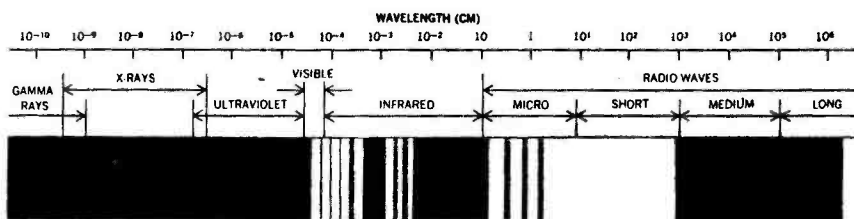

The Earth's Atmospheric 'Windows' (white), and absorption (black strips).

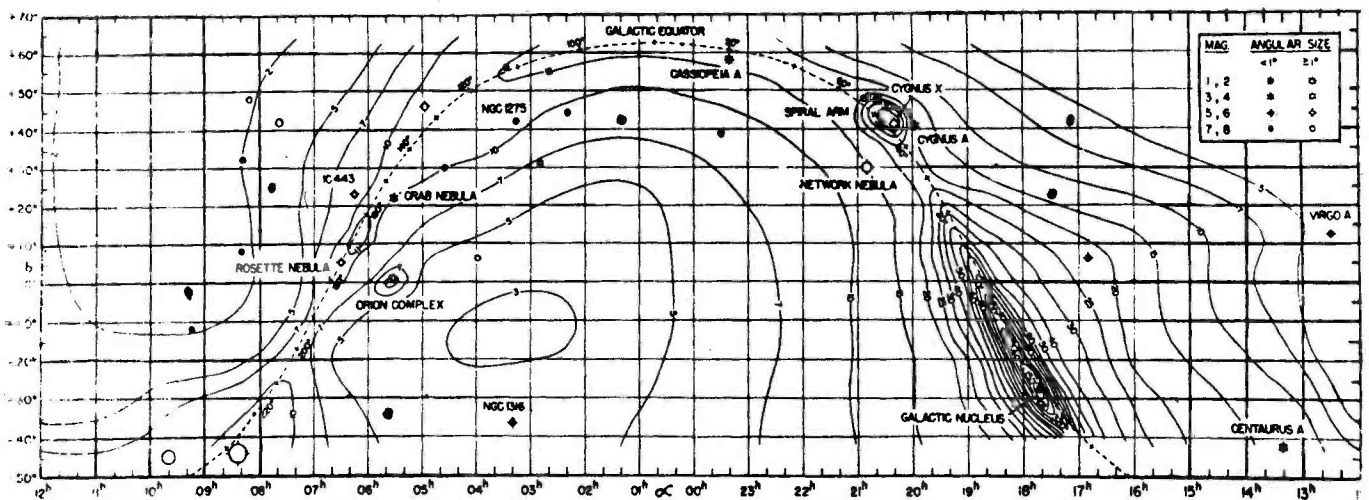

Map of 'radio brightness' of the sky. Point sources of identified stars shown as black dots.

Railway tracks, street lamps, roads, houses, trees, telegraph poles 'do not' merge as one at a distance.

But in astronomy we have no first hand experience of what is 'out there' we have no celestial tape measure to confirm that this or that object is really as we see it. The very distant point of starlight may belong to one, two, three, or more stars. Unless we can achieve high telescopic resolution we shall never know the answer to this conundrum.

Bigger and better telescopes are being built all the time but there are 'physical' limits to their size and precisional movement. It is doubtful if any optical telescope larger than 300 inches will be built on the surface of this planet unless some new and dramatic change in optical telescope design takes place. But with radio telescopes there is considerable room for improvement and advanced sophistication. The 1000 foot bowl of Arecibo has already been mentioned but we need not be hamstrung by the limit on physical size and mobility. We can circumnavigate this by building several Jodrell Bank sized telescopes and siting them in specific places all over the globe. In conjunction with these installations we link each radio telescope with its neighbour via a computer. The entire system is monitored by an atomic clock so that individual observations can be 'tagged' by time signals having accuracies of the order of one billionth of one second. By pre-programming each telescope to one specific area of the sky and matching their sum observations with the clock and analysing the result by computer, resolving powers of a few millisecond of Arc diameter are obtained!

We call this new system of observation, 'long baseline interferometry'. One day they may have such a system existing between the Earth and Moon!

NEW DISCOVERIES

During the last decade the science of radio astronomy has been shaken to its young foundations by the discovery of hitherto unsuspected objects - the Quasar and Pulsar. Most recently of all, other even more fascinating objects have been 'discovered' - black holes!

The Quasar, a distant yet fantastically powerful radiating source, has presented several conundrums to science. Their 'doppler shifts', a means of measuring speed and direction of travel, indicated that Quasars were immensely distant objects, yet other evidence pertaining to the signal strength indicated the opposite and that they were relatively close to us.

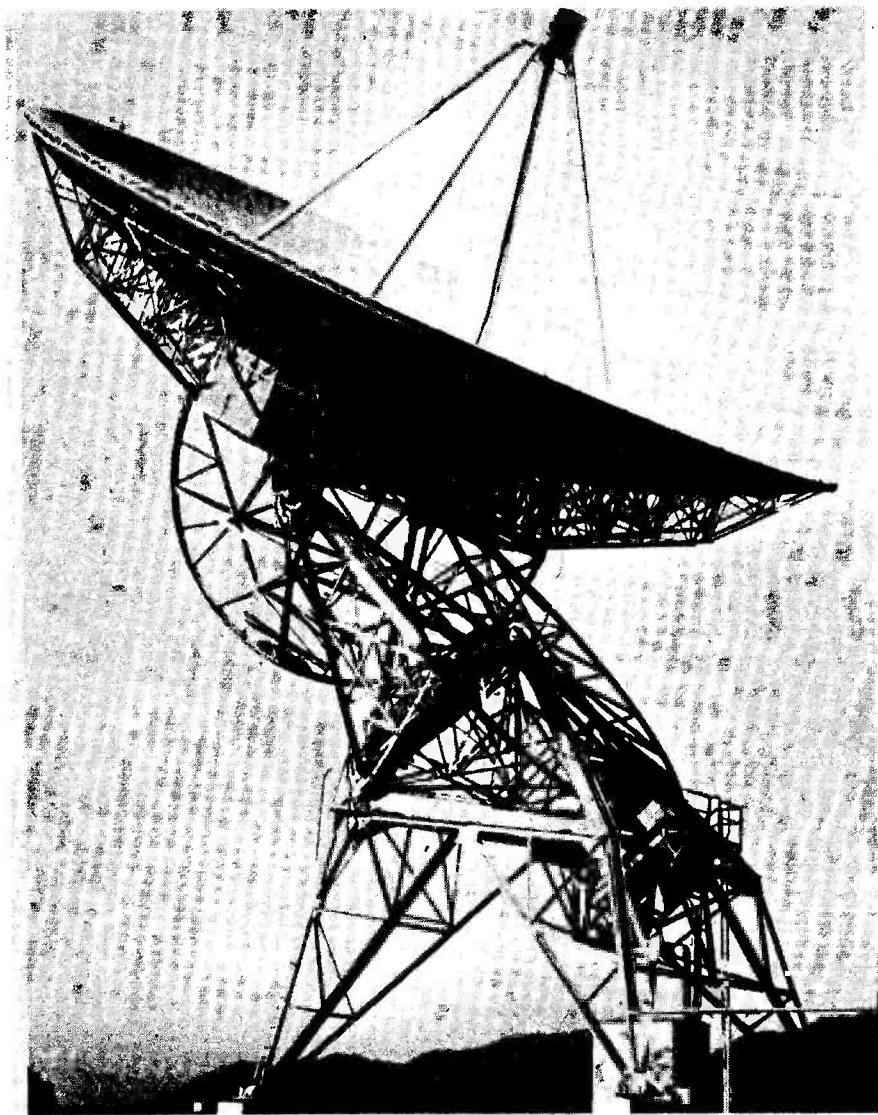

The 85 foot radio telescope at the U.S. National Radio Astronomy Observatory at Green Bank, West Virginia. Through the lens of this giant telescope American astronomers made the first observations of the surface of the planet Venus.

The Pulsar, another object yet equally powerful as a radiating source, confounded everybody at first by its inconceivable precision. Pulsars transmit pulses of radio energy just like earthbound radar transmitters. The 'ticking' rate varies from one Pulsar to another, but all exhibit astounding precision. One Pulsar stays switched on for a precise 1.33730113 seconds! Another delivers four pulses per second - 'on' time = .0601967 sec and 'off' time = .253071 sec.

As explained in the early section covering the sources of radio noise, gravitational collapse is the mechanism thought responsible for these almost unbelievable 'natural' objects. When they were first discovered it was thought that they were the product of some advance inhabitants of the Universe, they still seem like something to do with space travel and navigation rather than the objects most scientists would have us believe.

From the Pulsar we conclude our discussion pausing just for a few

moments to consider the newest and strangest of all phenomena - the 'black hole'. Astronomers are still arguing about its true nature or even in its existence! If, as stated earlier in this article, Pulsars can collapse down to absolute nothingness then surely there will just be a hole. Just like that proverbial oozelem bird that 'disappeared' after flying around in ever decreasing circles! However, other experts argue that should gravity collapse to this degree, *all* radiation, including 'light' and 'radio' would fail to escape from its grip and we should be quite unaware of its existence in the first place! The arguments and searching for 'real' black holes continues.

Several interesting ideas regarding time and space have evolved as a consequence of the 'black-hole' debate. Time itself will become changed by the huge force of compacted gravity, and, if one could survive the journey through the 'hole' where would one be on the other side? ●

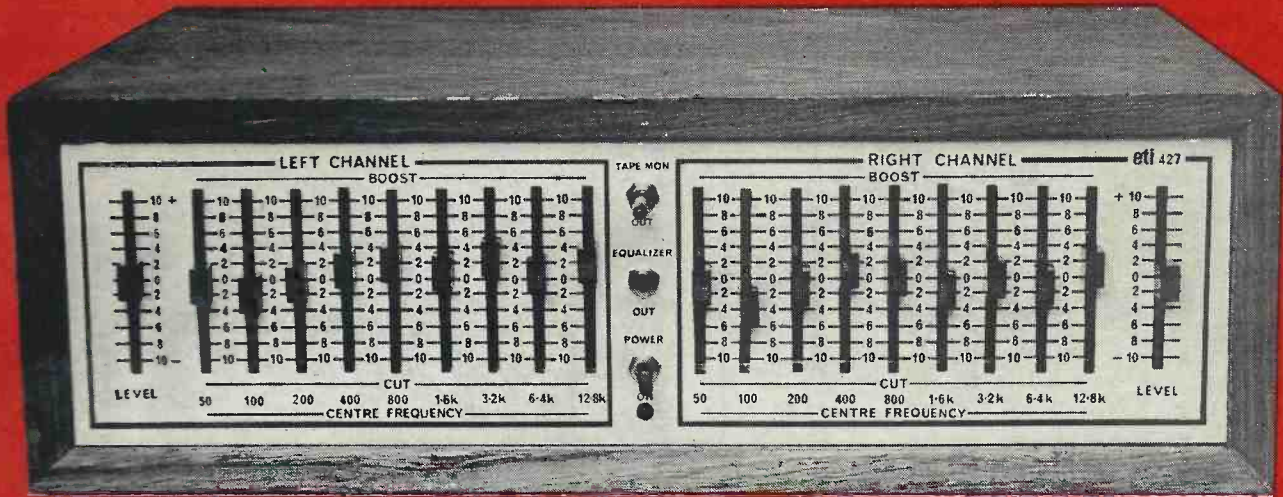

eti PROJECT 427

GRAPHIC EQUALIZER

A unit that compensates for speaker and room deficiencies.

MANY audiophiles are discovering the advantages of graphic equalizers in domestic as well as professional sound systems. Unfortunately the costs of such units have prevented them becoming as popular as warranted by the many advantages they offer.

The advantages of an equalizer are not generally well known but are as follows.

Firstly an equalizer allows the listener to correct deficiencies in the linearity of either his speaker system alone, or the combination of his speaker system and his living room.

As we have pointed out many times in the past, even the best speakers available cannot give correct reproduction in an inadequate room. It is a sad fact that very few rooms are ideal, and most of us put up with resonances and dips, sadly convinced that this is something we have to live with.

Whilst the octave equalizer will not completely overcome such problems, it is possible to minimize some non-linearities of the combined speaker/room system.

In a concert hall it is also possible to use the unit to put a notch at the frequency where microphone feedback occurs, thus allowing higher power levels to be used.

Thirdly, for the serious audiophile, an equalizer is an exceedingly valuable

tool in evaluating the deficiencies in a particular system. One adjusts the equalizer to provide a uniform response, the settings of the potentiometer knobs then graphically display the areas where the speaker etc is deficient.

There is a snag, however, one must have an educated ear in order to properly equalize a system to a flat response. It is not much use equalizing to your own preference of peaky bass etc in order to evaluate a speaker.

Ideally, a graphic equalizer should

MEASURED PERFORMANCE (of Prototype)

Frequency Response		
Equalizer out		Flat
Equalizer in	10 Hz – 10 kHz	$\pm \frac{1}{2}$ dB
and all controls at zero	1.5 Hz – 30 kHz	$+ \frac{1}{2} - 3$ dB
Range Of Control		
Individual filters		± 13 dB
Level control		$+ 14 - 9$ dB
Maximum Output Signal		> 6 volts
at $< 1\%$ distortion		
Maximum Input Voltage		3 volts
Distortion		
at 2 volts out, controls flat	100 Hz 1 kHz 6.3 kHz	$< 0.1\%$ $< 0.1\%$ $< 0.1\%$
Signal to Noise Ratio		
at 2 volts out (unweighted)		69 dB
Input Impedance		50 k
Output Impedance		4.7 k

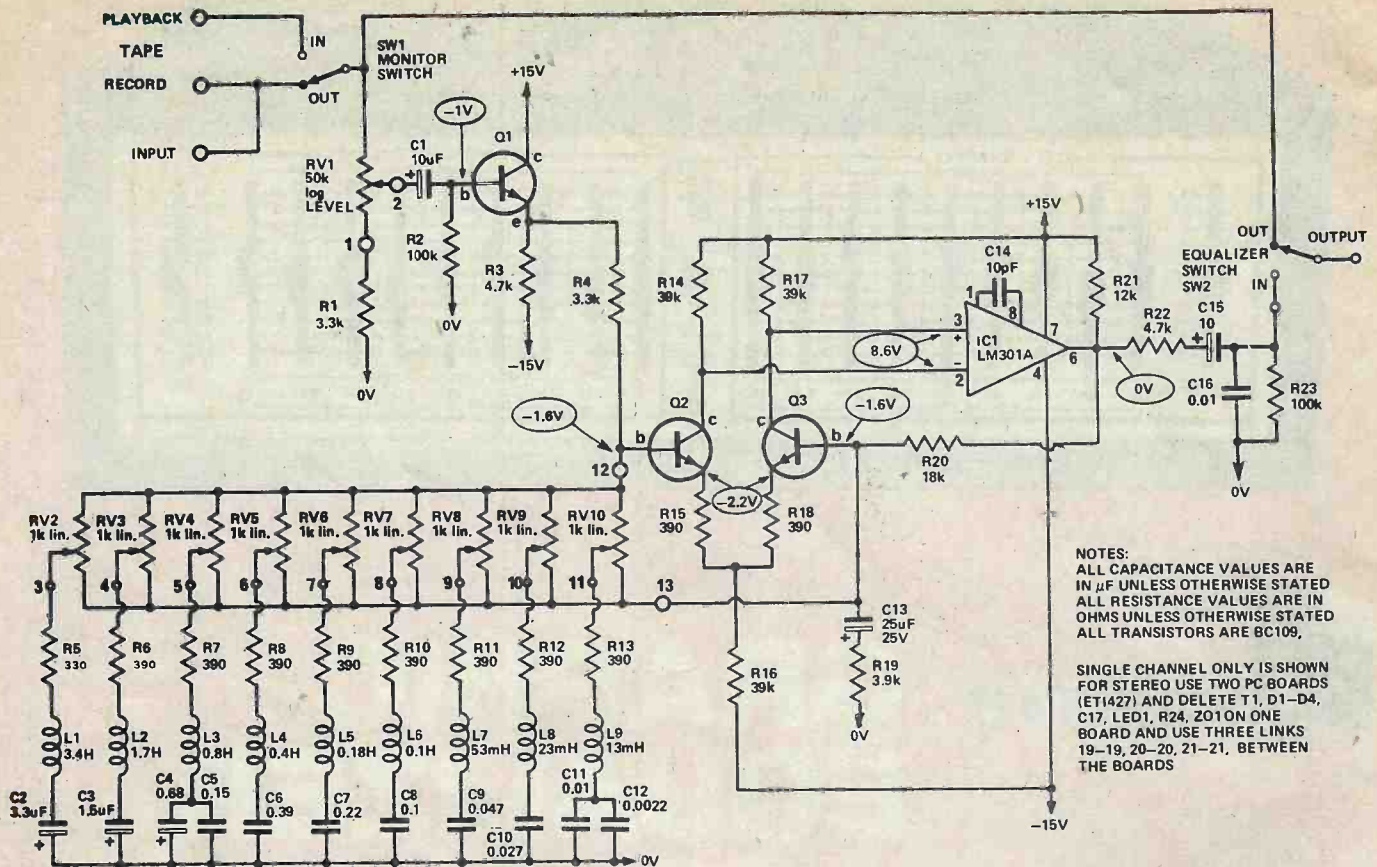

NOTES:
 ALL CAPACITANCE VALUES ARE IN μ F UNLESS OTHERWISE STATED
 ALL RESISTANCE VALUES ARE IN OHMS UNLESS OTHERWISE STATED
 ALL TRANSISTORS ARE BC109,
 SINGLE CHANNEL ONLY IS SHOWN FOR STEREO USE TWO PC BOARDS (ET1427) AND DELETE T1, D1-D4, C17, LED1, R24, Z01 ON ONE BOARD AND USE THREE LINKS 19-19, 20-20, 21-21, BETWEEN THE BOARDS

Fig. 1. Circuit diagram of one channel of the equalizer.

GRAPHIC EQUALIZER

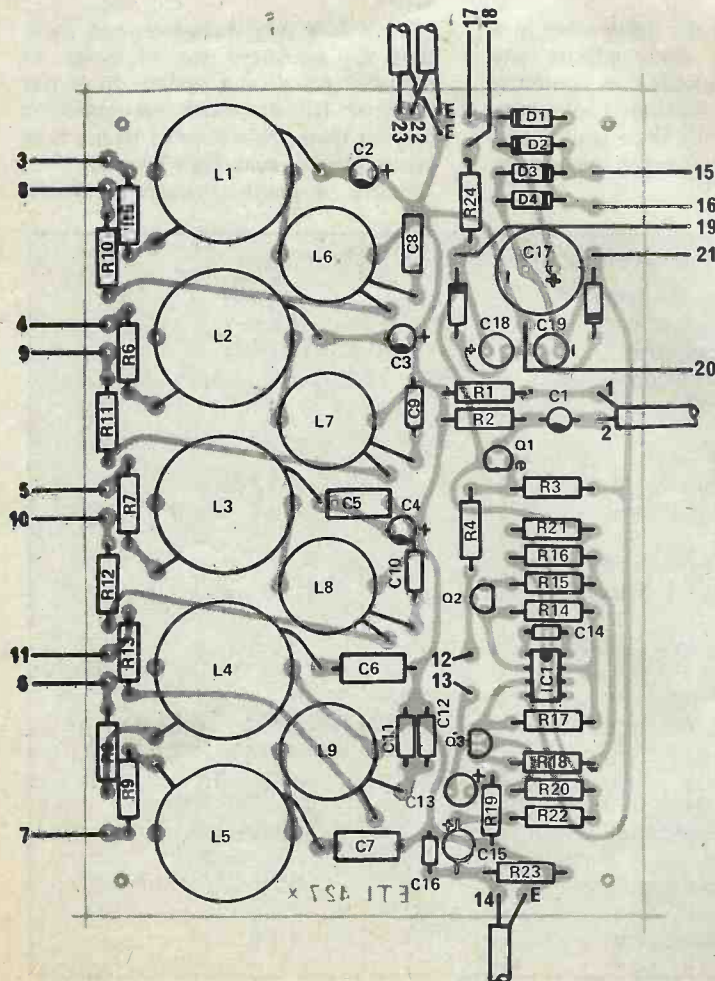

Fig. 2. Component overlay of the equalizer (one channel only)

have filter at 1/3 octave intervals, but except for sound studios and wealthy pop groups, the expense and size of such units are too much for most people.

Recently some excellent commercial units have become available with filters spaced at octave intervals. These are relatively inexpensive and cater for the needs of most professionals and domestic users. Such a unit is the Soundcraftsmen 2012 which we hope to review in the next issue.

The Electronics Today Equalizer has been designed to provide nine filters spaced at octave intervals in each of two channels. It is simple to construct and should be available inexpensively in kit form in the near future.

HOW IT WORKS ETI 427

This equalizer is basically similar to those used in the ETI Synthesizer and master mixer projects with the exception that it has nine filter sections per channel.

The equalizer stage is a little unusual in that the filter networks are arranged to vary the negative feedback path around the amplifier. If we consider one filter section alone, with all others disconnected, the impedance of the LCR network will be 390 ohms at the resonant frequency of the network. At either side of resonance the impedance will rise (with a slope dependant on the Q of the network which is 2.5) due to the uncancelled reactance. This will be inductive above resonance and capacitive below resonance. We can therefore represent the equalizer stage by the equivalent circuit below.

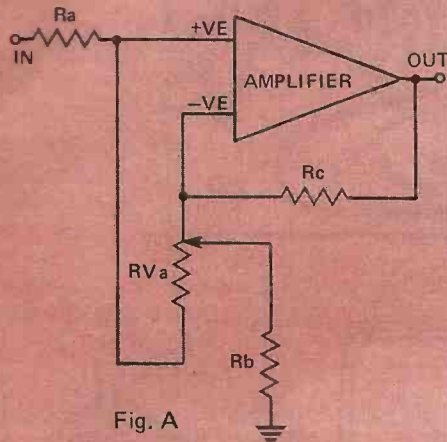

Fig. A

It must be emphasized that this equivalent circuit represents the condition with one filter only, at its resonant frequency. Additionally letters have been used to designate resistors to avoid confusion with components in the actual circuit.

With the slider of the potentiometer at the top end (Fig. A) we have 390 ohms to the OV line from the negative input of the

amplifier, and 1k between the two inputs of the amplifier. The amplifier, due to the feedback applied, will keep the potential between the two inputs at zero. Thus there is no current through RVA. The voltage on the positive input to the amplifier is therefore the same as the input voltage since there is no current through, or voltage drop across resistor RA.

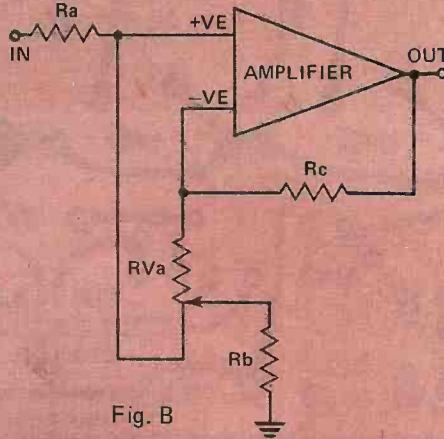

Fig. B

The output of the amplifier in this case is approximately the input signal times $(3300 + 390)/390$ giving a gain of 19 dB. If the slider is at the other end of the potentiometer, (Fig. B), the signal appearing at the positive input, and thus also the negative input, is about 0.11 $(390/(3300 + 390))$ of the input. There will still be no current in the potentiometer and in RC, thus the output will be 0.11 of the input. That is, the gain will be -19 dB.

If the wiper is midway, both the input signal and the feedback signal are attenuated equally, and the stage will have unity gain.

With all filter sections in circuit the maximum cut and boost available is reduced, but ± 14 dB is still available.

Reverting back now to the actual circuit,

the amplifier consists of IC1, Q2 and Q3. The transistors help to reduce the effect of the noise in the IC and add gain at the high-frequency end. This additional gain is required because the negative feedback, due to the potentiometer between the two inputs, causes high-frequency roll off. This does not affect operation of the unit provided the open-loop gain is above 60 dB over the entire audio range. An overall closed-loop gain of about 15 dB is

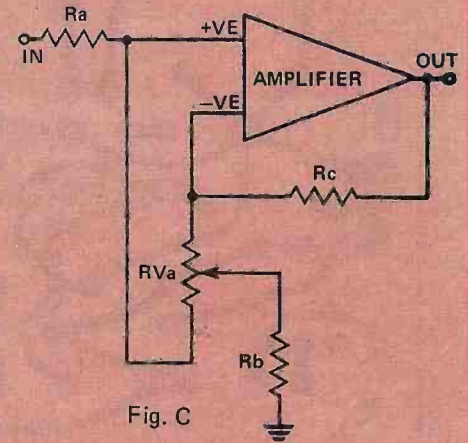

Fig. C

maintained by R20/R19 with the filter potentiometer at mid position.

The output of the amplifier is decoupled to the output of the unit via C15, and C16/R22 provide a cutoff above 30 kHz.

The input signal is buffered by Q1 because the equalizer stage requires a low impedance signal source for correct operation. Potentiometer RV1 provides level control with 0 to -23 dB range which, combined with the equalizer characteristic, results in an overall level range of +14 to -9 dB.

The power supply used is a simple, full-wave bridge filtered by C17. Plus and minus supplies are derived by means of two 15 volt zeners in series fed via R24. The front-panel power indicator is an LED connected in series with the dropping resistor R24.

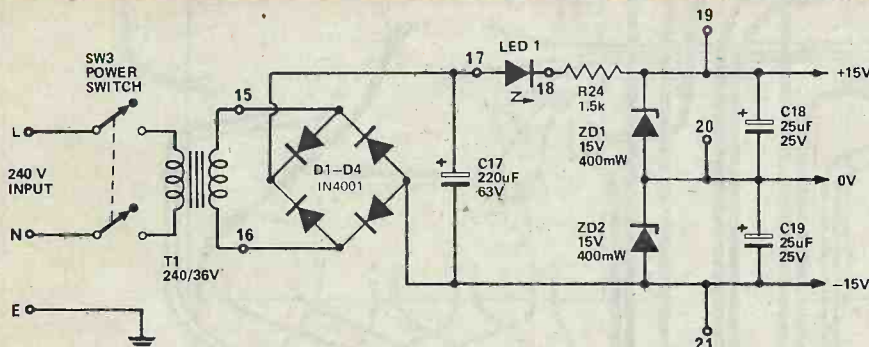

Circuit diagram of the equalizer power supply.

CONSTRUCTION

All components, with the exception of the transformer and the slide potentiometers, are mounted on two printed circuit boards — one for each channel. Whilst the layout is not critical, any alternative construction method could be used, we strongly recommend the use of printed-circuit boards to ease construction and eliminate a possible source of faults.

The components should be assembled to the boards with the aid of the overlay Fig. 2. Carefully check polarities of ICs, capacitors and transistors, etc, before soldering in place. Attach lengths of wire and Coax of adequate length to the board before mounting in position by means of 13mm spacers.

Due to the close spacing used for the slide potentiometers it is necessary to

mount the 9.6 mm spacers, to the potentiometer support-bars, before mounting the potentiometers. Use 6.4 mm long countersunk screws for this purpose.

The potentiometer assembly, and all other external components, (switches etc) can now be assembled to the chassis and the unit wired as shown in the interconnection diagram.

The circuits used have very high gains and it is necessary to take precautions

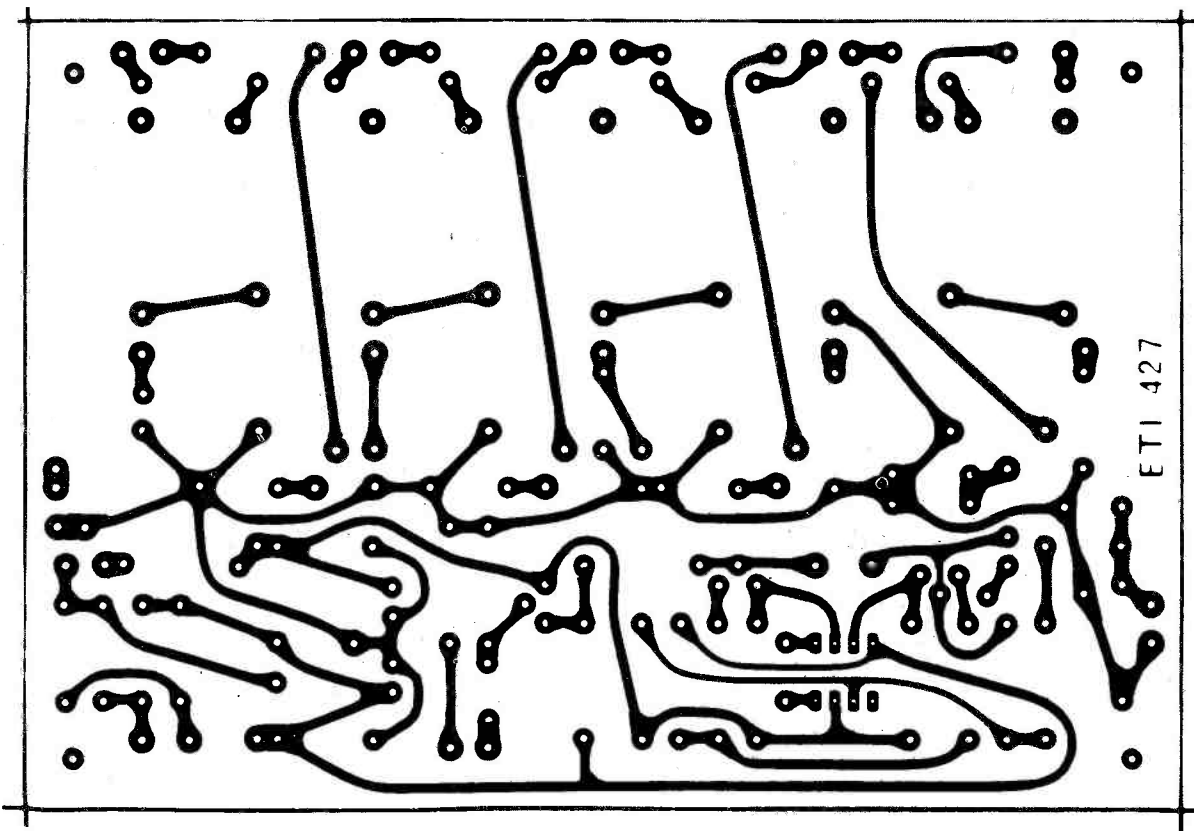

Fig. 4. Printed circuit board for the equalizer. Full size 152 x 103 mm.

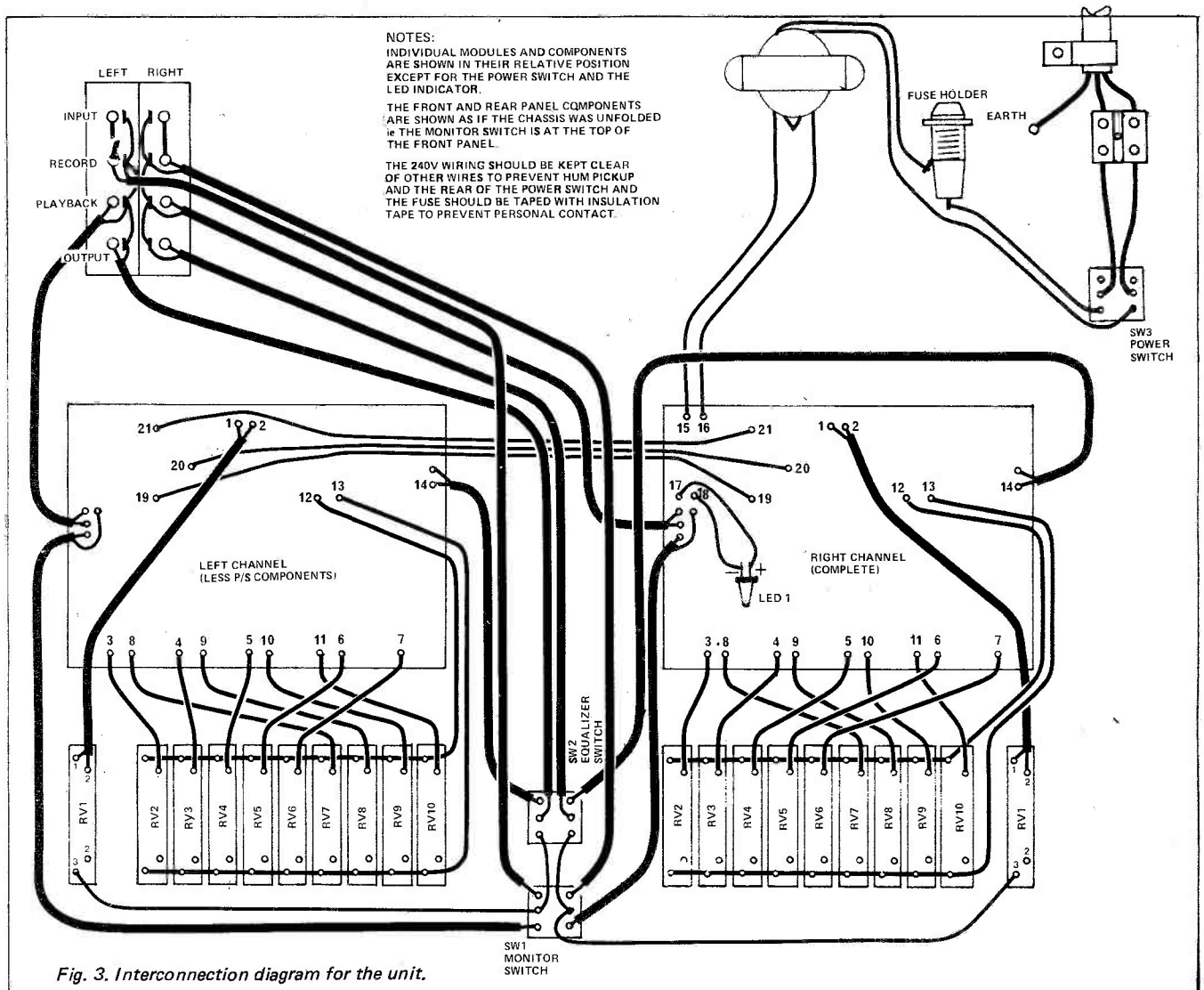

Fig. 3. Interconnection diagram for the unit.

against mains hum-pickup. The transformer should be mounted in the position shown, and the 240 volt wiring, to the front power switch, should be run down the right-hand side of the chassis and along the front, in front of the potentiometer support brackets. If hum pickup does occur, it may be necessary to mount the transformer inside a metal box to shield it.

Due to tolerances of resistors variations in V_{be} of Q2 and Q3 etc, the steady-state output of IC11 may be anywhere within plus or minus one volt of zero.

Hence it is desirable to determine the polarity of the steady state voltage at pin 6 of IC1 in order to determine which way round C15 should be inserted. If the output is positive insert as shown in Fig. 1. Alternatively C15 should be a non-polarized type.

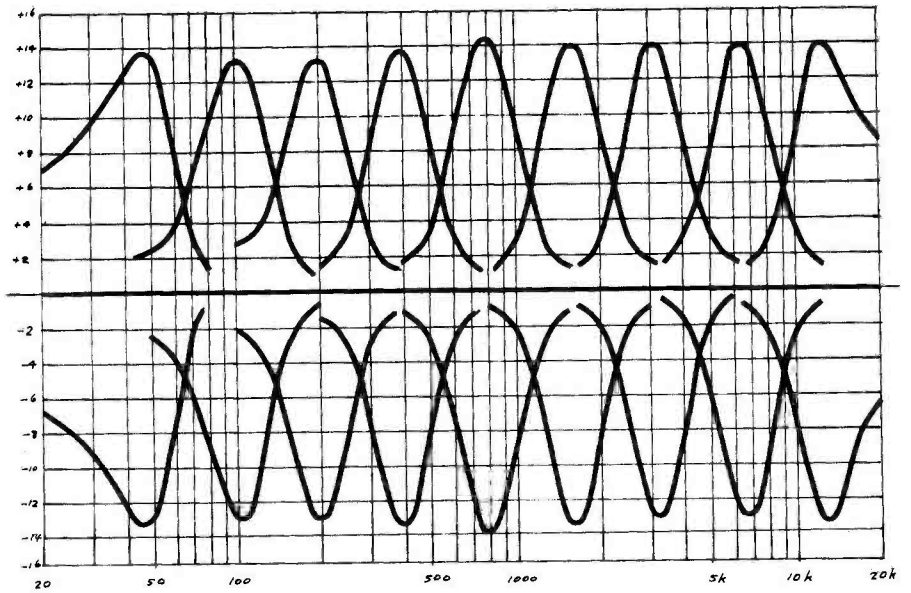

Fig. 5. Individual filter responses for the unit. Boost at top and cut at bottom.

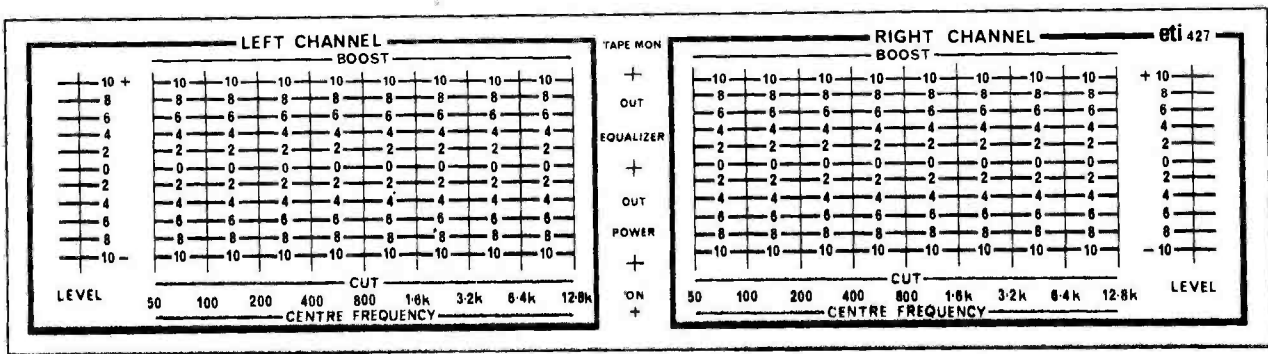
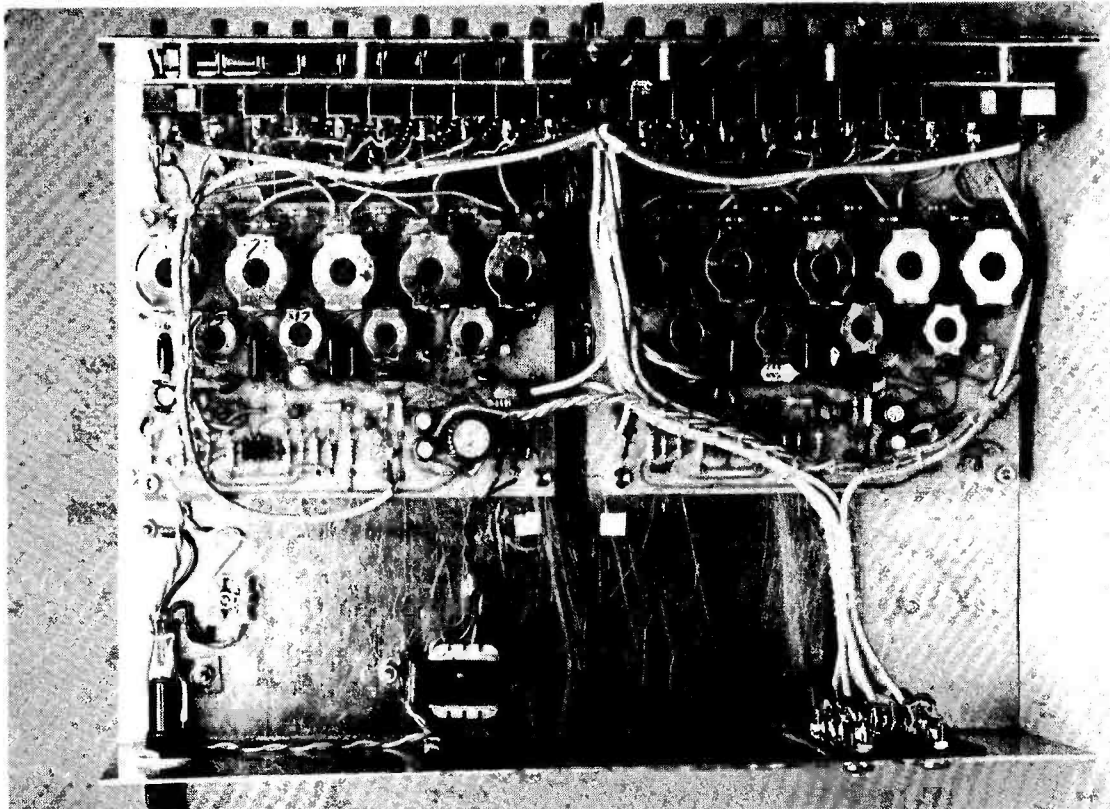

Fig. 6. Front panel artwork for the equalizer. Full size 336 x 88 mm.



Internal layout of the equalizer.

GRAPHIC EQUALIZER

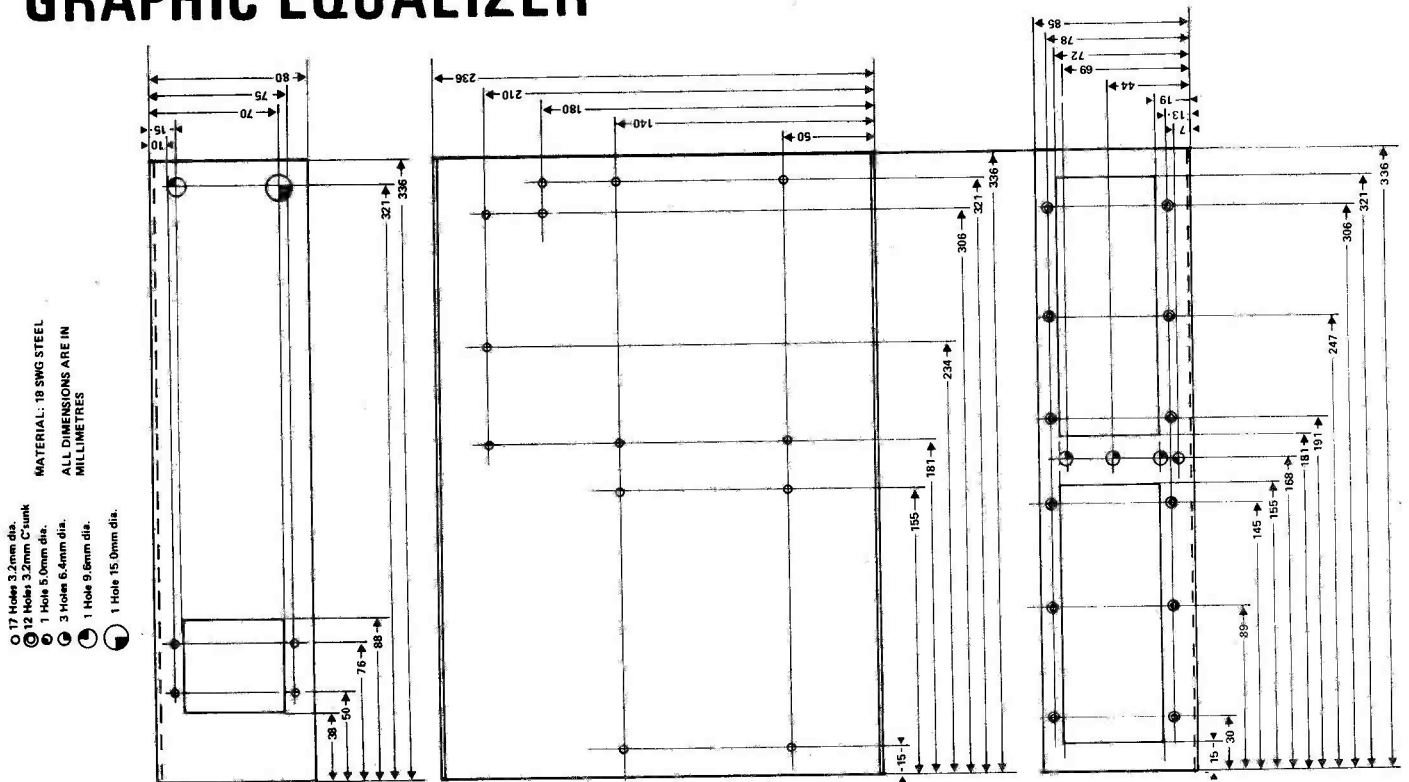

Fig. 7 Detail of the chassis.

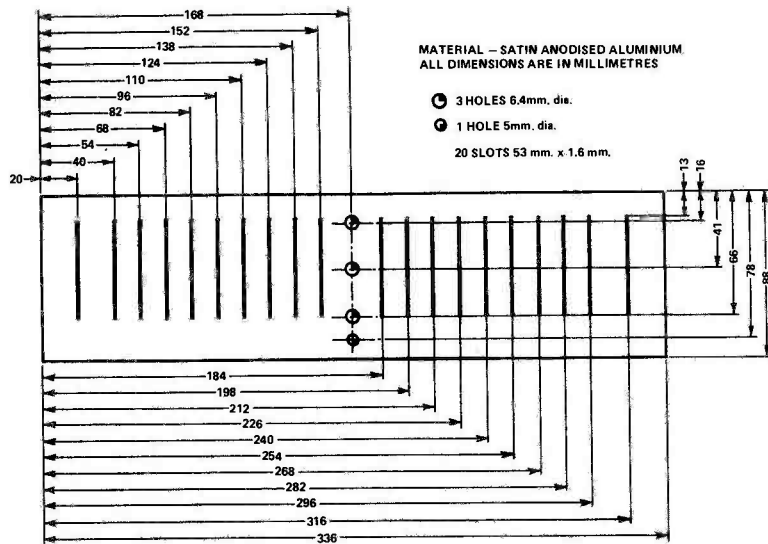

Fig. 8 Metalwork details of the front panel.

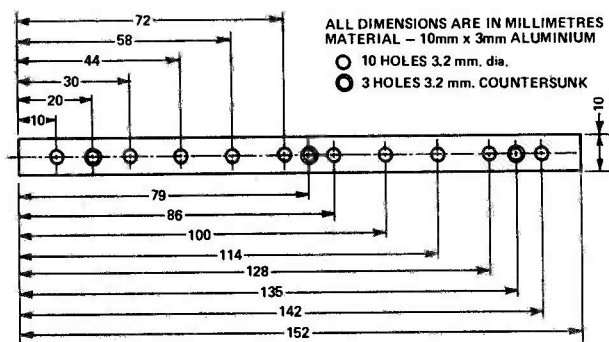

Fig. 9 Drilling details for potentiometer support brackets.

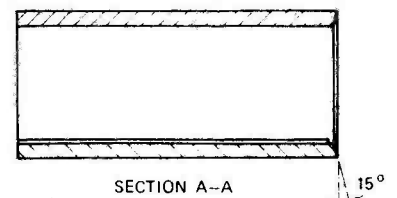
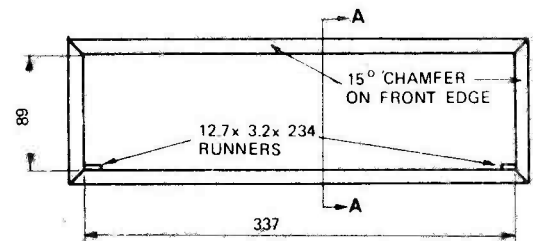
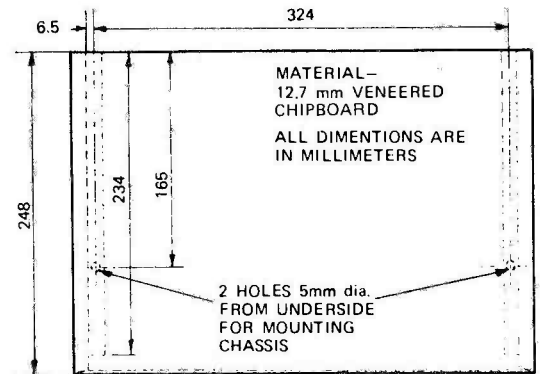

Fig. 10. Constructional details of the cabinet.

PARTS LIST - ETI 427

R5	Resistor	330	1/2W	5%
R6	"	390	1/2W	5%
R7,8,9	"	390	1/2W	5%
R10,11,12	"	390	1/2W	5%
R13,15,18	"	390	1/2W	5%
R24	"	1.5k	1/2W	5%
R1,4	"	3.3k	1/2W	5%
R19	"	3.9k	1/2W	5%
R3,22	"	4.7k	1/2W	5%
R21	"	12k	1/2W	5%
R20	"	27k	1/2W	5%
R14,16,17	"	39k	1/2W	5%
R2,23	"	100k	1/2W	5%
RV1	Potentiometer	1k lin	45mm slide	
RV2-10	Potentiometer	1k lin	45mm slide	
C17	Capacitor	220UF	63V electrolytic	
C13,18,19	Capacitor	25UF	25V electrolytic	
C1,15	Capacitor	10UF	16V electrolytic	
C2	"	3.3UF	10V tag. tant.	
C3	"	1.5UF	25V "	
C4	"	0.68UF	25V "	
C6	"	0.39UF	polyester	
C7	"	0.22UF	"	
C5	"	0.15UF	"	
C8	"	0.1UF	"	
C9	"	0.047UF	"	
C10	"	0.027UF	"	
C11	"	0.01UF	"	
C12	"	0.0022UF	"	
C16	"	0.001UF	"	
C14	"	10pF	ceramic	
L1-L9	Chokes	see table 1.		
Q1,2,3	Transistor	BC109 or similar		
D1,2,3,4	Diodes	1N4001 or similar		
ZD1,2	Zener Diode	15V, 400mW		
LED 1	Light emitting Diode			
IC1	Integrated Circuit	LM301A		

PC Board ETI 427
 For stereo operation double the above components except R24, C17, LED 1, ZD1, ZD2, D1-D4 where only one is required.
 Transformer 240V - 36V @ 30mA min.
 SW1,2,3 switch DPDT miniature toggle
 4-way phono socket, 2 off
 Chassis to Fig. 6.
 Front panel to Fig. 7 and 8.
 20 off knobs for slide pots.
 4 pot support rails (Fig. 9)
 12 threaded spacers 9.6mm long
 8 plain spacers 12.7mm long
 24 screws, countersunk head, 6.5mm long to suit spacers
 3 core flex and plug
 Cable clamp, grommet, terminal block.

TABLE 1 COIL WINDING DETAILS

Coil	Ind.	Turns	Wire	Core	Bobbin	Clip
L1	3.4H	707	40 swg	ITT-C26-4300	BD26	MS26*
L2	1.7H	500	40 swg	"	"	"
L3	0.8H	895	38 swg	Mullard LA4543	DT2534	DT2406**
L4	0.4H	632	38 swg	"	"	"
L5	0.18H	424	38 swg	"	"	"
L6	100mH	500	38 swg	Mullard LA4345	DT2470	DT2396**
L7	53mH	364	38 swg	"	"	"
L8	23mH	240	38 swg	"	"	"
L9	13mH	180	38 swg	"	"	"

* The MS26 clip is not currently available but will be in February 1975; a nylon screw and nut may be used to hold the core together.

** 2 required.

The pot cores and capacitors are being stocked for this project by Maplin Electronic Supplies, P.O. Box 3, Rayleigh, Essex. Maplin are planning to market a complete kit (less woodwork) of this project in the near future with a selling price of under £50. Arrangements have not been completed at the time of going to press but details from Maplin on receipt of an s.a.e.

MAPLIN ELECTRONIC SUPPLIES

★ SAME DAY SERVICE

P. O. Box 3, Rayleigh, Essex. Tel: Southend-on Sea (0702) 44101

VAT Please add 10% to the final total. Post and Packing FREE in U.K. (15p handling charge on orders under £1)



SYNTHESISER

We shall be stocking all the parts for this sensational new E.T.I. design. Send s.a.e. now for our detailed price list. (One available each month as the parts are published.)

YOU SIMPLY MUST SEE OUR PRICES!

ORGAN BUILDERS

MES announce the very latest development in organ circuitry.

THE DMO2

13 Master Frequencies on ONE tiny circuit board.

LOOK AT THESE AMAZING ADVANTAGES

- ★ 13 frequencies from C8 to C9. ★ Each frequency digitally derived from a SINGLE h.f. master oscillator.
- ★ Initial tuning for the WHOLE ORGAN: ONE SIMPLE ADJUSTMENT. ★ Relative tuning NEVER DRIFTS! ★ External control allows instant tune-up to other musicians. ★ Outputs will directly drive most types of dividers including the SAJ110. ★ And each output can also be used as a direct tone source. ★ Variable DEPTH AND RATE tremulant optional extra.
- ★ Gold-plated plug-in edge connexion. ★ Complete fibre glass board (including tremulant if required) ONLY 3" tin. x 4" Sin. ★ Very low power consumption.

★ EXTREMELY ECONOMICAL PRICE. ★ Ready built, tested and fully guaranteed.

DMO2T (with tremulant) ONLY £14.25.
 DMO2 (without tremulant) £12.25.

★ S.a.e. please for full technical details.

Trade enquiries welcome.

SAJ110 7-stage frequency divider in one 14 pin DIL package. Sine or square wave input allows operation from almost any type of master oscillator including the DMO2 (when 97 notes are available). Square wave outputs may be modified to saw-tooth by the addition of a few components. SAJ110: £2.63 each OR special price for pack of 12: £25.00. S.a.e. please for data sheet.

WE KNOW YOU NEED

IT!

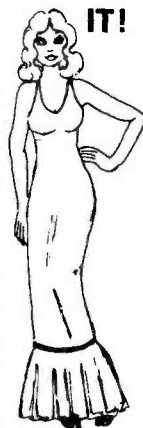

The MES 1974 Catalogue has over 75 pages and is STACKED with dozens of tempting new lines. BRIMMING OVER with clear illustrations and detailed data.

WE'RE WAITING TO RUSH YOU A COPY.

You'll be IMPRESSED with our POST FREE ordering system, EXCITED by our BIG VALUE discount vouchers, STAGGERED by our UNBEATABLE speed of service. Take the first step towards real service NOW! Send ONLY 25p for our beautifully produced catalogue and leave the rest to us!

LINEAR I.C.'s

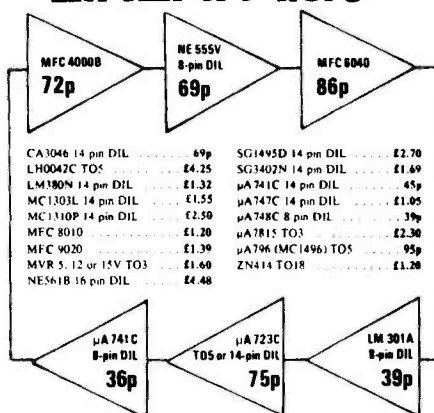

SUBSCRIPTIONS TO ETI



If you have no trouble obtaining ETI from your newsagent, that's the obvious place to get it. However five out of the last six issues have been sell-outs and early analysis of the reader questionnaire has shown that one in three readers has trouble in buying ETI.

If you are one of those having trouble, why not take out a subscription? Normally you receive your copy a few days before our official publication. Note also that although the cover price of ETI is now 25p, we have not raised our subscription rates for the time being.

Cut

To: SUBSCRIPTION DEPARTMENT
ELECTRONICS TODAY INTERNATIONAL
36 EBURY STREET,
LONDON SW1W 0LW.

Please find enclosed £3.60 which includes postage (£4.00 overseas) for my annual subscription to ETI starting with the next available issue.

Name

Address

JANUARY 1975

Marshall's

A Marshall & Son (London) Limited Dept. PW
42 Cricklewood Broadway London NW2 3HD Tel: 01 452 0161
& 85 West Regent Street Glasgow G2 2DD Tel: 041 332 4133

Everything you need is in our new catalogue available now price 20p

Trade and export enquiries welcome

PW. TELETENNIS KIT

as featured on BBC Nationwide and in the Daily Mail October 2nd 1974.

This exciting new game is now available in kit form. Due to popular demand we are now able to offer a fantastic saving on list prices. Ideal game for whole family. No need to modify your TV set, just plug in to aerial socket.

Parts list as follows...

A Resistor Pack	£1.00 p.p. 20p
B Potentiometer Pack	£1.25 p.p. 20p
C Capacitor Pack	£3.10 p.p. 20p
D Semiconductor Pack	£14.50 p.p. 20p
E IC Sockets	£4.00 p.p. 20p
F Transformer	£1.15 p.p. 25p
G PCB's	£7.50 p.p. 20p
H Switches	£4.50 p.p. 20p
I UHF Modulator Kit	£7.20 p.p. 20p

Special Prices - complete kit (excluding case) £42.00 p.p. 50p. Sections A-F incl. £23.50 p.p. 30p. Assembly instructions with complete kit or 75p on request.

SN7400 16p	SN7420 16p	SN7453 16p	SN7491 11.10
SN7401 16p	SN7423 37p	SN7454 16p	SN7492 75p
SN7401AN 38p	SN7425 37p	SN7460 16p	SN7493 65p
SN7402 16p	SN7427 45p	SN7470 30p	SN7494 85p
SN7403 16p	SN7430 16p	SN7472 30p	SN7495 80p
SN7404 24p	SN7432 45p	SN7473 44p	SN7496 £1.00
SN7405 24p	SN7437 35p	SN7474 48p	SN74100 £3.14
SN7406 43p	SN7438 35p	SN7475 39p	SN74107 43p
SN7407 45p	SN7440 16p	SN7476 45p	SN74118 £1.00
SN7408 25p	SN7441 85p	SN7480 75p	SN74119 £1.00
SN7409 33p	SN7442 85p	SN7481 £1.23	SN74121 87p
SN7410 16p	SN7443 £1.00	SN7482 87p	SN74122 80p
SN7411 28p	SN7446 £2.00	SN7483 £1.20	SN74123 72p
SN7412 28p	SN7447 £1.30	SN7484 95p	SN74141 £1.00
SN7413 80p	SN7448 £1.00	SN7485 £1.00	SN74180 £1.44
SN7416 45p	SN7480 16p	SN7486 45p	SN74190 £1.95
SN7417 30p	SN7481 16p	SN7490 65p	

OUR NEW GLASGOW SHOP IS NOW OPEN

Prices correct at August 1974, but all exclusive of V.A.T.
Post and Package 20p postage and package charges

Popular Semiconductors

2N696 22p	2N3707 13p	AD142	59p	BC309	10p	LM709	48p
2N697 18p	2N3708 70p	AD143	45p	BC237	21p	to 99	48p
2N698 40p	2N3715 £1.00	AD161	45p	BC238	19p	801L	38p
2N699 45p	2N3716 £1.00	AD161	45p	BCY70	17p	1401L	40p
2N1302	2N3771 £2.20	AD161	pr	BCY71	22p	LM723C	90p
2N1303 19p	2N3772 £1.00	AD162	pr	BCY72	13p	LM741	40p
2N1304 24p	2N3773 £2.65	AF109R	40p	BD123	32p	to 99	40p
2N1305 24p	2N3819 37p	AF115	24p	BD131	40p	801L	40p
2N1306 31p	2N3820 38p	AF124	30p	BD132	30p	ILD1L	38p
2N1307 22p	2N3823 £1.42	AF125	30p	BD135	42p	LM747	£1.00
2N1308 25p	2N3904 27p	AF126	28p	BD136	49p	LM7805	£2.00
2N1309 36p	2N3905 24p	AF127	28p	BD137	59p	MC1310	£2.92
2N1671 £1.44	2N4036 63p	AF128	39p	BD138	63p	MJ480	90p
2N1671A £1.54	2N4037 42p	AF129	35p	BD139	71p	MJ481	£1.14
2N1671B £1.72	2N4126 30p	AF179	55p	BD140	87p	MJ490	96p
2N1671C £1.32	2N4289 34p	AF180	58p	BF115	25p	MJ491	£1.38
2N2102 50p	2N4921 73p	AF239	31p	BF116	23p	MJ340	45p
2N2147 78p	2N4922 84p	AF240	72p	BF117	43p	MJ2955V	£1.12
2N2148 94p	2N4923 83p	AF279	34p	BF154	16p	MJ3055	64p
2N2160 60p	2N5190 92p	AF280	34p	BF163	32p	NE555V	70p
2N2218A 22p	2N5191 95p	BC107	16p	BF180	35p	OC28	70p
2N2219 24p	2N5192 £1.24	BC108	15p	BF181	34p	OC71	20p
2N2219A 26p	2N5195 £1.46	BC109	19p	BF184	30p	OC72	25p
2N2221 18p	2N5245 43p	BC147	12p	BF194	12p	SC35D	£1.48
2N2221A 21p	2N5457 49p	BC148	13p	BF195	12p	SC36D	£1.46
2N2222 20p	2N5458 49p	BC149	13p	BF196	13p	SC40D	£1.89
2N2222A 25p	2N5459 49p	BC167B	13p	BF197	15p	SC41D	£1.32
2N2646 55p	40361 48p	BC168B	13p	BF198	18p	SC45D	£1.00
2N2904 22p	40362 50p	BC168C	11p	BF200	40p	SC46D	£1.96
2N2904A 24p	40363 88p	BC169B	13p	BF237	22p	SC50D	£2.40
2N2905 24p	40406 44p	BC169C	13p	BF238	22p	SC51D	£2.39
2N2905A 26p	40407 33p	BC182	12p	BFX29	30p	SL414A	£1.00
2N2906 19p	40408 30p	BC182L	12p	BFX30	27p	TAA263	£1.00
2N2906A 21p	40409 32p	BC183	09p	BFX84	24p	TB800	£1.00
2N2907 22p	40410 32p	BC183L	09p	BFX85	30p	TB810	£1.00
2N2907A 24p	40411 2.23	BC184	11p	BFX87	28p	TIP29A	49p
2N2926 11p	40602 46p	BC184L	11p	BFX88	25p	TIP30A	38p
2N3053 25p	40604 54p	BC212K	10p	BFX89	45p	TIP31A	62p
2N3054 60p	40669 1.00	BC212L	14p	BFY19	62p	TIP32B	74p
2N3055 75p	AC117 20p	BC214L	21p	BFY51	23p	TIP33A	£1.01
2N3441 97p	AC126 20p	BC237	09p	BFY52	21p	TIP34A	£1.31
2N3442 £1.09	AC127 20p	BC238	09p	BFY90	75p	TIP35A	£2.90
2N3415 10p	AC128 20p	BC239	09p	BRV39	48p	TIP36A	£3.70
2N3416 15p	AC151V 25p	BC257	09p	CI060	65p	TIP41A	78p
2N3417 21p	AC152V 17p	BC258	09p	CA3020A 1.00	09p	TIP42A	93p
2N3702 11p	AC153K 25p	BC259	13p	CA3046 70p	13p	TIP2905	93p
2N3703 12p	AC176 18p	BC300	£2.12	CA3048 £2.11	11p	TIP3055	60p
2N3704 14p	AC176K 28p	BC301	34p	CA3089E £1.94	23p	ZTX300	13p
2N3705 12p	AC187K 23p	BC307	10p	CA3090644 23	23p	ZTX302	20p
2N3706 9p	AC188K 34p	BC308	09p	LM301A 46p	46p	ZTX500	15p

ETI OFFERS

transistors

This, as most readers will know, is the most universal transistor!

MAX RATINGS:

V_{CB0} 30V
 V_{CE0} 25V
 V_{EB0} 25V
 I_C 200mA
 H_{FE} ≥380
 F_T 250MHz
 P_{TOT} 300mW

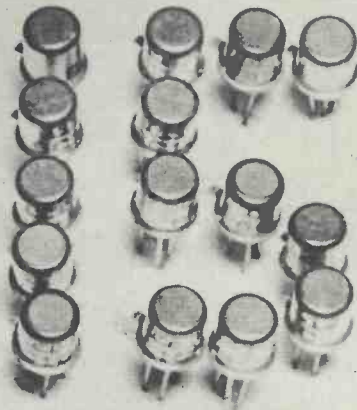

BC108C

Metal can TO18 silicon planar epitaxial construction

These are useful general purpose transistors and all are marked BC108C. The 'C' suffix indicates the top gain grouping - at least 450 at 2mA collector current.

FIFTEEN FOR £1

INC. VAT, POSTAGE AND PACKING
 LIMITED TO FIRST 4000 ORDERS
 ALLOW 21 DAYS DELIVERY

SEND MONEY, COUPON & STAMPED SELF-ADDRESSED ENVELOPE (for return of money if the offer is over-subscribed) TO MAPLIN ELECTRONIC SUPPLIES, P. O. BOX 3, RAYLEIGH, ESSEX SS6 8LR.

capacitors

- | | |
|---------------------|-------------------------------|
| (((three 10V 10µF | ((((((((six 25V 10µF |
| (((three 10V 22µF | (((three 25V 50µF |
| (((three 10V 50µF | ((((((((six 25V 100µF |
| (((three 10V 100µF | (((three 25V 500µF |
| (((three 15V 20µF | (((three 25V 1000µF |

THIRTY SIX ELECTROLYTICS FOR £2.50

INC. VAT AND POSTAGE AND PACKING. LIMITED TO FIRST 4000 ORDERS

A wide selection of common values for less than two thirds of the usual price!

SEND MONEY, COUPON AND STAMPED SELF-ADDRESSED ENVELOPE (for return of money if offer is over-subscribed) TO B. H. COMPONENT FACTORS LTD, 61 CHEDDINGTON ROAD, PITSTONE, NR. LEIGHTON BUZZARD, BEDS LU7 9AQ.

use these coupons:

THESE OFFERS OPEN DECEMBER 18TH 1974 AND CLOSE JANUARY 31ST 1975.

Cut

This offer is strictly limited to 15 transistors per coupon. TO: MAPLIN ELECTRONIC SUPPLIES P. O. Box 3, Rayleigh, ESSEX SS6 8LR.

I enclose a cheque/P.O. for £1 (payable to Maplin Electronic Supplies) plus a stamped self-addressed envelope for the return of my money should the offer be oversubscribed. Please send me 15 BC108C transistors.

NAME

ADDRESS

Allow 21 days for delivery.
 This offer opens Dec. 18th 1974 and closes Jan. 31st 1975.

Cut

This offer is strictly limited to 36 transistors per coupon. TO: B. H. COMPONENT FACTORS 61 Cheddington Road, Pitstone, Nr. Leighton Buzzard, BEDS. LU7 9AQ.

I enclose a cheque/P.O. for £2.50 (payable to B.H. Component Factors) plus a stamped self-addressed envelope for the return of my money should the offer be oversubscribed. Please send me 36 electrolytic capacitors of the values specified in January's ETI.

NAME

ADDRESS

Allow 21 days for delivery.
 This offer opens Dec. 18th 1974 and closes Jan. 31st 1975.

RICHARDS ELECTRICS

ex-stock components

FULL DATA ON ALL DEVICES - SAE OR PHONE US

GUARANTEED SEMICONDUCTORS - FULL SPEC.

BC107	13p	BFY51	18p	2N3702	12p	2S303	25p
BC108	12p	BSY95A	9p	2N3704	12p	OA91	9p
BC109	13p	C444	13p	2N3819	34p	1N914	6p
BC182LB	12p	OCP71	15p	2N3866	25p	1N4004	7p
BC212LB	13p	2N1711	30p	2N4058	14p	1N4007	11p

40871/2P - RCA 100V COMP. POWER IN FLAT PACK 75p each
 TIC44 - TEXAS 60 PIV .6A SCR IN TO-18 PACKAGE 37p
 4O486 - RCA 400 PIV 4A TRIAC IN TO-5 PACKAGE 60p

Bridges { N6002 100 PIV 2:2A 49p
 N7012 100 PIV 4A 65p

Clock Chip CT7001 with data £15.

We strongly advise use of our 28 pin dil socket-chip is MOS. CT7001 + 4x3" LITRONIX DISPLAYS £18; +6 DISPLAYS £20
 Automatic 28-30-31 day calendar; noise & radio alarm; snooze facility; battery standby; 12 or 24hr; 4 or 6 digit; interface for led display; this must be the most versatile digiclock chip available. SAE or phone for further data.
 LITRONIX .3" 7seg. Display £1.50 TIL209 .125" LED 26p (Red)
 DIL I.C. SOCKETS 8pin 18p; 14pin 20p; 16pin 22p; 28pin £1.25
 MIN. TOGGLES 12mm dolly SPST-35p; SPDT-38p; DPDT-42p
 50W RMS Power Module - superb spec. £9.25 or SAE 4 data.

all prices include VAT

ALL ORDERS INCLUDING 11p POST & PACKING TO
 16 FRIAR STREET, WORCESTER WR1 2LZ tel 0905-28550
 CALLERS WELCOME AT OUR SHOP

HART ELECTRONICS

Audio Kit Specialists since 1961

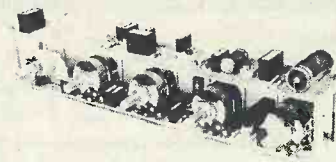

BAILEY/BURROWS/QUILTER PRE AMP This is the tone control section of the best pre-amp kit currently available. Consider the advantages: *First quality fibreglass printed circuits with roller tinned finish and all component locations printed on reverse. *Low noise carbon film and metal film resistors throughout. *Finest quality low-noise ganged controls with matched tracks and shafts cut to length. *Well engineered layout for total stability. *Special decoupling and earthing arrangements to eliminate hum loops. *Controls, switches and input sockets mount directly on the boards to TOTALLY ELIMINATE wiring to these components. (We know of one pre-amp kit which claims its controls mount directly on the board—and so they do, by their shaft bushes! You still have to wire them up!)

*We incorporate the Quilter modification which is most important as it reduces distortion and increases the bass and treble control range.

As can be seen from the photograph the tone control unit is very slim (only 1 1/2" from front to back) and may therefore be used in many other applications than our Bailey metalwork which it is designed to fit.

METALWORK AND WOODEN CASES These have been under review for some time;

F.M. TUNER This latest addition to our range is designed to offer the best possible performance allied to the ease of operation given by push button varicap tuning. We have taken great care to look after the constructors' point of view and there are no coils to wind, no RF circuits to wire and no alignment is required, in fact the whole unit can be easily completed and working in an evening as there are only 3 transistors, one IC and two ready built and aligned modules comprising the active components. We have abandoned the concept of having a tuner as large as the amplifier and this new unit has a frontal size of only 1 1/2 in. X 4 in. It can be mounted on the side of our Bailey amplifier metalwork thus turning it into a tuner/amplifier whilst only increasing its width by 1 1/2 in. Cost of tuner chassis (no case) is £22 for mono, £25.45 for stereo. Metal case £3.55. An extended wooden case to fit tuner and amplifier will be offered shortly.

STUART TAPE CIRCUITS Our printed circuits and components offer the easy way to convert any suitable quality deck into a very high quality Stereo Tape unit. Input and output levels suit Bailey pre amp. Total cost varies but around £35 is all you need. We can offer tape heads as well if you want new ones.

All above kits have fibreglass PCB's. Prices exclude VAT but P&P is included.

FURTHER INFORMATION ON ALL KITS FREE if you send us a 9 in. X 4 in. S.A.E.

REPRINTS Post free, no VAT. Bailey 30W 18p.

STUART TAPE RECORDER All 3 articles under one cover 30p.

BAILEY/BURROWS/QUILTER Preamp circuits, layouts and assembly notes 15p.

All prices exclude VAT.

2 Penylan Mill, Oswestry, Salop

Personal callers are always welcome, but please note we are closed all day Saturday

what to
look for in
February's



ANOTHER
ETI
READER
OFFER

COLOUR ORGAN PROJECT

Build a 3 channel high power light modulator to run off your Hi-Fi system.

TOUCH-CONTROL DIMMER PROJECT

One button raises the lighting, the other lowers it - allowing setting to any level from a number of remote locations.

POCKET TIMER ALARM PROJECT

The ETI "Meter Beater" will warn you to get back to your car before the meter runs out.

NEW SERIES: COLOUR TV

An understanding of what colour itself is becomes vital when dealing with CTV.

MOTIONAL FEEDBACK LOUDSPEAKERS REVIEW

Philips RH532 speakers correct distortion by monitoring the motion of the speaker itself.

electronics
today international

FEBRUARY 1975 ISSUE
ON SALE JANUARY 17TH

25p

AT YOUR NEWSAGENTS

The features mentioned here are, at the time of this issue going to press, in an advanced state of preparation. However, circumstances, including highly topical developments may affect the final contents.

NEW LOW COST STEREO TUNER

Basic stereo tuner **£15** post free.
Basic mono tuner **£12** post free.
6 position push button units with
integral pots **£2.92**.

TYP. SPECIFICATION
2µV for 30dB S/N
Image rejection 40dB
IF rejection 65dB



AVAILABLE AS BASIC OR COMPLETE KITS
No alignment required. Mullard LP1186 front end module used with Ceramic IF and IC amplifier. Push button tuning (6 position) with **Interstation Mute**, restricted range **AFC**, single LED tuning indicator, phase locked IC decoder, and complete metalwork and veneered cabinet. Complete with IC regulated PSU and full assembly instructions. (Mechanically identical to N-J Tuner.)

PRICE Complete stereo kit **£29.00** inc VAT, p&p
Complete mono kit **£24.74** " " "

Access

THE NEW NELSON-JONES FM TUNER PUSH-BUTTON VARICAP DIODE TUNING

(6 Position)

(WW JUNE '73)

Exclusive Designer Approved Kits

What are the important features to look for in an FM tuner kit? Naturally it must have an attractive appearance when built, but it must also embody the latest and best in circuit design such as:-

- MOSEFET front end for excellent cross modulation performance and low noise.
- 3 GANG tuning for high selectivity.
- VARICAP tuning diodes in back to back configuration for low distortion.
- CERAMIC filters for defined IF response.
- INTEGRATED circuit IF amplifiers for reliability and excellent limiting/AM rejection.

The Nelson-Jones Tuner has all of these features and many more, and more importantly the design is fully proven not just with a few prototypes but with many thousands of working tuners spread across the world.

- PHASE LOCKED Stereo decoder with Stereo mute, see below
- LED fine tuning indicators.
- PUSH BUTTON tuning (with AFC disable) over the FM band (88-104).
- IC STABILISED and S/C protected power supply.
- CABINET double veneered against warp.

Typ. Specn: 20 dB quieting 0.75µV. Image rejection -70dB.I.F. Rejection -85 dB

Basic tuner module prices start as low as **£12.31**, with complete kits starting at **£26.95** (mono) + P.P. 65p. and of course all components are available separately. Our low cost alignment service is available to customers without access to a signal generator. Please send large SAE for our latest price lists which details all of the many options and special low prices for complete kits. All our other products remain available.

PORTUS AND HAYWOOD PHASE LOCKED DECODER (W.W. Sept. '70). Still the lowest distortion P.L. decoder available. THD typically 0.05% (at Nelson-Jones Tuner O/P level)! Supplied complete with Red LED.

Price **£7.02** when bought with a complete N-J tuner kit or **£8.29** if bought separately (P.P. 21p.)

PLEASE NOTE. Existing tuners are readily convertible and kits/parts are available for this purpose.

TEXAN AMPLIFIER. We have designed the tuner case and metalwork to match the Texan amplifier (see photograph). Complete designer approved Texan kits are available at **£30.78** plus P.P. 65p including Teak Sleeve.

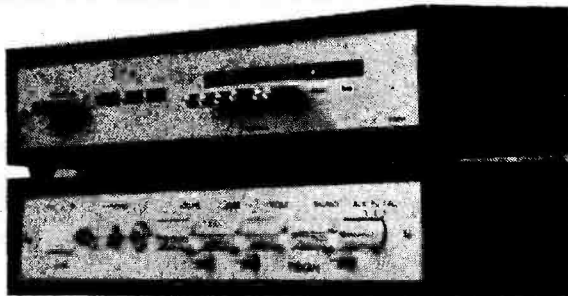

VAT at 8% is included in all prices

INTEGREX LIMITED, P.O. Box 45, Derby, DE1 1TW

Phone Swadlincote (0283 87) 5432 Telex 377106

Arbour Electronics Limited

CENTURION

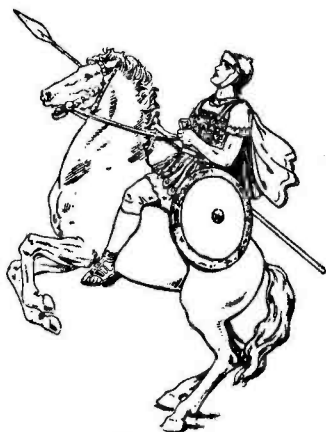

INSTRUMENT CASES

Model Nos 119 & 121 two part aluminium construction base front & back unit finished in white gloss, hooded cover finished in blue hammer stove enamel.

MODEL	D	W	H	PRICE
119	152mm	127mm	89mm	£1.60 each
121	152mm	202mm	76mm	£2.00 each

Model Nos 221F & 222F Flat packs. Front & Rear panels aluminium case mild steel front panel finished in white gloss other parts finished in blue hammer stove enamel.

MODEL	D	W	H	PRICE
221F	152mm	203mm	152mm	£2.80 each
222F	197mm	254mm	159mm	£3.40 each

Prices include P & P U.K. Add 8% VAT U.K. only.
Send S.A.E. for full brochure.

ARBOUR ELECTRONICS LIMITED

Unit 13 East Hanningfield Industrial Estate, Nr. Chelmsford,
Essex, CM3 5BG. Tel: Chelmsford (0245) 400700.
Sheet metal work wiring assembly service available.

PE SCORPIO Mk2 ignition system kit

6V OR 12V.....+ve OR -ve Ground

Here's the new, improved version of the original PE Scorpio Electronic Ignition System - with a big plus over all the other kits - the PE Scorpio Kit is designed for both positive and negative ground automotive electrical systems. Not just +ve ground. Nor just -ve ground. But both! So if you change cars, you can be almost certain that you can change over your PE Scorpio Mk. 2 as well.

Containing all the components you need, this Electro Spares PE Scorpio Mk. 2 Kit is simply built, using our easy to follow instructions. Each component is a branded unit by a reputable manufacturer and carries the manufacturer's guarantee. Ready drilled for fast assembly. Quickly fitted to any car.

When your PE Scorpio Mk. 2 is installed, you instantly benefit from all these PE Scorpio Mk. 2 advantages:

- ★ Easier starting from cold
- ★ Firing even with wet or oiled-up plugs
- ★ Smoother running at high speed
- ★ Fuel saving
- ★ More power from your engine
- ★ Longer spark plug life
- ★ No more contact-breaker burn.

Electro Spares prices:

De luxe Kit only **£11.50** inc. VAT and p & p.

Ready Made Unit **£14.75** inc. VAT and p & p.

State 6V or 12V system.

Send SAE now for details and free list.

ELECTRO SPARES



The Component Centre of the North

288 ECCLESALL RD., SHEFFIELD S11 8PE

Tel: Sheffield (0742) 668888

3½ Digit Field Effect a.c. Liquid Crystal Display

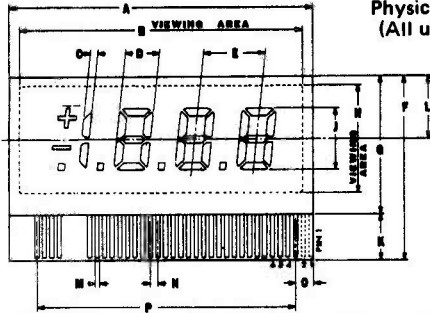

Physical Dimensions:
(All units in inches)

A = 2.000
B = 1.736
C = 0.050
D = 0.220
E = 0.400
F = 1.205
G = 0.905
H = 0.558
J = 0.400
K = 0.320
L = 0.410
M = 0.031
N = 0.050
O = 0.103
P = 1.580

- * Reflective mode - black digits on diffuse reflecting gold background.
- * Excellent contrast in ambient light (typical contrast ratio 30:1 at 7V a.c. r.m.s.).
- * Low voltage operation - TTL and MOS compatible (Bi-level operation: display is fully on at 7V a.c.; fully off at 3V a.c. r.m.s.).
- * Low power consumption - power consumption ON segment less than ¼ microwatt.
- * Wide operating temperature range (0°C to 70°C)
- * Operating lifetime (at 10V a.c. r.m.s., 60Hz) better than 11000 hours.

FULL DATA SHEET AND APPLICATION NOTES
SEND S. A. E.

**Price, Display + plug in connector : £12.50 exc. VAT
Post and pcking: 10p

LICRIL LTD.
7 Cross St., Enfield, Middx
Telephone: 01-366 3239



ELECTRONI-KIT

THE MOST VERSATILE ELECTRONIC KITS

THE PERFECT GIFT FOR ANY AGE

"...worthwhile, fun, entertainment, education, good value for money"
(Everyday Electronics)

"...Educational kits of exceptional quality" (Audio).
BUILD AND REBUILD ANY NUMBER OF TIMES

Radios, transmitters, burglar alarms, inter-comms, metal detectors, solar cell, photoelectric cell, voice relay, computer circuits, electronic cats, birds, guns, organs, illuminometers, voltmeters, meters of all types etc. etc, plus your own circuit diagrams.

NO SOLDERING, SCREWING OR WIRING.

No previous experience required.
Battery operated. Completely safe for any age.

16 different projects	£8.80
30 " " "	£10.45
45 " " "	£14.45
100 " " "	£20.45
150 " " "	£33.95

Add-on parts, manuals, spares, available as required.

Prices include EDUCATIONAL MANUALS, battery, p&p, VAT etc.

WONDERFUL VALUE!!!

(Money back if not satisfied)

Cheque/P.O. (or 7p for literature) to Dept ET1

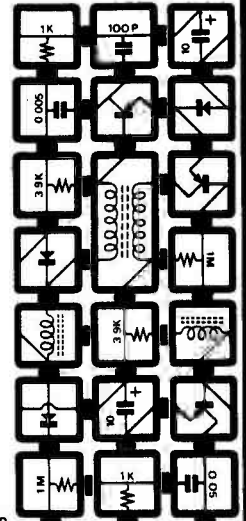

Satisfaction guaranteed

**ELECTRONI-KIT LTD, 408 St. John's Street,
London, EC1. [01-278 4579]**

SPARKRITE Mk II

Electronic Ignition... Better on all points

Because you keep your points!

The SPARKRITE MK.2 is a full capacitive discharge electronic system. Specifically designed to retain the points assembly - with all the advantages and none of the disadvantages. No misfire because contact breaker bounce is eliminated electronically by a pulse suppression circuit which prevents the unit firing if the points bounce open at high rpm. Contact breaker burn is eliminated by reducing the current to about 1/50th of norm, thus avoiding arcing. But you can still revert to normal ignition if need be. In seconds. If points go (very unlikely) you can get replacements anywhere. All these advantages.

- Fitted in 15 minutes. ● Up to 20% better fuel consumption. ● Instant all weather starting. ● Cleaner plugs - they last 5 times longer without attention.
- Faster acceleration. ● Faster top speeds.
- Coil and battery last longer. ● Efficient fuel burning with less air pollution.

The kit comprises everything needed

Ready drilled scratch and rust resistant case, metalwork, cables, coil connectors, printed circuit board, top quality 5 year guaranteed transformer and components, full instructions to make positive or negative earth system, and 6 page installation instruction leaflet.

WE SAY IT IS THE BEST SYSTEM AT ANY PRICE!

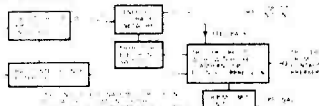

Sparkrite Mk II - full capacitive discharge electronic system - not just a transistorised inductive discharge booster.



PRICES

D.I.Y. Kit only £10.93 incl. VAT and P & P
Ready Built Unit £13.86 incl. VAT and P & P
(Both to fit all cars with coil/distributor ignition up to 8 cylinders).

We can supply units for any petrol-engined vehicle (boat, motorcycle etc) with coil/contact breaker ignition. Details on request. Call in and see us for a demonstration.

ORDER NOW TO:

ELECTRONICS DESIGN ASSOCIATES
(Dept ET 15) 82 Bath Street,
Walsall WS1 3DE Phone 33652

Please supply:

Sparkrite Mk 2 D.I.Y. Kit(s) at £10.93 each incl. VAT and P & P (Will make pos. or neg. earth).

Sparkrite Ready Built Neg. Earth Unit(s) at £13.86 each incl. VAT and P & P

Sparkrite Ready Built Positive Earth Unit(s) at £13.86 each incl. VAT and P & P

NAME _____

ADDRESS _____

I enclose cheque/P.O. for £ _____
Send SAE for brochure.



INTRODUCTION

Kits for the amateur constructor have gone through various phases in the last few years. In the mid-1960's most of the kits available were based on surplus equipment and components: frankly many of the kits were poor. Now the situation has changed considerably. Instructions and component quality is vastly better and there have probably never before been as many kits as now.

Originally kits were introduced to save money and many still show a worthwhile saving over the ready-built models. On the other hand many people opt for a kit mainly for satisfaction of having built it for themselves: indeed in some cases the kit costs more than a commercially built model.

Many companies now produce "modules". It is difficult to draw the line where kits and modules start. We have included modules where we consider that they constitute a kit but not when the module is really a built unit only

requiring a few wires.

In this survey we have tried to give a bit more information that is normally available such as service charges and building time. We have also included details of many less well-known kits available from smaller companies.

Under the main headings we have included all of the kits that we could find (except one company who would not give us information) but in the Miscellaneous and Test Gear sections the number of kits make it impossible to deal with all but a few.

Almost always a complete kit costs less than the individual components: additionally very attractive, often professional looking, cases are available.

All the companies we have included will service units which have been built up and fail to work. We have also given details of kits which are suitable for the beginner.

GUIDE EXPLANATION

Prices shown include VAT at 8% and postage except where goods are not available mail order, these are marked with an asterisk. Some prices include optional extras, such as cases. Prices are correct at the time of going to press but it may be necessary to check before ordering.

Time is the average in hours (indicated by the makers) for an average constructor.

Beginners indicates that the makers consider the kit suitable for beginners though many feel that ability to solder is essential.

Built indicates that complete guaranteed models of the kit are available from the same supplier.

Service Charge. All companies have a servicing facility and all, except for Josty, reserve the right to charge. Some companies have a basic charge but this does not mean they will always make it or that this is a maximum. In many cases replacement components are extra and charged at cost. Josty guarantee unconditionally no service charge. Heathkit charges vary but are never higher than 10% of the

kit's cost. A "V" in this column indicates that charges depend on the work necessary. Most companies (not all) make no charge if a faulty component is to blame.

Overseas. Some companies are not prepared to despatch orders overseas. Of those that do, virtually all charge extra postage but are less VAT making some prices cheaper, other dearer.

Literature. Leaflets are available for many of the kits. Josty, Heathkit, Tandy and Amtron have detailed catalogues which contain full details (Amtron have a 10p charge for this). A large stamped, self-addressed envelope should be sent when requesting leaflets etc.

Size. Dimensions of the completed unit to nearest 1/4".

Suppliers are listed at the end; the number refers to the company from whom details are available. Tandy kits are *not* available mail order; Josty kits are available mail order but only from certain retailers (these are given in their catalogue).

ETI KITS REVIEW

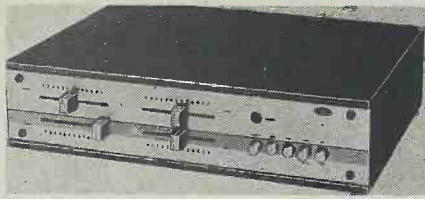

Amtron Shown above is the UK185 with 20W per channel and 0.5% distortion. Frequency response is 20Hz-20kHz ± 1 dB with three inputs. 15 transistors are used in the circuit. The UK187, shown on the cover, is also 20 r.m.s. per channel and has a similar specification, the main difference being a 'Quadrik' feature which gives a 4-channel effect. The UK110/A is a very simple amplifier without power supply and case but can be run from 12V.

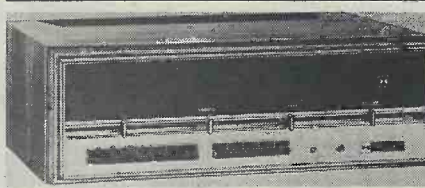

Heathkit do several stereo amplifiers, the one shown is the AA-29 producing about 35W per channel. The spec puts this into the true Hi-Fi category. The AA1214 gives 15W in each channel, has a good spec though not as high as the AA-29.

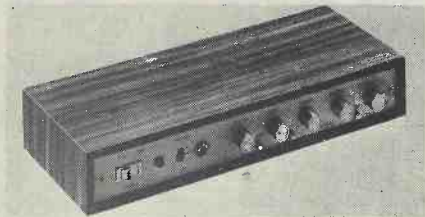

Henelec Texan Now a well established design, 20W per channel and with an excellent specification. Very slim line construction and originally designed by Texas engineers.

Harverson Despite the name this gives 14W r.m.s. per channel (nice that some people are conservative). Has very good specification. Price here includes power supply and cabinet which are available separately.

Josty 310 is made up from four individual kits which require a cabinet to house them. Specification is said to be good and output of the system is 10W per channel.

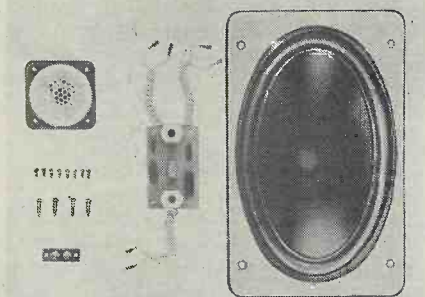

Helme XL Range includes five models, one is shown above. No soldering is necessary in most cases. Cabinets have to be built from your own resources but instructions and diagrams are provided.

Baker Major Module is provided as speakers with a simple crossover, handling power is 20W. Baffle board is provided.

STEREO AMPLIFIERS	PRICE	TIME	BEGINNERS		SERVICE CHARGE	OVERSEAS	LITERATURE	SIZE	NOTES	SUPPLIER
			BUILT	BUILT						
Amtron UK110/A	12.73	3	✓	X	V	X	C	7x3½x2	5W p.c. Needs case. 12V operation.	1
Amtron UK185	56.64	20	✓	X	1.00	✓	C	14½x10x3¼	20W p.c.	1
Amtron UK187	74.64	24	✓	X	1.00	✓	C	18½x10x3¼	50W p.c. Synthetic Quad facility.	1
Harverson 10+10	21.60	10	X	✓	5.00	✓	X	12x8x2¼	Testmeter essential	14
Heathkit AA-1214	49.70	10	✓	✓	V	-	C			15
Heathkit AA-29	113.50	24	✓	X	V	-	C	5¼x16½x14½		15
Henelec Texan	33.93	6	X	✓	2.00	✓	✓	14½x6x2		17
Josty 310	47.23*	4	✓	✓	-	✓	C	-	Uses GP310, NT310 and 2xAF310 kits.	20

LOUDSPEAKERS	PRICE	TIME	BEGINNERS		SERVICE CHARGE	OVERSEAS	LITERATURE	SIZE	NOTES	SUPPLIER
			BUILT	BUILT						
Baker Major Module	10.95	½	✓	✓	V	✓	✓	19x12½	Requires cabinet.	2
Helme XL Range	c 15-50	-	✓	✓	V	✓	✓	-	Various kits. Need cabinets (also available as kits).	16
R & TV Components 950	21.00	-	✓	X	-	X	X	-	5 speakers and crossover. Requires cabinet.	22
Heathkit AS-9515	14.05	2	✓	✓	V	-	C	7x12x6	15W	15
AS-9520	34.60	2	✓	✓	V	-	C	12x20x10	20W	
AS-9530	54.00	2	✓	✓	V	-	C	16x26x12	30W	
AS-9560	81.00	2	✓	✓	V	-	C	32x16x12	60W	

AM/FM TUNERS	PRICE	TIME	BEGINNERS		SERVICE CHARGE	OVERSEAS	LITERATURE	SIZE	NOTES	SUPPLIER
			BUILT	BUILT						
Amtron UK540/C	21.28	8	✓	X	1.00	✓	C	12x3¼x5½	Not stereo. Inc. cabinet.	1
Heathkit AJ1214	51.90	7	✓	✓	V	-	C			15
Heathkit AR2000	105.90	25	✓	X	V	-	C	24½x4¼x11	Cabinet extra.	15

Heathkit have four speakers covering 15W-60W. These come complete with cabinets.

R & TV Components have a set of five speakers with crossover which will handle 45W.

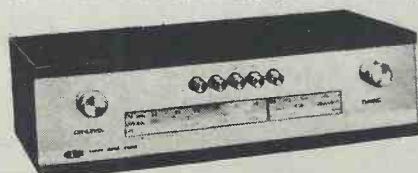

Amtron UK540/C. An AM/FM tuner (no amplifier). Inexpensive but does not have a decoder.



Heathkit AR2000 has LW/MW/SW and FM with a stereo amplifier giving 18W per channel. Spec lifts this into the Hi-Fi category. Alternative attractive cabinets are available for £10.80. A less expensive AM/FM tuner-amplifier from the same company is the AR1214 giving 15W r.m.s. Tuner has MW and FM bands. Cabinet included.

FM TUNERS	PRICE	TIME	BEGINNERS	BUILT	SERVICE CHARGE	OVERSEAS	LITERATURE	SIZE	NOTES	SUPPLIER
Heathkit AJ 29	124.20	18	✓	X	V	—	C	5¼x16¼x14½		15
Heathkit AJ1510	314.00	30	X	X	V	—	C	6x16½x14	Inc. cabinet. Reviewed in ETI Oct. 74.	15
Henelec Stereo FM Mk III	23.13	5	X	✓	2.00	✓	✓	7¼x6x2	Reviewed ETI June 74.	17
FM Varicap Stereo Tuner	28.50	2	✓	✓	V	✓	✓	8¼x2¼x6	Reviewed ETI June 74.	10
Josty HF325	28.44*	2	✓	✓	—	✓	C	—	No cabinet. Part module.	20
Nelson Jones	32.21	7	X	X	V	✓	✓	6¼x15½x2	Price Inc. Lowest cost decoder.	18
Hart FM3	31.16	3	✓	X	1.00	✓	✓	4½x11¼x10	Uses modules. Inc. Case.	13
Integrex Low-cost Stereo Tuner	29.00	3	✓	X	V	✓	✓	6¼x15½x2	Inter-station mute.	18



Heathkit have two, very high spec FM tuners. The AJ29 is of fairly conventional design but the AJ1510 is an incredible unit with digital tuning and a fabulous number of facilities. The AJ29 is illustrated above.



Henelec Stereo FM Mk III uses slider pot to control the varicap tuning. 9 transistors, 9 diodes and decoder i.c. are used. No test equipment is required. Can be modified to cover aircraft bands.

MISCELLANEOUS RADIOS	PRICE	TIME	BEGINNERS	BUILT	SERVICE CHARGE	OVERSEAS	LITERATURE	SIZE	NOTES	SUPPLIER
Sinclair Micromatic	2.68	1	✓	✓	V	✓	V	1¼x1¼x½	Ultra miniature, earphone only.	23
Heathkit Tiger FM	10.20	5	✓	X	V	—	C	11x6½x3		15
Heathkit 4-Band SW717	33.50	8	✓	X	V	—	C	5½x14½x8		15
Heathkit 6-Band GR78	96.15	16	✓	X	V	—	C	6¼x11½x9		15
Amtron UK525/C	12.71	4	✓	X	1.00	✓	C	6¼x5¼x2½	120—160MHz	1
Amtron UK 546 AM/FM	6.65	4	✓	X	1.00	✓	C	3x4x1¼	25—200MHz	1
Amtron UK515	7.92	4	✓	X	1.00	✓	C	6x3x1½	MW Radio	1
Amtron UK500	29.01	15	✓	X	1.00	✓	C	16x3¼x5	AM/FM Receiver	1
Josty HF75	3.95*	1	✓	✓	—	✓	C	—		20
Codar Multiband-6	17.33	5	✓	X	2.00	✓	✓	11x5x4		5
Johnson's CV2 Globe King	5.00	2	✓	✓	1.50	✓	✓	4x4x2	80—180MHz	19
HAC DX One-Valve	4.50	2	✓	X	1.50	✓	✓	6x6x4	S.W. tuner	12
HAC K Mark 2	8.50	2	✓	X	1.50	✓	✓	6x6x4	S.W. tuner	12
Globe Patrol	15.49*	3	✓	X	V	—	C	5x9x4	4 Bands	24

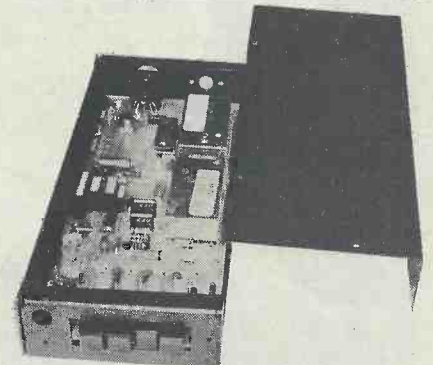

Hart produce an unusually shaped push-button tuner using prealigned modules. This is designed to be adjacent to record player plinth.

Electrospares FM varicap stereo tuner has five push-buttons and uses pre-aligned r.f. and i.f. modules. Incorporates PLL decoder. Attractive cabinet included.

Josty HF325 uses prealigned tuner which can operate from 12—55V. designed to connect to their HF330 stereo decoder (£11.40).

Integrex produce two FM tuners, the Nelson-Jones which got a good review in June's ETI albeit a fairly complex kit. They have since brought out a simpler, slightly cheaper model which uses prealigned modules.

Amtron have a variety of receivers and tuners covering most bands, including some unusual features. Those interested are referred to their catalogue.

Codar The Multiband-6 comes from a company who normally produce ready-built receivers. It is a TRF covering 550kHz—30MHz. Uses four coils and modules. SSB facility. Loudspeaker not supplied. Uses PP6 battery.

Heathkit have a wide range of receivers ranging from portable sets such as the Tiger FM up to multiband receivers of professional quality. The SW717 covers 550kHz to 30 MHz with a large dial. The GR78 has additional long wave and better bandsread. Runs off rechargeable batteries.

Johnson's market a triple purpose VHF kit covering 8—180MHz, it can be used as a converter, tuner feeder or as a receiver with headphones.

Tandy Globe Patrol. A simple receiver covering 540kHz—30MHz. Built-in speaker and comes with 'where to listen' guide. Battery powered.

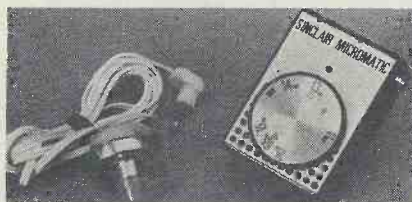

Sinclair Micromatic. Perhaps the most common introduction to kit building. Has been around for years but remains a favourite. TRF, reflex, two transistor circuit using two mercury batteries.

H.A.C. have two kits, one using a valve but is a tried, tested design. Ideal beginners kits.

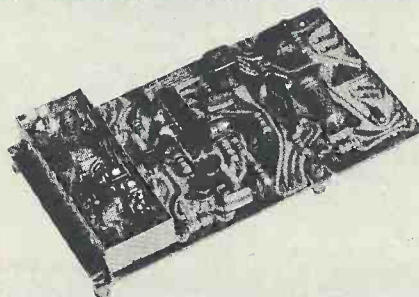

Josty The inexpensive HF75 will pickup high frequency transmission, either AM or FM including the aircraft bands.

ETI KITS REVIEW

Heathkit have a push-button car radio kit in their range suitable for 12V +ve or -ve chassis models. Medium and long wave coverage.



R & TV Components produce the inexpensive Tourist in two models, the Mk I which is cheaper but requires quite a bit of work but the Mk II is suitable for beginners as no soldering is required! The company tell us that there are considerable delays at present on the Mk II.



Heathkit have two induction balance metal locators in their range, the GD348 is shown. This has speaker output and a meter. The GD48 is an older model, still available, at a lower price.

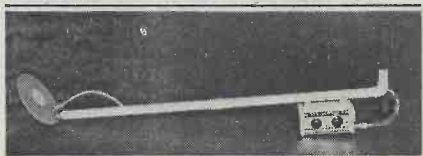

Minikits market the Treasure Tracer Mk III with speaker output and using the BFO principle. This comes with a prebuilt search head.

Amtron produce the electronics section for a metal locator operating using the BFO principle. A handle is all that is required.

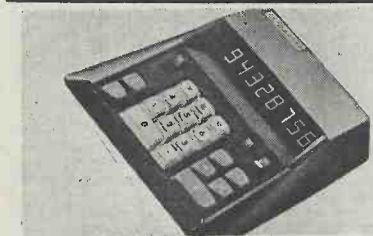

Heathkit have several calculators in their range, the one illustrated is the desktop IC2108 which is mains operated with large displays. Rechargeable models are also available.

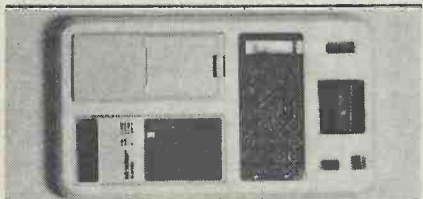

Sinclair calculator kits are well known and ETI has given details in the past of both the Cambridge and Scientific (the Scientific kit is illustrated). At £19.95 this is by far the cheapest scientific calculator available.

CAR RADIOS	PRICE	TIME	BEGINNERS		SERVICE CHARGE	OVERSEAS	LITERATURE	SIZE	NOTES	SUPPLIER
			BUILT	BUILT						
Heathkit CR9502	20.55	5	✓	X	✓		C	7x6x2	Push-button	15
Tourist I	7.15	7	X	X	2.50	X	✓	7x4½x2	Push-button	22
Tourist II	8.25	2	✓	X	2.50	X	✓	7x4½x2	As Tourist I but no soldering. (long deliveries at present)	22

METAL LOCATORS	PRICE	TIME	BEGINNERS		SERVICE CHARGE	OVERSEAS	LITERATURE	SIZE	NOTES	SUPPLIER
			BUILT	BUILT						
Amtron UK 780	13.09	2	✓	X	1.00		C		Handle not included	1
Heathkit GD 348	48.60		✓	X	✓		C	-	Induction Balance	15
Heathkit GD 48	37.80		✓	X	✓		✓	-	Induction Balance	15
Treasure Tracer Mk III	11.03		✓	✓	✓	✓	✓	-	BFO	21

CALCULATORS	PRICE	TIME	BEGINNERS		SERVICE CHARGE	OVERSEAS	LITERATURE	SIZE	NOTES	SUPPLIER
			BUILT	BUILT						
Heathkit IC 2006	39.95	8	✓	X	✓		C		Other models available	15
Heathkit IC 2108	43.20	8	✓	X	✓		C	7x2½x9"	Desk top model.	15
Sinclair Cambridge	14.95	2	✓	✓	2.50	✓	ads	4½x2x¾"		23
Sinclair Scientific	19.95	2	✓	✓	2.50	✓	ads	4½x2x¾"	Details in Oct. 74 ETI.	23

MULTIPLE BUILDING MODULES	PRICE	TIME	BEGINNERS		SERVICE CHARGE	OVERSEAS	LITERATURE	SIZE	NOTES	SUPPLIER
			BUILT	BUILT						
Electroni-kit	8.80 to 33.95	-	✓	-	-	✓	✓	-	Several versions	9
Tandy	8.99 to 17.95 *	-	✓	-	-	X	C	-	Several versions	24



Electroni-Kit have a wide range of building modules for the absolute beginner, the simplest of these will make up 16 projects whilst the largest enables 150 circuits to be built. There are 'add-on' kits also available. Each comes with a very extensive manual describing each circuit.

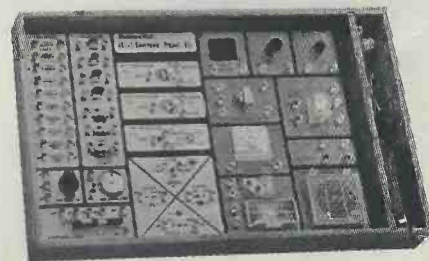

Tandy stores market four starters modules which are a base-board with spring clips. All that is necessary is to connect hook-up wires to the points specified. The simplest makes up 20 circuits whilst the dearest has 100 ideas. These come complete with an educational manual.

TEST GEAR	PRICE	TIME	BEGINNERS	BUILT	SERVICE CHARGE	OVERSEAS	LITERATURE	SIZE	NOTES	SUPPLIER
Cross-Hatch Generator	8.71	4	✓	✓	1.77	✓	✓	5½x3x3	Leads 54p extra	3
A.F. Signal Generator UK437	23.20	8	✓	X	1.00	✓	C			1
Digital Frequency Meter IB-1101	91.80	15	✓	✓	V		C	3½x8¼x9	1Hz-100MHz, 5-digit.	15
Chart Recorder IR-18M	100.45	20	✓	✓	V		C	15x6x9½	Paper rolls £2.20 each	15
5MHz General Scope IO-102	84.25	12	✓	✓	V		C	12¾x9¼x16¼		15

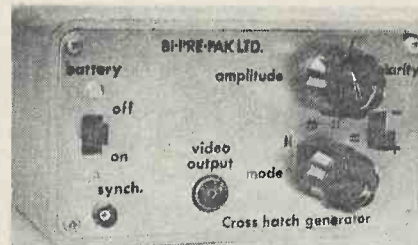

Bi-Pre-Pak sell a Cross-Hatch generator which enables a colour TV set to be properly converged. This is cheap enough to fit permanently into the back of your TV.

Amtron's UK437 shown on the cover and is an A.F. Signal generator covering 15Hz-22kHz in three ranges. It has distortion of 1% and a maximum output of 2V. Amtron's range in the test gear field is extensive and reference should be made to their catalogue.

The Amtron and Heathkit catalogues both contain an extensive range of test equipment. Readers interested primarily in test equipment are referred to these. Both these catalogues and the one from Josty contain details of numerous power supplies.



Heathkit have a very wide range of test gear in their catalogue. We show their IO-103 Scope and the IR-18M chart recorder on the cover. The range in the test gear is huge - several oscilloscopes and digital frequency meters for a start. This varies in cost from true professional to amateur market.

DIGITAL CLOCKS	PRICE	TIME	BEGINNERS	BUILT	SERVICE CHARGE	OVERSEAS	LITERATURE	SIZE	NOTES	SUPPLIER
Digitronic II	32.12	2	✓	✓	50p	✓	✓	5½x4¼x2½		4
Heathkit GC 1005	34.55	6	✓	-	V		C	7x2½x4¼	Alarm clock.	15
Amtron UK820GB	36.24	15	✓	X	£1	✓	C		Shows seconds.	1

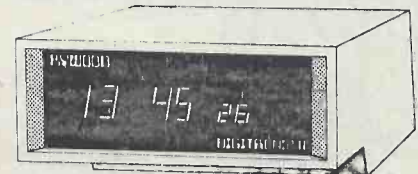

Bywood's Digitronic II is a kit available in various versions from a company who specialise in digital clocks. A recent ETI offer on these proved very popular. The Digitronic II is shown on the cover.

ELECTRONIC IGNITION	PRICE	TIME	BEGINNERS	BUILT	SERVICE CHARGE	OVERSEAS	LITERATURE	SIZE	NOTES	SUPPLIER
Amtron UK875	14.47	3	✓	X	1.00	✓	C	4x2½x2½	-ve earth.	1
Bi-Pre-Pak	6.73	6	X	X	1.87	✓	✓	5½x4x3	ETI Design, +, -ve earth.	3
Dabar Scorpio	12.72	4	✓	✓	2.16	✓	✓	7¼x4¼x2¼	6/12V, +, -ve earth.	7
Electrosparcs Scorpio	11.50	4	✓	✓	V	✓	✓	4¼x3½x2¼	6/12V, +, -ve earth.	10
Heathkit CP 1060	25.95	2	✓	X	V	-	C	3¼x3¼x6	-ve earth.	15
Sparkrite Mk2	10.93	2	✓	✓	2.20	✓	✓	6x4x3	+, -ve earth.	8
Tandy	28.95*	3	✓	X	2.50	X	C	5½x3x3¼	-ve, earth.	24



Heathkit's GC1005 is one of the company's most popular products and is featured on the cover their catalogue. It has an alarm facility. Another model - the GC1092A at £50.80 is now available with a variety of extra features including reserve battery operation.



Amtron also have a digital clock in their range which uses 15 TTL i.c.s.

Bi-Pre-Pak's electronic Ignition is based on the ETI design of September 1973. This is suitable for positive or negative chassis operation and incorporates a burglar foiling devices.

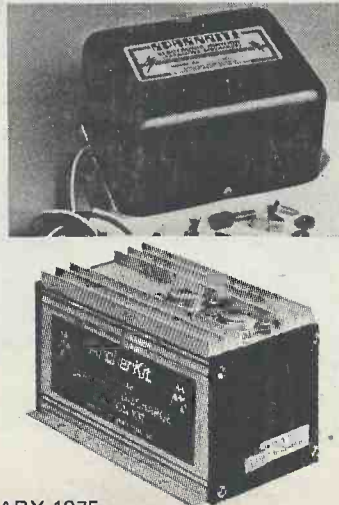

ETI KITS REVIEW

Forgestone have the only DIY colour TV kit on the market; this is available with several screen sizes. Details were given in November 1974 ETI.



Heathkit market a 12in. B & W TV for the U.K. UHF bands which can be mains or 12V battery operated.



E.D.A.'s Fluorescent light is a simple unit which runs from a 12V battery and produces 8W.

Cosmic's Nova Light Display is a slim unit which needs no direct connection to the sound source; a mike is used.

Teleradio's Microtol Radio control equipment is sophisticated and controls up to five functions.

Tandy market a pair of stereo headphones in kit form which incorporate a volume control for each ear. 8-24 ohms.

Tandy's Lie Detector relies on changes in skin resistance under tension which alters an audio tone.

Amtron's Noise Reduction unit alters the pass-band dependent on input level thus being more effective than a scratch control.

Amtron's Guitar Preamp has low output impedance and is suitable for most guitar magnetic pickups. Gives 32dB gain.

Aerial Preampers are available from Josty and Amtron. Details of frequency coverage and gain are in the catalogues.



Amtron market a number of burglar alarm units which use a variety of trigger systems. The UK790, a capacitive type, switches when a body comes near it.

Heathkit's Informer Ultrasonic Intrusion Alarm is built into book form. It has a built-in 30 sec delay. A suitable alarm bell is available for £7.55.

Light Dimmers covering 200W to 2.2kW are sold by Josty and Amtron.

TELEVISIONS	PRICE	TIME	BEGINNERS	BUILT	SERVICE CHARGE	OVERSEAS	LITERATURE	SIZE	NOTES	SUPPLIER
Forgestone 400	About £200	70	X	X	V	✓	✓	Depends c.r.t.	Price depends on screen size. Colour.	11
Heathkit GR9900	68.00	12	✓	X	V		C	16½x10½x9	240V/12V B & W.	15

MISCELLANEOUS	PRICE	TIME	BEGINNERS	BUILT	SPECIAL CHARGE	OVERSEAS	LITERATURE	SIZE	NOTES	SUPPLIER
Fluorescent Light	3.19	½	✓	✓	85p	✓	✓	12x1½x2	Diffuser 59p each.	8
Nova Lighting Display	26.34	3	✓	✓	V	✓	✓	24x12x1½		6
Microtol Radio Control	88.60		X	✓	V	✓	✓	—	Complete system.	25
Stereo Headphones	13.49*	3	✓	X	V	X	C	—		24
Noise Reduction Unit UK127	8.76	4	✓	X	1.00	✓	C	4x3x1½		1
Lie Detector	7.95*	3	✓	X	V	X	C	—		24
Guitar Preamplifier UK835	5.62	2	✓	X	1.00	✓	C	4x3x1½		1
AM/FM Aerial Preamp UK230	3.59	2	✓	X	1.00	✓	C	3x2x1½	VHF/UHF (UK285)	1
Aerial Preamp HF380	6.51*	2	✓	X	—	✓	C	—		20
Capacitive Burglar Alarm UK790	8.94	3	✓	X	1.00	✓	C	4x3x1½		1
Ultrasonic Alarm UK815	26.08	20	✓	X	1.00	✓	C	6½x2x5½		1
Heathkit Informer GD-39	28.10	12	✓	X	V		C	2½x10½x7½	Ultrasonic	15
200W Light Dimmer UK640	8.84	2	✓	X	1.00	✓	C	3x2½x1½		1
400W Light Dimmer AT56	5.60*	2	✓	X	—	✓	C	—	2.2kW version available.	20
Psychadelic Light Control AT65	17.85*	2	✓	X	—	✓	C	—		20
Digital Thermometer ID-1390E	38.90	12	✓	X	V		C	2½x7x5		15
Stereo 21	20.55	4	✓	X	£2.50	X	X	—	No soldering.	22

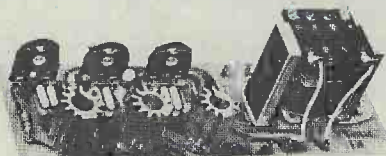

Josty's Psychadelic Light Control 400W in each of three frequency channels. Lights, case etc. are not included.



R & TV Components have a very inexpensive stereo system which gives a very decent sound if not Hi-Fi. Glue is all that is required.

Heathkit's Digital Thermometer has the appearance of a digital clock and gives either Fahrenheit or Centigrade readings in the range -30° to +50°C. Monitors both inside and outside temperature.

TELERADIO ELECTRONICS

If you require further data on radio control systems or quality amplifier kits send s.a.e. to

325-7 Fore Street,
Edmonton,
London N9 OPE.

INDEX TO KIT COMPANIES

1. Amtron (U.K.) Ltd.,
4-7 Castle Street,
Hastings,
Sussex.
2. Baker Loudspeaker Co.
Bensham Manor Passage,
Thornton Heath,
Surrey.
3. Bi-Pre-Pak Ltd.,
222-224 West Road,
Westcliff-on-Sea,
Essex.
4. Bywood Electronics,
181 Ebbens Road,
Hemel Hempstead,
Herts.
5. Codar,
Valcon Works, Burrell Buildings,
Churchill Industrial Estate,
Lancing, Sussex.
6. Cosmic Electronics,
62 Ongar Road,
Brentwood,
Essex.
7. Dabar,
98 Lichfield Street,
Walsall,
Staffs, WS1 1UZ.
8. Electronic Design Associates,
82 Bath Street,
Walsall,
Staffs, WS1 3DE.
9. Electroni-Kit,
498 St. John's Street,
London E.C.1.
10. Electrospares,
288 Ecclesall Road,
Sheffield.
11. Forgestone Colour Developments Ltd,
Ketteringham,
Wymondham,
Norfolk.
12. H.A.C. Shortwave Products,
P.O. Box 16,
East Grinstead,
Sussex, RH19 3SN.
13. Hart Electronics,
Penylan Mill,
Oswestry,
Salop.
14. Harverson Surplus Co. Ltd.,
170 High Street,
Merton,
London S.W.19.
15. Heath (Gloucester) Ltd.,
Gloucester GL2 6EE.
16. Helme Audio Products Ltd,
Summerbridge,
Harrogate,
Yorks.
17. Henry's Radio Ltd.,
303 Edgware Road,
London W2 1BW.
18. Integrex Ltd.,
P.O. Box 45,
Derby,
DE1 1TW.
19. Johnson's Radio,-
Shaw Street,
Worcester,
WR1 3QQ.
20. Josty Kit (U.K.) Ltd.,
P.O. Box 68,
Middlesbrough,
Cleveland,
TS1 5DQ.
21. Minikits Electronics,
35d Langley Drive,
London E11 2LN.
22. Radio & TV Components (Acton) Ltd.
21 High Street,
Acton,
London W3 6NG.
23. Sinclair Radionics,
St. Ives,
Hunts.
24. Tandy Corporation,
Bilston Road,
Wednesbury,
Staffs.,
WS10 7JN.
25. Teleradio,
325 Fore Street,
London N.9.

The FORGESTONE 400

a high quality colour television receiver.

A complete and up-to-the-minute Electronic Kit* with all these plus features . . .

- | | |
|--|--------------------------------------|
| 9 integrated circuits | Thick film resistor units |
| Ready-built and aligned IF module | Glass epoxy printed circuit panels |
| High quality components | Fully isolated power supply |
| Plugs and sockets for easy panel removal | Each module kit available separately |
| Full technical construction manual | LT supply regulator |

*less cabinet, which can be manufactured yourself from normal DIY sources.

Send for further details of the Forgestone 400 . . . the quality kit for the constructor of today.

Forgestone Components

FORGESTONE COLOUR DEVELOPMENTS LIMITED
Ketteringham, Wymondham, Norfolk
Telephone: Norwich 810453 (STD 0603)

AMTRON PRICES ARE GOING DOWN!

JUST LOOK AT THESE PRICE REDUCTIONS

- * UK 187 HI-FI QUADRIK STEREO AMPLIFIER 20 + 20 W.
OLD PRICE £110.45 NOW **£72.23**
- * UK 390 VOX
OLD PRICE £14.98 NOW **£11.17**
- * UK 460/S PM SIGNAL GENERATOR
OLD PRICE £19.96 NOW **£15.95**
- * UK 500 LW/MW/FM RECEIVER
OLD PRICE £43.60 NOW **£31.33**
- * UK 540/C LW/MW/FM TUNER
OLD PRICE £33.36 NOW **£21.03**
- * UK 560/S TRANSISTOR ANALYSER
OLD PRICE £36.22 NOW **£22.01**

PRICES INCLUDE VAT.



4 & 7 CASTLE ST.,
HASTINGS
SUSSEX TN34 3DY

TEL (0424) 437875.

ELECTRONIC IGNITION

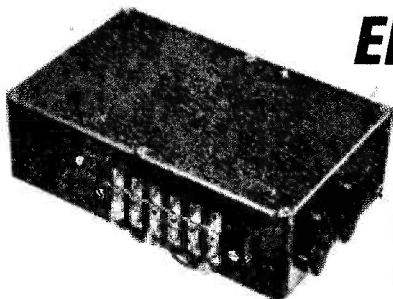

SCORPIO Mk II

Capacitor discharge ignition system

(Reviewed 'Safer Motoring' May 1974)

AVAILABLE IN 6V. or 12V. VERSIONS

- Promotes easier starting — even under sub-zero conditions.
- Improves acceleration, gives better high speed performance and quicker engine warm up.
- Eliminates excessive contact breaker burning and pitting.
- Promotes Fuel Economy.

DON'T TAKE OUR WORD FOR IT!

Send s.a.e. for copy of 'Safer Motoring's' independent test report, together with further details and prices.

Available in kit form £11 78
(Construction manual available separately at 25p)

Built and tested unit, ready for fitting to your vehicle £14.49

PLEASE ADD V.A.T. TO ALL ORDERS AND STATE WHETHER 6V. or 12V. UNITS REQUIRED.



DABAR ELECTRONIC PRODUCTS

98, Lichfield Street,
Walsall, Staffs. WS1 1UZ.





TRAMPUS ELECTRONICS LTD

58-60 GROVE ROAD,
WINDSOR, BERKS.

MONEY BACK IF NOT SATISFIED.
LARGE STOCKS. LOW PRICES.
ALL BRAND NEW TOP GRADE FULL
SPEC DEVICES. CALLERS WELCOME.

FAST SERVICE.

SEND C.W.O. ADD VAT TO ALL PRICES IN U.K. P&P 15P. EUROPE 25P. OVERSEAS 65P.

CATALOGUE/LIST FREE SEND S.A.E.

Digital Displays



MINITRON 3015F
0-9DP £1.15 ea
LED 0.3" digit
0-9DP £1.49 ea
JUMBO LED 0.6"
0-9DP £2.25 ea
LIQUID CRYSTAL
6 digit £18

LEDS 14P.

MINI PIN SOURCE OR RED DIFFUSE
LEDS. 109 STYLE. NO CLIP. 14P ea
TILLOS RED LED & CLIP 17P ea
BIG 1" RED LED & CLIP 18P ea
ORANGE & GREEN LEDES:
MINI 25P ea. BIG & CLIP 33P ea
INFRA RED LED £1.2N5777 33P.
PS12 PHOTO IC/amp/switch £1.

DIGITAL CLOCK

MOS INTEGRATED CIRCUITS.
AY51224 4 DIGIT CLOCK supplied
with 14pin socket & data £4.25
MM5311/14 6 DIGIT CLOCK with
28 pin socket & data £7.50
3DIGIT DVM AY53500 £7.50
4DIGIT COUNTER/DRIVER £7.50

CASSETTE mechanics £12.50

STEREO CASSETTE MECHANISM.
As used in imported types
costing £100. Only requires
a case & electronics. Heads
supplied. Send for data 15p.

IC's & Semiconductors

702 OPA 69p
703 RF/IF 28p
709 TO99 21p
709 DIL 14 29p
710 DIL 14 .36p
720 Radio £1.39
723 Regulator 67p
741 TO99 29p
741 DIL8 31p
741 DIL14 31p
747 Dual 741 89p
748 DIL 8 36p
1505 IC A/D
Converter £7

7805 1A5V £1.59
7808 1A8V £1.69
7812 1A12V £1.69
7815 1A15V £1.69
76009 1W AF 75p
76013 6W AF £1.39
8038 Sig Gen £3
CA3046 69p
LMS01 OPA 49p
LMS07 OPA 49p
LMS08 HiBoPa 95p
LMS09K Reg. £2.29
LMS71 RF/IF £2
LMS72N AF/IF £2
LMS73 £3
LMS77 2x2W £2.69
LMS80 2W AF 99p
LMS81 2xpre. £2
LMS82 amp £2
LMS900 4xOPA 69p

MC1303 £1.20
MC1306 49p
MC1310 & LED £2.69
MC1312 SQamp £2.50
MC1330 69p
MC1339 £1
MC1350 55p
MC1351 71p
MC1352 71p
MC1357 £1
MC1358 £1
MC1375 £1.25

MFC4000 1W AF 35p
MFC4060 54p
MFC6030 52p
MFC6040 90p
MFC8010 £1.10
MFC8040 £1
NE531 35V/us £2
NE536 FET OPA £2
NE540 Driver £1
NE546 AM Rx £1.50
NE550 2v ref 79p

NE555 TIMER 67p
NE556 Dual £1.30
NE560 PLL £3.15
NE561 PLL £3.15
NE562 PLL £3.19
NE565 PLL £2.69
NE566 Gen £2.49
NE567 code £2.69
SN72709 709 29p
SN72741 741 31p
SN72748 748 36p
SN76131 £1.20
SN76660 PMF £1
SN76611 IF £1.25
TAD 100 & IF £2
ZNA00E £3
ZNA02T £1.75
ZNA03 Servo £2.50
ZNA14 AM Rx £1.09

7400 etc gates 16p
7413 schmitt 31p
7447 driver £1.09
7470/72 32p
7473/74/76 39p
7475 48p
7490 Counter 63p
7492 Counter 69p
74121 mono 45p
74141 driver 83p
Full range in Cat.

SPECIAL OFFERS

741 29p MFC4000 35p
555 67p ZNA14 £1.09
BC107, BC108, BC109 9p ea
2N3055 39p Three for £1
115W/TO3 or 90W plastic
2N3819E 16p 2N3053 17p
BFY50/51/52/53 all 18p
LASOvrect 4p ea IN914 4p

Price each:-

AC127/128 16p
AC187/188 19p
AD161/162 35p
BC107/8/9 9p
BC132/4/7 18p
BC147/8/9 10p
BC157/8/9 12p
BC167/8/9 12p
BC177/8/9 18p
BC182/3/4*11p
BC212/3/4*12p
*A or L
BCY70/1/2 15p
BD131/2 39p
BFY53 17p
BSX20 17p
BZ2955 85p
MJE3055 62p
MPU131put 49p
OA91 8p
TIP29A 8p
TIP30A 57p
TIP31A 61p
TIP32A 75p
TIP41A 78p
TIP42A 89p

BZY88 400mW 9p
ZENERS 9p
BRIDGE RECT 4A/400V 55p
1A 50V 20p
GAS SENSOR £2
GAS " KIT £5

VERO

NEW LOW PRICES!

VERO PINSx36 25p.
COPPER CLAD VEROBOARD 0.1"
2 1/2x5" 27p. 2 1/2x3 1/2" 24p. 3 1/2x3 1/2" 27p.
3 1/2x5" 29p. 3 1/2x1 7" £1.50
DIL IC's BOARDS 6x4 1/2" £1.50
24 way edge connector 60p
36way 90P. PLAIN 3 1/2"x1 7" £1
FACE CUTTER 45p. PEC ETCHANT

DALOpen69p

PRINTED CIRCUIT BOARD KIT £1.69
COPPER BOARD 6x4" 40p.
DESOLDER BRAID reel 59p
HEATSINKS
5F/TO5 & 18F/TO18 5p ea.
TV4 12p. TV3/TO3 16p. 4Y1/TO3 29p.

CAPACITORS

22pf to 0.1uf 4p ea. ELECTROLYTIC
25V 2/10/50/100uf 6p. 1000uf 20p
PRESETS VERT: 5p. RESISTORS 5p 11p

POTS AB or EGIN

ROTARY: 12p. SWITCH 13p. DUAL 38p.
SLIDERS: SINGLE 26p. DOUBLE 48p.
SWITCHES: SPST 18p. DPDT 25p.
MINI 1": SPST 39p. PUSH 39p.
BENCH POWER SUPPLY 3-12V 15.
DIN PLUGS all 13p ea. Sockets 9p
TRANSFORMERS 1A 6/12V £1.34
BHA 0002 MODULE 15WATT AMP £5
EA1000 4W AF MODULE £2.49
8W/12V FLUORESCENT LIGHT £3.

Oil sockets

PROFESSIONAL
GOLD PLATED
& GREY NYLON.
8, 14 or 16 PIN
ONLY 15p each.

MHI CLOCK KITS

MHI kits are a mid-way approach to building digital clocks, mid-way that is between a complete kit and basic chips. The MHI kit contains clock chip, socket, CA3082 degment friver, and a fibreglass PCB. The outputs from the PCB are suitable for driving common anode LEDs such as the DL747 and DL707, most manufacturers versions of these displays can also be used. Other outputs from the PCB are for switches and any alarm facilities that the chip might have, thus we have a clock module in exactly the same way as you might buy an audio amp module.

The MHI clock kit is partnered by the MHI display kit, a set of four or six LED displays plus a PCB. This PCB interfaces directly to the clock PCB. The four main units (clock PCB, display PCB, switch matrix, transformer) may be mounted up to 15" apart from each other for use where there is not room for the whole unit behind the display board.

The additional components required to complete the unit are standard components available through most component outlets.

CLOCK KITS -

MHI-5314/S £ 9.40
MHI-5025/S £11.35
MHI-7001/S £12.50

DISPLAY KITS -

MHI-D707/4 £ 7.60
MHI-D707/6 £11.00
MHI-D747/4 £10.25
MHI-D747/6 £15.15

All prices on this advert exclude VAT.

DIGITAL CLOCK CHIPS

CLOCK CHIPS:

MM5314 Basic 12/24Hr, 6 digit, 50/60Hz chip. £ 7.20*
7 seg outputs. Very popular, simple chip.
MM5311 As MM5314 but with additional BCD £ 9.00
outputs.
MK50250 6 digit alarm chip with alarm tone out- £ 7.60*
put, Standard basic alarm facilities.
CT7001 Time, Date & Alarm on one 6 digit £ 9.80*
chip. The Alarm can be used in 3 modes
including a time switch. Clock-Radio &
Snooze features. 7 seg outputs, 50/60Hz
or 100.8kHz input frequency.
CT7002 As CT7001 but with BCD outputs not £ 9.80
7 seg.
TMS3952 Stopwatch chip, most reqd. stopwatch £10.50
functions 6 digits (hhmmss or mmssss),
300kHz input. 7 seg output. Special price.
HEEC2 8 digit (HhMmSsss), stop/start/reset, £ 8.50
50Hz/60Hz/100kHz input, BCD output
hard-wired alarm with repeat (snooze).
Can also be used as 8 digit decade counter.
CT6002 CMOS chip for Liquid-crystal displays, £19.54
12Hz, 1Hz colon, input 32768Hz or
65536Hz. Runs on 1.5V hearing aid
battery for a year.
MM5316 4 digit non-mplxd alarm chip, will £15.00
direct drive 1-c or phosphor-diode displays.

* Available in a MHI kit.

BYWOOD ELECTRONICS,
181 Ebbens Road,
Hemel Hempstead,
Herts. HP3 9RD.
Tel: 0442-62757



ed
product
test

YAMAHA CA800 AMPLIFIER

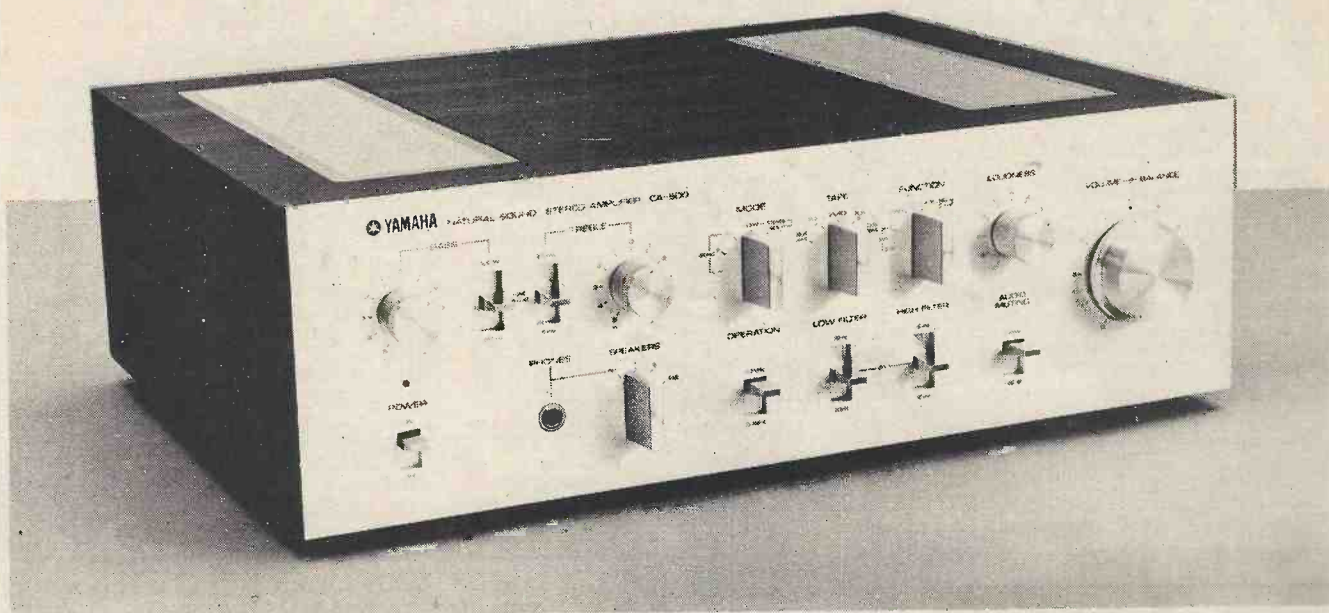

Yamaha's CA-800 switchable class A/class B amplifier reviewed.

A SMALL but vocal number of hi-fi enthusiasts insist that for truly distortion-free amplification, nothing but Class A operation will suffice.

Even the best of Class B amplifiers, they insist, is an electronic abomination.

Until now this argument has been difficult to evaluate. Whilst some Class A amplifiers are audibly better than their Class B counterparts, the difference may well be due to things

other than the operating mode of the output stages!

Now, Yamaha have produced a high-class amplifier with an output stage that can be switched to either Class A or Class B operation.

The amplifier, Yamaha's CA-800 — has a number of other unusual features as well. Like Leak's old Varislope units, the CA-800 features variable-slope cut-off frequencies for bass and treble filters. It also has a

variable loudness control that operates independently of the main volume control.

A very wide range of facilities is provided. There is a bass attenuator with a cut-off frequency selectable at either 500 Hz or 250 Hz — together with a central 'defeat' position; a treble filter with cut-off frequencies of 2.5 kHz and 5 kHz; a low frequency filter (70 Hz and 20 Hz) and a high frequency filter (12 kHz and 6 kHz).

Also provided is a switch for selecting Class A or Class B operation, and the aforementioned loudness control which provides a set of contours for true compensation for the physiological response of the ear.

The rear panel of the amplifier has all necessary inputs together with a preamplifier out and main amplifier input sockets with an electrical coupler switch; two microphone sockets; and a switch for selecting impedances of 100 k Ω , 50 k Ω , or 30 k Ω on phono 1 input.

With one or two minor exceptions, the amplifier is constructed to truly professional standards. For example, each of the audio sockets on the rear panel, with the exception of the speaker outputs, is terminated on a printed circuit card which is itself connected to the preamplifier cards via gold-plated plug-in sockets. The

Most power amplifiers have output stages that operate in what is usually called 'Class B'.

In this mode of operation, two power transistors are connected so that as one 'pushes' the other 'pulls'.

A positive going signal, for example, will cause one transistor to conduct and the other to turn off.

Class B is an efficient mode of operation and quite high power outputs can be achieved economically, but so-called 'cross-over' distortion will be generated unless the circuit is very carefully designed.

Despite this 'disadvantage', several modern Class B operation amplifiers have very low distortion indeed.

Class A amplifiers have an output stage arranged so that, with normal input levels, the output transistors are never driven into either cut-off or saturation.

In theory, the output waveform is identical to the input waveform. Distortion is very low indeed but the output stage's efficiency is very low. Because of this it is not practicable to build high power output Class A amplifiers.

SUMMARY: The Yamaha CA800 amplifier offers a performance which is generally better than most other amplifiers regardless of price. It is designed for the purist who is seeking the ultimate, but that the ultimate is "CLASS A" output operation is something that has yet to be proven!

preamplifier cards themselves are fully shielded from the rest of the unit by well designed steel covers to reduce magnetic and electrostatic induction. The function selectors extend through from the front panel to switches which are incorporated within this shielded cover. All of the circuitry mounted behind the front panel is also shielded in either individual sub-shields or partial shields around individual switches and terminations.

In keeping with the latest technique in amplifier layout, the main amplifier cards and their associated heat sinks are constructed as complete modules with direct connection between the printed circuits and the power transistors.

It was interesting to note that the leads running close to the heat sinks are individually protected with glass insulation spaghetti to preclude the possibility of melting or shorting wires. The printed circuit cards are all individually coated on the rear faces to prevent corrosion, electrolysis and fungus, problems which plagued many earlier and cheaper pieces of Japanese equipment.

One of the few details that precludes this amplifier from being a fully professional unit is the use of phenolic resin based cards in lieu of the more often used epoxy glass cards found in true professional equipment.

The amplifier design incorporates a number of highly desirable features including a relay operated protection circuit to switch off speakers in the event of a substantial dc level appearing at the speaker terminals. There is also a fully-electronic protection circuit to protect the output amplifier and its silicon power transistors against short-circuiting or unusually low speaker load impedances. In addition, each output amplifier card incorporates two fast acting fuses to provide a third stage of protection.

The amplifier is constructed on a strong steel chassis within a very well made and adequately ventilated veneered plywood cabinet. The unit is readily capable of being rack mounted should this be desired although its frontal dimensions are 50 mm short of the standard 482 mm (19") rack mounting.

HOW IT PERFORMED

Evaluating the electrical performance proved to be particularly interesting, for excellent though Yamaha's claimed specifications are — the unit is in most respects even better!

In the Class B mode for example, the amplifier is capable of producing a true 60 watts into both channels at 8Ω impedance with a distortion level lower than the manufacturer claims for 50 watts. Likewise, the performance at 12.5 watts in the Class A mode is better than Yamaha's claim for 10 watts (both channels driven into 8Ω).

It is of course the matter of distortion, its measurement, and its subjective evaluation, which makes this amplifier different from all others, for Yamaha have provided the facility for being able to select Class A or Class B operation at the flick of a switch.

Amplifiers, whether Class A or Class B generally produce more distortion at low power levels than at levels closer to their maximum power output.

A 60 watt Class B amplifier for example may generate four or five

times as much distortion at five watts output than at 50 watts output.

Class A amplifiers have similar characteristics, but to a lesser extent — so that a 10 watt unit (quite large for Class A operation) will be working closer to its lowest distortion point at the same five watt level.

At least that's what all the text books say — but to some extent Yamaha appear to have hoisted themselves by their own petard, because the CA-800 working in Class B produces so little distortion anyway that further reduction by switching to Class A seems to be of only academic interest. Certainly it can be *measured*, but after many hours of very careful listening at all sound levels we could not *hear* any difference.

Yamaha claim that the very low level of residual distortion at low listening levels (in Class B) *can* be heard. It could well be, but it must be by perfectionists whose hearing is a great deal more sensitive than ours!

Continued on next page.

YAMAHA CA800 STEREO AMPLIFIER

Power Output (at 1kHz)	CLASS B	60W (rms) into 8Ω both channels driven	
	CLASS A	12.5W (rms) into 8Ω both channels driven	
Frequency Response at rated output		20Hz to 20kHz ±1dB	
" " at 10W output		20Hz to 20kHz ±1dB	
" " at 1W output		20Hz to 20kHz ±1dB	
Channel Separation at Rated Output		100Hz -37.5dB	1kHz -38.0dB
Hum & Noise re Rated Power			
Volume control at maximum gain		-70dB (Lin.)	-87dB (A)
Volume control at minimum gain		-68dB (Lin.)	-87dB (A)
Input Sensitivity for Rated Output	CLASS A	CLASS B	
Aux. 1	50mV	100mV	
Aux. 2	50mV	100mV	
Tuner	50mV	100mV	
Phono 1		2.8mV	
Phono 2		2.8V	
Main Amp.	400mV	900mV	
Total Harmonic Distortion (at 60W output and 12.5W output respectively with both channels driven)	CLASS B (60W + 60W)	CLASS A (12.5W + 12.5W)	
100Hz	<0.01%	<0.01%	
1kHz	<0.01%	<0.01%	
6.3kHz	0.45%	0.02%	
Intermodulation Distortion	less than 0.05%		
Tone Controls		Filters	
Bass	50Hz	250Hz	500Hz
		+ 15dB	+ 17dB
		- 13dB	- 14dB
Treble	10kHz	5kHz	2.5kHz
		+ 6.5dB	+ 10.5dB
		- 7.5dB	- 10.0dB
Loudness Control (at constant volume control setting)			
Loudness control at 10	50Hz		+ 13dB
	10kHz		+ 5.5dB
Dimensions	436mm x 144mm x 323mm		
Weight	13.5kg		
Price	£210.25		

MEASURED PERFORMANCE

The measurable distortion of the amplifier is as low as any we have ever measured. In fact it presented us with a number of interesting problems in electrical measurement to be certain that our measurements were of amplifier distortion itself rather than distortion from our test oscillator.

The distortion products at maximum output were generally in the range -67 dB to -80 dB, re 0 dB at maximum output in the Class B mode, and in the range -74 dB to -80 dB re 0 dB at maximum output in the Class A mode.

Before embarking upon subjective tests we doubted our ability to be able to discriminate between distortion products 60 dB down on the fundamental component (less than 0.1%). After completing our tests we are *convinced* that we cannot hear such low distortion.

Is then the facility to switch to Class A operation a necessary or desirable feature — or is it just a gimmick?

Certainly its inclusion enables purists to decide for themselves whether or not Class A operation is worthwhile. A further advantage is that if you *can* still detect some distortion when switched to Class A, then you can be virtually certain that it's not coming from the amplifier! But our frank opinion is that for most people, the facility is an interesting gimmick. But, had Yamaha not incorporated such a superb Class B output stage, it would have been a different matter — as we said they've hoisted themselves by their own petard!

One very worthwhile and technically valid feature is the inclusion of a loudness control which is meant to be used as the preferred means of adjusting listening level. Whilst not unique to Yamaha, this feature is very desirable. Loudness controls are based on the psycho-acoustic fact that as sound levels decrease, high and low frequency components are heard at subjectively lower levels than mid-range sounds. Eventually, at very low sound levels, bass appears to drop out altogether.

Many amplifiers have 'loudness' controls that compensate for this phenomenon to some extent. Yamaha's method, used in the CA-800, is far more complex. The subjective effect is that the overall sound at all levels has the same apparent frequency response as at the higher levels.

The control is used by firstly setting the loudness knob to a 'flat' position. Then the volume control is set to the loudest volume that would normally be used. From then on, volume is adjusted solely with the loudness

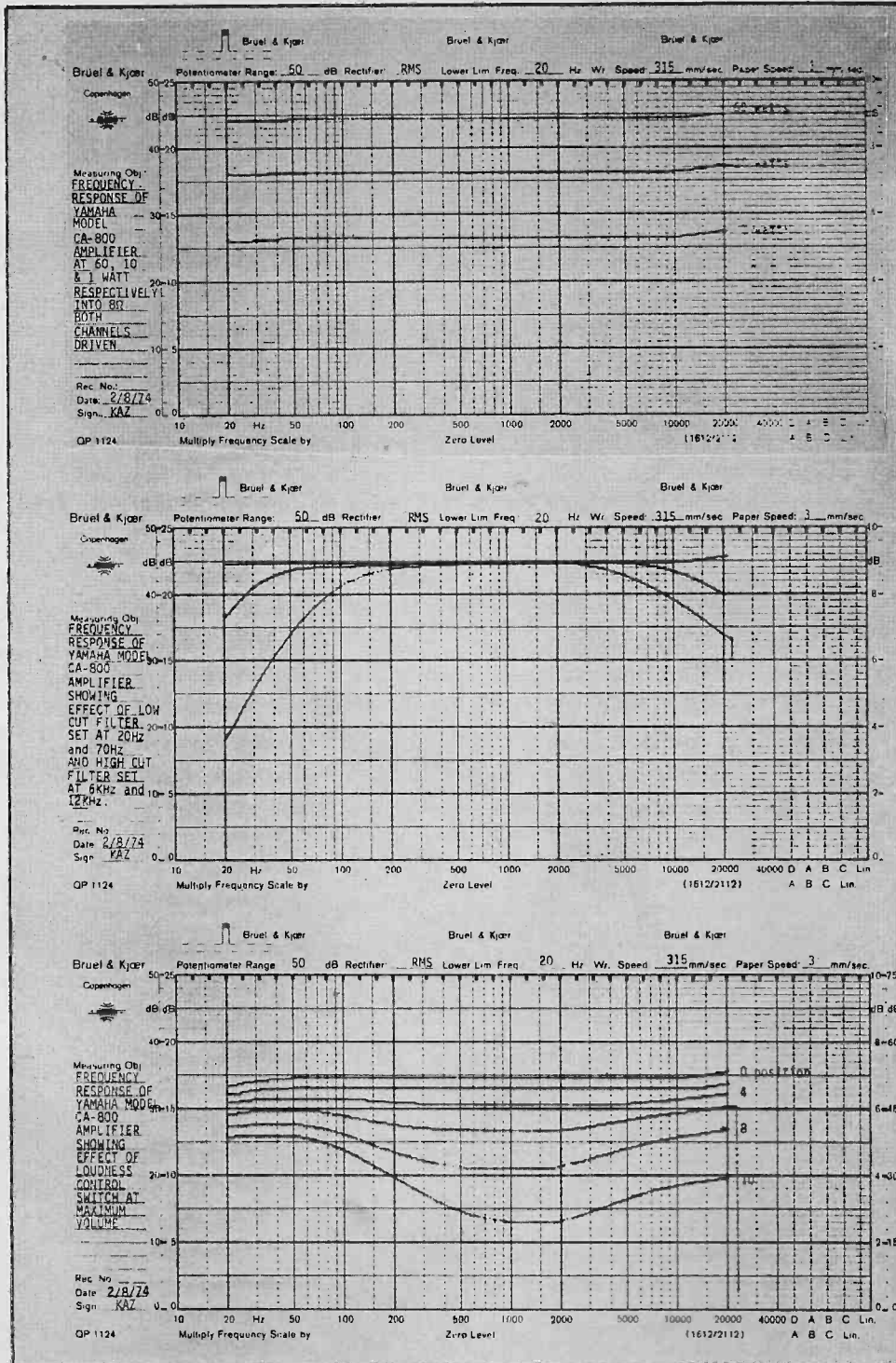

control — not with the main volume potentiometer.

As there are some hi-fi purists to whom loudness compensation is anathema, the volume control may be used normally — with loudness compensation switched out.

The tone controls and associated switch are well designed and the use of two "break" frequencies follows a growing trend. The choice of frequencies and the resultant response curves are not as different as might be expected, and a lower "break" frequency than 250 Hz and a higher break frequency than 5000 Hz may

well have been advantageous.

One fault became apparent during testing. With the amplifier set to maximum treble boost, and with the volume control set to maximum gain for response curve testing, we found it possible to introduce very high frequency (above audibility) instability in the output circuitry, and the amplifier could be induced into oscillation. This worried us, but it may well be that this was an isolated fault in this unit. In every other respect, however, the features of the amplifier were exemplary and it offered a superb performance.

Before you build a Heathkit send away for a free bookful of encouragement.

The new Heathkit catalogue.

In it you'll find the whole range of Heathkit electronic kits. The world's largest range, in fact.

Every one of which you can build yourself. Easily. And quickly.

And, if you're not convinced, we're sure a quick glance through our catalogue will soon encourage you to try.

You'll probably surprise yourself.

Because, even if you've never used a soldering iron in your life, you can build a Heathkit.

The easy to understand assembly manual and Kit Builder's Guide you'll get, see to that.

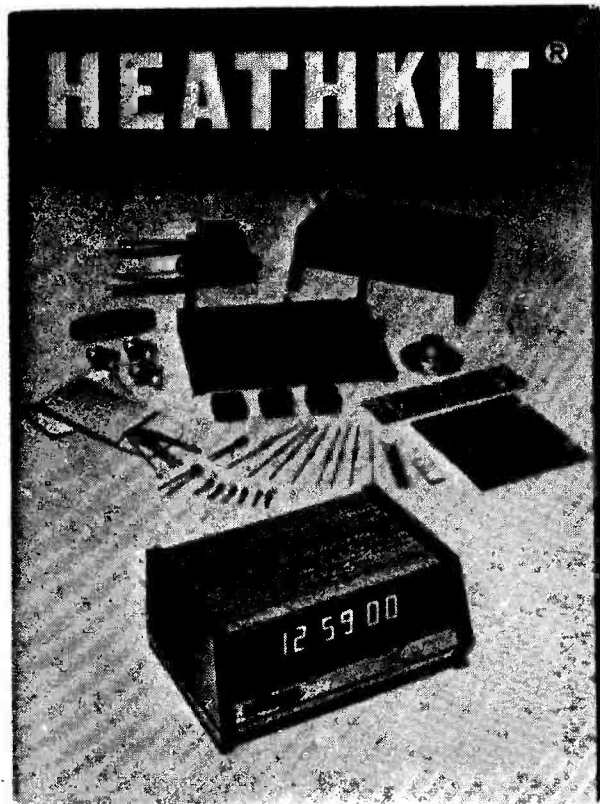

Start with something comparatively easy perhaps. Like our very popular digital alarm clock—the one on the front cover of the catalogue. It should only take you about three enjoyable evenings.



After which you may like to try your hand at the AR-1214 stereo receiver. Beautifully finished and delivering 20 watts music



power a channel, it's ideally suited to form the basis of a complete stereo system.

Or, if you want something to drag you away from watching television all night, we have just the thing: a television.

The GR-9900 to be precise. A 12" solid-state black and white television designed for mains or 12V battery operation.

So you can use it in the boat or caravan as well as at home.

Yet it's so straightforward to build that even a first time kit builder will probably be switching on after only a few short evenings of absorbing work.

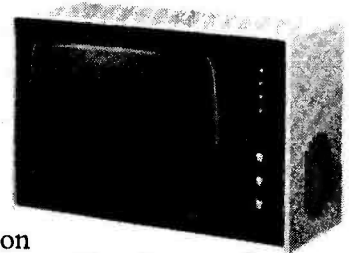

Send us the coupon now and we'll send you your free catalogue. Or, if you happen to be in London or Gloucester, call in and see us. The London Heathkit Centre is in Tottenham Court Road (where else?) at number 233.

The Gloucester showroom is next to our factory in Bristol Road.

At either one you can be sure you'll get a lot of encouragement.

Heath (Gloucester) Limited, Dept ETI-175, Bristol Road, Gloucester, GL2 6EE.

Telephone: Gloucester (0452) 29451.

The new Heathkit catalogue. Out now. FREE.

To: Heath (Gloucester) Limited, Dept ETI-175, Gloucester, GL2 6EE. Please send me my free Heathkit catalogue.

Name _____ Address _____

Remember easy terms are available with the Heathkit Monthly Budget Plan

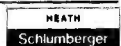

ELECTRONIC SPEED CONTROL FOR MOTORS

How various types of motor can be controlled in speed using semiconductor devices, Applications Department, Motorola, Phoenix.

SPEED CONTROL of motors in domestic appliances has been technically possible for a long time, but only recently has it become a good proposition economically.

Such diverse items as blenders, furnace blowers, clothes dryers, and food mixers can now use electronic controls. In this article, we review some of the common circuits being used today, and also describe some of the new circuits.

By far the easiest to control electronically are universal (or series-wound ac-dc) motors. Their characteristics and construction allow the use of a simple circuit to provide an electrical feedback so that speed is held relatively constant under varying load conditions.

Permanent-magnet motors are also easy to control. Perhaps surprisingly, the speed of several forms of induction motors may also be successfully controlled by electronic means — if these motors have a suitable load.

How AC power control

The most common method of electronic ac power control is called phase control.

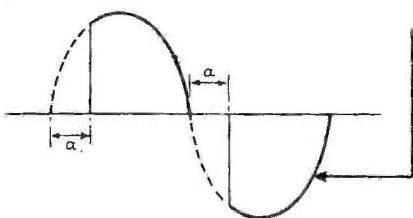

Fig.1. Illustrating the basic principles of phase control. The portion of the waveform applied to the load is shown shaded.

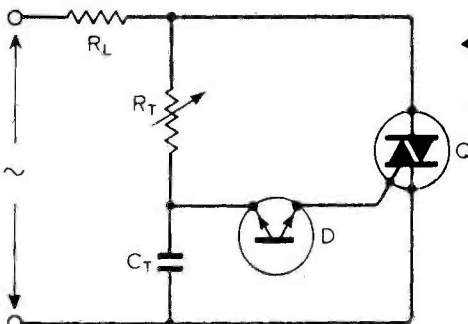

Fig.2. The simplest possible circuit for phase control. The load is represented by resistor R_L .

Figure 1 illustrates this concept. During the first portion of each half-cycle of the ac sine wave, an electronic switch is opened to block current flow. At some specific phase angle, α , this switch is closed to allow the full line voltage to be applied to the load for the remainder of that half-cycle. Varying α will control the portion of the total sine wave that is applied to the load (shaded area), and thereby regulate the power flow to the load.

The simplest circuit for accomplishing phase control is shown in Fig. 2. The electronic switch in this case is a triac (Q) which can be turned ON by a small current pulse to its gate. The triac turns OFF automatically when the current through it passes through zero.

In the circuit shown capacitor C_T is charged during each half-cycle by the current flowing through resistor R_T and the load. The fact that the load is in series with R_T during this portion of the cycle is of little consequence since the resistance of R_T is many times greater than that of the load. When the voltage across C_T reaches the breakdown voltage of the trigger diode (D), the energy stored in capacitor C_T is released. This energy produces a current pulse in the trigger diode, which flows through the gate of the triac and turns it ON. Since both the trigger diode and the triac are bidirectional devices, the values of R_T and C_T will determine the phase angle at which the triac will be triggered in both the positive and negative half-cycles of the ac sine wave.

The wave form of the voltage across the capacitor for two typical control conditions ($\alpha = 90^\circ$ and 150°) is shown in Fig. 3. If a silicon controlled rectifier is used in this circuit in place of the triac, only one half-cycle of the wave form will be controlled. The other half-cycle will be blocked, resulting in a pulsing dc output whose average value can be varied by adjusting R_T .

Characteristics of semiconductor switches

The silicon controlled rectifier (SCR) was the first of several thyristors developed for controlling electric power efficiently. It blocks current flow in both directions as long as no gate signal is applied and the applied voltage is below the rated breakover voltage. Exceeding the breakover voltage in the forward direction (with anode more positive than cathode) will cause the SCR to switch to its ON condition, in which the voltage from anode to cathode is approximately 1 V (and the current is limited only by the external circuitry). When the forward current is interrupted, the SCR recovers its blocking character.

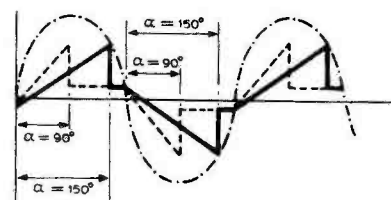
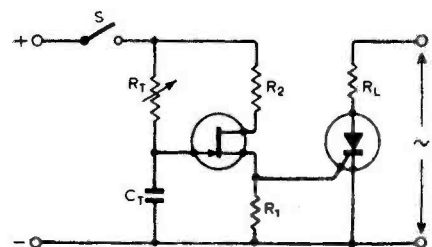

Fig.3. Waveforms across the capacitor at two different phase angles. The applied sine wave is shown dotted.

Fig.4. A typical phase control circuit using a unijunction transistor firing circuit.



Exceeding the reverse breakdown voltage of an SCR will destroy the device, most often causing a permanent short circuit.

Current flowing into the gate of an SCR will also cause it to turn ON when forward voltage is applied. Since the SCR is a regenerative device (that is, it remains in the ON condition as long as anode current is flowing), only a current pulse at the gate is necessary to effect switching. Thus, in the previously described circuits, a properly timed current pulse into the gate of an SCR can control average power flow to a load.

The triac is a bidirectional SCR. It is designed for use with alternating current, and functions the same way in both directions of applied voltage (as an SCR does in the forward direction). Its gate characteristics are different from that of an SCR in that gate current of either polarity will cause the triac to turn ON, with either polarity of applied anode voltage.

The trigger diode is a device designed specifically to provide current pulses to trigger SCR or triacs. In use, it acts much like a triac without a gate. That is, it will block current flow in either direction as long as the applied voltage is below the breakover voltage, which is generally between 16 and 36 V, depending on the device type. When the breakover voltage is exceeded, the device turns ON. In this state, the current is limited by the external circuitry, and the voltage drop across the diode is about 10 to 15 V. The trigger diode is most commonly used in circuits similar to the one shown in Fig. 2.

The unijunction transistor (UJT) is a three-terminal trigger device in which the characteristics of the emitter and base 1 are very much like those of the trigger diode. However, its breakover voltage can be controlled by the power supply voltage applied between base 1 and base 2. Since the UJT is a unidirectional device, unlike the bidirectional trigger diode, it requires a source of direct current for the interbase voltage as well as for the timing-circuit components, R_T and C_T . Figure 4 shows a UJT in a typical control circuit.

Because the breakover voltage of the UJT emitter is controlled by the interbase voltage, the unijunction transistor can be used for the timing circuit with a much lower source voltage than can be trigger diode, whose breakover voltage is controlled by the parameters of its structural materials. As a result, the UJT is quite popular for use with electronic control systems utilizing feedback.

In many applications it is desirable to vary motor speed in proportion to the magnitude of a change in a physical

Fig. 5 Motor speed control with a unijunction transistor using feedback.

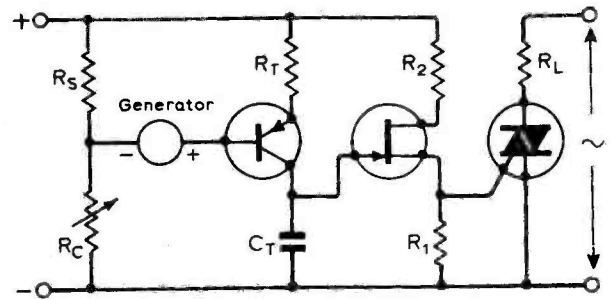
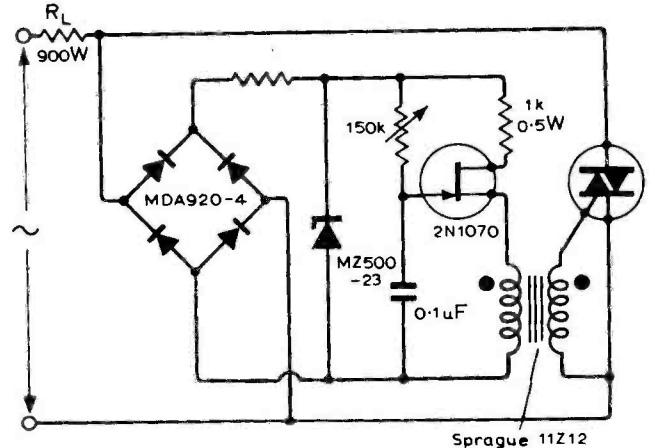

Fig. 6 Simple full-wave trigger circuit for a 900 W resistive load.



condition, such as a change in temperature. A furnace blower responding to the air temperature of a house is one example. Similarly, a control device can light a lamp in response to the fading twilight. Control of these circuits can be effected by resistors that change in value in response to a change in temperature or light intensity. A typical circuit using such a variable resistor is shown in Fig. 5. If motor speed is the quantity to be controlled, R_S may be a fixed resistor, and a direct-current tachometer generator may be inserted as shown. Only a few additional components are necessary to turn these elementary circuits into working modules.

Figure 6 shows a simple full-wave trigger circuit for controlling a 900 W load. The additional components required are a full-wave bridge, a resistor, and a Zener diode, which make up the dc power supply, and a

pulse transformer which provides the isolation between the UJT circuit and the power line, necessitated by the bridge rectifier. The feedback circuitry shown in Fig. 5 could also be added to this circuit.

Control of induction motors

Shaded-pole motors driving low-starting-torque loads such as fans and blowers may readily be controlled using any of the previously described full-wave circuits. One needs only to substitute the winding of the shaded-pole motor for the load resistor shown in the circuit diagrams.

Constant-torque loads or high-starting-torque loads are difficult, if not impossible, to control using the voltage controls described here. Figure 7 shows the effect of varying voltage on the speed-torque curve of a typical shaded-pole motor. A typical fan-load curve and a constant-torque-load curve have been superimposed upon this graph. It is not difficult to see that the torque developed by the motor is

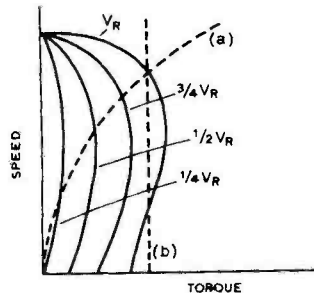

Fig. 7 Characteristics of a shaded pole motor at several voltages. V_R is the full rated voltage, (a) indicates a typical fan load and (b) shows a constant torque load.

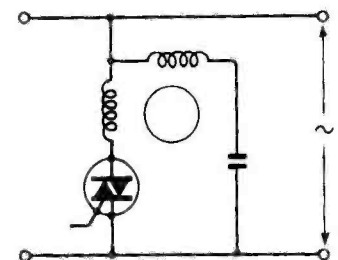

Fig. 8 Connection diagram for permanent split capacitor motors.

ELECTRONIC SPEED CONTROL FOR MOTORS

equal to the load torque at two different points on the constant-torque-load curve, giving two points of equilibrium and thus an ambiguity to the speed control. The equilibrium point at the lower speed is a condition of high motor current because of low counter emf and would result in burnout of the motor winding if the motor were left in this condition for any length of time. By contrast, the fan speed-torque curve crosses each of the motor speed-torque curves at only one point, therefore causing no ambiguities. In addition, the low-speed point is one of low voltage well within the motor winding's current-carrying capabilities.

Permanent-split-capacitor motors can also be controlled by any of these circuits, but more effective control is achieved if the motor is connected as shown in Fig. 8. Here only the main winding is controlled and the capacitor winding is continuously connected to the entire ac line voltage. This connection maintains the phase shift between the windings, which is lost if the capacitor phase is also controlled. Figure 9(a) shows the effect of voltage on the speed-torque characteristics of

this motor and a superimposed fan-load curve.

Not all induction motors of either the shaded-pole or the permanent-split-capacitor types can be controlled effectively using these techniques, even with the proper loads.

Motors designed for the highest efficiencies and, therefore, low slip also have a very low starting torque and may, under certain conditions, have a speed-torque characteristic that could be crossed twice by a specific fan-load speed-torque characteristic.

Figure 9(b) shows motor torque-speed characteristic curves upon which has been superimposed the curve of a fan with high starting torque. It is therefore desirable to use a motor whose squirrel-cage rotor is designed for medium-to-high impedance levels and, therefore, has a high starting torque. The slight loss in efficiency of such a motor at full rated speed and load is a small price to pay for the advantage of speed control.

A unique circuit for use with capacitor-start motors in explosive or highly corrosive atmospheres, in which the arcing or the corrosion of switch

contacts is severe and undesirable, is shown in Fig. 10. Resistor R_1 is connected in series with the main running winding and is of such a resistance that the voltage drop under normal full-load conditions is approximately 0.2 V peak. Since starting currents on these motors are quite high, this peak voltage drop will exceed 1 V during starting conditions, triggering the triac, which will cause current to flow in the capacitor winding. When full speed is reached, the voltage across the main winding will decrease to about 0.2 V, which is insufficient to trigger the triac — thus the capacitor winding will no longer be energized. Resistor R_2 and capacitor C_2 form a dv/dt suppression network; this prevents the triac from turning on due to line transients and inductive switching transients.

Control of universal motors

Any of the half-wave or full-wave controls described previously can be used to control universal motors. Non feedback, manual controls, such as those shown in Fig. 2, are simple and inexpensive, but they provide very little torque at low speeds. A comparison of typical speed torque curves using a control of this type with those of feedback control is shown in Fig. 11.

These motors have some unique characteristics which allow their speed to be controlled very easily and efficiently with a feedback circuit such as that shown in Fig. 12. This circuit provides phase-controlled half-wave power to the motor: that is, on the negative half-cycle, the SCR blocks current flow in the negative direction causing the motor to be driven by a pulsating direct current whose amplitude is dependent on the phase control of the SCR.

The theory of operation of this control circuit is not at all difficult to understand. Assuming that the motor has been running, the voltage at point A in the circuit diagram (Fig. 12) must be larger than the forward drop of diode D_1 , the gate-to-cathode drop of the SCR, and the emf generated by the residual (magneto-motive force) in the motor, to get sufficient current flow to trigger the SCR.

The waveform at point A (V_A) for one positive half-cycle is shown in Fig. 13, along with the voltage levels of the SCR gate (V_{scr}), the diode drop (V_D), and the motor-generated emf (V_M). The phase angle (α) at which the SCR would trigger is shown by the vertical dotted line. Should the motor for any reason speed up so that the generated motor voltage would increase, the trigger point would move upward and to the right along the curve so that the SCR would trigger

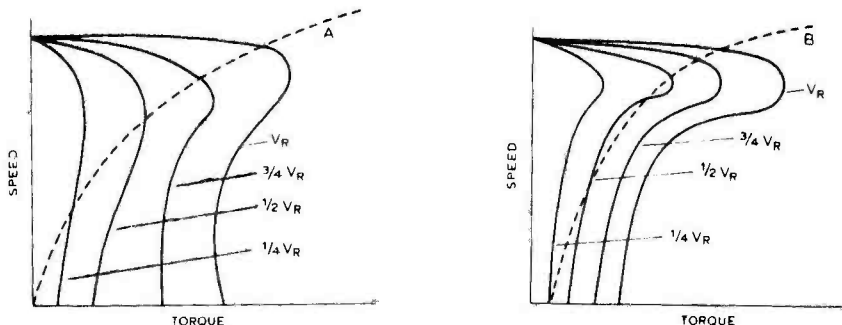

Fig. 9 Speed-torque curves for (A) high starting torque and (B) high efficiency permanent split capacitor motors at several voltages. The dotted line indicates a typical fan load and V_R is the full rated voltage.

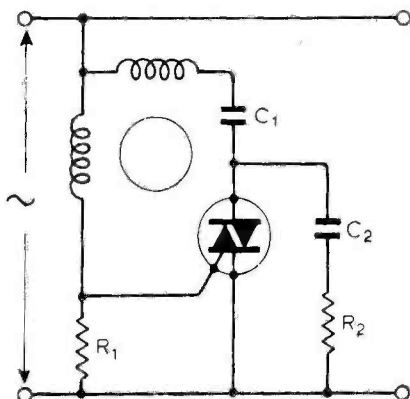

Fig. 10 Circuit diagram for a capacitor start motor.

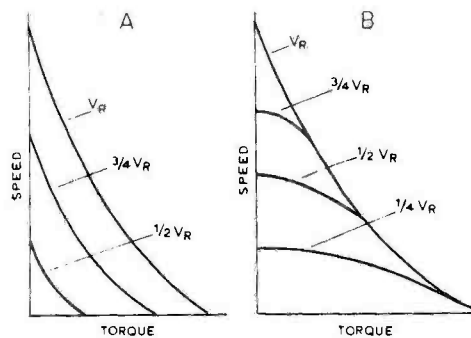

Fig. 11 Speed control, with (A) and without (B) feedback, compared.

later in the half-cycle and thus provide less power to the motor, causing it to slow down again.

Similarly, if the motor speed decreased, the trigger point would move to the left and down the curve, causing the triac to trigger earlier in the half-cycle providing more power to the motor, thereby speeding it up.

Resistors R_1 , R_2 and R_3 , along with diode D_2 and capacitor C_1 form the ramp-generator section of the circuit, as shown in the diagram in Fig.12. Capacitor C_1 is charged by the voltage divider R_1 , R_2 and R_3 during the positive half-cycle. Diode D_2 prevents negative current flow during the negative half-cycle, therefore C_1 discharges through only R_2 and R_3 during that half-cycle. Adjustment of R_3 controls the amount by which C_1 discharges during the negative half-cycle. Because the resistance of R_1 is very much larger than the ac impedance of capacitor C_1 , the voltage waveform on C_1 approaches that of a perfect cosine wave with a dc component. As potentiometer R_2 is varied, both the dc and the ac voltages are divided, giving a family of curves as shown in Fig.14.

The gain of the system, that is, the ratio of the change of effective SCR output voltage to the change in generator emf is considerably greater at low speed settings than it is at high speed settings. This high gain coupled with a motor with a very low residual emf will cause a condition sometimes known as cycle skipping. In this mode of operation, the motor speed is controlled by skipping entire cycles or groups of cycles, then triggering one or two cycles early in the period to compensate for the loss in speed. Loading the motor would eliminate this condition; however, the undesirable sound and vibration of the motor necessitate that this condition be eliminated. This can be done in two ways.

The first method is used if the motor design is fixed and cannot be changed. In this case, the impedance level of the voltage divider R_1 , R_2 and R_3 can be lowered so that C_1 will charge more rapidly, thus increasing the slope of the ramp and lowering the system gain. The second method, which will provide an overall benefit in improved circuit performance, involves a redesign of the motor so that the residual emf becomes greater. In general, this means using a lower grade of magnetic steel for the laminations. As a matter of fact, some people have found that ordinary cold-rolled steel used as rotor laminations makes a motor ideally suited for this type of electronic control.

Another common problem encountered with this circuit is that of

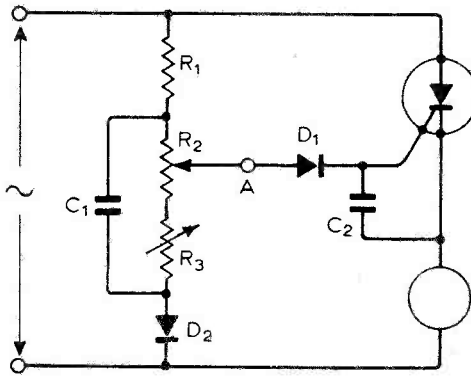

Fig. 12 Speed control scheme for universal motors.

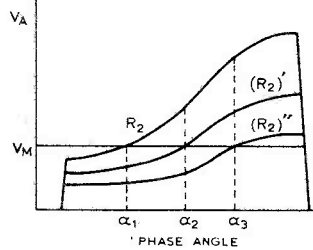

Fig. 14. Voltage waveform at point A (Fig. 12) for three different settings of R_2 .

thermal runaway. With the speed control set at low or medium speed, at high ambient temperatures the speed may increase uncontrollably to its maximum value. This phenomenon is caused by an excessive impedance in the voltage divider chain for the SCR being triggered. If the voltage-divider current is too low, current will flow into the gate of the SCR without turning it on, causing the waveform at point A to be as shown in Fig.15. The flat portion of the waveform in the early part of the half-cycle is caused by the SCR gate current loading the voltage divider before the SCR is triggered. After the SCR is triggered, diode D_1 is back-biased and a load is no longer on the voltage divider so that it jumps up to its unloaded voltage. As the ambient temperature increases, the SCR becomes more sensitive, thereby requiring less gate

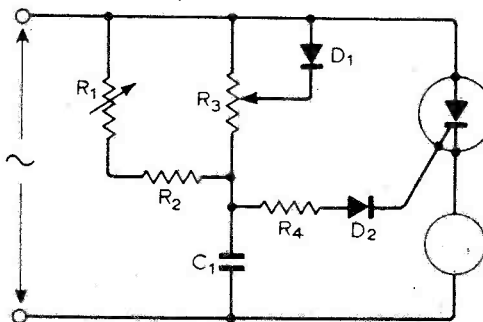

Fig. 16 Speed control of permanent magnet d.c. motors.

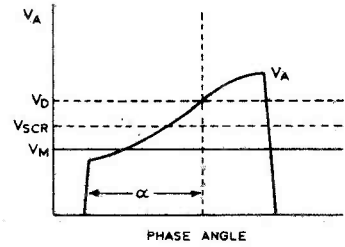

Fig. 13. Waveform for one positive half cycle in the circuit shown in Fig. 12.

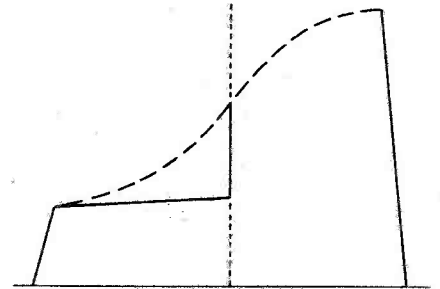

Fig. 15 When resistor R_1 (Fig. 12) is too large, this voltage waveform appears at point A. The dotted line is the unloaded waveform and the unbroken line is the actual waveform.

current to trigger, and is triggered earlier in the half-cycles. This early triggering causes increased current in the SCR thereby heating the junction still further and increasing the sensitivity of the SCR until maximum speed has been reached.

The solutions to this problem are the use of the most sensitive SCR practical and a voltage divider network of sufficiently low impedance. As a rough rule of thumb, the average current through the voltage divider during the positive half-cycle should be approximately three times the current necessary to trigger the lowest sensitivity (highest gate current) SCR being used.

In addition to the type of steel used in the motor laminations, consideration should also be given to the design of motors used in this half-wave speed control. Since the

Continued on page 59.

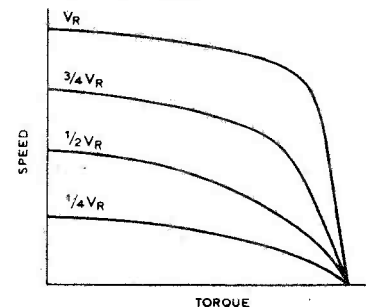
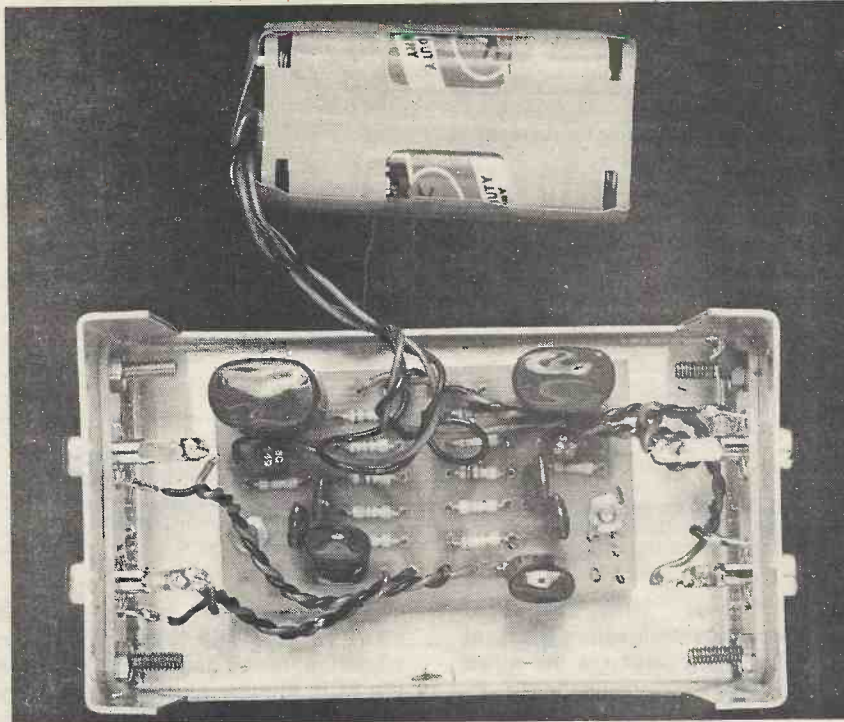

Fig. 17 Speed-torque characteristic of permanent magnet motors at various applied voltages.

STEREO RUMBLE FILTER

PROJECT



This internal view shows how the rumble filter is assembled.

Active filter design improves clarity of bass reproduction.

IN BYGONE DAYS rumble filters were very popular because even the best of turntables, used then, generated considerable vibration due to bearing and motor deficiencies. These vibrations, mechanically

transmitted to the pickup cartridge, resulted in an audible output. Hence high-pass filters were often incorporated in amplifiers to reduce this objectionable rumbling sound to an acceptable level, and as bass response seldom extended below 50 Hz, a simple RC filter with 6 dB per octave roll-off below 50 Hz was considered adequate.

Modern turntables have far smoother bearing and drive arrangements than their early counterparts — and for this reason many amplifier manufacturers no longer include a rumble filter facility.

Those that do are rarely satisfactory. Their slope is generally inadequate and the main effect of switching them in is to roll off the low-frequency response to the detriment of programme content.

At first sight it would seem better to exclude the rumble filter altogether and just make sure that our turntables do not generate any appreciable rumble.

Surprisingly perhaps, a rumble filter is still very much required and if designed correctly, can make an appreciable improvement to reproduction — even when used with turntables that generate no rumble at all!

The reason why will be clearly apparent if you take the front grille

HOW IT WORKS

The filter consists of three separate sections:—

1. A passive RC filter consisting of R1 and C1.
2. An active filter comprising C2, 3, R2, 3, 4 & 5 and Q1.
3. A passive filter comprising C4 and R6.

The active filter (from input of C2 to output to C4) is a standard design with the exception that values have been selected to give a peak in the response at the cut-off frequency. The maximum lift is about 2 dB and this characteristic, combined with those of the two RC filters, gives a sharp knee to the roll-off. The composite filter has a lift of 0.2 dB before turning over sharply.

Thus low frequency response is maintained substantially flat down to 50 Hz and is only 2 dB down at 40 Hz. Thereafter the response drops very rapidly and is in excess of 30 dB

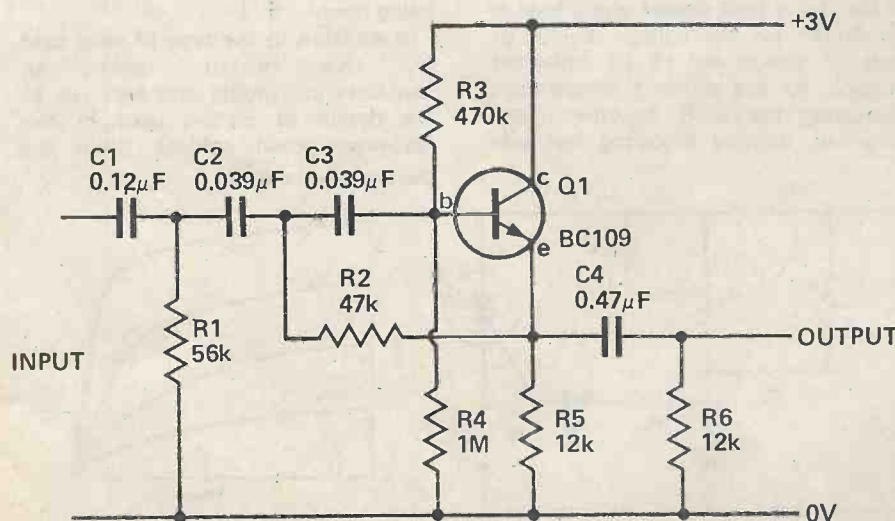

Fig. 1. Circuit diagram of the rumble filter. Two required for stereo.

off one of your speakers and — with the phono-cartridge tracing a section of record that has no recorded content (or very low level content) — turn the volume control up fairly high. You will almost certainly find that the cone of the bass driver is making wild excursions to and fro, probably at frequencies between 5 Hz and 15 Hz.

So it's sub-audible — why then does it matter?

Well it really does — and we'll explain just why later in this article — but first let us consider just where this 5 Hz — 15 Hz content comes from.

Firstly, modern turntables and arms have mechanical resonances lying within the 5-15 Hz region. Secondly, stereo cartridges are sensitive in the vertical as well as horizontal planes and will respond to unevenness in record or turntable surfaces. They will also respond to a defect in the record surface known as pressing rumble.

In addition the noise finds its way onto the record during the actual recording process. This recorded noise is due to LF noise and rumble sometimes being induced in the recording lathe by seismic disturbances, and by vibration in drive gears and cutting head carriage rails.

Lastly vibration of a low frequency nature, due to people walking past the turntable or vehicles passing by outside, may well excite the turntable and arm resonances even though the turntable is reasonably well sprung.

WHY SUB-AUDIBLE NOISE MATTERS

This very low-frequency noise is responsible for a remarkable amount of intermodulation distortion which generally makes the bass sound

muddy. In extreme cases it may cause the reproduction to sound as if speaker cone break-up is occurring. The reasons for this are as follows.

Preamplifier stages usually have two or three transistors around which large negative feedback is applied for equalization and/or tone control. At sub-audio frequencies these feedback networks are not generally effective. Thus the LF signals may well receive considerably more amplification in the preamplifier than would normally be expected. Secondly although the magnitude of the LF signal may not itself be sufficient to overload the preamplifier, the combined LF and music signals may well cause the preamplifier to clip. Even if clipping does not occur the LF signal will cause intermodulation distortion despite the fact that the LF signal is inaudible!

Most modern power amplifiers are quite capable of amplifying this noise signal, presenting it to the loudspeaker at a surprisingly high power level. The speaker itself has very little acoustic loading at these low frequencies and

PARTS LIST				
R1	Resistor	56k	1/4W	5%
R2	"	47k	"	"
R3	"	470k	"	"
R4	"	1M	"	"
R5,6	"	12k	"	"
C1	Capacitor	0.12μF	polyester	
C2,3	"	0.39μF	"	
C4	"	0.47μF	"	
Q1	Transistor	BC109 or similar		
* for stereo 2 off each of the above parts are needed.				
PC Board				
2 dual phono sockets				
2 dual battery holders or one 4 way holder.				
4 1.5V batteries.				
2 8mm long spacers				
1 small aluminium box.				

SPECIFICATION

Input Impedance (rises below 50 Hz)	47k
Output Impedance	< 5k
Input voltage (maximum)	250mV
Cut-off Frequency (-3dB)	36 Hz
Cut-off Slope (maximum)	24dB/octave
Attenuation at 10 Hz	37 dB
Gain at 1 KHz	-0.2 dB.

the cone will thus move considerably and may even be driven beyond its linear excursion region. Even if not actually overdriven, the presence of such large cone excursions will produce a high level of intermodulation distortion.

Whilst elimination of factors causing the noise is by far the best procedure, a lot of these factors are completely beyond the control of the average hi-fi owner. Hence a rumble filter would seem to be the obvious answer. But, we do not want to sacrifice any low frequency response and we want signals in the offending 5-15 Hz region to be attenuated as far as possible — two apparently conflicting requirements. In addition, as LF noise cannot be allowed to enter the equalization stages of the preamplifier,

down below 15 Hz where most LF noise occurs.

Current drain of the two filters is only 100 μA and the batteries will last their normal shelf life of about 12 months, thus no power switch is required. Batteries should be replaced annually.

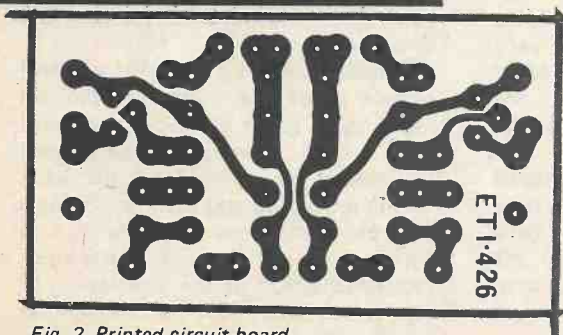
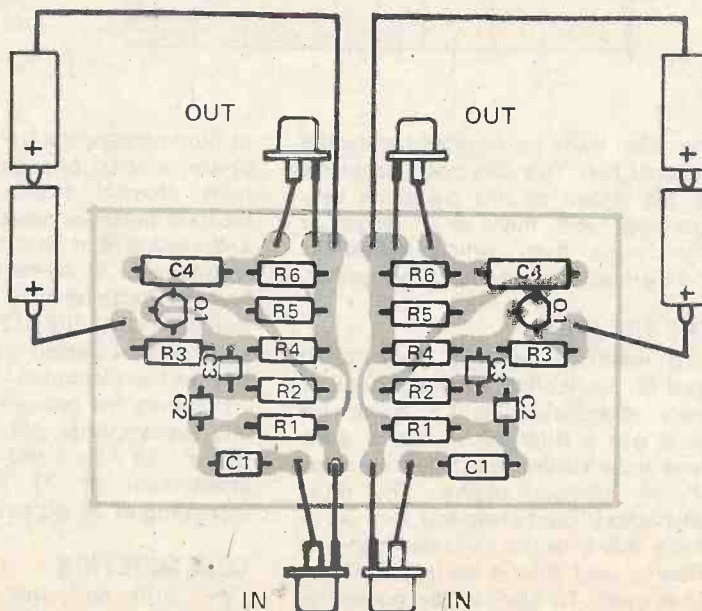

Fig. 2. Printed circuit board layout for the rumble filter 40mm x 70mm.



STEREO RUMBLE FILTER

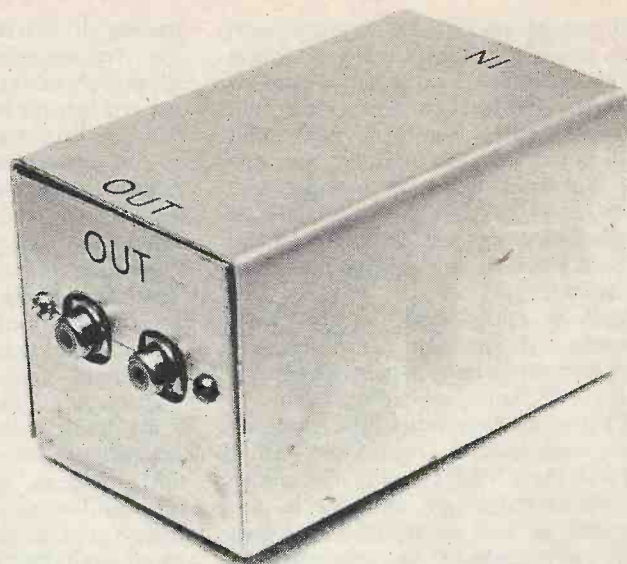
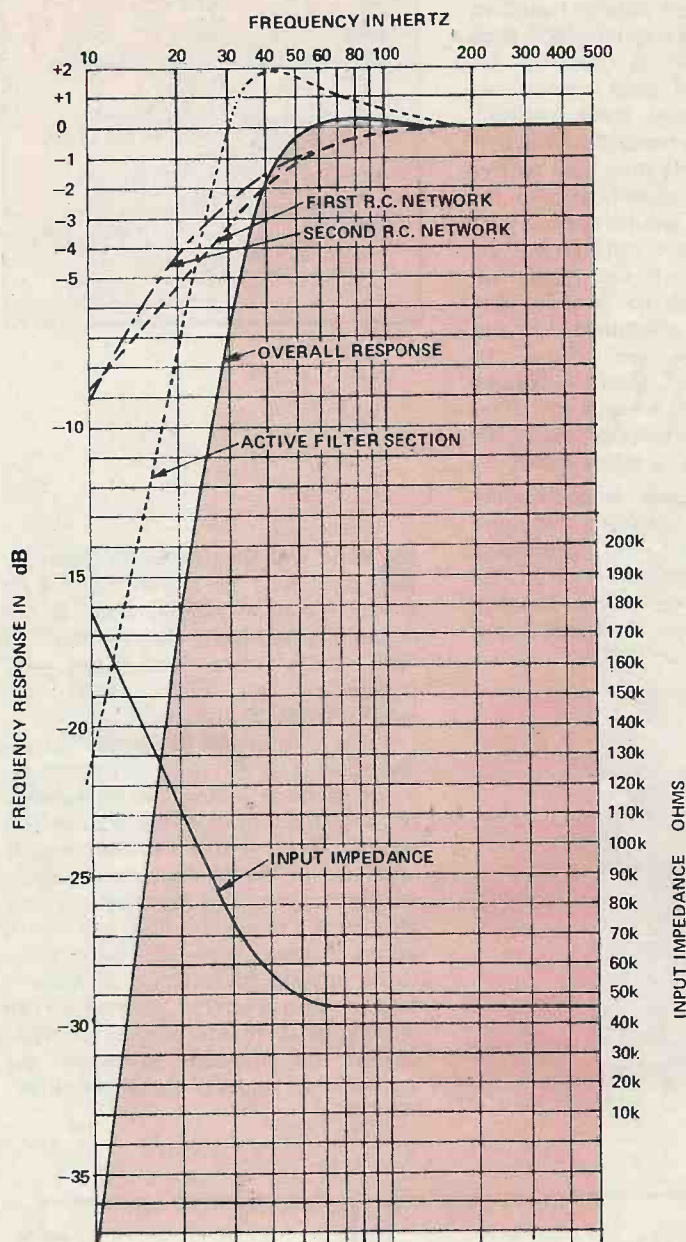

Fig. 4. Characteristics of the rumble filter.

the filter must be situated before the preamplifier. This also poses problems as the signals at this point are very low-level, and there is a danger of introducing hum which would be merely replacing one fault by another.

THE SOLUTION

To maintain response down to at least 50 Hz, whilst obtaining 30 dB or more attenuation to LF noise, we must use a filter which has a sharp knee and an ultimate attenuation slope of 24 dB per octave. The most satisfactory (and cheapest) method of doing this is to use an active high-pass filter — and this is the approach we have used. To obviate the possibility

of hum-pickup, the unit uses a battery power supply, one each for left and right channel filters. The use of separate batteries prevents earth loops and ensures that channel separation is maintained. As current drain is very low the batteries may be expected to last their shelf life (12 months or so) and for that reason an on/off switch has not been included.

The unit fits between the turntable and the amplifier, cuts any frequency below 35 Hz and has a total attenuation of 37 dB at 10 Hz increasing at 24 dB/octave below that.

CONSTRUCTION

We built our unit onto a small

printed circuit board, but layout is not critical and other alternative methods, such as matrix or Veroboard, may be used successfully.

The signal levels involved are extremely small (about 100 μ V at 50 Hz) and for this reason a metal box is a must if hum pickup is to be minimized. And, as said before, two separate battery supplies should be used in order to avoid earth loops. We used a conventional four-way battery holder to hold the two sets of batteries. These holders normally connect all four batteries in series. However it is a simple matter to snip the connection between the two sets of two cells.

The phono sockets for both input and output should be insulated from the metal case. When connecting the unit we found minimum hum was introduced by earthing the turntable to the metal box and then, by taking a separate earth from the metal box to the amplifier. However experimentation in the positioning of earths may well show that some other configuration is best for your particular setup.

EX-BEA VISUAL DISPLAY UNITS

7" ELECTROSTATIC TUBE
11 x 8 cm VIEWING AREA

MANUFACTURED IN THE USA BY BUNKER-RAMO
STANDARD 240V 50HZ MAINS INPUT

These units are inspected to see that no parts are missing. No circuit diagrams or information is available. We are in the process of obtaining circuits, information, etc, and a copy will be forwarded to all purchasers at the earliest possible time.

Therefore these units are sold as received at £30 each.

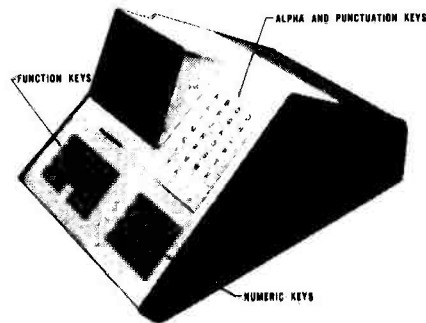

GRATICULES, 12 cm. by 14 cm. in High Quality plastic. 18p each. P. & P. 5p.

PANEL mounting lamp holders. Red or green. 5p ea. Miniature. **PANEL** mounting lamp with holders—10V 15MA 5p ea.

BECKMAN MULTITURN DIAL
Model RB. Brand new.
£1.90. P. & P. 10p.

FIBRE GLASS PRINTED CIRCUIT BOARD. Brand New. Single or Double sided. Any size 1½p per sq. in. Postage 10p per order.

LIGHT EMITTING DIODES (Red) from Hewlett-Packard. Brand New. 38p ea. Information 5p. Holders 1p.

METERS. Ernest Turner Model 402. 100 micro amps. BRAND NEW. Lousy scale—hence £2.25 ea. P. & P. 25p.

METERS by SIFAM type M 42. 25—0—25 micro amp. Scaled 25—0—25 green; 250—0—250 red; linear. As new. £2.98 ea. P. & P. 37p.

VISCONOLEMT CAPACITORS

0.05mfd 2.5kv 50p ea. 0.01mfd 5kv 40p ea. 0.05mfd 8kv 50p ea. 0.01mfd 10kv 50p ea.

BLOCK PAPER CAPACITORS AVAILABLE. S.A.E. with requirements.

PHOTOCELL equivalent OCP 71. 13p ea.

MULLARD OCP70 10p ea.

POTENTIOMETERS
COLVERN 3 watt. Brand new. 25K at 13p ea.

MORGANITE Special Brand new. 2.5: 10: 100: 250: 500K: 1in. sealed. 17p ea.

BERCO 2½ Watt. Brand new. 5: 10: 50: 250: ohms; 1: 2.5: 10: 25 at 18p ea.

STANDARD 2 meg. log pots. Current type 15p ea.

INSTRUMENT 3in. Colvern 5 ohm 35p ea.; 50K and 100K 50p ea.

BOURNS TRIMPOT POTENTIOMETERS. 20: 50: 100: 200: 500 ohms; 1: 2: 5: 5: 10: 25K at 35p ea. ALL BRAND NEW.

RELIANCE P.C.B. mounting. 270: 470: 500 ohms; 10K at 35p ea. ALL BRAND NEW.

VENNER Hour Meters—5 digit. wall mount—sealed case. Standard mains. £3.75 ea. P. & P. 45p.

TRANSFORMERS. All standard inputs. Gard/Part. 450—400—0—400—450. 180 MA. 2 x 6.3v. £3 ea.

FANTASTIC VALUE
Miniature Transformer. Standard 240V input. 3Volt 1 amp output. Brand New. 65p ea. P. & P. 15p. Discount for quantity.

CAPACITOR PACK 60 Brand new components only 80p. P. & P. 17p.

P.C. MOUNT SKELETON PRE-SETS. Screwdriver adjust 10, 5 and 2.5M @ 2p ea. 1M, 500, 250 and 25K @ 4p ea. Finger adjust 10, 5 and 2.5M @ 3p ea. 1M, 500, 250 and 25K @ 5p ea. Min P. & P. 10p.

1000pf FEED THRU CAPACITORS. Only sold in packs of 10—30p. P. & P. 10p.

RECTANGULAR INSTRUMENT FANS. American Ex-equ. Size 4½ x 4½ x 1½". 115 Volt. Very quiet £3 ea. P. & P. 37p.

DELIVERED TO YOUR DOOR 1 cwt. of Electronic Scrap chassis, boards, etc. No Rubbish. FOR ONLY £4. N. Ireland £2 extra.

P.C.B. PACK S & D. Quantity 2 sq. ft.—no tiny pieces. 50p plus P. & P. 20p.

FIBRE GLASS as above £1 plus P. & P. 20p.

TRIMMER PACK, 2 Twin 50/200 pf ceramic; 2 Twin 10/60 pf ceramic; 2 min strips with 4 preset 5/20 pf on each; 3 air spaced preset 30/100 pf on ceramic base. ALL BRAND NEW 25p the LOT. P. & P. 10p.

ALMA precision resistors 200K; 400K; 497K; 998K; 0.1% 27p ea.; 3.25K, 5.6K, 13K—0.1% 20p ea.

RELAYS

Varley VP4 plastic covers 4 pole c/o 15K—33p; 5.8K—40p ea.

BRAND-NEW 12in. LONG PERSISTENCE TUBES
New stocks—new price. Only £8.50 (whilst stock lasts)
Ideal for SSTV; educational purposes.
Type 12DP7A, connections, voltages etc.
Price includes carriage & VAT.

Large quantity LT, HT, EHT transformers and chokes.

Vast quantity of good quality components—NO PASSING TRADE—so we offer 3 LB. of ELECTRONIC GOODIES for £1.50 post paid.

CRYSTALS. Colour 4.43MHz. Brand New. £1.25 ea. P. & P. 10p.

Beehive Trimmer 3/30 pf. Brand new. Qty 1—9 13p ea. P. & P. 15p; 10—99 10p ea. P. & P. 25p; 100—999 7p ea. P. & P. free.

HF Crystal Drive Unit. 19in. rack mount. Standard 240V input with superb crystal oven by Labgear (no crystals) £6 ea. Carr. £1.50.

ROTARY SWITCH PACK—6 Brand New switches (1 ceramic; 1—4 pole 2 way etc.). 50p. P. & P. 20p.

CONSTANT VOLTAGE TRANSFORMERS

1 Kilowatt etc.
S.A.E. with requirements.

LOW FREQUENCY WOBBULATOR

Primarily intended for the alignment of AM Radios; Communication Receivers; Filters, etc., in the range of 250 KHZ to 5 MHZ, but can be effectively used to 30 MHZ. Can be used with any general purpose oscilloscope. Requires 12V AC input. Three controls—RF level; sweep width and frequency. Price £8.50. P. & P. 35p.

A second model is available as above but which allows the range to be extended down in frequency to 20 KHZ by the addition of external capacitors. Price £11.50. P. & P. 35p.

Both models are supplied connected for automatic 50 HZ sweeping. An external sweep voltage can be used instead. These units are encapsulated for additional reliability, with the exception of the controls (not cased, not calibrated).

DON'T FORGET
YOUR MANUALS
S.A.E. WITH
REQUIREMENTS

MAKE YOUR SINGLE BEAM SCOPE INTO A DOUBLE WITH OUR NEW LOW PRICED SOLID STATE SWITCH.
2 HZ to 8 MHZ. Hook up a 9 volt battery and connect to your scope and have two traces for ONLY £6.25. P. & P. 25p.
STILL AVAILABLE our 20 MHZ version, at £9.75. P. & P. 25p.

20HZ to 200KHZ SINE AND SQUARE WAVE GENERATOR

In four ranges. Wien bridge oscillator thermistor stabilised. Separate independent sine and square wave amplitude controls. 3V max sine, 6V max square outputs. Completely assembled P.C. Board, ready to use. 9 to 12V supply required. £8.85 each. P. & P. 25p. Sine Wave only £6.85 each. P. & P. 25p.

LARGE QUANTITY OF OSCILLOSCOPE & DISPLAY TUBES FROM 1" to 24" S.A.E. FOR COMPREHENSIVE LIST

All of our tubes can be supplied with nu-metal shields or Telcon nu-metal tape.

WIDE RANGE WOBBULATOR

5 MHZ to 150 MHZ (Useful harmonics up to 1.5 GHZ) up to 15 MHZ sweep width. Only 3 controls, preset RF level, sweep width and frequency. Ideal for 10.7 or TV IF alignment, filters, receivers. Can be used with any general purpose scope. Full instructions supplied. Connect 6.3V AC and use within minutes of receiving. All this for only £8.75. P. & P. 25p. (Not cased, not calibrated.)

TRANSISTOR INVERTORS

TYPE A
Input: 12V DC
Output: 1.3kV AC 1.5MA

Price £3.45

TYPE B
Input: 12V DC
Output: 1.3kV DC 1.5MA

Price £4.70

TYPE C
Input: 12V to 24V DC
Output: 1.5kV to 4kV AC 0.5MA

Price £6.35

TYPE D
Input: 12V to 24V DC
Output: 14kV DC 100 micro amps at 24V.
Progressively reducing for lower input voltages
Price £11

Postage & Packing 36p

Unless stated—please add £2.00 carriage to all units.

VALUE ADDED TAX not included in prices—please add 8%

Official Orders Welcomed, Gov./Educational Depts., Authorities, etc., otherwise Cash with Order

Open 9 am to 6.30 pm any day (later by arrangement.)



CHILTMHEAD LTD



7/9 ARTHUR ROAD, READING, BERKS. (rear Tech. College, Kings Road) Tel.: Reading 582605/65916

The largest selection

BRAND NEW FULLY GUARANTEED DEVICES

Type	Price	Type	Price	Type	Price	Type	Price	Type	Price	Type	Price	Type	Price	Type	Price	Type	Price	Type	Price
AC107	0.22	AD161 &		BC150	0.20	BD131	0.55	BF182	0.44	MJE2955	0.95	2G308	0.39	2N2102	0.39	2N3391	0.16	2N4060	0.13
AC113	0.20	AD162(MP)	0.75	BC151	0.22	BD132	0.66	BF183	0.44	MJE3055	0.62	2G309	0.39	2N2193	0.39	2N3391A	0.18	2N4061	0.13
AC115	0.22	AD1740	0.55	BC152	0.19	BD133	0.72	BF184	0.28	MJE3440	0.55	2G339	0.29	2N2194	0.39	2N3392	0.16	2N4062	0.13
AC117K	0.32	AF114	0.27	BC153	0.31	BD135	0.44	BF185	0.33	MPP102	0.46	2G339A	0.18	2N2217	0.24	2N3393	0.16	2N4284	0.19
AC122	0.13	AF115	0.27	BC154	0.33	BD136	0.44	BF187	0.30	MPP104	0.41	2G344	0.20	2N2218	0.22	2N3394	0.16	2N4285	0.19
AC125	0.19	AF116	0.27	BC157	0.20	BD137	0.50	BF188	0.44	MPP105	0.41	2G345	0.18	2N2219	0.22	2N3395	0.19	2N4286	0.19
AC126	0.19	AF117	0.27	BC158	0.13	BD138	0.55	BF194	0.13	OC19	0.39	2G371	0.18	2N2220	0.24	2N3402	0.23	2N4287	0.19
AC127	0.20	AF118	0.39	BC159	0.13	BD139	0.61	BF195	0.13	OC20	0.70	2G371B	0.13	2N2221	0.22	2N3403	0.23	2N4288	0.19
AC128	0.20	AF124	0.33	BC160	0.50	BD140	0.66	BF196	0.16	OC22	0.52	2G373	0.19	2N2222	0.22	2N3404	0.31	2N4289	0.19
AC132	0.16	AF125	0.33	BC161	0.55	BD155	0.88	BF197	0.16	OC23	0.54	2G374	0.19	2N2368	0.19	2N3405	0.46	2N4290	0.19
AC134	0.16	AF126	0.31	BC167	0.13	BD175	0.66	BF200	0.50	OC24	0.62	2G377	0.33	2N2369	0.16	2N3414	0.17	2N4291	0.19
AC137	0.16	AF127	0.31	BC168	0.13	BD176	0.66	BF222	£1.05	OC25	0.42	2G378	0.18	2N2369A	0.16	2N3415	0.17	2N4292	0.19
AC141	0.20	AF139	0.39	BC169	0.13	BD177	0.72	BF257	0.50	OC26	0.32	2G381	0.18	2N2411	0.27	2N3416	0.31	2N4293	0.19
AC144K	0.32	AF178	0.55	BC170	0.13	BD178	0.72	BF258	0.66	OC28	0.55	2G382	0.18	2N2412	0.27	2N3417	0.31	2N5172	0.13
AC142	0.20	AF179	0.55	BC171	0.16	BD179	0.77	BF259	0.94	OC29	0.55	2G401	0.33	2N2646	0.52	2N3525	0.83	2N5294	0.60
AC142K	0.28	AF180	0.55	BC172	0.16	BD180	0.77	BF262	0.61	OC35	0.46	2G414	0.33	2N2711	0.23	2N3614	0.74	2N5457	0.35
AC151	0.17	AF181	0.55	BC173	0.16	BD185	0.72	BF263	0.61	OC36	0.55	2G417	0.28	2N2712	0.23	2N3615	0.82	2N5458	0.35
AC154	0.22	AF186	0.55	BC174	0.16	BD186	0.72	BF270	0.39	OC41	0.22	2N388	0.39	2N2714	0.23	2N3616	0.82	2N5459	0.44
AC155	0.22	AF239	0.41	BC175	0.24	BD187	0.77	BF271	0.33	OC42	0.27	2N388A	0.61	2N2904	0.19	2N3644	0.10	2N6221	0.75
AC156	0.22	AL102	0.72	BC177	0.21	BD188	0.77	BF272	0.88	OC44	0.17	2N404	0.22	2N2904A	0.23	2N3702	0.13	2N801	0.55
AC157	0.27	AL103	0.72	BC178	0.21	BD189	0.88	BF273	0.39	OC45	0.14	2N404A	0.31	2N2905	0.23	2N3703	0.13	2N802A	0.46
AC165	0.22	ASV26	0.28	BC179	0.21	BD190	0.83	BF274	0.39	OC70	0.11	2N524	0.46	2N2905A	0.23	2N3704	0.14	2N802	0.46
AC166	0.22	ASV27	0.33	BC180	0.27	BD195	0.94	BFW10	0.66	OC71	0.11	2N527	0.54	2N2906	0.17	2N3705	0.13	2N803	0.62
AC167	0.22	ASV28	0.28	BC181	0.27	BD196	0.94	BFX29	0.30	OC72	0.16	2N598	0.46	2N2906A	0.20	2N3706	0.13	2N804	0.77
AC168	0.27	ASV29	0.28	BC182	0.16	BD197	0.99	BFX84	0.24	OC74	0.16	2N599	0.50	2N2907	0.22	2N3707	0.14	2N805	0.86
AC169	0.16	ASV50	0.28	BC182L	0.16	BD198	0.99	BFX85	0.33	OC75	0.17	2N606	0.14	2N2907A	0.24	2N3708	0.09	2N806	0.86
AC176	0.22	ASV51	0.28	BC183	0.16	BD199	£1.05	BFX86	0.24	OC76	0.17	2N607	0.15	2N2923	0.14	2N3709	0.10	2N807	0.86
AC177	0.27	ASV52	0.28	BC183L	0.16	BD200	£1.05	BFX87	0.27	OC77	0.17	2N608	0.27	2N2924	0.16	2N3710	0.10	2N821	0.62
AC178	0.31	ASV54	0.28	BC184	0.22	BD205	0.88	BFX88	0.24	OC81	0.28	2N699	0.39	2N2925	0.16	2N3711	0.10	2N822	0.46
AC179	0.31	ASV55	0.28	BC184L	0.22	BD206	0.88	BFY50	0.22	OC81D	0.17	2N706	0.09	2N2926(G)	0.12	2N3819	0.31	2N822A	0.46
AC180	0.22	ASV56	0.28	BC186	0.31	BD207	£1.05	BFY51	0.22	OC82	0.17	2N706A	0.10	2N2926(Y)	0.12	2N3820	0.55	2N823	0.62
AC180K	0.32	ASV57	0.28	BC187	0.31	BD208	£1.05	BFY52	0.22	OC82D	0.17	2N708	0.13	2N2926(O)	0.11	2N3821	0.39	2N824	0.77
AC181	0.22	ASV58	0.28	BC207	0.12	BDY20	£1.10	BFY53	0.19	OC83	0.22	2N711	0.33	2N2926(R)	0.11	2N3823	0.31	2N825	0.77
AC181K	0.32	ASV73	0.28	BC208	0.12	BF115	0.27	BSX19	0.17	OC139	0.22	2N717	0.39	2N2926(B)	0.11	2N3903	0.31	2N826	0.77
AC187	0.24	ASZ21	0.44	BC209	0.13	BF117	0.50	BSY20	0.17	OC140	0.22	2N718	0.27	2N3010	0.77	2N3904	0.33	2N827	0.77
AC187K	0.25	BC107	0.14	BC212L	0.14	BF118	0.77	BSY25	0.17	OC169	0.28	2N718A	0.55	2N3011	0.16	2N3905	0.31	2N701	0.46
AC188	0.24	BC108	0.14	BC213L	0.14	BF119	0.77	BSY26	0.17	OC170	0.28	2N726	0.31	2N3053	0.19	2N3906	0.30	40361	0.44
AC188K	0.25	BC109	0.15	BC214L	0.18	BF121	0.50	BSY27	0.17	OC171	0.28	2N727	0.31	2N3054	0.51	2N4068	0.13	40362	0.50
AC17	0.28	BC113	0.11	BC215	0.28	BF123	0.55	BSY28	0.17	OC200	0.28	2N743	0.22	2N3055	0.55	2N4059	0.11		
AC19	0.22	BC114	0.17	BC226	0.39	BF125	0.50	BSY29	0.17	OC201	0.31	2N744	0.22						
AC198	0.22	BC115	0.17	BC301	0.30	BF127	0.55	BSY38	0.20	OC202	0.31	2N914	0.16						
AC20	0.22	BC116	0.17	BC302	0.27	BF152	0.61	BSY39	0.20	OC203	0.28	2N918	0.33	Type	Price	Type	Price	Type	Price
AC21	0.22	BC117	0.20	BC303	0.35	BF153	0.50	BSY40	0.31	OC204	0.28	2N929	0.23	AA119	0.09	BY128	0.17	OA10	0.15
AC22	0.18	BC118	0.11	BC304	0.40	BF154	0.50	BSY41	0.31	OC205	0.39	2N930	0.23	AA120	0.09	BY130	0.18	OA47	0.08
AC27	0.20	BC119	0.33	BC340	0.34	BF155	0.77	BSY45	0.14	OC309	0.44	2N1131	0.22	AA129	0.09	BY133	0.23	OA70	0.08
AC28	0.21	BC120	0.88	BC360	0.40	BF156	0.53	BSY46A	0.14	OC371	0.48	2N1132	0.24	AA30	0.10	BY164	0.55	OA79	0.08
AC29	0.39	BC125	0.13	BC370	0.27	BF157	0.61	BU105	£2.20	ORP12	0.48	2N1302	0.16	AAZ13	0.11	BYN38,30	0.46	OA81	0.08
AC30	0.31	BC126	0.20	BCY31	0.29	BF158	0.61	CU11E	0.55	ORP60	0.44	2N1303	0.16	BA100	0.11	BYZ10	0.39	OA85	0.10
AC31	0.31	BC132	0.13	BCY32	0.33	BF159	0.66	C400	0.33	ORP61	0.44	2N1304	0.19	BA116	0.23	BYZ11	0.33	OA90	0.07
AC34	0.23	BC134	0.20	BCY33	0.24	BF160	0.44	C407	0.28	P20	0.55	2N1305	0.19	BA126	0.24	BYZ12	0.33	OA91	0.07
AC35	0.23	BC135	0.13	BCY34	0.28	BF162	0.44	C424	0.28	P346A	0.22	2N1306	0.23	BA148	0.16	BYZ13	0.28	OA95	0.08
AC36	0.31	BC136	0.17	BCY70	0.16	BF163	0.44	C425	0.55	P397	0.46	2N1307	0.23	BA154	0.13	BYZ16	0.44	OA200	0.07
AC40	0.19	BC137	0.17	BCY71	0.22	BF164	0.44	C426	0.39	ST140	0.14	2N1308	0.26	BA155	0.16	BYZ17	0.39	OA202	0.08
AC41	0.20	BC139	0.44	BCY72	0.16	BF165	0.44	C428	0.22	ST141	0.19	2N1309	0.26	BA156	0.15	BYZ18	0.39	SD10	0.66
AC44	0.39	BC140	0.33	BCZ10	0.22	BF167	0.24	C441	0.33	T1843	0.34	2N1613	0.22	BA173	0.16	BYZ19	0.31	SD19	0.66
AD130	0.42	BC141	0.33	BCZ11	0.28	BF173	0.24	C444	0.39	UT46	0.30	2N1711	0.22	BY100	0.17	CG62	1N34	0.08	
AD140	0.53	BC142	0.33	BCZ12	0.28	BF176	0.39	C445	0.39	ZX414	£1.20	2N1889	0.35	BY101	0.13	(OA91Eq)	0.66	1N34A	0.08
AD142	0.53	BC143	0.33	BD115	0.68	BF177	0.39	C450	0.24	ZG301	0.21	2N1890	0.50	BY105	0.19	CG651 (OA70-79)	0.07	1N914	0.06
AD143	0.42	BC145	0.50	BD116	0.88	BF178	0.39	C450	0.24	ZG302	0.21	2N1893	0.41	BY114	0.13	OB5	0.39	1N916	0.06
AD149	0.55	BC147	0.11	BD121	0.66	BF179	0.33	MAT100	0.21	ZG303	0.21	2N2147	0.79	BY124	0.13	OA5	0.39	1N4148	0.06
AD161	0.39	BC148	0.11	BD123	0.72	BF180	0.33	MAT101	0.21	ZG304	0.27	2N2148	0.63	BY126	0.16	OA5 short leads	0.23	1S921	0.07
AD162	0.39	BC149	0.13	BD124	0.76	BF181	0.33	MAT121	0.22	ZG306	0.44	2N2160	0.66	BY127	0.17				

DIODES AND RECTIFIERS

LINEAR I.C.'s—FULL SPEC.

Type No.	Price	100 +	
72702	0.50	0.48	0.45
72709	0.35	0.33	0.30
72709P	0.33	0.31	0.29
72710	0.45	0.43	0.40
72741	0.40	0.38	0.35
72741C	0.45	0.43	0.40
72741P	0.38	0.36	0.34
72748P	0.38	0	

-the lowest prices!

P.W. TELE-TENNIS KIT OF PARTS

Including all resistors, capacitors, semi-conductors, I.C. sockets, switches and transformer

Our Usual Price £27.50

SPECIAL OFFER
£23.50 incl. V.A.T. and P. & P.

We regret free pack not applicable to this offer

120 NIXIE DRIVER TRANSISTOR		
suitable replacement for 38X 21, C 407, 2N 1893 20vcb.		
1	25	100+
1.19	0.17	0.16

Sil. trans. suitable for PE Organ. Metal To-18 Eqv't. ZTX300 6p each. Any Qty.

GP 100 TO3 METAL CASE GERMANIUM		
V _{be} = 80V. V _{ceo} = 50V. I.C. = 10 amps. P _{tot} = 30 W. h _{fe} = 30-170. Replaces the majority of Germanium power transistors in the OC, AD and NKT range.		
1	25	100+
0.47	0.44	0.40

GP 300 TO3 METAL CASE SILICON		
V _{be} = 100V. V _{ceo} = 60V. I.C. = 15 amps. P _{tot} = 115W. h _{fe} = 20. 100FT. = 1MHz. Suitable replacement for 2N 3055, BDY 11 or BDY 20.		
1	25	100+
0.55	0.53	0.51

NEW 8th EDITION 250 pages

TRANSISTOR EQUIVALENTS BOOK. A complete cross reference and equivalents book for European, American and Japanese Transistors. Exclusive to BI-PAK £1.85 each.

A LARGE RANGE OF TECHNICAL AND DATA BOOKS ARE NOW AVAILABLE EX. STOCK. SEND FOR FREE LIST.

INTEGRATED CIRCUIT PAKS

Manufacturers' "Fall Outs" which include Functional and Part Functional Units. These are classed as "out-of-spec" from the maker's very rigid specifications, but are ideal for learning about I.C.'s and experimental work.

Pak No.	Contents	Price	Pak No.	Contents	Price	Pak No.	Contents	Price
UIC00	= 12 x 7400	0.55	UIC46	= 5 x 7446	0.55	UIC90	= 5 x 7490	0.55
UIC01	= 12 x 7401	0.55	UIC48	= 5 x 7448	0.55	UIC91	= 5 x 7491	0.55
UIC02	= 12 x 7402	0.55	UIC50	= 12 x 7450	0.55	UIC92	= 5 x 7492	0.55
UIC03	= 12 x 7403	0.55	UIC51	= 12 x 7451	0.55	UIC93	= 5 x 7493	0.55
UIC04	= 12 x 7404	0.55	UIC53	= 12 x 7453	0.55	UIC94	= 5 x 7494	0.55
UIC05	= 12 x 7405	0.55	UIC54	= 12 x 7454	0.55	UIC95	= 5 x 7495	0.55
UIC06	= 8 x 7406	0.55	UIC60	= 12 x 7460	0.55	UIC96	= 5 x 7496	0.55
UIC07	= 8 x 7407	0.55	UIC70	= 8 x 7470	0.55	UIC100	= 5 x 74100	0.55
UIC10	= 12 x 7410	0.55	UIC72	= 8 x 7472	0.55	UIC121	= 5 x 74121	0.55
UIC20	= 12 x 7420	0.55	UIC73	= 8 x 7473	0.55	UIC141	= 5 x 74141	0.55
UIC30	= 12 x 7430	0.55	UIC74	= 8 x 7474	0.55	UIC151	= 5 x 74151	0.55
UIC40	= 12 x 7440	0.55	UIC76	= 8 x 7476	0.55	UIC154	= 5 x 74154	0.55
UIC41	= 5 x 7441	0.55	UIC80	= 5 x 7480	0.55	UIC183	= 5 x 74183	0.55
UIC42	= 5 x 7442	0.55	UIC81	= 5 x 7481	0.55	UIC199	= 5 x 74199	0.55
UIC43	= 5 x 7443	0.55	UIC82	= 5 x 7482	0.55			
UIC44	= 5 x 7444	0.55	UIC83	= 5 x 7483	0.55	UICX1	= 25 Assorted	
UIC45	= 5 x 7445	0.55	UIC86	= 5 x 7486	0.55			74's £1.65

Paks cannot be split, but 25 assorted pieces (our mix) is available as PAK UIC X1.

2 Amp. BRIDGE RECTS.	
50 v RMS	35p each
100 v RMS	41p "
200 v RMS	45p "
400 v RMS	50p "
1000 v RMS	55p "
Size 16 mm x 16 mm.	

D1699 NPN SILICON DUAL TRANSISTOR (Similar to 2N2060)		
1	25	100+
0.28	0.26	0.23

LINEAR INTEGRATED CIRCUIT PAKS			
ULIC700	10 - 709	..	0.55
ULIC710	7 - 710	..	0.55
ULIC741	7 - 741	..	0.55
ULIC747	5 - 747	..	0.55
ULIC748	7 - 748	..	0.55

QUALITY TESTED SEMICONDUCTORS

Pak No.	Description	Price
Q 1 20	Red spot transistor PNP	0.55
Q 2 16	White spot R.F. transistors PNP	0.55
Q 3 4	OC77 type transistors	0.55
Q 4 6	Matched transistors OC44/45/81/81D	0.55
Q 5 4	OC75 transistors	0.55
Q 6 5	OC72 transistors	0.55
Q 7 4	AC128 transistors PNP high gain	0.55
Q 8 4	AC126 transistors PNP	0.55
Q 9 7	OC81 type transistors	0.55
Q10 7	OC71 type transistors	0.55
Q11 2	AC127/128 Complementary pairs PNP/NPN	0.55
Q12 3	AF116 type transistors	0.55
Q13 3	AF117 type transistors	0.55
Q14 3	OC171 H.F. type transistors	0.55
Q15 7	2N2926 Sil. Epoxy transistors mixed colours	0.55
Q17 5	NPN 2xST.141 & 3xST.140	0.55
Q18 4	MADT'S 2xMAT 100 & 2xMAT 120	0.55
Q19 3	MADT'S 2xMAT 101 & 1xMAT 121	0.55
Q20 4	OC44 Germanium transistors A.F.	0.55
Q21 4	AC127 NPN Germanium transistors	0.55
Q22 20	NKT transistors A.F. R.F. coded	0.55
Q23 10	OA202 Silicon diodes sub-min.	0.55
Q24 8	OA81 diodes	0.55
Q25 15	1N914 Silicon diodes 75PIV 75mA	0.55
Q26 8	OA95 Germanium diodes sub-min 1N69	0.55
Q27 2	10A PIV Silicon rectifiers 18425R	0.55
Q28 2	Silicon power rectifiers BYZ13	0.55
Q29 4	Silicon transistors 2x2N696, 1x2N697, 1x2N698	0.55
Q30 7	Silicon switch transistors SN706 NPN	0.55
Q31 6	Silicon switch transistors 2N708, NPN	0.55
Q32 3	PNP Silicon transistors 2x2N1131, 1x2N1132	0.55
Q33 3	Silicon NPN transistors 2N1711	0.55
Q34 7	Silicon NPN transistors 2N2369, 500MHz (code P397)	0.55
Q35 3	Silicon PNP TO-5, 2x2N2904 & 1x2N2905	0.55
Q36 7	2N3046 TO-18 plastic 300MHz NPN	0.55
Q37 3	2N3053 NPN Silicon transistors	0.55
Q38 7	PNP transistors 3x2N3703, 2x2N3702	0.55

555 I.C. 65p each

MAMMOTH I.C. PACK

APPROXIMATELY 200 PIECES ASSORTED MANUFACTURERS FALL-OUT INTEGRATED CIRCUITS INCLUDING LOGIC 74 SERIES LINEAR and AUDIO AMPLIFIERS MANY CODED also SOME UNKNOWN TYPES - YOU TO IDENTIFY

PAK NO. M.I.C. 200

PRICE £1.25 per PAK including p & p & V.A.T.

1974 CATALOGUE NOW READY 10p

CADMIUM CELLS ORP12 48p

NEW LOW PRICED TESTED S.C.R.'s

PIV	1A	3A	5A	5A	7A	10A	16A	30A
50	0.26	0.28	0.39	0.39	0.52	0.55	0.59	£1.27
100	0.28	0.37	0.52	0.52	0.55	0.64	0.70	£1.54
200	0.39	0.41	0.54	0.54	0.63	0.67	0.83	£1.70
400	0.48	0.52	0.62	0.62	0.74	0.83	1.03	£1.93
600	0.59	0.63	0.75	0.75	0.85	1.07	1.38	—
800	0.70	0.77	0.88	0.88	0.99	1.32	1.65	£4.40

2N3055

115 WATT SIL POWER NPN 55p EACH

KING OF THE PAKS

Unequalled Value and Quality

SUPER PAKS NEW BI-PAK UNTESTED SEMICONDUCTORS

Money back refund if not satisfied

Pak No.	Description	Price
U 1	120 Glass Sub-Min. General Purpose Germanium Diodes	0.55
U 2	Mixed Germanium Transistors AF/RF	0.55
U 3	75 Germanium Gold Bonded Sub-Min. like OA5, OA47	0.55
U 4	Germanium Transistors like OC81, AC128	0.55
U 5	60 200mA Sub-Min. Silicon Diodes	0.55
U 6	30 Sil. Planar Trans. NPN like BSY95A, 2N706	0.55
U 7	16 Sil. Rectifiers TOP-HAT 750mA VLTG. RANGE up to 1000	0.55
U 8	50 Sil. Planar Diodes DO-7 Glass 250mA like OA200/202	0.55
U 9	20 Mixed Voltages, 1 Watt Zener Diodes	0.55
U10	20 BAY50 charge storage Diodes DO-7 Glass	0.55
U11	PNP Sil. Planar Trans. TO-5 like 2N1132, 2N2904	0.55
U13	30 PNP-NPN Sil. Transistors OC200 & 2S 104	0.55
U14	150 Mixed Silicon and Germanium Diodes	0.55
U15	NPN Sil. Planar Trans. TO-5 like BFY51, 2N697	0.55
U16	10 3 Amp Silicon Rectifiers Stud Type up to 1000PIV	0.55
U17	30 Germanium PNP AF Transistors TO-5 like ACY 17-22	0.55
U18	8 6 Amp Silicon Rectifiers BYZ13 Type up to 600 PIV	0.55
U19	Silicon NPN Transistors like BC108	0.55
U20	12 1.5 Amp Silicon Rectifiers Top Hat up to 1000 PIV	0.55
U21	30 AF. Germanium Alloy Transistors 2G300 Series & OC71	0.55
U23	MADT's like MHz Series PNP Transistors	0.55
U24	20 Germanium 1 Amp Rectifiers GJM Series up to 300 PIV	0.55
U25	25 300MHz NPN Silicon Transistors 2N708, BSY27	0.55
U26	30 Fast Switching Silicon Diodes like 1N914 Micro-Min.	0.55
U29	10 1 Amp SCR's TO-5 can, up to 600 PIV CRS1/25-600	1.10
U32	25 Zener Diodes 400mW DO-7 case 3-18 volts mixed	0.55
U33	15 Plastic Case 1 Amp Silicon Rectifiers 1N4000 Series	0.55
U34	30 Silicon PNP Alloy Trans. TO-5 BCY26 2S302/4	0.55
U35	25 Silicon Planar Transistors PNP TO-18 2N2906	0.55
U36	Silicon Planar NPN Transistors TO-5 BFY50/51/52	0.55
U37	30 Silicon Alloy Transistors SO-2 PNP OC200, 2S322	0.55
U38	20 Fast Switching Silicon Trans. NPN 400MHz 2N3011	0.55
U39	30 R.F. Germ. PNP Transistors 2N1303/5 TO-5	0.55
U40	10 Dual Transistors 6 lead TO-5 2N2060	0.55
U43	25 Sil. Trans. Plastic TO-18 A.F. BC113/114	0.55
U44	20 Sil. Trans. Plastic TO-5 BC115/116	0.55
U45	7 3A SCR. TO66 up to 600PIV	1.10
U46	20 Unijunction transistors similar to T1S43	0.55
U47	10 TO220AB plastic triacs 50V 6A	1.10
U48	9 NPN Sil. power transistors like 2N3055	1.10
U49	12 NPN Sil. plastic power trans. 60W like 2N5294/5296	1.10

Code Nos. mentioned above are given as a guide to the type of device in the pak. The devices themselves are normally unmarked.

FREE One 55p Pak of your own choice free with orders valued £4 or over.

SIL. RECTS. TESTED

PIV	300mA	750mA	1A	1.5A	3A	10A	30A	
50	0.05	0.06	1N4001	0.05	0.08	0.15	0.21	0.60
100	0.05	0.07	1N4002	0.06	0.10	0.17	0.23	0.75
200	0.06	0.10	1N4003	0.07	0.12	0.22	0.25	£1.00
400	0.08	0.15	1N4004	0.08	0.15	0.30	0.38	£1.36
600	0.09	0.17	1N4005	0.10	0.18	0.36	0.45	£1.90
800	0.12	0.19	1N4006	0.11	0.20	0.38	0.55	£2.10
1000	0.14	0.30	1N4007	0.12	0.25	0.48	0.66	£2.50
1200	—	0.35	—	—	0.30	0.58	0.75	£3.00

DIACS FOR USE WITH TRIACS BR100 (D32) 25p each

10 amp POTTED BRIDGE RECTIFIER on heat sink, 100PIV, 99p each

TRIACS	VBO2A	6A	10A
TO-5 TO-66 TO-48	£	£	£
	100	0.33	0.55
	200	0.55	0.66
	400	0.77	0.83

Circle No. 188 1976

Please send all orders direct to warehouse and debit by cheque

BI-PAK

P.O. BOX 6, WARE, HERTS

Postage and packing add 11p Overseas add extra for airmail Minimum order 50p Cash with order please

Guaranteed Satisfaction or Money Back



GIRO NO. 331 7056
C.W.O. only, P. & P. 10p on orders below £5
Discount: £10-10%, £20-15% (except net items)
Export Order enquiries welcome (VAT free)

Official Orders accepted from
Educational & Government Departments
ALL PRICES INCLUDE VAT

SPECIAL RESISTOR KITS (Prices include post & packing)
10E12 1/2W KIT: 10 of each E12 value, 22 ohms—1M, a total of 570 (CARBON FILM 5%), £3 65 net
10E12 1/4W KIT: 10 of each E12 value, 22 ohms—1M, a total of 570 (CARBON FILM 5%), £3 85 net
25E12 1/2W KIT: 25 of each E12 value, 22 ohms—1M, a total of 1425 (CARBON FILM 5%), £8 35 net
25E12 1/4W KIT: 25 of each E12 value, 22 ohms—1M, a total of 1425 (CARBON FILM 5%), £8 45 net
20E12 1/2W KIT: 20 of each E12 value, 22 ohms—2M2, a total of 1220 (METAL FILM 5%), £11 05 net

ALL QUANTITIES SPECIFIED ABOVE ARE APPROXIMATE.

MULLARD POLYESTER CAPACITORS C280 SERIES

250V P.C. Mounting: 0.01µF, 0.015µF, 0.022µF, 0.033µF, 0.047µF, 3p. 0.068µF, 0.1µF, 4p. 0.15µF, 4p. 0.22µF, 5p. 0.33µF, 8p. 0.47µF, 9p. 0.68µF, 12p. 1µF, 13p. 1.5µF, 23p. 2.2µF, 26p.

MULLARD POLYESTER CAPACITORS C296 SERIES

400V: 0.001µF, 0.0015µF, 0.0022µF, 0.0033µF, 0.0047µF, 2p. 0.0068µF, 0.01µF, 0.015µF, 0.022µF, 0.033µF, 3p. 0.047µF, 0.068µF, 0.1µF, 4p. 0.15µF, 6p. 0.22µF, 8p. 0.33µF, 12p. 0.47µF, 14p. 160V: 0.01µF, 0.015µF, 0.022µF, 3p. 0.047µF, 0.068µF, 3p. 0.1µF, 4p. 0.15µF, 5p. 0.22µF, 5p. 0.33µF, 6p. 0.47µF, 8p. 0.68µF, 12p. 1µF, 14p.

MINIATURE CERAMIC PLATE CAPACITORS

50V: (pF) 22, 27, 33, 39, 47, 56, 68, 82, 100, 120, 150, 180, 220, 270, 330, 390, 470, 560, 680, 820, 1K, 1K5, 2K2, 3K3, 4K7, 6K8, (µF) 0.01, 0.015, 0.022, 0.033, 0.047, 2p. each: 0.1, 30V, 4p.

POLYSTYRENE CAPACITORS 160V 5%

(pF) 10, 15, 22, 33, 47, 68, 100, 150, 220, 330, 470, 680, 1000, 1500, 2200, 3300, 4700, 6800, 10,000, 4p.

RESISTORS

CF—High Stab Carbon Film, 5%	MF—High Stab Metal Film, 5%		
W. Type Range	1-99	100-999	500-999
CF 22-1M	1	0 75	0 60
CF 22-2M2	1	0 75	0 60
C= 22-1M	1	0 75	0 60
MF 10-2M7	2	1 54	1 32
MF 10-2M2	2	1 43	1 21
MF 10-10M	3	1 98	1 81
2 MF 10-10M	4 5	3 52	3 08

For value mixing prices, please refer to our catalogue. (price in pence each)
VALUES AVAILABLE—E12 Series only. (Net prices above 100)

PRESET SKELETON POTENTIOMETERS

MINIATURE 0-25W Vertical or horizontal 6p each 1K, 2K2, 4K7, 10K, etc. up to 1M Ω.
SUB-MIN 0.05W Vertical, 100 Ω to 220K Ω 5p each

B. H. COMPONENT FACTORS LTD.

(ET) 81 CHEDDINGTON ROAD, PITSTONE,
NR. LEIGHTON BUZZARD, BEDS, LU7 9AQ
Tel.: Cheddington 668446 (Std. Code 0296)
PLEASE WRITE FOR FREE CATALOGUE

Miniature Mullard Electrolytics

1.0µF 63V 6p	68µF 16V 6p
1.5µF 63V 6p	68µF 63V 12p
2.2µF 63V 6p	100µF 10V 6p
3.3µF 63V 6p	100µF 25V 6p
4.0µF 40V 6p	100µF 63V 14p
4.7µF 63V 6p	150µF 16V 6p
6.8µF 63V 6p	150µF 63V 15p
8.0µF 40V 6p	220µF 6.4V 6p
10µF 16V 6p	220µF 10V 6p
10µF 25V 6p	220µF 16V 8p
10µF 63V 6p	220µF 63V 21p
15µF 63V 6p	330µF 16V 12p
15µF 63V 6p	330µF 63V 25p
16µF 40V 6p	470µF 6.4V 9p
22µF 25V 6p	470µF 40V 20p
22µF 63V 6p	680µF 16V 15p
32µF 10V 6p	680µF 40V 25p
33µF 16V 6p	1000µF 16V 20p
33µF 40V 6p	1000µF 25V 25p
33µF 63V 6p	1500µF 6.4V 15p
47µF 10V 6p	1500µF 16V 25p
47µF 25V 6p	2200µF 10V 25p
47µF 63V 8p	3300µF 6.4V 26p

VEROBOARD 0.1 0.15

2 1/2 x 5"	28p 28p
3 1/2 x 3 1/2"	26p 19p
3 1/2 x 5"	32p 33p
3 1/2 x 3 1/2"	28p 28p
2 1/2 x 1"	7p 7p
2 1/2 x 5" (Plain)	— 14p
2 1/2 x 3 1/2" (Plain)	— 12p
5 x 3 1/2" (Plain)	— 12p
Insertion tool	59p 59p
Track Cutter	44p 44p
Pins, Pkt. 25	10p 10p

TRANSISTORS

AC127 16p	BC212L 12p
AC128 22p	BC213L 12p
BC107 11p	BC214L 17p
BC108 12p	OC44 18p
BC109 13p	OC71 13p
BC148 12p	OC81 16p
BC149 12p	OC170 23p
BC182L 12p	TIS43 33p
BC183L 12p	2N2926 11p
BC184L 13p	2N3702 11p

POTENTIOMETERS

Carbon Track 5K Ω to 2M Ω, log or lin. Single, 16p Dual Gang 46p. Log Single with switch 26p
Slider Pots: 10K, 100K, 500K, 30mm, 34p. 45mm, 47p. 60mm, 55p. (Semi-log)

DIODES

IN4001 6p
IN4002 7p
IN4003 9p
IN4004 9p
IN4005 12p
IN4006 14p
IN914 7p
IN916 7p
BA100 10p
OA5 42p
OA47 9p
OA81 11p
OA200 8p

PLUGS

DIN 2 Pin 12p
3 Pin 13p
5 Pin 180° 13p
Std. Jack 14p
2.5mm Jack 11p
Phone 5p

ELECTROLYTIC CAPACITORS. Tubular & Large Cans

(µF/V): 1/25, 2/25, 4/25, 4.7/10, 5/25, 8/25, 10/10, 10/50, 16/25, 22/63, 25/25, 25/50, 32/25, 50/25, 100/10, 100/25, 6p. 50/50, 8p. 100/50, 200/25, 11p. 250/50, 18p. 500/10, 11p. 500/25, 13p. 500/50, 18p. 1000/10, 13p. 1000/25, 22p. 1000/50, 40p. 2000/10, 20p. 1000/100, 90p. 2000/25, 30p. 2000/100, 95p. 2500/25, 38p. 2500/50, 62p. 3000/50, 80p. 5000/25, 66p. 5000/50, £1.10

HI-VOLT: 4/450, 14p. 8/350, 19p. 8/450, 20p. 16/350, 22p. 16/450, 23p. 32/350, 33p. 50/250, 20p. 100/500, 88p.

METALLISED PAPER CAPACITORS

250V 0.05µF, 0.1µF, 6p. 0.25, 6p. 0.5µF, 7p. 1µF, 9p. 500V 0.025, 0.05, 6p. 0.1, 6p. 0.25, 7p. 0.5, 9p. 1000V: 0.01, 11p. 0.022, 13p. 0.047, 0.1, 15p. 0.22, 23p. 0.47, 28p.

Integrated Circuits

µA709C 50p
µA741C 55p
µA723C £1
2N414 £1.32p

Screened Wire, Metre

Twin Screened Wire, Metre 12p
Stereo Screened Wire, Metre 12p
Connecting Wire, All colours, Metre 2p
Neon Bulb, 90V Wire Ended 5 for 24p
Panel Neon, 240V Red, Amber, Clear 8p

NEW KIT SET2 1/2W METAL FILM 5% ULTRA LOW NOISE NEW RESISTORS WITH FULL COLOUR CODING 5 EACH E12 VALUE 10Ω-1M, TOTAL 305 £2.78

BYWOOD CHANTICLEER

- * READ: TIME & ALARM
- * ELECTRONIC 'BEEP' ALARM TONE
- * TEN MINUTE 'SNOOZE' FEATURE
- * BRIGHT, CLEAR DISPLAY
- * NO MOVING PARTS
- * EXECUTIVE STYLING
- * SOLID STATE RELIABILITY

Digital clock

The heart of the CHANTICLEER is a tiny electronic package containing thousands of transistors which divide the 50 cycles/second mains frequency into precise time units. The clock "movement" in fact has no moving parts to wear out or tick or tock or hum or click.

RECOMMENDED PRICE **£19.95** + VAT.

COMPLETELY ELECTRONIC NO MOVING PARTS

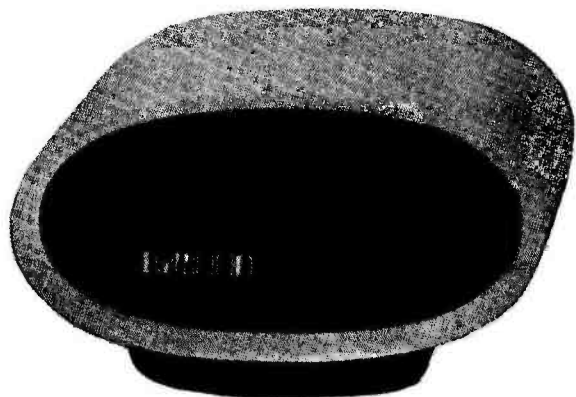

Alarm

Has a.m. or p.m. setting with alarm on/off indicator. A gentle electronic 'beep' tone with special snooze feature that resets the alarm for ten-minute intervals. The snooze is activated by simply tilting the clock forward and then releasing. Upon cancelling, the alarm can be immediately reset for the same time next day.

BYWOOD BYWOOD ELECTRONICS,
181 Ebbens Road,
Hemel Hempstead,
Herts. HP3 9RD.
Tel: 0442-62757

ETI TOP PROJECTS

Shown below are the contents of the ETI TOP PROJECTS special 100-page issue containing reprints of over 20 of the most popular projects from past issues of ETI. Thousands have already been sold. Be sure to get your copy while there are still supplies.

ON SALE AT YOUR NEWSAGENTS

75p

AUDIO	
100W GUITAR AMPLIFIER	6
<i>Rugged, high quality circuit handles 100W continuous power</i>	
MIXER PREAMPLIFIER	11
<i>Simple circuit for use with 100W guitar amp</i>	
MASTER MIXER	38
<i>Major project gives professional performance</i>	
SIMPLE AMPLIFIER	83
<i>1.5W amplifier using discrete components</i>	
SIMPLE LOUDHAILER	90
<i>A few components — a lot of power</i>	
TEST GEAR	
WIDE RANGE VOLTMETER	14
<i>Solid-state circuit has 22 ranges — from 10mV to 1000V a.c./d.c.</i>	
TRANSISTOR TESTER	23
<i>Basic circuit measures gains up to 1000</i>	
FET DC VOLTMETER	24
<i>Cheap-to-build with 10MΩ input impedance</i>	
OSCILLOSCOPE CALIBRATOR	65
<i>A circuit to build into your 'scope</i>	
AUDIO ATTENUATOR	84
<i>Provides 0–59dB attenuation in 1dB steps</i>	
FOR THE MOTORIST	
ELECTRONIC TRANSISTORISED IGNITION	30
<i>A popular design to improve your car's performance</i>	
THE REVEALER	60
<i>Is there metal or filler underneath the paint?</i>	
BRAKE LIGHT WARNING	76
<i>Dashboard indicator shows when brake lights are o.k.</i>	
FOR THE PHOTOGRAPHER	
PHOTOGRAPHIC TIMER	26
<i>Provides accurate timing of photographic processes</i>	
SOUND OPERATED FLASH	66
<i>Can be triggered by anything from a dropping pin to a thunderclap</i>	
FOR THE HOME	
TEMPERATURE METER	19
<i>Gives a meter reading — even at a distance</i>	
UHF TV PREAMP	20
<i>One transistor circuit peeps up weak signals</i>	
BURGLAR ALARM	86
<i>A variety of alarm circuits are described</i>	
MISCELLANEOUS	
LOW POWER LASER	62
<i>Build your own laser for about £100</i>	
COIN COLLECTOR METAL LOCATOR	70
<i>Simple but sensitive circuit</i>	
EASY WAY TO MAKE P.C. BOARDS	80
<i>Solves messy painting and hours of time</i>	
TECH-TIPS	92
<i>A collection of circuit ideas for the experimenter</i>	

IN CASE OF DIFFICULTY, USE THIS FORM TO OBTAIN YOUR COPY DIRECTLY FROM US.

cut

To: ETI TOP PROJECTS BOOK, Electronics Today International, 36 Ebury Street, London SW1W 0LW.

Please send me a copy of the ETI Top Projects Book. I enclose a cheque/P.O. for 85p (payable to Electronics Today International) which includes 10p postage (applicable to surface mail world-wide).

Name
Address

Jan 75

ELECTRONIC SPEED CONTROL FOR MOTORS

Continued from page 51.

maximum rms voltage available to the motor under half-wave conditions is less than for full-wave, the motor should be designed for use under these conditions to obtain maximum speed.

CONTROL OF PERMANENT MAGNET MOTORS

As a result of recent developments in ceramic permanent-magnet materials that can be easily moulded into complex shapes at low cost, the permanent-magnet motor has become increasingly attractive as an appliance component. Electronic control of this type of motor can be easily achieved using techniques similar to those just described for the universal motor. Figure 16 is a circuit diagram of a control system to control permanent-magnet motors presently being used in blenders. Potentiometer R_3 and diode D_1 form a dc charging path for capacitor C_1 ; variable resistor R_1 and resistor R_2 form an ac charging path which creates the ramp voltage on the capacitor. Resistor R_4 and diode D_2 serve to isolate the motor control circuit from the ramp generator during the positive and negative half-cycles, respectively.

A small amount of cycle skipping can be experienced at low speeds using this control, but not enough to necessitate further development work. Since the voltage generated during off time is very high, the thermal runaway problem does not appear at all.

HEATER CONTROL AND TIMERS

The circuit shown in Fig.2 or 3 could well be made to control heaters in domestic appliances without any modifications.

If the capacitor C_T in Fig.3 is made very large a timer results. The time delay is set by the value of C_T and the variable resistor R_T .

We must emphasize that this article is not intended as a constructional one and component values cannot be supplied. However a number of practical circuits covering speed control are scheduled for the magazine in two months.

ELECTRONICS —it's easy!

PART 11b

This month we continue our discussion of Amplification by looking at the basics of the transistor amplifier.

Fig.9. The basic structure and symbols for the two elementary transistor types.

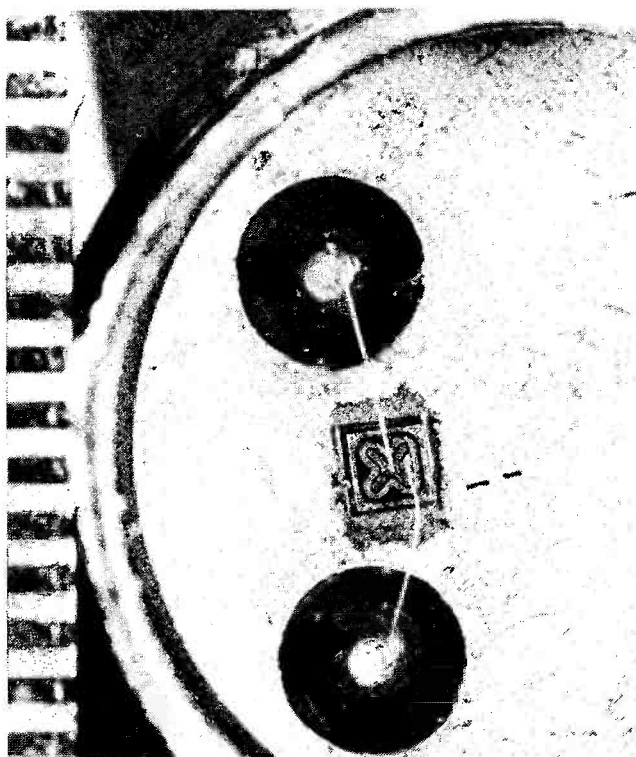
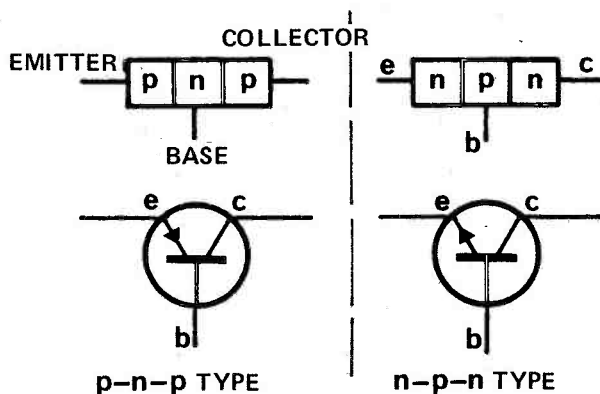
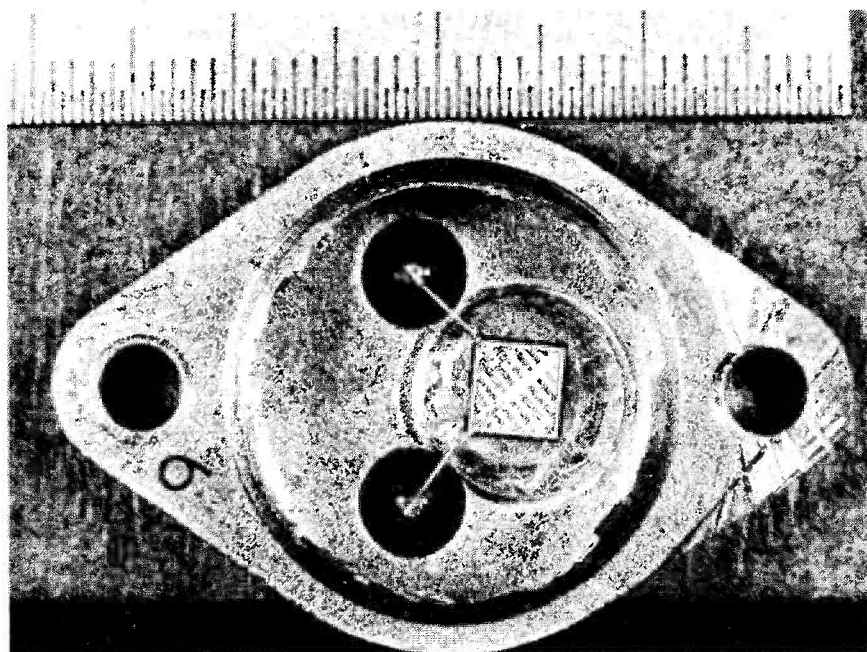

Fig.10. The actual transistor chip is indeed tiny — as these enlargements show. The scales at left half millimetre divisions. The smaller chip is a high-frequency small-signal transistor, mounted in a TO5 case, the other a power transistor mounted in a TO3 case.



THE TRANSISTOR

Transistors are made from two basic materials — germanium or silicon. These two materials are known as semiconductors because they are neither good insulators, nor good conductors. That is, they are somewhere in between.

Germanium was used for early transistors, but has largely (although not entirely) been replaced by silicon in modern devices. Although there are some important differences between transistors constructed from these two materials, the basic theory, as follows, is the same.

The basic pure material is modified by adding a controlled amount of impurities called dopants, to form two new materials, one (called P type) having a deficiency of electrons and one (called N type) having a surplus of electrons.

If two pieces of these differently doped materials are intimately joined we have what is called a PN junction. Such a junction of P and N materials will conduct current more readily in one direction than in the other — it is in fact a rectifier, or in other words, a semiconductor diode.

Current flow occurs when the P type material is made more positive than the N type material. The physics involved in this phenomenon are complex, but of little interest at this stage. We are only interested in the fact that it happens.

To make a transistor we add a third layer of material to form a three-layer sandwich in either NPN or PNP format. We refer to the transistors in this way — as a silicon NPN or PNP type etc. The symbols for the two types are shown in Fig.9. Each terminal is given the name as shown, the base being the centre connection, the emitter the one marked by an arrow and the collector unmarked. Note particularly that the direction of the emitter arrow denotes whether the transistor is a PNP or NPN type also that the symbol is the same for both germanium and silicon devices.

In actual manufacturing processes the three layers are formed by selectively growing N and P crystal layers, or by diffusing P and N impurities into the opposite sides of a pure, silicon or germanium crystal.

The actual transistor chip may be extremely small, often pin-head size and is generally a tiny fraction of the total packaged volume of the device. This is illustrated in Fig.10 which shows the inner construction of different types of transistor. From this we see that although small, a conventionally packaged transistor wastes a relatively enormous amount of space. Integrated circuits, where both active and passive components are made and connected by layering and diffusion processes, are logical developments from transistor technology — it is just as easy to fit 20 or 100 transistors in a TO5 case as it is to fit one.

The main problems in integration are in limiting power dissipation within a given chip or case, and in fabricating resistors and capacitors.

SYMBOLS

As we go further in electronics we must use shorthand methods of expressing things — otherwise explanations tend to become unwieldy. For example, in our discussion of transistor parameters we will be considering the currents, voltages and impedances etc. associated with each lead of the device. To avoid having to write for example, "current in the collector lead" we simply write I_c . The main symbol I tells us we are concerned with current and the subscript 'C' tells us that it is the collector lead we are talking about.

- Thus E_b = base voltage
- E_c = collector voltage
- I_b = base current
- E_{ce} = voltage between collector and emitter.

Now that we have established our shorthand we are in a position to examine the practical characteristics of transistors.

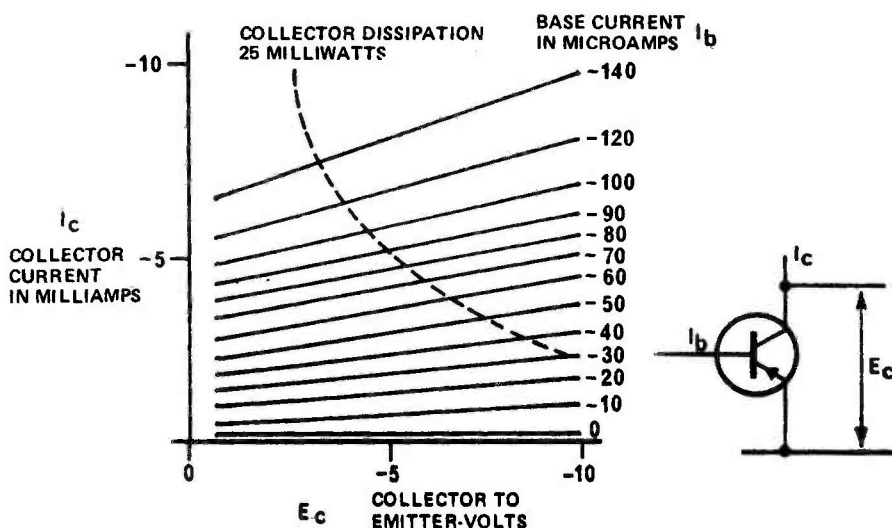

Fig.11. Typical characteristic curves for a small signal PNP-transistor.

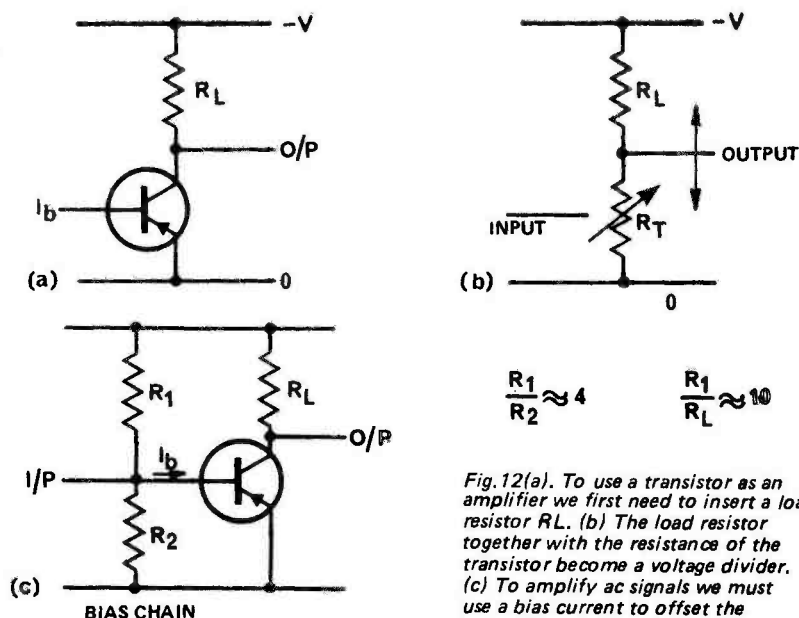

Fig.12(a). To use a transistor as an amplifier we first need to insert a load resistor R_L . (b) The load resistor together with the resistance of the transistor become a voltage divider. (c) To amplify ac signals we must use a bias current to offset the operating point.

CHARACTERISTIC CURVES

Let us examine what happens if we hold the collector-to-emitter voltage, E_{ce} , constant at -5 volts and then vary the base current, I_b from 50 to 60 μA we find that we have a corresponding I_c change of 500 μA (0.5 mA). Thus we have a gain, β of 500/10 = 50.

Note that corresponding changes in I_b at other points (e.g. 90 to 100 μA) do not result in the same gain. In fact, there is non-linearity at extremes of I_b which would result in distortion of the signal.

In practice it is not necessary to perform these calculations, the manufacturer tells us the gain in his data sheet. This is referred to as β or H_{fe} (don't worry about interpretation of this latter symbol) and is the ratio of the change in collector current

resulting from a small change in base current.

$$\text{That is } \beta = \frac{\Delta I_c}{\Delta I_b} \quad (\Delta \text{ means small change in})$$

Values of β range from 5 or so for early transistors to several hundred, or even thousands in modern components. Manufacturing tolerances don't allow all transistors of any type to have the same β and the manufacturer usually specifies the limits within which the device current-gain will fall.

For example the BC108 featured in this month's offer is specified as having H_{fe} (β) greater than 125 but less than 900 at $I_c=2mA$ and $V_{ce}=5$ volts.

Referring back to Fig.11, we find a dotted line across the curves which represents the maximum permissible

ELECTRONICS —it's easy!

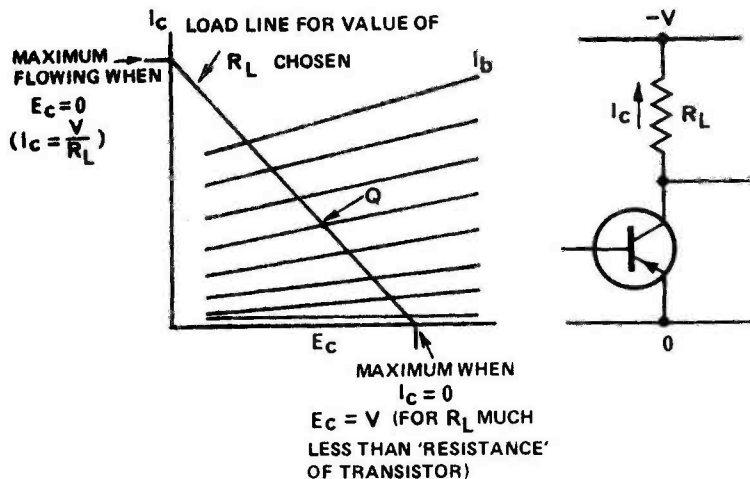

Fig. 13. Output impedance of the stage is equal to the value of R_L . R_L is generally chosen to be about one-tenth of the input impedance of the following stage provided that $(\frac{V}{2})^2 R$ does not exceed the rated device dissipation. The load line is then drawn and operating point Q determined as detailed in the text.

power dissipation for the device. This is determined by the maximum heat that can be dissipated without the chip being destroyed, unless the device is cooled by a heat sink or with forced air circulation.

For example if the transistor of Fig. 11 has an E_{ce} of 5 V, then the collector current must not exceed 5 mA if the dissipation is to be less than 25 mW. Thus the user must check his design to ensure that under worst case conditions (component tolerances, power supply voltage etc.) this dissipation is not exceeded. The device must never be operated at any point above and to the right of the dissipation curve.

Thus we see that much information can be extracted from the characteristic curves.

THE BASIC AC AMPLIFIER

Used alone, the transistor cannot amplify ac waveforms. The two main limitations are its inherent rectifying action and an effect known as thermal runaway. In addition we must devise a way of taking an output from the transistor.

The transistor may be considered as a resistor whose value is varied by the input base current. Hence, if we place a resistor in series with the collector lead of the transistor, we will have a voltage divider as shown in Fig. 12. The collector current, as it changes in response to changes in base current, will produce an output voltage across the series resistor. This series resistor is called the 'load' resistor and is denoted by the symbol R_L .

Note that to drive more current into the base we must raise E_b towards the collector supply voltage. The resulting

increase in I_C will cause the voltage at the collector, E_C , to fall. Thus the output voltage will be the inverse of the input. In other words, the transistor connected in this fashion, changes the phase of the input voltage by 180°.

BIASING

If a sine wave were to be applied to the base of the transistor in Fig. 12a, the negative half cycles would be clipped off — the waveform would be rectified as previously explained. We can overcome this by applying a dc 'bias' current to the base such that the input signal either adds or subtracts from this current but never drives the base current to zero.

Hence the collector current will also be biased away from zero and will follow the variations in base current. In practical circuits it is not feasible to have a separate battery or power supply to provide bias, so it is usually derived from the collector supply. The most common method is by using a voltage divider as illustrated in Fig. 12c.

Biasing can also be illustrated using characteristic curves. For any chosen R_L value, there will be corresponding pairs of I_C and E_C values — Ohms law again. This means for any value of R_L we can draw a line — called the load line — across the characteristic curve as in Fig. 13. The importance of this curve is that the input signal, I_b moves up and down this line. If we do not add a bias current to I_b we would be operating at the bottom end, where $I_b = 0$, and only negative swings of I_b would be amplified. By adding a quiescent bias current we put the mean operating point at a place

midway (this is called the Q point) along the load line and both half cycles of our input signal will be amplified linearly.

The degree of distortion is decided by the extent to which the input signal varies I_b up and down about the Q-point. Small signal changes will be undistorted but not large ones. One cause of this is that the gain I_C/I_b will change at the limits.

Secondly, if the input signal increases still further, the peaks of the sine wave will be clipped, at one end by the base current reaching zero, and at the other by the collector voltage being driven to zero (this latter condition is called saturation). Hence it can readily be seen, from the characteristic curves and load line, what maximum input signal can be applied without distortion occurring.

Note that the load line must always lie below the maximum power dissipation curve.

THERMAL RUNAWAY

As well as the currents I_b and I_C that are designed to flow in the transistor there is leakage current through the normally reverse-biased, collector-base junction. Some of this current will flow through the base-emitter junction (actually all of it if the base is not connected) appearing as a normal signal. The apparent signal current will be amplified causing an I_C of βI_b .

Now here is the danger — the leakage current is proportional to temperature. So the increased I_C heats the transistor, the leakage current increases, I_C increases still further — and the process may continue until the transistor destroys itself.

The actual process is more involved than we have described but the explanation suffices for our purposes.

With silicon transistors leakage current is very small and of little importance but silicon has another temperature effect that produces similar, although not as serious, thermal runaway. This is that the E_{be}

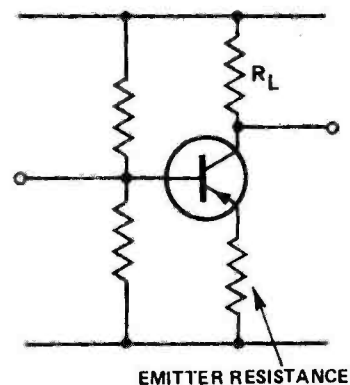

Fig. 14. The amplifier is stabilized against the effects of thermal runaway by adding an emitter resistor.

ELECTRONICS -it's easy!

of a silicon transistor, required for a certain collector current, falls with temperature. Hence with a fixed input voltage the resultant I_c causes a rise in temperature, which causes a decrease in E_{be} required, and hence a further rise in I_c - result thermal runaway.

Silicon transistors can be used over a much wider range than can germanium but thermal runaway must be compensated for with both types.

Fortunately this potentially damaging effect is easily overcome, in both cases, by adding a resistor into the emitter path as shown in Fig. 14. Its effect is as follows.

As the collector current rises (due to leakage current) the voltage dropped across the emitter resistor, R_e , increases thus reducing the base-emitter voltage V_{be} . This reduces the base current, and almost restores the collector current to its original

value. Mathematics tells us the ideal conditions to achieve stability and show that an emitter resistance roughly one sixth of the collector load resistance is about right. The bias chain values must be readjusted for this and again there are complex mathematical expressions for optimizing the values. In practice a good choice is that the chain has values in the same ratio as the collector chain but about ten times larger.

BYPASSING

Having overcome thermal runaway conditions we now find the amplifier is nicely stable but lacks gain. This is because the same collector current flows through the emitter resistor as through the load resistor. Hence the gain can only be equal to the ratio of R_L to R_e , that is, in our case 6. And

this is completely independent of β . We can restore our gain by adding one more component - a capacitor across R_e .

Thermal effects occur slowly by comparison with ac signals (10 Hz and above) so a capacitor connected across the emitter resistor will act as a low impedance to ac signals (thus restoring ac gain) but as a non-existent component to dc. Hence we get the best of both worlds - thermal runaway is eliminated and ac gain is maintained. The capacitor is chosen such that its reactance is about one tenth the value of R_e at the lowest frequency of interest. ●

Further reading:
"Understanding Solid State Electronics" Texas Instruments Ltd. Manton Lane, Bedford.

ELECTRONICS - in practice

THE CIRCUIT of a typical ac amplifier, for audio frequencies, is given in Fig. 15. The input signal is coupled in via a capacitor that provides dc isolation between the preceding stage and the bias network.

As the capacitor needs to be fairly large (X_c less than one tenth the resistance from base to ground at lowest frequency) it is usually an electrolytic. An electrolytic may be used as long as the positive terminal is connected to the most positive dc potential.

The circuit uses the transistors in this month's offer and may be put to work (and tested) by adding the components as shown in Fig. 16.

In effect we now have a light intensity meter which can be used to monitor the modulated content of the radiation from a fluorescent-light tube. Note that it does not measure the steady-state light radiation.

The light dependant resistor, type ORP12, provides a small amplitude 100 Hz signal when excited by the light from a fluorescent tube. The amplifier increases the signal amplitude by about forty times. The output from the amplifier may then be half-wave rectified to provide a dc output proportional to the level of the 100 Hz light signal. This may be measured by a normal multimeter, or alternatively, the ac signal may be fed directly to high impedance headphones. You will then hear the 100 Hz tone from the light radiation.

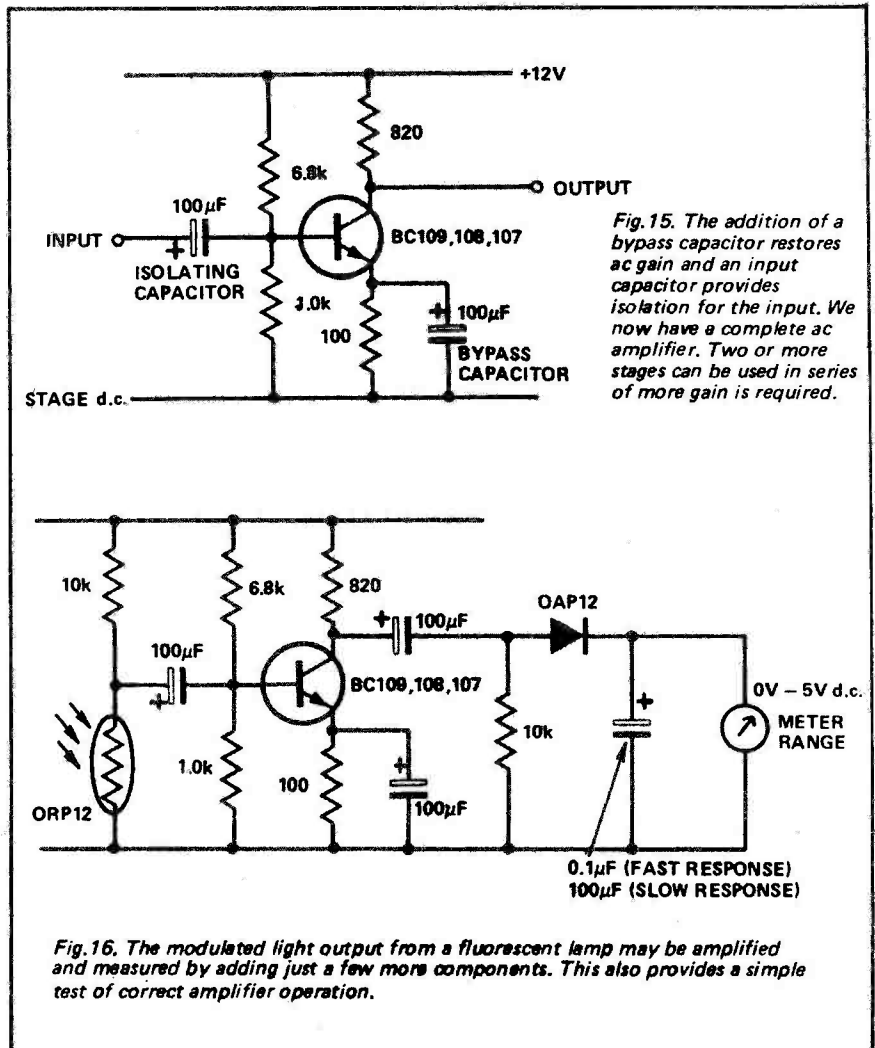

Fig. 15. The addition of a bypass capacitor restores ac gain and an input capacitor provides isolation for the input. We now have a complete ac amplifier. Two or more stages can be used in series if more gain is required.

Fig. 16. The modulated light output from a fluorescent lamp may be amplified and measured by adding just a few more components. This also provides a simple test of correct amplifier operation.

Electronics by John Miller-Hickpatrick Tomorrow

**PETROL PRICES UPI Food Prices
Upl Cigarette Prices Upl Electronics
Prices Downl**

Has it ever occurred to you that whereas most products in this country, in fact in the world, have suffered from price inflation, products connected with the electronics industry tend to go down in price. Such things as television sets, HiFi sets, calculators, clocks, etc. all tend to go down in price regardless of the rate of inflation. This is quite possibly because most of the raw materials used in the electronics industry are cheap and reasonably plentiful. Even those materials which are expensive or rare (such as are used in semiconductor manufacture) are used in such small quantities per finished unit that the cost per unit is relatively small. If the material cost is low then the only inflationary costs involved are power and labour, thus the price of such components is based substantially on the actual manufacturing costs. Thus to keep prices down the manufacturer must use less of the expensive materials and at the same time automate as much as possible. The LSI integrated circuit has meant that more functions can be packed onto a small silicon chip and therefore fewer of those functions need to be made up from discrete components on a PCB, this cuts the component cost, PCB cost, assembly cost and testing costs.

As the finished PCB becomes simpler to assemble and contains fewer and fewer components other than ICs so the economics of automated assembly become more feasible. Machinery already exists for automatically assembling PCBs from ICs and discretcs, other machines can automatically make the ICs from the raw materials, yet other machines can produce and/or purify these raw materials. From shovelling in the basic materials at one end (which could be done automatically) to producing the finished PCB at the other end, the whole process can be done automatically and controlled by a computer. This same computer can also test the finished PCBs and auto-

matically reject or perhaps repair any that are below spec.

Of course, the human brain is still used in the original design and layout of the ICs and PCBs - or is it? Computer Aided Design is now used for optimum design in most ICs and some of the more complex PCBs. The computer uses pre-written programs and sub-routines to route the tracks of the various parts of the IC and to calculate the amount of material required to give the resistance or capacitance needed. Similarly, the computer can help out with the theoretical circuit design by simulating the circuit under any conditions and changing theoretical values for other values. By using massive sub-routines the computer can call in complete IC functions in one go, ie it could call up the equivalent of a 7490 decade counter rather than incorporating one built from basic principles. The computer can also be taught to build in much larger units into its circuits design, the designer could call for a ten decade count module or a clock module or a 256 bit RAM, all of these units can be simulated by computer programs and built into the PCB or IC being designed.

At some stage in the operation the human designer has to tell the computer to incorporate, so the system is not completely automated yet. The computer cannot 'think' for itself - or can it? Most large computers now are capable of scheduling their own workload and deciding which programs or sub-routines it requires at any one time. The computer also usually writes its own programs, the human programmer in fact programs in a language more like English or mathematical notation and the computer converts from these high-level language programs into its own machine language instructions by using another program called a compiler. The computer can also modify these programs if it thinks that the programmer has made a mistake, or if the computer knows of a better way to approach the problem. When the program is

being executed the machine can still alter the program to make the most efficient use of the core, disk or tape storage available. The programs could be models of a system the designer is testing and the computer will write its own program by trial and error until the absolute optimum is developed.

Our computer is now capable of designing a program to design a set of ICs and PCBs, another program to control the machine that will assemble the PCBs, another program for a minicomputer to test the finished units. There is no reason why the machine could not also pack the units for despatch to customers, debit the customers account, produce invoices and statements, print "solicitor's letters" for overdue payments, etc. At the other end of the business the computer could turn out designs for, let us say, calculators, list the components required either make them or send out orders for them, it could write letters to all existing customers about its new calculators, schedule incoming orders against production, etc. Most of these functions can and are being done by computers now in various companies. If all of these functions could be controlled by one computer then that computer could do its own design, ordering, scheduling, marketing and sales. All you do is to sit back and press a 'start' button and collect the profits - if the computer decides to pay you! Impossible? - No. The cost of such an exercise could be too high even to contemplate but there are some companies who could afford to extend their existing system until it became like our system. The only hope we have is that the computer is going to break down or need servicing at some time. But wait a minute, our computer is electronic and is in the electronics business, could it? - no, its not possible, it couldn't diagnose its own faults, design replacements and then design a machine to install those replacements. - Could it?

N.B. The above should be read very late at night after a heavy meal

MM 5378 AUTOMOTIVE CLOCK WITH NSN 74 DISPLAYS

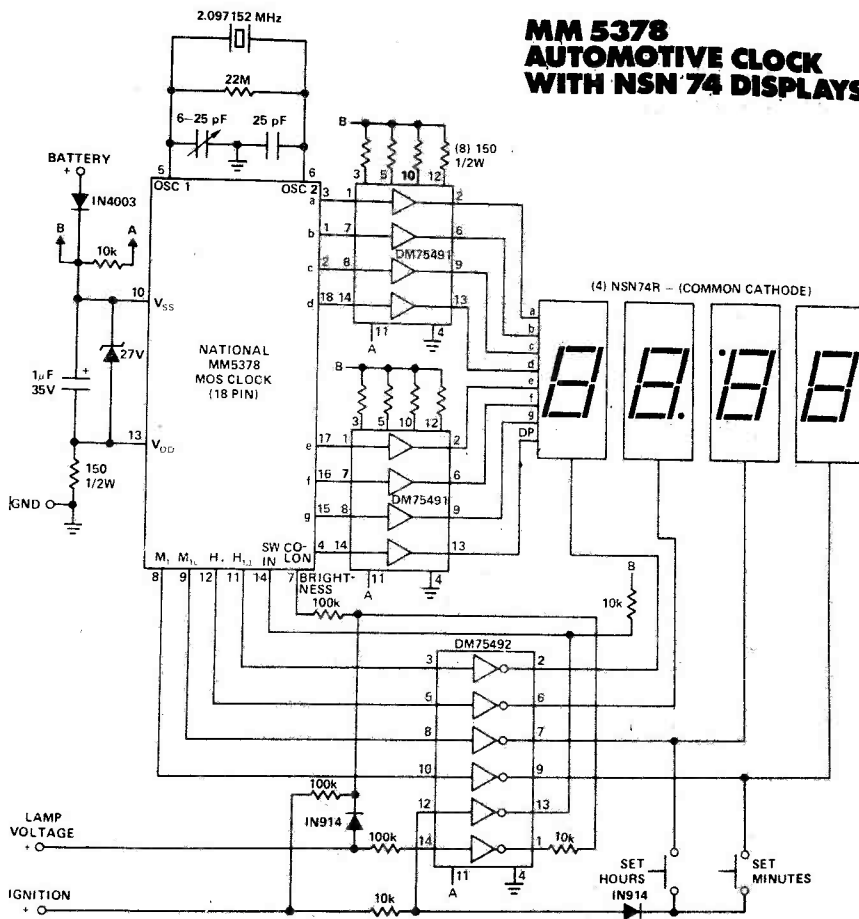

of cheese and perhaps just a little wine. Pleasant dreams!

AND NOW FOR SOMETHING COMPLETELY (?) DIFFERENT

National Semiconductors (UK) Ltd have just released a new list of digital clock chips. These chips are extensions of their existing range of chips and some of them we have mentioned in this column before. The first commercial clock chip available and readily obtainable in this country was the NS MM5311, the 5311 family was then extended to the 5312, 5313 and 5314 chips and the MM5314 is still (but only just) the cheapest 6-digit clock chip on the market. This family has now been extended to include the MM5309 and the MM5315, these are basically the MM5311 and MM5313 with a reset to zero function added - now we might see some decent digital stopwatch designs incorporating these chips.

The MM5370 and MM5371 alarm chips with passive interface to high-voltage displays are now available. These chips were mentioned in ETI some months ago (it was even news to some NS people!) and so we will not repeat details here again. Suffice

to say that they are definitely now available, I have even seen one working, but for some obscure reason with a Phosphor-diode display not a Gas-discharge display.

One of the very new families is the MM5375. This is basically one chip which can be mask programmed (ie before production) to give several options of use for its second count register, and such things as 50/60Hz, or Timer functions in the second 12/24 Hour, Alarm tone or switch, etc. Already NS have 6 versions of this chip with various options, it seems a shame that they could not design the chip so that some of the options such as the 50/60Hz could not be selected at operation time rather than at production time. I assume that the lack of these options is due to the fact that the clock chip has only 18 pins, presumably to save on space and cost. I would refer the NS designers to *Electronics Tomorrow* in the August 1974 edition of ETI.

Another of the NS 18 pin chips is the MM5378 'Auto' (car) clock chip. This runs from a quartz crystal at 2,097152MHz, with a minimum of additional components and gives a digital clock system suitable for use in cars, boats, etc. In the diagram it can be seen with a circuit to drive LEDs but it would also direct drive

Phosphor-diode type displays, thus cutting the component count even further. The MM5378 functions are basic four digit clock in 12 hour mode with flashing colon and brightness control, another chip with the same spec but with circuitry for driving Gas-discharge type displays is the MM5379. The only problem with the 5379 is where do you get 200V necessary for the display in a car environment, surely NS could have put an inverter driver onto the chip at very little extra cost?

Having written this much of this column I decided to ring NS and check the prices of the MM5375 and MM5378, they're not as cheap as one would expect for 18 pin chips. The one-off prices of the MM5375 are £9.00 and the MM5378 at £8.40, I expected them both to be in the £5 area. *National Semiconductors (UK) Ltd, The Precinct, Broxbourne, Herts.*

BACK NUMBERS

Back numbers are available for 30p each plus 10p postage on one, 15p for two or more.

We are unable to supply the following:

April, May 1972

February, November 1973

March, September 1974

There are very limited supplies of certain other issues.

Many popular constructional features in the issues no longer available are in the Top Projects Book available for 75p + 10p postage.

Orders should be sent to:

BACK NUMBERS DEPT.

Electronics Today International,
36 Ebury Street, London SW1W
0LW.

ETI TOP PROJECTS

A special bumper issue containing reprints of over 20 of some of the most popular ETI constructional projects published in the past 2½ years. Now available at your newsagents.

75p

tech-tips

NI-CAD DISCHARGE LIMITER

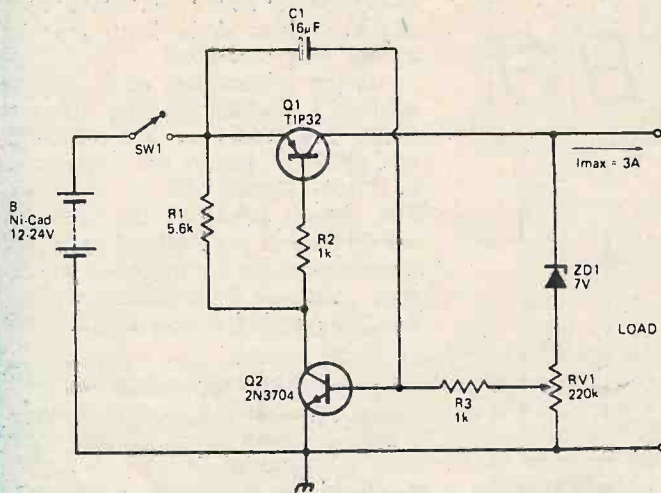

Nickel-cadmium batteries should never be completely discharged as this leads to shortened life. The circuit shown may be used to disconnect the battery from the load when ever output voltage falls below a preset level.

In operation C1 charges through R1 and turns on Q1, the collector current of which flows through R2, turning Q1 on. Thus the battery is connected to the load. When the output voltage falls below a point set by RV1, Q2 turns off, Q1 turns off and further discharge of the battery is prevented.

AUDIO AMPLIFIER

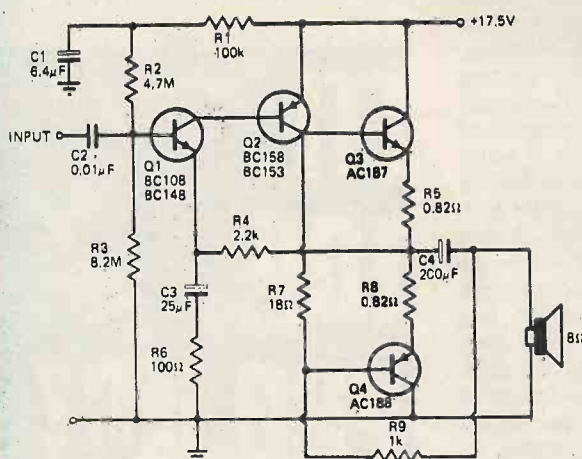

A high input impedance of 1.1 megohm is made possible in this amplifier by keeping the collector current of Q1 low, and by using a high level of ac and dc feedback. The input sensitivity is adjusted by altering the value of R3.

The quiescent current of the output stage is 2.5 mA and is stabilised by resistors R5 and R8. With a 17.5 volt supply the amplifier will deliver 2.5 watts across 8 ohms with a distortion of less than 1% at 1 kHz.

OPTICAL PULSE CONDITIONER

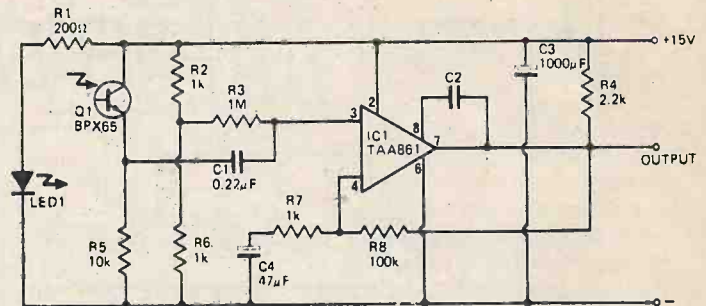

This circuit generates a fast rise time pulse each time the illumination of the BPX65 photo transistor by the LED is broken by a small object or rotating disc segment etc.

The operational amplifier, Siemens type TAA861, amplifies the signal from the photo-transistor and generates the fast rise time pulse the duration of which is determined by the value of C2: 5 microseconds when C2 = 47 pF, 1 microsecond for C2 equal to 16 pF and 0.4 microsecond when C2 equals 5 pF. The amplitude of the output pulse is 200 millivolt.

The circuit is thus ideal for generating pulses for an electronic counter. The maximum separation between the LED and the photo-transistor is around 20 mm.

A SIMPLE TEMPERATURE-CONTROL SYSTEM

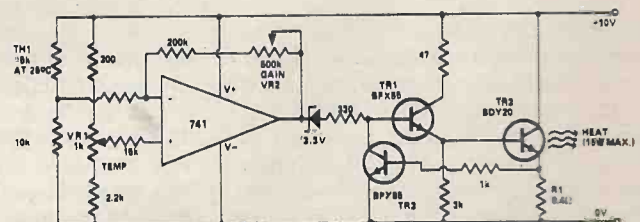

In electronics the need often arises to stabilise the temperature of critical sections of circuitry, such as master oscillators, log converters, and reference supplies. This circuit will control the temperature of a small mass of metal, such as a heat sink onto which critical components can be mounted, simply and efficiently.

The difference between a reference voltage set up on the temperature setting control VR1, and a voltage derived via thermistor TH1, is amplified by the op-amp, gain being set via VR2. This output voltage is applied to heater transistor TR2 via current amplifier TR1. ZD1 is essential for voltage-shifting since without it even the negative saturation voltage of the 741 would leave TR2 turned on. The current flowing in TR2 is limited to 1.5Amp by TR3, which shunts current from TR1 base if the voltage developed across R1 exceeds 0.6V. This arrangement leaves most of the supply voltage across TR2 and hence it is the only component dissipating significant heat.

ETI is prepared to consider circuits or ideas submitted by readers for this page. All items used will be paid for. Drawings should be as clear as possible and the text should preferably be typed. Circuits must not be subject to copyright. Items for consideration should be sent to the Editor, Electronics Today International 36 Ebury Street, London SW1W 0LW.

TR2 is bolted to the mass of metal to be temperature-stabilised, and TH1 mounted as close to its flange as possible, using silicon grease for good thermal contact. The less thermal time-lag between them, the higher the gain that can be used without instability, and hence the lower the steady-state error of the system. Instability can be easily checked for by monitoring the op-amp output; if this is stable at the non-saturated value, then the system is probably operating correctly. TH1 must be the type of thermistor that has a small head of sensitive material at the extreme end of the glass encapsulation; other types have too much thermal inertia.

The prototype held a small (3°C/W) heatsink within ½°C for temperature settings between 30°C and 70°C, when shielded from draughts. The unit must be powered from a 10V PSU having good voltage regulation, to attain this performance.

A DOUBLE PRECISION-RECTIFIER CIRCUIT

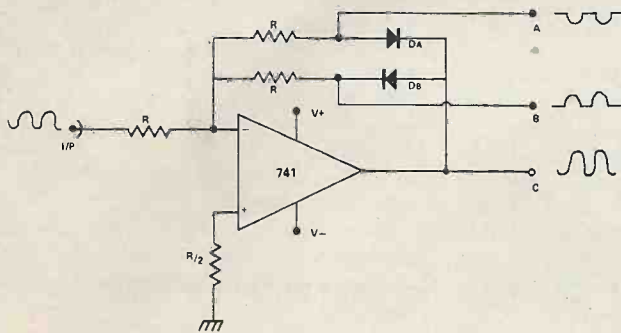

This circuit separates the positive and negative halves of an input waveform, and presents them (both phase-inverted) at separate output terminals. When the input swings positive, terminal A swings negative by an equal amount, terminal B remaining at zero voltage due to the reverse-biasing of DB and the virtual-earth action of the op-amp. For negative inputs, terminal B swings positive by an equal amount, terminal A remaining at zero due to the reverse-biasing of DA.

The insertion of a resistance of value R/2 in series with the non-inverting input gives partial cancellation of drift due to input offset-current changes. A suitable general-purpose value for R is 10K; note that the input-impedance is always R due to virtual-earth action.

A waveform appears at terminal C (at low impedance) that is the inverted input waveform with the addition of two diode-voltage-drops, in such a way that the central part of the waveform is "stretched". If the input is an audio source resulting distortion provides an interesting electronic music effect.

The circuit is particularly useful because positive and negative of a waveform can be operated on separately, and then combined in a simple virtual-earth mixer. For example, using two single-polarity log converters on the two outputs would provide bipolar logarithmic conversion upon recombination.

A SELF-TRIGGERING TIMING CIRCUIT

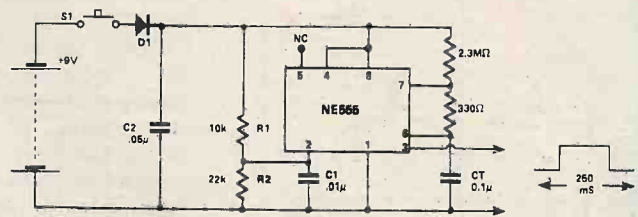

This circuit demonstrates a method of triggering a single time-period from a 555 timer supply by applying power to the circuit, thus eliminating the need for two switches or a two-pole push switch. The original application required that a single 250mSec pulse be produced when a push-button was operated, and the method shown allows the timer circuitry to be switched on and triggered simultaneously by a single MAKE contact. This also economises on battery power as there is no stand-by period.

A 555 timer triggers when the voltage on Pin 2 falls below 1/3V_{CC}. When S₁ is closed Pin 2 remains briefly below 1/3V_{CC} due to the finite time C₁ takes to charge via R₁, and then climbs to 2/3V_{CC}. Meanwhile the 555 has triggered and the time-period has begun. When S₁ is released, after the end of the period, C₁ discharges through R₂ and the circuit is ready for re-triggering in less than a millisecond. C₂ is essential to prevent supply-line transients resetting the 555 as soon as it triggers, and D₁ provides reverse-polarity protection.

Timing components (C₁ and associated resistors) are shown with values for 250mSec pulses, though a wide range of different values can be used.

12V-9, 7.5, or 6V CONVERTER (AUTOMOBILE)

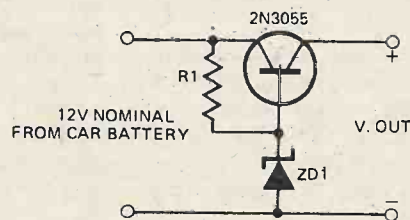

OUTPUT VOLTAGE	9	7.5	6
R1 (½ WATT)	180Ω	270Ω	330Ω
ZENER DIODE (250 mW)	10V	8V1	6V6

Many transistorised items such as radio, cassettes and other electrical items operate on batteries. Usually these are in the 6-12V range and sockets are provided for external power supply.

This circuit enables these devices to be operated from a car's electrical supply.

The table gives values for resistors and specified diode types for different voltage. Should more than one voltage be required a switching arrangement could be incorporated. For high currents the transistor should be mounted on a heatsink.

tech-tips

HOW NOT TO DESIGN YOUR OWN BURGLAR ALARM

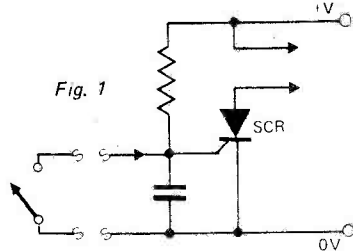

Innumerable designs have been published for simple burglar alarms based on variations of the circuit shown in Fig. 1. In these circuits an SCR is normally prevented from triggering by the external guard circuit — which is supposed to short the SCR gate to cathode.

These circuits are fine if the external leads are only a few inches long — but completely hopeless for most alarm applications where the external circuit may extend to hundreds of feet.

Never ever hang an 'aerial' onto the gate of an SCR. If you do, that SCR will be triggered by every electrical disturbance for miles. Thunderstorms, arc welders, contactors, fluorescent light starters, power drills — everything and anything is liable to trigger the SCR into conduction — and thus cause false alarms.

Many of these circuits show a capacitor or resistor connected from cathode to gate — this the project explains — is to prevent false triggering.

It doesn't.

The problem may be completely overcome by adding a capacitor, a unijunction and a few resistors as shown in Fig. 2. This circuit is virtually false-alarm proof. As long as the external loop is closed, the

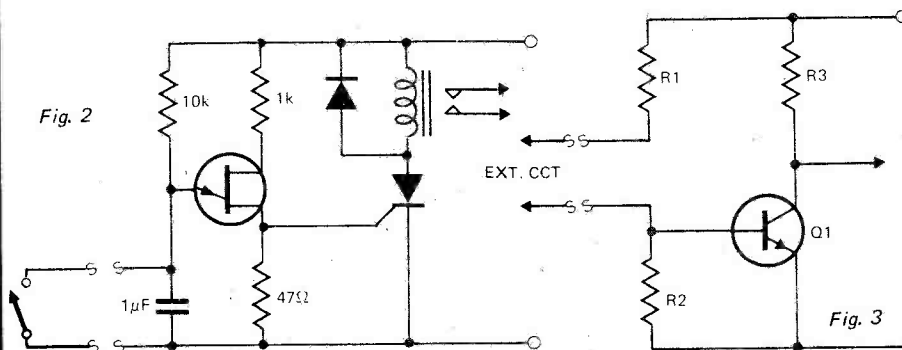

capacitor is shorted out. There is no way in the world that the UJT can oscillate — and until it does, that SCR is firmly held off.

Another advantage of the revised circuit is that, by suitably selecting C1/R1, a time delay may be built into the triggering circuit. This delay should preferably be half a second to one second. It is very worthwhile incorporating as it will prevent false alarms due to an external alarm switch momentarily vibrating open due perhaps to sudden wind gusts physically disturbing a structure.

A further problem with the circuit (Fig. 1) is that the SCR may also be triggered by signals picked up in the SCR anode leads to the alarm bell.

This can be overcome by using the SCR to trigger a relay. If a second pair of contacts are available then these should be used to self-latch the relay thus further ensuring that the alarm will stay latched on (the SCR is of course self-latching).

With transistor alarm circuits, another problem may arise if a circuit such as that shown in Fig. 3 is used.

Here the external triggering circuit is part of the bias circuit for Q1. Normally the closed external circuit will cause Q1 to be biased on via R1.

This circuit works well if fairly low value resistors are used for R1 and R2. However if R1 exceeds 75 k or so, problems may arise. What happens is that moisture across the external switches or leads can create a high resistance 'short' across the alarm circuit. This 'short' will appear to the alarm input as a closed switch and will prevent the alarm functioning if external triggering switches are opened.

So keep the values of those bias resistors down low. About 47 k for R1 and 4.7 k for R2 is about right.

A VARIABLE ZENER DIODE

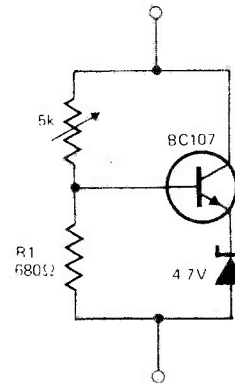

The circuit shown behaves like a Zener diode over a large range of voltages. The current passing through the voltage divider R1 — R2 is substantially larger than the transistor base current and is in the region of 8 mA. The stabilising voltage is adjustable over the range 5 — 45 V by changing the value of R2. The total current drawn by the circuit is variable over the range 15 mA to 50 mA. This value is determined by the maximum dissipation of the Zener diode. In the case of a 250 mW device this is of the order of 50 mA.

When stabilising higher voltages or operating at higher currents it is necessary to fit a small heatsink to the transistor.

WHITE AND PINK NOISE GENERATOR

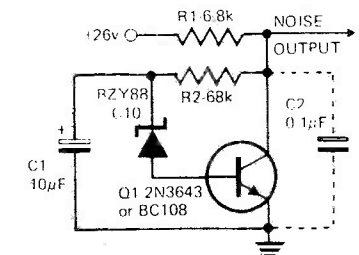

A basic noise generator can be built using one transistor and a Zener diode.

The 10 volt Zener acts as the noise source and also stabilizes the transistor operating point. Adding capacitor C2 will change the output from 'white' noise to 'pink' noise.

Output level for components specified will be about 15 V for white noise and about 14.5 V for pink noise.

The transistor should be a BC 108 or 2N3643 — other similar transistors will do.

DX MONITOR

Compiled by Alan Thompson

One of my favourite relaxations (apart from DXing, of course!) is tussling with a crossword: fellow addicts will know that this leads to the acquisition of strange, and frequently useless, pieces of information gleaned whilst searching through dictionaries for "A South American invertebrate (9 letters)" which appears to start with a Z and ends with PNF. Hunting for some such word, my eye chanced on the definition of "to monitor" in the "Penguin English Dictionary" - "(to) listen to and report on foreign broadcasts; check accuracy of wavelength". What a succinct definition that is of monitoring in the DX usage of the word.

In various parts of the world there are professional monitoring stations belonging to various governments and their agencies whose job is to listen to foreign broadcasts and check the content of their programmes and the frequencies on which they are transmitted. As one might expect such installations tend to be complex and to be provided with a huge quantity of extremely expensive, and sophisticated, technical equipment. However; good, accurate, detailed monitoring is within the scope of any DXer however simple his equipment provided that he possesses the mental stamina which it certainly calls for, and has the sort of mind one finds in the crossword addict - a mind which likes raking small clues, looking at them from all angles and arriving at the answer by a process of elimination and a study of the probabilities.

Essentially, so far as the hobby-DXer is concerned, there are two quite distinct kinds of monitoring, or, perhaps, three if you make a distinction between two aspects of the first type. The first, and simplest, is the monitoring of fairly easy-to-hear stations either just for the sake of sending off a Reception Report and getting a QSL in return, or - and this is the aspect you can split off into a sub-category - the monitoring of a particular station, day after day, as an official monitor for that radio station. The vast majority of major radio stations around the world are interested in knowing how their signals are being heard and casual (one-off) reports are of only limited use to them. What they seek is a succession of reports, compiled over a longish period of one day or for the same period over say 14 days, which pin-point for them a variation in quality of their signals over the period concerned. If this kind of work interests you it is worth writing to the Chief Engineer of the station concerned offering your services and asking which frequencies and services they would like you to send reports on. Very often, small gifts - things like calendars, picture books, LPs and other souvenirs - will come your way in return for a long series of reports, and you will, if nothing else, gain a great deal of insight into the programming pattern of the station concerned, the "slanting" of its programmes, a better understanding of the problems of frequency planning and propagation, and the satisfaction of being of assistance to the people on the transmitting end of the programmes you enjoy (or, quite possibly, hate: many people *do* monitor stations whose programmes they hate hoping that their comments will lead to changes for the better!).

SLEUTHING!

Monitoring of the kind I've just described can be arduous enough if it entails listening to repetitious programming at around 0600, day after day. It's not at all bad in the cool of a Summer's morning but it can be sheer hell dragging yourself out of bed when the thermometer is at -10°C and it's dark, dank Winter morning. Still, there are such things as time switches... and tape recorders!

"Sleuthing" is my name for the second kind of monitoring and about the only use for a time switch in this regard is that it can a) turn on the radio gear 30 minutes before you arrive on the scene, and b) provide - given the necessary equipment and electro-mechanical facility - a hot cup of tea to start you on your way. More seriously, this kind of monitoring is one of the arts of DXing and you can do it whether you have the latest £1000+ receiver or just a decent transistorised short-wave portable. Your results will be quite different but that isn't the idea of the exercise which is to take a particular part of the broadcast-band spectrum and monitor it, day after day, for the signals it will disgorge. If you like problems this is just the exercise for you, because it will get steadily more difficult as the days progress and you identify more and more stations and find yourself left with a handful which call for all the crossword addict's ingenuity to unravel their identity.

If you feel like trying this kind of monitoring a suitable place to begin is with the 49, 41 or 31 metre bands and a reasonable time slot would be 1800-2100 in the evening. The first piece of advice is to give yourself something reasonable and not bite off a great deal more than even the expert would find it difficult to chew: so, confine yourself to a range like 9500-9750kHz or 6000-6250kHz.

Certain times of year are better than others for this sort of exercise as stations using the international short-wave bands change frequency at 0100 G.M.T. on the first Sundays in March, May, September and November. Consequently, the periods from the beginning of March-end April and early September-end October are rather short for ones first essays into this field. The present frequency period, officially known as D(1974), is with us until 0100 on 2 March 1975 so now is a good time to get started, as the chopping-and-changing of frequencies which always takes place in the first few weeks of a frequency period will be over by the time you read this.

For preference - but it is by no means essential! - one should have a copy of the current "World Radio-TV Handbook", a copy of the current "Tentative High Frequency Broadcasting Schedule" (published by the I.T.U.), and as many station schedules as you can get hold of. However, since that means some £10-worth of books let's assume that they are not available and that one is starting right from scratch. The first fact to be absorbed is that international SW stations operate at 5kHz intervals and that frequencies are shared by various broadcasters in the course of a day - indeed, many "sharings" of a particular frequency is now the rule. Given those facts, it is now all a question of listening and recording one's results in usable form!

KEEPING THE BOOKS

It's worthwhile devoting some time to setting-up the exercise before actually getting down to listening. If you have some form of bandspread on your receiver a graph of bandspread setting against frequency is almost a must as it saves a lot of time later. No bandspread? Well, it makes things rather more difficult but not impossible - you have to start by logging stations whose frequencies you know (from announcements or their schedules) and "fill in the gaps". How you record the information is entirely a matter for you: some people like to use sheets of card rules in a grid of quarter-hours along the top and frequencies (at 5kHz intervals: see above) down the left-hand side. Others - and this is my own favourite method - get hold of a pack of 5" x 3" index cards and use one for each 5kHz channel (i.e. one for, say, 9500kHz: another for 9505, one for 9510, and so on).

The first essay into band monitoring may make the thing seem fairly easy. In a couple of hours, over a chosen band of say 250kHz - which means 51 channels 5kHz apart - it isn't too difficult to record something like 20 or 30 separate stations with accuracy. The next foray will fill in a good number of the gaps, or let you complete the "scan" which was left uncompleted on the previous occasion. Slowly, things will start to get a lot harder! What are those two stations fighting it out on, say, 9625kHz? What is that confounded interval signal? That station wasn't there last time and what language is it using? And so it goes on! Gradually you will build up a, virtually, complete picture of what is happening on your chosen piece of band over a few hours of the day and, I have no doubt, you'll manage to add a few interesting stations to your log over the course of a frequency season.

EDXC BAND SURVEYS

If you find yourself "grabbed" by this kind of DXing - which is one of the more esoteric aspects of the art! - then, maybe, you would like to take part in some of the European DX Council's Band Surveys which are held from time to time. Monitors with the necessary devotion to this kind of exercise are hard to find and if you would like to take part in future EDXC surveys please write to me and I will pass your letters along to the coordinator for those exercises, the results of which are of great interest and value to serious BC-band DXers. Please write to me, marking your letters "Band Surveys", at 16 Ena Avenue, Neath, West Glamorgan SA11 3AD. I am afraid that I am unable to assist with individual queries on "unidentifieds" but general letters about DXing will be replied to if you enclose a self-addressed and stamped envelope.

CCTV INSPECTION

This CCTV system is used at the Ferranti factory in Wythenshawe to help check the complex printed circuit boards used in Argus computers. The method avoids the risk of eye-strain inherent in purely optical methods.

Ferranti stack their PCB's in several layers to achieve the required packing density, and so that through-connections can be made, tight dimensional tolerances have to be applied during manufacture. Precise checking of the boards can only be carried out using a magnified image. A miniature TV camera scans a photographic negative which is used in the manufacturing process. The beam is accurately positioned so that any out-of-tolerance dimensions can be detected by an operator watching the screen. The magnification obtained by this method is up to fourteen times.

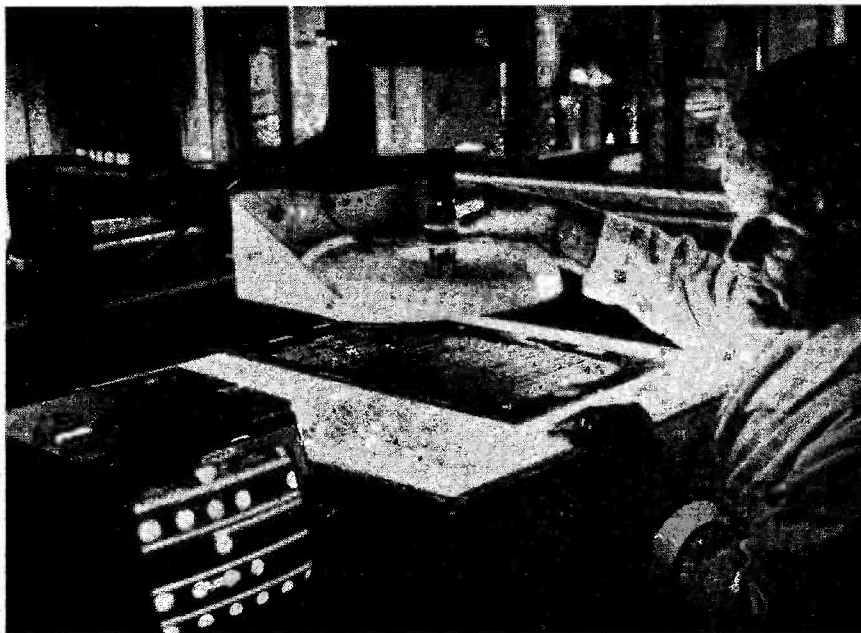

8-TRACK STEREO CARTRIDGE RECORDER

JVC have a new 8-track cartridge recorder numbered ED1230. The 16 transistors and 9 diodes give a frequency response of 70-12,000Hz (+3dB) and a S/N ratio above 50dB at 1kHz. An AGC circuit controls the tape head recording current to ensure that all signals are recorded at the optimum level for maximum S/N ratio, and minimum distortion. JVC's paralalled head-shift mechanism keeps the 3-in-1 head in intimate contact with the tape no matter which programme is playing, to reduce distortion still further, keep cross-talk below 60dB and channel separation over 40dB at 1kHz. The precision tape transport system keeps wow and flutter down to 0.2% (rms).



The player starts as soon as a cartridge is slotted in, programme changing and recording are effected by means of push buttons, and a third push button provides a 2-way programming facility. This will automatically eject the cartridge after all 4 programmes have played once, or just play continuously. RRSF is £67.90 inc. VAT.

QUAD OPTO ISOLATOR

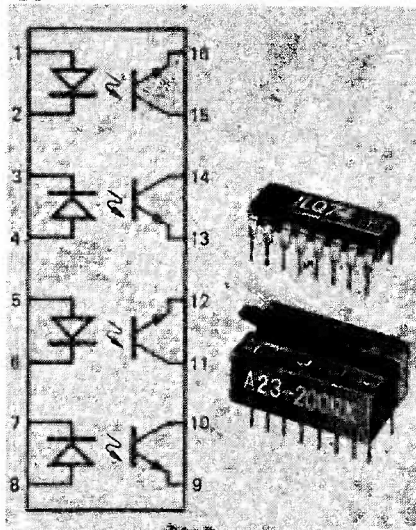

The first ever quad opto coupler is now available from Jermyn Industries. The coupler is made by Litronix one of the leading manufacturers of opto-electronic devices in Europe, and is designated 1LQ74. The coupler is compatible with most medium speed logic families and each channel has a typical isolation resistance of 100,000,000 ohms and a minimum breakdown voltage of 1500V. The device is housed in a sixteen pin dual-in-line package. The cost's £2.87 for one off and £1.65 for 1,000 off quantities.

SOLAR POWERED WATCH

Production is now said to have begun on the light-powered Ragen Synchron-ar watch.

A feature of the LED digital watch is its 100-year calendar, which is pre-programmed to allow for monthly aberrations and leap years to the year 2100.

An average exposure to sunlight of 10-15 minutes per day is claimed to be adequate to charge the watch.

PLUG-IN WHITE NOISE GENERATOR

Growing interest in the effect of artificially created background noise on office environments has prompted the Milbank Electronics Group Limited, to introduce a simple, white noise generator for use with their professional amplifiers. The EQA 16 has been developed as a two-tier, three device, plug-in equaliser circuit which can be adjusted to produce white, pink, green or blue noise.

Although, in some offices, noise must be reduced to assist communication and privacy and to alleviate annoyance, trials have shown that, in other areas, the introduction of artificially created background white noise can effectively reduce fatigue and increase over-all efficiency.

The price of the EQA 16 is £12.72 and the unit is available from Milbank Electronics Group, Bellbrook Estate, Uckfield, Sussex.

ERRATA

Projects Book page 95. The phone number of Marco Trading is WHIXHALL 464, STD CODE 094872, and not as printed.

LM380 Projects December issue page 32 and 34.

In Fig. 2 and Fig. 5 the pin on the IC marked '13' should be pin 14. All other drawings have correct pin markings. Also in Fig. 2 the symbols for the batteries are the wrong way round but the polarities are marked correctly.

MINI-ADS

FOR FURTHER INFORMATION
PHONE: BOB EVANS
01-730-2139

NEW

12v 8w

FLUORESCENT LIGHT KIT



You can build this reverse polarity proof light for use in homes, garages, caravans, for camping, or emergency lighting. Everything; tube, all metalwork, all components, P.C.B., instructions etc., is supplied.

Price only £3-19 inc. VAT
DIFFUSER ONLY 59p extra p & p
ORDER NOW TO - inc. VAT

ELECTRONICS DESIGN ASSOCIATES
82 Bath Street Walsall WS1 3DE
Phone 33652

HARDWARE

Screws, nuts, washers etc. Sheet aluminium cut to size or in standard packs, plain or punched/drilled to spec.

Printed circuit boards for published designs or individual requirements, one-off or small runs.

Facia panels, dials, nameplates etc. in etched aluminium. 6p for details.

RAMAR CONSTRUCTOR SERVICES
29 Shelbourne Road,
Stratford on Avon, Warwicks.

TV Convergence Panels 2xAC128, 3 slugged coils, 3 slide switches, 11 wire-wound pots, 3 carbon presets, 2 ferrite chokes etc. £1.10 C.P. First Grade C/Clad Fibre Glass Panels 12½"x7" 75p C.P. 13"x11" £1.20 C.P. Paxolin Panels C/Clad 5½"x5½" 6-55p 1½"x9" 3-£1.00 C.P. Large Computer Panels 35-50 transistors with long leads 85p post 30p.

J.W.B. RADIO
2 Barnfield Crescent, Sale,
Cheshire M33 1NL.
PRICES INCLUDE VAT

SPECIAL OFFER!

**SANKEN 25W
AUDIO AMPLIFIER
TYPE SI-1025A**

(Normal price £9.00 + VAT)
**SPECIAL OFFER PRICE
ONLY
£7.00 + VAT**

PHOTAIN CONTROLS LTD.
RANDALLS ROAD,
LEATHERHEAD,
SURREY.

*Why not also send for details of our wide range of photo-cells?

DRAUGHTING AIDS

Give your P.C.B.'s that professional look. Tapes, pads and I.C. groups for 1:1 masters. S.A.E. for price list.

**ADELTA, 54 Dickens Avenue,
Hillingdon, Middlesex.**

Electronic Doorbell. Four note, programmable. IDEAL XMAS GIFT. Module and speaker with instructions £8.95. M. Davidson Box. No. 11.

AERIAL BOOSTERS: £3.00

Can produce remarkable improvements on the picture and the sound in fringe or difficult areas. L11 for the VHF radio. L12 for the VHF TV bands (please state Band 1 and 3 channels). L45-tunable over the complete UHF TV range. P and P 10p.

LANCASHIRE MAIL ORDER SUPPLIES,
6 William Street, Stubbs, Ramsbottom,
Bury, Lancs.

TTL AT LOW PRICES!

(All devices ex-stock. Prices include VAT)

1/24 25/99		1/24 25/99		
7400	17p	7402	17p	
7404	20p	7410	17p	
7420	17p	7430	17p	
7440	17p	7442	74p	
7445	£1.03	96p	7447AN	98p
7451	17p	15p	7473	36p
7474	36p	34p	7475	56p
7576	35p	32p	7480	53p
7483	£1.02	95p	7489	£3.56
7490	57p	55p	7492	57p
7493	59p	56p	74121	37p
74123	72p	67p	7486	36p
74157	87p	81p	74175	£1.01

All devices full spec. by famous manufacturers. Devices may be mixed for 25/99 prices. SAE for full list. 10p P&P on orders under £1, otherwise post free.

J. C. JONES
46 Burstellers, St. Ives, Hunting PE17 4XX
(Mail Order only)

RECRUITMENT

MARCONI INSTRUMENTS LIMITED

ELECTRONIC TECHNICIANS

are required to work on calibration, fault-finding and testing of telecommunications measuring instruments. The work is varied and will enable technicians with experience of r.f. circuits to broaden their knowledge of the latest techniques employed in the electronics and telecommunications industries by bringing them into contact with a wide range of the most advanced measuring instruments embracing all frequencies up to u.h.f.

Entrants may be graded as Test Technicians, Senior Test Technicians or Technician Engineers according to experience and qualifications. Our production and servicing programme, geared to our recognised export achievement, provides employment combined with prospects of advancement, not only within these grades, but into other technical and supervisory posts within the Company at St. Albans and Luton.

Salaries are attractive and conditions excellent. A Pension Scheme includes substantial life assurance cover provided by the Company. Assistance with removal may also be given in appropriate cases. Please write or telephone, quoting reference ET7410, for application form to:



Mr. P. Elsip,
Personnel Officer,
Marconi Instruments Ltd,
Longcross, St. Albans, Herts.
Tel: St. Albans 59292



Member of GEC-Marconi Electronics 3890

RESETTABLE COUNTERS: 5 Figure 18/22V will work on 12V £2.25 post 25p. **STEPPING SWITCH;** 22 way with reset a.c. mains operated £1 post 25p.

NEONS WIRE ENDED: Bank of 5 with 5-C407 driver transistors 55p post 10p.

COUNTING UNIT With 10-DM160 min. magic eyes, ferrite pot core three transistors etc. In smart black case with plug and socket £2 post 25p.

SINGLE SIDED COPPER CLAD PAXOLIN PANELS: 6x9ins. 3-50p, 11½x9ins. 3-£1. 12½x12ins. 2-£1 all post paid.

SMALL PANELS: Three transistor audio amp, transistors equiv. to AC128, OC72 5 electrolytic diodes etc. with circuit 40p each 3-£1. Four transistor panel 2-2N3702, 2-AC153 silicon bridge rectifier 30V 300mA. Electrolytics 3-10MFD 50V, 250MFD 35V and 1000MFD 35V, 6.8 MFD tantalum 35V signal diodes and resistors 45p. Twelve transistor panel 2-2N930, 10-CS4/BC108, 5x0.1 caps 2-10 MFD 20V tantalum caps, diodes and hi-stabs 25p. Post on these 10p any number.

POLYSTYRENE CAPACITORS 125V 50 100 120 150 180 220 330 390 470 560 680 800 820 1200 1500 1800 2200 2700 3300 3900 5600 6800 8200 0.01 0.012. Price 2p each 100 assorted less 10% Post 10p.

3LBS HIGH QUALITY COMPUTER PANELS £1.50 POST PAID. Send 10p for lists of Valupaks. Refund on purchase.

J.W.B. RADIO
2 BARNFIELD CRESCENT, SALE,
CHESHIRE M33 1NL.
Prices include VAT.

SPECIAL OFFER

Prices include VAT and carriage

Qty	Price
10 for	£2.60
741 8-pin DIL	25 £5.75
100	£21.00

GREENWELD ELECTRONICS,
51 Shirley Park Road, Southampton

HOLIDAY FOR BOYS

14 - 16 years, August 1975. Tuition and practical work in electronics, radio production and tape recording, engineering (Karting) and photography. 11 days in Norfolk: £23.00. Write for free brochure

INTER-SCHOOL CHRISTIAN FELLOWSHIP,
c/o 1 Hubbard Road,
London SE27 9PJ

SPECIAL OFFER POST FREE INCLUSIVE

741	8 PIN	5 for	1.45
		10 for	2.80
741	OP-AMP	20 for	5.40
	SOCKETS. ADD 11P. PER I.C.		

ISLAND DEVICES, PO BOX 11, MARGATE, KENT.

IDEAS, inventions, new products, contact me immediately. Make money, winning team. Do it now and win. S.A.E. P.O. Box 17, ETI

FERRIC CHLORIDE

Anhydrous to Mil-spec in double-sealed packs. 1lb 55p (22p) 3lb £1.32 (30p) 10lb £3.85 (60p).

7lb BARGAIN PARCELS

Contain hundreds of resistors, switches, capacitors, pot (all new) + crystals, transistor panels and loads of odds and ends. Only £1.82 (40p).

VERSATILE POWER UNIT

Contains double insulated mains transformer, 2 amp thermal cut-out and bridge rectifier. Will give 1.7V-10.5V output with two extra capacitors (provided). Ideal for Nickel-Cad charger, 5V TTL supply, cassettes, radios, etc. Supplied complete with information 95p (20p). Also available as model garage woth lamp, switch, jack plug, etc. £1.35 (30p).

3W TAPE AMPLIFIERS

Polished wood cabinet 14 x 13 x 9" containing a sensitive 20(V) 4 valve amplifier with tone and volume controls, 3 watts output to the 7 x 4" 3 speaker. Also included is a non-standard tape deck. Supplied in good working condition with circuit Mains operated. £3.30 (£1.25). Amplifier chassis complete and tested (2xECC83, EL84, EZ80) and speaker £2.20 (45p).

COMPUTER PANELS

3lbs assorted panels £1.10 (30p) 7lbs £2.20 (40p). Pack containing at least 500 components including at least 50 transistors 66p (20p). 12 high quality panels with power transistors, trimpots, IC's, etc. £2.20 (30p) 100 for £13.00 (£1.00). Trade supplied.

ALL PRICES INCLUDE VAT; Carriage in brackets, SAE list, enquiries.

GREENWELD (ET2), 51 Shirley Park Road, Southampton, New Retail/Wholesale/Mail Order Premises. Tel. 0703 772501. Also Retail shop at 38 Lower Addiscombe Road, Croydon.

BARGAIN PACKS: P & P 15p, VAT inclusive, price list send SAE or 10p stamp 48 hr. service. 100 transistors 54p, 100 Diodes 54p. Resistors E12 5% 1/4W, 1/2W 1 1/2p each. Small Red LED's 13p each. 50 400mW Zeners 54p. 40 2W Zeners 54p. 5 LED's 60p/100. Box. No. 15.

MAINS UNITS for all types of TRANSISTOR EQUIPMENT

RUN YOUR TAPE RECORDER OFF AC MAINS

Mains unit supplied complete and ready to plug into your cassette-recorder. (State voltage, make and type of plug required. If in doubt send diagram of recorder socket).

ONLY £2.97

CAR OWNERS

Buy a British Made battery eliminator for your car. This unit enables you to run your cassette tape recorder from the car whilst travelling. It is easily fitted and comes complete with fitting instructions. Please state make of cassette, voltage and type of plug required.



Price £2.65



MAINS UNIT FOR TRANSISTOR RADIO ONLY

For single outputs, 6v or 9v £2.42. For two separate outputs, 6v + 6v, or 6v + 9v, £2.97 per unit. (Please state outputs required).

All units are completely isolated from mains by double wound transformer ensuring 100% safety.

ALL PRICES INC VAT & P. & P

BRITISH MADE

FULL REFUND IF NOT COMPLETELY SATISFIED

R.C.S. PRODUCTS (RADIO) LTD. (Dept ETI)

36 Raymond Ave., South Woodford London, E18 2HG

PRECISION POLYCARBONATE CAPACITORS

440V AC (±10%)	63V				
	Range ±1% ±2% ±5%				
0.1µF (1 1/8" x 1/4")	50p	0.47µF	56p	46p	36p
0.22µF (1 3/8" x 5/8")	56p	1.0µF	66p	56p	46p
0.25µF (1 3/8" x 5/8")	62p	2.2µF	80p	65p	55p
0.47µF (1 3/8" x 1/2")	71p	4.7µF	£1.30	£1.05	85p
0.5µF (1 3/8" x 1/2")	75p	6.8µF	£1.64	£1.29	£1.09
0.68µF (2" x 1/4")	80p	10.0µF	£2.00	£1.80	£1.40
1.0µF (2" x 1/4")	91p	15.0µF	£2.75	£2.15	£1.90
2.0µF (2" x 1/4")	£1.22p	22.0µF	£3.50	£2.90	£2.55

Transformers. Pr. 220-240V, Sec. 12V @ 2A, 24V @ 1A. £2.00 + 22p postage

TANTALUM BEAD CAPACITORS—Values available:

0.1, 0.22, 0.47, 1.0, 2.2, 4.7, 6.8µF at 15V/25V or 35V; 10.0µF at 16V/20V or 25V; 22.0µF at 6V/10V or 16V; 33.0µF at 6V or 10V; 47.0µF at 3V or 6V; 100.0µF at 3V. All at 10p each; 10 for 95p; 50 for £4.00.

TRANSISTORS:

BC107/8/9	8p	BC212/212L	14p	BFY50	20p
BC147/8/9	10p	BC547	12p	BFY51	20p
BC157/8	12p	BC568A	12p	BFY52	20p
BC182/182L	11p	BF194	12p	OC71	12p
BC183/183L	11p	BF197	13p	2N3055	50p
BC184/184L	12p	AF178	30p	2N3702/4	11p

POPULAR DIODES: All brand new and marked: 1N914 8p; 8 for 45p; 18 for 90p; 1N916 8p; 6 for 45p; 14 for 90p; 1S44 5p; 11 for 50p; 24 for £1.00. 1N4148 5p; 6 for 27p; 12 for 48p. LOW PRICE ZENER DIODES

400mW, Tol. ±5% at 5mA. Values available: 3V; 3.6V; 4.7V; 5.1V; 5.6V; 6.2V; 6.8V; 7.5V; 8.2V; 9.1V; 10V; 11V; 12V; 13V; 13.5V; 15V; 16V; 18V; 20V; 22V; 24V; 27V; 30V. All at 7p each; 6 for 39p; 14 for 84p. Special Offer: 100 Zeners for £5.50. RESISTORS: High stability, low noise carbon film 5%; 1/4W at 40°C; 1/3W at 70°C. E12 series only - from 2.2Ω to 2.2MΩ. All at 1p each; 8p for 10 of any one value; 70p for 100 of any one value.

Special Pack: 10 of each value 2.2Ω to 2.2MΩ (730 resistors) £5.00. SILICON PLASTIC RECTIFIERS - 1.5A - Brand new wire ended DO27: 100 P.I.V. - 7p (4/26p) 400 P.I.V. - 8p (4/30p) 800 P.I.V. - 11p (4/42p) BRIDGE RECTIFIERS: 2x4 200V-40p 350V-45p 800V-55p. SUBMINIATURE VERTICAL PRESETS - 0.1W only:

All at 5p each: 56Ω, 220Ω, 470Ω, 680Ω, 1k, 2.2k, 4.7k, 6.8k, 10k, 15k, 22k, 47k, 100k, 250k, 500k, 1M, 2.5M, 5M.

Please add 10p Post and Packing on all orders below £5.00. All export orders add cost of Sea/Airmail. Please add 8% VAT to orders. Send SAE for lists of additional ex-stock items. Wholesale price lists available to bona fide companies.

MARCO TRADING Dept. T10, The Old School, Edleston, Near WEM, Salop. Tel: WHIXHALL 464 (STD 094872) (Proprs: Minicoat Trading Ltd.)

Wilmslow Audio

THE firm for speakers!



Baker Group 25, 3, 8 or 15 ohm	£7.75
Baker Group 35, 3, 8 or 15 ohm	£8.50
Baker Deluxe, 8 or 15 ohm	£10.75
Baker Major, 3, 8 or 15 ohm	£8.50
Baker Regent, 8 or 15 ohm	£7.75
Baker Superb, 8 or 15 ohm	£14.50
Celestion PST8 (for Unilux)	£2.55
Celestion MH 1000 horn, 8 or 15 ohm	£10.95
EMI 13 x 8, 3, 8 or 15 ohm	£2.25
EMI 13 x 8, 150 d/c 3, 8 or 15 ohm	£2.50
EMI 13 x 8, 450 t/w 3, 8 or 15 ohm	£3.75
EMI 13 x 8, 350, 8 or 15 ohm	£8.25
EMI 13 x 8, 20 watt bass	£6.60
EMI 2 1/2" tweeter 8 ohm	£0.65
EMI 8 x 5, 10 watt, d/c, roll/s 8 ohm	£2.60
Elac 59RM 109 15 ohm, 59RM 114 8 ohm	£2.80
Elac 6 1/2" d/c, cone, roll/s 8 ohm	£3.50
Elac TW4 4" tweeter	£1.21
Fane Pop 15 watt 12"	£4.80
Fane Pop 25/2 25 watt 12"	£6.95
Fane Pop 40, 10" 40 watt	£8.50
Fane Pop 50 watt, 12"	£11.00
Fane Pop 55, 12" 60 watt	£12.50
Fane Pop 60 watt, 15"	£13.00
Fane Pop 100 watt, 18"	£22.50
Fane Crescendo 12A or B, 8 or 15 ohm	£29.00
Fane Crescendo 15, 8 or 15 ohm	£36.00
Fane Crescendo 18, 8 or 15 ohm	£49.95
Fane 807T 8" d/c, roll/s, 8 or 15 ohm	£3.85
Fane 801T 8" d/c, roll/s, 8 ohm	£7.00
Goodmans 8P 8 or 15 ohm	£5.00
Goodmans 10P 8 or 15 ohm	£5.30
Goodmans 12P 8 or 15 ohm	£12.95
Goodmans 12P-D 8 or 15 ohm	£16.75
Goodmans 12P-G 8 or 15 ohm	£15.75
Goodmans Audiom 100 8 or 15 ohm	£12.00
Goodmans Axent 100 8 ohm	£7.25
Goodmans Axiom 401 8 or 15 ohm	£17.25
Goodmans Twinaxiom 8" 8 or 15 ohm	£8.25
Goodmans Twinaxiom 10" 8 or 15 ohm	£9.00
Kef T27	£5.25
Kef T15	£8.00
Kef B110	£7.25
Kef B200	£8.25
Kef B139	£14.75
Kef DN8	£2.00
Kef DN12	£4.95
Kef DN13	£3.30
Richard Allan CGBT 8" d/c roll/s	£6.35
STC4001 G super tweeter	£6.19
Fane 701 twin ribbon horn	£35.00
Baker Major Module each	£10.75
Fane Model One each	£9.90
Goodmans DIN 20 4 ohm each	£9.75
Helme XLK25 (pair)	£22.00
Helme XLK30 (pair)	£14.95
Helme XLK50 (pair)	£39.95
Kefkit 2 each	£24.75
Kefkit 3 each	£36.75
Peerless 3-15 (3 sp. system) each	£15.00
Richard Allan Twinkit each	£8.95
Richard Allan Triple 8 each	£13.75
Richard Allan Triple each	£19.95
Richard Allan Super Triple each	£23.75
Wharfedale Linton 2 kit (pair)	£19.25
Wharfedale Glendale 3 kit (pair)	£34.50
Wharfedale Doveedale 3 kit (pair)	£52.50

PRICES INCLUDE VAT

Cabinets for PA and HiFi, wadding, vynair, etc.

Send stamp for free booklet "Choosing a Speaker".

FREE with orders over £7—"HiFi loudspeaker enclosures" book.

All units guaranteed new and perfect.

Prompt despatch.

Carriage: Speakers 38p each, tweeters and crossovers 20p each, kits 75p each (pair £1.50).

WILMSLOW AUDIO

Swan Works, Bank Square, Wilmslow, Cheshire SK9 1HF Tel. Wilmslow 29599 (Discount HiFi, PA and Radio at 10 Swan St, Wilmslow.)

- ★ ELECTRONIC PIANO KIT
- ★ SYNTHESISER KIT
- ★ ELECTRONIC ORGAN KITS



There are five superb Electronic Organ kits specially designed for the D-I-Y enthusiast. With the extreme flexibility allowed in design, you can build an organ to your requirements, which will compare with an organ commercially built costing double the price.

★ Portable organ with 4 octave keyboard, £145.29. ★ Console organ with 5 octave keyboard, £250.95 ★ Console organ with 2 x 4 octave keyboards and 13 note pedal board. £470.65. ★ Console organ with 2 x 5 octave keyboards and 32 note pedal board. £680. ★ Console organ with 3 x 5 octave keyboards and 32 note pedal board. £960. ★ W/W Sound Synthesiser Kit. £130. ★ W/W Touch Sensitive Electronic Piano. £100.

All components can be purchased separately, i.e., semi-conductor devices, M.O.S. master oscillators, coils, keyboards, pedal boards, stop tabs, draw bars, key-contacts, etc.

Send 50p for catalogue which includes 5 x 10p vouchers or send your own parts list, enclosing S.A.E. for quotation.

ELVINS

ELECTRONIC MUSICAL INSTRUMENTS

Designers and component suppliers to the musical industry
12 Brett Road, Hackney, London, E8 1JP. Tel. 01-986 8455

INDEX TO ADVERTISERS

Ambit	9
Amtron	42
Arbour	33
B.H. Components	58
B.I.E.T.	75
Bi-Pak	56/57
Bi-Pre-Pak	17
B.N.R.S	71
Bywood	43/58
Chiltmead	55
Dabar	42
Decon	74
Doram	76
E.D.A.	34
Electroni-Kit	34
Electrospares	33
Elvin's	74
Forgestone Components	42
Greenweld	73
Hart Electronics	32
Heathkit	47
Henry's	2
Integrex	33
J.E.T.	71
Licril	34
Marco Trading	73
Maplin	29
Marconi	72
Marshall's	30
Minikits	16
P.E.C.	9
Photain	72
R.C.S. Products	73
Richards	32
Sinclair Calculators	4/5
Sintel	9
Trampus	43
Wilmslow	73

P.C. BORED?

— not with the

DECON-DALO 33PC



A unique drafting aid for the electronics engineer enabling him to prepare in minutes a perfect PCB.

A fine-tipped marker charged with a free-flowing etch-resist ink. Simply draw the desired circuit onto copper laminated board—etch—clean.

The circuit is ready to use.

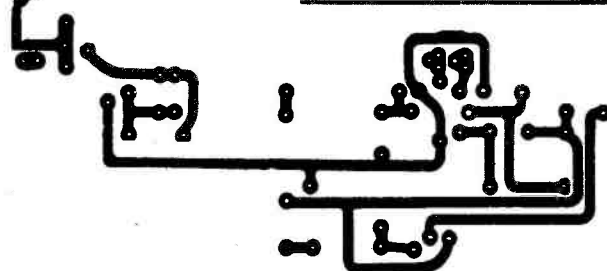

NO MESS — NO MASKING

£1.10 for one off £4.40 for six £8.80 for twelve VAT and post included. Available now in every country in EUROPE!

The Decon-Dalo 33 PC marker is now available in France, Germany, Italy, Switzerland, Austria and all Scandinavian countries. Send for details of local supplier.

Please send me further details on the 33PC:

Name

Address

Post to: DECON LABORATORIES LTD.

FREEPOST

PORTSLADE, BRIGHTON, ENGLAND

(No Stamp Needed) Phone 0273 414371

Henry's

LARGEST SELECTION OF ELECTRONIC COMPONENTS AND EQUIPMENT. LOW PRICES— MEAN LESS VAT.

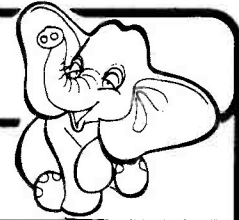

You can build the Texan and Stereo FM Tuner

TEXAN 20 -- 20 WATT IC STEREO AMPLIFIERS

Features glass fibre PC board. Gardeners low ... old transformer 6 ICs, 10 transistors plug diodes etc. Designed by Texan instruments engineers for Henry's and P.W. '972. Supplied with full chassis work, detailed construction handbook and all necessary parts. Full input and control facilities. Stabilised supply, overall size 15 1/2 in. x 2 1/2 in. x 6 1/8 in. mains operated. Free teak sleeve with every kit.



£31.00 (GB post paid) Built and tested £37.50
STEREO FM TUNER

Features capacity diode tuning, led and tuning meter indicators, stabilized power supply—mains operated. High performance and sensitivity with unique station indication IC stereo decoder. Overall size in teak sleeve 8 in. x 2 1/2 in. x 6 1/8 in.

£21.00 Complete kit with teak sleeve £24.95 (GB post paid). Built and tested
JOIN THE LARGE BAND OF HAPPY CONSTRUCTORS!

TRANSISTORISED MODULES

Tuners—Power Suppliers—Amplifiers

Amplifiers (All single channel unless stated)		
4-300 9 volt 300 MW	£1.75	
2004 9 volt 250 MW	£2.70	
104 9 volt 1 watt	£3.10	
304 9 volt 3 watt	£3.95	
555 12 volt 3 watt	£4.10	
555ST 12 volt 1 1/2 x 1 1/2	£5.95	
E1208 12 volt 5 watt	£5.10	
608 24 volt 10 watt	£4.95	
410 28 volt 10 watt	£4.95	
620 45 volt 30 watt	£9.95	
240 30/35 volt 15 watt	£5.45	
260 45/50 volt 25 watt	£6.95	
SA6817 24 volt 6-6 watt	£10.20	

Amplifiers with controls		
E1210 12 volt 2 1/2 + 2 1/2 watts 8 ohms	£8.25	
RE500 Mains 5 watts 4-16 ohms	£11.30	
SA14 Mains 7 + 7 watts 8 ohms	£6.75	
SA130 Mains 15 + 15 watts 8 ohms	£14.95	
CA038 9 volt 1 1/2 + 1 1/2 watts 8 ohms	£5.45	
CA068 12 volt 3 + 3 watts 8 ohms	£10.50	

FM Modules		
Mullard LF 1186 FM tuner (front end) with data 10.7MHz o/p	£4.85	
Mullard LF 1185 10.7MHz IF unit	£4.50	
Gorler Permeability FM tuner (front end) 10.7MHz o/p	£4.20	

FM and AM tuners and decoders		
FM 5231 (ru 216 volt FM tuner)	£7.95	
TU3 12 volt version (FM use with decoder)	£7.95	
SD49 12 Stereo Decoder for Tu 3 12 volt	£7.95	
SP62H 6 volt stereo FM tuner	£14.95	
A1007 9 volt MW-AM tuner	£4.80	
Sinclair 12/45 volt FM tuner stereo recorder for above	£7.45	
A1018 9 volt FM tuner in cabinet	£13.95	
A1005M (S) 9-12 volt stereo decoder FM for above	£7.50	
1062 12 volt stereo decoder. General purpose	£6.50	

Preamplifiers		
Sinclair Stereo 60 Preamplifier	£6.75	
E1300 CARTRIDGE/MIC INPUTS 9 volt	£2.85	
E1310 Stereo 3-30mV mag. carr. 9 volt	£4.75	
FF3 Stereo 3mV tape head 9 volt	£4.95	
3402 Stereo 5-20mV Mag. carr. mains	£5.95	
EQ25 Mono 3-25mV Tape/carr./flat 9 volt	£1.95	

Power Supplies—Mains input (*chassis-rest cased)		
470C 6.7/7.9V 300mA with adaptors	£2.25	
P500 9 volt 500mA	£3.20	
H244R 3/6/7.9 volt 400mA stabilised	£5.50	
*P1124 volt 1 amp £3.30, *P15 28 volt 1 amp	£4.80	
*P1080 12 volt 1A £4.70, *P1081 45 volt 0.9A	£7.80	
P12 4-12 volt 0.4-1 amp	£7.15	
SK01A 3/6/8/12 volt 1 amp stabilised	£12.75	
P1076 3/4/6/7.9/12 volt 1 amp	£4.20	
SK800A 1-15 volt 0-1A stabilised	£17.50	

1250-watt Light Dimmer

£3.50 pp 20p
MANUFACTURED BY ULTRA LTD.
Supplied with Plate, Knob and Instructions.

Denshi Board Kits

SR-2A 16 PROJECTS	£7.70
SR-3A 100	£14.95
ST-45 45	£10.50
ST-100 100	£13.20

Radionic Kits

X20 20 PROJECTS	£5.70
X40 40 PROJECTS	£12.75
X40A ADD-ON	£10.45

Turner Kits

10 in 1 10 PROJECTS	£6.80
50 in 1 50	£15.45
150 in 1 150	£23.65

SINCLAIR MODULES AND KITS



ST80 stereo pre-amplifier	£11.95
Audio filter unit	£5.95
240 15 watt amplifier	£5.45
250 25 watt amplifier	£6.95
725 power supplies for 1 or 2 240	£4.95
725 power supplies (IS TRS) for 1 or 2 240	£4.95
725 power supplies (IS TRS) for 1 or 2 250	£7.95
Transformer for P28	£7.95
FM tuner	£11.95
Stereo decoder	£7.95
All above post paid (GB only)	

Sinclair Project 80

PACKAGE DEALS (Carriage/packing 35p)

2 x 240, S780, P28	£25.80
2 x 250, S780, P28	£27.75
2 x 260, S780, P28 + Trans	£34.40

* Project 80 stereo pre-amplifier £8.75 post 20p
* Project 805 kit £19.95 post 25p
* Cambridge calculator kit £13.88 post 15p

EMI SPEAKERS

Special Purchase

13x8 chassis speakers (carr/packing 30p each or 50p pr)
* 150 TC 10 watt 8 ohm twin cone 2.20
* 450 10 watt 4, 8, 15 ohm with twin tweeters and crossover £3.85 each.
EW 15 watt 8 ohm with tweeter £5.25
350 20 watt 8, 15 ohm with tweeter £7.80 each. Polished wood cabinet £4.80 carr., etc. 35p each or 50p pair.



EXCLUSIVE 5 WATT IC AMPLIFIERS

Special purchase 5 watt output 8-16 ohm load. 30 volt max DC operation complete with data.
Price £1.50 each or 2 for £2.85.
Printed Circuit Panels 50p.

UHF TV TUNERS

625 line receiver UHF transistorised tuners FM, UK operation. Brand new. TYPE C variable tuning £2.50. TYPE B 4-button push-button (adjustable) £3.50. (Post/packing 25p each).

PA-DISCO-LIGHTING EQUIPMENT

Without doubt UK's best range of modular and complete equipment. Lighting, mixing, microphones, accessories, speakers, amplifiers, lenses, etc., etc. FREE stock lists (Ref. No. 18) on request CALL IN AND SEE FOR YOURSELF at Henry's Disco Centre. 309 Edgware Road, 01-723 6963.

CALCULATORS

Sinclair Cambridge Kit	£13.50
Sinclair Cambridge Kit (built)	£17.50
Sinclair memory	£22.50
Sinclair scientific	£26.95
Sinclair scientific kit	£18.50

L450 RECHARGEABLE BATTERY

2V 400ma/HR 50p pp 15p

PHILLIPS 12V FLOURESCENT INVERTER

For 8W Fluorescent tube. Supplied with instructions and tube.
£3.50 pp 30p

TEST EQUIPMENT MULTIMETERS

(carr/packing 35p)

U4324 20KΩV with case	£9.25
U435 20KΩV with steel case	£8.75
U4313 20KΩV with steel case	£12.50
U4324 20KΩV with case	£9.25
U435 20KΩV with steel case	£8.75



U4313 20KΩV with steel case	£12.50
U4327 20KΩV with case	£16.50
U4341 33KΩV plus transistor tester steel case	£10.50
U4323 20KΩV plus 1KHz 466KHz OSC with case	£7.70
IT-2 20KΩV slim type THL33D (L33DX) 2KΩV robust	£7.50

TP55N 20KΩV (Case £2.00)	£8.25
TPS10S 2KΩV	£6.25
TW20S 20KΩV	£10.00
TW50K 50KΩV	£11.25
EP10KN 10KΩV	£9.95

AF105 50KΩV De-Luxe (Case £1.90)	£12.50
S100TR 100KΩV plus transistor tester	£22.50
New Revolutionary Supertester 690R Multi-Tester	£18.50

440KHz 28MHz	£19.95
TE66 28 range valve voltmeter or TE20D RF generator	£22.50
120KHz-200KHz	£19.95
HM350N In circuit transistor tester	£19.50

-C3025 De-Luxe meter 1-300MHz	£6.95
-TT145 Compact transistor tester	£14.75
-G3-36 R-C osc. 20Hz-200KHz	£14.75
-C3042 SWR Meter	£5.75
-SE350A De-Luxe signal tracer	£12.95
-SE400 Mini-lab all in one tester	£15.50
C1-5 Scope 500,000Hz (carr £1.00)	£43.00
-S3045 5 CH F/A meter 1-300 MHz Resistance sub box	£2.40
Capacitor 20p	£2.10
2 amp variable transformers (carr £1)	£6.55
Radio activity counter 0-10r (carr £1)	£9.97
Mains unit for above (carr 50p)	£3.75

Marriot XRSP/17 1/2-track high	£2.50
Marriot XRSP/18 1/2-track med	£3.50
Marriot XRSP/36 1/2-track med	£5.00
Marriot XRSP/63 1/2-track high	£1.75
Marriot BX12E 343 1/2-track erase	.75
Marriot erase heads for XRSP 17/18/36 (KES11)	0.75
R/RP record/play 1/2-track	0.45
H/RP single-track/record/play	0.35
Bogen type UL290 erase	£1.50
Miniature stereo-cassette rec/play pp 15p	£2.25

AC103	£0.12
AC104	£0.12
AC128	£0.15
AC187	£0.21
AC177	£0.40
ACY17	£0.40
ACY39	£0.78
AD149	£0.50
AD151	£0.44
AD162	£0.44
AF117	£0.24
AF118	£0.37
AF139	£0.41
AF186	£0.48
AF239	£0.64
BA115	£0.33
BA115	£0.10
BAK13	£0.05
BC107	£0.14
BC109	£0.13
BC109	£0.14
BC109	£0.16
BC113	£0.15
BC147	£0.10
BC149	£0.10
BC149	£0.10
BC169	£0.15
BCY55	£0.24
BCY70	£0.18
BCV71	£0.22
BCV72	£0.22
BD131	£0.42
BF115	£0.42
BF194	£0.20
BF194	£0.10
BFX13	£0.26
BFY88	£0.24
BFY88	£0.24
BFY64	£0.20
BFY90	£0.81

ACT103	£0.12
ACT104	£0.12
ACT128	£0.15
ACT187	£0.21
ACT177	£0.40
ACTY17	£0.40
ACTY39	£0.78
AD149	£0.50
AD151	£0.44
AD162	£0.44
AF117	£0.24
AF118	£0.37
AF139	£0.41
AF186	£0.48
AF239	£0.64
BA115	£0.33
BA115	£0.10
BAK13	£0.05
BC107	£0.14
BC109	£0.13
BC109	£0.14
BC109	£0.16
BC113	£0.15
BC147	£0.10
BC149	£0.10
BC149	£0.10
BC169	£0.15
BCY55	£0.24
BCY70	£0.18
BCV71	£0.22
BCV72	£0.22
BD131	£0.42
BF115	£0.42
BF194	£0.20
BF194	£0.10
BFX13	£0.26
BFY88	£0.24
BFY88	£0.24
BFY64	£0.20
BFY90	£0.81

BLV36	£0.00
BU105	£0.13
BU105	£2.20
BY100	£0.27
BY127	£0.12
BY213	£0.42
C106D	£0.54
GET111	£0.72
GET115	£0.90
GET880	£0.80
LM309A	£2.90
MA121	£0.28
MJE340	£0.47
MJE520	£0.83
MJE308	£0.77
MJE2955	£1.27
MPE105	£0.36
NK7404	£0.66
OA5	£0.72
OA81	£0.18
OA201	£0.06
OA202	£0.06
OC28	£0.66
OC35	£0.55
OC36	£0.90
OC44	£0.20
OC77	£0.84
OC78	£0.84
OC81	£0.28
OC83	£0.27
OC140	£1.14
OC170	£0.18
OC200	£0.54
OC202	£0.90
OC271	£1.20
ORP12	£0.80
ORP60	£0.85
P346A	£0.81
TIL209	£0.20
TIP29A	£0.47
TIP30A	£0.81
TIP31A	£0.81
TIP41A	£0.74

TIP42A	£0.90
TIS100	£0.25
V405A	£0.22
ZTK108	£0.08
ZTK300	£0.13
ZTK300	£0.13
ZTK500	£0.18
ZTK500	£0.18
2N706	£0.12
2N930	£0.18
2N937	£0.45
2N1132	£0.24
2N1304	£0.28
2N1613	£0.21
2N1671	£1.20
2N2147	£0.78
2N2160	£0.78
2N2926	£0.12
2N3055	£0.45
2N3054	£0.48
2N3055	£0.45
2N3442	£1.39

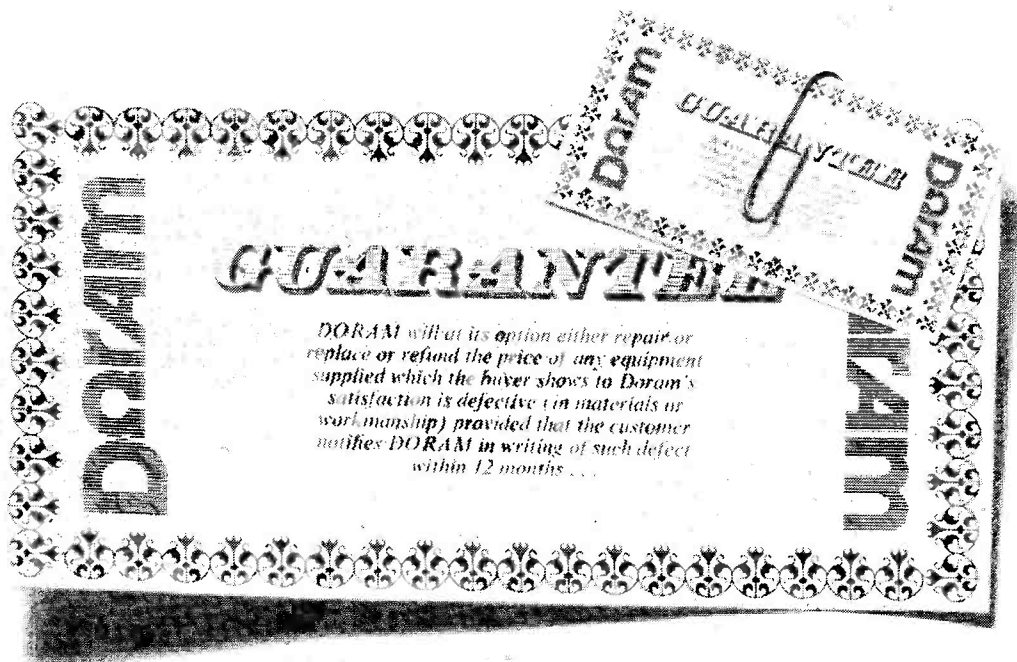

With the Doram catalogue, even the guarantee is guaranteed.

Doram is an entirely new way of buying electronic components.

So, to succeed, it's got to have something going for it, right?

We agree with you. And where Doram scores is in the security it gives the amateur buyer.

We'll give you peace of mind three ways.

No-quibble guarantee.

Firstly, we guarantee to replace any component which arrives faulty. Absolutely free of charge.

And secondly, our guarantee is backed by the biggest electronics distribution Group in Britain.

7-day service.

Thirdly, we guarantee you'll have your components within 7 days from our receipt of your orders.

We're so confident of our service that if we can't supply

the part you want within 7 days we'll give you an immediate refund.

So you'll never get a tedious wait.

You know just where you stand with Doram.

All branded goods.

All goods supplied by Doram are made by big-name manufacturers. And they're all to manufacturer's specifications. They're the best money can buy.

In fact, Doram gives the amateur the sort of service only professionals have enjoyed before.

Millions of components.

All in all, we're big enough to offer you stocks of millions of components, on over 4,000 product lines.

All you do is buy the Doram catalogue for 25p (that's a yearly reference book for the price of a pint of lager) and then take your pick from it.

Use the coupon now. Send today for the first-ever Doram catalogue. It can take a lot of worry out of amateur components buying.

And for 25p that's not bad, is it?

I ENCLOSE 25p* PLEASE SEND ME THE NEW DORAM CATALOGUE.

Name.....

Address.....

Doram Electronics Limited,
PO Box TR8,

Wellington Road, Industrial Estate,
Wellington Bridge, Leeds LS12 2UF.

*This will be refunded on orders of £5 (less V.A.T. or more) received by us before March 31st 1975.

DORAM

ETI 1 75