

# electronics today

INTERNATIONAL

20p

**UNDER 18?**

**10** 'LONGS' START-YOU-OFF KITS WORTH £30 EACH MUST BE WON BY YOUNG READERS

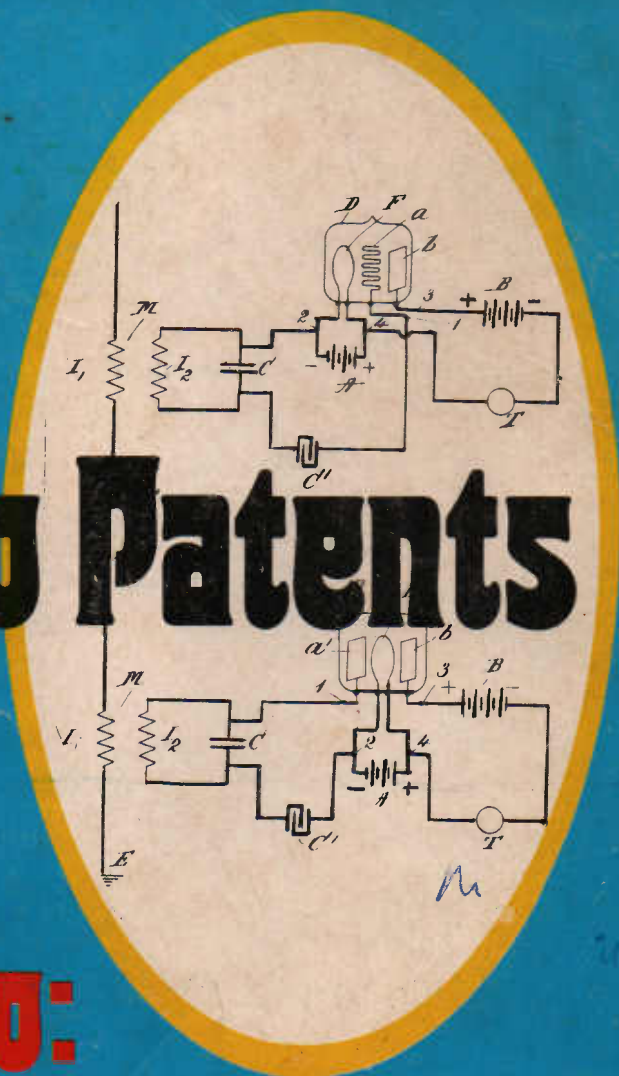
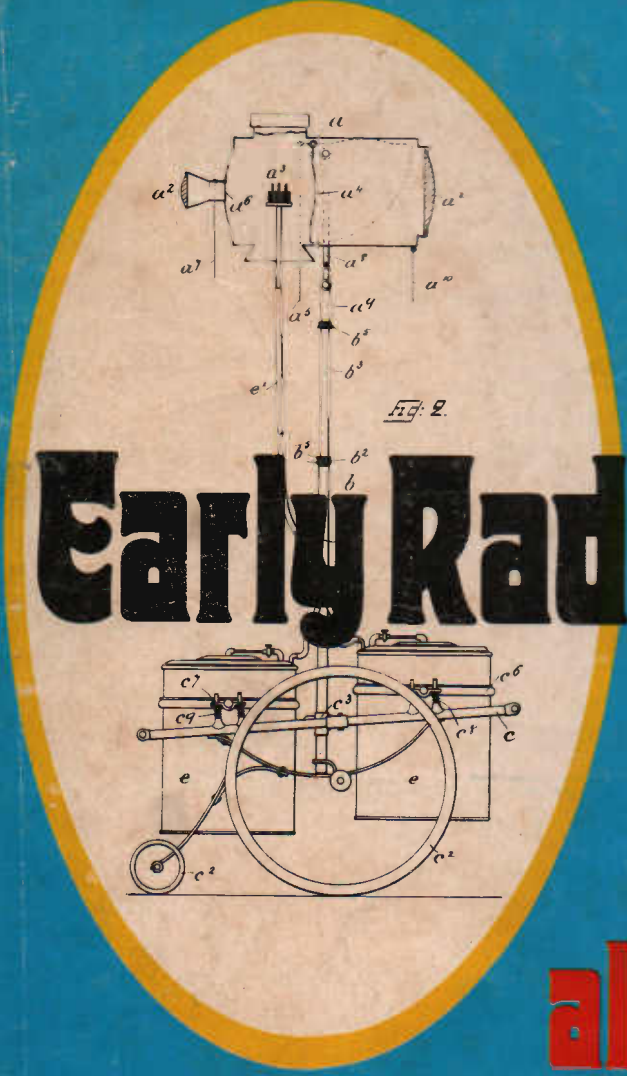

# Early Radio Patents

**also:**

4-CHANNEL PSYCHO-ACOUSTICS ■ HI-FI TESTS  
DISCRETE SQ DECODER ■ VHF KITS REVIEWED

... CONSTRUCTION ... COMMUNICATIONS ... DEVELOPMENTS



# Longs

## Longs Ltd

Hanworth Lane Trading Estate, Chertsey, Surrey. KT16 9LZ  
Telephone Chertsey (093 28) 61241 Telex 929811  
Registered Office Registered No. 68496 England

Halvor W. Moorshead  
Electronics Today International  
36 Ebury Street  
London  
SW1W 0LW

DEG/jc

Dear Sirs,

We are pleased to be associated with the competition in the June issue of your magazine.

Our 'start-you-off' tool kit has been put together with the same professional care that has made us a major supplier of specialised hand tool kits to industry everywhere.

Should any of your readers contact you for further information, we would be only too pleased to provide details of the wide range of products that we have available.

Yours faithfully

*David E. Green*

David E. Green  
Marketing Manager.



Precision Rubber Rollers and specialised Hand Tools for Industry  
Distributors of Office Machines, replacement parts and workshop equipment

# electronics today

INTERNATIONAL

JUNE 1974

Vol.3 No.6

## main features

EARLY RADIO PATENTS — PART ONE . . . . .	10
<i>A history of radio up until 1914</i>	
TRIBUTE TO MARCONI . . . . .	16
<i>Centenary year of Marconi's birth</i>	
FOUR-CHANNEL PSYCHO-ACOUSTICS . . . . .	18
<i>3 plus 1 may optimize 4-channel sound</i>	
AMBISONIC SOUND . . . . .	20
<i>3 plus 1 or just straight three!</i>	
LOCAL RADIO IN BRITAIN — PART TWO . . . . .	28
<i>Up-to-date- report on the new radio stations</i>	
CREATIVE AUDIO . . . . .	46
<i>Final part on how to create and produce your own sound</i>	
ELECTRONICS—ITS EASY . . . . .	52
<i>A new approach to basic electronics</i>	
THIN FILM LASER SWITCH . . . . .	59
<i>New switch modulated light in laser communications system</i>	

## projects

INTERNATIONAL MUSIC SYNTHESISER — PART SIX . . . . .	24
<i>Voltage controlled filter module cover 100: 1 range</i>	
DISCRETE SQ DECODER . . . . .	60
<i>Full decoder circuit not using an I.C.</i>	

## product tests

ACOUSTIC RESEARCH AR-7 LOUDSPEAKERS . . . . .	38
<i>Tiny speakers have exceptional performance for the price</i>	
TANBERG HULDRA 10 TUNER AMPLIFIER . . . . .	40
<i>A versatile unit - at a price</i>	
ARMSTRONG 621 AMPLIFIER . . . . .	42
<i>Good all-round performer</i>	
VHF/FM TUNER KITS . . . . .	44
<i>Tuners you build yourself</i>	

## news & information

EDITORIAL . . . . .	5
NEWS DIGEST . . . . .	6
READER QUESTIONNAIRE . . . . .	33
PREVIEW OF JULY'S ETI . . . . .	36
ELECTRONICS TOMORROW . . . . .	64
TECH-TIPS . . . . .	66
DX MONITOR . . . . .	68
WIN ONE OF TEN 'LONGS' START-YOU-OFF TOOLKITS . . . . .	35

Cover: Radio is generally considered to have had its birth around the turn of the Century. Our article starting on page 10 however gives details of the patents in this field which led up to the birth of radio and up until 1914.

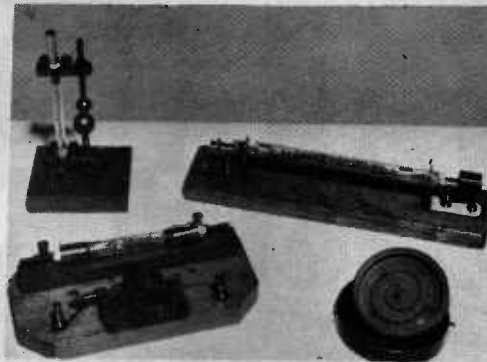

Page 10

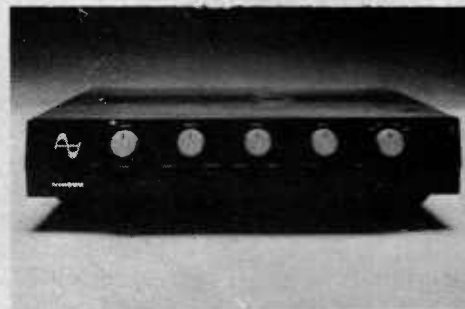

Page 42

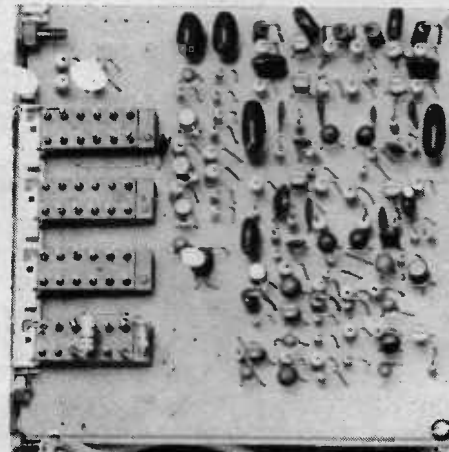

Page 60

EDITORIAL & ADVERTISEMENT OFFICES  
36 Ebury Street, London SW1W 0LW

Phone: 01-730 2139

Published by: MODERN MAGAZINES  
(HOLDINGS) LTD

Distributed by: Argus Press Ltd  
INTERNATIONAL ASSOCIATES: Modern  
Magazines (Holdings) Ltd, Ryrie House,  
15 Boundary Street, Rushcutters Bay 2011,  
Sydney, Australia. ACP, Room 401, 1501  
Broadway, New York, USA, Bancho  
Media Service, 15 Sanveicho, Shinjuku-Ku  
Tokyo, Japan.

Printed in England by: Alabaster Passmore  
& Sons Ltd, London & Maidstone

© Copyright Worldwide  
Subscription rates per year: Home—£3.60  
Overseas—£4.00

# ELECTROVALUE

Present

## ELECTRONIC COMPONENTS FOR THE WIDEST POSSIBLE RANGE OF APPLICATIONS

EVERYTHING BRAND NEW AND TO SPEC ★ GOOD DISCOUNTS ★ FREE POSTAGE (U.K.)

### ELECTROVALUE "SPECIALS"

Amongst an extensive range of specialised electronic components which we stock are

**Magneto Resistors**  
**Liquid Crystal Displays**  
**Hall Effect Probes**  
**Touch Switch I.C.s**  
**Magnetically operated I.C.s**  
**Photo-electronic devices**

### FERRITE COMPONENTS

Pot cores in a wide range of useful sizes  
Double Aperture Cores  
Ring Cores

### TRANSISTORS

Very wide range of types is shown together with grouped and tabulated specifications for each one. Outlines are illustrated and there is a full range of supporting hardware. Also near equivalent tables are given.

### I.C.s

Here too a wide range of TTL types are shown, together with linear and special purpose types. Over 60 circuit and connection diagrams as well as much other useful information is included.

### MINITRON DIGITAL INDICATORS

**3015F** Seven segment filament, compatible with standard logic modules. 0-9 and decimal point. 9mm characters in 15 lead DIL. **£1.20**  
**Suitable 8CD decoder driver 7447** **£1.15**  
**3015G** showing - or & 1 & dec pt. **£1.20**

### CAPACITORS POLYESTER C.280

Radial leads for P.C.B. mounting. Working voltage 250V d.c.  
0.01 0.015 0.022 0.033 0.047 ea 3p  
0.068 0.1 0.15 ea 4p  
0.22 5p 0.33 7p C 47 8p 0.68 11p 1.0 14p 1.5 21p  
2.2 24p

### TANTALUM BEAD

0.1 0.22 0.47 1.0mF 35V ea 13p  
2.2 16V 2.2 35V 4.7 16V 10 6.3V ea 13p  
4.7 35V 10 16V 22 6.3V ea 16p  
10 25V 22 16V 47 6.3V 100 3V ea 18p

### POLYCARBONATE

Type B32540 Working Voltage 250V  
Values in mF: 0.0047; 0.0068; 0.0082; 0.1; 0.012; 0.015; 0.018; 0.022; 0.027; 0.033; 0.039; 0.047; 0.056; 0.068; 0.082; 0.1 ea 4p

### SILVERED MICA

Working voltage 500V d.c.  
Values in pFs -2.2 to 820 in 32 stages ea 6p  
1000 1500 7p 1800 8p 2200 10p 2700 3600 12p  
4700 5000 15p 6800 20p 8200 10.000 25p

### CERAMIC DISC

1000pF 500 2000 500 5000 500 0.01mF 50 0.02mF 50  
0.1mF 3--each 2p. 0.05mF 50V--3p

### CERAMIC PLATE

In a range of 26 values from 22 to 6800pF 50V d.c. each 2p

### POTENTIOMETERS

**ROTARY CARBON TRACK.** Double wipers for good contact and long working life  
P 20 SINGLE linear 100ohms to 2.2megohms ea 14p  
P 20 SINGLE log. 4.7Kohms to 2.2megohms ea 14p  
JP 20 DUAL GANG lin. 4.7Kohms to 2.2megohms ea 48p  
JP 20 DUAL GANG log. 4.7Kohms to 2.2megohms ea 48p  
JP 20 DUAL GANG Log. anti-log 10K. 22K 47K 1 megohm only ea 48p  
JP 20 DUAL GANG anti-log 10K only ea 48p  
2A DP mains switch for any of above 14p extra.  
Decades of 10, 22 and 47 only available in ranges above.  
Skeleton Carbon Presets Type PR, horizontal or vertical 6p each.

### SLIDER

Linear or log 4.7K to 1 meg. in all popular values ea 30p  
Escutcheon plates black white or light grey ea 10p  
Control knobs blk wht red yel grn blue dk grey lt grey ea 7p

### JACKS AND PLUGS

**SOCKETS**  
2 circuit unswitched S1 SS 12p  
2 circuit 2 break contacts S1 BB 15p  
3 circuit unswitched (Not GPO) S3 SSS 17p  
3 circuit with 3 break contacts S3 BBB 20p  
2 circuit with chrome nut and black white red green or grey unswitched S5 S5 16p  
with 2 break contacts S5 BB 20p  
Miniature 3.5mm 2 circuit (black) 2 break contacts 9p

### PLUGS

2 circuit screened top entry P1 24p  
side entry SEP1 36p  
Line socket mono 231 40p  
Line socket stereo 244 45p  
3 circuit unswitched black grey white P4 46p  
2 circuit unswitched black white red black green grey P2 18p  
3 circuit screen top entry P3 53p  
side entry SEP3 56p  
Miniature 3.5mm 2 circuit screened P5 13p  
Miniature 3.5mm 2 circuit unswitched various colours P6 10p

### INSULATED SCREW TERMINALS

In moulded polypropylene with nickel plate on brass.  
With insulating set washers tag and nuts. 15A 250V  
In black brown red yellow green blue grey white Type  
TP 1 ea 14p

### DIN CONNECTORS

2 way loudspeaker Socket 10p Plug 12p  
3 way audio Socket 10p Plug 12p  
5 way audio 180 Socket 12p Plug 15p  
5 way audio 240 Socket 12p Plug 15p  
6 way audio Socket 13p Plug 15p

### RESISTORS

Code	Watts	Ohms	1 to 9	10 to 99	100 up
C 13	4.7	470K	13	11	0.9 nett
C 12	4.7	10M	13	11	0.9 nett
C 34	4.7	10M	15	12	0.9 nett
C 4	4.7	10M	3.2	2.5	1.9
MO 12	10	1M	4	3.3	2.3 nett
WW 1	0.22	39Ω	9	9	8
WW 3	1	10K	7	7	6
WW 7	1	10K	9	9	8 nett

**Codes:**  
C carbon film high stability low noise  
MO metal oxide Electrofil TR5 ultra low noise  
WW wire wound Plessey

**Values:** All E12 except C 1W C 1W and MO 1W  
E12: 10 12 15 18 22 27 33 39 47 56 68 82 and their decades  
E24 as E12 plus 11 13 16 20 24 30 36 43 51 62 75 91 and their decades

**Tolerances:**  
5% except WW 10% ±0.50Ω below 10Ω and MO 1W 2%  
Prices are in pence each for quantities of the same ohmic value and power rating. NOT mixed values.  
(Ignore fractions of one penny on total value of resistor order.) Prices for 100 up in units of 100 only.

### ZENER DIODES

Full range E24 values 400mW 2.7V to 33V 14p each  
1W: 6.8V to 82V 21p each; 1.5W: 4.7V to 75V 48p each  
Clip to increase 1.5W rating to 3 watts (type 266F) 5p.

### VEROBOARD

Copper clad 0.1 matrix—2.5 x 3.75 ins.—27p;  
3.75 x 3.75 ins.—30p; 2.5 x 5 ins.—30p; 3.75 x 5 ins.—53p; Copper clad 0.15in. matrix 2.5 x 3.75 ins.—20p; 3.75 x 3.75 ins.—30p; 2.5 x 5 ins.—36p; Vero spot face cutter (any matrix) 43p. 0.040 pins (for 0.1 matrix) per 100—35p; 0.052 pins (for 0.15 matrix) per 100—35p.

## ELECTROVALUE LTD

28, ST. JUDES ROAD, ENGLEFIELD GREEN, EGHAM, SURREY TW20 0HB

Telephone Egham 3603. Telex 264475

Shop hours: 9-5.30 daily, 9-1 pm Sats.

NORTHERN BRANCH: 680, Burnage Lane, Burnage, Manchester M19 1NA

Telephone (061) 432 4945

Shop hours: Daily 9-1 and 2-5.30pm; 9-1pm Sats.

U.S.A. CUSTOMERS are invited to contact ELECTROVALUE AMERICA, P.O. Box 27, Swarthmore PA 19081.

### CATALOGUE 7

#### SECOND PRINTING

112 pages, thousands of items, illustrations, diagrams, much useful technical information. The 2nd printing of this catalogue has been updated as much as possible on prices. It still costs only 25p post free and still includes a refund voucher for 25p for spending when ordering goods list value £5 or more.

### COVERS & HEATSINKS

Many types including  
T03 transistor cover. clip on 7p  
HEATSINK  
Type 6W Extruded aluminium 1" C W undrilled 60p  
drilled 78p

### KNOBBS

All for 1" shafts in a very wide range of types from utilitarian to modern solid aluminium

### S-DEC

Unsurpassed for "breadboard work" can be used indefinitely without deterioration. Components just push into plug holes and connect automatically. Slot for control panel. 70 holes **£1.98**

### T-DEC

For more advanced work with 208 contacts in 38 rows. Will take one 16 lead carrier **£3.63**. (Carriers supplied separately.)

### DESOLDER BRAID

6ft strip 66p  
25mtr reel **£7.15**

### ELECTROLYTIC CAPACITORS

Axial Lead	3V	6.3V	10V	16V	25V	40V	63V	100V
0.47								
1.0						11p		8p
2.2							8p	8p
4.7							8p	8p
10				11p			8p	8p
22							8p	8p
47	8p		9p	8p	8p	8p	8p	13p
100	9p	8p	8p	8p	9p	10p	12p	19p
220	8p	8p	9p	10p	10p	11p	17p	28p
470	9p	10p	10p	11p	13p	17p	24p	45p
1000	11p	13p	13p	17p	20p	25p	41p	
2200	15p	18p	23p	26p	37p	41p		
4700	26p	30p	39p	44p	58p			
10000	42p	46p						

## This is EV Service

GIRO ACCOUNT No.38/671/4002

### DISCOUNTS

Available on all items except those shown with NETT PRICES 10% on orders from £5 to £14.99 15% on orders £15 and over

### FREE PACKING AND POSTAGE

in U.K. for pre-paid mail orders. For mail orders for £2 list value and under there is an additional handling charge of 10p. Overseas orders—carriage charged at cost.

### GUARANTEE OF QUALITY

All goods are sold on the understanding that they conform to manufacturers' specifications and satisfaction is guaranteed as such—no rejects seconds or sub-standard merchandise is offered for sale.

Prices quoted do not include V.A.T. for which 10% must be added to total net value of order. Every effort is made to ensure the correctness of information and prices in this advertisement at time of going to press. Prices subject to alteration without notice.

Every effort is made to ensure the correctness of information and prices in this advertisement at time of going to press. All postal communications mail orders etc. to Head Office at Egham address Dept EIT6 S.A.E. with enquiries requiring answers.

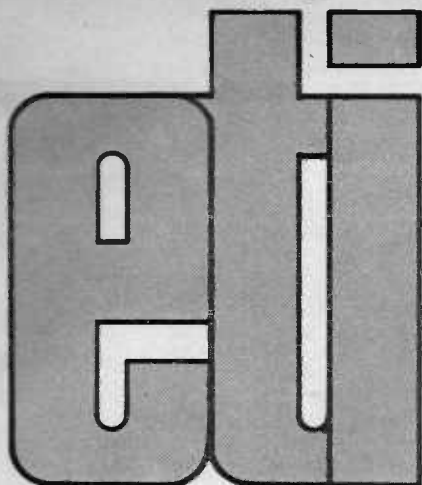

## FOUR-CHANNEL FOLLIES

**HALVOR MOORSHEAD**  
*Editor*

**ROBERT EVANS**  
*Advertisement Manager*

**HELEN GIMPLE**  
*Editorial Assistant*

**JEAN BELL**  
*Production Assistant*

Electronics Today International  
36 Ebury Street  
London SW1W 0LW  
01-730 2139

### International Editions

**COLLYN RIVERS**  
*Editorial Director*

#### Australia

**BRIAN CHAPMAN**  
*Technical Editor*

**BARRY WILKINSON**  
*Engineering Manager*

Electronics Today International  
Ryrie House, 15 Boundary Street  
Rushcutters Bay 2011  
Sydney, Australia

#### France

**DENIS JACOB**  
*Editor-in-chief*

**CHRISTIAN DARTEVELLE**  
*Editor*

Electronique Pour Vous  
International  
17 Rue de Buci  
Paris, France

**EUROPEAN NEWS BUREAU**  
Harold Dvoretzky, Manager  
107 Fleet Street  
London, E.C.4, U.K.

DESPITE extensive promotion, four-channel sound has not been the overwhelming success that many expected.

Obviously this situation is partially due to uncertainty as to which of the competing systems will be accepted as the industry standard.

But apart from this there are many hi-fi enthusiasts who feel that four-channel sound, in its present form, does not add a great deal to their listening pleasure.

In this issue, two of our contributors — each highly respected in his own field — discuss why this is so.

Interestingly, both agree that much of the problem is due to the recording industry's present practice of re-arranging their existing four-channel master tapes — that just happened to be their studio standard — and marketing the result as four-channel sound.

Even worse has been their attempt to justify their musical gymnastics by describing the 'new musical experience' as part of the course of the evolution of music. A truly nonsensical act.

We believe that surround-sound is here to stay. It may well be achieved within the format of one of the presently competing systems. But if it is, there will probably be major changes in the manner in which recordings are made.

It is reliably reported that several companies are actively developing totally new recording techniques that take full advantage of the considerable but currently unrealised potential of both matrix and discrete equipment. Some of these developments may well be revealed later this year.

In the meantime it is ironic that by far the most convincing demonstration of four-channel sound we have ever heard was via conventional stereo headphones reproducing Sennheiser's extraordinary binaural record.

The experience was quite uncanny — it being possible subjectively to locate sound sources with apparent precision, not only front and rear — but within the vertical plane as well.

Sennheiser's binaural record is intended solely for reproduction through headphones. However Professor Sennheiser told us that his company's experiments may eventually lead to a whole new concept of equipment and recording techniques.

It seems as if 1974 will be an interesting year!

# electronics today international

# news digest

## NEW 'SCOPES

The competition at the low-price end of the 'scope market is hotting up, the latest entrant to the field is Advance Electronics who have introduced two new models.

Carrying a price of £107 plus VAT is the single-beamed OS140, while at £125 plus VAT is the OS240, a dual-beam unit.

At the recent launching of these oscilloscopes, Advance said that they thought that the greatest market in the U.K. was for technical colleges whilst overseas the largest market is in schools. ETI put it to Advance that this price was still rather high to capture the mass market of schools and hobbyists. The reply was that whilst it was perfectly possible to produce a cheaper scope, the performance would be considerably poorer. The company's aim is to persuade people to use better 'scopes.

Apart from the electronic performance of both units, the most impressive aspect is the production engineering. The circuitry is all contained on three p.c. boards which themselves interconnect, eliminating cable looms and reducing point-to-point wiring to practically nothing.

The p.c. boards are made using a computer to insert the majority of the components. The construction also means that the interior is uncluttered, allowing for easy servicing.

Surprisingly only one i.c. is used in the circuit; the reason given for this was that off-the-shelf linear i.c.'s do not lend themselves to the circuit. A photocoupler is used in the bright-up circuit

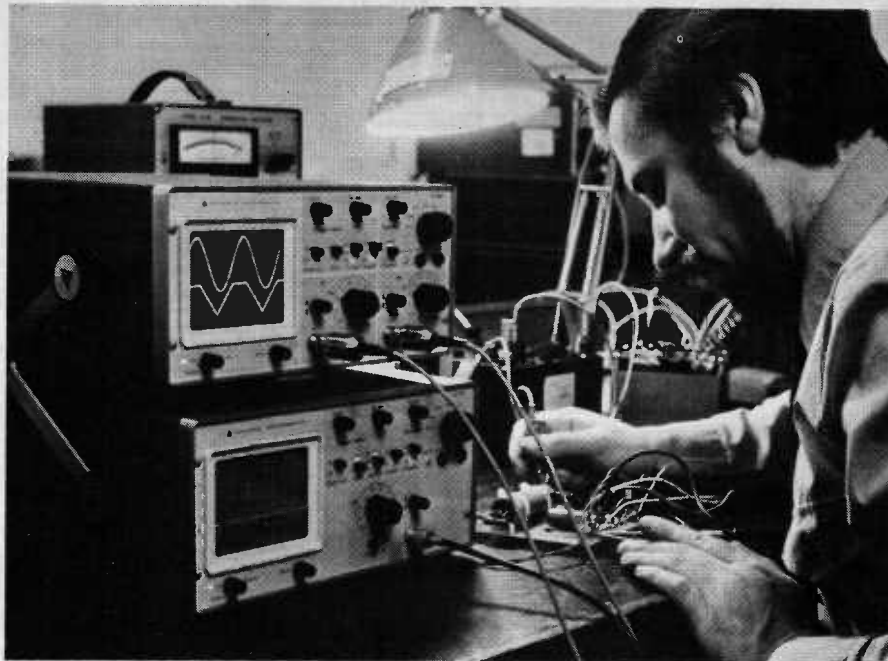

to bridge the 1.5kV potential between cathode and ground and control the grid with respect to the cathode. The power supply is fully stabilised.

Both units have a 10MHz bandwidth and a maximum sensitivity of 5mV per division (0.8cm instead of the usual 1cm). Timebase speeds are 200nS to greater than one second per division. The tube is flat-faced, 10cm across.

Full trigger level control is available, even when using the 'bright-line' facility in the absence of an input. The source can be internal or external on the OS140 and from Y<sub>1</sub>, Y<sub>2</sub> channels or external on the OS240. Slope can be

positive or negative, and coupling may be a.c., a.c. fast or t.v. frame.

The OS240 has an X-Y mode using the Y<sub>1</sub> channel for X deflection and the Y<sub>2</sub> channel for Y deflection. In dual-trace operation, chopped or alternate modes can be automatically selected on the timebase switch.

Both instruments measure 132 x 270 x 317mm and weigh approximately 5kg. Optional accessories include passive probe kits offering X1 or X10 attenuation.

*Advance Electronics Limited,  
Instrument Division, Roebuck Road,  
Hainault, Essex.*

## VIDEO TAPE RECORDERS LIKELY TO PACE ELECTRONICS INDUSTRY GROWTH

Video tape recorders and video disc systems will be this decade's hottest selling consumer electronics items in the U.S.A., according to Chase Econometric Associates in an analysis of the consumer electronics industry.

In the report prepared for industrial clients, the Chase Manhattan Bank subsidiary forecasted that the industry's sales will increase at a compound annual rate of 6.2% during the 1972 to 1982 period, the major growth resulting from sales of video tape recorders and video disc systems.

At the same time, the report said, "the television set will become a home communications, information and security centre.

*"The cable run into each subscriber's*

*home will transmit from the viewer as well as to him in the future. Broader informational services based on two-way communications . . . will include printed facsimile transmission of newspapers, 'mail-order' facilities, and reference services, for example, thus making the television set a communications necessity."*

*By 1982 "there will be 14.5 million video recorders in U.S. homes and over 1.5 million in use by the institutional sector."*

The study identified three definitive phases in the development of the video market, with the introductory or start-up phase concluding in 1974. The next stage, from 1975 to 1977, will see sales to the home and institutional markets grow rapidly, with home purchases of video disc systems peaking in 1977 at \$1.46 billion in hardware sales. This phase will also see a decline in the average

unit price in addition to a shift towards lower-priced systems.

The final stage, to 1982, will be marked by slower unit growth and slackening dollar sales for both sectors. Software sales, considered of vital importance to the whole video recorder industry, will exceed hardware sales in both sectors.

"Within the audio sector of the consumer electronics industry," Chase Econometrics predicted that from 1972 to 1982 "the fastest growing product line will be tape equipment, which includes tape recorders, players and accessories."

The Chase subsidiary predicted growing consumer sophistication resulting in the gradual replacement of stereophonic sound and quadrasonic sound products. By 1982, four channel phonographs, components and tape equipment will dominate the audio market, Chase Econometrics said.

## 20 YEARS OF COLOUR TV



Twenty years ago last March, colour TV started in the USA, giving them a considerable lead over the rest of the world. The early days were tough and it was only the determination of RCA and their associated TV network NBC that kept going.

The picture shows RCA's first

receiver a 15" round tube set using 37 valves, next to one of their latest receiver, a 15" diagonal set which is now all solid-state.

The RCA engineer in the picture is John Konkel who has been associated with both models.

## INFRARED BEAM LINKS COMPUTERS

The US Naval Weapons Laboratory in Dahlgren, Virginia has solved the problem of transmitting computer data across an intervening airstrip, by using an infrared data transmission system to send data directly over the airstrip which lies between two computer installations.

The airstrip barrier was one part of a data transmission problem that also included requirement for a data link capable of moving 40.8 kilobits per second for effective high-speed, computer-to-computer communication.

Both problems were solved by roof-top installations of two Optran optical data-transmission links. These Optrans are now speeding a stream of

data between a Control Data Corp. 6700 super-scale computer system and a CDC 1700 system, both housed in buildings flanking the airstrip.

## JAPAN'S SUNSHINE PROGRAMME

Goals for Japan's "sunshine programme", a national project to bring new energy sources into practical, large-scale use have now been made specific.

Among targets for 1985 recommended by the Industrial Technology Council (an advisory group to the Ministry of International Trade and Industry) are 100,000-kW generating stations powered by solar energy and geothermal heat, production of one million cubic metres a day of synthetic natural gas, and new methods of producing hydrogen.

## COLOUR TV TUBES

Two new ranges of colour television tubes developed by Toshiba - which claim to offer reduced accessory costs and greater efficiency in receiver production - are now being marketed in Britain. Featuring vertical stripe screens, they are the SSI 90° tubes and the RIS wide angle 110°.

The SSI 90° tubes, designed for use in smaller screen and portable TV sets, offer simplified dynamic convergence, a slotted mask and an in-line gun. Features claimed are better focus with less spherical aberration; better convergence quality with adjustment requiring only two controls; lower deflection power (70% of that of conventional 90°); shorter tube length; constant white balance independent of brightness changes; and high brightness and better contrast.

The 110° RIS colour tubes, with rectangular cone, in-line gun and slotted mask, offer highly improved convergence and electron beam landing - ideally suited for the new generation of wide-angle colour TV receivers.

Features of the RIS tubes include; lower deflection power by the rectangular cone with semi-toroidal deflection yoke; excellent convergence and beam landing with simplified adjustment by the vertical stripe screen; better focus and high voltage stability provided by the large diameter electron gun; short tube length; and high brightness and better contrast.

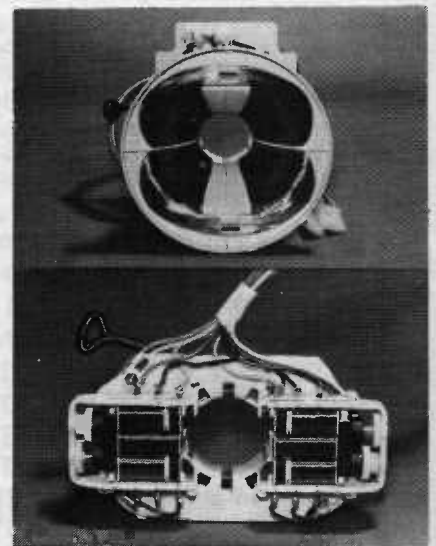

Compatible neck components for Toshiba's new colour TV tubes are manufactured - to Toshiba specification - and marketed by Denki Onkyo Co. of Tokyo. Pictured here are (TOP) a deflection yoke and (BOTTOM) a convergence yoke for the Toshiba RIS 110° wide-angle tubes.

# NEW KITS & NEW PRICES

Due to the fantastic demand for our kits, we are able to bring down our retail prices on the 5314-Jumbo and the 5316 kits. We are also pleased to announce the first kit in our MHI series, the MHI-5314/C. This simple project is the lowest cost digital clock kit ever offered, at only £16 for the basic kit. Send us an order and we will send you the kit, send us an s.a.e. and we'll send you further information, phone us and chat about it, you see —  
**BYWOOD HAS TIME FOR YOU!**

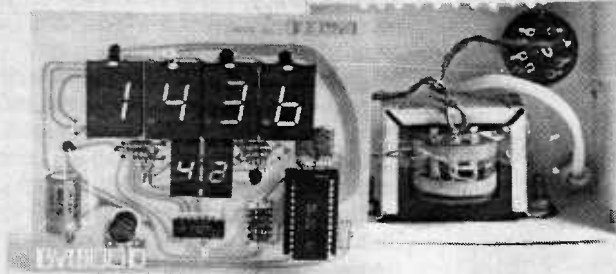

## 5314 - JUMBO EVALUATION KIT

Our most popular kit so far is our 5314 - JUMBO Evaluation Kit, due to the large orders that we have received from amateurs and from industrial users we are able to offer this kit at a new price of £22.80.

The MM5314 is a 24-pin LSI chip containing all the logic necessary for a 12/24 hour, 4/6 digit, 50/60Hz digital clock. The new 0.6" LED display from Litronix (the Jumbo) is readable from distances of over 25ft. We supply MM5314, socket, 4 Jumbo's, 2 DL707 0.3" digits, CA3081 driver and a 5" x 4" fibreglass PCB. You supply 16 resistors, 3 capacitors, 2 diodes, 6 transistors, transformer and switch.

**KIT PRICE: £22.80**

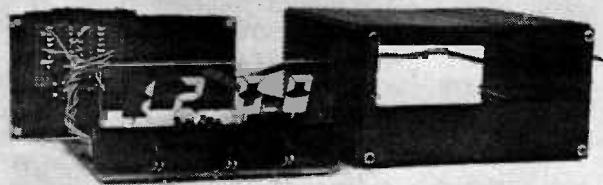

## 5316 - LC EVALUATION KIT

The MM5316 is a 40-pin LSI chip containing all the logic necessary for a four digit alarm clock. The chip also has sleep and snooze features with alternative display of minutes and seconds, and reset to zero facilities. The TA8055 is a four digit liquid crystal display unit with 0.6" digits. The MM5316 chip has the necessary a.c. drive for the LC display unit and thus probably the cheapest way of running any LC demonstration unit. We supply MM5316, socket, TA8055 and connector.

**KIT PRICE: £30.00**

## NEW CLOCK KIT

### MHI - 5314/C:

The MHI - 5314/C is a low cost basic kit for a four or six digit electronic digital clock. The chip offers the option of 12/24 hour operation but as the European standard is becoming 24 hour we have designed the PCB to use this option, a simple solder break on the board gives the 12 hour option. The outputs from the PCB will drive four or six LED digits of the DL707 and DL747 types.

If four digits is all that is required, then a simple modification gives the option of minutes and seconds display in place of hours and minutes to enable accurate time setting. Our experience in digital kits has allowed us to produce a simple PCB which means that virtually anybody that can use a soldering iron can build this kit. Please note that the kit does not include a socket for the main I.C. for cost reasons, this is not part of the normal MHI policy.

The MHI - 5314/C kit contains MM5314 clock chip, CA3081 driver and PCB.

**MHI - D707/4:** This kit contains a PCB and four DL707 0.3" LED digits. The digits are presented in a multiplexed format suitable for the MM5314.

**MHI - D707/6:** As above but with six DL707 displays.

**MHI - D747/4:** As MHI - D707/4 but using the larger DL747 0.6" digit display.

**MHI - D747/6:** As above but with six DL747 displays.

**Prices:**

<b>MHI - 5314/C + MHI - D707/4</b>	<b>£16.00</b>
<b>MHI - 5314/C + MHI - D707/6</b>	<b>£19.80</b>
<b>MHI - 5314/C + MHI - D747/4</b>	<b>£18.50</b>
<b>MHI - 5314/C + MHI - D747/6</b>	<b>£23.75</b>

Samos case suitable for the above £1.00, 24-pin socket £1.00. As these units are ideally suitable for teaching and many similar applications, quantity discounts are available.

**CLOCK DATA SHEETS** — SAE. **ADVICE** — PHONE 0442-62757

POST & PACKING — 10p. OVERSEAS (AIRMAIL) 50p. VAT — ALL PRICES EXCLUDE VAT.  
 PAYMENT C.W.O. or ACCOUNT. ACCESS. ORDERS & PAYMENT BY PHONE ACCEPTED.  
 QUANTITY DISCOUNTS ON MOST ITEMS — STATE REQUIREMENTS FOR QUOTATION.

# BYWOOD

**BYWOOD ELECTRONICS**  
 181 EBBERNS ROAD  
 HEMEL HEMPSTEAD  
 HERTS. TEL. 0442-62757.  
 24 HOUR ANSAPHONE ON-LINE.



## DISCOUNT TRADING DOMINATES THE AUDIO BUSINESS

Discount traders continue to make an increasing share of hi-fi sales. They accounted for over 27% of all audio business in Britain last year, and their share of the quality Hi-Fi end of the market is as high as 40%.

These are among the conclusions of a new report, "Audio Equipment Distribution", part of the Finresearch Audio Industry Service. The report, available from Ovum at £30, shows clearly that the multiple chains and the discount houses have been growing fastest in the audio boom, while the independent retailers are getting a much smaller share of the new business and have to accept decreasing profit margins.

Biggest by far of the discounters is Comet Radiovision Services, with audio sales worth an estimated £25 million in 1973. "Comet dominates the scene, arousing considerable fear and consequent animosity in other sectors of the trade", notes the report. (Comet's total sales have soared from £2.8 million in 1969-70 to £44 million in 1972-3).

However, this booming growth in sales has not yet been fully reflected in profitability except in the case of Comet and other big, but less specialised, discount houses such as the Trident chain operated by Telefusion. Smaller specialised audio discounters such as F Cave, now part of the Audiotronic group, and Global Audio have been showing margins of less than 1% on sales compared with 5% or more achieved by Comet.

Manufacturers as well as retailers are becoming increasingly concerned about discounting. Reasons are that it weakens the position of the traditional retail outlets, it can harm the brand image, and it presents the danger that a manufacturer may become too dependent on a single outlet.

## FAIRCHILD TO MAKE CONSUMER PRODUCTS

The USA's Fairchild group are actively planning to enter the consumer products market, according to a usually reliable source.

Fairchild's first products are believed to be a low-end of the market one-chip hand-held calculator with 8-12 digits. However several industry commentators query Fairchild's ability to produce the necessary MOS chips, quoting Lester Hogan's (president of Fairchild) own description of his company's performance in the MOS field as 'disappointing'.

## LIGHT TALK

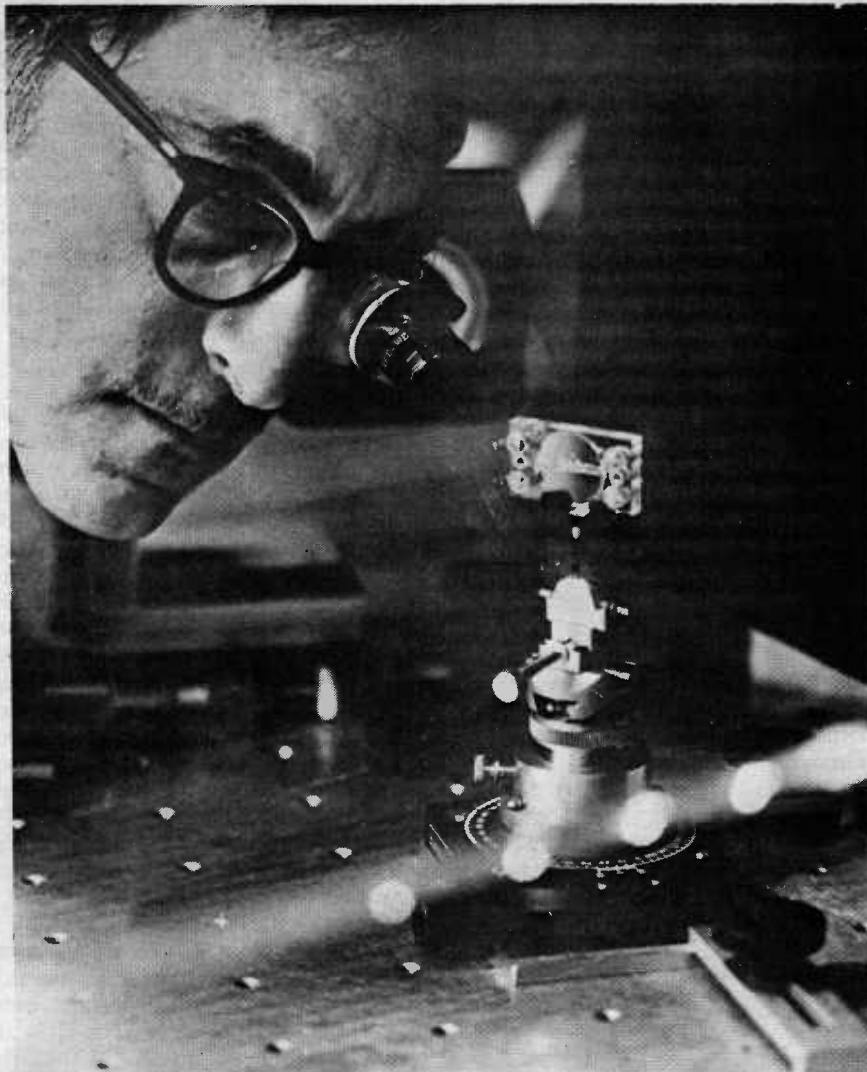

As many as 25,000 persons may someday talk simultaneously over a single laser beam in a telephone circuit employing a new electro-optic modulator similar to the experimental unit being examined by Dr. Jacob M. Hammer of RCA Laboratories in Princeton, N.J., U.S.A.

The new RCA device can also modulate a laser beam to carry up to 20 TV programmes at one time. It is the first electro-optic modulator truly compatible with integrated circuits. RCA scientists hope to employ the

modulator in a "communications system of the future" using glass fibres to carry the modulated laser beam. Such a system potentially offers low cost and high capacity and provides considerable immunity to present-day wiretapping technologies and to natural and man-made static or noise.

The bright light spots in the picture result from the transverse diffraction of a laser beam that is used to check the basic dimensions of the modulator structure.

## CERAMIC THERMOELECTRIC MODULE

Cambion have introduced a new competitively priced thermoelectric module with the capability of heating or cooling.

The new ceramic module is suitable for use in water coolers, small refrigerators, hot and cold temperature

sources and in many other applications.

Unique ceramic construction of the module combined with metallised plates affords high thermal transfer with maximum electrical isolation.

Operating characteristics include a maximum current of 8.5A, a nominal voltage of 3.5V d.c. and a maximum operating temperature of 100°C.

Cambion Electronic Products Limited, Castleton, Nr. Sheffield.

The development of telecommunications and radio was not an overnight process. The progress can be traced through the patents that have been filed. This article deals with the very early days while Part Two in the next issue takes us up to 1914.

# EARLY RADIO

THOMAS ALVA EDISON, whilst experimenting with electric lamps, discovered that *"if a conducting substance is interposed anywhere in the vacuous space within the globe of an incandescent electric lamp, and the said conducting substance is connected outside of the lamp with one terminal, preferably the positive one, of the incandescent conductor, a portion of the current will, when the lamp is in operation, pass through the shunt-circuit thus formed, which shunt-circuit includes a portion of the vacuous space within the lamp"*.

Edison's inventive genius was matched by a strong commercial instinct. Accordingly, and as he had done on many occasions before with other inventions, he took the necessary steps to obtain Patent protection for what came to be known as the 'Edison Effect'. Because he did this, a contemporary technical description of his discovery, which may be considered to be the practical starting point of modern electronics, was made available for public inspection. This description, which includes the passage quoted above, appears in the specification of U.S. Patent No. 307031, dated 21st October, 1884.

The fact that Patent specifications are publicly available is perhaps not as widely appreciated as it should be, and indeed the tales of Patents being used by manufacturers to conceal inventions (such as razor blades that last forever and cars that run on water) never seem to lose their popularity. This concept of public availability is, however, most definitely an important feature of the World's Patent systems and has been an important feature for a very long time.

In Britain, Patent specifications were introduced as an essential feature of the already existing Patent system in 1716. Before that, as demonstrated by official Patent Office records which go back to 1617, and other records which go back even further, at least to the 15th century, Patents were granted but little more than titles were entered on the records.

It will, therefore, be appreciated that Patent specifications constitute both a valuable source of technical information and also an important link with the past. And their relevance is by no means limited to the works of especially Patent conscious inventors such as Edison. Indeed there are few famous names that do

not appear in Patent records. Thus, for example, the development of telecommunications can be traced through the Patents of men such as Cooke and Wheatstone, Marconi, Edison, Fleming, de Forest, to say nothing of the host of less well known and unknown inventors that optimistically sought protection for their ideas.

## EARLY TELEGRAPHY

At the close of the 18th century, communication systems using optical signalling techniques were in widespread use, but there were already signs of things to come. In 1747, for example, a certain Dr. Watson transmitted static electricity through 2800ft wire and 8000ft water thereby demonstrating both long distance transmission of electric signals and also the use of an 'earth' conductor. Six years later, in the 'Scots Magazine', Charles Morrison proposed an electric signalling system using 26 wires, one for each letter of the alphabet. An electrostatic generator was used as the transmitter and 26 spark gaps as the receiver.

At the start of the 19th century a more convenient source of electrical energy than the electrostatic generator was developed - Volta's electric battery, and inventors were not slow to recognise its advantages. Thus, in 1809 a 26-line galvanic telegraph was

devised using the electrolytic action of the electric current for detection purposes. A major problem however was still that of finding a suitable detector, for the electrolytic detector was little more reliable than the spark gaps and suspended pith balls used with the electrostatic systems.

A satisfactory solution to this problem was finally found in the 1830's inspiration being derived from Oersted's discovery in 1807 that a current carrying wire was capable of deflecting a nearby compass needle. The use of a magnetic needle type detector was proposed by Schilling in 1832 for use in a 5-wire system, and single wire systems were proposed the following year by Schilling and also Gauss and Weber. Up to this time there were few British Patents in this field, perhaps partly due to the fact that until the latter part of the 19th century Patenting was a dauntingly complex and expensive procedure (due to the large number of irrelevant officials, including someone called the *Deputy Chaff-Wax*, who had to be approached and amply paid), and perhaps partly due to the fact that much of the work done had been by way of pure experiment rather than as a commercial enterprise.

This situation changed most definitely in 1837. That year Cooke and Wheatstone obtained Patent No. 7390 for *"improvements in giving*

*Schillings magnetic needle detector (All photographs in this article by courtesy of the Science Museum where all the items illustrated can be seen).*



# PATENTS

signals and sounding alarms in distant places by means of electric currents transmitted through metallic circuits". In the specification of their Patent they described a "five needle telegraph" which worked "by the simultaneous deflection of two of the magnetic needles whose coils are included in the circuit, the required letter being found on a dial at the point to which they converge". This proved to be a practical proposition and was put into use on the Great Western Railway almost immediately.

At about the same time, in the USA, Morse, deriving inspiration not from Oersted's discovery but rather from Sturgeon's development in 1825 of the electromagnet, was working on a telegraph system using a single wire and an electromagnetically operated 'tapper' as the receiver.

Morse also used the electromagnet to enable signals to be transmitted over very long distances from relay

## PART ONE

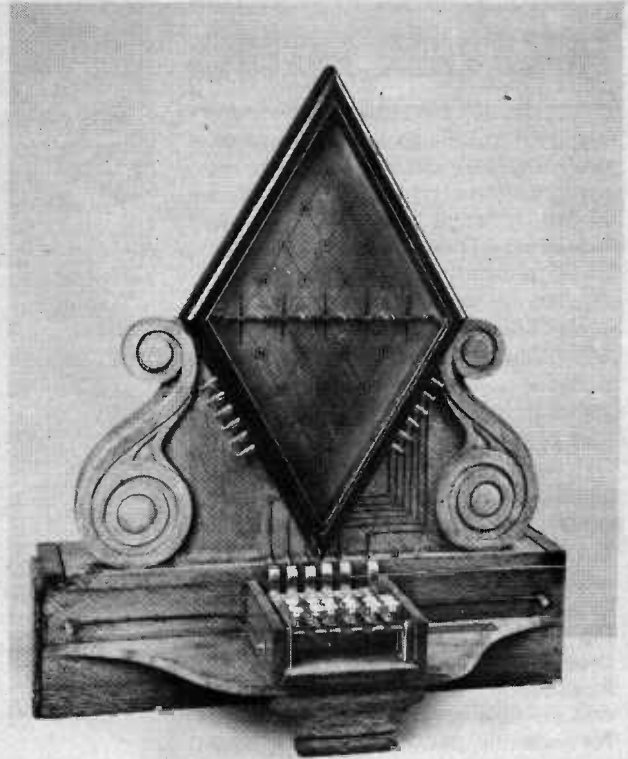

Cooke and Wheatstone's 5-needle telegraph, Patent No. 7390.

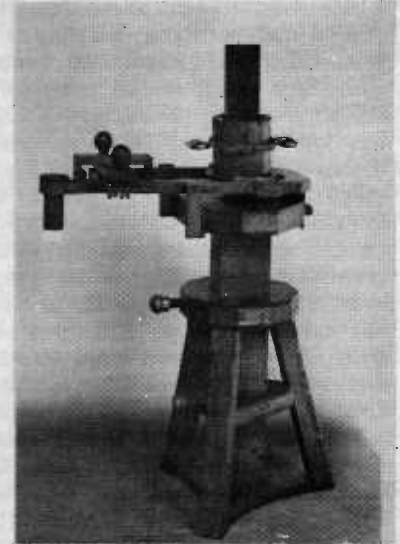
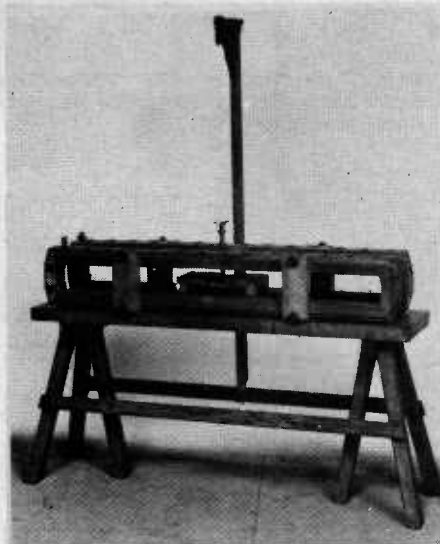

Various items of the Gauss and Weber Telegraph.

station to relay station. Cooke and Wheatstone also described the use of a 'relay' in their original Patent. Their relay was for use in sounding an alarm bell at the receiving station and comprised a wire on a magnetic needle which dipped into mercury on deflection of the needle and thereby completed a local alarm circuit.

## SPANNING THE OCEANS BY WIRE

Having solved the problem of transmitting signals overland, the next goal was to cross the seas. In 1845, in British Patent 10939, the Patentee,

J. Brett, described an improved form of printing telegraph and referred to the possibility of using it with an 'Oceanic Line'. Five years later concessions were granted to certain Messrs. Brett for a cross-channel telegraph and the line was finally laid in 1851. A transatlantic cable came into use in 1858. Two major problems arose in connection with underwater cables: that of satisfactorily insulating the conductors from each other, and that of attaining high transmission speeds despite the retarding effect of the interconductor capacitance.

One suggestion for overcoming

these problems appeared in British Patent No. 1909 of 1853, involving the use of two separate conductors contained not in the same cable but separated by an appropriate distance and totally uninsulated. In the case of a trans-atlantic link the appropriate separation, advised the Patentee, could be achieved by running one wire from Land's End, in the South of England, and the other from any convenient point on the Scottish coast. The problems were in the end solved in a more mundane manner, by the improvement of insulation techniques and materials and by the invention by

# EARLY RADIO PATENTS

W. Thomson (later Lord Kelvin) of a particularly sensitive receiver, the mirror galvanometer, which is described in British Patent 329 of 1858. Later, in 1867, Thomson Patented (No. 2147) a variation of his mirror galvanometer, a sensitive ink marking receiver known as the syphon recorder, which became widely accepted.

## DEVELOPMENT OF 'WIRELESS' SYSTEMS

The electric telegraph was clearly one of the wonders of the 19th century, but it had its shortcomings. Quite apart from all the problems involved in manufacturing, insulating and laying miles of cable, there was the problem of providing a reliable link in situations in which it was obviously not possible to use a fixed cable, as for example between ships, between shore and lighthouse and between station and train. Patent No. 10929 of 1895 represented one attempt to solve the problem of ship-to-ship communications. Each ship was provided with conductors around its hull and all that was required to link two ships was to manoeuvre the ships so as to bring their conductors into contact with each other! The need for a system involving no contact, a 'wireless' system, was clearly apparent: indeed this was by no means a new idea. In 1788, for example, in the fictional 'Voyage du Jeune Anarchis' the author, Abbé Barthelemy suggested a system using "synthetic magnets" of sufficient power as to transmit their influence to each other over great distances. On a more practical level, in Patents Nos. 843 of 1862 and 2682 of 1863 the first of many ideas relating to inductive and earth leakage current transmissions appeared. These Patents describe the use of coils and also conductive plates buried in the ground. The coils and plates of the transmitting station face those of the receiving station and seemingly the

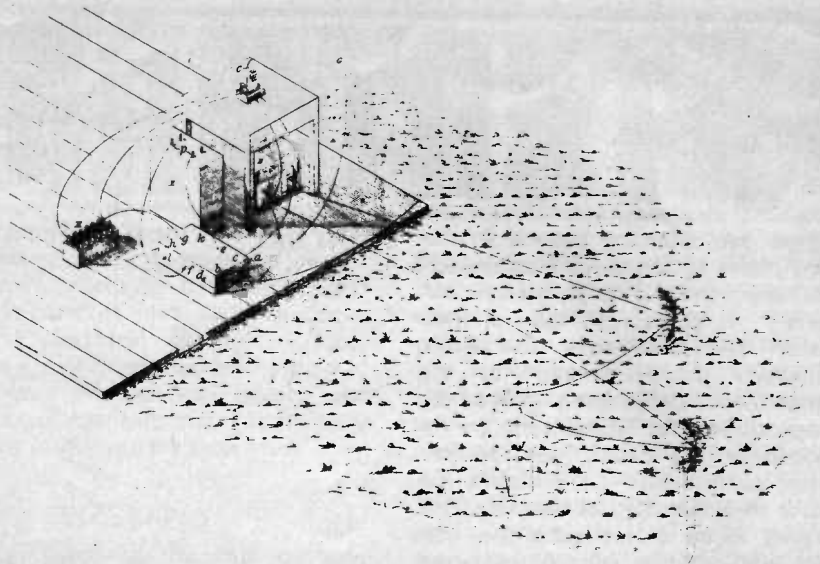

British Patent 2682 of 1863. "Wireless" transmitter 33 years before Marconi, using both electromagnetic induction and earth leakage currents.

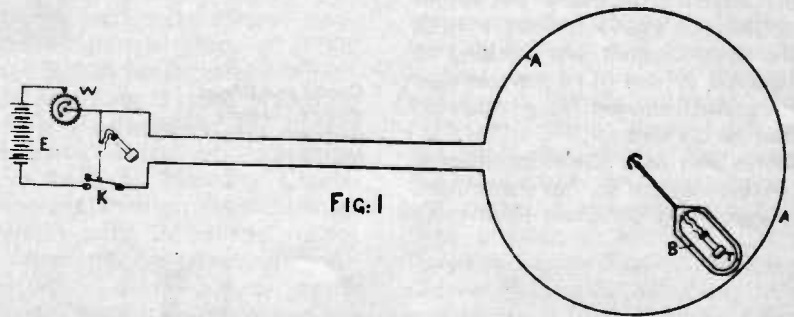

British Patent 22600 of 1895. "Wireless" system using electrostatic induction between spaced plates (H). The transmitter incorporates an induction coil (E) and the receiver a neon lamp (F).

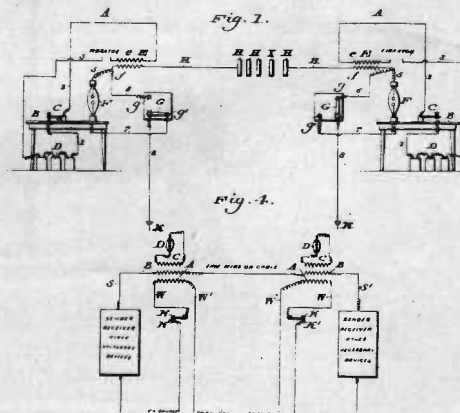

British Patent 10161 of 1892. "Wireless" system using electromagnetic induction between underwater loop (A) and lightship circuit (B).

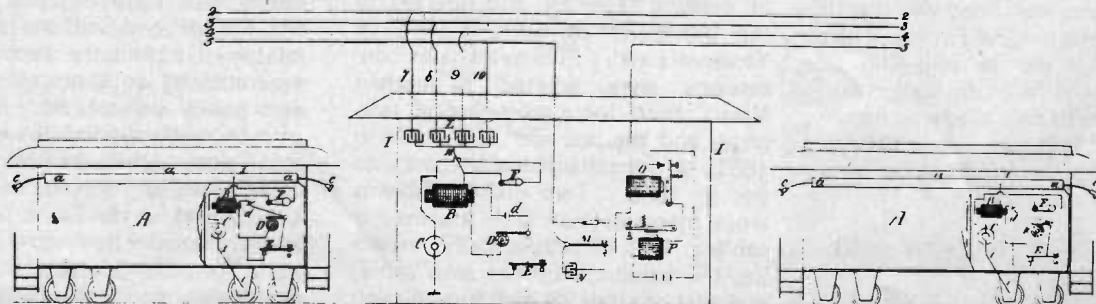

British Patent 7583 of 1885. Edison's "wireless" system using electrostatic induction between a metal surface (a) on a railway carriage and overhead wires connected to a rail-side transmitting/receiving shack.

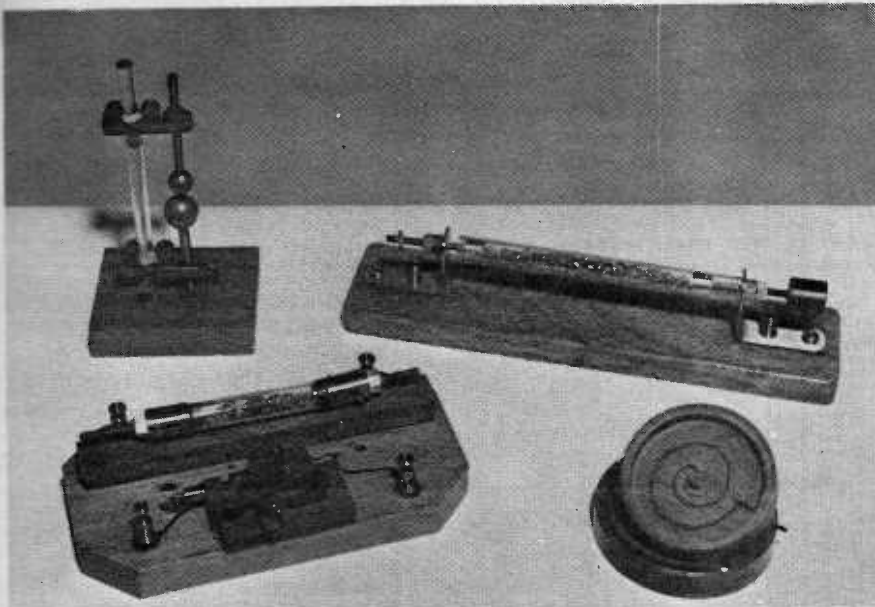

Above and below are shown Lodge's experimental apparatus.

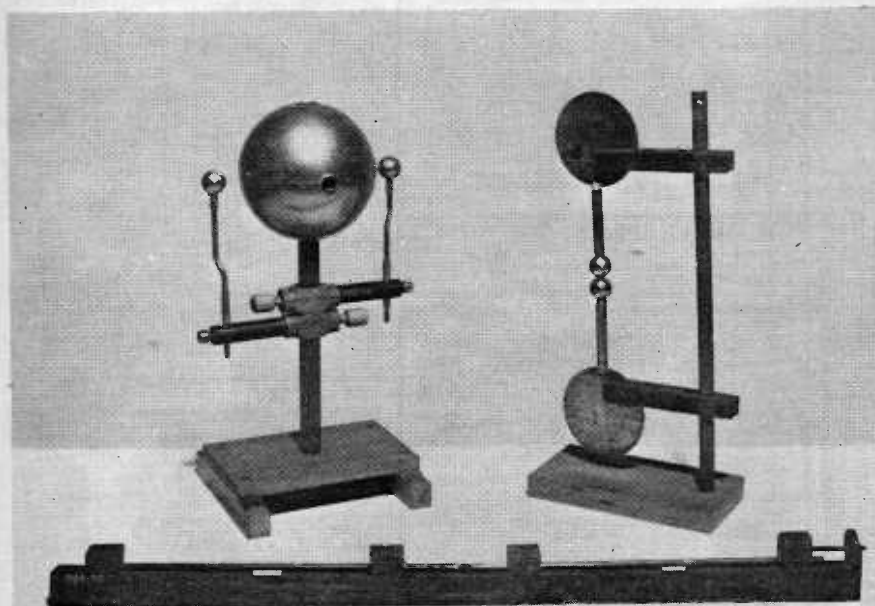

idea was that electrical signals would pass between transmitter and receiver, part by earth leakage currents and part by induction, although the circuitry is bafflingly complex. In the Official Patent Office abridgement of the earlier of the two Patents it is admitted that "the method of working is not clearly specified". Patent No.

974 of 1871 is an example of a popular variation on the earth leakage current theme. The Patent in question describes a trans-oceanic link using at one station a zinc electrode and at the other a copper electrode. The electrodes are immersed in the sea and are linked by a single conductor. With this arrangement the sea acts not

only as the other conductor but in conjunction with the electrodes as a giant battery. For transmitting across both land and sea the inventor suggested the "rivers of acidulated or salt water can be constructed and so placed as to communicate through porous substances with the sea".

## INDUCTION

The induction theme is taken up in Patent No. 3132 of 1879 which describes telegraphic transmissions to a light-ship by induction between a fixed underwater cable connected to the land based station and a trailing cable towed behind the ship. Patent No. 14496 of 1884 described an inductive link between a train and track side stations, and Patent No. 10161 of 1892 described an inductive link between shore and lighthouse. Inductive systems were at one time popular and in certain circumstances provided a quite satisfactory form of communication, as for example, between shore and lighthouse, where reliable communication was important but fixed cables out of the question.

In 1885, Edison patented (No. 7583) a telegraphic system employing electrostatic induction. Metal plates were positioned on top of a train and also alongside the rail track and the idea was that electrostatic charges could be transmitted between the plates. A system using electrostatic induction is also described in Patent No. 22600 of 1895. In this Patent, the transmitter incorporates an induction coil the secondary of which is connected to a line wire and to earth. The receiver has a neon tube also connected to the line wire and earth. The line wire is not continuous but is broken and incorporates parallel spaced plates which electrostatic charges can be passed inductively.

By the 19th century the idea of using the earth as one conductor was of course well known. Patent No. 4220 of 1883 however went one further and replaced the other conductor as well - by the air! The transmitter and receiver were each

*Continued on page 17*

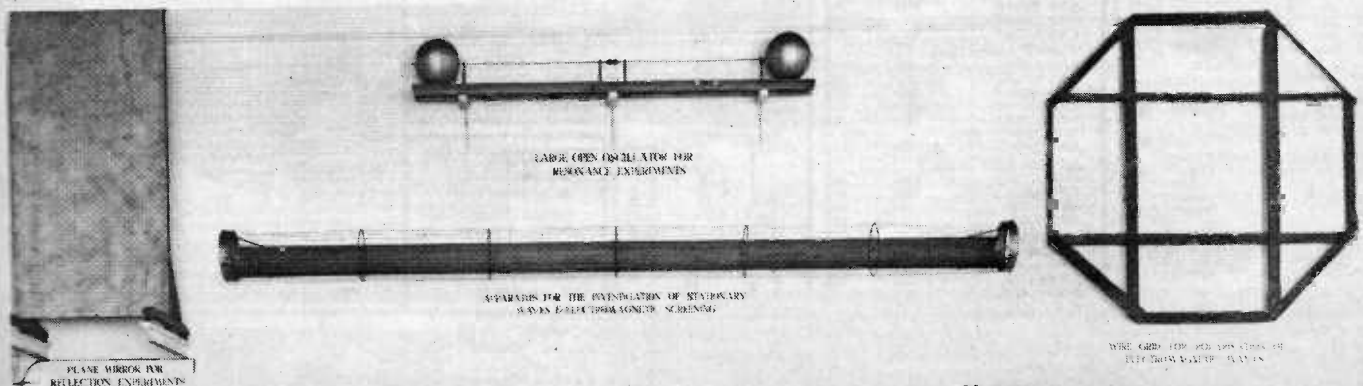

Replica of the original Hertz apparatus used in his early experiments. This is on show in the Science Museum.

# Henry's U.K.'s LARGEST RANGE OF BRANDED AND GUARANTEED DEVICES. (Quantity Discounts 10% 12+, 15% 25+, 20% 100+) (Any one type except where quantity discounts show) Min. Order £1.00 please. Post 10p.

## INTEGRATED CIRCUITS

VERY IMPORTANT. ONLY branded I.C.'s are to the FULL manufacturers specifications. ALL others are not. Henry's sell only branded integrated Circuits... From TEXAS... I.T.T. ... FAIRCHILD... SIGNETICS. So why buy alternatives or under spec. devices when you can purchase the genuine article from us—ex stock... need we say more!

Type	1/11 12/29 30/99	Type	1/11 12/29 30/99	Type	1/11 12/29 30/99
SN7400N	0-20 0-18 0-16	SN7448N	1-50 1-27 1-13	SN74141N	1-00 0-90 0-80
SN7401N	0-20 0-18 0-16	SN7450N	0-20 0-18 0-16	SN74142N	2-80 2-80 2-52
SN7401AN	0-38 0-38 0-33	SN7451N	0-20 0-18 0-16	SN74145N	2-44 1-44 1-26
SN7402N	0-20 0-18 0-16	SN7453N	0-20 0-18 0-16	SN74147N	2-30 2-30 1-83
SN7403N	0-20 0-18 0-16	SN7454N	0-20 0-18 0-16	SN74148N	2-01 2-01 1-63
SN7403AN	0-38 0-38 0-33	SN7460N	0-20 0-18 0-16	SN74150N	2-30 2-30 2-01
SN7404N	0-24 0-21 0-18	SN7470N	0-20 0-18 0-16	SN74151N	1-15 1-15 1-00
SN7405N	0-20 0-18 0-16	SN7472N	0-38 0-38 0-34	SN74153N	1-09 1-09 0-85
SN7405AN	0-44 0-44 0-38	SN7473N	0-44 0-41 0-37	SN74154N	2-30 2-30 2-01
SN7406N	0-40 0-38 0-35	SN7474N	0-48 0-48 0-42	SN74155N	1-15 1-15 1-00
SN7407N	0-40 0-38 0-35	SN7475N	0-59 0-55 0-51	SN74156N	1-09 1-09 1-00
SN7408N	0-25 0-22 0-19	SN7476N	0-45 0-36 0-32	SN74157N	1-09 1-09 0-95
SN7409N	0-20 0-18 0-16	SN7477N	0-80 0-70 0-50	SN74159N	2-44 2-44 2-14
SN7410N	0-20 0-18 0-16	SN7478N	1-25 1-10 0-95	SN74160N	1-58 1-58 1-38
SN7411N	0-25 0-23 0-21	SN7479N	0-87 0-80 0-72	SN74161N	1-58 1-58 1-38
SN7412N	0-28 0-28 0-25	SN7482N	1-20 1-10 1-00	SN74162N	1-58 1-58 1-38
SN7412AN	0-38 0-38 0-33	SN7483N	1-87 1-87 1-63	SN74163N	1-58 1-58 1-38
SN7413N	0-30 0-27 0-25	SN7486N	0-50 0-50 0-44	SN74164N	2-01 2-01 1-76
SN7414N	0-72 0-72 0-63	SN7489N	4-32 4-32 3-78	SN74165N	2-16 2-16 1-89
SN7416N	0-30 0-27 0-25	SN7411N	1-10 1-00 0-90	SN74167N	2-16 2-16 1-89
SN7417N	0-30 0-27 0-25	SN7492N	0-75 0-70 0-63	SN74170N	2-88 2-88 2-52
SN7420N	0-20 0-18 0-16	SN7493N	0-75 0-70 0-63	SN74172N	5-76 5-76 5-04
SN7422N	0-28 0-28 0-25	SN7494N	0-85 0-80 0-75	SN74173N	1-66 1-66 1-45
SN7422AN	0-38 0-38 0-33	SN7495N	0-85 0-80 0-75	SN74174N	1-80 1-80 1-57
SN7423N	0-37 0-37 0-32	SN7496N	0-90 0-80 0-75	SN74175N	1-29 1-29 1-13
SN7425N	0-37 0-37 0-32	SN74100N	2-16 1-89 1-89	SN74176N	1-44 1-44 1-26
SN7427N	0-37 0-37 0-32	SN74104N	0-60 0-53 0-45	SN74177N	1-44 1-44 1-26
SN7428N	0-43 0-43 0-37	SN74105N	0-60 0-53 0-45	SN74180N	1-44 1-44 1-26
SN7430N	0-20 0-18 0-16	SN74107N	0-51 0-51 0-45	SN74181N	5-18 5-18 4-53
SN7432N	0-37 0-37 0-32	SN74110N	0-57 0-57 0-50	SN74182N	1-44 1-44 1-26
SN7433N	0-43 0-43 0-38	SN74111N	0-86 0-85 0-75	SN74184N	2-16 2-16 1-89
SN7433AN	0-57 0-57 0-50	SN74116N	2-16 1-89 1-89	SN74185AN	2-16 2-16 1-89
SN7437N	0-43 0-43 0-37	SN74118N	1-00 0-90 0-83	SN74188N	6-48 6-48 5-67
SN7438N	0-43 0-43 0-37	SN74190N	1-92 1-92 1-68	SN74191N	2-30 2-30 2-01
SN7438AN	0-57 0-57 0-50	SN74192N	1-05 1-05 0-92	SN74192N	2-30 2-30 2-01
SN7440N	0-20 0-18 0-16	SN74193N	0-57 0-57 0-50	SN74193N	2-30 2-30 2-01
SN7441AN	0-85 0-79 0-73	SN74194N	0-80 0-80 0-70	SN74194N	1-72 1-72 1-51
SN7442N	0-85 0-79 0-73	SN74123N	1-44 1-44 1-26	SN74195N	1-44 1-44 1-26
SN7443N	1-50 1-27 1-13	SN74125N	0-69 0-69 0-60	SN74196N	1-58 1-58 1-38
SN7444N	1-50 1-27 1-13	SN74126N	0-69 0-69 0-60	SN74197N	1-58 1-58 1-38
SN7445N	2-16 2-16 1-89	SN74132N	0-72 0-72 0-63	SN74198N	3-16 3-16 2-77
SN7446N	2-16 2-16 1-89	SN74139N	0-63 0-63 0-55	SN74199N	2-88 2-88 2-52
SN7447AN	1-80 1-80 1-57				

## EASY TO BUILD KITS BY AMTRON

— Everything supplied

Model No.	2-98
310 Radio control receiver	5-95
300 4-channel R/C transmitter	5-95
345 Superhet R/C receiver	12-33
455 AM signal generator	1-40
65 Simple transistor tester	3-90
115 8 watt amplifier	4-70
120 12 watt amplifier	5-70
125 Stereo control unit	3-60
130 Mono control unit	4-55
605 Power supply for 115	4-55
610 Power supply for 120	5-73
615 Power supply for 2 x 120	2-93
230 AM/FM serial amplifier	5-90
240 Auto peaking light	6-08
275 Mic. preamplifier	15-80
370 LF generator 10Hz-1MHz	14-60
590 Sq. wave generator 20Hz-20KHz	12-85
620 Ni-CAD charger 1-2x12v	8-00
630 STAB Power supply 6-12v 0-25-0-1A	8-15
690 DC motor speed Gov.	2-87
700 Electronic Chaffinch	7-00
705 Windscreen wiper timer	6-80
760 Acoustic switch	10-75
780 Metal Detector (electronics only)	9-85
790 Capacitive Burglar alarm	6-85
835 Guitar preamp.	4-25
840 Delay car alarm	6-15
875 CAP. Discharge ignition for car engine (-Ve Earth)	13-15
-80 Scope Calibrator	2-25
255 SWR indicator	6-15
525 120-160MHz VHF timer	11-30
715 Photo cell switch	4-30
795 Electronic continuity tester	13-25
860 Photo timer	7-15
371 Slide projector auto. feed control	7-80
4 Acoustic Alarm for radio	8-75
465 Quartz XTAL checker	

ALL KITS OFFERED SUBJECT TO STOCK AVAILABILITY  
Prices correct at time of preparation. Subject to change without notice

## EXCLUSIVE SPECIAL OFFERS

MW/LW CAR RADIO	
+ or - Earth with speakers and fixings. £8-50 carr/packg 30p	
8 TRACK CAR STEREO	
(- Earth) with speakers, in pods and fixings £12-80 carr/packg 40p	
PORTABLE BATTERY CASSETTE TAPE PLAYER	£7-25
CAR LIGHTER PLUG AND ADAPTOR for all cassette radio 67/9 volt output (state width)	£1-95 each
ROTEL STEREOPHONES	
RH630	£4-50
RH700	£6-75
RH430	£3-30
ROTEL RA310	
15 + 15 watt Stereo Amplifier (List £52-00)	£34-52
AKAI GX40	
Stereo cassette recorder	£59-95 carr/packg 50p
Pair Akai ADM microphones	£8-95 carr/packg 20p
WEIN W500	
Battery/Mains Cassette Recorder	£12-75
PORTABLE CASSETTE TAPE	
Player - for car or carry around.	£7-25 carr/packg 20p
HANIMAX BC808 POCKET CALCULATOR WITH KEY	£28-95
HANIMAX BC11M	
Memory Version	£37-50
Mains Unit for BC808, BC811M (state model)	£2-85
HANIMAX H101 STEREO COMPACT RECORD PLAYER	
2x7 watts. Complete with speakers. (List £54-50) Price	£39-95
Plus free pair of stereo phones.	

## NEW RANGES BRIDGE RECTIFIERS

FEATURES SMALL SIZE AND LOW COST. Sizes are approximate.

250M/A QUARTER AMP	
B025/05 50 PIV 16p	
B025/10 100 PIV 16p	
1/2 x 1/2" dia.	
1/2 x 1/2" Pricng	
Type P.I.V. Price ea.	
B05/05 50v 20p	
B05/10 100v 22p	
B05/20 200v 23p	
B05/40 400v 25p	
B05/60 600v 27p	
3/4 x 3/4" dia.	
1 AMP P.I.V.	
B1/05 50v 25p	
B1/10 100v 25p	
B1/20 200v 28p	
B1/60 600v 30p	
3/4 x 3/4" dia.	
1 AMP P.I.V.	
W005 50v 29p	
W01 100v 30p	
W02 200v 32p	
W06 600v 35p	
1/2 x 3/8" Tubular	
2 AMPS P.I.V.	
B2/05 50v 35p	
B2/10 100v 40p	
B2/20 200v 45p	
B2/60 600v 50p	
B2/100 1000v 55p	
3/4 x 3/4" dia.	
4 AMPS P.I.V.	
B4/100 100v 55p	
B4/200 200v 55p	
B4/400 400v 65p	
B4/600 600v 75p	
B4/800 800v £1-00	
3/4 x 3/4" dia.	
6 AMPS P.I.V.	
B6/05 50v 65p	
B6/10 100v 70p	
B6/20 200v 80p	
B6/40 400v 90p	
B6/60 600v £1-00	
3/4 x 3/4" dia.	

All prices correct at time of press. 10% VAT to be added to all orders (UK only) Export & UK Manufacturers Colleges supplied. E. & D. E.

## FREE BOOKLET

All types of Transistors Rectifiers—Bridges SCR's—Triacs Integrated Circuits F.E.T.—Light Devices OVER 1500 DIFFERENT DEVICES ENTIRELY NEW 1973 EDITION More Devices ★ New Prices ★ New Ranges ★ This is a must for all Semi-conductor Users. (Ask for booklet No. 36.) SEND FOR YOUR FREE COPY TODAY

**TBA800 5 WATT I.C.**  
Suitable alternative to SL403D 5/30 volt operated. 8/16 OHM 5 watt output. With circuits and data £1-50.

**Strobe Tube** Suitable for Dec. 73 Pract. Electronics ST2 (D32) DIAC £2-50 CR5 1/40 SCR 45p

**Ultrasonic Transducers** Operate at 40KHz up to 100 yds. Ideal remote switching and signalling. Complete with data transmitter and receiver new I.C. circuits. Per pair £5-90. TA960 with socket £1-80

**Sinclair IC21** with circuits and data. 6 watt IC with printed circuit board. 28 volt. operated. £2-00.

**ZN414 IC** Integrated circuit radio as featured by many magazines (PW Jan. 73 Reprint Ref. No. 19 for 10p). £1-20.

**TIL209 LED** 24p each 22p per 10

**3015F 7 SEG.** I.C. size complete with data price £1-70 each (digital clock circuits ref. No. 31, 15p).

## BUILD YOURSELF A POCKET CALCULATOR

A complete kit, packaged in a polystyrene container and taking about 3 hours to assemble—that's the Sinclair Cambridge pocket calculator from Henry's. Some of the many features include interface chip, thick-film resistor pack, printed circuit board, electronic components pack. Size 4 1/2" long x 2 1/2" wide x 1 1/2" deep. Free of charge with the kit for the more advanced technologist is a 32-page booklet explaining how to calculate Logs, Tangents, Sines etc. Price £24-95 + VAT. Also available assembled ready to use £27-20 + VAT

**LIVING SOUND LOW NOISE TOP QUALITY CASSETTES MADE BY EMI TAPES LTD TO INTERNATIONAL STANDARDS ESPECIALLY FOR HENRY'S. ALL POST PAID LESS THAN 1/2 REC. PRICES COMPLETE WITH LIBRARY CASES. 3 for £1-00 6 for £1-80 10 for £2-80 25 for £6-75**

**C 90** £1-33 £2-57 £4-20 £10-25  
**C 120** £1-62 £3-15 £5-00 £12-25

Quantity and trade enquiries invited.

**LEARN A LANGUAGE—complete with phrase book. German—French—Spanish—Italian £1-36 per course. £5 for any 4.**

## A SELECTION OF INTERESTING ITEMS

C3025 Compact transistor tester	6-30 p & p 15p
I1300 Mono mag. cart. preamp.	2-75 p & p 15p
E1310 Stereo mag. cart. preamp.	4-62 p & p 25p
Easiphone telephone amplifier	7-95 p & p 25p
LT1203 Teleamp. with PU coil	7-40 p & p 20p
Chattalite (lights as you talk)	13-90 p & p 20p
1 Kw Dimmer/controller	3-00 p & p 10p
9" Twin spring unit For	3-30 p & p 15p
16" Twin spring unit Reverbs	6-85 p & p 25p
Car Tachometer Electronic	8-95 p & p 15p
VHF 105 Aircraft band corrector	4-50 p & p 15p
B2005 4 Ch. mic. mixer	3-75 p & p 15p
B2000 4 ch. Stereo mixer	5-95 p & p 15p
BK3 Kit. Each your own printed circuits	1-50 p & p 20p

LARGER QUANTITY AND O.E.M. PRICES PHONE (01) 723 3646. PRICING OF SN7400 SERIES IS CALCULATED ON THE TOTAL NUMBER ORDERED REGARDLESS OF MIX. SN74... HIGH POWER... SN74... LOW POWER SERIES IN STOCK... SEND FOR LIST 36, FREE ON REQUEST. LOW PROFILE SOCKETS 14 PIN... 15p. 16 PIN... 17p. 8 PIN... 14p.

## TRANSISTORS

A SELECTION FOR FULL LIST SEND FOR BOOKLET 36 TODAY.

AA213 10p	BC182 12p	BYZ13 35p	OC36 65p	ZTX108 10p	2N3714 1-60
AC107 35p	BCY32 85p	CI06D 55p	OC44 18p	ZTX300 14p	2N3711 1-75
AC128 20p	BCY39 1-00	GET111 55p	OC45 18p	ZTX302 18p	2N3773 2-25
AC187 20p	AC95 2-50	GET115 75p	OC71 15p	ZTX500 15p	2N3790 2-25
ACY17 35p	BCY70 1-50	CE1780 55p	OC77 55p	2C301 40p	2N3819 35p
ACY39 65p	BCY71 20p	LM309K	OC77 55p	2N697 15p	2N3866 75p
AD149 50p	BCY72 13p	MAT121 1-87	OC81 28p	2N706 10p	2N3903 15p
AD161 39p	BD124 80p		OC83 25p	2N930 20p	2N4002 14p
AD182 39p	BD131 45p		OC140 65p	2N987 45p	2N4126 15p
AF117 20p	BF115 22p	MJE340 50p	OC170 25p	2N1132 25p	2N4871 35p
AF119 50p	BF180 35p	MJE320 85p	OC200 55p	2N1304 22p	2N4577 36p
AF139 33p	BF194 13p	MJE3055	OC202 90p	2N1613 20p	25001 0-00
AF186 40p	BFX13 25p		OC202 90p	2N1671 1-00	25026 8-90
AF239 44p	BFX34 55p	MPP105 46p	OC202 90p	ORP12 55p	2N2147 75p
AS27 30p	BFX88 22p	NKT217 45p	OC202 90p	ORP60 45p	2N2160 69p
BA115 10p	BFY50 20p	NKT404 60p	OC202 90p	P346A 20p	2N2926 10p
BA113 5p	BFY51 60p		OC202 90p	TIL209 25p	2N3053 20p
BC107 15p	BFY64 50p	OA81 10p	OC202 90p	TIP305A 55p	40408 40p
BC108					



Now built and used by thousands of satisfied customers. Features slim design overall size in cabinet 16 1/2" x 2 1/2" x 6 1/2" 6-IC's, 10 transistors, stabilisers Gardners low field transformer. Fibre Glass PC Panel, complete chassis work. Now available built and tested as well as in kit form. **HIGH QUALITY AND STABILITY ARE PRE-DOMINANT FEATURES - DEVELOPED BY TEXAS ENGINEERS FOR PERFORMANCE, RELIABILITY AND EASE OF CONSTRUCTION. FACILITIES.**

On/off switch indicator, headphones socket, separate treble, bass, volume and balance controls, scratch and rumble filters, mono/stereo switch, input selector; Mag. P.U. Radio Tuner, Aux. Can be altered for Mic., Tape, Tape-head, etc. Constructional details Ref. No. 21 30p. Distributed by Henry's throughout UK.

FREE—Teak cabinet with complete kit.

## KIT PRICE £28-50

(+VAT+50p carr/packing) or built and tested £35-00 (+VAT+50p carr/packing) as illustrated.

## BUILD THE TEXAN

### 20 + 20 WATT IC STEREO AMPLIFIER

As featured by Practical Wireless 1972

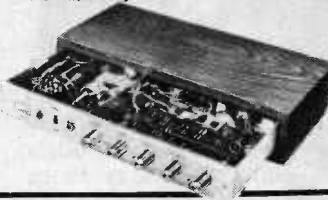

## EARN YOURSELF EASY MONEY, WITH PORTABLE DISCO EQUIPMENT

- DISCO MINI A complete portable disco, fitted mixer/preamp, 2 decks all facilities £98-50
- As above but with Slider Controls £118-50
- 100 watt amplifier for above £42-50
- SOLS 100 100 watt mixer/amplifier with slider controls £89-00
- R50 50 watt mixer/amplifier £49-50
- R100 100 watt mixer/amplifier £57-50
- DISCO AMP 100 watt mixer/amplifier chassis unit £73-00
- DISCO MIXER/PREAMPLIFIERS (OP for up to 6-100 watt amplifiers)
- SDLI (rotary controls) £58-50
- SDLI (slider controls) £49-50
- DISCO VOX (slider controls) the complete disco preamp £72-00
- DJ100 100 watt power amplifier for above £49-50
- DJ30L 3 channel 3kw sound to light £36-00
- DJ40L as 30L plus built in microphone £47-50
- DIMAMATIC 1 kW adjustable speed auto dimmer £25-00
- Carlabro reverberation unit £44-00
- SCENE STROBE £19-00. ROAD STROBE £25-00
- SUPER STROBE £45
- Disco anti-feedback microphone £11-95
- Colt 150 watt liquid wheel projector £22-50
- 150 watt QI liquid wheel projector £50-00
- 150 watt QI cassette wheel projector £50-00
- Spare Effects and liquid cassettes large range of patterns £6-00

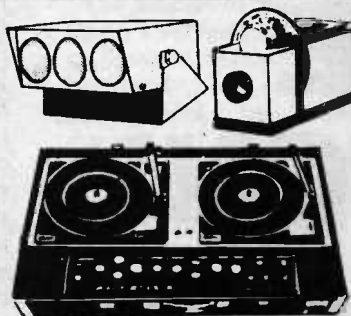

- 6" Liquid wheels £5-50
- Mini spot bank fitted 3 lamps £12-95
- Auto Trille (mini with flashers) £17-00
- Bubblemaster with 1 gall. Liquid £41-15
- Mixer/Misc/Speakers/Lighting UK's largest range.
- FREE stock list ref. No. 18 on request.
- AKG/Realo/DJ/Carlabro/Eagle Mics, Stands, Mixers, Cabinets, Chassis & complete speaker systems, megaphones, turntables, Public Address Components.

## BUILD THE NEW HENELEC STEREO FM TUNER

A completely new high stability stereo FM tuner. Features variable capacity diode tuning, stabiliser power supply, IC Decoder, high gain low noise. IF stages. LED indicators, Tuning meter, AFC, easy to construct and use. Mains operated. Slim modern design with fibre glass PC, teak cabinet etc. Available as a kit to build or ready built. Overall size 8" x 2 1/2" x 6 1/2". Produced to give high performance with a realistic price. (Parts list and constructional details Ref. No. 5 30p). Henry's are sole distributors UK and Europe.

Kit price **£21-00 (+ VAT)**

OR BUILT AND TESTED £24-95 (+ VAT)

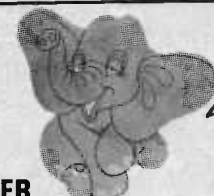

You pay less VAT with Henry's Low Prices



## EXCLUSIVE DECCA KELLY SPEAKERS

12 watt speaker Tweeter systems. 8" Bass/Midrobe and Melinex Domed HF radiator plus cross-over £12-50 per pair of systems (carr/packg 40p) or built into veneered cabinets, size 18x12x6 1/2" £19-50 pair (carr £1).



## HI-FI TAPE EQUIPMENT

UK's largest range with discounts and demonstrations for callers. Latest stock lists on request (Ref No. 17). Phone 01-402 4736 for Barclay/Access Card. Direct orders and latest prices.

## ELECTRONIC SUPPLIES

UK's largest range for every application. Small quantity discounts. Also Trade, Export and Industrial enquiries invited. Latest stock list (ref No. 36). Including valves on request.

## TRANSISTORS/ SEMICONDUCTORS

Specialists in electronics for more than 30 years. Trade and industry supplies - every type of component and equipment.

## MINIATURE AMPLIFIERS

- AMPLIFIERS (carr. etc. 20p).
- 4-300, 0-3 watt 9 volt £1-75
- 104, 1 watt 9 volt £2-80
- 304, 3 watt 9 volt £3-10
- 555, 3 watt 12 volt £5-10
- E1208, 5 watt 12 volt £4-10
- 608, 10 watt 24 volt £4-95
- 410, 10 watt 28 volt £9-95
- E1206, 30 watt 45 volt £5-25
- E1200, 2 1/2 + 2 1/2 watts 12 volt £6-30
- RE200, 5 watt IC mains operated Amplifier with controls £8-70
- SAC14, 7 + 7 watt Stereo with controls £11-75
- SAC13, 15 + 15 watt Stereo with controls £11-75
- SINCLAIR UNITS (carr. 20p) Z30 £3-57, Z50 £4-37
- Stereo 60 Pre-amplifier £4-77
- PZ5 £3-97, PZ6 £6-31, PZ8 (for Z50) £4-77 (TRANS £2-95)
- AFU £4-45, PROJECT 605 KIT £19-95 PROJECT 605 £20-95

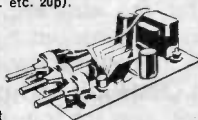

## POWER SUPPLIES FOR EVERY PURPOSE

(All cased unless stated chassis)

- 470C 6 7/8 9 volt 300 MA (includes Multi-Adaptor for Tape Recorders, etc.) £2-15 post 20p
- Car Lighter Voltage Adaptors 300mA (State voltage 6v, 7 1/2v, 9v) £1-95 ea. post 25p
- SC202 3 6/7 9 volt 400mA £3-35 carr. 30p
- HC244R Stabilised version £4-35 carr. 30p
- P500 9 volt 500mA £2-90 post 20p
- P11 24 volt 500mA (chassis) £2-90 post 20p
- P15 26/28 volt 1 amp (chassis) £2-90 post 20p
- P1080 12v 1 amp (chassis) £4-25 post 20p
- P1081 45v 0-9 amp (chassis) £7-50 post 20p
- P12 4 1/2-12 volt 0-4-1 amp £7-15 post 30p
- SE101A 3 6/9 12 volt 1 amp (Stab.) £10-30 post 25p
- RP164 6 7/8 9 12 1 amp (Stab.) £10-20 post 30p



## LOW COST HI-FI SPEAKERS

- SPECIAL OFFER
- EMI 13" x 8"—full range speakers (post 20p each or 30p pair)
- \*150TC—8 ohms Twin Cone 10 watt £2-20 each or £4-00 pair.
- \*450 10 watt C/o Twin Tweeters 3, 8 or 15 ohms £3-50 each or £6-90 pair.
- EW 15 watt 8 ohms C/o Tweeter £4-30 each or £7-90 pair.
- \*50 20 watt C/o Tweeters 8 or 15 ohms £7-50 each or £14-20 pair.
- \* Polished wood cabinet £4-60 post 35p.



## SPEAKER KITS (carr. etc. 35p)

- 20-2 8" 30 watt
- 20-3 8" 40 watt
- LINTON 2 20 watt
- GLENDALE 3 30 watt
- DOVEDALE 3 50 watt
- KEF KK2
- KEF KK3

- £10-00 each
- £15-00 each
- £15-95 pair
- £28-95 pair
- £42-00 pair
- £20-40 each
- £32-00 each

## NEW SINCLAIR PROJECT 80

- Stereo Pre-Amplifier £11-95
- Audio Filter Unit £6-95
- Z40 15 Watt amplifier £5-45
- Z60 Watt Amplifier £6-95
- PZ6 Mod. for 1 or 2 Z40 £4-98
- PZ6 Mod. (S Tab) 1 or 2 Z40 £7-98
- PZ6 Mod. (S Tab) 1 or 2 Z60 £7-98
- TRANSFORMER FOR PZ8 £3-95
- NEW FM TUNER £11-95
- STEREO DECODER £7-45

All items post paid.

## SPECIAL PURCHASES

AVOMETER MOVEMENTS  
 AVO 8 or 9 50uA MOVEMENTS  
 Ex Brand New AVO's £3-50 Post 20p



## UHF TV TUNERS CHANNELS 21 TO 64

Brand new transistorised geared tuners for 625 Line Receiver 1 Output. £2-50 Post 20p

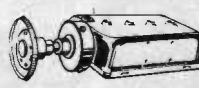

All types offered subject to availability. Prices correct at time of proof. Subject to change without notice. E. & O. E. 10% VAT to be added to all orders. Export supplied.

## GARRARD BATTERY TAPE DECK

GARRARD 2 speed 9 volt tape decks. Fitted record/play and oscillator/erase heads. Wind and rewind controls. Takes up to 4" spools. Brand new complete with head circuits. £9-50 carr. 30p.



## FIBRE OPTICS

0-01 Diam. Mono Filament £1-50 per 25 metre reel  
 0-13 Diam. 64 Fibres Sheathed £1-00 per metre  
 SPRAYS 15mm Diam. Mares Tails £9-50

## TOP QUALITY SLIDER CONTROLS

60mm stroke high quality controls complete with knobs (post, etc., 15p any quantity).  
 Single Line and Lin 5K, 10K, 22K, 50K, 100K, 250K, 500K, 1 Mega 45p each.  
 Ganged Log and Lin 10K, 22K, 50K, 100K, 250K, 500K each. (Quantity discounts available.) Complete with knobs.

## MARRIOT TAPE HEADS

4 TRACK MONO or 2 TRACK STEREO '17' High Impedance £2-00. '18' Medium Impedance £2-00. R730/E73 2 track mono Record/Erase low imp. 75p pair. Erase Heads for '17' and '18' 75p. 53-2 track mono. HI Imp. £1-75. '43' Erase Head for 53' 75p. (Post, etc., 15p any quantity.)

## TEST EQUIPMENT MULTIMETERS (carr. etc. 30p)

- M210 20K/Volt Slimline £8-75.
- TLH33D 2K/Volt Robust £7-50.
- U437 10K/Volt Steel case. AC up to 40KHz £4-95. U4324 20K/Volt with AC current ranges £8-00.
- AF105 50K/Volt £11-95. U4313 20K/Volt AC current. Steel case £10-50. U4341 Plus Built in transistor tester £10-50. Model 500 30K/Volt £9-95.



## OTHER EQUIPMENT

- SE250B Pocket Signal Injector 2-10 carr. 15p. SE500 Pocket Signal Tracer £1-70 carr. 15p.
- TE15 Grid Dip meter 440kHz-280MHz 15-00 carr. 30p. TE40 AC Millivoltmeter 1-2mHz 18-95 carr. 35p. TE65 28 Range valve voltmeter 18-95 carr. 40p.
- TE20D 120kHz-500MHz RF Generator 17-95 carr. 40p.
- TE22D 20Hz-200kHz Audio Generator 18-95 carr. 40p.
- SE350A Deluxe Signal Tracer 12-50 carr. 20p. SE400 Volts/ohms/R-C sub/RF field/RF gen. 14-75 carr. 20p.

## SUPER TESTER 680R - The complete testing system

- Volts AC = 11 ranges from 2V to 2500V
- Volts DC = 13 ranges from 100mV to 2KV
- Amp DC = 12 ranges from 500A to 10A
- Amp AC = 10 ranges from 2000A to 5A
- Ohms = 6 ranges from one tenth of Ohm to 100MΩ
- Reactance = 1 range from 0 to 10MΩ
- Capacity = 6 ranges from 0 to 500pF and from 0 to 0.5µF and from 0 to 50.000pF
- Frequency = 2 ranges from 0 to 500Hz and from 0 to 5000Hz
- Output Voltage = 9 ranges 10V to 2500V
- Decibels = 10 ranges from -24 to +70dB



price **£18-50**

## Accessories

- Transistor tester £11-00
- Electronic voltmeter £18-00
- Amp/amp £11-95
- Temperature probe £11-95
- Gauss meter £11-95
- Signal Injector £5-95
- Phase Sequence £5-95
- EHT Probe £5-95
- Shunts 25/50/100A £4-50 each



*Photograph of Marconi taken in London in 1896, showing the original apparatus brought by him from Italy.*

# A TRIBUTE TO MARCONI

**Centenary year of birth of Guglielmo Marconi, the father of 'wireless'.**

ONE HUNDRED years ago, (April 25th, 1874) Guglielmo Marconi was born in Bologna, the younger son of a wealthy Italian landowner, Giuseppe Marconi, and his Irish wife Annie, the daughter of Andrew Jameson, a whiskey distiller from County Wexford in Ireland.

To Guglielmo Marconi must go the credit for seeing the wider possibilities of wireless. Of taking it out of the laboratory where pure science had shackled it, and developing practical systems for the benefit of mankind. His work, and that of the brilliant men with whom he surrounded himself in the company he formed, laid the foundations of the electronics industry as we know it today.

Marconi was interested in science from an early age. By his late teens he was experimenting with electro-magnetic waves as a communication medium. By the summer of 1895 he had succeeded in transmitting signals over a few yards of space, and in August, using an earth and an elevated aerial at both transmitter and receiver, he was able to transmit Morse Code over 1 3/4 miles.

The Italian Government was not greatly interested in Marconi's invention, so in 1896 he came to England where he filed the world's first patent for a system of telegraphy using Hertzian waves. A letter of introduction to William Preece,

Engineer in Chief of the GPO, led to a series of demonstrations culminating in 1897 in a record transmission across 8.7 miles of the Bristol Channel, where Preece himself was experimenting with inductive methods, but with far less success.

The potential of wireless telegraphy was becoming clear and in 1897 the world's first radio company was formed to develop Marconi's apparatus commercially. First called the Wireless Telegraph and Signal Company, it was later renamed Marconi's Wireless Telegraph Company and in 1963, The Marconi Company.

By the end of the century, wireless had been adopted by the British and the Italian Navies, it had spanned the English Channel, it had proved its worth to the mercantile navy as a life saver and Marconi had introduced his system to the USA, where he registered The Marconi Wireless Telegraph Company of America — later to become the Radio Corporation of America (RCA).

One of Marconi's ambitions had been to use wireless as a means of ending the isolation of those at sea, and in 1900 the Marconi International Marine Communication Company was created to work an exclusive licence for all maritime purposes. At this time also he took out his famous Four Sevens patent for tuned coupled circuits.

In 1901, the world's first wireless

school opened at Frinton, later transferring to Chelmsford where it still flourishes.

This was a vintage year of Marconi. Having achieved communication over 198 miles between the Isle of Wight and the Lizard, he embarked, with the assistance of Dr J.A. Fleming (Scientific Adviser to the Company), R.N. Vyvyan, G. Kemp and P.W. Paget, on his famous transatlantic experiment. After many vicissitudes he succeeded in receiving, through an earpiece, signals at St John's, Newfoundland, transmitted from Poldhu, Cornwall. Even at the moment of this, his greatest triumph, some said that he mistook atmospheric for the Morse code 'S'. To those doubters it has been pointed out that for long distance communication to have evolved from the system that pushed three faint dots across 2000 miles is a marvel; had there been no dots, its evolution has been a miracle. Two months later, signals from Poldhu were recorded on a morse inker on s.s. 'Philadelphia' — 2099 miles away — thus dispelling any doubt about his original claim. In December 1902, Poldhu's permanent opposite number was built at Glace Bay.

During the next few years, many important patents were filed, notably those for the magnetic detector, the radio valve developed by Dr Fleming, and the directional aerial, which was used at Clifden, in Ireland — a station that took over the transatlantic service from Poldhu. In 1909, Marconi shared a Nobel Prize for Physics in recognition of his contribution to wireless telegraphy.

The decade that preceded the First World War also saw the first use of wireless in the air, transmission initially being achieved from a captive balloon and then, in 1910, from an aeroplane flown by J.D.A. McCurdy. It also saw wireless used to assist the capture of the notorious murderer, Dr Crippen, and to save lives when the ill-fated 'Titanic' foundered.

When war broke out in 1914, the Admiralty at once took over the Marconi radio factory. This, the first in the world, had transferred in 1912 from Hall Street, Chelmsford, to a new, purpose-designed building a mile or so away. The Clifden station and Marconi's operational equipment in Chelmsford and London were also taken over, along with the first long-wave transatlantic wireless station for direct communication with the USA, completed by Marconi during 1914.

The company, having developed



direction-finding techniques before the war, established a chain of stations that were used to devastating effect against enemy Zeppelins, submarines and surface ships, and led, indeed, to the Battle of Jutland. For the Royal Navy's world-wide communications network, the company built a dozen widely dispersed stations.

Air-to-ground telegraphy was perfected and the difficulties of ground-to-air telephony were overcome by three Marconi engineers, Major C.E. Prince, Capt. H.J. Round and Lt. J.M. Furnival — the last named also supervising the achievement of inter-aircraft telephony in 1917.

Marconi himself was commissioned in the Italian Army. He later became deeply involved in diplomatic work for Italy, and, after the war, was appointed Plenipotentiary Delegate to the Paris Peace Conference.

In 1919, Marconi bought his yacht, 'Elettra', which he equipped as a laboratory; a Marconi engineer made the first east to west transatlantic telephony transmission; and the embryo of broadcasting took shape in Chelmsford.

In 1920, at Marconi's Works, Nellie Melba gave a song recital for Britain's first advertised public broadcast. Twenty months later the company was licensed for regular broadcasting and erected the famous 2MT station in an ex-army hut at its Writtle Laboratories. A licence was also granted for the 2LO station in Marconi House, London. Later in 1922, at the instigation of the PMG, Marconi's and five other manufacturers formed the British Broadcasting Company, superseded in 1926 by the British Broadcasting Corporation.

The Marconiphone Company, formed in 1922 to satisfy the demand for domestic receivers, was sold to RCA in 1929 and later merged with two other companies to become EMI, of which Marconi was President.

Meanwhile, the company supplied the equipment for the BBC's new longwave station at Daventry, which took over the 5XX call sign of an

earlier station built at Chelmsford.

Running parallel with the company's broadcasting activity was Marconi's involvement with the Government's plan to link Britain through a wireless communication network. First mooted in 1906, the Imperial Wireless chain contract was awarded to Marconi in 1924, exactly fifty years ago. The first station was opened in 1926 and, in common with all those that followed, used the Marconi-Flanklin Beam System — a newly developed, revolutionary form of shortwave directional transmission. The Company too built its own beam stations for communicating with countries outside Britain.

The success of the Imperial Wireless Chain so threatened the British cable companies that, in 1929, at the instigation of the respective governments, their interests were merged with those of the Marconi Company in a new organization, Cable and Wireless Limited.

This step shattered Marconi's life-long ambition to control an Empire-wide wireless network. Disappointed and in ill-health, he was increasingly drawn to his home in Italy, from which he conducted microwave experiments, installing the first microwave telephone link in 1932, and in 1935 demonstrating principles of radar.

Meanwhile his company in England was advancing the new medium of television, its interests in which it merged with those of EMI to form the Marconi-EMI Television Company Limited (later dissolved) whose system was adopted in 1936 by the BBC for the world's first public high definition television service.

In Italy, Marconi's health was deteriorating rapidly. He was taken ill on 19th July 1937 and died the following day. Of all the tributes that followed, the most impressive, the gesture that was unique, was the closing down for two minutes of wireless stations throughout the world. The 'ether' was as quiet as it had been before Marconi. ●

## EARLY RADIO PATENTS

*Continued from page 13*

provided with an aerial and "moist air, mist or clouds" was required to complete the circuit.

### HERTZ

In 1883 Hertz laid the practical foundations of what we now understand by the term 'wireless' telecommunications. He confirmed Maxwell's predictions by detecting with a broken loop of wire radio signals radiated by a spark from an induction coil. A spark was produced at the break in the loop. A more sensitive detector of radio waves was however required to enable experimental work on the properties of radio waves to be taken much further and this was provided in the form of the 'coherer', by a Frenchman, Eduard Branly. As far back as 1850 the coherence of conductive particles and the consequent lowering of their resistance in an electric field had been observed and in 1879, Hughes noted a similar effect with a microphone invented by him and comprising carbon rods resting on a steel plate (the Hughes microphone is shown in Patent No. 2202 of 1878).

In 1890 Branly developed a coherer in a practical form, a sealed evacuated glass tube with conductors at each end and metal filings between them. This was used in England, by Lodge to demonstrate the transmission of radio waves over short distances and his experiments roused much interest. In 1895 a Russian, Popov, celebrated in the East much as Marconi is in the West as the inventor of radio; was also experimenting with Branly's coherer although he was mainly interested in detecting radio waves produced by lightning flashes.

Branly, Lodge, Popov and a whole host of others who experimented with 'Hertzian' waves before 1896 had one thing in common, they were primarily interested in examining the nature and properties of these waves from an academic point of view.

TO BE CONTINUED

### BACK NUMBERS

Back numbers are available for 25p each plus 7p postage on one, 10p on two. We are unable to supply the following:

April, May 1972

February, November 1973.

There are very limited supplies of January, March and April 1974 (we had to turn away several orders for March 1974 but a small number are now available).

We are anxious to obtain a number of April 1972 and will pay 32p each for any in good condition sent to us. Orders should be sent to:

Back Numbers Dept. ET1, 36 Ebury Street, London SW1W 0LW.



Marconi with the equipment used in the first Transatlantic transmission across the Atlantic in 1901.

# FOUR-CHANNEL PSYCHO-ACOUSTICS

— is 'three plus one' the answer? asks Dr. Farrimond, Reader in Psychology, University of Waikato, Hamilton, New Zealand.

THERE has been in general a lukewarm reception to quadrasonic sound.

Probably this has been due to three factors. Firstly, the uncertainty as to which system will prevail. Secondly, many listeners have not been convinced that there has been sufficient gain in realism to justify purchasing what is virtually a second stereo system. Thirdly is the tendency of some recording companies to indulge in audio gymnastics — combined with an attempt to justify the "new musical experience" as part of the course of evolution of music.

It has always been possible to perform music by locating musicians in the four corners of the concert hall, but it is debatable whether audiences like sounds coming from sources which they cannot see except by turning around.

Psychologically there is a correspondence between the 180° visual field and hearing. Unlike most mammals, Man does not have the ability to rotate his ears so as to locate sounds arriving from a 360° arc, consequently we focus on sound sources which are outside our visual field by turning our heads. The tendency is a strong one and appears to be innate, Wertheimer (1961) has shown that even one-hour old infants attempt to turn towards the source of a sound.

---

... if we are to feel comfortable when listening to recorded music then the important sounds should be at the front and easily locatable with perhaps only the ambient effects being reproduced at the rear . . .

---

This suggests that if we are to feel comfortable when listening to recorded music then the important sounds should be at the front and easily locatable with perhaps only the ambient effects being reproduced at the rear of the listening area to simulate concert-hall spaciousness.

## INAPPROPRIATE TECHNIQUE

It is axiomatic that the closer a recording can approach to reproducing the same sound pressure level

variations at the ear of the listener that he would experience in a concert hall, then the more realistic will be the effect. Attempts to create a *different* musical world simply in order to use a new recording technique are questionable, except for music written especially for surround-sound effects. The technique is simply not appropriate for most conventional music.

For loudspeaker listening, the problem of reproducing the correct sound pressure fluctuations at the ears of the listener is more complex than for headphone listening. Loudspeakers must duplicate the *gradients* of acoustic energy in the listening area if the sound is to be accepted as like the original; consequently head movements should not destroy the illusion.

Recording for headphone listening is easier, since in this case it is relatively simple to produce sound pressure level changes which are virtually identical to those which could be detected in the recording studio, substituting microphones for two human ears.

In this case, head movements constitute no threat, since the headphone-wearer takes his listening environment with him. However, headphone listening can only produce a *static* auditory field, that is, one which remains uniform even though the listener moves his head. In this respect, therefore, the situation is artificial.

## KALEIDOSCOPIC SUMMATION

In real life, this condition is not encountered, and it seems probable that loudspeakers could provide a more convincing sound panorama if used in the correct way. It should be noted that even though we only use two eyes and ears in sampling our environment, the processes of learning to see and learning to hear depend upon a kaleidoscopic summation of impressions which the brain stores and interprets. The build-up of three-dimensional visual ability depends upon numerous perceptions of objects as viewed from a multiplicity of different angles.

The same holds true but to a lesser extent for the auditory modality. It

implies that movement of the listener's head relative to the sound source is an essential element in the establishment of auditory perception. The corollary to this is, that if we are to reproduce a realistic sound image, then the principles which were involved in the development of our auditory abilities should not be violated, otherwise the sound will be heard as unlike the real thing.

---

The aim of reproducing realistic sound by means of loudspeakers, should be to provide a sound pressure level field in which head movements bring about changes in sound intensity and directionality similar to those which would exist in real-life conditions.

---

The aim of reproducing realistic sound by means of loudspeakers, therefore, should be to provide a sound pressure level *field* in which head movements bring about changes in sound intensity and directionality similar to those which would exist under real-life conditions. This cannot be accomplished using only two speakers, nor can changing gradients in response to head-movement be duplicated using headphones, although appropriate recording techniques can give an accurate sound image as if from *one position* in the recording studio. It would appear that the establishment of equivalent sound pressure level gradients should therefore be aimed for in the further development of audio techniques and the technology of quadrasonic provides an opportunity for producing this closer approximation to reality.

## REDUCING HAAS EFFECT

If the frontal sound source of the conventional stereo system could be stabilized and improved by using one of the channels of quadrasonic to provide a discrete sound source, then this would help to minimise one of the bugbears of stereophonic listening, that is, Haas effect, in which lateral displacements of the listener's head cause a broadening and shifting of the sound image in the direction of the movement.

Attempts have been made in the past to provide a sound-source between the speakers of a stereo pair. For example, David Haffler (1970) used an additional speaker in this way and fed it with the combined signals from left and right channels. (He also used out-of-phase signal components to feed a speaker providing ambience effects.) However, in this case, the central frontally-located speaker does not carry discrete signals.

A closer approach to realism could be achieved by using one of the discrete quadraphonic channels to provide a central sound source, whilst the remaining fourth channel could relay ambience information from a rear-mounted speaker. In the reproduction of a piano concerto, for example, the centre speaker would relay mainly piano information, along with the sounds from centrally-located instruments in the background, and the left and right speakers would provide the sounds from the remaining instruments of the orchestra from their correct positions.

---

A closer approach to realism could be achieved by using one of the discrete quadraphonic channels to provide a central sound source, whilst the remaining fourth channel could relay ambience information from a rear-mounted speaker.

---

The adoption of a "three plus one" discrete system such as this, would mean that not only would Haas effect diminish, so that if the listener moved to left or right, the piano would remain in the centre, but also a further advantage would be that for music recorded from conventionally grouped instruments, each loudspeaker would only need to handle something under one-third of the total information as compared with half for conventional stereo or slightly less than half for a quadraphonic system.

Of course the recording technique for the "three plus one" approach would need to be tailored accordingly. The aim would be to duplicate, via the three speakers, the wave-fronts which were produced in the recording studio at three equivalent directional microphones (or groups of microphones) placed in such a way as to take in one third of the sound-stage to which they were presented. This would result in the production of a lateral distribution of sound which would maintain its directional properties far better than can a conventional stereophonic or quadraphonic system. In the case of stereo it has been suggested by John

Crabbe (1973), that "skewing" sound distribution, by using careful speaker design, would reduce the unwanted effects brought about by lateral head displacements. That is, the left-hand speaker could be made to give an increasing intensity of sound from left to centre, whilst the right-hand speaker could be made to produce a skewed and increasing intensity distribution from right to centre. In this way, manipulation of time and intensity would assist in stabilizing the stereo image so that lateral movements would not be so disruptive as they are with conventional "properly-adjusted" stereo. In the case of a four-speaker surround-sound system, skewing the sound distribution for the two speakers at the front could also be accomplished, but an attempt to compensate for fore and aft movements of the listener by varying energy distribution in a static fashion, would not work. It could be done only by means of a monitoring device which would give positional information to the amplifiers, so controlling their output depending upon the position of the (one) listener. This is impracticable, but I mention it for the benefit of lonely electronics wizards who may like to experiment and who don't mind not sharing their recorded musical experiences with another person!

### HEADPHONES ALSO

Theoretically, since we have only two ears, it seems at first sight that it should be possible to duplicate life-like sounds by reproducing at the ears the same variations in sound pressure level which would occur at the concert hall. This automatically suggests the use of headphones, but as already stated, the effect will be a static one as though the head of the listener were clamped immovably in the concert hall. Head movements, with consequent selective focussing of attention upon one instrument or groups of instruments, are not possible in the case of headphone listening.

But there is no reason why the proposed "three plus one" system should not be adaptable for headphone listening as well as for loudspeaker listening, (nor would it be necessary to have a central bone-conduction third headphone!) The signal from the centre channel could be fed equally to left and right earphones in order to produce a central sound image in combination with the discrete left and right information. Much to the sorrow of headphone enthusiasts there have been few recordings made specifically for the headphone listener, although when these needs are taken into

consideration and recordings are made specifically for headphones, then the results are said to be extremely realistic. The technique "transports" the listener's head (in effect) to the position occupied by the microphones during recording. In the case of loudspeakers the situation for stereo reproduction is in many ways less satisfactory than for headphone listening, since to achieve stability, the listener must stay on a line equidistant from the two loudspeakers. The impression that a sound comes from between the two speakers is purely illusory and requires that both speakers produce identical signals. Any movement of the listener's head towards one of the speakers will destroy the illusion and the sound image of the centrally-located piano will move towards the nearer (and now apparently louder) loudspeaker.

Stereophonic listening has similarities to the Phi phenomenon in vision where if two lights a short distance apart flash on and off alternately at a particular rate, then the light appears to move from one side to the other and back again. This depends upon the ability of the brain to interpret the rate of alternate flashing as a "movement" from one side to the other. However, the observer cannot attend to what is happening between the two lights since there is nothing there.

The limitation of stereophonic listening is that the illusion of a centre-stage sound source is easily destroyed, since there is no stable sound source which can preserve directionality in the presence of movement of the listener from a central position.

### HOW MANY SPEAKERS?

Ideally for maximum realism, each musical instrument should be represented by its own discrete channel and loudspeaker, but the psychological determinant of how many loudspeakers should be used for the reproduction of music is the sound-resolving acuity of the listener. For example, what is the smallest angular separation between sound sources which can be resolved by a listener? (This is a problem on which some work is being carried out by the writer). The other determinant of the number of loudspeakers which can be used is the limitation due to physical size. Few living rooms would conveniently house more than three electrostatic speakers in line abreast. (Nor one imagines would they be allowed to!) This would be particularly so in the case of the excellent double Quad speakers constructed by "The Radio People" in Hong Kong.

*Continued on page 21*

# AMBISONIC SOUND

Terry Mendoza reports

'three plus one' — or just plain three.

THE history of sound reproduction has been punctuated by a series of advances, each attempting to bring the fidelity nearer to that of the original performance.

The first systems were monophonic. They could approximate the sound but with no directional information.

Then, directional content, covering a sector (between  $30^{\circ}$  and  $90^{\circ}$ ) in front of the listener, was achieved by imprinting two channels of information onto the record groove. Recording technique permitting, realistic 'instrument placement' was now possible. However, the results were a poor copy of the original. The recorded ambience lacked the 'surrounding' quality of the original performance, which existed above and to the rear of the concert goer. Not just in the sector ahead of him.

The answer was to register enough extra signal information which was related, but not identical, to the information carried by the original two channels, so that fill-in speakers could be placed to the rear of the listener. 'Quadrophony' was hailed as the means by which this most realistic reproduction could be achieved.

## AN ERRONEOUS CONCEPT

But at this point the industry confused the public with an erroneous concept of what the use of 'quadrophony' should actually be. It should not have been, for the re-creation of the four-channel master tapes that just happened to be the current studio standard, but to re-create the stage before i.e. the original performances.

Secondly, the conventional so-called 'matrixed' disc could just as correctly be termed a 'mixed' disc, for no matter how elaborately it has been mixed down, it will only contain *two* channels of information. But these two channels can be connected (if desired) to a multiplicity of speakers, and in numerous ways, so that each speaker produces an individual, but not completely independent, output.

Despite what has been said regarding matrixing, it *is* possible to derive unambiguous directional information to locate a source anywhere over the whole listening sphere from suitably encoded material on a two-channel disc.

Unfortunately this system is not

being correctly used by the record companies. They have found that they can get more mileage from their four-channel masters by blending between adjacent tracks — in the same way that a stereo pan-pot positions sound between speakers. This pair-blending results in the listener receiving the subjective impression of being in the centre of the orchestra, but does not re-create the original ambience which should surely be the point of the exercise.

## FOUR CHANNELS UNNECESSARY

In practice, four discrete channels are unnecessary. In most cases identical results could be achieved using only three information channels. Indeed a realistic panoramic plot is only possible on a four-channel pair-blending system if the microphones used have a perfect sinusoidal polar response over  $180^{\circ}$  and a zero response over the other  $180^{\circ}$  — as yet no such mikes exist!

Conventional stereo broadcasting utilises a sub-carrier with double sidebands, hence there is sufficient band-width here to provide a third information channel derived by the phase modulation of the sub-carrier. Now the information channels on a conventional disc need not only be regarded as 'left side groove modulation' translating into left channel, and 'right side' into right channel, but they may also be thought of in terms of lateral modulation providing a monophonic signal and vertical ('hill and dale') modulation determining stereo difference. Considered in this fashion a 'third channel' disc principle could follow from the earlier example of three-channel FM transmissions.

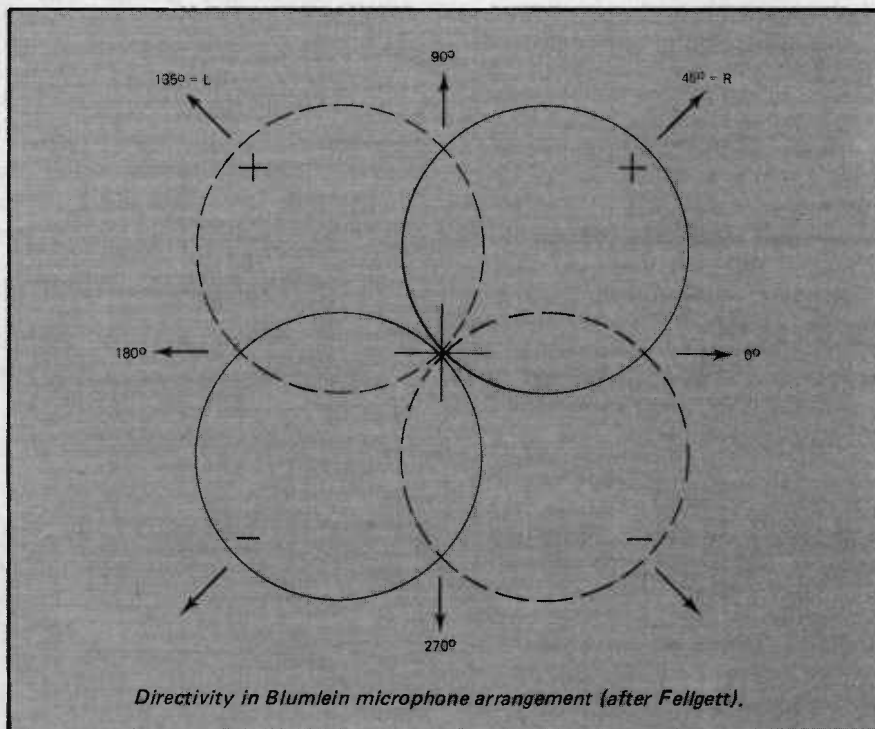

## AMBISONIC REPRODUCTION

Ambisonic reproduction, that is re-creating the ambience of the original recording situation with associated directionality, can be sub-divided into periphonic and pantophonic systems, the former concerning a complete sphere of information, the latter relating to a horizontal circle (of which stereo can

# FOUR-CHANNEL PSYCHO-ACOUSTICS

be regarded as forming one quadrant) Pantophonic reproduction does not distinguish vertical directionality, but still achieves remarkable realism.

All reproduction systems must relate back to the original microphone placement and mix-down. Surprisingly, the Blumlein configuration which was one of the earliest of stereophonic microphone arrangements, is tailor-made for pantophonic purposes — it consists of two matched mutually-perpendicular figure-of-eight microphones. When considered for this application, its two basic drawbacks are phasing difficulties when ultimately fed to loudspeakers, and a 180° ambiguity, i.e. a sound could be in front and to the left of the listener, or behind and to his right. Adding a pressure microphone to the Blumlein arrangement provides a phase reference which removes ambiguity; the outcome is a feasible arrangement whereby realistic 360° pantophonic sound can be conveyed via three information channels. This, as has been discussed earlier, could already be compatible with FM transmissions and, subject to certain limitations, could be applied to a two channel disc.

In conclusion, four-channel sound now suffers from the situation where an existing means was adapted towards a dubious end. With the possibility of far greater realism offered by ambisonic sound, the means are now being re-assessed.

Nevertheless, the adaptation of any ambisonic system will still allow the option of pan-potting multi-channel inputs around the panorama. The problem will be to dissuade the record companies from re-processing their four-channel masters and developing instead the new record art-form necessary to use ambisonics to best advantage.

REFERENCES: FELLGETT, P.: 'Ambisonic Reproduction of Sound', Electronics & Power 15th November 1973.

FELLGETT, P.: 'Directional Information in Reproduced Sound', Wireless World, September 1972.

GERZON, M.: 'Experimental Tetrahedral Recording', Studio Sound, Aug., Sept. & Oct. 1971. ●

Continued from page 19

It is difficult to generalise about the number of speakers which would be required to duplicate all the spatial characteristics of, for example, a symphony orchestra, since the ability to locate with any degree of accuracy, the source of a particular sound depends upon a large number of factors. The accuracy of localization of sounds varies with frequency (Stevens & Newman 1934, 1936). High frequencies are more easily localized than low frequencies since high frequency sounds tend to be propagated in narrow beams unless steps are taken to avoid this. Low frequency sounds tend to be propagated in an omnidirectional fashion and so their source of origin is more difficult to locate. Transients also have properties which make it possible to determine their source more easily than that of a steady tone. There are possibly several reasons for this, one of which may be that transients tend to have a high frequency content which may aid localization for the reason previously stated. This extended high frequency content of cymbal transients can be shown by playing a stereo record through a CD-4 demodulator, for example the cymbal clashes on the Decca test record SKLM 4861 cause the "Radar" pilot light to be activated, indicating that the frequencies extend up to that of the CD-4 carrier signal. (Some distortion is produced when this occurs so that stereo records should not normally be played via a demodulator in the CD-4 mode).

... the ear apparently responds to high intensity spikes by generating a range of frequencies rather than a narrow band. In other words the ear 'generates' additional information which may aid in localization.

A property of the auditory system, which may also assist in localization of transients, is that it reacts maximally to abrupt changes in energy level. The high contrast feature of transients may in addition make them less easily obscured by reflected or standing waves of about the same frequency. Transients tend also to be of high amplitude and the ear apparently responds to high intensity spikes by

generating a range of frequencies rather than a narrow band. In other words the ear "generates" additional information which may aid in localization. Hendrickson (1973) states that: "work with single units of the auditory nerve has shown that they respond to a single or narrow band of frequencies at threshold intensities and to an increasing range of frequencies as intensity is increased".

## THREE IN LINE

Some or possibly all of these properties assist in the auditory localization of sounds, and from a practical point of view, the accuracy of sound reproduction provided by three speakers arranged in line represents a reasonable compromise between convenience and effectiveness.

To summarise, there is a possible argument for the modification of recording and playback techniques in the case of quadraphonic sound to give a three discrete-channel frontal sound source and one discrete rear channel for ambience. The argument stresses the need to duplicate sound pressure level gradients in the case of loudspeaker listening so as to stabilize the auditory image and give an improved sense of directionality. An additional advantage would be a reduction in the information load which the frontally-located speakers would carry.

... quadrophony will stand or fall upon its ability to bring a greater degree of realism to the reproduction of music.

Quadraphony will stand or fall upon its ability to bring a greater degree of realism to the reproduction of music. The race for supremacy between rival quadraphonic systems may eventually be decided not by parameters such as decibels of channel separation, but by the utilization of the system in a way which will persuade music-lovers that there is a significant gain in realism.

Possibly the proposed "three plus one echo" system may convince them that there is an audible advantage over stereo or the present quadraphonic "two plus two echoes" system. ●

# The largest selection

## EX COMPUTER BOARDS

Packed with transistors, diodes, capacitors and resistors—COMPONENT VALUE £1.50. 3 for ONLY 55p + p & p 30p  
**SPECIAL.** As above PLUS Power Transistors ONLY 55p each + p & p 15p  
**STABILISED POWER MODULES**  
 Complete with circuit diagrams, etc. 99p each + p & p 15p  
**PAXOLINE BOARDS** 7 1/2 x 9" approx. 4 for 30p + p & p 20p.

## FIBRE-GLASS PRINTED CIRCUIT BOARDS

1 x 4" approx. 2 for 55p

## DECON-DALO 33pC Marker

etch resistant printed circuit marker pen 7p each

## VEROBOARDS

Packs containing approx. 50sq. ins. various sizes, all 0-1 metric 55p

## REPANCO CHOKES & COILS

4/F Chokes  
 CH1. 2.5mH 25p CH2. 5.0mH 25p  
 CH3. 7.5mH 25p CH4. 10mH 25p  
 CH5. 1.5mH 25p

## COILS

DRX1 Crystal set 56p DRR2 Dual range 45p

## COIL FORMERS & CORES

NORMAN 1/2 Cores & Formers 7p  
 1/2 Cores & Formers 5p

## SWITCHES

DP/DT Toggle 25p SP/ST Toggle 15p

## FUSES

1 1/2" and 20mm, 100mA, 200mA, 250mA, 500mA, 1A, 1.5A, 2A  
 QUICK-BLOW 4p ea. ANTI-SURGE 5p ea.

## EARPHONES

Crystal 2.5mm plug 89p  
 Crystal 3.5mm plug 89p  
 8 ohms 2.5mm plug 22p  
 8 ohms 3.5mm plug 22p

## DYNAMIC MICROPHONES

B1293. 200 ohms plus on/off switch and 2.5mm and 3.5mm plugs £1.60

## 3-WAY STEREO HEADPHONE JUNCTION BOX

H1012 £1.87

## 2-WAY CROSSOVER NETWORK

K4007. 80 ohms Imp. Insertion loss 3dB £1.21

## TRANSISTOR EQUIVALENT BOOK

8th EDITION  
 256 pages of cross references and equivalents for European, American and Japanese transistors. Approximately 9,000 types with more than 55,000 substitutes have been included. The tables were compiled with the utmost care from manufacturers own specification. The most comprehensive Equivalents Book on the market today!  
**ONLY £1.85**

## INSTRUMENT CASES



(Black Vinyl covered)  
 No. Length x Width x Height Price  
 BV1 8" x 5 1/2" x 2" 90p  
 BV2 11" x 8" x 3" £1.20

## ALUMINIUM BOXES

BA1 5 1/2" x 2 1/2" x 1 1/2" 42p  
 BA2 4" x 4" x 1 1/2" 41p  
 BA3 4" x 2 1/2" x 1 1/2" 41p  
 BA4 5 1/2" x 4" x 1 1/2" 47p  
 BA5 4" x 2 1/2" x 2" 41p  
 BA6 3" x 2" x 1" 84p  
 BA7 7" x 5" x 2 1/2" 66p  
 BA8 8" x 6" x 3" 84p  
 BA9 6" x 4" x 2" 54p

PLEASE NOTE: ALL OUR PRICES INCLUDE V.A.T.  
**MODEL AMTRON KITS**

Model No.	Description	Price
UK65	Simple transistor tester	£ 1.88
UK145	Amplifier 1.5W	£ 4.37
UK220	Signal Injector	£ 3.13
UK230	A.M./FM Antenna Amplifier	£ 3.88
UK275	Mike Pre-amplifier	£ 8.03
UK300	4-channel Radio Control Transmitter	£ 8.03
UK310	Radio Control Receiver	£ 3.93
UK325	'GCX' Channel splitting unit 1,000 & 2,000 Hz	£ 9.44
UK330	'GCX2' Channel splitting unit 1,500 & 2,500 Hz	£ 9.44
UK000	Superhetrodyne Radio Control Receiver	£ 7.85
UK525	VHF Tuner 120 to 160 MHz	£14.93
UK555	Radio Control Field Strength Meter	£12.74
UK705	Windscreens Wiper timer	£ 8.98
UK710	4-Channel AF mixer	£14.68
UK750	Electronic Unit for Metal Detector	£12.74
UK835	Guitar pre-amplifier	£ 5.67
UK875	Capacitive Discharge Electronic Ignition for Internal Combustion Engines	£17.41

## VISIT OUR COMPONENT SHOP

18 BALDOCK ST., WARE, HERTS. (A10)

open Mon.-Thurs. 9.15-6 p.m. Sat. 9.15-5.30. Late Night Shopping until 7 Fri. Tel. 61593

## BIB HI-FI ACCESSORIES

De Luxe Groov-Kleen  
 Model 42 £1.84  
 Chrome Finish Model 60 £1.50



Ref. 36A. Record/Stylus Cleaning Kit 28p  
 Ref. 43. Record Care Kit £2.85  
 Ref. 31. Cassette Head Cleaner 54p  
 Ref. 32. Tape editing Kit £1.54  
 Model 9. Wire Stripper/Cutter 83p

Ref. P. Hi-Fi Cleaner 31p  
 Ref. 32A. Stylus Balance £1.88  
 Ref. J. Tape Head Cleaning Kit 51p  
 Ref. 34. Cassette Case £1.27  
 Ref. 56. Hi-Fi Stereo Hints & Tips 32p

## ANTEX SOLDERING IRONS

X25. 25 watt £1.93  
 CCN 240. 15 watt £2.15  
 Model G. 18 watt £2.15  
 SK2. Soldering Kit £2.86  
 STANDS: ST1 £1.21. ST2 77p  
 SOLDER: 18SWG Multicores 7oz 82p  
 22SWG 7oz 82p. 18SWG 22ft 28p  
 22SWG Tube 22p

## ANTEX BITS and ELEMENTS

Bits No.  
 102 For model CCN240 3 1/2" 38p  
 104 For model CCN240 4" 38p  
 1100 For model CCN240 3 1/2" 38p  
 1101 For model CCN240 4" 38p  
 1102 For model CCN240 4" 38p  
 1020 For model G240 3 1/2" 38p  
 1021 For model G240 4" 38p  
 1022 For model G240 4" 38p  
 50 For model X25 1 1/2" 38p  
 51 For model X25 1" 38p  
 52 For model X25 1 1/4" 38p

## ELEMENTS

ECN 240 £1.16 EOCN 240 £1.32  
 EG 240 £1.16 EX 25 £1.16

## ANTEX HEAT SINKS 10p

V A T included in all prices. Please add 10p P. & P. (U.K. only). Overseas orders—please add extra for postage.

## NEW COMPONENT PAK BARGAINS

Pack No. Qty.	Description	Price
C1 250	Resistors mixed values approx. count by weight	0.55
C2 200	Capacitors mixed values approx. count by weight	0.55
C3 50	Precision Resistors mixed values 1-2%	0.55
C4 75	1/2W Resistors mixed preferred values	0.55
C5 5	Pieces assorted Ferrite Rods	0.55
C6 2	Tuning Gangs, MW/LW VHF	0.55
C7 7	Pack Wire 50 metres assorted colours	0.55
C8 10	Reed Switches	0.55
C9 3	Micro switches	0.55
C10 15	Assorted Pots & Pre-Sets	0.55
C11 5	Jack Sockets 3 x 3.5mm 2 x Standard Switch Type	0.55
C12 40	Paper Condensers preferred types mixed valued	0.55
C13 20	Electrolytic Trans. types	0.55
C14 1	Pack assorted Hardware—Nuts/Bolts, Grommets etc.	0.55
C15 4	Mains Slide Switches, 2 Amp	0.55
C16 20	Assorted Tag Strips & Panels	0.55
C17 10	Assorted Control Knobs	0.55
C18 4	Rotary Wave Change Switches	0.55
C19 3	Relays 6-24V Operating	0.55
C20 4	Sheets Copper Laminate approx. 10" x 7"	0.55

## PLUGS AND SOCKETS

PS	Description	Price
PS 35 DIN	2 Pin (Speaker)	0.06
PS 36 DIN	3 Pin	0.10
PS 37 DIN	8 Pin 180°	0.10
PS 38 DIN	5 Pin 240°	0.10
PS 39	Jack 2.5mm Switched	0.09
PS 40	Jack 3.5mm Switched	0.10
PS 41	Jack 1" Switched	0.17
PS 42	Jack Stereo Switched	0.26
PS 43	Phono Single	0.08
PS 44	Phono Double	0.10
PS 45	Car Aerial	0.09
PS 46	Co-Axial Surface	0.09
PS 47	Co-Axial Flush	0.14

## PLUGS

PS	Description	Price
PS 21	D.I.N. 2 Pin (Speaker)	0.13
PS 22	D.I.N. 3 Pin	0.17
PS 23	D.I.N. 5 Pin 180°	0.17
PS 24	D.I.N. 5 Pin 240°	0.17
PS 25	Jack 2.5mm Plastic	0.10
PS 26	Jack 3.5mm Plastic	0.12
PS 27	Jack 1" Plastic	0.24
PS 28	Jack 1" Screened	0.28
PS 29	Jack Stereo Plastic	0.22
PS 30	Jack Stereo Screened	0.32
PS 31	Phono Screened	0.14
PS 32	Car Aerial	0.15
PS 33	Co-Axial	0.17

## CABLES

CP	Description	Price
CP 1	Single Lapped Screen	0.06
CP 2	Twin Common Screen	0.08
CP 3	Stereo Screened	0.08
CP 4	Four Core Common Screen	0.23
CP 5	Four Core Individually Screened	0.30
CP 6	Microphone Fully Braided Cable	0.10
CP 7	Three Core Mains Cable	0.07
CP 8	Twin Oval Mains Cable	0.06
CP 9	Speaker Cable	0.04
CP 10	Low Loss Co-Axial	0.10

## CARBON POTENTIOMETERS

VC	Description	Price
VC 1	Single Less Switch	0.14
VC 2	Single D.P. Switch	0.26
VC 3	Tandem Less Switch	0.44
VC 4	1K Lin Less Switch	0.14
VC 5	100K Log anti-Log	0.14

## HORIZONTAL CARBON PRESETS

0.1 watt 0.06 each  
 100, 220, 470, 1K, 2.2K, 4.7K, 10K, 22K, 47K, 100K, 220K, 470K, 1M, 2M, 4.7M

## SELENIUM BRIDGE RECTIFIERS

18V. 2A. Ideal for those building battery, chargers. 15p each. 10 for 55p

## REPANCO TRANSFORMERS

240V. Primary. Secondary voltages available from selected tapplings 4V, 7V, 8V, 10V, 14V, 15V, 17V, 19V, 21V, 25V, 31V, 33V, 40V, 50V, and 25V-0-25V.

Type	Amps	Price	P * P
MT50/4	1/4	£1.83	30p
MT50/1	1	£2.42	35p
MT50/2	2	£3.30	40p

## WORLD SCOOP! JUMBO SEMICONDUCTOR PACK

Transistors-Germ and Silicon  
 Rectifiers-Diodes-Triacs-Thyristors  
 I,C's and Zenners ALL NEW AND CODED  
**APPROX 100 PIECES!**

Offering the amateur a fantastic bargain Pak and an enormous saving—identification and data sheet in every Pak  
**ONLY £2 p & p 20p**

## EX-COMPUTER BOARDS—BY THE BOXFULL!!

20 Boards packed with Semiconductors and other Electronic Components. Each board approx. size 8" x 7". All known type no. and easily recognisable  
**FANTASTIC VALUE AT £2.20 per BOX p & p 52p.**

**SPECIAL PURCHASE by BI-PAK 2N3055.** Silicon Power Transistors NPN  
 Famous manufacturers out-of-spec devices free from open and short defects—115 watts TO3. Metal Case.  
**OUR SPECIAL PRICE 8 for £1.**

**LOW COST CAPACITORS**  
 0.1 µF 400V 3p each  
 500 µF 50V Elect. 10p each

**RECORD STORAGE/CARRY-CASES**  
 7" EP. 18 1/2" x 7" x 8". (50 records) £2.10  
 12" LP. 13 1/2" x 7 1/2" x 12 1/2". (50 records) £2.95

**CASSETTE CASES**  
 Holds 12. 10" x 3 1/2" x 5". Lock & Handle £1.30

**8-TRACK CARTRIDGE CASES**  
 Holds 14. 13" x 5" x 6". Lock & Handle. £1.95  
 Holds 24. 13 1/2" x 8" x 5 1/2". Lock & Handle. £2.70

COLOURS: Red, Black and Tan—Please state preference.

## ALL PRICES INCLUDE VAT

## CARTRIDGES

ACOS GP91-1SC. 200mV at 1.2cms/sec £1.16  
 ACOS GP93-1. 280mV at 1cm/sec £1.65  
 ACOS GP96-1. 100mV at 1cm/sec £2.65  
 TJC J-2005. Crystal/Hi Output 95p  
 TJC J-200. 10C Crystal/Hi Output Compatible £1.10  
 TJC J-200 CS Stereo/Hi Output £1.60  
 TJC J-2105 Ceramic/Med. Output £1.64

## CARBON FILM RESISTORS

The E12 Range of Carbon Film Resistors. 1/2 watt available in PAKS of 50 pieces, assorted into the following groups:—  
 R1 50 Mixed 100 ohms-820 ohms 40p  
 R2 50 Mixed 1K ohms-8.2K ohms 40p  
 R3 50 Mixed 10K ohms-82K ohms 40p  
 R4 50 Mixed 100K ohms-1 Meg. ohms 40p  
**THESE ARE UNBEATABLE PRICES—LESS THAN 1p EACH INCL. V.A.T.**

## BI-PAK SUPERIOR QUALITY LOW-NOISE CASSETTES

C60, 32p C90, 41p C120, 52p

**SEE OUR COMPLETE RANGE IN PRACTICAL ELECTRONICS, PRACTICAL WIRELESS, RADIO CONSTRUCTOR, EVERYDAY ELECTRONICS, WIRELESS WORLD**

**OR SEND 10p. FOR THE FULL LIST OF ALL BI-PAK PRODUCTS**

## BOOK BARGAIN BUNDLE

- 8 Books comprising:
  - 2 Transistor Equivalent books
  - 1 Radio & Electronic colour code and data chart
  - 1 Radio valve guide PLUS
  - 3 Other constructional books on Receivers, EM Tuners, etc.
  - AT 80 1 General construction book**VALUE £3. OUR PRICE £2 p & p 10p.**
- BP1 Handbook of Transistor Equivalents & Substitutes 40p
- BP2 Handbook of Radio, T.V. & Industrial Tube & Valve Equiv. 40p
- BP3 Handbook of Tested Transistor Circuits 40p
- BP4 International Handbook of the World's Short Wave Radio Stations and FM/T.V. Listings 35p
- BP5 Handbook of Simple Transistor Circuits 35p
- BP7 Radio and Electronics colour codes and Data Chart 15p
- BP8 Sound and Loudspeakers Manual 50p
- BP9 38 Practical Tested Diode Circuits for the Home constructor 35p
- BP10 Modern Crystal and Transistor Set Circuits for beginners 35p
- BP11 Practical Transistor Novelty Circuits 40p
- BP13 Electronic Novelties for the Motorist 50p
- BP14 Second book of Transistor Equivalents 95p
- BP15 Constructors Manual of Electronic Circuits for the home 50p
- 129 Universal Gram Motor Speed Indicator 3p
- 138 How to make FM and T.V. serials Bands 1/2/3 18p
- 141 Radio Servicing for Amateurs 20p
- 146 High Fidelity Loudspeaker enclosures 33p
- 156 Transistor Circuits Manual No. 1 15p
- 160 Coil design and Construction Manual 30p
- 161 Radio T.V. and Electronic Data book 25p
- 174 Transistor sub-miniature receivers 33p
- 175 Transistor Test Equipment & Servicing Manual 25p
- 176 Manual of Transistor Audio Amplifiers 40p
- 178 A comprehensive Radio Valve Guide—Book 5 30p
- 183 How to receive foreign T.V. programmes on your set by simple modifications 33p
- 196 AF-HF Reactance-Frequency chart for Constructors 15p
- 200 Handbook of Practical Electronic Musical Novelties 50p
- 201 Practical Transistorised Novelties for Hi-Fi Enthusiasts 35p
- 202 Handbook of Integrated Circuits Equivalents and Substitutes 75p
- RCO Resistor Colour Code DTM Calculator 10p

# -the lowest prices!

## 74 Series T.T.L. I.C.'S

BI-PAK STILL LOWEST IN PRICE FULL SPECIFICATION  
GUARANTEED. ALL FAMOUS MANUFACTURERS

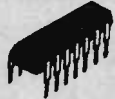

1			25			100+			1			25			100+		
7400	0-18	0-17	0-16	7448	£1.10	£1.07	£1.05	74122	£1.50	£1.45	£1.40						
7401	0-18	0-17	0-16	7450	0-18	0-17	0-16	74123	£3.00	£2.90	£2.80						
7402	0-18	0-17	0-16	7451	0-18	0-17	0-16	74141	0-85	0-82	0-79						
7403	0-18	0-17	0-16	7453	0-18	0-17	0-16	74145	£1.65	£1.55	£1.45						
7404	0-18	0-17	0-16	7454	0-18	0-17	0-16	74151	£1.10	£1.05	£1.00						
7405	0-18	0-17	0-16	7460	0-18	0-17	0-16	74153	£1.30	£1.20	£1.10						
7406	0-39	0-34	0-31	7470	0-32	0-29	0-27	74154	£1.98	£1.90	£1.75						
7407	0-39	0-34	0-31	7472	0-32	0-29	0-27	74155	£1.50	£1.45	£1.35						
7408	0-20	0-19	0-18	7473	0-41	0-39	0-35	74156	£1.50	£1.45	£1.35						
7409	0-20	0-19	0-18	7474	0-41	0-39	0-35	74157	£2.00	£1.90	£1.80						
7410	0-18	0-17	0-16	7475	0-50	0-48	0-46	74160	£2.10	£2.00	£1.90						
7411	0-28	0-27	0-26	7476	0-44	0-43	0-42	74161	£2.10	£2.00	£1.90						
7412	0-39	0-34	0-31	7480	0-74	0-71	0-64	74162	£4.40	£4.15	£3.85						
7413	0-32	0-31	0-30	7481	£1.30	£1.25	£1.20	74163	£4.40	£4.15	£3.85						
7414	0-48	0-44	0-42	7482	0-96	0-95	0-94	74164	£2.10	£2.00	£1.90						
7417	0-48	0-44	0-42	7483	£1.20	£1.15	£1.05	74165	£2.20	£2.10	£2.00						
7420	0-18	0-17	0-16	7484	£1.10	£1.05	£1.00	74166	£3.20	£3.10	£3.00						
7422	0-55	0-53	0-50	7485	£3.50	£3.40	£3.30	74174	£2.50	£2.40	£2.30						
7423	0-55	0-53	0-50	7486	0-35	0-34	0-33	74175	£1.75	£1.65	£1.55						
7424	0-55	0-53	0-50	7487	£4.00	£3.75	£3.50	74176	£1.85	£1.75	£1.65						
7425	0-48	0-46	0-44	7490	0-74	0-71	0-64	74177	£1.85	£1.75	£1.65						
7427	0-50	0-46	0-44	7491	£1.10	£1.05	£1.00	74180	£1.50	£1.40	£1.30						
7428	0-55	0-53	0-50	7492	0-74	0-71	0-64	74181	£5.00	£4.50	£4.00						
7430	0-18	0-17	0-16	7493	0-74	0-71	0-64	74182	£2.00	£1.90	£1.75						
7432	0-50	0-46	0-44	7494	0-85	0-82	0-75	74184	£3.20	£3.10	£3.00						
7433	0-75	0-73	0-70	7495	0-85	0-82	0-75	74188	£2.15	£2.10	£2.00						
7437	0-70	0-68	0-65	7496	0-86	0-83	0-74	74190	£2.15	£2.10	£2.00						
7438	0-70	0-68	0-65	74100	£1.50	£1.45	£1.40	74191	£2.15	£2.10	£2.00						
7440	0-18	0-17	0-16	74104	£1.07	£1.04	£1.00	74192	£2.15	£2.10	£2.00						
7441	0-74	0-71	0-64	74105	£1.07	£1.04	£1.00	74193	£2.15	£2.10	£2.00						
7442	0-74	0-71	0-64	74107	0-44	0-42	0-40	74194	£2.98	£2.86	£2.75						
7443	£1.20	£1.15	£1.10	74110	0-60	0-55	0-50	74195	£2.00	£1.95	£1.90						
7444	£1.20	£1.15	£1.10	74111	£1.38	£1.27	£1.21	74196	£1.95	£1.90	£1.85						
7445	£1.98	£1.95	£1.90	74118	£1.10	£1.05	£1.00	74197	£1.95	£1.90	£1.85						
7446	£1.20	£1.15	£1.10	74119	£1.50	£1.40	£1.30	74198	£5.00	£4.75	£4.50						
7447	£1.10	£1.07	£1.05	74121	0-50	0-48	0-45	74199	£5.00	£4.75	£4.50						

NOW WE GIVE YOU 50W PEAK (25W R.M.S.) PLUS THERMAL PROTECTION!

### The NEW AL60 Hi-Fi Audio Amplifier

- Max Heat Sink temp 90°
- Thermal Feedback
- Frequency Response 20Hz to 100KHz
- Latest Design Improvements
- 0.1% Distortion
- Load - 3, 4, 8 or 16 ohms
- Distortion better than 1% at 1KHz
- Signal to noise ratio 80dB
- Supply voltage 10-35 volts
- Overall size 63mm x 105mm x 13mm

FOR ONLY  
**£3.95**



Especially designed to a strict specification. Only the finest components have been used and the latest solid state circuitry incorporated in this powerful little amplifier which should satisfy the most critical A.F., enthusiast.

FULLY BUILT - TESTED and GUARANTEED

## STABILISED POWER

MODULE SPM80

**£3.25**



AP80 is especially designed to power 2 of the AL50 Amplifiers, up to 15 watt (r.m.s.) per channel simultaneously. This module embodies the latest components and circuit techniques incorporating complete short circuit protection. With the addition of the Mains Transformer MT80, the unit will provide outputs of up to 1.5 amps at 35 volts. Size: 63 mm x 105 mm x 20 mm. These units enable you to build Audio Systems of the highest quality at a hitherto unobtainable price. Also ideal for many other applications including: Disco Systems, Public Address, Intercom Units, etc. Handbook available, 10p.

TRANSFORMER BMT80 £2.15 p. & p. 25p

DEVICES MAY BE MIXED TO QUALIFY FOR QUANTITY PRICE & (TTL 74 SERIES ONLY) DATA AVAILABLE FOR THE ABOVE SERIES OF I.C.'S IN BOOK FORM. PRICE 35p.

### INTEGRATED CIRCUIT PAKS

Manufacturers "Pak Outs" which include Functional and Part-Functional Units. These are classed as 'out-of-spec' from the maker's very rigid specifications, but are ideal for learning about I.C.'s and experimental work.

Pak No.	Contents	Price	Pak No.	Contents	Price	Pak No.	Contents	Price
UI000	-12 ± 7400	0-55	UI048	-5 x 7448	0-55	UI090	-5 x 7490	0-55
UI001	-12 x 7401	0-55	UI049	-5 x 7448	0-55	UI091	-5 x 7491	0-55
UI002	-12 x 7402	0-55	UI050	-12 x 7480	0-55	UI092	-5 x 7492	0-55
UI003	-12 x 7403	0-55	UI051	-12 x 7481	0-55	UI093	-5 x 7493	0-55
UI004	-12 x 7404	0-55	UI052	-12 x 7483	0-55	UI094	-5 x 7494	0-55
UI005	-12 x 7405	0-55	UI054	-12 x 7484	0-55	UI095	-5 x 7495	0-55
UI006	-5 x 7406	0-55	UI060	-12 x 7480	0-55	UI096	-5 x 7496	0-55
UI007	-8 x 7407	0-55	UI070	-8 x 7470	0-55	UI100	-10 x 74100	0-55
UI010	-12 x 7410	0-55	UI072	-8 x 7472	0-55	UI121	-5 x 74121	0-55
UI020	-12 x 7420	0-55	UI073	-8 x 7473	0-55	UI141	-5 x 74141	0-55
UI030	-12 x 7430	0-55	UI074	-8 x 7474	0-55	UI151	-5 x 74151	0-55
UI040	-12 x 7440	0-55	UI076	-8 x 7476	0-55	UI154	-5 x 74154	0-55
UI041	-5 x 7441	0-55	UI080	-5 x 7480	0-55	UI198	-5 x 74198	0-55
UI042	-5 x 7442	0-55	UI081	-5 x 7481	0-55	UI199	-5 x 74199	0-55
UI043	-5 x 7443	0-55	UI082	-5 x 7482	0-55			
UI044	-5 x 7444	0-55	UI083	-5 x 7483	0-55	UIOXI	-25 Assorted 74's 1-55	
UI045	-5 x 7445	0-55	UI086	-5 x 7486	0-55			

Packs cannot be split, but 25 assorted pieces (our mix) is available as PAK UIO X1.

## STEREO PRE-AMPLIFIER TYPE PA100

Built to a specification and NOT a price, and yet still the greatest value on the market, the PA100 stereo pre-amplifier has been conceived from the latest circuit techniques. Designed for use with the AL50 power amplifier system, this quality made unit incorporates no less than eight silicon planar transistors, two of these are specially selected low noise NPN devices for use in the input stages.

Three switched stereo inputs, and rumble and scratch filters are features of the PA100, which also has a STEREO/MONO switch, volume, balance and continuously variable bass and treble controls.

**SPECIAL COMPLETE KIT MK50 COMPRISING 2 AL50's, 1 SPM80, 18MT80 & 1 PA100 ONLY £25.30 FREE p.&p.**



only **£13.15**

### LINEAR I.C.'S - FULL SPEC.

Type No.	Case	1	25	100+
Z2702	DIL 14	0.50	0.48	0.45
Z2709	DIL 14	0.35	0.33	0.30
Z2710	DIL 14	0.45	0.43	0.40
Z2741	DIL 14	0.40	0.38	0.35
Z2741C	TO-5	8	0.45	0.43
Z2741P	DIL 8	0.38	0.36	0.34
Z2748P	DIL 8	0.38	0.36	0.34
SL201C	TO-5	8	0.50	0.45
SL201C	TO-5	8	0.50	0.45
SL202C	TO-5	8	0.50	0.45
TA3263	TO-18	4	0.80	0.70
TA3269	TO-18	4	0.85	0.70
TA3350A	TO-5	10	£1.85	£1.80
pa708C	TO-5	6	0.28	0.26
pa709C	TO-5	8	0.35	0.33
pa711	TO-5	10	0.45	0.43
ZN414	TO-18	4	1.20	

### DTL 930 SERIES LOGIC I.C.'S

Type	1	25	100+
BI9300	0.15	0.14	0.13
BI9302	0.16	0.15	0.14
BI9303	0.16	0.15	0.14
BI9304	0.16	0.15	0.14
BI9305	0.16	0.15	0.14
BI9306	0.16	0.15	0.14
BI9307	0.16	0.15	0.14
BI9308	0.16	0.15	0.14
BI9309	0.16	0.15	0.14
BI9310	0.16	0.15	0.14
BI9311	0.16	0.15	0.14
BI9312	0.16	0.15	0.14
BI9313	0.16	0.15	0.14
BI9314	0.16	0.15	0.14
BI9315	0.16	0.15	0.14
BI9316	0.16	0.15	0.14
BI9317	0.16	0.15	0.14
BI9318	0.16	0.15	0.14
BI9319	0.16	0.15	0.14
BI9320	0.16	0.15	0.14
BI9321	0.16	0.15	0.14
BI9322	0.16	0.15	0.14
BI9323	0.16	0.15	0.14
BI9324	0.16	0.15	0.14
BI9325	0.16	0.15	0.14
BI9326	0.16	0.15	0.14
BI9327	0.16	0.15	0.14
BI9328	0.16	0.15	0.14
BI9329	0.16	0.15	0.14
BI9330	0.16	0.15	0.14
BI9331	0.16	0.15	0.14
BI9332	0.16	0.15	0.14
BI9333	0.16	0.15	0.14
BI9334	0.16	0.15	0.14
BI9335	0.16	0.15	0.14
BI9336	0.16	0.15	0.14
BI9337	0.16	0.15	0.14
BI9338	0.16	0.15	0.14
BI9339	0.16	0.15	0.14
BI9340	0.16	0.15	0.14

### DUAL-IN-LINE SOCKETS.

Type	Description	1	25	100+
301GE	Minimum 7 Segment Indicator			£1.50
MAX 3M	L.E.D. Segment Display 0.27" High Characters			£1.90
CD 66	Side Viewing Sixix-Type Tube 13mm			£1.87
GR 116	Side Viewing Nixix-Type Tube 13mm			£1.70

### 3 TERMINAL POSITIVE VOLTAGE REGULATORS

Type	1	25	100+
pa7805	5V (Equip. to 3V/RSV)		£1.76
pa7812	12V (Equip. to 3V/RSV)		£1.76

### TEAK VENEERED CABINETS for:

- STEREO 20  
TC 20. £3.95 p&p 30p.
- MK 50 KIT  
TC 100. £6.50 p&p 40p.
- E.M.I. LEK 350 Loudspeaker System Enclosure kit in Teak Veneer, including speakers.  
Rec Retail Price £45.50 per pr.  
OUR SPECIAL PRICE £35.50 per pair p&p £1. ONLY WHILE STOCKS LAST!

## The STEREO 20

The 'Stereo 20' amplifier is mounted, ready wired and tested on a one-piece chassis measuring 20 cm x 14 cm x 5.5 cm. This compact unit comes complete with on/off switch volume control, balance, bass and treble controls, Transformer, Power supply and Power amp. Attractively printed front panel and matching control knobs. The 'Stereo 20' has been designed to fit into most turntable plinths without interfering with the mechanism or, alternatively, into a separate cabinet. Output power 20w peak. Input 1 (Cer.) 300mV into 1M. Freq. res. 25Hz-25KHz. Input 2 (Aux.) 4mV into 30K. Harmonic distortion. Bass control ±12dB at 60Hz typically 0.25% at 1 watt. Treble con. ±14dB at 14KHz.

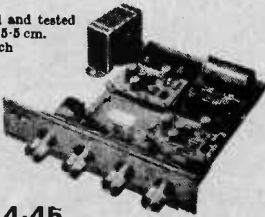

**£14.45**

### FRONT PANEL, 4 knobs, Headphone Socket, on/off switch and neon for PA 100/MK 50. FPK 100 £2.95.

### TRANSFORMERS

T461 (Use with AL10)	£1.88 P & P 15p
T538 (Use with AL20)	£1.98 P & P 15p
BMT80 (Use with AL30 & AL60)	£2.15 P & P 25p

### POWER SUPPLIES

PS 12. (Use with AL10 & AL20)	88p
SPM 8	

# INTERNATIONAL MUSIC SYNTHESIZERS

The Voltage Controlled Filter module has a 100:1 control range.

**eti** 3600/4600

THIS month we describe the operation and construction of the Voltage Controlled Filters (VCF). These filters have more than a two decade range and provide switchable lowpass, highpass and bandpass modes of operation, all with a 12 dB per octave slope.

The operation of this filter is covered by Provisional Patent (Aust) 3651.

## CONSTRUCTION

The method of assembly is similar to that used for most of the other modules. A small aluminium bracket is used to hold the printed circuit board and associated switches and potentiometers.

When assembling the components to the printed circuit board the usual care must be taken with the orientation of

### PARTS LIST V.C.F.

R1	Resistor	220 k	¼W	5%
R2	"	22k	"	"
R3	"	680Ω	"	"
R4	"	6.8 k	"	"
R5	"	39Ω	"	"
R6	"	330Ω	"	"
R7,8,14	"	1.2 k	"	"
R17,	"	1.2 k	"	"
R9	"	200 k	"	"
R10	"	150 k	"	"
R11	"	100 k	"	"
R7,8,14	"	10 k	"	"
R15,18,19	"	10 k	"	"
R20	"	3.3 k	"	"
RV1	Potentiometer	100 k log		
		rotary		
RV2	"	25 k lin	rotary	
C1,5,10,15	Capacitor	33pF	ceramic	
C2	"	470pF	"	
C3	"	47pF	"	
C4	"	0.082μF	polyester	
C6,8,11,13	"	0.022μF	polyester	
C7,9,12,14	"	0.0047μF	polyester	
C16,17,18,20	"	10μF 20V	tag tantalum	
			or pc	
			electrolytic	
C19	"	0.01μF	polyester	
Q1,3	Transistor	PN3638	or similar	
Q2	"	PN3643	"	
IC1,3,4,5	integrated circuit	LM301A		
IC2	integrated circuit	SCL4001AL	**	
IC6	integrated circuit	SCL4016AL	*	

\*\* MUST be Solid State Scientific.  
\* Prefix and suffix varies from manufacturer to manufacturer.  
D1-D3 diode 1N914  
SW1 3 pole 3-position rotary switch  
SW2 4-pole 2-position toggle switch

PC Board ETI 601 h  
metal bracket to Fig. 3.

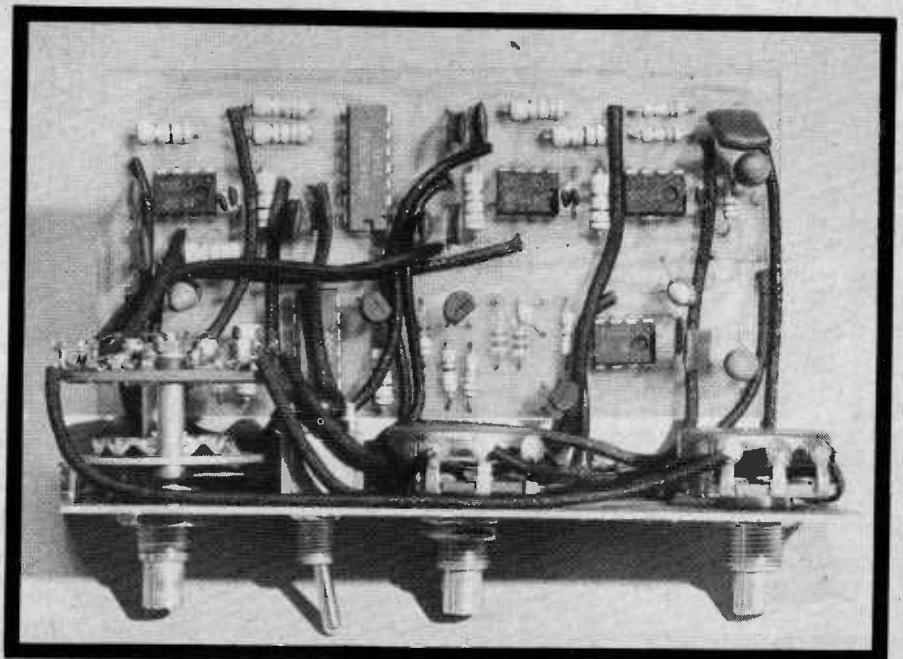
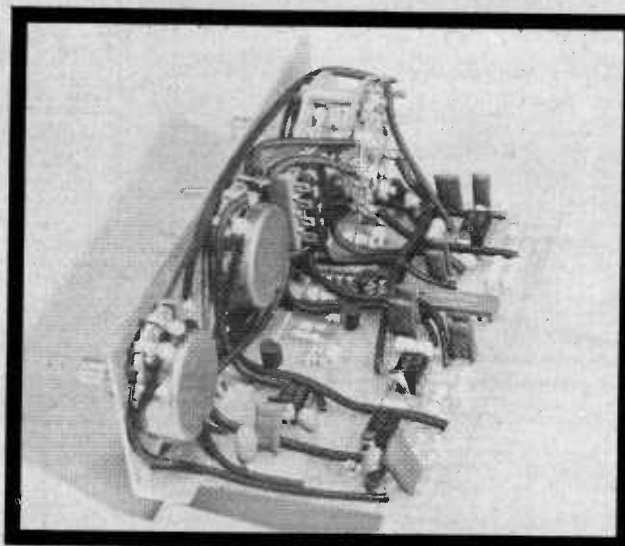



# ERRATA

March 1974, page 79.  
 In the parts list for the mixer Q1, Q21, Q41, Q61 and Q81 should be BC558 or BC178. Q2, Q22, Q42, Q62, Q82 should be BC548 or BC108. (The two lines were inadvertently transposed).

NOTES  
 O1, O7 PN3638 OR SIMILAR  
 O3 PN3643 OR SIMILAR  
 D1 D3 1N914  
 IC1, IC3, IC4, IC5, LM301A  
 IC2 SCL4001 AL  
 (SOLID STATE SCIENTIFIC ONLY)  
 IC6 SCL4016 AL

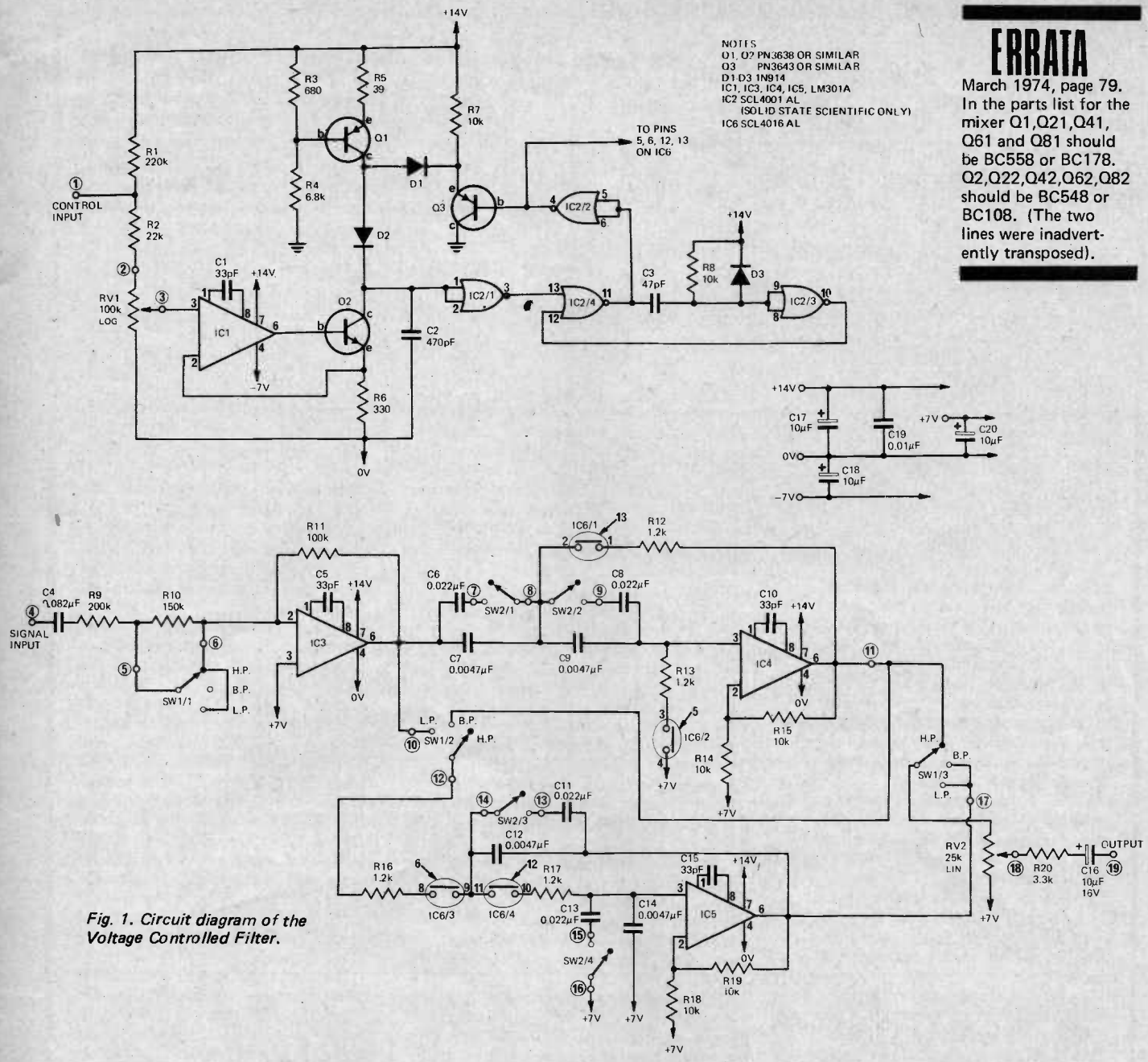
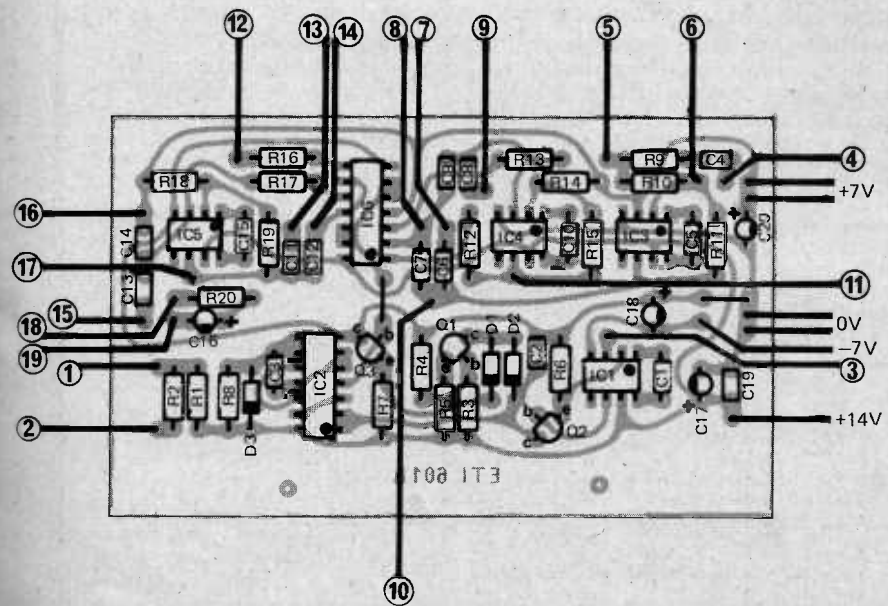

Fig. 1. Circuit diagram of the Voltage Controlled Filter.

Fig. 2. Component overlay of VCF.



## SPECIFICATION

MODES	low pass high pass band pass
SLOPES	12 dB/octave
Q	bandpass 1.5
CONTROL RANGE	> 100 : 1
FREQUENCY RANGE (Nominal)	
Low range	20 Hz - 2 kHz
High range	100 Hz - 10 kHz
INPUT VOLTAGE RANGE	
Time control at maximum.	30 mV - 5 V

NOTE: Low end of range is limited by the chopping frequency dropping below 20 kHz thus becoming audible. High end of range is limited by the maximum obtainable oscillator frequency. (> 2MHz).

# INTERNATIONAL MUSIC SYNTHESIZERS

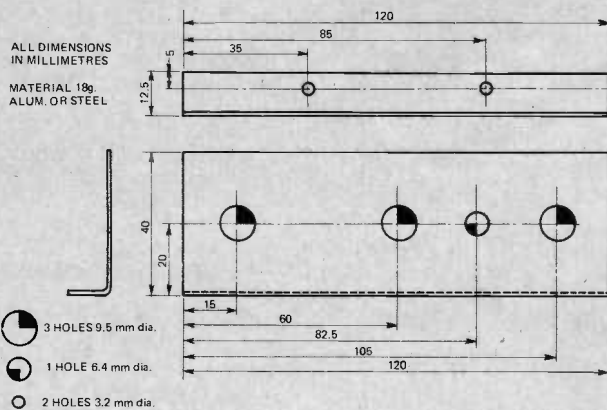

Fig. 3. VCF mounting bracket.

## HOW IT WORKS

The voltage Controlled Filter consists of four main sections:

1. The Buffer Amplifier.
2. A High Pass Filter.
3. A Low Pass Filter.
4. A Voltage/Frequency Converter.

The buffer amplifier, IC3, is used to provide a high input impedance (greater than 200 k) and a level shift. In the low pass and high pass modes the gain is approximately -6 dB and in the bandpass mode -11 dB. The reason for this will become obvious as we proceed. Note, that although we have called this circuit an amplifier, the output is in fact less than the input.

If, for the moment, the CMOS ICs (which are analogue switches) are considered to be ON (IC6, 4016), it may be seen that the highpass (IC4) and lowpass (IC5) filters are normal 2-pole active types. They have a gain of 6 dB (which accounts for the 6 dB loss in the buffer) and have a 1 dB rise just before cutoff frequency is reached.

In the bandpass mode the two filters are connected in series and the resultant overall gain is 11 dB, hence the 11 dB cut in the buffer-amp in this mode.

Thus it can be seen that by selecting buffer gains the overall gain is held at unity in all modes.

Note that the supply rails are +14 volts and zero. Thus the 'common' line, as used internally in the unit, is +7 volts.

To vary cutoff frequency, either the resistive or capacitive arms of the filter must be altered. To select the HIGH or LOW range (10 kHz or 2 kHz nominal upper limit) we change the capacitive arms. For voltage control we use special circuitry to change the resistive arms as follows:

If a resistor is switched in and out of circuit at a variable rate, and for a fixed duration, the effective resistance will be equal to  $R_x \text{ TOTAL TIME/ON TIME}$ . A voltage-controlled oscillator is used to switch the resistive arms of the

filter on for a period of 200 nanoseconds and off for a time which is made variable. Take for example R12 (1.2 k) which is switched by IC6/1 (CMOS IC has a resistance of about  $300\Omega$  when on). If IC6/1 is switched at 1 MHz the effective resistance will be

$$\frac{(1200 + 300) \times 10^{-6}}{200 \times 10^{-9}} = 7500\Omega$$

If the oscillator frequency is reduced to 100 kHz the effective resistance will be 75 k, since the cutoff frequency of the filter is proportional to resistance, and the resistance is proportional to chopping frequency. If now the chopping frequency is made proportional to input voltage, it can be seen that cutoff frequency will be proportional to input voltage.

The voltage-to-frequency converter used does in fact have a linear relationship from about 10 kHz to 3.5 MHz. Frequencies below 20 kHz however should not be used, as the chopping frequency will become audible.

A variable constant-current source is provided by IC1 and Q2, where the base-emitter voltage of Q2 is compensated by taking feedback from the emitter of Q2 to IC1. A further constant current source is provided by Q1. The current from Q1 can flow either via Q3 to ground (output of IC2/2), or through Q2 as well as into C2. The current provided by Q1 is higher than the maximum available through Q2 and thus C2 will be charged by a constant current

polarized components. Assemble the components to the board in accordance with the overlay Fig. 2, using sockets for the CMOS ICs at least. Note that IC2 MUST be a SCL4001AL as made by Solid State Scientific. Although this component is made under the same number by other companies, the Solid State Scientific version is much faster and has a much narrower linear region. If another brand is substituted the oscillator may work over a restricted range, or worse still may not work at all.

Wiring from the printed circuit board to switches and potentiometers is as shown in Fig. 4.

(when IC2/2 is high) the value of which is determined by the input voltage.

The voltage on C2 is passed to the input of IC2/1 such that if this voltage is above approximately 7 volts the output of IC2/1 will be low (0V) whereas if the input voltage is less than 7 volts the output will be high (+14V).

A monostable having a pulse duration of 200 nanoseconds is formed by IC2/3 and IC2/4. If the input at pin 13 of IC2/4 goes high a negative going 200 nanoseconds wide, pulse occurs at pin 11 and is inverted by IC2/2. This positive pulse will turn off Q3 allowing the current from Q1 to charge C2. The voltage across C2 will rise about 3V in the 200 nanoseconds, and will go above the 7V level causing IC2/1 output to go low. Capacitor C2 will now be discharged by the current through Q2 until C2 voltage falls below the 7V level, retriggering the monostable, thus generating another 200 nanosecond pulse.

The repetition rate of the pulse is determined by the current through Q2 and hence is proportional to the input voltage. The 200 nanosecond pulse thus derived is used to turn on the CMOS switches in the active filters.

The input voltage to IC1 is variable by means of RV1 which thus acts as a 'tune' control. Resistor R1 provides a static voltage across RV1 which allows the filter to be tuned to a fixed frequency in the absence of a control input.

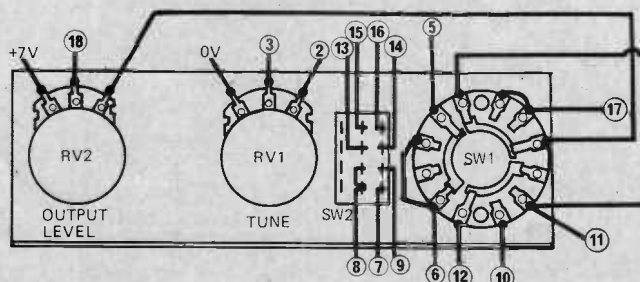
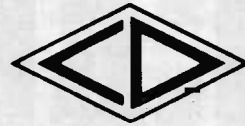

Fig. 4. Wiring diagram for switches potentiometers.

**NOW AVAILABLE IN THE U.K!**

**CHINAGLIA**



**PROFESSIONAL QUALITY TEST EQUIPMENT FROM ONE OF ITALY'S LEADING MAKERS**

One example from the big range of sophisticated instruments

**CORTINA MINOR  
33 RANGE POCKET MULTIMETER**

- SENSITIVITY 20,000Ω/VOLT (D.C.), 4,000Ω/VOLT (A.C.)
- ROBUST DIODE PROTECTED PRECISION MOVEMENT.
- 33 RANGES D.C. VOLTS 0-100mV, 1.5V, 5V, 15V, 50V, 150V, 500V, 1,500V. D.C. CURRENT 0-50μA, 5mA, 50mA, 500mA, 2.5A. A.C. VOLTS, 0.7.5V, 2.5V, 7.5V, 250V, 750V, 1,500V. A.C. CURRENT 0-25mA, 250mA, 2.5A, 12.5A. dB RANGES: -10 to +69. AF VOLTS RANGES 0-1,500V. RESISTANCE RANGES 10kΩ, 10MΩ F.S.D. CAPACITANCE RANGES 100μF, IF F.S.D.
- ACCURACY—RESISTANCE, D.C. VOLTAGE AND CURRENT, 2.5%. A.C. VOLTAGE AND CURRENT 3.5%.
- RESISTANCE RANGES POWERED BY INTERNAL BATTERIES.
- COMPACT SIZE: 150 × 85 × 40mm. 350gr.
- CLEARLY CALIBRATED DIAL WITH ANTI-PARALLAX MIRROR.
- PROFESSIONAL QUALITY COMPONENTS EMPLOYED THROUGHOUT.
- FULLY GUARANTEED FOR 12 MONTHS.
- AFTER SALES SERVICE AND SPARES FACILITIES.
- SUPPLIED WITH ADDITIONAL SHOCKPROOF PLASTICS CARRYING CASE, TWO HIGHLY INSULATED TEST LEADS AND INSTRUCTION BOOKLET.
- SPECIAL 30kV PROBE FOR D.C. MEASUREMENT AVAILABLE AS AN OPTIONAL EXTRA.

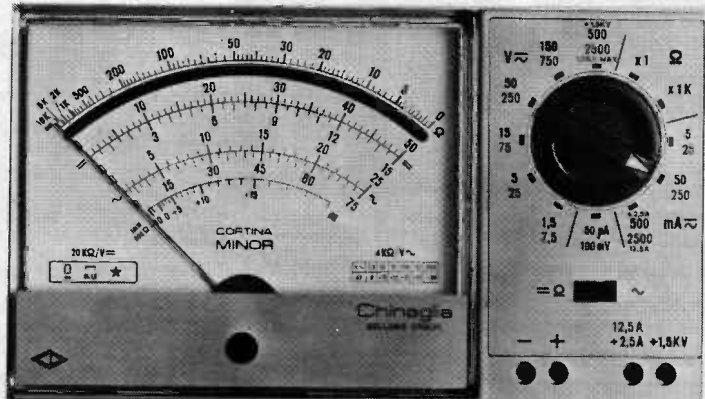

**METER PRICE £13.75 (p & p 80p) PROBE £8.00 inclusive of V.A.T.**

for further information on the "Cortina Minor" or other instruments from the exciting Chinaglia range write or telephone:—

**CHINAGLIA (U.K.) LIMITED**

**19 Mulberry Walk, London S.W.3.**

**Telephone 01-352 1897**

TRADE ENQUIRIES WELCOMED

**MAPLIN ELECTRONIC SUPPLIES**

**★ SAME DAY SERVICE**

P. O. Box 3, Rayleigh, Essex. Tel: Southend-on Sea (0702) 44101

**VAT** Please add 10% to the final total. Post and Packing FREE in U.K. (10p handling charge on orders under 50p)



**SYNTHESISER**

We shall be stocking all the parts for this sensational new E.T.I. design. Send s.a.e. now for our detailed price list. (One available each month as the parts are published.)

**YOU SIMPLY MUST SEE OUR PRICES!**

**ORGAN BUILDERS**

MES announce the very latest development in organ circuitry.

**THE DMO2**

13 Master Frequencies on ONE tiny circuit board.  
LOOK AT THESE AMAZING ADVANTAGES  
★ 13 frequencies from C8 to C9. ★ Each frequency digitally derived from a SINGLE h.f. master oscillator.  
★ Initial tuning for the WHOLE ORGAN: ONE SIMPLE ADJUSTMENT. ★ Relative tuning NEVER DRIFTS! ★ External control allows instant tune-up to other musicians. ★ Outputs will directly drive most types of dividers including the SAJ110. ★ And each output can also be used as a direct tone source. ★ Variable DEPTH AND RATE tremulant optional extra.  
★ Gold-plated plug-in edge connexion. ★ Complete fibre glass board (including tremulant if required) ONLY 3-7in. x 4-5in. ★ Very low power consumption.

★ EXTREMELY ECONOMICAL PRICE. ★ Ready built, tested and fully guaranteed.  
DMO2T (with tremulant) ONLY £14.25.  
DMO2 (without tremulant) £12.25.

★ S.a.e. please for full technical details.

Trade enquiries welcome.

SAJ110 7-stage frequency divider in one 14 pin DIL package. Sine or square wave input allows operation from almost any type of master oscillator including the DMO2 (when 97 notes are available). Square wave outputs may be modified to saw-tooth by the addition of a few components. SAJ110: £2-63 each OR special price for pack of 12: £25-00. S.a.e. please for data sheet.



**WE KNOW YOU NEED**

**IT!**

The MES 1974 Catalogue has over 75 pages and is STACKED with dozens of tempting new lines. BRIMMING OVER with clear illustrations and detailed data.

**WE'RE WAITING TO RUSH YOU A COPY.**

You'll be IMPRESSED with our POST FREE ordering system, EXCITED by our BIG VALUE discount vouchers, STAGGERED by our UNBEATABLE speed of service. Take the first step towards real service NOW! Send ONLY 25p for our beautifully produced catalogue and leave the rest to us!

**QUALITY ICs AT LOWEST POSSIBLE PRICES**

CA3046	14-pin DIL	Transistor Array	69p*
LH0042C	TO5	FET I/P Op.Amp	£4.25*
LM301A	8-pin DIL	Op. Amp	50p*
NE555V	8-pin DIL	Timer	79p*
NE561B	14-pin DIL	Phase Locked Loop	£4.45*
SG1495D	14-pin DIL	Four Quadrant Multiplier	£2.70*
SG3402N	14-pin DIL	Wideband Amp/Multiplier	£1.69*
µA723C	14-pin DIL	2-37V Voltage Regulator	80p*
µA741C	8-pin DIL	Op. Amp	36p*
ZN414	TO5	A.M. Radio TRF	£1.20
MC1303L		Stereo Preamp	£1.39
MC1310P		FM Stereo Decoder	£3.15
MFC8010		1W Power Amp	£1.20

\*Full data in our catalogue. Price 25p

# LOCAL RADIO

PART TWO

## IN BRITAIN

KEITH PITT REPORTS

### CHOOSING THE PROGRAMME COMPANIES

Strict criteria were laid down for the composition of both financial and managerial aspects of programme contractors. The IBA formulated a basic scheme of one station with a general information and entertainment content in each of its franchise areas. The one exception was Greater London, where two stations were to be established, London General and London News. These two would be somewhat different in function from the others because of the size of the coverage -- eight and a half million compared with up to two and a half million.

One of the most successful aspects of ITV is Independent Television News, ITN. This is a company jointly owned by the programme contractors. It was IBA's intention to set up the London News station with the specific function of providing a similar network news service. For this reason, the second London station would probably have much less emphasis on news, especially local news, than its colleagues round the country.

### APPLICATIONS

Intending applicants for contracts were invited to make submissions of their proposals and then interviewed on how these would be carried out. Space limited the details of the criteria established by the Authority, but some of the general points follow.

The prime aim is -- quoting from the White Paper -- "a truly public service ----- combining popular programming with fostering a greater awareness of local affairs and involvement in the community". As a result, local aspects will have very strong influence on the choice of contractors. The make up of the financial backing is studied very carefully to make sure

that no individual organisation or person has a major or controlling interest, probably no greater than about 20%. A small holding from TV companies will be permitted, but independence of radio and TV programming is one major aim. Overseas interests appear to be unsuitable in the opinion of the Authority for running a local service. Local newspapers are given the opportunity of taking shares, but must not individually have a large or majority stake. (This to try to help them avoid too much financial hardship from the arrival of a new medium competing for advertising). Exceptions to newspaper participation may be made if this could become an extension of an existing monopoly in local news coverage.

### PROGRAMME COMPANY OWNERS

As an example of the makeup of programme companies already chosen, a total of 33% of the shares of Piccadilly Radio, formerly Greater Manchester Independent Radio, is held by newspaper interests, with no individual paper having more than 11%. Granada TV has 8% and well known individuals such as Dr. Michael Winstanley a few percent each.

Radio Clyde's backing is similar: 32% is held by newspapers, 7% by Scottish Television, 2% each by the General and Municipal Workers Union and the Electrical, Electronic, Telecommunication and Plumbers Union. Banks and the Scottish Co-operative Society as well as many other organisations are also represented. Among the individuals are the singer, Kenneth McKellar, who is a member of the Board, Sean Connery and Jackie Stewart.

The Authority requires to know from its applicants, among other things, their plans for preparing and presenting local news and background information and who will be

responsible for this. It also wants to know the general aims and contents of the programme schedules and what factors govern their choice. Evidence is needed to show that the Company would be capable of carrying out its professed intentions and that the overall effect would be to produce a community station as well as an entertainment medium. Despite these overall criteria, the IBA is essentially flexible in its approach and realises that requirements differ from area to area.

Very little has been published on the reasons for the choice of particular towns for the establishment of ILR stations, but, being financially supported by advertisements, at least the first few must cover a big enough population to make them viable while the pattern of local broadcasting is developing. The first few are all large metropolitan areas except Swansea with around 1.5 to 2 million population. The next stage envisages the coverage of medium size, towns such as Portsmouth or Plymouth, but includes the much smaller Reading area. This last one will be a test of whether the true independent local radio station can be financially self supporting in the United Kingdom. If it succeeds, then the way will be open to the target of sixty; if it fails, then the whole network may have to be reconsidered in terms of minimum size of station which is practicable.

### RENTALS

The rentals for the first five companies, subject to the retail price index, will increase annually during the three year period, presumably as revenue rises. (A second rental based on profits is also provided for in the contracts but appears unlikely to apply in the first few years of operation). A review will be made after each year on the air. Successful performance will result in a similar extension,

bringing the time up to three again. Failure to reach promised standards will mean that the twelve months extension would not be granted, leaving two years to run. Good performance after this 'warning' would qualify for a return to the original terms but a second failure would amount in effect to a year's notice of termination of contract.

to be general in its coverage with a mixture of ingredients including music and entertainment. In the next section we look at LBC and then examine Capital Radio in more detail.

### LONDON BROADCASTING COMPANY, LBC: THE LONDON NEWS STATION

On October 6th 1973 LBC went on

and interests of all groups. It devotes for example, several hours on Saturday afternoons in winter to a detailed coverage of London's football.

In its morning magazine programmes travel and traffic information features prominently together with informal but detailed weather forecasts. Advantage is taken of the nature of the station to bring in detailed immediate coverage of any important event such as the Ealing train disaster. LBC's coverage of this brought the news to the public very soon after it happened and they can legitimately claim a scoop over the BBC.

LBC's backers include a 16% shareholding from the London Evening News with a very small one from local newspaper groups. The Automobile Association holds 3% and the other shares are spread over a number of interests.

Almost since its start there were reports that the income from advertisements was insufficient and it is known that reserve capital has recently been taken up. A number of major upheavals have taken place with the Managing Director and Chief Editor resigning. At Christmas 1973 no definite audience figures had been released, but the flow of advertisements that could be heard appeared to be very thin. It is difficult for an outsider to determine whether this

### PROPOSED RENTALS FOR THE FIRST FIVE STATIONS

AREA	APPROXIMATE COVERAGE	YEAR 1	YEAR 2	YEAR 3
LONDON GENERAL	8500000	£315000	£350000	£380000
LONDON NEWS	8500000	£185000	£205000	£230000
MANCHESTER	2400000	£108000	£120000	£132000
GLASGOW	1900000	£ 85000	£ 95000	£105000
BIRMINGHAM	1700000	£ 75000	£ 85000	£ 95000

### INDEPENDENT NATIONAL NEWS COVERAGE

A specialist news station, for which the contract was awarded to the London Broadcasting Company, LBC, has been set up in London. Its function is to provide both a direct service to its own area and it also has access to the IBA network for supply of national and international news and information to other stations. It would, if required, also provide local news for London's General station. Capital is said to pay about £100,000 for its service from LBC and Radio Clyde's fee has been reported as £34,200, but the Scottish station will provide its own local news.

The network news is supplied and distributed by Independent Radio News, IRN, a subsidiary of London Broadcasting. The local stations can take IRN's output of news either live or recorded, or, alternatively, as Capital does, recast into their own bulletins. They will also have access to many specialist topics such as City or Parliamentary information from the same source. The IBA's intention when choosing the Contractor was that London News would set a standard for the other companies in their treatment of local news, have its own style of presentation and match the standards and accuracy of ITN and the BBC.

The news station is financed both from its own advertising and also from fees from other stations for its services. It is envisaged that in addition to this, advertisements may be networked with the news, defraying part of its cost. The actual details will depend on the successful growth of LBC and IRN and of the other members of the network.

To avoid direct competition, the second London station was designed

the air as Britain's first commercial station. It had the advantage of appearing during the first few days of the Middle East War and, by providing frequent news bulletins and headlines, was able to attract a lot of genuine listeners as well as those just tuning in for the novelty value. It broadcasts twenty four hours a day and most of the output is spoken, with music reserved mainly for record reviews and similar items. (When required it is fully equipped to broadcast in

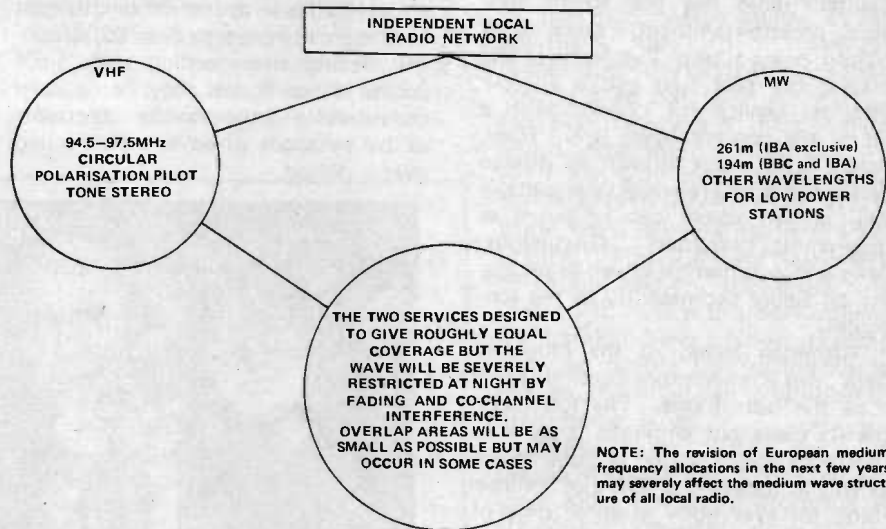

Some technical features of the IBA local radio network.

stereo). LBC provides ten minutes each of local and national news every hour and also two headline bulletins in certain of the peak hours. Most programmes are in the magazine format with one or more presenter and interviews, reports and comments on many topics. Telephone programmes also occupy long periods on the air where the public can discuss problems with personalities in the news. The station's aims are to provide a true community service reflecting the views

was because advertisers had not yet turned to the new medium of sound broadcasting in sufficient numbers or because they felt the audience was too small. A new Managing Director and Chief Editor have both been appointed and new programme schedules are in process of introduction in order both to reduce the cost of operations and also to raise the audience figures.

An expert on local radio has said that he feels that LBC's news coverage

is not deep enough or sufficiently frequent to attract the large audiences of its USA counterparts. Radio critics in the national papers have suggested that the magazine programmes are not well prepared or professional enough in style. It was a deliberate LBC policy to use many new people with fresh approaches rather than recruit from the BBC in order to present a completely new face to their station. As part of the rescheduling operation, Douglas Cameron has joined Alan McKenzie at the beginning of March on the early morning news and information show, now renamed "AM". Mr Cameron is well known in this field to listeners to BBC Radio 4's "Today".

It is to be hoped that these are only teething troubles and that the changes will be effective, enabling LBC to take its appointed place as the lynch-pin of the Independent Local Radio Network. As local radio spreads round the country, LBC's income should rise as it supplies news to more and more commercial broadcasting companies. Certainly, in mid March the number of advertisements appears very much greater than before. This may be a reflection of many factors, but, to an outsider looks much more encouraging.

### CAPITAL RADIO: THE LONDON GENERAL STATION

Capital Radio has the accent very much on entertainment -- much of its output being music, but features also play a key part. Its aim is a lively, informal service for London with a lot of the content being live. They, unlike LBC, have drawn on proven personalities where available and many well known voices can be heard as programme presenters. Discussions, news and information as well as phone-ins all figure prominently in the schedules.

Although much of the music is 'pop', this is much more discriminating than the old pirates. The top forty has its place but emphasis is given to the more sophisticated popular music as well as today's hits. The aim is something for everybody at some time of the day.

Detailed surveys have been made of the size and nature of the potential listening audience as a function of the time of day and the programmes are tailored to fit. It is immediately apparent from Capital's figures that the mass audience is in the early and mid morning with first of all people getting ready to go to work and then women listening while doing the house work. The audience is still large over the lunch period and during the early afternoon. It begins to tail away as evening approaches and is down to a



*Marsha Hunt presenting her Soul and Reggae programme to Capital's late evening listeners.*

small 'hard core' in the early hours of the morning.

The cost of advertising on Capital is related to the period of the day -- the division being roughly as described above. Advertisements range from a ten second station announcement in increases of ten seconds up to several minutes if required. Costs vary from about £3 for a minimum length spot in the small hours to over £200/minute during the morning peak. Of course these figures may be reduced considerably by quantity discounts or by packages of adverts distributed over a period.

No listening figures have yet been released for Capital, but their extremely professional and carefully planned approach appears to have held a lot of listeners who originally switched on out of curiosity. There seems to be a large number of advertisements at peak times but they appear to be less during the rest of the day. Many well known personalities appear not only on the air, but also in the list of stockholders and on the Board. Richard Attenborough is Chairman and Lord 'Ted' Willis, creator of Dixon of Dock Green and Bryan Forbes are both Directors. Newspaper



*London Broadcasting Company's Janet Street-Porter talking to David Nixon and Mr. Charles Lupton, winner of LBC's jingle competition. Miss Street-Porter has quickly established herself as one of commercial radio's outstanding personalities.*



Capital Radio's Roger Scott presenter of the stations three hour early morning show in partnership with Monty Modlyn.

interests including the Evening Standard, Observer and a large local group together hold 32% of the ordinary shares.

Capital have recruited established broadcasters wherever necessary in their efforts to make a big impact on London. In the Christmas schedules, for example, music took precedence with a wide variety of records presented by such people as Mr. Attenborough himself, Robin Ray and Gerald Harper. The more popular style is regularly represented by "Kenny and Cash" -- Kenny Everett and Dave Cash both well known to listeners to the BBC.

Marsha Hunt, shown surrounded by electronics equipment, has quickly become a popular member of the station's team. Monty Modlyn appears in the early morning shows and is, as usual, in his element out and about talking to Londoners.

Several short drama programmes are regulars in the schedules, including "Dapple Downs" with Adrienne Corri and, in addition, a weekday historical series. There is even a strip cartoon of the air -- "Honey Adair" starring Miriam Karlin and Rosalind Shanks. Saturday afternoons provide an alter-

and Roll, pop records selected by Jim Rice and "Hullabaloo", a programme for eight to sixteen year olds. (Capital feel that sport is adequately covered by other stations and they thus provide an alternative).

A technical problem for both of London's ILR stations is that the wavelengths are shared, Capital's with a Dutch pirate. Medium wave coverage is not good at night, particularly on LBC. No doubt there will be a great improvement when the Saffron Green station goes on the air in 1974 and this will help to increase the potential audience to the predicted level.

## FUTURE PROSPECTS

During 1974 Independent Local Radio stations are due to open at Birmingham, Manchester, Swansea and Merseyside, with several more scheduled for later in the year. The pattern of U.K. broadcasting will change much, but the commercial stations have a tough job in front of them to win listeners away from the BBC local and national networks. The crunch will come when the smaller stations start to compete directly in an area where a BBC local is well established. This critical stage will probably not come in one of the large metropolitan areas but at somewhere like Portsmouth or Nottingham which are both scheduled for the 1974/6 period. If these can establish themselves as financially viable alternatives to the BBC, then commercial radio will really have arrived. The difficulties that have upset London Broadcasting arise not so much from the fact that they have to share audiences with Capital and Radio London -- the eight and half million population is big enough to support them all -- but from its entirely new nature as a News Station. This is a new phenomenon to Britain and the public has to get used to it. Once this has happened, the London News Station should become as much a part of the capital's life as its American equivalents in their home cities.

Whatever the future many able people are convinced that commercial local radio has good prospects and are committing their money and their careers to it. For the general public the result is going to be a greater freedom of choice and, in a democratic society this can only be a good thing.

## ACKNOWLEDGEMENTS

Thanks are due to IBA, BBC, LBC and Capital Radio for their help and information in the preparation of this article. Particular thanks go to David Hobbs at Broadcasting House and Bob Gunnell in Brighton for providing guidance on BBC local radio. ●

## INDEPENDENT LOCAL RADIO STATIONS

### ON THE AIR OR DUE BY SUMMER 1974

#### LONDON: 8500000

CAPITAL, VHF 95.8, 194m, (539m)\*  
LONDON BROADCASTING, VHF 97.3,  
261m, (417m)\*

#### GLASGOW: 1900000

RADIO CLYDE, VHF 95.1, 261m

#### BIRMINGHAM: 1700000

BIRMINGHAM SOUND BROADCAST-  
ING, VHF 94.8, 261m

#### MANCHESTER: 2400000

PICCADILLY RADIO VHF 97.0, 261m

#### SWANSEA

SWANSEA SOUND, VHF 95.1, 257m  
(PROB JUNE 1974)

#### TYNE AND WEAR

METROPOLITAN BROADCASTING,  
VHF 97.0, 261m (PROB JULY 1974)

\* THESE FREQUENCIES ARE THOSE  
BEING USED FOR THE TIME BEING.  
PERMANENT FREQUENCIES WILL BE  
ADOPTED LATER THIS YEAR.

### DUE AUTUMN 1974 ONWARDS

#### LIVERPOOL

SOUND OF MERSEY VHF 96.7,  
194m. (AUTUMN 1974)

#### EDINBURGH

RADIO FORTH, VHF 96.8, 194m  
(AUTUMN 1974)

#### SHEFFIELD

VHF 95.2 (MAIN), 95.9 (RELAY),  
194m

#### PLYMOUTH

VHF 96.0, 261m

#### NOTTINGHAM

#### PORTSMOUTH

AFTER THE SIX STATIONS ABOVE,  
THE FIVE BELOW ARE PLANNED:  
BRADFORD, IPSWICH, READING,  
TESSIDE, WOLVERHAMPTON.

NINE MORE ARE PLANNED BUT NO  
DATES OR DETAILS ARE YET AVAIL-  
ABLE: BELFAST, BLACKBURN, BOUR-  
NEMOUTH, BRIGHTON, BRISTOL,  
CARDIFF, COVENTRY, HUDDERS-  
FIELD, LEEDS.

# BI-PRE-PAK

SUPPLIERS OF SEMI-CONDUCTORS TO THE WORLD



## Telephone Corner

COMPLETE TELEPHONES

Normal Household Type

EX. G.P.O. Only **£1-05p** P & P 45p each

## TELEPHONE DIALS

Standard Post Office type. Guaranteed in working order

Only **27 1/2p** POST & PACKING 16p

## Tested and Guaranteed Paks



- B79 4 IN4007 Sil. Rec. diodes. 1,000 PIV lamp plastic 55p
- B81 10 Reed Switches, 1" long, 1/8" dia. High Speed P.O. type 55p
- H35 100 Mixed Diodes, Germ, Gold bonded, etc. Marked and Unmarked. 55p
- H38 30 Short lead Transistors, NPN Silicon Planar types 55p
- H39 6 Integrated Circuits. 4 Gates BMC 962, 2 Flip Flops BMC 945 55p
- H41 2 Sil Power transistors comp pair BD131/132 55p
- H64 4 3819 N Channel FETs 2N3819 in plastic case 55p
- H65 4 40361 Type NPN Sil. transistors TO-5 can comp to H66 55p
- H66 4 40362 Type PNP Sil. transistors TO-5 can comp to H65 55p



## Unmarked Untested Paks

- B1 50 Germanium Transistors PNP, AF and RF 55p
- B66 150 Germanium Diodes Min. glass type 55p
- B84 100 Silicon Diodes DO-7 glass equiv. to OA200, OA 202 55p
- B86 100 Sil. Diodes sub. min. IN914 and IN916 types 55p
- H16 15 Experimenters' Pak of Integrated Circuits. Data supplied. 55p
- H34 15 Power Transistors, PNP, Germ. NPN Silicon TO-3 Can. 55p
- H67 10 3819N Channel FETs plastic case type 55p

## Make a rev counter for your car

The 'TACHO BLOCK'. This encapsulated block will turn any 0-1mA meter into a linear and accurate rev. counter for any car with normal coil ignition system.

**£1-10p each**

## Ex GPO Push Button Intercom Telephones

Exactly as internal telephone systems still in everyday use where automatic internal exchanges have not taken over. Available in 5, 10 or 15 ways. Complete with circuits and instructions. Necessary 24 pair cable 22p per yard. Price of each instrument is independent of the number of ways.

**£2.75 p.p. 38 1/2p**

Cable can be sent by parcel post. Postage and packing per 50 yards: 73p.  
EXTENSION TELEPHONES: 71p each, postage and packing 27p. £1.37 1/2 for 2. P&P 55p.

## ELECTRONIC TRANSISTOR IGNITION

**£6.60p** Complete kit inc. VAT p&p 11p

Ready built & tested unit **£9.90 inc. VAT** Now in kit form, we offer this "up to the minute" electronic ignition system. Simple to make, full instructions supplied with these outstanding features:—  
Transistor and conventional switchability, burglar proof lock up and automatic alarm, negative and positive compatibility.

## New X Hatch

Our new, vastly improved Mark Two Cross Hatch Generator is now available. Featuring plug in I.C.'s and a more sensitive sync. pick-up circuit. The case is virtually unbreakable — ideal for the engineer's tool box — and only measures 3"x5 1/4"x3". We have already received a large order from a major TV rental company. Ready built unit only. **£10-92** Complete kit **£8-72** (Includes VAT and p&p but no batteries)

## Over 1,000,000 Transistors in stock

We hold a very large range of fully marked, tested and guaranteed transistors, power transistors, diodes and rectifiers at very competitive prices. Please send for free catalogue.

## Our very popular 4p Transistors

TYPE "A" PNP Silicon alloy, TO-5 can  
TYPE "B" PNP Silicon, plastic encapsulation  
TYPE "E" PNP Germanium AF or RF  
TYPE "F" NPN Silicon plastic encapsulation  
TYPE "G" NPN silicon similar ZTX 300 range  
TYPE "H" PNP silicon similar ZTX 500 range

## 8 RELAYS FOR £1-10p

## High Speed Magnetic Counter



4-Digit (non-reset) 24V or 48V (state which)  
4 x 1 x 1in. 33p. P&P 5p.

## Plastic Power Transistors NOW IN TWO RANGES



These are 40W and 90W Silicon Plastic Power Transistors of the very latest design, available in NPN or PNP at the most shatteringly low prices of all time. We have been selling these successfully in quantity to all parts of the world and we are proud to offer them under our Tested and Guaranteed terms.

Range 1. VCE. Min 15. HFE Min 15.  
40 Watt 1-12 13-25 26-50  
22p 20p 18p  
90 Watt 26p 24p 22p

Range 2. VCE. Min. 40. HFE Min 40  
40 Watt 1-12 13-25 26-50  
33p 31p 29p  
90 Watt 38p 36p 33p

Complementary pairs matched for gain at 3 amps. 11p extra per pair. Please state NPN or PNP on order.

## LM380 AUDIO I.C.

As featured in Practical Wireless Dec. issue. Complete with application data **£1-10p**.

## INTEGRATED CIRCUITS

We stock a large range of I.C.s at very competitive prices (from 11p each). These are all listed in our FREE Catalogue, see coupon below.

**METRICATION CHARTS** now available  
This fantastically detailed conversion calculator carries thousands of classified references between metric and British (and U.S.A.) measurements of length, area, volume, liquid measure, weights etc.  
Pocket Size 15p Wall Chart 18p

## LOW COST DUAL IN LINE I.C. SOCKETS

14 pin type at 16p each } Now new low profile  
16 pin type at 18p each } type

## BOOKS

We have a large selection of Reference and Technical Books in stock.

Send for lists of publications

## Our famous P1 Pak is still leading in value

Full of Short Lead Semiconductors & Electronic Components, approx. 170. We guarantee at least 39 really high quality factory marked Transistors PNP & NPN, and a host of Diodes & Rectifiers mounted on Printed Circuit Panels. Identification Chart supplied to give some information on the Transistors.

11p P & P on this Pak.

**Please ask for Pak P.1. only 55p**

Please send me the FREE Bi-Pre-Pak Catalogue.

NAME .....

ADDRESS .....

ALL PRICES INCLUDE 10% VAT

MINIMUM ORDER 50p. CASH WITH ORDER PLEASE. Add 11p post and packing per order  
OVERSEAS ADD EXTRA FOR POSTAGE

**BUY THESE GOODS WITH ACCESS**

**BI-PRE-PAK LTD**

Co. Reg. No 820919

Dept. U 222-224 WEST ROAD, WESTCLIFF-ON-SEA, ESSEX.

TELEPHONE: SOUTHBEND (0702) 46344.



# Help us to help you.....

SINCE ETI was launched in April 1972, it has established a regular readership which is currently growing rapidly. Like most magazines, we have made several changes to our contents and presentation and we would like to know what readers like and dislike about ETI.

In September 1972 we ran a similar questionnaire which was completed by about 1000 readers. The findings were carefully analysed and a number of changes were made as a direct result (for instance record reviews were dropped and Tech-

Tips were increased).

We would like to hear from readers who like things as they are as well as those who want some changes.

As a small reward for those readers who fill in the questionnaire, we will be giving away 25 annual subscriptions to ETI, these will be selected in a draw which will be held once all the forms are in. Closing date is June 30th. The forms may be sent with the competition entries on page 35 if you are eligible.

## 1. Editorial Content

Please tick in the appropriate box.

FEATURES:	Interest			Technical Level		
	High	Fair	Low	Too High	O.K.	Too Low
Electronics	<input checked="" type="checkbox"/>	<input type="checkbox"/>	<input type="checkbox"/>	<input type="checkbox"/>	<input checked="" type="checkbox"/>	<input type="checkbox"/>
Technology	<input type="checkbox"/>	<input checked="" type="checkbox"/>	<input type="checkbox"/>	<input type="checkbox"/>	<input checked="" type="checkbox"/>	<input type="checkbox"/>
Audio	<input type="checkbox"/>	<input checked="" type="checkbox"/>	<input type="checkbox"/>	<input type="checkbox"/>	<input checked="" type="checkbox"/>	<input type="checkbox"/>
Hi-Fi Tests	<input checked="" type="checkbox"/>	<input type="checkbox"/>	<input type="checkbox"/>	<input checked="" type="checkbox"/>	<input type="checkbox"/>	<input type="checkbox"/>
News Digest	<input type="checkbox"/>	<input type="checkbox"/>	<input checked="" type="checkbox"/>	<input checked="" type="checkbox"/>	<input type="checkbox"/>	<input type="checkbox"/>
DX Monitor	<input type="checkbox"/>	<input checked="" type="checkbox"/>	<input type="checkbox"/>	<input type="checkbox"/>	<input checked="" type="checkbox"/>	<input type="checkbox"/>
Electronics Tomorrow	<input type="checkbox"/>	<input checked="" type="checkbox"/>	<input type="checkbox"/>	<input type="checkbox"/>	<input checked="" type="checkbox"/>	<input type="checkbox"/>
Tech-Tips	<input checked="" type="checkbox"/>	<input type="checkbox"/>	<input type="checkbox"/>	<input type="checkbox"/>	<input checked="" type="checkbox"/>	<input type="checkbox"/>
Projects	<input checked="" type="checkbox"/>	<input type="checkbox"/>	<input type="checkbox"/>	<input type="checkbox"/>	<input type="checkbox"/>	<input checked="" type="checkbox"/>
Electronics-It's Easy	<input checked="" type="checkbox"/>	<input type="checkbox"/>	<input type="checkbox"/>	<input type="checkbox"/>	<input type="checkbox"/>	<input checked="" type="checkbox"/>

Please delete as appropriate.

Do you consider yourself a regular reader? YES/NO ~~NO~~

If a regular, approximately how long have you been one? 1 Year

If you have been a reader for more than 6 months, how does this issue compare to earlier ones? ~~Worse~~/Same/Better

About how many other people read your copy? 3 or 4

Do you ever have trouble buying ETI? YES/NO ~~NO~~

Do you usually keep your copies for more than 3 months? YES/NO ~~NO~~

Have you taken advantage of any of our recent special offers or entered any of the competitions? YES/NO ~~NO~~

## 2. Employment

Do you read ETI as an extension of your job? YES/NO ~~NO~~

Are you employed in the electronics or closely related field? YES/NO ~~NO~~

If yes, in which capacity (Please tick)

Management  Buying  R & D  Technician

Production  Other  State what: \_\_\_\_\_

If you change your job, is this likely to be in the electronics field? YES/NO ~~NO~~

Have you ever considered furthering your knowledge or qualifications in electronics (through a course for example?) YES/NO ~~NO~~

## 3. Which of the following magazines do you read?

	Reg.	Freq.	Rarely or Never
Wireless World	<input type="checkbox"/>	<input type="checkbox"/>	<input checked="" type="checkbox"/>
Practical Wireless	<input checked="" type="checkbox"/>	<input type="checkbox"/>	<input type="checkbox"/>
Practical Electronics	<input checked="" type="checkbox"/>	<input type="checkbox"/>	<input type="checkbox"/>
Everyday Electronics	<input checked="" type="checkbox"/>	<input type="checkbox"/>	<input type="checkbox"/>
Radio & Electronics Constructor	<input type="checkbox"/>	<input checked="" type="checkbox"/>	<input type="checkbox"/>
Hi-Fi News	<input type="checkbox"/>	<input checked="" type="checkbox"/>	<input type="checkbox"/>
Hi-Fi Sound	<input type="checkbox"/>	<input checked="" type="checkbox"/>	<input type="checkbox"/>
Popular Hi-Fi	<input type="checkbox"/>	<input type="checkbox"/>	<input checked="" type="checkbox"/>
Hi-Fi for Pleasure	<input type="checkbox"/>	<input type="checkbox"/>	<input checked="" type="checkbox"/>
Hi-Fi Answers	<input checked="" type="checkbox"/>	<input type="checkbox"/>	<input type="checkbox"/>
Audio	<input type="checkbox"/>	<input checked="" type="checkbox"/>	<input type="checkbox"/>
New Scientist	<input type="checkbox"/>	<input type="checkbox"/>	<input checked="" type="checkbox"/>
Electron	<input type="checkbox"/>	<input type="checkbox"/>	<input checked="" type="checkbox"/>
New Electronics	<input type="checkbox"/>	<input type="checkbox"/>	<input checked="" type="checkbox"/>
Electronics Weekly	<input type="checkbox"/>	<input type="checkbox"/>	<input checked="" type="checkbox"/>

## 4. Personal Information

The following questions need not be answered but if you are prepared to answer them it will give us a better profile of our readers.

Age:	Education Level reached	Salary Level
Under 18 <input checked="" type="checkbox"/>	C.S.E. <input type="checkbox"/>	Student <input checked="" type="checkbox"/>
11-25 <input checked="" type="checkbox"/>	'O' Level <input type="checkbox"/>	Under £1000 <input checked="" type="checkbox"/>
26-35 <input type="checkbox"/>	'A' Level <input type="checkbox"/>	£1001-£1750 <input type="checkbox"/>
36-45 <input type="checkbox"/>	HNC & Equivalents <input type="checkbox"/>	£1751-£2250 <input type="checkbox"/>
46-55 <input type="checkbox"/>	Degree <input type="checkbox"/>	£2251-£2750 <input type="checkbox"/>
56-65 <input type="checkbox"/>	Other <input type="checkbox"/>	£2751-£3500 <input type="checkbox"/>
over 66 <input type="checkbox"/>		£3501-£4500 <input type="checkbox"/>
		over £4500 <input type="checkbox"/>

## 5. Any General Comments.

First  
Fold  
▼

◀ Second Fold

Stamp  
please

Electronics Today International  
Reader Questionnaire Dept.  
36 Ebury Street,  
London SW1W 0LW.

◀ Third Fold and Tuck In

### 25 ANNUAL SUBSCRIPTIONS TO BE WON

As a small reward for those readers taking the trouble to fill in and return this questionnaire, we will draw 25 of the replies once they are all in and each will receive an annual subscription to ETI. You do not have to complete question 5 to qualify. If you wish to be considered please fill in your name and address clearly.

Name . . . [ ] . . . . .

Address . . . [ ] . . . . .

. . . [ ] . . . . .

. . . [ ] . . . . .

Information given on this form will be treated as confidential and will only be used for the purpose stated.

▲  
First  
Fold

# 10 'LONGS' TOOL KITS WORTH £30 EACH MUST BE WON!

THIS COMPETITION is being run in conjunction with Longs Ltd, who have donated the tool kits and our series *Electronics - It's Easy*. Whilst this series is by no means only for younger readers, this competition is only open to those aged under 18.

Electronics construction is a matter of putting components and chassis-work together and at every stage you will need tools. Cheap tools are available everywhere but they are usually poor value. ETI has always advocated the use of the best quality tools, as do all experienced constructors and those engaged in electronics professionally. For this reason ETI have worked together with Longs Ltd who are specialists in this field to compile a first class tool kit which will set the newcomer up in style.

The retail value of the tool kit is £30 and this alone demonstrates the high quality of the contents. The Eagle Multimeter and the Antex Soldering Iron are both well-known and fine examples of their type. The essential fine-nosed pliers, side-cutters tweezers and various screwdrivers are standard in their appearance but are of the highest professional quality and designed to last a life-time.

Two less well-known items are included, both being exclusive to Longs. The first is a screwdriver that grips the head of the screw, allowing easy insertion and removal in confined spaces. The second is Longs Solder Sipper, designed for the easy removal of previously soldered components. In these days of multi-pin I.C.'s, this can no longer be regarded as a luxury. A spring-loaded piston is released when the nozzle is brought up to the molten solder, sucking it up, leaving a clean, solder-free area.

All the tools are fitted into an executive type brief-case as shown which makes the tools easy to get to and to carry around. There is also room for service sheets and other paperwork.

## HOW TO ENTER

Answer the questions on the entry form on the right. Readers who have been following the series *Electronics - It's Easy* should have no trouble as the answers, or how to derive them have all been given in earlier parts of the series.

## RULES

The competition is open only to those readers aged under 18 on the competition closing date. Proof of age will be required from the winners. All entries must be on the form cut from the magazine. There is no entry fee and readers may submit as many entries as they wish. Any entry not on the correct form will be deemed invalid.

The prizes will be awarded to the first 10 correct entries drawn after the closing date. The judges' decision will be final and no correspondence can be entered into concerning the competition. Winners will be notified by post. The answers and a list of prize-winners will appear in a future issue of ETI.

Readers not resident in the U.K. may enter but, if successful, the prize will only be delivered to an address in the U.K. as ETI is unable to make export arrangements.

Entries should be addressed to *Longs Tool Kit Competition, Electronics Today International, 36 Ebury Street, London SW1W 0LW*.

Closing date is June 30th, 1974.

OPEN TO  
READERS AGED  
UNDER 18



Each tool kit comprises the following: Longs Solder Sipper, Eagle 20000 ohms/V Multimeter, Antex Soldering Iron, Philips-head Screwdriver, Standard Screwdriver, Mains-tester Screwdriver, Head-gripping Screwdriver, Fine-nosed Pliers, Side-cutters, Tweezers and solder. All are fitted into an executive type brief-case.

## ENTRY FORM

When completed should be sent to: LONGS TOOL KIT COMPETITION,  
ELECTRONICS TODAY INTERNATIONAL,  
36 EBURY STREET, LONDON SW1W 0LW.

Answer the following questions:

1. Give Ohms law in one of its common forms  $V = I \times R$
2. Three resistors are connected in parallel,  $1000\Omega$ ,  $470\Omega$  and  $220\Omega$ . To the nearest  $1\Omega$ , give the effective resistance.  $130\Omega$
3. In the Electron Flow concept, is the direction of flow from positive-to-negative or negative-to-positive? Neg. to Pos.
4. What is the value and tolerance of a resistor coded Grey, Red, Yellow, Gold.
5. When measuring an unknown voltage on a multimeter, do you start with a low range, somewhere in the middle or on a high range? High range
6. When a multimeter is measuring current, a resistor is usually connected in parallel with the movement; what is this resistor usually called? Shunt

I will be under 18 years of age on June 30th, 1974. I have read the rules and agree to abide by the judges' decision.

SIGNED . . . . . DATE  $4^{th}$  June - 74 . . . . .

NAME (block letters) . . . . .

ADDRESS . . . . .

The reader questionnaire may be sent with this entry form but no other correspondence must be enclosed. Closing date for the competition is June 30th, 1974.

# DART electro services

24 South Town, Dartmouth, Devon.  
Telephone: Dartmouth 2967

## SICK OF WAITING FOR COMPONENTS?

Try our express service (normally return-of-post)

RESISTORS (E24 Series)			SCREWS, NUTS AND WASHERS		
1/2W	5%	Carbon Film	1p	0BA	18sets 40p
1/2W	2%	Metal Oxide	3 1/2p	2BA	" 15p
2 1/2W	5%	Wire-wound	9p	4BA	" 10p
5W	5%	Wire-wound	10p	6BA	" 13p
1/4W	5%	Carbon Film	1 1/2p		

## SEMICONDUCTORS

BC107/8/9	10p	2N3054	54p	1N4006/7	12p
2N1302/3	16p	2N3055	57p	2N3773	£3.20
2N1304/5	21p	2N3702	12p	2N3819	32p
2N1306/7	23p	1N4001/2/3	7p	2N3703/4/5/6/7	
2N3053	.24p	1N4004/5	9p		12p

Full Range of 7400 Series I.C.'s available

## CAPACITORS

µF	Volts	Price
1	100	6p
2.2	63	6p
4.7	35	6p
10	16	6p
10	63	7p
22	35	7p
100	10	7p
100	50	11p
220	50	17p
470	35	21p
1000	25	24p

## SILVER-MICA CAPACITORS

2.2pF to 820pF	7p
1000pF to 1800pF	10p

## I.C. HOLDERS

8-way DIL	16p
14-way DIL	24p
16-way DIL	27p

## CROC CLIPS

Std. 42mm: 4p, Min. 27mm 3p

## SINCLAIR CAMBRIDGE

CALCULATOR (ready-built).....£26.50

ADD 10p for p&p PLUS 10% VAT

Send 20p for our illustrated catalogue containing competitive prices and descriptions of hundreds of components, accessories etc.

# A SPARK OF GENIUS



## THE SPARKRITE MK2 ELECTRONIC IGNITION KIT

All necessary components — ready drilled case and metal-work, cables, coil connectors, printed circuit boards, top quality 5 year guaranteed transformer and components and 8 page instruction leaflet.

When you complete the unit it can be fitted to your vehicle in only 15 minutes using the standard coil and contact breaker points. To give you:-

Instant all weather starting, 10%—20% fuel saving, longer coil and battery life, higher top speed, faster acceleration, spark plugs last about 5 times longer, mis-fire due to contact breaker bounce electronically eliminated, purer exhaust emission resulting in less air pollution, contact breaker burn eliminated, elimination of plug fouling. Suitable for all petrol engines up to 8 cylinder with standard coil contact breaker ignition.

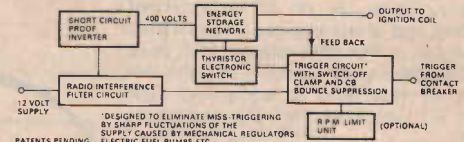

## 12V CAR KIT ONLY £11.62

Ready built car unit £14.85

Unit for single cylinder motor cycle £17.60

Unit for twin coil twin contact breaker motor cycle £23.24

Unit for triple coil triple contact breaker points motor cycle £27.50

PRICES INCLUDE VAT AND P AND P. ORDER NOW FROM

I.C.E. ELECTRONIC SYSTEMS

Dept. ETI, 114 Park Farm Road, Birmingham B43 7QH.

# What to look for in July's ETI



## IS THE DEATH-RAY LASER A POSSIBILITY

In a recent ETI issue, we covered the use of lasers in measurement: generally low powers are used for this but high power lasers are already here. They are being used for such everyday functions as cutting out cardboard cartons and cloth. More unusual uses include the deliberate starting of controlled forest fires. With these increased powers can we expect the death laser which has for so long been forecast by the science fiction writers?

## REPAIRING DIGITAL EQUIPMENT

Digital circuitry is being used more and more; its benefits are enormous but there is a catch: it is accompanied by major problems in servicing and repair. The techniques necessary have so far been given little coverage in the technical press. Next month ETI puts this right with a major feature devoted to the repair of digital equipment.

## PLUS:

BURGLAR-PROOF YOUR HOME

ETI MUSIC SYNTHESIZER

HI-FI REVIEWS

## ON SALE JUNE 21st — 20p

THE FORTHCOMING ARTICLES MENTIONED ON THIS PAGE ARE, AT THE TIME OF THIS ISSUE GOING TO PRESS, IN AN ADVANCED STATE OF PREPARATION. HOWEVER, ETI TAKES A REAL PRIDE IN BEING REALLY UP-TO-DATE AND TOPICAL ARTICLES MAY REPLACE THOSE SHOWN.

# electronics today

INTERNATIONAL

# THE NEW NELSON-JONES FM TUNER

**PUSH-BUTTON VARICAP DIODE TUNING**  
**(6 Position)** ('WW' JUNE '73)

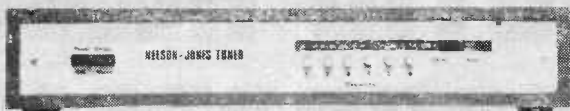

Exclusive Designer Approved Kits

What are the important features to look for in an FM tuner kit? Naturally it must have an attractive appearance when built, but it must also embody the latest and best in circuit design such as:—

**MOSFET** Front end for excellent cross modulation performance and low noise.  
**3 GANG VARICAP** Tuning for high selectivity tuning diodes in back to back configuration for low distortion.  
**CERAMIC INTEGRATED** circuit IF amplifiers for reliability and excellent limiting/AM rejection.

**PHASE LOCKED LED** Stereo decoder with Stereo mute, see below. fine tuning indicators.  
**PUSH BUTTON** tuning (with AFC disable) over the whole FM band.  
**IC STABILISED** and S/C protected power supply.  
**CABINET** veneered inside and out.

The Nelson-Jones Tuner has all of these features and many more, and more importantly the design is fully proven not just with a few prototypes but with many thousands of working tuners spread across the world.

Basic tuner module prices start as low as £10.79, with complete kits starting at £23.95 (mono) PP 50p. and of course all components are available separately.

Our low cost alignment service is available to customers without access to a signal generator. Please send large SAE for our latest price lists which detail all of the many options and special low prices for complete kits. All our other products remain available.

**PORTUS AND HAYWOOD PHASE LOCKED DECODER** (W.W. Sept. '70). Still the lowest distortion P.L. decoder available. THD typically 0.05% (at Nelson-Jones Tuner O/P level)! Supplied complete with Red LED.

Price £5.50 when bought with a complete N-J tuner kit or £7.68 if bought separately (P.P. 19p.)

**PLEASE NOTE.** Existing tuners are readily convertible and kits/parts are available for this purpose.

**TEXAN AMPLIFIER.** We have designed the tuner case and metalwork to match the Texan amplifier (see photograph). Complete designer approved Texan kits are available at £28.50 plus p.p 50p including Teak Sleeve.



## THE RONDO QUADRAPHONIC SYSTEM (20 WATTS/CHANNEL)

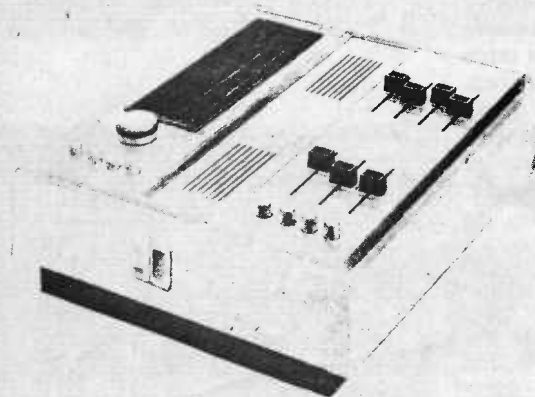

Complete designer approved kits for this outstanding Quadraphonic Sound System ('P.E.' Sep. '73, etc.) with the following features:—

- ★ SWITCHING FACILITIES AND MODULES FOR SQ, QS AND CD4.
- ★ COMPLETE LOUDSPEAKER ENCLOSURE DESIGN.
- ★ MODULAR BUILT IN-AM/FM RADIO.
- ★ INDIVIDUAL KITS MAY BE INCORPORATED IN EXISTING EQUIPMENT.
- ★ LOW COST, FULLY ENGINEERED, INTEGRAL DESIGN.
- ★ KITS AVAILABLE AS PUBLISHED—SEE BELOW.

★ COMPLETE LOUDSPEAKER SYSTEMS AVAILABLE

CBS SQ* MATRIX DECODER <small>*TM CBS INC.</small>	Complete Kit	<b>£8.00</b>	Post Free	VAT Extra
PREAMPLIFIER BOARD	Complete Kit	<b>£3.00</b>	Post Free	VAT Extra
MASTER VOL./TONE/BALANCE BOARD	Complete Kit	<b>£8.50</b>	Post Free	VAT Extra
POWER AMP. BOARD AND HEATSINK <small>STEREO PAIR</small>	Complete Kit per Board	<b>£7.50</b>	Post Free	VAT Extra
POWER SUPPLY BOARD	Complete	<b>£5.00</b>	Post Free	VAT Extra
MAIN SMOOTHING CAPACITORS (TWO REQD)	Per Pair	<b>£1.50</b>	Post Free	VAT Extra
MAINS TRANSFORMER	Complete Kit	<b>£6.25</b>	Post Free	VAT Extra
CHASSIS—PUNCHED and DRILLED WITH SCREENS	Complete Kit	<b>£3.25</b>	Post Free	VAT Extra
QUAD SELECTOR SWITCH		<b>£1.30</b>	Post Free	VAT Extra
WOODEN CASE		<b>£1.75</b>	Post Free	VAT Extra
HARDWARE PACK		<b>£2.00</b>	Post Free	VAT Extra
CONTROL SECTION FACIA		<b>£3.50</b>	Post Free	VAT Extra

THE COMPLETE P.E. RONDO SYSTEM IS AVAILABLE AS PUBLISHED.

PLEASE PHONE OR WRITE FOR FULL DETAILS

**Access**

You can order these goods by Telephone on Access. Simply quote your Access Number.

### OPTO-DEVICES

Panel mounting LED's.					7 Seg LED's
RED	1-9	29p	10-24	23p	0.325" RH Dec Point. Common Anode 1-4 £2.00; 5-24 £1.80. Common Cathode 1-4 £2.00; 5-24 £1.80. 7447 Dec Driver £1.30 (C.A.)
GREEN	1-9	59p	10-24	49p	

V.A.T. Please add V.A.T. at 10% to all prices for U.K. orders.

**INTEGREX LIMITED, P.O. Box 45, Derby, DE1 1TW**

**Phone Repton (028389) 3580**

# eti product test

# ACOUSTIC RESEARCH AR-7 LOUDSPEAKERS

ACOUSTIC RESEARCH have built up an enviable reputation over many years. Their loudspeakers are known world-wide for their true fidelity and lack of colouration.

We reviewed the AR-6 speaker in February 1972, and felt then — as in fact we still do — that here was one of the few bookshelf speakers that could provide a compromise-free performance comparable with more conventionally sized units.

The new AR-7 is the smallest and by far the cheapest speaker made by Acoustic Research. It is so small that when we picked up the box of the AR-7 without having seen the contents, we asked where the other box was — and were told that both speakers were in one carton. (Actual dimensions are 248 x 400 x 159 mm).

As with other AR speakers, the AR-7 enclosures are well made and very rigid. The veneer is not of the same standard as that used on other AR enclosures, the grille cloth, however, appears to be AR's standard material.

Two drive units are used — a new 200 mm (nominally 8") acoustically suspended bass unit, and a 38 mm cone tweeter similar to that used in the AR-6.

A 'flat/normal' two-way switch is located at the rear of the enclosure.

When assessing hi-fi equipment we normally compare units with others of

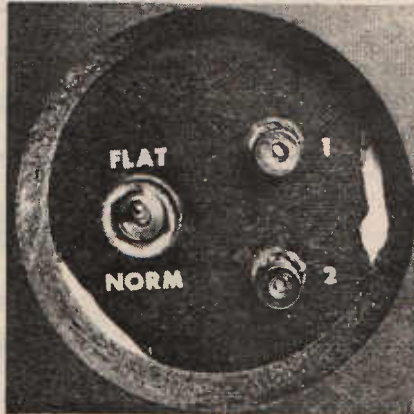

the same type and approximate price — and to some extent with other units from the manufacturer's range.

The AR-7s presented us with rather a problem, for there are few speakers with any worthwhile performance, hence comparisons on a price basis are virtually impossible to make.

### HOW THEY SOUNDED

Likewise it is difficult to relate the AR-7s to other AR speakers, for unlike AR's other products some performance compromises have obviously been made in order to obtain small overall size and a very low selling price. Bass response for example is not as extended as that from the excellent, but of course, more expensive AR-6.

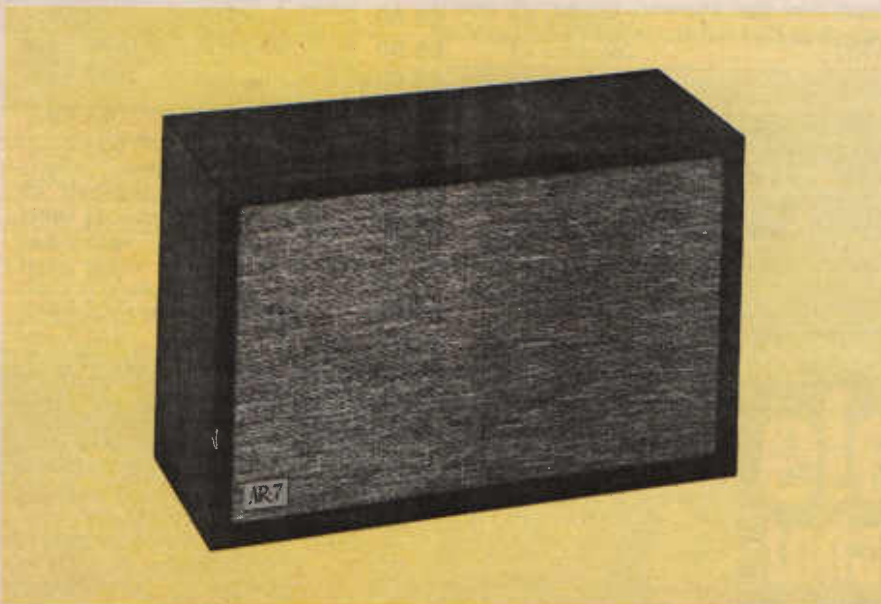
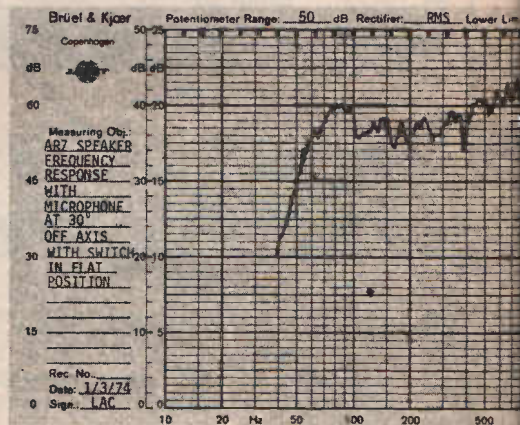
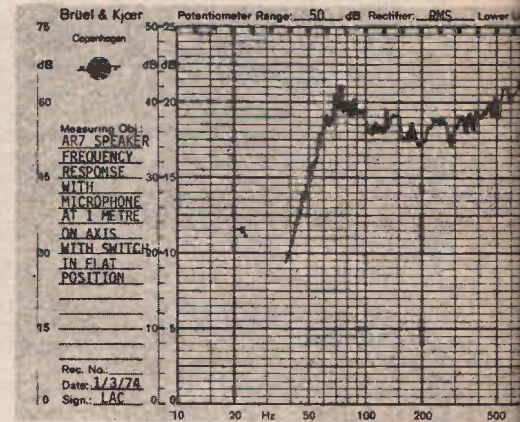

### MEASURED PERFORMANCE OF AR-7 SPEAKER

Total Harmonic Distortion  
(for 90dB at 2 metres on axis)  
50Hz 6%  
100Hz 0.9%  
1kHz 0.45%  
6.3kHz 0.2%

Electro-Acoustic Efficiency  
(for 90dB at 2 metres on axis) 12.4W

Measured Impedance  
100Hz 6 ohms  
1kHz 9 ohms  
6.3kHz 5.5 ohms

Speaker Resonance  
45Hz with 12 ohm impedance.  
Cross-over Frequency 2.6kHz  
Dimensions 400 x 248 x 159mm.

Recommended Retail Price £29.75 inc. VAT.

## SUMMARY

The AR-7 is a remarkably small unit — about 16in. x 10in. x 6in. — and not expensive with a recommended price of under £30. It is not perfect, but the small size makes this not unexpected. However for its size and price, it is exceptional value for money.

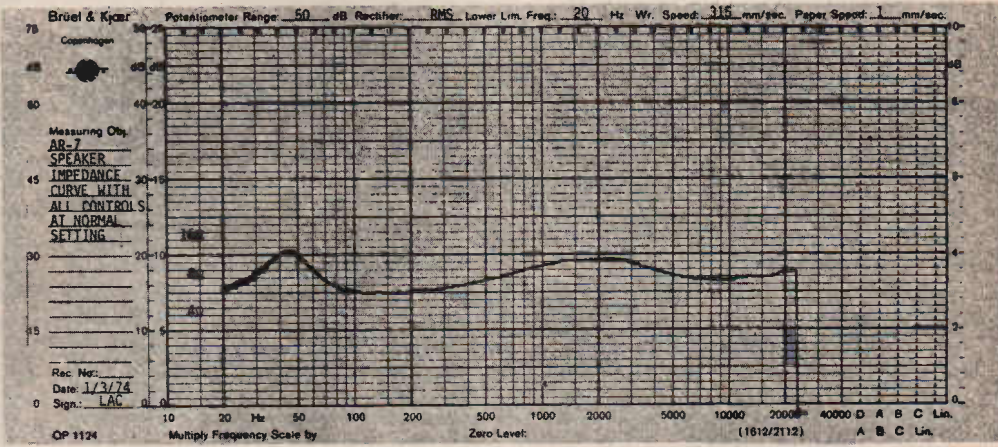
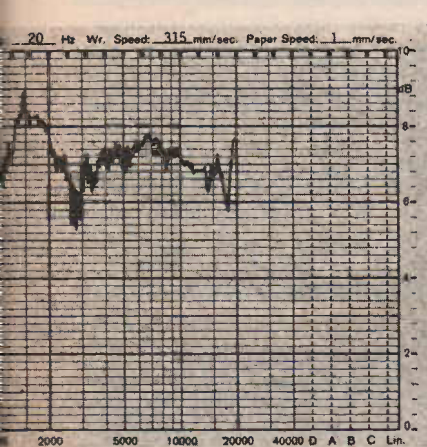
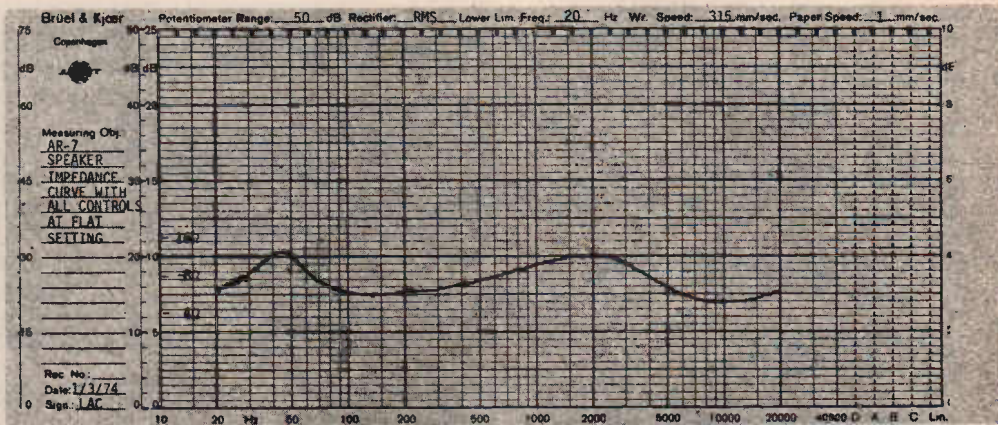
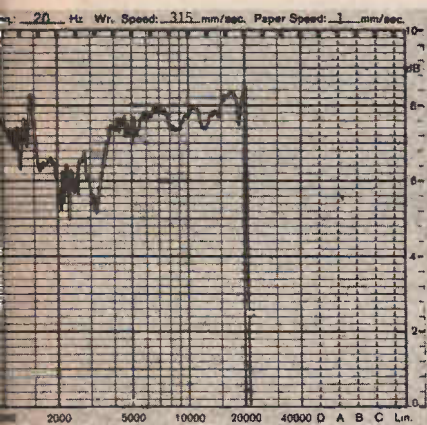

Overall response is not subjectively flat, and as we subsequently saw, drops significantly in the region of the crossover range between woofer and tweeter.

The measured response at least of the unit tested, was not as flat as the data sheets indicated. The tweeter is relatively flat, but the acoustically-suspended woofer is rather non-linear.

As with the AR-6, the high frequency dispersion is particularly good — in fact exceptionally so if the very low price is taken into account.

The manufacturers claim that these speakers can be driven with amplifiers of up to 100 watts per channel. Certainly our tests with a twin 80 watt amplifier at maximum output showed this statement to be reasonably true — if one is prepared to ignore the high level of distortion that occurs at such

high levels. Even so the power handling capacity of the speaker is good.

Acoustic Research do not provide any details of the crossover system but by looking at the price and the measured frequency response it is clear that the crossover network is particularly simple and most probably consists of a simple capacitor crossover network. There is measurable interaction between the woofer and tweeter of 1500 and 3000 Hz. This interaction results in audible colouration which is not typical of other AR speakers, and which we found to be particularly apparent using the AR Demonstration Record.

The overall distortion characteristic of this speaker is good above 100 Hz. Distortion is audible as frequency doubling or second harmonic distortion below 100 Hz, but only at

moderately high power levels. Below 20 watts we could detect no audible distortion at all.

The impedance characteristics are particularly smooth — in fact more so than any other system that we can recollect testing.

Maximum impedance occurs at the resonance frequency of 45 Hz and there is no great difference between the shape of the curves with the switch in either the flat or normal position.

The AR-7s may well be exactly what a substantial number of people are seeking.

They are not perfect — in fact there is quite noticeable colouration, concessions have to be made when one designs a speaker of this size and/or price.

But for their size and price, the AR-7s offer exceptional value for money. ●

# eti product test

# TANBERG HULDRA 10 TUNER/AMPLIFIER

UNIVERSAL is certainly the most suitable epithet for the Huldra 10 made by Tandberg, a Norwegian firm best known for its tape recorders. Unlike its Japanese counterparts, this instrument includes a powerful AM tuner, comprehensive because its five ranges allow not only long and medium wave reception but short waves of 3 to 30MHz as well which, is sufficiently unusual to be worthy of mention.

## A CONVENTIONAL SET

In spite of its typically Scandinavian origins, the look of the Huldra 10 amplifier-tuner is not particularly out of the ordinary: its dial is divided into two and spreads over the whole of the front. As for the controls, they are of the conventional rotating knob type for the potentiometers, with keys for the switches. A genuine wood superstructure protects the electronic parts, whilst the rear black aluminium panel is designed to dissipate the heat from the power transistors.

Underneath the controls, a swing-down strip allows access to a set of buttons for the selection of FM preset stations and for the bringing into operation of filters for the amplifier. This strip is spring-loaded and fitted with a stock absorber.

A minor detail worth noting: Since the keys located underneath the strip are invisible, the maker has incorporated indicator lights in the dial, these lighting up when one of these keys is depressed.

The output points are to DIN standard, except the one for the stereo headphones which is a conventional jack.

The AM tuner calls for special attention. On the long wave and medium wave side, reception is possible either by a ferrite rod incorporated in the set (it is underneath the wooden cover) or by an external aerial. A switch, hidden under the swing-down strip gives one the choice of either method of operation.

The dial scale is about 10in. long, facilitating easy selection of the stations. The dial is marked in frequencies for all ranges. However, for long and medium wave, some stations are



Closeup of the station setting pots under the flap.

indicated by name, in addition to the frequencies, by some indication of the transmission bands (for example: 49m), or those bands reserved for amateur radio transmissions.

On the technical side, we note the absence of any ceramic filter, the makers having replaced this by more conventional tuned circuits.

The FM tuner itself is conventional; no I.C.'s. On the other hand, the decoder which uses no coil, hence quicker adjusting and more stable performance in the long run.

Tuning on the FM side is by vari-caps. Four keys enable choice of station, the frequency of which will have been initially preset by means of one of the potentiometers located underneath the spring-loaded strip.

On the FM tuner, the tuning knob is separated from that of the AM tuner.

Two meters have been fitted for tuning: the first one, used for both AM and FM, indicates the signal strengths; the second one is for FM operation only, with central zero point, permitting very fine tuning - this however not without creating some difficulties when presetting stations. Fortunately, there is a key which brings the AFC into operation.

There is a coax connection for an outside aerial and a two-pin DIN connection for an inside FM aerial.

The construction technique adopted is interesting: all the wires, whether screened or not, are end-fitted with a lug or terminal connector, these being mounted on the wire itself; the lugs are then plugged into wedges soldered onto the printed circuits. Each module can therefore be adjusted before it is placed in position on the frame and subsequently easily dismantled.

There is a switch at the back of the unit making it possible to use either a ceramic or a magnetic pickup. There are two filters, a high-pass filter and a low-pass one which make it possible to avoid switching over too often, the flap being comparatively difficult to get at. A slightly more projecting strip would have allowed improved operation.

## MEASURED PERFORMANCE OF TANBERG HULDRA 10

### AMPLIFIER SECTION

Power Output: 32W r.m.s. per channel into 4ohms, both channels driven  
21W " " 8ohms, "

Frequency Response: 20Hz to 60kHz ( $\pm 1$ dB) see graph

Channel Separation: 35dB at 1kHz

Signal-to-Noise Ratio (weighted):

P.U. -73dB

Aux -80dB

Total Harmonic Distortion: 0.14% at 1kHz at Rated Output

Intermodulation Distortion: 0.6% (50Hz and 6kHz, 4:1 ratio)

Transient Time: 2.5 $\mu$ S at 10kHz

### TUNER SECTION

Sensitivity for a signal-to-noise ratio of 30dB

VHF: 1.8 $\mu$ V

MW: 18 $\mu$ V

LW: 30 $\mu$ V

SW: 20 $\mu$ V

Recommended Retail Price (inc. VAT): £197.63



**SUMMARY:**

This is a conventional design with plenty of additional facilities such as a short-wave tuner. The performance is satisfactory in all aspects. The Tanberg Huldra 10 however is an expensive unit at nearly £200 and potential buyers will have to weigh the facilities offered against the price.

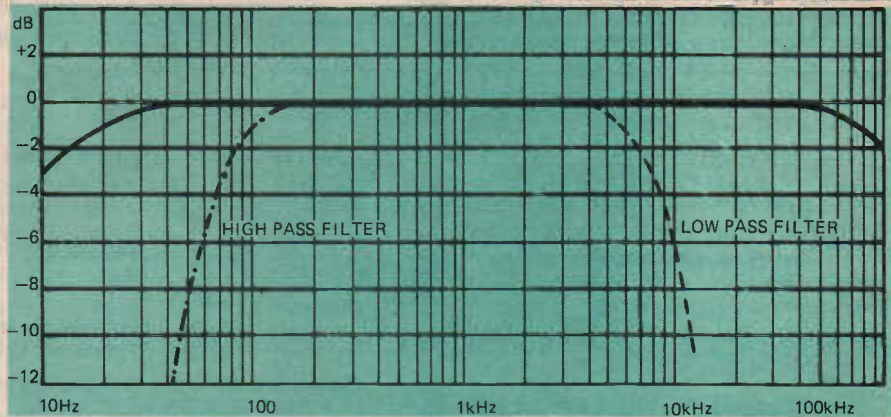
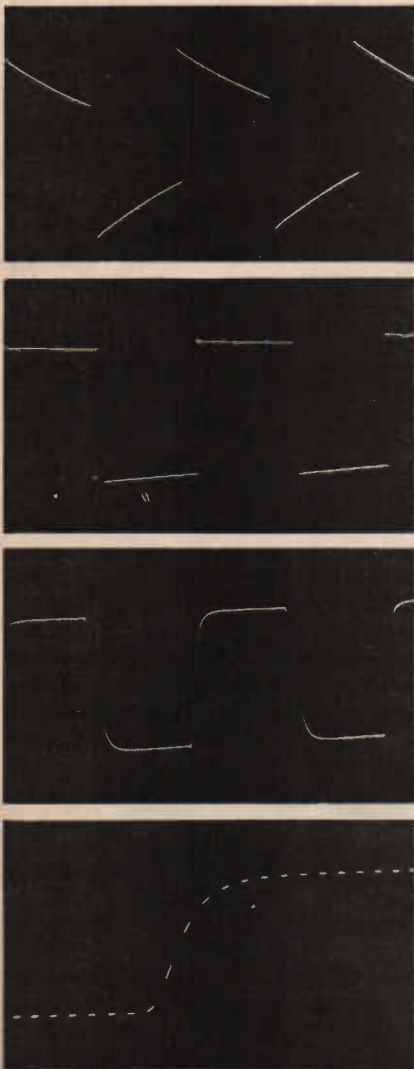
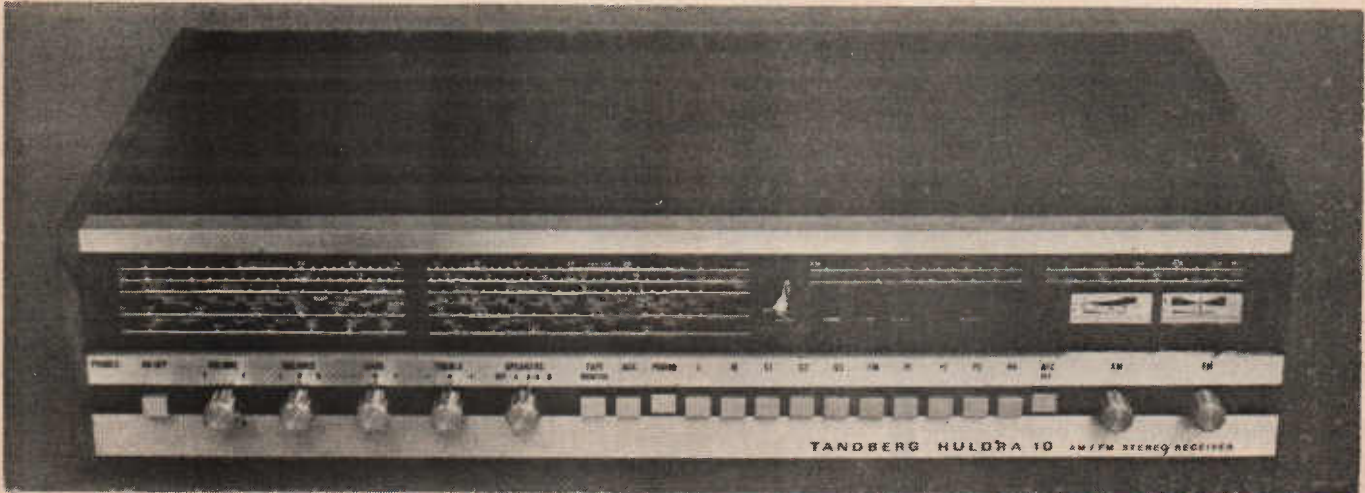

Frequency response of the amplifier with tone controls flat. The dotted lines show the effect of the high pass and low pass filters.

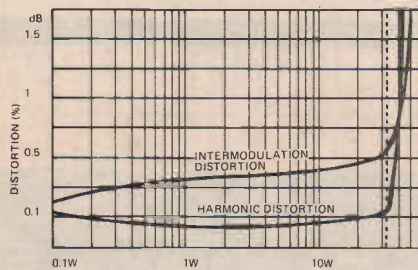

Above is shown the harmonic distortion and the intermodulation distortion plotted against the output.

On the left are shown the square-wave results. Top photograph is at 40Hz, the second at 1kHz, the third at 20kHz. The transient times are only 2.5µs at 10kHz.

**USE AND TEST RESULTS**

The preset stations potentiometer buttons, although small are easily set. As regards the keys, whilst they are numerous they are an adequate distance apart from each other.

Owing to its adequate output power, the amplifier can tackle any type of speaker, including low efficiency models.

The frequency response shows a very extended band, particularly at the upper end where it reaches exceptional limits which are confirmed by a good rise time. The two filters - high-pass and low-pass - are well placed in the spectrum.

The signal-to-noise ratio is excellent for the magnetic pickup input, one of the best we have measured since it reaches -73dB. The ratio is also low for other inputs.

# edi product test

# ARMSTRONG 621 AMPLIFIER

THE ARMSTRONG SERIES 600 Models are all similar in appearance with a styling that might be described as 'Continental' in view of the low slimline look that has been adopted. The 621 amplifier is also the basis of the rest of the 680 series i.e., models with integrated tuner sections but for all models the amplifier performance is the same.

Power output is rated as 40W (r.m.s. based) per channel for an 8 ohm load and inputs are provided via DIN sockets for magnetic pickup cartridges (high or low output) radio tuner, tape and auxiliary. Details of input signal requirements are shown in the test results table. There is also a tape recording output that can be used in conjunction with a tape monitor switch to obtain direct or off-tape signals and a stereo headphone socket that can be used with virtually all types of headphones and with or without loudspeakers operating. Volume, tone, stereo balance and signal selection controls are rotary types, the remainder of the functions such as speaker selection (two outputs provided), tape monitor, filters, mono/stereo and loudness being operated from press tabs along the lower half of the front panel.

One of the special features of the 621 and all other 600 series models, is diode switching in signal circuits to prevent annoying clicks which usually occur when signal circuitry is switched.

## MEASURED PERFORMANCE OF ARMSTRONG 621 AMPLIFIER

Power Output:	43W per channel, both channels driven	
Power Bandwidth:	25Hz (-1.4dB) to 45kHz (-3dB)	
Frequency Response:	See Graph	
Total Harmonic Distortion		
	1000Hz	15kHz
At 40W	0.04%	0.08%
At 20W	0.04%	-
At 10W	0.045%	-
At 5W	0.05%	-
Intermodulation Distortion	0.8% (40Hz and 5000Hz, 4:1 ratio 35W into 8ohms)	
Signal-to-Noise Ratio:	P.U.1 -67dB	
	P.U.2 -68dB	
	Aux and Radio better than -69dB	
Crosstalk:	Better than -65dB at 1000Hz	
Filters:	See graphs	
Tone Controls:	Bass ±15dB at 70Hz	
	Treble ±13dB at 14kHz	
Loudness Control:	+10dB (70Hz) +5dB 10kHz (relative -20dB, 1000Hz)	
Inputs:	P.U.1 2.7mV	47kohms
	P.U.2 10mV	47kohms
	Tape 250mV	68kohms
	Radio 120mV	68kohms
	Aux 120mV	68kohms
Outputs:	Tape 270mV (variable)	
	Headphones Most types	
	Speakers 4 to 16ohms	
Damping Factor:	Into 8ohms, better than 50	
Recommended Retail Price:	£81.95 including VAT.	

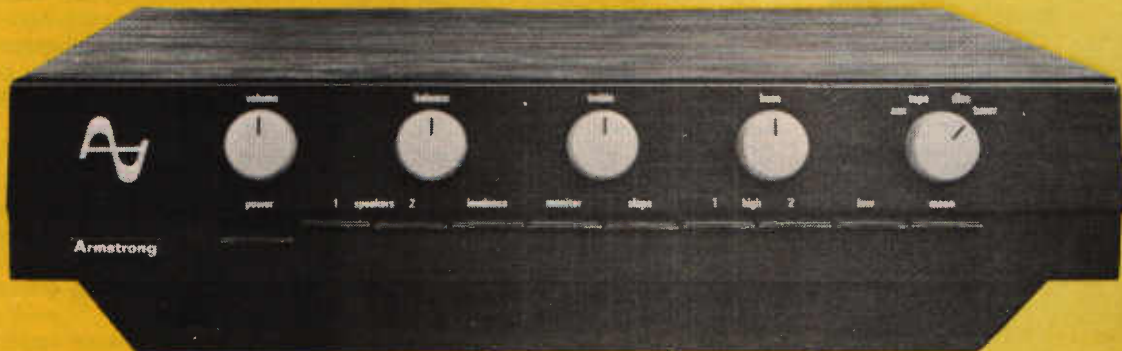

**SUMMARY:** This is an excellent amplifier and one that has gained a high reputation since it came on to the market about a year ago. There is no doubt about its performance being to high fidelity standard and an excellent one at that. The only criticism is of the DIN type loudspeaker sockets. These have to handle large power levels if the volume control is turned up and that means large current flowing. More robust screw type terminals would have been better.

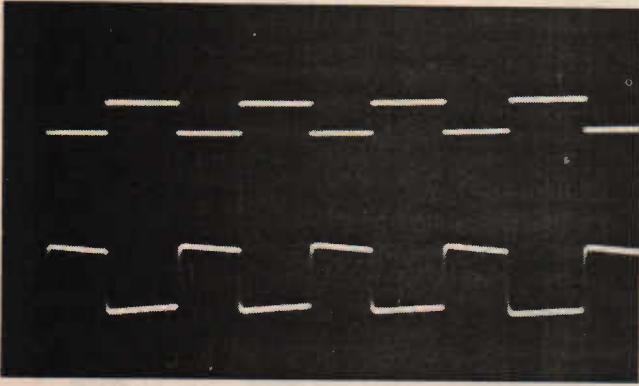

Fig. 3. Square-wave response of 1kHz; the top is the input, the lower wave form the output.

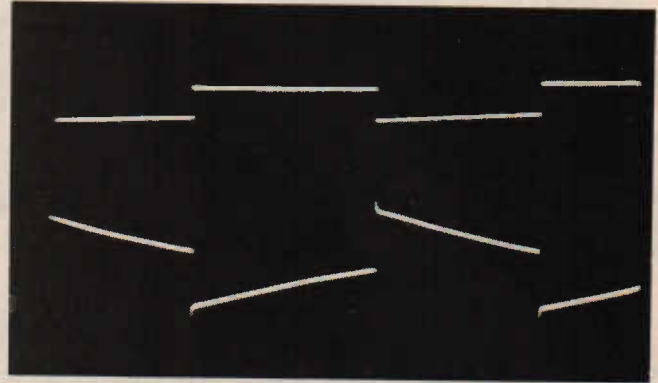

Fig. 4. Square-wave response of 12Hz. Input at the top, output at the bottom.

This provides a noiseless and smooth fade in of any selected signal source. Other features are the use of a field-free, toroidally-wound mains transformer to obtain the lowest possible hum level, overload protection for the output transistors, interchangeable fibreglass circuit boards and an h.f. filter with four different roll-off characteristics.

## PERFORMANCE

The high power output of the Armstrong 621 makes it suitable for modern loudspeakers of relatively low efficiency. Tests yielded a little more than the specified 40W power per channel with both driven. Power bandwidth too was in accordance with the maker's specification. The overall frequency response is shown in Fig. 1 together with the responses of the tone controls and the low frequency (rumble) filter. The responses of the high frequency filters are shown in Fig. 2. The 621 has an excellent overall response verified by the 1000Hz square-wave test (Fig. 3) and moreover a very uniform low frequency response backed up by the oscillogram (Fig. 4) showing a square-wave check at 12Hz. Few amplifiers have such a good response even at 100Hz.

The frequency response from the pickup input was virtually flat from 25Hz to over 20,000Hz, indicative of a good RIAA characteristic and the overload margin a very acceptable 70mV for the 2mV input and 300mV for the 10mV input.

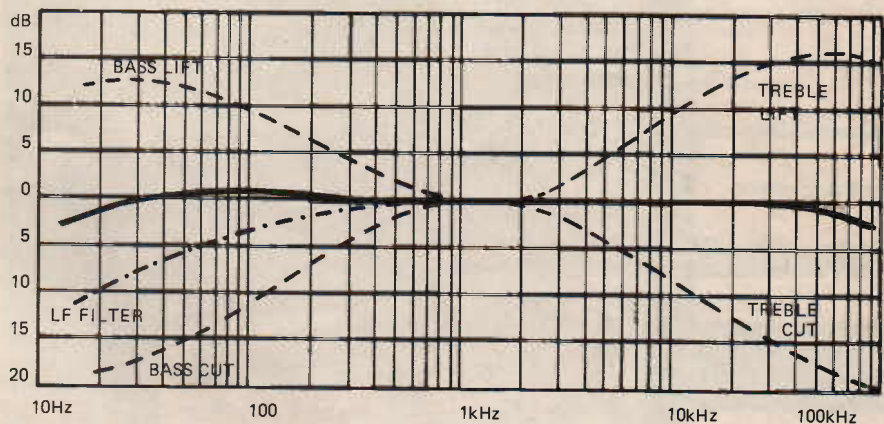

Fig. 1. Overall frequency response (solid line). Tone controls and LF filter dotted lines.

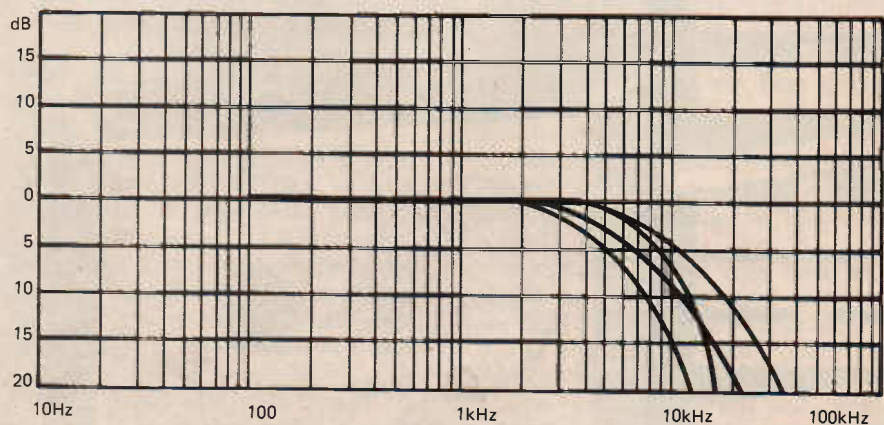

Fig. 2. Responses of HF filters.

Total harmonic distortion was checked at various power levels and frequencies (see test results) and was well within the specified 0.08%. Signal-to-noise performance and cross-

talk etc. were also well within specification as the test figures show, in fact none of the parameters checked gave results that were not up to specification.

# VHF/FM TUNER KITS

Continuing his series of electronic kit reviews, Jeff Maynard looks at some VHF/FM tuners.



*Varicap Stereo*



*Nelson-Jones*



*Henelec*

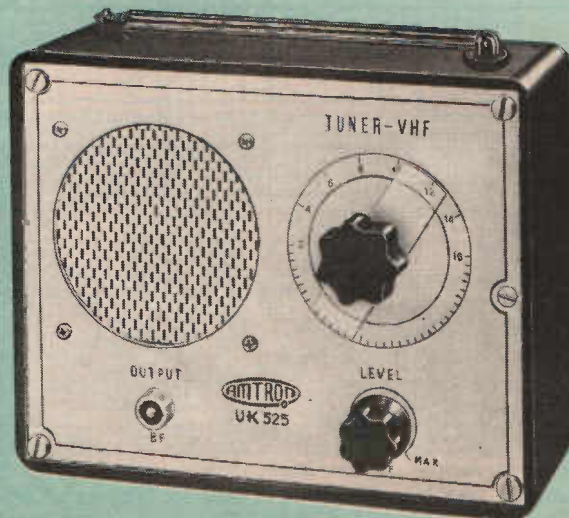

*Amtron*

AS THE BBC extend their coverage of stereo transmissions, particularly those fed via PCM links, the possibilities for high quality radio reception become available to a wider audience.

Having listened extensively to Radio 2 from Holme Moss, the writer is convinced of the important part that radio must play in any Hi-Fi enthusiast's listening pattern. BBC stereo signals received via a good aerial and "state-of-the-art" tuner rival, for quality, even the best discs and tapes currently available. The excellence of the stereo image is most marked when listening to any live shows.

The easiest way of adding FM stereo to an existing tape or disc set up is to install a tuner (i.e. receiver without amplifier) which can utilize existing power amplifiers. The requirements of a high quality tuner are good sensitivity, high signal-to-noise ratio, usable output, good AM rejection and usable tuning range.

Typical figures to look for are:

Sensitivity	2.5 $\mu$ V
S/N ratio	55dB
Output	150mV
AM rejection	40dB
Tuning range	87-104MHz

The home constructors requirements for a high quality tuner can be met by the three readily available units discussed here.

## VARICAP STEREO

The "Varicap Stereo" from Electrospares is the first on the market using the Mullard LP1186 and LP1185 RF and IF modules. These are each encapsulated in a 2in. x 1in. metal case and are factory aligned and tested. Such is the completeness of these that the tuner part of this kit contains only 3 capacitors and one resistor in addition to the modules. The constructor is thus relieved of the problems of handling delicate RF devices and the complexities of alignment of both RF and IF stages.

Being based on the varicap principle, tunning is achieved by means of a potentiometer, this particular unit has five skeleton pre-sets selected by a smart push button unit (also containing a mains on-off switch). A varicap unit requires a very stable voltage if tuning is not to drift whilst the unit is in use. The output of a bridge rectifier, fed from a 12V step-down transformer, is smoothed and fed to a Motorola MFC4060A IC regulator. During the power reductions earlier this year the tuning voltage remained absolutely constant.

The remaining occupants of the screen printed, pretinned PCB are those associated with the MC1310P decoder chip (supplied with socket).

Interconnections between the board

and the push-button unit and sockets etc. take longer than the assembly of the PCB such is the small number of discrete components used. The complete unit can be assembled in about two hours.

Only two adjustments are required: firstly the output of the voltage regulator is adjusted to 9V and secondly the decoder oscillator is centred. This latter adjustment is easier than it sounds, involving the adjustment of a preset pot to the midway point of the range over which the stereo beacon is lit when receiving a stereo broadcast.

The instructions provided with this unit are clear, although the layout could have been made neater. However, construction is very easily accomplished and this excellent tuner could be built and aligned even by a novice in an evening.

### NELSON-JONES

By contrast the Nelson-Jones tuner and Portus-Haywood phase locked loop decoder from Integrex is not for the novice. Not only does it require a deal of skill and experience during the construction stage but it requires facilities beyond those normally encountered in the amateur workshop for receiver alignment.

Despite these apparent drawbacks, the units performance could well be considered to outweigh any problems encountered during construction. However, more of that later, when the details of construction have been discussed.

The kit arrives securely packed complete with all hardware, metalwork, PCB's and components sorted into polythene bags. The constructor requires only the usual tools, solder and connecting wire to commence work. Five circuit boards require construction as described below.

The logical point to begin construction is the power supply unit which can be assembled in just under an hour. Two integrated circuits are employed to ensure a regulated voltage for the varicap tuning. The only points to watch with this board are to ensure that the heatsink is fitted to one IC before it is soldered and to take great care fitting the skeleton presets as the fixing holes are a fraction on the small side. Alignment consists of adjusting two presets for the required output voltage.

The tuning indicator board (containing two red leds for station selection and a green led for stereo indication) and the varicap board can both be built in under one hour and require no alignment. The varicap board is later mounted upside down on the main receiver board.

The stereo decoder board (based

on the Portus-Haywood PLL design) requires about four hours building effort since it contains some one hundred discrete components plus 13 transistors and three integrated circuits. As with all the boards, this one is screen printed with component numbers and locations and is roller tinned.

Alignment consists of adjusting some presets whilst monitoring the voltage at certain test points and should take no more than a few minutes.

Alignment of the RF board is a bigger problem requiring a Wobulator (or at least a signal generator) and a 'scope - Integrex will undertake alignment of receivers following user construction.

Time for the RF board is about 3 hours during which great care must be taken when handling and soldering some of the more delicate semiconductors and smaller discrete components. IC's are fitted directly to the board and require a very fine iron bit used carefully with fine solder.

Total construction time, including

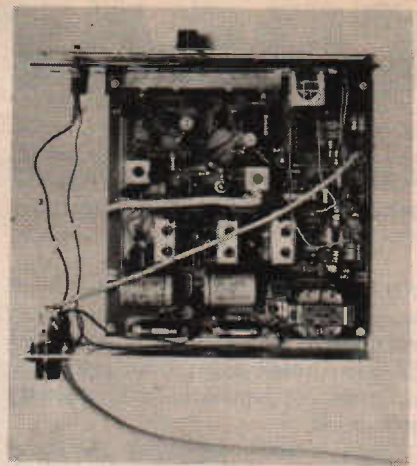

*The interior of the Henelec Tuner.*

problems and would therefore be more suitable for the beginner. The general appearance will be very similar and the price will be in the £27 region.

### HENELEC

A 12-page manual describes the circuit constructional details, alignment and

### VHF/FM TUNER KITS

Varicap Stereo Tuner	Electro Spares, 288 Ecclesall Road, Sheffield S11 8PEA. Price £28.50.
Nelson-Jones FM Tuner	Integrex Limited, P.O. Box 45, Derby DE1 1TW. Price £32.95 (low-gain version less 56p. alignment of RF board £1.60). (available with an MC1310 decoder at less £1.35).
Henelec FM Tuner	Henry's Radio Limited, Edgware Road, London W2. Price £23.10.
Amtron UK 525/145	Amtron UK, 4 Castle Street, Hastings, Sussex TN34 3DY. Price £16.08.

All prices include VAT.

fitting boards into the wooden cabinet can be completed in about 11 hours providing the constructor is experienced. The instructions provided would be a bit thin for the beginner - no order of assembly being given. However, the interested buyer is provided with a wealth of background information describing the design objectives in great detail.

The careful construction required together with the problems of alignment are quickly forgotten once the unit is complete. Performance is absolutely first rate both for high-quality local listening and for DXing. As with the other units subjective listening tests were carried out using a Texan amplifier (which matches the Integrex tuner) and Rank Domus 250 speakers recently acquired by the writer.

Integrex tell us that they are introducing a new tuner kit towards the end of June which incorporates a Mullard front-end and modular construction which eliminates lining-up

use of the Henelec Stereo Tuner from component suppliers Henry's Radio.

As usual these days, the circuit is based on varicap diodes and uses the principle that the capacitance of such a diode varies with the width of the depletion region within its junction. The greater the reverse bias voltage applied to the junction, the greater the width of the depletion layer.

Following RF amplification signals are fed to the mixer transistor the output of which (following filters etc.) is the 10.7MHz IF.

A conventional IF stage feeds ultimately to a stereo decoder based on the MC1310 chip - the chips output is fed to a 5-pin DIN socket for connection to a power amplifier.

Operating descriptions and circuit functions occupy a large part of the Henelec manual whilst the constructional content is small. The narrative type assembly instructions require the builder to identify component locations from the screen printed PCB.

*Continued on page 57*

# CREATIVE AUDIO PART 7

**A practical guide to creating and producing your own sound.**

MUSIC is composed of a series of events occurring in a definite relationship to a time scale, and many devices have been designed for automatic or semi-automatic sequence generation.

These include switching mixers — passive devices fed from a diversity of prepared sound sources, to ring generators in which trigger pulses shock a sequence of resonant circuits into brief oscillation. This latter category includes the rhythm machines that organists use to accompany their playing.

Digital circuitry is well suited to sequential control, and various memory systems have been devised to encode and store voltage levels for interfacing with voltage control systems; at its simplest it can provide a pseudo-random sequence of voltage levels used at low frequency as a control source, at higher frequencies functioning as a white noise source or chromatic generator (band width limited white noise).

At the other end of this scale, whole computer programmes have been devised for electronic music generation, and to this end a number of bigger studios have custom-built computers, notably the R.C.A. system.

The Oramic sound-system to be discussed later also belongs in this category.

## SWITCH/MIXERS

Before solid-state switching had become commonplace, the B.B.C. Radiophonic Workshop had found a great necessity for some form of multiple input switching mixer.

The B.B.C. devised one unit based on capacitance control in the form of a motor-driven rotary air-vane variable capacitor. It sequentially scans the 16 input sockets at a preset rate, noiselessly fading each up in turn for the required duration.

There are many ways in which an electronically-switched sequencer may be designed, the simplest being the previously described ring generator. The duration of each output pulse becomes controllable if a ring of one-shot multivibrators is substituted for the ring generator and if each output pulse is fed to its own envelope generator, more than one parameter may be programmed into the sequence. For instance the envelope generator may be used to provide a voltage output to a voltage-controlled oscillator, governing its pitch, as well as performing amplitude control. The circuits illustrated in Figs. 1 and 2 designed by Ehle, first appeared in "dB", March 1969. It is, in essence, a twelve-channel ring sequencing device, with provision for external trigger. When the switch is at 'interrupt' a single 12-event sequence occurs. The start button is pressed to insert a pulse into the ring generator and, by pressing this button more than once, it is possible to generate highly complex

sound patterns, as the multiple pulses follow each other round the ring.

## DRUM SIMULATING DEVICES

A variety of percussive sounds may be obtained with variations on a simple twin-T oscillator of the type illustrated in Fig. 3. The table is given as a guide to the frequency determining and envelope shaping components. Further details can be found in the paper "Electronic Percussion Instruments" by C. Muller, Electronics World, February 1967.

The rhythmic pulses necessary to control a set of circuits of this kind could be obtained from the output of a multivibrator and dividing chain. Alternatively, they could be derived from a ring counter, or even electromechanically — this could be based on a gramophone-type turntable with raised studs which trip microswitches fixed on arms above the turntable (Fig. 4).

The drawback with the automated rhythm devices just described, is that they are unresponsive — once set to give a particular tempo, they are unable to compensate for human variation, the outcome being that the musician struggles to regulate his tempo to that of his machine.

R.A. Hoare of New Zealand has explored the possibility of a system which could continuously adjust itself to the tempo of the musician (Figs. 5 and 6).

The musician taps his foot on a microswitch as he plays, each tap causing a linear ramp voltage to reach its maximum and return to zero. The maximum voltage is stored in an operational amplifier 'memory', throughout the succeeding period.

A series of potentiometers are used to set selected fractions of this stored maximum, each one feeding a leg of its own comparator, the other leg fed by the currently rising ramp. When any comparator's potentiometer-selected fraction of the 'memory' voltage is reached by the rising ramp, that comparator switches to give the required pulse, which can be sent to a drum effects circuit of the type illustrated.

The device always bases its tempo on the preceding period. A rough estimate of the correct rise time is necessary to give a suitable maximum voltage without 'bottoming' the operational amplifier.

In the illustration, switch 2 should be closed first, setting the maximum, followed rapidly by switch 1 which

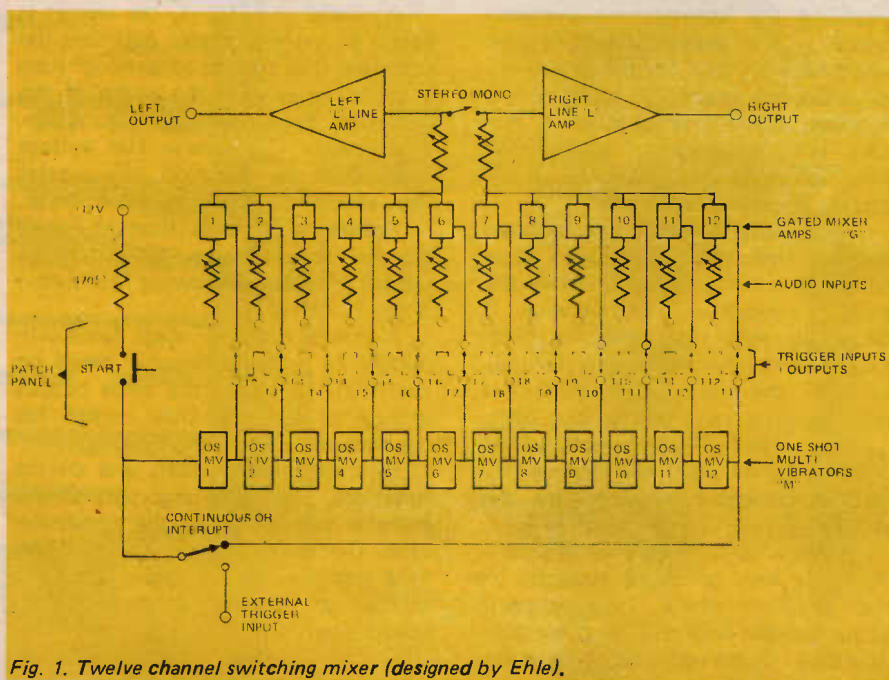

Fig. 1. Twelve channel switching mixer (designed by Ehle).

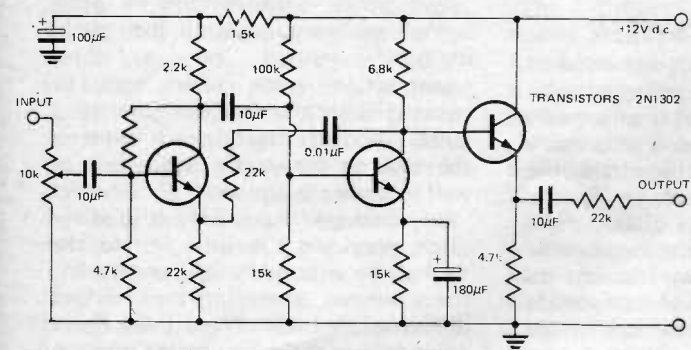
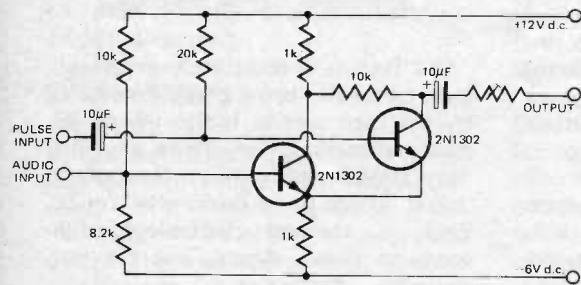
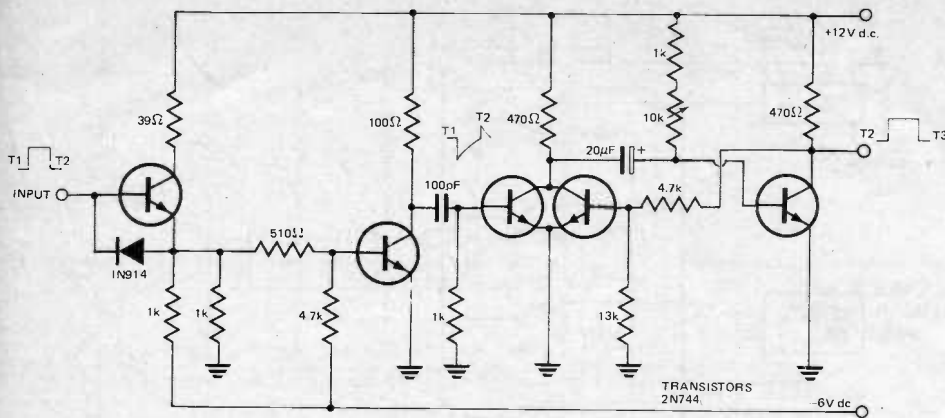
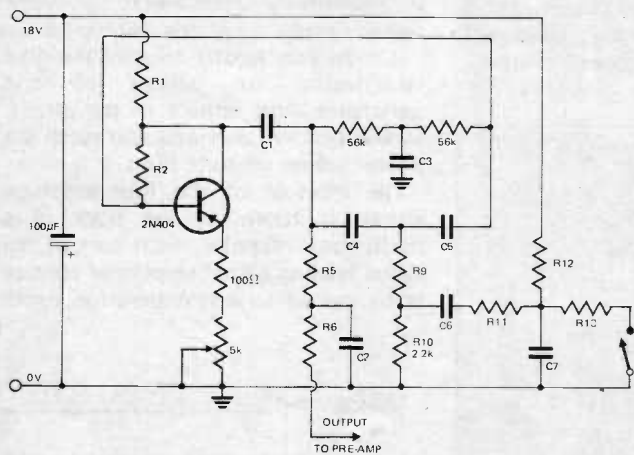

Fig. 2. Circuit details of switching mixer shown in Fig. 1. TOP: One-shot multivibrator 'M'. CENTRE: Gated mixer-amplifier 'G'. BOTTOM: Line-amplifier 'L'.



	ORUM	TOM-TOM	BONGO	BLOCKS
R5	22K	82K	82K	330K
R6	10K	82K	82K	not used
R9	2.7K	6.8K	6.8K	6.8K
R11	82K	22K	27K	not used
R12	1M	0.56M	1M	1M
R13	2.7K	2.7K	2.7K	6.8K
C1	0.1	0.047	0.047	0.047
C2	0.1	0.01	0.01	not used
C3	0.1	0.047	0.033	0.01
C4	0.1	0.027	0.015	0.0033
C5	0.1	0.027	0.015	0.0033
C7	0.1	0.1	0.01	0.1

all 1/2 watt 10%

Fig. 3. Twin-T circuit for percussion effects.

zero's the ramp. This could be accomplished by constructing a pedal with switching derived from a double key-switch, as used in an electric organ, one contact being slightly bent back to achieve the requisite delay. Another possibility is to feed a dc voltage, switched via a single microswitch, to a pair of relay coils, one of which is slugged, (Fig. 7).

The best method would be some form of digital logic to generate a pair of pulses; these could be interfaced directly with transistor or FET switches.

## DIGITAL LOGIC SEQUENCE GENERATION

The Triadex "Muse" is a commercially available 'automatic' melody composer consisting of a sophisticated array of digital shift-registers. It has two banks of linear multiposition switches, one bank controlling rhythm, and the other pitch. In addition to the information indicated by the position of the switches, a visual readout of the programme is also shown by a line of LED indicators.

The type of short digital shift-register to be described can be programmed to produce a wide variety of binary words, with the minimum of logic hardware.

The output is in the form of a serial stream of different voltage levels. These are fed to a voltage controlled oscillator to transform voltage variations to frequency variations. The output is taken to a loudspeaker.

The output from the simplified generator illustrated in Fig.8, although asymmetric in one period is perfectly symmetrical from period to period. At higher clocking rates the audio frequency output resembles random noise, but more detailed examination will reveal the true periodic nature of this waveform, which is thus termed 'pseudo-noise'. It has a very high harmonic content and, due to the unit delay of events in the sequence, it is easy to filter by direct digital methods — the complete hardware consisting of a dozen on-off switches. Many thousands of waveforms may be generated with this simple register, a few of these are illustrated in Fig.9.

This type of register has not as yet achieved much popularity in the field of synthesizer design, but could easily form the basis of a versatile tone-generating module. A keyboard potential divider arrangement would give the desired incremental voltage changes, which could control the frequency of a voltage controlled square wave clock generator. Drastic tonal changes could now be accomplished simply by flicking the

# CREATIVE AUDIO

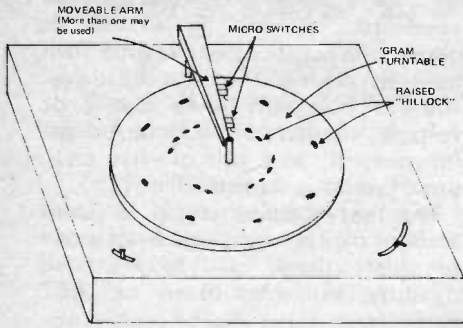

Fig. 4. Electro-mechanical rhythm generator.

various switches which make up the digital filter.

This topic has been covered in depth by Burhans in his paper "Pseudo Noise Timbre Generators", Journal of the Audio Engineering Society, April 1972, Vol. 20 No.3. He includes a computer print-out and full explanation which clarifies the action of the filter switches, and discusses the potential of such a generator in a low-cost music synthesizer apparatus.

## THE R.C.A. SYNTHESIZER

This is a complete electronic music studio which uses a punched paper roll to control two independent channels, each specifying five parameters — frequency (fine tune) octave, timbre, envelope (specified as growth, duration and decay) and volume. The method of control is similar to that employed by the old steam organ, except that the sensing is done directly by a 'key frame' of microswitches, and not indirectly by keys actuated by air pulsing through the holes. A second similarity with the steam organ is size — the R.C.A. synthesizer occupies ten

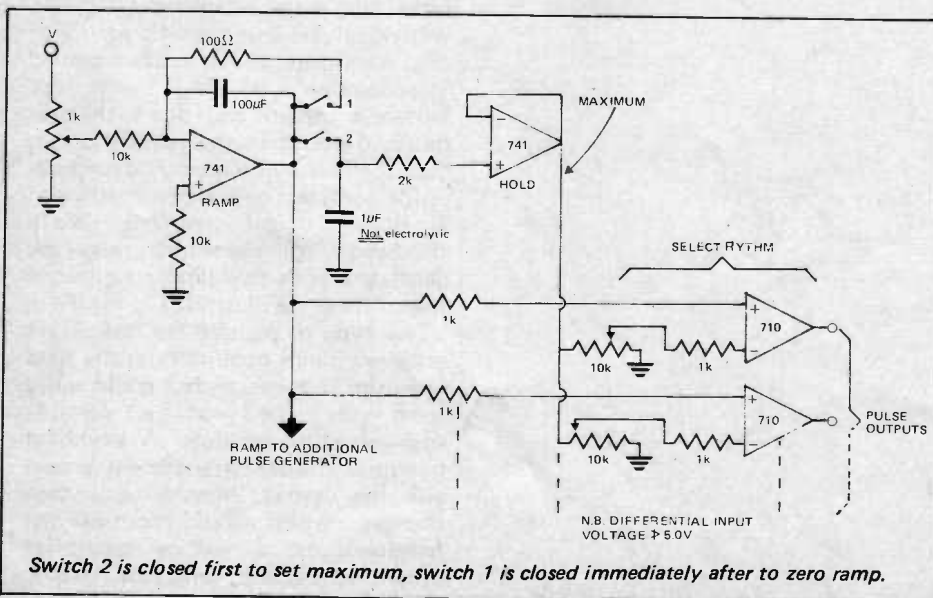

Fig. 6. Experimental circuit for rhythm generator having 'live performance' control.

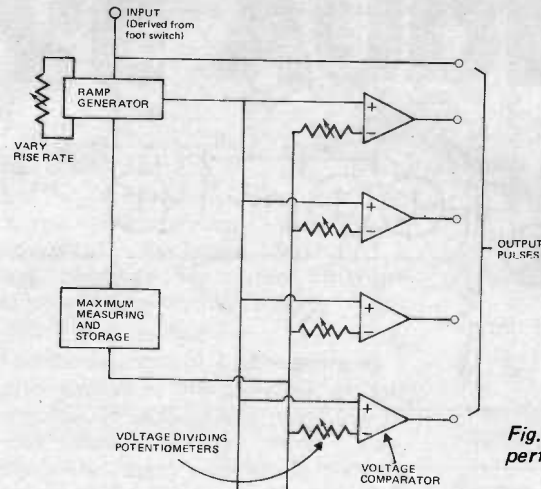

Fig. 5. Rhythm generator with 'live performance' control capability.

2-metre racks with its multitude of tuning-fork oscillator banks, frequency dividers, relays and amplitude controllers.

Despite its versatile range of parameters it is restricted, in that once the paper roll has been punched, it is not easy to juggle parameters around independently.

## THE ORAMIC SOUND SYSTEM

Music played on a conventional acoustic instrument is endowed with various qualities absent from music played on, for example, a laboratory sine wave generator, these are the qualities of inexactitude — subtle wandering of pitch, quaver and vibrato; variations in the number of overtones present from moment to moment and continual amplitude changes. In addition there will be the different types of operating noises discussed earlier in the series.

Daphne Oram has developed and patented a method to enable enough control over electronic music, to allow the composer to add whatever degree of 'humanising' influence he wishes.

The system is completely graphical, each parameter being drawn free-hand by the composer in Indian ink on 35 mm. transparent film. There are nine film 'tracks' which are synchronously pulled along by a sprocketed roller. Each is scanned photoelectrically, some to derive digital, and the rest analogue, information.

Two tracks, corresponding to 'open string' positions, control the pitch, digitally assisted by a third transposition track which can be equated with the fret positions on a guitar. Another digital track controls the rest of the studio equipment as well as timbre selection.

One analogue track only is used for pitch, providing a realistic vibrato, the rest of the analogue tracks controlling the volume (envelope) of four different timbres. The timbres are composed in the same graphic manner, but as waveforms are periodic, only one cycle needs to be drawn, and this is repetitively scanned to give the signal.

It is an easy matter to alter the time relationship or quality of one parameter with respect to the others, as the timbre, envelope and pitch are composed on separate films.

The mixture of the four envelope signals is taken to one track of a multi-track recorder, with part of the signal feeding a final amplitude control track routed to a reverberation room

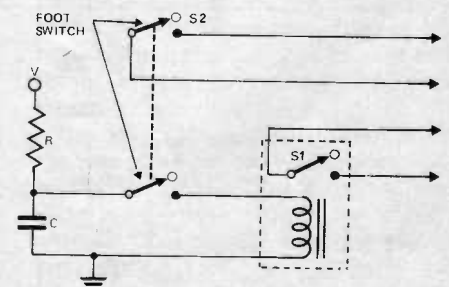

Fig. 7. Using a slugged relay to give the required time differential for circuit shown in Fig. 6.



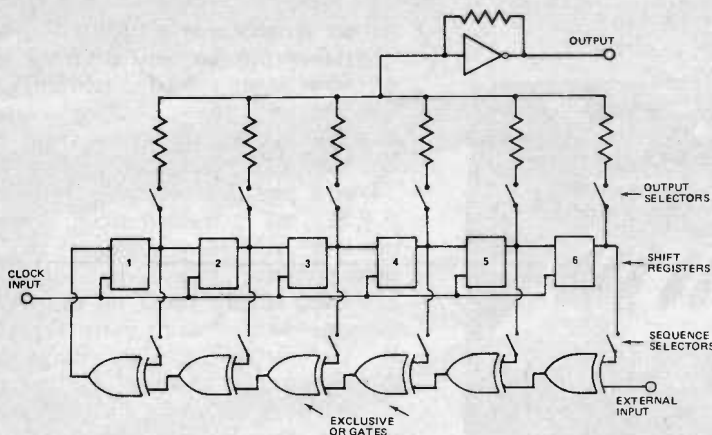

Fig. 8. LEFT: Pseudo-noise generator circuit RIGHT: Truth table of EX-OR gate.

INPUT		OUTPUT
A	B	X
0	0	0
0	1	1
1	0	1
1	1	0

to allow control over reverberation amplitude as well.

### SYNTHESIZERS

A glut of voltage controlled synthesizer designs have arisen since Dr. Robert Moog's first synthesizer went into production in the mid-1960's. Very briefly, these devices operate by converting each control parameter to a linear voltage variation; in many cases this means interfacing a logarithmic or exponential convertor circuit before the actual control input, because our sense of hearing responds linearly to exponential changes of loudness, frequency and so on. Doubling the voltage with such a converter in circuit will double the loudness, or raise the frequency one octave.

The advantage of such a system is that one control voltage may be used to influence any number of devices in tandem, which will track together in synchronisation with control voltage changes. Long runs of cable may be freely interposed between the device and its control apparatus which can be

a voltage generator (oscillator) or some form of potential divider — keyboard, ribbon controller or 'joystick'.

New synthesizer designs, including Electronics Today's version are opting for matrix patching between modules to obviate the spider's web of jack-leads which characterise the Moog systems (with the exception of the live performance Mini-Moog which utilises switched pre-patching).

The British E.M.S. 'A.K.S.' a matrix patching system, has provision for plug-in pre-patched blocks, but this is no great advantage in live performance as, when going from one patch to the next, alteration of all the control settings is also necessary.

Instead of a matrix system, the A.R.P. 2500 synthesizer (Fig. 10) routes its signal and controls via a bank of multi-way switches wired in to a busbar arrangement.

Many synthesizers provide their own particular 'one-off' facilities — in

addition to the complement of oscillators, amplitude controllers and filters.

The Mini-Moog (Fig. 11) has a high accuracy 440 Hz (standard A) generator for tuning purposes.

Moog also make a ribbon controller, which is a resistive strip with an extended conductor suspended above its length; it is played by bringing the conductor into contact with the strip Hawaiian guitar fashion.

The A.R.P. Odyssey (Fig. 12) although monophonic in the strict sense of the word, can route two keyboard voltages simultaneously to separate oscillators. This takes it at least one step nearer to polyphony.

Joystick control is common to the whole of the E.M.S. (and also the Electronics Today) range, and allows independent control over two parameters — one by forwards-backwards movement and the other by side-to-side operation.

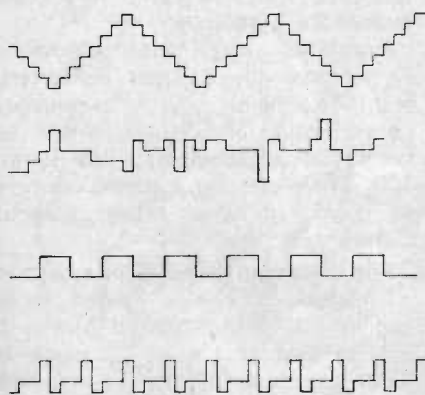

Fig. 9. These are just a few of the many waveforms that can be produced by the circuit shown in Fig. 8

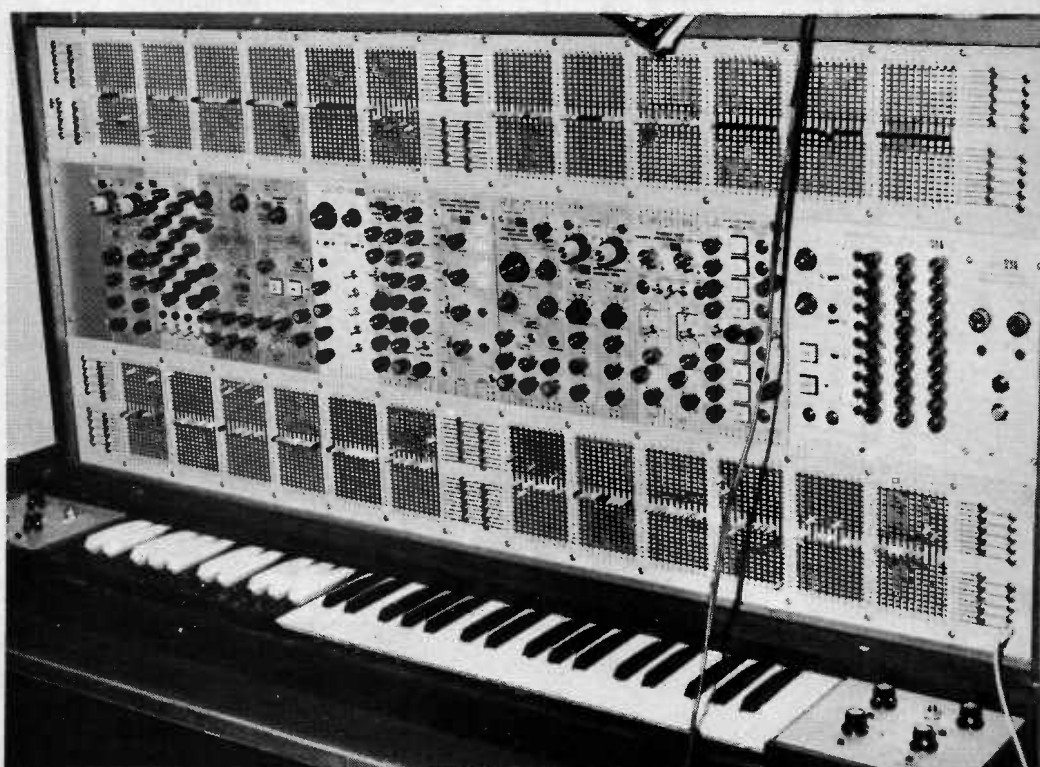

Fig. 10. A.R.P.-Synthesizer.

## CREATIVE AUDIO



Fig. 11. Mini-Moog synthesizer.

One fascinating, if temperamental, device is the E.M.S. pitch to voltage convertor. It detects the fundamental pitch of a signal derived from a microphone or other source, even if this occupies only 10% of the total sound level, and locks on to it. After passing through the sophisticated analogue filtering stage, the period of the fundamental is measured and converted into a proportional voltage suitable for control functions. A track and hold buffer ensures spurious outputs don't occur whilst the signal is dying away. Period measurement is used as opposed to counting zero-crossings in unit time, as it produces results far more rapidly.

Both A.R.P. and Moog synthesizers incorporate modest voltage sequencers, occupying a number of layers; the outputs are routed to

chosen devices and the control at each sequence step is proportional to the setting of the potentiometer. In order to set up a small melody, the painstaking operation of tuning each potentiometer is necessary.

E.M.S. have chosen the alternative of a digital memory bank for their sequencer. The major model, available free-standing (Fig. 13) or integrated in the Synthi 100, records 256 events in six simultaneous layers, each layer of which may control a different parameter.

The memory may be programmed from the keyboard and, once a layer has been registered, there are many possibilities — the voltage pattern can be routed to control another device, the memory can be made to repeat a certain section many times over, or play it forwards or backwards with a



Fig. 12. ARP Odyssey synthesizer can route two keyboard voltages simultaneously to separate oscillators.

tempo variable over a 1000 : 1 range. Mistakes can be 'edited' from the memory, layers can be re-written, and if desired the clocking speed controlled from signals recorded on one track of a multi-track recorder.

Their briefcase synthesizer, the A.K.S., has a rather more limited one-layer 256 event memory; this is programmed from an integral keyboard which, based on capacitive control, has no moving parts (Fig. 14). It too offers a wide range of recording/replay speeds.

This brings us to the final area, the use of the full-size computer for electronic music realisation.

## COMPUTERS

In the early days the computer was used for the actual production of the tone, i.e. feeding its digital message directly to a loudspeaker. This is tedious, time-consuming and expensive for the composer, as each parameter of every tone has to be completely specified.

On the other hand, although the voltage controlled synthesizer has boundless possibilities, it responds markedly to minute variations of its control settings, and once a particular sound has been devised, it may be difficult to regain with accuracy on a future occasion.

In Britain, Dr. Peter Zinovieff has pioneered the idea of a computerised studio, in which the computer works through an interface which transfers the digital information to voltage levels compatible with the voltage-controlled analogue devices.

His studio, a picture of which accompanied the first article in this series, consists of the E.M.S. Synthi 100 synthesizer, analogue-to-digital and digital-to-analogue converters, PDP.8 Processor, 4 K. Core, 32 K. Disc and Teletype.

Programs can be run through which will tune the oscillators and carry out frequency measurements and similar tasks, relieving the composer of the bulk of the 'setting up'.

Zinovieff's digital interface has 4 six-bit analogue-to-digital converters, and 64 six-bit digital-to-analogue converters, to allow the computer to control all the devices in the Synthi 100. There are also 4 ten-bit controls to permit glissando effects without audible stepping.

The composer may use the system in a number of ways, guided by a generalised program called Musys. It can be used as a giant sequencer to examine, store, modify as necessary and replay events registered by the Synthi.

Musical scores may be devised and typed directly on to the Teletype in a

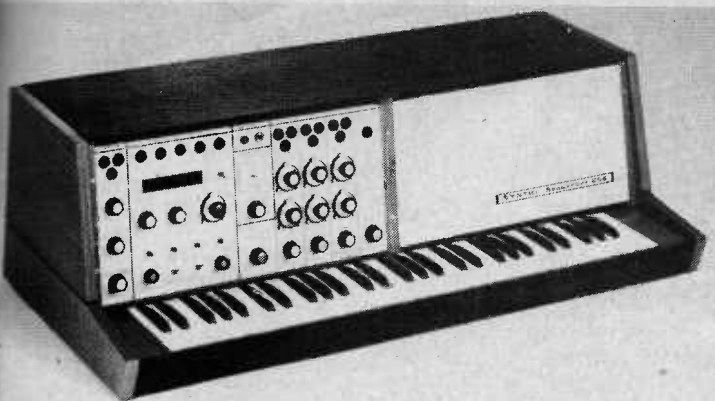

Fig. 13. (LEFT) EMS' sequencer has inbuilt digital memory bank.

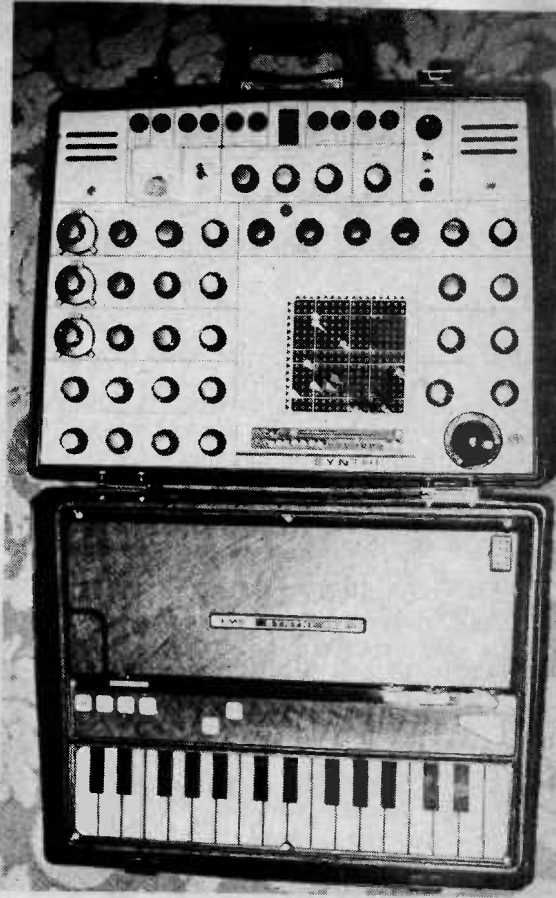

Fig. 14. (RIGHT) AKS 'briefcase' synthesizer has in-built one-layer 256 event memory.

number of ways. They may be in the form of letter/number instructions i.e. O2.15, E3.5, F7.30. This example would route oscillator 2 through envelope 3 and filter 7 with settings of oscillator frequency 15, envelope attack 5, and so on.

The program also allows the composer to specify groups and arrangements of sounds by collective terms, a glissando as GLISS and a crescendo as CRESC. Musical 'chores' such as transposition and repetition are easily carried out. In common with

the integral sequencer of the Synthi, the PDP8 clocking signals may be derived externally, for instance from one track of a multi-track tape.

In conclusion, it is evident from the foregoing that this is one activity in which technology and art occupy common ground. It may appear that this feature has had little in common with the other topics in the series, but one should remember that the common denominator is *tape* — every device mentioned is inevitably involved with the tape recording

process at some stage in electronic music realisation.

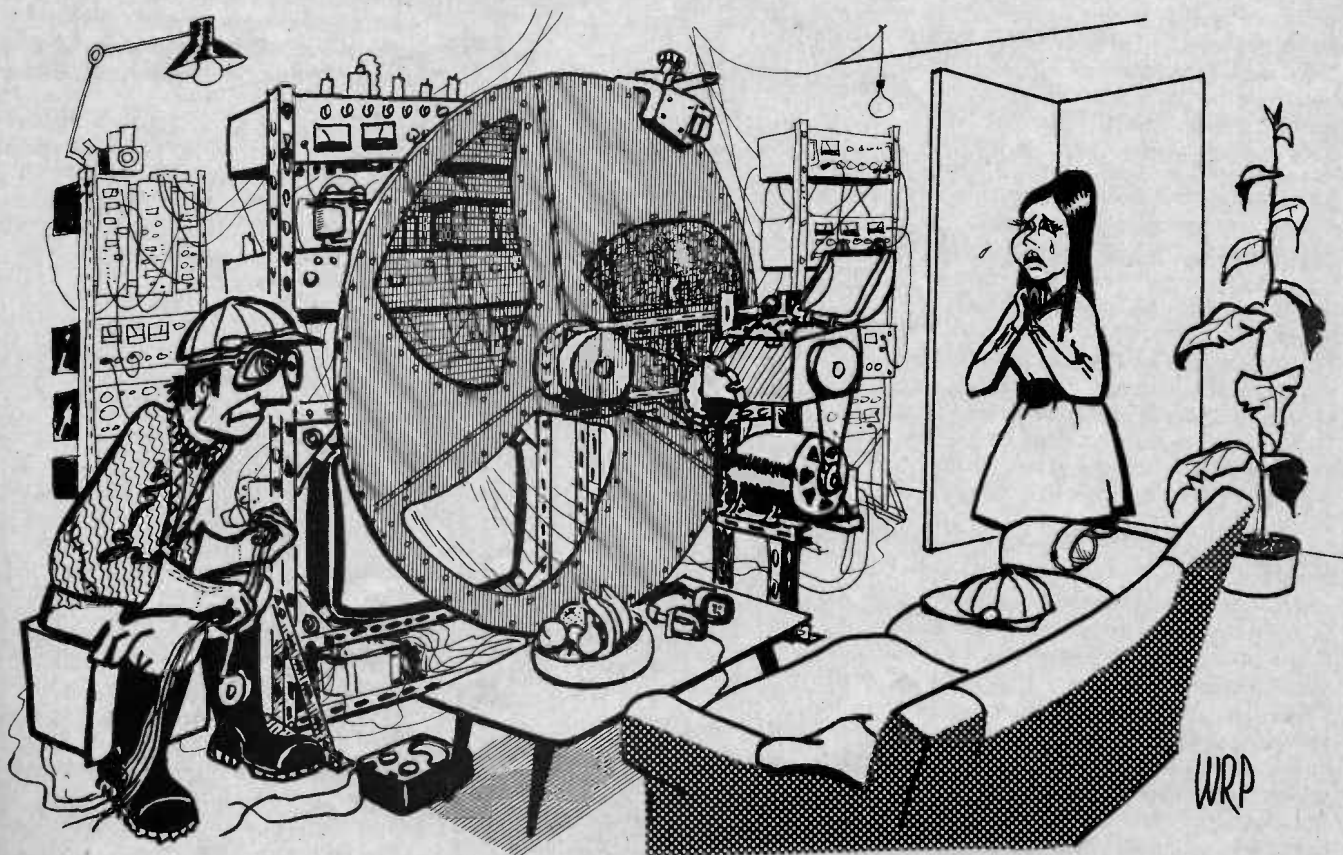

"Your Hi-Fi was bad enough, but its a fine thing when the neighbours call in the police every time our colour set is on!"

# ELECTRONICS

## -it's easy!

This course, written in down-to-earth language, takes the mystery out of electronics — explaining it as the logical, fundamentally simple, yet far ranging subject it really is.

### OUR LARGE RANGE OF FREQUENCIES

Electronics in essence may be seen as a vast, tremendously versatile service facility providing the means of transferring energy between input and output devices.

A TV set, as we showed in the first part of this series, receives its signals from the broadcasting station, processes them, and finally uses these signals to recreate the sound and picture of the original programme material. An alarm circuit uses some form of switch to operate a warning device. A computer accepts information — in the form of coded electrical impulses, or holes in paper tape or cards, and then processes this information to produce further holes in paper, tape or cards, printed output data, or whatever.

In radio broadcasting we use high frequency radio waves to carry the audio sound waves across vast distances. In contrast, the same high frequencies may be used for heating and welding plastics, and for deep-heating in medical therapy.

A microwave oven uses very high frequency energy to heat — a case where information transfer is not a factor.

Examples such as these indicate why such a wide range of frequencies is needed to handle our diverse needs. The frequency that we need to use is often related to the speed with which we need to transfer or process information.

At the low end of the frequency spectrum is the simple alarm circuit where one piece of information needs to be transmitted only when needed. Is the alarm contact open? (If not, it must be closed).

There is little need for extremes of operating speeds as the relatively slow human senses are used to interpret and act on the data received.

Computers may need to process literally millions of pieces of information in as short a space of time as possible. Because of this their

frequency of operation is for ever being increased and present day computers have switches capable of operating at speeds in excess of 1000 million cycles per second.

### GRAPHICAL REPRESENTATION

At the beginning of this part of the series we introduced amplitude/frequency graphs operational sequence in a system where things are happening faster than our senses can follow.

In many electronic systems, such as hi-fi equipments, we often need to know the amplitude of a signal at a particular frequency or range of frequencies. To do this we can use a graph on which amplitude is plotted as before, but with time replaced by frequency on the horizontal axis.

Figure 8 shows the frequency response of a hi-fi amplifier; that is an

indication of how output level varies with constant level input at various frequencies. Ideally an amplifier should have a 'flat response' — that is, it should amplify all signals within the audio range by an equal amount regardless of frequency.

The first thing to note about Fig.8 (and all similar graphs) is that frequency is not plotted on a linear scale. A logarithmic scale is used instead. The reason for this is that to cover the audio frequency range (that is from approx 20 Hz to 20 kHz) linearly would require several yards of paper. The use of a logarithmic scale compresses the information needed into a more satisfactorily handled format.

The graph shown in Fig.8 starts at 10 Hz and passes through 100, 1000, and 10 000 Hz decades. Paper ruled in this fashion is usually obtained ready printed, but it is worth remembering

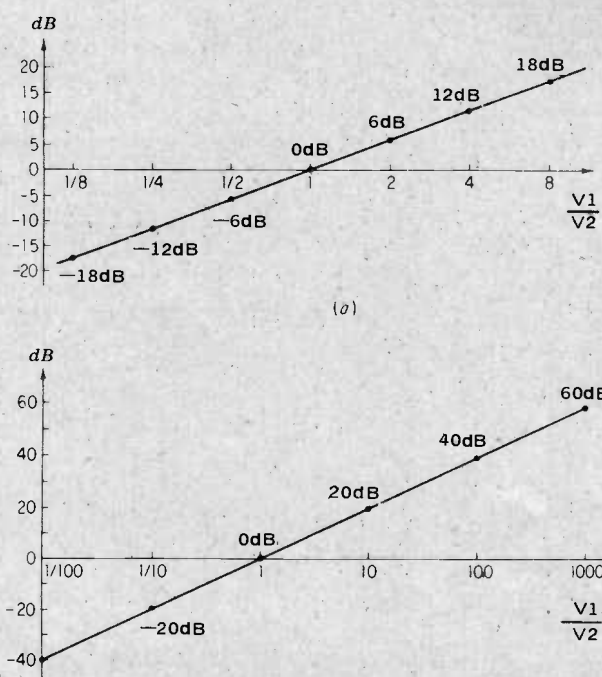

Fig.9. These charts and table give rapid conversion between voltage gain and the equivalent decibel value.

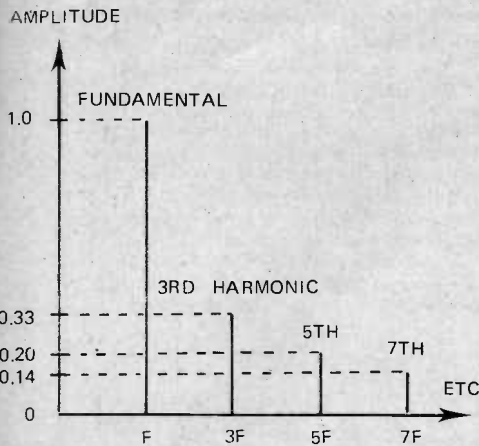

Fig. 10. Frequency spectrum of squarewave signal.

that a crude log plot may be made by ruling lines at equal intervals for each decade, then subdividing each decade by three equal intervals delineating the 2 and 5 unit positions.

Although it does not appear to be so at first sight, the vertical scale in Fig. 8 has also been compressed logarithmically. Here, although the actual markings are at linear intervals, the response has been plotted in units called decibels (dB) — units used to relate voltage or power levels on a logarithmic basis.

As with frequency, voltage and power levels used in electronics cover an enormously wide range. Several thousands of billions in fact. Thus to show a signal varying amplitude from say, 1 nanovolt ( $10^{-9}$ ) to 10 volts, would require an enormously wide piece of paper to allow us any resolution at all. So again we need to compress the scale.

The decibel method compresses the values logarithmically *before* plotting and by so doing produces a linear scale — as Fig. 8 shows.

As with many electronic circuits, the response of an amplifier is a matter of relative comparisons between two values, in this case a constant amplitude input signal and the resultant (amplified) output signal. For voltage levels the decibel value is obtained by the expression —

$$\text{dB} = 20 \text{Log}_{10} \frac{V1}{V2}$$

Some useful values and charts are given in Fig. 9.

We should now be in a position to interpret Fig. 8. The graph shows us that the output of the amplifier falls off as the frequency falls below 30 Hz. Above this we say that its response is 'flat'. The curve terminates at each end, not because an amplifier cannot be made to work beyond these frequencies, but because it has no useful function beyond these limits.

### THE FREQUENCY SPECTRUM

Another form of frequency plot is the so-called frequency spectrum. Previously we have discussed the response of a 'black box' to various input signals. A frequency spectrum on the other hand displays what frequencies are present in a signal and with what relative amplitudes. Figure 10 shows the amplitude/frequency spectrum of a square wave.

A spectrum of particular and general interest is that of electromagnetic radiation. It is the one that involves radiations of energy travelling at the speed of light.

The electromagnetic spectrum is shown in Fig. 11. It gives the names that have been adopted for the various ranges of frequencies that can be used. There is no concept of amplitude here

— the graph merely illustrates the range. It is a very good example of the need for logarithmic scaling — for the known extent of the frequency spectrum ranges from zero frequency up to  $10^{25}$  Hz.

### PHASE

So far we have discussed relationships between amplitude and time or frequency. Phase is also important.

When two or more signals of the same frequency exist together, their relative timing can be important. If they pass through zero in the same direction at the same time we say they are in phase. If not, they are out of phase. The units used to express this relationship are degrees, fractional cycles or actual time periods. Phase/time and phase/frequency graphs can be drawn. In some applications these are vital, but generally to consider phase in this way is rather rare.

At this point it is appropriate to point out that the discussion above applies not just to electrical and electronic signals but to any periodic phenomena — for example, in mechanical, acoustical or even optical systems.

### SEEING THE WAVEFORM

As an ac waveform varies in amplitude with time, a single instantaneous measurement does not necessarily provide the information sought.

If the waveshape is accurately known, as for instance the reasonably closely controlled 240 volt 50 Hz mains supply (sinewave), it is feasible to measure its effective value. This is done with some form of averaging

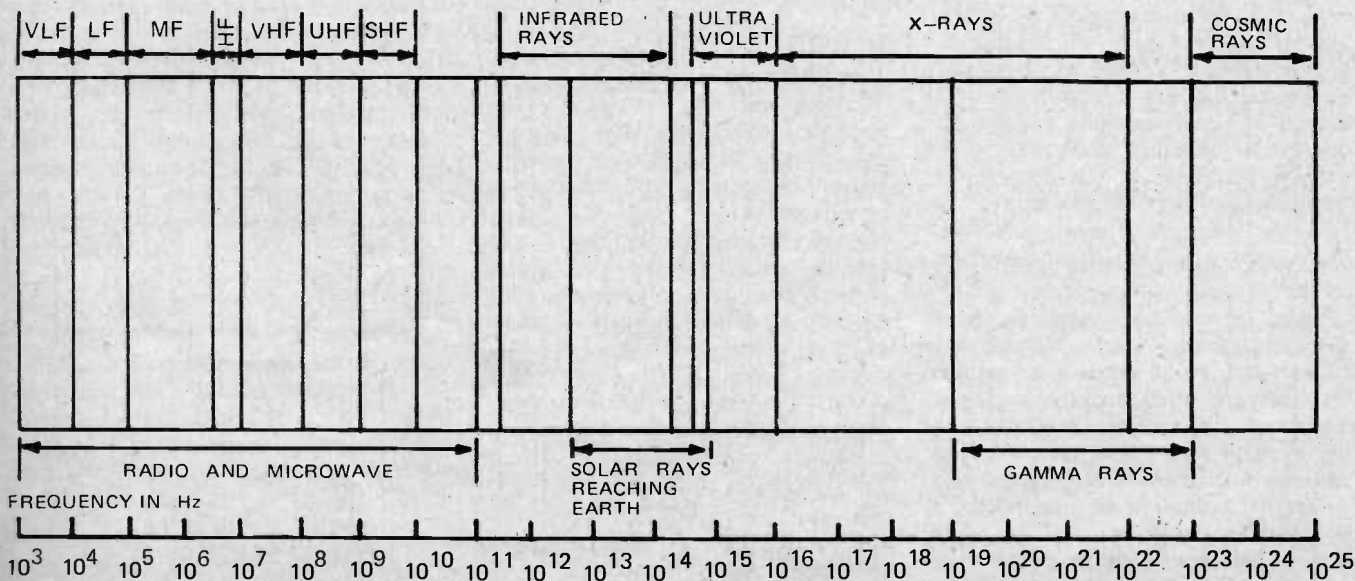

Fig. 11. This chart shows the enormously wide frequency range of the electromagnetic spectrum.

device thus providing what appears to be a single measurement. The ac scale on a multimeter does this.

But if the waveshape and frequency are not known it is necessary to have some means that tells us what is happening.

For extremely slowly varying waveforms, such as squarewaves with periods of minutes, a meter, (reading zero in the centre of the scale) will enable us to observe the amplitude in each direction and the time taken to switch back and forth.

Unfortunately most signals vary faster than we can observe them. More sophisticated methods are necessary.

The most versatile instrument for this (and other) purposes is the cathode ray oscilloscope. Its operation is shown in Fig. 12. In its simplest form it displays what is happening to the signal amplitude as a vertical deflection of a spot of light on a display screen, whilst a signal proportional to time deflects the spot to and fro on the horizontal axis.

By triggering the horizontal sweep at precisely the same place on the repetitive waveform to be observed, the spot traces out a piece of signal wavetrain that persists on the screen long enough to be seen. When the sweep reaches the end it is again re-triggered thus overlaying a second swept pattern on top of the first — and so on.

Oscilloscopes enable us to see waveforms from periods of one cycle per thousand seconds to gigahertz frequencies. Even the cheapest of oscilloscopes will cover the audio spectrum and well beyond — but very wide range 'scopes are expensive devices.

Next to the multimeter, the oscilloscope is the most useful diagnostic tool available. Its price (from £50 upwards) unfortunately rules it out for most amateur work, but any course given by an educational institute would use them. As we do not expect our readers to obtain one this course will not normally require its use in the practical exercises.

If the frequency of the signal to be measured lies in the region from dc to 10 kHz, it is usually possible to 'see' the waveform by using a suitable chart recorder.

These devices use some kind of electro-mechanically operated pen that follows the input signal producing a displacement corresponding to input signal. A mechanism similar to a moving coil meter is often used. The movement of the pen is then recorded on paper which moves under it at a constant known speed.

Chart recorders come into their own when the signal is varying slowly — such as air temperature variations over

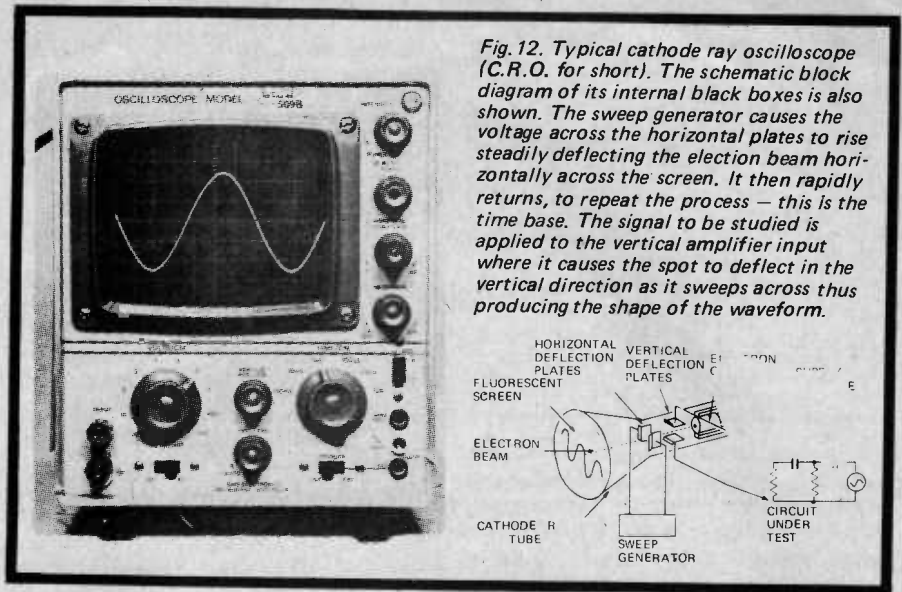

Fig. 12. Typical cathode ray oscilloscope (C.R.O. for short). The schematic block diagram of its internal black boxes is also shown. The sweep generator causes the voltage across the horizontal plates to rise steadily deflecting the electron beam horizontally across the screen. It then rapidly returns, to repeat the process — this is the time base. The signal to be studied is applied to the vertical amplifier input where it causes the spot to deflect in the vertical direction as it sweeps across thus producing the shape of the waveform.

a monthly period: they also provide a permanent record.

### DC LEVEL OF AN AC SIGNAL

So far we have described ac signals in which the current alternates with equal amplitude in both directions.

It is however possible to have an ac waveform that is *not* symmetrical about zero. An ac signal can be produced, or adjusted, to produce this lopsided situation.

In Fig. 13, the sinusoid is symmetrical about zero in (a) but is biased to progressively greater extents in (b) and (c), in fact the waveform shown in (c) never swings negative at all. Some would argue that waveform (c) is not an ac signal but merely a varying dc signal. But nevertheless it would normally be regarded as an ac signal superimposed on a dc level.

It is possible to separate the ac and dc components of such waveforms very simply — more of this later.

### MEASUREMENT OF AC VOLTAGE AND CURRENT

Just as with dc signals, it is very necessary to be able to measure ac signals, such as voltage and current, in order to be able to check circuit operation.

If the signals are sinusoidal (as many are) we can measure the various values, such as rms, peak and average, with a meter made for ac measurements such as the moving iron repulsion type shown in Fig. 14. In this type of meter, the coil is fed with the ac signal, thus producing an electromagnetic field (rather like the relay described in the second article in this series). The electromagnetic field repels a moving iron vane. The greater the amplitude of the signal, the stronger the magnetic field and hence the greater the movement of the vane.

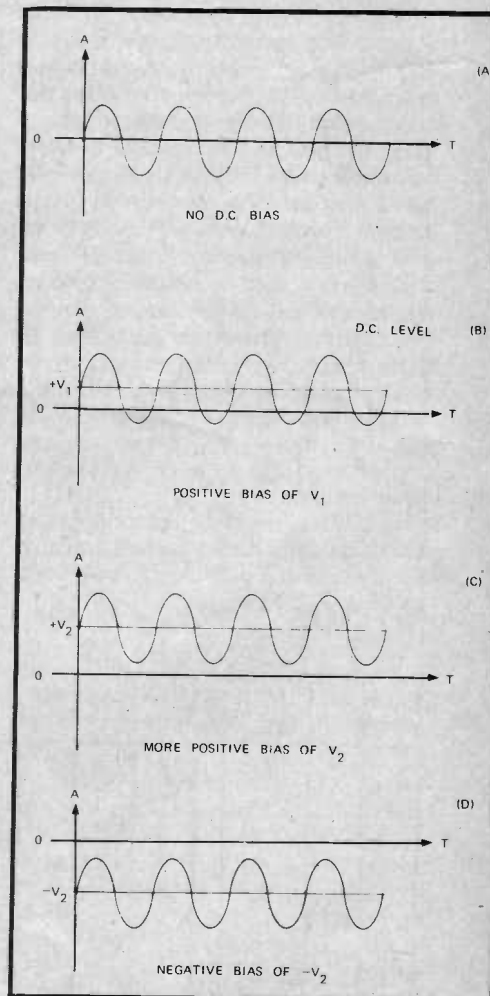

Fig. 13. These graphs show how dc and ac can exist together in a circuit, the dc level providing 'bias' to the ac signal.

Although cheap and robust, moving iron meters are not very sensitive. Apart from this they have non-uniform deflection characteristics (i.e. vane movement is not linearly related to signal strength). AC moving

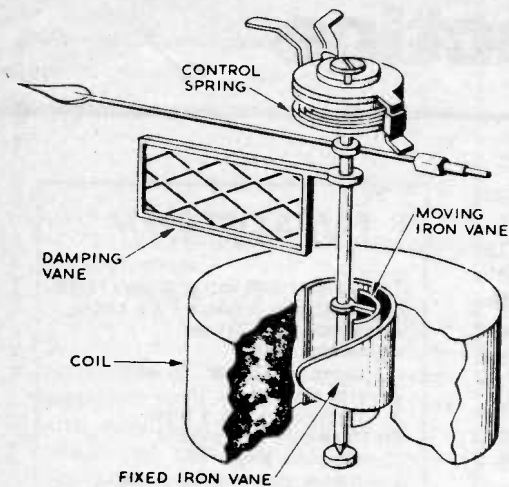

Fig.14. How the moving-iron meter works — illustrating the principle of attraction. This type of meter will also work on dc signals. The scale, shown right, is non-linear.

the difficulty of adequate smoothing.

A better method of rectification is to use a switch that reverses the polarity of the negative half cycles — thus making them positive. This is illustrated in Fig. 15b (centre).

This process is called full-wave rectification and is the most usual method of converting ac signals or power to dc.

This has taken us back to where we came in — measuring ac on a multimeter. We have seen that when an ac range is selected, the range switch inserts a rectifier between the input terminals and the meter

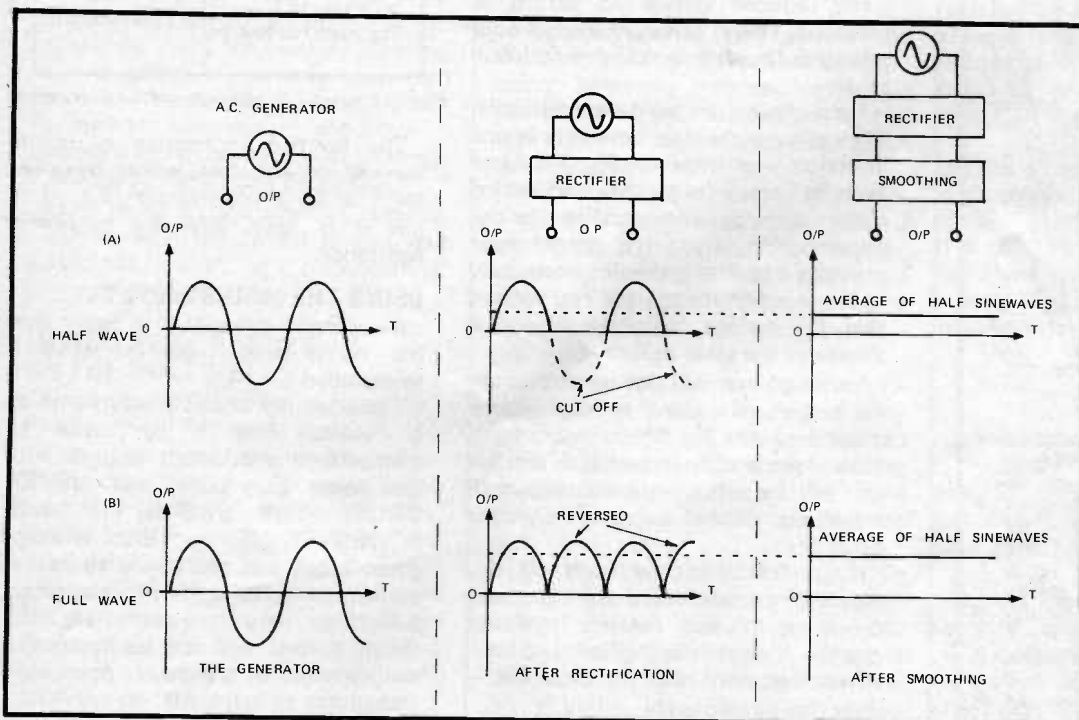

Fig. 15. Halfwave and fullwave rectification — and the black-box representation of the process used. Note the higher output level obtained from the fullwave process.

coil meters (described in this series recently are more sensitive than their moving iron equivalents.

If ac current is fed directly to the meter movement, the needle will attempt to follow the positive and negative excursions of the current. It will vibrate about the zero point indicating little except that the signal is ac not dc.

### RECTIFYING AC TO PRODUCE DC

Each ac cycle of an unbiased waveform has a positive half cycle and a negative half cycle. If a 'switch' is used to let the positive half cycles through but to block the negative half cycles the resultant waveform will appear as shown in Fig. 15a (centre).

If the positive half cycles passed by the switch are now passed into an

'energy store', the fluctuating ac signal will be smoothed out and dc obtained.

This process is called half-wave rectification and the switch used is called a rectifier.

An ac signal rectified in this way can be measured by a conventional moving-coil meter calibrated in rms ac signals. In meters of this kind, the mechanical inertia of the meter movement acts as the averaging energy store (much in the same way as a flywheel smooths out the individual firing impulses of a car engine). In other circuits a capacitor is used instead.

Although simple, half wave rectification is inefficient. Half the available energy is blocked by the rectifier and cannot be used. Also the discontinuity of the waveform adds to movement, and if need be, adjusts the

various shunts and multipliers to obtain the correct rms readings.

Later in this course we will return to look at the various kinds of rectifiers and their use. Their design and operation is relevant when building power supplies to operate electronic equipment powered by the ac mains supply.

### A BASIC ELECTRONICS LIBRARY

It is impossible to remember all the facts of electronics. So as the course progresses we will recommend various inexpensive books or data sheets that are worth collecting.

A good start is to obtain an electronics dictionary of terms such as the paper-back —

S. Handel 'A Dictionary of Electronics' 3rd. Ed. 1971, Penguin Reference Books,

# ELECTRONICS-in practice

THIS month the intention is to provide experience with ac signals and the use of ac ranges on the multimeter.

One way to obtain this, that is both useful and instructive, is to build a small dc power supply operated from the ac mains. This will provide familiarity with ac components and connecting equipment to the mains.

## A MAINS OPERATED SUPPLY

This unit, to which we will later add a circuit that controls its (adjustable) output voltage regardless of changes in supply voltage, provides dc current at a voltage ranging from 18 volts maximum off-load to 10 volts minimum on full load.

The completed unit may be used to replace your 12 volt battery supply in simple electronic applications, such as the relay circuit described in Part 2. It may also be used to power any other normal low current 12 volt devices such as model trains, portable cassette recorders etc.

## HOW IT WORKS

The household mains supply delivers power at 240 volts rms 50 Hz.

To obtain the required 12 volt output it is necessary to reduce this voltage. This is done with the transformer-shown in Fig. 16.

Inside the transformer are two separate, insulated windings, enclosed by a magnetic iron loop. By appropriate choice of the number of turns in each winding, it is possible to

reduce (or increase) the voltage of an ac supply to the level needed.

Transformers will be discussed later in this course, but for now it is only necessary to recognise that in the transformer used for our simple project there are only four leads. Two of these go to the mains, two to the 12 volt circuit. Most transformers have these leads clearly marked. If not it is essential for you to ask a knowledgeable person.

The reduced voltage ac has to be rectified. This is achieved using diodes arranged in what is called a fullwave bridge.

These diodes are solid-state switches. They allow current to flow only in one direction — as shown in Fig. 17. As an exercise trace out the conducting paths through the rectifier bridge remembering that the transformer provides opposite polarities alternately to the input to the bridge. You will see that the output from the bridge is always of the same polarity.

Although you will not be able to see the waveform without an oscilloscope it will look like Fig. 15b.

Our next and final stage is to arrange to average out the non-smooth waveform. This is done by the capacitor.

It is vital that the leads of this capacitor be connected the right way round as reverse polarity will not provide correct operation and will almost certainly ruin the capacitor — sometimes explosively!

## PARTS LIST ET217

Transformer 240 volt primary: 12-15 volt secondary (approx 1-1½ amps).  
 4 — diodes 1N4001 or equivalents.  
 1 — capacitor 220  $\mu$ F, 25 volt working electrolytic  
 2 — terminals 1 red, 1 black  
 6ft three-core mains cable.  
 1 — three-pin plug.  
 1 — rubber grommet for power cable.  
 3ft 23/0076 connecting wire  
 Tag strips, screws, etc.

The positive connection is usually marked on the case, either by a red mark or by a positive sign (i.e. +). If not it is again advisable to obtain assistance.

## USING THE MAINS SUPPLY

We cannot stress too strongly that the mains supply can be lethal if mishandled.

There is only one safe way in which to work. This is to make all connections and circuit changes with the power plug pulled out. NEVER TRUST THE SWITCH IN THE POWER POINT, for such switches often break just one of the two wires connected to the outlet. If incorrectly wired, as they frequently are, full mains voltage will still be applied to one terminal of the power point even though the switch is off.

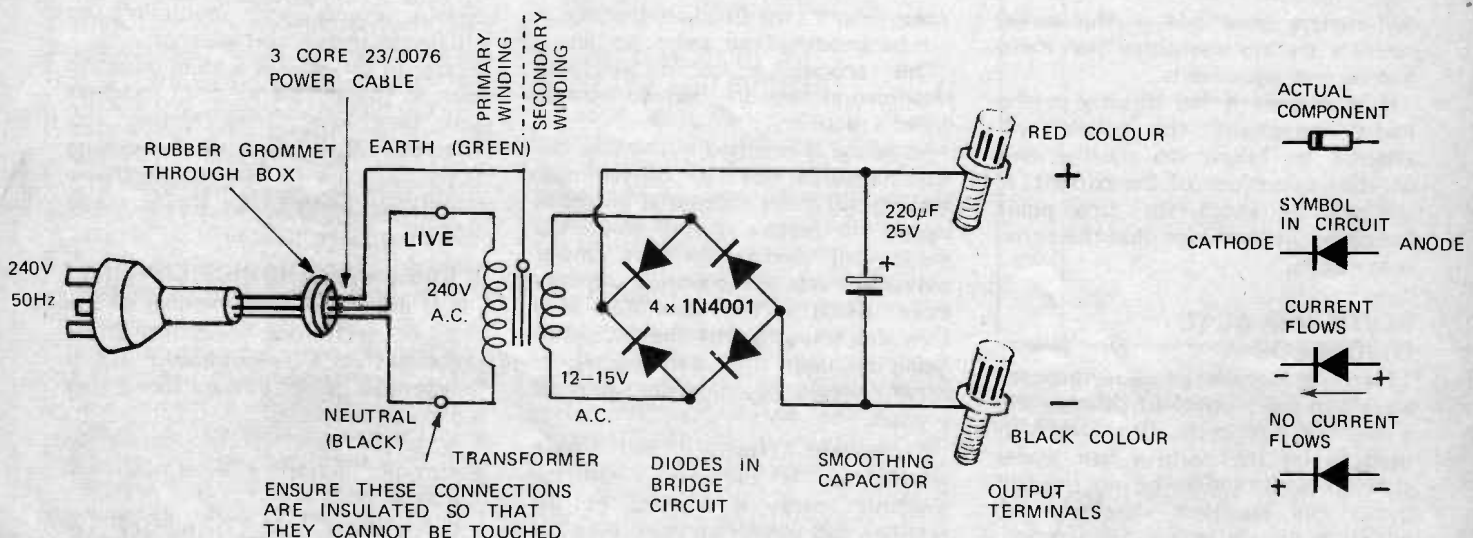

Fig. 16. Circuit/pictorial drawing of mains-operated, unregulated, dc supply.

Fig. 17. Corrections for the rectifier diodes used in the project shown in Fig. 16.



## VHF/FM TUNER KITS

Continued from page 45

This warning should not be taken as a discouragement to use the mains supply. Correct practice will safeguard you at all times.

The power supply unit should be earthed. That is, the earth wire from the three pin plug and cord must be connected to all the metal parts associated with ac. In our case the earth wire must be connected to the transformer case, and to the power supply case — if it is made of metal.

Modern plugs have the pin connections clearly marked.

Once the input (or primary winding, as it is called) is correctly connected there is little danger, for the 18 volt (approx.) secondary winding is insulated from the mains and produces a voltage too low to be dangerous.

Even so, it is good practice never to make or alter the circuit in any way unless the power plug is pulled out of the mains socket.

### USING THE AC RANGES ON THE MULTIMETER

Having built the power unit you will need to know if it works correctly.

Plug it in and turn on the mains. Then, using the ac volts range set to read 12 volts around mid-scale, measure the voltage across the secondary winding.

It is wise at this stage, not to measure the primary voltage, for a slip of the finger could give you quite a fright. If there is secondary voltage available, then the primary must be operating.

Now switch to a dc volts range and measure the voltage across the output terminals. This should be about 16 volts depending on the transformer used. This is the peak value of the half sinewaves (the capacitor charges up to the maximum peak value with no load applied).

Finally carry out a load test. This is done by progressively adding loads until the minimum allowed measuring voltage is obtained when the load is added.

The results are then plotted on linear graph paper with voltage on the vertical axis and load current on the horizontal axis. This is called a regulation curve — it shows what happens to our 'black box' as load is increased.

Depending on the multimeter used, you can also measure currents in the various wires. Remember that current is measured by placing the meter in series with the lead of interest. (Not all multimeters have ac current scales). ●

Detailed instructions are however given for fitting a LED to the slider potentiometer used as for tuning. The LED is subsequently visible through the preprinted tuning scale and indicates tuning position.

The circuit contains 9 coils which would normally make alignment very difficult. However a particularly lucid section of the manual on setting up will, if followed correctly, allow the user with only the minimum of instruments (i.e. a VOM) to achieve spot-on alignment.

Construction is very simple and the completed circuit requires no alignment; however, compressing or expanding the ready wound tuning coil will move the receivers coverage about the band quoted.

The complete kit unit is housed in a moulded plastic case into which the user must cut a 10mm hole for the telescopic aerial. The front panel contains tuning, volume/on-off controls, loudspeaker and earphone output jack.

Construction time is about 1½ hours and is helped by high quality components and a neatly overprinted PCB. Incidentally, the screen printing on the component side of the board gives values and circuit numbers for each component.

Construction details and circuit descriptions are contained in two manuals of 8-pages and 6-pages for the tuner amplifier respectively. The test unit worked first time and immediately pulled in a wealth of signals from Manchester Airport, a distance of some twenty five miles from the listening point. The combination 525/145 is an ideal receiver for aircraft fans or anyone interested in exploring the area of the 2 metre band.

The teak finish cabinet is supplied in separate parts with premitred or grooved corners; even the clumsiest of woodworkers being able to achieve a first class finish.

### AMTRON

A slightly different type of VHF receiver is the 525/C kit by Amtron designed to cover the 120–160MHz band. Such coverage will pull in aircraft, police, taxis and the 2 metre (144MHz) amateur band.

The basic four transistor circuit has an output for an earpiece or external amplifier only although a companion kit (no. 145) converts the unit into loudspeaker output (the speaker being included in the 525 kit).

BUILD THE

# TREASURE TRACER MK III

METAL LOCATOR



AS SEEN ON BBC-1 & BBC-2 TV

- Genuine 5-silicon transistor circuit, does not need a transistor radio to operate.
- Incorporates unique varicap tuning for extra stability.
- Search head fitted with Faraday screen to eliminate capacitive effects.
- Loudspeaker or earphone operation (both supplied).
- Britain's best selling metal locator kit.
- Kit can be built in two hours using only soldering iron, screw-driver, pliers and side-cutters.
- Excellent sensitivity and stability.
- Kit absolutely complete including drilled, tinned, fibreglass p.c. board with components siting printed on.
- Complete after sales service.
- Weighs only 22oz; handle knocks down to 17" for transport.

Send stamped, self-addressed envelope for literature.

Complete kit with pre-built search coil

**£9.80**  
Plus 35p Post  
(inc. VAT)

Built, tested and Guaranteed

**£13.75**  
Plus 35p Post  
(inc. VAT)

MINIKITS ELECTRONICS,  
35d Langley Drive, Wanstead,  
LONDON E11 2LN  
(Mail order only)

## WILMSLOW AUDIO

The firm  
for  
speakers!



Baker Group 25,2 8 or 15 ohm	£ 6.60
Baker Group 35,3 8 or 15 ohm	£ 7.50
Baker Deluxe 12" d/cone	£ 9.75
Baker Major	£ 7.50
Baker Major Module	£ 9.50
Baker Regent	£ 7.00
Celestion PST8(for Unilex)	£ 2.55
Celestion MF1000 horn	£10.45
Celestion HF1300	£ 6.16
EMI 13x8,3 8 or 15 ohm	£ 2.15
EMI 13x8,150 d/c 3,8,15 ohm	£ 2.35
EMI 13x8,t/tw,450,3,8,15 ohm	£ 3.60
EMI 13x8 type 350 8 ohm	£ 8.25
Fane Pop 100 watt 18"	£22.50
Fane Pop 60 watt 15"	£13.00
Fane Pop 50 watt 12"	£11.00
Fane Pop 25/2 12"	£ 6.40
Fane Pop 15 watt 12"	£ 4.40
Fane Crescendo 18	£47.50
Fane Crescendo 15	£36.00
Fane Crescendo 12A or 12B	£29.00
Fane Crescendo 12BL	£30.00
Fane 807T 8"roll surr.8or15 ohm	£ 3.85
Elac 59RM109 15 ohm,59RM114 8 ohm	£ 2.65
Elac 6 1/2" d/c roll surr.8 ohm	£ 3.35
Elac 4" tweeter TW4	£ 1.21
Goodmans 8P 8 or 15 ohm	£ 4.49
Goodmans 10P 8 or 15 ohm	£ 4.70
Goodmans 12P 8 or 15 ohm	£11.65
Goodmans 15P 8 or 15 ohm	£18.00
Goodmans 18P 8 or 15 ohm	£31.00
Goodmans 12PD 8 or 15 ohm	£15.25
Goodmans 12PG 8 or 15 ohm	£14.50
Goodmans Audiomax 12AX	£39.65
Goodmans Audio 100	£ 9.50
Goodmans Axent 100	£ 6.60
Goodmans Axiom 401	£15.10
Goodmans Twinaxiom 8	£ 6.79
Goodmans Twinaxiom 10	£ 7.61
Kef T27	£ 4.75
Kef T15	£ 5.75
Kef B110	£ 6.75
Kef B200	£ 7.50
Kef B139	£11.75
Kef DN8	£ 1.92
Kef DN12	£ 4.12
Kef DN13	£ 2.75
Richard Allan CG8T 8" d/c 8ohm	£ 6.35
Wharfedale Super 10 RS/DD	£ 9.80
Wharfedale Lintin 11 kit (pair)	£19.25
Wharfedale Glendale (pair)	£34.50
Wharfedale Dovedale (pair)	£52.00
Richard Allan Twinkit each	£ 8.25
Richard Allan Triple 8 each	£13.00
Richard Allan Triple each	£18.00
Richard Allan Super Triple each	£21.50
Goodmans DIN 20 each	£ 8.75
Fane Mode 1 each	£ 9.90
Helme XLK25 (pair)	£18.17
Helme XLK50 (pair)	£37.18
Kefkit 11 each	£23.50
Kefkit 111 each	£34.00

### PRICES INCLUDE VAT.

Cabinets for Hi-Fi and PA., wadding, vynair etc. Send for free booklet-"Choosing a Speaker".

**FREE with orders over £7-HiFi Loud-speaker enclosures book.**

**All units guaranteed new and perfect.**

Prompt despatch

Carriage and insurance: Speakers 35p each, Kits 75p each (£1.50 pair)  
Tweeters and crossovers 20p each.

## WILMSLOW AUDIO

Dept ET1

Swen Works, Bank Square, Wilmslow,  
Cheshire SK9 1HF.

# MODERN Component Storage?

A TREMENDOUS OFFER OF  
QUALITY STEEL UNITS AT  
BARGAIN PRICE.

### F26-06

A 6 drawer metal cabinet with polystyrene drawers, each drawer front filled with twin label holders for indexing and easy identification. This flexible filing system accepts a 9 section insert for component storage giving 54 compartments measuring 75 x 103 x 26mm.

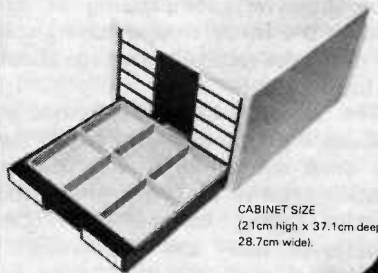

CABINET SIZE  
(21cm high x 37.1cm deep  
28.7cm wide).

### PRICE OF CABINET (excluding insert trays)

9 compartment inserts are 56p each incl. p and p and VAT.

Incl.  
VAT.  
**£9.35.**

F26-06 and F55-03 Insert trays can be purchased separately minimum quantity of 6 each.

### F55-03

This unit offers facility for 45 component storage compartments measuring 72 x 57 x 55mm.

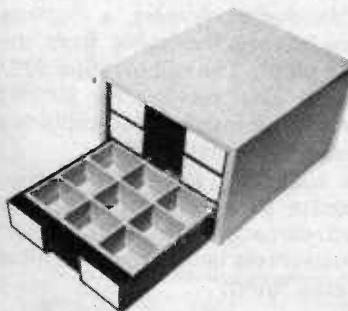

### PRICE OF CABINET (excluding insert trays)

15 compartment inserts are 80p each incl. p and p and VAT.

DELIVERY: Please allow approximately 14 days.

Incl.  
VAT.  
**£8.48.**

## PLANETRON SYSTEMS

Dept. 24

76 CASTLE STREET,  
FARNHAM, SURREY.

(MAIL ORDER ONLY)

## AMBIT INTERNATIONAL

Microcircuit  
specialists

Did you know we supply Signetics PLL, National linear and digital, ECL from Fairchild etc. ? Devices like the 95H90 - a decade counter at 220 megs. £9.05. Or the AF amplifier LM380, by National for only £1.00. See our new A4 size catalogue for details of our full range of devices, modules, and our unique datacopying service.

AMBIT is the UK distributor for coils and filters by TOKO inc. eg:

**Ceramic filters for AM:**  
CFT455B 455kHz-8kHz 45p  
CFT455C 455kHz-6kHz 45p

**Mechanical filters for**  
top quality MW/SSB:

MPH71T 455kHz-7kHz 135p  
MPH41T 455kHz-4kHz 135p

**Ceramic filters for FM:**  
CFS10.7 10.7MHz 45p

(Sim. to Murata & Veritron filters.)

Plus coils/chokes etc. for radio and tv.

### FM TUNER EQUIPMENT:

7251 tuner set by Larsholt - a combination of MOSFET

and varicap tunerhead, and the CA3053/ca3089E

IF amplifier. Includes MUTE, AFC, METEF DRIVE.

Outstanding performance and quality. The essence of any HI-FI FM Tuner.

£17.00 built and tested. Stereo decoders:

MCL310P full kit w/1h

socket, LED etc. £5.10  
CA3090Q built £6.60

The AMBIT catalogue is full of data - get your copy now !

TERMS-----  
P&P 17p. VAT +10% please  
Send to: AMBIT int.,  
37 High Street-Brentwood  
ESSEX. CM14 4RH (216029)

TRADE ENQUIRIES WELCOME.

New switch may be used to modulate light in laser communication systems.

# THIN FILM LASER SWITCH

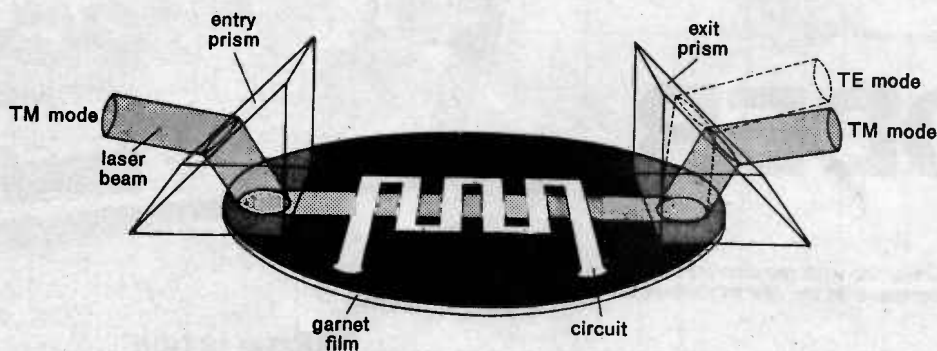

*Path of a laser beam through the thin film switch*

A NEW light switch for use with lasers has been devised by Bell Telephone Laboratories (BTL) scientists.

The magnetically-controlled switch, which can modulate light passing through a thin, single-crystal garnet film, may some day be the heart of a miniature circuit in an optical communications system. Scientists have been seeking such a switch as part of a system that would permit them to transmit large amounts of information over light beams.

The light switch measures about 19mm across in its present experimental form, but could be miniaturized further to meet the prism requirements of an optical communications system.

The switch consists of a yttrium-gallium-scandium-iron garnet film, about 2.5 micrometres thick. The film is grown, on a gadolinium-gallium-garnet substrate, and it serves as a waveguide for the light waves. Two types of light waves can propagate in this film. One type has magnetic transverse fields or so-called TM modes. The other types has electric transverse (or TE) fields.

Two prisms are positioned, one at

either end of the garnet crystal wafer. One prism serves to guide the beam from an external laser into the film. The second "exit" prism guides the laser beam out of the film. This technique for coupling an external laser beam into an optical circuit was advanced by Dr. Tien and his colleagues in 1969. The exit prism, which is made of a bi-refringent material, has an additional property in that it guides the laser beam out of the film in one direction for the TM type of lightwave and in another direction for the TE type of lightwaves.

A tiny serpentine-shaped electronic circuit, made by conventional integrated circuit techniques, is applied to the surface of the garnet wafer, overlapping the path followed by the laser beam through the garnet film. In the experiment, the light wave is fed into the film by the "input" prism in a TM mode. When a current is passed through the serpentine circuit, a small magnetic field, in the order of  $2 \times 10^{-5}$  tesla is created. When the magnetic field is present, the light wave is converted from the TM mode to the TE mode because of the magnetic-optic property of the film. The exit prism guides the TE and the

TM light waves out of the film in two different directions. The light beam can be switched back and forth by turning the induction current, and thus the magnetic field, on and off in the circuit.

By switching or modulating the light in a precisely controlled pattern, information could be coded into the light beam. The beam could then be transmitted through a glass fibre to a distant receiving station where the information would be retrieved by a light detector.

In an eventual optical system, the input prism may not be needed, since the light wave may be generated in the film by a thin-film laser. The exit prism also would be replaced by a thin-film polarizer and a film-fibre coupler. The modulator or switch would thus be extremely simple, involving only a magnetic film and a tiny electric circuit. Because of the serpentine structure, the inductance of the circuit is less than 0.1 microhenry. In the experiment, less than 100 mW of electrical power was used to modulate the light from a 1.15 micrometre helium-neon laser at a modulation frequency of 80 mHz. ●



Alternative decoder offers same performance as IC version.

# DISCRETE SQ DECODER

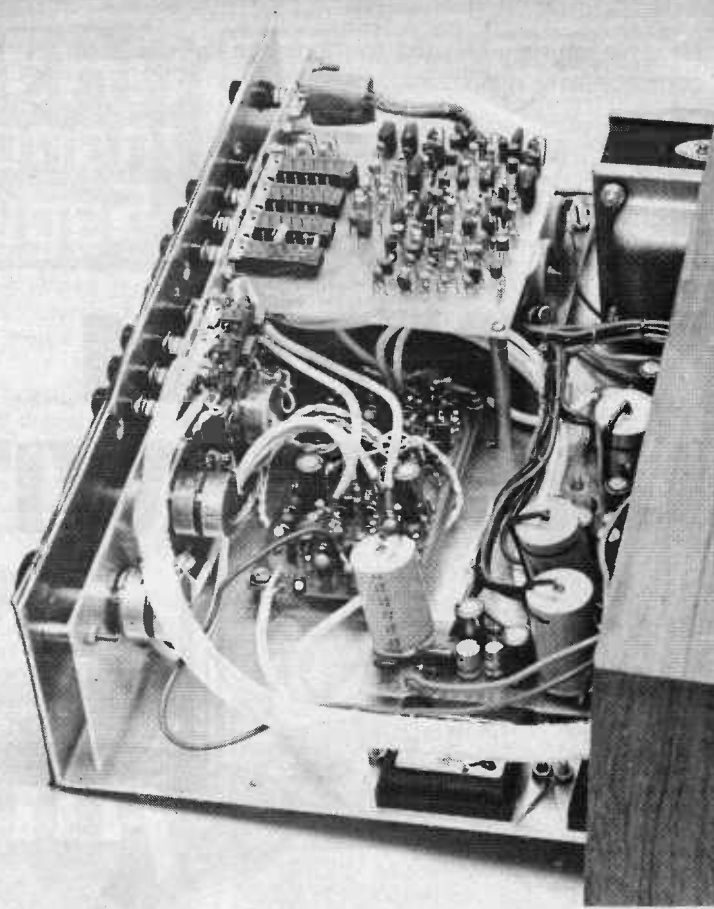

*This photo shows the ETI 420 amplifier with the discrete decoder fitted. Note the supporting spacer at the rear of the board. ▶*

THE ETI 420 4-channel amplifier published in the April 1974 issue has achieved instant popularity. In the original article we promised to do a follow-up giving details of a decoder using discrete components. The I.C. decoder is still available from Trampus Electronics who are also stocking the specially made push-button switches for this project. (Their address is P.O. Box 29, Bracknell, Berks.)

The discrete decoder published here does have a slightly better performance than offered by the I.C., though the cost is also higher. The decoder published here is a direct replacement for the one given in the April issue. It may of course also be used for building your own 4-channel amplifier.

The specification of the amplifier, incorporating the discrete SQ decoder, is virtually the same, with the exception that the SQ decoder phase shift is now  $90^\circ \pm 10^\circ$  from 30 Hz to 20 kHz, rather than from 100 Hz to 10 kHz as with the I.C.

## CONSTRUCTION

The construction is straightforward. The usual precautions should be taken with all polarized components, transistors and capacitors etc, with regard to polarity. Assembly of the

board should be performed in accordance with Fig. 3. Note that the switch should be pressed fully home on the board and the contacts soldered to the tracks where applicable.

## INSTALLATION

The board is mounted in exactly the same manner as the IC version, with the exception that a long spacer (56 mm) should be used to support the

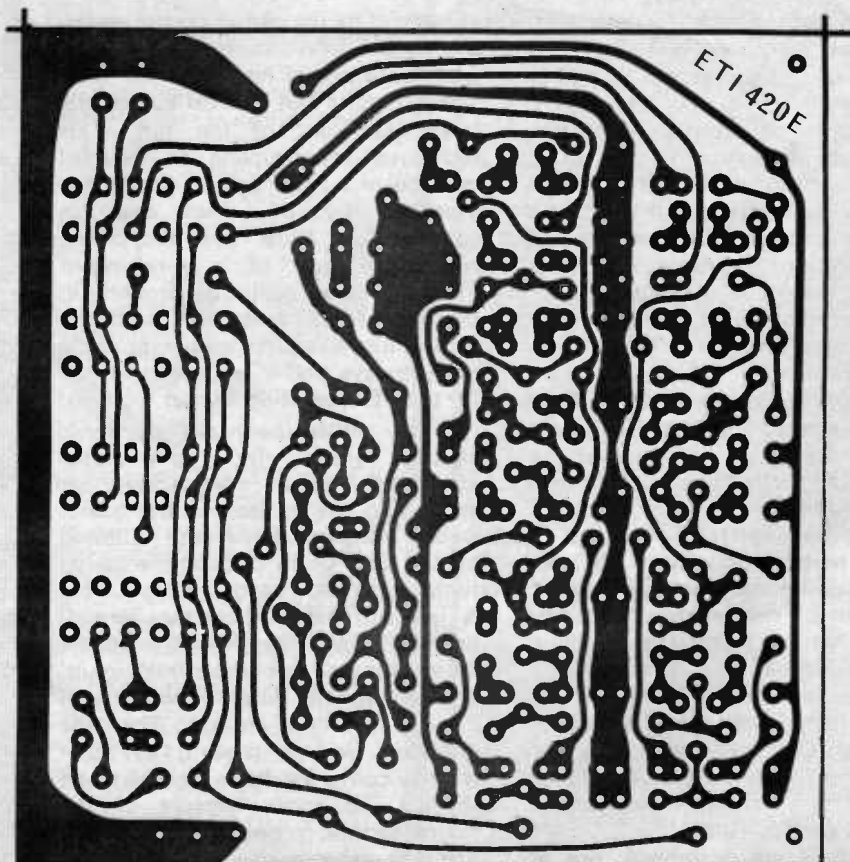

*Fig. 1. Printed circuit board for the decoder (full size). ▶*

# DISCRETE SQ DECODER

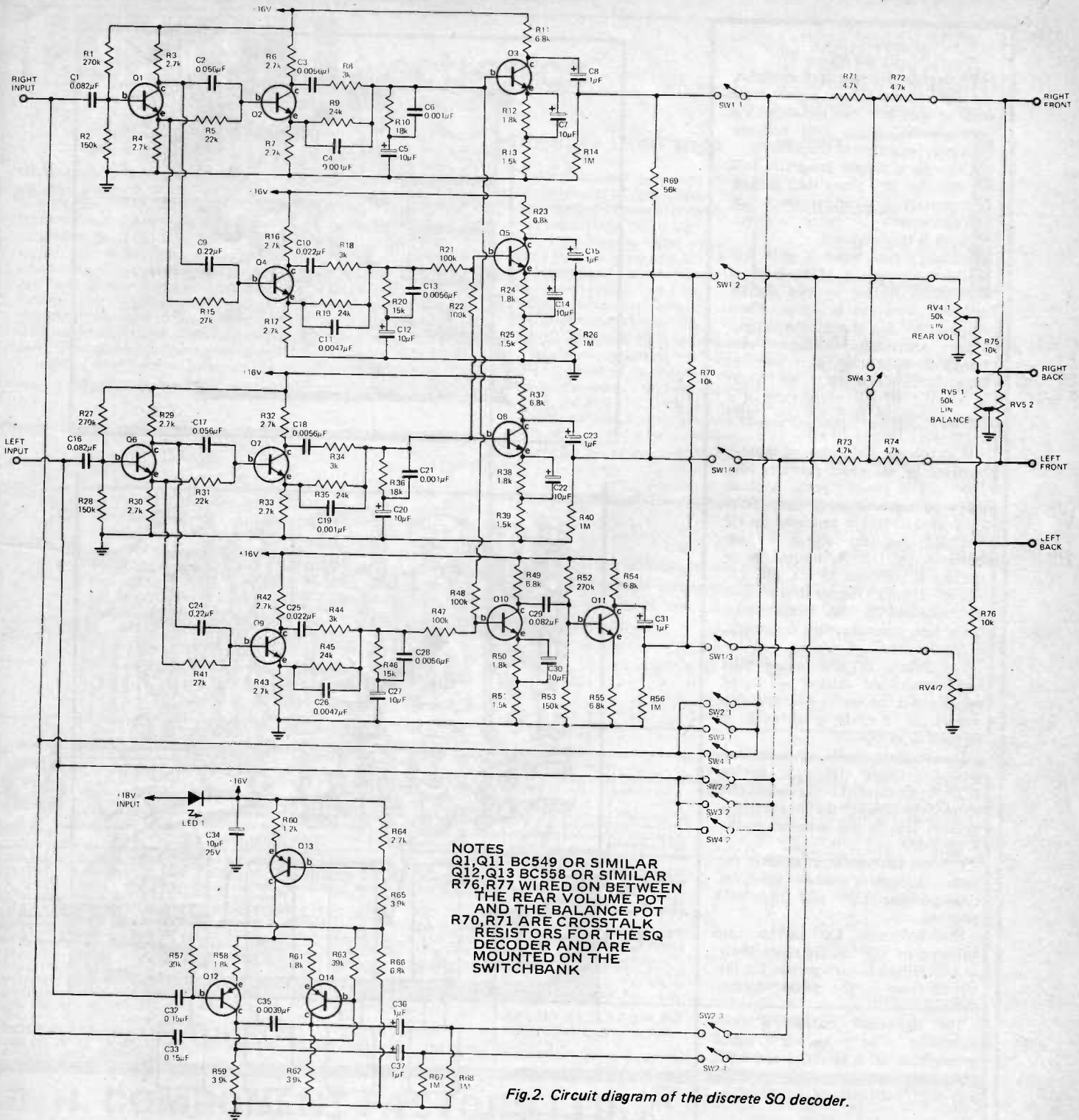

Fig.2. Circuit diagram of the discrete SQ decoder.

## PARTS LIST - DECODER BOARD

Resistor	270k	150k	1/2W	or 1/4W	5%				
R1,27,52	270k					R71,72,73,74	4.7k		
R2,28,53	150k					RV4,5	Potentiometer	50 k dual lin rotary	
R3,4,6,7,16,17,29,30,32	2.7k					C1,16,29	Capacitor	0.082µF	Polyester
R33,42,43,64	2.7k					C2,17	"	0.056µF	"
R5,31	22k					C3,13,18,28	"	0.0056µF	"
R8,18,34,44	3k					C4,6,19,21	"	0.001µF	"
R9,13,35,45	24k					C5,7,12,14	Capacitor	10µF 10V	electrolytic PC mounting
R10,36	18k					C20,22,27,30	"	10µF 10V	electrolytic PC mounting
R11,23,37,49,54,55,66	6.8k					C8,15,23,31,36,37	Capacitor	1µF 16V tag tantalum	
R12,24,38,50,58,61	1.8k					C9,24	"	0.22µF	Polyester
R13,25,39,51	1.5k					C10,25	"	0.022µF	"
R14,26,40,56,67,68	1M					C11,26	"	0.0047µF	"
R15,41	27k					C32,33	"	0.15µF	"
R20,46	15k					C34	Capacitor	10µF 25V electrolytic PC mounting	
R21,22,47,48	100k					C35	"	0.0039µF Polyester	
R57,63	39k					Q1-Q11	Transistors	BC109,BC549 or similar	
R59,62,65	3.9k					Q12-Q14	"	BC178,BC558	
R60	1.2k					LED 1	light emitting diode	TIL209	
R69	56k						PC board	ETI 420E	
R70,75,76	10k					SW1,2,3,4	switchbank	(see text)	

## HOW IT WORKS

To decode SQ matrixed material, the left and right input signals must each be split into two signals with a constant 90° phase shift between each pair, regardless of frequency.

Although a simple integrator will provide the 90° phase shift it does not provide a constant amplitude (-6 dB/octave). A more complex network is thus required.

Basically, each input is split into two components at 180°. Each is then phase shifted by two slightly different networks in series. When referred to the input, the output phase continually changes with frequency (maximum shift 540° at 20 kHz). However when one output is referred to the other there is a constant phase shift of 90° ±10° between 30 Hz and 20 kHz.

In detail, the right channel input is buffered by Q1 which provides two, 180° out of phase, signals. A phase shift varying between 0° and 180° (90° at 130 Hz) is provided by C2 and R5 and this signal is then buffered by Q2. Additional phase shifting is provided by C3, C4, C6, R8, R9 and R10 to provide a total of 540° shift at 20 kHz. This network has a loss, constant with frequency, of 10 dB.

The values of the phase shift components are critical - stated values *must* be used. The resulting output of the above network is referred to as Rφ°.

The output of Q1 also feeds a second network (Q4 etc), having different phase shift components, the output of which lags the first network by 90°. This output is known as the R(φ-90°).

The left channel input receives the same treatment and produces corresponding Lφ° and L(φ-90°) outputs.

The Rφ° and Lφ° outputs are buffered by Q3 and Q8 respectively and amplified to compensate for the 10 dB loss in the phase shifting networks.

The right-back output is now produced by mixing equal proportions of R(φ-90°) and Lφ°. These are mixed by R21 and R22 and then buffered and amplified by Q5.

Similarly the left-back output consists of equal proportions of L(φ-90°) and Rφ°. These are mixed by R47 and R48 and then buffered and amplified by Q10. This output, as required by the SQ coding, is then phase shifted 180° by Q11.

Some crosstalk between left and right channels is recommended and R69 provides 10% mixing of left and right front channels, whilst R70 provides 40% mixing of the rear channels. These two resistors are mounted on the switch bank.

Except for component numbering, the ambience mode is as described last month.

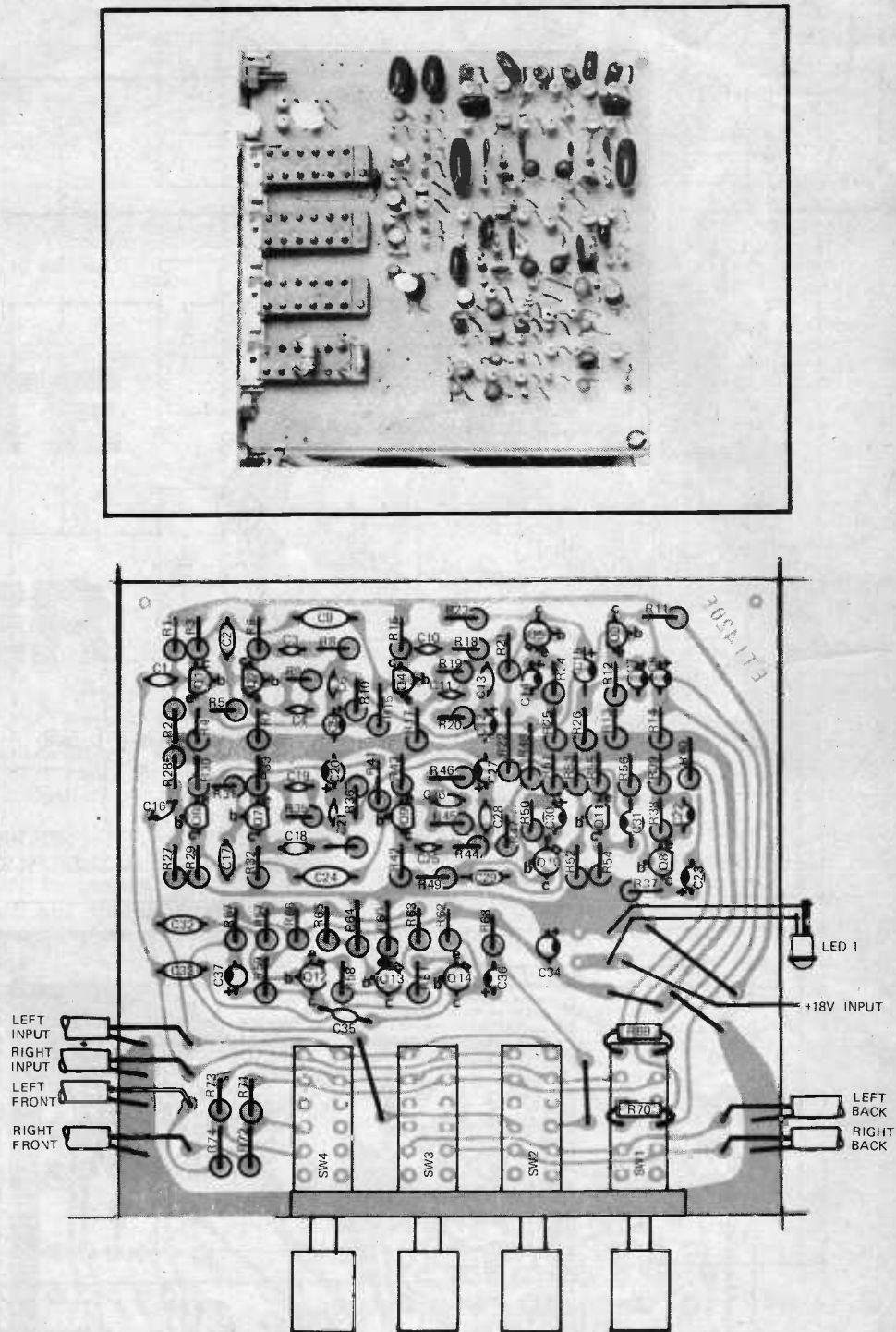

## D.I.Y. 2½kW per channel, three channel sound to light module

In response to many requests from people who have already installed the lights in their home or disco but who lack the sound to light conversion, we have now developed an extremely powerful three channel module (2½kW per channel) which will meet all requirements of home or disco. Coming ready assembled and tested, the module, measuring approx. 7" x 5", has all the advantages of our other models - no wiring to amps or speakers, gain control on a flying lead for panel mounting, full 3 channel facility etc. To operate, all that is required is to mount the module somewhere convenient, attach the mains lead to the terminal block, attach the lamp wiring to the terminal block and voila, you have a very powerful sound to light display with which to impress your friends. What would you do without us!!

Price £ 18.48.

## THE NOVA LIGHT SHOW

The Nova is a self contained three channel sound to light display for home use and comes in a teak veneered cabinet 24" x 12" x 2½". Requiring no input other than a mains supply, the NOVA will immediately convert any sound in the room into ever changing patterns of light in Red, Green and Blue on the Opal Display screen. In Kit form

£23.18 complete, or ready assembled at £26.04.

Now also available is the SUPERNOVA, the big brother to the NOVA - 480W of shimmering coloured light in Red, Green and Blue contained in a rexined cabinet 4' x 2' x 8". With its opal Screen, the SUPERNOVA is a must for all discos and party givers. A Slave unit which plugs into the Master to expand the system to 320W per channel is now available.

Prices £59.50 Master, £39.50 Slave, both ready assembled.

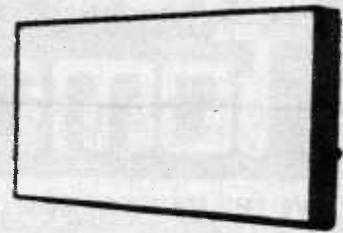

## TRAFFIC LIGHTS

Here we have a self-contained, three channel unit for those who require high powered light PROJECTION, ideal for the mobile disco. Three 100W Osram PAR 38 Floodlights in Red, Green and Blue built into a rexined cabinet 33" x 6" x 6", project pulsating light into the room in response to the presence of sound. Again the only input required is a mains supply and a sensitivity control is fitted as standard. Slave units to expand the system to 200W are also available.

Prices £45.00 Master, £24.75 Slave. Assembled only.

Please note the address of our new shop and showroom as above, to which all correspondence should be sent. Personal callers are very welcome, and demonstrations and advice will be gladly given.

All prices shown include all carriage and VAT.

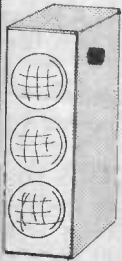

GIRO NO. 331 7056  
C.W.O. only. P. & P. 10p on orders below £5  
Discount: £10-10%, £20-15% (except net items)  
Export Order enquiries welcome (VAT free)

Official Orders accepted from  
Educational & Government Departments

**ALL PRICES INCLUDE VAT**

## SPECIAL RESISTOR KITS (Prices include post & packing)

10E12 ½W KIT: 10 of each E12 value, 22 ohms—1M, a total of 670 (CARBON FILM 5%), £3 65 net  
10E12 ¼W KIT: 10 of each E12 value, 22 ohms—1M, a total of 670 (CARBON FILM 5%), £3 85 net  
25E12 ½W KIT: 25 of each E12 value, 22 ohms—1M, a total of 1425 (CARBON FILM 5%), £8 35 net  
25E12 ¼W KIT: 25 of each E12 value, 22 ohms—1M, a total of 1425 (CARBON FILM 5%), £8 45 net  
20E12 ½W KIT: 20 of each E12 value, 22 ohms—2M2, a total of 1220 (METAL FILM 5%), £11 05 net  
15E12 1W KIT: 15 of each E12 value, 10 ohms—1M, a total of 915 (METAL FILM 5%), £13 35 net  
10E12 2W KIT: 10 of each E12 value, 10 ohms—1M, a total of 610 (METAL FILM 5%), £17 15 net

## RESISTORS

CF—High Stab Carbon Film, 5% MF—High Stab Metal Film, 5%.

W. Type Range	1-99	100-499	500-999	1000	Size mm
± CF 22-1M	1	0 75	0 60	0 55	2.4 x 7.5
± CF 22-2M2	1	0 75	0 60	0 55	3.9 x 10.5
± CF 22-1M	1	0 75	0 60	0 55	5.5 x 16
± MF 10-2M7	2	1 54	1 32	1 1	3 x 7
± MF 10-2M2	2	1 43	1 21	0 99	4.2 x 10.8
± MF 10-10M	3	1 98	1 81	1 65	6.6 x 13
± MF 10-10M	4 5	3 52	3 08	2 75	8 x 17.5

For value mixing prices, please refer to our catalogue. (price in pence each)

VALUES AVAILABLE—E12 Series only. (Net prices above 100)

## PRESET SKELETON POTENTIOMETERS

MINIATURE 0 25W Vertical or horizontal 6p each 1K, 2K2, 4K7, 10K, etc. up to 1MΩ  
SUB-MIN 0 05W Vertical, 100Ω to 220KΩ 5p each

**MULLARD POLYESTER CAPACITORS C280 SERIES**  
250V P.C. Mounting: 0 01µF, 0 015µF, 0 022µF, 0 033µF, 0 047µF, 3p. 0 068µF, 0 1µF, 4p. 0 15µF, 4p. 0 22µF, 5p. 0 33µF, 5p. 0 47µF, 8p. 0 68µF, 12p. 1µF, 15p. 1 5µF, 23p. 2 2µF, 26p.

**MULLARD POLYESTER CAPACITORS C295 SERIES**  
400V: 0 001µF, 0 0015µF, 0 0022µF, 0 0033µF, 0 0047µF, 2p. 0 0068µF, 0 01µF, 0 015µF, 0 022µF, 0 033µF, 3p. 0 047µF, 0 068µF, 0 1µF, 4p. 0 15µF, 6p. 0 22µF, 8p. 0 33µF, 12p. 0 47µF, 14p.  
160V: 0 01µF, 0 015µF, 0 022µF, 3p. 0 047µF, 0 068µF, 3p. 0 1µF, 4p. 0 15µF, 5p. 0 22µF, 5p. 0 33µF, 6p. 0 47µF, 8p. 0 68µF, 12p. 1µF, 14p.

**MINIATURE CERAMIC PLATE CAPACITORS**  
50V: (pF) 22, 27, 33, 39, 47, 56, 68, 82, 100, 120, 150, 180, 220, 270, 330, 390, 470, 560, 680, 820, 1K, 1K5, 2K2, 3K3, 4K7, 6K8, (µF) 0 01, 0 015, 0 022, 0 033, 0 047, 2p. each. 0 1, 30V, 4p.

**POLYSTYRENE CAPACITORS 160V 5%**  
(pF) 10, 15, 22, 33, 47, 68, 100, 150, 220, 330, 470, 680, 1000, 1500, 2200, 3300, 4700, 4p. 6800, 10,000, 4p.

# B. H. COMPONENT FACTORS LTD.

(ETI) 61 CHEDDINGTON ROAD, PITSTONE,  
NR. LEIGHTON BUZZARD, BEDS, LU7 9AQ  
Tel.: Cheddington 668446 (Std. Code 0296)  
PLEASE WRITE FOR FREE CATALOGUE

## Miniature Mullard Electrolytics

1 0µF 63V 6p	68µF 16V 6p
1 5µF 63V 6p	68µF 63V 12p
2 2µF 63V 6p	100µF 10V 6p
3 3µF 63V 6p	100µF 25V 6p
4 0µF 40V 6p	100µF 63V 14p
4 7µF 63V 6p	150µF 16V 6p
6 8µF 63V 6p	150µF 63V 15p
8 0µF 40V 6p	220µF 6 4V 6p
10µF 16V 6p	220µF 10V 6p
10µF 25V 6p	220µF 16V 8p
10µF 63V 6p	220µF 63V 21p
15µF 16V 6p	330µF 16V 12p
15µF 63V 6p	330µF 63V 25p
16µF 40V 6p	470µF 6 4V 9p
22µF 25V 6p	470µF 40V 20p
22µF 63V 6p	680µF 16V 15p
32µF 10V 6p	680µF 40V 25p
33µF 16V 6p	1000µF 16V 20p
33µF 40V 6p	1000µF 25V 25p
32µF 63V 6p	1500µF 6 4 15p
47µF 10V 6p	1500µF 16V 25p
47µF 25V 6p	2200µF 10V 25p
47µF 63V 8p	3300µF 6 4 26p

## VEROBOARD 0 1 0-15

2½ x 5"	28p 28p
2½ x 3½"	26p 19p
3½ x 5"	32p 33p
3½ x 3½"	28p 28p
2½ x 1"	7p 7p
2½ x 5" (Plain)	— 14p
2½ x 3" (Plain)	— 12p
5 x 3" (Plain)	— 22p
Insertion tool	59p 59p
Track Cutter	44p 44p
Pins, Pkt. 25	10p 10p

## TRANSISTORS

AC127 16p	BC212L 12p
AC128 22p	BC213L 12p
BC107 11p	BC214L 17p
BC108 12p	OC44 18p
BC109 13p	OC71 13p
BC148 12p	OC81 16p
BC149 12p	OC170 23p
BC182L 12p	TS43 33p
BC183L 12p	2N2926 11p
BC184L 13p	2N3702 11p

## POTENTIOMETERS

Carbon Track 5KΩ to 2MΩ, log or lin. Single, 16p Dual Gang 46p. Log Single with switch 26p  
Slider Pots. 10K, 100K, 500K, 30mm, 34p, 45mm, 47p, 60mm, 55p. (Semi-log)

## DIODES

IN4001 6p
IN4002 7p
IN4003 9p
IN4004 9p
IN4005 12p
IN4006 14p
IN914 7p
BA100 10p
OA5 42p
OA47 9p
OA81 11p
OA200 8p

## PLUGS

DIN 2 Pin 12p
3 Pin 13p
5 Pin 180° 15p
Std. Jack 14p
2.5mm Jack 11p
Phono 5p

## SOCKETS

DIN 2 Pin 10p
3 Pin 10p
5 Pin 180° 12p
Std. Jack 14p
2.5mm Jack 11p
Phono 5p

## ELECTROLYTIC CAPACITORS. Tubular & Large Cans

(µF/V): 1/25, 2/25, 4/25, 4 7/10, 5/25, 8/25, 10/10, 10/50, 16/25, 22/63, 25/25, 25/50, 32/25, 50/25, 100/10, 100/25, 6p, 50/50, 8p, 100/50, 200/25, 11p, 250/50, 18p, 500/10, 11p, 500/25, 15p, 500/50, 18p, 1000/10, 15p, 1000/25, 22p, 1000/50, 40p, 2000/10, 20p, 1000/100 90p, 2000/25, 30p, 2000/100, 95p, 2500/25, 38p, 2500/50, 62p, 3000/50, 80p, 5000/25, 66p, 5000/50, £1.10

## HI-VOLT:

4/450, 14p, 8/350, 19p, 8/450, 20p, 16/350, 22p, 16/450, 23p, 32/350, 33p, 50/250, 20p, 100/500, 88p.

## METALLISED PAPER CAPACITORS

250V 0 05µF, 0 1µF, 6p, 0 25, 6p, 0 5µF, 7 p, 1µF, 9p, 500V, 0 025, 0 05, 6p, 0 1, 6p, 0 25, 7p, 0 5, 9p, 1000V, 0 01, 11p, 0 022, 13p, 0 047, 0 1, 15p, 0 22, 23p, 0 47, 28p.

## Integrated Circuits

µA709C 50p
µA741C 55p
µA723C £1
µL914 35p

## Screened Wire, Metre

Twin Screened Wire, Metre 6p
Stereo Screened Wire, Metre 12p
Connecting Wire, All colours, Metre 2p
Neon Bulb, 90V Wire Ended 5 for 24p
Panel Neon, 240V Red, Amber, Clear 16p

## NEW KIT 5E12 ½W METAL FILM 5% ULTRA LOW NOISE

NEW RESISTORS WITH FULL COLOUR CODING 5 EACH E12 VALUE 10Ω-1M, TOTAL 305 £2.75

# Electronics by John Miller-Hickpatrick Tomorrow

## GIVE THE MAN A LEMON!

Having got your lemon, what can you do with it? Squeeze it onto your pancakes, put it into the author's gin & tonic or run a digital clock off it. A lemon is a citrus fruit and as such contains a juice called citric acid. My physics teacher spent many long hours trying to persuade me that given an acid and two different types of metal it is possible to end up with a simple battery. Our lemon gives us the acid and most people have small pieces of copper and zinc or similar materials lying around, so we have a simple battery. If you try it you will find that you can get about 0.5V to 1.5V out of this battery and, of course, two or three wired in series will give you 3-4V. There are limitations to the amount of juice, sorry, power that you can get out of this battery in the way of milliamps and this has tended to limit any applications in the past. If you happen to have a grove of lemon trees growing in your back garden it might be conceivable to assume that you no longer have to worry about power cuts. However, as most of us do not have a large, unending supply of lemons we will have to find another application for our battery.

Most readers will have gathered by now that the above preamble is to introduce some new development, well you're wrong. It is intended to introduce you to CMOS chips which themselves are not new but which are now available in packages and configurations that many of you will recognise. If we give you a hint that a MM74C00 is a CMOS quad 2-input NAND integrated circuit then you may begin to get the idea.

National Semiconductors have a range of CMOS devices that are pin compatible with the normal TTL 74 series and thus any logic circuitry using TTL can now use CMOS with little, if any, changes being required. If you have never heard of CMOS before, you might ask what advantages it has over TTL, but then having read the preamble you might not have to ask.

I quote from the NS data sheet, "The 74C product line uses complementary MOS transistors (CMOS) to

provide functional equivalents to the 7400 TTL product line. The use of CMOS gives the advantage of ultra-low power, high noise margin, wide power supply range and ease of power supply design". The voltage range of the 74C range of CMOS is 3 to 15V, a noise margin of 1.0V or better and supply currents that have to be seen to be believed. The MM74C192 is a synchronous 4 bit up/down decade counter, functionally identical to a 74192 and similar to the 7490 you all know and love. The supply current for a 74192 is quoted as 65mA and that of the 74C192 as a maximum of 50 $\mu$ A, a ratio, if my maths is any better than my physics, of over 1:1000. The average TTL digital clock requires about 0.5A or more to drive the TTL and the display but a CMOS digital clock with a liquid crystal display would require less than 1mA, and possibly a lot less.

The 74C devices so far announced are as follows: 00, 02, 04, 08, 10, 13, 20, 30, 32, 42, 47 (not yet released), 73, 74, 76, 83, 85, 86, 89, 95, 107, 151, 154, 160, 161, 162, 163, 164, 165, 173, 192, 193, 195. The pinouts and functions for these devices are as the equivalent numbered TTL device.

The cost of these CMOS chips is approximately 3-4 times that of the equivalent TTL gate with a MM74C00 costing 59p. A digital clock built using CMOS discretes might be too expensive but it might be interesting to try some simple TTL logic circuits in CMOS and try running them from your lemon battery (they will also run from conventional batteries of course).

MM74C data can be obtained from *National semiconductors (UK) Ltd., The Precinct, Broxbourne, Herts*; the devices can be obtained from *Atlantic Components, 143 Loughborough Rd, Leicester*.

## MORE ON THE CT6002

A lot of readers have shown a lot of interest in the CT6002 digital watch chip mentioned a few months ago. One of the problems mentioned at that time is that the chip was designed to drive low-voltage Field Effect liquid crystal displays which are quite expensive. We have since

heard from CAL-TEX that it is possible to drive LC's with up to 36V peak-to-peak, this includes RCA and Siemens LC units. These dynamic scattering LC's are about one third of the cost of the field effect units and are typically about £13 for a four digit unit. We have also had some prices on the CT6002/40 (40 pin DIL package) and on the complete watch module, these are £28.10 and £96.80 respectively. The completed watches will be available within the next few weeks at £195.

The CT6002 is available from *Bywood Electronics, 181 Ebbw Vale Rd, Hemel Hempstead, Herts*.

As the CT6002 is a CMOS chip requiring a 1.5V it might be possible to run that from a lemon as well, although why anyone would want to carry a lemon on their wrist I don't know.

## RPM vs MPG

Every time that something happens to cause a petrol crisis there is a rash of petrol saving gimmicks, most of which do not work. The only way to really save on petrol is to drive with a light foot. The emergence of electronic ignition systems has led to some more petrol saving ideas and the one shown here would seem to work as its principle is an automatic 'light foot'.

When an electronic ignition system has been specified for a vehicle it is a relatively simple matter to enlarge the system to perform other functions derived from the ignition signal. Siemens have developed a circuit that derives a signal from the contact breaker and uses it to provide ignition pulses to the ignition coil, to indicate the instantaneous RPM on a tachometer, and to limit the maximum RPM achieved by the engine. This last item is the 'light foot' and has not normally been implemented on petrol-engined vehicles, but the need for an accurate and reliable control of engine speed is becoming apparent as engines become more powerful and operate at higher RPM speeds.

The circuit shown was fitted to a 2.6 litre, 6 cylinder car and tested with the RPM limiter set to cut out at



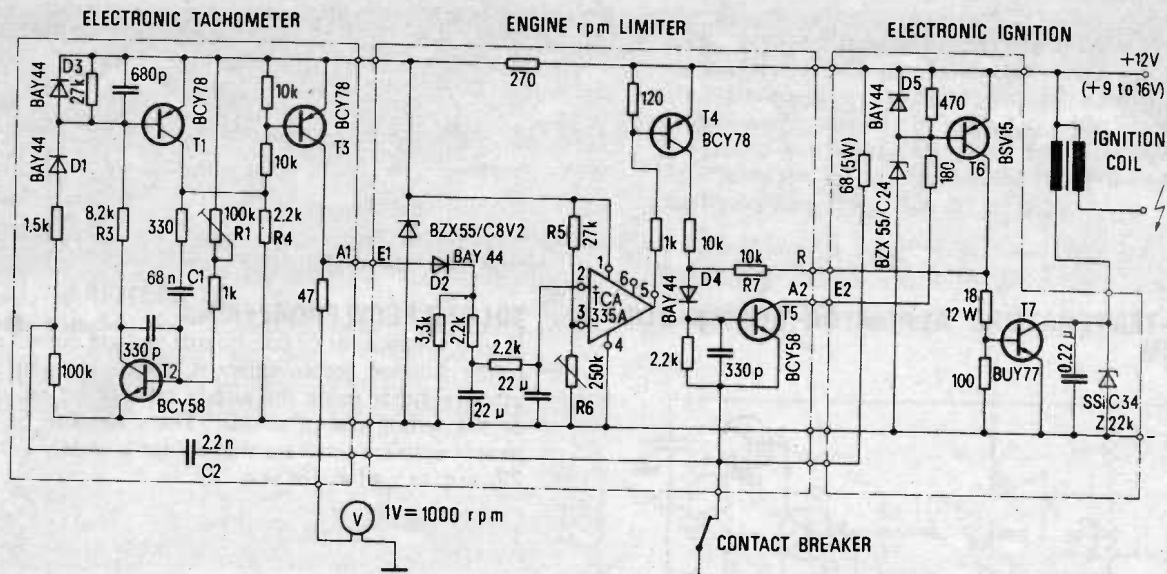

Siemens electronic ignition and RPM limiter circuit.

6,600 RPM and to cut back in again at 6,500 RPM. When the engine speed was accelerated to a maximum speed a slight but discernable vibration was felt by the driver as the ignition cut out, which informed the driver that the time had come to change into a higher gear. The circuit is designed so that the possibility of mis-timed sparks is eliminated at the moment of cut-off so that back-firing does not occur. The point at which the ignition is cut off can be adjusted by R6, and the circuit can be altered for four or eight or twelve cylinder cars by altering an RC network.

The circuit is in three main parts: the tachometer, the RPM limiter and the electronic ignition. The spark timing is derived from the contact breaker and fed to a monostable multivibrator to provide a tachometer signal of 1V per 1000 RPM, indicated by a moving coil meter. This signal is filtered and integrated before comparison with a DC voltage derived from a resistor chain in the TCA335A, which is a high gain OP amp. The output from this amp controls transistors T4 and T5 when the maximum RPM is exceeded, and prevents the contact breaker signal from driving the ignition output transistors T6 and T7. The feedback resistor R7 prevents mis-firing by ensuring that the ignition is switched off at the correct moment.

### OPTO-DESIGNERS KIT

More and more manufacturers and their distributors are becoming aware of the fact that a large number of their potential customers do not like data sheets. Let me expand on that statement to say that a working example is always easier to comprehend than is any amount of written screed. Some time ago Fairchild announced a seven segment LED display, the

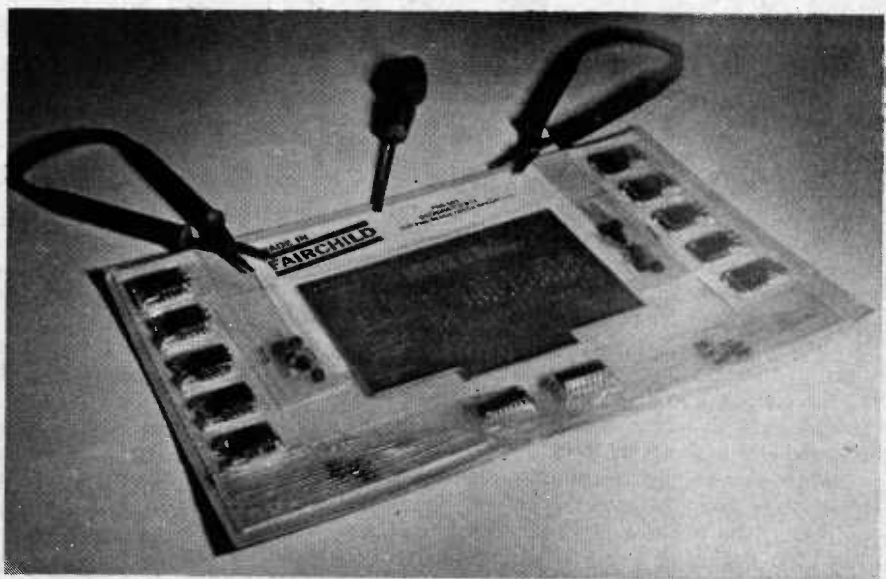

Opto-designer's kit from Gothic Components.

FND70 (Superdigit). Now, one of Fairchild's distributors has released a kit of parts which explains how various parts of a display system work. The kit contains 5 digits, 5 digit drivers, 8 segment drivers, a one-of-ten decoder and a seven segment decoder, plus IC sockets and resistors. The kit priced at £23.78 is intended to assist the professional designer in developing prototype circuits, and the accompanying application notes gives several examples of TTL/DTL coupling. One of the features of the kit is the simplicity of presentation, which will enable a thorough comprehension of digital and segmental drive to be readily achieved. Multiplexing, where segment drivers are shared to save components, is explained simply, and can be seen to operate successfully. This kind of kit could have been produced by Fairchild or another manufacturer several years ago when seven segment digits first came out, as the kit is based on logic at the level of TTL it might be a little

late in this world of LSI circuits. Further details of the opto-designer's kit are available from *Gothic Electronic Components Limited, Beacon House, Hampton Street, Birmingham 19. Telephone 021-236-8541.*

### COMMON REFERENCE SOURCE

If you find that when you try to contact somebody about a product mentioned here or elsewhere in ETI they do not seem to understand, try mentioning ETI as a common reference source. When you are both looking at the same magazine there can be no mistakes on either side.

### LATE NEWS!

*The CT6002 watch will be available from a company called Bywood Trading of 28 Oriole Way, Larkfield, Kent. Unfortunately it is mail order only, but if you want one, that's one place to get one (£195).*

# Tech-Tips

## LOW-TEMPERATURE ALARM OR LIGHTS-OUT ALARM

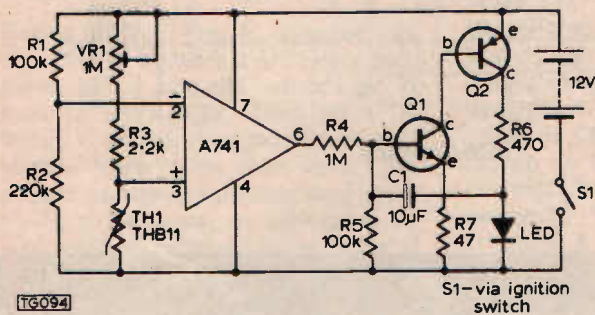

The figure shows a general purpose 741 op amp acting as a sensitive level amplifier of the voltage across the points X and Y of the bridge circuit. Resistors R1 and R2 set the inverting terminal (2) of the op amp at about 6V with respect to ground. The voltage at the non-inverting terminal (3) is determined by the temperature of the thermistor Th1. As the temperature of the thermistor falls, its resistance rises, because it is a negative temperature coefficient type, and the voltage at pin 3 rises. If this voltage rises above that of pin 2, the voltage at the output pin 6 of the op amp goes positive. The temperature at which the output goes positive can be selected within limits by VR1.

When the voltage at pin 6 goes positive, the complementary pair of transistors Q1 and Q2 operate as an oscillator, the positive feedback being provided by C1. The LED flashes at a rate determined partly by its own resistance but also dependent largely on the value of C1. The resistor R6 should be adjusted to maintain a current through the LED at a value less than its rated maximum.

Switch S1 is the ignition switch on the car. Transistor Q1 is the npn type ZTX300 in the prototype and Q2 a pnp ZTX500, but other complementary pairs of medium-current audio frequency transistors can be used. The thermistor used is a glass bead type having a nominal resistance of 1MΩ at 25°C. The type indicated is from RS Components Limited.

## TRANSISTOR IDENTIFICATION

Those who do a lot of lashups on S-Dec etc and use the same components time after time will find that transistor identifications soon rub off. Why not take a few minutes to colour code your transistors with paint or nail varnish. You can work out your own coding but for instance PNP can be blue, NPN red; high gain types can have yellow, r.f. types green etc. Therefore a PNP, high r.f. transistor would have blue, yellow and green blobs on them.

Woolworths and model shops sell sets of tiny pots of paint for models. This will give you about six colours for only a few pence.

## SOLDER FLOW PROBLEMS

If you solder a lot of p.c. boards and are cursed with the solder flowing across adjacent tracks, chances are that you are either using the wrong type of bit on your iron or the wrong size of solder. There seem to be a lot of people who are unaware that solder is widely available in 22s.w.g. as well as 18s.w.g.

## ZERO-CROSSING PULSE GENERATOR

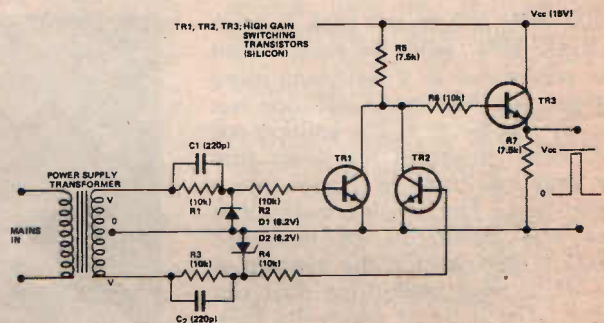

The circuit was originally used to provide a narrow zero-crossing pulse for switching on triacs in a mains sound to light converter. A narrow zero-crossing pulse is required to reduce RFI (caused by switching large current) by switching when there is no voltage across the load. As a bonus the life of the bulb is substantially improved.

The circuit operation is as follows: TR1 and TR2 form a NOR gate, the output of which is high only when both inputs to transistor bases are low (i.e. at the zero-crossing points of the mains cycle). TR3 as an output buffer. R1-4 and D1-2 are included to provide voltage and current protection for the bases of TR1 and TR2. Note for large values of transformer voltage 'V' the pulse width tends to zero.

## TRANSFORMERS IN REVERSE

It is frequently overlooked that there is nothing magic about the primary and secondary windings of a transformer: a 250V to 9V will operate equally as well as a 9V to 250V.

## EXTENDING BATTERY LIFE

Cell batteries are expensive but it is possible to recharge these to a certain extent. If they are connected to a suitable power supply (positive to positive, negative to negative) before they are too run down, it is possible to extend the life considerably. This can be done several times though each recharging will last a shorter time.

Layer batteries (PP3, PP7, PP9 etc) cannot be recharged in this way.

ETI is prepared to consider circuits or ideas submitted by readers for this page. All items used will be paid for. Drawings should be as clear as possible and the text should preferably be typed. Circuits must not be subject to copyright. Items for consideration should be sent to the Editor, Electronics Today International 36 Ebury Street, London SW1W 0LW.

### CRYSTAL EARPIECES

One of the cheapest and most useful items of test equipment is a simple crystal earpiece. These are very sensitive and have such a high impedance that they will not load the circuit. Cut off the plug and add a couple of croc clips.

### TOUCH TRIGGERED BISTABLE

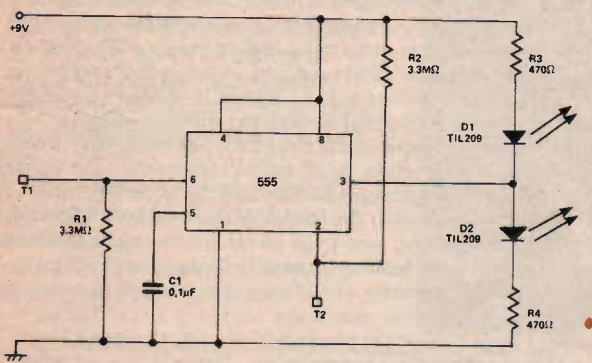

This circuit was devised as part of a touch controlled lighting system. It uses a 555 timer operated in the bistable mode.

Due to the high input impedance presented by the threshold and trigger terminals the 555 can be set and reset by the touch of a finger. Touching T2 causes the output to go high; D2 conducts and D1 extinguishes. Touching T1 causes the output to go low; D1 conducts and D2 is cut off.

The output from pin 3 can also be used to operate other circuits e.g. a triac controlled lamp. In this case the LEDs are useful for finding the touch terminals in the dark.

The capacitor C1 is not absolutely necessary but helps to prevent the circuit triggering from spurious pulses.

### LOUDSPEAKER CHECKING

If you suspect that the coil on a loudspeaker is out of alignment and rubbing you can check this easily. Hold the cone of the speaker against your ear and gently thump the back of the magnet with the flat of your hand. If the thump is 'clean' the problem lies elsewhere. If a rasping or scratching is heard the coil is out of alignment.

Pressing in the cone with your fingers should be avoided for unless the pressure is even you can cause the problem you are looking for.

### VOLTAGE PROCESSOR

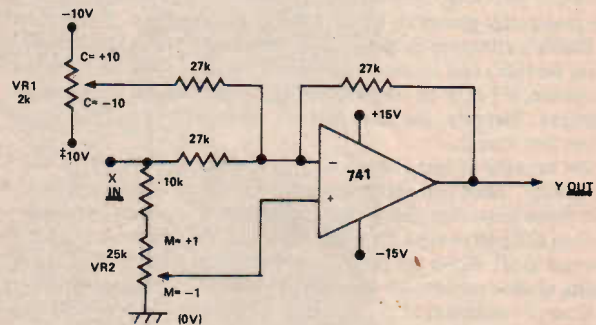

This circuit takes an input voltage  $x$ , and outputs a voltage  $y$  in accordance with the general linear equation  $y=mc+c$ . The offset is variable between +10V and -10V, by setting VR1, and gain  $m$  can be set anywhere between +1 and -1 (including zero) using VR2. There is no interaction between these two controls.

The circuit is very useful for processing electronic music synthesiser control voltages, and for coupling tuner to IF strips that have AGC systems operating in different senses. The input voltage should be derived from a low impedance (less than  $1k\Omega$ ) source.

### SIMPLE LIGHT SHOW CIRCUIT

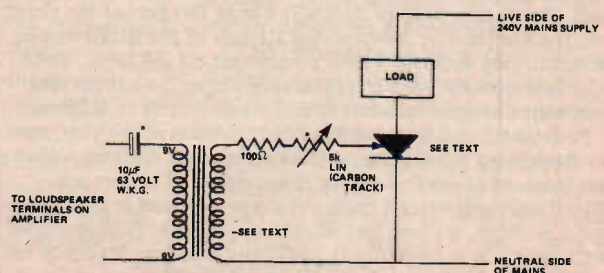

Most people think that sound activated light shows are expensive items of equipment, this need not be so, in fact a simple but effective unit can be made very cheaply. The circuit shown is very flexible. Any thyristor that has a low gate sensitivity may be used. The transformer is used in reverse i.e. the amplifier is connected across the secondary of the transformer via a capacitor and the gate of the thyristor is connected to the primary of the transformer via a fixed and variable resistor. The components marked \* can be altered to vary the frequency response of the unit. The sensitivity of the unit is not as high as more expensive units.

# DX MONITOR

Compiled by Alan Thompson

I make no claims to be the greatest amateur meteorologist who has gone into print: indeed, you may recall that in the February 1974 edition of "DX MONITOR" I said that "I'd guess it is odds on that 1973-74 will rank as the coldest Winter for many years". Ah well, as this is being written, in mid-April, it has been the mildest Winter since I know not when and the birds are nesting, the roses are covered in buds and, here in the mild south-west, frost and snow have practically passed us by over the last six months. Nevertheless, the Editor's attempts to have me "press-ganged" into the Meteorological Service - and located on Rockall, no less! - did seem somewhat precipitate, if I may be forgiven for expressing such a treasonable sentiment. Happily, the offer was not accepted and so here we are for another month.

The months of May, June and July are the very trough of the DXing year. Now and again, something or other occurs to give the DXer some hope that things will improve but, generally, there is precious little to cause a fluttering amongst the log books. Long days and short nights are far from being the best of conditions for chasing elusive stations on the other side of the world especially at the time of minimum of the sunspot cycle. Evening sessions, too, are fraught with disappointment on more occasions than those which bring success to one's endeavours. The high levels of local atmospheric noise characteristic of thundery conditions make DXing the tropical bands an exercise in avoiding having one's ears blasted off by the horrendous crash which accompanies a burst of thunder and lightning many hundreds of miles away, even if the local conditions are fairly quiet.

However, the serious DXer frequently turns his attention at this time of year to the so-called Tropical Bands occupying the 120, 90 and 60 metre areas and, occasionally his persistence is rewarded with some really rare loggings as a result. Few DXers who had the good fortune to be listening at the time will ever forget the astonishing opening of the 120 metre band on the night of 17/18 June 1972 when, for just a few hours, the 120 metre band pulsed with South American stations of under a 1000 watts coming through at the strength which one associates with local European stations. Those conditions, you may recall, were associated with a gigantic ionospheric disturbance, an event which has not recurred in the same degree since that date. However, the chance is always there, and the 120 metre band (which runs roughly from 2200 to 2450kHz) is always worth a tune through in the midnight hours of a warm mid-summer night. As well as South American stations, look for the all-night service of the South African Broadcasting Corporation which usually uses 2376 or 2346kHz during this part of the year: look, too, for the very low-powered stations of the Israeli Armed Forces carrying the Galei Tsahal programme on 2442kHz, which not so infrequently make an appearance during the late evening hours with a programme of news and music entirely in Hebrew.

Both the 60 and 90 metre bands, at this time of the year, tend to vary from being full of stations to being virtually deserted. What one hears is a combination of chance and a variety of factors too difficult to attempt to set them out in any reasoned order. For what it is worth, it seems that reception is often at premium level after a long, hot and still day in which any thundery tendency has passed away as the sun sets. If those local conditions prevail as the night settles in, and the band is not marked by random bursts of distant static discharge, then there is more than a fair chance that it will be worth losing a few hours of sleep in pursuit of stations located in the Latin American region. At irregular, and unpredictable, intervals those stations may be heard at amazing strength especially towards the dawn period. On the higher frequencies, one station which often makes an appearance at this period of the year is the elusive Radio Tahiti, on 15170kHz, signing on at 0300 G.M.T. in Tahitian and carrying a programme of messages for local people regarding parcels and letters which await collection from the main Post Office.

Given the same quiet conditions, the low-frequency bands offer a very short chance to hear some of the local stations of Papua-New Guinea just around 2000 G.M.T. when they sign on with their morning programme. It is indeed a very short chance - something of the order of 25 to 30 minutes at most - before the sunrise over Papua destroys any chance of low-frequency signals propagating to Europe.

Channels to try are 3925, 3385 and 3335kHz amongst many others - 4890kHz, too, sometimes offers a brief reception from this area at this time but, more usually, the channel is covered by signals from Dakar which make reception impossible. After 2030, the 3925kHz channel may offer reception of NSB in Tokyo, one of the Japanese Home Service networks and this one frequently holds-up until as late as 2130-2200 under good conditions. Do not confuse NSB with the better known NHK, Tokyo, otherwise known as Radio Japan - NSB is a domestic service, whereas NHK is designed as an Overseas Service.

The weekend of 31 May to 3 June will see a real gathering of DXers in the charming city of Canterbury as the 8th EDXC Annual Conference takes place. This year, for the first time, a British DX Club will be playing host - the World DX Club - and I am looking forward to meeting many DXers and DX personalities from all round the world. The European DX Council (EDXC) has been established for some 8 years and, currently, has as its Secretary-General Wolfgang Scheunemann of Frankfurt. Inevitably, there will, I suspect, be the somewhat uninteresting sessions which any Conference must have in order to arrange its business for the year ahead - the presentation of Reports, the accounts by "experts" of what their Committees have tried to achieve in the last 12 months, and all the other minutiae that go with any business meeting. However, the real purpose of any Conference of hobbyists - whether it is a meeting of philatelists, dog-fanciers, rose-growers and anything else - is the informal exchanges of ideas and the cementing of friendships which take place after the formal sessions are over: exchanges which, in my experience, tend to go on far into the night whenever DXers forgather. I am looking forward to being present at the meeting in the dual-capacity of a DXer and someone who writes and broadcasts on DX matters; should any readers of this article be attending I hope to have the pleasure of meeting them and I hope they will make themselves known to me. It would give me great pleasure to meet, in the flesh, some of the correspondents with whom I have been in touch over the last year or so. I hope I may be forgiven, as an ex-Secretary General of EDXC and one of the founders of the World DX Club, for hoping that this will be the most successful EDXC Conference yet! The August edition of "DX MONITOR" will be given over to a report on the Conference and some of the topics which will be discussed in those hectic four days.

I said that this piece was being written in mid-April - in fact, it is just a few days before the Easter break, and I am planning to spend the Easter weekend in moving my "shack" to a new location in an attic which has been awaiting the arrival of all my gear for many months. The plans are all complete, down to the last solder joint and the last millimetre! From past experience, I know that hours spent designing and planning the move is time well spent: if this stage is rushed then at too late a stage you discover that a hundredweight of receiver which measures 19 $\frac{3}{4}$ in. across is expected to fit into a space of just 19 $\frac{1}{2}$ in. width - a traumatic experience as steel radio cabinets have a great disinclination to "shrink" that crucial  $\frac{1}{2}$ in. and getting the so-and-so thing into place usually means undoing the hard work of the last day and unmaking and remaking dozens of solder joints!

Those being the plans for the next few weeks at Maison Thompson, I beg forgiveness for any absence of replies to your letters whilst things get sorted out. However, I hope that anyone making the "pilgrimage" to Canterbury will drop me a line and the address (slightly changed with the recent boundary changes) is: Alan Thompson, 16 Ena Avenue, Neath, West Glamorgan SA11 3AD. If anyone reads this so late that they haven't time to drop me a line, you can reach me at NEATH 4040 most evenings after about 1900 B.S.T. - on STD, the code is 0-639-4040. Hope to meet some fellow hobbyists in Canterbury and I promise a new "shack picture" as soon as all is safely in place. Keep your fingers crossed for me as the "designs" look like the blueprints for a major telephone exchange and anyone who has ever made this sort of move will know that, inevitably, you end up with (at least!) one wire the destination of which seems to have escaped both the design-stage and the ingenuity of the builder. 73 de ABT.

## WIND GENERATORS

A new range of wind generators from 100W to 4kW has been introduced by Industrial Instruments Ltd.

These are intended for lighthouses, fog and light signals, telemetry stations, VHF relays, radio links, radio location beacons energy sources in inaccessible places, e.g. drilling platforms in the North Sea, deserts, arctic deserts, etc.

The wind speed limit to deliver nominal power is about 14 knots though the machines begin to deliver power at 6 to 7 knots. (The mean wind velocity at Dover over the last ten years has varied between 7 and 13 knots). The more expensive models, with variable pitch propellers, will deliver nominal power up to 160 knots. At wind speed in excess of this figure the blades automatically feather and the unit ceases to function. The dead wind speed is now over this velocity.

A solid state control box ensures efficient charging of storage batteries excessive gassing.

*Industrial Instruments Limited,  
Stanley Road, Bromley, Kent.*



## SOUND PICTURE BY ACOUSTIC SCANNING

A new method of acoustically scanning optical images by the sound reflections caused by light on a photosensitive surface-wave delay line has been developed at the University of Helsinki.

M. Luukkala and P. Meriläinen describe the new method in a letter, 'Image scanning by acoustoelectro-optic interaction', published in a recent issue of *Electronics Letters*.

The light pattern causes small impedance variations along a photo-conductively coated delay line, and, when a short readout 'pip' is sent along the line, the resulting reflected acoustic surface wave has the light pattern superimposed on it.

As the readout pip scans the image in one dimension, 2-dimensional pictures are obtained either by mechanically scanning the image in the other direction or by using a rotating mirror.

A 5cm-long yz-cut 75MHz LiNbO<sub>3</sub> delay line coated with a 0.5µm-thick CdSe film is used in the Helsinki work, and a light sheet is focused on a transparency or object in such a way that the illuminated section is projected on to a 3cm-long, 2mm-wide active area of the delay line.

A 0.1µs scanning pip at 75MHz is sent along the line, and the amplitude variations in the reflected surface wave are used to z-modulate the intensity of an oscilloscope, thus giving the light pattern as an intensity modulation on the oscilloscope.

Two-dimensional pictures were obtained by synchronising the transparency or object. The resolution on the delay line was 0.2mm.

A 1.5-mW helium-neon laser was used for illumination, but daylight could also be used.

Copies of *Electronics Letters* may be obtained from the *Publication Sales Department, IEE, Station House, Nightingale Road, Hitchin, Hertfordshire SG5 1RJ.*

## VARIABLE CONTROL FOR RECORDING APPLICATIONS

The characteristics of a compressor, a noise gate, and limiter and a dynamic reverser have now been combined together in a single integral package from Feldon Audio.

Primarily intended for recording and broadcasting applications, the *Eventide Omnipresser* is a professional quality dynamic modifier with an unusually wide range of controls which allows it to be used in virtually any application where programme con-

trolled gain change is valuable. It can also be used to generate totally new effects including infinite compression and dynamic reversal - to make high level input signals lower than corresponding low level inputs.

Musically this facility reverses the attack-decay envelope of plucked strings, and produces a 'talking backwards' effect on voice signals.

The Omnipresser has a continuously variable expansion compression control which goes from an expansion range of 5 to 1 (gate) to a compression range of -5 to 1 (abrupt reversal). Attenuation and gain limit controls adjust the gain control range from a full 60db to as little as ± 1db. Thus, with the gain limit set at 0, the unit can attenuate up to 30db, but cannot boost the input signal. Depending upon the setting of the compression control, all signals below 0dbm will not be modified - the gain increase is limited - while all signals above 0dbm will be attenuated at the appropriate ratio. A variable step time constant control adjusts attack/decay times over an approximate 100 to 1 ratio. A bass cut switch is provided to limit low frequency response in the level detector.

Full details including technical data and demonstrations may be obtained from *Feldon Audio Limited, 126, Great Portland Street, London W1.*

## FIRST WORKING DIGITAL LINE SYSTEM



An advance field trial for the British Post Office's 120 Mbit/s experimental digital line system is now in operation after installation at Guildford by Standard Telephones and Cables Limited. This is believed to be the first installed digital transmission system operating above 100 Mbit/s in Europe.

The advance field trial is related to a contract awarded to STC by the BPO for the design, development, manufacture and installation of a fully operational coaxial line system capable of carrying information at the rate of 120 Mbit/s over existing small diameter coaxial cables. This experimental system will operate over the Guildford to Portsmouth cable and is scheduled for completion in November 1974.

The equipment that has been installed at Guildford will provide continuous data on the operational efficiency of such systems and will be left running until the main field trial is completed. The equipment consists of a complete terminal unit together with two pairs of dependent regenerators operating over an actual 8km route. An artificial 2km path is used to complete the loop system, which is currently carrying simulated traffic, produced by a specially developed pattern generator.

Among the major advantages of

digital transmission systems are their natural flexibility and the wider range of services that can be made available. The 120 Mbit/s system can accommodate either 1680 telephone channels, or one suitably coded colour television channel, or 18 viewphone channels or up to 224 music or speech broadcast channels. A combination of these types of traffic, together with computer data, adding up to a total capacity of 120 Mbit/s may be transmitted simultaneously over the transmission path.

## TRAINING CENTRE KITS

Amtron Kits have been adopted by the Department of Employment in ten training centres this year with a view to a complete changeover in all 60 training centres throughout the country by 1975.

Amtron have appointed Philip Harris Limited of Birmingham, manufacturers and suppliers of Scientific apparatus; the agency for supplying all schools and Educational Authorities with Amtron Electronics Kits as from 1st April 1974.

All enquiries from educational authorities should address to *Philip Harris Limited, Ludgate Hill, Birmingham B3 1D.*

## STROBE! STROBE! STROBE!

Build a Strobe Unit, using the latest type Xenon white light flash tube. Solid state timing and triggering circuit. 230/250V a.c. operation. **EXPERIMENTERS' ECONOMY KIT** Speed adjustable 1 to 30 flash per sec. All electronic components including Xenon Tube and instructions £6.30. Post 30p.

**INDUSTRIAL KIT** Ideally suitable for schools, laboratories, etc. Speed adjustable 1-80 f.p.s. Approx. 1/4 output of Hy-Lyght. Price £12.00. Post 50p.

**HY-LYGHST STROBE MK III** For use in large rooms, halls and utilises a silica tube, printed circuit. Speed adjustable 0-20 f.p.s. Light output greater than many (so called 4 Joule) strobes. £12. Post 50p.

### THE 'SUPER' HY-LYGHST KIT

Approx. four times the light output of our well proven Hy-Lyght strobe.

- Variable speed from 1-13 flash per sec.
- Reactor control circuit producing an intense white light. ONLY £20. Post 75p.

**ROBUST, FULLY VENTILATED METAL CASE.** For Hy-Lyght Kit including reflector £5.75 Post 25p. Super Hy-Lyght case including reflector £8. Post 60p.

### 7-inch POLISHED REFLECTOR

Ideally suited for above Strobe kits. Price 55p. Post 15p.

### RAINBOW STROBE FOUR LIGHT CONTROL MODULE

Will operate four of our Hy-Lyght or Super Hy-Lyght Strobes in either 1, 2, 3, 4 sequence; 2 + 2; or all together. Thoroughly tested and reliable. Complete with full connection instructions. Price: £18. Post 50p. Send S.A.E. for details.

### COLOUR WHEEL PROJECTOR

Complete with oil-filled colour wheel. 100 watt lamp. 200/240V A.C. Features extremely efficient optical system. £18.50. Post 50p. **6 INCH COLOUR WHEEL** As used for Disco lighting effects, etc. Price £4.50 Post 30p.

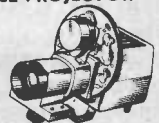

### BIG BLACK LIGHT

400Watt. Mercury vapour ultra violet lamp. Powerful source of u.v. Innumerable industrial applications also ideal for stage, display, discos, etc. P.F. ballast is essential with these bulbs. Price of matched ballast and bulb £16. Post £1. Spare bulb £7. Post 40p.



**BLACK LIGHT FLUORESCENT U.V. TUBES** 4ft 40 watt. Price £5.50. Post 30p. 2ft 20 watt. £4.25. Post 25p. (For use in standard bi-pin fittings.)

MINI. 12in 8 watt. £1.60. Post 15p. 9in 6 watt. £1.30. Post 15p. Complete ballast unit and holders for 9in and 12in tube. £1.70. Post 25p. (9in and 12in measures approx.)

### AUTO FADE COLOUR BLEND MODULE

Will fade up to 750W of lighting. Automatic fade-up/fade-down at a manually pre-selected timing, which may be varied between 1/2 second and 1 minute. Based on 10A Triac for maximum reliability. Ready built with Switch and Time Control, on 4 1/2" x 5 1/2" glass P.C. Board. Three Modules or over can be sequenced to obtain fantastic range of colour blending etc. £12.50 post 30p. per module

### PROGRAMME TIMERS

230/240V a.c. 15 r.p.m. Motors. Each cam operates a c/o micro switch. Ideal for lighting effects, animated displays, etc. Ex equipment tested.

4 cam model. £2.50 post 30p.  
6 cam model. £3.25 post 30p.  
12 cam model. £4.00 post 35p.



### INSULATION TESTERS NEW!

Test to I.E.E. Spec. Rugged metal construction, suitable for bench or field work, constant speed clutch. Size L, 8in, W, 4in, H, 6in, weight 6lb. 1,000V, 1,000 megohms, £34.00 Incl. P. & C.



ADD 10% VAT TO ALL ORDERS

## SERVICE TRADING CO

All Mail Orders—Callers—Ample Parking  
Dept. ET5, 57 BRIDGMAN ROAD  
CHISWICK, LONDON W4 5BB  
Phone 01-995 1560

Showroom open Mon.-Fri.

Personal callers only. Open Sats.  
9 LITTLE NEWPORT STREET  
LONDON WC2H 7JJ

# P.C. BORED?

— not with the

# DECON— DALO 33PC



A unique drafting aid for the electronics engineer enabling him to prepare in minutes a perfect PCB.

A fine-tipped marker charged with a free-flowing etch-resist ink. Simply draw the desired circuit onto copper laminated board—etch—clean.

The circuit is ready to use.

## NO MESS— NO MASKING

£1.10 for one off £4.40 for six £8.80 for twelve VAT and post included. Available now in every country in EUROPE!

*The Decon-Dalo 33 PC marker is now available in France, Germany, Italy, Switzerland, Austria and all Scandinavian countries. Send for details of local supplier.*

Please send me further details on the 33PC:

Name .....

Address .....

Post to: **DECON LABORATORIES LTD.**  
**FREEPOST**  
**PORTSLADE, BRIGHTON, ENGLAND**  
(No Stamp Needed) Phone 0273 414371

# TOP QUALITY 'PE' HI-FI KITS FROM ELECTRO SPARES

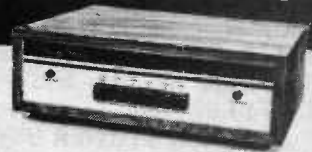

## FM VARICAP STEREO TUNER

Featured in the May 1973 issue of 'Practical Electronics', this superb Hi-Fi tuner is available as a kit for the incredibly low price of **£28.50** including VAT and postage. Electro Spares supply everything from the slim-line cabinet down to the last nut and bolt, and you can assemble it in just one evening! It's that simple. Incorporating five pre-set stations you choose yourself, with no difficult drive cord and pulley systems — spot on station selection every time. Construction time has been reduced to a minimum through the use of new pre-set Mullard modules for R.F. and I.F. circuits. Positively no alignment needed — just a simple d.c. voltmeter adjustment. Motorola I.C. Phase Lock Loop Decoder gives perfect stereo reception. Guaranteed first time results — or send it back, and we'll return it in perfect order (for a nominal handling charge).

**£28.50** inc. VAT and p & p.

Please send SAE (preferably 9 x 4 minimum) for full details.

Full constructional details only 10p post free.

All parts sold separately.

Only "design approved" kit available.

**100's  
ALREADY SOLD  
TO SATISFIED  
CUSTOMERS**

## 'GEMINI' STEREO AMPLIFIER

**Guaranteed  
30 watts RMS  
per channel**

Make this superior quality Hi-Fi unit at home, using simple step-by-step instructions. With a specification equal to many commercial amplifiers costing far more, the "Gemini" built from our kit has a guaranteed output of 30 watts RMS per channel into 8 ohms. Full power THD is a mere 0.02%, and frequency response of —3 dB from 20 Hz to 100 kHz into 8 or 15 ohms. Regulated power supply, 2A, 55 v continuous, 6A instantaneous. Electro Spares have already sold 100s and 100s of these kits — and no wonder — they give you a fabulous amplifier which is virtually the ultimate in Hi-Fi reproduction. In fact, we've never heard it so good! We supply everything except the case — and give you various choices of some components. That's why the total cost, inc. case, can vary from **£55 to £60** inc. VAT and p & p. All components as specified by original authors, and sold separately if you wish. Full constructional data book with specification graphs, fault finding guides etc. 55p plus 4p postage. Price list only. Please send S.A.E. (preferably 9 x 4 minimum) for full details.

Get it all together from

# ELECTRO SPARES

The Component Centre of the North



288 ECCLESALL ROAD,  
SHEFFIELD, S11 8PEA  
Tel: Sheffield (0742) 668888.

VISITORS WELCOME

EASY PARKING

# MINI-ADS

FOR FURTHER INFORMATION  
PHONE: BOB EVANS  
01-730-2139

## FERRIC CHLORIDE

Anhydrous to Mil-spec in double-sealed packs. 11b 55p (22p) 31b £1.32 (30p) 101b £3.85 (60p).

## 71b BARGAIN PARCELS

Contain hundreds of resistors, switches, capacitors, pots (all new) + crystals, transistor panels and loads of odds and ends. Only £1.82 (40p).

## VERSATILE POWER UNIT

Contains double-insulated mains transformer, 2 amp thermal cut-out and bridge rectifier. Will give 1.7V-10.5V output with two extra capacitors (provided). Ideal for Nickel-Cad charger, 5V TTL supply, cassettes, radios, etc. Supplied complete with information 95p (20p).

## 3W TAPE AMPLIFIERS

Polished wood cabinet 14x13x9" containing a sensitive (20µV) 4 valve amplifier with tone and volume controls. 3 watts output to the 7x4" 3 speaker. Also included is a non-standard tape deck. Supplied in good working condition with circuit. Mains operated. £3.30 (£1.25). Amplifier chassis complete and tested (2xECC83, EL84, EZ80) and speaker £2.20 (45p).

## AMPLIFIER UNIT

Ex-PO equip., uses 2xGET116 on heat sinks, 2 zeners, 1% resistors and caps, 4 small transformers, 3 pot cores etc. All in screened case 5½x5x3" 70p (30p) 4 for £2.20 (65p).

ALL PRICES INCLUDE VAT; Carriage in brackets, SAE list, enquiries.

GREENWELD (ETI) 24 Goodhart Way, West Wickham, Kent. Shops at 21 Deptford Broadway SE8, Tel. 01-692 2009, and 38 Lower Addiscombe Road, Croydon.

## AERIAL BOOSTERS £3.30.

Can produce remarkable improvements on the picture and the sound in fringe or difficult areas.

B11—For the VHF radio band.

B12—For the VHF television band.

Please state band 1 and 3 channels

B45—Tunable over the complete UHF television range.

All boosters are complete with battery for next to the set fitting.

## PLUGS AND SOCKETS

CO-AX, Plug-6p, Surface Socket-7p, DIN PLUGS, 2 Pin-15p, 3 Pin-15p, 5 Pin-15p. JACK PLUGS, Standard-15p, 3.5mm-10p, 2.5mm-10p. TOGGLE SWITCH S.P.S.T. with on/off Plate-10p. P and P 10p.

ELECTRONIC MAILORDER LTD.

62, Bridge Street, Ramsbottom, Bury, Lancs.

## ETI "International 420"

### 4 Channel Amplifier Parts Kits.

As specified in Electronics Today International April 1974.

Pre-Amplifier Kit £7.00+70p VAT of parts with switch.

†Decoder Kit of £7.00+70p VAT parts with switch.

Power Supply Kit. £6.00+60p VAT

Power Amp Boards £4.40 pair + 44p Kit. \*Less S1.1010Y VAT modules.

Steel Chassis plus £4.25+42p VAT Switch Plate.

Aluminium Facia .95+ 9p VAT (Printed)

Teak Veneer £4.20+42p VAT Cabinet

Accessories (DINs, £2.50+25p VAT PHONO etc.)

Prices include postage and packing

\* Sanken S1.1010Y Modules available only from PHOTAIN LTD of Leatherhead see article. Alternative module available from us modified to suit project s.a.e. for details.

† Kit for discrete module decoder to be available when published.

M. C. PRODUCTS

62A Brewery Road, London N.1.

PLEASE MENTION ETI WHEN  
REPLYING TO  
ADVERTISEMENTS

## LABORATORY CLEARANCE

Oscilloscopes, AF/RF Oscillators, Audio and General Test Equipment, Tape Heads, Decks, Millivoltmeters, Bridges, Sweep Generators, Etc. Etc. Tel. Lower Beeding 236.

## HAVE YOU GOT IT?

Have you got that magic ability, whatever it is, that means that you are one of the people that we are looking for? If we mentioned our company name you would recognise it immediately, and the products we sell. More and more people are coming to us for our supplies and services, and this is our problem. What started as a small mail-order company selling specialist electronic components is now a small full-time distributor, and we require a larger sales force.

The company is setting up a new division specifically for the distribution of our specialist components in a fast growing market. We require people who can organise their own sales area, work 170 or more hours per week, help out with customer problems (large or small), think up new approaches to old ideas, and enjoy it all.

The pay is not good but the commission is; (we're still a small company). As we do not intend to stay a small company the opportunities for the right people are fabulous! If you think that you have this indefinable charisma that we require, please write giving some details of experience and a telephone number to:

Box Number 41,  
Electronics Today International,  
36 Ebury Street,  
London SW1W 0LW.

## PRECISION POLYCARBONATE CAPACITORS

440V AC (±10%)	Range	±1%	±2%	±5%
0.1µF (1 1/8"x3/4")	50p	0.47µF	56p	46p 36p
0.22µF (1 3/8"x5/8")	69p	1.0µF	66p	56p 46p
0.25µF (1 3/8"x5/8")	62p	2.2µF	80p	65p 55p
0.47µF (1 3/8"x3/4")	71p	4.7µF	£1.30	£1.05 85p
0.5µF (1 3/8"x3/4")	75p	6.8µF	£1.64	£1.29 £1.09
0.68µF (2"x3/4")	80p	10.0µF	£2.00	£1.60 £1.40
1.0µF (2"x3/4")	91p	15.0µF	£2.75	£2.15 £1.90
2.0µF (2"x1")	£1.22p			

All high stability-extremely low leakage.

TANTALUM BEAD CAPACITORS—Values available: 0.1, 0.22, 0.47, 1.0, 2.2, 4.7, 6.8µF at 15V/25V or 35V; 10.0µF at 16V/20V or 25V; 22.0µF at 6V/10V or 16V; 33.0µF at 6V or 10V; 47.0µF at 3V or 6V; 100.0µF at 3V. All at 10p each; 10 for 95p; 50 for £4.00.

## TRANSISTORS:

BC107/8/9	9p	BC212/212L	14p	BFY50	20p
BC147/8/9	10p	BC547	12p	BFY51	20p
BC157/8	12p	BC558A	12p	BFY52	20p
BC182/182L	11p	BF194	12p	OC71	12p
BC183/183L	11p	BF197	13p	2N3055	50p
BC184/184L	12p	AF178	30p		

## POPULAR DIODES: All brand new and marked:

1N914 6p; 8 for 45p; 18 for 90p; 1N916 8p; 6 for 45p; 14 for 90p; 1S44 5p; 11 for 50p; 24 for £1.00. 1N4148 5p; 6 for 27p; 12 for 48p. LOW PRICE ZENER DIODES 400mW; Tol. ±5% at 5mA. Values available: 3V; 3.6V; 4.7V; 5.1V; 5.6V; 6.2V; 6.8V; 7.5V; 8.2V; 9.1V; 10V; 11V; 12V; 13V; 13.5V; 15V; 16V; 18V; 20V; 22V; 24V; 27V; 30V. All at 7p each; 6 for 39p; 14 for 84p. Special Offer: 100 Zeners for £5.50. RESISTORS: High stability, low noise carbon film 5%; ¼W at 40°C; 1/3W at 70°C. E12 series only - from 2.2Ω to 2.2MΩ. All at 1p each; 8p for 10 of any one value; 70p for 100 of any one value. Special Pack: 10 of each value 2.2Ω to 2.2MΩ (730 resistors) £5.00. SILICON PLASTIC RECTIFIERS - 1.5A - Brand new wire ended DQ27: 100 P.I.V. - 7p (4/26p) 400 P.I.V. - 8p (4/30p) 800 P.I.V. - 11p (4/42p) BRIDGE RECTIFIERS: 2½A 200V-40p 350V-45p 600V-55p. SUBMINIATURE VERTICAL PRESETS - 0.1W only: All at 3p each: 100Ω, 220Ω, 470Ω, 680Ω, 1k, 2.2k, 4.7k, 6.8k, 10k, 15k, 22k, 47k, 100k, 1M.

Please add 10p Post and Packing on all orders below £5.00. All export orders add cost of Sea/Airmail.

PLEASE ADD 10% VAT TO ORDERS

Please add 10% VAT to orders. Send S.A.E. for lists of additional ex-stock items. Wholesale price lists available to bona fide companies.

## MARCO TRADING

Dept. T6, The Maltings, Station Road, WEM, Shropshire.  
Tel: NANTWICH (Cheshire) 63291 (STD 0270)  
(Props: Minicost Trading Ltd.)

Are you having trouble building your electronic projects. Is it not working efficiently. We will design, assemble or repair most electronic projects.

## LYNTON ELECTRONICS

Lynton House,  
The Green,  
Downham Market,  
Norfolk PE38 9DX.

Tel. Downham Market (036 63) 3719.

## ZN414 IC's FOR SALE

Full spec devices, properly coded. £7.50 for 10, £60 for 100. Prices inclusive of VAT. No single orders.

For details write to:

Box No. 31, Electronics Today International, 36 Ebury Street, London SW1W 0LW



# RECRUITMENT

## TECHNICIANS AND ENGINEERS FOR ST. ALBANS AND LUTON

### QUALIFIED OR NOT!

**OPPORTUNITIES** for challenging work on testing and calibrating valve and solid-state electronic measuring equipments embracing all frequencies up to u.h.f. in Production, Service and Calibration departments.

**APPLICATIONS** are invited from people of all ages with experience or formal training in electronics and from Ex-Service technicians.

**HIGHLY COMPETITIVE SALARIES**, negotiable and backed by valuable fringe benefits. Overtime normally available.

**GENEROUS RE-LOCATION EXPENSES** available in most instances.

**CONDITIONS** excellent; free life assurance, pension schemes, canteen, social club.  
37½ hour, 5-day, working week.

**WRITE** or phone for application forms quoting reference ETI 744.



MARCONI INSTRUMENTS LTD.  
Longacres, St. Albans, Herts  
Tel: St. Albans 59292  
Luton Airport, Luton, Beds  
Tel: Luton 33866

A GEC-Marconi Electronics Company



## HARDWARE

Screws, nuts, washers etc. Sheet aluminium cut to size or in standard packs, plain or punched/drilled to spec.

Printed circuit boards for published designs or individual requirements, one-off or small runs.

Facia panels, dials, nameplates etc. in etched aluminium. 6p for details.

**RAMAR CONSTRUCTOR SERVICES**  
29 Shelbourne Road,  
Stratford on Avon, Warwicks.

## CITY AND GUILDS EXAMINATIONS

Make sure you succeed with an ICS home study course for C and E Electrical Installations, Telecommunications Technicians and Radio Amateurs. Free details from:- International Correspondence Schools, Dept. 755B, Intertext House, London SW8 4UJ.

## COLOUR TV SERVICING

Make the most of the current boom! Learn the techniques of servicing Colour and Mono TV sets through new home study courses, approved by leading manufacturers. Also radio and audio courses. Free details from: International Correspondence Schools, Dept. 755B2, Intertext House, London SW8 4UJ.

## TECHNICAL TRAINING

Get the qualifications you need to succeed. Home study courses in Electronics and Electrical Engineering, Maintenance, Radio, TV, Audio, Computer Engineering and Programming. Also self-build radio kits. Free details from: International Correspondence Schools, Dept. 755B3, Intertext House, London SW8 4UJ.

## BUILDING YOUR OWN HI-FI AMPLIFIER?



### WHY NOT USE A PROFESSIONAL CASE?

We have a limited number of high quality case assemblies valued at over £15.00 which must be sold.

#### LOOK AT THESE FEATURES:

- \* Ready punched steel chassis
- \* 3 piece, teak veneered case
- \* Screen printed front and rear plates
- \* Full compliment of hardware.

#### FRONT PANEL

Function switch for P.U./TAPE selection, MONO/STEREO and SCRATCH FILTER switches. Bass, treble, volume and balance. On/off and neon indicator.

#### BACK PANEL

P.U. input socket. Tuner input socket. Tape in/out socket. MAGNETIC (CERAMIC) switch. Speaker output sockets. Headphone output socket. A.C. outlet socket. Fuse holder and mains lead.

#### HARDWARE COMPLIMENTS includes

Push button switch rails, potentiometers, sockets, knobs, plastic feet, slide switch, neon indicator, screws, nuts etc.

#### COMPLETE KIT OF PARTS ONLY £8.80 POST FREE.

#### ALSO AVAILABLE

Stereo pre-amplifier p.c. board and circuit diagram to suit £2.75 post free. Teak plinth to match amplifier (out to accept B.S.R. MP60, C123 etc.) £3.30 post free. Smoked dust covers £2.20 post free. B.S.R. C123 deck (less cartridge) £8.25 post free. B.S.R. MP60 deck (less cartridge) £12.10 post free.

S.A.E. for full list.

#### SOUND ELECTRONICS (NEWCASTLE) LIMITED.

43, Heaton Grove, Newcastle-upon-Tyne, NE6 5NP.

Tel: 650 108.



## WOODSTOCK PHOTOSOUND LIMITED

300 High Street,  
Sutton, Surrey  
01-643 7277

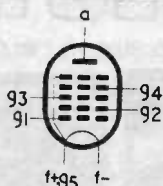

## VALVES

## KLYSTRONS

## MAGNETRONS

## SEMICONDUCTORS

### PHOTO EMISSIVE DEVICES

Low Power Rectifiers and Detectors

Microwave Diodes

Silicon Rectifiers

Zener Diodes

Transistors

Transistor Substitutes

### CONSULT US ON ALL YOUR ELECTRONIC AND PROFESSIONAL PHOTOGRAPHIC EQUIPMENT BUYING PROBLEMS.

We can also undertake any camera repair to professional or amateur equipment in our own well-equipped workshops.

# WELLBERRY CASES

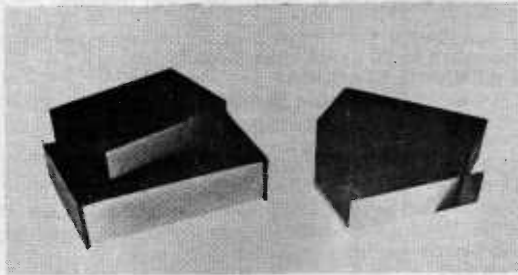

INSTRUMENT CASES FOR THE HOME CONSTRUCTOR BLACK LEATHERGRAIN FINISHED VYNIL ON STEEL COVER 20 s.w.g. ALUMINIUM BASE FRONT AND BACK UNIT.

6" x 4½" x 1¾"	18g Base	95p
8" x 5" x 2"	18g Base	£1.10p
9" x 5" x 2½"	18g Base	£1.22p
11" x 6" x 3"	18g Base	£1.44p
11" x 7½" x 3½"	16g Base	£2.15p
19" x 9" x 3½"	14g Base	£6.60p

Add 15p post and packing per order.

Wellberry Limited, (Mail Order Division),  
24, The Sycamores, Baldock, Hertfordshire.

## INDEX TO ADVERTISERS

Ambit	58
Amtron	76
B.H. Component Factors	63
B.I.E.T.	75
Bi-Pak	22
Bi-Pre-Pak	32
Bywood	8
Chinaglia	27
Cosmic	63
Dart	36
Decon	71
Electronic Mail Order	72
Electrospares	71
Electrovalue	4
Greenweld	72
Henry's Radio	14
I.C.E.	36
I.C.S. Intertext	73
Integrex	37
Laboratories	72
Longs	2
Lynton Electronics	72
Maplin	27
Marco Trading	72
Marconi Instruments	73
M.C. Products	72
Minikits Electronics	57
Planetron	58
Ramar Constructor Services	73
Sound Electronics (Newcastle)	73
Wellberry	74
Wilmslow	58
Woodstock Photosound	73

# WORLD SHORTAGES?

Recent copies of ETI have joined the list of world shortages — they are in short supply.

Unlike some of our competitors, we do run a back numbers service but we cannot help with some recent issues.

There are two ways to ensure yourself of a copy: place a regular order with your newsagent or take out a subscription which will cost you a bit more due to postage but will guarantee you your copy.



Cut

To: SUBSCRIPTION DEPARTMENT  
ELECTRONICS TODAY INTERNATIONAL  
36 EBURY STREET,  
LONDON SW1W 0LW.

Please find enclosed £3.60 which includes postage (£4.00 overseas) for my annual subscription to ETI starting with the next available issue.

Name . . . . .

Address . . . . .

June 1974 . . . . .

# FREE!

## Over 150 ways to engineer a better future



Practical Radio & Electronics Certificate course includes a learn while you build **3 transistor radio kit.**

Everything you need to know about **Radio & Electronics** maintenance and repairs for a **spare time income** and a **career** for a better future.

**HIGHER PAY**      **A BETTER JOB**

**SECURITY**

### find out how in just 2 minutes

That's how long it will take you to fill in the coupon. Mail it to B.I.E.T. and we'll send you full details and a free book. B.I.E.T. has successfully trained *thousands* of men at home - equipped them for higher pay and better, more interesting jobs. We can do as much for YOU. A low-cost B.I.E.T. home study course gets results fast - makes learning easier and something to look forward to. There are no books to buy and you can pay-as-you-learn.

Why not do the thing that really interests you? Without losing a day's pay, *you* could quietly turn yourself into something of an expert. Complete the coupon (or write if you prefer not to cut the page). No obligation and nobody will call on you . . . but it could be the best thing you ever did.

#### Others have done it, so can you

"Yesterday I received a letter from the Institution informing that my application for Associate Membership had been approved. I can honestly say that this has been the best value for money I have ever obtained - a view echoed by two colleagues who recently commenced the course".—Student D.I.B., Yorks.

"Completing your course, meant going from a job I detested to a job that I love, with unlimited prospects".—Student J.A.O. Dublin.

"My training with B.I.E.T. quickly changed my earning capacity and, in the next few years, my earnings increased fourfold".—Student C.C.P., Bucks.

#### FIND OUT FOR YOURSELF

These letters - and there are many more on file at Aldermaston Court - speak of the rewards that come to the man who has given himself the specialised know-how employers seek. There's no surer way of getting ahead or of opening up new opportunities for yourself. It will cost you a stamp to find out how we can help *you*. Write to B.I.E.T. Dept. BE101 Aldermaston Court, Reading RG7 4PF.

**CUT OUT THIS COUPON**  
Tick or state subject of interest.  
Post to address below.

<input type="checkbox"/> MECHANICAL	<input type="checkbox"/> Man. Prod.—cont.	<input type="checkbox"/> Construction-cont.
<input type="checkbox"/> A.M.S.E. (Mech.)	<input type="checkbox"/> Quality Control	<input type="checkbox"/> Building
<input type="checkbox"/> Boiler Inspect.	<input type="checkbox"/> Salesmanship	<input type="checkbox"/> Building Drawing
<input type="checkbox"/> & Operation	<input type="checkbox"/> Storekeeping	<input type="checkbox"/> Build. Foreman
<input type="checkbox"/> C & G Eng. Crafts	<input type="checkbox"/> Work Study	<input type="checkbox"/> Carpentry & Join.
<input type="checkbox"/> C & G Fabricat.	<input type="checkbox"/> Works	<input type="checkbox"/> Civil & Municipal
<input type="checkbox"/> Diesel Eng.	<input type="checkbox"/> Management	<input type="checkbox"/> Engineering
<input type="checkbox"/> Eng. Inspection	<input type="checkbox"/> DRAUGHTSMANSHIP	<input type="checkbox"/> Constructional
<input type="checkbox"/> Eng. Metallurgy	<input type="checkbox"/> A.M.I.E.D.	<input type="checkbox"/> Engineering
<input type="checkbox"/> Inst. Eng. & Tech.	<input type="checkbox"/> Design of Elec.	<input type="checkbox"/> Construction
<input type="checkbox"/> Inst. Motor Ind.	<input type="checkbox"/> Machines	<input type="checkbox"/> Surveyors
<input type="checkbox"/> Mainten. Eng.	<input type="checkbox"/> Die & Press Tool	<input type="checkbox"/> Institute
<input type="checkbox"/> Mechanical Eng.	<input type="checkbox"/> Design	<input type="checkbox"/> Clerk of Works
<input type="checkbox"/> Sheet Metal Work	<input type="checkbox"/> Electrical	<input type="checkbox"/> Council Eng.
<input type="checkbox"/> Welding	<input type="checkbox"/> Draughtsman-ship	<input type="checkbox"/> Geology
<input type="checkbox"/> ELECTRICAL & ELECTRONIC	<input type="checkbox"/> Gen. Draughts-ship	<input type="checkbox"/> Health Eng.
<input type="checkbox"/> A.M.S.E. (Elec.)	<input type="checkbox"/> Jig & Tool Des.	<input type="checkbox"/> Heat & Vent.
<input type="checkbox"/> C & G Elec. Eng.	<input type="checkbox"/> Tech. Drawing	<input type="checkbox"/> Hydraulics
<input type="checkbox"/> C & G Elec. Inst.	<input type="checkbox"/> RADIO & TELE-COMMUNICATIONS	<input type="checkbox"/> Inst. of Builders
<input type="checkbox"/> C & G Elec. Tech.	<input type="checkbox"/> Colour TV	<input type="checkbox"/> Inst. Works &
<input type="checkbox"/> Computer Elect.	<input type="checkbox"/> C & G Radio/TV/	<input type="checkbox"/> Highway Sup.
<input type="checkbox"/> Elec. Maths	<input type="checkbox"/> Electronics	<input type="checkbox"/> Painting & Dec.
<input type="checkbox"/> Elec. Science	<input type="checkbox"/> C & G Telecomm.	<input type="checkbox"/> Public Hygiene
<input type="checkbox"/> Electronic Eng.	<input type="checkbox"/> Tech.	<input type="checkbox"/> Road Engineer.
<input type="checkbox"/> Electrical Eng.	<input type="checkbox"/> Prac. Rad. Elec.	<input type="checkbox"/> Structural Eng.
<input type="checkbox"/> Install. & Wiring	<input type="checkbox"/> (with kit)	<input type="checkbox"/> Surveying
<input type="checkbox"/> Meters	<input type="checkbox"/> Radio Amateurs	<input type="checkbox"/> GENERAL
<input type="checkbox"/> & Measuring Instruments	<input type="checkbox"/> Exam.	<input type="checkbox"/> Agricultural Eng.
<input type="checkbox"/> MANAGEMENT & PRODUCTION	<input type="checkbox"/> Radio Servicing & Repairs	<input type="checkbox"/> Council of Eng. Inst.
<input type="checkbox"/> Auto. Control	<input type="checkbox"/> Radio & TV Eng.	<input type="checkbox"/> Farm Science
<input type="checkbox"/> Computer Prog.	<input type="checkbox"/> Trans. Course	<input type="checkbox"/> General Educat.
<input type="checkbox"/> Electronic Data Processing	<input type="checkbox"/> TV Main. & Serv.	<input type="checkbox"/> Gen. Plastics
<input type="checkbox"/> Estimating	<input type="checkbox"/> AUTO & AERO	<input type="checkbox"/> Pract. Maths
<input type="checkbox"/> Foremanship	<input type="checkbox"/> Aero Eng.	<input type="checkbox"/> Pract. Slide Rule
<input type="checkbox"/> Inst. Cost & Man. Accountants	<input type="checkbox"/> A.M.I.M.I.	<input type="checkbox"/> Pure & Applied Maths
<input type="checkbox"/> Inst. Marketing Management	<input type="checkbox"/> A.E.C. Cert.	<input type="checkbox"/> Refrigeration
<input type="checkbox"/> Metrication	<input type="checkbox"/> Auto Engineer.	<input type="checkbox"/> Rubber Tech.
<input type="checkbox"/> Motor Trade Man.	<input type="checkbox"/> Auto Repair	<input type="checkbox"/> Sales Engineers
<input type="checkbox"/> Network Plan.	<input type="checkbox"/> C & G Auto Eng.	<input type="checkbox"/> Tech. Report
<input type="checkbox"/> Numerical Cont.	<input type="checkbox"/> Garage	<input type="checkbox"/> Writing
<input type="checkbox"/> Operational Research	<input type="checkbox"/> Management	<input type="checkbox"/> Timber Trade
<input type="checkbox"/> Personnel Man.	<input type="checkbox"/> MAA/IMI Dipl.	<input type="checkbox"/> University Ent.
<input type="checkbox"/> Planning Eng.	<input type="checkbox"/> Motor Vehicle Mechanics	<input type="checkbox"/> G.C.E.
<input type="checkbox"/> Production Eng.	<input type="checkbox"/> CONSTRUCTIONAL	<input type="checkbox"/> 58 'O' & 'A' LEVELS SUBJECTS Over 10,000 group passes
	<input type="checkbox"/> Architecture	

Coaching for many major exams including ONC, C & G, etc.

## POST TODAY FOR A BETTER TOMORROW

To B.I.E.T., Dept. BE.101 QN  
Aldermaston Court, Reading RG7 4PF BE.101

NAME \_\_\_\_\_  
Block Capitals Please  
ADDRESS \_\_\_\_\_

OTHER SUBJECTS \_\_\_\_\_ AGE \_\_\_\_\_

Accredited by C.A.C.C.

BRITISH INSTITUTE OF ENGINEERING TECHNOLOGY

# Transmitter & Receiver Convertors from Wolffers Electronics

Convert any MW Radio into an aircraft, amateur or VHF 142-162 MHz AM Receiver, simply by connecting the output of the converter to the aerial input, or wind three turns

round the Ferrite Rod, and tune your radio to 1500KHz Medium Wave. All these units are supplied on fibre glass printed circuit boards, ready tuned and tested.

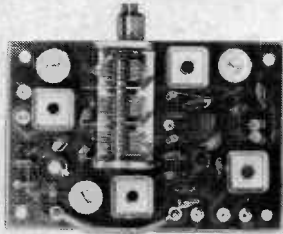

**WT7 AIRCRAFT BAND TUNER**  
110 MHz 130 MHz  
Operates 9-12Volt D.C. £14.45

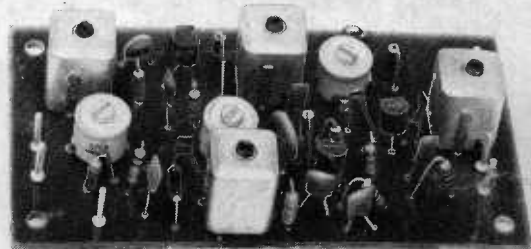

**WT15 TWO METER AMATEUR BAND TUNER**  
144-146 MHz (Varicap tuned)  
Operates 9-12 Volts D.C. £14.08

**WT9 VHF BAND TUNER**  
142-162 MHz  
Operates 9-12Volt D.C. £14.45

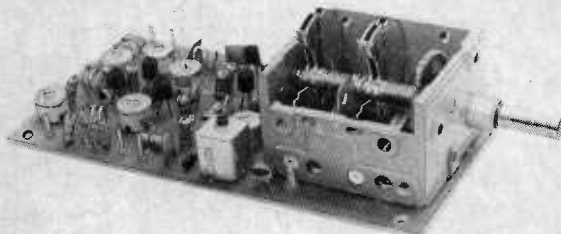

**WZ9 FM TRANSMITTER (2 meter band)**  
VFO Controlled. Ready made and tuned.  
Operates from 12 Volts D.C.  
Output 200mW (WT15 & WZ9  
make a complete receiver) £18.63

## ALSO AVAILABLE FROM WOLFFERS

**WA7 ANTENNA AMPLIFIER**  
60-150 MHz  
15dB gain at 100MHz  
Operates from 9-12 Volt D.C. Supply. £2.97

**TI 1 CRYSTAL SET**  
In kit form—All parts including  
earphone, ferrite rod, tuning cap  
and P.C.Board. £2.29

ALL UNITS ARE SUPPLIED WITH FULL WIRING INSTRUCTIONS  
AND ARE FULLY GUARANTEED

NOTE A Ministry of Posts & Telecommunications Licence is required for reception of transmissions by Aircraft, Fire Brigade etc.

All prices include VAT. Add 20p Post & Packing

*Trade enquiries invited.*

# TRADER IMPORTS

4 & 7 CASTLE STREET, HASTINGS, SUSSEX. TN34 3DY. Telephone HASTINGS 437875